



Driver's handbook

Dacia LODGY

Welcome aboard your vehicle

This Driver's Handbook contains the information necessary:

- for you to familiarise yourself with your vehicle, to use it to its best advantage and to benefit fully from all the functions and the technical developments it incorporates.
- to ensure that it always gives the best performance by following the simple, but comprehensive advice concerning regular maintenance.
- to enable you to deal quickly with minor faults not requiring specialist attention.

It is well worth taking a few minutes to read this handbook to familiarise yourself with the information and guidelines it contains about the vehicle and its functions and new features. If certain points are still unclear, our Network technicians will be only too pleased to provide you with any additional information.

The following symbol will help you when reading this handbook:



To indicate a hazard, danger or safety recommendation.

The descriptions of the models given in this handbook are based on the technical specifications at the time of writing. **This handbook covers all items of equipment** (both standard and optional) **available for these models, but whether or not these are fitted to the vehicle depends on the version, options selected and the country where the vehicle is sold.**

This handbook may also contain information about items of equipment to be introduced later in the model year.

Throughout the manual, the “approved dealer” is your DACIA dealer.

Enjoy driving your new vehicle.

Translated from French. Copying or translation, in part or in full, is forbidden unless prior written permission has been obtained from the vehicle manufacturer.



C O N T E N T S

Sections

Getting to know your vehicle

1

Driving

2

Your comfort

3

Maintenance

4

Practical advice

5

Technical specifications

6

Alphabetical index

7



Section 1: Getting to know your vehicle

Keys, radio frequency remote control: general information	1.2
Locking and unlocking the doors	1.5
Automatic locking of opening elements when driving	1.7
Opening and closing the doors	1.8
Headrests	1.10
Front seats	1.11
Seat belts	1.12
Methods of restraint in addition to the front seat belts	1.17
Side protection devices	1.21
Additional methods of restraint	1.22
Child safety: general information	1.23
mounting a child seat	1.26
fitting a child seat	1.28
deactivating, activating the front passenger airbag	1.36
Rear-view mirrors	1.39
Driving position: left-hand drive	1.40
Warning lights	1.42
Displays and indicators	1.46
On-board computer	1.48
Steering wheel, Clock	1.53
Exterior lighting and signals	1.54
Adjusting the headlight beam height	1.56
Audible and visual signals	1.57
Windscreen washer, wiper, De-icing	1.58
Fuel tank (filling with fuel)	1.60

KEYS, RADIO FREQUENCY REMOTE CONTROL: general information (1/2)

A



Key A

- 1 Coded key for ignition switch, doors and fuel filler cap.

The key must not be used for any function other than those described in the handbook (removing the cap from a bottle, etc.).

B

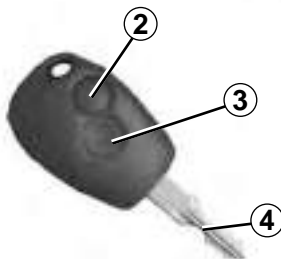

Radio frequency remote control B

- 2 Locks all the opening elements.
- 3 Unlocks all the opening elements.
- 4 Coded key for ignition switch, driver's door and fuel filler cap.

Advice

Avoid leaving the remote control in hot, cold or humid areas.



Driver's responsibility

Never leave your vehicle with the keys inside when leaving a child (or animal) in the car, even for a short period.

The reason for this is that the child may endanger himself or others by starting the engine, activating equipment such as the window winders for example, or locking the doors.

Risk of serious injury.

KEYS, RADIO FREQUENCY REMOTE CONTROL: general information (2/2)

The remote control unit operating range

This varies according to the environment. It is therefore important when handling the remote control to ensure that you do not lock or unlock the vehicle by inadvertently pressing the buttons.

Interference

The presence of certain objects (metal objects, mobile telephones, or an area with strong electromagnetic radiation, etc.) close to the key may create interference and affect the operation of the system.

Replacement and additional keys or remote controls

If you lose your remote control key or require another, you can obtain one from an approved dealer.

If a remote control or key is replaced, it will be necessary to take the vehicle **and all of its remote control keys** to an authorised dealer to reset them.

You may use up to four remote control keys per vehicle.

Remote control key failure

Make sure that the correct battery type is being used, and that the battery is in good condition and inserted correctly. These batteries have a service life of approximately two years.

Refer to the information on “Radio frequency remote control: Batteries” in Section 5.

KEYS/RADIO FREQUENCY REMOTE CONTROL: use



Unlocking the doors

Press unlocking button **2**.

The hazard warning lights and indicator lights **flash once** to indicate that the doors have unlocked.

Note: if a door is not opened within approximately 2 seconds of the door being unlocked by remote control, the doors will lock again automatically.

Locking the doors

Press locking button **1**.

The hazard warning lights and indicator lights **flash twice** to indicate that the doors have locked.

If a door or the tailgate is open or not properly shut, the doors or tailgate lock then quickly unlock and the hazard warning lights and indicator lights do not flash.

The key must not be used for any function other than those described in the handbook (removing the cap from a bottle, etc.).



Driver's responsibility

Never leave your vehicle with the key inside and never leave a child (or a pet) unsupervised, even for a short while.

They may pose a risk to themselves or to others by starting the engine, activating equipment such as the electric windows or by locking the doors.

Risk of serious injury.

LOCKING AND UNLOCKING THE DOORS (1/2)

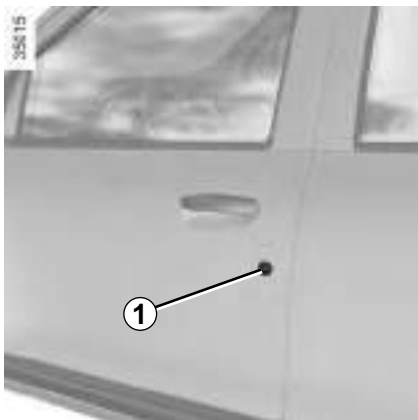

Manual control

From the outside

Unlock the doors using the key in a door lock **1**.

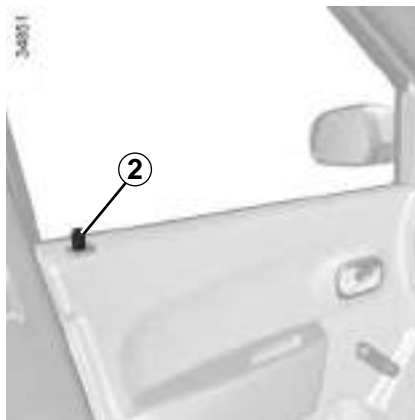

From the inside (depending on vehicle)

Push in button **2** to lock and lift button **2** to unlock.



Locking the doors manually (depending on vehicle)

If the remote control does not work, you can manually lock each door.

Turn screw **3** with the door open (using the end of the key) and close the door.

This means that the doors are then locked from the outside.

The doors may then only be opened from the inside or by using the key in the front left-hand door.



Never leave your vehicle with the key or remote control inside.



Driver's responsibility

If you decide to keep the doors locked when you are driving, remember that it may be more difficult for those assisting you to gain access to the passenger compartment in the event of an emergency.

LOCKING AND UNLOCKING THE DOORS (2/2)

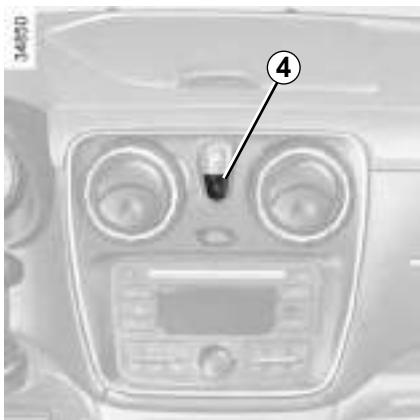

Electric central locking

It simultaneously locks or unlocks the doors and the tailgate.

Lock or unlock the doors by pressing switch **4**.

The front door mechanism cannot be locked if the door is open.



Never leave your vehicle with the key or remote control inside.

Locking the opening elements without the radio frequency remote control

For example, in the event of a discharged battery or the radio frequency remote control temporarily not working.

With the engine switched off and an opening element (door or boot) open, press and hold switch **4** for more than five seconds.

When the door is closed, all the doors and the tailgate will be locked.

The vehicle can only be locked from the outside using the radio frequency remote control.

Door and tailgate status indicator

With the ignition on, the warning light integrated in switch **4** informs you of the locking status of the opening elements:

- indicator light on, the doors and tailgate are locked;
- indicator light off, the doors and tailgate are unlocked.

When you lock the doors, the indicator light remains lit and then goes out.

AUTOMATIC LOCKING WHEN DRIVING



You must first decide if you want to activate this function.

To activate

With the engine running, press switch **1** for approximately 5 seconds, until you hear a beep. The indicator light built into the switch comes on when the doors are locked.

To deactivate

With the engine running, press switch **1** for approximately 5 seconds, until you hear a beep.

Operating principle

When the engine is started, the system automatically locks the doors when the vehicle reaches a speed of approximately 4 mph (7 km/h).

Operating faults

If you notice an operating fault (automatic locking impossible), first check that all doors are correctly locked. If they are correctly locked and the fault is still present, contact an approved Dealer.

Also make sure that locking has not been inadvertently deactivated.

If necessary, refer to the activation procedure.



If you decide to keep the doors locked when you are driving, remember that it may be more difficult for those assisting you to gain access to the passenger compartment in the event of an emergency.

OPENING AND CLOSING THE DOORS (1/2)

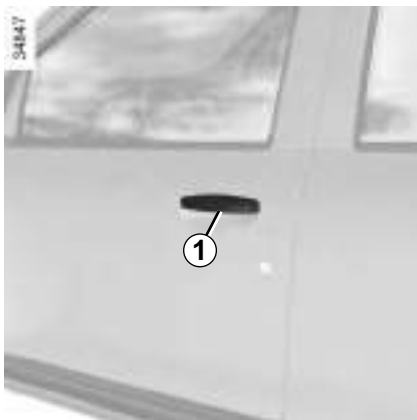

Opening manually from the outside

With the doors unlocked (refer to the information on “Locking/unlocking the doors” in Section 1), place your hand on the handle **1** and pull towards you.



Opening the doors manually from the inside

Unlock the door and pull handle **2**.



As a safety precaution, the doors should only be opened or closed when the vehicle is stationary.

Lights-on warning buzzer

If you have left the lights on after switching off the ignition, a reminder buzzer will sound when the driver's door is opened.

Door/tailgate open buzzer

Depending on the vehicle, this alarm is fitted to the driver's side door or on all opening elements.

With the vehicle at a standstill, a warning light  will come on if a door or the boot is open or not properly closed.

While driving, as soon as the vehicle reaches 12 mph (20 km/h), a warning

light  comes on with an audio beep.

Special note

Depending on the vehicle, accessories (e.g. radio) stop working either when the engine is switched off or when the doors are locked, or when the driver's door is opened.

OPENING AND CLOSING THE DOORS (2/2)



Child safety

To make it impossible for the rear doors to be opened from the inside, move lever **3** on each door and check from the inside that the doors are securely locked.



Driver's responsibility when parking or stopping the vehicle

Never leave an animal, child or adult who is not self-sufficient alone on your vehicle, even for a short time.

They may pose a risk to themselves or to others by starting the engine, activating equipment such as the electric windows or by locking the doors.

Also, in hot and/or sunny weather, please remember that the temperature inside the passenger compartment increases very quickly.

RISK OF DEATH OR SERIOUS INJURY.

FRONT HEADRESTS

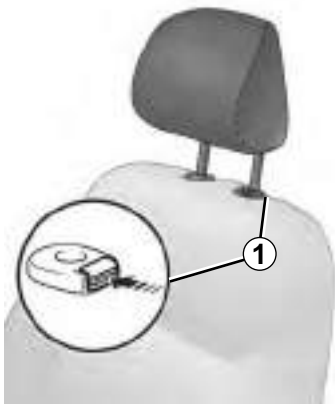

To raise the headrest

Pull the headrest upwards to the desired height.

To lower the headrest

Press button **1** and guide the headrest down to the desired height.

To remove the headrest

Press tab **1** and lift the headrest to release it (tilt the seatback backwards if necessary).

To refit the headrest

Insert the rods into the sleeves, with the notches facing forwards, and lower the headrest to the desired height.



The headrest is a safety component. Ensure that it is fitted and in the correct position: the top of your head should be in line with the top of the headrest.

FRONT SEATS

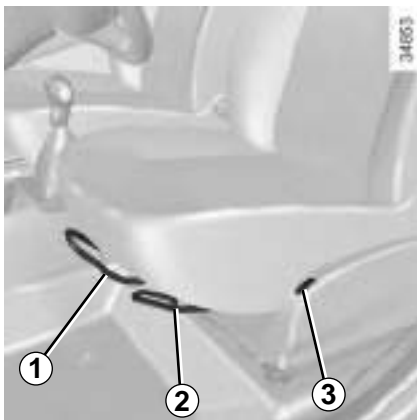

To move forwards or backwards

Lift bar **1** to release.

Release the bar **1** once the seat is in the correct position and ensure that the seat is fully locked into place.

To raise or lower the driver's seat surface

Depending on the vehicle, lift lever **2**, adjust the seat base to the desired height, then release the lever.



To tilt the seatback

Turn control knob **4** and tilt the seatback to the desired position.

Heated seats

Depending on the vehicle, with the ignition on, press switch **3**.

The system, which has a thermostat, decides whether or not the heating is needed.

To exit this function, press switch **3** again.



For safety reasons, carry out any adjustments when the vehicle is not being driven.

We would advise you not to recline the seatbacks too far to ensure that the effectiveness of the seat belts is not reduced.

Make sure that the seatbacks are correctly locked in place.

Nothing should be placed on the floor (area in front of driver) as such objects may slide under the pedal during braking manoeuvres, thus obstructing its use.

SEAT BELTS (1/5)

Always wear your seat belt when travelling in your vehicle. You must also comply with the legislation of the particular country you are in.

Make sure that the rear bench seat is securely locked in position so that the rear seat belts will operate efficiently. Refer to information in the paragraph on “Second row rear seats: functions” and “Third row rear seats: functions” in Section 3.



Incorrectly adjusted or twisted seat belts may cause injuries in the event of an accident.

Use one seat belt per person, whether child or adult. Even pregnant women should wear a seat belt. In this case, ensure that the lap belt is not exerting too much pressure on the abdomen, but do not allow any slack.

Before starting, first adjust your driving position, then ask all occupants to adjust their seat belts to ensure optimum protection.

Adjusting your driving position

(depending on the vehicle)

- **Sit well back in your seat** (having removed your coat or jacket etc.). This is essential to ensure your back is positioned correctly;
- **adjust the distance between the seat and the pedals.** Your seat should be as far back as possible while still allowing you to depress the clutch pedal fully. The seatback should be adjusted so that your arms are slightly bent when you hold the steering wheel;
- **adjust the position of your headrest.** For the maximum safety, your head must be as close as possible to the headrest;
- **adjust the height of the seat.** This adjustment allows you to select the seat position which offers you the best possible view;
- **adjust the position of the steering wheel.**



Adjusting the seat belts

Sit with your back firmly against the seatback.

The shoulder strap **1** should be as close as possible to the base of the neck but not on it.

Lap belt **2** must be worn flat over the thighs and against the pelvis. The seat belt must be worn as close to the body as possible. i.e.: avoid wearing heavy clothing or keeping bulky objects under the belts, etc.

SEAT BELTS (2/5)



To fasten

Unwind the belt **slowly and smoothly** and ensure that buckle **3** locks into catch **5** (check that it is locked by pulling on buckle **3**).

If the belt jams, allow it to return slightly before attempting to unwind it again.

If your seat belt is completely jammed, pull slowly, but firmly, so that just over 3 cm unwinds. Allow it to return slightly before attempting to unwind it again.

If there is still a problem, contact an approved dealer.

Unlocking

Press the button **4** on catch **5** and the seat belt will be rewound by the inertia reel. Hold by the buckle to make this easier.



Front seat belt reminder warning light

Depending on the vehicle, it comes on when the engine is started and if the driver's and/or passenger's seat belt is not fastened. When the vehicle is being driven, it comes on and a beep sounds for approximately 2 minutes until the driver's seat belt is fastened.

Note: You are not recommended to rest any object on the passenger seat. This may trigger the front seatbelt reminder warning light.



Adjusting the front seat belt height

Move button **6** to select the position you require so that the chest strap **1** is worn as described above.

Make sure that the seat belt is locked in position correctly after you have adjusted it.

SEAT BELTS (3/5)

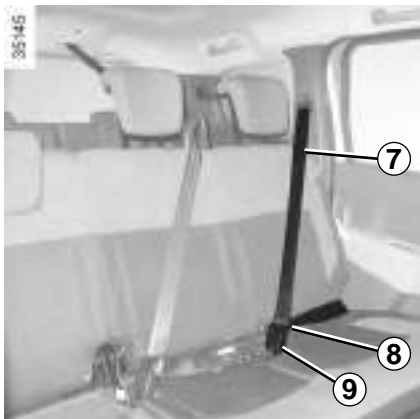

Second row rear seats

Rear side seat belts

Slowly unwind belt **7** and click buckle **8** into red catch **9**.

Operating the rear seats. Please see the information in the paragraphs on “Second row rear seats: functions” and “Third row rear seats: functions” in Section 3.

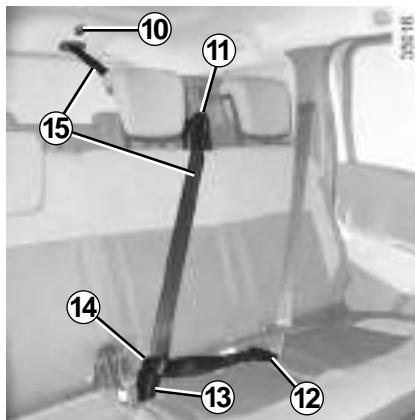

Centre seat belt

Unwind belt **15** slowly from its housing **10**.

Pass the two buckles and the belt **15** in the belt guide **11**.

Click the smallest buckle into the catch with the black locking button **12**.

Fasten the largest buckle and slide **14** in the catch with the red unlocking button **13**.



Check that the rear seat belts are positioned and operating correctly each time the rear seats are moved.

SEAT BELTS (4/5)



Third row rear seats

Remove strap **16** from hook **A**. Slowly unwind the strap **16**.

Fasten the buckle **17** into the corresponding catch with the red unlocking button **18**.



When handling, the third row rear seat belt strap **16** must always be fastened to hook **A** to prevent damage to the strap or luggage compartment cover (if fitted to the vehicle).

Operating the rear seats. Please see the information in the paragraphs on “Second row rear seats: functions” and “Third row rear seats: functions” in Section 3.



Check that the rear seat belts are positioned and operating correctly each time the rear seats are moved.

SEAT BELTS (5/5)

The following information applies to the vehicle's front and rear seat belts.



- No modification may be made to the component parts of the originally fitted restraint system: seat belts, seats and their mountings. For special operations (e.g. fitting child seats), contact an authorised dealer.
- Do not use devices which allow any slack in the belts (e.g. clothes pegs, clips, etc.): a seat belt which is worn too loosely may cause injury in the event of an accident.
- Never wear the shoulder strap under your arm or behind your back.
- Never use the same belt for more than one person and never hold a baby or child on your lap with your seat belt around them.
- The belt should never be twisted.
- Following an accident, have the seat belts checked and replaced if necessary. Always replace your seat belts as soon as they show any signs of wear.
- When putting back the rear bench seat, take care that the seat belts are correctly positioned so that they can be used properly.
- Make sure that the buckle is inserted into the appropriate catch.
- Ensure that no objects are placed in the area around the seat belt catch as they could prevent it from being properly secured.
- Make sure the seat belt catch is properly positioned (it should not be hidden away, crushed or flattened by people or objects).

SYSTEMS IN ADDITION TO THE FRONT SEAT BELTS (1/4)

Depending on the vehicle, they are composed of:

- **seat belt pretensioners;**
- **chest force limiters;**
- **front airbags for driver and front passenger.**

These systems are designed to act independently or together when the vehicle is subjected to a frontal impact.

Depending on the severity of the impact, the system can trigger:

- seat belt locking;
- the seat belt pretensioner (which engages to correct seat belt slack);
- the air bag and the force limiter are also triggered when there are severe impacts.

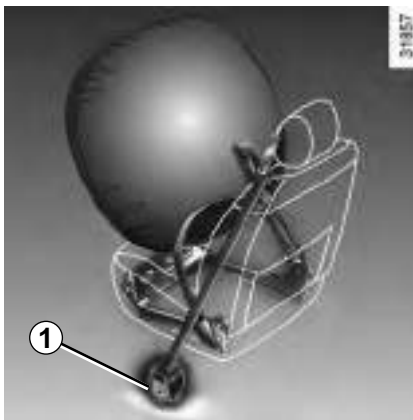

Pretensioners

The pretensioners hold the seat belt against the body, holding the occupant more securely against the seat, thus increasing the seat belt's efficiency.

With the ignition on, following a significant frontal impact and depending on the severity of the impact, the system may trigger the seat belt inertia reel pretensioner **1**, which instantly retracts the seat belt.



- Have the entire restraint system checked following an accident.
 - No operation whatsoever is permitted on any part of the system (air bags, electronic control units, wiring) and the system components must not be reused on any other vehicle, even if identical.
- To avoid premature triggering of the system which may cause injury, only qualified Network personnel are authorised to work on the methods of restraint in addition to the front seat belt.
- The electric trigger system may only be tested by a specially trained technician using special equipment.
- When the vehicle is scrapped, contact an approved dealer for disposal of the pretensioner and airbag gas generators.

SYSTEMS IN ADDITION TO THE FRONT SEAT BELTS (2/4)

Load limiter

Above a certain severity of impact, this mechanism is used to limit the force of the belt against the body so that it is at an acceptable level.

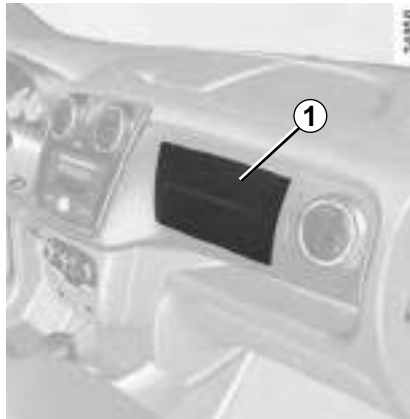

Driver's and passenger air bags

They are fitted on the driver's side and, depending on the vehicle, on the passenger side.

Depending on the vehicle, the presence of this equipment is indicated by the word "airbag" on the steering wheel and dashboard (airbag zone 1) and a symbol on the lower section of the windscreen.

Each air bag system consists of:

- an airbag and gas generator fitted on the steering wheel for the driver and, depending on the vehicle, in the dashboard for the front passenger;
- an electronic unit for system monitoring which controls the gas generator electrical trigger system;
- a single warning light ;
- remote sensors.



The air bag system uses pyrotechnic principles. This explains why, when the air bag inflates, it will generate heat, produce smoke (this does not mean that a fire is about to start) and make a noise upon detonation. An air bag may inflate immediately, causing some minor, superficial grazing to the skin or other discomfort.

SYSTEMS IN ADDITION TO THE FRONT SEAT BELTS (3/4)

Operation

This system is only operational when the ignition is switched on.

If a severe **frontal** impact occurs, the air bag(s) inflate(s) rapidly, cushioning the impact of the driver's head and chest against the steering wheel and the front passenger's head against the dashboard. The air bag then deflates immediately so that the passengers are not impeded in any way when they get out of the vehicle.



The air bag system uses pyrotechnic principles. This explains why, when the air bag inflates, it will generate heat, produce smoke (this does not mean that a fire is about to start) and make a noise upon detonation. In a situation where an air bag is required, it will inflate immediately and this may cause some minor, superficial grazing to the skin or other problems.

SYSTEMS IN ADDITION TO THE FRONT SEAT BELTS (4/4)

All of the warnings below are given so that the air bag is not obstructed in any way when it is inflated and also to prevent the risk of serious injuries caused by items which may be dislodged when the air bag inflates.



Warnings concerning the driver's air bag

- Do not modify the steering wheel or the steering wheel boss.
- Do not cover the steering wheel boss under any circumstances.
- Do not attach any objects (badge, logo, clock, telephone holder, etc.) to the steering wheel boss.
- You must not remove the steering wheel (such work must only be performed by trained personnel from our Network).
- When driving, do not sit too close to the steering wheel. Sit with your arms slightly bent (see the information on “Adjusting your driving position” in Section 1). This will allow sufficient space for the air bag to inflate properly and be fully effective.

Warnings concerning the passenger air bag

- Do not attach or glue any objects (badge, logo, clock, telephone holder, etc.) to the dashboard in the proximity of the air bag housing.
- Do not place anything between the dashboard and the passenger (pet, umbrella, walking stick, parcels, etc.).
- The passenger must not put his or her feet on the dashboard or seat as there is a risk that serious injuries may occur. In general, all parts of the body should be kept away from the dashboard (knees, hands, head etc.).
- The devices in addition to the front passenger seat belt should be reactivated as soon as a child seat is removed, to ensure the protection of the passenger in the event of an impact.

IT IS PROHIBITED TO FIT A REAR-FACING CHILD SEAT TO THE FRONT PASSENGER SEAT UNLESS THE RESTRAINT SYSTEMS IN ADDITION TO THE FRONT PASSENGER SEAT BELT HAVE BEEN DEACTIVATED.

(Refer to the information on “Child safety: front passenger airbag deactivation/activation” Section 1).

SIDE PROTECTION DEVICES

Side air bags

These air bags may be fitted to the front seats and are deployed at the sides of the seats (door side) to protect the occupants in the event of a severe side impact.



Warnings concerning the side air bag

- **Fitting seat covers:** seats equipped with an airbag require covers specifically designed for your vehicle. Contact an authorised dealer to find out if these covers are available. The use of any covers other than those designed for your vehicle (including those designed for another vehicle) may affect the operation of the airbags and reduce your protection.
- Do not place any accessories, objects or even pets between the seatback, the door and the internal fittings. Do not cover the seatback with any items such as clothes or accessories. This may prevent the air bag from operating correctly or cause injury when the air bag is deployed.
- No work or modification whatsoever may be carried out on the seat or internal fittings, except by qualified personnel from an approved dealer.

ADDITIONAL METHODS OF RESTRAINT

All of the warnings below are given so that the air bag is not obstructed in any way when it is inflated and also to prevent the risk of serious injuries caused by items which may be dislodged when the air bag inflates.



The air bag is designed to complement the action of the seat belt. The air bag and the seat belt are integral parts of the same protection system. It is therefore essential to wear the seat belt at all times. If seat belts are not worn, the occupants are exposed to the risk of serious injury in the event of an accident. It may also increase the risk of minor superficial injuries occurring when the air bag is deployed, although such minor injuries are always possible with air bags.

If the vehicle should overturn or suffer a rear impact, however severe, the pretensioners and air bags are not always triggered. Impacts to the underside of the vehicle, e.g. from pavements, potholes or stones, can all trigger these systems.

- No work or modification **whatsoever** may be carried out on any part of the driver or passenger air bag system (air bag, electronic unit, wiring, etc.), except by qualified personnel from our Network.
- To ensure that the system is in good working order and to avoid accidental triggering of the system which could cause injury, only qualified personnel from our Network may work on the air bag system.
- As a safety precaution, have the air bag system checked if your vehicle has been involved in an accident, or is stolen or broken into.
- When selling or lending the vehicle, inform the user of these points and hand over this handbook with the vehicle.
- When scrapping your vehicle, contact an approved Dealer for advice on disposing of the gas generator and air bags.



Operating faults

This warning light **1** will light up on the instrument panel when the ignition is switched on and then go out after a few seconds.

If it does not come on when the ignition is switched on, or if it comes on when the engine is running, there is a fault with the system (air bags, pretensioners, etc.) in the front and/or rear seats.

Contact an authorised dealer as soon as possible. The efficiency of protection will be reduced until this fault is rectified.

CHILD SAFETY: General information (1/2)

Carrying children

Children, and adults, must be correctly seated and strapped in for all journeys. The children being carried in your vehicle are your responsibility.

A child is not a miniature adult. Children are at risk of specific injuries as their muscles and bones have not yet finished growing. The seat belt alone would not provide suitable protection. Use an approved child seat and ensure you use it correctly.



To prevent the doors being opened, use the “Child safety” device (refer to the information on “Opening and closing the doors” in Section 1).



A collision at 30 mph (50 km/h) is the same as falling a distance of 10 metres. Transporting a child without a restraint is the equivalent of allowing him or her to play on a fourthfloor balcony without railings.

Never travel with a child held in your arms. In the event of an accident, you will not be able to keep hold of the child, even if you yourself are wearing a seat belt.

If your vehicle has been involved in a road accident, replace the child seat and have the seat belts and ISOFIX fittings checked.



Special features of LPG versions

The vehicle's LPG installation may lead to changes to the vehicle's features compared to the petrol version.

This may relate to the number of seats and the installation of child seats.

Please contact an authorised dealer.



Never leave a child unattended in the vehicle.

Check that your child is always strapped in and that the belt or safety harness used is correctly set and adjusted. Avoid wearing bulky clothing which could cause the belts to slacken.

Never let your child put their head or arms out of the window.

Check that the child is in the correct position for the entire journey, especially if asleep.

CHILD SAFETY: General information (2/2)

Using a child seat

The level of protection offered by the child seat depends on its ability to restrain your child and on its installation. Incorrect installation compromises the protection it offers the child in the event of harsh braking or an impact.

Before purchasing a child seat, check that it complies with the regulations for the country you are in and that it can be fitted in your vehicle. Consult an approved dealer to find out which seats are recommended for your vehicle.

Before fitting a child seat, read the manual and respect its instructions. If you experience any difficulties during installation, contact the manufacturer of the equipment. Keep the instructions with the seat.

Set a good example by always fastening your seat belt and teaching your child:

- to strap themselves in correctly;
- to always get in and out of the car at the kerb, away from busy traffic.

Do not use a second-hand child seat or one without an instruction manual.

Check that there are no objects in the vicinity of the child seat which could impede its operation.



Never leave a child unattended in the vehicle.

Check that your child is always strapped in and that the belt or safety harness used is correctly set and adjusted. Avoid wearing bulky clothing which could cause the belts to slacken.

Never let your child put their head or arms out of the window.

Check that the child is in the correct position for the entire journey, especially if asleep.

CHILD SAFETY: choosing a child seat



Rear-facing child seats

A baby's head is, proportionally, heavier than that of an adult and its neck is very fragile. Transport the child in this position for as long as possible (until the age of 2 at the very least). It supports the head and neck. Choose a bucket type seat for better side protection and replace it as soon as the child's head extends past the seat shell.



Forward-facing child seats

The child's head and abdomen need to be protected as a priority. A forward-facing child seat which is firmly attached to the vehicle will reduce the risk of impact to the head. Ensure your child travels in a forward-facing seat with a harness for as long as their size permits. Choose a wrap-around seat for better side protection.



Booster cushions

From 15 kg or 4 years, the child can travel using a booster seat, which will enable the seat belt to be adapted to suit his/her size and shape. The booster seat cushion must be fitted with guides to position the seat belt on the child's thighs rather than the stomach. It is recommended that you use a seat-back fitted with a belt strap guide which can be adjusted in terms of height to position the seat belt in the centre of the shoulder. It should never rest on the neck or over the arm. Choose a bucket type seat for better side protection.

CHILD SAFETY: mounting a child seat (1/2)

Attachment via the seat belt

The seat belt must be adjusted to ensure that it is effective in the event of harsh braking or an impact.

Ensure that the strap paths indicated by the child seat manufacturer are respected.

Always check that the seat belt is correctly fastened by pulling it up, then pulling it out fully whilst pressing on the child seat.

Check that the seat is correctly held by moving it from side to side and back to front: the seat should remain firmly fixed.

Check that the child seat has not been installed at an angle and that it is not resting against a window.



Do not use the child seat if it may unfasten the seat belt restraining it: the base of the seat must not rest on the buckle and/or catch of the seat belt.



The seat belt must never be twisted or the tension relieved. Never pass the shoulder strap under the arm or behind the back.

Check that the seat belt has not been damaged by sharp edges.

If the seat belt does not operate normally, it will not protect the child. Consult an approved dealer. Do not use this seat until the seat belt has been repaired.



No modifications may be made to the component parts of the restraint system (belts, ISOFIX and seats and their mountings) originally fitted.

Attachment with the ISOFIX system

Authorised ISOFIX child seats are approved in accordance with regulation ECE-R44 in one of the three following scenarios:

- ISOFIX universal 3 point forward-facing seat;
- ISOFIX semi-universal 2 point seat;
- specific.

For the latter two, check that your child seat can be installed by consulting the list of compatible vehicles.

Attach the child seat with the ISOFIX locks, if these are provided. The ISOFIX system allows quick, easy, safe fitting.

The ISOFIX system is composed of 3 rings for each second row rear side seat.



Before using an ISOFIX child seat that you purchased for another vehicle, check that its installation is authorised. Consult the list of vehicles which can be fitted with the seat with the equipment manufacturer.

CHILD SAFETY: mounting a child seat (2/2)

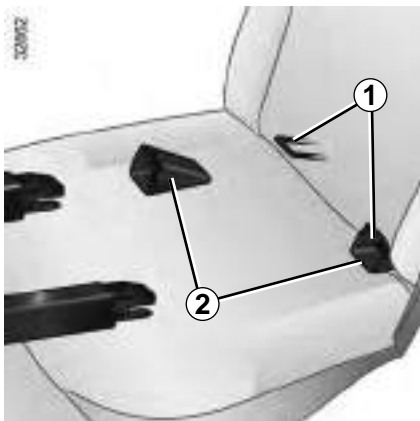

The two ISOFIX rings **1** are located between the seatback and the base and are present on each side of the vehicle.

To ensure your child seat can be easily fitted and locked on rings **1**, use access guides **2** on the child seat.

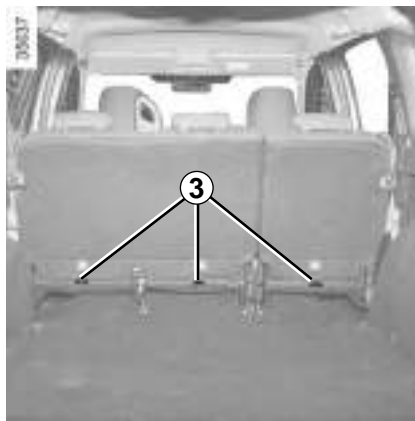

The third ring **3** of each side seat is used to attach the upper strap on some child seats.

Attach the hook on the belt to one of the rings **3** located at the rear of the first row rear seats at the base of each seatback.

Pull the belt so that the back of the child seat comes into contact with the back of the vehicle seat.



Anchorage **3** must be used to attach the child seat's upper strap.

It is forbidden to use other mounting points to attach this strap.



The ISOFIX anchorage points have been exclusively designed for child seats with the ISOFIX system. Never fit a different type of child seat, seat belt or other objects to these fittings.

Check that nothing is obstructing the anchorage points.

If your vehicle has been involved in a road accident, have the ISOFIX fittings checked and replace your child seat.

CHILD SAFETY: fitting a child seat (1/8)

Some seats are not suitable for fitting child seats. The diagram on the following page shows you how to attach a child seat.

The types of child seats indicated may not be available. Before using a different child seat, check with the manufacturer that it can be fitted.



Fit the child seat in a rear seat wherever possible.

Check that when installing the child seat in the vehicle it is not at risk of coming loose from its base.

If you have to remove the headrest, check that it is correctly stored so that it does not come loose under harsh braking or impact.

Always attach the child seat to the vehicle even if it is not in use so that it does not come loose under harsh braking or impact.

In the front seat

The laws concerning children traveling in the front passenger seat differ in every country. Consult the legislation in force and follow the indications on the diagram on the following page.

Before fitting a child seat in this seat (if authorised):

- deactivate the front passenger air bag;
- lower the seat belt as far as possible;
- move the seat as far back as possible;
- gently tilt the seatback away from vertical (approximately 25°);
- on equipped vehicles, raise the seat base as far as possible.

Do not change these settings after the child seat is installed.



RISK OF DEATH OR SERIOUS INJURY: before fitting a rear-facing child seat in this seat, check that the air bag has been deactivated (refer to the information on “Deactivating the front passenger air bags” in Section 1).

CHILD SAFETY: fitting a child seat (2/8)

In the rear side seat

A carrycot can be installed across the vehicle and will take up at least two seats. Position the child with his or her feet nearest the door.

Before fitting a child seat to the ISOFIX anchorages on the rear side seat, ensure that the seat belt buckles are not positioned between the two ISOFIX anchorages on this seat. If necessary, move the buckle from the seat in question towards the centre of the vehicle.

Move the front seat as far forward as possible to install a rear-facing child seat, then move back the seat in front as far as it will go, although without allowing it to come into contact with the child seat.

For the safety of the child in the forward-facing seat, do not move the seat in front back past the middle of the runner, do not tilt the seatback too far (maximum of 25°) and raise the seat as much as possible.

Check that the forward-facing child seat is resting against the back of the vehicle seat and that the headrest of the vehicle is not obstructing its use.

Rear centre seat

A child seat may only be fitted in this seat if it is equipped with an inertia-reel seat belt. For any additional information, contact an approved dealer.



Ensure that the child seat or the child's feet do not prevent the front seat from locking correctly.

Refer to the information on the "Front seats" in Section 1.

CHILD SAFETY: fitting a child seat (3/8)

The table below summarises the information already shown in the diagram on the following pages, to ensure the applicable regulations are respected.

Five-seater versions						
Type of child seat	Weight of the child	Seat size	Front passenger seat		Rear seats	
			with airbag without deactivation (1)	without airbag or with airbag deactivated (2)(3)	Side seats	Centre seat
Transverse carrycot Approved for group 0	< 10 kg	F - G	X	X	U - IL (4)	U (4)
Rear-facing shell seat Approved for group 0 or 0+	< 13 kg	E	X	U	U - IL (5)	U - IL (5)
Rear-facing seat Approved for group 0+ or 1	< 13 kg and 9 to 18 kg	C, D	X	U	U - IL (5)	U - IL (5)
Forward-facing seat Approved for group 1	9 kg to 18 kg	A, B, B1	X	X	U - IUF IL (6)	U - IUF - IL (6)
Booster seat Approved for group 2 or 3	15 kg to 25 kg and 22 kg to 36 kg	–	X	X	U (6)	U (6)



(1) RISK OF DEATH OR SERIOUS INJURY: never fit a child seat on the front seat if the vehicle has a passenger airbag which cannot be deactivated.

(2) RISK OF DEATH OR SERIOUS INJURY: before fitting a rear-facing child seat on the front passenger seat, check that the airbag has been deactivated (please refer to the information on “Child safety: front passenger airbag deactivation, activation” in Section 1).

CHILD SAFETY: fitting a child seat (4/8)

Refer to the “Child safety equipment” booklet available from the network to choose the seat suited to your child and recommended for your vehicle.

X = Seat not suitable for fitting child seats.

U = Seat which allows a child seat with “Universal” approval to be installed using a seat belt; check that it can be fitted.

IUF = Seat which allows forward facing child seats with “Universal” approval to be attached by the ISOFIX device; check that it can be fitted correctly.

IL = Seat which allows child seats with “Semi-universal” or “vehicle specific” approval to be attached by the ISOFIX device; check that it can be fitted correctly.

- (3)** Only a rear-facing child seat can be fitted in this seat: raise the seat to the maximum and position it as far back as possible, tilting the seatback slightly (approximately 25°).
- (4)** A carrycot can be installed across the vehicle and will take up at least two seats. Position the child with his or her feet nearest the door.
- (5)** Move the front seat as far forward as possible to install a rear-facing child seat, then move back the seat in front as far as it will go, although without allowing it to come into contact with the child seat. Raise the headrest or remove it.
- (6)** Forward-facing child seat; position the seatback of the child seat in contact with the seatback of the vehicle seat. Adjust the height of the headrest or remove it if necessary; do not push the seat in front of the child more than halfway back on its runners and do not recline the seatback more than 25°.

CHILD SAFETY: fitting a child seat (5/8)

Visual installation of the five-seater version



Check the status of the air bag before fitting a child seat or allowing a passenger to use the seat.



Seat not suitable for fitting child seats.

Child seat attached using the belt

U Seat which allows a child seat with “Universal” approval to be attached by a seat belt.

Child seat attached using the ISOFIX fitting



Seat which allows an ISOFIX child seat to be attached.

The rear seats are fitted with an anchorage point which allows a forward-facing ISOFIX child seat with universal approval to be attached. The anchorage points are located on the bench seat and are visible.

The size of the ISOFIX child seat is indicated by a letter:

- A, B and B1: for forward-facing seats in group 1 (9 to 18 kg);
- C: rear-facing seats in group 1 (9 to 18 kg);
- D and E: shell seat or rear-facing seats in group 0 or 0+ (less than 13 kg);
- F and G: cots in group 0 (less than 10 kg).



RISK OF DEATH OR SERIOUS INJURY: before fitting a rear-facing child seat on the front passenger seat, check that the airbag has been deactivated (please refer to the information on “Child safety: front passenger airbag deactivation, activation” in Section 1).



Using a child safety system which is not approved for this vehicle will not correctly protect the baby or child. They risk serious or even fatal injury.

CHILD SAFETY: fitting a child seat (6/8)

Visual installation, 7-seater version



Check the status of the air bag before fitting a child seat or allowing a passenger to use the seat.



Seat not suitable for fitting child seats.

Child seat attached using the belt

U Seat which allows a child seat with “Universal” approval to be attached by a seat belt.

Child seat attached using the ISOFIX fitting



Seat which allows an ISOFIX child seat to be attached.

The rear seats are fitted with an anchorage point which allows a forward-facing ISOFIX child seat with universal approval to be attached. The anchorage points are located on the bench seat and are visible.

The size of the ISOFIX child seat is indicated by a letter:

- A, B and B1: for forward-facing seats in group 1 (9 to 18 kg);
- C: rear-facing seats in group 1 (9 to 18 kg);
- D and E: shell seat or rear-facing seats in group 0 or 0+ (less than 13 kg);
- F and G: cots in group 0 (less than 10 kg).



RISK OF DEATH OR SERIOUS INJURY: before fitting a rear-facing child seat on the front passenger seat, check that the airbag has been deactivated (please refer to the information on “Child safety: front passenger airbag deactivation, activation” in Section 1).

CHILD SAFETY: fitting a child seat (7/8)

The table below summarises the information already shown on the diagram on the previous page, to ensure the applicable regulations are respected.

Seven-seat version							
Type of child seat	Weight of the child	Seat size	Front passenger seat		2nd row rear seats		3rd row rear seats
			with airbag without deactivation (1)	without airbag or if the airbag is deactivated (2) (3)	Side seats	Centre seat	
Transverse carrycot Approved for group 0	< 10 kg	F - G	X	X	U - IL (4)	U (4)	U
Rear-facing shell seats Approved for group 0 or 0+	< 13 kg	E	X	U	U - IL (5)	U - IL (5)	U
Rear-facing seats Approved for groups 0+ and 1	< 13 kg and 9 to 18 kg	C, D	X	U	U - IL (5)	U - IL (5)	U
Forward-facing seat Approved for group 1	9 kg to 18 kg	A, B, B1	X	X	U - IUF - IL (6)	U - IUF - IL (6)	U
Booster seat Approved for group 2 or 3	15 to 25 kg and 25 to 36 kg	-	X	X	U (6)	U (6)	U



(1) RISK OF DEATH OR SERIOUS INJURY: never fit a child seat on the front seat if the vehicle has a passenger airbag which cannot be deactivated.

(2) RISK OF DEATH OR SERIOUS INJURY: before fitting a rear-facing child seat on the front passenger seat, check that the airbag has been deactivated (please refer to the information on "Child safety: front passenger airbag deactivation, activation" in Section 1).

CHILD SAFETY: fitting a child seat (8/8)

Refer to the “Child safety equipment” booklet available from the network to choose the seat suited to your child and recommended for your vehicle.

X = Seat not suitable for fitting child seats.

U = Seat allowing a child seat with “Universal” approval to be attached by seat belt; check that it can be fitted correctly.

IUF = Seat which allows a forward-facing child seat with “Universal” approval to be attached by the ISOFIX device; check that it can be fitted.

IL = Seat which allows child seats with “Semi-universal” or “Vehicle specific” approval to be attached by the ISOFIX device; check that it can be fitted.

- (3)** Only a rear-facing child seat can be fitted in this seat: raise the seat to the maximum and position it as far back as possible, tilting the seatback slightly (approximately 25°).
- (4)** A carrycot can be installed across the vehicle and will take up at least two seats. Position the child with his or her feet nearest the door.
- (5)** Move the front seat as far forward as possible to install a rear-facing child seat, then move back the seat in front as far as it will go, although without allowing it to come into contact with the child seat. Raise the headrest or remove it.
- (6)** Forward-facing child seat; position the seatback of the child seat in contact with the seatback of the vehicle seat. Adjust the height of the headrest or remove it if necessary; do not push the seat in front of the child more than halfway back on its runners and do not recline the seatback more than 25°.

CHILD SAFETY: deactivating/activating the front passenger air bag (1/3)

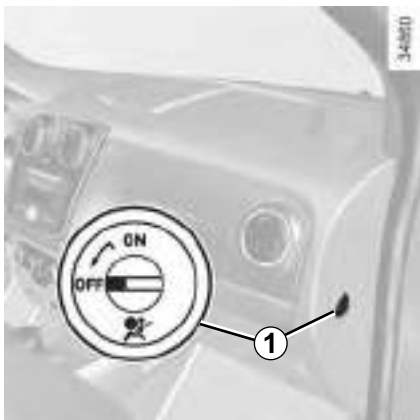

Deactivating the front passenger air bags (depending on vehicle)

In order to be able to install a rear-facing child seat on the front passenger seat, you **must** deactivate the front passenger seat belt additional restraint systems.

To deactivate the passenger airbag, with the ignition off, press and turn button 1 to the OFF position.



With the ignition on, it is **essential** to check that the 2  warning light is lit up.

This warning light remains continuously lit to let you know that you can fit a child seat.



The passenger air bag must be activated or deactivated with the **ignition off**.

If handled when the ignition is on, the warning light  comes on.

Switch the ignition off then on again to reset the air bag in accordance with the lock.

CHILD SAFETY: deactivating/activating the front passenger air bag (2/3)

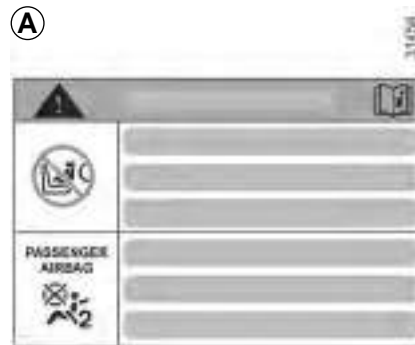

DANGER

Since front passenger airbag triggering and the position of a rear-facing child seat are incompatible, **NEVER** use a restraining device for rear-facing children on a seat with an **ACTIVATED AIRBAG** in front of it. This provides a risk of **DEATH** or **SERIOUS INJURY** to the **CHILD**.

The markings on the dashboard and labels **A** on each side of the passenger sun visor **3** (example: label shown above) remind you of these instructions.

CHILD SAFETY: deactivating/activating the front passenger air bag (3/3)

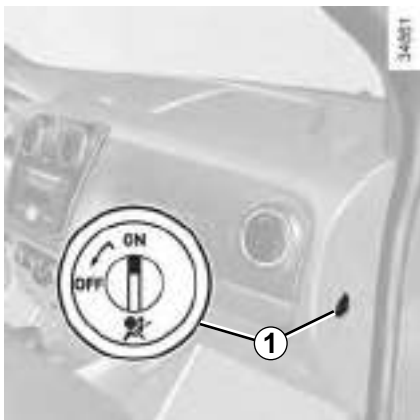

Activation of the front passenger air bag (depending on vehicle)

You should reactivate the air bag as soon as you remove the child seat from the front passenger seat to ensure the protection of your front passenger in the event of an impact.

To reactivate the airbag: with the vehicle at a standstill and with the ignition switched off, press and turn button **1** to the **ON** position.

With the ignition on, you **must** check that the warning light **2**  is off.



Operating faults

It is forbidden to fit a rear-facing child seat to the front passenger seat if the air bag activation/deactivation system is faulty.

Allowing any other passenger to sit in that seat is not recommended.

Contact your approved dealer as soon as possible.



DANGER

Since front passenger airbag triggering and the position of a rear-facing child seat are incompatible, **NEVER** use a restraining device for rear-facing children on a seat with an **ACTIVATED AIRBAG** in front of it. This provides a risk of **DEATH** or **SERIOUS INJURY** to the **CHILD**.



The passenger air bag must be activated or deactivated with the **ignition off**.

If handled when the ignition is on, the warning light  comes on.

Switch the ignition off then on again to reset the air bag in accordance with the lock.

REAR VIEW MIRRORS

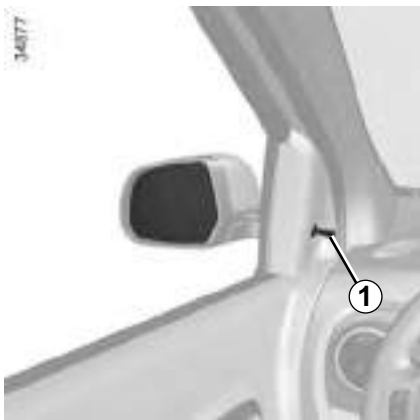

Door mirrors with manual adjustment

To adjust the door mirror, move switch **1**.

Foldable door mirrors

Fold the door mirror manually against the door window.

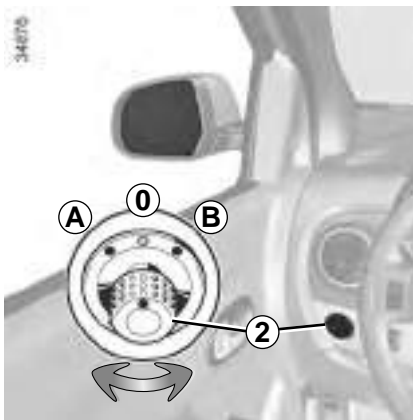

Door mirrors with electrical adjustment:

With the ignition on, move button **2**:

- position **A** to adjust the left-hand door mirror;
- position **B** to adjust the right-hand door mirror;

0 is the neutral centre position.

Heated door mirrors

With the engine running, de-icing is performed when the rear screen is de-iced/demisted; refer to the information in the paragraph on “Heated rear screen”.



Interior rear view mirror

The interior rear-view mirror is adjustable. When driving at night, tilt lever **3** to avoid being dazzled by the headlights of the vehicle behind.

DRIVER'S POSITION, LEFT-HAND DRIVE (1/2)

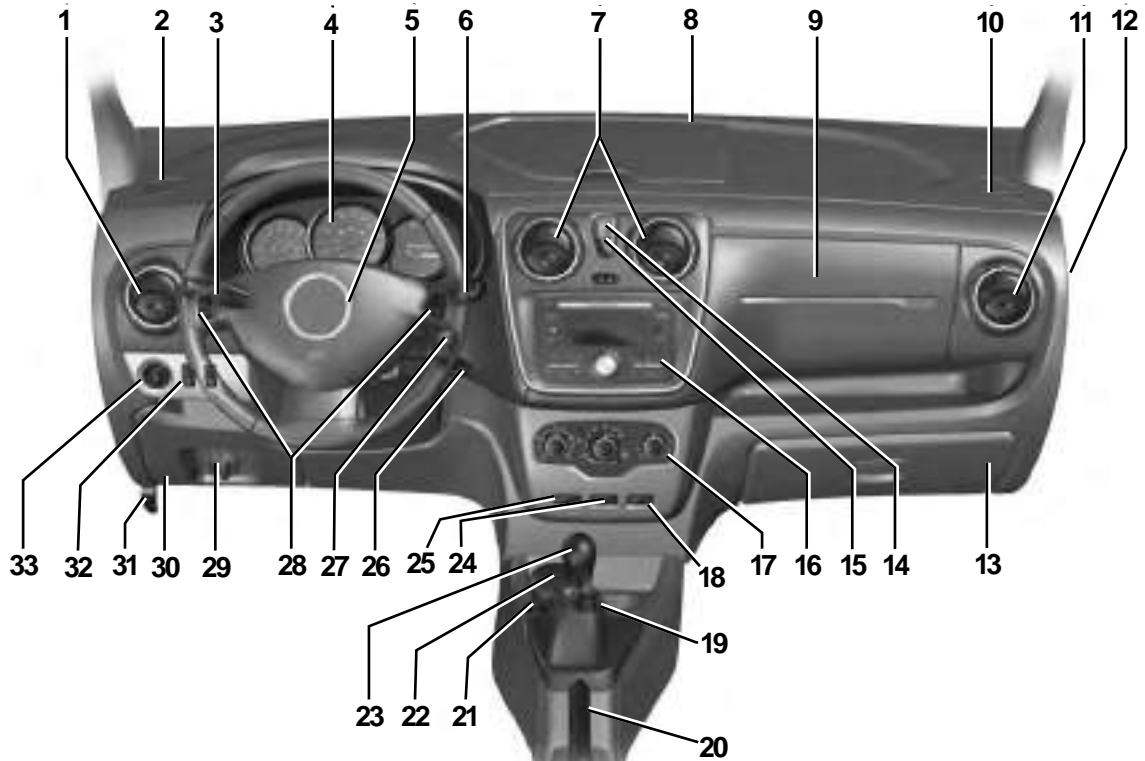

36-500

DRIVER'S POSITION, LEFT-HAND DRIVE (2/2)

The presence of the equipment **DEPENDS ON THE VEHICLE VERSION AND COUNTRY.**

- | | | |
|---|--|--|
| 1 Side air vent. | 11 Side air vent. | 23 Gear lever. |
| 2 Side demister outlet. | 12 Passenger airbag activation/deactivation switch. | 24 ECO mode switch. |
| 3 Stalk for: <ul style="list-style-type: none">– direction indicator lights,– exterior lights,– front fog lights,– rear fog lights,– horn. | 13 Glovebox. | 25 Cruise control/speed limiter main control. |
| 4 Instrument panel. | 14 Hazard warning lights switch. | 26 Ignition switch. |
| 5 Location for driver's airbag. | 15 Electric central locking switch. | 27 Radio remote control. |
| 6 Steering column stalk for windscreen and rear screen wash/wipe. On-board computer information readout control. | 16 Location for radio or storage compartment. | 28 Cruise control/speed limiter controls. |
| 7 Centre air vents. | 17 Heating and ventilation controls. | 29 Beam height adjustment control. |
| 8 Central demister outlet. | 18 Rear screen and door mirror de-icing control | 30 Fuse box.
Storage box. |
| 9 Location for passenger airbag or storage compartment. | 19 Cigarette lighter.
Accessories socket. | 31 Bonnet release control. |
| 10 Side demister outlet. | 20 Handbrake. | 32 Controls for: <ul style="list-style-type: none">– activating/deactivating the traction control system,– activating/deactivating the parking distance control. |
| | 21 LPG control | 33 Door mirror adjustment control. |
| | 22 Location for ashtray or cup holder. | |

WARNING LIGHTS (1/4)

The presence and operation of the warning lights **DEPEND ON THE EQUIPMENT AND COUNTRY.**





Instrument panel A



If no lights or sounds are apparent, this indicates a fault in the instrument panel. This indicates that it is essential to stop immediately (as soon as traffic conditions allow). Ensure that the vehicle is correctly immobilised and contact an approved Dealer.



The red warning light  requires you to stop immediately, for your own safety, as soon as traffic conditions allow. Switch off the engine and do not restart it. Contact an Authorised Dealer.

If the orange warning light  comes on while you are driving, **drive carefully** to an authorised dealer as soon as possible. Failure to follow this recommendation risks damaging your vehicle.



Main beam headlight tell-tale light



Dipped beam headlight tell-tale



Front fog light tell-tale light



Rear fog light tell-tale



Left-hand direction indicator tell-tale



Right-hand direction indicator tell-tale



Gear change indicator

This lights up to advise you to change to a higher gear (up arrow) or lower gear (down arrow).

WARNING LIGHTS (2/4)

The presence and operation of the warning lights **DEPEND ON THE EQUIPMENT AND COUNTRY.**



Handbrake “on” warning light and brake circuit incident warning light

This comes on when the ignition is switched on. If it comes on during braking and is accompanied by a beep, it indicates that the fluid level in the circuit is low; it may be dangerous to continue driving - please contact an authorised dealer.

Warning light malfunction (red or orange)

Urgent stop warning light (red)

This lights up when the ignition is switched on and goes out as soon as the engine is started. It lights up at the same time as other warning lights, and is accompanied by a beep.

It requires you to stop immediately, for your own safety, as soon as traffic conditions allow. Switch off the engine and do not restart it.

Contact an approved Dealer.

Warning light (orange)

This lights up when the ignition is switched on and goes out as soon as the engine is started. It may come on in conjunction with other warning lights on the instrument panel.

It means you should **drive very carefully** to an authorised dealer as soon as possible. If you fail to follow this recommendation, you risk damaging your vehicle.

Coolant temperature warning light

If this remains lit while driving, accompanied by a beep, this means the engine is overheating. Stop and allow the engine to run at idle speed for a minute or two. The temperature should drop. If not, stop the engine. Let it cool down before checking the coolant level. Contact an authorised dealer if necessary.

Warning light for monitoring exhaust gas

It comes on when the ignition is switched on and then goes out.

- If it lights up continuously, consult an authorised dealer as soon as possible;
- If it flashes, reduce the engine speed until the light stops flashing. Contact your approved Dealer as soon as possible.

Please refer to the information on “Maintenance and antipollution advice” in Section 2.

WARNING LIGHTS (3/4)

The presence and operation of the warning lights **DEPEND ON THE EQUIPMENT AND COUNTRY.**



Oil pressure warning light

This lights up when the ignition is switched on and goes out after a few seconds.

If it comes on on the road, accompanied by a beep, stop immediately and cut the ignition.

Check the oil level (refer to “Engine oil level: general information” in Section 4). If the level is normal, the light has come on for another reason: Consult an authorised dealer straight away.



Preheating warning light (on diesel version)

This should come on when the ignition is switched on. It indicates that the heater plugs are in operation. It goes out after preheating is sufficient and the engine can be started.



Airbag warning light

This comes on when the ignition is switched on and goes out after a few seconds. If it does not come on when the ignition is switched on or if it flashes, there is a fault in the system. Contact an approved Dealer as soon as possible.



Battery charge warning light

If it comes on when you are driving, it indicates that the circuit has discharged. Stop and consult an approved Dealer as soon as possible.



Anti-lock braking warning light

This lights up when the ignition is switched on and goes out after a few seconds.

If it does not go out after the ignition is switched on, or lights up when driving, there is a fault with the ABS. Braking will then be as normal, without the ABS system.

Contact an approved Dealer as soon as possible.



Low fuel level warning light

This comes on when the ignition is switched on and goes out after a few seconds. If it comes on when driving accompanied by a beep, fill up with fuel as soon as possible. There is only approximately 30 miles (50 km) worth of fuel left after the warning light first comes on.



Tyre pressure loss warning

Please refer to the information on the “Tyre pressure loss warning” in Section 2.

WARNING LIGHTS (4/4)

The presence and operation of the warning lights **DEPEND ON THE EQUIPMENT AND COUNTRY.**



 **Seat belt reminder light**
It is displayed on the console **B**.
It stays on when the engine is started if the driver and/or passenger seat belt is not fastened. When the vehicle is being driven, it comes on and a beep sounds for approximately 2 minutes until the driver's seat belt is fastened.

 **Front passenger air bag deactivated warning light**

Refer to the information on "Child safety: deactivating, activating the front passenger airbag".

 **Electronic Stability Program (ESP) and traction control system (ASR) activation warning light**

There are several reasons for the warning light to come on: please refer to the information on the "Electronic stability program (ESP) with understeer control and traction control (ASR)" in Section 2.

 **Door(s) open warning light**

Refer to "Opening/closing the doors" in Section 1.

 **ECO mode warning light**

This comes on when ECO mode is activated.
Please refer to the information on "Driving advice, Eco-driving" in Section 2.

 **Cruise control warning lights**

Refer to the information on "Cruise control" in Section 2.

 **Speed limiter warning light**

Refer to the information on "Speed limiter" in Section 2.

 **Water in the diesel filter warning light**

This lights up when the ignition is switched on and goes out after a few seconds.

If it comes on when driving, it indicates the presence of water in the diesel.

Contact your approved Dealer as soon as possible.

 **Traction control system (ASR) deactivation warning light**

Please refer to information on "Driver correction devices and aids" in Section 2.

DISPLAYS AND INDICATORS (1/2)



Rev counter 1 (rpm x 1,000)



Speedometer 2 (km or miles per hour)

Overspeed buzzer

Depending on the vehicle, a buzzer sounds for approximately 10 seconds every 30 seconds, as long as the vehicle is travelling in excess of 72 mph (120 km/h).

DISPLAYS AND INDICATORS (2/2)

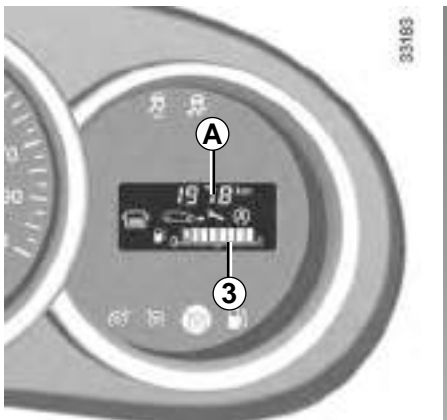

Fuel gauge warning light 3 or 4

The number of squares lit shows the fuel level. When it is at minimum, the squares disappear and the low fuel level warning light flashes.

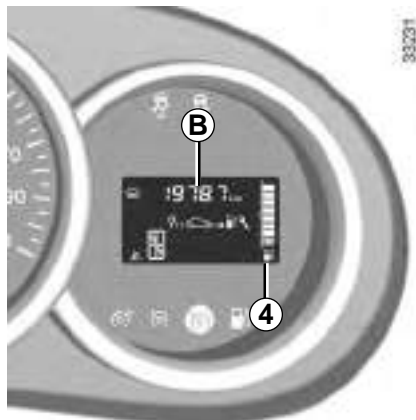

On-board computer *A* or *B*

Refer to the information on the “Trip computer and warning system” in Section 1.

ON-BOARD COMPUTER (1/5)

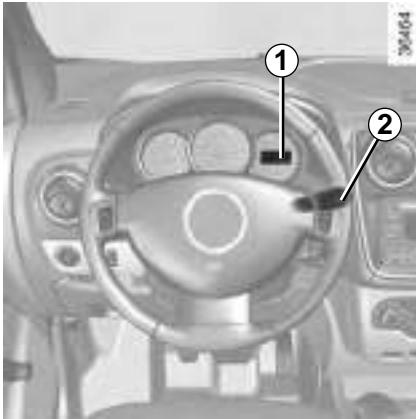

On-board computer 1

Display selection key 2

The display depends on the vehicle and the country.

Scroll through the following information by pressing the button 2:

- a) Total mileage recorder
- b) Trip mileage recorder
- c) Fuel consumed
- d) Average fuel consumption
- e) Current fuel consumption

- f) Estimated range
- g) Distance travelled
- h) Average speed
- i) Oil change interval
- j) Speed limiter
- k) Time
- l) Exterior temperature
- m) reset the tyre pressure.

Refer to the table on the following pages showing display examples.

Resetting the trip mileage

To reset the trip mileage recorder, the display must show the Trip mileometer function.

Press and hold button 2.

Interpreting some of the values displayed after resetting

The values showing average fuel consumption, range and average speed will become more stable and reliable the further you travel after pressing the reset button.



For the first few miles after pressing the reset key you will notice that the range increases as you travel. This range takes into account the average fuel consumption since the last time the reset button was pressed. Therefore, the fuel consumption may decrease when:

- the vehicle stops accelerating;
- the engine reaches its operating temperature (if the engine was cold when the reset key was pressed);
- when driving from an urban area onto the open road.

Resetting is automatic when the maximum capacity of any of the memories is exceeded.



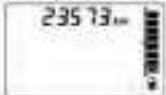
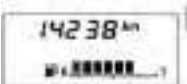
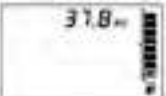

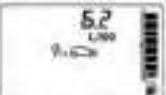
ON-BOARD COMPUTER (2/5)

The display of information shown below **DEPENDS ON THE VEHICLE EQUIPMENT AND COUNTRY.**

Examples of selections		Interpreting the display selected
Display A	Display B	
		➔ a) Total mileage recorder.
		➔ b) Trip mileage recorder.
	-	➔ c) Fuel used since the last time the reset button was pressed.
	-	➔ d) Average fuel consumption since the last time the reset button was pressed. This value is displayed after driving 400 metres and takes into account the distance travelled and the fuel used since the last time the reset button was pressed.

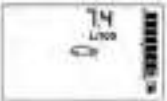



ON-BOARD COMPUTER (3/5)

The display of information shown below **DEPENDS ON THE VEHICLE EQUIPMENT AND COUNTRY.**

Examples of selections		Interpreting the display selected
Display A	Display B	
	-	➔ e) Current fuel consumption. This value is displayed after a speed of approximately 20 mph (30 km/h) is reached.
	-	➔ f) Estimated range with remaining fuel. This range takes into account the average fuel consumption since the last time the reset button was pressed. The value is displayed after driving around 400 metres.
	-	➔ g) Distance travelled since the last time the reset button was pressed.
	-	➔ h) Average speed since the last reset. The value is displayed after driving around 400 metres.

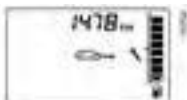



ON-BOARD COMPUTER (4/5)

The display of information shown below **DEPENDS ON THE VEHICLE EQUIPMENT AND COUNTRY.**

Examples of selections		Interpreting the display selected
Display A	Display B	
		<p>➔ j) Mileage before service</p> <p>Distance remaining until the next oil change.</p> <p>There are several scenarios:</p> <ul style="list-style-type: none">– mileage before oil change service less than 1000 miles. Warning light  on the instrument panel comes on accompanied by the message “1000 miles”.– mileage before oil change service 0 miles. Warning light  on the instrument panel comes on accompanied by the message “--- miles”. <p>The distance appears on the display for approximately 8 seconds when the ignition is switched on as soon as the distance is less than or equal to 1000 miles.</p> <p>The vehicle requires an oil change as soon as possible.</p>
<p>Note: depending on the vehicle, the mileage before an oil change varies according to the driving style (frequent driving at low speed, door-to-door journeys, extensive use at idle speed, towing a trailer etc.). The distance remaining until the next oil change can therefore decrease more quickly in some cases than the actual distance travelled.</p> <p>The oil change intervals are independent of the vehicle's maintenance schedule: please refer to your vehicle's maintenance document.</p> <p>Resetting: to reset the mileage before an oil change, press and hold the display reset button for approximately 10 seconds until the display shows the range permanently.</p>		

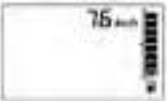
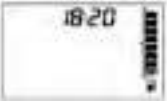
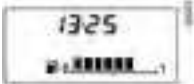
ON-BOARD COMPUTER (5/5)

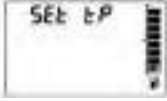
The display of information shown below **DEPENDS ON THE VEHICLE EQUIPMENT AND COUNTRY.**

Examples of selections		Interpreting the display selected
Display A	Display B	
		➔ j) Cruise control and speed limiter programmed speed (if activated). Refer to the information on the “Speed limiter” and “Cruise control” in Section 2.
		➔ k) Time.
		➔ l) Exterior temperature.
		➔ m) Reset the tyre pressure. Please refer to the information on the “Tyre pressure loss warning” in Section 2.

STEERING WHEEL/CLOCK

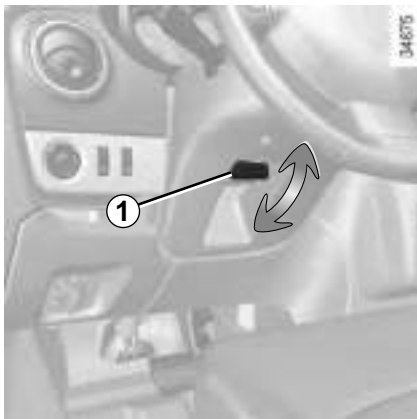

Adjusting the steering wheel

Depending on the vehicle, the steering wheel position is adjustable.

Pull lever **1** and move the steering wheel to the required position. Then push the lever to lock the steering wheel.

Make sure that the steering wheel is correctly locked.



For safety reasons, carry out any adjustments when the vehicle is stationary.



Setting the time

Resetting the clock **2**

Display the “Clock” display on the instrument panel by pressing the button **3**.

Press and hold button **3** to enter the hour setting mode.

When only the hours flash, press button **3** briefly, to scroll through them.

Press and hold button **3** to enter the minute setting mode.

When only the minutes flash, press button **3** briefly, to scroll through them.

Confirm by pressing and holding button **3**.

If the power supply is cut (battery disconnected, supply wire cut, etc.), the clock must be reset.

We recommend that you do not adjust these settings while driving.

EXTERIOR LIGHTING AND SIGNALS (1/2)

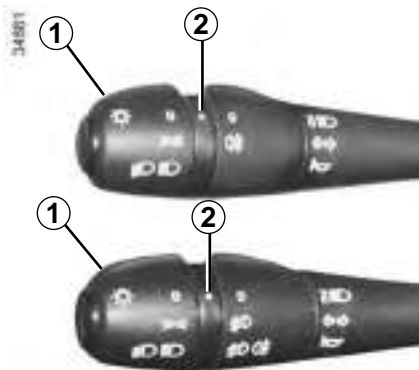

Side lights

Turn the end of stalk **1** until the symbol is opposite mark **2**.

Dipped beam headlights

Turn the end of stalk **1** until the symbol is opposite mark **2**.

This indicator light on the instrument panel comes on.

Main beam headlights

With the dipped beam headlights lit, push stalk **1**. This indicator light on the instrument panel comes on.

To return to the dipped headlight position, pull the stalk **1** towards you again.

Switching off the lights

Turn the end of stalk **1** until the symbol is opposite mark **2**.

Daytime running lights function

(front lights only)

These lights are automatically lit during daylight hours. They are deactivated when the main and dipped beams are lit.

Lights-on reminder buzzer

If the lights are on after the engine is switched off, a warning beep sounds when the driver's door is opened to warn you that the lights are still on.



Before driving at night, check that the electrical equipment is operating correctly and adjust the headlight beams (if your vehicle is not carrying its normal load).

Check that the lights are not obscured (by dirt, mud, snow or objects which could cover them).

EXTERIOR LIGHTING AND SIGNALS (2/2)

34681



Front fog lights

Turn centre ring **3** on the stalk until the symbol faces mark **2**.

The fog lights only light up if the exterior lights have been switched on. An indicator light on the instrument panel then lights up.

Do not forget to switch off the fog lights when they are no longer needed, to avoid inconveniencing other road users.



Rear fog lights

Turn centre ring **3** on the stalk until the symbol faces mark **2**.

The fog lights only light up if the exterior lights have been switched on. An indicator light on the instrument panel then lights up.

Remember to switch off the these lights when they are no longer required to avoid inconveniencing other road users.



Turning off the fog lights

Turn centre ring **3** on the stalk until the symbol faces mark **2**.

The corresponding indicator light goes out on the instrument panel.

The front and rear fog lights switch off when the exterior lights are switched off.

If driving on the left in a left-hand drive vehicle (or vice versa), drivers must have the lights adjusted by an authorised dealer for the duration of the trip.

HEADLIGHT BEAM ADJUSTMENT

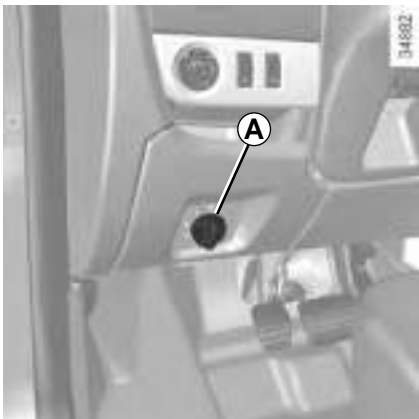

Control **A** is used to adjust the height of the headlight beams according to the load.

Turn control **A** anticlockwise to lower the beams and clockwise to raise them.

If driving on the left in a left-hand drive vehicle (or vice versa), drivers must have the lights adjusted by an authorised dealer for the duration of the trip.

	Examples of positions for adjusting control A according to the load
Driver alone or with front passenger	0
Driver with one front passenger and one rear passenger	1
Do not use	2
Driver with one front passenger and two or three rear passengers	3
Driver with one front passenger, three rear passengers and luggage	3

AUDIBLE AND VISUAL SIGNALS



Horn

Press the end of the stalk **1**.

Headlight flasher

Pull stalk **1** towards you to flash the headlights.



Hazard warning lights

Press switch **2**.

This switch activates all four direction indicators and the side indicator lights simultaneously.

It must only be used in an emergency to warn drivers of other vehicles that you have had to stop in an area where stopping is prohibited or unexpected, or that you are obliged to drive under special conditions.

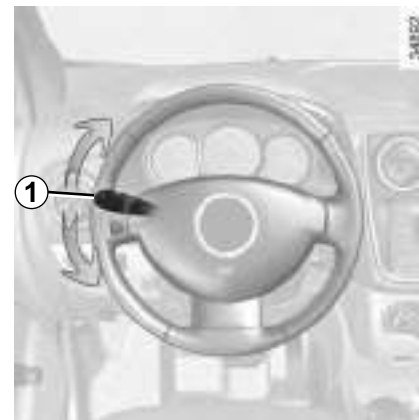

Direction indicators

Move stalk **1** parallel to the steering wheel and in the direction you are going to turn it.

One-touch mode

When driving, it is possible that the steering wheel may not be turned sufficiently to return the stalk automatically to its starting position.

In this case, briefly turn stalk **1** to the intermediate position, then release it: the stalk returns to its original point and the indicator light flashes three times.

WINDSCREEN WASH/WIPE

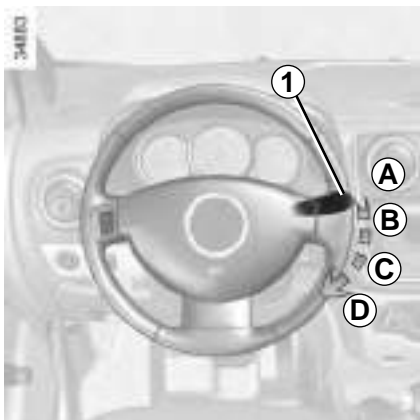

Windscreen wiper

With the ignition on, move stalk **1** around the steering wheel:

- A** Park.
- B** Intermittent wiping.
The wipers will pause for several seconds between sweeps.
- C** Normal wiping speed.
- D** Fast wiping speed.



Windscreen wiper

With the ignition on, pull stalk **1** towards you.

A brief pull will trigger a single sweep of the wipers, in addition to the windscreen washer.

A longer pull will trigger three sweeps of the wipers, in addition to the windscreen washer.



When working in the engine compartment, ensure that the windscreen wiper stalk is in position **A** (park). Risk of injury.



Before any action on the windscreen (washing the vehicle, de-icing, cleaning the windscreen, etc.) return stalk **1** to position **A** (park).

Risk of injury and/or damage.

REAR SCREEN WASH/WIPE, DE-ICING

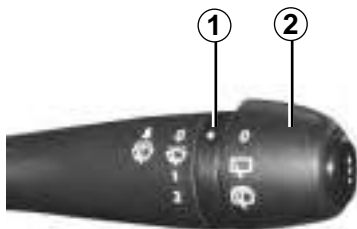

Rear screen wiper (depending on vehicle)

With the ignition switched on, turn the end of stalk **2** to align the symbol with mark **1**.

Rear screen washer/ wiper

(depending on vehicle)

With the ignition switched on, turn the end of stalk **2** to align the symbol with mark **1**.

When the stalk is released, it returns to the rear wipe position.

Before using the rear wiper, check that no object is obstructing the travel of the blade.

In frosty weather, make sure that the wiper blades are not stuck by ice (to avoid the risk of the motor overheating).

Keep an eye on the condition of the blades. Replace the wiper blades as soon as they begin to lose efficiency (approximately once a year).

Regularly clean your rear screen.



Heated rear screen

This function de-ices/demists the rear screen and rearview mirrors (depending on the vehicle).

With the engine running, press switch **3**. The indicator light in the switch lights up.

Depending on the vehicle, the function is stopped:

- automatically after 12 minutes of operation;
- by pressing button **3** again.

The integrated indicator light goes off.

FUEL TANK (1/5)

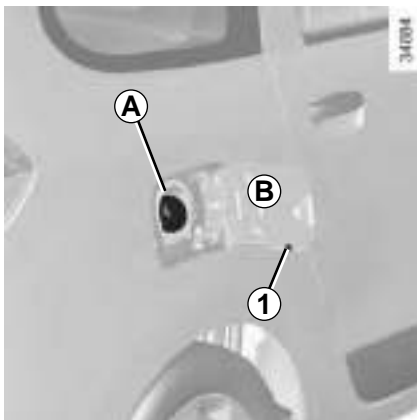

Petrol and diesel versions

Capacity of the fuel tank: 50 litres approximately.

The cap **A** can be unlocked with the ignition key.

For details on filling the fuel tank, refer to the information on “Filling with fuel”.

There is a cap holder **1** on the fuel filler flap for holding the cap when the tank is being filled.



Do not wash the filler area with a high-pressure washer.



Do not mix even small amounts of petrol (unleaded or E85) with diesel.

Do not use ethanol-based

fuel if your vehicle is not compatible with this fuel.

Do not add any additives to the fuel, you risk damaging the engine.



Fuel filler cap: this is specific to the vehicle type. If

you have to replace it, make

sure the new cap is of the

same type. Contact an approved

dealer.

Never place the cap near a source of heat or flame.

Do not wash the filler area with a high-pressure washer.

Fuel grade

Use a high-grade fuel that complies with the legislation in force in each country. It must conform to the specifications given on label **B** inside the fuel filler flap.

Refer to the “Engine specifications” table in Section 6.

Vehicles running on ethanol-based fuel

Always use unleaded petrol or fuel containing a maximum of 85 percent ethanol (E85).

In very cold conditions it may be difficult or even impossible to start the engine. To avoid this problem, use unleaded petrol.

Note: you may notice an increase in fuel consumption with this type of fuel.

When the fuel is changed the engine must adjust, which may cause minor inconveniences for a few minutes (longer starting times, cutting out, etc.).

FUEL TANK (2/5)

Petrol version

It is **essential** to use unleaded petrol. The octane rating (RON) should match the information given on the label **B** located inside the fuel filler flap.

Diesel versions

It is **essential** to use diesel fuel that conforms to the specifications given on the label inside fuel flap **B**.

Filling with fuel

With the ignition off, insert the nozzle to open the valve and insert it **fully** before turning it on to fill the fuel tank (risk of splashing).

Keep the nozzle in this position throughout the entire filling operation. When the pump cuts out automatically at the end of the filling procedure, a maximum of two further filling attempts may be made, as there must be sufficient space in the fuel tank to allow for expansion.

Make sure that no water enters the fuel tank during filling. The valve and its surround must remain clean.

Petrol versions

Using leaded petrol will damage the antipollution system and may lead to a loss of warranty.

To ensure that the fuel tank is not filled with leaded petrol, the fuel tank filler neck contains a restrictor fitted with a foolproof system which **only allows the nozzle for unleaded petrol to be used** (at the pump).



Persistent fuel odour

If you notice a persistent fuel odour you should:

- stop the vehicle as soon as traffic conditions allow and switch off the ignition;
- switch on the hazard warning lights and ask your passengers to leave the vehicle and stay clear of the traffic;
- contact an approved Dealer.

FUEL TANK (3/5)

LPG versions

Useful capacity of fuel tank: approx. 32 litres.

Filling up with LPG

Engage the handbrake, stop the engine, switch off the ignition and switch off the lights.

Always respect the safety instructions given at filling stations.

When filling the tank, add the desired quantity of LPG.

When the pump stops delivering LPG, or when the pump flow reduces significantly, the maximum LPG level has been reached.

At this point, do not attempt to carry on filling.



38115

Filling stations without self-service

If service station staff fill your vehicle with LPG, give them a filling adapter **2**, as supplied in a pouch in the glovebox.

IMPORTANT:

The adapter **2** depends on the country in which the vehicle is sold.

Before travelling to another country, please consult an authorised dealer.

FUEL TANK (4/5)

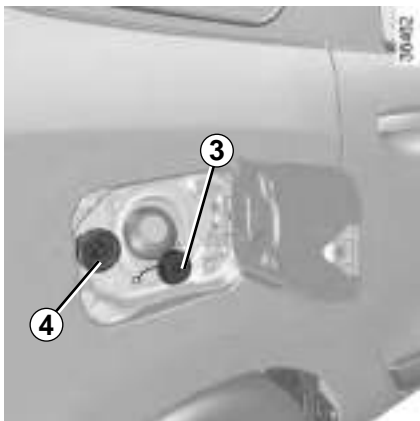

Filling stations with self-service

We recommend that you wear gloves when handling the LPG pistol.

Open your vehicle's tank cover and unscrew the cap **3** from the end piece of the LPG filler **4**.

Carefully follow the information explaining how to refill using the LPG distributor.

When the pump finishes or if it has difficulties operating, this means that the maximum tank fill level (80%) has been reached.

The filling will stop as soon as you release the button. Release the stop lever (a small amount of gas may be released), lift the pistol and place it on the distributor.

Replace the cap **3** to avoid any water or foreign bodies from entering the system.

FUEL TANK (5/5)

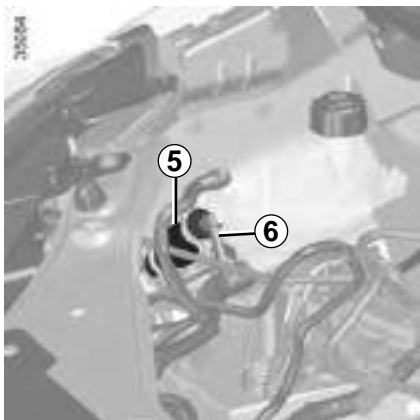

Running out of fuel on diesel versions

Vehicles with priming pump 5

After a breakdown caused by completely running out of fuel, the system must be reprimed before the engine is restarted:

Operate priming bulb **5** until the fuel flows through the hose **6**.

If the engine does not start after several attempts, contact an approved dealer.

Vehicles without manual priming pump

Put the ignition key in "Ignition On" (M) position and wait a few minutes before starting. This will enable the fuel circuit to be primed. If the engine does not start, repeat the procedure.



No modifications whatsoever are permitted on any part of the fuel supply system (computers, wiring, fuel circuit, injector, protection covers, etc.) as this may be dangerous (such work must be undertaken by qualified Network personnel).



The engine may be hot when working in close proximity. In addition, the engine cooling fan may come on at any moment.
Risk of injury.

Section 2: Driving

(Advice on use relating to fuel economy and the environment)

Running in, Ignition switch.	2.2
Starting, stopping the engine.	2.3
Special features of petrol versions	2.4
Special features of diesel versions	2.5
Special features of LPG versions	2.6
Driving advice, Eco-driving	2.9
Maintenance and antipollution advice	2.13
Environment	2.14
Tyre pressure loss warning	2.15
Gear lever	2.18
Handbrake	2.19
Power-assisted steering	2.19
Driver correction devices and aids	2.20
Speed limiter	2.23
Cruise control	2.26
Parking distance control	2.30

RUNNING IN, IGNITION SWITCH

Petrol version

For the first **600 miles (1,000 km)**, do not exceed 78 mph (130 km/h) in the highest gear, or 3,000 to 3,500 rpm.

You may only expect top performance from your vehicle after approximately **1,800 miles (3,000 km)**.

Oil change frequency: please refer to your vehicle's maintenance document.

Diesel version

For the first **1,000 miles (1,500 km)**, do not exceed 80 mph (130 km/h) in the highest gear, or 2,500 rpm. After completing this mileage you may drive faster, although you may only expect top performance after approximately 3,600 miles (6,000 km).

During the running in period, do not accelerate hard while the engine is still cold and do not let the engine over-rev.

Service intervals: refer to the Maintenance Document for your vehicle.



Stop and steering lock position St

To lock: remove the key and turn the steering wheel until the steering column locks.

To unlock: turn the key and the steering wheel slightly.

Accessories position A

When the ignition is switched off, any accessories (radio, etc.) will continue to function.

Ignition on position M

The ignition is switched on:

- **petrol version:** the engine may be started.
- **diesel version:** the engine is pre-heating.

Start position D

If the engine fails to start at the first attempt, turn the key back before activating the starter again.

Release the key as soon as the engine starts.

STARTING/STOPPING THE ENGINE

Starting the engine

In very cold conditions (temperatures below -20°C): so that it is easier to start the engine, switch on the ignition for several seconds **before** starting the engine.

When starting the engine, if the outdoor temperature is very low (below -10°C): hold down the clutch pedal until the engine starts.

Petrol injection

- Activate the starter **without depressing the accelerator**.
- Release the key as soon as the engine starts.



Diesel injection

Turn the ignition key to ignition “On” position **M**, and hold this position until the preheating warning light goes out.

Move the key to “Start” position **D** without accelerating. Release the key as soon as the engine starts.

LPG versions

The engine is always started using petrol:

- activate the starter without accelerating;
- release the key as soon as the engine starts.

The system will automatically determine the switchover from petrol to LPG.

When operating on LPG, the fuel gauge may indicate a drop in the petrol level and the on-board computer will not operate.

Every 3,000 miles driven using LPG, drivers are recommended to drive for around 3 to 6 miles in petrol mode.

To enable the system to operate smoothly and to prevent any wear to the vehicle’s electric petrol pump, the petrol tank should always be around 1/4 full.

Stopping the engine

With the engine idling, turn the key back to “Stop” position **St**.

Special note

Depending on the vehicle, accessories (e.g. radio) stop working either when the engine is switched off or when the doors are locked, or when the driver’s door is opened.



Never leave your vehicle with the key or remote control inside and never leave a child (or a pet) unsupervised, even for a short while.

The reason for this is that the child may endanger himself or others by starting the engine, activating equipment such as the window winders for example, or locking the doors.

Risk of serious injury.

Never switch off the ignition before the vehicle has stopped completely. Once the engine has stopped, the brake servo, power assisted steering and passive safety equipment such as air bags will no longer operate.

The steering is locked when the key is removed.

SPECIAL FEATURES OF PETROL VERSIONS

The following operating conditions should be avoided:

- driving for long periods when the low fuel level warning light is lit;
- using leaded petrol;
- using fuel or lubrication additives which are not approved.

Or operating faults such as:

- faulty ignition, running out of fuel or disconnected spark plugs resulting in the engine misfiring or cutting out when driving;
- loss of power,

may cause the catalytic converter to overheat, reducing its efficiency **which may irreparably damage it and cause heat damage to the vehicle.**

If you notice any of the above operating faults, have the necessary repairs carried out as soon as possible by an approved dealer.

These faults may be avoided by regularly taking your vehicle to an approved Dealer at the intervals specified in the Maintenance Document.

Starting problems

To avoid damaging the catalytic converter, **do not keep** trying to start the engine (using the start button, or by pushing or towing the vehicle) **without having identified and corrected the cause of the fault.**

If the fault cannot be identified, do not continue to try and start the engine, but contact an approved dealer.



Do not park the vehicle or run the engine in locations where combustible substances or materials such as grass or leaves can come into contact with the hot exhaust system.

SPECIAL FEATURES OF DIESEL VERSIONS

Diesel engine speed

Diesel engines are fitted with an injection pump **which prevents the engine speed being exceeded** irrespective of the gear selected.

When driving, depending on the fuel grade used, it is possible that white smoke may be emitted.

This is due to the exhaust particle filter being cleaned automatically, and does not affect the way the vehicle runs.

Running out of fuel

If the tank has been **completely drained**, the system must be reprimed after the tank is refilled: see information on the “Fuel tank” in section 1 before restarting the engine.

Precautions to be taken in winter

To avoid any faults in icy weather:

- ensure that the battery is always fully charged,
- always keep the diesel tank relatively full to avoid water vapour condensing in it and accumulating at the bottom of the tank.



Do not park the vehicle or run the engine in locations where combustible substances or materials such as grass or leaves can come into contact with a hot exhaust system.

SPECIAL FEATURES OF LPG VERSIONS (1/3)

LPG vehicles

These vehicles operate using petrol or LPG.
They have two separate tanks.

What is LPG?

LPG stands for Liquefied Petroleum Gas.
It can be readily identified by its characteristic smell.



An LPG installation on a vehicle may lead to changes to the vehicle's features, compared to petrol versions. This may relate to the number of seats, mass (usable capacity) and towing capacity.

Contact an authorised dealer.

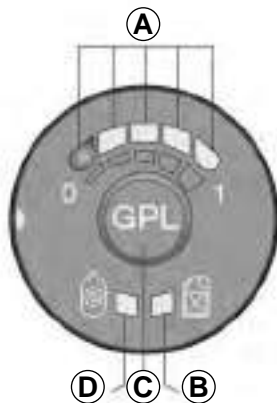

LPG/petrol fuel mode selection control C

This enables the driver to switch from one fuel to another.

Green warning light D

A lit warning light indicates that LPG mode is selected,

Yellow warning light B

A lit warning light indicates that petrol mode is selected.

Fuel gauge warning light A

Warning lights A (4 green lights and 1 red light) indicate the level in the LPG tank (1 light = approximately 1/5).

The red warning light indicates the fuel tank.

The amount of LPG indicated is an indicative value.

The red warning light indicates that the tank is almost empty and that the engine is operating using the fuel tank (approximately 11 to 13 litres).



If the yellow warning light is on while the green warning light flashes slowly and a beep is heard, please take your vehicle to an authorised dealer for inspection.

SPECIAL FEATURES OF LPG VERSIONS (2/3)

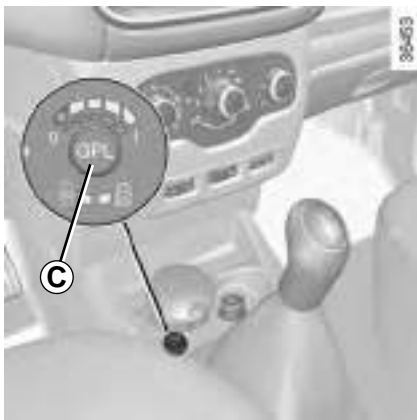

Changing fuel while driving

You are recommended to use the fuel mode selection control **C** once the vehicle is started.

To switch from petrol to LPG

Press control **C**. The vehicle will switch to LPG the next time the accelerator pedal is pressed.

The LPG fuel level **A** is activated. The yellow warning light **B** goes out and the green warning light **D** flashes quickly, then stops flashing to confirm that LPG has been selected.



To switch from LPG to petrol.

Release the accelerator pedal and press the control **C**.

Petrol mode is indicated by the yellow warning light **B**.

Automatic switch to petrol

The system automatically switches to petrol mode if there is no more LPG remaining in the tank. You will be informed by:

- the green **D** and yellow **B** warning lights coming on;
- a beep sounds.

Pressing control **C** stops the beep from sounding and only the yellow warning light **B** stays on.

Operating fault

In the event of a fault which may affect the correct operation of the engine, the system automatically switches from LPG to petrol mode.

This is confirmed by:

- the appearance of the yellow warning light **B**;
- slow flashing of the green warning light **D**;
- a beep sounds.



If the yellow warning light is on while the green warning light flashes slowly and a beep is heard, please take your vehicle to an authorised dealer for inspection.

SPECIAL FEATURES OF LPG VERSIONS (3/3)

If driving under severe conditions

If driving under severe conditions (heavily laden vehicle, high outside temperature, starting on a steep slope, etc), you are recommended to switch to petrol mode.

In the event of an accident

The main precautions to be taken are the same as with petrol vehicles:

- apply the handbrake;
- stop the engine (a safety device that stops **LPG** from entering the engine is automatically triggered);
- switch off the ignition;
- observe local regulations.



LPG has a very specific smell so you will be able to detect any leaks easily. If you smell gas in your vehicle or immediately surrounding your vehicle:

- switch to petrol mode immediately and make sure there are no flames or sources of fire near the vehicle;
- go to an authorised dealer.



Do not touch, hit or dismantle any part of the LPG system components.

DRIVING ADVICE, ECO-DRIVING (1/4)

Fuel consumption is accredited in accordance with a standard regulatory method. Identical for all manufacturers, this enables vehicles to be compared with one another. Consumption in real time depends on vehicle usage conditions, the equipment fitted and the user's driving style. To optimise fuel consumption, please refer to the following advice.

Depending on the vehicle, you will have various functions which enable you to lower your fuel consumption:

- the rev counter;
- gear change indicator;
- **ECO** mode activated by button **ECO**.

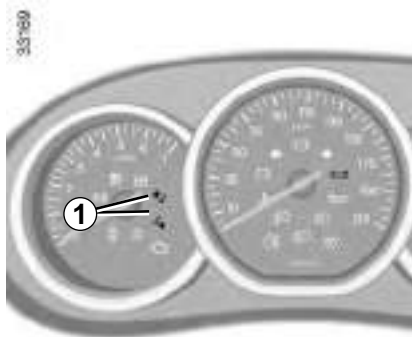

Gear change indicator 1

Depending on the vehicle, to obtain optimum consumption levels, a warning light on the instrument panel lets you know the best time to move up or down a gear:



move up a gear;



move down a gear.

DRIVING ADVICE, ECO-DRIVING (2/4)

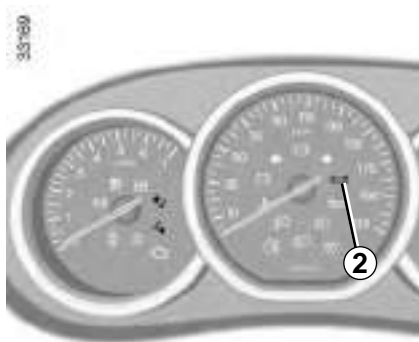

ECO mode

ECO mode is a function which optimises fuel consumption. Depending on the vehicle, this acts on certain consumption elements, such as the engine.

Activating the function

Press switch **3**.

The **2 ECO** warning light comes on on the instrument panel to confirm activation.



While driving, it is possible to leave the **ECO** mode temporarily in order to improve engine performance.

To do this, press the accelerator pedal firmly and fully.

ECO mode is reactivated when you take pressure off the accelerator pedal.

Disabling the function

Press switch **3**.

The **2 ECO** light goes out on the instrument panel to confirm deactivation.

DRIVING ADVICE, ECO-DRIVING (3/4)



Driving advice, Eco-driving

Behaviour

- Drive carefully for the first few miles until the engine reaches its normal operating temperature, rather than let it warm up while the vehicle is stationary.
- Speed is expensive.
- Sporty driving uses a lot of fuel: drive with a light right foot.
- Do not overrev the engine in the intermediate gears.
You should always use the highest gear possible.

- Avoid sudden acceleration.
- Brake as little as possible. If you anticipate an obstacle or bend in advance, you may then simply release the accelerator pedal.
- Do not try to maintain the same speed up a hill, accelerate no more than you would on the level. Keep your foot in the same position on the accelerator pedal.
- Double declutching and accelerating before switching off are unnecessary in modern vehicles.
- Bad weather, flooded roads:



Do not drive through floods if the water is above the lower edge of the wheel rims.



Obstructions to the driver

On the driver's side, only use mats suitable for the vehicle, attached with the pre-fitted components, and check the fitting regularly. Do not lay one mat on top of another.

There is a risk of wedging the pedals

DRIVING ADVICE, ECO-DRIVING (4/4)

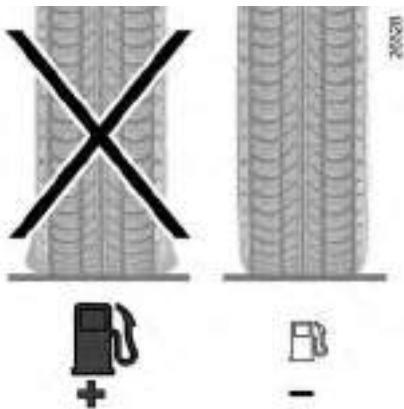

Tyres

- An underinflated tyre increases fuel consumption.
- The use of non-recommended tyres can increase fuel consumption.



Advice on use

- Favour ECO mode.
- Electricity is fuel; switch off all the electrical components which are not really needed. **However** (safety first), keep your lights on when the visibility is bad ("see and be seen").
- Use the air vents. Driving with the windows open at 60 mph (100 km/h) will increase fuel consumption by 4%.
- Never fill the fuel tank right to the brim to avoid overflow.

- In vehicles fitted with air conditioning, it is normal to observe an increase in fuel consumption (especially in urban conditions) when it is used. For vehicles fitted with manual air conditioning, switch off the system when it is not required.

Advice for reducing consumption and therefore helping to preserve the environment:

If the vehicle has been parked in the sun, open the doors for a few moments to let the hot air escape before starting the engine.

- Do not leave an empty roof rack fitted to the vehicle.
- It is better to fit a trailer for bulky objects.
- When towing a caravan, fit a wind deflector and adjust it carefully.
- Avoid using the car for door-to-door calls (short journeys with long waits in between) because the engine never reaches its normal operating temperature.

MAINTENANCE AND ANTIPOLLUTION ADVICE

Your vehicle complies with criteria for recycling and recovering vehicles at the end of their service life which will come into force in 2015.

Some parts of your vehicle have therefore been designed to facilitate future recycling.

These parts are easy to remove so that they can be recovered and reprocessed by recycling companies.

By virtue of its design, moderate fuel consumption and initial settings, your vehicle also conforms to current antipollution regulations. The manufacturer is actively striving to reduce pollutant exhaust gas emissions and to save energy. But the fuel consumption of your vehicle and the level of pollutant exhaust gas emissions are also your responsibility. Ensure that it is maintained and used correctly.

Maintenance

It is important to remember that failure to respect antipollution regulations could lead to legal action being taken against the vehicle owner.

In addition, replacing engine, fuel supply system and exhaust components with parts other than those originally recommended by the manufacturer may alter your vehicle so that it no longer complies with antipollution regulations.

Have your vehicle adjusted and checked by an approved Dealer, in accordance with the instructions given in your maintenance schedule: they will have all the equipment necessary for ensuring that your vehicle is maintained to its original standard.

Engine adjustments

– **Spark plugs:** for optimum conditions of use, output and performance the specifications laid down by our Design Department must be strictly applied.

If the spark plugs have to be changed, use the make, type and gap specified for your vehicle's engine. Contact an authorised dealer for this.

- **Air filter:** a choked element will reduce efficiency. It must be replaced.
- **Ignition and idle speed:** no adjustment is needed.

Exhaust gas monitoring system

The exhaust gas monitoring system will detect any operating faults in the vehicle's antipollution system.

If this system malfunctions, toxic substances may be released into the atmosphere or damage may occur.



This warning light on the instrument panel will indicate if there are any faults in the system:

This lights up when the ignition is switched on and goes out when the engine is started.

- If it lights up continuously, consult an approved Dealer as soon as possible;
- if it flashes, reduce the engine speed until the light stops flashing. Contact your approved dealer as soon as possible.

ENVIRONMENT

Your vehicle has been designed with respect for the **environment** in mind for its entire service life: during production, use and at the end of its life.

This commitment is illustrated by the of the manufacturer eco² signature.

Manufacture

Your vehicle has been manufactured at a factory which complies with a policy to reduce the environmental impact on the surrounding areas (reduction of water and energy consumption, visual and noise pollution, atmospheric emissions and waste water; sorting and re-using waste).

Emissions

Your vehicle has been designed to emit fewer greenhouse gases (CO₂) while in use, and therefore to consume less fuel (eg. 140 g/km, equivalent to 5.3 l/100 km for a diesel vehicle).

Our vehicles are also equipped with a particle filter system including a catalytic converter, an oxygen sensor and an active carbon filter (the latter prevents vapour from the fuel tank being released into the open air).

For certain diesel vehicles, this system also has a particle filter to reduce the volume of soot particles emitted.

Please make your own contribution towards protecting the environment too

- Worn parts replaced in the course of routine vehicle maintenance (vehicle battery, oil filter, air filter, batteries, etc.) and oil containers (empty or filled with used oil) must be disposed of through specialist organisations.

- At the end of the vehicle's service life, it should be sent to approved centres to ensure that it is recycled.
- In all cases, comply with local legislation.

Recycling

Your vehicle is 85% recyclable and 95% recoverable.

To achieve these objectives, many of the vehicle components have been designed to enable them to be recycled. The materials and structures have been carefully designed to allow these components to be easily removed and reprocessed by specialist companies.

In order to preserve raw material resources, this vehicle incorporates numerous parts made from recycled plastics or renewable materials (vegetable or animal-derived materials such as cotton or wool).

TYRE PRESSURE LOSS WARNING (1/3)

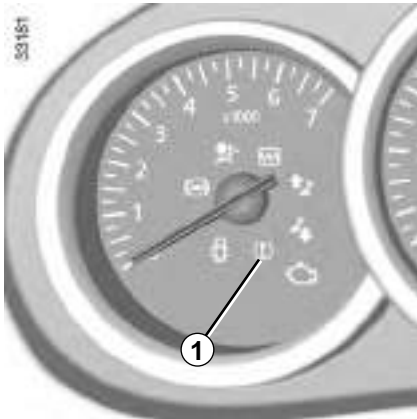

If fitted on the vehicle, while driving, this system notifies the driver if one or more tyres lose pressure.

Operating principle

Each wheel (except for the emergency spare wheel) has a sensor in the inflation valve which periodically measures the tyre pressure while driving.

Warning light  1 comes on to notify the driver if the pressure is too low.

Resetting the standard level for the tyre pressures

This should be done:

- when the standard tyre pressure needs to be changed to adapt to usage conditions (empty, carrying a load, motorway driving, etc.);
- after changing a wheel.

It should always be done after checking the tyre pressure of all four tyres when cold.

Tyre pressures must correspond to the current usage of the vehicle (empty, carrying a load, motorway driving, etc.).



This function is an additional driving aid.

However, the function does not take the place of the driver. It cannot, therefore, under any circumstances replace the vigilance or the responsibility of the driver.

Check the tyre pressures, including the emergency spare wheel, once a month.

TYRE PRESSURE LOSS WARNING (2/3)



With the engine stopped:

- repeatedly press the button **3** to select “SEt tP” on the display **2**;
- press and hold (around 3 seconds) button **3** to start initialisation. “SEt tP” flashes then comes on steady. When “SEt tP” disappears, the standard tyre pressure is saved.

Reinitialisation is carried out after a few minutes' driving.

Note:

The standard tyre pressure cannot be less than that recommended and indicated on the door frame.

Display

Display **2** on the instrument panel informs you of any tyre pressure faults (flat tyre, punctured tyre, etc.).

Check tyre pressure

The warning light  comes on (not flashing). This indicates that at least one tyre is flat.

Check and, if necessary, readjust the pressures of the four wheels when cold.

The warning light  goes off after a few minutes' driving.

The sudden loss of pressure in a tyre (burst tyre, etc.) cannot be detected by the system.

Puncture

The warning light  and the red warning light  light up on the instrument panel, alongside a beep.



This indicates that at least one wheel is punctured or severely underinflated. Replace it or contact an authorised dealer if it is punctured. Top up the tyre pressure if the wheel is deflated.



The red warning light  requires you to stop immediately, for your own safety, as soon as traffic conditions allow.

TYRE PRESSURE LOSS WARNING (3/3)

Check tyre sensors

The warning light  flashes for several seconds, then stays on, along with the orange warning light . This indicates that the sensor on at least one wheel is missing or faulty.

Readjustment of tyre pressures

The tyre pressures must be adjusted when cold (please refer to the label located on the edge of the driver's door). If tyre pressures cannot be checked when the tyres are **cold**, the recommended pressures must be increased by **0.2** to **0.3** bar (3 PSI).



Never deflate a hot tyre.

Replacing wheels/tyres

This system requires specific equipment (wheels, tyres, hubcaps, etc.). Contact an approved Dealer to fit new tyres and to find out about available accessories compatible with the system and available from your dealer network: the use of any other accessory could affect the correct operation of the system or damage a sensor.

Emergency spare wheel

If the vehicle is equipped with an emergency spare wheel, it will not have a sensor.

When fitted to the vehicle, the warning light  and the orange warning light  are displayed on the instrument panel.

Inflation kit

Because the valves are specially designed, only use equipment approved by the approved network.

GEAR LEVER



Selecting reverse gear (vehicle stationary)

Follow the grid marked on knob **1** and, depending on the vehicle, lift the ring against the knob to engage reverse gear.

The reversing lights will come on as soon as reverse gear is selected with the ignition on.



An impact to the underside of the vehicle while manoeuvring (e.g.: striking a post, raised kerb or other street furniture) may result in damage to the vehicle (e.g.: deformation of an axle).

To prevent any risk of accident, have your vehicle checked by an approved dealer.

HANDBRAKE/POWER-ASSISTED STEERING



Handbrake

To release

Pull lever **1** up slightly, press button **2** and then lower the lever to the floor.

The red warning light on the instrument panel will come on if you are driving with an incorrectly released handbrake.



Make sure that the handbrake is properly released when driving (red indicator light off), otherwise overheating, or even damage, may occur.

To apply

Pull lever **1** upwards and make sure the vehicle is immobilised.



Depending on the gradient and/or vehicle load, it may be necessary when stationary to apply the brake by at least a further two notches and engage a gear (1st or reverse gear).

Power-assisted steering

With the engine running, do not leave the steering wheel at full lock while stationary as this may damage the power-assisted steering pump.

With the engine switched off, or if there is a system fault, it is still possible to turn the steering wheel. The force required will be greater.



Never switch off the ignition when travelling downhill, and avoid doing so in normal driving (assistance is not provided).

DRIVER CORRECTION DEVICES/AIDS (1/3)

Depending on the vehicle, this is composed of:

- of the **ABS (anti-lock braking system)**;
- of the **electronic stability control ESC with understeer control and traction control ASR**;
- **emergency brake assist with, depending on the vehicle, braking anticipation**;



These functions are an additional aid in the event of critical driving conditions, enabling the vehicle behaviour to be adapted to suit the driving conditions.

However, the functions do not take the place of the driver. **They do not increase the vehicle's limits and should not encourage you to drive more quickly.** Therefore, they can under no circumstances replace the vigilance or responsibility of the driver when manoeuvring the vehicle (the driver must always be ready for sudden incidents which may occur when driving).

ABS (anti-lock braking system)



Under heavy braking, the ABS prevents the wheels from locking, allowing the stopping distance to be managed and keeping control of the vehicle.

Under these circumstances, the vehicle can be steered to avoid an obstacle whilst braking. In addition, this system can increase stopping distances, particularly on roads with low surface grip (wet ground etc.).

You will feel a pulsation through the brake pedal each time the system is activated. The ABS does not in any way improve the vehicle's physical performance relating to the road surface and road-holding. It is still **essential** to follow the rules of good driving practice (such as driving at a safe distance from the vehicle in front, etc.).

In an emergency, apply **firm and continuous pressure** to the brake pedal. There is no need to pump it repeatedly. The ABS will modulate the force applied in the braking system.

Operating faults:

- If the  warning light on the instrument panel comes on while driving, **braking is still operational**;
- If the  and  warning lights on the instrument panel come on when driving, **this indicates a fault with the braking system.**

In this case, ABS, ESC and emergency braking assist are also deactivated.

Consult an approved dealer.



Your braking systems are partially operational. However, it is **dangerous to brake suddenly** and it is essential to stop immediately, as soon as traffic conditions allow. Contact an approved dealer.

DRIVER CORRECTION DEVICES/AIDS (2/3)

Electronic stability control ESC with understeer control and traction control ASR

Electronic stability control ESC

This system helps you to keep control of the vehicle in critical driving conditions (avoiding an obstacle, loss of grip on a bend, etc.).

Operating principle

A sensor in the steering wheel detects the direction selected by the driver.

Other sensors throughout the vehicle measure the actual direction.

The system compares driver input to the actual trajectory of the vehicle and corrects the trajectory if necessary by controlling the braking of certain wheels and/or engine power. In the event that the system is engaged, indicator light



flashes on the instrument panel.

Understeer control

This system optimises the action of the ESC in the case of pronounced understeering (loss of front axle road holding).

Traction control ASR



This system helps to limit wheelspin of the drive wheels and to control the vehicle when pulling away accelerating or decelerating.

Operating principle

Using the wheel sensors, the system measures and compares the speed of the drive wheels at all times and slows down their over-rotation. If a wheel is starting to slip, the system brakes automatically until the drive supplied becomes compatible with the level of grip under the wheel again.

The system also adjusts the engine speed to the grip available under the wheels, independently of the pressure exerted on the accelerator pedal.

Operating faults

When the system detects an operating fault, the  and/or  warning lights on the instrument panel come on. In this case, the ESC and ASR are deactivated.

Consult an approved dealer.

DRIVER CORRECTION DEVICES/AIDS (3/3)



Disabling the function ASR

In some situations (driving on very wet ground: snow, mud, etc. or driving with snow chains fitted), the system may reduce the engine output to limit wheel-spin. If this is not required, it is possible to deactivate the function by pressing switch **1**. In this case, the warning light



comes on, on the instrument panel. This action does not deactivate the ESC.

The traction control ASR offers additional safety, it is recommended that you do not drive with the function disabled. Correct this as soon as possible by pressing switch **1** again.

Note: The function is reactivated automatically when the ignition is switched on or when a speed of approximately 30 mph (50 km/h) is exceeded.

Emergency brake assist

This is an additional system to ABS which helps reduce vehicle stopping distances.

Operating principle

The system detects an emergency braking situation. In this case, the braking assistance immediately develops maximum power and may trigger ABS regulation.

ABS braking is maintained as long as the brake pedal is not released.

Hazard warning lights switching on
Depending on the vehicle, these may light up in the event of sudden deceleration.

Operating faults

When the system detects an operating fault, the warning light  is displayed on the instrument panel.

Consult an approved dealer.

Braking anticipation

Depending on the vehicle, when you rapidly release the accelerator, the system anticipates the braking manoeuvre in order to reduce stopping distances.

CRUISE CONTROL/SPEED LIMITER: speed limiter function (1/3)



The speed limiter function helps you stay within the driving speed limit that you choose, known as the **limit speed**.



Controls

- 1 Main "On/Off" switch.
- 2 Limit speed activation, storage and increase switch (+).
- 3 Decreasing the limit speed (-).
- 4 Activation and recall of memorised limit speed (R).
- 5 Speed limiter function standby (with limited speed memory) (O).



Switching on

Press the side switch **1** . Indicator light **6** comes on, lit orange, and the message "LIMIT" appears on the instrument panel, accompanied by dashes to indicate that the speed limiter function is activated and waiting to store a limited speed.

To store the current speed, press switch **2** (+): the limit speed will replace the dashes.

The minimum stored speed is 20 mph (30 km/h).

CRUISE CONTROL/SPEED LIMITER: speed limiter function (2/3)



Driving

When a limited speed has been stored and this speed is not reached, driving is similar to driving a vehicle without the speed limiter function.

Once you have reached the stored speed, no effort on the accelerator pedal will allow you to exceed the programmed speed except in an emergency (refer to information on “Exceeding the limit speed”).

Varying the limit speed

The limit speed may be changed by repeatedly pressing:

- switch **2** (+) to increase speed;
- switch **3** (-) to reduce speed.

Exceeding the limit speed

It is possible to exceed the limit speed at any time. To do this: press the accelerator pedal **firmly and fully** (beyond the resistance point).

While the speed is being exceeded, the programmed speed displayed on the instrument panel flashes.

Then, release the accelerator: the speed limiter function will return as soon as you reach a speed lower than the stored speed.

Limited speed cannot be maintained

If driving up or down a steep gradient, the system is unable to maintain the limit speed: the stored speed will flash on the instrument panel information display to inform you of this situation.



The speed limiter function is in no way linked to the braking system.

CRUISE CONTROL/SPEED LIMITER: speed limiter function (3/3)



Putting the function on standby

The speed limiter function is suspended when you press switch **5** (O). In this case, the limit speed remains stored and the message "MEM" accompanied by this speed appears on the instrument panel.

Recalling the limit speed

If a speed has been saved, it can be recalled by pressing switch **4** ((R)).

When the speed limiter is put on standby, pressing switch **2** (+) reactivates the function without taking into account the stored speed: it is the speed at which the vehicle is moving that is taken into account.



Switching off the function

The speed limiter function is deactivated if you press switch **1**: in this case a speed is no longer stored. The orange instrument panel warning light  goes out, confirming that the function is stopped.

CRUISE CONTROL/SPEED LIMITER: cruise control function (1/4)



The cruise control function helps you to maintain your driving speed at a speed that you choose, called the **cruising speed**.

This cruising speed may be set at any speed above 20 mph (30 km/h).



The cruise control function is in no way linked to the braking system.



This function is an additional driving aid. However, the function does not take the place of the driver.

Therefore, it can under no circumstances replace the driver's responsibility to respect speed limits and to be vigilant (the driver must always be ready to brake).

Cruise control must not be used in heavy traffic, on undulating or slippery roads (black ice, aquaplaning, gravel) and during bad weather (fog, rain, side winds etc.).

There is a risk of accidents.



Controls

- 1 Main "On/Off" switch.
- 2 Cruising speed activation, storage and increase switch (+).
- 3 Decreasing cruising speed (-).
- 4 Activation with recall of saved cruising speed (R).
- 5 Switch the function to standby (with cruising speed saved) (O).

CRUISE CONTROL/SPEED LIMITER: cruise control function (2/4)



Switching on

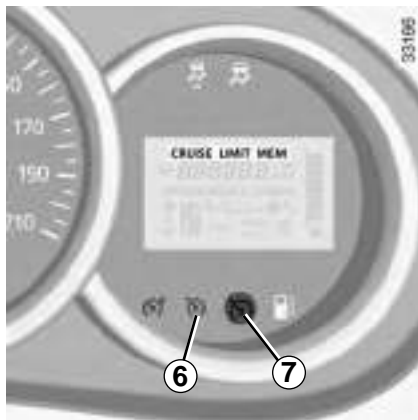

Press switch 1 side .

The warning light 6 comes on, lit green, and the message "CRUISE" appears on the instrument panel, accompanied by dashes to indicate that the cruise control function is activated and waiting to store a cruising speed.



Activating cruise control

At a steady speed (above 18 mph (30 km/h approximately)) press switch 2 or (+): the function is activated and the current speed is saved.

The cruising speed replaces the dashes and the cruise control is confirmed by the appearance of the message "CRUISE" and the warning light 6  being lit green, as well as the warning light 7 .



Driving

Once a cruising speed is stored and the cruise control function is active, you may lift your foot off the accelerator pedal.



Important: you are nevertheless advised to keep your feet close to the pedals in order to react if necessary.

CRUISE CONTROL/SPEED LIMITER: cruise control function (3/4)



Adjusting the cruising speed

The cruising speed may be changed by pressing the following repeatedly:

- switch **2** (+) to increase the speed,
- switch **3** (-) to decrease the speed.



The cruise control function is in no way linked to the braking system.

Exceeding the cruising speed

The cruising speed may be exceeded at any time by depressing the accelerator pedal. While it is being exceeded, the cruising speed flashes on the instrument panel.

Then, release the accelerator: after a few seconds, the vehicle will automatically return to its set cruising speed.

Cruising speed cannot be maintained

When driving down a steep gradient, the system is unable to maintain the cruising speed: the stored speed will flash on the instrument panel information display to inform you of this situation.

CRUISE CONTROL/SPEED LIMITER: cruise control function (4/4)



Putting the function on standby

The function is set to standby if you:

- use the switch **5** (O);
- the brake pedal;
- the clutch pedal;

In all three cases, the cruising speed remains stored and the message “MEM” appears on the instrument panel. Standby is confirmed by warning light  going out.

Returning to the cruising speed

If a speed is stored, it can be recalled, once you are sure that the road conditions are suitable (traffic, road surface, weather conditions, etc.). Press switch **4** (R) if the vehicle speed is above 20 mph (30 km/h).



When the stored speed is recalled, activation of the cruise control is confirmed by the illumination of the  warning light.

NB: if the speed previously stored is much higher than the current speed, the vehicle will accelerate more rapidly to reach this threshold.

When the cruise control function is put on standby, pressing switch **2** (+) reactivates the cruise control function without taking into account the stored speed: it is the speed at which the vehicle is moving that is taken into account.



Switching off the function

The cruise control function is deactivated if you press switch **1**: in this case a speed is no longer stored. The two instrument panel warning lights  and  go out to confirm that the function is deactivated.



Putting the cruise control on standby or switching it off does not cause a rapid reduction in speed: you must brake by depressing the brake pedal.

PARKING DISTANCE CONTROL (1/2)

Operating principle

Ultrasonic sensors, fitted in the vehicle's rear bumper, measure the distance between the vehicle and an obstacle when reversing.

This measurement is indicated by beeps which become more frequent the closer you come to the obstacle, until they become a continuous beep when the vehicle is approximately 40 centimetres from the obstacle.

There is a beep when reverse gear is engaged. If the beep sounds for a long time (3 seconds), this signals an operating fault.

NB: ensure that the ultrasonic sensors are not obscured (by dirt, mud, snow, etc.).



An impact to the underside of the vehicle while manoeuvring (e.g.: striking a post, raised kerb or other street furniture) may result in damage to the vehicle (e.g.: deformation of an axle).

To avoid any risk of accident, have your vehicle checked by an approved dealer.



This function is an additional aid that indicates the distance between the vehicle and an obstacle whilst reversing, using sound signals.

Under no circumstances should it replace the driver's care or responsibility whilst reversing.

The driver should always look out for sudden hazards during driving: always ensure that there are no moving obstacles (such as a child, animal, pram, bicycle, etc.) or small, narrow objects such as stones or posts in your path when manoeuvring.

PARKING DISTANCE CONTROL (2/2)

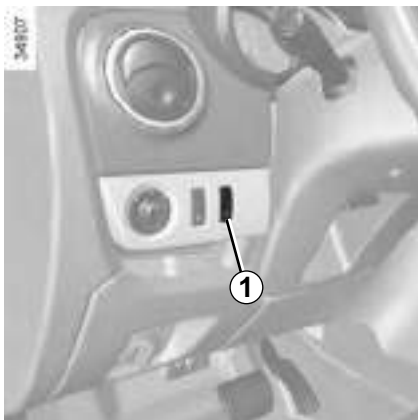

Deactivating the system

You can deactivate the system by pressing switch **1**.

The warning light built into the switch remains lit constantly.

The deactivated system can be reactivated by pressing the switch again.

Operating faults

When the system detects an operating fault, there will be a three-second continuous beep as a warning. Please consult an authorised dealer.

Section 3: Your comfort

Air vents, air outlets	3.2
Heating, Ventilation, Air conditioning	3.4
Air conditioning: information and advice on use	3.7
Electric windows	3.8
Interior lighting	3.10
Sun visor, Grab handle	3.11
Passenger compartment storage space and fittings	3.12
Ashtrays, Cigarette lighter, Accessories socket	3.16
Rear headrests	3.17
Rear seats:	3.19
second row	3.19
third row	3.22
grouping of seats	3.25
Boot	3.28
Boot storage space and fittings	3.29
Transporting objects in the boot	3.30
Transporting objects: towing, attachments	3.31
Luggage net	3.32
Luggage cover	3.33
Multimedia equipment	3.34

AIR VENTS, air outlets (1/2)

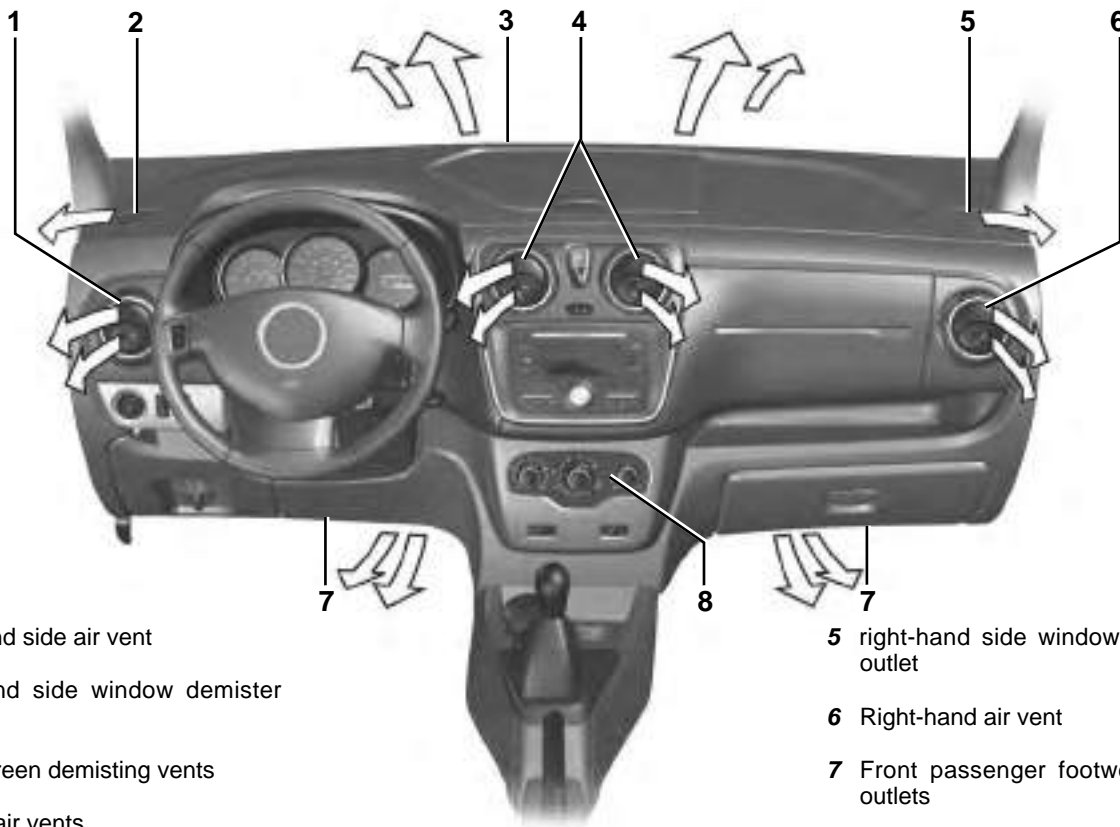

1 Left-hand side air vent

2 Left-hand side window demister vent

3 Windscreen demisting vents

4 Centre air vents

5 right-hand side window demister outlet

6 Right-hand air vent

7 Front passenger footwell heater outlets

8 Control panel

AIR VENTS, air outlets (2/2)

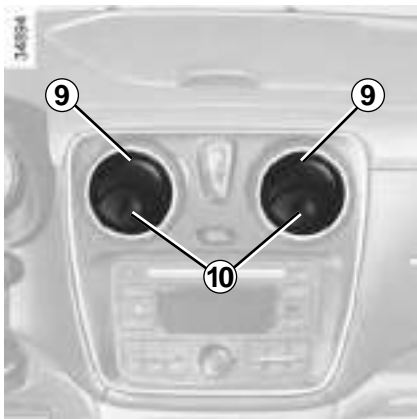

Centre and side air vents

Air flow

To open air vent **9**, press on the air vent (point **10**) until it is open as far as required.

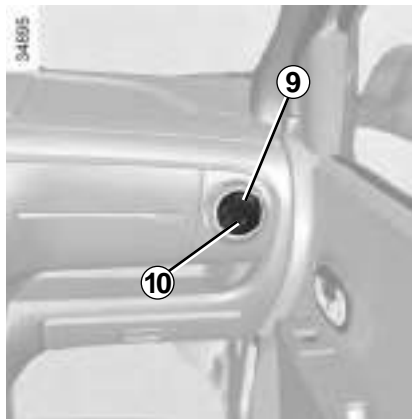

Direction

To direct the air flow, swivel side air vent **9**.

To remove bad odours from your vehicles, only use the systems designed for this purpose. Consult an approved Dealer.



Do not add anything to the vehicle's ventilation circuit (for example, to remove bad odours).

There is a risk of damage or of fire.

HEATING, VENTILATION, AIR CONDITIONING (1/3)

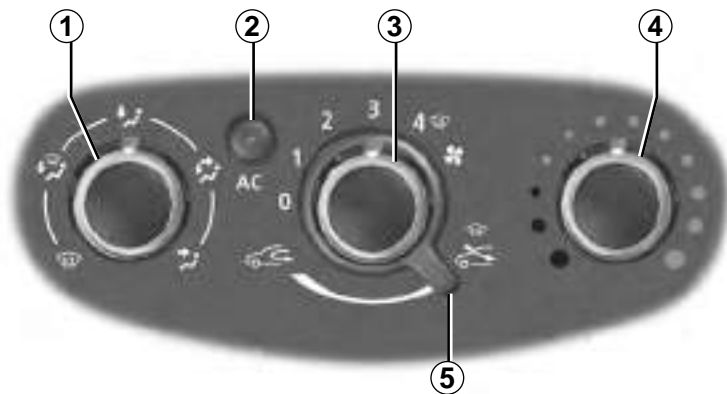

Controls

The controls will depend on the vehicle equipment level.

- 1 Distribution of air.
- 2 Switching air conditioning on or off.
- 3 Adjusting the ventilation fan speed.
- 4 Air temperature adjuster.
- 5 Switching passenger compartment isolation mode/air recirculation mode on.

Information and advice on use: refer to information on “Air conditioning: information and advice on use”.

Adjusting the air temperature

Turn control **4** to obtain the desired temperature. The further the pointer is in the red, the more the temperature will be increased.

Adjusting the ventilation fan speed.

Turn control **3** from 0 to 4. The further to the right it is positioned, the more air is blown into the passenger compartment. If you want to shut off the flow of air completely and stop the system, set control **3** to 0.

The system is deactivated: the ventilation speed for the passenger compartment air is zero (vehicle stationary), you can however still feel a slight flow of air when the vehicle is moving.

Leaving this control in position 0 for prolonged periods can lead to condensation forming on the side windows and windscreen and problems due to the use of non-renewed air in the passenger compartment.

HEATING, VENTILATION, AIR CONDITIONING (2/3)

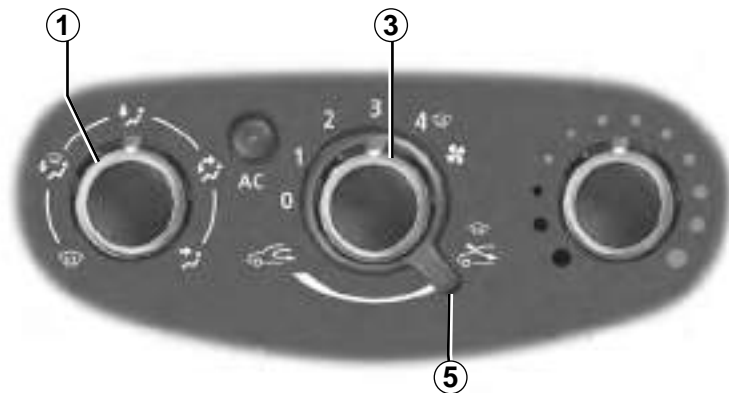

Switching passenger compartment isolation mode/ air recirculation mode on.

Bring lever **5** to position .

Under these conditions, air is taken from the passenger compartment and is recirculated, with no air being taken from outside the vehicle.

Air recirculation is used to:

- to isolate the passenger compartment from the external atmosphere (e.g. driving in polluted areas, etc.);
- to bring the passenger compartment to the desired temperature as quickly as possible.

Rapid demisting

Turn controls **1**, **3** and **5** to positions



- air from the outside;
- maximum fan speed;
- demisting.

Using the climate control increases the speed of demisting.

Prolonged use of air recirculation can lead to condensation forming on the side windows and windscreen, and discomfort due to the use of non-renewed air in the passenger compartment.

You are therefore advised to return to normal mode (external air) as soon as the air recirculation function is no longer required, by turning control **5** to the right.

HEATING, VENTILATION, AIR CONDITIONING (3/3)

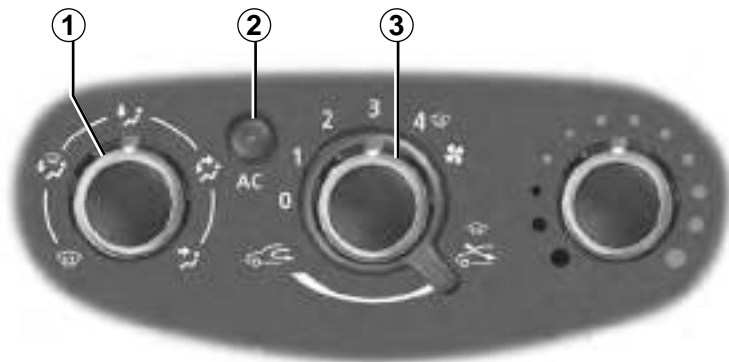

Distribution of air in the passenger compartment

Turn control **1** to choose the distribution option.



All the air flow is directed to the dashboard vents.



The air flow is directed towards the dashboard vents and the footwells.



The air flow is mainly distributed between the front and rear footwells and the dashboard vents. Close the dashboard vents to direct all the air to the foot wells.



The air flow is distributed between all the air vents, the front side window demisting air vents, the windscreen demisting vents and the footwells.



All the air is then directed to the windscreen and front side window demisting vents.

Switching air conditioning on or off

The air conditioning is switched on (indicator light illuminated) or off (indicator light extinguished) using button **2**.

Activation is not possible if control **3** is set to 0.

The air conditioning system is used for:

- lower the temperature inside the passenger compartment;
- eliminate condensation more quickly.

Fuel consumption increases when the air conditioning is being used (switch it off when it is not required).

The air conditioning does not operate when the exterior temperature is low.

AIR CONDITIONING: information and advice on use

Fuel consumption

You will normally notice an increase in fuel consumption (especially when driving in town) when the air conditioning is operating.

For vehicles fitted with air conditioning with no automatic mode, switch off the system when it is not required.

Advice for reducing consumption and helping to preserve the environment

Drive with the air vents open and the windows closed.

If the vehicle has been parked in the sun, open the doors for a few moments to let the hot air escape before starting the engine.

Maintenance

Refer to the Maintenance Document for your vehicle for the inspection frequency.

Operating faults

As a general rule, contact your approved dealer in the event of an operating fault.

- **Reduction in de-icing, demisting or air conditioning performance.**
This may be caused by the passenger compartment filter cartridge becoming clogged.
- **No cold air is being produced.**
Check that the controls are set correctly and that the fuses are sound. Otherwise, switch off the system.

Presence of water under the vehicle

After prolonged use of the air conditioning system, it is normal for water to be present under the vehicle. This is caused by condensation.



Do not open the refrigerant fluid circuit. The fluid may damage eyes or skin.

ELECTRIC WINDOWS (1/2)



Safety of rear occupants

The driver can prevent operation of the rear electric windows by pressing switch **4**.

Driver's responsibility

Never leave your vehicle with the key inside and never leave a child (or a pet) unsupervised, even for a short while. They may pose a risk to themselves or to others by starting the engine, activating equipment such as the electric windows or by locking the doors. If a body part gets trapped, reverse the direction of travel of the window as soon as possible by pressing the relevant switch.

Risk of serious injury.

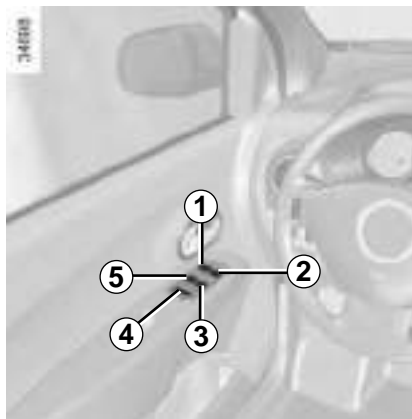

Electric windows

Press the window switch down or lift it up to lower or raise the window to the desired height.



From the driver's seat, use switch:

- 1** for the driver's side;
- 2** for the front passenger side;
- 3** and **5** for the rear passengers.

From the passenger seats, use switch **6**.

Avoid resting any objects against a half-open window: there is a risk that the electric window could be damaged.

ELECTRIC WINDOWS (2/2)

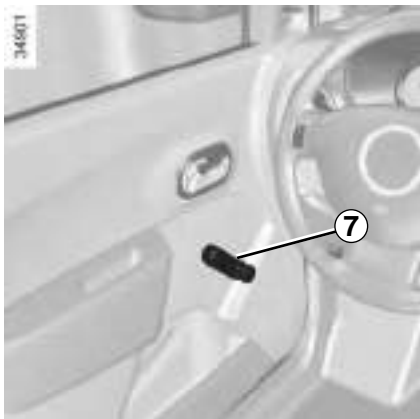

Manual window winders

Turn handle **7** to lower or raise the window to the desired height.

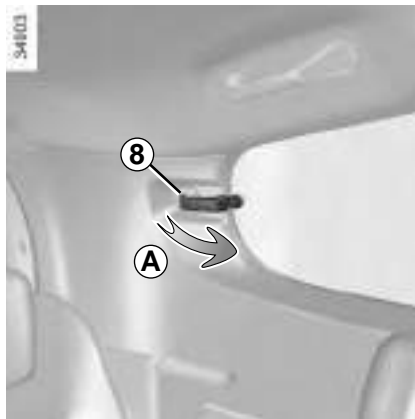

Rear side screen

To half-open the window, turn handle **8** (movement **A**) then lock it by pushing the handle to the right.

Make sure it is properly latched into position when it is closed.

INTERIOR LIGHTING



Courtesy lights

Press switch **1** of **3** for:

- continuous lighting;
- lighting operated by opening just the driver's door, or by opening one of the four doors, depending on the vehicle. The light only goes out when the doors are correctly closed;
- no lighting.

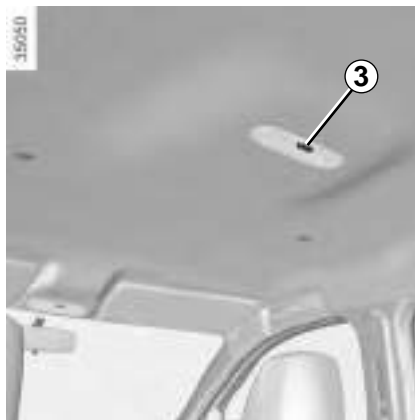

Map reading light

Press switch **2**.

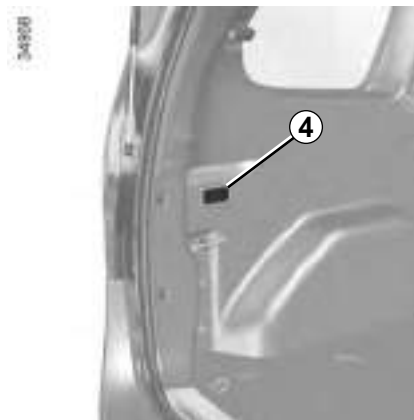

Luggage compartment light **4**

Unlocking and opening the doors or luggage compartment switches on the timed courtesy lights.

SUN VISOR/GRAB HANDLE

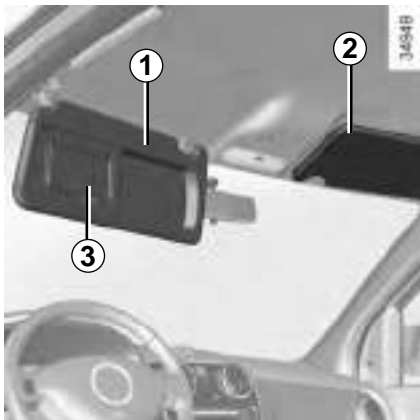

Front sun visor

Lower the sun visor **1** or **2** over the windscreen or unclip it and turn it over the side window.

Vanity mirror

If the sun visor is fitted with a courtesy mirror **3**, it has a cover.



When driving, ensure the courtesy mirror cover is closed. Risk of injury.

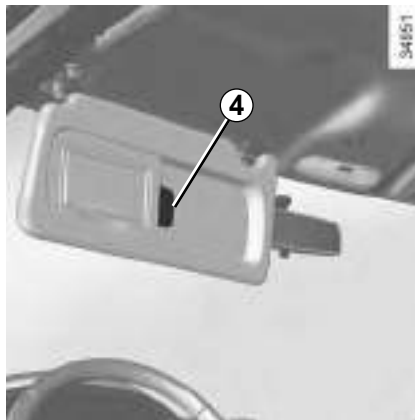

Sun visor storage **4**

It can be used to hold motorway passes, etc.

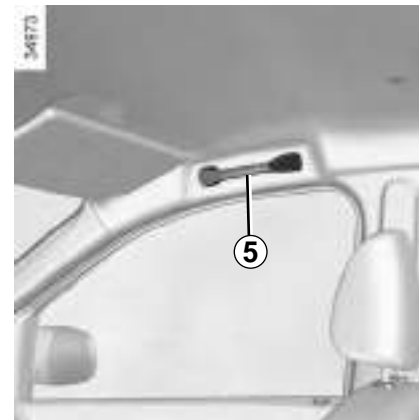

Grab handle **5**

This offers support and can be held when the vehicle is being driven.

Do not use it for getting into or out of the vehicle.

PASSENGER COMPARTMENT STORAGE/FITTINGS (1/4)

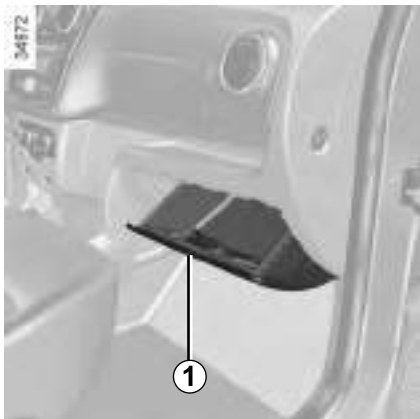

Glove box

If fitted on the vehicle, pull paddle 1 to open.



Storage compartment 2



Ensure that no hard, heavy or pointed objects are placed in the "open" storage compartments in such a way that they may fall onto passengers during sudden turning, braking or in the event of an accident.

PASSENGER COMPARTMENT STORAGE/FITTINGS (2/4)



Dashboard storage compartment 3

If the storage compartment has a cover, lift to open.

You should avoid keeping liquids in this compartment (if a liquid leaks there is a risk of seepage).



Storage compartment A

Pass a hand in location 4 and pull to open the storage compartment A.



Nothing should be placed on the floor area in front of the driver as such objects may slide under the pedal during braking manoeuvres, thus obstructing its use.



Door storage compartment 5



Ensure that no hard, heavy or pointed objects are placed in the “open” storage compartments in such a way that they may fall onto passengers during sudden turning, braking or in the event of an accident.

PASSENGER COMPARTMENT STORAGE/FITTINGS (3/4)

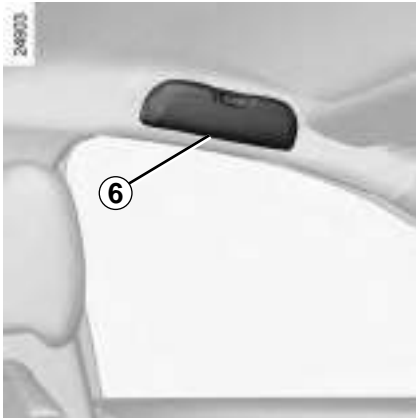

Sunglasses holder 6



Front seat storage pockets 7

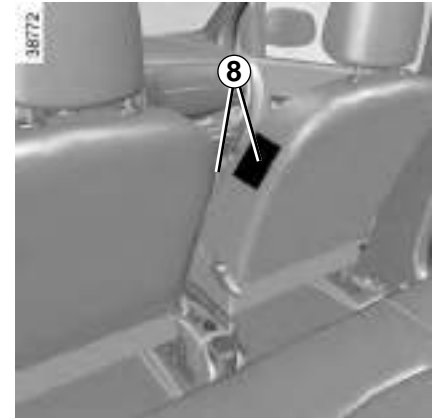

Mobile phone storage compartment 8
(depending on the vehicle)

PASSENGER COMPARTMENT STORAGE/FITTINGS (4/4)

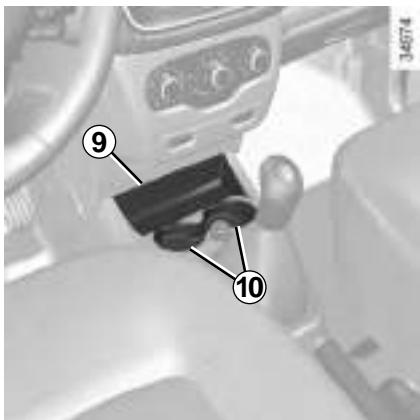

Storage compartment 9

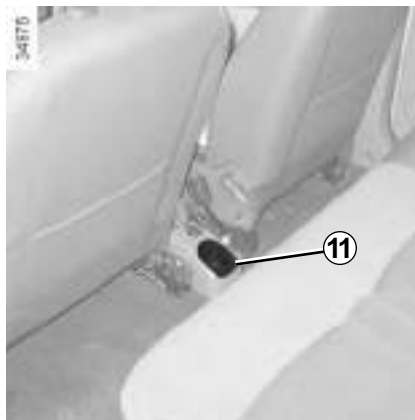

Cup holder 10, 11 and 12

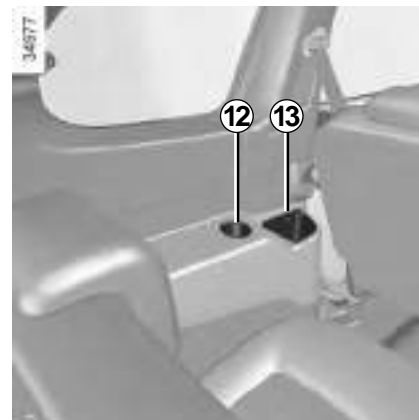

Storage compartment 13

ASHTRAY/CIGARETTE LIGHTER/ACCESSORIES SOCKET

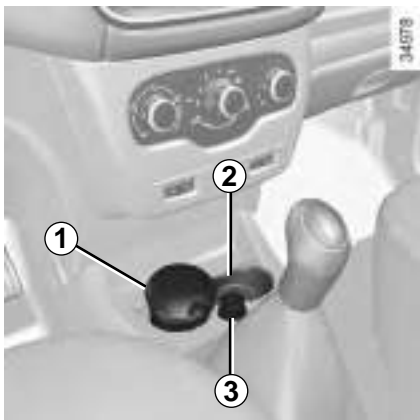

Ashtray 1

This may be in location **2**, **4** or **6**.

Lift the cover to open.

To empty, pull the ashtray towards you and it will be released from its housing.

If your vehicle is not fitted with a cigar lighter and an ashtray, these can be obtained from an approved Dealer.

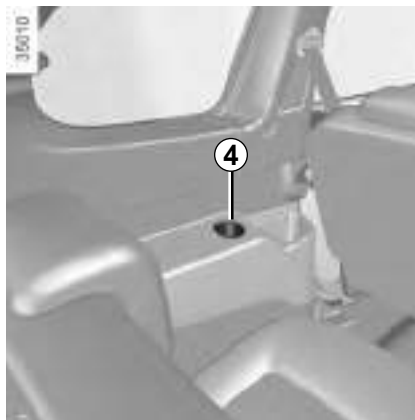

Cigarette lighter or accessories socket 3

With the ignition on, push in the cigarette lighter **3**. It will spring back with a click when it is ready. Pull it out to use.

After use, replace it without pushing it all the way in.

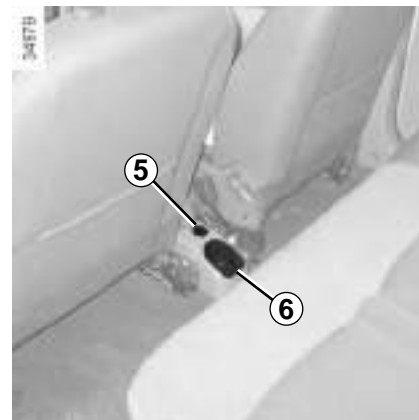

Accessories socket 5

It is provided for connecting accessories approved by our Technical Department with a maximum power of 120 Watts (12V).



Connect accessories with a maximum power of 120 Watts only.

Fire hazard.

REAR HEADRESTS (1/2)

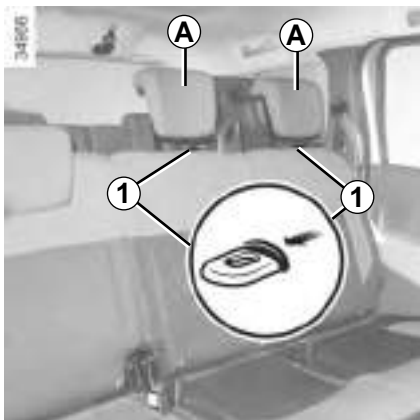

Position for using headrest A

Lift the headrest to maximum height, then lower it until it locks.

To raise the headrest A

Raise the headrest as far as it will go, then press tab(s) **1** and remove the headrest.



To put the headrest back in place A

Insert the rods into the holes, press the tab(s) **1** and lower the headrest.

Headrest A storage position B

Press tab **1** and lower the headrest fully.

When the headrest is set at the lowest position, B this is for storage only: it should not be in this position when a seat is occupied.



The headrest is a safety component. Ensure that it is fitted and in the correct position: the top of your head should be in line with the top of the headrest.

REAR HEADRESTS (2/2)

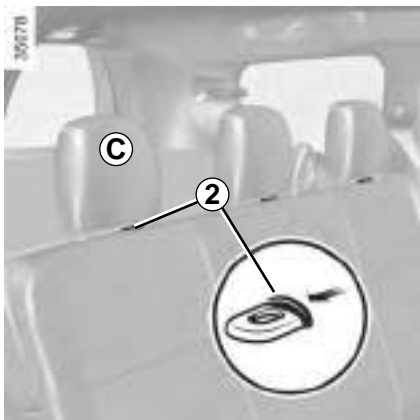

To adjust the height of the headrest **C** (depending on vehicle)

Press lock tab **2** and simultaneously slide the headrest to the required position.

To raise the headrest **C**

Press lock tab **2** and remove the headrest.

To put the headrest back in place **C**

Insert the rods into the holes, press lock tab **2** and lower the headrest.



The headrest is a safety component. Ensure that it is fitted and in the correct position: the top of your head should be in line with the top of the headrest.

REAR SEAT FUNCTIONS: second row (1/3)



Fixed rear bench seat

To fold down the seatback

- Bring the front seats forward;
- insert the rear seatbelt buckle in housing 1;
- Lower door handle 2;
- lower the seatback onto the seat base;
- adjust the front seats.



When moving the rear seats, check that the anchoring points are clean (they must be free from grit, cloths, toys, etc.)



Check that the rear seat belts are positioned and operating correctly each time the rear bench seat is moved.

To reposition the seatback

- Raise the seatbacks;
- make sure you lock the seat back in place.



For safety reasons, carry out any adjustments when the vehicle is not being driven.

REAR SEAT FUNCTIONS: second row (2/3)

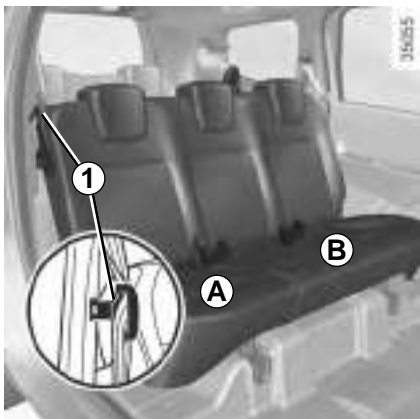

Rear bench seat with folding seat back and seat cushion

To fold down the seat A or bench seat B

- Bring the front seats forward;
- insert the rear seatbelt buckle in housing **1**;
- lower the headrests (refer to the information on the “Rear headrests” in Section 3);
- lower handle **2**;
- lower the seatback onto the seat base;
- raise the seat until vertical;
- adjust the front seats, making sure they are properly locked in place.

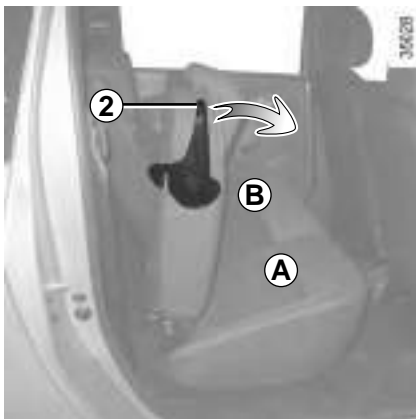

When moving the rear seats, check that the anchoring points are clean (they must be free from grit, cloths, toys, etc.)



Check that the rear seat belts are positioned and operating correctly each time the rear bench seat is moved.



To reposition the seat A or bench seat B

- Lower the bench seat until it locks in position;
- Fold the seatbacks up again;
- make sure that the seat bases and seatbacks lock into position correctly.



For safety reasons, carry out any adjustments when the vehicle is not being driven.

REAR SEAT FUNCTIONS: second row (3/3)



Accessing the third row rear seats

- Lower handle 2;
- lower the seatback onto the seat base;
- raise the seat until vertical.

To put the seat back into its initial position, perform the same procedure in reverse.



Make sure that the seatback is correctly locked. If necessary, remove any obstacles behind the seats.

Repeat the above until the seat is locked correctly.



Restriction of use

If a passenger is occupying one of the second row seats, do not drive with the other second row seat folded down.



To avoid all risk of injury, ensure that nobody is close to the moving parts.



When refitting the seatback, make sure it is correctly locked in place.

If seat covers are fitted, make sure these do not prevent the seatback latch from locking in. Make sure that the seat belts are positioned correctly. Reposition the headrests.

REAR SEAT FUNCTIONS: third row (1/3)



The third row rear seats can be folded down or removed for transporting bulky objects.

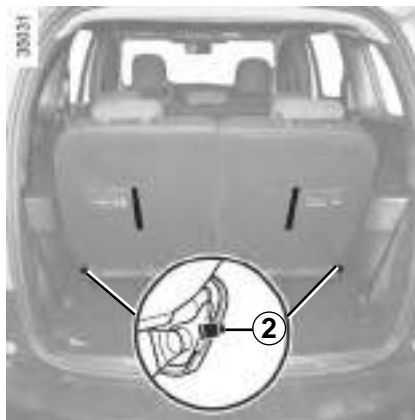

To fold down the seats

- Ensure that the rear seat belts are correctly positioned on the hooks **1**;
- lower the headrests (refer to the information on the "Rear headrests" in Section 3);
- unlock controls **2**, press on the middle of the seat backs and lower the seatbacks onto the base;
- pull the strap **3** to release the bench seat and lift the seat base until it is vertical.

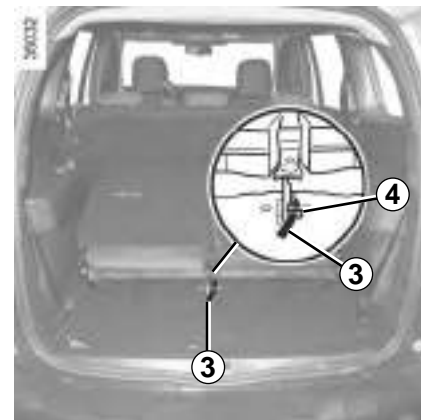

Ensure that the strap **3** is securely fixed in its metal ring **4**. Risk of damage.



For safety reasons, carry out any adjustments when the vehicle is not being driven.



Check that the rear seat belts are positioned and operating correctly each time the rear bench seat is moved.

REAR SEAT FUNCTIONS: third row (2/3)

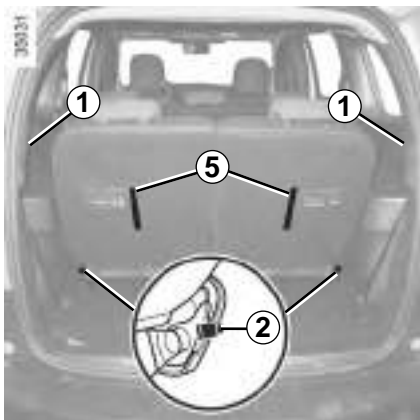

To reposition the seats

- Ensure that the rear seat belts are correctly positioned on the hooks **1**;
- Lower the seat base until it locks in position;
- unlock the controls **2** while pressing on the top of the seat back and raise the seat backs using the straps **5**;
- Make sure that the seat base and seatbacks lock into position correctly.



Check that the rear seat belts are positioned and operating correctly each time the rear seat is moved.



When moving the rear seats, check that the anchoring points are clean (they must be free from grit, cloths, toys, etc.)

Restriction of use

If a passenger is one of the third row seats, do not drive with one of the seat backs or a second row seat folded down.



No person or animal should be on the third row rear seats if the luggage compartment cover is not removed.

REAR SEAT FUNCTIONS: third row (3/3)

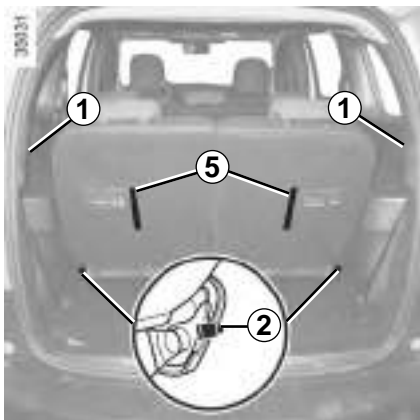

To remove the seats

- Ensure that the rear seat belts are correctly positioned on the hooks **1**;
- lower the headrests (refer to the information on the “Rear headrests” in Section 3);
- unlock controls **2**, press on the middle of the seat backs and lower the seatbacks onto the base;
- pull strap **3** to release and lift the seat base until it is vertical;
- unlock controls **6**;
- lift the seats to either remove them or to group them together with the second row.

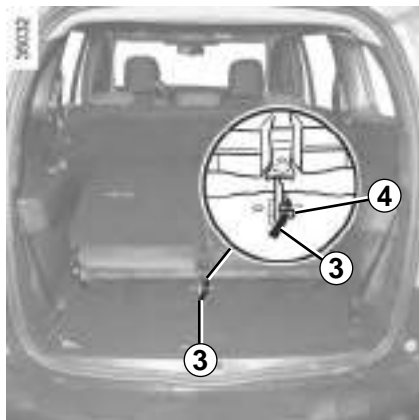

To install seats

- Ensure that the rear seat belts are correctly positioned on the hooks **1**;
- reposition the seats with the roof hooks **7**;
- Lower the seat base until it locks in position;
- unlock controls **2** and raise the seat backs using strap **5**;
- Make sure that the seat base and seatbacks lock into position correctly.



Ensure that the strap **3** is securely fixed in its metal ring **4**. Risk of damage.



When moving the rear seats, check that the anchoring points are clean (they must be free from grit, cloths, toys, etc.)

REAR SEAT FUNCTIONS: Grouping of seats (1/3)

30040



The two rows of the rear seats can be grouped together to free up a maximum load surface area at the rear of the vehicle.

For more information, see the following pages.



For safety reasons, carry out any adjustments when the vehicle is stationary.

The third row bench seat is quite heavy. For your own safety, please handle it carefully

REAR SEAT FUNCTIONS: grouping of seats (2/3)

To group together the two rows of rear seats

Fold down the second row rear seats. Refer to the information on the “Second row rear seats” in Section 3.

Remove the third row rear seats Refer to the information on the “Third row rear seats” in Section 3.

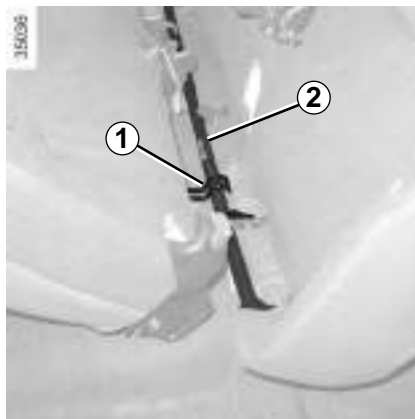

Return the third row rear seats (seat forwards and headrest upwards). Position them against the second row rear seats, with the hook **1** on the bar **2**.

Fold down the third row rear seats against the second row rear seats.

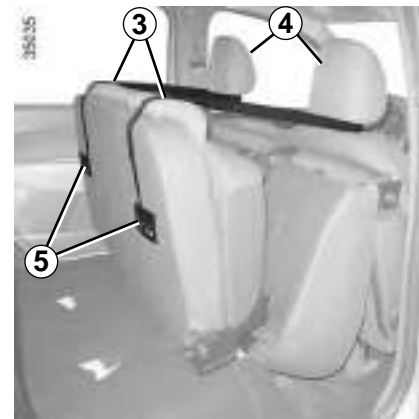

Take the adjustable attachment straps **3** out of the storage pockets **5** and pass them around the front headrest rods **4**.

Pull on the attachment straps **3** to ensure everything is attached.



For safety reasons, carry out any adjustments when the vehicle is stationary.

The third row bench seat is quite heavy. For your own safety, please handle carefully.

REAR SEAT FUNCTIONS: grouping of seats (3/3)



To reposition the seats

Loosen and remove the attachment straps **3** from the front headrest and store them in the storage pockets **5**.

Lift and release the third row rear seats.

Return the third row rear seats (seat downwards, headrest upwards) and bring them back towards the rear.



Replace the third row rear seats in position. Refer to the information on the "Third row rear seats" in Section 3.

Reposition the second row rear seats. Refer to the information on the "Second row rear seats" in Section 3.



For safety reasons, carry out any adjustments when the vehicle is stationary.

The third row bench seat is quite heavy. For your own safety, please handle carefully.

LUGGAGE COMPARTMENT

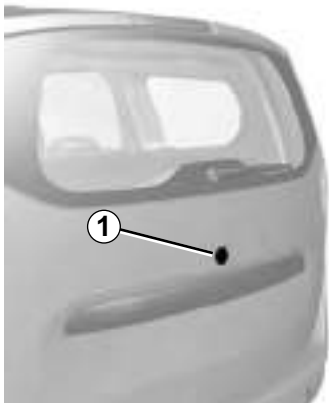

To open

Electric central locking

With the opening elements unlocked, press button **1** and lift the tailgate.

Manual locking

Insert the key in the boot lock, turn and press button **1**.



To close

Pull down the tailgate using handle **2** inside the tailgate to assist you.

When the tailgate reaches shoulder height, gently push it shut.



For your safety, check that all the vehicle's doors are properly closed before starting the engine.

LUGGAGE COMPARTMENT STORAGE SPACE AND FITTINGS

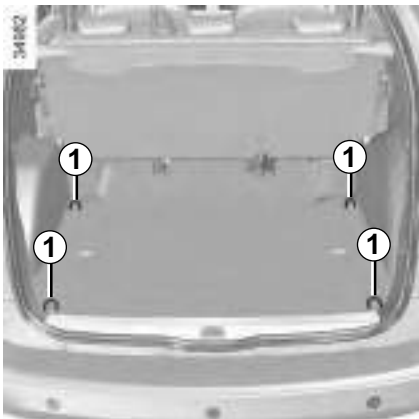

Anchorage points

Anchorage points **1** located on each corner of the luggage compartment allow loads to be secured.

Always place objects being transported so that the heaviest items are resting against the back of the rear bench seat.



Always position the heaviest items directly on the floor. If the vehicle is equipped with anchorage points on the luggage compartment floor, use them. The luggage should be loaded in such a way that no items will be thrown forward and strike the occupants if the driver has to brake suddenly. Fasten the rear seat belts, even if the seats are not occupied.

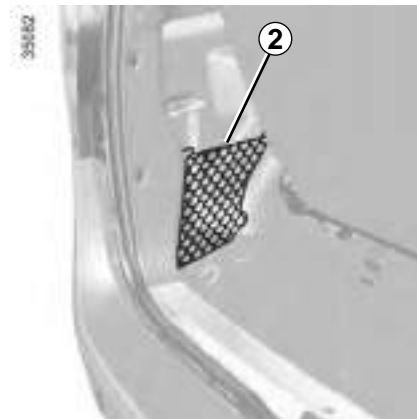

Storage net 2

TRANSPORTING OBJECTS IN THE LUGGAGE COMPARTMENT

Always position the objects transported so that the largest surface is against:

– the rear bench seatbacks, for normal loads (eg: **A**);



– the front seats when the second and/or third row rear seats are folded down. Refer to the information on the “Second row rear seats” in this section (eg: **B** and **C**).



Always position the heaviest items directly on the floor.



Always position the heaviest items directly on the floor. Use the lashing points on the luggage compartment floor, if these are fitted to the vehicle. The luggage should be loaded in such a way that no items will be thrown forward and strike the occupants if the driver has to brake suddenly. Fasten the rear seat belts, even if the seats are not occupied.

TRANSPORTING OBJECTS towing, attachments

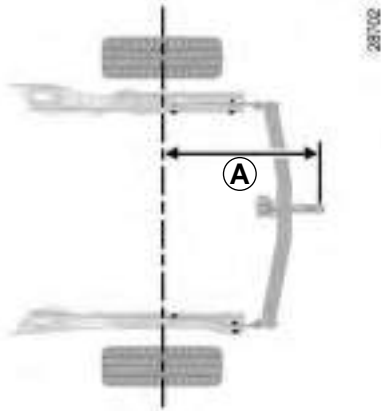

A = 940.6 mm

If the towbar ball obscures the registration plate or the rear lights, it should be removed when not in use.

In all cases, comply with local legislation.



Permissible nose weight, maximum permissible towing weight braked and unbraked:

Refer to the information on “Weights” in Section 6.

Refer to the manufacturer’s instructions for information on how to fit and operate the towing attachments.

Please keep these instructions with the rest of the vehicle documentation.

TRANSPORTING OBJECTS Luggage net

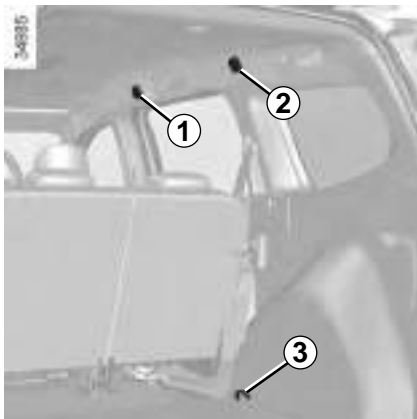

If fitted, this can be used when transporting animals or luggage to isolate them from the passenger section.

It is fitted behind the second row bench seat or behind the driver and passenger seats.

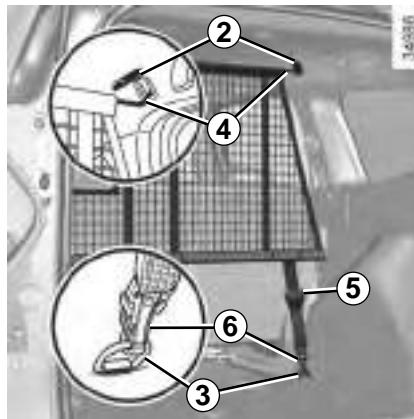

Fitting the luggage net behind the second row rear seats

Inside the vehicle on each side:

- lower cover **2** to gain access to the anchoring points for the top part of the luggage net;
- insert the top rod of net **4** into the anchoring points;
- attach the two hooks **6** of the straps **5** from the net onto the anchoring points **3**;
- adjust the net strap **5** so that it is taut.

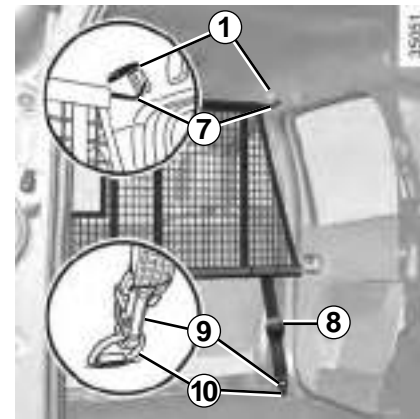

Fitting the luggage net behind the front seats

Inside the vehicle on each side:

- lower cover **1** to gain access to the anchoring points for the top part of the luggage net;
- insert the top rod of net **7** into the anchoring points;
- attach the two hooks **9** of the straps **8** from the net onto the anchoring points **10**;
- adjust the net strap **8** so that it is taut.



The luggage net must not be used to restrain or hold objects.

Risk of injury.

LUGGAGE COMPARTMENT COVER

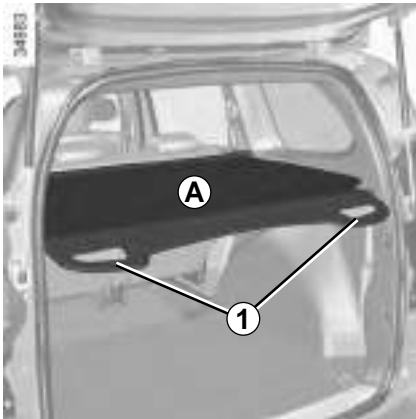

How to remove the luggage compartment cover A

Using handle **1**, pull it gently to release the pins from their mounting points located on each side of the luggage compartment.

Guide the luggage cover using handles **1**.

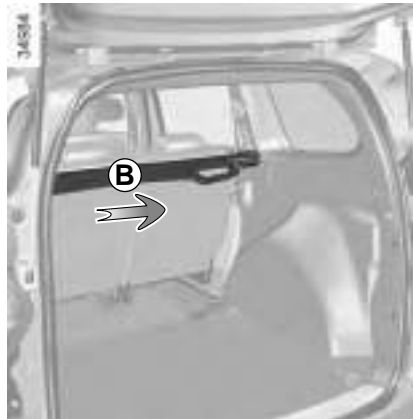

Removing the luggage compartment cover

Push the luggage cover to the right (movement **B**) and lift the left-hand side of the inertia reel.

Refitting the luggage compartment cover

Insert the right-hand side, then push it to the right and lower the left-hand side of the inertia reel into its housing.



No person or animal should be on the third row rear seats if the luggage compartment cover is not removed.



Do not place any objects, especially heavy or solid objects on the luggage compartment cover. These may pose a risk to the vehicle occupants if the driver has to brake suddenly or if the vehicle is involved in an accident.

MULTIMEDIA EQUIPMENT

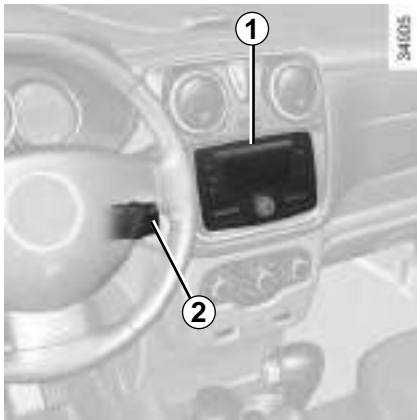

The presence and location of this equipment depends on the vehicle's multimedia equipment.

- 1 Radio or navigation system;
- 2 Steering column control;
- 3 Microphone.

Refer to the equipment instructions for information on how to operate this equipment.

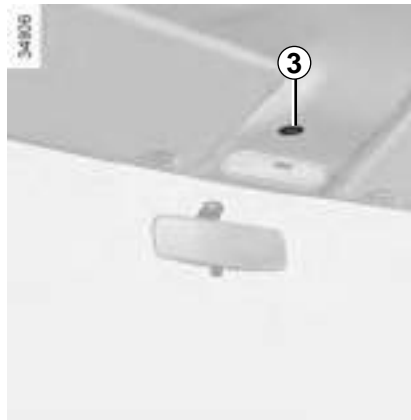

Hands-free telephone integrated control

On equipped vehicles, use microphone **3** and steering column control **2**.



Using the telephone

We remind you of the need to conform to the legislation in force concerning the use of such equipment.

Section 4: Maintenance

Bonnet	4.2
Engine oil level: general information	4.3
Engine oil level: topping up, filling	4.4
Levels:	4.6
Brake fluid	4.6
Engine coolant	4.7
Windscreen washer reservoir	4.7
Power-assisted steering fluid	4.8
Filters	4.8
Battery	4.9
Tyre pressures	4.10
Bodywork maintenance	4.12
Interior trim maintenance	4.14

BONNET



To open the bonnet, pull the handle 1.

Unlocking the bonnet catch

To unlock, gently lift the bonnet and push tab 2 in the direction of arrow A to release the bonnet.



The engine may be hot during operations in close proximity. In addition, the engine cooling fan may come on at any moment.

Risk of injury.

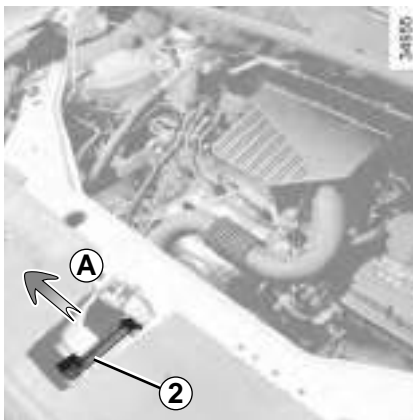

Opening the bonnet

Lift the bonnet; you will need to guide it as it is held by a strut.

Closing the bonnet

Check that nothing has been left in the engine compartment.

To close the bonnet again, hold the bonnet in the middle and lower it to 30 cm above the closed position, then release it. It will latch automatically under its own weight.



Do not press down on the bonnet: there is a risk that the bonnet may accidentally close.



Ensure that the bonnet is properly locked.

Ensure that nothing is preventing locking (grit, cloths, etc.).



Make sure nothing is left in the engine compartment (cloth, tools, etc.).

These may damage the engine or cause a fire.



In the event of even a slight impact involving the radiator grille or bonnet, have the bonnet lock checked by an approved Dealer as soon as possible.

ENGINE OIL LEVEL: general information

An engine uses oil to lubricate and cool moving parts and it is normal to top up the oil between oil changes.

However, contact your approved Dealer if more than 0.5 litres is being consumed every 600 miles (1,000 km) after the running in period.

Oil change frequency: check the oil level from time to time and certainly before any long journey to avoid the risk of damaging your engine.

Consult your approved dealer at once if you notice an abnormal or repeated drop in any of the fluid levels.

In order to prevent splashback, it is recommended that a funnel be used when topping up/filling with oil.

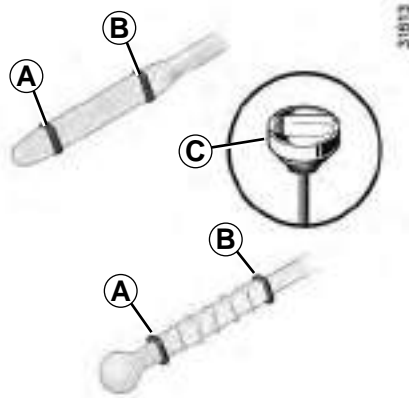

Reading the oil level

The oil level should be read with the vehicle on level ground, after the engine has been switched off for some time.

The dipstick must be used to read the exact oil level and make sure that the maximum level has not been exceeded (risk of engine damage). Refer to the following pages.

- remove the dipstick and wipe with a clean, lint-free cloth;
- push the dipstick in as far as it will go (for vehicles equipped with a cap-type dipstick **C**, screw the cap in as far as it will go);
- take out the dipstick again;
- read the level: it should never fall below minimum mark **A** or exceed maximum mark **B**.

Once the operation has been completed, ensure that the dipstick is pushed in as far as it will go or that the “cap-type dipstick” is completely screwed in.



Exceeding the maximum engine oil level

Under no circumstances must the maximum fill level **B** be exceeded: risk of damage to the engine and catalytic converter. If the oil level exceeds the maximum level, **do not start your vehicle** and contact an approved Dealer.

ENGINE OIL LEVEL: topping up/filling (1/2)

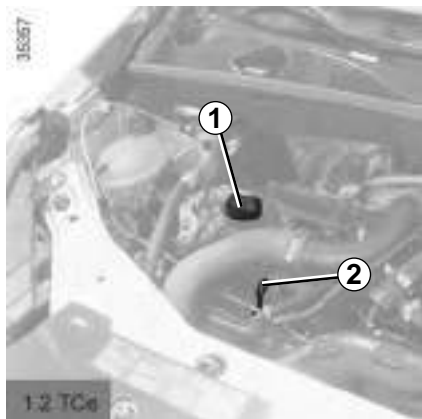

Topping up/Filling

The vehicle must be parked on level ground and the engine should be cold (for instance, before the engine is started up for the first time in the day).

In order to prevent splashback, it is recommended that a funnel be used when topping up/filling with oil.

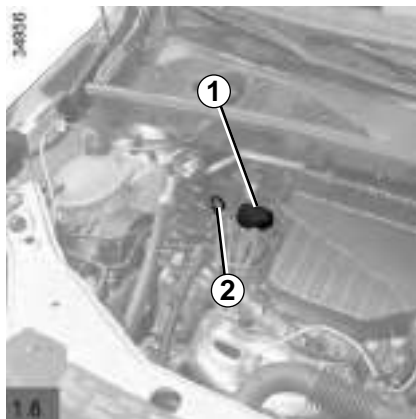

- Unscrew cap **1**;
- top up the level (as a guide, the capacity between the minimum and maximum reading on the dipstick **2** is between 1.5 and 2 litres, depending on the engine);
- wait for approximately 20 minutes to allow the oil to flow into the engine;
- check the level using the dipstick **2** (as described above).

Once the operation has been completed, ensure that the dipstick is pushed in as far as it will go or that the “cap-type dipstick” is completely screwed in.

Do not exceed the **max** level and do not forget to refit cap **1** and dipstick **2**.

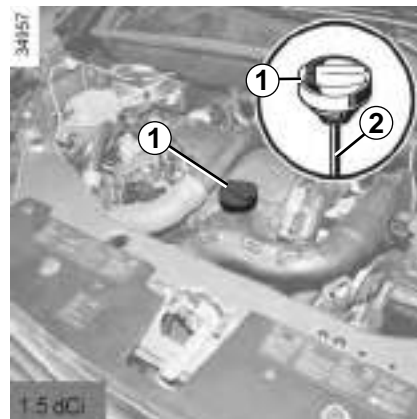

Exceeding the maximum engine oil level

Under no circumstances must the maximum fill level be exceeded: risk of damage to the engine and catalytic converter. If the oil level exceeds the maximum level, **do not start your vehicle** and contact an approved Dealer.

ENGINE OIL LEVEL: topping up/filling (2/2)

Oil change

Service interval: refer to the Maintenance Document for your vehicle.

Oil change capacity

Please refer to the maintenance document for your vehicle, or contact an authorised dealer.

Always check the engine oil level using the dipstick, as explained previously (it should never fall below the minimum level, or be over the maximum level on the dipstick).

Engine oil grade

Refer to the Maintenance Document for your vehicle.



Filling: take care when topping up the oil that no oil drips onto engine components - risk of fire.

Remember to refit the cap securely as there is a risk of fire if oil splashes onto hot engine components.



Never run the engine in an enclosed space as exhaust gases are poisonous.



The engine may be hot during operations in close proximity. In addition, the engine cooling fan may come on at any moment.

Risk of injury.



Engine oil change: if you are changing the oil when the engine is hot, be careful not to scald yourself if the oil overflows.

Consult an approved dealer at once if you notice an abnormal or repeated drop in any of the fluid levels.

LEVELS (1/3)



Brake fluid level

This should be checked frequently, and immediately if you notice even the slightest loss in braking efficiency.

The level should be read with the engine switched off and on level ground.



The engine may be hot during operations in close proximity. In addition, the engine cooling fan may come on at any moment.

Risk of injury.

Level

It is normal for the level to drop as the brake shoes become worn, but it must never drop lower than the “**MINI**” warning line shown on brake fluid reservoir **1**.

If you wish to check the disc and drum wear yourself, you should obtain the document explaining the checking procedure from the approved dealer network or from the manufacturer’s web site.

Consult your approved dealer at once if you notice an abnormal or repeated drop in any of the fluid levels.

Topping up

After any operation on the hydraulic circuit, a specialist must replace the fluid. Only use fluids approved by the Technical Department and which have been taken from a sealed container.

Replacement intervals

Refer to the Maintenance Document for your vehicle.

LEVELS (2/3)



Coolant

With the engine switched off and on level ground, the level **when cold** must be between the MINI and MAXI marks on reservoir **2**.

Top this level up **when cold** before it reaches the MINI mark.



No operations should be carried out on the cooling circuit when the engine is hot.

Risk of burns.

Checking intervals

Check the coolant level regularly (very severe damage is likely to be caused to the engine if it runs out of coolant).

If the level needs to be topped up, only use products approved by our Technical Department which ensure:

- protection against freezing;
- anti-corrosion protection of the cooling system.

Replacement intervals

Refer to the Maintenance Service Booklet for your vehicle.

Consult an approved dealer at once if you notice an abnormal or repeated drop in any of the fluid levels.



The engine may be hot during operations in close proximity. In addition, the engine cooling fan may come on at any moment.

Risk of burns.

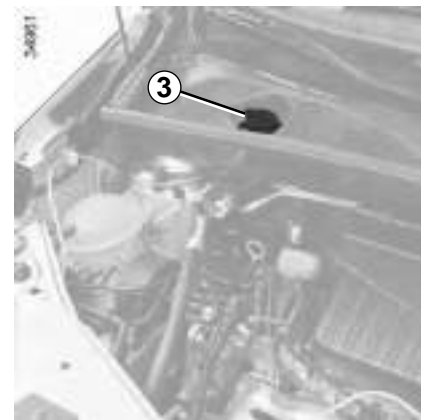

Windscreen washer reservoir

Filling: Remove cap **3**, fill until you can see the fluid, then refit the cap.

This reservoir supplies the front and rear headlight screen washers (if the vehicle is equipped with them).

Liquid: Special windscreen washer fluid (antifreeze product for winter).

Jets: Depending on the vehicle, use a tool such as a needle to adjust the height of the windscreen washer jets.

LEVELS (3/3)/FILTER

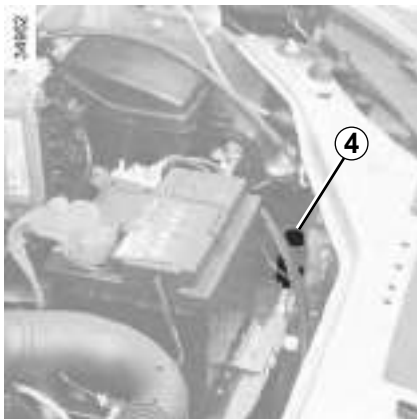

Power-assisted steering fluid reservoir

Level: for a correct level **when cold**, with the engine switched off and on level ground, it must be visible between the “MINI” and “MAXI” marks on reservoir **4**.

For maintenance operations on the power-assisted steering, contact an approved dealer.

If you feel any variation in the effectiveness of the power-assisted steering, consult an authorised dealer.

Filters

The replacement of filter elements (air filter, cabin filter, diesel fuel filter, etc.) is scheduled in the maintenance operations for your vehicle.

Replacement intervals for filter elements: please refer to your vehicle's maintenance document.



The engine may be hot when carrying out operations in close proximity. In addition, the engine cooling fan can come on at any moment.

Risk of injury.

Consult an approved dealer at once if you notice an abnormal or repeated drop in any of the fluid levels.

BATTERY



The battery **1** does not require any maintenance.



Handle the battery with care as it contains sulphuric acid, which must not come into contact with eyes or skin. If it does, wash the affected area with plenty of water and see a doctor if necessary.

Ensure that naked flames, red hot objects and sparks do not come into contact with the battery as there is a risk of explosion.

The charge status of your battery can decrease especially if you use your vehicle:

- for short journeys;
- for driving in town;
- when the temperature drops;
- after extended use of consumers (radio etc.) with the engine switched off.

Replacing the battery

As this operation is complex, we advise you to contact an approved Dealer.



As the battery is **specific to the vehicle** (presence of a ventilation pipe to expel corrosive and explosive gases), make sure that it is replaced with a battery that enables this pipe to be connected. Consult an approved Dealer.

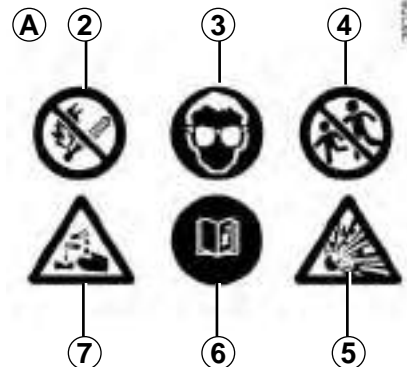

Label A

- Observe the indications on the battery:
- **2** Naked flames and smoking are forbidden;
 - **3** Eye protection required;
 - **4** Keep away from children;
 - **5** Explosive materials;
 - **6** Refer to the handbook;
 - **7** Corrosive materials.



The engine may be hot during operations in close proximity. In addition, the engine cooling fan may start at any moment.

Risk of injury.

TYRE PRESSURE (1/2)

35114

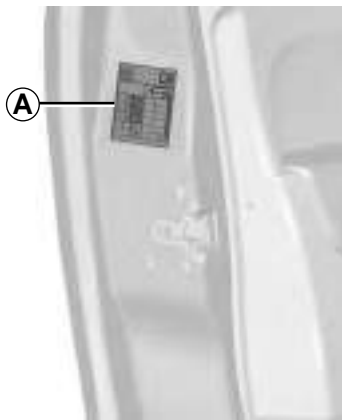

Label A

Open the driver's door to read it.

Tyre pressures should be checked when the tyres are cold.

If the tyre pressures cannot be checked when the tyres are **cold**, increase the pressures from **0.2 to 0.3 bar (or 3 PSI)**. **Never deflate a hot tyre.**

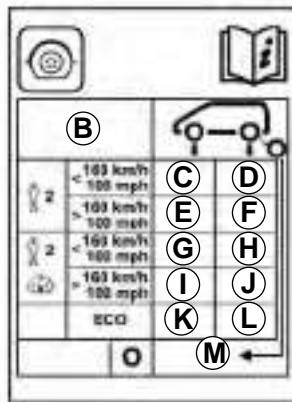

34893

B: dimension of the tyres fitted to the vehicle.

C: tyre pressures for the front wheels (non-motorway) (maximum of 2 people on board).

D: tyre pressures for the rear wheels (non-motorway) (maximum of 2 people on board).

E: tyre pressures for the front wheels (motorway) (maximum of 2 people on board).

F: tyre pressures for the rear wheels (motorway) (maximum of 2 people on board).

G: tyre pressures for the front wheels (non-motorway) (more than 2 people on board).

H: tyre pressures for the rear wheels (non-motorway) (more than 2 people on board).

I: tyre pressures for the front wheels (motorway) (more than 2 people on board).

J: tyre pressures for the rear wheels (motorway) (more than 2 people on board).

K: recommended tyre pressures for the front wheels for optimising fuel consumption.

L: recommended tyre pressure on the rear wheels for optimising fuel consumption.

M: tyre pressure for the emergency spare wheel.

TYRE PRESSURE (2/2)

Special note concerning fully laden vehicles (Maximum Permissible All-Up Weight) **and towing a trailer:** the maximum speed must be limited to **60 mph** (100 kph) and the tyre pressure increased by **0.2 bar**.

Please refer to the information on “Weights” in Section 6.

Tyre safety and use of snow chains: Refer to the information on “Tyres” in Section 5 for the servicing conditions and, depending on the version, the use of chains.



When they need to be replaced, only tyres of the same make, size, type and profile should be used on a single axle.

Tyres fitted to the vehicle should either be identical to those fitted originally or conform to those recommended by your approved dealer.

BODYWORK MAINTENANCE (1/2)

A well-maintained vehicle will last longer. It is therefore recommended to maintain the exterior of the vehicle regularly.

Your vehicle has been treated with very effective anti-corrosion products. It is nevertheless subject to various outside influences.

Corrosive agents in the atmosphere

- atmospheric pollution (built-up and industrial areas),
- saline atmospheres (near the sea, particularly in hot weather),
- seasonal and damp weather conditions (e.g. road salt in winter, water from road cleaners, etc.).

Minor impacts

Abrasive action

Dust and sand in the air, mud, road grit thrown up by other vehicles, etc.

You should take a number of minor precautions in order to safeguard your vehicle against such risks.

What you should not do

Do not degrease or clean mechanical components (e.g. the engine compartment), underneath the body, parts with hinges (e.g. inside the doors) and painted plastic external fittings (e.g. bumpers) using high-pressure cleaning equipment or by spraying on products not approved by our Technical Department. Doing this could give rise to corrosion or operational faults.

Wash the vehicle in bright sunlight or freezing temperatures.

Do not scrape off mud or dirt without pre-wetting.

Allow dirt to accumulate on the exterior.

Allow rust to form following minor impacts.

Do not use solvents not approved by our Technical Department to remove stains as this could damage the paintwork.

Do not drive in snow or muddy conditions without washing the vehicle, particularly under the wheel arches and body.

You should

Wash your car frequently, **with the engine off**, with cleaning products recommended by the manufacturer (never use abrasive products). Rinse thoroughly beforehand with a jet:

- spots of tree resin and industrial grime;
- mud in the wheel arches and underneath the body which forms damp patches;
- **bird droppings**, which cause a chemical reaction with the paint that **rapidly discolours paintwork and may even cause the paint to peel off**;
- wash the vehicle **immediately** to remove these marks since it is impossible to remove them by polishing;
- salt, particularly in the wheel arches and underneath the body after driving in areas where the roads have been gritted.

Remove any plant matter (resin, leaves, etc.) from the vehicle regularly.

BODYWORK MAINTENANCE (2/2)

Respect local regulations about washing vehicles (e.g. do not wash your vehicle on a public highway).

Observe the vehicle stopping distances when driving on gravelled surfaces to prevent paint damage.

Repair, or have repaired quickly, areas where the paint has been damaged, to prevent corrosion spreading.

Remember to visit the body shop periodically in order to maintain your anti-corrosion warranty. Refer to the Maintenance Document.

If it is necessary to clean mechanical components, hinges, etc., spray them with products approved by our Technical Department to protect them after they have been cleaned.

We have selected special products to care for your vehicle and you can obtain these from the manufacturer's accessory outlets.

Vehicles with a matte paint finish

This type of paint requires certain precautions.

Do not do the following

- use wax-based products (polishing);
- rub hard;
- wash the vehicle in a roller-type car wash;
- wash the vehicle using a high-pressure device;
- attach stickers to the paintwork (risk of leaving marks).

You should do the following

Wash the vehicle by hand using plenty of water, using a soft cloth or a gentle sponge.

Using a roller type car wash

Return the windscreen wiper stalk to the Park position (refer to the information on the “Windscreen washer, wiper” in Section 1). Check the mounting of external accessories, additional lights and mirrors, and ensure that the wiper blades are secured with adhesive tape. Remove the radio aerial mast if your vehicle is fitted with this equipment. Remember to remove the tape and refit the antenna after washing.

Cleaning the headlights

As the headlights are made of plastic “glass”, use a soft cloth or cotton wool to clean them. If this does not clean them properly, moisten the cloth with soapy water, then wipe clean with a soft damp cloth or cotton wool. Finally, carefully dry off with a soft dry cloth.

Cleaning products containing alcohol must not be used.

INTERIOR TRIM MAINTENANCE (1/2)

A well-maintained vehicle will last longer. It is therefore recommended to maintain the interior of the vehicle regularly.

A stain should always be dealt with swiftly.

Whatever type of stain is on the trim, use **cold** (or warm) **soapy water with natural soap**.

Detergents (washing-up liquid, powdered products, alcohol-based products) should not be used.

Use a soft cloth.

Rinse and soak up the excess.

Glass instrument panel

(e.g. instrument panel, clock, exterior temperature display, radio display, etc.)

Use a soft cloth (or cotton wool).

If this does not clean it properly, use a soft cloth (or cotton wool) slightly moistened with soapy water and then wipe clean with a soft damp cloth or cotton wool.

Finally, **carefully** dry off with a soft dry cloth.

Cleaning products containing alcohol must not be used under any circumstances.

Seat belts

These must be kept clean.

Use products selected by our Technical Department (Approved outlets) or warm, soapy water and a sponge and wipe with a dry cloth.

Detergents or dyes must not be used under any circumstances.

Textiles (seats, door trim, etc)

Vacuum-clean the textiles **regularly**.

Liquid stain

Use soapy water.

Dab lightly (never rub) with a soft cloth, rinse and remove the excess.

Solid or pasty stain

Carefully remove the excess solid or pasty material **immediately** with a spatula (working from the edges to the centre to avoid spreading the stain).

Clean as for a liquid stain.

Special instructions for sweets or chewing gum

Put an ice cube on the stain to solidify it, then proceed as for a solid stain.

For further recommendations for maintaining the interior, and/or for any unsatisfactory results, please see an authorised dealer.

INTERIOR TRIM MAINTENANCE (2/2)

Removal/replacing removable equipment originally fitted in the vehicle

If you need to remove equipment in order to clean the passenger compartment (for example, mats), always ensure that they are correctly refitted and are the right way around (the driver's mat should be fitted on the driver's side, etc.) and fit them with the components supplied with the equipment (for example, the driver mat should always be fixed using the pre-fitted mounting components).

With the vehicle stationary, ensure that nothing will impede driving (anything obstructing the pedals, heel wedged by the mat, etc.).

You should not:

You are strongly advised not to position objects such as deodorants, scents, etc. near air vents, as this could damage your dashboard trim.



You are strongly recommended not to use high-pressure or spray cleaning equipment inside the passenger compartment: use of such equipment could impair the correct functioning of the electrical or electronic components in the vehicle, or have other detrimental effects.



Section 5: Practical advice

Tools	5.2
Puncture	5.3
Tyre inflation kit	5.5
Wheel trim – Wheel rims	5.11
Changing a wheel	5.12
Tyres (tyre and wheel safety, use in winter)	5.14
Front lights: changing bulbs.	5.17
Fog lights: changing bulbs.	5.18
Rear and side lights: changing bulbs.	5.19
Interior lights: changing bulbs	5.22
Fuses.	5.24
Radio frequency remote control unit: batteries	5.28
Battery	5.29
Wiper blades	5.31
Towing: troubleshooting.	5.32
Fitted audio equipment	5.34
Accessories	5.35
Operating faults	5.36

TOOLS

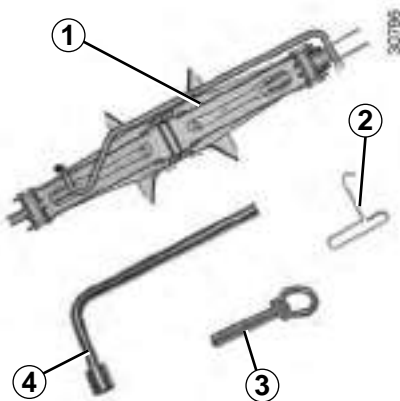

Accessing the tools

The tools are located in the luggage compartment.

The presence of the tools depends on the vehicle.

Jack 1

To use the jack, unscrew nut 5. When replacing the jack, fold it up completely and replace it in its housing. Tighten the nut 5 to secure the jack.

Hubcap tool 2

Removes the wheel hubcaps. Located behind the jack.

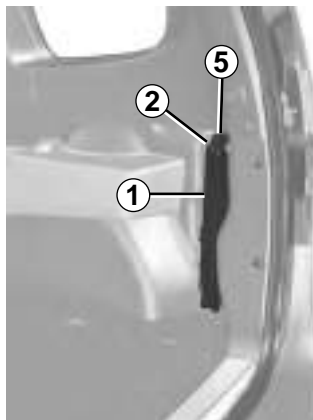

Wheelbrace 4

This is used to tighten/loosen the wheel bolts and, depending on the vehicle, to access the emergency spare wheel.

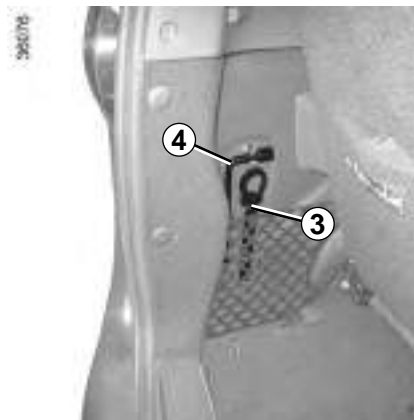

Tow eye 3

Please see "Towing: breakdown recovery" in Section 5.



Never leave tools unsecured in the vehicle: there is a risk that they may be thrown about during braking. After use, make sure the tools are correctly positioned in their housings: there is a risk of injury.

If wheel bolts are supplied in the tool kit, only use these bolts for the emergency spare wheel: refer to the label affixed to the emergency spare wheel. The jack is designed for wheel changing purposes only. Under no circumstances should it be used for carrying out repairs underneath the vehicle or to gain access to the underside of the vehicle.

PUNCTURE (1/2)

In the event of a puncture, depending on the vehicle, you will have:

An emergency spare wheel or tyre inflation kit (refer to the information on the following pages).



If the emergency spare wheel has been stored for several years, have it checked by your Dealer to ensure that it is safe to use.

Vehicle fitted with an emergency spare wheel that differs from the other wheels:

- Never fit more than one emergency spare wheel to the same vehicle.
- As the punctured wheel is wider than the emergency spare wheel, the vehicle's ground clearance is reduced.
- Replace the emergency spare wheel as soon as possible with a wheel identical to the original one.
- When this is fitted to the vehicle, which must only be a temporary measure, the driving speed must not exceed the speed indicated on the label on the wheel.
- Fitting an emergency spare wheel may alter the way the vehicle usually runs. Avoid sudden acceleration or deceleration and reduce your speed when cornering.
- If you need to use snow chains, fit the emergency spare wheel to the rear axle and check the tyre pressure.

PUNCTURE (2/2)



Emergency spare wheel 2

This is stored in cage 4 under the floor at the rear of the vehicle.

To access the emergency spare wheel

- Open the tailgate;
- Undo the nut with wheelbrace 1 stored in the boot;
- Detach the cage 4 using handle 3;
- Release the emergency spare wheel.



Do not touch the exhaust as it could burn.

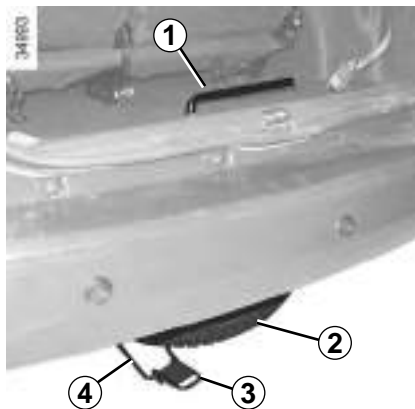

To store the wheel in the cage

- Make sure the wheel is correctly positioned in the cage 4, valve facing down.
- Re-attach the subframe using handle 3 and retighten the nut using spanner 1 to refit the assembly.
- Make sure it is correctly locked.

If the cage 4 cannot be re-attached, this means that the wheel is poorly positioned. If this happens, open the cage, push the wheel in as far as it will go and close again.



Do not leave the tools unsecured inside the vehicle as they may come loose under braking. After use, make sure the tools are correctly positioned in their housings: risk of injury.

If wheel bolts are supplied in the tool kit, only use these bolts for the emergency spare wheel: refer to the label affixed to the emergency spare wheel.

The jack is designed for wheel changing purposes only. Under no circumstances should it be used for carrying out repairs underneath the vehicle or to gain access to the underside of the vehicle.

TYRE INFLATION KIT (1/6)

30798



The kit repairs tyres with tread **A** damaged by objects smaller than **4 mm**. It cannot repair all types of puncture, such as cuts of more than **4 mm**, or cuts in tyre sidewall **B** etc.

Ensure also that the wheel rim is in good condition.

Do not pull out the foreign body causing the puncture if it is still in the tyre.



Do not attempt to use the inflation kit if the tyre has been damaged as a result of driving with a puncture.

You should therefore carefully check the condition of the tyre sidewalls before any operation.

Driving with underinflated, flat or punctured tyres can be dangerous and may make the tyre impossible to repair.

This repair is temporary

A tyre which has been punctured should always be inspected (and repaired, where possible) as soon as possible by a specialist.

When replacing a tyre repaired with this kit, you must consult a specialist. When driving, vibration may be felt due to the presence of the repair product injected into the tyre.



The kit is only approved for inflating the tyres of the vehicle originally equipped with the kit.

It must never be used to inflate the tyres of another vehicle, or any other inflatable object (rubber ring, rubber boat, etc.).

Avoid spillage on skin when handling the repair liquid bottle. If droplets do leak out, rinse them off with plenty of water.

Keep the repair kit away from children.

Do not dispose of the empty bottle in the countryside. Return it to your approved dealer or to a recycling organisation.

The bottle has a limited service life which is indicated on its label. Check the expiry date.

Contact an approved dealer to replace the inflation tube and repair product bottle.

TYRE INFLATION KIT (2/6)

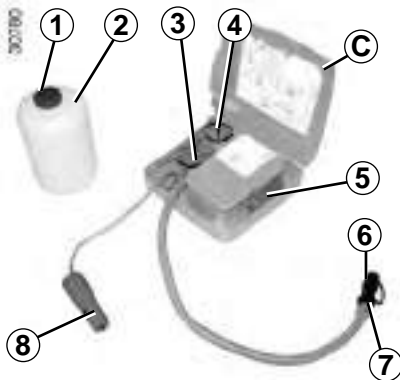

Inflation kit C

Depending on the vehicle, in the event of a puncture, use the kit **C** located in the boot.



Before using this kit, park the vehicle at a sufficient distance from traffic, switch on the hazard warning lights, apply the handbrake, ask all passengers to leave the vehicle and keep them away from traffic.



Open the kit, remove caps **1** and **3** (it is **essential** not to remove the cap from the bottle) then screw bottle **2** to its base **3**.

With the engine running and the handbrake applied,

- unscrew the valve cap on the wheel concerned and screw the inflation adapter **6** onto valve;
- connect adapter **8** to accessories socket **9** on the dashboard of the vehicle;



If the vehicle is parked on the hard shoulder, you must warn other road users of your vehicle's presence with a warning triangle or with other devices as per the legislation applying to the country you are in.

TYRE INFLATION KIT (3/6)

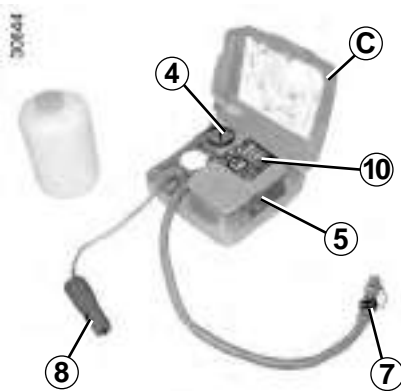

- press switch **5** to inflate the tyre to the recommended pressure (check the label affixed to the edge of the driver's door);
- after a maximum of **5** minutes, stop inflating and read the pressure (on the pressure gauge **4**);

Note: while the bottle is emptying (approximately 30 seconds), pressure gauge **4** will briefly indicate a pressure of 6 bar, then the pressure will drop.

- adjust the pressure: to increase it, continue inflating with the kit, to reduce it, turn button **7** located on the inflation adapter.

If a minimum pressure of 1.8 bar is not reached after 15 minutes, repair is not possible; do not drive the vehicle but contact an approved dealer.

Once the tyre is inflated correctly:

- stop using the kit;
- close the integrated cap on the bottle again;
- disconnect the adapter **8**;
- affix driving recommendation label **10** to the dashboard where it can easily be seen by the driver;



Nothing should be placed around the driver's feet as such objects may slide under the pedals during sudden braking manoeuvres and obstruct their use.

- store the kit;
- after the first inflation procedure the tyre will still be leaking; it is vital to drive in order to plug the hole;
- start immediately and drive at between 12 and 36 mph (20 and 60 km/h) to distribute the product evenly throughout the tyre, stopping after a distance of 2 miles (3 kilometres) to check the pressure;



Following repair with the kit, do not travel further than 120 miles (200 km). In addition, reduce your speed and under no circumstances exceed 48 mph (80 km/h). The sticker, which you must affix in a prominent position on the dashboard, reminds you of this.

Depending on the country or local legislation, a tyre repaired with the tyre pressure kit will need to be replaced.

TYRE INFLATION KIT (4/6)

- if the pressure is greater than 1.3 bar but less than the recommended pressure (refer to the label affixed to the edge of the driver's door), readjust it; otherwise, please contact an authorised dealer: the tyre cannot be repaired.

Note: after using the inflation kit, you should visit an approved dealer to replace the inflation hose and the bottle of repair product.

Precautions when using the kit

The kit should not be operated for more than 15 consecutive minutes.



Important: a missing or loose valve cap may compromise the tyre seal and cause a loss of pressure.

Always use valve caps which are identical to the originals and fully tightened.



Following repair with the kit, do not travel further than 120 miles (200 km). In addition, reduce your speed and under no circumstances exceed 48 mph (80 km/h). The sticker, which you must affix in a prominent position on the dashboard, reminds you of this.

Depending on the country or local legislation, a tyre repaired with the tyre pressure kit will need to be replaced.

TYRE INFLATION KIT (5/6)

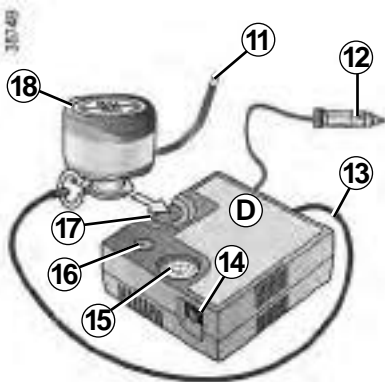

Inflation kit **D**

Depending on the vehicle, in the event of a puncture, use the kit **D** located in the boot or underneath the boot carpet.



Before using this kit, park the vehicle at a sufficient distance from traffic, switch on the hazard warning lights, apply the handbrake, ask all passengers to leave the vehicle and keep them away from traffic.

With the engine running and the handbrake engaged:

- unroll the hose from the container;
- connect the compressor hose **13** to the container inlet **18**;
- depending on the vehicle, connect the container **18** to the compressor from the container recess **17**;
- unscrew the valve cap on the relevant wheel and screw on the container's inflation adapter **11**;
- adapter **12** must be connected to the vehicle accessories socket;
- press switch **14** to inflate the tyre to the recommended pressure (please refer to the information on “Tyre pressure”);

- after a maximum of **15** minutes, stop inflating and read the pressure (on pressure gauge **15**).

Note: while the container is emptying (approximately 30 seconds), the pressure gauge **15** will briefly indicate a pressure of up to **6** bar. The pressure will then drop.

- adjust the pressure: to increase it, continue inflation with the kit; to reduce it, press button **16**.

If a minimum pressure of 1.8 bar is not reached after 15 minutes, repair is not possible; do not drive the vehicle but contact an approved dealer.



If the vehicle is parked on the hard shoulder, you must warn other road users of your vehicle's presence with a warning triangle or with other devices as per the legislation applying to the country you are in.

TYRE INFLATION KIT (6/6)

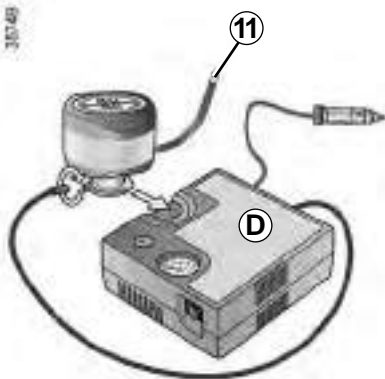

Once the tyre is correctly inflated, remove the kit: slowly unscrew the inflation adapter **11** to prevent any repair product from escaping and store the container in plastic packaging to prevent the product from escaping.



Nothing should be placed around the driver's feet as such objects may slide under the pedals during sudden braking manoeuvres and obstruct their use.

- Affix the driving recommendation label to the dashboard where it can easily be seen by the driver;
- Put the kit away.
- At the end of this initial inflation operation, air will still escape from the tyre. You must drive a short distance in order to seal the hole.
- Start immediately and drive at between 12 and 40 mph (20 and 60 km/h) in order to distribute the product evenly in the tyre and, after driving for 2 miles (3 km), stop and check the pressure.
- If the pressure is greater than 1.3 bar but less than the recommended pressure (refer to the label affixed to the edge of the driver's door), readjust it. Otherwise, please contact an authorised dealer: the tyre cannot be repaired.

Precautions when using the kit

The kit should not be operated for more than 15 consecutive minutes.



Please be aware that a poorly tightened or missing valve cap can make the tyres less airtight and may lead to pressure loss.

Always use valve caps identical to those fitted originally and tighten them fully.



Following repair with the kit, do not travel further than 120 miles (200 km). In addition, reduce your speed and under no circumstances exceed 48 mph (80 km/h). The sticker, which you must affix in a prominent position on the dashboard, reminds you of this.

Depending on the country or local legislation, a tyre repaired with the inflation kit may need to be replaced.

WHEEL TRIM - WHEELS

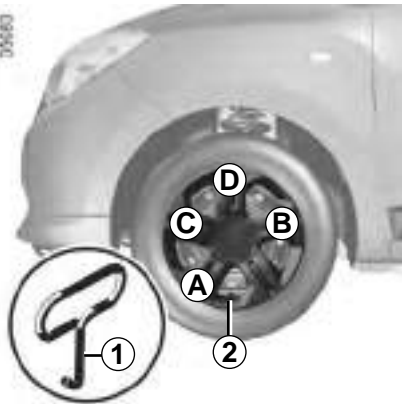

Wheel trim with concealed wheel bolts

Remove the wheel trim using the hubcap tool **1**, by inserting the tool into valve recess **2**.

To refit the wheel trim, align it with valve **2**. Push the retaining hooks in fully, starting with side **A** near the valve, followed by **B** and **C**, finishing at **D** opposite the valve.



Wheel trim with visible wheel bolts

To remove it without removing the wheel, press it at the points indicated by the arrows.

Turn it so that the retaining brackets holding it in place behind the wheel bolts are released.

To refit the hubcap, proceed in reverse order.

Anti-theft bolts

If you use anti-theft bolts, use the instructions on the inside of the wheel trim to position the bolts (wheel trim may not be able to fit).

CHANGING A WHEEL (1/2)

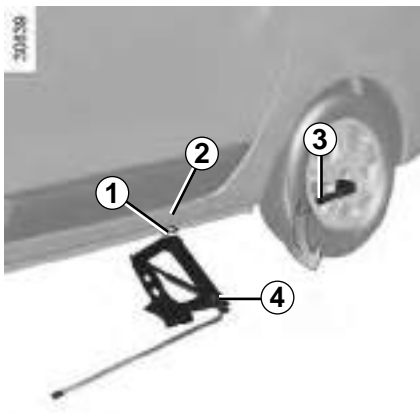

Switch on the hazard warning lights.

Keep the vehicle away from traffic and on a level surface where it will not slip.

Apply the parking brake and engage a gear (first or reverse).

Ask all passengers to leave the vehicle and keep them away from traffic.

Vehicles equipped with a jack and wheelbrace

If necessary, remove the hubcap.

Use the wheelbrace **3** to slacken off the wheel bolts. Fit it so that you press downwards rather than pulling upwards.

If the vehicle is not equipped with a jack or wheelbrace, you can obtain these from your approved dealer.



If the vehicle is parked on the hard shoulder, you must warn other road users of your vehicle's presence with a warning triangle or with other devices as per the legislation applying to the country you are in.

Place the jack **4** horizontally; the jack head **must** be lined up with the sill **1** closest to the wheel concerned, as shown by arrow **2**.

Crank up the jack **4** by hand at first to align the base plate (which should be inclined further inwards than the jack head).

Turn the wheelbrace until the wheel lifts off the ground.



To prevent any risk of injury or damage to the vehicle, only crank the jack until the wheel you are replacing is a maximum of 3 centimetres off the ground.

CHANGING A WHEEL (2/2)

Undo the bolts and take off the wheel.

Fit the emergency spare wheel on the central hub and turn it to locate the mounting holes in the wheel and the hub.

If bolts are supplied with the emergency spare wheel, only use these bolts for the emergency spare wheel.

Tighten the bolts, checking that the wheel is correctly positioned on its hub and lower the jack.

With the wheel on the ground, tighten the bolts fully and have the tightness of the bolts checked (tightening torque: 110 N.m) and the emergency spare wheel pressure checked as soon as possible.

Anti-theft bolts

If you use anti-theft bolts, please refer to the instructions given on the interior of the wheel trim to position the bolts (wheel trim may not be able to fit).



If you have a puncture, replace the wheel as soon as possible. A tyre which has been punctured should always be inspected (and repaired, where possible) by a specialist.

TYRES (1/3)

Tyre and wheel safety

The tyres are the only contact between the vehicle and the road, so it is essential to keep them in good condition.

You must make sure that your tyres conform to local road traffic regulations.



When they need to be replaced, only tyres of the same make, size, type and profile should be used.

Tyres fitted to the vehicle should either be identical to those fitted originally or conform to those recommended by your approved Dealer.



Maintaining the tyres

The tyres must be in good condition and the tread form must have sufficient depth; tyres approved by our Technical Department have wear warning strips **1** which are **indicators moulded into the tread at several points.**

When the tyre tread has been worn to the level of the warning strips, **they become visible 2**: it is **then** necessary to replace your tyres because the tread rubber is now only **1.6 mm deep at most, resulting in poor road holding on wet roads.**

An overloaded vehicle, long journeys by motorway, particularly in very hot weather, or continual driving on poorly surfaced minor roads will lead to more rapid tyre wear and affect safety.



Incidents which occur when driving, such as striking the kerb, may damage the tyres and wheel rims, and could also lead to misalignment of the front or rear axle geometry.

In this case, have the condition of these checked by an approved dealer.

TYRES (2/3)

Tyre pressures

Adhere to the tyre pressures (including the emergency spare wheel). The tyre pressures should be checked at least once a month and additionally before any long journey (refer to the label affixed to the edge of the driver's door).



Incorrect tyre pressures

lead to abnormal tyre wear and unusually hot running. These are factors which may seriously affect safety and lead to:

- poor road holding,
- risk of bursting or tread separation.

The pressure depends on the load and the speed of use. Adjust the pressure according to the conditions of use (refer to the label affixed to the edge of the driver's door).

Pressures should be checked when the tyres are cold; ignore higher pressures which may be reached in hot weather or following a fast journey.

If tyre pressures cannot be checked when the tyres are **cold**, assume an increase of **0.2** to **0.3** bar.

Never deflate a hot tyre.

Special note

Depending on the vehicle, there may be an adapter which needs to be positioned on the valve before air is added.



Please be aware that a poorly tightened or missing valve cap can make the tyres less airtight and lead to pressure loss.

Always use valve caps identical to those fitted originally and tighten them fully.

Changing wheels around

This practice is not recommended.

Emergency spare wheel

Refer to the information on “Puncture” and “Changing a wheel” in Section 5.

Fitting new tyres



For safety reasons, this operation must be carried out by a specialist.

Fitting different tyres may change your vehicle as follows:

- it may mean that your vehicle no longer conforms to current regulations;
- It may change the way it handles when cornering;
- It may cause the steering to be heavy;
- it may affect the use of snow chains.

TYRES (3/3)

Use in winter

Chains

For safety reasons, fitting snow chains to the rear axle is strictly forbidden.

Chains must not be fitted to tyres which are larger than those originally fitted to the vehicle.



Chains may only be fitted to tyres of the same size as those originally fitted to **your vehicle**.

Only certain chains can be fitted to tyres. Consult an approved dealer.

Special note for versions fitted with 16" wheels: snow chains may not be fitted.

If you wish to fit snow chains, you must use **special equipment**.

Consult your approved dealer.

Snow or Winter tyres

We would recommend that these be fitted to all **four wheels** to ensure that your vehicle retains maximum adhesion.

Warning: These tyres sometimes have a specific direction of rotation and a maximum speed index which may be lower than the maximum speed of your vehicle.

Studded tyres

This type of equipment may only be used for a limited period and as laid down by local legislation.

It is necessary to observe the speed specified by current legislation.

These tyres must, at a minimum, be fitted to the two front wheels.

In all cases, we would recommend that you contact your approved Dealer who will be able to advise you on the choice of equipment which is most suitable for your vehicle.

FRONT LIGHTS: changing bulbs

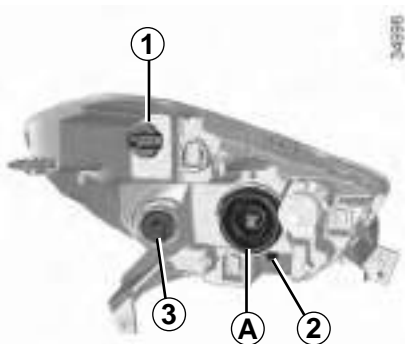

The following bulbs can be replaced. However, we would advise you to have them replaced by an approved dealer if it proves difficult.

To comply with current legislation, or as a precaution, you can obtain an emergency kit from your approved dealer containing a set of spare bulbs and fuses.

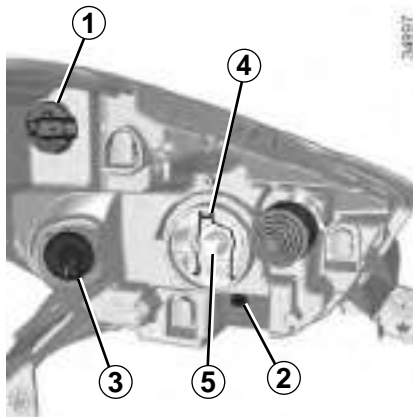

Main beam headlights, dipped beam headlights

Remove the connector from the bulb 5.

Remove cover A.

Unclip the spring 4 and take out the bulb.

Bulb type: H4 anti UV (see box).

Do not touch the bulb glass. Hold it by its base.

When the bulb has been changed, make sure you refit the cover correctly.

Daytime running light

Turn the bulb holder 1 a quarter of a turn and take out the bulb.

Bulb type: P21W.

Front side light

Turn the bulb holder 2 a quarter of a turn and take out the bulb.

Bulb type: W5W.

Direction indicator lights

Turn the bulb holder 3 a quarter of a turn and take out the bulb.

Bulb type: PY21W.



The engine may be hot during operations in close proximity. In addition, the engine cooling fan may come on at any moment.

Risk of injury.



The bulbs are under pressure and can break when replaced.

Risk of injury.

FOG LIGHTS: changing bulbs



Front fog lights 1

Consult an approved dealer.

Bulb type: H16LL.



The bulbs are under pressure and can break when replaced.

Risk of injury.

Additional lights

If you wish to fit fog lights to your vehicle, please see an authorised dealer.



Any operation on (or modification to) the electrical system must be performed by an approved Dealer since an incorrect connection might damage the electrical equipment (harness, components and in particular the alternator). In addition, your Dealer has all the parts required for fitting these units.



The engine may be hot during operations in close proximity. In addition, the engine cooling fan may come on at any moment.

Risk of injury.

REAR AND SIDE LIGHTS: changing bulbs (1/3)



Direction indicator, brake and side lights

Undo bolt **1** to remove the light.

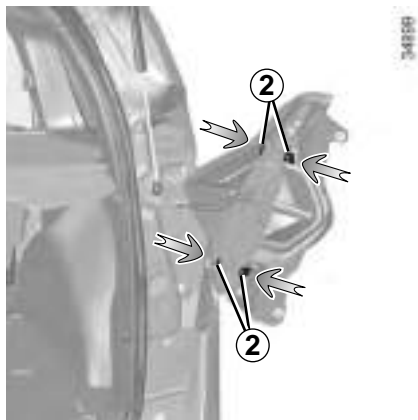

Release the light assembly from outside the vehicle by pulling towards the rear.

Remove the bulb holder **3** by releasing clips **2**.

Refitting

To refit, proceed in the reverse order, taking care not to damage the wiring, and fasten clips **2** on the bulb holder **3**.

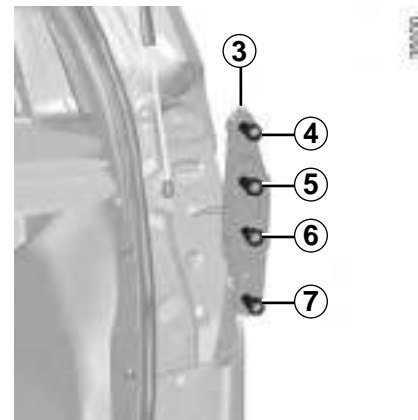

4 Side light and brake light

Bulb type 4: P21/5W.

5 Indicator light

Bulb type 5: PY21W.

6 Reversing light (right-hand side only)

Bulb type 6: P21W.

7 Fog light (left-hand side only)

Bulb type 7: P21W.

REAR AND SIDE LIGHTS: changing bulbs (2/3)

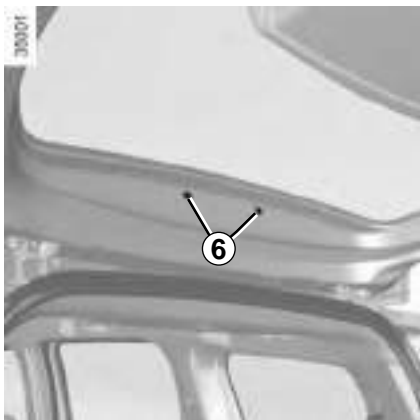

High-level brake light

- Remove the two plastic blanking covers **6** from the inside.
- Unclip the light using a screwdriver, by releasing the metal clips from their housings.
- Remove light from the outside. Replace the bulb without disconnecting the wiring.

Bulb type 7: W16W.



Refitting

To return it, proceed in the reverse order to removal.

Check the tabs are correctly locked in position.



The bulbs are under pressure and may break when replaced.

Risk of injury.

REAR AND SIDE LIGHTS: changing bulbs (3/3)

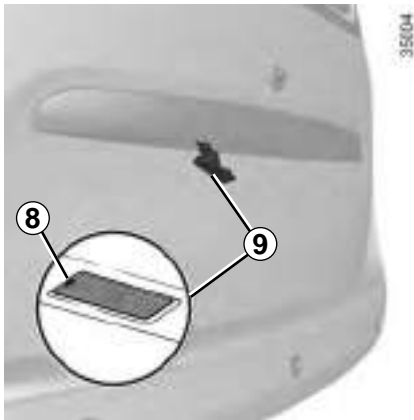

Number plate lights **9**

Unclip light **9** by pressing tab **8** using a flat-blade screwdriver or similar.

Remove the light cover to gain access to the bulb.

Bulb type: W5W

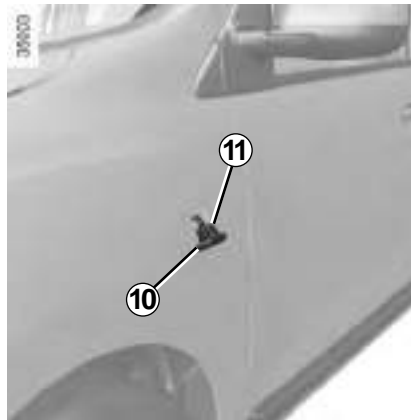

Side indicator lights **10**

Unclip the side mounted indicator light **10** (using a flat-blade screwdriver or similar).

Turn the bulb holder **11** a quarter of a turn and take out the bulb.

Bulb type: W5W.



The bulbs are under pressure and can break when replaced.

Risk of injury.

INTERIOR LIGHTING: changing bulbs (1/2)



Courtesy light

Unclip lens **1** using a flat-blade screwdriver or similar.



Remove the bulb.

Bulb type 2: W5W.



Rear courtesy light

Remove the lens **3** using a tool such as a flat-blade screwdriver.

Release the bulb.

Bulb type: W5W.



The bulbs are under pressure and may break when replaced.

Risk of injury.

INTERIOR LIGHTING: changing bulbs (2/2)

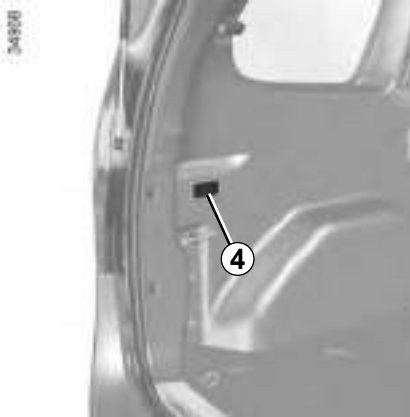

Luggage compartment light

Unclip the light **4** (using a tool such as a flat-blade screwdriver).

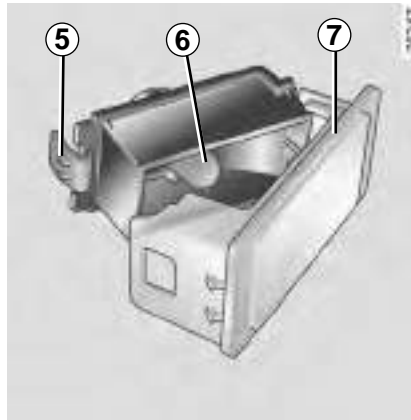

Press tab **5** to release the lens **7** and access bulb **6**.

Bulb type: W5W.



The bulbs are under pressure and may break when replaced.

Risk of injury.

FUSES (1/4)



Fuses in passenger compartment A

If any electrical component does not work, check the condition of the fuses. Unclip the access flap **A**.

To comply with current legislation, or as a precaution, you can obtain an emergency kit from your approved dealer containing a set of spare bulbs and fuses.

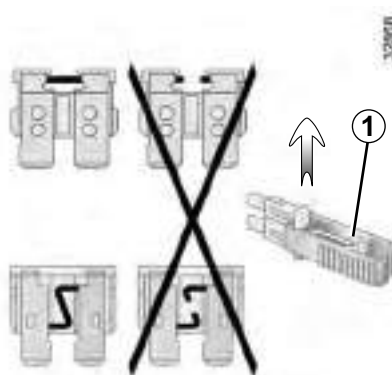

Clip 1

Remove the fuse using tweezers **1**, located at the back of flap **A**. To remove the fuse from the tweezers, slide the fuse to the side. It is not advisable to use the free fuse locations.



Check the fuse in question and **replace it**, if necessary, **with a fuse of the same rating**.

If a fuse is fitted where the rating is too high, it may cause the electrical circuit to overheat (risk of fire) in the event of an item of equipment using an excessive amount of current.

FUSES (2/4)

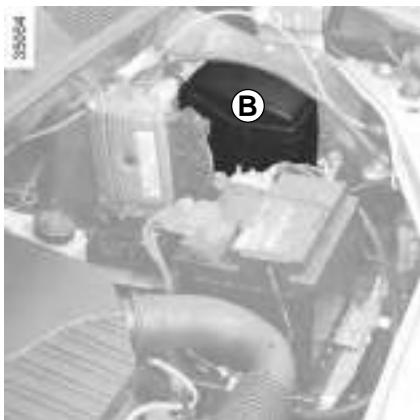

Fuses in engine compartment **B**

Some functions are protected by fuses located in the engine compartment (unit **B**).

However, because of their reduced accessibility, **we advise you to have your fuses replaced by an approved Dealer.**

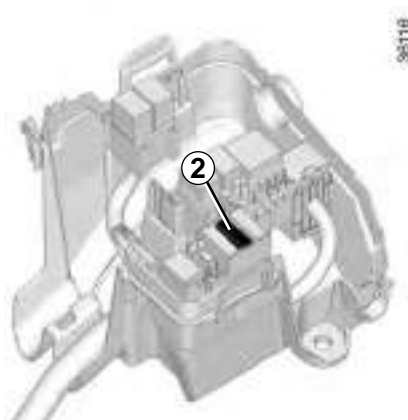

Special features of LPG versions

The specific LPG circuit shut-off fuse **2** is located in the box **B**.



The engine may be hot during operations in close proximity. In addition, the engine cooling fan may come on at any moment.

Risk of injury.

FUSES (3/4)

Allocation of fuses in the passenger compartment
(the presence of certain fuses DEPENDS ON THE VEHICLE EQUIPMENT LEVEL)

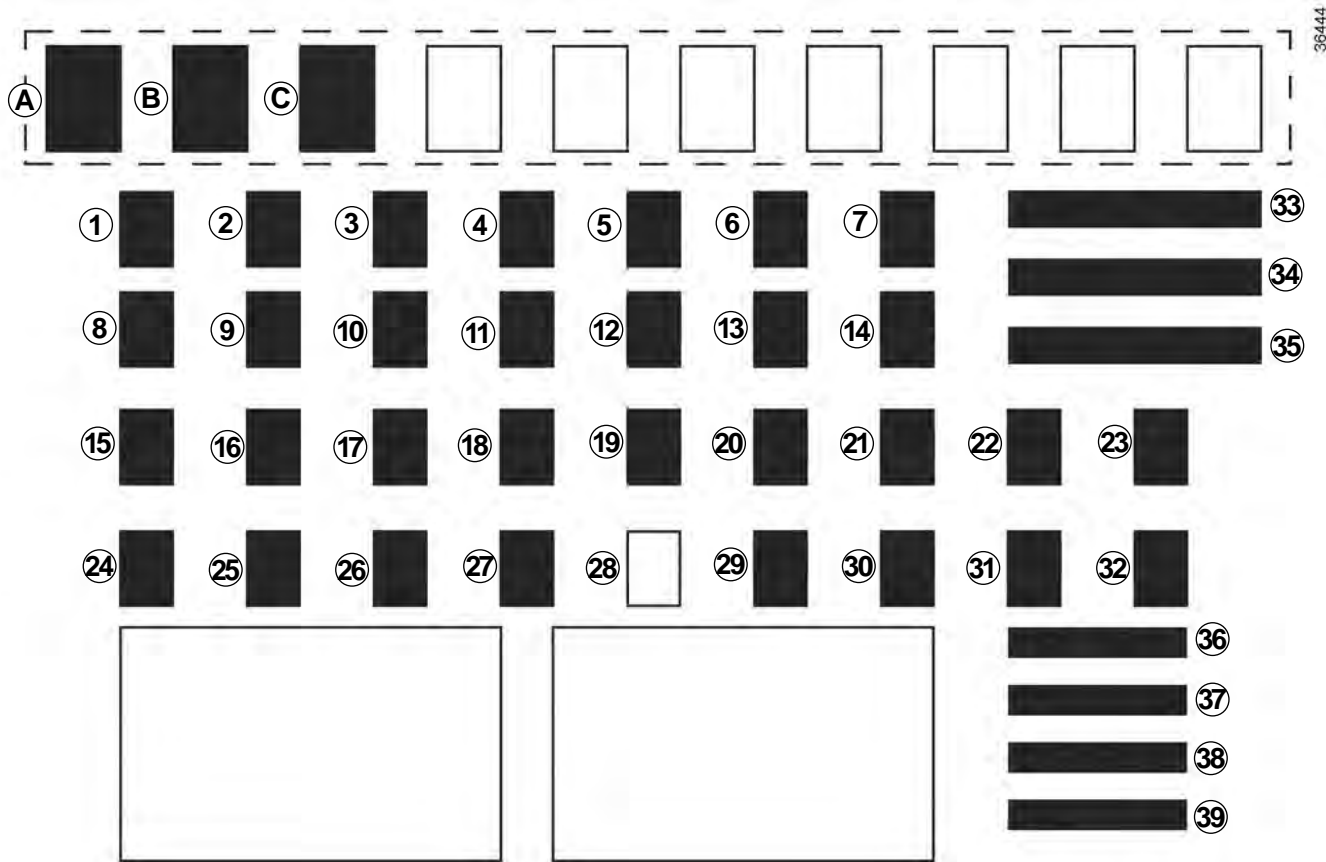

FUSES (4/4)

Number	Allocation
A	Electric rear window
B	Electric door mirrors
C	Front electric window
1	LPG
2	Left-hand main beam headlight
3	Right-hand main beam headlight
4	Left-hand dipped beam headlight
5	Right-hand dipped beam headlight
6	Left-hand side lights
7	Right-hand side lights
8	Rear accessories socket
9	Rear fog lights
10	Horn
11	Automatic door locking

Number	Allocation
12	ESC
13	Courtesy light
14	ABS-ESC
15	Reverse gear, windscreen wiper
16	Cruise control-Speed limiter, rear windscreen, unfastened seatbelt warning, parking distance control
17	Daytime running lights
18	Brake lights
19	Fuel pump, Injection
20	Airbag
21	Heated seats
22	Power-assisted steering
23	Location reserved for additional equipment.
24	Direction indicator light

Number	Allocation
25	Passenger compartment ECU
26	Passenger compartment ECU
27 and 29	Steering column control
28	Not used
30	Location reserved for additional equipment.
31	Instrument panel
32	Radio
33	Starter
34	Windscreen wiper
35	Passenger compartment ventilation
36	Cigar lighter
37	Diagnostic socket
38	Defrosting rearview mirror
39	Front fog lights

RADIO FREQUENCY REMOTE CONTROL: batteries

27346

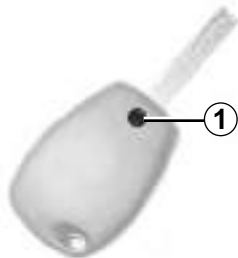

Replacing the remote control battery

Undo screw **1** to remove the remote control cover.

The batteries are available from approved Dealers, and their service life approximately two years.

Check that there is no dye on the battery: risk of an incorrect electrical contact.

27347



Replace battery **2** according to the direction marked on the cover.

Note: It is not advisable to touch the electronic circuit in the key cover when replacing the battery.

When refitting, ensure that the cover is correctly clipped on and the screw tightened.

20910



Do not throw away your used batteries; give them to an organisation responsible for collecting and recycling batteries.

BATTERY: troubleshooting (1/2)

To avoid all risk of sparks:

- Ensure that any consumers (courtesy lights, etc.) are switched off before disconnecting or reconnecting the battery;
- when charging, stop the charger before connecting or disconnecting the battery;
- to avoid creating a short circuit between the terminals, do not place metal objects on the battery;
- always wait at least one minute after the engine has been switched off before disconnecting a battery;
- make sure that you reconnect the battery terminals after refitting.

Connecting a battery charger

The battery charger must be compatible with a battery with nominal voltage of 12 volts.

Do not disconnect the battery when the engine is running. **Follow the instructions given by the manufacturer of the battery charger you are using.**



Some batteries may have specific conditions for recharging. Consult your approved dealer. Avoid the risk of sparks, as this could cause a sudden explosion, and always charge the battery in a well-ventilated area.

Risk of serious injury.



Handle the battery with care as it contains sulphuric acid, which must not come into contact with eyes or skin. If it does, wash the affected area with plenty of cold water and consult a doctor, if necessary.

Ensure that naked flames, red hot objects and sparks do not come into contact with the battery as there is a risk of explosion.

The engine may be hot when carrying out operations in close proximity. In addition, the engine cooling fan can come on at any moment.

Risk of injury.

BATTERY: troubleshooting (2/2)

Starting the vehicle using the battery from another vehicle

If you have to use the battery from another vehicle to start, obtain suitable jump leads (with a large cross section) from an approved dealer or, if you already have jump leads, ensure that they are in perfect condition.

The two batteries must have an identical nominal voltage of 12 volts. The battery supplying the current should have a capacity (amp-hours, Ah) which is at least the same as that of the discharged battery.

Ensure that there is no risk of contact between the two vehicles (risk of short circuiting when the positive terminals are connected) and that the discharged battery is properly connected. Switch off your vehicle ignition.

Start the engine of the vehicle supplying the current and run it at an intermediate engine speed.

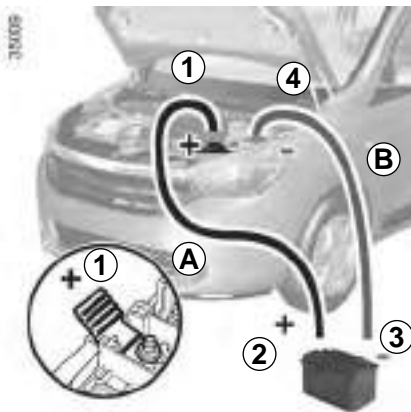

Connect the positive cable (+) **A** to the (+) terminal **1** of the discharged battery, then to the (+) terminal **2** of the battery supplying the current.

Connect the negative cable (-) **B** to the (-) **3** terminal of the battery supplying the current and then to the (-) **4** terminal of the discharged battery.

Start the engine as normal. As soon as it starts, disconnect cables **A** and **B** in reverse order (**4-3-2-1**).



Check that there is no contact between leads **A** and **B** and that the positive lead **A** is not touching any metal parts on the vehicle supplying the current.

Risk of serious injury and/or damage to the vehicle.

WIPER BLADES

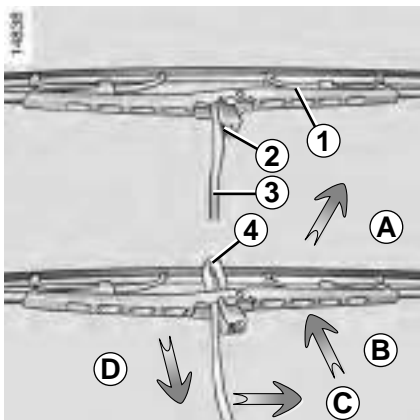

Replacing windscreen wiper blades 1

- With the ignition switched off, lift wiper arm **3**;
- turn the blade horizontally (movement **A**);
- press tab **2** and slide the wiper blade downwards (movement **D**) until hook **4** on the wiper arm is released.
- slide the blade (movement **C**) then lift it (movement **B**) to release it.

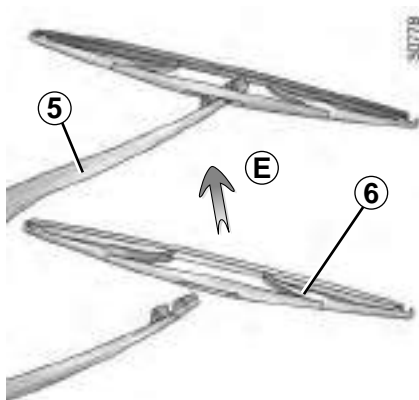

Replacing the rear screen wiper blade 6

- With the ignition switched off, lift wiper arm **5**;
- pivot the blade **6** until some resistance is met;
- pull the blade to release it (movement **E**).

Refitting a front or rear wiper blade

To refit the wiper blade, proceed in reverse order to removal. Make sure that the blade is correctly locked in position.

Check the condition of the wiper blades. You are responsible for their service life:

- clean the blades, windscreen and rear screen regularly with soapy water;
- do not use them when the windscreen or rear screen are dry;
- free them from the windscreen or rear screen when they have not been used for a long time.



– In frosty weather, make sure that the wiper blades are not stuck by ice (to avoid the risk of the motor overheating).

- Check the condition of the wiper blades.

Replace the wiper blades as soon as they begin to lose efficiency (approximately once a year).

Whilst changing the blade, take care not to drop the arm onto the window after it has been removed as this may break the window.

TOWING: breakdown (1/2)

The steering wheel must be unlocked and the ignition key must be in position M (ignition on) to provide brake lights and hazard warning lights on the towed vehicle. At night the vehicle must have its lights on.

Furthermore, it is essential to respect the towing regulations set out in the legislation of the country concerned and, if your vehicle is the towing vehicle, not to exceed the towing weight of your vehicle. Contact an approved Dealer.



Do not remove the key from the ignition when the vehicle is being towed.



When the engine is stopped, steering and braking assistance are not operational.

TOWING: breakdown (2/2)



Only use the front **1** and rear **4** towing points.

These towing points may only be used for towing: never use them for lifting the vehicle directly or indirectly.

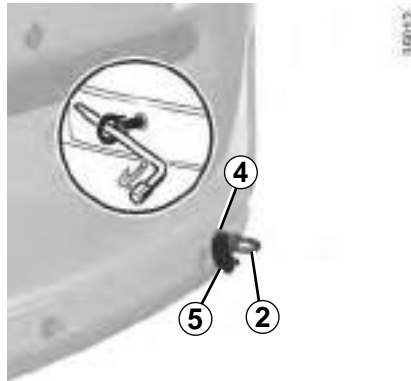

Access to towing points

Unclip cover **3** or **5** by inserting a flat-blade screwdriver or similar under the cover.

Tighten towing hitch 2 fully: as much as possible by hand at first, then finish tightening it using the wheelbrace.

Use only towing hitch **2** and the wheelbrace located under the luggage compartment carpet in the tool kit (please refer to the information on the "Tool kit" in Section 5).



– Use a rigid towing bar. If a rope or cable is used (where the law allows this), the vehicle being towed

- must be able to brake.
- A vehicle must not be towed if it is not fit to be driven.
- Avoid accelerating or braking suddenly when towing, as this may result in damage being caused to the vehicle.
- When towing a vehicle, it is advisable not to exceed **15 mph (25 km/h)**.



Do not leave the tools unsecured inside the vehicle as they may come loose under braking.

FITTING A RADIO



If your vehicle is not fitted with an audio system, one can be fitted and locations have been provided for:

- the radio **1**;
- door-encased speakers **2**.

To install any equipment, please consult an authorised dealer.

Radio location 1

Unclip and remove storage compartment **1**.



Door speakers 2

Unclip cover **2** using a flat-blade screwdriver or similar.

- In all cases, it is very important to follow the manufacturer's instructions carefully.
- The specifications of the brackets and wires (available from our network) vary depending on the equipment level of your vehicle and the type of radio. Consult your approved Dealer to find out the correct part number.
- No work may be carried out on the vehicle's electrical or radio circuits, except by approved Dealers: an incorrectly connected system may result in damage being caused to the electrical equipment and/or the components connected to it.

ACCESSORIES



Electrical and electronic accessories

Before installing this type of accessory (particularly for transmitters/receivers: frequency bandwidth, power level, position of the aerial, etc.), make sure it is compatible with your vehicle. You can get advice from an authorised dealer.

Connect accessories with a maximum power of 120 watts only. **Fire hazard.**

No work may be carried out on the vehicle's electrical or radio circuits, except by authorised dealers: an incorrectly connected system may result in damage being caused to the electrical equipment and/or the components connected to it.

If the vehicle is fitted with any aftermarket electrical equipment, make sure that the installation is correctly protected by a fuse. Establish the rating and position of this fuse.

Use of transmission/receiving devices (telephones, CB equipment etc.).

Telephones and CB equipment with integrated aerials may cause interference to the electronic systems originally fitted to the vehicle: it is advisable only to use equipment with an external aerial. **Furthermore, we remind you of the need to conform to the legislation in force concerning the use of such equipment.**

Fitting after-market accessories

If you wish to install accessories on the vehicle: please contact an authorised dealer. Also, to ensure the correct operation of your vehicle, and to avoid any risk to your safety, we recommend that you use only accessories specifically designed for your vehicle, which are the only accessories for which the manufacturer will provide a warranty.

If you are using an anti-theft device, only attach it to the brake pedal.

Obstructions to the driver

On the driver's side, only use mats suitable for the vehicle, attached with the pre-fitted components, and check the fitting regularly. Do not lay one mat on top of another. **There is a risk of wedging the pedals.**

OPERATING FAULTS (1/5)

The following advice will enable you to carry out quick, temporary repairs. For safety reasons you should always contact an approved dealer as soon as possible.

The starter is activated	POSSIBLE CAUSES	WHAT TO DO
Warning lights dim or fail to come on; the starter does not run.	Battery terminals disconnected, oxidised or incorrectly secured.	Retighten them, reconnect them or clean them if they are oxidised.
	Battery discharged or worn.	Connect another battery to the faulty battery. Refer to the information on "Battery: troubleshooting" in Section 5 or replace the battery if necessary. Do not push the vehicle if the steering column is locked.
The engine will not start.	Starting conditions are not fulfilled.	Please refer to the information on "Starting, stopping the engine" in Section 2.
The steering column remains locked.	Steering wheel locked.	To unlock, gently move the key and the steering wheel (refer to the information on the "Ignition switch" in Section 2).

OPERATING FAULTS (2/5)

On the road	POSSIBLE CAUSES	WHAT TO DO
Vibrations.	Tyres not inflated to correct pressures, incorrectly balanced or damaged.	Check the tyre pressures; if this is not the cause, have their condition checked by an approved dealer.
Coolant boiling in the coolant reservoir.	Mechanical fault: cylinder head gasket damaged, faulty coolant pump.	Stop the engine. Contact an approved dealer.
	Engine cooling fan not working.	Contact an approved dealer.
Smoke under the bonnet.	Short circuit or cooling system leak.	Stop, switch off the ignition, move away from the vehicle and contact an approved dealer.
The oil pressure warning light comes on:		
on a bend or under braking	The engine oil level is too low.	Top up the engine oil level (refer to the information on "Engine oil level: topping up/filling" in Section 4).
at idle speed	Low oil pressure.	Go to your nearest approved dealer.
The oil pressure warning light takes a long time to go out or remains lit during acceleration.	Loss of oil pressure.	Stop the vehicle: contact an approved dealer.

OPERATING FAULTS (3/5)

On the road

POSSIBLE CAUSES

WHAT TO DO

Abnormal white smoke from the exhaust

Mechanical fault: damaged cylinder head gasket.

Stop the engine.
Contact an approved dealer.

or

This is not necessarily a fault.
Smoke may be caused by regeneration of the particle filter.

Please refer to the information on “Special features of diesel versions” in Section 2.

The power-assisted steering becomes heavy.

Belt broken.

Have the belt replaced.

No power-assisted steering oil

For maintenance operations on the power-assisted steering, contact an authorised dealer.



Radiator: If there is a significant lack of coolant, remember that it must never be topped up using cold coolant while the engine is very warm. After any procedure on the vehicle which has involved even partial draining of the cooling system, it must be refilled with a new mixture prepared in the correct proportions. Reminder: only products approved by the Technical Department may be used for this purpose.

OPERATING FAULTS (4/5)

On the road	POSSIBLE CAUSES	WHAT TO DO
Whistling	Roof aerial poorly positioned.	Position the aerial.
The engine overheats. The coolant temperature indicator light comes on.	Engine cooling fan not working.	Stop the vehicle, switch off the engine and contact an approved dealer.
	Coolant leaks.	Stop the vehicle, switch off the engine and check the coolant reservoir: it should contain fluid. If there is no coolant, consult an approved dealer as soon as possible.
The oil change warning light remains lit after an oil change.	Warning not reset after oil change.	Reset the warning after changing the oil; refer to the information in the paragraph on the "On-board computer" in Section 1.



Radiator: If there is a significant lack of coolant, remember that it must never be topped up using cold coolant while the engine is very warm. After any procedure on the vehicle which has involved even partial draining of the cooling system, it must be refilled with a new mixture prepared in the correct proportions. Reminder: only products approved by the Technical Department may be used for this purpose.

OPERATING FAULTS (5/5)

Electrical equipment	POSSIBLE CAUSES	WHAT TO DO
The wipers do not work.	Wiper blades stuck.	Free the blades before using the wipers.
	Faulty electrical circuit.	Consult an approved dealer.
The wiper does not stop.	Faulty electrical controls.	Consult an approved dealer.
Direction indicators flashing more quickly.	Bulb blown.	Replace the bulb.
The direction indicators do not work.	Faulty electrical circuit.	Consult an approved dealer.
The headlights do not switch on or off.	Faulty electrical circuit or control.	Consult an approved dealer
Traces of condensation in the lights.	This is not a fault. Traces of condensation are a natural phenomenon caused by variations in temperature. The traces will disappear slowly once the lights are switched on.	

Section 6: Technical specifications

Vehicle identification plates	6.2
Engine identification plate	6.3
Engine specifications.	6.4
Dimensions	6.5
Weights (in kg).	6.6
Replacement parts and repairs	6.8
Service sheets	6.9
Anti-corrosion check	6.15

ENGINE IDENTIFICATION PLATES

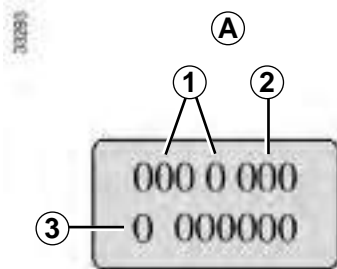

The details given on engine plate **A** should be included with all correspondence and orders (location varies depending on engine).

- 1 Engine type
- 2 Engine suffix
- 3 Engine number

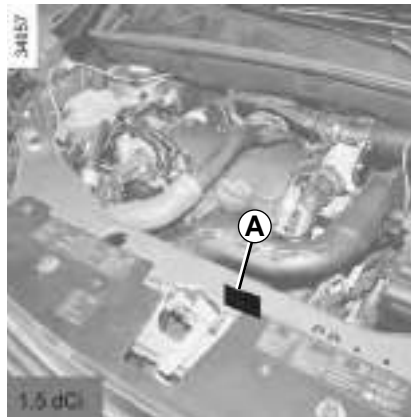

ENGINE SPECIFICATIONS

Versions	1.6 8V	1.2 TCe	1.5 dCi
Engine type (see engine plate)	K7M	H5Ft	K9K
Cubic capacity (cc)	1 598	1 197	1.461
Type of fuel Octane rating	<p>The use of unleaded petrol is essential, with the octane rating as stated on the label inside the fuel filler flap.</p> <p>If not available, for a limited time only, use unleaded fuel:</p> <ul style="list-style-type: none"> – with an Octane rating of 91 for a label showing 95 or 98; – with an octane rating of 87 for a label showing 91, 95 or 98. 		<p>Diesel</p> <p>The label located in the fuel filler flap indicates the authorised fuels.</p>
Spark plugs	<p>Only use spark plugs specified for your vehicle's engine.</p> <p>The type should be marked on a label stuck inside the engine compartment. If it is not then contact your approved Dealer.</p> <p>Fitting spark plugs other than those specified may damage the engine.</p>		

DIMENSIONS (in metres)

33109

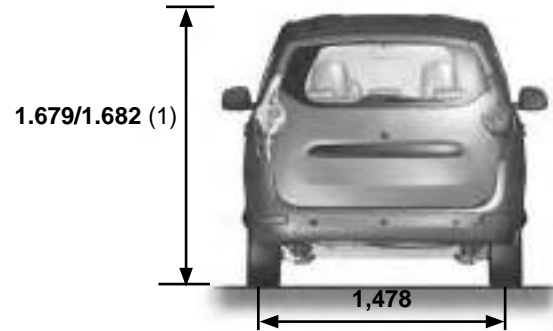
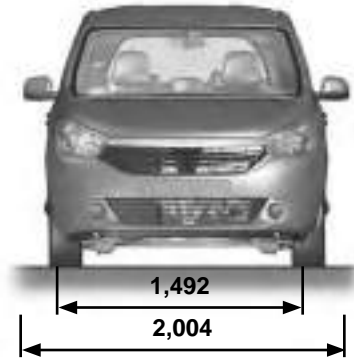
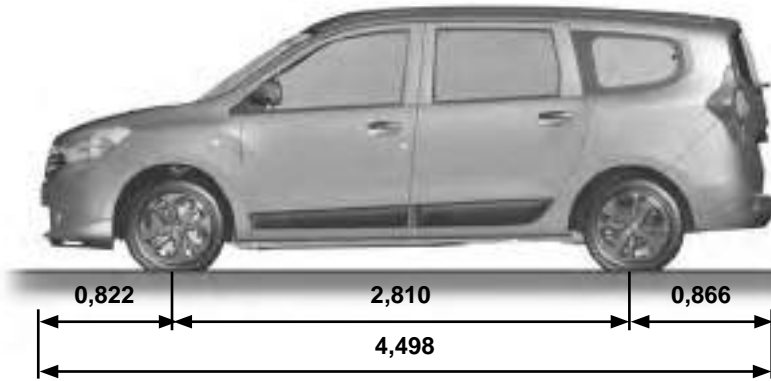

(1) Empty (five and seven-seater versions).

WEIGHTS (in kg) (1/2)

The weights indicated are for a basic vehicle without options: they vary depending on the your vehicle's equipment. Consult an approved Dealer

Five-seater versions	
Maximum permissible all-up weight (MMAC) Gross Train Weight (MTR)	Weights indicated on the manufacturer's plate (refer to Section 6 "Vehicle identification plate")
Braked Trailer Weight*	found by calculating: MTR- MMAC
Unbraked Trailer Weight*	580
Permissible nose weight*	75
Maximum permissible load on roof with a carrying device	80 (including carrying equipment)

* Towing weight (towing a caravan, boat, etc.)

Towing is prohibited when the MTR - MMAC calculation is equal to zero, or when the MTR is equal to zero (or is not listed) on the identification plate.

- It is important to comply with the towing weights, governed by local legislation in each country and, in particular, laid down in the Road Traffic Regulations. Contact an approved Dealer about any towing equipment.
- When towing, under no circumstances may **the total train weight (vehicle + trailer) be exceeded**. However the following is permitted:
 - rear axle MMTA exceeded by no more than 15%,
 - maximum MMAC exceeded by no more than 10% or 100 kg (whichever is reached first).In either case, the maximum speed of the vehicle and trailer must not exceed 60 mph (100 km/h) and the tyre pressures must be increased by 0.2 bar (3 PSI).
- The engine output and climbing capability are reduced with altitude. We recommend that the maximum load be reduced by 10% at an altitude of 1,000 metres and by an additional 10% for each 1,000 metres thereafter.

Weight transfer on Estate versions (depending on local laws)

If the Maximum Authorised Mass of the vehicle has not been reached, up to 200 kg can be transferred to the braked trailer, within the limits of the Gross Train Weight.

WEIGHTS (in kg) (2/2)

The weights indicated are for a basic vehicle without options: they vary depending on the your vehicle's equipment. Consult an approved dealer.

7-seater version	
Maximum Permissible All-Up Weight (MMAC) Total Train Weight (MTR)	Weights indicated on the manufacturer's plate (refer to Section 6 "Vehicle identification plate")
Braked Trailer Weight*	obtained using the calculation: MTR - MMAC
Unbraked Trailer Weight*	630
Permissible nose weight*	75
Maximum permissible load on roof with a carrying device	80 (including carrying equipment)

* Towing weight (towing a caravan, boat, etc.)

Towing is prohibited when the GTW - MAM calculation is equal to zero, or when the GTW is equal to zero (or is not listed) on the identification plate.

- It is important to comply with the towing weights, governed by local legislation in each country and, in particular, laid down in the Road Traffic Regulations. Contact an approved Dealer about any towing equipment.
- When towing, under no circumstances may **the total train weight (vehicle + trailer) be exceeded**. However the following is permitted:
 - the Maximum permissible weight at the rear may be exceeded by no more than 15%,
 - the maximum permissible all-up weight may be exceeded by no more than 10% or 100 kg (whichever occurs first).In either case, the maximum speed of the vehicle and trailer must not exceed 60 mph (100 km/h) and the tyre pressures must be increased by 0.2 bar (3 PSI).
- The engine output and climbing capability are reduced with altitude. We recommend that the maximum load be reduced by 10% at an altitude of 1,000 metres and by an additional 10% for each 1,000 metres thereafter.

Weight transfer on Estate versions (depending on local laws)

If the Maximum Authorised Mass of the vehicle has not been reached, up to 200 kg can be transferred to the braked trailer, within the limits of the Gross Train Weight.

REPLACEMENT PARTS AND REPAIRS

Original parts are based on strict specifications and are subject to highly-specialised tests. Therefore, they are of at least the same level of quality as the parts fitted originally.

If you always fit genuine replacement parts to your vehicle, you will ensure that it performs well. Furthermore, repairs carried out within the manufacturer's Network using original parts are guaranteed according to the conditions set out on the reverse of the repair order.

SERVICE SHEETS (1/6)

VIN:

Date: _____ Miles (Km): _____		Invoice number: _____		Comments/miscellaneous	
Type of operation:		Stamp			
Service <input type="checkbox"/>					
..... <input type="checkbox"/>					
Anti-corrosion check:					
OK <input type="checkbox"/> Not OK* <input type="checkbox"/>					
*See specific page					
Date: _____ Miles (Km): _____		Invoice number: _____		Comments/miscellaneous	
Type of operation:		Stamp			
Service <input type="checkbox"/>					
..... <input type="checkbox"/>					
Anti-corrosion check:					
OK <input type="checkbox"/> Not OK* <input type="checkbox"/>					
*See specific page					
Date: _____ Miles (Km): _____		Invoice number: _____		Comments/miscellaneous	
Type of operation:		Stamp			
Service <input type="checkbox"/>					
..... <input type="checkbox"/>					
Anti-corrosion check:					
OK <input type="checkbox"/> Not OK* <input type="checkbox"/>					
*See specific page					

SERVICE SHEETS (2/6)

VIN:

Date:	Miles (Km):	Invoice number:	Comments/miscellaneous
Type of operation:		Stamp	
Service	<input type="checkbox"/>		
.....	<input type="checkbox"/>		
Anti-corrosion check:			
OK	<input type="checkbox"/>	Not OK*	<input type="checkbox"/>
*See specific page			

Date:	Miles (Km):	Invoice number:	Comments/miscellaneous
Type of operation:		Stamp	
Service	<input type="checkbox"/>		
.....	<input type="checkbox"/>		
Anti-corrosion check:			
OK	<input type="checkbox"/>	Not OK*	<input type="checkbox"/>
*See specific page			

Date:	Miles (Km):	Invoice number:	Comments/miscellaneous
Type of operation:		Stamp	
Service	<input type="checkbox"/>		
.....	<input type="checkbox"/>		
Anti-corrosion check:			
OK	<input type="checkbox"/>	Not OK*	<input type="checkbox"/>
*See specific page			

SERVICE SHEETS (3/6)

VIN:

Date: _____ Miles (Km): _____		Invoice number: _____		Comments/miscellaneous	
Type of operation:		Stamp			
Service <input type="checkbox"/>					
..... <input type="checkbox"/>					
Anti-corrosion check:					
OK <input type="checkbox"/> Not OK* <input type="checkbox"/>					
*See specific page					

Date: _____ Miles (Km): _____		Invoice number: _____		Comments/miscellaneous	
Type of operation:		Stamp			
Service <input type="checkbox"/>					
..... <input type="checkbox"/>					
Anti-corrosion check:					
OK <input type="checkbox"/> Not OK* <input type="checkbox"/>					
*See specific page					

Date: _____ Miles (Km): _____		Invoice number: _____		Comments/miscellaneous	
Type of operation:		Stamp			
Service <input type="checkbox"/>					
..... <input type="checkbox"/>					
Anti-corrosion check:					
OK <input type="checkbox"/> Not OK* <input type="checkbox"/>					
*See specific page					

SERVICE SHEETS (4/6)

VIN:

Date: _____ Miles (Km): _____		Invoice number: _____		Comments/miscellaneous	
Type of operation:		Stamp			
Service <input type="checkbox"/>					
..... <input type="checkbox"/>					
Anti-corrosion check:					
OK <input type="checkbox"/> Not OK* <input type="checkbox"/>					
*See specific page					
Date: _____ Miles (Km): _____		Invoice number: _____		Comments/miscellaneous	
Type of operation:		Stamp			
Service <input type="checkbox"/>					
..... <input type="checkbox"/>					
Anti-corrosion check:					
OK <input type="checkbox"/> Not OK* <input type="checkbox"/>					
*See specific page					
Date: _____ Miles (Km): _____		Invoice number: _____		Comments/miscellaneous	
Type of operation:		Stamp			
Service <input type="checkbox"/>					
..... <input type="checkbox"/>					
Anti-corrosion check:					
OK <input type="checkbox"/> Not OK* <input type="checkbox"/>					
*See specific page					

SERVICE SHEETS (5/6)

VIN:

Date: _____ Miles (Km): _____		Invoice number: _____		Comments/miscellaneous	
Type of operation:		Stamp			
Service <input type="checkbox"/>					
..... <input type="checkbox"/>					
Anti-corrosion check:					
OK <input type="checkbox"/> Not OK* <input type="checkbox"/>					
*See specific page					
Date: _____ Miles (Km): _____		Invoice number: _____		Comments/miscellaneous	
Type of operation:		Stamp			
Service <input type="checkbox"/>					
..... <input type="checkbox"/>					
Anti-corrosion check:					
OK <input type="checkbox"/> Not OK* <input type="checkbox"/>					
*See specific page					
Date: _____ Miles (Km): _____		Invoice number: _____		Comments/miscellaneous	
Type of operation:		Stamp			
Service <input type="checkbox"/>					
..... <input type="checkbox"/>					
Anti-corrosion check:					
OK <input type="checkbox"/> Not OK* <input type="checkbox"/>					
*See specific page					

SERVICE SHEETS (6/6)

VIN:

Date:	Miles (Km):	Invoice number:	Comments/miscellaneous
Type of operation: Service <input type="checkbox"/> <input type="checkbox"/>		Stamp	
Anti-corrosion check: OK <input type="checkbox"/> Not OK* <input type="checkbox"/> *See specific page			

Date:	Miles (Km):	Invoice number:	Comments/miscellaneous
Type of operation: Service <input type="checkbox"/> <input type="checkbox"/>		Stamp	
Anti-corrosion check: OK <input type="checkbox"/> Not OK* <input type="checkbox"/> *See specific page			

Date:	Miles (Km):	Invoice number:	Comments/miscellaneous
Type of operation: Service <input type="checkbox"/> <input type="checkbox"/>		Stamp	
Anti-corrosion check: OK <input type="checkbox"/> Not OK* <input type="checkbox"/> *See specific page			

ANTICORROSION CHECK (1/6)

If the continuation of the warranty is subject to repair, it is indicated below.

VIN:

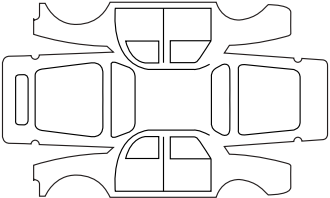
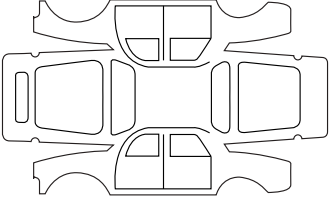
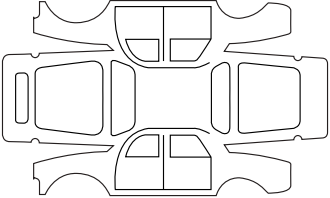
Corrosion repair operation to be carried out:		Stamp
Date of repair:		
Repair to be carried out:		Stamp
Date of repair:		
Repair to be carried out:		Stamp
Date of repair:		

ANTICORROSION CHECK (2/6)

If the continuation of the warranty is subject to repair, it is indicated below.

VIN:

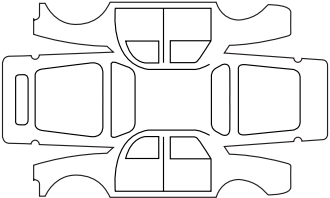
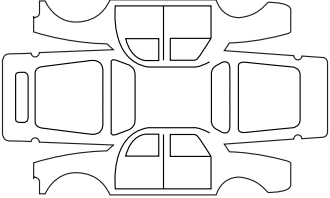
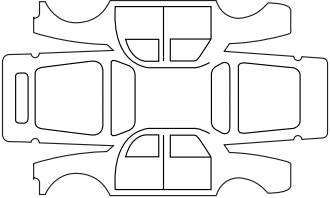
Corrosion repair operation to be carried out:		
Corrosion repair operation to be carried out:		Stamp
Date of repair:		
Repair to be carried out:		
Repair to be carried out:		Stamp
Date of repair:		
Repair to be carried out:		
Repair to be carried out:		Stamp
Date of repair:		

ANTICORROSION CHECK (3/6)

If the continuation of the warranty is subject to repair, it is indicated below.

VIN:

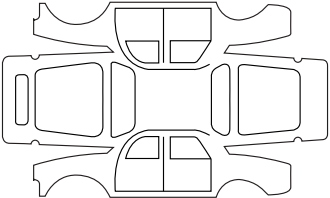
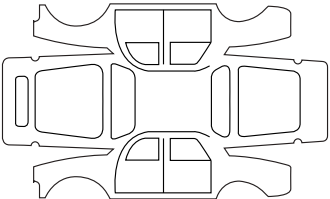
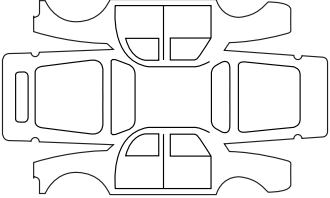
Corrosion repair operation to be carried out:		
Corrosion repair operation to be carried out:		Stamp
Date of repair:		
Repair to be carried out:		
Repair to be carried out:		Stamp
Date of repair:		
Repair to be carried out:		
Repair to be carried out:		Stamp
Date of repair:		

ANTICORROSION CHECK (4/6)

If the continuation of the warranty is subject to repair, it is indicated below.

VIN:

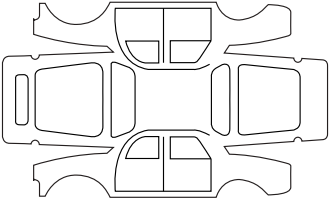
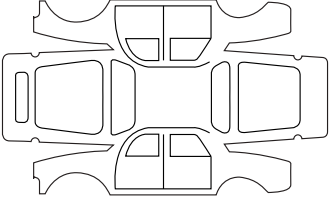
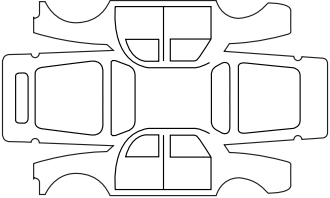
Corrosion repair operation to be carried out:		
Corrosion repair operation to be carried out:		Stamp
Date of repair:		
Repair to be carried out:		
Repair to be carried out:		Stamp
Date of repair:		
Repair to be carried out:		
Repair to be carried out:		Stamp
Date of repair:		

ANTICORROSION CHECK (5/6)

If the continuation of the warranty is subject to repair, it is indicated below.

VIN:

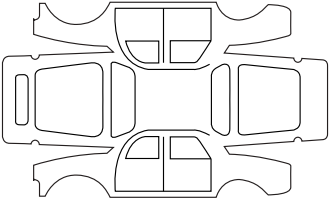
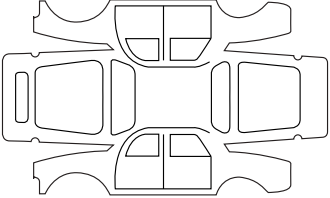
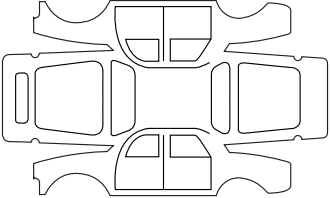
Corrosion repair operation to be carried out:		Stamp
Date of repair:		
Repair to be carried out:		Stamp
Date of repair:		
Repair to be carried out:		Stamp
Date of repair:		

ANTICORROSION CHECK (6/6)

If the continuation of the warranty is subject to repair, it is indicated below.

VIN:

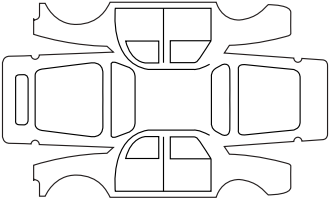
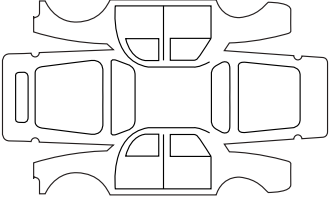
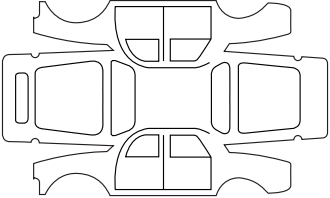
Corrosion repair operation to be carried out:		
Corrosion repair operation to be carried out:		Stamp
Date of repair:		
Repair to be carried out:		
Repair to be carried out:		Stamp
Date of repair:		
Repair to be carried out:		
Repair to be carried out:		Stamp
Date of repair:		

ALPHABETICAL INDEX (1/5)

A

ABS	2.20 → 2.22
accessories.....	5.35
accessories socket	3.16
additional methods of restraint	1.22
adjusting your driving position	1.12 → 1.16, 3.17 – 3.18
advice on antipollution.....	2.13
air bag.....	1.17 → 1.22
activating the front passenger air bags.....	1.38
deactivating the front passenger air bags.....	1.36
air conditioning	3.4 → 3.7
air vents.....	3.2 – 3.3
anti-corrosion check	6.15 → 6.20
anti-corrosion protection.....	4.12
anti-lock braking system: ABS.....	2.20 → 2.22
antipollution	
advice	2.13
ashtrays.....	3.16
ASR (traction control).....	2.20 → 2.22

B

battery.....	4.9
troubleshooting	5.29 – 5.30
battery (remote control)	5.28
bonnet.....	4.2
brake fluid.....	4.6
bulbs	
changing	5.17 → 5.21

C

capacity of mechanical components.....	4.3
catalytic converter.....	2.4
central door locking	1.5 – 1.6, 1.8
changing a bulb	5.17 → 5.21
changing a wheel.....	5.12 – 5.13
changing fuel while driving	2.6 → 2.8

changing gear.....	2.18
child booster seat	1.23 → 1.25
child restraint/seat	1.23 → 1.38
child safety.....	1.2, 1.4, 1.9, 1.23 → 1.38
child seats.....	1.23 → 1.35
cigar lighter.....	3.16
cleaning:	
inside the vehicle	4.14 – 4.15
clock	1.53
closing the doors	1.8 – 1.9
control instruments	1.42 → 1.47, 1.53 → 1.55
courtesy light	3.10
cruise control	2.26 → 2.29
cruise control-speed limiter.....	2.23 → 2.29

D

dashboard.....	1.40 – 1.41
de-icing	
rear screen.....	1.59
demisting	
windscreen.....	3.6
dimensions	6.5
dipstick.....	4.3 → 4.5
display	1.46 – 1.47
doors.....	1.5 → 1.9
driver's position	1.40 – 1.41
driving.....	2.2 → 2.5, 2.9 → 2.12, 2.19 → 2.31
driving recommendations	2.9 → 2.12

E

ECO driving	2.9 → 2.12
electric door locking.....	1.5 – 1.6
electric windows	3.8 – 3.9
emergency brake assist.....	2.22
emergency braking.....	2.20 → 2.22
emergency spare wheel	5.3 – 5.4, 5.14 → 5.16

ALPHABETICAL INDEX (2/5)

engine	
technical specifications	6.4
engine coolant	4.7
engine immobiliser (switch)	2.2
engine oil	4.3 → 4.5
engine oil level.....	4.4 – 4.5
engine specifications	6.4
environment.....	2.14
ESC: electronic stability control	2.20 → 2.22

F

faults	
operating faults	5.36 → 5.40
filter	
diesel filter.....	1.64
particle filter	2.5
fitting a radio	5.34
fittings	3.12 → 3.15
fog lights	1.55
front passenger air bag deactivation	1.36
front seat adjustment.....	1.11
front seats.....	1.11
adjustment	1.11
fuel	
advice on fuel economy	2.9 → 2.12
consumption	2.9 → 2.12
filling.....	1.61
grade.....	1.60, 6.4
fuel consumption	2.9 → 2.12
fuel economy	2.9 → 2.12
fuel filler cap	1.60
fuel grade.....	1.60
fuel level	1.47
fuel priming bulb	1.64
fuel tank	1.60 → 1.64
fuel tank capacity.....	1.60

fuses	5.24 → 5.27
-------------	-------------

G

gear lever.....	2.18
glove box	3.12
grab handle.....	3.11

H

handbrake.....	2.19
hands-free telephone integrated control.....	3.34
hazard warning lights signal	1.57
headlight beam adjustment	1.56
headlight flashers	1.57
headrest.....	1.10, 3.17 – 3.18
heated seats	1.11
heating and air conditioning system	3.2 → 3.7
heating system	3.2 → 3.7
horn	1.57
hubcap tool	5.2

I

ignition switch	2.2
indicators	1.57, 5.17
indicators:	
direction indicators	1.57
instrument panel	1.46 – 1.47
instrument panel.....	1.42 → 1.52
instrument panel messages.....	1.48 → 1.52
interior trim	
maintenance	4.14 – 4.15
Isofix	1.26 → 1.35

J

jack	5.2, 5.12 – 5.13
------------	------------------

ALPHABETICAL INDEX (3/5)

K

keys 1.2 → 1.4

L

levels 4.3, 4.6 → 4.8

lifting the vehicle

changing a wheel 5.12 – 5.13

lighting:

exterior 1.54 – 1.55, 5.17 → 5.21

interior 3.10, 5.22 – 5.23

lights 1.54 → 1.56

additional 5.18

adjustment 1.56

lights:

adjusting 1.56

brake lights 5.19 – 5.20

dipped beam headlights 1.54, 5.17

direction indicators 1.57, 5.17

fog lights 1.55, 5.18

hazard warning 1.57

main beam headlights 1.54, 5.17

reversing lights 5.19, 5.21

side lights 1.54, 5.17

load permitted on the roof 6.6 – 6.7

locking the doors 1.4, 1.8

LPG 1.23, 1.62 – 1.63, 2.3, 2.6 → 2.8, 5.24 → 5.27

luggage compartment cover 3.33

luggage retaining net 3.32

M

maintenance 2.13

maintenance:

bodywork 4.12 – 4.13

interior trim 4.14 – 4.15

mechanical 4.3, 4.6 → 4.8, 6.9 → 6.14

map reading lights 3.10

methods of restraint in addition to the front seat belts 1.17 → 1.20

methods of restraint in addition to the seat belts ... 1.17 → 1.22

mirrors 3.11

multimedia equipment 3.34

N

navigation 3.34

navigation system 3.34

O

oil change 4.5

opening the doors 1.8 – 1.9

operating faults 5.36 → 5.40

overspeed buzzer 1.46

P

paintwork

maintenance 4.12 – 4.13

reference 6.2

parking distance control 2.30 – 2.31

power-assisted steering 2.19, 4.8

power-assisted steering pump 4.8

practical advice 1.64, 5.17 – 5.18, 5.36 → 5.40

pretensioners 1.17

puncture 5.3 – 5.4, 5.12 – 5.13

R

radio 3.34

fitting a radio 5.34

radio frequency remote control/key

use 1.2, 1.4

rear bench seat 3.19 → 3.24

rear screen

demisting 1.44

ALPHABETICAL INDEX (4/5)

rear seats	
functions	3.19 → 3.24
rear view mirrors	1.39
remote control door locking	
batteries	5.28
remote control door locking unit	1.2 – 1.3
remote control electric door locking	1.4
RENAULT ANTI-INTRUDER DEVICE (RAID)	1.7
replacement parts	6.8
reverse gear	
selecting	2.18
reversing sensor	2.30 – 2.31
running in	2.2

S

seat belts	1.12 → 1.22
service sheets	6.9 → 6.14
side indicator lights	
changing bulbs	5.21
side protection devices	1.21
signals and lights	1.54 – 1.55
speakers	
location	5.34
special features of diesel versions	2.5
special features of LPG versions	2.6 → 2.8
special features of petrol vehicles	2.4
speed limiter	2.23 → 2.25
starting	2.2 – 2.3
starting the engine	2.3
steering wheel	
adjustment	1.53
storage compartment	3.12 → 3.15
storage compartments	3.12 → 3.15, 3.29
sun visor	3.11

T

tailgate	3.28 – 3.29
tanks and reservoirs	
brake fluid	4.6
coolant	4.7
tanks and reservoirs:	
windscreen washer	4.7
technical specifications	6.2, 6.4, 6.8
telephone	3.34
towing	6.6 – 6.7
breakdown	5.32 – 5.33
towing equipment	3.31
towing a caravan	6.6 – 6.7
towing hitch	5.2, 5.32 – 5.33
towing rings	1.26 – 1.27, 3.30
towing weights	6.6 – 6.7
traction control: ASR	2.20 → 2.22
transporting children	1.23 → 1.38
transporting objects	
in the luggage compartment	3.30
trims	5.11
trip computer and warning system	1.48 → 1.52
tyre inflation kit	5.5 → 5.10
tyre pressure	2.15 → 2.17, 4.10 – 4.11, 5.15
tyre pressure loss warning	2.15 → 2.17
tyre pressures	4.10 – 4.11
tyres	2.15 → 2.17, 4.10 – 4.11, 5.14 → 5.16

V

vehicle identification	6.2
vehicle identification plates	6.2 – 6.3
ventilation	
heating and air conditioning system	3.4 → 3.7

W

warning buzzer	1.8 – 1.9, 1.54
----------------------	-----------------

ALPHABETICAL INDEX (5/5)

warning lights.....	1.42 → 1.45, 1.48 → 1.52
washing	4.12 – 4.13
weights	6.6 – 6.7
wheelbrace	5.2
windows.....	3.8 – 3.9
windscreen washer.....	1.58 – 1.59, 4.7
wiper blades	5.31
wipers	1.58 – 1.59, 5.31
blades	5.31

ELF, THE EXCLUSIVE PARTNER FOR MY DACIA

DACIA RECOMMENDS ELF LUBRICANTS



