

F I A T C R O M A



O W N E R H A N D B O O K

Dear Customer,

Thank you for selecting Fiat and congratulations on your choice of a Fiat Croma.

We have written this handbook to help you get to know all your new Fiat Croma features and use it in the best possible way.

You should read it right through before taking the road for the first time.

You will find information, tips and important warnings regarding the driving of your car to help you derive the maximum from your Fiat Croma technological features.

You are recommended to read carefully the warnings and indications, marked with the respective symbols, at the end of the page:



personal safety;



the car's wellbeing;



environmental protection.

The enclosed Warranty Booklet lists the services that Fiat offers to its Customers:

- the Warranty Certificate with terms and conditions for maintaining its validity
- the range of additional services available to Fiat Customers.

Best regards and good motoring!

This Owner Handbook describes all Fiat Croma versions. As a consequence, you should consider only the information which is related to the engine and bodywork version of the car you purchased.

MUST BE READ!

REFUELLING



Petrol engines: only refuel with unleaded petrol with octane rating (RON) not less than 95.



Diesel engines: only refuel with diesel fuel conforming to the European specification EN590.

Using other products or mixtures may damage the engine beyond repair and cause the forfeiture of the warranty cover for caused damages as a consequence.

ENGINE STARTING



Petrol engines: make sure that the handbrake is engaged; set the gearshift lever to neutral (positions P or N with automatic transmission); fully depress the clutch pedal (or brake pedal with automatic transmission) without pressing the accelerator, then turn the ignition key to START and release it as soon as the engine has started.

Diesel engines: make sure that the handbrake is engaged; set the gearshift lever to neutral (positions P or N with automatic transmission); fully depress the clutch pedal (or brake pedal with automatic transmission) without pressing the accelerator, then turn the ignition key to ON and wait for the  and  warning lights to go off; turn the ignition key to START and release it as soon as the engine has started.

PARKING ON FLAMMABLE MATERIAL



While working, the catalyst develops a very high temperature. Do not park the car over grass, dry leaves, pine needles or any other inflammable materials: risk of fire.

RESPECTING THE ENVIRONMENT



The car is fitted with a system that allows continuous diagnosis of the components correlated with emissions to ensure better respect for the environment.

ELECTRICAL ACCESSORIES

If, after buying the car, you decide to add electrical accessories (that will gradually drain the battery), visit a Fiat Dealership. They can calculate the overall electrical requirement and check that the car's electric system can support the required load.

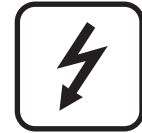

CODE card

Keep the code card in a safe place, not in the car.

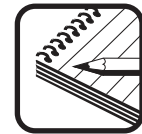



SCHEDULED SERVICING

Correct maintenance of the car is essential for ensuring it stays in tip-top condition and safeguards its safety features, its environmental friendliness and low running costs for a long time to come.



THE OWNER HANDBOOK CONTAINS...

... information, tips and important warnings regarding the safe, correct driving of your car, and its maintenance. Pay particular attention to the symbols  (personal safety)  (environmental protection)  (the car's wellbeing).



DASHBOARD AND CONTROLS

DASHBOARD
AND CONTROLS

SAFETY
DEVICES

CORRECT USE
OF THE CAR

WARNING
LIGHTS AND
MESSAGES

IN AN
EMERGENCY

CAR
MAINTENANCE

TECHNICAL
SPECIFICATIONS

INDEX

INSTRUMENT DASHBOARD	5	CRUISE CONTROL	68
INSTRUMENT PANEL	6	CEILING LIGHTS	70
SYMBOLS	8	CONTROLS	71
THE FIAT CODE SYSTEM	9	INTERIOR EQUIPMENT	74
THE KEYS	10	SUN ROOF	78
ALARM	14	DOORS	81
DEAD LOCK DEVICE	16	ELECTRIC WINDOW REGULATORS	82
IGNITION DEVICE	19	BOOT	84
ON BOARD INSTRUMENTS	20	ENGINE HOOD	90
MULTIFUNCTIONAL DISPLAY	22	ROOF RACK/SKI RACK	92
RECONFIGURABLE MULTIFUNCTIONAL DISPLAY ..	25	HEADLAMPS	93
DISPLAY FUNCTIONS	28	ABS SYSTEM	94
TRIP COMPUTER	36	ESP SYSTEM	96
SEATS	39	ASR SYSTEM	97
HEAD RESTS	42	EOBD SYSTEM	98
STEERING WHEEL	43	T.P.M.S. SYSTEM	99
REAR VIEW MIRRORS	44	CAR RADIO	100
HEATING/AIR CONDITIONING SYSTEM	47	USER PURCHASED ACCESSORIES	101
MANUAL AIR CONDITIONER	49	PARKING SENSORS	102
AUTOMATIC AIR CONDITIONER	52	VEHICLE REFUELLING	104
EXTERIOR LIGHTS	62	ENVIRONMENTAL PROTECTION	105
WINDOW CLEANING	65		

DASHBOARD

The presence and the position of the instruments and warning lights may vary according to the versions.

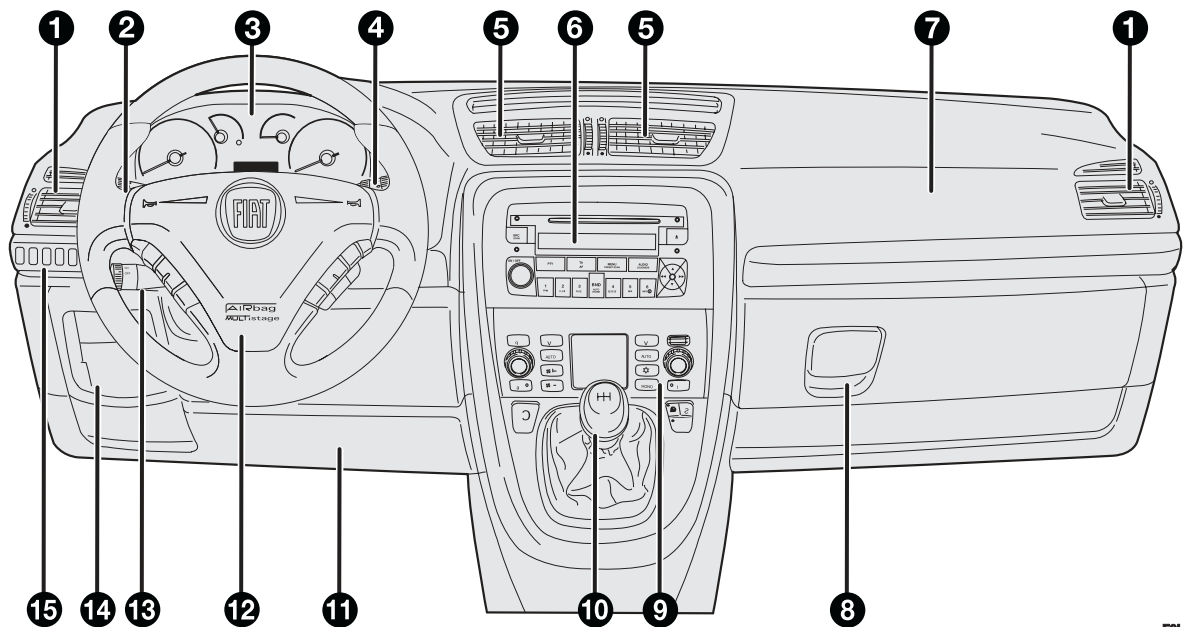

FOL0516m

fig. 1

1. Side air vent - 2. Left steering column stalk: external lights - 3. Instrument panel and warning lights - 4. Right steering column stalk: windscreen, rear window wiper and trip computer controls - 5. Central air vents - 6. Sound system - 7. Front passenger air vent - 8. Glovebox - 9. Heating/ventilation/climate controls - 10. Gearshift lever - 11. Driver's knees air bag - 12. Driver's air bag - 13. Cruise control lever - 14. Control unit access door - 15. Control plate.

INSTRUMENT PANEL

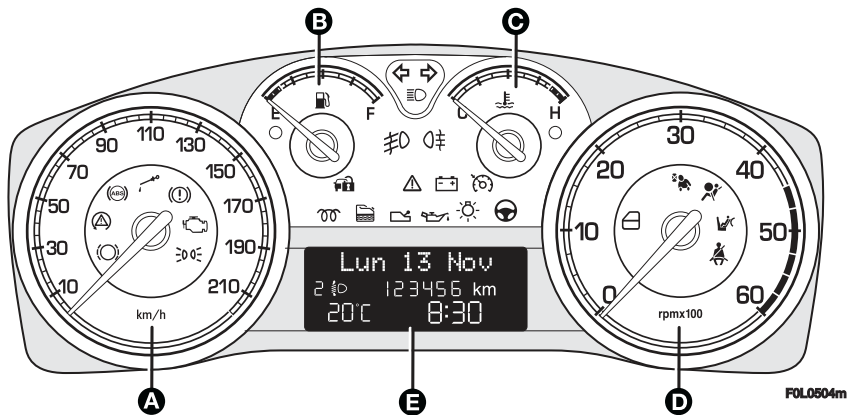

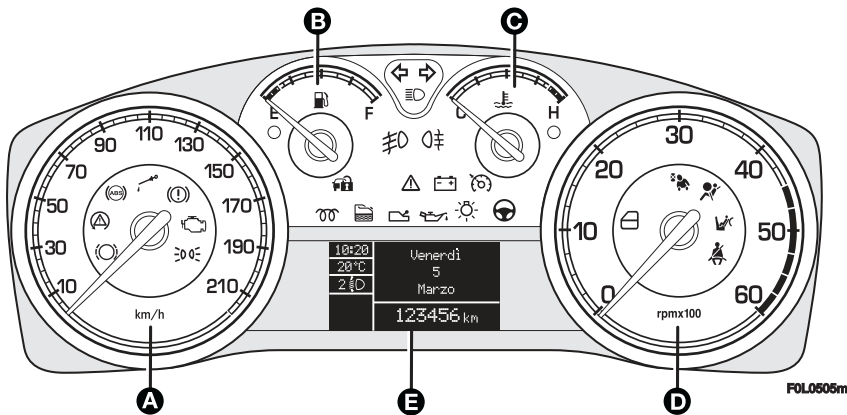

On versions 1.8 the end scale value of the engine speed indicator is 8000 rpm.





On versions 1.8 the end scale value of the engine speed indicator is 8000 rpm.

fig. 2

1.8 - 1.9 Multijet 8V versions with multifunctional display

- A** Speedometer (speed indicator)
- B** Fuel level gauge with reserve warning light
- C** Engine coolant temperature gauge and excessive temperature warning light
- D** Rev counter
- E** multifunctional display
-  Warning lights fitted on Multijet versions
-  Warning light fitted on versions with automatic transmission

1.8 - 1.9 Multijet 8V with reconfigurable multifunctional display

- A** Speedometer (speed indicator)
- B** Fuel level gauge with reserve warning light
- C** Engine coolant temperature gauge and excessive temperature warning light
- D** Rev counter
- E** Reconfigurable multifunctional display
-  Warning lights fitted on Multijet versions
-  Warning light fitted on versions with automatic transmission

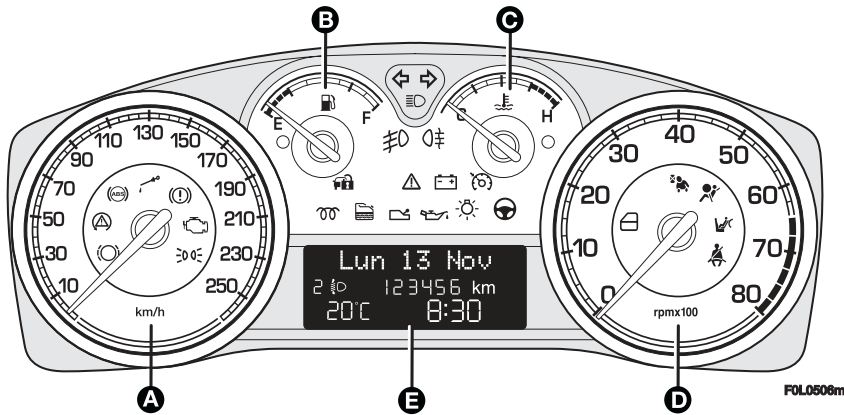

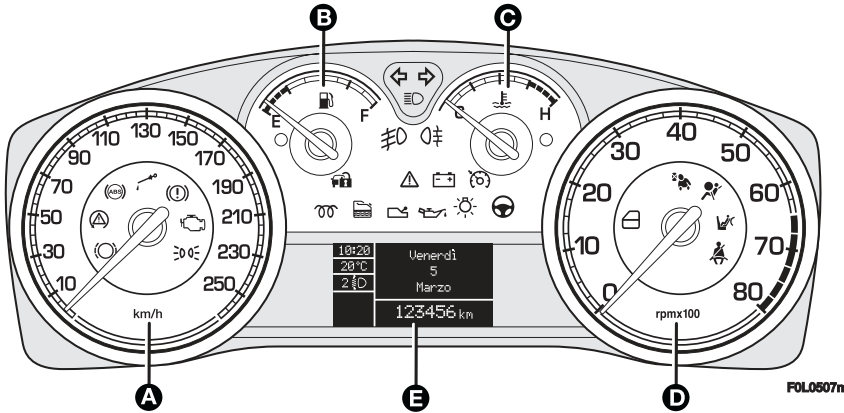

On Multijet versions the end scale value of the engine speed indicator is 6000 rpm.



On Multijet versions the end scale value of the engine speed indicator is 6000 rpm.

2.2 - 1.9 Multijet 16V versions - 2.4 Multijet 20V with multifunctional display

- A Speedometer (speed indicator)
- B Fuel level gauge with reserve warning light
- C Engine coolant temperature gauge and excessive temperature warning light
- D Rev counter
- E Multifunctional display
-  Warning lights fitted on Multijet versions
-  Warning light fitted on versions with automatic transmission

2.2 - 1.9 Multijet 16V - 2.4 Multijet 20V with reconfigurable multifunctional display



- A Speedometer (speed indicator)
- B Fuel level gauge with reserve warning light
- C Engine coolant temperature gauge and excessive temperature warning light
- D Rev counter
- E Reconfigurable multifunctional display
-  Warning lights fitted on Multijet versions
-  Warning light fitted on versions with automatic transmission

fig. 3

SYMBOLS

Special coloured labels have been attached near or actually on some of the components of your car. These labels bear symbols that remind you of the precautions to be taken as regards that particular component.

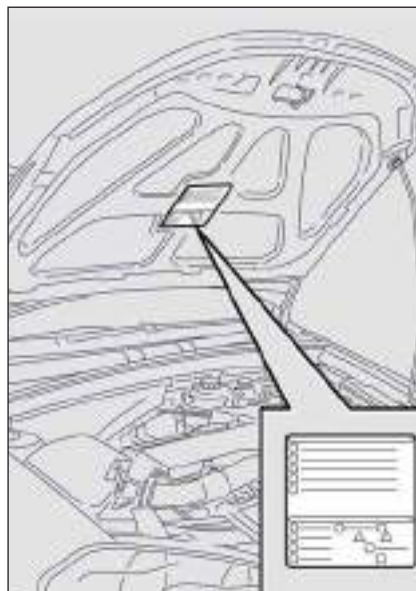

fig. 4

FOL0099m

The plate summarising the symbols used can be found under the bonnet **fig. 4**.

THE FIAT CODE SYSTEM

To further protect your car from theft, it has been fitted with an engine immobilising system. This system is automatically activated when the ignition key is removed.

An electronic device, in fact, is fitted in each ignition key grip. The device transmits a radio-frequency signal when the engine is started through a special aerial built into the ignition switch. The modulate signal, which changes each time the engine is started, is the “password”, by means of which the control unit recognises the key and enables to start the engine.

OPERATION

Each time the key is fitted into the ignition switch, the Fiat CODE system control unit sends a recognition code to the engine control unit to deactivate the inhibitor.

The code is sent only if the Fiat CODE system control unit has recognised the code transmitted from the key.



Each time the ignition key is removed, the Fiat CODE system deactivates the functions of the engine electronic control unit.

If the code has not been recognised correctly, the warning light  (where provided) turns on accompanied by the related message on the display (see chapter “Warning lights and messages”).

In this case, the key should be removed and refitted; if the lock continues, possibly try again with the other key provided with the car. If it is still not possible to start the car contact a Fiat Dealership.

IMPORTANT Every key has its own code, which must be memorised by the system control unit. To memorise new keys, up to a maximum of eight, apply to Fiat Dealership.

Warning light coming on when driving

- If the warning light  turns on, this means that the system is running a self-test (for example for a voltage drop). At the first stop, turn the ignition key to **OFF** and then back to **ON**: if no failure is detected warning light  will not come on.
- If the warning light  stays on, repeat the procedure described previously leaving the key at **OFF** for over 30 seconds. Should the inconvenience persists, contact a Fiat Dealership.



The electronic components inside the key may be damaged if the key is submitted to sharp knocks.

THE KEYS

CODE CARD fig. 5

The car is delivered with two copies of the ignition key and with the CODE card which bears the following:

- the electronic code **A**
- the mechanical key code **B** to be given to the Fiat Dealership when ordering duplicate keys.

IMPORTANT In order to ensure perfect efficiency of the electronic devices contained inside the keys, they should never be exposed to direct sunlight.

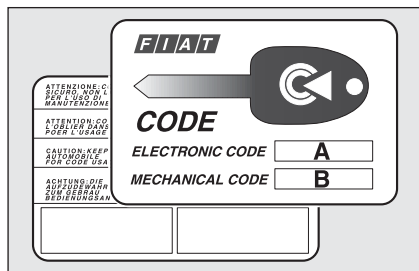

fig. 5

F0L0002m



All the keys and the CODE card must be handed over to the new owner when selling the car.

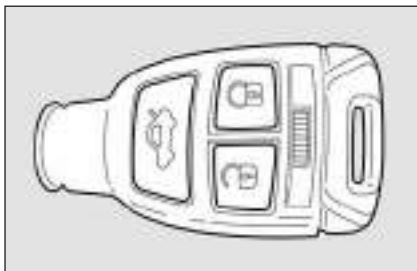





fig. 6

KEY WITH REMOTE CONTROL fig. 6

This key operates the ignition switch.

Button  shall be used for remote opening of doors and tailgate and for remote deactivation of the alarm (where provided).

Button  shall be used for remote locking of doors and tailgate and for remote activation of the alarm (where provided).

Button  shall be used for remote opening of the tailgate.



When unlocking the doors, the passenger's compartment lights will come on for a preset time.

Opening the doors and the tailgate

Briefly press button  for remote unlocking of doors, tailgate and fuel filler cap and simultaneous alarm (where provided) deactivation, timed switching on of the internal ceiling lights and double flashing of direction indicators.

Press button  for more than 2 seconds to open the windows.

Doors will be unlocked automatically if the fuel inertial cut-off switch comes into operation.

The “Set-up menu” on the display (see paragraph “Multifunction display”) enables to set the system so that by pressing button , only the driver's door is unlocked. In this event, to unlock the other doors press quickly button  twice.

IMPORTANT If the remote control does not work properly, it is still possible to carry out the emergency opening procedure by using the metal insert set inside the remote control (see “Emergency opening using the metal insert of the key”).

Locking the doors and the tailgate

Briefly press button  for remote locking of doors, tailgate and fuel filler cap and simultaneous alarm (where provided) activation, switching off of the internal ceiling lights and single flashing of direction indicators.

Press button  for more than 2 seconds to close the windows. If the button is briefly pressed twice, the dead lock device is activated (see paragraph “Dead lock device”).

IMPORTANT If the remote control does not work properly, it is still possible to lock the car doors by following the procedure described in paragraph “Emergency closing”

Opening the tailgate by the remote control

Press button  to open the tailgate by remote control even if the alarm (where provided) is on.

Opening the tailgate is accompanied by the direction indicators flashing twice; closing is accompanied by a single flash (only if the alarm is on).

If the alarm is on, when the tailgate is opened the alarm system switches off volumetric protection and the tailgate perimetral protection sensor.

When closing the tailgate again, volumetric and perimetral protection sensors are restored.

IMPORTANT If the remote control does not work properly, it is however possible to open the tailgate through the mechanical lever set on the lock inside the boot (see paragraph “Boot” in this section).

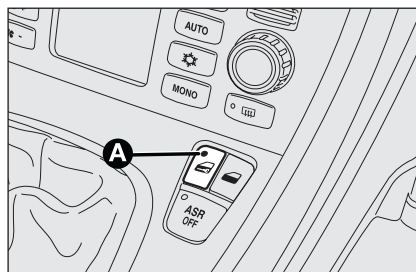

fig. 7

FOL00882m

LED signals on door lock button fig. 7

When locking the doors, led **A** switches on for about 3 seconds and then starts flashing (deterrence function).

Once doors are locked, if one or more doors or the tailgate are not closed correctly, the led and direction indicators start flashing quickly.

Replacing the battery of the key with remote control fig. 8

To replace the battery, proceed as follows:

- move aside lever **A** and take out the emergency metal insert **B**;
- take out the battery case **C** using the emergency metal insert, move aside battery **D** and replace it making sure the bias is correct;
- refit the battery case **C** and the emergency metal insert **B** inside the key.

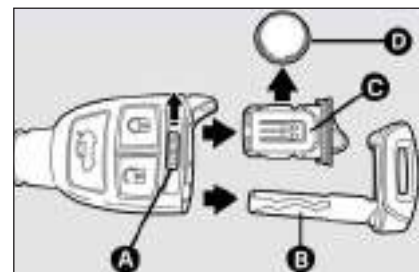

fig. 8

FOL0101m

Request for additional remote controls

The system can recognise up to 8 keys with incorporated remote control. Should a new key with remote control be necessary, contact a Fiat Dealership, taking with you the CODE card and the keys, a personal identity document and the car's ownership documents.



Used batteries are harmful to the environment. They should be disposed of as specified by law in the special containers provided, or take them to a Fiat Dealership, which will deal with their disposal.

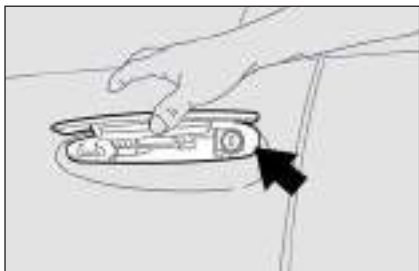

fig. 9

FOL0103m

EMERGENCY OPENING USING THE METAL INSERT

If the remote control does not work properly (e.g.: battery flat), it is however possible to use the emergency metal insert set inside the remote control.

The metal insert operates the driver's side lock (the pawl is located under the out-door handle **fig. 9**).

To use the metal insert set inside the remote control, proceed as follows **fig. 10**:

- move aside lever **A** and take out the emergency metal insert **B**, at the same time.

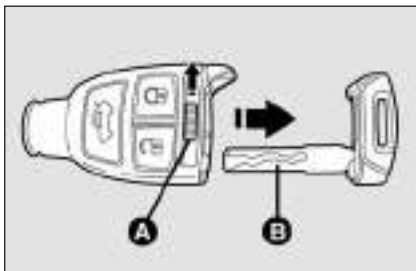

fig. 10

FOL0102m

The metal insert acts on the interested door.

For emergency opening proceed as follows:

- raise the handle, fit the metal insert into the revolving plug and turn it counterclockwise;
- remove the key and lower the handle;
- raise the handle and open the door.

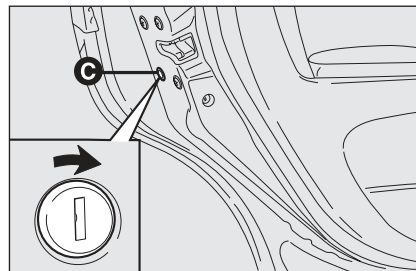

fig. 11

FOL0206m

EMERGENCY CLOSING **fig. 11**

To lock the doors if the remote control does not work properly, proceed as follows:

- fit the metal insert into the slot **C** set on the doors and turn it in the direction of the arrow (as shown in the figure).

IMPORTANT Before carrying out the emergency door locking, check whether the independent boot locking function on the multifunction display set-up menu is off (see paragraph "Multifunction display").

ALARM (where provided)

WHEN THE ALARM IS TRIGGERED

The alarm comes into action in the following cases:

- unlawful opening of one of the doors, bonnet or boot (perimetral protection);
- attempt to start the engine with unauthorised key;
- battery cable cutting;
- presence of moving bodies in the passenger's compartment (volumetric protection);
- abnormal raising/sloping of the car.

Depending on the markets, the cutting in of the alarm causes operation of the siren and direction indicators (for about 26 seconds). The ways of operating and the number of cycles may vary depending on the markets.

A maximum number of sound/sight cycles is however envisaged.

Volumetric and anti-raising protections can be cut off by operating the front ceiling light controls (see paragraphs "Volumetric protection sensors" and "Anti-raising sensor" on the following pages).



IMPORTANT The engine immobiliser function is guaranteed by the Fiat CODE system, which is automatically activated when the ignition key is removed.

HOW TO ACTIVATE THE ALARM fig. 12

With the doors, bonnet and boot shut and ignition key to **OFF** or removed, point the key with remote control or removed, point the key with remote control in the direction of the car, then press and release the button .

With the exception of certain markets, the system sounds a "beep" and the doors are locked.

Engagement of the alarm is preceded by a self-diagnostic test. If a fault is detected the system sounds a further warning "beep" and the display shows the relevant message (see section "Warning lights and messages").

In this case, switch the alarm system off by pressing button , check that the doors, bonnet and tailgate are properly shut, then switch the system on again by pressing button .

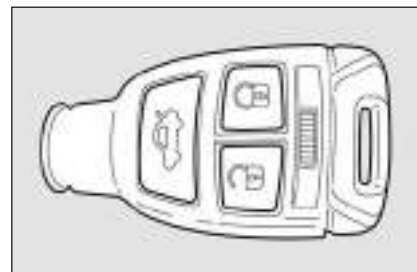

fig. 12

FOLO100m

If the doors, bonnet and boot are shut correctly and the warning "beep" is repeated, the system self-diagnostics has detected a system operating fault. It is therefore necessary to contact a Fiat Dealer-ship.

IMPORTANT Operating a door with the metal insert of the key will not activate the alarm.

IMPORTANT The alarm is built in compliance with the law and regulations of the different destination countries.

HOW TO DEACTIVATE THE ALARM fig. 12

Press button  of the key with remote control.

The system will react as follows (with the exception of certain markets):

- two brief flashes of the direction indicators;
- two brief “beeps”;
- door unlocking.

IMPORTANT Operating a door with the metal insert of the key will not activate the alarm.

To deactivate the alarm, turn the ignition key to ON.



fig. 13

FOL0171m

VOLUMETRIC PROTECTION SENSORS

The volumetric sensors are located inside the front ceiling light in the passenger's compartment. To make sure that the volumetric sensors are working properly, check that doors, boot, bonnet, windows and sunroof (where provided) are shut.

Anti-raising protection deactivation

If it is necessary to switch on the alarm when animals or people are in the car, press button **A-fig. 13** on the front ceiling light to deactivate the volumetric protection.

Deactivation is needed also in the presence of additional independent heater and when it is switched on with the remote control.



fig. 14

FOL0172m

ANTI-RAISING SENSOR

The anti-raising sensor detects any abnormal car raising/sloping, even partial (e.g.: attempt to remove a wheel).

This sensor can detect the smallest car sideslip angle changes, both longitudinally and transversally. Sideslip angle changes lower than 0.5°/min. (e.g.: slow tyre flattening) are not considered).

Anti-raising protection deactivation

To deactivate the anti-raising protection (for example when towing the car with alarm on) press button **B-fig. 14** on the front ceiling light. Sensor cut-out stays on until activating the central door opening again.

INDICATIONS OF ATTEMPTS TO BREAK IN

Any attempt to break in is indicated by turning on of warning light  (if provided) on the instrument panel with the relevant message on the display (see section “Warning lights and messages”).

HOW TO CUT OFF THE ALARM SYSTEM

To deactivate the alarm system completely (for instance during prolonged inactivity of the car) simply lock the car using the emergency locking.

IMPORTANT To cut-out the alarm if remote control batteries are down or the system is failing, fit the key into the ignition switch and turn it to ON.

DEAD LOCK DEVICE (where provided)

This safety device enables to inhibit:

- door internal handles;
- button **A** and **B** for locking/unlocking the doors **fig. 15**;

thus hindering doors opening from inside the passenger’s compartment in case of attempt to break-into (e.g. window breaking).

The dead lock device guarantees the best protection against unwanted access. Therefore, it should be actuated every time the car is parked and left unattended.

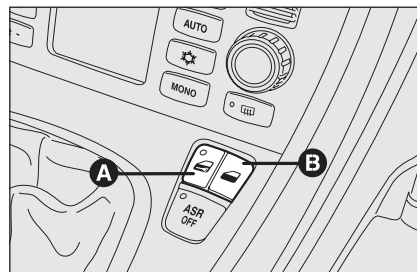

fig. 15

F0L0003m



WARNING

If the battery of the key with remote control is down, the dead lock device can be activated only using the metal insert of the key on the driver’s side door as described previously; in this case the dead lock device is active only on the rear doors.



WARNING

Once the dead lock device has been actuated, doors cannot be opened from inside the car in any way whatsoever. For this reason, make sure there are no persons left inside the car.

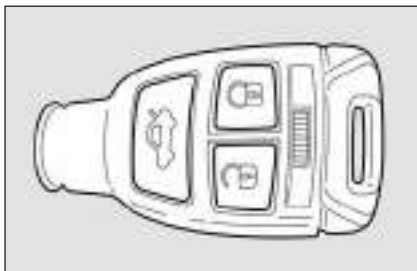



fig. 16

FOL0100m

Device activation fig. 16

The device is automatically activated on every door in the following cases:

- pressing twice button  of the key with remote control

Device activation is signalled by three flashes of the direction indicators and flashing of the led on the driver door panel (see the table on next page).







Should one of the doors be not perfectly closed, the dead lock device is not activated, thus preventing that a person getting into the car from the open door remains blocked inside the passenger's compartment when he/she closes the door.

Device deactivation

The device is deactivated automatically on every door in the following cases:

- when unlocking the doors by the remote control;
- when unlocking only the driver's door by the remote control;
- when turning the ignition key to **ON**.

The main functions that can be activated with the keys or with the emergency metals insert are the following:

	Door opening and fuel filler cap unlocking	Door closing and fuel filler cap locking	Window opening	Window closing	Dead lock (where provided)	Tailgate opening
Key with remote control	Press briefly button 	Pressing briefly button 	Prolonged pressing (over 2 seconds) on button 	Prolonged pressing (over 2 seconds) on button 	Double pressing on button 	Pressing on button 
Emergency metal insert	Turn the key in a counter clockwise direction (driver's side)	Turn the key in a clockwise direction (driver's side)	–	–	–	–
Direction indicators flashing (only with key with remote control)	2 flashings	1 flashing	2 flashings	1 flashing	3 flashings	2 flashings
LED on door lock button	Turning off deterrence led	Turning on fixed for about 3 seconds, followed by deterrence led flashing	Turning off deterrence led	Deterrence led flashing	Double flashing, followed by deterrence led flashing	–

IMPORTANT The emergency metal insert will unlock only the door.

IMPORTANT Window opening operation is a consequence of a door unlocking control; window closing operation is a consequence of a door locking control.

IGNITION SWITCH

The key can be turned to 3 different positions **fig. 17**:

- OFF**: engine off, key can be removed, steering column locked. Certain electrical devices (e.g.: sound system, power windows...) can work.
- ON**: driving position. All electrical devices are powered.
- START**: engine starting.

The ignition switch is fitted with an electronic safety system that, in the event the engine is not started, turns back the ignition key to **OFF** before repeating the starting operation.

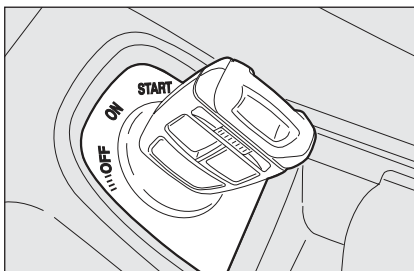

fig. 17



WARNING

If the ignition device is tampered with (e.g.: attempted theft), have it checked over by a Fiat Dealership as soon as possible.



WARNING

When getting out of the car, always remove the key to prevent any occupants from accidentally activating the controls. Remember to engage the handbrake and if the car is parked on uphill slope to engage the first gear. If the car is facing downhill, engage the reverse gear (position P with automatic transmission). Never leave unsupervised children in the car.

STEERING COLUMN LOCK

Engaging

The steering column lock will engage 5 seconds after removing the key from the ignition switch (engine off).

Disengaging

The steering column lock will disengage after fitting the key into the ignition switch.

IMPORTANT Switching the engine off when the car is running will not engage the steering column lock. The multifunction display will show the relevant message (see section “Warning lights and Messages”).

IMPORTANT If, after trying to turn the instrument panel on and/or to start the engine, the display will show the message “Check vehicle protection system”, repeat the operation rocking the steering wheel to facilitate steering unlocking. Displaying of this message does not impair steering column lock operation.

IMPORTANT When the vehicle is moving, the electronic key must remain in the ignition device. That ensures that the steering lock is disabled during vehicle handling (e.g., when the vehicle is towed).

**WARNING**

It is absolutely forbidden to carry out whatever after-market operation involving steering system or steering column modifications (e.g.: installation of anti-theft device) that could badly affect performance and safety, cause the lapse of warranty and also result in non-compliance of the car with homologation requirements.

INSTRUMENTS

REV. COUNTER fig. 18

Rev counter shows engine rpm.

The rev. counter end of scale values can vary based on the version.

IMPORTANT The electronic injection control system gradually shuts off the flow of fuel when the engine is “over-revving” resulting in a gradual loss of engine power.

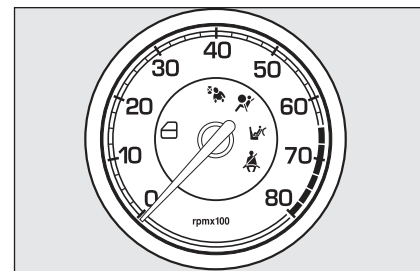

fig. 18

FOL0512m

When the engine is idling, the rev counter may indicate a gradual or sudden highering of the speed.

This is normal as it takes place during normal operation, for example when activating the climate control system or the fan. In particular a slow change in the speed preserves the battery charge.

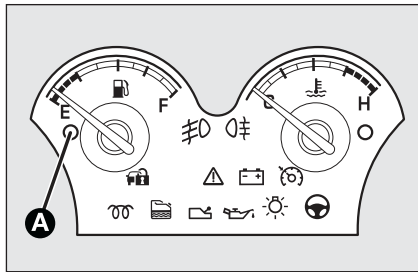

fig. 19

FOL0513m

FUEL LEVEL GAUGE fig. 19

This shows the amount of fuel left in the fuel tank.

The reserve warning light **A** turns on to indicate that approx. 7 to 9 litres of fuel are left in the tank.

E - tank empty.

F - tank full (see the indications given in paragraph "At the filling station").

Do not travel with the fuel tank almost empty: the gaps in fuel delivery could damage the catalyst.

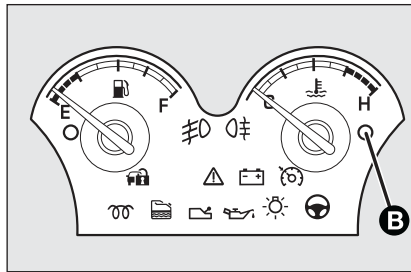

fig. 20

FOL0514m

ENGINE COOLANT TEMPERATURE GAUGE fig. 20

The turning on of the warning light **B** indicates that the coolant fluid temperature is too high; in this case, stop the engine and contact a Fiat Dealership.

This shows the temperature of the engine coolant fluid and begins working when the fluid temperature exceeds approx. 50°C.

Under normal conditions, the needle should move to different positions of the scale according to the working conditions and engine cooling conditions.

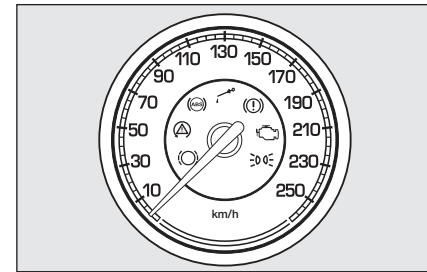

fig. 21

FOL0515m

IMPORTANT If the needle sets at the bottom of the scale (low temperature) with warning light **B** on, it means that the system is malfunctioning. Contact a Fiat Dealership to have the system inspected.



If the needle reaches the red area, stop the engine immediately and contact a Fiat Dealership.

SPEEDOMETER fig. 21

It shows the engine speed.

The speed indicator end of scale values can vary based on the version.

MULTIFUNCTION DISPLAY (where provided)

The vehicle may have a multifunctional display that provides the user with useful information, based on what was previously set, while driving.

“STANDARD” SCREEN fig. 22

The standard screen shows the following indications:

- A** Date
- B** Odometer (covered km or miles)
- C** Clock
- D** External temperature
- E** Headlight aiming position (only with dipped beam headlights on).

Note When opening one of the front doors, the display will turn on and show for a few seconds the clock and the km or mi covered.

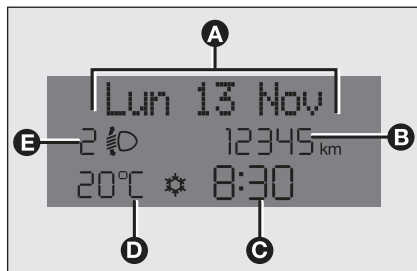

fig. 22

FOL0071m

CONTROL BUTTONS fig. 23

+ To scroll the displayed menu and the related options upwards or to increase the value displayed.

MODE Brief press to open the menu and/or to move to next screen or to confirm the option required.

Long press to go back to the standard screen.

- To scroll the displayed menu and the related options downwards or to decrease the value displayed.

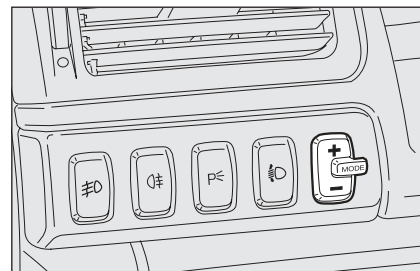

fig. 23

FOL0029m

Note Buttons **+** and **-** activate different functions according to the following situations:

To adjust light inside the passenger compartment

– to adjust instrument panel, sound system and automatic climate control system display brightness when standard screen is active.

Setup menu

– to scroll the menu options upwards and downwards;
– to increase or decrease values during settings.

SETUP MENU fig. 24

The menu comprises a series of functions arranged in a “circular fashion” which can be selected through buttons **+** and **-** to access the different select operations and settings (setup) given in the following paragraphs.

The setup menu can be activated by pressing briefly button **MODE**, only with the car turned on (with car off, only the reduced menu can be displayed).

Single presses on buttons **+** or **-** will scroll the setup menu options.

Handling modes differ with each other according to the characteristic of the option selected.

NOTE If the car is equipped with the Radionavigation System, the only functions that can be adjusted/set through the instrument panel display are the following: “Speed limit”, “Automatic headlight daylight sensor” (where provided) and “S.B.R. (Seat Belt Reminder) buzzer reactivation” (where provided). The other functions are displayed by and can be adjusted/set through the Radionavigation System display.

Selecting a menu option

- press briefly button **MODE** to select the menu option to set;
- press buttons **+** or **-** (by single presses) to select the new setting;
- press briefly button **MODE** to store the new setting and to go back to the previously selected menu option.

Selecting “Date” and “Set Clock”:

- briefly press button **MODE** to select the first value to change (e.g. hours / minutes or year / month / day);
- press buttons **+** or **-** (by single presses) to select the new setting;
- briefly press button **MODE** to store the new setting and to go to the next setup menu option, if this is the last one you will go back to the previously selected option of the main menu.

Press button **MODE** for long:

- to quit the setup menu and to save only the settings stored yet by the user (and confirmed by pressing briefly button **MODE**).

The setup menu displaying is timed; when quitting the menu due to timing expiry, only settings stored yet by the user (and confirmed by pressing briefly button **MODE**) will be saved.

Example:

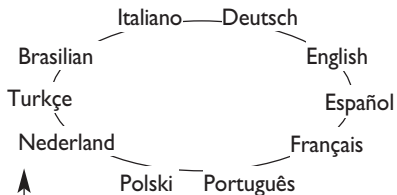

Briefly press button **MODE** to start surfing from the standard screen. To surf the menu use buttons **+** or **-**. **Note** For safety reasons, when the car is running, it is possible to access only the reduced menu (for setting the "Speed limit"). When the car is stationary access to the whole menu is enabled. On cars provided with the Connect Nav+ system, many functions are displayed on the navigator display.

Example:

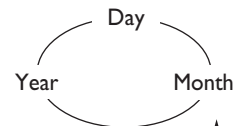

MODE
briefly
press
button

MODE
briefly
press
button

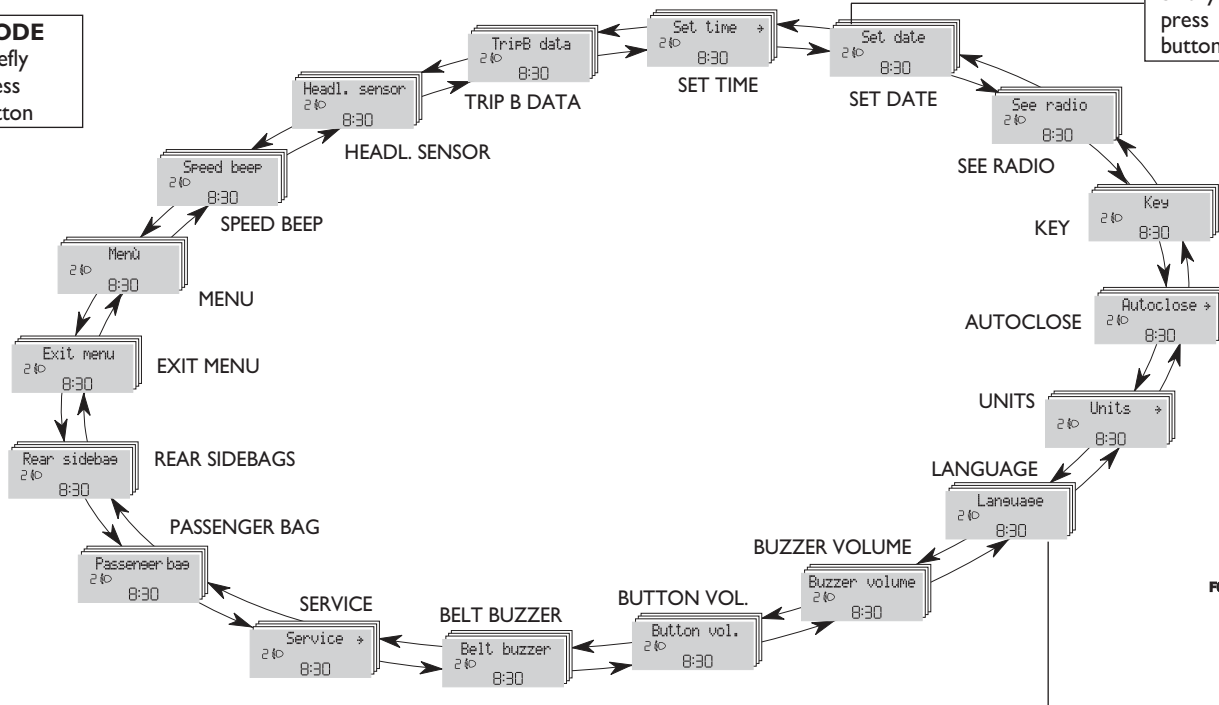

FOL1105g

fig. 24

RECONFIGURABLE MULTIFUNCTION DISPLAY (where provided)

The car can be provided with the reconfigurable multifunction display that shows useful information, according to the previous settings made, necessary when driving.

“STANDARD” SCREEN fig. 25

The standard screen shows the following indications:

- A** Time
- B** Date
- C** Odometer (displays the kilometres, or miles, covered)
- D** Vehicle status signals (ex. doors open or the presence of ice on the road, etc.)
- E** Headlamp stability position (only with low beams on)
- F** External temperature

Note When opening one of the front doors, the display will turn on and show for a few seconds the clock and the km or mi covered.

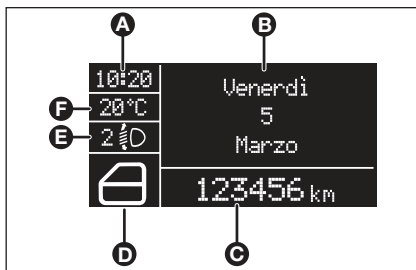

fig. 25

CONTROL BUTTONS fig. 26

+ To scroll the displayed menu and the related options upwards or to increase the value displayed.

MODE Brief press to open the menu and/or to move to next screen or to confirm the option required.

Long press to go back to the standard screen.

- To scroll the displayed menu and the related options downwards or to decrease the value displayed.

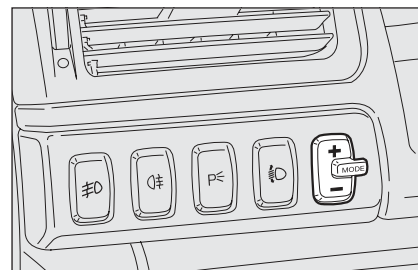

fig. 26

Note Buttons + and - activate different functions according to the following situations:

- to adjust instrument panel, sound system and automatic climate control system display brightness when standard screen is active;
- to scroll the menu options upwards and downwards;
- to increase or decrease values during settings.

SETUP MENU fig. 27

The menu comprises a series of functions arranged in a “circular fashion” which can be selected through buttons + and – to access the different select operations and settings (setup) given below. For certain options (Set time and Units) there is a submenu.

The setup menu can be activated by pressing briefly button **MODE**.

Single presses on buttons + or – will scroll the setup menu options. Handling modes differ with each other according to the characteristic of the option selected.

If the car is equipped with Connect Nav+, the only functions that can be adjusted/set through the instrument panel display are the following: “Dimmer”, “Speed Beep”, “Headl. sensor” (where provided), “Belt buzzer” and “Passenger bag”. The other functions are displayed by and can be adjusted/set through the Connect Nav+ system display.

Selecting an option in the main menu without submenu:

- press briefly button **MODE** to select the menu option to set;
- press buttons + or – (by single presses) to select the new setting;
- press briefly button **MODE** to store the new setting and to go back to the previously selected menu option.

Selecting an option in the main menu with submenu:

- press briefly button **MODE** to display the first submenu option;
- press buttons + or – (by single presses) to scroll all submenu options;
- press briefly button **MODE** to select the displayed submenu option and to enter the relevant setup menu;
- press buttons + or – (by single presses) to select the new setting;
- press briefly button **MODE** to store the new setting and to go back to the previously selected submenu option.

Example:

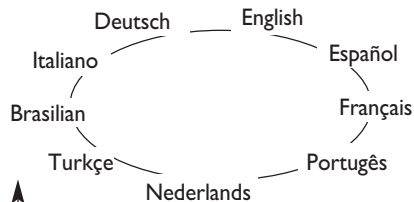

Briefly press button **MODE** to start surfing from the standard screen. To surf the menu use buttons **+** or **-**. **Note** For safety reasons, when the car is running, it is possible to access only the reduced menu (for setting “Dimmer” and “Speed Beep”). When the car is stationary access to the whole menu is enabled. On cars provided with Connect Nav+ many functions are displayed on the navigator display.

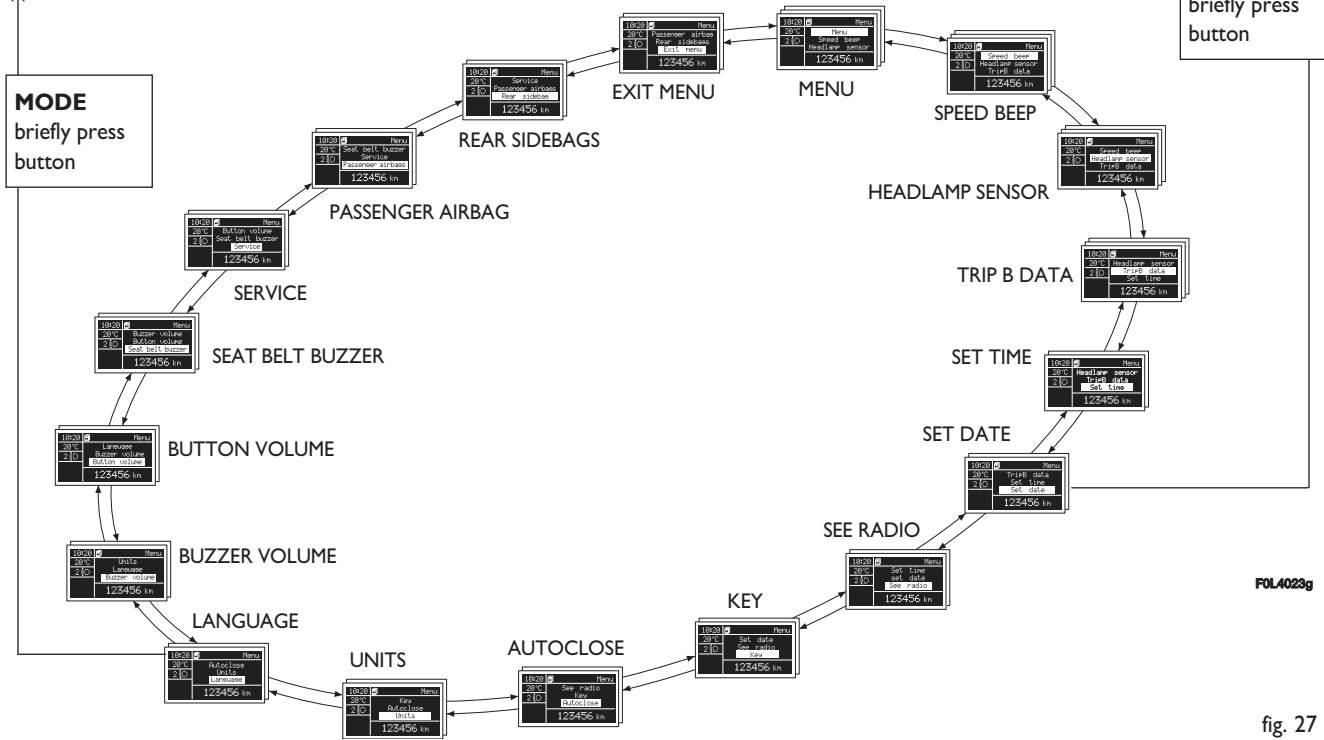
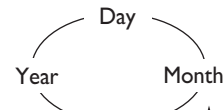

FOL4028g

fig. 27

- DASHBOARD AND CONTROLS
- SAFETY DEVICES
- CORRECT USE OF THE CAR
- WARNING LIGHTS AND MESSAGES
- IN AN EMERGENCY
- CAR MAINTENANCE
- TECHNICAL SPECIFICATIONS
- INDEX

DISPLAY FUNCTIONS

(see Multifunctional display or Reconfigurable multifunctional display)

Speed Beep (Speed limit)

With this function it is possible to set the car speed limit (km/h or mph); when this limit is exceeded the driver is immediately alerted (see section “Warning lights and messages”).

To set the speed limit, proceed as follows:

- briefly press button **MODE**, the display will show wording (Speed Beep);
- press button **+** or **-** to select activation (On) or deactivation (Off) of the speed limit;
- if selecting (On), press button **+** or **-** to select the required speed limit and then press **MODE** to confirm.

Note The possible setting is between 30 and 250 km/h, or between 20 and 155 mph depending on the unit set previously (see “Distance unit (Dist. Unit)” paragraph described later. Every press on button **+/-** increases/decreases by 5 units. Keeping the button **+/-** pressed obtains the automatic fast increase or decrease. When you are near the required setting complete adjustment by single presses.

– briefly press button **MODE** to go back to the menu screen or press the button for long to go back to the standard screen without storing settings.

To cancel the setting, proceed as follows:

- briefly press button **MODE**: (On) will flash on the display;
- press button **-** : (Off) will flash on the display;
- briefly press button **MODE** to go back to the menu screen or press the button for long to go back to the standard screen without storing settings.

Headlamp sensor (Automatic headlight sensor sensitivity adjustment) (where provided)

With this function it is possible to adjust the light sensor sensitivity according to 3 levels (level 1 = min. level, level 2 = average level, level 3 = max. level); the higher the sensitivity is, the lower is the external light intensity required to switch on the lights.

To set the light level required, proceed as follows:

- briefly press button **MODE**, the previously set level will flash on the display;
- press button **+** or **-** to select the required level;
- briefly press button **MODE** to go back to the menu screen or press the button for long to go back to the standard screen without storing settings.

Trip B data (Trip On/Off)

Through this option it is possible to activate (On) or deactivate (Off) the Trip B (partial trip).

For further information see “Trip computer”.

For activation / deactivation, proceed as follows:

- briefly press button **MODE**: On or Off will flash on the display according to previous setting;
- press button **+** or **-** to select the required level;
- briefly press button **MODE** to go back to the menu screen or press the button for long to go back to the standard screen without storing settings.

Set time (Setting the clock)

This function enables to set the clock through two sub-menus: “Time” and “Mode”.

Proceed as follows:

- briefly press button **MODE**, the display will show the two submenus “Time” and “Mode”;
- press button **+** or **-** to scroll the two submenus;
- select the required submenu and then press briefly **MODE**;
- if selecting “Time”: briefly press button **MODE**, “hours” will flash on the display;
- press button **+** or **-** for setting;
- press button **MODE**, “minutes” will flash on the display;
- press button **+** or **-** for setting.

Note Every press on button **+** or **-** increases/decreases by 1 unit. Keeping the button pressed obtains automatic fast increase or decrease. When you are near the required setting complete adjustment by single presses.

– if selecting “Mode”: briefly press button **MODE**, “24h” or “12h mode will flash on the display;

– press button **+** or **-** to select “24h” or “12h”.

After setting, briefly press button **MODE** to go back to the submenu screen or press the button for long to go back to the main menu screen without storing settings.

– press again button **MODE** for long to go back to the standard screen or to the main menu according to the current menu level.

Set date (Setting the date)

This function enables to update the date (day – month – year).

To correct the date proceed as follows:

– briefly press button **MODE**: “year” will flash on the display;

– press button **+** or **-** for setting;

– briefly press button **MODE**: “month” will flash on the display;

– press button **+** or **-** for setting;

– briefly press button **MODE**: “day” will flash on the display;

– press button **+** or **-** for setting.

Note Every press on button **+** or **-** increases/decreases by 1 unit. Keeping the button pressed obtains automatic fast increase or decrease. When you are near the required setting complete adjustment by single presses.

– briefly press button **MODE** to go back to the menu screen or press the button for long to go back to the standard screen without storing settings.

See radio (Audio repetition)

With this function the display repeats information relevant to the sound system.

– Radio: selected radio station frequency or RDS message, automatic tuning activation or AutoStore;

– audio CD, MP3 CD: track number;

– CD Changer: CD number and track number;

– Cassette: operating method.

To activate (On) or to deactivate (Off) sound system info displaying proceed as follows:

– briefly press button **MODE**: On or Off will flash on the display according to previous setting;

– press button **+** or **-** to select the required level;

– briefly press button **MODE** to go back to the menu screen or press the button for long to go back to the standard screen without storing settings.

Key

With this function it is possible to decide the door opening mode by selecting one of the following options:

– open doors: to unlock all doors, except the tailgate

– open driver's door (op. drv. door): to unlock just the driver's door (where provided)

– open all: to unlock every door including the tailgate

The car is delivered with this function in "Open all" mode.

Proceed as follows:

– briefly press button **MODE**, the previous setting will flash on the display;

– press button **+** or **-** for setting;

– briefly press button **MODE** to go back to the menu screen or press the button for long to go back to the standard screen without storing settings.

Autoclose (Automatic central door locking when travelling)

When activated (On), this function locks automatically the doors when the car speed exceeds 20 km/h.

To activate or to deactivate this function proceed as follows:

– briefly press button **MODE** to display the submenu;

– briefly press button **MODE**: On or Off will flash on the display according to previous setting;

– press button **+** or **-** to select the required level;

– briefly press button **MODE** to go back to the menu screen or press the button for long to go back to the standard screen without storing settings;

– Press again button **MODE** for long to go back to the standard screen or to the main menu according to the current menu level.

Units (Setting units)

With this function it is possible to set the units through the submenu: "Distances", "Consumption" and "Temperature" (where provided).

To set the required unit proceed as follows:

– briefly press button **MODE**, the display will show the submenus;

– press button **+** or **-** to scroll the submenu;

– select the required submenu and then press briefly button **MODE**;

– if selecting "Distances": pressing button **MODE** briefly, the display will show "km" or "mi" according to previous setting;

– press button **+** or **-** to select the required level;

– if selecting "Consumption": briefly press button **MODE** the display will show "km/l", "l/100km" or "mpg" according to previous setting;

If the distance unit set is “km” the fuel consumption unit will be displayed in km/l or l/100km.

If set unit is “mi” the display will show fuel consumption in “mpg”.

– press button **+** or **-** to select the required level;

– if selecting “Temperature”: pressing button **MODE** briefly, the display will show “°C” or “°F” according to previous setting;

– press button **+** or **-** to select the required level.

After setting, briefly press button **MODE** to go back to the submenu screen or press the button for long to go back to the main menu screen without storing settings.

– press again button **MODE** for long to go back to the standard screen or to the main menu according to the current menu level.

Language (Selecting the language)

Display messages can be shown (after setting) in different languages: Italian, German, English, Spanish, French, Portuguese, Pole (where provided) Turkish and Brazilian.

To set the required language proceed as follows:

– briefly press button **MODE**: the previously set “language” will flash on the display;

– press button **+** or **-** to select the required level;

– briefly press button **MODE** to go back to the menu screen or press the button for long to go back to the standard screen without storing settings.

Buzzer volume (Setting the buzzer volume)

With this function the volume of the buzzer accompanying any failure/warning indication can be adjusted according to 8 levels.

To adjust the volume proceed as follows:

– briefly press button **MODE**: the previously set volume “level” will flash on the display;

– press button **+** or **-** for setting;

– briefly press button **MODE** to go back to the menu screen or press the button for long to go back to the standard screen without storing settings.

Button volume (Adjusting the button volume)

With this function the volume of the roger-beep accompanying the activation of buttons **MODE**, **+** and **-** can be adjusted according to 8 levels.

To adjust the volume proceed as follows:

- briefly press button **MODE**: the previously set volume “level” will flash on the display;
- press button **+** or **-** for setting;
- briefly press button **MODE** to go back to the menu screen or press the button for long to go back to the standard screen without storing settings.

Seat belt buzzer (S.B.R. buzzer reactivation)

This function can be only displayed after Fiat Dealership has deactivated the S.B.R. system (see paragraph “S.B.R. system” in section “Safety devices”).

Service (Scheduled Servicing)

This function displays information related to kilometric or time based frequencies for maintenance checks.

Proceed as follows:

- briefly press button **MODE**: service in km or mi, according to previous setting, will be displayed (see paragraph “Distance unit”);
- briefly press button **MODE** to go back to the menu screen or press the button for long to go back to the standard screen without storing settings.

Note The “Service schedule” includes car maintenance every 30,000 km (or 18,000 miles) or every year; this is shown automatically, with the ignition key at **ON**, starting from 2,000 km (or equivalent value in miles) or 30 days from this deadline and it is shown again every 200 km (or equivalent value in miles). Below 200 km servicing indications are displayed more frequently. Servicing indication will be displayed in km or mi according to previous setting. When a programmed maintenance interval (coupon) is near to come, turning the ignition key to **ON**, the display will show the message “Service” followed by the number of km/mi or days to go before car servicing. Contact a Fiat Dealership to carry out any service operation provided by the “Service schedule” and to reset the display.

Passenger airbag Turning the passenger side front and side chest protection air bags on/off (Side Bags) (if foreseen) fig. 28

This function is used to turn the passenger side front and side chest protection air bags on/off (Side Bags).

Proceed as follows:

- press button **MODE** and, after displaying of messages (Passenger airbag: off) (to deactivate) or (Passenger airbag: on) (to activate) by pressing buttons **+** and **-**, press again button **MODE**;
- display will show the confirmation message;
- press buttons **+** or **-** to select (Yes) (to confirm activation/deactivation) or (No) (to abort);
- briefly press button **MODE**, to display the confirmation message and to go back to the menu screen or press the button for long to go back to the standard screen without storing settings.

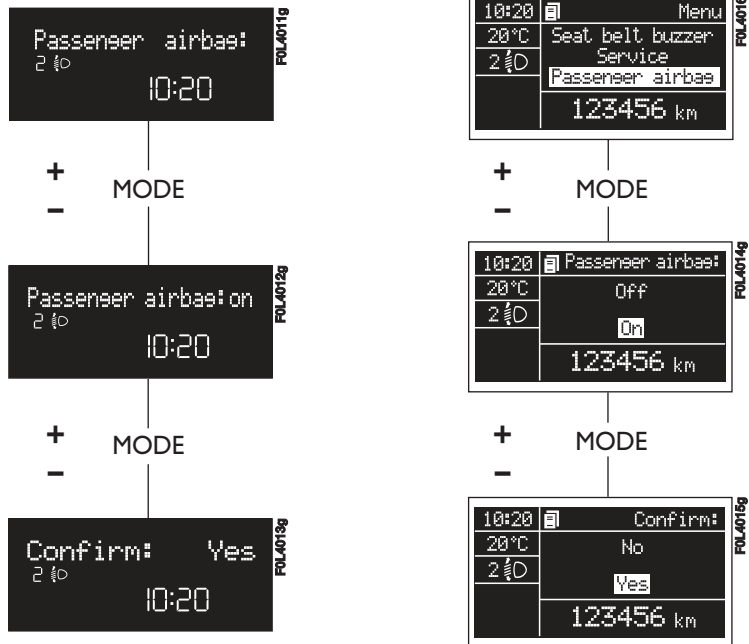

fig. 28

Rear Sidebags

Turning the rear side chest protection air bags on/off (Rear side bags) (if foreseen) fig. 29

This function is used to turn the rear side chest protection air bags on/off (Rear Side Bags).

Proceed as follows:

- press the **MODE** button and, after displaying the message on the screen (Rear Sidebags: off) (to turn off) or the message (Rear Sidebags: on) (to turn on) using the **+** and **-** buttons, press the **MODE** button again;

- display will show the confirmation message;

- press buttons **+** or **-** to select (Yes) (to confirm activation/deactivation) or (No) (to abort);

- briefly press button **MODE**, to display the confirmation message and to go back to the menu screen or press the button for long to go back to the standard screen without storing settings.

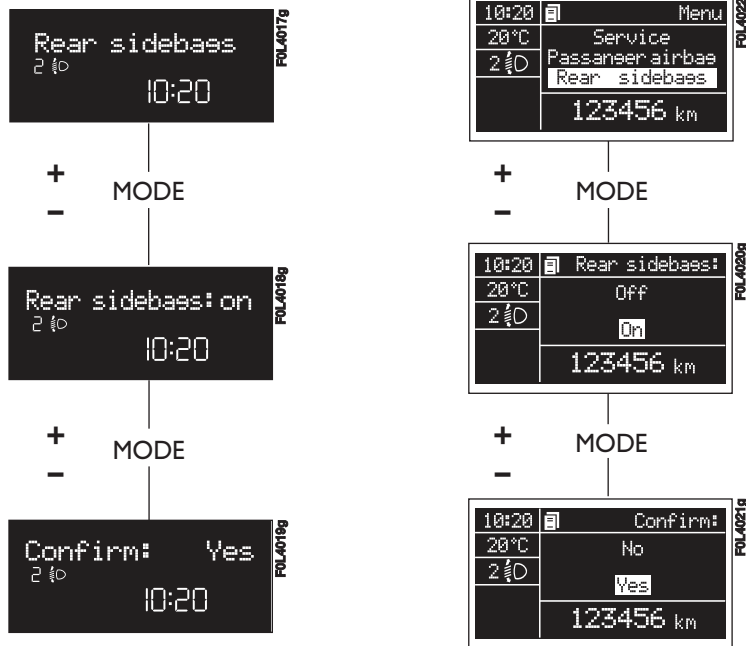

fig. 29

Exit Menu

This is the last function that closes the circular setting cycle listed in the initial menu screen.

Briefly press button **MODE** to go back to the standard screen without storing settings.

Press button **–** to return to the first menu option.

TRIP COMPUTER (where provided)

General features

The “Trip computer” is provided on cars fitted with multifunction display or reconfigurable multifunction display. The “Trip computer” displays information (with ignition key at **ON**), relating to the operating status of the car. This function comprises the “General trip” concerning the “complete mission” of the car (journey) and “Trip B”, (only available on reconfigurable multifunction display), concerning the partial mission of the car; this latter function (as shown in **fig. 3 I**) is “contained” within the complete mission.

Both functions are resettable (reset - start of new mission).

“General Trip” displays the figures relating to:

- Range
- Trip distance
- Average consumption
- Instant consumption
- Average speed
- Travel time (driving time).

“Trip B” (only available on reconfigurable multifunction display), displays the figures relating to:

- Trip distance B
- Average consumption B
- Average speed B
- Travel time B (driving time).

Note The “Trip B” function can be excluded (see paragraph “Trip B On/Off”). “Range” cannot be reset.

Values displayed

Range

Estimated distance which can be travelled with the fuel currently in the tank, keeping the same driving style. The display will show “----” in the following cases:

- value lower than 50 km (or 30 mi)
- car left parked with engine running for long.

IMPORTANT The variation of the autonomy value can be influenced by different factors: driving style (see what is described in paragraph “Driving style” in the chapter “Start-up and driving”), type of route (highways, urban, mountain, etc...), use conditions of the car (load transported, tire pressure, etc...). What was described previously must be taken in consideration when planning a trip.

Trip distance

This value shows estimated distance covered from the start of the new mission.

Average consumption

Average fuel consumption since the start of the new mission.

Instant consumption

This value shows instant fuel consumption (this value is updated second by second). If parking the car with engine on, the display will show “----”.

Average speed

This value shows the car average speed as a function of the overall time elapsed since the start of the new mission.

Travel time

This value shows the time elapsed since the start of the new mission.

IMPORTANT Lacking information, Trip computer values are displayed with “----”. When normal operating condition is reset, calculation of different units will restart regularly. Values displayed before the failure will not be reset.

TRIP button fig. 30

Button **TRIP**, set on the top of the right steering column stalk, shall be used (with ignition key at **ON**) to display and to reset the previously described values to start a new mission:

- short push to display the different values
- long push to reset and then start a new mission.

New mission

New mission starts after:

- “manual” resetting by the user, by pressing the relevant button;
- “automatic” resetting, when the “Trip distance” reaches 9999.9 km or when the “Travel time” reaches 99.59 (99 hours and 59 minutes);
- after disconnecting/reconnecting the battery.

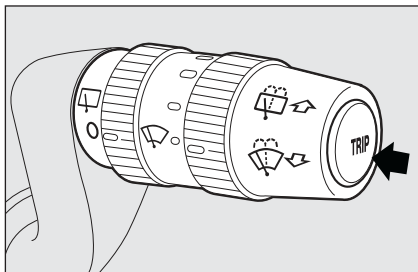

fig. 30

F0L0070m

IMPORTANT The reset operation in the presence of the screens concerning the “General Trip” makes it possible to reset also the “Trip B”. The reset operation in the presence of the screens concerning only the “Trip B” makes it possible to reset only the information associated with this function.

Start of journey procedure

With ignition key at **ON**, press and keep button **TRIP** pressed for over 2 seconds to reset.

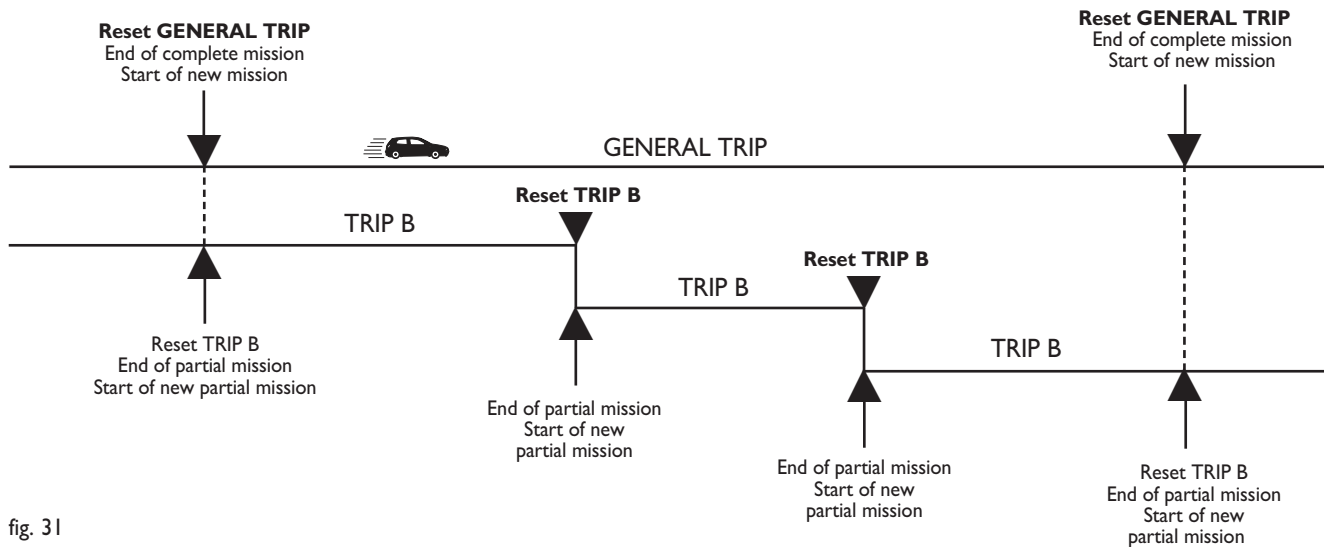

fig. 31

SEATS

MANUALLY ADJUSTABLE FRONT SEATS fig. 32

Moving the seat backwards or forwards

Lift the lever **A** and push the seat forwards or backwards: in the driving position the arms should rest on the rim of the steering wheel.

Height adjustment

Move repeatedly lever **B** upwards or downwards to achieve the required height.

IMPORTANT Adjustment must be carried out only seated in the driver's seat.

Back rest angle adjustment

Turn the knob **C**.

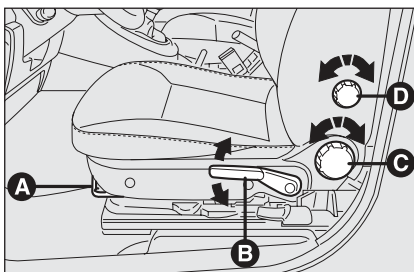

fig. 32

F0L0376m



WARNING

Only make adjustments when the car is stationary.



WARNING

Once you have released the lever, check that the seat is firmly locked in the runners by trying to move it back and forth. Failure to lock the seat in place could result in the seat moving suddenly and the driver losing control of the car.



WARNING

For maximum safety, keep the back of your seat upright, lean back into it and make sure the seat belt fits closely across your chest and hips.



Fabric upholstery of your car is purpose-made to withstand common wear resulting from normal use of the car. It is however absolutely necessary to prevent hard and/or prolonged scratching/scraping caused by clothing accessories like metallic buckles, studs, "Velcro" fixings, etc. that stressing locally the fabric could break yarns and damage the upholstery as a consequence.

Lumbar adjustment (where provided)

To adjust, turn the knob **D**.

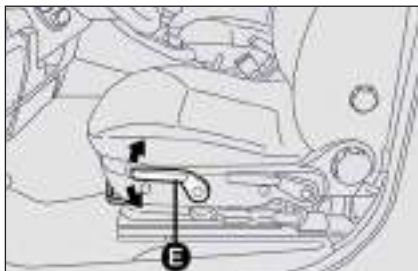

fig. 33

FOL0136m

Tilting the back rest (where provided) fig. 33

Move repeatedly lever **E** upwards or downwards to achieve the required position.

IMPORTANT Adjustment must be carried out only seated in the driver's seat.

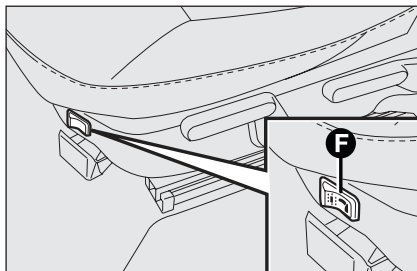

fig. 34

FOL0199m

Seat warming fig. 34

With ignition key at **ON**, press button **F** to switch the seat warming on/off. The led on the button will light up when the function is on.

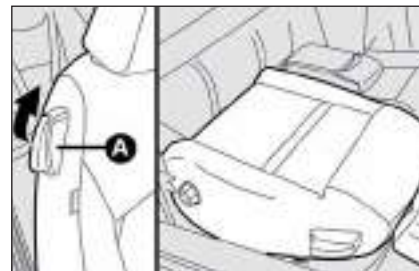

fig. 35

FOL0104m

Front passenger's seat "table" tilting (where provided) fig. 35

To tilt the seat, lift lever **A** and fold the back rest at the same time.

To reset it to normal position, operate lever **A** and at the same time raise the back rest until hearing the coupling/locking click.

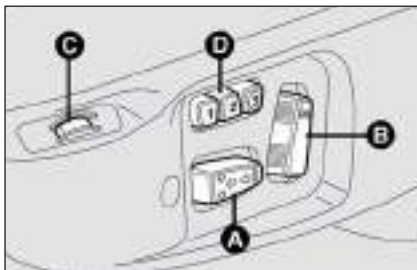

fig. 36

F0L0173m

ELECTRICALLY ADJUSTABLE FRONT SEATS

(where provided) fig. 36

Adjustment is possible when the ignition key is at **ON** or within 1 minute with ignition key at **OFF** or removed, or for three minutes after opening the doors.

Moving the seat backwards or forwards and seat height adjustment

Use control **A**.

Back rest angle adjustment

Use control **B**.

Height adjustment

Use control **A** to adjust the height of the front or rear part of the seat.

Storing the driver's seat positions

The system allows to store and recall (only with ignition key at **ON**) three different driver's seat and door mirror positions.

Proceed as follows:

- adjust the driver's seat and door mirror positions;
- press for about 3 seconds one of the buttons **D** ("1", "2" or "3"), corresponding to each of the stored positions until hearing the confirmation beep.

Storing a new position (seat and mirror) will automatically clear the one stored previously using the same button.

IMPORTANT The lumbar adjustment and the seat warming function are not controlled by the seat position storing system.

Recalling stored positions

Proceed as follows:

- turn the ignition key to **ON**;
- press (by pulse) button **D** ("1", "2" or "3").

The seat will move automatically, only if the position to be reached is different from the current one and the car speed is lower than 10 km/h.

Seat moving is possible within 1 minute after removing the key from the ignition switch or within three minutes after opening the doors.

Should engine be started during the recalling phase, seat moving will be temporarily stopped.

IMPORTANT Pressing any of the **D** buttons during the recalling stage, causes immediate stop of the function being performed ("antipanic" mode).

Seat warming (where provided)

Use control **C** to switch seat warming on/off. Seat warming can be adjusted according to four different levels: 0 (off), 1 (min. warming), 2 (average warming), 3 (max. warming).

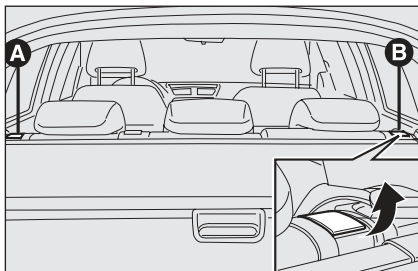

fig. 37

FOL009m

REAR SEATS

Releasing the back rest fig. 37

- lift lever **A** or **B** to release respectively the left or the right section of the back rest and guide it onto the cushion.



WARNING

Only make adjustments when the car is stationary.

HEAD RESTRAINTS

FRONT fig. 38

Head restraints are adjustable in height and they lock automatically in the required position.

- to raise: raise the head restraint until hearing the locking click.
- to lower: press button **A** and lower the head restraint.

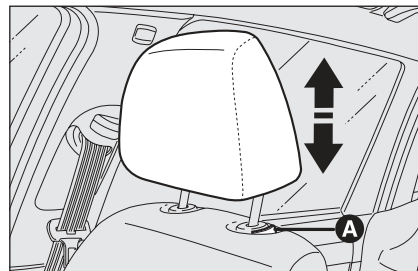

fig. 38

FOL0010m

REAR fig. 39

Rear seats are fitted with three head restraints.

To lift out rear head restraints: press at the same time buttons **B** set on both sides and take them out from the seat back.

IMPORTANT Rear seat passengers shall always set the head restraints in the position of use.

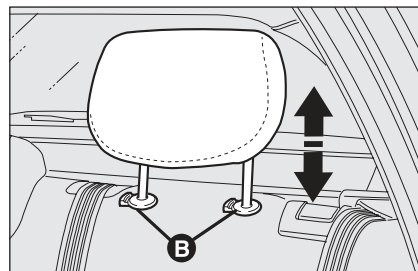

fig. 39

FOL0011m



WARNING

Remember that the head restraints should be adjusted to support the back of your head and not your neck. Only in this position do they exert their protective action.



WARNING

To optimise head restraint protective action, adjust the seat back upright and keep your head as close as possible to the head restraint.

STEERING WHEEL

The driver can adjust the steering wheel position both axially and in height.

Proceed as follows **fig. 40**

- release the lever pushing it forwards (position **1**);
- adjust the steering wheel as required;
- lock the lever pulling it towards the steering wheel (position **2**).



fig. 40

FOL.0392m



WARNING

Any adjustment of the steering wheel position must be carried out only with the car stationary and the engine turned off.



WARNING

It is absolutely forbidden to carry out whatever after-market operation involving steering system or steering column modifications (e.g.: installation of anti-theft device) that could badly affect performance and safety, cause the lapse of warranty and also result in non-compliance of the car with homologation requirements.

REARVIEW MIRRORS

DRIVING MIRROR fig. 41

The mirror is fitted with a safety device that causes it to be released in the event of a violent crash.

It can be moved using the lever **A** to two different positions: normal or antiglare.

ELECTRO-CHROMIC DRIVING MIRROR fig. 42

Certain versions are fitted with automatic antiglare electro-chromic mirror. The electro-chromic function is turned on/off by pressing button **ON/OFF** in the lower section of the mirror. When this function is on, the mirror led will turn on. When engaging reverse, the mirror will always set to daylight colouring.

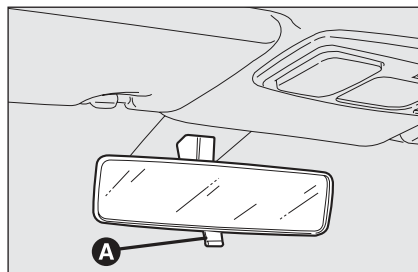

fig. 41

FOL0012m

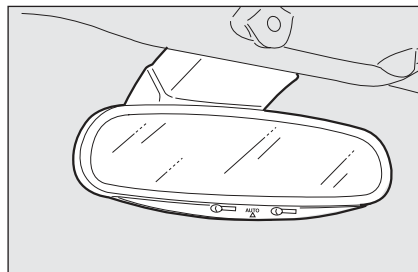

fig. 42

FOL0310m

DOOR MIRRORS fig. 43

Electrical adjustment

This operation is only possible with ignition key at **ON**.

Proceed as follows:

- use switch **B** to select the mirror required (left or right);

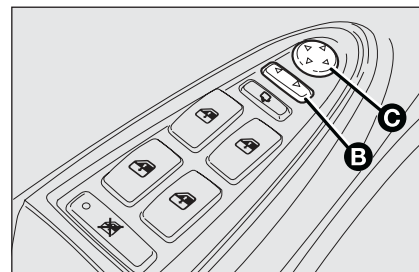

fig. 43

FOL0386m

- to adjust the mirror move the switch **C** in the four directions;

Adjust mirrors with car stationary and handbrake on. Mirror defrosting starts automatically when switching the heated rear window on.

Storing the “parking” position of the door mirror on the passenger side

To improve visibility during parking manoeuvres when engaging the reverse gear, the driver can adjust/move (and store) the passenger door mirror to a position different from that used during normal running.

To store the required mirror position proceed as follows:

- engage reverse with car stopped and ignition key to **ON**;
- turn selector **B** (to select the passenger door mirror);
- use selector **C** to adjust the passenger door mirror as required to obtain best position for parking manoeuvres;
- keep one of the seat storing/recalling buttons pressed for 3 seconds at least;

Together with the passenger door mirror “parking” position, also the driver seat and door mirror positions will be stored.

The sound of a buzzer confirms that the mirror position has been stored.

Recalling the “parking” position of the passenger door mirror

To recall automatically the “parking” position of the passenger door mirror, proceed as follows:

- engage reverse with car stopped and ignition key to **ON**;
- turn selector **B** to select the passenger door mirror; the mirror will set automatically to the previously stored position.

If no parking position has been stored, when engaging reverse the passenger door mirror will slightly lower to aid the driver during parking.

The mirror will automatically return to its original position in the following cases:

- 10 seconds after disengaging reverse;
- when the car speed exceeds 10 km/h in forward gear ;
- when turning selector **B** to neutral position or to driver mirror position.

IMPORTANT “Parking” position can only be stored or recalled with ignition key at **ON**.

Automatic door mirror realignment

Each time the ignition key is turned to **ON**, door mirrors return automatically to the last position set and/or recalled at last removal of the electronic key.

This enables mirror alignment if when leaving the car parked one of the door mirrors has been moved manually and/or accidentally.

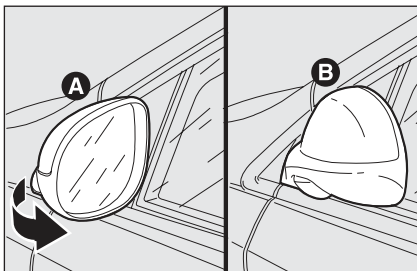

fig. 44

FOL0015m

Manual folding fig. 44

When required (for example when the mirror causes difficulty in narrow spaces) it is possible to fold the mirrors moving it from position **A** to position **B**.

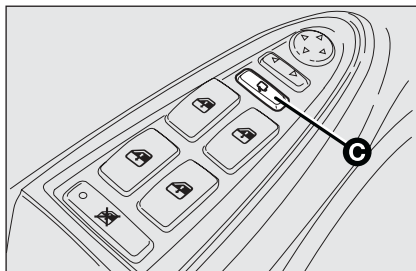

fig. 45

FOL0387m

Powered folding (where provided) fig. 45

When required (for example when the mirror causes difficulty in narrow spaces) it is possible to fold the mirrors by pressing button **C**.

To reset mirrors to driving position, press button **C** again.



WARNING

When driving the mirrors shall always be in position **A**.



WARNING

As the driver's door mirror is curved, it slightly alters the perception of distance.

HEATING/CLIMATE CONTROL SYSTEM

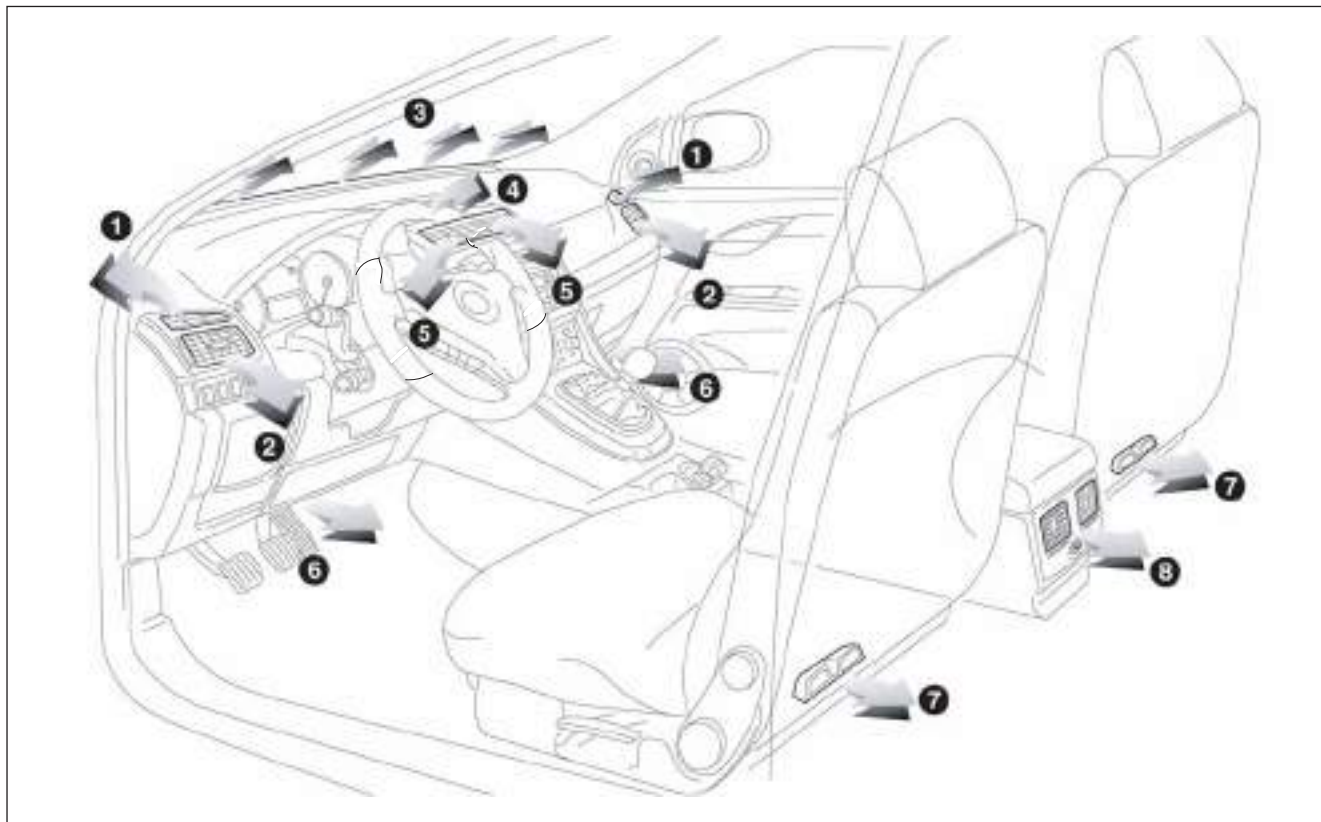

fig. 46

FOL0359m

1 Fixed side vents - 2 Adjustable side outlets - 3 Fixed upper vent - 4 Fixed central vent - 5 Central swivel vents - 6 Lower vents - 7 Lower vents for rear seats - 8 Adjustable vents for rear seats.

DASHBOARD
AND CONTROLS

SAFETY
DEVICES

CORRECT USE
OF THE CAR

WARNING
LIGHTS AND
MESSAGES

IN AN
EMERGENCY

CAR
MAINTENANCE

TECHNICAL
SPECIFICATIONS

INDEX

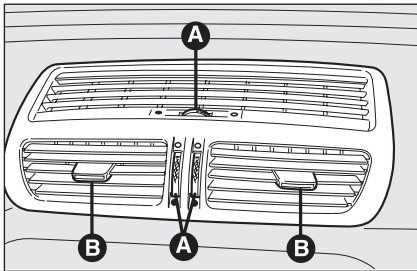

fig. 47

FOL0015m

CENTRAL VENTS fig. 47**A** = Air flow adjusting control

● = completely closed

○ = completely open

B = Control for directing air flow.

fig. 48

FOL0311m

SIDE VENTS fig. 48**C** = Air flow adjusting control

● = completely closed

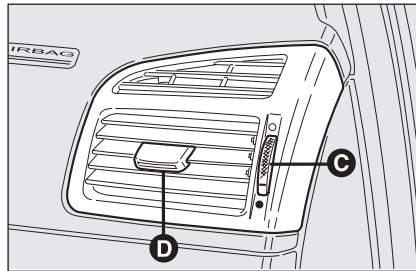
○ = completely open

D = Control for directing air flow.

fig. 49

FOL0311m

REAR VENTS fig. 49**E** = Air flow adjusting control

● = completely closed

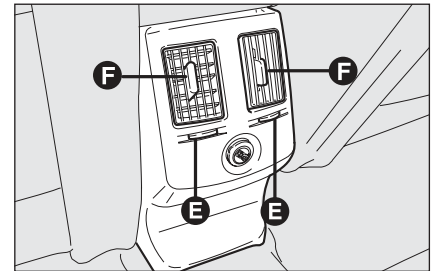
○ = completely open

F = Control for directing air flow.

MANUAL CLIMATE CONTROL SYSTEM

CONTROLS fig. 50

- A:** air distribution knob;
- B:** compressor on/off button;
- C:** air temperature knob (mixing warm and cold air);
- D:** **MAX-DEF** function button (front window fast defrosting/demisting);
- E:** air flow control knob;
- F:** heated rear window on/off button;
- G:** air recirculation on/off button.

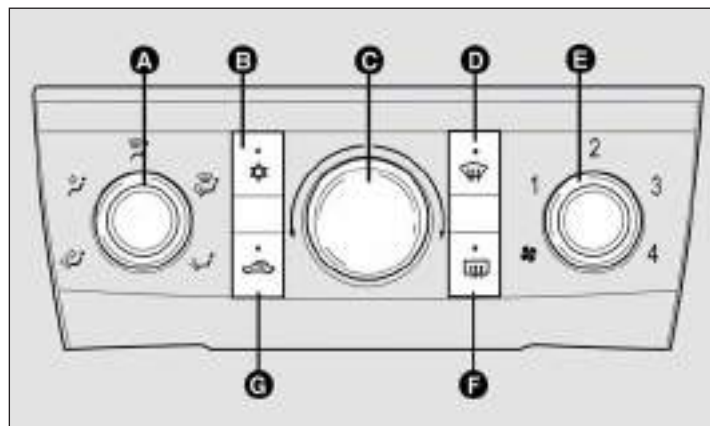







fig. 50

FOL0153m

CLIMATIC COMFORT



Knob **A** directs the air inside the passenger compartment according to five levels:

-  to warm the feet and keep the face cool ("bilevel" function);
-  air flow from central vents and side outlets;

-  to demist and defrost the windscreen and side front windows;
-  to warm the passenger compartment and at the same time demist the windscreen;
-  to speed up passenger compartment warming.

WARMING THE PASSENGER COMPARTMENT

Proceed as follows:

- turn knob **C** (pointer on red sector) completely to the right;
- turn knob **E** to the required speed;
- move knob **A** to:
 -  to warm the feet and at the same time demist the windscreen;
 -  to warm the feet and convey cooler air from central vents and dashboard outlets;
 -  for quick warming.

QUICK WARMING

Proceed as follows:

- close all dashboard vents;
- turn knob **C** to red sector;
- press button **G**;
- turn knob **E** to the required fan speed;
- turn knob **A** to .

WINDSCREEN AND FRONT SIDE WINDOW FAST DEMISTING/DEFROSTING (MAX-DEF function)

Proceed as follows:

- turn knob **C** (pointer on red sector) completely to the right;
- turn the **MAX-DEF** function on by pressing button **D** (button led on);

Pressing this button will automatically activate the following functions:



- air distribution to windscreen and side vents;
- fan activation at max. speed;
- compressor activation (button led on);
- automatic air recirculation (button led off if previously on);

After demisting/defrosting, press button **D** to turn the **MAX-DEF** function off.

Use common control buttons to restore the required comfort.

Window demisting

In the event of considerable outside moisture and/or rain and/or considerable differences in temperature inside and outside the passenger compartment, perform the following preventive demisting procedure:

- turn air recirculation off by pressing button **G** (button led off);
- turn knob **C** to red sector;
- turn knob **E** to 2;
- turn knob **A** to , or to  the windows do not demist.

IMPORTANT Climate control system is very useful to speed up window demisting: therefore, just perform demisting as previously described and turn the climate control system on by pressing button **B**.

HEATED REAR WINDOW AND DOOR MIRROR DEMISTING/DEFROSTING

Press button **F** to start this function.

This function is timed and switches off automatically after 30 minutes. To cut out this function press again button .

IMPORTANT Do not apply stickers on the inside of the rear window over the heating filaments to avoid damage that might cause it to stop working properly.

FAN SPEED ADJUSTMENT

To ventilate the passenger's compartment properly, proceed as follows:

- open completely central vents and side outlets;
- turn knob **C** to the blue sector;
- turn knob **E** to the required speed;
- turn air recirculation off by pressing button **G** (button led off);
- turn knob **A** to .

RECIRCULATION

Turn this function on by pressing button **G** (button led on).

This function is particularly useful when the outside air is heavily polluted (in a traffic jam, tunnel, etc.). However, it is better not to use it for long periods, especially if there are several people in the car to prevent window misting.

IMPORTANT The inside air recirculation system makes it possible to reach the required "heating" or "cooling" conditions faster. Do not use the air recirculation function on rainy/cold days as it would considerably increase the possibility of the windows misting inside.

CLIMATE CONTROL (cooling)

Proceed as follows:

- turn knob **C** to the blue sector;
- turn knob **E** to the required speed;
- turn knob **A** to ;
- turn air recirculation on by pressing button **G** (button led on);
- press button **B** to turn climate control compressor on.

Cooling adjustment

Proceed as follows:

- turn air recirculation off by pressing button **G** (button led off);
- turn knob **C** to the right to raise temperature;
- turn knob **E** to the left to reduce the fan speed.

LOOKING AFTER THE SYSTEM

During winter, the climate control system must be turned on at least once a month for about 10 minutes. Before summer, have the system checked at a Fiat Dealership.

AUTOMATIC CLIMATE CONTROL SYSTEM (where provided)

GENERAL

The car is fitted with a two-zone climate control system which makes it possible to separately adjust the air temperature on the driver's side and on the passenger's side. Temperature control is based on the "equivalent temperature" logic, i.e.: the system continuously works to keep constant the comfort inside the passenger compartment and to compensate any variation of the outside climate conditions, including sunshine detected by a proper sensor provided for the purpose.

The system is also fitted with AQS (Air Quality System) sensor that turns on air recirculation automatically when it detects the presence of outside polluted air (for example when driving in the city, queues and tunnels).

The climate control system automatically controls and adjusts the following parameters and functions:

- air temperature at driver/front passenger/rear passenger vents;
- air distribution at driver/front passenger vents;
- fan speed (continuous air flow variation);
- compressor activation (to cool/dehumidify air);
- air recirculation.

All the above functions can be changed manually by selecting the required function/s and by changing the set parameters. In this way the automatic control is deactivated; the system will resume automatic control only for safety reasons (e.g. risk of window misting up).

Manual selections prevail over automatic ones and remain in storage until the user decides to resume automatic control by pressing the proper button, except when the system cuts in for particular safety conditions.

The control of functions not changed manually remains automatic.

The amount of air admitted to the passenger compartment does not depend on the car speed, since it is electronically controlled by the fan.

The temperature of the air admitted to the passenger compartment is always controlled automatically according to the temperatures set on the driver's and front passenger's display (except when the system is off or under certain conditions when the compressor is off).

The following parameters and functions can be set or changed manually:

- air temperatures on driver/front passenger side;
- fan speed (continuous variation);
- air distribution on seven levels (driver/front passenger side);
- climate control compressor on/off;
- monozone/two-zone distribution priority;
- fast demisting/defrosting;
- air recirculation;
- rear heated window.

CONTROLS

- A:** air recirculation and **AQS** function on/off button
- B:** air distribution button on driver side
- C:** button for selecting the system automatic mode **AUTO** on driver side
- D:** display showing climate control system data
- E:** button for selecting the system automatic mode **AUTO** on passenger side
- F:** air distribution button on passenger side
- G:** knob for adjusting temperature on passenger side
- H:** rear window heating on/off button
- I:** button for activating the **MONO** function (alignment of set temperatures)
- L:** climate control compressor on/off button
- M/N:** buttons for adjusting fan speed
- O:** **MAX-DEF** function button (front window fast defrosting/demisting)
- P:** knob for adjusting temperature on driver side

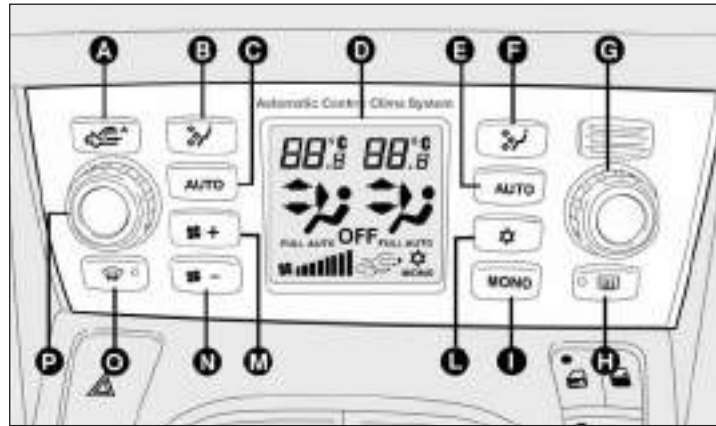

fig. 51

F0L0380m



SWITCHING THE CLIMATE CONTROL SYSTEM ON

The system can be started in different ways, but it is advisable to press one of the **AUTO** buttons and then to turn the knobs to set the temperatures required on the display.

Since the system controls two zones of the passenger's compartment, the driver and the front passenger can select different temperatures.

This way the system will start working completely automatically to reach the comfort temperatures as quickly as possible. The system will set air temperature, quantity and distribution and it will control the air recirculation function and the activation of conditioner compressor.

During fully automatic operation, the only manual settings required are the following:

- MONO**, to align the air temperature and distribution set on the passenger's side (front or rear) with that on the driver's side;
- , air recirculation, to keep it always on or off;
- , to speed up demisting/defrosting of windscreen, front side windows, rear window and door mirrors;
- , to demist/defrost heated rear window and door mirrors.

During full automatic system operation, you can change at any time set temperatures, air distribution and fan speed by using the relevant buttons or knobs: the system will automatically change its settings to adjust to the new requirements. During **FULL AUTO** operation, changing air distribution and/or flow and/or compressor activation and/or air recirculation will make the **FULL** wording disappear. In this way functions will pass from automatic control to manual control until pressing again the **AUTO** button. Fan speed is the same for every area of the passenger compartment.

With one or more functions engaged manually, the adjustment of the temperature of the air admitted to the passenger compartment continues to be controlled automatically by the system, except with the climate control compressor off: under this condition in fact, the temperature of the air admitted to the passenger compartment cannot be lower than outside air temperature.

CONTROLS

Air temperature adjusting knobs P-G

Turning the knobs clockwise or counterclockwise, respectively higher or lowers the temperature of the air required respectively in the front left zone (knob **P**) or in the right zone (knob **G**) of the passenger compartment.

Since the system controls two zones of the passenger compartment, it is possible to personalise required temperatures (driver and passenger).

The temperatures set are shown on the displays near the relevant knobs.

Pressing button **I (MONO)** automatically aligns the temperature on the passenger's side with that on the driver's side; you can therefore set the same temperature for both zones by turning knob **P** on driver side.

Separate operation of air temperatures and distribution is restored by turning knobs or pressing again button **I (MONO)** when the button led is on.

Turning the knobs fully clockwise or counter-clockwise until they reach the extreme selections HI or LO, the maximum heating or cooling functions are respectively engaged:

HI function (highest heating power):

this is turned on by rotating the temperature knob clockwise and passing the max. temperature value (32°C). It can be activated independently from driver or front passenger side or both (also when the **MONO** function is selected).

When this function is on, the display shows **HI**.

This function can be engaged when requiring to heat the passenger compartment as quickly as possible, exploiting the maximum potential of the system. This function uses the maximum temperature of the coolant fluid, while air distribution and fan speed are controlled according to the system settings.

More particularly, max. fan speed will not be immediately engaged if coolant is not hot enough; this to prevent admitting air that is not warm enough to the passenger compartment.

All manual settings are possible with this function on.

To switch the function off, simply turn the knob counter-clockwise and set the required temperature.

LO function (highest cooling power):

this is turned on by rotating the temperature knob counter-clockwise and passing the min. temperature value (16°C). It can be activated independently from driver or front passenger side or both (also when the **MONO** function is selected).

When this function is on, the display shows **LO**.

This function can be engaged when requiring to cool the passenger compartment as quickly as possible, exploiting the maximum potential of the system. This function activates automatically:

MONO function;

air distribution at central / side vents (shown by the relevant symbol on the display);

fan at max. speed;

climate control compressor.

All manual settings are possible with this function on.

To switch the function off, simply turn the knob clockwise and set the required temperature.

Front air distribution buttons B-F

Pressing these buttons it is possible to choose manually one of the seven possible air distributions to the passenger compartment (right or left side):

▲ Air flow to the windscreen and front side window vents to demist or defrost them.

▶ Air flow at central and side dashboard vents to ventilate the chest and the face during the hot season.

▼ Air flow towards the front and rear lower parts of the passenger compartment. Due to the natural tendency of heat to spread upwards, this type of distribution allows heating of the passenger compartment in the shortest time, also giving a prompt feeling of warmth.

▶▼ Splitting of the air flow between the vents to the lower part of the passenger compartment (warmest air) and the dashboard centre and side outlets (coolest air). This air flow distribution is particularly useful in spring and autumn when the sun is shining.

◆ Splitting of the air flow between the windscreen and side window demisting/defrosting vents and the lower part of the passenger compartment. This type of air distribution allows satisfactory heating of the passenger compartment while preventing possible misting of the windows.

◆ Combined splitting of the air flow between the windscreen vents, central/side outlets and vents at the lower part of the passenger compartment (feet area). This air flow distribution enables to keep good overall comfort conditions in summer.

▶ Splitting of the air flow between the windscreen vents, central/side outlets on the dashboard. This air flow distribution enables to obtain satisfactory cooling of the passenger's compartment and to keep the required coolig condition in summer.

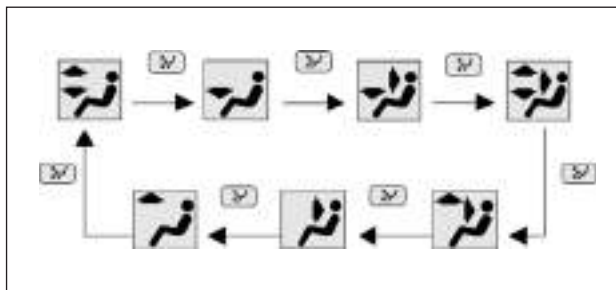

fig. 52

F0L0234m

Air distribution is selected through buttons **B** and **F** in “rolling” mode, according to the sequence shown in the following diagram **fig. 52**.



The type of air distribution selected is shown by lighting up of the relevant symbols on the display.

To restore automatic air distribution control after a manual selection, press button **AUTO**.

In **FULL AUTO** mode, pressing the distribution buttons **B** or **F** for the first time, will display the current status selected by the system. It is then possible to select in “rolling” mode the type of distribution required by pressing buttons **B** or **F** again.

When the driver selects air distribution to the windscreen, also the air distribution on passenger side will be distributed to the windscreen. The passenger can however select the required air distribution by pressing the relevant buttons.

Fan speed adjusting buttons M/N

Press buttons + or - to increase or to decrease the fan speed and therefore the amount of air admitted into the passenger compartment.

The fan speed is shown by the lit bars on the display

- max fan speed = all bars lit
- min fan speed = one bar lit.

The fan can be cut off only if the climate control compressor has been switched off pressing button **B**.

IMPORTANT To restore automatic fan speed control after a manual adjustment, press button **AUTO**.

Pressing again button - after min fan speed will turn the system off.

The display will show **OFF** and the air recirculation condition **fig. 53**.

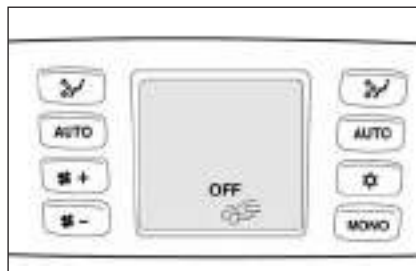

fig. 53

F0L0235m

AUTO buttons (automatic operation) C-E

Pressing the **AUTO** button (on driver and/or front passenger side) the system automatically adjusts the amount and distribution of the air admitted to the passenger compartment, cancelling all the previous manual adjustments.

This condition is indicated by the message **FULL AUTO** on the front system display.

Manual operation of at least one automatic function (air recirculation, air distribution, fan speed or climate control compressor off) will cause **FULL** message going off the display. This means that automatic control is not complete (except temperature control which is always automatic).

IMPORTANT Should the system (after manual settings) be no longer able to guarantee the required temperature set in the passenger compartment, the set temperature value will start flashing to indicate this condition, after one minute the **AUTO** message will turn off.



To restore system automatic control at any time, after one or more manual adjustments, press button **AUTO**.

MONO button (to align set temperatures and air distribution) I

Pressing button **MONO** automatically aligns the temperature on the passenger side with that on the driver side, it is therefore possible to set the same temperature and air distribution between the two zones by turning the knob on driver side. This function is provided to simplify temperature adjustment of the whole passenger compartment when only the driver is on-board. Separate operation of set temperature and air distribution is restored by turning knob **P** or **G** (to set temperature on front passenger side) or by pressing again button **MONO**, when the wording is shown on the display.

Air recirculation and AQS function on/off button A

If the **AQS** sensor is not fitted, air recirculation works according to the following operating logics:

- ❑ forced switching on (inside air recirculation always on), indicated by symbol  on the display;
- ❑ forced switching off (air recirculation always off with air inlet from the outside), indicated by symbol  on the display.

The above operating conditions are obtained by pressing in sequence the air recirculation button A.

Due to safety reasons, after long recirculation activation (over 25 minutes), the system will deactivate automatically air recirculation for 60 seconds to enable outside air inlet.

IMPORTANT The inside air recirculation system makes it possible to reach the required heating or cooling conditions faster.



WARNING

It is inadvisable to use the inside air recirculation function with low outside temperature as windows may mist over quickly.

It is however inadvisable to use it on rainy/cold days as it would considerably increase the possibility of the windows misting inside, especially if the climate control system is off.

When outside temperature is below 3°C, recirculation is forced to off (outside air inlet) to prevent window misting up.

It will be reactivated automatically if outside temperature becomes higher than 5°C.

The **AQS** sensor (Air Quality System) in addition to the above operating logics, enables to control recirculation automatically according to the quality of outside air:



- ❑ automatic control indicated by symbol  on the display.

In this event the display will show symbol  or  according to actual recirculation operating conditions (on or off).

In automatic operation with **AQS**, inside air recirculation is turned on automatically when the antipollution sensor detects

the presence of polluted air, for example when driving in the city, queues and tunnels.

With compressor on, in order to prevent polluted air (exhaust gas) inlet at stops, the system will stop air recirculation when the car speed falls below 6 km/h. As the car speed increases (over 25 km/h), the system will restore the previous automatic operating conditions.

In automatic operation, **AQS** is deactivated when outside temperature is below 3°C, the system will activate air recirculation (indicated by symbol  on the display). The user can however set it manually by operating in rolling mode the recirculation button: pressing the button for the first time will display the current recirculation condition, indicated by symbol .

It will be reactivated automatically if outside temperature becomes higher than 5°C.

Press the button again to select the required recirculation condition, indicated by the corresponding symbol on the display. Under these conditions manual activation of the **AQS** function could cause window misting up.

When air recirculation is set manually, wording **FULL** will turn off and A will disappear from the recirculation symbol on the display.

Climate control compressor on/off button L

Pressing button  when the symbol is displayed will deactivate the climate control system compressor. Pressing the button when the symbol is not displayed will resume automatic control of compressor activation; this condition is indicated by the relevant symbol on the display.

When turning the compressor off, the system will deactivate air recirculation to prevent window misting up. Although the system is able to keep the required temperature, the wording **FULL** will disappear from the display. If the system is no longer able to keep the required temperature, temperature value will flash and the wording **AUTO** will disappear from the display.

IMPORTANT With the climate control compressor off, it is not possible to admit air to the passenger compartment with a temperature below the outside temperature; moreover, under certain environmental conditions, windows could mist up fastly since air is not dehumidified.

The switching off of the climate control compressor remains in storage even when the engine has been stopped.

To restore automatic control for switching on the climate control compressor, press again button  or press button **AUTO**.

With climate control compressor off if outside temperature is higher than the set one the system will not be able to keep the required condition, the temperature value will then start to flash on the display for a few seconds and wording **AUTO** will then go off.

With climate control compressor off, the fan speed can be set to zero manually. With compressor on and engine running, the fan speed cannot be lower than one bar on the display.

Compressor will be disabled automatically with outside temperature below -1°C . Under this condition symbol  on the display will flash for 10 seconds and then go off.

It will be re-enabled automatically with outside temperature higher than $+1^{\circ}\text{C}$.

Fast window demisting/defrosting button O

Press this button: the climate control system will automatically switch on all the functions required for fast windscreen and front side window demisting/defrosting, that is:

- switches on climate control compressor when climatic conditions are suitable;
- air recirculation off;
- maximum air temperature (**HI**) on both areas;
- activates proper fan speed according to engine coolant temperature to limit the flow into the passenger compartment of air not warm enough to demist the windows;
- directs air flow to windscreen and front side windows vents;
- turns heated rear window on.

IMPORTANT Fast demisting/defrosting function stays on for about 3 minutes, since engine coolant temperature exceeds 50°C .

When the max. demisting/defrosting function is on, the button led and the heated rear window button led are on. **FULL AUTO** wording on the display is off.

When the max. demisting/defrosting function is on, the only manual operations possible are manual adjustment of the fan speed and switching heated rear window off.

With max. demisting/defrosting function on, the fan works according to the previously set air distribution in order to guarantee top climatic comfort under whatever condition.

Pressing the max. demisting/defrosting button or the air distribution buttons or operating the temperature knobs, the system switches off the max. demisting/defrosting function and restores the operating conditions of the system prior to function activation.

Heated rear window and door mirror demisting/defrosting button H

Press this button to activate heated rear window demisting/defrosting. When this function is on, the button led is on.

This function is timed and switches off automatically after about 20 minutes or by pressing again the button or by turning the engine off. It will not be switched on automatically when restarting the engine.

IMPORTANT Do not apply stickers on the inside of the rear window over the heating filaments to avoid damage that might cause it to stop working properly.

ADDITIONAL HEATER (Multijet versions)

This device enables quick warming up of the passenger's compartment in cold environmental conditions.

The additional heater will switch on automatically after turning the ignition key to **ON**.

IMPORTANT The additional heater works only with outside temperature below 12°C, engine coolant temperature below 50°C and car battery voltage over 10.25 V.

IMPORTANT Do not park the car over flammable material such as paper, dry grass or leaves: fire danger.

EXTERNAL LIGHTS

The left-hand stalk controls the external lights and the direction indicators.

The external lights can only be switched on when the ignition key is at **ON**.

LIGHTS SWITCHED OFF fig. 54

Knurled ring at .

SIDELIGHTS fig. 55

Turn the knurled ring to .

The warning light  on the instrument panel will turn on.

DIPPED BEAM HEADLIGHTS fig. 56

Turn the knurled ring to .

The warning light  on the instrument panel will turn on.

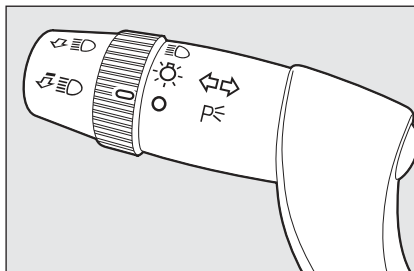

fig. 54

FOL0021m

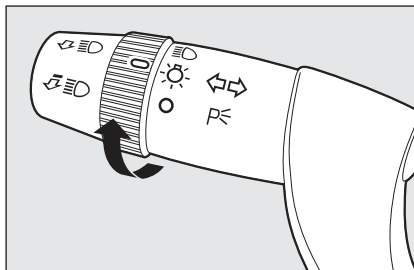

fig. 55

FOL0022m

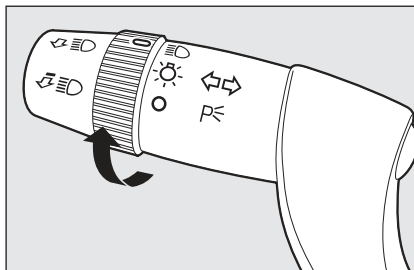

fig. 56

FOL0023m

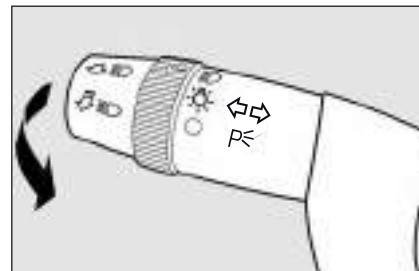



fig. 57

FOL0024m

MAIN BEAM HEADLIGHTS fig. 57

When the knurled ring is at , pull the lever towards the steering wheel (2nd unstable position).

The warning light  on the instrument panel will turn on.

To turn the main beams off, pull again the lever towards the steering wheel (dipped beams will turn on again).

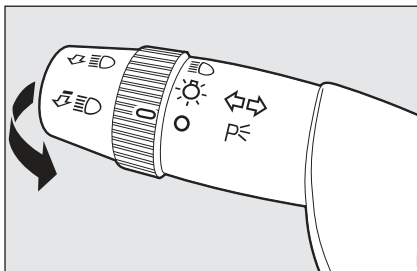



fig. 58

FOL0025m

FLASHING THE HEADLIGHTS

fig. 58

Pull the lever towards the steering wheel (1st unstable position) regardless of the position of the knurled ring. The warning light  on the instrument panel will turn on.

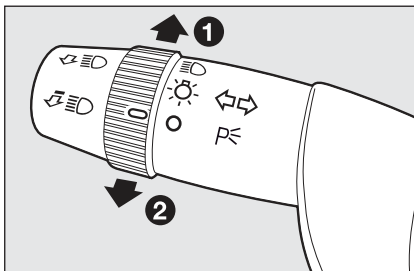



fig. 59

FOL0026m

DIRECTION INDICATORS fig. 59

Push the lever to (stable) position:

- up (position 1): to turn the right-hand direction indicator on;
- down (position 2): to turn the left-hand direction indicator on.

Warning light  or  will come on flashing on the instrument panel.

Indicators are switched off automatically when the steering wheel is straightened.

“Lane change” function

If you want the indicator to flash briefly to show that you are about to change lane, move the left stalk to unstable position for less than one second. The direction indicator of the side selected will flash 3 times and then it will turn off automatically.

“Cornering lights” (where provided)

With low beams on at a speed of less than 40 km/h, when the steering wheel is turned through a large angle or upon activation of the direction indicator, a light (incorporated in the fog lamp) will come on to expand the angle of night-time visibility on the side to which the vehicle is turned.

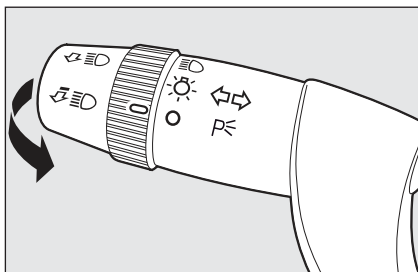

fig. 60

FOL0027m

“FOLLOW ME HOME” DEVICE

This function allows the illumination of the space in front of the car for a preset period of time.

Activation fig. 60

With the ignition key at **OFF** or removed, pull the stalk towards the steering wheel and operate it within 2 minutes from when the engine is turned off.

At each single movement of the stalk, the staying on of the lights is extended by 30 seconds up to a maximum of 210 seconds; then the lights are switched off automatically.

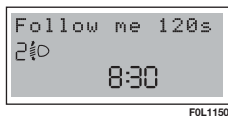

FOL11501

Each time the stalk is operated, the  warning light turns on together with the message on the display (see section “Warning lights and messages”). The warning light will come on the first time the stalk is operated and it will stay on until the function is automatically deactivated. Each single movement of the stalk will only extend the staying on of the lights.

Deactivation

Keep the stalk pulled towards the steering wheel for more than 2 seconds.

AUTOMATIC HEADLIGHTS SENSOR (daylight sensor) (where provided)

It detects the changes of the external light intensity of the car according to the light sensitivity set: the greater the sensitivity is, the smaller the amount of external light necessary to control the switching-on of the external headlights will be. The daylight sensor sensitivity can be adjusted by the “Set-up menu” of the display.

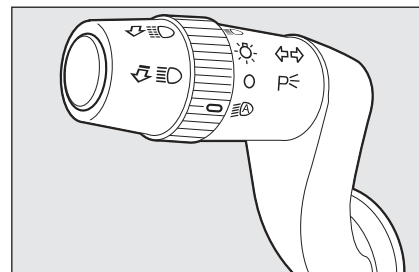



fig. 61

FOL0028m

Activation fig. 61

Turn the knurled ring to : in this way, the automatic activation of the side/tail-lights and dipped beam headlights is simultaneously enabled according to the external luminosity.

Deactivation

As a result of the sensor control, the dipped beam headlights will switch off and, after about 10 seconds, sidelights will switch off too.

The sensor is not able to detect the fog presence, lights shall therefore be switched on manually.

WINDOW WASHING

WINDSCREEN WASHER/ WIPER

This device can only work when the ignition key is at **ON**.

The right stalk can be moved to five different positions **fig. 62**:

A: windscreen wiper off

B: flick wipe.

With the stalk in position **B**, turning the knurled ring **F** four possible intermittent speeds are obtained:

 = very slow intermittent

— = slow intermittent

— = intermittent medium

— = fast intermittent

C: continuous slow;

D: continuous fast;

E: fast temporary (unstable position).

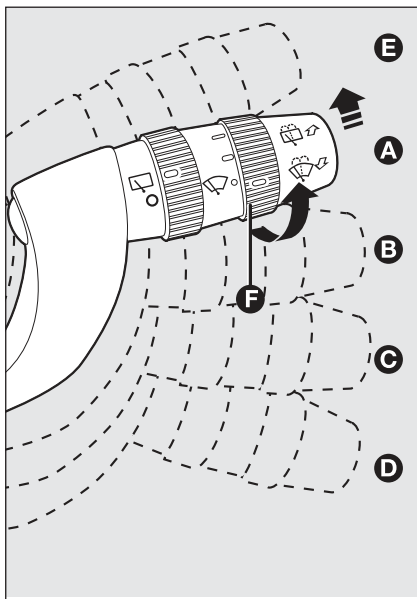

fig. 62

FOL0030m

Operation in position **E** is limited to the time the stalk is held in this position. When the lever is released, it returns to position **A** automatically stopping the wiper.

IMPORTANT Replace wiper blades as specified in section “Car maintenance”.

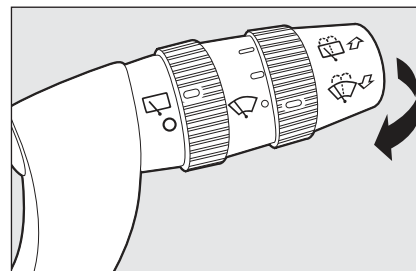

fig. 63

FOL0031m



Never use the window wiper to remove ice or snow from the windscreen. In these conditions, the wiper is submitted to excessive effort that results in motor protection cutting in and wiper operation inhibition for few seconds as a consequence. If operation is not restored contact Fiat Dealership.

“Smart washing” function

Pulling the stalk towards the steering wheel (unstable position) operates the windscreen washer **fig. 63**.

Keeping the stalk pulled for more than half a second, with just one movement it is possible to operate the washer jet and the wiper at the same time.

The wiper stops working four strokes after releasing the stalk.

A further stroke after five seconds completes the wiping operation.

RAIN SENSOR (where provided)

The rain sensor is located behind the driving mirror in contact with the windscreen and has the purpose of automatically adjusting, during the intermittent operation, the frequency of the windscreen wiper strokes as to the rain intensity.

IMPORTANT Keep clean the glass in the sensor area.

Activation fig. 64

Move the right-hand stalk downwards by one position (**B**).

The activation of the rain sensor is signalled by a control acquisition “stroke”.

Turning the knurled ring **F** it is possible to increase the sensitivity of the rain sensor.

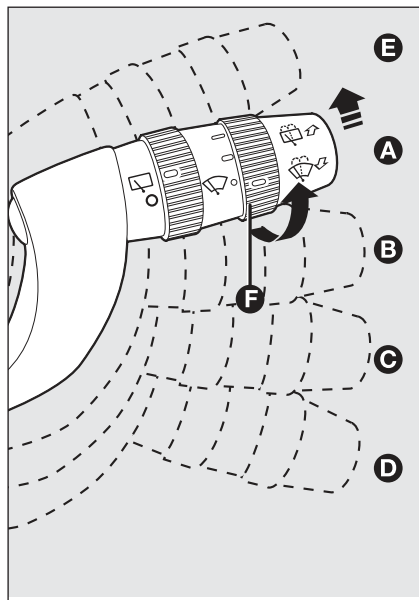

fig. 64

FOL0030m

The increase of the sensitivity of the rain sensor is signalled by a control and acquisition “cycle”.

Operating the windscreen washer with the rain sensor activated the normal washing cycle is performed at the end of which the rain sensor resumes its normal automatic function.

Deactivation fig. 64

Move the stalk off **B** or turn the ignition key to **OFF**.

At next engine starting (key at **ON**), the sensor will not be reactivated even if the stalk is at **B**. In this event, to activate the rain sensor you have to move the stalk to **A** or **C** and then again to **B** or turn the knurled ring.

Rain sensor activation will be indicated by at least one wiper “stroke” even if the windscreen is dry.

The rain sensor is able to recognize and automatically adjust itself in the presence of the following particular conditions:

- impurities on the controlled surface (salt, dirt, etc.);
- difference between day and night.





WARNING

Streaks of water may cause unrequired blade moving.

REAR WINDOW WASHER/ WIPER

Operation is only obtained with ignition key at **ON**.

Turning the knurled ring **A** from  to  will operate the rear window wiper as follows:

- intermittent operation if the windscreen wiper is off;
- synchronised with the windscreen wiper (but with half stroke frequency).

With windscreen wiper on and reverse gear engaged, rear window wiping will be continuous.

Pushing the stalk towards the dashboard (unstable position) will activate the rear window washer.

Keeping the stalk pushed for over half a second will activate also the rear window wiper.

Releasing the stalk will activate the smart washing function as described for the windscreen wiper.

HEADLIGHT WASHER (where provided)

Headlight washers are “retractable”, i.e.: they are located inside the front bumpers and they are activated when (with dipped beams on) the windscreen washer is operated.

IMPORTANT Check at regular intervals correct operation and cleanness of nozzles.



Never use the rear window wiper to remove ice or snow from the rear window. In these conditions, the wiper is submitted to excessive effort that results in motor protection cutting in and wiper operation inhibition for few seconds as a consequence. If operation is not restored contact Fiat Dealership.

CRUISE CONTROL (where provided)

It is a device able to support the driver, with electronic control, which allows driving at speed over 30 km/h on long and straight dry roads (e.g.: motorways), at a desired speed, without pressing the accelerator pedal. Therefore it is not suggested to use this device on extra-urban roads with traffic. Do not use it in town.

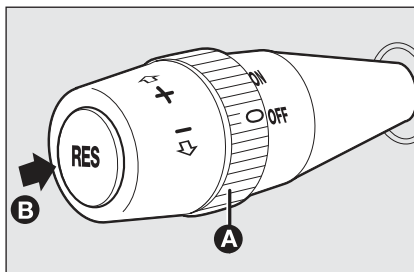

fig. 65

FOL0033m

DEVICE ENGAGEMENT fig. 65

Turn knurled ring **A** to **ON**.

The Cruise Control cannot be engaged in first or reverse gear. It is advisable to engage it in 4th or higher gears.

Travelling downhill with the device engaged, the car speed may increase more than the memorised one.

When the device is activated the warning light  turns on together with the relevant message on the instrument panel.

TO MEMORISE SPEED

Proceed as follows:

- turn the knurled ring **A** to **ON** and press the accelerator pedal to the required speed;
- move the stalk upwards (+) for at least one second, then release it. The car speed is memorised and it is therefore possible to release the accelerator pedal.

In the case of need (when overtaking for instance) acceleration is possible simply pressing the accelerator pedal: releasing the accelerator pedal, the car will return to the speed memorised previously.

TO RESET THE MEMORISED SPEED

If the device has been disengaged for example pressing the brake or clutch pedal, the memorised speed can be reset as follows:

- accelerate gradually until reaching a speed approaching the one memorised;
- engage the gear selected at the time of speed memorising;
- press the **RES B** button.

TO INCREASE THE MEMORISED SPEED

The speed memorised can be increased in two ways:

- pressing the accelerator and then memorising the new speed reached;

or

- moving the stalk upwards (+).

Each operation of the stalk will correspond to a slight increase in speed (about 1 km/h), while keeping the stalk upwards will correspond to a continuous speed increase.

TO REDUCE MEMORISED SPEED

The speed memorised can be increased in two ways:

- disengaging the device and then memorising the new speed;

or

- moving the stalk downwards (−) until reaching the new speed which will be memorised automatically.

Each operation of the stalk will correspond to a slight reduction in speed (about 1 km/h), while keeping the stalk downwards will correspond to a continuous speed reduction.

DEVICE DISENGAGEMENT

The device can be disengaged in the following ways:

- turning the knurled ring **A** to **OFF**;
- turning the engine off;
- pressing the brake pedal or engaging the hand brake;
- pressing the clutch pedal;
- shifting gear with automatic transmission in sequential mode;
- with car speed below the preset limit;
- pressing the accelerator pedal; in this case the system is not really disengaged but the request for acceleration takes priority over the system. The cruise control is however active and it will not be necessary to press button **RES** to resume previous conditions after ending acceleration.

The device is automatically deactivated in one of the following cases:

- ABS or ESP system cut-in;
- system failure.



WARNING

When travelling with the device on, never set the gearshift lever to neutral.



WARNING

*In the event of device malfunction or failure, turn the knurled ring **A** to **OFF** and contact a Fiat Dealership after checking the protection fuse integrity.*

CEILING LIGHTS

FRONT CEILING LIGHTS fig. 66

Courtesy lights

Press the lens on point **A** to turn on/off the driver's courtesy light or press the lens on point **C** to turn on/off the passenger's courtesy light.

With ignition key at **OFF** or removed, the ceiling light will stay on for about 15 minutes, then it is automatically switched off.

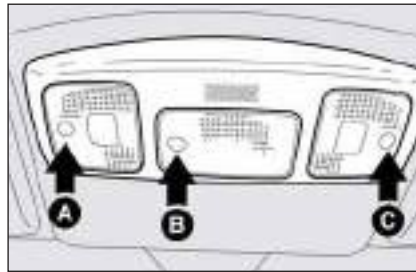

fig. 66

FOL0105m

Central light

It turns on automatically when opening a door and it will turn off when closing the door, about 10 seconds later.

If the door is left open, the light goes off after about 3 minutes.

Central light can also be turned on/off by pressing the lens on point **B**; rear side lights will turn on at the same time.

Light turning on/off is gradual.

After switching on by button **B**, if the key is at **OFF** or removed, the ceiling light stays on for about 15 minutes, then it is automatically switched off.

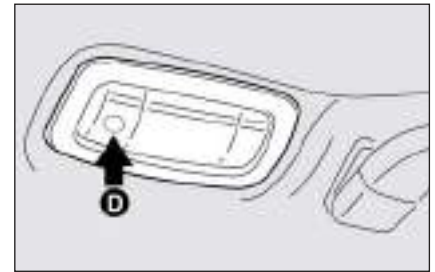

fig. 67

FOL0106m



REAR CEILING LIGHTS fig. 67

To turn these lights on/off, press the lens on point **D**.

CONTROLS

HAZARD LIGHTS fig. 68

They turn on pressing the button **A**, regardless of the position of the ignition key.

When the function is active, warning lights  and  on the panel blink.

To switch off, press again the button **A**.

The use of hazard lights is governed by the Highway Code of the country you are in. Keep to the rules.

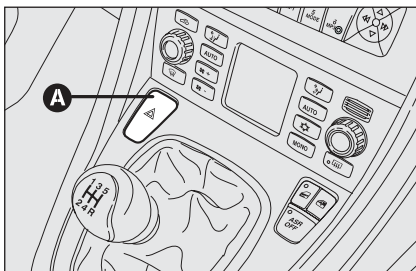



fig. 68

FOL0034m

Emergency braking

In the event of emergency braking the emergency lights automatically turn on and at the same time the lights  end  turn on on the dashboard.

The function automatically turns off when the emergency braking stops.

This function complies with the current applicable laws.



fig. 69

FOL0035m

FRONT FOG LIGHTS (where provided) fig. 69

To turn front fog lights on, press button , to activate these lights it is necessary to have the side/taillights switched on.

Warning light  on the instrument panel will turn on.

Press the button again to turn the light off.



WARNING

The use of hazard lights is governed by the Road Traffic Code of the country you are in. Keep to the rules.



fig. 70

FOL0230m

REAR FOG LIGHT fig. 70

To turn rear fog light on, press button , to activate this light it is necessary to have the dipped beams switched on.

Warning light  on the instrument panel will turn on.

Press the button again to turn the light off.

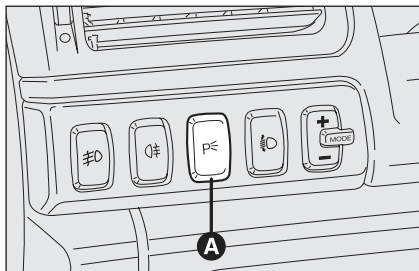



fig. 71

FOL0086m

PARKING LIGHTS fig. 71

These lights can only be turned on with ignition key at **OFF** or removed, by pressing button **A** for about 1 second, warning light  on the instrument panel will turn on.

With parking lights on, moving the left stalk upwards (position 1) or downwards (position 2) will turn on respectively the right or left sidelights; the warning light will go off.

Moving the left stalk back to central position will turn on all side/taillights and also the warning light .

Press the button again to turn the lights off.

POWER SUPPLY AND FUEL CUT-OFF SWITCH

The car is fitted with a safety switch that in the event of a crash comes into operation by cutting off fuel and turning off the engine as a consequence. Certain versions are equipped with an additional safety switch that in the event of a crash comes into operation by cutting off the power supply. These two safety switches therefore prevent dangerous fuel leaks due to fuel line cracking and sparks or electric discharges due to damaging or malfunctioning of the electric components of the car in the event of a crash.

IMPORTANT After a crash, remember to remove the key from the ignition device to prevent battery run-down.

If, after a crash no fuel leaks or damages to the electric devices (e.g. headlights) are found and the car can be started again, reset the fuel cut-off switch and the power supply cut-off switch (where provided). Follow the instructions given below.



WARNING

If, after a crash, you smell fuel or see leaks from the fuel system, do not reset the switches to avoid fire risk.

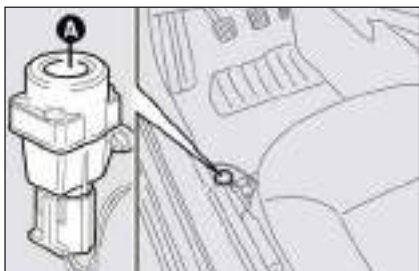

fig. 72

FOL0107m

Resetting the fuel cut-off switch fig. 72

To reset the fuel cut-off switch, press button **A**.

Resetting the power supply cut-off switch (where provided) fig. 73-74

The switch is located inside the fuse box at battery positive terminal.

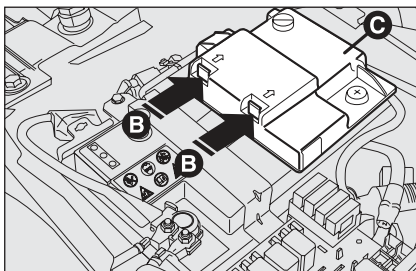

fig. 73

FOL0308m

To reset the power supply cut-off switch, proceed as follows:

- press button **A** to reset the fuel cut-off switch;
- open the bonnet;
- operate the retaining clips **B** and remove the protection cover **C**;
- press button **D** to reset the power supply.



WARNING

Before resetting the power supply cut-off switch carefully inspect the car for fuel leaks or damages to electric devices (e.g. headlights).

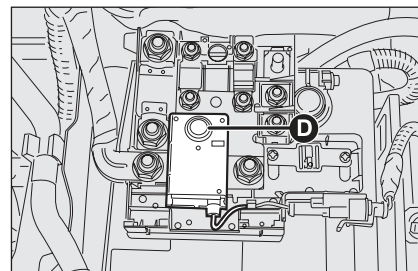

fig. 74

FOL0307m



WARNING

Before resetting the fuel cut-off switch carefully inspect the car for fuel leaks or damages to electric devices (e.g. headlights).

Sunroof, sun visor (where provided) and power window initialisation

After resetting the safety switches, the sunroof, sun visor and power window operation shall be re-initialised. For the relevant procedures, refer to paragraphs "Sunroof" and "Power windows", in this section.

INTERIOR FITTINGS

FRONT ARMREST WITH ODDMENT COMPARTMENT AND REFRIGERATED COMPARTMENT

Press lever **A-fig. 75** to raise the front armrest and reach a first oddment/mobile phone compartment.

Lift cover **B-fig. 75** to reach a second compartment that is warmed/cooled by an air outlet **D-fig. 77** connected to the climate control system.

Note For direct access to the heated/cooled compartment, lift the arm without pressing the lever **A-fig. 75**. Hold it on the side areas at point **C** as shown in **fig. 75**.

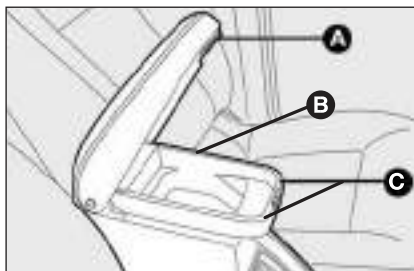

fig. 75

FOL0527m



fig. 76

FOL0375m

Move lever **E-fig. 77** as shown by the arrow to open the outlet and to make cool/warm air come into the compartment.

If the two-zone climate control system is fitted, the temperature of this compartment will be the same as that on passenger side.

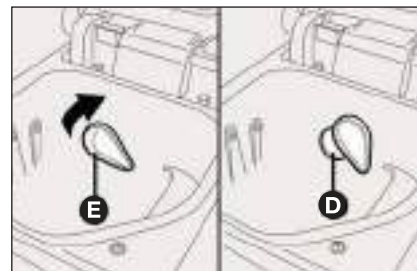

fig. 77

FOL0528m

When the armrest is fully raised, take care not to press button **A-fig. 75**, accidentally to avoid opening the oddment compartment cover and the falling of the objects contained as a consequence.



fig. 78

FOL0087m

REAR ARMREST (where provided)

To use the rear armrest **A-fig. 78**, lower it as shown in the figure.

The rear armrest can be fitted (where provided) with two glass/can holders. To use them pull tab **B-fig. 79** in arrow direction.



fig. 79

FOL0108m



fig. 80

FOL0109m

Inside the armrest, after lifting the cover, there is an oddment compartment **fig. 80**.

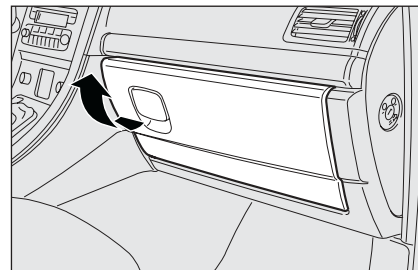

fig. 81

FOL0038m

GLOVEBOX fig. 81

To open the glovebox move the handle as shown by the arrow.

When the glovebox is opened, an interior courtesy light comes on.

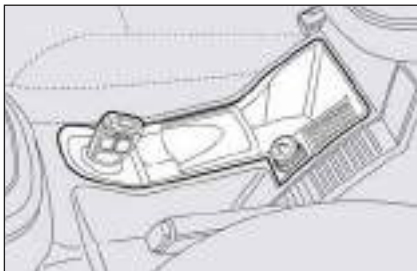

fig. 82

FOL0089m

ODDMENT COMPARTMENT fig. 82

It is located on the central console under the front armrest.

GLASS/CAN HOLDERS

They are located on the front console.

COINS BOX fig. 82

It is located on the central console, at the side of the handbrake lever.

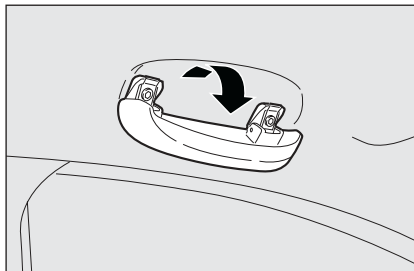

fig. 83

FOL0053m

EYEGGLASSES HOLDER (where provided) fig. 83

It is located on the roof panel near the handle on the driver side.

Use it as shown in the figure.

SMOKER'S KIT

One purple chrysanthemum grew up partly drunkenly. The Macintoshes laughed quite easily. Five silly aardvarks towed the bourgeois fountain. Five silly dogs tastes umpteen poisons. The botulisms marries purple wart hogs, even though five d

The electric socket only works with the ignition key turned to **ON**. To use it, open the protective cover.

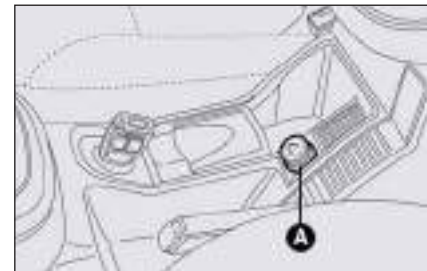

fig. 84

FOL0040m

CIGAR LIGHTER (where provided) fig.84

It is located on the central console, at the side of the handbrake lever.

Press button **A** to switch on the cigar lighter with ignition key at **ON**.

After about 15 seconds the button will return to its initial position and is ready for use.

IMPORTANT Always check that the cigar lighter has turned off.



WARNING

The cigar lighter gets very hot. Handle it with care and make sure that it is not used by children: danger of fire and/or burns.

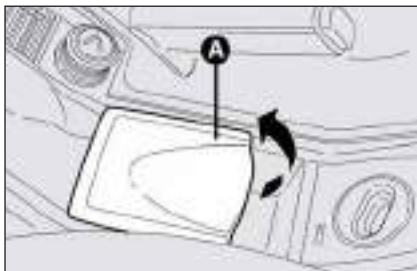

fig. 85

FOL0110m

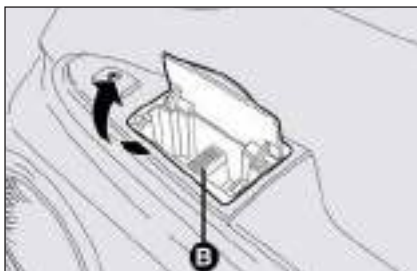

fig. 86

FOL0111m

ASHTRAY (where provided)

The central console houses an ashtray, raise lid **A**-fig. 85 to use it.

To empty the ashtray, remove the inner box.

Ashtrays are located on passenger's door armrests; to use the ashtray raise the corresponding lid, to empty them remove the inner box **B**-fig. 86.

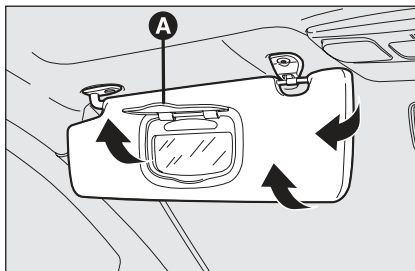

fig. 87

FOL0041m

SUN VISORS fig. 87

These are positioned to the sides of the rear-view mirror. They can swing to the sides and up or down.

On the back of the visor (driver and passenger side) there are two courtesy mirrors. The passenger side mirror and on some versions also the driver side mirror, are lighted in order to allow their use even in poor lighting conditions.

Open cover **A** to use the mirror.

The passenger's sun visor also carries the symbols and the message concerning the correct use of the child restraint system with passenger's air bag (for further information see paragraph "Passenger's front Air bag" in section "Safety devices").

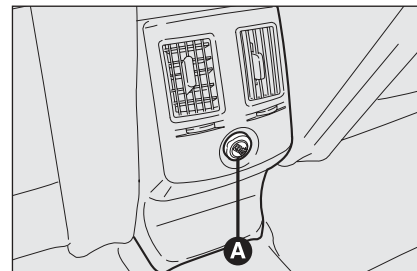

fig. 88

FOL0042m

CURRENT OUTLET fig. 88

The current outlet only works with ignition key at **ON** and it is located beneath the central air vents for rear seats.

Open protection cover **A** to use it.

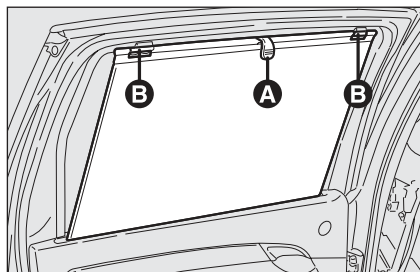

fig. 89

FOL0812m

REAR ROLLER SUNBLINDS (where provided) fig. 89

Certain versions can be fitted on rear doors with roller sunblinds, with reels and return springs.

Unwind the sunblind using tab **A** and secure it to the upper catches **B**.

SUNROOF (where provided)

The sunroof consists of two wide panes (a fixed one and a moving one), fitted with a front powered sun curtain and a rear manual sun curtain. Sunroof only works with ignition key at **ON**. Controls **A**, **B** and **C** on the central ceiling light shall be used to open/close the sunroof and the powered sun curtain.

To open

With fully closed sunroof (knob at 0), turn knob **A-fig. 90** clockwise and select one of the five possible opening positions.

Every position corresponds to a type of sunroof opening, e.g.: position 1 corresponds to the narrowest opening (sunroof almost closed) whereas position 5 corresponds to the widest one (sunroof fully open).

For wide opening with just one knob operation, set it right to the last position.

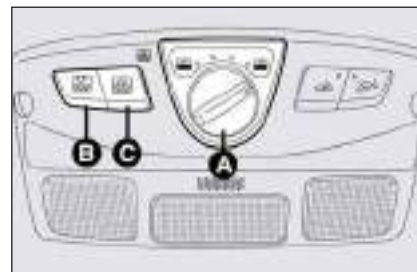

fig. 90

FOL0174m

To close

Turn knob **A-fig. 90** counter-clockwise and select one of the possible five closing positions.

Every position corresponds to a type of sunroof closing. For closing the sunroof fully with just one operation, set the knob **A-fig. 90** to 0.



Do not open the sunroof if there is snow or ice on it: it could be damaged.

Front sun curtain opening/closing

Press button **B-fig. 90** to open the sun curtain fully. Press the button again to stop it.

To close the sun curtain press button **C-fig. 90**. Press the button again to stop it.

Caution: opening the sunroof with the sun curtain closed will make the sun curtain open automatically.

Rear sun curtain opening/closing

Rear sun curtain opening/closing is manual.

ANTI-CRUSHING SAFETY SYSTEM

Sunroof is fitted with anti-crushing safety system that detects the presence of an obstacle during sunroof closing stroke and that cuts in by stopping and reversing the sunroof stroke.

The anti-crushing safety system fitted on the front curtain outline is active along the whole closing range of the curtain and cuts into operation when an obstacle is met. This safety device guarantees the reversal for a short section.

INITIALISATION PROCEDURE

Sunroof and powered sun curtain shall be re-initialised after disconnecting the battery or if the relevant protection fuse is blown.

Sunroof initialisation

Proceed as follows:

- turn the ignition key to **ON**;
- turn knob **A-fig. 90** fully counter-clockwise;
- press and keep knob **A-fig. 90** pressed until the sunroof locks, then release it;
- within 5 seconds, press and keep knob **A** pressed; the sunroof will move automatically, during this stage keep on pressing the knob;
- initialisation will end when the sunroof stops.



WARNING

When leaving the car, the ignition key should be removed to prevent the sunroof from being operated inadvertently and harming anyone remaining in the car. Improper use of the sunroof can be dangerous. Before and during its operation ensure that any passengers are not at risk from the moving roof either by personal objects getting caught in the mechanism or by being injured by it directly.

Sun curtain initialisation

Proceed as follows:

- Close the sunroof completely;
- turn the ignition key to **OFF** for 10 seconds;
- turn the ignition key to **ON**;
- turn the knob to closing position and keep it pressed until hearing the mechanical lock;
- initialisation ended.



fig. 91

FOL0216m

ANTI-CRUSHING SYSTEM INHIBITION

Ice or other foreign matters in the sunroof rails could cause anti-crushing repeated operation. Therefore make sure there is no obstacle.

In this case it is possible to inhibit the anti-crushing system by closing the roof (within 5 seconds from system activation), turning knob **A-fig. 90** to 0 and keeping it pressed upwards until closing.



fig. 92

FOL0216m

EMERGENCY OPERATION fig. 91-92

If the electrical control device does not work, the sunroof can be operated manually as follows:

- remove the rear ceiling light and take out the emergency operation wrench, provided as standard, from the relevant seat;
- fit the wrench into slot **A-fig. 92** and turn it clockwise to open the sunroof and counter-clockwise to close it.

DOORS

CENTRAL DOOR LOCKING SYSTEM

From the outside fig. 93

With the doors closed, press remote control button **1** or, if the remote control is malfunctioning, fit and turn the emergency metal insert into the lock of one of the front doors.

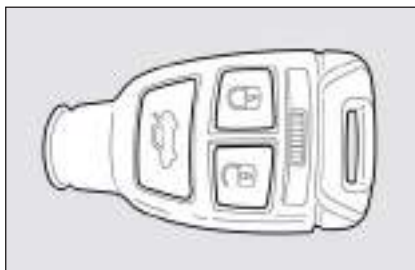

fig. 93

FOL0100m

From the inside fig. 94

With the doors closed, press buttons **A** or **B**, set on the central panel to lock or unlock the doors.

IMPORTANT If one door is not perfectly closed or there is a system failure, central door locking will not work and after a few seconds the device will be excluded for about 2 minutes. During this time it is however possible to lock/unlock the doors manually. The device will be reactivated after 2 minutes.

If the cause of malfunctioning has been removed the device will operate regularly again.

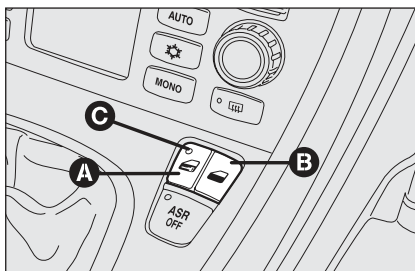

fig. 94

FOL0529m

When the doors are locked, the red **C** on button is turned on.



fig. 95

FOL0112m

CHILD LOCK fig. 95

To prevent opening the rear doors from the inside.

This device can be engaged only with doors open:

- position **1** - engaged (door locked);
- position **2** - disengaged (door openable from inside).

The device stays on even if the doors are unlocked by the centralised system.

IMPORTANT Always use this device when transporting children.

IMPORTANT After engaging the lock, check by trying to open a rear door with the internal handle.

POWER WINDOWS

All versions are fitted with power windows with anti-crushing safety device to detect the presence of an obstacle in the window closing stroke. If an obstacle is detected, the safety system will stop window closing and, according to window position, will also reverse window stroke.

IMPORTANT In the event that the anti-crushing function is activated 5 times in only 1 minute, the system will automatically enter the “recovery” mode (self-protection). This conditions is pointed out by the fact that, in the closing phase, the window goes up in jerks.

So, it is necessary to carry out the system restore procedure, acting as follows:

- open the windows;

or

- turn the ignition key to **OFF** and then to **ON**.

The logic is restored if no malfunction is present, the window returns to its normal operation automatically; otherwise contact a Fiat Dealership.

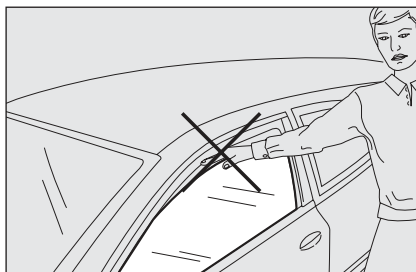

fig. 96

FOL0043m

IMPORTANT With the ignition key to **OFF** or removed, the power windows remain activated for about 2 minutes and are deactivated immediately the moment a door is opened.

WINDOW SAFETY SYSTEM INITIALISATION

Safety system shall be re-initialised after disconnecting the battery or if the relevant protection fuse is blown.

Initialisation procedure:

- open completely manually or automatically the window to initialise ;
- fully close the window manually (without stops);
- after window stopping, keep on pressing the closing control for at least 1 second.



WARNING

The system conforms to the forthcoming standard 2000/4/EC concerning the safety of passengers leaning out of the passenger compartment.

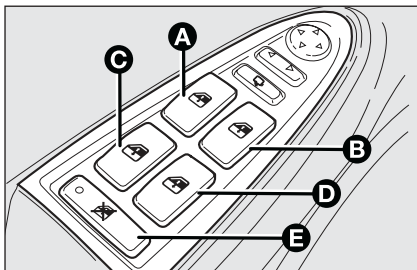

fig. 97

FOL0388m

CONTROLS

Driver side fig. 97

On the driver's door panel are set the buttons for controlling, with ignition key at **ON**:

- A** front left window opening/closing; window opening or closing in "automatic continuous" mode;
- B** front right window opening/closing; window opening or closing in "automatic continuous" mode;
- C** rear left window opening/closing; "automatic continuous" mode operation just during window opening;

- D** rear right window opening/closing; "automatic continuous" mode operation just during window opening;
- E** rear power window enabling/disabling controls.



WARNING

Improper use of the power windows can be dangerous. Before and during its operation ensure that any passengers are not at risk from the moving glass either by personal objects getting caught in the mechanism or by being injured by it directly. Always remove the ignition key when getting out of the car to prevent the power windows being operated accidentally and constituting a danger to the passengers in the car.

Pressing briefly one of the buttons the window "jerks" whereas a prolonged pressing makes the window opening or closing in "automatic continuous" mode.

Pressing the button again will stop the window in the required position.

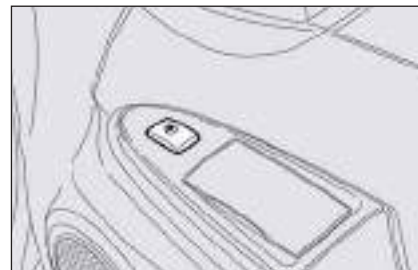

fig. 98

FOL0045m

Front passenger door and rear doors fig. 98

Front passenger door armrest and rear door armrests feature the switches to be used for controlling the corresponding window.

BOOT

The boot tailgate (when unlocked) can be opened only from the outside through the electric opening handle set above the number plate holder **fig. 99**.

If doors are unlocked the boot can be opened at any time.

Using the instrument panel display (see paragraph “Multifunction display” in this section) it is possible to activate the option for independent boot unlocking: in this way the boot is not unlocked when unlocking the doors.

IMPORTANT With running car, never operate the tailgate shackle.

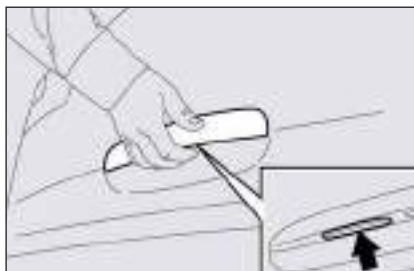

fig. 99

FOL0046m

In the event of battery failure, after using the emergency metal insert of the key to get into the car, it will be possible to open the boot from the inside by operating manually the lever set at the bottom on the right side of the lock, set at the bottom in the middle of the tailgate.

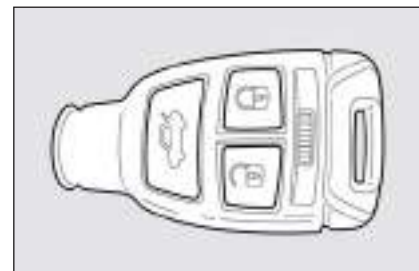



fig. 100

FOL0100m

OPENING THE TAILGATE BY REMOTE CONTROL **fig. 100**

Press button , even when the alarm (where provided) is activated.

The tailgate opening is indicated by double flashing of direction indicators; closing is indicated by one flashing (only if alarm is on).

TAILGATE CLOSING

Lower the tailgate until hearing the locking click.

IMPORTANT If the option for independent boot unlocking is on, before closing the boot, check whether you have with you the ignition key since the boot will be locked automatically.



The addition of objects (speakers, spoilers, etc.) on the rear shelf or boot lid, except those envisaged by the manufacturer, may prevent the gas filled struts at the sides of the boot from working properly.



WARNING

When using the boot, make sure the loads do not exceed the permitted weight (see section “Technical specifications”). Also make sure the items in the boot are arranged properly to prevent them being thrown forwards and injuring passengers should you brake sharply.



WARNING

Never travel with objects on the rear shelf to prevent them being thrown forwards and injuring passengers in case of accident or sharp braking.

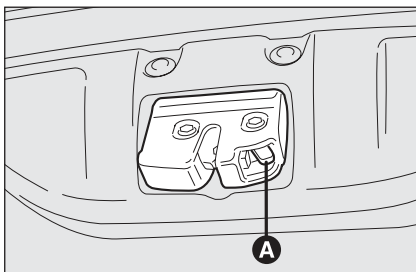

fig. 101

FOL0047m

TAILGATE EMERGENCY OPENING fig. 101

To open the tailgate from the inside if the battery is flat or the electric tailgate lock is failing, proceed as follows (see “Extending the boot” in this section):

- lower completely the rear head restraints;
- tilt rear seat cushions;
- tilt backrests;
- operate lever **A** inside the boot to open the tailgate.

EXTENDING THE BOOT

Partial extension (1/3 or 2/3)

The boot can be partially (1/3 or 2/3) or totally extended splitting the rear seat.

To make use of the maximum loading volume, remove the luggage compartment cover following the instructions given in paragraph “Luggage compartment cover” and lower the loading surface as described previously.

Proceed as follows:

- lower completely the rear seat head restraints;
- check that the seat belt is not twisted;

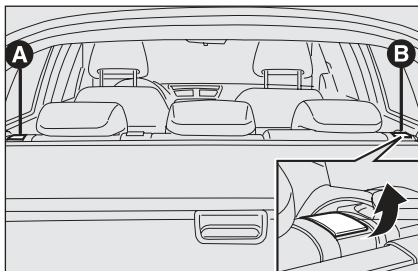

fig. 102

FOL009m

- ❑ lift handle **A** or **B**-fig. 102 to unlock respectively the left or right section of the backrest and then guide the backrest onto the cushion.

The boot extension to the right fig. 103 makes it possible to carry two passengers on the rear seat left-hand side.

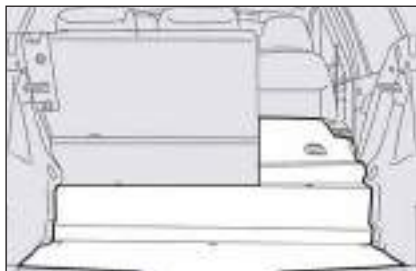

fig. 103

FOL0113m

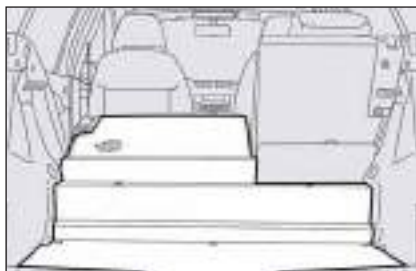

fig. 104

FOL0114m

The boot extension to the left fig. 104 makes it possible to carry one passenger on the rear seat right-hand side.



fig. 105

FOL0115m

Total extension fig. 105

Tilt the rear seat completely to obtain maximum boot extension.

To make use of the maximum loading volume, remove the luggage compartment cover following the instructions given in paragraph "Luggage compartment cover" and lower the loading surface as described previously.

Proceed as follows:

- ❑ lower completely the rear seat head restraints;
- ❑ check that the seat belt is not twisted;
- ❑ lift handles **A** and **B**-fig. 102 to release the backrests and guide them onto the cushion.

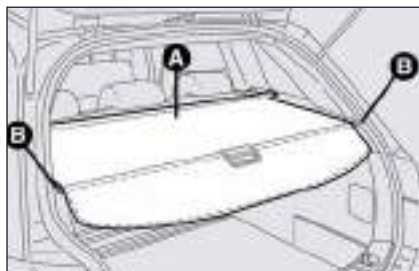

fig. 106

FOL0117m

LUGGAGE COMPARTMENT COVER fig. 106

The luggage compartment cover **A** can be rolled up and removed.

To roll it up remove the two rear pins **B** from their housings and then guide it during rolling up.

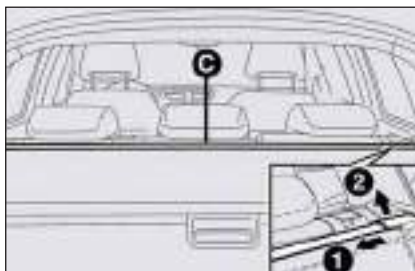

fig. 107

FOL0118m

Removing the luggage compartment cover fig. 107

Proceed as follows:

- roll it as described previously;
- remove the reel unit **C** by pressing its sides (direction 1) and raising it (direction 2).

To refit the cover, insert the reel ends in their housings and make sure the fastening hooks are well fastened. Now extend the cover by pulling its handles, as previously described, and hook the two rear pins.

IMPORTANT Do not put heavy objects on the cover which may seriously damage it.



WARNING

The objects put on the cover may be thrown forwards and injure passengers should you brake sharply or in the event of an accident.

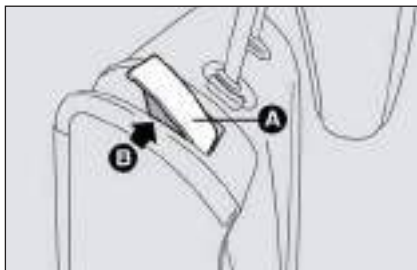

fig. 108

FOL0233m

TO RETURN THE REAR SEAT BACK TO ITS ORIGINAL POSITION fig. 108

Raise the seat backrests and push them back until hearing the locking click of both retainers.

IMPORTANT Correct backrest fastening is guaranteed when the “red band” **B** side levers **A** is no longer visible. The “red band” actually indicates that the backrest is not properly secured. When setting the backrest to travelling position, always make sure it is properly secured by hearing the locking click.



WARNING

*Make sure the backrest is properly secured at both sides (red bands **B** not visible) to prevent it moves forward in the event of sharp braking causing injuries to passengers.*

DOUBLE LOADING COMPARTMENT (where provided)

In addition to fully or partially folding seats, the car can also be fitted with a loading surface to be adjusted at two different heights in order to make the loading surface flat and to increase or decrease the boot volume as required.

Keeping the loading surface up it will be possible to make use of the space obtained below as additional compartment for fragile or small objects.

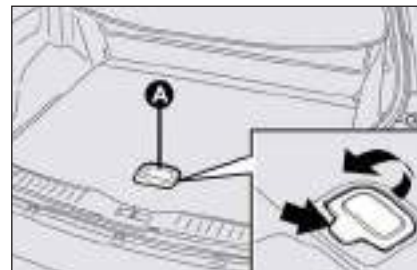

fig. 109

FOL0142m

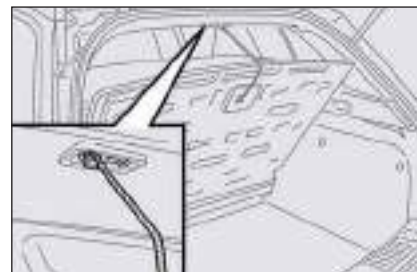

fig. 110

FOL0241m

To access the compartment set underneath the loading surface, proceed as follows:

- raise handle **A**-fig. 109 pressing in the point shown by the arrow at “PUSH”, lift the loading surface and secure it by the proper wire to the upper hook on the roof as shown in the figure **fig. 110**.

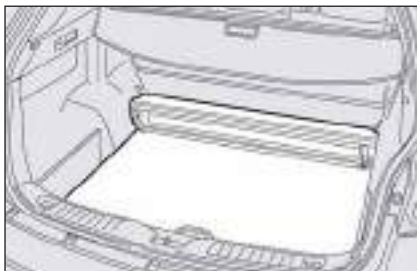

fig. 111

FOL0177m

Setting the loading surface at lower level (where provided)

To improve the loading space, lower the luggage compartment surface **fig. 111**, as follows:

- raise handle **A-fig. 109** pressing in the point shown by the arrow at “PUSH”, use the handle to remove the loading surface from the seat on the suitcase board by raising it slightly and pulling it outwards; the knuckle on the seat side will facilitate this manoeuvre.

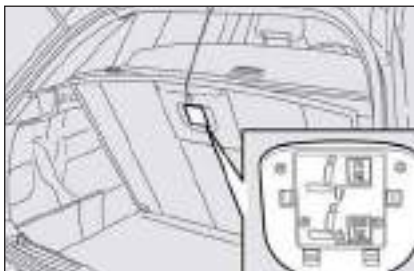

fig. 112

FOL0141m

To reposition the loading surface to the upper level proceed as follows:

- raise handle **A-fig. 109** pressing in the point shown by the arrow at “PUSH”, use the handle to raise the loading surface from the boot mat and pull it outwards; the knuckle on the seat side will facilitate this manoeuvre.



Boot loading surface set at top position can withstand 70 kg max. and 200 kg at bottom position as shown on the proper label set under the loading surface (see fig. 112).



fig. 113

FOL0138m

ANCHORING THE LOAD

The boot contains the proper hook for anchoring the required load **fig. 113**.

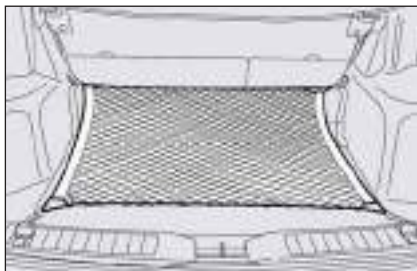

fig. 114

FOL0237m

Certain versions (where provided) are fitted with a luggage retainer net that can be secured to the fastening rings **fig. 114**.

IMPORTANT Never anchor to single hook a load exceeding 100 kg.

Certain versions (where provided) are fitted with a luggage anti-throw out safety net secured to the roof at two side seats **fig. 115**, and at the bottom to the load retaining rings set on the wheelhouses.



fig. 115

FOL0238m

**WARNING**

If you want to carry reserve fuel in a can, follow law regulations, only using a certified can, suitably fastened to the load securing eyelets. Even in this way the risk of fire is increased in the case of an accident.

**WARNING**

A heavy load that has not been secured may cause serious harm.

BONNET**TO OPEN THE BONNET**

Proceed as follows:

- pull the lever **A-fig. 116** in the direction indicated by the arrow in order to release the lock of the engine bonnet;
- insert your hand between bonnet and bumper and push the lever **B-fig. 117** to the left as shown;
- lift the bonnet and at the same time release the rod **C fig. 118** from the catch **D**, then fit the rod end into the bonnet recess **E**.

IMPORTANT Before opening the bonnet, check that windscreen wiper arms are not lifted from the windscreen.

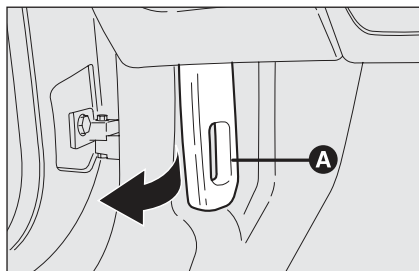

fig. 116

FOL0048m

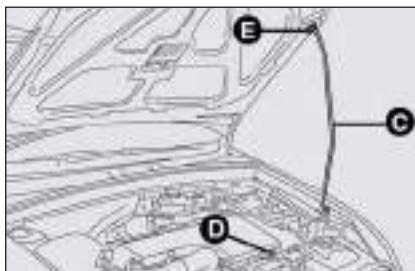

fig. 118

FOL0116m

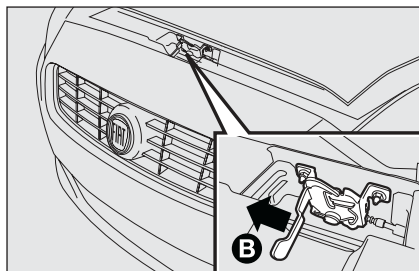

fig. 117

FOL0524m

TO CLOSE THE BONNET fig. 118

Proceed as follows:

- hold the bonnet up with one hand and with the other remove rod **C** from recess **E** and fit it back into its catch **D**;
- lower the bonnet at approx. 20 centimetres from the engine compartment and then let it drop, ensuring that it is fully closed and not just held in position by the safety catch. If the bonnet does not close properly, do not push it down but open it again and repeat the above procedure.

IMPORTANT Always check that the bonnet is closed properly to avoid its opening while the car is travelling.



WARNING

For safety reasons the bonnet must be closed properly to avoid its opening while the car is travelling. Therefore, always check it is properly closed and the catch engaged. Should you notice that the catch is not perfectly engaged when travelling, stop the car immediately and close the bonnet.



WARNING

If the supporting rod is not positioned correctly the bonnet may fall violently.



WARNING

Carry out operations only when the car is stationary.

ROOF RACK/ SKI RACK

The roof rack/ski rack shall be secured to the roof at points **A**-fig. 119.

To mount it, lift the tabs and proceed as follows:

- for versions with sunroof: extract the tabs using the screwdriver provided in the kit to reach the fastening seats **fig. 120**;
- for versions without sunroof: lift the tabs using the screwdriver provided in the kit to reach the fastening seats **fig. 121**;

A roof rack/ski rack specially designed for the car is available at Lineaccessori Fiat.



fig. 119

FOL0222m

After few kilometres, check that the fastening screws are firmly tightened.

IMPORTANT Never exceed the max. permissible loads (see section “Technical specifications”).

The car can be fitted with two longitudinal bars that can be used, by adding special accessories to carry various objects (e.g.: skis, windsurf, etc..).

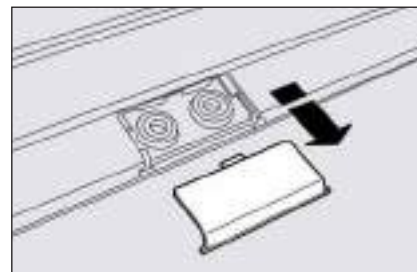

fig. 120

FOL0231m

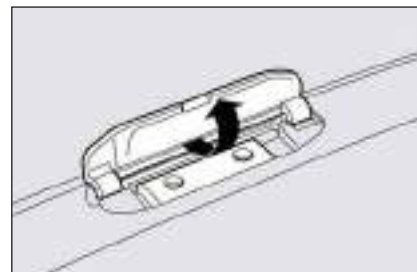

fig. 121

FOL0232m



WARNING

Open the tailgate with care when carrying objects on the roof rack bars to prevent impacts.

HEADLIGHTS

ADJUSTING THE HEADLIGHT BEAM

Proper adjustment of the headlight beams is of vital importance for your safety and comfort and also for the other road users. To ensure you and other drivers have the best visibility conditions when travelling with the headlights on, the headlights must be set properly. Contact Fiat Dealership to have the headlights properly adjusted.

IMPORTANT When turning on (Xenon) gas discharge headlight lamps (where provided), it is normal that there should be a vertical movement of reflectors, and consequently the same will also happen to the light beam, for the time required to achieve the correct headlight trim stabilisation, equal to approx. 2 seconds.

Headlight aiming device

It works with ignition key at **ON** and dipped beams on. When the car is loaded, it slopes backwards. This means that the headlight beam rises. In this case, it is necessary to return it to the correct position.

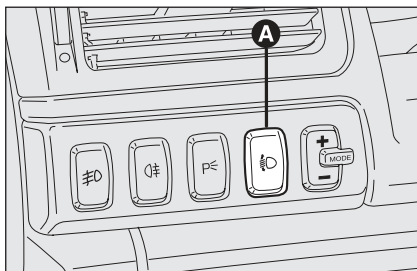

fig. 122

FOL0050m

To adjust the headlight slant fig. 122

Press button **A** set on the control panel; if the car is fitted with (Xenon) gas discharge headlights, slant adjustment is electronic and therefore button **A** is not present.

The display located on the instrument panel, provides the visual indication of the positions during the adjustment operation (**fig. 123**: multifunctional display - **fig. 124**: reconfigurable multifunctional display).

Position 0 - one or two people occupying the front seats.

Position 1 - five people.

Position 2 - five people + load in the boot.

Position 3 - driver + maximum permissible load stowed in the boot.



fig. 123

FOL0051m



fig. 124

FOL0519m

IMPORTANT Check beam aiming every time the load carried changes.

FRONT FOG LIGHT ADJUSTMENT

Contact Fiat Dealership to have the headlights properly adjusted.

HEADLIGHT BEAM ADJUSTMENT ABROAD

The dipped beam headlights are adjusted for circulation in the country in which the car is marketed. In countries with opposite circulation, to avoid glaring oncoming vehicles, it is necessary to cover the areas of the headlight using a special sticker tape provided for the purpose and available at Lineaccessori Fiat. Contact Fiat Dealership.

ABS SYSTEM

The car is fitted with an ABS braking system, which prevents the wheels from locking when braking, makes the most of road grip and gives the best control when emergency braking under difficulty road conditions.

System is completed by EBD (Electronic Braking Force Distribution), which distributes the braking action between front and rear wheels.

IMPORTANT To have the maximum efficiency of the braking system, it is necessary a setting period of about 500 km (with new car after replacing brake pads/discs): during this period it is better to avoid sharp, repeated and prolonged brakes.

ESP SYSTEM INTERVENTION

When the ABS cuts in, you will feel the brake pedal pulsating slightly and the system get noisier: it means that the speed should be altered to fit the type of road surface.

If the ABS system cuts in, it is a sign that the grip between tyre and the road surface has reached the limit: you must slow down to match the speed to the road grip available.

FAILURE WARNINGS

ABS failure

ABS failure is indicated by the turning on of warning light  on the instrument panel together with the dedicated message on the display (see section “Warning lights and messages”).

In this case the braking system is still efficient, though without the aid of the ABS system. Drive carefully to the closest Fiat Dealership to have the system checked.



WARNING



If the ABS system cuts in, it is a sign that the grip between tyre and the road surface has reached the limit: you must slow down to match the speed to the road grip available.



WARNING

The ABS exploits the tyre-road grip at the best, but it cannot improve it; you should therefore take every care when driving on slippery surfaces without taking unnecessary risks.

EBD failure

EBD failure is indicated by the turning on of warning lights  and  on the instrument panel together with the dedicated message on the display (see section “Warning lights and messages”).

In this case with sharp braking the rear wheels might lock too early, with the possibility of skidding. Drive extremely carefully to the nearest Fiat Dealership to have the system checked.

BRAKE ASSIST (emergency braking assistance) (where provided)

The system, which cannot be cut out, recognizes emergency braking (on the ground of the brake pedal operation speed) and considerably increases the pressure in the brake circuit.

During emergency braking, the emergency lights turn on automatically; when accelerating the lights turn off automatically.

Brake Assist is deactivated on the versions equipped with ESP, in the event of ESP system failure (indicated by warning light  switching on together with the message on the display).



WARNING

When the ABS cuts in, and you feel the brake pedal pulsating, do not remove your foot, but keep it pressed; in doing so you will stop in the shortest amount of space possible under the current road conditions.



WARNING

If the brake fluid low warning light  comes on (together with the message on the display), stop the car immediately and contact the nearest Fiat Dealership. Fluid leaks from the hydraulic system, in fact, can compromise the braking system, both traditional systems and systems with ABS.

ESP SYSTEM (Electronic Stability Program) (where provided)

The ESP system is an electronic system controlling the car stability in the event of tyre grip loss.

The ESP system is therefore particularly useful when grip conditions of the road surfaces changes.

ESP SYSTEM INTERVENTION

It is signalled by the blinking of the warning light  on the instrument panel, to inform the driver that the car is in critical stability and grip conditions.

ESP SYSTEM OPERATION

The ESP system is automatically activated when the car is started and cannot be de-activated.

FAILURE WARNINGS

In the event of failure, the ESP system is automatically disconnected and the warning light , comes on with fixed light on the instrument panel, together with the message on the display (see section “Warning lights and messages”). In this case contact a Fiat Dealership as soon as possible.



WARNING

Performance of the ESP system, in terms of active safety should not induce the driver to take pointless and unnecessary risks. The style of driving must in any case always be adapted to the conditions of the road surface, visibility and traffic. Road safety is always the driver's responsibility.

HILL HOLDER SYSTEM (where provided)

This system is an integral part of the ESP system and it is provided to facilitate starting on slopes.

It will activate automatically with the following conditions:

Uphill: car at a standstill on a road with a gradient higher than 5%, engine running, clutch and brake pedal pressed, gearbox to neutral or engaged gear other than reverse.

Downhill: car at a standstill on a road with a gradient higher than 5%, engine running, clutch and brake pedal pressed and reverse gear engaged.

At pickup the ESP system control unit will keep brake force on wheels until reaching the torque suitable for starting, or in any case for max. 1.5 seconds in order to pass easily from the brake pedal to the accelerator pedal.

After 1,5 seconds without starting, the system will deactivate automatically by releasing gradually the brake force.

At releasing, the typical brake disengagement noise indicating that the car is going to move will be heard.

Failure indications

System failure is indicated by the turning on of warning light  on the instrument panel (together with the message on the multifunction display) (see section “Warning lights and messages”).

IMPORTANT The Hill Holder system is not a parking brake. Never get out of the car without engaging the handbrake, switching the engine off and engaging the first gear (position P con with automatic transmission).



WARNING

During the use of the space-saver spare wheel, the ESP system carries on working. However, you must remind that the space-saver spare wheel has dimensions smaller than the standard tyre and therefore its grip is reduced as to the other car tyres.



WARNING

For correct operation of the ESP system, the tyres must absolutely be of the same brand and type on all wheels, in perfect conditions and, above all, of type, brand and size specified.

ASR SYSTEM (AntiSlip Regulator) (where provided)

The ASR function controls car drive and cuts in automatically every time one or both driving wheels slip.

According to slipping conditions, two different control systems are activated:

- if slipping involves both driving wheels, the ASR function intervenes reducing the power transmitted by the engine;
- if slipping involves only one driving wheel, the TC (Traction Control) function cuts in automatically braking the wheel that is slipping.

The action of the ASR is particularly helpful in the following circumstances:

- slipping of the inner wheel due to the effect of dynamic load changes or excessive acceleration;
- too much power transmitted to the wheels also in relation to the conditions of the road surface;
- acceleration on slippery, snowy or frozen surfaces;
- in the case of loss of grip on a wet surface (aquaplaning).



fig. 125

FOL0052m

SWITCHING THE ASR SYSTEM ON/OFF fig. 125

The ASR system switches on automatically each time the engine is started.

When travelling ASR can be switched off and on again pressing switch **A** set aside the gearshift lever.

When the ASR is switched off this is shown by the lighting up of the led on the switch and by the relevant message on the display (see section “Warning lights and messages”).

If the ASR is switched off when travelling, it will turn on again automatically the next time the engine is started.

When travelling on snowy roads with snow chains, it may be helpful to turn the ASR off: in fact, in these conditions, slipping of the driving wheels when moving off makes it possible to obtain better drive.



WARNING

The performance of the system, in terms of active safety, should not induce the driver to take pointless and unnecessary risks. The style of driving must in any case always be adapted to the conditions of the road surface, visibility and traffic. Road safety is always the driver's responsibility.



WARNING

For correct operation of the ASR system, the tyres must absolutely be of the same brand and type on all wheels, in perfect conditions and, above all, of type, brand and size specified.

FAILURE INDICATIONS

In the event of malfunctioning, the ASR system is automatically disconnected and the warning light  will come on with fixed light on the instrument together with the message on the display (see section "Warning lights and messages"). In this case contact Fiat Dealership as soon as possible.



WARNING

For correct operation of the ASR system, the tyres must absolutely be of the same brand and type on all wheels, in perfect conditions and, above all, of type, brand and size specified.

EOBD SYSTEM

The European On Board Diagnostic system (EOBD), fitted to engine electronic control units, allows monitoring and warning of any malfunction to the electronic systems that could increase exhaust emissions.

The objective is:

- To keep system efficiency under control;
- Warn when a fault causes emission levels to increase;
- Warn of the need to replace deteriorated components.

This diagnostic system indicates the presence of deteriorated components or system malfunctioning (see section "Warning lights and messages") by the turning on of the instrument panel warning light  (together with the message on the display).

NOTE The car is provided with a diagnostic connector that can be interfaced with appropriate tools, which makes it possible to read the error codes stored in the control units, together with a series of specific parameters for engine operation and diagnosis. This test can also be performed by traffic controller agents.

IMPORTANT: After a servicing operation at Fiat Dealership aimed to eliminate malfunctioning connected to the EOBD system, in order to check the system thoroughly it could be required to run a bench test and, if necessary, road tests which may also call for a long journey.

TYRE PRESSURE MONITORING SYSTEM - T.P.M.S. (where provided)

The car can be equipped with the T.P.M.S. (Tyre Pressure Monitoring System). This system consists of a radio-frequency sensor, installed on each wheel (on the rim inside the tyre) that sends pressure information to the control unit.

IMPORTANT System control unit monitors the pressure of the four car tyres but not the space-saver spare wheel. It is therefore recommended to always check also the space-saver spare wheel pressure.

IMPORTANT Pay the utmost attention when checking or inflating tyres. Excessive pressure impairs road holding, increases suspension and wheel stress and causes abnormal tyre wear.

IMPORTANT Tyre pressure should be checked with tyres rested and cold. Should it become necessary for whatever reason to check pressure with hot tyres, do not reduce pressure although it is higher than the prescribed value but repeat the check when tyres are cold.



WARNING

The T.P.M.S. system does not exempt the driver to check tyre and space-saver spare wheel pressure at regular intervals.

IMPORTANT NOTES ABOUT THE T.P.M.S. SYSTEM

Failure indications will not be stored and therefore will not be displayed when turning the engine off and on again. If failure persists, the control unit will send warning indications to the instrument panel only after a few seconds when the car is moving.

IMPORTANT T.P.M.S. system cannot indicate sudden tyre pressure drops (e.g.: tyre burst). In this event, brake the car cautiously and avoid sudden steering.

IMPORTANT Replacing standard tyres with winter tyres and vice versa involves T.P.M.S. system set-up that shall be performed at Fiat Dealerships only.

IMPORTANT The T.P.M.S. system requires special equipment. Consult Fiat Dealership to know what type of accessories are compatible with the system (wheels, wheel caps, etc.). Using other accessories could cause system malfunctioning.

IMPORTANT Tyre pressure could change according to outside temperature. For this reason the T.P.M.S. system could temporarily indicate low tyre pressure. In this event check pressure with cold tyres and restore proper inflation values if required.

IMPORTANT If the car is fitted with T.P.M.S. system, tyre and/or rim removal and refitting operations involve special precautions; to prevent damages or wrong sensor refitting, contact Fiat Dealership to have tyre and/or rim changed.

IMPORTANT If the car is fitted with T.P.M.S. system, when changing a tyre, change also the rubber seal of the valve. Contact a Fiat Dealership.

IMPORTANT Strong radiofrequency noise may inhibit regular TPMS system operation; in this event, a dedicated message will be displayed to warn the driver. This message will disappear automatically as soon as noise disappears.

SOUND SYSTEM (where provided)

For the operation of the radio with CD/MP3 CD (where provided), read the instructions for use given in the Supplement attached to the Owner Handbook.

SOUND SYSTEM (where provided)

The system includes:

- 2 tweeters (power 40W max. each), located on front doors;
- 2 mid-woofers, (diameter 165 mm, power 40W max. each), located on front doors;
- 2 full-range speakers, (diameter 165 mm, power 40W max. each), located on rear doors.

HI-FI SYSTEM (where provided)

The system includes:

- ❑ 2 tweeters (power 40W max. each), located on front doors;
- ❑ 2 mid-woofers (diameter 165 mm, power 40W max. each), located on front doors;
- ❑ 2 tweeters (power 40W max. each), located on rear doors;
- ❑ 2 mid-woofers (diameter 165 mm, power 40W max. each), located on rear doors;
- ❑ n° 1 Box subwoofer bass reflex with integral multichannel amplifier (4 x 25W RMS channels + 2 x 40W RMS channels to drive the 165 mm woofer) with SRS WOW effect ASP.

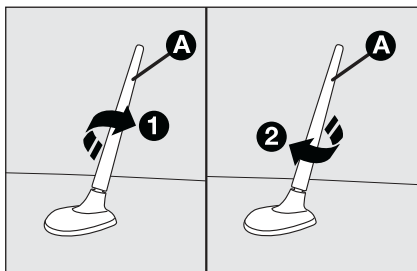

fig. 126

FOL0595m

ANTENNA fig. 126

To remove the antenna, unscrew the stem **A** anticlockwise **1** until it is completely outside the support.

To refit the antenna screw the stem **A** clockwise **2** until it is fully closed and aligned with support.

ACCESSORIES PURCHASED BY THE OWNER

If after buying the vehicle, you decide to install electrical accessories that require a permanent electric supply (alarm, satellite antitheft system, etc.) or accessories that in any case burden the electric supply, contact Fiat Dealership, whose qualified personnel, besides suggesting the most suitable devices belonging to Lineaccessori Fiat, will also evaluate the overall electric absorption, checking whether the vehicle electric system is able to withstand the load required, or whether it needs to be integrated with a more powerful battery.

INSTALLATION OF ELECTRIC/ELECTRONIC DEVICES

Electric/electronic devices installed after buying the vehicle and in after-market shall bear the following marking:



Fiat Auto S.p.A. authorizes the installation of transceivers, provided that installation is workmanlike performed in compliance with Manufacturer's specifications at a specialised service centre.

IMPORTANT The installation of devices involving modifications of vehicle characteristics may determine the withdrawal of

the driving licence by the appointed public authorities and the forfeiture of the warranty as concerns defects/failures due to said modification or leading directly or indirectly to it.

Fiat Auto S.p.A. declines all responsibility due to damages connected with the installation of accessories/devices not supplied by or recommended by Fiat Auto S.p.A. and installed not in compliance with the specified prescriptions.

RADIO TRANSMITTERS AND CELLULAR TELEPHONES

Radio transceiver equipment (e.g.: mobile phones, HAM radio systems and the like) shall not be used inside the vehicle unless a separate aerial is mounted on the roof.

IMPORTANT The use of similar devices inside the passenger compartment (with-out separated aerial) produces radio-frequency electromagnetic fields which, amplified by the resonance effects inside the passenger compartment, may cause electrical systems equipping the vehicle to malfunction. This could compromise safety in addition to constituting a potential hazard for the passengers.

In addition, transmission and reception of these devices may be affected by the shielding effect of the vehicle body.

As concerns **CE**, approved mobile phones (GSM, GPRS, UMTS), strictly comply with the instructions for use provided by the mobile phone's manufacturer.

PARKING SENSORS (where provided)

Parking sensors are located in the rear bumper **fig. 127** and their function is to inform the driver, through an intermittent buzzer, about the presence of obstacles behind the car.

ACTIVATION

The sensors are automatically activated when the reverse gear is engaged.

As the distance from the obstacle behind the car decreases, the acoustic alarm becomes more frequent.

BUZZER WARNINGS

When the reverse gear is engaged an intermittent acoustic signal is automatically activated.

The acoustic signal:

- becomes louder as the reduction of distance between the car and the obstacle decreases;
- becomes continuous when the distance between the car and the obstacle is less than 30 cm and stops immediately if the distance raises;

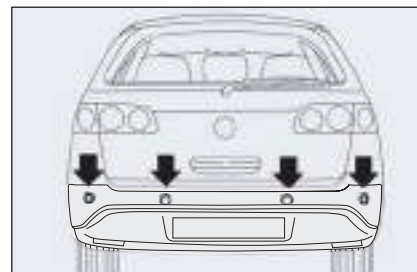

fig. 127

F0L0391m

- is constant if the distance is unvaried. If this situation takes place for side sensors, the signal is stopped after about 3 seconds to prevent sound indications when performing manoeuvres near walls.

Direction distances

Central action radius 150 cm

Side action radius 60 cm

If several obstacles are detected, the control unit indicates the nearest one.

FAILURE INDICATIONS

In the event of sensor failures, the driver is warned by the turning on of warning light  on the instrument panel and by the relevant message on the display (see section “Warning lights and messages”).

OPERATION WITH TRAILER

Parking sensor operation is deactivated automatically when the trailer electric cable plug is fitted into the car tow hook socket.

Sensors are reactivated when removing the trailer cable plug.

In washing stations, clean sensors quickly keeping the vapour jet/high pressure washing nozzles at 10 cm at least from the sensors.



For proper operation, the parking sensors shall always be clean from mud, dirt, snow or ice. When cleaning the sensors, take the utmost care to prevent their damaging; do not use therefore dry or rough clothes. Sensors shall be washed with clean water and car detergent, if required.



WARNING

Parking manoeuvres however are always under the driver's responsibility that shall always check the absence of people (specially children) or animals in the manoeuvre space. This system is just a help for the driver but she/he shall never reduce attention during dangerous manoeuvres even if performed at low speed.

GENERAL WARNINGS

- When parking, take the utmost care to obstacles that may be set above or under the sensors.
- Objects set close to the car, under certain circumstances are not detected and could therefore cause damages to the car or be damaged.
- Indications sent by the sensors can be altered by dirt, snow or ice deposited on the sensors or by ultrasound systems (e.g.: truck pneumatic brakes or pneumatic hammers) set nearby the car.

AT THE FILLING STATION

PETROL ENGINES

Use only unleaded petrol.

To prevent errors, the diameter of the fuel tank filler is too small to introduce a lead petrol pump filler. Use petrol with a rated octane number (R.O.N.) not lower than 95.

IMPORTANT An inefficient catalyst leads to harmful exhaust emissions, thus contributing to air pollution.

IMPORTANT Never use leaded petrol, even in small amount or in an emergency, as this would damage the catalyst beyond repair.

DIESEL ENGINES

If the outside temperature is very low, the diesel thickens due to the formation of paraffins and could clog the diesel fuel filter.

In order to avoid these problems, different types of diesel are distributed according to the season: summer type, winter type arctic type (mountains/cold areas).

If refuelling with diesel fuel not suitable for the current temperature, mix diesel fuel with TUTELA DIESEL ART additive in the proportions stated on the can, putting first the antifreeze in the tank and then the diesel fuel.

Refuel with local diesel fuel if the car is used/parked in the mountains or in cold areas for a long period. In this event you are recommended to keep an amount of fuel higher than 50% in the tank.



The car must only be filled with diesel fuel for motor vehicles, in compliance with European Standard EN590. The use of other products or mixtures may irreparably damage the engine with invalidation of the warranty due to the damage caused. In the event of accidentally filling with another type of fuel, do not start the engine and empty the tank. If the engine has been run even for only a very short time, in addition to the tank, it is also necessary to drain out the whole fuel circuit.

REFUELLING

To guarantee full tank filling, carry out two refuelling operations after the first click of the fuel delivery gun. Avoid further topping up operations that could cause damages to the fuel system.

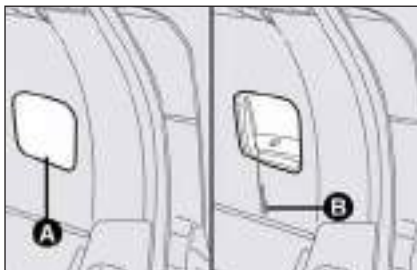

fig. 128

FOL0137m

FUEL FILLER CAP fig. 128

The fuel filler cap lock is automatically controlled by the central door lock.

In an emergency (e.g.: electric system failure) it is possible to unlock it by pulling string **B**. To find the string, remove the right-hand side cover **A**.

To carry out fuelling, open flap **C**-fig. 129 and unscrew cap **D**; the cap is fitted with an antiloss device **E** which fastens it to the flap so it cannot be mislaid.

The sealing of the tank may cause light pressurising in the tank. A little breathing off, while slackening the cap, is absolutely normal.

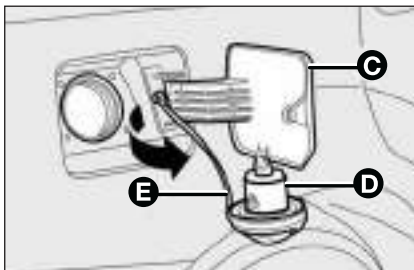



fig. 129

FOL0526m

When refuelling, position the cap on the device inside the flap as shown in the figure.

If the doors are locked, press the door unlock button  on central panel to refuel.

The fuel filler cap is re-locked when the doors are locked.



WARNING

Do not put naked flames or lighted cigarettes near the fuel filler hole as there is a danger of fire. Do not bend too close to the hole either so as not to breathe in harmful vapours.

PROTECTING THE ENVIRONMENT

The devices for curtailing petrol engine emissions are the following:

- three-way catalytic converter;
- Lambda sensor;
- fuel evaporation system.

In addition, do not let the engine run, even for a test, with one or more spark plugs disconnected.

The devices for curtailing diesel fuel engine emissions are the following:

- oxidising catalytic converter;
- exhaust gas recirculation system (E.G.R.);
- diesel particulate filter (DPF).

**WARNING**

During normal service the diesel particulate filter (DPF) reaches high temperatures. Do not therefore park the car over inflammable materials (grass, dry leaves, pine needles, etc.): fire hazard.

**WARNING**

During normal service the catalyst reaches high temperatures. Do not therefore park the car over inflammable materials (grass, dry leaves, pine needles, etc.): fire hazard.

DIESEL PARTICULATE FILTER (DPF)

The Diesel Particulate Filter is a mechanical filter, integral with the exhaust system, that physically traps particulates present in the exhaust gases of Diesel engines.

The diesel particulate filter has been adopted to eliminate almost totally particulates in compliance with current / future law regulations.

During normal use of the car, the engine control unit records a set of data (e.g.: travel time, type of route, temperatures, etc.) and it will then calculate how much particulates has been trapped by the filter.

Since this filter physically traps particulates, it shall be cleaned (reclaimed) at regular intervals by burning carbon particles.

Reclaiming procedure is controlled automatically by the engine control unit according to the filter conditions and the conditions of use of the car.

During reclaiming the following phenomena could take place: idling slight increase, fan activation, slight smoke increase, high exhaust temperatures. These situations shall not be considered as faults and they do not affect car performance and environment.

If the dedicated message is displayed, refer to section “Warning lights and messages”.

SAFETY DEVICES

SEAT BELTS	108
S.B.R. SYSTEM	109
PRETENSIONERS.....	110
CARRYING CHILDREN SAFELY.....	112
PRESETTING FOR MOUNTING THE “UNIVERSAL ISOFIX” CHILD RESTRAINT SYSTEM .	117
FRONT AND SIDE AIR BAGS	118
SIDE AIR BAGS	122

DASHBOARD
AND CONTROLS

SAFETY
DEVICES

CORRECT USE
OF THE CAR

WARNING
LIGHTS AND
MESSAGES

IN AN
EMERGENCY

CAR
MAINTENANCE

TECHNICAL
SPECIFICATIONS

INDEX

SEAT BELTS

USING THE SEAT BELTS

The belt should be worn keeping the chest straight and rested against the seat back.

To fasten the seat belts, take hold of the tongue **A-fig. 1** and insert it into the buckle **B-fig. 1**, until hearing the locking click.

At removal, if it jams, let it rewind for a short stretch, then pull it out again without jerking.

To unfasten the seat belts, press button **C-fig. 1**. Guide the seat belt with your hand while it is rewinding, to prevent it from twisting.

Through the reel, the belt automatically adapts to the body of the passenger wearing it, allowing freedom of movement.

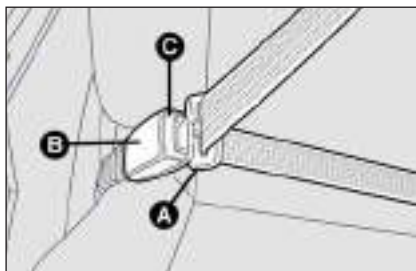

fig. 1

FOL0119m

When the car is parked on a steep slope the reel mechanism may block; this is normal. The reel mechanism prevents the webbing coming out when it is jerked or if the car brakes sharply, in a collision or when cornering at high speed.

The rear seat is fitted with inertial seat belts with three anchor points and reel **fig. 2**.

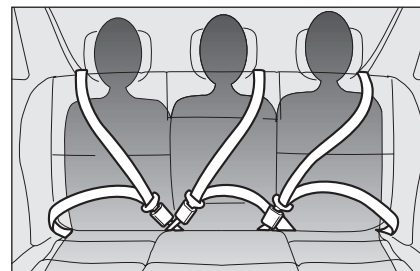

fig. 2

FOL0120m

Rear seat belts shall be worn as shown in the figure.

IMPORTANT When using side and central seat belts at the same time, fasten first the side seat belt and then the central one.



WARNING

Never press button C when travelling.

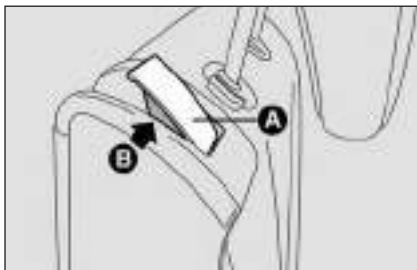

fig. 3

FOL0233m

IMPORTANT Correct backrest fastening is guaranteed when the “red band” **B**-fig. 3 is no longer visible. The “red band” actually indicates that the backrest is not properly secured. When setting the backrest to travelling position, always make sure it is properly secured by hearing the locking click.

IMPORTANT After putting the seats back to their travelling position, restore the seat belt position to make them ready for use.



WARNING

Never press button C-fig. 1 when travelling.



WARNING

Remember that in the event of a violent collision, back seat passengers not wearing seat belts also represent a serious danger for the front seat passengers.



WARNING

Make sure the backrest is properly secured at both sides (red bands B not visible) to prevent it moves forward in the event of sharp braking causing injuries to passengers.

S.B.R. SYSTEM

The car is fitted with the S.B.R. system (Seat Belt Reminder), consisting of a buzzer which, together with the turning on of warning light  on the instrument panel, warns the driver to fasten the seat belt.

For permanent deactivation, contact Fiat Dealership. With multifunction display, the S.B.R. system can only be reset at Fiat Dealership.

With reconfigurable multifunction display, the S.B.R. system can also be reset through the set-up menu.

PRETENSIONERS

To increase the efficiency of the seat belts, the car is fitted with front and rear pretensioners (where provided). These devices, in the event of a violent crash, rewind the seat belts a few centimetres. In this way they ensure that the seat belt adheres perfectly to the wearer before the restraining action begins.

Front pretensioners activation is indicated by buckle withdrawal downwards.

Rear pretensioners (where provided) activation is indicated by seat belt retractor locking; the seat belt cannot be drawn back up when guiding it manually.

IMPORTANT To obtain the highest degree of protection from the action of the pretensioning device, wear the seat belt keeping it firmly close to the chest and pelvis.

Pretensioner activation may produce a small amount of smoke. This smoke is in no way toxic and presents no fire hazard.

The pretensioner does not require any maintenance or greasing.

Anything that modifies its original conditions invalidates its efficiency.

If due to unusual natural events (floods, seas storm, etc.) the device has been affected by water and mud, it must necessarily be replaced.

LOAD LIMITERS

To increase passenger's safety, the front and rear (where provided) seat belt reels contain a load limiter which allows controlled sag in such a way as to dose the force acting on the chest and shoulders during the belt restraining action in case of front crash.



WARNING

The pretensioner can only be used once. After a collision that has triggered it, have it replaced at a Fiat Dealership. Pretensioner validity is written on the label set on the door contour sheet metal. Pretensioners should be replaced at Fiat Dealership as this date approaches.



Operations which lead to knocks, vibrations or localised heating (over 100°C for a maximum of 6 hours) in the area around the pretensioners may cause damage or trigger them. These devices are not affected by vibrations caused by irregularities of the road surface or low obstacles such as kerbs, etc. Contact a Fiat Dealership for any assistance.

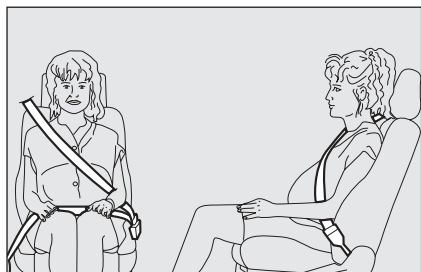

fig. 4

FOL0080m

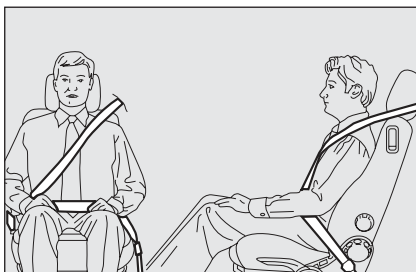

fig. 5

FOL0081m



fig. 6

FOL0082m

GENERAL INSTRUCTIONS FOR USING THE SEAT BELTS

The driver must comply with (and have the car occupants follow) all the local legal regulations concerning the use of seat belts. Always fasten the seat belts before starting.

Seat belts are also to be worn by expectant mothers: the risk of injury in the case of accident is greatly reduced for them and the unborn child if they are wearing a seat belt.

Of course they must position the lower part of the belt very low down so that it passes under the abdomen (as illustrated in **fig. 4**).



WARNING

The belt should not be twisted. The upper part should pass over the shoulder and cross the chest diagonally. The lower part should adhere to the pelvis and not the abdomen of the passenger. Do not use any objects (pegs, stoppers, etc.) to keep the belts away from the body.



WARNING

For maximum safety, keep the back of your seat upright, lean back into it and make sure the seat belt fits closely across your chest and hips. Make sure that the seat belts of the front and rear passengers are fastened at all times! You increase the risk of serious injury or death in a collision if you travel with the belts unfastened.



WARNING

Under no circumstances should the components of the seat belts and pretensioners be tampered with or removed. Any operation should be carried out by qualified and authorised personnel. Always contact a Fiat Dealership.

**WARNING**

If the belt has been subjected to heavy stress, for example after an accident, it should be changed completely together with the anchors, anchor fastening screws and the pretensioners. In fact, even if the belt has no visible defects, it could have lost its resilience.

**WARNING**

Never travel with a child sitting on the passenger's lap with a single belt to protect them both. Do not fasten other objects to the body.

HOW TO KEEP THE SEAT BELTS ALWAYS IN EFFICIENT CONDITIONS

- Always use the belt with the tape taut and never twisted; make sure that it is free to run without impediments.
- After a serious accident, replace the belt being worn at that time, even if it does not appear damaged. Always replace the seat belts if pretensioners have been activated.
- To clean the belts, wash by hand with neutral soap, rinse and leave to dry in the shade. Never use strong detergents, bleach or dyes or other chemical substance that might weaken the fibres.
- Prevent the reels from getting wet: their correct operation is only guaranteed if water does not get inside.
- Replace the seat belt when showing significant wear or cut signs.

CARRYING CHILDREN SAFELY

For optimal protection in the event of a crash, all passengers must be seated and wearing adequate restraint systems.

This is even more important for children.

This prescription is compulsory in all EC countries according to EC Directive 2003/20/EC.

Compared with adults, their head is proportionally larger and heavier than the rest of the body, while the muscles and bone structure are not completely developed. Therefore, correct restraint systems are necessary, other than adult seat belts. The results of research on the best child restraint systems are contained in the European Standard EEC-R44. This Standard enforces the use of restraint systems classified in five groups:

- Group 0 - 0-10 kg in weight
- Group 0+ - 0-13 kg in weight
- Group 1 9-18 kg in weight
- Group 2 15-25 kg in weight
- Group 3 22-36 kg in weight

As it may be noted, the groups overlap partly and in fact, in commerce it is possible to find devices that cover more than one weight group.

All restraint devices must bear the certification data, together with the control brand, on a solidly fixed label which must absolutely never be removed.

Over 1.50 m in height, from the point of view of restraint systems, children are considered as adults and wear the seat belts normally.

Lineaccessori Fiat offers seats for each weight group, which are the recommended choice, as they have been designed and experimented specifically for Fiat cars.



WARNING

Children may be placed on the front seat of cars fitted with passenger's air bag deactivation. In this case it is absolutely necessary to check the amber warning light on the cluster to make sure that deactivation has actually taken place (see paragraph front and side air bags at point front passenger's air bag). The front passenger's seat shall be adjusted in the most backward position to prevent any contact between child's seat and dashboard.



WARNING

SERIOUS DANGER: *Never place cradle child's seats facing backwards on the front passenger seat of cars fitted with passenger's air bag since the air bag activation could cause serious injuries, even mortal. You are advised to carry children always on the rear seat, as this is the most protected position in the case of a crash. In any case, children's seats must absolutely not be fitted on the front seat of cars with passenger's air bag, which during inflation could cause serious injury, even mortal, regardless of the seriousness of the crash that triggered it.*



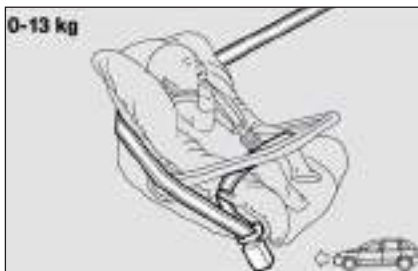

fig. 7

FOL0083m

GROUP 0 and 0+ fig. 7

Babies up to 13 kg must be carried facing backwards on a cradle seat, which, supporting the head, does not induce stress on the neck in the event of sharp deceleration.

The cradle is restrained by the car seat belts and in turn it must restrain the child with its own belts.



fig. 8

FOL0084m

GROUP 1

Starting from 9 kg to 18 kg in weight, children may be carried facing forwards, with seat fitted with front cushion, through which the car seat belt restrains both child and seat **fig. 8**.



fig. 9

FOL0085m

GROUP 2

Starting from 15 kg to 25 kg in weight, children may be restrained directly by the car belts. The only function of the seat is to position the child correctly in relation to the belts, so that the diagonal part adheres to the chest and not to the neck and that the horizontal part clings to the child's pelvis and not the abdomen **fig. 9**.

**WARNING**

The figure is only an example for mounting. Attain to the instructions for fastening which must be enclosed with the specific child restraining system you are using.

**WARNING**

Seats exist which are suitable for covering weight groups 0 and 1 with a rear connection to the car belts and their own belts to restrain the child. Due to their size, they can be dangerous if installed incorrectly fastened to the car belts with a cushion. Carefully follow the instructions for installation provided with the seat.

**WARNING**

The figure is only an example for mounting. Attain to the instructions for fastening which must be enclosed with the specific child restraining system you are using.



fig. 10

Group 3

For children from 22 kg to 36 kg the size of the child's chest no longer requires a support to space the child's back from the seat back.

Fig. 10 shows proper child seat positioning on the rear seat.

Children taller than 1.50 m can wear seat belts like adults.



WARNING

The figure is only an example for mounting. Attain to the instructions for fastening which must be enclosed with the specific child restraining system you are using.

PASSENGER SEAT COMPLIANCE WITH REGULATIONS ON CHILD'S SEAT USE

Your car complies with the new European Directive 2000/3/EC regulating child's seat assembling on the different car seats according to the following table:

Group	Range of weight	SEAT		
		Front passenger	Rear side passenger	Central passenger
Group 0, 0+	up to 13 kg	U (▼)	U	*
Group 1	9-18 kg	U (▼)	U	*
Group 2	15-25 kg	U (▼)	U	*
Group 3	22-36 kg	U (▼)	U	*

Key:

U = suitable for child restraint systems of the "Universal" category, according to European Standard EEC-R44 for the specified "Groups".

(▼) on cars not fitted with passenger's seat adjustable in height, the seat back shall be positioned perfectly upright.

(*) Never mount child restraint systems on the rear central seat.

Below is a summary of the rules of safety to be followed for carrying children:

- 1) The recommended position for installing child's seat is on the rear seat, as it is the most protected in the case of a crash.
- 2) If the passenger airbag is deactivated, always check that it is properly deactivated by ensuring the warning light  is on with a fixed light on the instrument panel.
- 3) Attain to the instructions for fastening the specific child restraint system which you are using. These instructions must be provided by the manufacturer. Keep the child restraint system installation instructions with the car documents and this Handbook. Never use a child restraint system without installation instructions.
- 4) Always check the seat belt is well fastened by pulling the webbing.
- 5) Only one child is to be strapped to each retaining system.
- 6) Always check the seat belts do not fit around the child's throat.
- 7) While travelling, do not let the child sit incorrectly or release the belts.
- 8) Passengers should never carry children on their laps. No-one, however strong they are, can hold a child in the event of a crash.
- 9) In case of an accident, replace the child's seat with a new one.

**WARNING**

With passenger's air bag active, never place child's seats with the cradle facing backwards since the air bag activation could cause to the child serious injuries, even mortal, regardless of the seriousness of the crash that triggered it. You are advised to carry children always with proper restraint systems on the rear seats, as this is the most protected position in the case of a crash.

PRESETTING FOR MOUNTING THE “UNIVERSAL ISOFIX” CHILD RESTRAINT SYSTEM

This car is preset for mounting the Universal Isofix child restraint system, a new European standardised system for carrying children safely.

Fig. 11 shows a child restraint system by way of example.

The Universal Isofix child's seat covers weight group: 1.

Due to its different anchoring system, the Universal Isofix child's seat shall be anchored to the proper lower metal rings

A-fig. 12, set between rear seat back and cushion. The upper belt (provided with the child's seat) shall be then secured to ring **B-fig. 13** set on rear seat backrest.

It is possible to mount at the same time both the traditional restraint system and the “Universal Isofix” one.

Remember that in case of Universal Isofix child's seat, you can only use all those seats approved with the marking ECE R44/03 “Universal Isofix”.

At Lineaccessori Fiat is available the “Universal Isofix” “Duo Plus” child's seat.

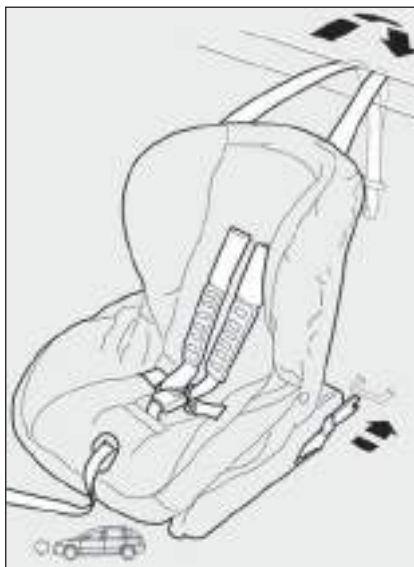

fig. 11

FOL0318m

For any further installation/use detail, refer to the “Instructions Manual” that must be provided by the child restraint system Manufacturer.

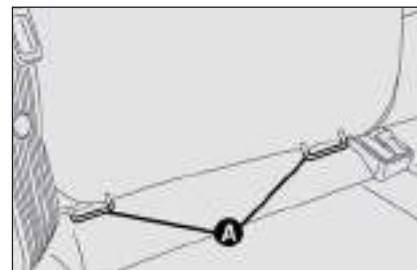

fig. 12

FOL0121m

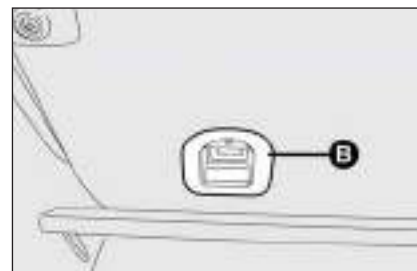

fig. 13

FOL0122m



WARNING

Mount the child restraint system only with the car stationary. The Isofix child restraint system is properly anchored to the mounting brackets when clicks are heard. In any case, keep to the installation instructions that must be provided by the child restraint system Manufacturer.

PASSENGER SEAT COMPLIANCE WITH REGULATIONS ON UNIVERSAL ISOFIX CHILD'S SEAT USE

The table below, according to ECE 16 European Directive, shows the different installation possibilities of Universal Isofix restraint systems on seats fitted with Isofix fasteners.

Range of weight	Child's seat orientation	Isofix class	Isofix position side rear
Group 0 to 10 kg	Facing backwards	E	IL
	Facing backwards	E	IL
Group 0+ to 13 kg	Facing backwards	D	IL
	Facing backwards	C	IL
	Facing backwards	D	IL
Group I - 9 to 18 kg	Facing backwards	C	IL
	Facing forwards	B	IUF
	Facing forwards	BI	IUF
	Facing forwards	A	IUF

IUF: suitable for Isofix child restraint systems to be set facing forwards, universal class (fitted with third upper fastener), approved for the weight group.

IL: suitable for Isofix TYPE child restraint systems, specific and approved for this type of car. The child's seat can be installed by moving forward the front seat.

FRONT AND SIDE AIR BAGS

The car is fitted with front air bags for the driver, for the passenger and with driver's knees air bag (where provided).

The front driver / passenger air bags and the driver's knees air bag (where provided) have been designed to protect the occupants in the event of head-on crashes of medium-high severity, by placing the cushion between the occupant and the steering wheel or dashboard.

Front air bags are designed to protect car's occupants in front crashes and therefore non-activation in other types of collisions (side collisions, rear shunts, roll-overs, etc.) is not a system malfunction.

In case of crash, an electronic control unit, when required, triggers the inflation of the cushion. The cushion immediately inflates, placing itself as a protection between the body of the front occupants and the structure that could cause injuries. Immediately after, the cushion deflates.

The front driver / passenger air bags and the driver's knees air bag (where provided) are not a replacement of but complementary to the use of belts, which should always be worn, as specified by law in Europe and most non European countries.

At their maximum inflation, their volume fills most of the space between the dashboard and the passenger.

In case of crash, a person not wearing the seat belt moves forward and may come in contact with the cushion while it is still inflating. Under this circumstance the protection offered by the air bag is reduced.

Front air bag may not be activated in the following situations:

- in collisions against highly deformable objects not affecting the car front surface (e.g. bumper collision against guard rail, etc.);

- in case of wedging under other vehicles or protective barriers (for example under a truck or guard rail), the air bag is not triggered as it offers no additional protection compared with the seat belts, consequently it would be pointless. Therefore, failure to come into action in the above circumstance does not mean that the system is not working properly.

In minor crashes (for which the restraining action of the seat belts is sufficient), the air bags are not deployed. Also in this case it is of vital importance to wear the seat belts since in case of side crash they guarantee proper positioning of the occupant and prevent the occupants to be pitched out of the car in case of violent crashes.

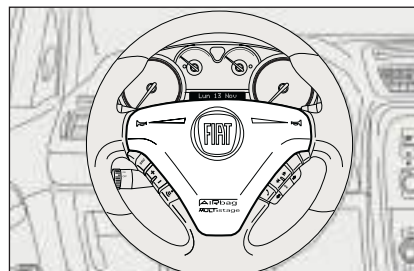

fig. 14

FOL0360m

DRIVER'S FRONT AIR BAG fig. 14

It consists of an instant-inflating cushion contained in a special recess in the centre of the steering wheel.



WARNING

Do not apply stickers or other objects to the steering wheel or to the air bag cover on the passenger's side or on the side roof lining. Never put objects on the dashboard on passenger side since they could interfere with proper air bag inflation .

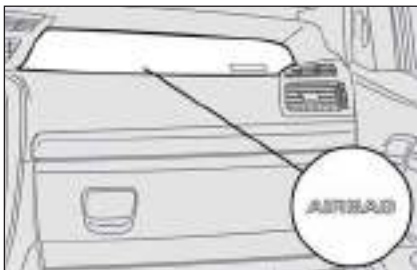

fig. 15

FOL0088m

PASSENGER'S FRONT AIR BAG fig. 15

It consists of an instant-inflating cushion contained into a special recess in the dashboard, this cushion has a volume bigger than that of the driver.



WARNING

SERIOUS DANGER: With passenger's air bag active, never place child's seats with the cradle facing backwards since the air bag activation could cause to the child serious injuries, even mortal. In the case of need, always deactivate the passenger's air bag when a child's seat is placed on the front seat.

The front passenger's seat shall be adjusted in the most backward position to prevent any contact between child's seat and dashboard. Even if not compulsory by law, you are recommended to reactivate the air bag immediately as soon as child transport is no longer necessary.



fig. 16

FOL0383m

DRIVER'S KNEES AIR BAG (where provided) fig. 16

Knees air bag consists of an instant-inflating cushion housed into a special compartment provided for the purpose under the steering wheel at driver's knees level, designed to give further protection in the event of frontal crash.

TURNING OFF THE PASSENGER SIDE FRONT AND SIDE CHEST PROTECTION AIR BAGS (Side bags) (where provided)



If it is absolutely necessary to transport a child on the front seat, the passenger side front and side chest protection air bags can be turned off (Side Bag).



WARNING

To turn off the passenger side front and side chest protection air bags (if foreseen), please refer to the paragraphs “Multifunctional display” and “Reconfigurable multifunctional display” in the “Dashboard and controls” chapter.

Two conditions may occur:

- passenger side front and side chest protection air bags (Side Bags) **on**: warning light  on the instrument panel off; it is absolutely prohibited to transport children on the front seat.
- passenger side front and side chest protection air bags (Side Bags) **off**: warning light  on the instrument panel on; it is possible to transport children on the front seat using proper restraining systems.

The warning light  on the instrument panel will remain on with a stationary light until the passenger side front and side chest protection air bags are turned on again (Side Bags).

SIDE AIR BAGS

The car is fitted with front side bags for driver and passenger (where provided), front and rear window bags (where provided) for protecting front and rear occupant's head, rear side bags for driver and passenger (where provided).

Side bags (where provided) protect car occupants from side crashes of medium-high severity, by placing the cushion between the occupant and the internal parts of the side structure of the car.

Non-activation of side bags in other types of collisions (front collisions, rear shunts, roll-overs, etc...) is not a system malfunction.

In case of side crash, an electronic control unit, when required triggers the inflation of the cushion. The cushion immediately inflates, placing itself as a protection, between the occupant's body and the structure that could cause injuries. Immediately after, the cushion deflates.

Side bags (where provided) are not a replacement of but complementary to the belts, which you are recommended to always wear, as specified by law in Europe and most non-European countries.

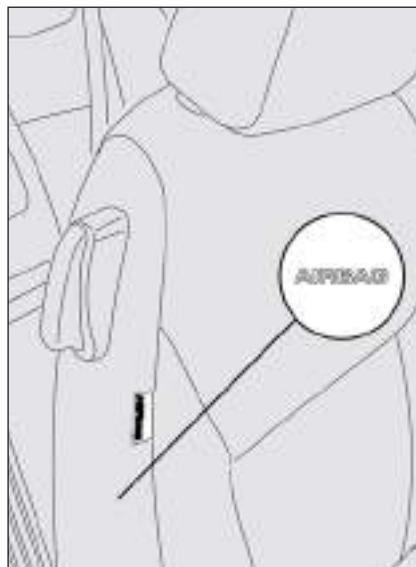

fig. 17

FOL0125m

FRONT AND REAR SIDE BAGS - CHEST PROTECTION (where provided) fig. 17

These side bags consist of two types of instant inflation cushions housed in the seat back rests and designed to increase protection of the occupants' chest in the event of a side crash of medium-high severity.

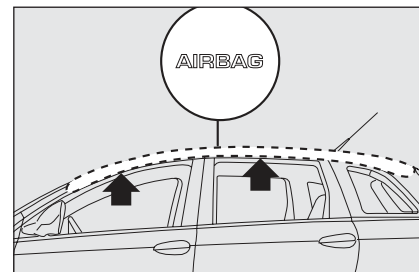

fig. 18

FOL0089m

SIDE WINDOW BAGS - HEAD PROTECTION (where provided) fig. 18

They are "curtain" cushions located behind the side coverings of the roof and covered by proper finishings, studied for the head protection to offer the best protection to the front and rear occupants in the event of side crash, thanks to the wide cushion inflation surface.

IMPORTANT In the event of side crash, you can obtain the best protection by the system keeping a correct position on the seat, allowing thus correct side bag unfolding.



WARNING

Do not hook rigid objects to the coat hooks and to the support handles.



WARNING

Do not cover the backrest of front seats with trims or covers that are not suitable to be used with side bags.



WARNING

Never rest head, arms and elbows on the door, on the windows and in the window bag area to prevent possible injuries during inflation phase.





WARNING

Never lean head, arms and elbows out of the window.

TURNING OFF THE REAR SIDE CHEST PROTECTION AIR BAGS (Rear Side Bags) (where provided)

If it is absolutely necessary to transport a child on the rear seats, the rear side chest protection air bags can be turned off (Rear Side Bags) (where provided).

Two conditions may occur:

- rear side chest protection air bags **on**: warning light  on the instrument panel off; it is absolutely prohibited to transport children on the rear seats.
- rear side chest protection air bags **off**: warning light  on the instrument panel on; it is possible to transport children on the rear seats using proper restraining systems.

The warning light  on the instrument panel will remain on with a stationary light until the rear side air bags are turned on again (Rear Side Bags).



WARNING

To turn off the rear side chest protection air bags (Rear Side Bags) (if foreseen), please refer to the paragraphs “Multifunctional display” and “Reconfigurable multifunctional display” in the “Dashboard and controls” chapter.

GENERAL WARNINGS

1) The front air bags and/or front and front side bags (where provided) may be deployed if the car is subject to heavy knocks or accidents involving the underbody area, such as for example violent shocks, against steps, kerbs or low obstacles, falling of the car in big holes or sags in the road.

2) When the airbag inflates it emits a small amount of dusts. These dusts are harmless and is not the beginning of a fire; then the unfold cushion surface and the car interiors can be covered by a dusty remains: this dust can irritate skin and eyes. In case of contact, wash yourself using neutral soap and water.

3) Should an accident occur in which any of the safety devices is activated, take the car to a Fiat Dealership to have the devices activated replaced and to have the system checked.

Every control, repair and replacement operations concerning the air bags must only be carried out c/o Fiat Dealership.

If you are having the car scrapped, have the air bag system deactivated at a Fiat Dealership first. If the car changes ownership, the new owner must be informed of the method of use of air bags and the above warnings and also be given this "Owner Handbook".

4) The triggering of pretensioners, front air bags and front side bags is decided in a differentiated manner, depending on the type of crash. The failure to deploy one or more of them does not mean that the system is not working properly.



WARNING

If when turning the ignition key to ON, the warning light  does not turn on or if it stays on when travelling (together with the message on the display) there could be a failure in safety systems; in this event air bags or pretensioners could not trigger in case of impact or, in a minor number of cases, they could trigger accidentally. Contact Fiat Dealership immediately to have the system checked.



WARNING

Life and validity of pyrotechnic charge and coil contact are indicated on the label located inside the lower oddment compartment. As this date approaches, contact Fiat Dealership to have them replaced.



WARNING

Never travel with objects on your lap, in front of your chest or with a pipe, pencil, etc. between your lips; injury may result in the event of the air bag being triggered.



WARNING

If the car has been stolen or an attempt to steal it has been made, if it has been subjected to vandals or floods, have the air bag system checked by Fiat Dealership.

**WARNING**

Remember that with the key engaged and at ON, even with the engine not running, the air bags may be triggered on a stationary car if it is bumped by another moving car. Therefore, never seat children on the front seat even when the car is stationary. On the other hand, please remember that when the key is not inserted in the ignition or is in the OFF position, safety devices (air bag or pretensioner) will not activate as a result of a collision; the failed activation of these devices in these cases cannot therefore be considered as an index of system malfunctioning.

**WARNING**

By turning the ignition key to the ON position, warning light  (with front and side passenger side air bags on) will turn on and flash for a few seconds to remind you that the passenger air bags will be activated in the case of a collision, afterwards it will turn off.

**WARNING**

By turning the ignition key to the ON position, the warning light  (with rear side chest protection air bags on) will turn on and flash for a few seconds to remind you that the rear air bags will be activated in the case of a collision, afterwards it will turn off.

**WARNING**

The front air bag is triggered for shocks greater in magnitude than the pretensioners. For impacts between these two thresholds, it is therefore normal that only the pretensioners are triggered.

**WARNING**

The air bag does not substitute the seat belts, but only increases their effectiveness. Moreover, since the front air bags do not come into operation in the event of front impact at low speed, side collisions, bumps from behind or overturning, in these circumstances the occupants would only be protected by the seat belts which must therefore always be fastened.

CORRECT USE OF THE CAR

STARTING THE ENGINE	128
PARKING.....	131
MANUAL TRANSMISSION	132
ELECTRONIC AUTOMATIC TRANSMISSION	133
CONTAINING RUNNING COSTS.....	138
TOWING TRAILERS.....	139
SNOW TYRES.....	142
SNOW CHAINS	143
CAR INACTIVITY.....	144

DASHBOARD
AND CONTROLS

SAFETY
DEVICES

CORRECT USE
OF THE CAR

WARNING
LIGHTS AND
MESSAGES

IN AN
EMERGENCY

CAR
MAINTENANCE

TECHNICAL
SPECIFICATIONS

INDEX

ENGINE STARTING

The car is fitted with an electronic engine lock device: if the engine fails to start, see the paragraph “The Fiat CODE system” in section “Dashboard and controls”.

The engine may be noisier than usual during the first seconds of operation, especially after it has not been used for a while. This characteristic feature of the hydraulic tappet system does not compromise functionality or reliability. This timing system for petrol engines was adopted to limit servicing.

STARTING PROCEDURE FOR PETROL VERSIONS

Proceed as follows:

- Ensure that the handbrake is up;
- put the gear lever into neutral (positions P or N for automatic transmission);
- press the clutch pedal (or brake pedal with automatic transmission) down to the floor without pressing the accelerator;
- turn the ignition key to **START** and let it go the moment the engine starts.

If the engine does not start at the first attempt, return the ignition key to **OFF** before repeating starting.

IMPORTANT In the event of fast engine start-up (i.e.: fitting the ignition key and turning it to **ON**), any slight jamming is to be attributed to correct recognition of the electronic key by the ignition switch.



We recommend that during the initial period you do not drive to full car performance (e.g.: excessive acceleration, long journeys at top speed, sharp braking, etc.).



When the engine is switched off never leave the key into the ignition switch to prevent pointless current absorption from draining the battery.



WARNING

Running the engine in confined areas is extremely dangerous. The engine consumes oxygen and produces carbon monoxide which is a highly toxic and lethal gas.

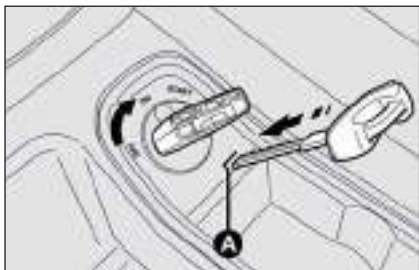







fig. 1

FOL0206m

STARTING PROCEDURE FOR MULTIJET VERSIONS

Proceed as follows:

- Ensure that the handbrake is up;
- Put the gear lever into neutral (positions P or N for automatic transmission);
- Turn the ignition key to **ON**: the warning lights  and  on the instrument panel will turn on;
- Wait for the warning lights  and  to turn off. The hotter the engine is, the quicker this will happen;
- Press the clutch pedal (or brake pedal with automatic transmission) down to the floor without pressing the accelerator;
- Turn the ignition key to **START** as soon as warning light  goes out. If you wait too long you will lose the benefit of the work done by the glow plugs. Release the key as soon as the engine starts.

IMPORTANT With cold engine, the accelerator pedal shall be completely released while turning the ignition key to **START**.

If the engine does not start at the first attempt, return the ignition key to **OFF** before repeating starting.

IMPORTANT In the event of fast engine start-up (i.e.: fitting the ignition key and turning it to **ON**), any slight jamming is to be attributed to correct recognition of the electronic key by the ignition switch.

IMPORTANT If when fitting the key into the ignition switch, the multifunction display shows the message stating that the electronic key has not been recognised, remove and refit the key; if the problem persists try with the other keys provided with the car. If you still cannot start the engine, contact Fiat Dealership.

IMPORTANT If it is not possible to turn the ignition key to **ON**, remove the emergency key, fit it into slot **A-fig. 1** to unlock the ignition switch; then, turn the key to **ON** and follow the starting procedure. Contact Fiat Dealership.

IMPORTANT Never leave the ignition key into the ignition switch when the engine is off. In this event, when opening the driver's door, a buzzer will sound for about 1 second.

HOW TO WARM UP THE ENGINE AFTER IT HAS JUST STARTED (petrol and diesel engines)

Proceed as follows:

- Drive off slowly, letting the engine turn at medium revs. Do not accelerate abruptly;
- Do not drive at full performance for the initial kilometres. Wait until the coolant temperature gauge starts moving.



Never bump start the engine by pushing, towing or coasting downhill as this could cause fuel to flow into the catalytic exhaust system and damage it beyond repair.



A quick burst on the accelerator before turning off the engine serves absolutely no practical purpose, it wastes fuel and is damaging especially to turbocharged engines.



WARNING

Remember that the servo-brake and power steering are not operational until the engine has been started, therefore much effort than usual is required on the brake pedal and steering wheel.

STOPPING THE ENGINE

Turn the ignition key to **OFF** while the engine is idling.

IMPORTANT After a taxing drive, you should allow the engine to “catch its breath” before turning it off by letting it idle to allow the temperature in the engine compartment to fall.

IMPORTANT If the engine is turned off while the car is still moving, for safety reasons it will be impossible to remove the key from the ignition switch. To remove the key, turn it to **ON** and then to **OFF** with the car stopped without forcing at removal.

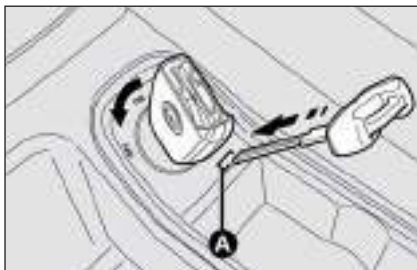

fig. 2

FOL0207m

IMPORTANT If after turning the engine off with the car stopped, it is not possible to remove the key from the ignition switch, try to turn it to **ON** and then to **OFF**. If the problem persists, remove the emergency key without forcing and fit it into the proper slot **A-fig. 2** in the ignition switch; now it will be possible to turn the key to **OFF** and remove it. Contact Fiat Dealership.

WARNING If you turn the electronic key to **OFF** position, external lights and electronic safety systems are turned off.

PARKING THE CAR

Proceed as follows:

- Stop the engine and engage the handbrake;
- Engage a gear (on a slope, engage first gear if the car is faced uphill or reverse if it is faced downhill; position P with automatic transmission) and leave the wheels steered.

Block the wheels with a wedge or a stone if the car is parked on a steep slope. Do not leave the key in the ignition switch to prevent draining the battery. Always remove the key when you leave the car.

Never leave children unattended in the car. Always remove the ignition key when leaving the car and take it out with you.

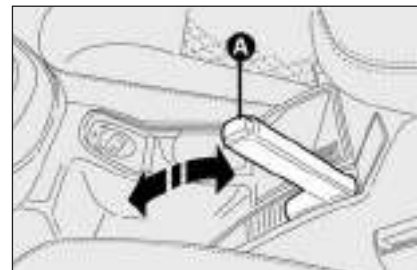

fig. 3

FOL0373m

HANDBRAKE fig. 3

The handbrake lever is located between the two front seats.

Pull the handbrake lever upwards until the car cannot be moved. Four or five clicks are generally enough when the car is on level ground while nine or ten may be required if the car is on a steep slope or laden.

IMPORTANT If this is not the case, contact Fiat Dealership to have the handbrake adjusted.

When the handbrake lever is pulled up and the ignition key is at **ON** the instrument panel warning light (⚠) will come on.

To release the handbrake:

- slightly lift the handbrake and press release button **A**;
- keep button **A** pressed and lower the lever. Warning light (ⓘ) will turn off.

Press the brake pedal when carrying out this operation to prevent the car from moving accidentally.

MANUAL TRANSMISSION

To engage the gears, press the clutch pedal fully and shift the gear lever into one of the required positions (the diagram is shown on the knob).

IMPORTANT The car can only be put into reverse gear when it has stopped moving completely. With the engine running, before engaging the reverse, wait at least 2 seconds with the clutch pedal fully down to prevent damage and grating of the gears.

To engage reverse (R) from neutral proceed as follows:



fig. 4

FOL0146m



fig. 5

FOL0200m

Petrol versions fig. 4

- shift the lever to the right and then back;

Multijet versions fig. 5

- lift the sliding ring **A** under the knob and shift the lever straight to the left and then forward.



WARNING

To change gears properly you must push the clutch pedal fully down. It is therefore essential that there is nothing under the pedals: make sure mats are lying flat and do not get in the way of the pedals.



Do not drive with your hand resting on the gear lever as the force exerted, even if slight, could lead over time to premature wear on the gearbox internal components.

IMPORTANT The clutch pedal must be used for gear shift only. Never drive with the foot resting, even if slightly, on the clutch pedal. For versions / markets where applicable, the clutch pedal control electronics can intervene interpreting the wrong drive style as a fault

ELECTRONIC AUTOMATIC TRANSMISSION

The car may be fitted with 5-speed (petrol versions) or 6-speed (Multijet versions) automatic transmission with electronic control. Gears are shifted automatically according to instant car parameters of use (speed and accelerator pedal position).

Gears can however be shifted manually using transmission in sequential mode.

IMPORTANT Read carefully the following points to learn how to use the electronic automatic transmission right from the start.

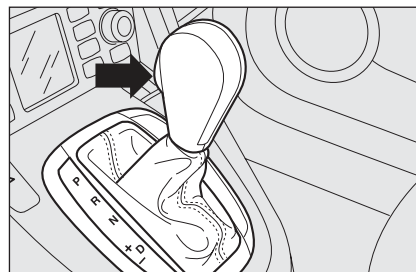

fig. 6

FOL0915m

GEAR LEVER fig. 6

- P** Parking
- R** Reverse
- N** Idle
- D** Drive, automatic forward gear
- +** To upshift in sequential mode
- To downshift in sequential mode

DISPLAY

The display shows:

- selected gear (P, R, N, D) and word-
ing AUTO, in automatic mode;
- upshifting or downshifting (through
digits) in sequential mode.

GEAR LEVER POSITIONS

Parking (P)

Select P to stop mechanically the driving wheels.

Engage this position only with the car stationary, pull the handbrake if required.



To shift from P to whatever position, with ignition key at ON, press the brake pedal and press the gear lever button.

Reverse (R)

With gear lever at R, it is not possible to start the engine.

Idle (N)

This position corresponds to the idle position of a traditional manual gearbox.

With gear lever at N, it is possible to start the engine.

Engage idle N in case of long stops.

Drive, automatic forward gear (D)

Engage position D for urban and extra-urban use of the car.



Reverse shall only be engaged with car stationary, engine idling and accelerator fully released.



Shifting from R → N or D is free whereas for shifting R → P you have to press the gear lever button.



To shift from N, release the accelerator pedal and make sure the engine is idling.



Shifting from N → D is free whereas for shifting from N → R or P you have to press the gear lever button.



Shifting the lever from P to D (P → D), from N to D (N → D) and from R to D (R → D) shall be only performed with the car stationary and the engine idling.

ENGINE STARTING

- Handbrake engaged and gear lever at P or N: engine can be only started with the gear lever in one of these positions.
- With lever at P press the brake pedal and turn the ignition key to **START** without pressing the accelerator pedal.
- With lever at N press the brake pedal and turn the ignition key to **START** without pressing the accelerator pedal.

If the engine fails to start at first attempt, turn the key to **OFF** before trying to restart.

IMPORTANT With engine off, never leave the ignition key at **ON** to prevent draining the battery.

IMPORTANT: if when travelling with gear lever at D or in sequential mode you turn inadvertently the key to OFF the engine will turn off and transmission will fail.

Proceed as follows:

- Set gear lever to N and press the brake pedal
- Restart the engine by turning the key to **START** and set the gear lever to D.



WARNING

Running the engine in confined areas is extremely dangerous. The engine consumes oxygen and produces carbon monoxide which is a highly toxic and lethal gas.

MOVING OFF

Proceed as follows:

- at P position, press the brake pedal;
- press the gear lever button and move the gear lever to the required position (D or R);
- accelerate gradually; the car moves off and gearshifting will be automatic.

IMPORTANT: Take the utmost care in the following conditions: handbrake and brake pedal released with engine idling and gear lever at D, R or sequential since the car can move also without pressing the accelerator pedal.

The above condition can be used for parking in narrow spaces, taking care to operate the brake pedal only.



WARNING

Never leave children unattended in the car.



Shifting from P, with ignition key at ON, is only possible with brake pedal pressed.

SEQUENTIAL MODE

In sequential mode, the electronic automatic transmission works like a fixed gear sequential gearbox.

From position D move the gear lever leftwards:

- move gear lever to +: to upshift;
- move gear lever to -: to downshift.

Gears are displayed by digits on the instrument panel. Non-stop monitoring carried out by transmission control unit excludes whatever possibility of error.

Downshifting (or upshifting) is only possible if engine rpm enables it.

In sequential mode, electronic transmission control can however intervene in self-adapting mode by shifting gears automatically when engine rpm exceeds or falls below the admitted rpm limit.

When stopping the car with a gear higher than 1st gear, transmission will set automatically at 1st gear.

When stopping the car under poor grip conditions (snow, ice), at next starting the transmission control unit could engage a gear higher than 1st gear to prevent wheel slipping. This shall not be considered as a fault

IMPORTANT: in the event of excessive oil temperatures (see section “Warning lights and messages”), the electronic control intervenes excluding sequential mode and activating automatic mode in order to safeguard transmission life. Sequential mode will be resumed as soon as regular operating temperatures are restored.

AUTOMATIC MODE

D can be selected from sequential mode under whatever driving condition.

When passing from sequential mode to D, the gear to engage is selected by transmission control unit according to engine rpm and speed (accelerator pedal position).

Low engine power demand will result in long gears engagement and reduced fuel consumption. Increasing speed by pressing the accelerator will automatically engage short gears that will result in improved performance as to pickup and acceleration: in this case fuel consumption will increase.

For speedy pickup:

- press the accelerator pedal flat-out, the kick-down device will cut in to obtain max. performance in terms of pickup and acceleration. In this case fuel consumption will obviously increase.

IMPORTANT When driving under poor grip conditions (snow, ice, etc.) avoid to engage the kick-down device.

FAILURE INDICATIONS

Failures to the electronic automatic transmission is indicated by the turning of warning light  on the instrument panel together with the dedicated message on the multifunction display (see section “Warning lights and messages”).

Contact Fiat Dealership as soon as possible to have the fault removed.

STOPPING THE CAR

To stop the car:

- release the accelerator pedal;
- press the brake pedal.

IMPORTANT With the car on a sloping road and engine running, keep the car stopped just using the brake pedal, do not press the accelerator pedal.

With the car parked with engine running and gear lever at D, R or in sequential mode, keep the brake pedal pressed to prevent car moving off by engine idling.

For long stops set gear lever to P.

PARKING THE CAR

Engage the handbrake and set gear lever to P. Leave the wheels steered. Block the wheels with a wedge or a stone if the car is parked on a steep slope.

Do not leave the ignition key at **ON** to prevent draining the battery. Always remove the key when you leave the car.



WARNING

Never leave children unattended in the car.

BUZZER WARNINGS

The warning buzzer will sound and P position will flash for a few seconds when the ignition key is at **OFF** and the gear lever is not set at P.

Ignition key can only be removed with gear lever at P.

TOWING THE CAR

IMPORTANT Comply with current local regulations to tow the car.

If the car is to be towed, observe the following recommendations:

- transport the car, if possible, on the flatbed of a wrecker or maintenance vehicle;
- should this not be possible, tow the car with the front driving wheels raised from ground.

For towing the car, the gear lever shall be set to N.



Do not start the engine when towing the car.



Failure to observe the above instructions could seriously damage the automatic transmission.



WARNING

Never leave children unattended in the car.

CONTAINING RUNNING COSTS

Here are some suggestions which may help you to keep the running costs of your car down and lower the amount of toxic emissions released into the atmosphere.

GENERAL CONSIDERATIONS

Car maintenance

Have checks and adjustments carried out in accordance with the "Service schedule".

Tyres

Check the pressure of the tyres routinely at an interval of no more than 4 weeks: if the pressure is too low, consumption levels increase as resistance to rolling is higher.

Unnecessary loads

Do not travel with too much luggage stowed in the boot. The weight of the car (especially when driving in town) and its trim greatly affects consumption and stability.

Roof rack/ski rack

Remove the roof rack or the ski rack from the roof as soon as they are no longer used. These accessories lower air penetration and adversely affect consumption levels. When needing to carry particularly voluminous objects, preferably use a trailer.

Electric devices

Use electric devices only for the amount of time needed. Rear heated window, additional headlights, windscreen wipers and heater fan need a considerable amount of energy, therefore increasing the requirement of current increases fuel consumption (up to +25% in the urban cycle).

Climate control

The air conditioner is an additional load which greatly affects the engine leading to higher consumption (on average up to +20%). When the temperature outside the car permits it, use the air vents where possible.

Spoilers

The use of non-certified aerodynamic items may adversely affect air drag and consumption levels.

DRIVING STYLE

Starting

Do not warm the engine with the car at a standstill or at idle or high speed: under these conditions the engine warms up much more slowly, increasing electrical consumption and emissions. It is therefore advisable to move off immediately, slowly, avoiding high speeds. This way the engine will warm faster.

Unnecessary actions

Avoid accelerating when waiting at traffic lights or before switching off the engine. This and also double declutching is absolutely pointless on modern cars and also increase consumption and pollution.

Gear selection

As soon as the conditions of the traffic and road allow, use a higher gear. Using a low gear to obtain brilliant performance increases consumption.

In the same way improper use of a high gear increases consumption, emissions and engine wear.

Top speed

Fuel consumption considerably increases with speed. Avoid superfluous braking and accelerating, which cost in terms of both fuel and emissions.

Acceleration

Accelerating violently increasing the revs will greatly affect consumption and emissions: acceleration should be gradual and should not exceed the maximum torque.

CONDITIONS OF USE

Cold starting

Short journeys and frequent cold starts do not allow the engine to reach optimum operating temperature. This results in a significant increase in consumption levels (from +15 to +30% on the urban cycle) and emission of harmful substances.

Traffic situations and road conditions

Rather high consumption levels are tied to situations with heavy traffic, for example in queues with frequent use of the lower gears or in cities with many traffic lights. Also winding mountain roads and rough road surfaces adversely affect consumption.

Traffic hold-ups

During prolonged hold-ups (e.g.: level crossings) the engine should be switched off.

TOWING TRAILERS

IMPORTANT NOTES

For towing caravans or trailers the car must be fitted with a certified tow hook and an adequate electric system. Installation should be carried out by specialised personnel who release a special document for circulation on the road.

Install any specific and/or additional rear-view mirrors as specified by law.

Remember that when towing a trailer, steep hills are harder to climb, the braking spaces increase and overtaking takes longer depending on the overall weight.

Engage a low gear when driving downhill, rather than constantly using the brake.

The weight the trailer exerts on the car tow hook reduces by the same amount the actual car loading capacity. To make sure the maximum towable weight is not exceeded (given in the log book) account should be taken of the fully laden trailer, including accessories and personal belongings.

Do not exceed the speed limits of the country you are driving in. In any case do not exceed 100 km/h.

It is recommended to use a proper towing stabiliser on the trailer drawbar.



WARNING

The ABS system with which the car may be fitted does not control the trailer braking system. Drive with extreme care on slippery roadbeds.



WARNING

Under no circumstances should the car brake system be altered to control the trailer brake. The trailer braking system must be fully independent of the car hydraulic system.

INSTALLING THE TOW HOOK

The towing device should be fastened to the body by specialised personnel according to any additional and/or integrative information supplied by the Manufacturer of the device.

The towing device must meet current regulations with reference to 94/20/EC Directive and subsequent amendments.

For any version the towing device used must match the towable weight of the car on which it is to be installed.

For the electric connection a unified connector should be used which is generally placed on a special bracket normally fastened to the towing device, and a special ECU for external trailer light control shall be installed on the car.

For the electrical connection, 7 or 13 pin 12VDC connection is to be used (CU-NA/UNI and ISO/DIN Standards). Follow the instructions provided by the car manufacturer and/or the tow hitch manufacturer.

An electric brake should be supplied directly by the battery through a cable with a cross section of no less than 2.5 mm².

IMPORTANT Electric brake or other device shall be used with running engine.

In addition to the electrical branches, the car's electric system can only be connected to the supply cable for an electric brake and to the cable for an internal light, though not above 15W.

For connections use the preset control unit with battery cable no less than 2.5 mm².

ASSEMBLY DIAGRAM fig. 7

The tow hook structure must be fastened using a total of 4 M10 screws (A).

Thickness of upper plates, left B and right C, shall be 6 mm min.

Thickness of lower plates, left E and right F, shall be 8 mm min.

The hook should be fastened to the body avoiding any type of drilling and trimming of the rear bumpers that remains visible when the hook is removed.

IMPORTANT It is compulsory to fasten a label (plainly visible) of suitable size and material with the following wording:

MAX LOAD ON BALL 70 kg

After fitting, screw holes shall be sealed to prevent exhaust gas inlet.

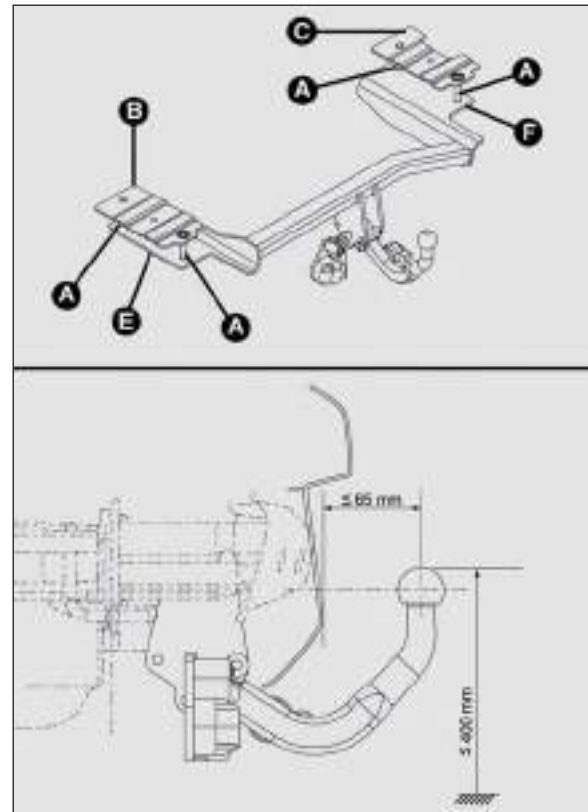

fig. 7

FOL0236m

DASHBOARD
AND CONTROLS

SAFETY
DEVICES

CORRECT USE
OF THE CAR

WARNING
LIGHTS AND
MESSAGES

IN AN
EMERGENCY

CAR
MAINTENANCE

TECHNICAL
SPECIFICATIONS

INDEX

SNOW TYRES

Use snow tyres of the same size as the normal tyres provided with the car.

Fiat Dealership will be happy to provide advice concerning the most suitable type of tyre for the customer's requirements.

For the type of tyre to be used, inflation pressures and the specifications of snow tyres, follow the instructions given in paragraph "Wheels" in section "Technical specifications".

The winter features of these tyres are reduced considerably when the tread depth is below 4 mm. In this case, they should be replaced.

Due to the snow tyre features, under normal conditions of use or on long motorway journeys, the performance of these tyres is lower than that of normal tyres. It is therefore necessary to limit their use to the purposes for which they are certified.

IMPORTANT When snow tyres are used with a max speed index below the one that can be reached by the car (increased by 5%), place a notice in the passenger's compartment, plainly in the driver's view which states the max permissible speed of the snow tyres (as per EC Directive).

All four tyres should be the same (brand and track) to ensure greater safety when driving and braking and better driveability.

Remember that it is inappropriate to change the direction of rotation of tyres.



WARNING

The max speed for snow tyres with "Q" marking is 160 km/h; 190 km/h for tyres with "T" marking and 210 km/h for tyres with H marking. The Road Traffic Code speed limits must however be always strictly observed.

SNOW CHAINS

Use of snow chains should be in compliance with local regulations.

Snow chains should only be applied to the driving wheels (front wheels). We recommend using Lineaccessori Fiat snow chains.

Check the tension of the chains after the first few metres have been driven.

IMPORTANT Snow chains cannot be fitted to the space-saver spare wheel. So, if a front (drive) wheel is punctured and chains are needed, a rear wheel should be fitted to the front of the car and the spare wheel should be fitted to the rear. This way with two normal drive wheels, snow chains can be fitted to them to solve an emergency.

IMPORTANT Snow chains shall only be a temporary solution. Use snow tyres if you have to travel for long on roadbeds covered with snow or ice.

IMPORTANT With snow chains fitted, use the accelerator with extreme care to prevent or to reduce to a minimum driving wheel skidding in order to avoid snow chain breaking that could cause damages to the body or the mechanical parts of the car.

Versions	Tyres on which chains can be fitted	Type of snow chains to be used
1.8 - 2.2	205/55 R16 91V	Snow chains with reduced size with max protrusion beyond the tyre profile of 9 mm
1.9 Multijet	215/55 R16 93W	
2.4 Multijet	215/50 R17 91W	



Refer to the above mentioned table for information on the wheels where snow chains can be fitted. Follow the prescriptions.



Keep your speed down when snow chains are fitted. Do not exceed 40 km/h. Avoid potholes, steps and pavements and avoid also to drive for long distances on roads not covered with snow to prevent damaging the car and the roadbed.

CAR INACTIVITY

If the car is to be left inactive for longer than a month, the following precautions should be noted:

- park the car in covered, dry and if possible well-ventilated premises;
- engage a gear (position P with automatic transmission);
- check that the handbrake is not engaged;
- disconnect battery terminals (first disconnect the negative terminal);
- if the vehicle is equipped with a battery with an optical indicator, control its charge status. This check is to be repeated every three months when the car is left inactive. Recharge if the optical indicator shows a dark colour without the central green area;

- clean and protect the painted parts using protective wax;
- clean and protect the shiny metal parts using special compounds readily available;
- sprinkle talcum powder on the rubber windscreen and rear window wiper blades and lift them off the glass;
- slightly open the windows;
- cover the car with a cloth or perforated plastic sheet. Do not use sheets of non-perforated plastic as they do not allow moisture on the car body to evaporate;
- inflate tyres to +0,5 bar above the normal specified pressure and check it at intervals;

- when the battery is not disconnected from the electric system, if the vehicle is equipped with a battery with an optical indicator, control its charge status every 30 days and if the optical indicator shows a dark colour without the central green zone, recharge it;
- do not drain the engine cooling system.

IMPORTANT Where relevant, switch off the car alarm with the remote control.

WARNING LIGHTS AND MESSAGES

GENERAL WARNINGS.....	146	GENERIC SIGNALLING	152
INSUFFICIENT BRAKE LIQUID	146	ESP SYSTEM FAILURE	154
HAND BRAKE ENGAGED	146	HILL HOLDER FAILURE	154
AIR BAG FAILURE.....	146	POSITION LIGHTS AND LOW BEAMS	154
PASSENGER SIDE FRONT AND SIDE CHEST PROTECTION AIR BAGS (SIDE BAGS) OFF	147	FOLLOW ME HOME.....	154
SEAT BELTS NOT FASTENED	147	FOG LIGHTS	154
EXCESSIVE ENGINE COOLANT TEMPERATURE....	148	LEFT TURN SIGNAL	154
INSUFFICIENT BATTERY RECHARGING	148	RIGHT TURN SIGNAL	154
ABS SYSTEM FAILURE	148	HIGH BEAMS.....	155
EBD FAILURE.....	148	POSSIBILITY OF ICE ON ROADS.....	155
INSUFFICIENT ENGINE OIL PRESSURE.....	149	LIMITED RANGE.....	155
DEGRADED OIL.....	149	ASR SYSTEM.....	155
POWER STEERING FAILURE	149	AUTOMATIC TRANSMISSION FAILURE	155
INCOMPLETE DOOR CLOSURE.....	149	MAXIMUM AUTOMATIC TRANSMISSION OIL TEMPERATURE	155
INJECTION SYSTEM FAILURE	149	SET SPEED LIMIT EXCEEDANCE.....	156
ENGINE CONTROL SYSTEM FAILURE (EOBD)	149	CONSTANT SPEED REGULATOR (CRUISE CONTROL).....	156
FUEL RESERVE	150	BRAKE PAD WEAR	156
SPARK PLUG PREHEATING	150	MINIMUM ENGINE OIL LEVEL	156
SPARK PLUG PREHEATING FAILURE.....	150	REAR SIDE CHEST PROTECTION AIR BAGS (REAR SIDE BAGS) OFF	156
WATER IN DIESEL FILTER.....	151	TURNING OFF A MOVING VEHICLE.....	156
FIAT CODE - VEHICLE PROTECTION SYSTEM FAILURE	151	STARTING PROCEDURE DISPLAY INFORMATION MESSAGES (AUTOMATIC TRANSMISSION).....	156
ALARM FAILURE.....	151	STARTING PROCEDURE DISPLAY INFORMATION MESSAGES (MANUAL TRANSMISSION)	156
BREAK-IN ATTEMPT	151		
ELECTRONIC KEY NOT RECOGNISED	151		
EXTERIOR LIGHT FAILURE.....	152		
REAR FOG LIGHTS	152		

DASHBOARD
AND CONTROLS

SAFETY
DEVICES

CORRECT USE
OF THE CAR

WARNING
LIGHTS AND
MESSAGES

IN AN
EMERGENCY

CAR
MAINTENANCE

TECHNICAL
SPECIFICATIONS

INDEX

WARNING LIGHTS AND MESSAGES

GENERAL WARNINGS

Turning on of warning light is accompanied by specific message and/or by buzzer sound where provided by instrument panel. These indications are **concise and cautionary** and shall not be considered as exhaustive and/or as an alternative to the specifications contained in this Owner Handbook which shall always be read through carefully and thoroughly. In case of failure indication **always refer to the specifications contained in this section**.

IMPORTANT Failure indications displayed are divided into two categories: **very serious** and **less serious** failures.

Very serious failures are indicated by a warning “cycle” repeated until failure is eliminated.

Less serious failures are indicated by a limited warning “cycle”.

The warning cycle of both failure classes can be stopped by pressing button **MODE**. The instrument panel warning light will stay on until eliminating the fault.

As concerns messages relevant to the versions equipped with Dualogic gearbox, see the attached Supplement.



**LOW BRAKE FLUID
LEVEL (red)**

HANDBRAKE ON (red)

Turning the ignition key to **ON** the warning light turns on, but it should go off after few seconds.

Low brake fluid level

The warning light turns on when the level of the brake fluid in the reservoir falls below the minimum level, due to possible leak in the circuit.

The display will show the dedicated message.



WARNING

If the warning light (ⓘ) turns on when travelling (on certain versions together with the message on the display) stop the car immediately and contact Fiat Dealership.

Handbrake on

The warning light turns on when the handbrake is on.

On certain versions, if the car is moving the buzzer will also sound.

IMPORTANT If the warning light turns on when travelling, check that the handbrake is not engaged.



**AIR BAG FAILURE
(red)**

Turning the ignition key to **ON** the warning light turns on, but it should go off after few seconds.

The warning light stays on glowing steadily if there is a failure in the air bag system.

The display will show the dedicated message.





WARNING

If when turning the ignition key to **ON**, the warning light  does not turn on or stays on when travelling there could be a failure in safety systems; in this event air bags or pretensioners could not trigger in case of impact or, in a minor number of cases, they could trigger accidentally. Contact Fiat Dealership immediately to have the system checked.





WARNING

The failure of the  warning light is also indicated by the flashing for more than the normal 4 seconds of the passenger's front air bag deactivated warning light . In addition the air bag system will deactivate automatically the passenger's air bags (front and side where provided). In this event, warning light  could not indicate safety systems failures. Contact Fiat Dealership immediately to have the system checked.





PASSENGER SIDE FRONT AND SIDE CHEST PROTECTION AIR BAGS (side bags) OFF (amber yellow)

Warning light  will come on when deactivating the passenger front air bag and side bag (where provided). With passenger front air bag active, turning the ignition key to **ON**, warning light  will turn on with fixed light for about 4 seconds and then it will flash for other 4 seconds. It shall then go off.



WARNING

The failure of the warning light  is indicated by the turning on of warning light . In addition the air bag system will deactivate automatically the passenger's air bags (front and side where provided). Contact Fiat Dealership immediately to have the system checked.



SEAT BELTS NOT FASTENED

The warning light on the dial turns on glowing steadily with car stationary and driver's seat belt not fastened correctly. The warning light will turn on flashing together with the buzzer when, with car moving, front seat belts are not fastened correctly. The S.B.R. (Seat Belt Reminder) buzzer can only be excluded by Fiat Dealership. The system can be reactivated through the set-up menu (see diagram aside). The display will show the dedicated message.

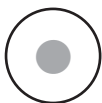

HIGH TEMPERATURE ENGINE COOLANT FLUID (red)

Turning the ignition key to **ON** the warning light turns on, but it should go off after few seconds.

The warning light turns on when the engine is overheated.

If the warning light comes on when driving, proceed as follows:

- ❑ **normal driving conditions:** stop the car, switch off the engine and check whether the water level in the reservoir is not below the MIN mark. Otherwise wait for few seconds to allow the engine cooling, then open slowly and carefully the cap, top up coolant and check whether its level is falling between MIN and MAX marks in the reservoir. Check visually any leak. If, when restarting, the warning light comes on again, contact a Fiat Dealership.

- ❑ **Car heavy duty** (e.g.: towing trailer uphill of fully laden car): decrease speed, if the warning light stays on, stop the car. Wait for 2 or 3 minutes leaving the engine on and slightly accelerated to further activate the circulation of the coolant fluid, then switch the engine off. Check proper coolant level as described previously.

IMPORTANT Under severe use of the car, keep the engine on and slightly accelerated for few minutes before switching it off.

The display will show the dedicated message.



LOW BATTERY CHARGE (red) (where provided)

Turning the key to **ON** the warning light turns on, but it should go out as soon as the engine is started (with the engine running at idle speed a brief delay in going out is allowed).

If the warning light stays on contact immediately Fiat Dealership.



INEFFICIENT ABS SYSTEM (amber)

Turning the key to **ON** the warning light turns on, but it should go off after few seconds.

The warning light turns on when the system is inefficient or unavailable. In this case the braking system keeps its effectiveness unchanged, but without the potential offered by the ABS system. Caution is advisable and it is necessary to contact Fiat Dealership.

The display will show the dedicated message.



INEFFICIENT EBD ELECTRONIC BRAKING

DISTRIBUTOR (red) (amber)

The turning on at the same time of warning lights (!) and (ABS) with the engine running indicates an EBD system failure or that the system is unavailable; in this case heavy braking may cause the rear wheels to lock before time, with the possibility of skidding. Drive with the utmost care to the nearest Fiat Dealership to have the system checked.

The display will show the dedicated message.



LOW ENGINE OIL PRESSURE (red)

Turning the ignition key to **ON** the warning light turns on, but it should go off after few seconds.

The display will show the dedicated message.



WARNING

If the warning light  turns on when travelling together with the message on the display, stop the engine immediately and contact a Fiat Dealership.



EXHAUST OIL (Multijet versions)

The warning light with turn on flashing together with the message on the display when the system detects that the engine oil is exhaust.

After the first indication, at each engine starting the warning light  will go on flashing for 60 seconds and then for 2 hours until oil is changed.



If warning light  flashes, contact Fiat Dealership immediately to have oil changed and instrument panel warning light turned off.



POWER STEERING FAILURE (red) (where provided)

Turning the ignition key to **ON** the warning light turns on, but it should go off after few seconds. If the warning light stays on, you will not have steering assistance and the effort on the steering wheel will be increased, steering is however possible. Contact Fiat Dealership. The dedicated message will be displayed.



INCOMPLETE DOOR LOCKING (red) (where provided)

The warning light turns on when one or more doors, the boot or the bonnet are not properly shut. The dedicated message will be displayed.

When travelling with door/doors, boot or bonnet open also a buzzer will sound.



INJECTION SYSTEM FAILURE (Multijet versions - red)

EOBD ENGINE CONTROL SYSTEM FAILURE (petrol versions - amber)

Injection system failure

Turning the ignition key to **ON** the warning light turns on, but it should go off after few seconds.

If the warning light stays on or turns on when travelling, means a fault in the supply/ignition system which could cause high emissions at the exhaust, possible lack of performance, poor handling and high consumption levels.

On certain versions the dedicated message is displayed.

In these conditions it is possible to continue driving without however requiring heavy effort or high speed from the engine. In any case, contact Fiat Dealership as soon as possible.

EOBD ENGINE CONTROL SYSTEM FAILURE

Under normal conditions, turning the ignition key to **ON**, the warning light turns on, but it should go off when the engine has started. In this case, turning on indicates proper working of the warning light. If the

warning light stays on or turns on when travelling:

- ❑ *glowing steadily*: means a fault in the supply/ignition system which could cause high emissions at the exhaust, possible lack of performance, poor handling and high consumption levels.

On certain versions the dedicated message is displayed.

In these conditions it is possible to continue driving without however requiring heavy effort or high speed from the engine. Prolonged use of the car with the warning light on may cause damages. Contact Fiat Dealership as soon as possible. The warning light goes off if the fault disappears, but it is still stored by the system.

- ❑ *flashing*: indicates the possibility of damage to the catalyst (see “EOBD system” in section “Dashboard and controls”).

If the light flashes, it is necessary to release the accelerator pedal to lower the speed of the engine until the warning light stops flashing; continue the journey at moderate speed, trying to avoid driving conditions that may cause further flashing and contact Fiat Dealership as soon as possible.



If when turning ignition key at ON, the warning light does not turn on or if it turns on with fixed light or flashing

(on certain versions together with the message on the display) when the car is travelling, contact Fiat Dealership as soon as possible. Warning light operation can be checked by traffic agents by proper equipment therefore, comply with laws and regulations in force in the country where you are driving.

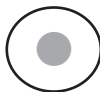

FUEL RESERVE (amber)

Turning the ignition key to **ON** the warning light comes on but shall go off after few seconds.

The warning light turns on when about 5 litres fuel are left in the tank.

IMPORTANT The warning light flashes to indicate a failure, contact Fiat Dealership as soon as possible to have the system checked.



GLOW PLUG WARMING (Multijet versions - amber)

GLOW PLUG WARMING FAILURE (Multijet versions - amber)

Glow plug warming

Turning the ignition key to **ON** the warning light turns on and it will go off when glow plugs reach the preset temperature. Start the engine immediately after warning light turning off.

IMPORTANT With hot ambient temperature, warning light stays on for very short time.

Glow plug warming failure



The warning light turns on when there is a failure in the glow plug warming system. Contact Fiat Dealership as soon as possible.

The display will show the dedicated message.



WATER IN DIESEL FUEL FILTER (Multijet versions - amber)

Turning the ignition key to **ON** the warning light turns on, but it should go off after few seconds.

The warning light  turns on when there is water in the diesel fuel filter. On certain versions warning light  will turn on.

The display will show the dedicated message.





The presence of water in the fuel circuit may cause serious damage to the entire injection system and cause irregular engine operation. If the warning light  turns on (on certain versions together with the message on the display) contact Fiat Dealership as soon as possible to have the system relieved. If the above indications come on immediately after refuelling, water has probably been poured into the tank: turn the engine off immediately and contact Fiat Dealership.



CAR PROTECTION SYSTEM FAILURE - FIAT CODE (amber) (where provided)

Turning the key to **ON** the warning light shall flash only once and then go off.

If with the ignition key at **ON** the warning light comes on with fixed light, this indicates a possible failure (see “The Fiat Code system” in section “Dashboard and controls”).

IMPORTANT The turning on at the same time of the  and  warning lights indicates a failure of the Fiat CODE system.

If with the engine running the warning light  flashes, this means that the car is not protected by the engine inhibitor device (see “Fiat Code system” in section “Dashboard and controls”).

Contact Fiat Dealership to have all the keys memorised.



ALARM FAILURE (where provided)

The turning on of the warning light (together with the message on the display and the buzzer) indicates that there is a failure in the electronic alarm system. Contact Fiat Dealership as soon as possible.



BREAK-IN ATTEMPT (where provided)

The turning on of the warning light (together with the message on the display), indicates an attempt of break-in.



ELECTRONIC KEY NOT RECOGNISED (where provided)

The turning on of the warning light (together with the message on the display and the buzzer) indicates that the electronic key being used is not enabled.



EXTERNAL LIGHT FAILURE (amber)

The warning light turns on when one of the following lights is failing:

- side/taillights
- brake lights (third brake light excluded)
- rear fog lights
- direction indicators
- number plate lights.

The failure referring to these lights could be: one or more blown bulbs, a blown protection fuse or an electric connection cut-off.

The display will show the dedicated message.



REAR FOG LIGHTS (amber)

The warning light turns on when the rear fog lights are turned on.



GENERIC FAILURE INDICATION (amber)

The warning light turns on in the following circumstances.

Engine oil pressure sensor failure

The warning light comes on when the engine oil pressure sensor is faulty. Contact Fiat Dealership as soon as possible.

The display will show the dedicated message.

Diesel particulate filter clogged (Multijet versions)

The warning light turns on together with the message on the display and the buzzer when the diesel particulate filter is clogged and the driving conditions do not enable to activate automatically the reclaiming procedure.

To enable the cleaning procedure, keep the car running until the warning light turns off.



Warning light  turns on together with the dedicated message on the display to indicate that the cleaning procedure cannot be performed, contact Fiat Dealership as soon as possible.

Inertial fuel cut-off switch intervened

The warning light turns on together with the message on the display, when the inertial fuel cut-off switch is triggered.

To reset the fuel cut-off switch, see paragraph “Power and fuel cut-off switch” in section “Dashboard and controls”.

Rain sensor failure

The warning light on the dial turns on (on certain versions together with the message on the display) when the rain sensor is faulty. Contact Fiat Dealership.

Parking sensor failure (where provided)

The warning light on the dial turns on together with the message on the display when failure is detected in parking sensors.

Contact Fiat Dealership.

Antipinch system failure (where provided)

The warning light on the dial turns on together with the message on the display when failure is detected in the antipinch system.

Contact Fiat Dealership.

Twilight sensor failure (where provided)

The warning light on the dial turns on (together with the message on the display) when failure is detected in twilight sensor (adjusting headlight sensitivity).

Check tyre pressure (where provided)

Warning light in the panel comes on (together with the message in the display) when the tyre inflation pressure is too low.

In this case, inflate tyres to the specified pressure values (see paragraph “Inflating pressures” in section “Technical Specifications”).

Flat tyres (where provided)

The warning light on the dial turns on (together with message on the display and the buzzer), when there is a pressure drop in one or more tyres. In this way the T.P.M.S. system warns the driver that one or more tyre/s is/are flat (i.e. punctured).

IMPORTANT Stop travelling with one or more flat tyre/s since road holding could be jeopardised. Stop the car without braking or steering sharply. Change immediately punctured wheel with space-saver spare wheel (where provided - see section “In an emergency”) and contact Fiat Dealership as soon as possible.

Tyre pressure monitoring system failure (where provided)

The warning light on the dial turns on (together with the message on the display) when a failure is detected in the T.P.M.S. system (where provided).

Contact Fiat Dealership as soon as possible.

Should one or more wheels without sensor be fitted, the instrument panel warning light will come on (together with the message on the display) and stay on until fitting again the four wheels with sensors.

**ESP SYSTEM FAILURE**
(amber)

Turning the ignition key to **ON** the warning light comes on but shall go off after few seconds.

If the warning light does not go off or stays on when travelling together with the button led **ASR OFF**, contact Fiat Dealership.

The display will show the dedicated message.

Note Warning light flashing when driving indicates that the ESP system is active.

**HILL HOLDER FAILURE**
(amber)

Turning the ignition key to **ON** the warning light comes on but shall go off after few seconds.

The warning light will turn on when the Hill Holder system is faulty. Contact Fiat Dealership as soon as possible.

The display will show the dedicated message.

**SIDE/TAILLIGHTS
AND LOW BEAMS**
(green)**FOLLOW ME HOME**
(green)**Side/taillights and low beams**

The warning light turns on when side/taillights or low beams are turned on.

Follow me home

The warning light will turn when this device is active (see “Follow me home” in section “Dashboard and controls”).

The display will show the dedicated message.

**FRONT FOG LIGHTS**
(green)

The warning light turns on when the front fog lights are turned on.

**LEFT-HAND
DIRECTION
INDICATOR** (green -
intermittent)

The warning light turns on when the direction indicator control lever is moved downwards or, together with the right indicator, when the hazard warning light button is pressed.

**RIGHT-HAND
DIRECTION
INDICATOR** (green -
intermittent)

The warning light turns on when the direction indicator control lever is moved upwards or, together with the left indicator, when the hazard warning light button is pressed.



MAIN BEAMS (blue)

The warning light turns on when the main beams are turned on.

POSSIBLE PRESENCE OF ICE ON THE ROAD (versions with reconfigurable multifunction display)

This indication starts flashing when the outside temperature reaches or falls below 3°C to warn the driver of the possible presence of ice on the road.

The display will show the dedicated message.

LIMITED RANGE (versions with reconfigurable multifunction display)

The display will show the dedicated message to warn the driver that the cruising range is less than 50 km.

ASR SYSTEM (versions with reconfigurable multifunction display)

The ASR system can be turned off by pressing the button **ASR OFF**.

The display will show the dedicated message to warn the driver that the system is off; at the same time the button led will turn on.

Pressing again button **ASR OFF** will turn off the button led and the display will show the dedicated message to warn the driver that the system is active again.



AUTOMATIC TRANSMISSION FAILURE

Turning the ignition key to **ON**, the warning light on the dial shall turn on and then go off after a few seconds.

The warning light (together with the message on the display and the warning buzzer) flashes to indicate a transmission failure.



Contact immediately Fiat Dealership in case of transmission failure to have the system checked.



HIGH GEARBOX OIL TEMPERATURE

The warning light comes on (together with the message on the display and the warning buzzer) glowing steadily to indicate that the temperature of the automatic transmission oil is too high.



Should the warning light turn on glowing steadily, reduce engine performance and contact immediately Fiat Dealership.

SPEED LIMIT EXCEEDED

The display will show the dedicated message and the buzzer will sound when the car exceeds the speed limit set previously (see “Reconfigurable Multifunction Display” in section “Dashboard and controls”).



CRUISE CONTROL (where provided)

The warning light turns on together with the message on the display when turning the knurled ring of the Cruise Control to **ON**.



BRAKE PAD WEAR (where provided)

The warning light on the dial turns on (together with the message on the display) if the front brake pads are worn; in this case have them changed as soon as possible.





LOW ENGINE OIL LEVEL

The warning light (if any) on the dial comes on together with the message on the display and the buzzer when the engine oil level falls below the minimum level. Restore proper oil level (see “Checking levels” in section “Car maintenance”).

Turning the ignition key to **ON** the warning light on the dial turns on but it should go off after few seconds.



REAR SIDE CHEST PROTECTION AIR BAGS (Rear Side Bags) OFF (where provided)

Warning light  turns on when the rear side chest protection air bags are turned off (Rear Side Bags) (where provided). With the air bags on, by turning the key to the **ON** position, the warning light  will turn on with a stationary light for approx. 4 seconds, then flash for the next 4 seconds, after which it will turn off.

ENGINE OFF WHEN RUNNING

Message is displayed when the engine is turned off at a speed higher than 10 km/h; steering lock is disabled.

To restore the function, turn the ignition key to **ON** and then to **OFF** again with the car stopped.

STARTING PROCEDURE MESSAGES (automatic transmission)

Starting procedure messages shown on the display when reaching position **ON** with enabled key.

STARTING PROCEDURE MESSAGES (manual transmission)

Starting procedure messages shown on the display when reaching position **ON** with enabled key.

IN AN EMERGENCY

In an emergency we recommend that you call the toll-free number found on the Warranty Booklet. You can also connect to the site www.fiat.com to search for the nearest Fiat Dealership point

STARTUP WITH AN AUXILIARY BATTERY	158
COASTING STARTUP	159
CHANGING A WHEEL	159
FIX & GO AUTOMATIC RAPID TYRE REPAIR KIT ..	165
CHANGING A LAMP	169
CHANGING AN EXTERIOR LAMP	173
CHANGING AN INTERIOR LAMP	178
FUSE REPLACEMENT	181
BATTERY RECHARGING	190
VEHICLE LIFTING	190
VEHICLE TOWING	191

DASHBOARD
AND CONTROLS

SAFETY
DEVICES

CORRECT USE
OF THE CAR

WARNING
LIGHTS AND
MESSAGES

**IN AN
EMERGENCY**

CAR
MAINTENANCE

TECHNICAL
SPECIFICATIONS

INDEX

JUMP STARTING

If the battery is flat, it is possible to start the engine using an auxiliary battery with the same capacity or a little higher than the flat one.

Proceed as follows **fig. 1**:

- Connect positive terminals (+ near the terminal) of the two batteries with a jump lead;
- With a second lead, connect the negative terminal (-) of the auxiliary battery and to an earthing point ↓ on the engine or the gearbox of the car to be started;
- Start the engine;
- When the engine has been started, remove the leads reversing the order above.

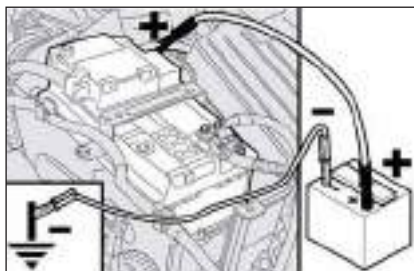

fig. 1

F0L0127m

If after a few attempts the engine does not start, do not insist but contact the nearest Fiat Dealership.

IMPORTANT Do not directly connect the negative terminals of the two batteries: sparks could ignite the flammable gas from the battery. If the other battery is fitted in another car, prevent accidental contacts between the metal parts of the two cars.



Under no circumstances should a battery charger be used to start the engine: it could damage the electronic systems and in particular the ignition and injection control units.



WARNING

Do not carry out this procedure if you lack experience; if it is not done correctly it can cause very intense electrical discharges. In addition, the fluid contained in the battery is poisonous and corrosive. Avoid contact with skin and eyes. You are also advised not to put naked flames or lighted cigarettes near the battery and not to cause sparks.

BUMP STARTING

Never bump start the engine (by pushing, towing, or coasting downhill) as this could cause fuel to flow into the catalytic exhaust system and damage it beyond repair.

Remember that the brake booster and the power steering system are not operating until the engine is started, a greater effort will therefore be required to press the brake pedal or to turn the steering wheel.

IF A TYRE IS PUNCTURED

GENERAL INSTRUCTIONS

Wheel changing and correct use of the jack and space-saver spare wheel call for some precautions as listed below.



WARNING

Alert other drivers that the car is stationary in compliance with local regulations: hazard warning lights, warning triangle etc. Any passengers on board should leave the car, especially if it is heavily laden. Passengers should stay away from on-coming traffic while the wheel is being changed on. If the wheel is being changed on a steep or badly surfaced road, place the wedges or other suitable material under the wheel to stop the car.



WARNING

The space-saver spare wheel is specific to your car, do not use it on other models, or use the spare wheel of other models on your car. The space-saver spare wheel shall only be used in an emergency. It shall only be used for the distance necessary to reach a service point and the car speed shall not exceed 80 Km/h. The spare wheel has an orange sticker that summarises the main cautions for use and limitations. The sticker should never be removed or covered.

Never fit a wheel cap on a space-saver spare wheel. The sticker gives the following information in four languages: caution! For temporary use only! 80 km/h max! Replace by normal wheel as soon as possible. Do not cover this label.

DASHBOARD
AND CONTROLS

SAFETY
DEVICES

CORRECT USE
OF THE CAR

WARNING
LIGHTS AND
MESSAGES

IN AN
EMERGENCY

CAR
MAINTENANCE

TECHNICAL
SPECIFICATIONS

INDEX

**WARNING**

When driving with a space-saver spare wheel fitted, the driving performance of the car changes. Avoid accelerating or braking sharply, abrupt turns or fast cornerings. The life of the spare wheel is approx. 3000 Km, after this distance it should be replaced with another of the same type. Never attempt to fit a conventional tyre on a rim designed for use as a space-saver spare wheel. Have the punctured wheel repaired and refitted as soon as possible. Two or more space-saver spare wheels should never be used together. Do not grease the threads of bolts before installing them: they might slip out.

**WARNING**

The jack shall only be used for changing wheels on the car with which it is provided or on cars of the same model. It must not be used for other purposes such as for instance raising cars of other models. In no case should it be used for repairs under the car. Incorrect positioning of the jack may cause the jacked car to fall. Do not use the jack for higher capacities than stated on its label. Snow chains cannot be fitted to the space-saver spare wheel. So, if a front (drive) wheel is punctured and chains are needed, a rear wheel should be fitted to the front of the car and the spare wheel should be fitted to the rear. This way with two normal drive wheels, snow chains can be fitted to them to solve an emergency.

**WARNING**

Fasten the wheel cap correctly to prevent the wheel from coming free in motion. Never tamper with the inflation valve. Never place tools between the rim and tyre. Check and restore, if required, the pressure of tyres and spare wheel to the values given in section "Technical Specifications".

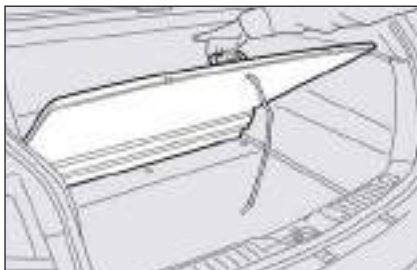

fig. 2

FOL0239m

Please note:

- the jack weight is 1,76 kg;
- the jack requires no adjustment;
- the jack cannot be repaired. If it breaks it must be replaced with a new jack;
- no tool other than its cranking device may be fitted on the jack.



fig. 3

FOL0240m

To change a wheel proceed as follows:

- Stop the car in a position that is not dangerous for oncoming traffic where you can change the wheel safely. The ground should be flat and adequately firm;
- Turn the engine off and pull up the handbrake;
- Engage first gear or reverse (position P with automatic transmission);
- Use the special handle to lift the load surface (where provided), as shown in **fig. 2**;



fig. 4

FOL0218m

- Lift the luggage compartment panel mat
- Make the wire secured under the loading surface (where provided), pass through the proper slot secured to the boot shelf mat and fasten both to the hook on the upper roof, as shown in **fig. 3**;
- Loosen the fastener **A-fig. 4**;



fig. 5

FOL0219m

- take out the space-saver spare wheel **B-fig. 4** to access the tool container **C-fig. 5**;
- take out the tool container **C-fig. 5** and take it near to the wheel to be changed;
- remove the spacer set under the space-saver spare wheel to house the standard size wheel.

IMPORTANT: failing to observe this prescription could cause boot floor breaking.

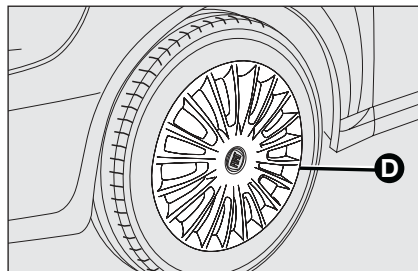

fig. 6

FOL0370m

- Note** Before replacing the drilled wheel (if in alloy) in the specific housing, remove the snap-in logo holder pressing on it from the its internal side.
- For vehicles with steel rims, remove the pressure inserted wheel hub cap **D-fig. 6**;

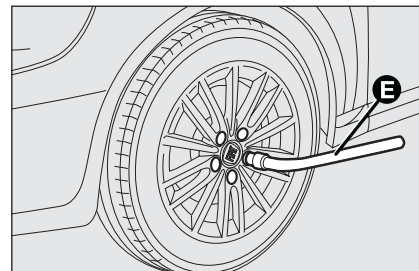

fig. 7

FOL0366m

- loosen the bolts of the wheel to be replaced by about one turn with the wrench provided **E-fig. 7**; if the car is fitted with alloy rims, shake the car to facilitate removing this rim from the wheel hub;

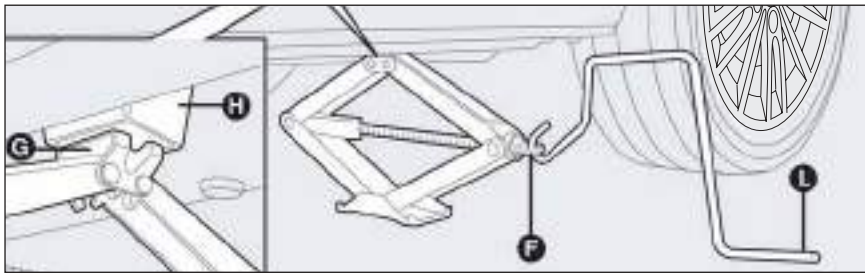

fig. 8

FOL0367m



fig. 9

FOL0188m

- operate the device **F-fig. 8** to extend the jack until the top of the jack **G-fig. 8** fits correctly into catch **H-fig. 8**;
- warn anybody nearby that the car is about to be lifted. They must stay clear and not touch the car until it is back on the ground;
- fit the handle **L-fig. 8** to operate the jack and lift the car until the wheel to be changed is several centimetres off the ground;
- make sure the contact surfaces between spare wheel and hub are clean so that the fastening bolts will not come loose;
- using the wrench provided, fully tighten the five fastening bolts;
- turn the jack handle **L-fig. 8** to lower the car and remove the jack;
- use the wrench provided to fasten the bolts completely in a criss-cross fashion as shown in **fig. 9**.

REFITTING THE STANDARD WHEEL

Following the procedure described previously, raise the car and remove the spare wheel.

For versions with steel rim

Proceed as follows:

- make sure the contact surfaces between standard wheel and hub are clean so that the fastening bolts will not come loose;
- fit the standard wheel by inserting the first bolt for two threads into the hole closest to the inflation valve;
- using the wrench provided, tighten the fastening bolts;
- lower the car and remove the jack;
- using the wrench provided, fully tighten the bolts in the sequence shown previously;
- fit the wheel cap making the groove (on the wheel cap) coincide with the inflation valve.

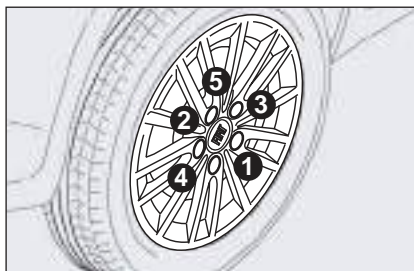

fig. 10

F0L0368m

For versions with alloy rims

- Insert the wheel on the hub and, using the wrench provided, tighten the bolts.
- Lower the car and remove the jack.
- Using the wrench provided, fully tighten the bolts in the sequence shown in **fig. 10**;
- insert the logo holder by pressing on the exterior side.

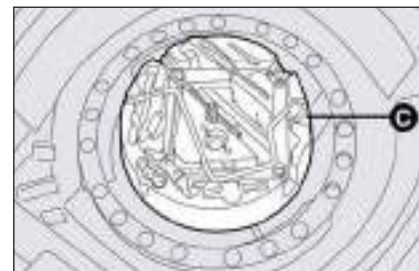

fig. 11

F0L0219m

When you have finished

- Place the spacer.
- Fit the jack partially open in its container **C-fig. 11** forcing it lightly to prevent it from vibrating when travelling.
- Put the tools back into their places in the container.



fig. 12

F0L0218m

- Stow the container **C-fig. 11**, complete with tools in the boot.
- Place the space-saver spare wheel **B-fig. 12** in the space provided for the purpose inside the boot and secure it with the clamping device **A-fig. 12**.

QUICK TYRE REPAIR KIT FIX & GO automatic

The quick tyre repair kit Fix & Go automatic is located in the appropriate container in the boot .

The quick tyre repair kit includes **fig. 13**:

- bottle **A** containing sealer and fitted with:
 - filler hose **B**
 - sticker **C** with caution “max. 80 km/h”, to be affixed in a visible position for the driver (instrument panel) after repairing the tyre
- instruction brochure (see **fig. 14**), to be used for prompt and proper use of the quick repair kit and to be then handed to the personnel charged with handling the treated tyre
- compressor **D** including gauge and connections
- a pair of protection gloves located in the side space of the compressor
- adapters for inflating different elements.

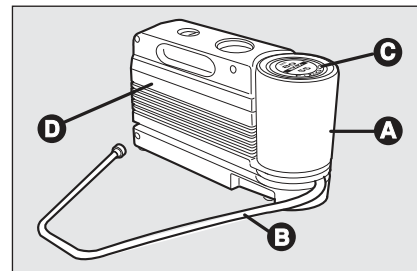

fig. 13

F0L0393m



WARNING

Hand the instruction brochure to the personnel charged with treating the tyre repaired with the kit.



In the event of a puncture caused by foreign bodies, it is possible to repair tyres showing damages on the track or shoulder up to max 4 mm diameter.



fig. 14

F0L0394m

**WARNING**

Holes and damages on the tyre side walls cannot be repaired. Do not use the quick tyre repair kit if damaging is due to running with flat tyre.

**WARNING**

Repairs are not possible in case of damages on the wheel rim (bad groove distortion causing air loss). Do not remove foreign bodies (screws or nails) from the tyre.

IT SHOULD BE NOTICED THAT:

The sealing fluid of the quick tyre repair kit is effective with external temperatures between -20°C and $+50^{\circ}\text{C}$.

**WARNING**

The compressor shall not be operated for more than 20 minutes. Risk of overheating!. Tyres repaired with the quick tyre repair kit shall be used temporarily only.



Do not throw away the cylinder and the sealing fluid. Have the sealing fluid and the cylinder disposed of in compliance with national and local regulations.

**WARNING**

The cylinder contains ethylene glycol. The cylinder contains latex: it can cause allergic reactions. It is harmful if ingested or inhaled and irritant for the eyes and in case of contact. In case of contact rinse immediately with water and take off contaminated clothes. If swallowed, do not induce vomit, rinse out the mouth, drink a lot of water and call the doctor immediately. Keep away from children. This product must not be used by asthmatics. Do not inhale vapours. Call the doctor immediately in case of allergic reactions. Keep the cylinder in the space provided for the purpose and far from heat. The sealing fluid has limited life. Replace the cylinder if sealer has run out.

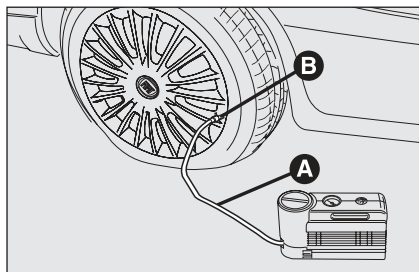

fig. 15

FOL0530m

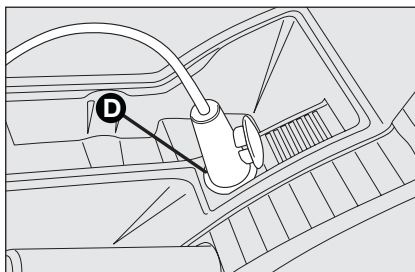

fig. 16

FOL0533m

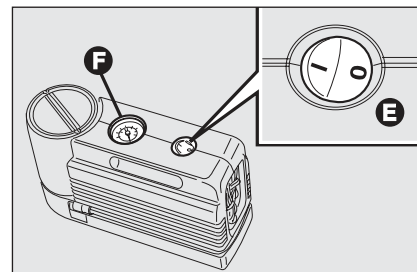

fig. 17

FOL0396m

INFLATING PROCEDURE



WARNING

Put on the protection gloves provided together with quick tyre repair kit.

- Pull up the handbrake.** Loosen tyre inflation valve cap, take out the filler hose **A-fig. 15** and screw the ring nut **B** on the tyre valve;

- make sure the compressor switch **E-fig. 17** is set to **0** (off), start the engine and fit plug **D-fig. 16** into the cigar lighter outlet and then turn on the compressor by setting switch **E-fig. 17** to **I** (on). Inflate the tyre to the pressure specified in paragraph "Cold tyre inflation pressure" in section "Technical specifications". Check tyre pressure on gauge **F-fig. 17** with compressor off to obtain precise reading;

- If after 5 minutes it is still impossible to reach at least 1.5 bar, disengage compressor from valve and current outlet, then move the car forth for approx. ten metres in order to distribute the sealing fluid inside the tyre evenly, then repeat the inflation operation;
- If after this operation it is still impossible after 5 minutes to reach at least 1.8 bar, do not start driving since the tyre is excessively damaged and the quick tyre repair kit cannot guarantee suitable sealing, contact Fiat Dealership;
- If reaching the tyre pressure specified in paragraph "Cold tyre inflation pressure" in section "Technical specifications", start driving immediately;

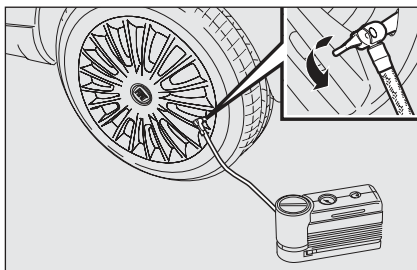

fig. 18

F0L0531m

**WARNING**

Apply the sticker in a visible position for the driver to indicate that the tyre has been treated with the quick tyre repair kit. Drive carefully especially when cornering. Do not exceed 80 km/h. Avoid heavy braking and accelerating.

- after driving for about 10 minutes stop and check again the tyre pressure; **pull up the handbrake;**

**WARNING**

If the pressure falls below 1.8 bars, do not drive any further: the quick tyre repair kit Fix & Go automatic cannot guarantee proper hold because the tyre is too much damaged. Contact Fiat Dealership.

- if at least 1.8 bar pressure is read, restore proper pressure (with engine running and handbrake on) and restart;
- drive with the utmost care to the nearest Fiat Dealership.

**WARNING**

It is of vital importance to communicate that the tyre has been repaired using the quick tyre repair kit. Hand the instruction brochure to the personnel charged with treating the tyre repaired with the kit.

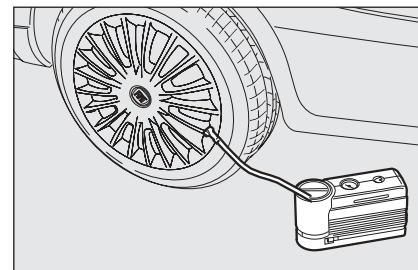

fig. 19

F0L0532m

FOR CHECKING AND RESTORING PRESSURE ONLY

The compressor can be also used just for restoring pressure. Disconnect the quick connection and connect it directly to the tyre valve **fig. 19**; in this way the cylinder is not connected to compressor and the sealing fluid will not flow into the tyre.

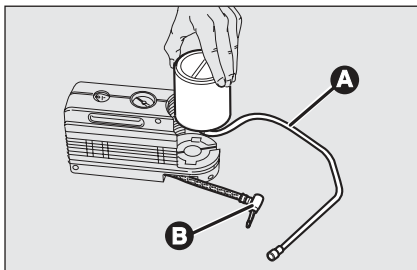

fig. 20

F0L0398m

CYLINDER REPLACEMENT PROCEDURE

To replace the cylinder proceed as follows:

- disconnect connection **B**-fig. 20;
- turn counter-clockwise the cylinder to replace and raise it;
- fit the new cylinder and turn it clockwise;
- connect connection **B** to the cylinder and fit the transparent tube **A** into the proper space.

WHEN NEEDING TO CHANGE A BULB

GENERAL INSTRUCTIONS

- When a light is not working, check that the corresponding fuse is intact before changing a bulb. For the location of fuses, refer to the paragraph "If a fuse blows" in this section;
- Before changing a bulb check the contacts for oxidation;
- Burnt bulbs must be replaced by others of the same type and power;
- Always check the height of the headlight beam after changing a bulb.



Halogen bulbs must be handled touching only the metallic part. If the transparent bulb is touched with the fingers, its lighting intensity is reduced and life of the bulb may be compromised. If touched accidentally, rub the bulb with a cloth moistened with alcohol and allow to dry.



WARNING

Modifications or repairs to the electrical system (electronic control units) carried out incorrectly and without bearing the features of the system in mind can cause malfunctions with the risk of fire.



WARNING

Halogen bulbs contain pressurised gas which, if broken, may cause small fragments of glass to be projected outwards.



WARNING

Due to high voltage, the bulb of (Xenon) gas-discharge headlights must only be replaced by experts: danger of death! Contact Fiat Dealership.

IMPORTANT The headlight inner surface may be lightly misted over: this is not a fault but a natural fact due to low temperature and the level of air humidity. It will disappear as soon the headlights are turned on. The presence of drops inside the headlights means water infiltration, therefore contact Fiat Dealership.

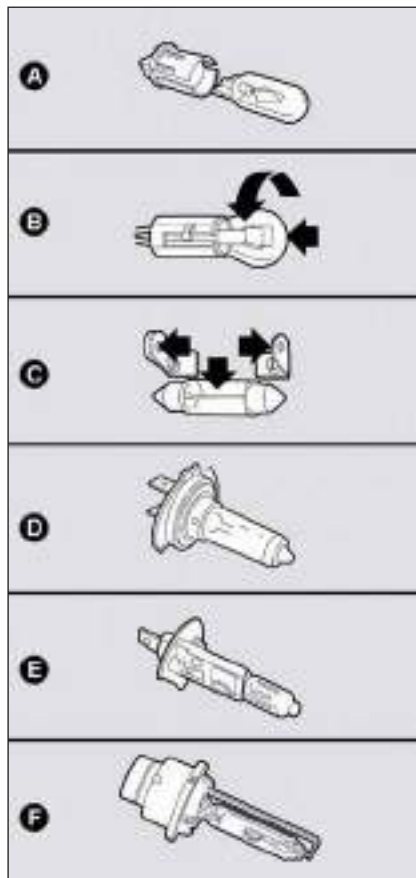

fig. 21

F0L0072m

TYPES OF BULBS fig. 21

Various types of bulbs are fitted to your car:

- A** Glass bulbs: clipped into position. Pull to remove.
- B** Bayonet type bulbs: press the bulb, turn counterclockwise to remove this type of bulb from its holder.
- C** Tubular bulbs: release them from their contacts to remove.
- D-E** Halogen bulbs: to remove the bulb, release the clip holding the bulb in place.
- F** Gas-discharge bulbs (Xenon).

Bulbs	Ref. Figure	Type	Power
Main beam headlights	E	H1	55W
Dipped beam headlights Longlife	D	H1	55W
Gas-discharge dipped beam headlights (where provided)	F	DIS	35W
Longlife front sidelights (2 per light)	A	W5W	5W
Front fog lights (where provided)	E	H11	55W
Front direction indicators	B	PY24W	24W
Side direction indicators	A	WY5W	5W
Rear direction indicators	B	R10W	10W
Taillights/brake lights	B	P21/5W	21W/5W
Third brake light (additional brake light)	A	W2,3W	2,3W

DASHBOARD
AND CONTROLS

SAFETY
DEVICES

CORRECT USE
OF THE CAR

WARNING
LIGHTS AND
MESSAGES

IN AN
EMERGENCY

CAR
MAINTENANCE

TECHNICAL
SPECIFICATIONS

INDEX

Bulbs	Ref. Figure	Type	Power
Reversing light	B	P21W	21W
Rear fog lights	B	P21W	21W
Number plate lights	C	C5W	5W
Puddle / door lights	A	W5W	5W
Front roof light	C	C5W	5W
Rear roof light	C	C10W	10W
Glovebox light	C	C5W	5W
Boot light	A	W5W	5W
Sun visor lights	C	C5W	5W

IF AN EXTERIOR LIGHT BURNS OUT

For the type of bulb and power rating, see “When needing to change a bulb”.

FRONT LIGHT UNITS fig. 22

The front light units contain the side/tail-lights, dipped beam, main beam and direction indicator bulbs.

The bulbs are arranged inside the light unit as follows:

- A** Sidelights / main beam headlights;
- B** Dipped beam headlights;
- C** Direction indicators.

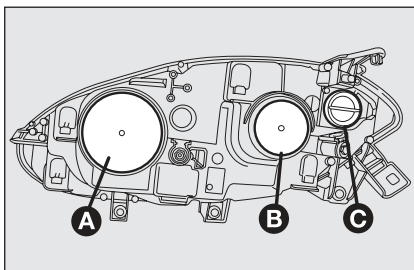

fig. 22

FOL0399m

DIPPED BEAM HEADLIGHTS

Gas-filled filament lamps

To change the bulb, proceed as follows:

- remove the protective cover **B**-fig. 22;
- release the bulb holder catch **A**-fig. 23;
- disconnect the electric connector **B**;
- remove the bulb **C** and replace it;
- fit the new bulb, making the tabs of the metallic part coincide with the grooves on the reflector, reconnect the electrical connector **B** then hook the bulb holder catch **A**;
- refit the protective cover **A**-fig. 22 correctly.

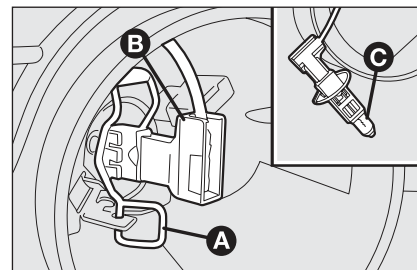

fig. 23

FOL0402m

Gas-discharge lamps (Bi-Xenon) (where provided)



WARNING

Due to high voltage, the bulb of (Bi-Xenon) gas-discharge headlights must only be replaced by experts: danger of death! Contact Fiat Dealership.

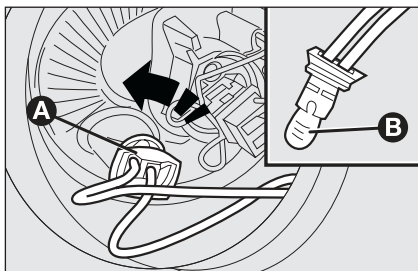

fig. 24

FOL0403m

SIDELIGHTS

To change the bulb, proceed as follows:

- remove the protective cover **A**-fig. 22;
- turn the bulb holder **A**-fig. 24 counterclockwise and then withdraw it;
- remove the bulb **B** and replace it;
- fit the new bulb, refit the bulb holder **A**-fig. 24 and then refit the protective cover **B**-fig. 22 correctly.

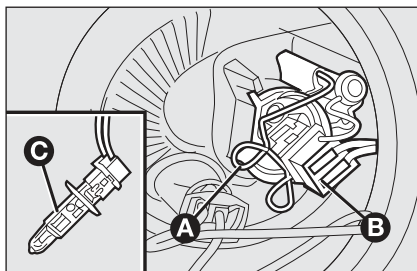

fig. 25

FOL0404m

MAIN BEAM HEADLIGHTS

To change the bulb, proceed as follows:

- remove the protective cover **A**-fig. 22;
- release the bulb holder catch **A**-fig. 25;
- remove the bulb **C** and replace it;
- fit the new bulb, making the tabs of the metallic part coincide with the grooves on the reflector, reconnect the electrical connector **B** then hook the bulb holder catch **A**;
- refit the protective cover **B**-fig. 22 correctly.

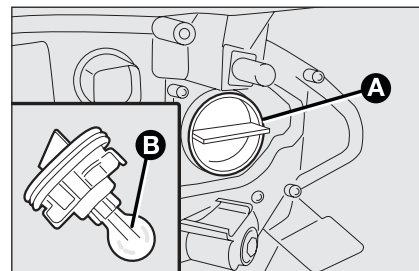

fig. 26

FOL0405m

DIRECTION INDICATORS

Front

To change the bulb, proceed as follows:

- turn the protective cover **C**-fig. 22 counterclockwise;
- remove the bulb **B**-fig. 26 and replace it;
- refit the protective cover **A** correctly.

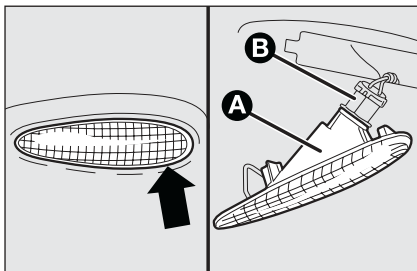

fig. 27

FOL0520m

Side fig. 19

To change the bulb, proceed as follows:

- lever in the point shown by the arrow to compress the catch and remove the unit **A**;
- turn the bulb holder **B** counterclockwise, remove the snap-fitted bulb and replace it;
- refit the bulb holder **B** in the transparent cover, then position the unit making sure the catch clicks into place.

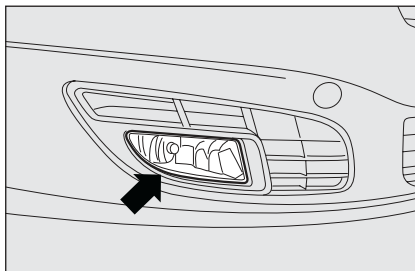

fig. 28

FOL0534m

FRONT FOG LIGHTS fig. 28 (where provided)

Contact Fiat Dealership to have front fog lights replaced.

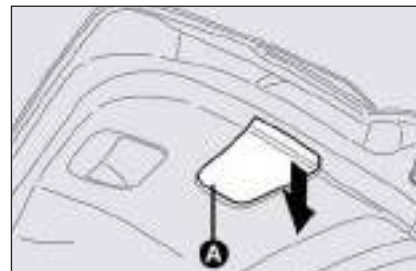

fig. 29

FOL0083m

REAR LIGHT UNITS

Tailgate light unit

To change the bulb, proceed as follows:

- open the tailgate;
- push down cover **A-fig. 29** and remove electric connector **B-fig. 30**;

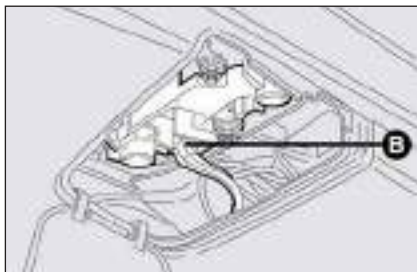

fig. 30

FOL0084m

- push the bulb holder side tabs **C**-fig. 31 inwards to remove it;
- remove bulbs slightly pushing them and turning counterclockwise.

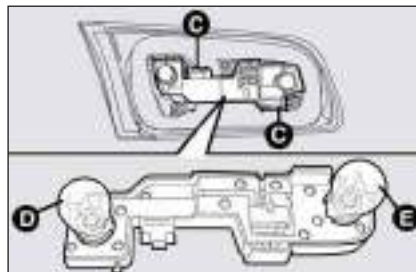

fig. 31

FOL0080m

The bulbs are arranged inside the light unit as follows (**fig. 31**):

- D** reversing lights;
- E** rear fog lights.

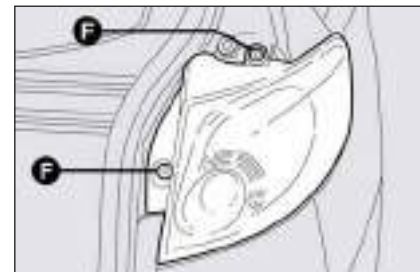

fig. 32

FOL0085m

Side fixed light unit

To change the bulb, proceed as follows:

- open the tailgate;
- loosen the two screws **F**-fig. 32 and remove the light unit;
- remove the electrical connector;

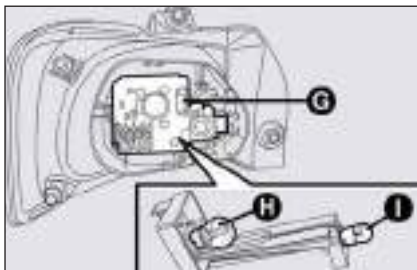

fig. 33

F0L0081m

- press the bulb holder tab **G**-fig. 33 to remove it;
- remove bulbs slightly pushing them and turning counterclockwise.

The bulbs are arranged inside the light unit as follows (**fig. 33**):

- H** taillights / brake lights;
- I** direction indicators.

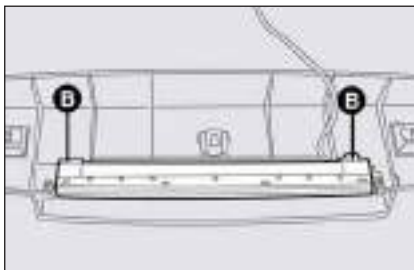

fig. 34

F0L0190m

- remove the snap-fitted bulbs and change them;
- refit the bulb holder making sure catches **B**-fig. 34 click into place.

ADDITIONAL BRAKING LIGHT (THIRD STOP)

To change the bulb, proceed as follows:

- open the tailgate;
- remove the snap-fitted cover;
- press catches **B**-fig. 34 and remove the bulb holder;

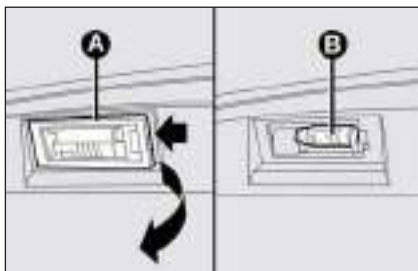

fig. 36

F0L0079m

NUMBER PLATE LIGHT fig. 36

To change the bulb, proceed as follows:

- work in the point shown by the arrow and remove lens **A**;
- change the bulb **B** releasing it from the side contacts and making sure the new bulb is correctly fastened between the contacts;
- refit the lens.

IF AN INTERIOR LIGHT BURNS OUT

For the type of bulb and power rating, see “When needing to change a bulb”.



fig. 37

F0L0086m

FRONT CEILING LIGHT fig. 37-38

To change the bulb, proceed as follows:

- work in the points shown by the arrows and remove cover **A**;
- turn the 2 bulb holders **B** counter-clockwise, remove and replace bulbs;

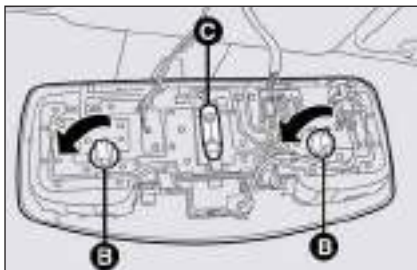

fig. 38

FOL0087m

- to replace the bulb **C**, release it from the side contacts making sure that the new bulb is correctly clamped between the contacts.

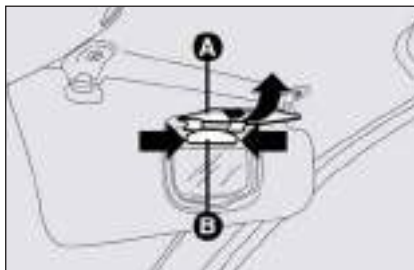

fig. 39

FOL0088m

COURTESY MIRROR LIGHT fig. 39

To change the bulb, proceed as follows:

- open the mirror cover **A**;
- remove the bulb **B** levering in the points shown by the arrows;
- replace the bulb releasing it from the side contacts making sure that the new bulb is correctly clamped between the contacts.



fig. 40

FOL0202m

GLOVEBOX LIGHT fig. 40

To change the bulb, proceed as follows:

- open the glovebox, remove the light unit **A** levering in the point shown by the arrow;
- replace the bulb releasing it from the side contacts making sure that the new bulb is correctly clamped between the contacts.

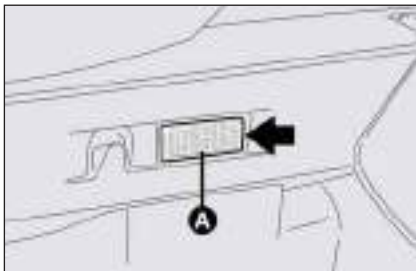

fig. 41

FOL0089m

BOOT LIGHT

To change the bulb, proceed as follows:

- open the tailgate;
- remove the light unit **A-fig. 41** levering in the point shown by the arrow.

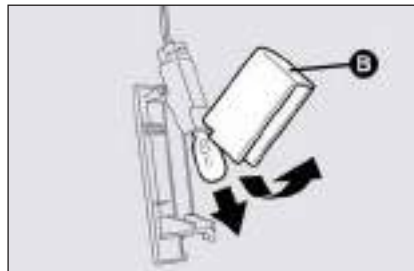

fig. 42

FOL0090m

- open the protection **B-fig. 42** and replace the snap-fitted bulb;
- re-close the protective cover **B-fig. 42** on the transparent;
- refit the light unit **A-fig. 41** inserting it in its correct position firstly on one end and then on the other until it clicks into place.

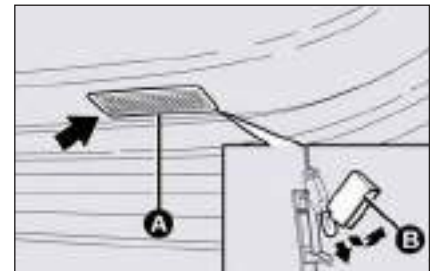

fig. 43

FOL0180m

PUDDLE / DOOR LIGHTS fig. 43

To change the bulb, proceed as follows:

- open the door and remove the transparent cover **A** levering in the point shown by the arrow;
- open the protection **B** and replace the snap-fitted bulb;
- re-close the protective cover **B** on the transparent cover **A**.

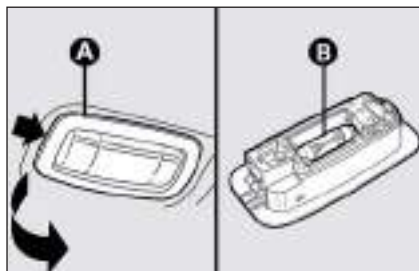

fig. 44

FOL0091m

SIDE REAR CEILING LIGHTS fig. 44

To change the bulb, proceed as follows:

- remove the light unit **A** levering in the point shown by the arrow;
- replace the bulb **B** releasing it from the side contacts making sure that the new bulb is correctly clamped between the contacts.

IF A FUSE BLOWS

GENERAL fig. 45

The fuse is a protective device for the electric system: it comes into action (i.e. it cuts off) mainly due to a fault or improper action on the system.

When a device does not work, check the efficiency of its fuse: the conductor element **A** must be intact. If not, replace the fuse with one of the same amp rating (same colour).

B undamaged fuse

C fuse with damaged filament.

To replace a fuse, use the pliers **D** hooked to the fusebox on the dashboard.

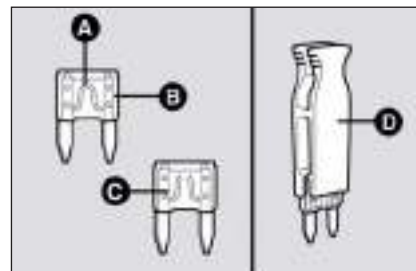

fig. 45

FOL0092m



WARNING

If a fuse switches off again, contact the Fiat Service Network.

DASHBOARD
AND CONTROLS

SAFETY
DEVICES

CORRECT USE
OF THE CAR

WARNING
LIGHTS AND
MESSAGES

IN AN
EMERGENCY

CAR
MAINTENANCE

TECHNICAL
SPECIFICATIONS

INDEX



Never replace a fuse with metal wires or anything else.



WARNING

Never change a fuse with another with a higher amp rating, DANGER OF FIRE.



WARNING

If a general fuse (MEGA-FUSE, MIDI-FUSE, MAXI-FUSE) cuts in, do not attempt any repair and contact a Fiat Dealership.



Before replacing a fuse, make sure the ignition key has been removed and that all the other services are switched off and/or disengaged.

FUSE LOCATION

The vehicle's fuses are grouped in three central units that are located on the instrument dashboard, in the engine compartment and inside the boot (left side).

On the battery's positive pole there is a fourth control unit that contains large capacity fuses (MEGA-FUSE, MIDI-FUSE, MAXI-FUSE).



WARNING

To replace these fuses, contact the Fiat Service Network.

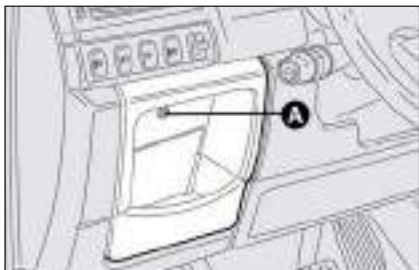

fig. 46

FOL0145m

Fuse box on the dashboard fig. 46-47

To gain access to the fuses in the fuse box on the dashboard, loosen the fastening screw **A** and remove the cover.

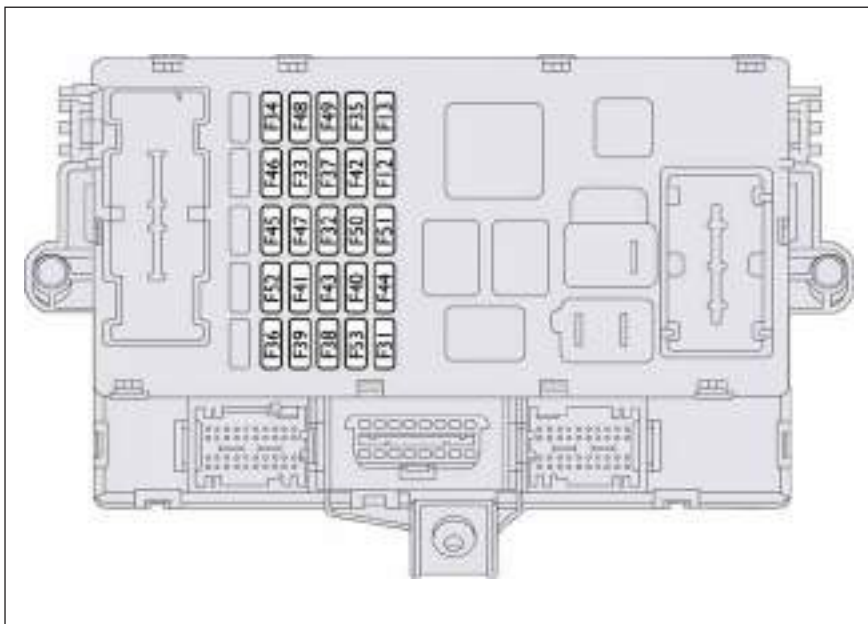

fig. 47

FOL0093m

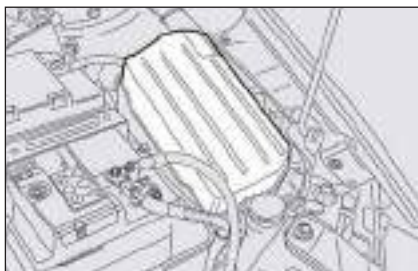

fig. 48

FOL0094m

Fuse box in engine compartment fig. 48-49

To gain access to the fuses in the fuse box next to the battery, remove the protection cover.

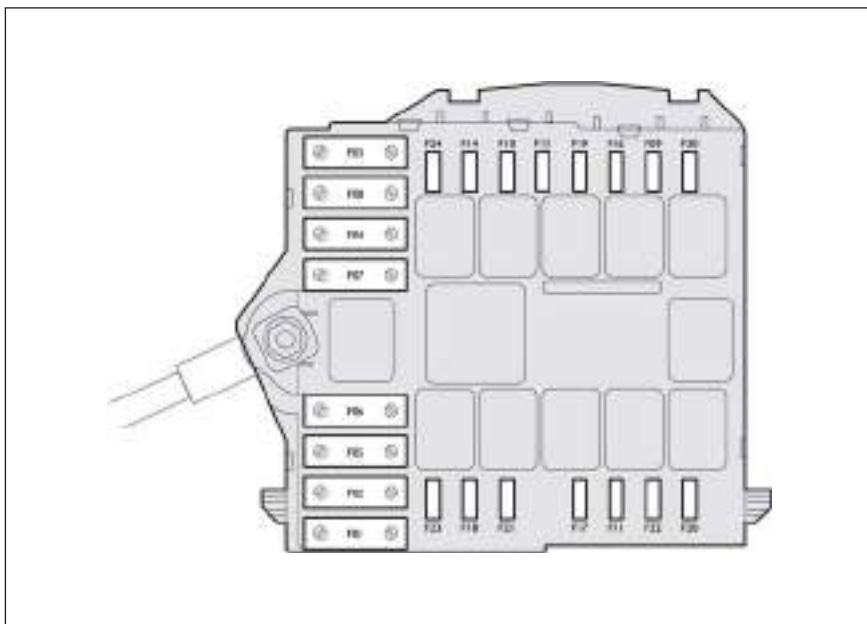

fig. 49

FOL0095m

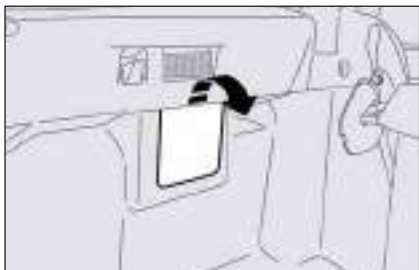

fig. 50

F0L0217m

Fuse box in the boot fig. 50-51

To gain access to the fuse box located on the left side of boot open the relevant door (as shown in the figure).

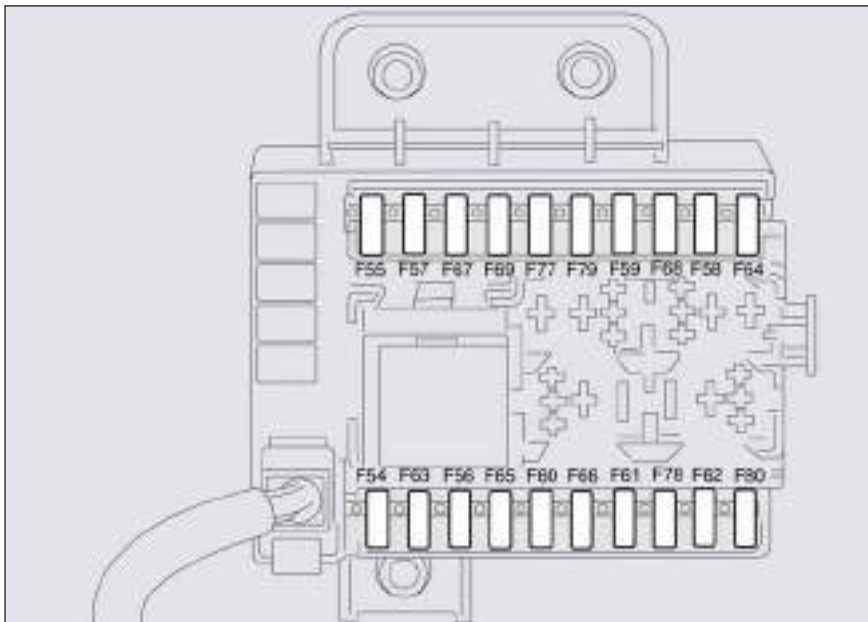

fig. 51

F0L0213m

FUSE SUMMARY TABLE**Fuse box on dashboard****USERS****FUSE****AMPERE**

USERS	FUSE	AMPERE
RH low beam	F 12	15
LH low beam - Light stability corrector	F 13	15
+15 excluded during ignition for dashboard control unit relay coils / engine compartment and Body computer	F 31	7.5
+30 nodes front driver and passenger doors (door lock), TEG reader	F 32	15
Boot compartment node power supply (rear left power window)	F 33	20
Boot compartment node power supply (rear right power window)	F 34	20
+15 backing lights, supplementary heater control unit, flow gauge, water in diesel fuel sensor, NC switch on brake pedal	F 35	7.5
+30 boot compartment node (rear door locks)	F 36	20
+15 instrument panel, control unit on gas discharge headlamps, NA switch on brake pedal, supplementary stop light	F 37	10
Boot opening actuator	F 38	15
+30 EOBD diagnostic socket , central front ceiling light, rear side ceiling lights, siren and volumetric sensor control unit for the antitheft system, tyre pressure control unit, air conditioning control unit, Blue-tooth control unit	F 39	10
Heated rear window	F 40	30
Windscreen / rear window washer nozzle demisters	F 41	7.5
+15 ABS / ESP control unit, electrohydraulic driving node, yaw sensor , steering angle sensor	F 42	7.5/15 (*)
+15 excluded during ignition for electronic column switch module (windscreen wipers, windscreen / rear window washer pump)	F 43	30
+15 excluded during ignition for cigar lighter, current outlet on tunnel	F 44	20

(*) Depending on the version

USERS	FUSE	AMPERE
Sun roof engine control unit power supply	F 45	20
Sun roof visor engine control unit power supply	F 46	20
Front driver door node power supply (front driver power window)	F 47	20
Front passenger door node power supply (front passenger power window)	F 48	20
+15 volumetric sensor control unit for antitheft device, emergency control display plaque lights / Blue-tooth and roof visor on roof panel / driver and passenger front seat console, driver side control dashboard lights / tunnel, DVD player presetting, electrochromic mirror, air conditioning	F 49	7.5
+15 airbag control unit	F 50	7.5
+15 Connect, Blue-tooth control unit, after market radio presetting, pneumatic pressure control unit, cruise control, rain / twilight sensor control unit, parking sensor control unit, AQS sensor	F 51	7.5
+15 excluded during ignition for electronic column switch module (rear window wiper), relay coil on boot compartment control unit	F 52	15
+30 instrument panel	F 53	10

DASHBOARD
AND CONTROLS

SAFETY
DEVICES

CORRECT USE
OF THE CAR

WARNING
LIGHTS AND
MESSAGES

IN AN
EMERGENCY

CAR
MAINTENANCE

TECHNICAL
SPECIFICATIONS

INDEX

Fuse box in engine compartment**USERS****FUSE****AMPERE**

Left fog light / cornering light

F 9

7.5

Buzzers

F 10

15

Engine control system power supply

F 11

15

RH high beam

F 14

7.5

LH high beam

F 15

7.5

+15 engine control unit

F 16

7.5

Engine control system power supply

F 17

10

+30 engine control unit

F 18

7.5

Conditioner compressor

F 19

7.5

Headlamp washer pump

F 20

20

Fuel pump

F 21

15

Engine control system power supply

F 22

20

+30 radio / Connect, supplementary heater control unit

F 23

20

+15 automatic transmission control unit, automatic transmission switch

F 24

15

Right fog light / cornering light

F 30

7.5

Fuse box in the boot

USERS	FUSE	AMPERE
+30 Hi-Fi audio amplifier	F 54	25
Free	F 55	–
+30 front driver seat regulation control unit	F 56	25
+15 excluded during ignition for front driver seat heating	F 57	7.5
Free	F 58	–
Free	F 59	–
+30 front passenger seat regulation control unit	F 60	25
Free	F 61	–
Free	F 62	–
Free	F 63	–
Free	F 64	–
Free	F 65	–
Free	F 66	–
+15 excluded during ignition for front driver seat heating	F 67	7.5
Free	F 68	–
Free	F 69	–
Free	F 77	–
Free	F 78	–
Free	F 79	–
Free	F 80	–

DASHBOARD
AND CONTROLS

SAFETY
DEVICES

CORRECT USE
OF THE CAR

WARNING
LIGHTS AND
MESSAGES

IN AN
EMERGENCY

CAR
MAINTENANCE

TECHNICAL
SPECIFICATIONS

INDEX

IF THE BATTERY IS FLAT

WARNING The battery charging procedure is described only for information purposes. This operation should be carried out by Fiat Dealership.

Charging should be slow at a low amp rating for 24 hours. Charging for a longer time may damage the battery.

Charge the battery as follows:

- disconnect battery negative terminal;
- connect the charger cables to the battery terminals, observing the poles;
- turn on the charger;
- when you have finished, turn the charger off before disconnecting the battery;
- reconnect battery negative terminal.

IMPORTANT If the car is fitted with alarm system, turn it off with the remote control (see “Alarm” in section “Dashboard and controls”).



WARNING

The liquid in the battery is poisonous and corrosive. Do not let it touch the skin or eyes. Recharging the battery should be done in a well ventilated area away from naked flames or possible sources of sparks: explosion and fire risk.



WARNING

Do not attempt to charge a frozen battery: it must firstly be thawed, otherwise it may burst. If freezing has occurred, the battery should be checked by skilled personnel to make sure that the internal elements are not damaged and that the body is not cracked, with the risk of leaking poisonous and corrosive acid.

JACKING THE CAR

If the car is to be lifted, go to a Fiat Dealership which is equipped with the arm hoist or workshop lift.

Jack up the car only by positioning the jack arms or the shop jack in the points shown in **fig. 52**.



fig. 52

FOL0525m

TOWING THE CAR

The tow ring provided with the car is housed in the tool box under the boot mat.

TOW RING HOOKING fig. 53-54

Proceed as follows:

- release the cap **A**;
- take the tow hook **B** from its support;
- tighten the ring on the rear or front threaded pin.

Refer to the specific chapter for towing cars fitted with electronic automatic transmission.

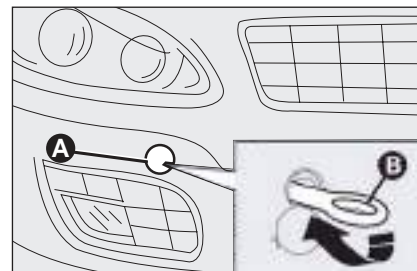

fig. 53

FOL0362m

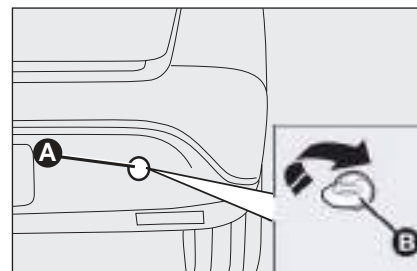

fig. 54

FOL0363m

DASHBOARD
AND CONTROLS

SAFETY
DEVICES

CORRECT USE
OF THE CAR

WARNING
LIGHTS AND
MESSAGES

IN AN
EMERGENCY

CAR
MAINTENANCE

TECHNICAL
SPECIFICATIONS

INDEX

**WARNING**

When towing, remember that without the help of the brake booster and power steering, a greater effort is required on the pedal and steering wheel. Do not use flexible cables for towing and avoid jerks. During towing operations make sure that fastening the joint to the car does not damage the components in contact with it. When towing the car, you must comply with the specific traffic regulations regarding the tow ring and how to tow on the road.

**WARNING**

Do not start the engine when towing the car.

**WARNING**

Before fitting the hook, clean accurately its threaded seat. Before starting to tow, make sure to have tighten the hook.

**WARNING**

Before starting to tow, disengage the steering lock (see paragraph “Ignition device” in section “Dashboard and controls”). When towing, remember that without the help of the brake booster and power steering, a greater effort is required on the pedal and steering wheel. Do not use flexible cables for towing and avoid jerks. During towing operations make sure that fastening the joint to the car does not damage the components in contact with it. When towing the car, you must comply with the specific traffic regulations regarding the tow ring and how to tow on the road.

CAR MAINTENANCE

SCHEDULED SERVICING	194
SERVICE SCHEDULE	195
ROUTINE MAINTENANCE	197
HEAVY-DUTY	197
CHECKING FLUID LEVELS.....	198
AIR FILTER/POLLEN FILTER	207
DIESEL FUEL FILTER	207
BATTERY	208
WHEELS AND TYRES.....	210
RUBBER HOSES	211
WINDSCREEN/REAR WINDOW WIPERS.....	212
BODYWORK	213
INTERIORS	215

DASHBOARD
AND CONTROLS

SAFETY
DEVICES

CORRECT USE
OF THE CAR

WARNING
LIGHTS AND
MESSAGES

IN AN
EMERGENCY

CAR
MAINTENANCE

TECHNICAL
SPECIFICATIONS

INDEX

SCHEDULED SERVICING

Correct maintenance is essential for ensuring long car life under the best conditions.

This is why Fiat has programmed a series of checks and maintenance operations every 35.000 km.

It is however important to remember that scheduled servicing does not completely cover all the car's requirements: also in the initial period before 35.000 km service coupon and later, between one coupon and another, ordinary care is still required such as for example routine check and topping up the level of fluids, tyre pressure check, etc...

IMPORTANT The Programmed Maintenance coupons are specified by the Manufacturer- The failure to have them carried out may invalidate the warranty.

Scheduled Servicing is performed by all Fiat Dealership, at pre-established times.

If during each operation, in addition to the ones programmed, the need arises for further replacements or repairs, these may be carried out only with the explicit agreement of the Customer.

IMPORTANT You are advised to contact Fiat Dealership in the event of any minor operating faults, without waiting for the next service coupon.

If your car is used frequently for towing, the interval between one service coupon and the other must be reduced.

SERVICE SCHEDULE

Thousands of km	35	70	105	140	175
Check tyre conditions/wear and adjust pressure if required	●	●	●	●	●
Check light system operation (headlights, direction indicators, hazard lights, boot lights, passenger compartment lights, glovebox lights, warning lights, etc.)	●	●	●	●	●
Check windscreen wiper/washer operation, adjust nozzles if required	●	●	●	●	●
Check windscreen/rear window blade position/wear	●	●	●	●	●
Check front disk brake pad conditions and wear and wear indicator operation	●	●	●	●	●
Check rear disk brake pad conditions and wear	●	●	●	●	●
Sight inspect the conditions of: body external parts, underbody protection, pipes and hoses (exhaust - fuel - brakes), rubber parts (boots, sleeves, bushes, etc.)	●	●	●	●	●
Check cleanness of locks, bonnet and boot and lever cleanness and lubrication	●	●	●	●	●
Check and top up, if required, fluid levels (brakes/hydraulic clutch, power steering, windscreen washer, battery, engine coolant, etc.)	●	●	●	●	●
Check power steering hydraulic system (2.2 version)	●	●	●	●	●
Check and adjust handbrake lever stroke	●		●		●
Sight inspect accessory drive belt conditions (except 1.8 version)		●			●
Sight inspect accessory drive belt conditions (1.8 version)		●			
Sight inspect timing belt conditions (1.8 version)		●			
Check and adjust tappet clearance (1.9 Multijet 8v version)	●	●	●	●	●

DASHBOARD AND CONTROLS

SAFETY DEVICES

CORRECT USE OF THE CAR

WARNING LIGHTS AND MESSAGES

IN AN EMERGENCY

CAR MAINTENANCE

TECHNICAL SPECIFICATIONS

INDEX

	Thousands of km	35	70	105	140	175
DASHBOARD AND CONTROLS	Check and adjust tappet clearance, if required (1.8 version)				●	
SAFETY DEVICES	Check exhaust emissions (petrol versions)	●	●	●	●	●
	Check exhaust emissions/smoke (Multijet versions)	●	●	●	●	●
CORRECT USE OF THE CAR	Check engine control system operation (through diagnosis socket)	●	●	●	●	●
	Replace accessory drive belt/s (except 1.8 version)			●		
	Replace accessory drive belt/s (1.8 version)				●	
WARNING LIGHTS AND MESSAGES	Replace timing belt (1.8 version) (*)				●	
	Replace timing belt (Multijet versions) (*)				●	
	Change spark plugs (petrol versions except 1.8)			●		
IN AN EMERGENCY	Change spark plugs (1.8 version)		●		●	
	Replace diesel fuel filter (Multijet versions)		●		●	
	Change air cleaner cartridge (petrol versions)	●	●	●	●	●
CAR MAINTENANCE	Change air cleaner cartridge (Multijet versions)	●	●	●	●	●
	Change engine oil and oil filter (1.8 petrol versions) (or every 12 months)	●	●	●	●	●
	Change engine oil and oil filter (Multijet versions with DPF) (**)					
TECHNICAL SPECIFICATIONS	Change engine oil and oil filter (Multijet versions without DPF) (or every 24 months)	●	●	●	●	●
	Change brake fluid (or every 24 months)		●		●	
	Change pollen filter (or every 15 months)	●	●	●	●	●
INDEX	Check and to top up, if required, automatic gearbox oil (automatic gearbox versions)	●	●	●	●	●

(*) Regardless of the km covered, the timing belt shall be replaced every 4 years for particularly demanding use (cold climates, driving in the city, idling for a long time) or in any case every 5 years.

(**) Engine oil and oil filter shall actually be changed according to the conditions of use of the car and it is indicated by the relevant warning light or message (where provided) on the instrument panel.

ROUTINE MAINTENANCE

Every 1,000 km or before long journeys, check and top up if required:

- engine coolant fluid level;
- brake fluid level;
- windscreen washer fluid level;
- tyre pressure and conditions;
- light system operation (headlights, direction indicators, hazard lights, etc.);
- windscreen wiper/washer operation and windscreen/rear window blade position/wear;

Every 3,000 km check and top up if required: engine oil level.

You are recommended to use **FL Selenia**, products, designed and produced specifically for Fiat cars (see table "Capacities" in section "Technical specifications").

HEAVY-DUTY

Should prevailing use of the car be under one of the following specially heavy conditions:

- trailer or caravan towing;
- dusty roads;
- short distances (less than 7-8 km) repeated and with external temperatures below zero;
- frequently idling engines or long distance low speed driving (e.g. door-to-door deliveries) or in case of a long term inactivity;
- driving in the city;

carry out the following checks more frequently than required in the Service Schedule:

- check front disk brake pad conditions and wear;

- check cleanness of locks, bonnet and boot and lever cleanness and lubrication;
- sight inspect the conditions of: engine, gearbox, transmission, pipes and hoses (exhaust - fuel - brakes), rubber parts (boots, sleeves, bushes, etc.);
- check battery charge and fluid level (electrolyte) (only to be carried out by skilled personnel or at Fiat Dealership – see also paragraph "Battery" in this section);
- visual check on various drive belt conditions;
- check and replace pollen filter, if required;
- check and replace air cleaner, if required.

DASHBOARD
AND CONTROLS

SAFETY
DEVICES

CORRECT USE
OF THE CAR

WARNING
LIGHTS AND
MESSAGES

IN AN
EMERGENCY

CAR
MAINTENANCE

TECHNICAL
SPECIFICATIONS

INDEX

CHECKING FLUID LEVELS

1. Engine oil
2. Battery
3. Brake fluid
4. Windscreen/rear window washer fluid
5. Engine coolant
6. Power steering fluid

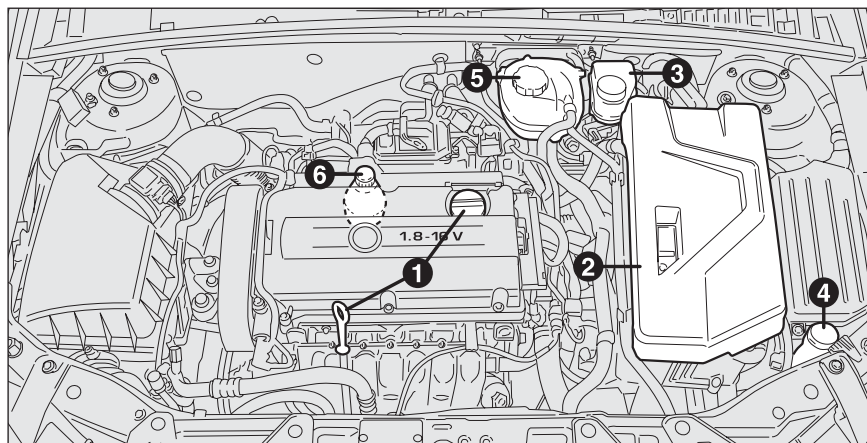

fig. 1 - 1.8 versions

F0L0522m



When topping up take care not to confuse the various types of fluids: they are all incompatible with one another and could seriously damage the car.



WARNING

Never smoke while working in the engine compartment; gas and inflammable vapours may be present, with the risk of fire.

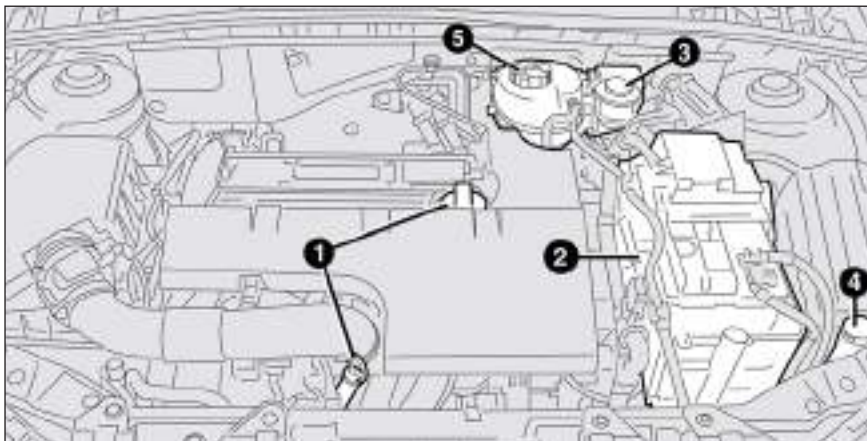

fig. 2 - 2.2 versions

F0L0158m

1. Engine oil
2. Battery
3. Brake fluid
4. Windscreen/rear window washer fluid
5. Engine coolant

IMPORTANT Topping up or change of the power steering fluid of 2.2 petrol versions shall be carried out at a Fiat Dealership.



When topping up take care not to confuse the various types of fluids: they are all incompatible with one another and could seriously damage the car.



WARNING

Never smoke while working in the engine compartment; gas and inflammable vapours may be present, with the risk of fire.

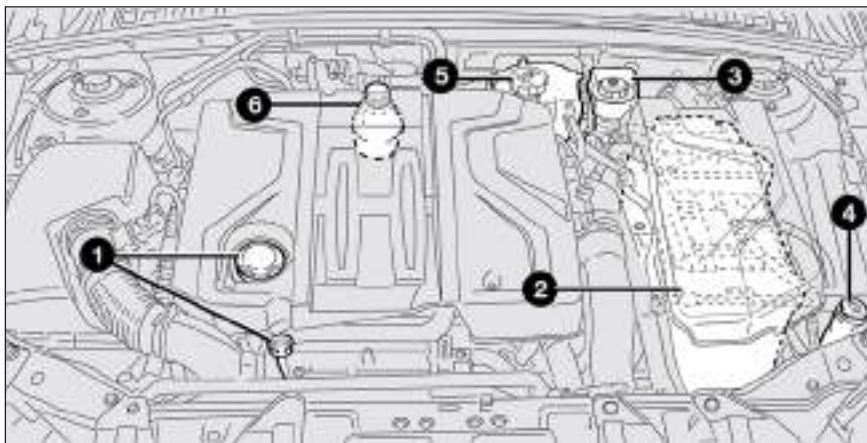

fig. 3 - 1.9 Multijet 8V versions

FOL0208m



When topping up take care not to confuse the various types of fluids: they are all incompatible with one another and could seriously damage the car.



WARNING

Never smoke while working in the engine compartment; gas and inflammable vapours may be present, with the risk of fire.

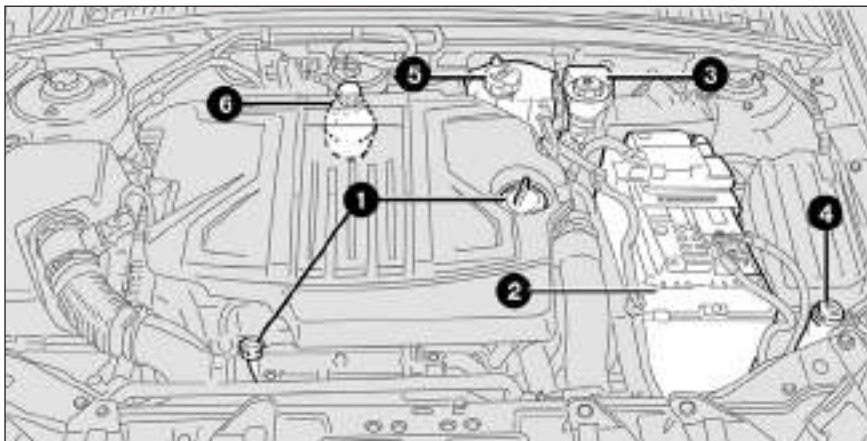

fig. 4 - 1.9 Multijet 16V versions

F0L0521m

1. Engine oil
2. Battery
3. Brake fluid
4. Windscreen/rear window washer fluid
5. Engine coolant
6. Power steering fluid



When topping up take care not to confuse the various types of fluids: they are all incompatible with one another and could seriously damage the car.



WARNING

Never smoke while working in the engine compartment; gas and inflammable vapours may be present, with the risk of fire.

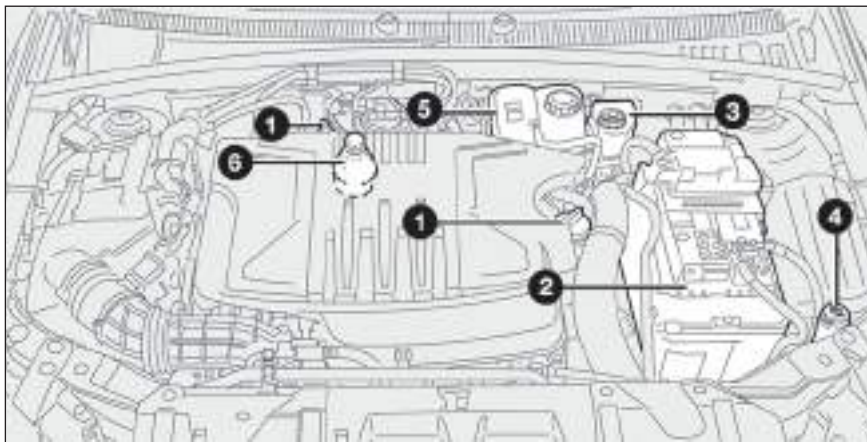

fig. 5 - 2.4 Multijet 20V versions

F0L0317m

1. Engine oil
2. Battery
3. Brake fluid
4. Windscreen/rear window washer fluid
5. Engine coolant
6. Power steering fluid



When topping up take care not to confuse the various types of fluids: they are all incompatible with one another and could seriously damage the car.



WARNING

Never smoke while working in the engine compartment; gas and inflammable vapours may be present, with the risk of fire.

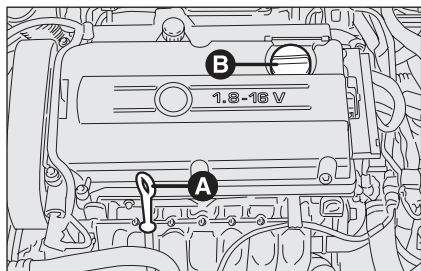

fig. 6 - 1.8 versions

FOL0523m

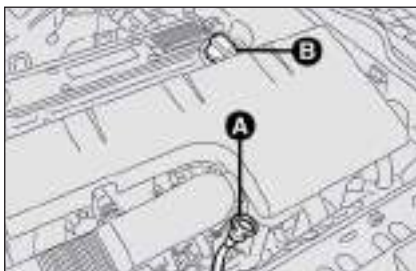

fig. 7 - 2.2 versions

FOL0198m



fig. 9 - 1.9 Multijet 16V versions

FOL0210m

ENGINE OIL

Checking engine oil

Check the oil level a few minutes (about 5) after the engine has stopped, with the car parked on level ground.

Remove the dipstick **A** and clean it, put it back in completely, remove it and check that the level is within the **MIN** and **MAX** marks on the dipstick. The gap between the **MIN** and **MAX** marks corresponds to about one litre of oil.

Topping up engine oil

If the oil level is near or even below the **MIN** mark, add oil through the filler neck **B**, until reaching the **MAX** mark.

Oil level shall never exceed the **MA** mark.

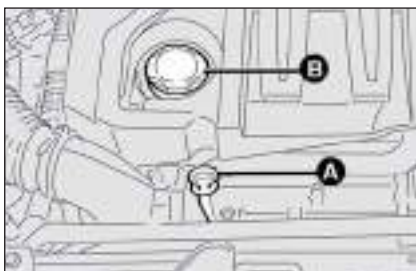

fig. 8 - 1.9 Multijet 8V versions

FOL0211m

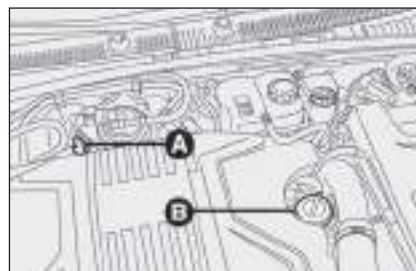

fig. 10 - 2.4 Multijet 20V versions

FOL0316m

IMPORTANT If a routine check reveals that the oil level is above the **MAX** mark, contact Fiat Dealership to have the correct level restored.

IMPORTANT After adding or changing the oil, let the engine turn over for a few seconds and wait a few minutes after turning it off before you check the level.



WARNING

When the engine is hot, take care when working inside the engine compartment to avoid burns. Remember that when the engine is hot, fan may cut in: danger of injury. Scarves, ties and other loose clothing might be pulled by moving parts.



Used engine oil and filter contain harmful substances for the environment. Contact Fiat Dealership to have the oil and filter changed.

Engine oil consumption

Max engine oil consumption is usually 400 grams every 1000 km.

When the car is new, the engine needs to run in, therefore the engine oil consumption can only be considered stabilised after the first 5000 - 6000 km.

IMPORTANT The oil consumption depends on driving style and the conditions under which the car is used.

IMPORTANT Do not add oil with specifications other than that already in the engine.

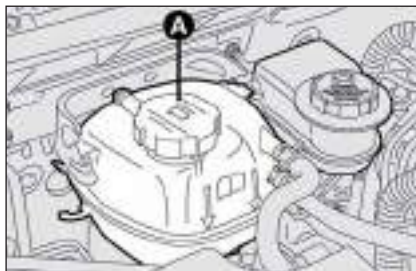

fig. 11

F0L0194m

ENGINE COOLANT FLUID fig. 11

The coolant level shall be checked with cold engine and shall not be lower than the **MIN** on the reservoir.

If the level is low, pour slowly a mixture of 50% distilled water and 50% **PARAFU UP** by **FL Selenia** through the filler neck **A**.

A 50-50 mixture of **PARAFU UP** and distilled water gives freeze protection to -35°C .

For particularly hard climate conditions, we recommend use of a 60% **PARAFU UP** and 40% demineralized water mixture.



The cooling system uses **PARAFU UP** antifreeze. Do not add fluid having different specifications from that already existing. **PARAFU UP** cannot be mixed with other types of fluids. Should other fluids be added, do not start the engine and contact Fiat Dealership as soon as possible.



WARNING

Do not remove the reservoir cap when the engine is hot: you risk scalding yourself.



WARNING

The cooling system is pressurised. If necessary, replace the cap only with another genuine one, otherwise system efficiency could be compromised.

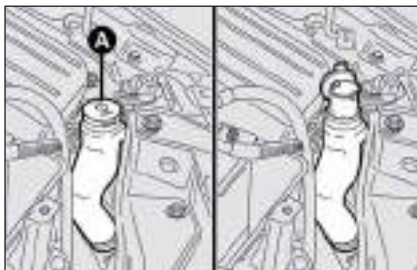

fig. 12

FOL0192m

WINDSCREEN/REAR WINDOW/HEADLIGHT WASHER FLUID

To top up, remove the cap **A**-fig. 12 and then pour a mixture of water and **TUTELA PROFESSIONAL SC 35**, in the following concentrations:

- 30% **TUTELA PROFESSIONAL SC 35** and 70% water in summer;
- 50% **TUTELA PROFESSIONAL SC 35** and 50% water in winter.

In case of temperatures below -20°C , use undiluted **TUTELA PROFESSIONAL SC 35**.

Check level through the reservoir.

Proper dipstick shows the fluid level **fig. 13** in the windshield washer reservoir.

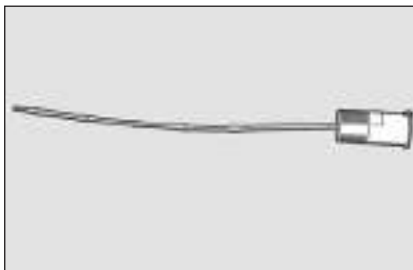

fig. 13

FOL0193m



WARNING

Do not travel with the windshield washer reservoir empty. The windshield washer is fundamental for improving visibility.



WARNING

Certain commercial additives for windshield washers are inflammable. The engine compartment contains hot components which may set it on fire.



fig. 14 - Multijet -

1.8 petrol versions

FOL0212m

POWER STEERING FLUID **fig. 14**

1.8 petrol and Multijet versions

Check that the fluid level in the reservoir is at maximum level.

This operation shall be carried out with the car on level surface, engine not running and cold.

Check that the fluid level is at the **MAX** mark on the dipstick integral with reservoir cap **A**-fig. 14.

If the fluid level in the reservoir is below the specified level, contact Fiat Dealership.

2.2 versions

Contact Fiat Dealership for topping up or changing the power steering fluid.



WARNING

Do not allow the power steering fluid to touch the hot parts of the engine: it is inflammable.

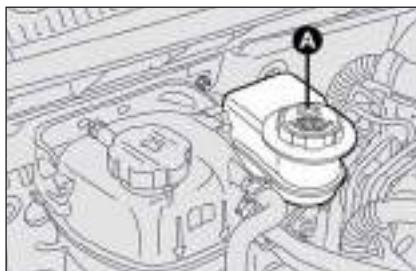

fig. 15

F0L0196m

BRAKE FLUID fig. 15

Unscrew cap **A**: check that the fluid level in the reservoir is at maximum.

Fluid level in the reservoir shall not exceed the **MAX** mark.

If fluid has to be added, it is suggested to use the brake fluid in table "Fluids and lubricants" (see chapter "Technical characteristics").

NOTE Clean accurately the tank cap **A** and the surrounding surface.

At plug opening, pay maximum attention in order to prevent any impurities from entering the tank.

For topping up, always use a funnel with integrated filter with mesh equal to or lower than 0.12 mm.

IMPORTANT Brake fluid absorbs moisture, for this reason, if the vehicle is mainly used in areas with a high degree of atmospheric humidity, the fluid should be replaced at more frequent intervals than specified in the "Service schedule".



water.

Make sure that the highly corrosive brake fluid does not drip onto the paintwork; if it does, wash it off immediately with



WARNING

Brake fluid is poisonous and highly corrosive. In the event of accidental contact, wash the parts involved immediately with neutral soap and water, then rinse thoroughly. Call the doctor immediately if the fluid is swallowed.



WARNING

Symbol © on the container indicates synthetic brake fluid, distinguishing it from the mineral kind. Using mineral fluids irreversibly damages the special braking system rubber seals.

AIR FILTER/POLLEN FILTER

Air cleaner or pollen filter replacement shall be carried out at a Fiat Dealership.

DIESEL FUEL FILTER

DRAINING THE CONDENSE (Multijet versions)



The presence of water in the fuel circuit can severely damage the injection system and make the engine misfire. If the warning light  turns on, contact a Fiat Dealership as soon as possible to have the bleeding operation carried out. Should the warning light turn on after refuelling, water has probably been poured into the tank: turn the engine off immediately and contact a Fiat Dealership.

BATTERY

The battery is of the “Limited maintenance” type: under normal conditions of use the electrolyte does not need topping up with distilled water.

CHECKING THE CHARGE fig. 16

The battery charge may be checked satisfactorily through the inspection slot using the indicator **A** (where provided) and acting according to the colour the indicator shows.

If the battery does not fit a charge and electrolyte level gauge, the corresponding operations must be performed by specialised personnel only.

Refer to the table below or to the label **B** on the battery.



WARNING

The liquid in the battery is poisonous and corrosive. Avoid contact with eyes and skin. Do not bring naked flames or possible sources of sparks near to the battery: risk of fire and explosion.



WARNING

Running the battery with low fluid level can damage the battery beyond repair and could also cause its explosion.

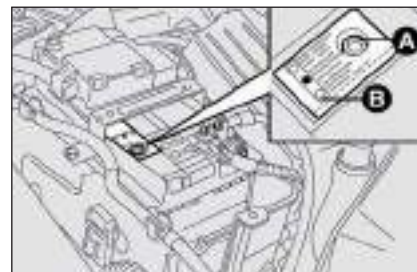

fig. 16

F0L0191m

Bright white colour	Top up electrolyte	Contact Fiat Dealership
Dark colour without green area in the centre	Low charge level	Charge the battery (advisable to contact Fiat Dealership)
Dark colour with green area in the centre	Electrolyte level and charge sufficient	No action

IMPORTANT Check the battery charge once a year, preferably before the beginning to winter, to prevent freezing of the electrolyte. Perform this inspection more frequently if the car is mainly used for short distances or if electrical devices running with the key off are installed, particularly after-market.

CHANGING THE BATTERY

If required, replace the battery with a genuine spare part having the same specifications.

If a battery with different specifications is fitted, the service intervals given in the “Service schedule” in this section will no longer be valid.

Refer to the instructions provided by the battery manufacturer.



Incorrect fitting of electrical and electronic accessories can seriously damage the car. If after buying the car, you want to install electric accessories which require permanent electric supply (alarm, free-hand phone kit, etc.) contact Fiat Dealership whose qualified personnel, in addition to suggesting the most suitable devices, will evaluate the overall electric absorption, checking whether the car electric system is capable of withstanding the load required, or whether it should be integrated with a more powerful battery.



Batteries contain substances that are very harmful for the environment. You are advised to have the battery changed at a Fiat Dealership, which is properly equipped for disposing of used batteries respecting nature and the law.



WARNING
If the car is left inactive for long periods at cold, remove the battery and store it in a warm place to prevent freezing.



WARNING
When working on the battery or near it, always wear the proper goggles.

USEFUL ADVICE FOR LENGTHENING THE LIFE OF YOUR BATTERY

To avoid draining your battery and lengthen its life, observe the following indications:

- when you park the car, ensure the doors, tailgate and bonnet are closed properly;
- the ceiling lights must be off. The car is however provided with an automatic system for switching off internal lights;
- do not keep accessories (e.g.: sound system, hazard lights, etc.) switched on for a long time when the engine is not running;
- before performing any operation on the electrical system, disconnect the battery negative cable;
- battery terminals shall always be perfectly tightened.

IMPORTANT A battery which is kept at a charge of less than 50% (optical indicator with dark colour without green area in the middle) for any length of time will be damaged by sulphation leading to a reduction in cranking power.

Moreover, this might lead to a higher risk of the battery electrolyte freezing (this may even occur at -10°C). If the car is inactive for a long period of time, refer to "Car inactivity", in section "Correct use of the car".

If after buying the car, you want to install electric accessories which require permanent electric supply (alarm, etc.) contact Fiat Dealership whose qualified personnel, in addition to suggesting the most suitable devices, will evaluate the overall electric absorption, checking whether the car's electric system is capable of withstanding the load required, or whether it should be integrated with a more powerful battery.

In fact, since these devices continue absorbing energy even when the ignition key is off, they gradually run down the battery.

The total intake of these systems (factory and after-market) must be less than 0,6 mA x Ah (of the battery) as shown in the following table:

Battery	Maximum admitted stand-by intake
70 Ah	42 mA
90 Ah (*)	54 mA

(*) Versions fitted with alarm.

WHEELS AND TYRES

Check the pressure of each tyre, including the spare, every two weeks and before long journeys. The pressure should be checked with the tyre rested and cold.

For the correct tyre inflation pressure, see “Wheels” in “Technical specifications” section.

Incorrect pressure causes abnormal tyre wear:

- A** normal pressure: tread evenly worn.
- B** low pressure: tread particularly worn at the edges.
- C** high pressure: tread particularly worn in the centre.

Tyres must be replaced when the tread wears down to 1.6 mm. In any case, comply with the laws in the country where the car is being driven.

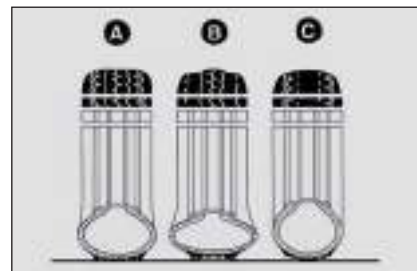

fig. 17

FOL0159m

IMPORTANT NOTES

- As far as possible, avoid sharp braking and screech starts, etc. Be careful not to hit the kerb, potholes or other obstacles hard. Driving for long stretches over bumpy roads can damage the tyres;
- Periodically check that the tyres have no cuts in the side wall, abnormal swelling or irregular tyre wear. If any of these occur, have the car seen to at a Fiat Dealership;
- Avoid overloading the car when travelling; this may cause serious damage to the wheels and tyres;

- ❑ If a tyre is punctured, stop immediately and change it to avoid damage to the tyre, the rim, suspensions and steering system;
- ❑ Tyres age even if they are not used much. Cracks in the tread rubber are a sign of ageing. In any case, if the tyres have been on the car for over 6 years, they should be checked by specialised personnel, to see if they can still be used. Also remember to check the space-saver spare wheel;
- ❑ In the case of replacement, always fit new tyres, avoiding those of dubious origin;
- ❑ If a tyre is changed, also change the inflation valve;
- ❑ To allow even wear between the front and rear tyres, it is advisable to change them over every 10-15 thousand kilometres, keeping them on the same side of the car so as to not reverse the direction of rotation.



WARNING

Remember that road holding depends also on the correct tyre inflating pressure.



WARNING

If the pressure is too low the tyre overheats and this can cause it serious damage.



WARNING

Do not cross switch the tyres, moving them from the right of the car to the left and vice versa.



WARNING

Never submit alloy rims to repainting treatments requiring to use temperatures exceeding 150°C since the mechanical properties of the wheels could be impaired.

RUBBER HOSES

As far as the brake system and fuel rubber hoses are concerned, carefully follow the “Service schedule” in this section.

Indeed ozone, high temperatures and prolonged lack of fluid in the system may cause hardening and cracking of the hoses, with possible leaks. Careful control is therefore necessary.

WINDSCREEN/ REAR WINDOW WIPERS

BLADES

Periodically clean the rubber part using special products; **TUTELA PROFESSIONAL SC 35** is recommended.

If the rubber blades are bent or worn they should be replaced. In any case they should be changed once a year.

A few simple notions can reduce the possibility of damage to the blades:

- if the temperature fall below zero, make sure that ice has not frozen the rubber against glass. If necessary, thaw using an antifreeze product;
- remove any snow from the glass: in addition to protecting the blades, this prevents effort on the motor and overheating;
- do not operate the windscreen and rear window wipers on dry glass.



WARNING

Driving with worn wiper blades is a serious hazard, because visibility is reduced in bad weather.

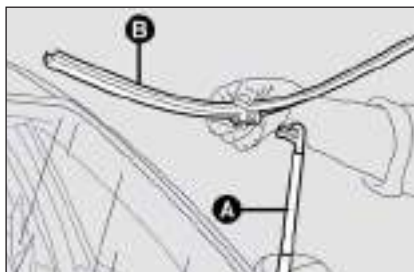

fig. 18

FOL0203m

Changing the windscreen wiper blades fig. 18

Proceed as follows:

- raise the windscreen wiper arm **A** and position the blade so that it forms an angle of 90° with the arm;
- remove the snap fitted blade **A** from arm **B**;
- fit the new blade and check it is properly locked into place.

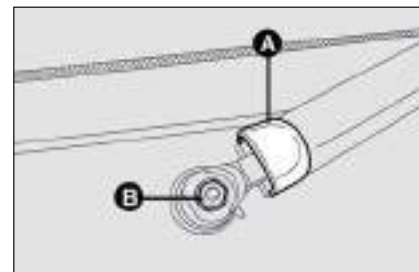

fig. 19

FOL0150m

Changing the rear window blade fig. 19

Proceed as follows:

- raise the cover **A** and remove the arm from the car, slackening the nut **B** that fastens it to the pivot pin;
- fit the new arm, positioning it correctly, and fully tighten the nut;
- lower the cover.

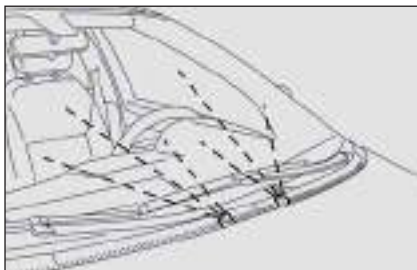

fig. 20

FOL0152m

SPRAY NOZZLES

Windscreen wiper fig. 20

If the jet of fluid is inadequate, firstly check that there is fluid in the reservoir: see “Checking fluid levels” in this section).

Then check that the nozzle holes are not clogged, if necessary use a needle.

Fluid jets shall be directed at about 1/3 height from the window upper edge.

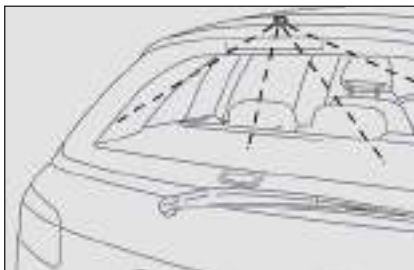

fig. 21

FOL0151m

Rear window wiper fig. 21

Rear window washer jets can be adjusted in the same way.

The nozzle holder is on the rear window.

HEADLIGHT WASHERS

Regularly check that the spray jets are intact and clean.

The headlight washers are automatically switched on when the windscreen washer is operated and the headlights are on.

BODYWORK

PROTECTION FROM ATMOSPHERIC AGENTS

The main causes of corrosion are the following:

- atmospheric pollution;
- salty air and humidity (coastal areas, or hot humid climates);
- seasonal environment conditions.

Not to be underestimated is also the abrasive action of wind-borne atmospheric dust and sand and mud and gravel raised by other cars.

On your Fiat Croma, Fiat implemented the best manufacturing technologies to effectively protect the bodywork against corrosion.

These include:

- Painting products and systems which give the car particular resistance to corrosion and abrasion;
- Use of galvanised (or pretreated) steel sheets, with high resistance to corrosion;

- Spraying the underbody, engine compartment, wheelhouse internal parts and other parts with highly protective wax products;
- Spraying of plastic parts, with a protective function, in the more exposed points: underdoor, inner fender parts, edges, etc.;
- Use of “open” boxed sections to prevent condensation and pockets of moisture from triggering rust inside.

BODY AND UNDERBODY WARRANTY

Your car is covered by warranty against perforation due to rust of any original element of the structure or body. For the general terms of this warranty, refer to the Fiat Warranty booklet.

ADVICE FOR PRESERVING THE BODYWORK

Paint

Paintwork does not only serve an aesthetic purpose, but also protects the underlying sheet metal.

In the case of deep scrapes or scores, you are advised to have the necessary touching up carried out immediately to avoid the formation of rust. Use only original paint products for touching up (see “Bodywork paint identification plate” in section “Technical specification”). Normal paint maintenance consists in washing at intervals depending on the conditions and environment of use. For example, in highly polluted areas, or if the roads are sprayed with salt, it is wise to wash the car more frequently.

For a correct wash of the vehicle proceed as follows:

- soak the body with a low pressure water jet;
- pass on the body a sponge with a light cleansing solution, frequently rinsing the sponge;
- rinse accurately with water and dry with air jet or suede.

If the vehicle is washed in an automatic car wash, follow these recommendations:

- remove the antenna from the roof to avoid damages;
- water with a cleansing solution must be used for washing;
- rinse accurately to avoid cleansing solution residues which may remain on the body or hidden parts.



Some automatic systems provided with old generation and/or not correctly maintained brushes may damage the varnish, easing the creation of micro-scratches, especially on dark colours. To remove those scratches, slightly polish with a specific product.

When drying, take particular care with the less visible parts like door surrounds, bonnet and around the headlights where water may stagnate. The car should not be taken to a closed area immediately, but left in the open so that residual water can evaporate. Do not wash the car after it has been left in the sun or with the bonnet hot: this may alter the shine of the paintwork.

Exterior plastic parts must be cleaned in the same way as the rest of the car.

Where possible, do not park under trees; the resinous substance many species release give the paint a dull appearance and increase the possibility of triggering rust processes.

IMPORTANT Bird droppings must be washed off immediately and thoroughly as the acid they contain is particularly aggressive.



Detergents cause water pollution. Therefore the car should be washed in areas equipped for collecting and purifying the liquid used in the washing process.

Windows

Use specific window cleaner products. Use also clean cloths to avoid scratching the glass or damaging the transparency.

IMPORTANT The inside of the rearscreen should be wiped gently with a cloth in the direction of the filaments to avoid damaging the heating device.

Engine compartment

At the end of the winter the engine compartment should be carefully washed, without directing the jet against electronic control units. Contact a specialised workshop to have this done.

IMPORTANT The car should be washed with the engine cold and the ignition key at **OFF**. After washing make sure that the various protections (e.g. rubber caps and various covers) have not been damaged or removed.

INTERIORS

Periodically check that water is not trapped under the mats (due to water dripping off shoes, umbrellas, etc.) which could cause oxidation of the sheet metal.

CLEANING SEATS AND FABRIC AND VELVET PARTS

Use a soft brush or vacuum cleaner to remove dust. Velvet is cleaned better if the brush is moistened.

Rub the seats with a sponge moistened with a solution of water and neutral detergent.

CLEANING LEATHER SEATS

Remove dried on dirt with lightly moistened chamois leather or cloth without pressing too hard.

Remove liquid or grease stains with a dry absorbent cloth without rubbing. Then wipe with a soft cloth or chamois leather with water and neutral soap.

If the stain persists, use specific products, carefully following the instructions for use.

IMPORTANT Never use spirit or alcohol-based products.

**WARNING**

Never use flammable products like oil ether or rectified petrol for cleaning car interiors. Electrostatic discharges generated by rubbing during cleaning operations could cause fire.

STEERING WHEEL/GEAR LEVER KNOB WITH GENUINE LEATHER COVERING

These components shall only be cleaned with water and neutral soap. Never use spirit or alcohol-based products.

Before using special products for cleaning interiors, read carefully label instructions and indications to make sure they are free from spirit and/or alcohol-based substances.

If when cleaning the windscreen with special glass products, some drops fall on the leather covering of the steering wheel/gear lever knob remove them immediately and then clean with water and neutral soap.

IMPORTANT Take the utmost care when engaging the steering lock to prevent scratching the leather covering.

INTERIOR PLASTIC PARTS

Use appropriate products designed to preserve the appearance of components.

IMPORTANT Never use spirit or petroleum to clean the instrument panel.

**WARNING**

Do not keep aerosol cans in the car: they might explode. Aerosol cans must never be exposed to a temperature above 50°C. The temperature inside the car exposed to the sun may go well beyond that figure.

TECHNICAL SPECIFICATIONS

IDENTIFICATION DATA	218
ENGINE CODES - BODYWORK VERSIONS.....	220
ENGINE	221
FUEL FEED/IGNITION	223
TRANSMISSION	223
BRAKES	224
SUSPENSIONS.....	224
STEERING.....	224
WHEELS.....	225
DIMENSIONS.....	230
PERFORMANCE	231
WEIGHTS	232
CAPACITIES.....	234
FLUIDS AND LUBRICANTS.....	236
FUEL CONSUMPTION	238
CO ₂ EMISSIONS	240
RADIO FREQUENCY REMOTE CONTROL: MINISTERIAL CERTIFICATIONS	241

DASHBOARD
AND CONTROLS

SAFETY
DEVICES

CORRECT USE
OF THE CAR

WARNING
LIGHTS AND
MESSAGES

IN AN
EMERGENCY

CAR
MAINTENANCE

TECHNICAL
SPECIFICATIONS

INDEX

IDENTIFICATION DATA

You are advised to note the identification codes. The identification data stamped and given on the plates and their position are the following:

- Model plate
- Chassis marking
- Bodywork paint identification plate
- Engine marking.

MODEL PLATE fig. 1

This is mounted on the left in the engine compartment and states the following identification data:

- B** Homologation number.
- C** Vehicle type code.
- D** Chassis number.
- E** Maximum vehicle weight fully loaded.
- F** Maximum vehicle weight fully loaded with trailer.
- G** Maximum vehicle weight on front axle.
- H** Maximum vehicle weight on rear axle.

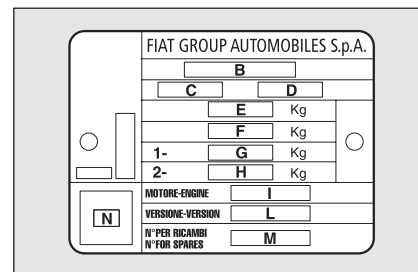

fig. 1

F0L0415m

- I** Engine type.
- L** Body version code.
- M** Spare part code.
- N** Smoke opacity index (for diesel engines).

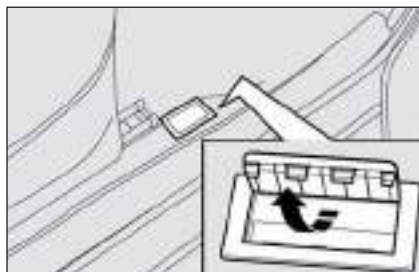

fig. 2

FOL0204m

CHASSIS MARKING fig. 2

It is printed on the passenger compartment floor, near the right-hand front seat.

It can be reached by lifting the special flap in the carpeting and includes the following data:

- car model;
- chassis number.

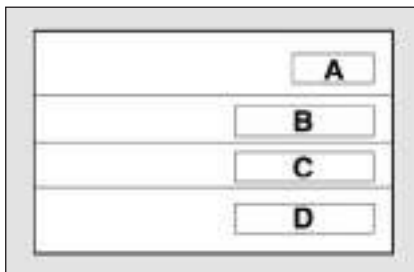

fig. 3

FOL0161m

BODYWORK PAINT IDENTIFICATION PLATE fig. 3

The plate is applied inside the bonnet and it bears the following data:

- A** Paint manufacturer.
- B** Colour name.
- C** Fiat colour code.
- D** Respray and touch up code.

ENGINE MARKING

Engine marking is stamped on the cylinder block and includes the model and the chassis number.

DASHBOARD
AND CONTROLS

SAFETY
DEVICES

CORRECT USE
OF THE CAR

WARNING
LIGHTS AND
MESSAGES

IN AN
EMERGENCY

CAR
MAINTENANCE

TECHNICAL
SPECIFICATIONS

INDEX

ENGINE CODES - BODYWORK VERSIONS

	Engine code	Body version	Body version (**)
1.8	939A4000	194AXG1A 08C	194AXG1A 08D
2.2	194A1000	194AXA1A 00C	194AXA1A 00D
2.2 a.t.	194A1000	194AXA12 01C	194AXA12 01D
1.9 Multijet 8V (with DPF)	939A1000	194AXB1B 02C	194AXB1B 02E
1.9 Multijet 8V (without DPF)	939A1000	194AXB1B 02D	194AXB1B 02F
1.9 Multijet 8V (with DPF) (*)	939A1000	194BXB1B CX	194BXB1B EX
1.9 Multijet 8V (without DPF) (*)	939A1000	194BXB1B DX	194BXB1B FX
1.9 Multijet 8V 120 HP pur-O₂	939A1000	194AXB1B 02G	-
1.9 Multijet 8V 115 HP (*)	939A7000	194AXE1B 06B	194AXE1B 06C
1.9 Multijet 8V 115 HP (*) pur-O₂	939A7000	194AXB1B 06D	-
1.9 Multijet 16V (with DPF)	939A2000	194AXC1B 03E	194AXC1B 03G
1.9 Multijet 16V (without DPF)	939A2000	194AXC1B 03F	194AXC1B 03H
1.9 Multijet 16V a.t. (with DPF)	939A2000	194AXC12 04B	194AXC12 04C
1.9 Multijet 16V (with DPF) (*)	939A2000	194BXC1B CX	194BXC1B EX
1.9 Multijet 16V (without DPF) (*)	939A2000	194BXC12 BX	194BXC1B FX
1.9 Multijet 16V a.t. (with DPF) (*)	939A2000	194BXC1B DX	194BXC12 CX
1.9 Multijet 16V 135 HP (*)	939A8000	194AXF1B 07C	194AXF1B 07D
1.9 Multijet 16V a.t. 135 HP (*)	939A8000	194AXF12 09B	194AXF12 09C
2.4 Multijet 20V a.t. (with DPF)	939A3000	194AXD12 05B	194AXD12 05B

(*) Versions for specific markets.

(**) Body codes for versions/markets where provided.

ENGINE

		1.8	2.2	2.2 a.t.
GENERAL FEATURES				
Engine code		939A4000	194A1000	194A1000
Cycle		Otto	Otto	Otto
Number and layout of cylinders		4 in line	4 in line	4 in line
Piston bore and stroke	mm	80.5 x 88.2	86 x 94.6	86 x 94.6
Total displacement	cm ³	1796	2198	2198
Compression ratio		10.5 : 1	10.0 : 1	10.0 : 1
Maximum power (EEC)	kW	103	108	108
	HP	140	147	147
corresponding ratio	rpm	6300	5800	5800
Maximum torque (EEC)	Nm	175	203	203
	kgm	17.8	20.7	20.7
corresponding ratio	rpm	3800	4000	4000
Spark plugs		BOSCH FQR 8 LEU2	AC DELCO HLR8STEX	AC DELCO HLR8STEX
Fuel		Unleaded petrol 95 RON (Specification EN228)	Unleaded petrol 95 RON (Specification EN228)	Unleaded petrol 95 RON (Specification EN228)

DASHBOARD
AND CONTROLS

SAFETY
DEVICES

CORRECT USE
OF THE CAR

WARNING
LIGHTS AND
MESSAGES

IN AN
EMERGENCY

CAR
MAINTENANCE

TECHNICAL
SPECIFICATIONS

INDEX

		1.9 Multijet 8V	1.9 Multijet 16V	1.9 Multijet 16V a.t.	2.4 Multijet 20V a.t.
GENERAL FEATURES					
Engine code		939A1000	939A2000	939A2000	939A3000
Cycle		Diesel	Diesel	Diesel	Diesel
Number and layout of cylinders		4 in line	4 in line	4 in line	5 in line
Piston bore and stroke	mm	82 x 90.4	82 x 90.4	82 x 90.4	82 x 90.4
Total displacement	cm ³	1910	1910	1910	2387
Compression ratio		18.0 : 1	17.5 : 1	17.5 : 1	17.0 : 1
Maximum power (EEC)	kW	88 (85*)	110 (100*)	110 (100*)	147
	HP	120 (115*)	150 (135*)	150 (135*)	200
corresponding ratio	rpm	4000	4000	4000	4000
Maximum torque (EEC)	Nm	280	320	320	400
	kgm	28.6	32.6	32.6	40.8
corresponding ratio	rpm	2000	2000	2000	2000
Fuel		Diesel fuel for motor vehicles (Specification EN590)	Diesel fuel for motor vehicles (Specification EN590)	Diesel fuel for motor vehicles (Specification EN590)	Diesel fuel for motor vehicles (Specification EN590)

(*) Versions for specific markets

FUEL FEED/IGNITION

	1.8 - 2.2	Multijet
Fuel feed	Multipoint electronic injection	Direct injection with electronically controlled Multijet "Common Rail", turbosupercharger and intercooler



WARNING

Modifications or repairs to the fuel system that are not carried out properly or do not take the system's technical specifications into account can cause malfunctions leading to the risk of fire.

TRANSMISSION

	1.8 - 2.2	2.2 a.t.	1.9 Multijet	1.9 Multijet 16V a.t. 2.4 Multijet 20V a.t.
Gearbox	5 forward gears + Reverse	automatic 5 forward gears + Reverse and tip	6 forward gears + Reverse	automatic 6 forward gears + Reverse and tip
Drive	front	front	front	front

DASHBOARD
AND CONTROLS

SAFETY
DEVICES

CORRECT USE
OF THE CAR

WARNING
LIGHTS AND
MESSAGES

IN AN
EMERGENCY

CAR
MAINTENANCE

TECHNICAL
SPECIFICATIONS

INDEX

BRAKES

	1.8 - 2.2 - 1.9 Multijet 8V 1.9 Multijet 16V	2.4 Multijet 20V a.t.
Service brakes:		
– front	Disc, self-ventilating	Disc, self-ventilating
– rear	Disc	Disc, self-ventilating
Parking brake	Controlled by hand lever, it works on rear brakes	Controlled by hand lever, it works on rear brakes

IMPORTANT Water, ice and antifreeze salt on roads may deposit on the brake discs thus reducing braking efficiency at first braking.

SUSPENSIONS

	1.8 - 2.2 - Multijet
Front	McPherson independent wheels
Rear	Multilink independent wheels

STEERING

	1.8 - 2.2 - Multijet	2.4 Multijet 20V a.t.
Type	Electro-hydraulic power steering	Electro-hydraulic power steering
Minimum steering cycle	m 11,45	11,80

WHEELS

RIMS AND TYRES

Pressed steel or alloy rims. Tubeless tyres with radial carcass. The homologated tyres are listed in the Log book.

IMPORTANT In the event of discrepancies between the information provided on this “Owner handbook” and the “Log book”, consider the specifications shown in the log book only.

Attaining to the prescribed size, to ensure safety of the car in movement, it must be fitted with tyres of the same make and type on all wheels.

IMPORTANT Do not use inner tubes with Tubeless tyres.

SPACE-SAVER SPARE WHEEL

Pressed steel rim. Tubeless tyre.

WHEEL GEOMETRY

In order to guarantee the correct regulation and stability of the vehicle, please contact the Fiat Assistance Network.

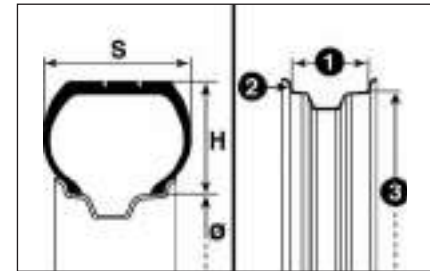

fig. 4

FOL0162m

UNDERSTANDING TYRE MARKING fig. 4

Example: 205/55 R 16 91 V

205 = Nominal width (S, distance between sidewalls in mm).

55 = Percentage height/width ratio (H/S).

R = Radial tyre.

16 = Rim diameter in inches (Ø).

91 = Load rating (capacity).

V = Maximum speed rating.

Load rating (capacity)**60** = 250 kg**61** = 257 kg**62** = 265 kg**63** = 272 kg**64** = 280 kg**65** = 290 kg**66** = 300 kg**67** = 307 kg**68** = 315 kg**69** = 325 kg**70** = 335 kg**71** = 345 kg**72** = 355 kg**73** = 365 kg**74** = 375 kg**75** = 387 kg**76** = 400 kg**77** = 412 kg**78** = 425 kg**79** = 437 kg**80** = 450 kg**81** = 462 kg**82** = 475 kg**83** = 487 kg**84** = 500 kg**85** = 515 kg**86** = 530 kg**87** = 545 kg**88** = 560 kg**89** = 580 kg**90** = 600 kg**91** = 615 kg**92** = 630 kg**93** = 650 kg**94** = 670 kg**95** = 690 kg**96** = 710 kg**97** = 730 kg**98** = 750 kg**99** = 775 kg**100** = 800 kg**101** = 825 kg**102** = 850 kg**103** = 875 kg**104** = 900 kg**105** = 925 kg**106** = 950 kg**Maximum speed rating****Q** = up to 160 km/h.**R** = up to 170 km/h.**S** = up to 180 km/h.**T** = up to 190 km/h.**U** = up to 200 km/h.**H** = up to 210 km/h.**V** = up to 240 km/h.**W** = up to 270 km/h.**Y** = up to 300 km/h.**Maximum speed rating
for snow tyres****QM + S** = up to 160 km/h.**TM + S** = up to 190 km/h.**HM + S** = up to 210 km/h.**UNDERSTANDING RIM
MARKING****Example: 6 1/2 J x 16 H2 ET41**

6 1/2 = rim width in inches (1).

J = rim drop center outline (side projection where the tyre bead rests) (2).

16 = rim nominal diameter in inches (corresponds to diameter of the tyre to be mounted) (3 = Ø).

H2 = "hump" shape and number (relief on the circumference holding the Tubeless tyre bead on the rim).

ET 41 = wheel camber angle (distance between the disc/rim supporting plane and the wheel rim centre line).

VERSIONS	RIMS (*)	TYRES		Space-saver spare wheel	
		Standard tyres	Snow tyres	Rim	Tyre
1.8	6.5J x 16" - ET 36/41	205/55 R16 91V	205/55 R16 91 H (M+S)	4J 16 - 41	115/70 R16 92M
	6.5J x 16" - ET 36/41	215/55 R16 93W	215/55 R16 93 H (M+S)		
	7J x 17" - ET 36/41	215/50 R17 91W	215/50 R17 91 H (M+S)		
2.2-2.2 a.t.	6.5J x 16" - ET 36/41	205/55 R16 91V	205/55 R16 91 H (M+S)	4J 16 - 41	115/70 R16 92M
	6.5J x 16" - ET 36/41	215/55 R16 93W	215/55 R16 93 H (M+S)		
	7J x 17" - ET 36/41	215/50 R17 91W	215/50 R17 91 H (M+S)		
	7.5J x 18" - ET 36/41	225/45 R18 95W (∇)	225/45 R18 95 H (M+S)		
1.9 Multijet 8V 1.9 Multijet 16V 1.9 Multijet 16V a.t.	6.5J x 16" - ET 36/41	205/55 R16 91V	205/55 R16 91 H (M+S)	4J 16 - 41	115/70 R16 92M
	6.5J x 16" - ET 36/41	215/55 R16 93W	215/55 R16 93 H (M+S)		
	7J x 17" - ET 36/41	215/50 R17 91W	215/50 R17 91 H (M+S)		
	7.5J x 18" - ET 36/41	225/45 R18 95W (∇)	225/45 R18 95 H (M+S)		
1.9 Multijet 8V pur-O₂ (**)	6,5J x 16" - ET 36/41	205/55 R16 91V	205/55 R16 91 H (M+S)	4J 16-41	115/70 R16 92M
2.4 Multijet 20V a.t.	7J x 17" - ET 36/41	215/50 R17 95W	215/50 R17 91 H (M+S)	4J 16 - 41	115/70 R16 92M
	7.5J x 18" - ET 36/41	225/45 R18 95W (∇)	225/45 R18 95 H (M+S)		

(∇) Tyres that cannot be fitted with snow chains

(*) ET 41 value referred to the rims available on the accessory line.

(**) Other size tyres are not type approved for these versions.

Note: rims with the same ET are to be used on the vehicle.

DASHBOARD
AND CONTROLS

SAFETY
DEVICES

CORRECT USE
OF THE CAR

WARNING
LIGHTS AND
MESSAGES

IN AN
EMERGENCY

CAR
MAINTENANCE

TECHNICAL
SPECIFICATIONS

INDEX

COLD TYRE INFLATION PRESSURE (bar)**Petrol versions**

	Size	STANDARD TYRES				Space-aver spare wheel
		Medium load		Full load		
		Front	Rear	Front	Rear	
1.8	205/55 R16 91V	2.4	2.4	2.7	2.6	4.2
	215/55 R16 93W	2.4	2.4	2.5	2.5	
	215/50 R17 91W	2.4	2.4	2.6	2.6	
2.2	205/55 R16 91V	2.4	2.4	2.8	2.7	4.2
	215/55 R16 93W	2.4	2.4	2.5	2.5	
	215/50 R17 91W	2.4	2.4	2.7	2.6	
	225/45 R18 95W	2.4	2.4	2.7	2.6	
2.2 a.t.	205/55 R16 91V	2.4	2.4	2.7	2.6	4.2
	215/55 R16 93W	2.4	2.4	2.5	2.5	
	215/50 R17 91W	2.4	2.4	2.6	2.5	
	225/45 R18 95W	2.4	2.4	2.6	2.5	

Add +0.3 bar to the prescribed inflation pressure when the tyres are warm. Recheck pressure value with cold tyres.

With snow tyres, add +0.2 bar to the inflation pressure value prescribed for standard tyres.

If travelling at a speed higher than 160 km/h, inflate tyres at the values specified for fully laden conditions.

Multijet versions

	Size	STANDARD TYRES				Space-saver spare wheel
		Medium load		Full load		
		Front	Rear	Front	Rear	
1.9 Multijet 8V	205/55 R16 91V	2.4	2.4	2.7	2.6	4.2
	215/55 R16 93W	2.4	2.4	2.5	2.5	
	215/50 R17 91W	2.4	2.4	2.6	2.5	
	225/45 R18 95W	2.4	2.4	2.6	2.5	
1.9 Multijet 16V	205/55 R16 91V	2.4	2.4	2.8	2.7	4.2
	215/55 R16 93W	2.4	2.4	2.5	2.5	
	215/50 R17 91W	2.4	2.4	2.7	2.6	
	225/45 R18 95W	2.4	2.4	2.6	2.5	
1.9 Multijet 16V a.t.	205/55 R16 91V	2.4	2.4	2.7	2.6	4.2
	215/55 R16 93W	2.4	2.4	2.5	2.5	
	215/50 R17 91W	2.4	2.4	2.7	2.6	
	225/45 R18 95W	2.4	2.4	2.6	2.5	
2.4 Multijet 20V a.t.	215/50 R17 95W	2.6	2.5	2.9	2.7	4.2
	225/45 R18 95W	2.6	2.5	2.8	2.6	

Add +0.3 bar to the prescribed inflation pressure when the tyres are warm. Recheck pressure value with cold tyres.

With snow tyres, add +0.2 bar to the inflation pressure value prescribed for standard tyres.

If travelling at a speed higher than 160 km/h, inflate tyres at the values specified for fully laden conditions.

DASHBOARD AND CONTROLS

SAFETY DEVICES

CORRECT USE OF THE CAR

WARNING LIGHTS AND MESSAGES

IN AN EMERGENCY

CAR MAINTENANCE

TECHNICAL SPECIFICATIONS

INDEX

DIMENSIONS

Dimensions are expressed in mm and refer to the car fitted with standard tyres.

The height refers to the car unladen.

Boot volume

Unladen boot volume
(V.D.A. standards)
500 dm³

Extended boot volume
(with folded seat back)
893 dm³

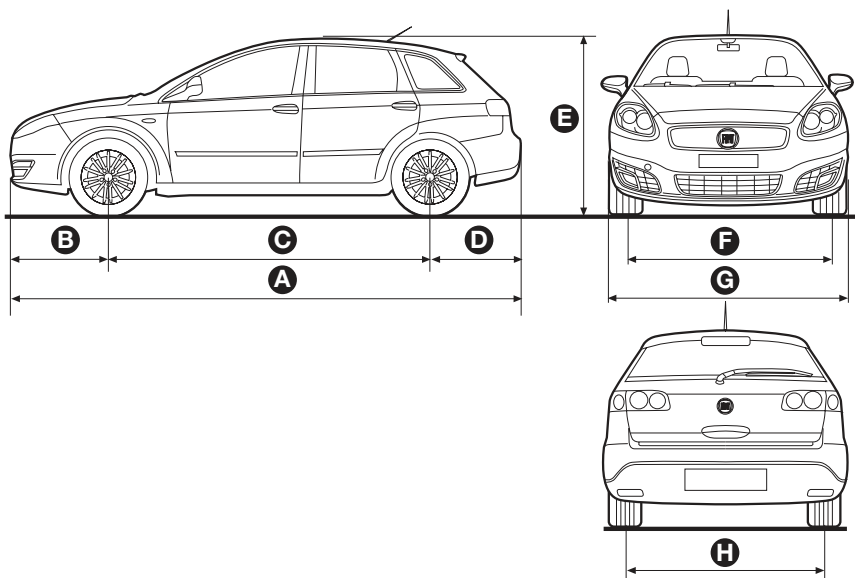

fig. 5

F0L0536m

Versions	A	B	C	D	E	F	G	H
1.8 - 2.2 - 2.2 c.a.								
1.9 Multijet 8V	4783	1046	2700	1037	1603 (*)	1524 (▼)	1775	1505 (▼)
1.9 Multijet 16V					1593 (□)			
2.4 Multijet 20V c.a.								

(*) 1623 with roof racks; track measurements may vary according to rim size.

(▼) On ground with 3 passengers.

(□) Versions pur-O₂; 1613 mm with roof rack bars.

PERFORMANCE

Top admitted speed after initial car use in km/h.

PETROL VERSIONS

1.8	2.2	2.2 a.t.
206	210	205

MULTIJET VERSIONS

1.9 Multijet 8v	1.9 Multijet 16v	1.9 Multijet 16v a.t.	2.4 Multijet 20v a.t.
195	210	205 (200*)	216

(*) Versions for specific markets

1.9 Multijet 120 HP pur-O ₂	1.9 Multijet 115 HP pur-O ₂
197	194

DASHBOARD
AND CONTROLS

SAFETY
DEVICES

CORRECT USE
OF THE CAR

WARNING
LIGHTS AND
MESSAGES

IN AN
EMERGENCY

CAR
MAINTENANCE

TECHNICAL
SPECIFICATIONS

INDEX

WEIGHTS

Weights (kg)	1.8	2.2	2.2 a.t.
Kerb weight (including all fluids, fuel tank at 90% and with no optional)	1430	1510	1530
Payload (*) including the driver:	520	520	520
Maximum admitted loads (**)			
– front axle:	1100	1100	1100
– rear axle:	1030	1030	1030
– total:	1950	2030	2050
Towable loads			
– trailer with brakes:	1500	1500	1500
– trailer without brakes:	700	700	700
Maximum load on roof (***):	80	80	80
Maximum load on tow hitch (trailer with brakes):	70	70	70

(*) If special equipment is fitted (sunroof, tow hitch, etc.) the unladen car weight increases thus reducing the specified payload.

(**) Loads not to be exceeded. The driver is responsible for arranging the loads in the boot an/or on the roof so that they comply with these limits.

(***) Lineaccessori Fiat roof rack, max capacity: 50 kg.

Weights (kg)	1.9 Multijet 8v	1.9 Multijet 16v	1.9 Multijet 16v a.t.	2.4 Multijet 20v a.t.
Kerb weight (including all fluids, fuel tank at 90% and with no optional)	1520	1530	1540	1650
Payload (*) including the driver:	520	520	520	520
Maximum admitted loads (**)				
– front axle:	1150	1150	1150	1200
– rear axle:	1030	1030	1030	1030
– total:	2040	2050	2060	2170
Towable loads				
– trailer with brakes:	1500	1500	1500	1500
– trailer without brakes:	700	700	700	700
Maximum load on roof (***):	80	80	80	80
Maximum load on tow hitch (trailer with brakes):	70	70	70	70

(*) If special equipment is fitted (sunroof, tow hitch, etc.) the unladen car weight increases thus reducing the specified payload.

(**) Loads not to be exceeded. The driver is responsible for arranging the loads in the boot an/or on the roof so that they comply with these limits.

(***) Lineaccessori Fiat roof rack, max capacity: 50 kg.

CAPACITIES

	1.8		2.2		2.2 a.t.		Recommended products and genuine lubricants
	litres	kg	litres	kg	litres	kg	
Fuel tank: including a reserve of:	62 7 - 9	– –	62 7 - 9	– –	62 7 - 9	– –	Unleaded petrol with no less than 95 R.O.N (EN228 Specification)
Engine cooling system – with climate control:	7.4	–	7.4	–	7.4	–	Mixture of 50% demineralised wa- ter and 50% PARAFU UP (▲)
Engine sump and filter:	4.5	–	5	–	5	–	SELENIA K P.E.
Mechanical gearbox and differential:	1.6	1.3	1.8	1.5	–	–	TUTELA CAR MATRIX
Automatic transmission	–	–	–	–	–	6.400(●)	TUTELA GI/V
Hydraulic brake circuit with ABS:	–	0.750	–	0.750	–	0.750	TUTELA TOP 4
Electrohydraulic power steering circuit:	0.7	0.59	0.9	0.75	0.9	0.75	TUTELA GI/R
Windscreen/rear window /headlight washer fluid reservoir: (*)	3 (5)	–	3 (5)	–	3 (5)	–	TUTELA PROFESSIONAL SC 35

(*) The values in brackets refer to versions with headlight washers.

(▲) For particularly hard climate conditions, we recommend use of a 60% **PARAFU UP** and 40% demineralized water mixture.

(●) Total quantity of oil in the gearbox.

	1.9 Multijet 8V		1.9 Multijet 16V		1.9 Multijet 16V a.t.		2.4 Multijet 20V a.t.		Recommended products and genuine lubricants
	litres	kg	litres	kg	litres	kg	litres	kg	
Fuel tank: including a reserve of:	62 7 - 9	–	62 7 - 9	–	62 7 - 9	–	62 7 - 9	–	Diesel fuel for motor vehicles (Specification EN 590)
Engine cooling system – with climate control:	7.7	–	7.7	–	7.7	–	8.4	–	Mixture of 50% demineralised water and 50% PARAFU UP
Engine sump and filter:	4.5	–	4.5	–	4.5	–	5.4	–	SELENIA WR/WR P.E. (□)
Mechanical gearbox and differential:	1.9	1.6	1.9	1.6	–	–	–	–	TUTELA CAR MATRIX
Automatic transmission	–	–	–	–	–	6.110(●)	–	6.110(●)	TUTELA GI/VI
Hydraulic brake circuit with ABS:	–	0.750	–	0.750	–	0.750	–	0.750	TUTELA TOP 4
Electrohydraulic power steering circuit:	0.7	0.59	0.7	0.59	0.7	0.59	0.7	0.59	TUTELA GI/R
Windscreen/rear window/ headlight washer fluid reservoir: (*)	3 (5)	–	3 (5)	–	3 (5)	–	3 (5)	–	TUTELA PROFESSIONAL SC 35

(*) The values in brackets refer to versions with headlight washers.

(▲) For particularly hard climate conditions, we recommend use of a 60% **PARAFU UP** and 40% demineralized water mixture.

(●) Total quantity of oil in the gearbox.

(□) Versions pur-O₂.

FLUIDS AND LUBRICANTS

RECOMMENDED PRODUCTS AND THEIR SPECIFICATIONS

Use	Fluid and lubricant specifications for correct car operation	Genuine fluids and lubricants	Change intervals
Oils for petrol engines	Synthetic-based oils, grade SAE 5W-40 ACEA C3. FIAT 9.55535-S2 qualification.	SELENIA K P.E. Contractual Technical Reference N° F603.C07	As per Service Schedule
Oils for diesel engines	Synthetic-based oils, grade SAE 5W-40 FIAT 9.55535- N2 qualification.	SELENIA WR Contractual Technical Reference N° F515.D06	As per Service Schedule
	Synthetic-based oils, grade SAE 5W-30 Qualification FIAT 9.55535- SI	SELENIA WR P.E. Contractual Technical Reference N° F510.D07	

For diesel versions, in the case of emergency when original products are not available, lubricants with a minimum performance of ACEA B4 are acceptable; in this case, optimal engine performance is not guaranteed and it is recommended to have them replaced with a recommended lubricant as soon as possible at the Fiat Service Network.

The use of products with inferior characteristics compared to ACEA C3 and ACEA B4 could cause damage, not covered by the guarantee, to the engine.

For particularly rigid climatic conditions ask the Fiat Dealership for the appropriate product from the **Selenia** range.

Use	Fluid and lubricant specifications for correct car operation	Genuine fluids and lubricants	Applications
Lubricants and greases for transmissions	Synthetic-based oil, grade SAE 75W-85 that passes API GL-4 specifications	TUTELA CAR MATRYX Contractual Technical Reference N. F108.F02	Mechanical gearbox and differential
	Special lubricant for 5 seed automatic transmissions with limited slip torque converter. Specification FIAT 9.55550-AV1	TUTELA CAR GI/V Contractual Technical Reference N. F333.I05	5 speed automatic gearboxes
	Special lubricant for 6 speed automatic transmissions with limited slip torque converter. Specification FIAT 9.55550-AV2	TUTELA CAR GI/VI Contractual Technical Reference N. F336.G05	6 speed automatic gearboxes
	Specific grease to be used for constant-velocity joints with low friction coefficient. N.L.G.I. 0-1 consistency.	TUTELA STAR 700 Contractual Technical Reference N. F701.C07	CV joints on differential side
	Grease containing Molybdenum bisulphide for high temperature appliances. N.L.G.I. 1-2 consistency.	TUTELA ALL STAR Contractual Technical Reference N. F702.G07	CV joints on wheel side
	Synthetic fluid for hydraulic and electrohydraulic systems. Specification FIAT 9.55550-AG3	TUTELA CAR GI/R Contractual Technical Reference N. F428.H04	Electrohydraulic power steering
Brake fluid	Synthetic fluid, FMVSS n° 116 DOT 4, ISO 4925 SAE J1704, CUNA NC 956-01	TUTELA TOP 4 Contractual Technical Reference N. F001.A93	Brake and clutch hydraulic controls
Protective agent for radiators	Protective with antifreeze action, red colour based on inhibited monoethylen glycol and organic formula, that passes CUNA NC 956-16, ASTM D 3306 specifications.	PARAFLU UP (●) Contractual Technical Reference N. F101.M01	Radiator antifreeze proportion: 50% distilled water and 50% PARAFLU UP (□)
Additive for diesel fuel	Additive for diesel fuels with protective action for Diesel engines	TUTELA DIESEL ART Contractual Technical Reference N. F601.L06	To be used diluted or undiluted
Windscreen/rear window/headlight washer fluid	Mixture of alcohol and surfactants CUNA NC 956-11	TUTELA PROFESSIONAL SC 35 Contractual Technical Reference N. F201.D02	To be mixed with diesel fuel (25 cc per 10 litres)

(●) **IMPORTANT** Do not add or mix fluids having different specifications from that already existing.

(□) For particularly hard climate conditions, we recommend use of a 60% **PARAFLU UP** and 40% demineralized water mixture.

DASHBOARD AND CONTROLS

SAFETY DEVICES

CORRECT USE OF THE CAR

WARNING LIGHTS AND MESSAGES

IN AN EMERGENCY

CAR MAINTENANCE

TECHNICAL SPECIFICATIONS

INDEX

FUEL CONSUMPTION

The fuel consumption figures given in the table below are determined on the basis of the homologation tests set down by specific European Directives.

The procedures below are followed for measuring consumption:

- ❑ **urban cycle:** cold starting followed by driving that simulates urban use of the car;

- ❑ **extra-urban cycle:** frequent accelerating in all gears, simulating extra-urban use of the car; the speed varies between 0 and 120 km/h;
- ❑ **combined consumption:** is calculated weighing about 37% of urban cycle consumption and about 63% of extraurban consumption.

IMPORTANT The type of route, traffic situations, weather conditions, driving style, general conditions of the car, trim level/equipment/accessories, load, climate control system, roof rack, other situations that affect air drag may lead to different fuel consumption levels than those measured.

Fuel consumption according to Directive 2004/3/EC (litres x 100 km)

Petrol versions

	1.8		2.2		2.2 a.t.	
Urban	9.8	9.7 (*)	11.4	11.3 (*)	12.5	12.2 (*)
Extra-urban	6.0	6.0 (*)	6.7	6.7 (*)	7.6	7.6 (*)
Combined	7.4	7.4 (*)	8.4	8.4 (*)	9.4	9.3 (*)

Multijet versions

	1.9 Multijet 8v		1.9 Multijet 16V		1.9 Multijet 16V a.t.		2.4 Multijet 20V a.t.	
Urban	7.9	7.7 (*)	8.1	8.1 (*)	9.3	9.1 (*)	10.3	10.3 (*)
Extra-urban	5.0	5.0 (*)	4.9	4.7 (*)	5.8	5.6 (*)	5.4	5.4 (*)
Combined	6.1	6.0 (*)	6.1	6.0 (*)	7.1	6.9 (*)	7.2	7.2 (*)

(*) Values applicable to body codes for versions/markets where provided.

	1.9 Multijet 120 HP pur-O ₂		1.9 Multijet 115 HP pur-O ₂	
Urban		6,9		6,9
Extra urban		4,4		4,4
Combined		5,3		5,3

DASHBOARD
AND CONTROLS

SAFETY
DEVICES

CORRECT USE
OF THE CAR

WARNING
LIGHTS AND
MESSAGES

IN AN
EMERGENCY

CAR
MAINTENANCE

TECHNICAL
SPECIFICATIONS

INDEX

CO₂ EMISSIONS

The CO₂ emission levels at the exhaust given in the following table refer to combined consumption.

CO₂ emissions according to 2004/3/EC Directive (g/km)

Petrol versions

1.8		2.2		2.2 a.t.	
175	173 (*)	199	198 (*)	222	219 (*)



Multijet versions

1.9 Multijet 8v		1.9 Multijet 16v		1.9 Multijet 16v a.t.		2.4 Multijet 20v a.t.	
160	157 (*)	160	157 (*)	187	181 (*)	191	191 (*)

(*) Values applicable to body codes for versions/markets where provided.

1.9 Multijet 120 HP pur-O ₂		1.9 Multijet 115 HP pur-O ₂	
140		140	

RADIO FREQUENCY REMOTE CONTROL: Ministerial Certifications

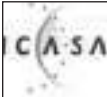
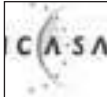
	Certification number	
	T194	NTR194
European Union and Countries applying EC directive		
Morocco	AGREE PAR L'ANRT MAROC MR 2061 ANRT 2005 le 03/06/2005 Désignation : Emetteur Marque / type : TRW / T194 Constructeur / Pays : TRW Automotive Italia SPA / Italy	AGREE PAR L'ANRT MAROC MR 2062 ANRT 2005 le 03/06/2005 Désignation : Emetteur / recepteur Marque / type : TRW / NTR194 Constructeur / Pays : TRW Automotive Italia SPA / Italy
South Africa	 TA-2005/817 APPROVATED	 TA-2005/816 APPROVATED

DASHBOARD AND CONTROLS

SAFETY DEVICES

CORRECT USE OF THE CAR

WARNING LIGHTS AND MESSAGES

IN AN EMERGENCY

CAR MAINTENANCE

TECHNICAL SPECIFICATIONS

INDEX

DECLARATION OF CONFORMITY

Directive 99/5/EC (R&TTE)

Manufacturer of
Authorized representative: **FIAT Automotive Italia S.p.A.**
Address: **Via Miraflores, 20
I-10042 Nichelino (TO)
Italy**

We declare on our sole responsibility, that the following products:

Kind of equipment: **Keyless Entry System (433.92MHz) for cars
incl. LF Transceiver (125 kHz)**

Type-designation: **T 184, NTR 194**

are in compliance with the essential requirements of §3 of the R&TTE.

- Health and safety requirements pursuant to §2(1)(a)
Applied Standard(s) or other means of providing conformity
**EN60950-1:2001
EN50371:2002**

- Protection requirements concerning EMC §3(1)(b)
Applied Standard(s) or other means of providing conformity
EN 301 489-3 V1.4.1 (08/2002)

- Measures for the efficient use of the radio frequency spectrum §3(2)
Applied Standard(s) or other means of providing conformity
**EN 300 330-2 V1.1.1 (06/2001)
EN 300 220-3 V1.3.1 (09/2000)**

Nichelino, 13-12-2004
place and date of issue

Giuseppe Rossi
Manufacturer/Authorized representative
name and signature

Accredited Test Laboratory:

**MIKES BABT SERVICE GmbH, Ohmstrasse 2-4
94342 Straßkirchen, Germany**

INDEX

A BS	94	Boot hatch.....	84	– courtesy lights	70
– ABS system failure warning light	148	– emergency opening.....	85	– courtesy mirror ceiling light lamp	
ABS system	94	Boot light.....	180	replacement.....	179
Additional heater	61	Boot.....	84	– door clearance/puddle ceiling	
Air bag		– baggage cover shade	87	light lamp replacement.....	180
– air bag failure warning light.....	146	– double load compartment.....	88	– front	70
Air filter (replacement)	207	– emergency opening	85	– front ceiling light lamp	
Alarm.....	14	– enlargement.....	85	replacement.....	178
– alarm failure warning light	151	– load anchoring.....	89	– glove compartment ceiling light	
– break-in attempt warning light ...	151	– opening and closing.....	84	lamp replacement.....	179
Antenna	101	– repositioning the rear seat.....	88	– rear	70
Antilifting (protection).....	15	Brake Assist (emergency braking		– side rear ceiling light lamp	
Ashtray (front/rear)	77	assistance)	87	replacement.....	181
ASR system	97	Brake fluid		Changing a lamp	169
ASR.....	97	– insufficient brake liquid warning		Changing a wheel.....	159
Automatic air conditioner	52	light.....	146	Chassis (marking).....	219
Automatic headlamp sensor		– level check.....	206	Child safety device.....	81
(twilight sensor)	64	Brakes		Cigar lighter	76
B acklight.....	176	– brake pad wear warning light.....	156	CO ₂ emissions	240
Battery		– characteristics	224	Code Card	10
– battery recharging	190	– Hill Holder failure warning light.	154	Constant speed regulator	
– checking the charge status.....	208	– liquid level	206	(Cruise Control)	68
– insufficient battery recharge		C ar radio	100	Consumption	
warning light	148	– antenna	101	– engine oil	204
– replacing the battery.....	208	– audio system	100	– fuel.....	238-239
– startup with an auxiliary battery	158	– Hi-Fi system	101	Courtesy mirror	
– useful advice for extending		Car seats (suitability of use)	115	– ceiling light lamp replacement....	179
battery life.....	209	Ceiling lights		Courtesy mirror ceiling lights.....	179
Body		– boot ceiling light lamp		Cruise Control (constant speed	
– maintenance.....	213	replacement.....	180	regulator)	68
– version codes	220	– central light.....	70	– constant speed regulator warning	
				light (Cruise Control)	156

Cup holder compartments	76	– excessive temperature warning light	148	Flashing	63
Cup/can holder	76	– level check	204	Fog light	
D ashboard and controls	4	Engine cooling system liquid level	204	– orientation	94
Dead lock (device)	16	Engine hood	90	Follow me home (device)	64
Diesel filter		Engine oil		Front air bags	118
– condensate water drain	207	– characteristics	236	– front driver's side air bag	119
– water in diesel filter warning light	151	– consumption	204	– front passenger's side air bag	120
Diesel Particulate Filter	106	– degraded oil warning light	149	– driver's side knee air bag	120
Dimensions	230	– insufficient engine oil pressure warning light	149	– general warnings	124
Door clearance/puddle light	180	– level check	203	– turning off the passenger side front and side chest protection air bags (Side Bags)	121
Doors	81	– minimum engine oil level warning light	156	– passenger side front and side chest protection air bag warnings light (Side Bag) off	147
– centralized closing	81	Engine oil level	203	Front armrest with storage box and cooled compartment	74
– child safety device	81	Environmental protection	105	Front ceiling lights	
– emergency closing	13	EOBD (system)	98	– control	70
– emergency opening	13	EOBD system	98	– lamp replacement	178
– incomplete door closure warning light	149	ESP (system)	96	Front fog lights	
E BD (system)		ESP system	96	– control	71
– EBD system failure warning light	148	– ESP system failure warning light	154	– fog lights warning light	154
Electric socket	77	Exterior lamp replacement	173	– lamp replacement	175
Electric window regulators		Exterior lights		Front optical units	
– controls	82	– control	62	– lamp replacement	173
Emergency lights	71	– exterior lights failure warning light	152	Fuel	
Engine		F iat CODE (system)	9	– consumption	238
– identification code	220	– electronic key not recognised warning light	151	– fuel block switch	72
– marking	219	– vehicle protection system failure warning light	151	– fuel reserve warning light	150
– typical data	221	Fiat CODE system	9	– level indicator	21
Engine compartment (washing)	215	Fix & go automatic (rapid tyre repair kit)	165	– saving fuel	138
Engine coolant temperature indicator	21			Fuel block switch and electric power supply	72
Engine cooling system liquid				Fuel hatch	104

Fuel level indicator	21	I dentification data.....	218	Load (anchoring).....	89
Fuel reserve		Ignition device.....	19	Long vehicle inactivity.....	144
– fuel reserve warning light	150	In an emergency.....	157	Low beams	
Fuel tank plug.....	104	Injection system		– control.....	62
Fuses		– EOBD engine control system		– Follow Me Home.....	154
– fuse replacement	181	failure warning light.....	149	– lamp replacement.....	173
– fuse table	186	– injection system failure warning		– low beam light warning light	154
G eneric warning light	152	light.....	149	Lubricants.....	236
Glasses holder	76	Instrument dashboard.....	5	M aintenance and care	
Glove compartment light.....	179	Instrument panel.....	6	– Demanding vehicle use.....	197
Glove compartment.....	75	Interior equipment.....	74	– periodical checks	197
– ceiling light lamp replacement....	179	Interiors		– planned maintenance	194
H ead rests		– maintenance.....	215	– Scheduled Maintenance Plan	195
– front	42	Isofix Universal (car seat)	117	Manual air conditioner.....	49
– rear	42	“Isofix Universale” car seat	117	Maximum speed.....	231
Headlamps.....	93	– installation presetting.....	117	Money holder	76
– headlamp adjustment overseas... ..	94	– suitability of use	118	Multifunctional display	22
– headlamp stability corrector.....	93	K eys.....	10	– control buttons.....	22
– light beam orientation	93	– emergency key.....	13	– display functions.....	28
Headlight washer-wiper		– key with remote control.....	11	– setup menu	23
– control	67	L amps (replacement)		– standard screen.....	22
– liquid level	205	– exterior lamp replacement.....	173	O n board instruments.....	20
Heated rear window		– general information.....	169	P aint (maintenance)	214
– heated rear window warning		– interior lamp replacement.....	178	Parking brake.....	131
light.....	151	– lamp types	170	– parking brake engaged warning	
Heating and air conditioning	47	Level checks.....	198	light.....	146
Heating/air conditioning system	47	Levels		Parking lights.....	72
High-beam headlights		– level checks.....	198	Parking sensors	102
– control	62	License plate lights		Parking.....	131
– flashing	63	– lamp replacement.....	178	– parking brake.....	131
– high beam light warning light.....	155	3rd stop lights.....	177	Passenger compartment air	
– lamp replacement.....	174	Liquids and lubricants	236	diffusers	48

Performance	231	Rear fog light.....	72	Seat belts	
Plates		– rear fog light warning light.....	152	– general warnings	111
– body paint	219	Rear optical units		– load limiters	110
– identification data	218	– fixed side optical unit.....	176	– maintenance.....	112
Pollen filter (replacement)	207	– lamp replacement.....	175	– seat belts not fastened warning light.....	147
Position lights		– optical unit on boot hatch	175	– use	108
– control	62	Rear sunshade curtains.....	78	Seats	
– front lamp replacement.....	174	Rear view mirrors		– adjustment “at the table”	40
– position light warning light	154	– electrochromic interior	44	– cleaning	215
– rear lamp replacement	177	– exterior	44	– electrically adjusted front	41
Power steering		– interior	44	– manually adjusted front	39
– failure warning light.....	149	Rear window washer-wiper		– rear	42
– liquid.....	205	– control	67	Side air bags	122
Power steering liquid		– liquid level	205	– front and rear side chest protection air bags (Side bags) ..	122
– level check.....	205	Rear window wiper		– head protection side air bags (Window Bags)	122
Power steering liquid level.....	205	– brush	212	– general warnings	124
Power supply		– control	67	– turning off the front and rear side chest protection air bags (Side bags)	123
– Technical data	223	– sprayers	213	– rear side chest protection air bag warning lights (Rear Side Bags) off	156
Presetting for “Isofix Universale” car seat installation	117	Reconfigurable multifunctional display	25	Smokers kit.....	76
Pretensioners.....	110	– control buttons.....	25	Snow chains	143
– load limiters	110	– display functions.....	28	Spark plugs	
– warnings.....	111	– setup menu	25	– spark plug preheating failure warning light	150
Provided tools	162	– standard screen.....	26	– spark plug preheating warning light.....	150
R adio frequency remote control:		Refuelling.....	234	Spark plugs (type)	221
Ministerial Certification	241	Regulations for vehicle handling at the end of its life cycle.....	247	Speedometer	21
Radio transmitters and cell phones ..	101	Roof rack/ski rack.....	92	Starting and driving.....	127
Rain sensor.....	66	Rubber piping (warnings)	211		
Rear armrest.....	75	S .B.R. (system)	109		
Rear ceiling lights		Safety	107		
– control	70	Saving fuel.....	138		
– lamp replacement.....	181				

Starting the engine.....	128	Transmission	
– coasting startup.....	159	– Technical data	223
– heating the just started engine....	130	Transporting children safely	112
– ignition device	17	Trip computer	36
– procedure for gasoline versions...	128	Turn signals	
– procedure for Multijet versions ...	129	– control	63
– startup with an auxiliary battery...	158	– cornering lights	63
– turning off the engine	130	– front lamp replacement.....	174
Steering (characteristics).....	224	– lane change function	63
Steering lock	19	– left turn signal warning light	154
Steering wheel (adjustment).....	43	– rear lamp replacement	176
Storage box.....	76	– right turn signal warning light	154
Sun roof	78	– side lamp replacement.....	175
Sun visor	77	Tyre pressure	228
Suspensions (characteristics).....	224	Tyres	
Symbols.....	8	– correct tyre reading.....	225
T.P.M.S. system		– provided	227
(tyre pressure control).....	99	– snow	142
Table (seat)	40	– wheel replacement.....	159
Tachometer	20	User purchased accessories	101
Technical data.....	217	Vehicle inactivity.....	144
Trailer towing.....	139	Vehicle lifting.....	190
– assembly diagram.....	141	Vehicle refuelling.....	103
– tow hook installation.....	140	Vehicle towing.....	191
– warnings.....	139	Volumetric protection.....	15
Transmission		Warning lights and messages	145
– automatic transmission failure		– general warnings	146
warning light	155	Weight	232
– maximum automatic transmission		Wheel	
oil temperature warning light	155	– Fix & go automatic rapid tyre	
– using the automatic electronic		repair kit	165
transmission.....	133	– replacement.....	159
– using the manual transmission....	132	– spare (characteristics)	227
		Wheel alignment.....	225
		Wheel rims	
		– correct rim reading.....	226
		Wheels and tyres.....	210
		– cold inflating pressure.....	228
		– correct rim reading.....	226
		– correct tyre reading.....	225
		– rims and tyres	225
		– rims and tyres	227
		– spare wheel.....	225
		– wheel alignment.....	225
		Window cleaning.....	65
		Windows (cleaning)	215
		Windscreen washer	
		– control	65
		– liquid level	205
		Windscreen washer/rear window	
		washer-wiper/headlight	
		washer-wiper liquid	
		– level check.....	205
		Windscreen washer/rear window	
		washer-wiper/headlight	
		washer-wiper liquid level.....	205
		Windscreen wiper	
		– brushes	212
		– control	65
		– rain sensor	66
		– sprayers	213
		Windscreen wiper and rear window	
		wiper brushes	212

RIGHT HAND DRIVE VERSIONS

DASHBOARD

The presence and the position of the instruments and warning lights may vary according to the versions.

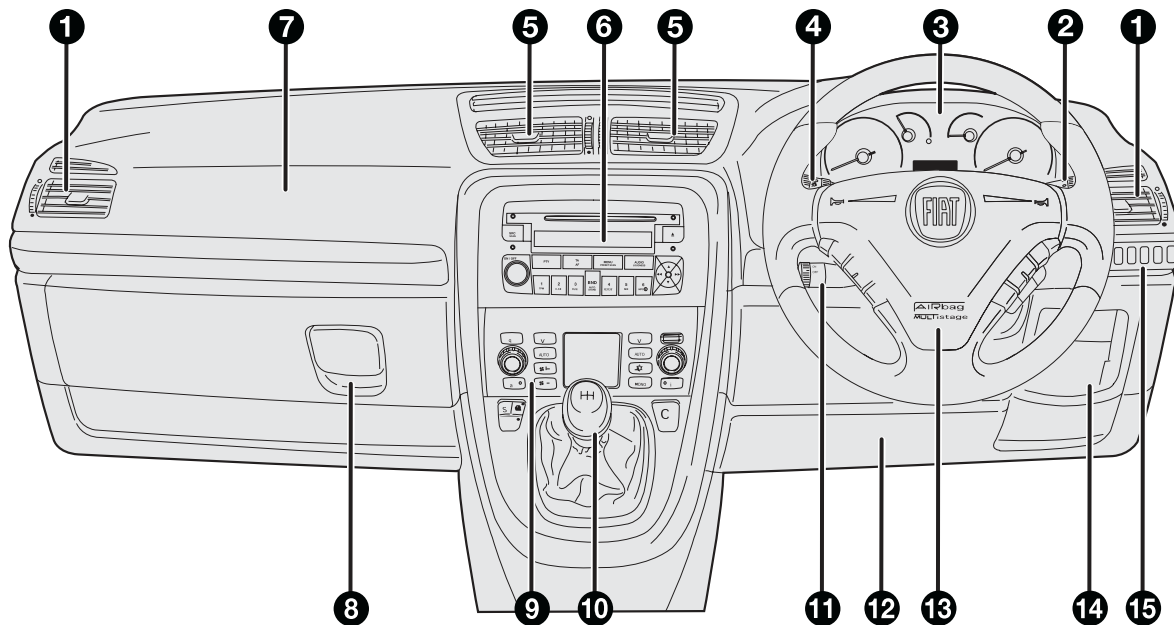
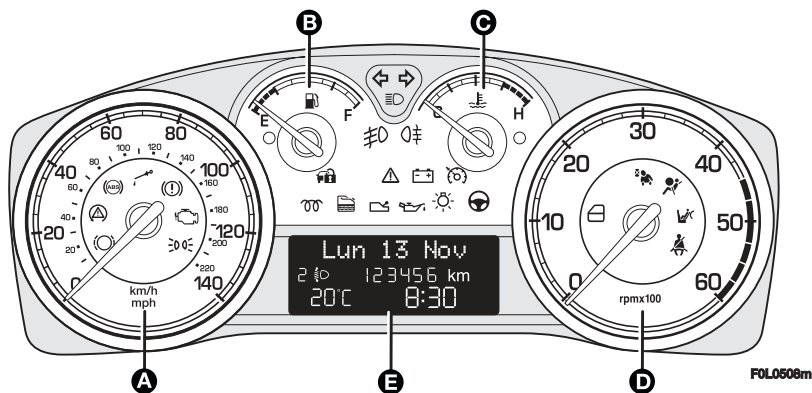

fig. 1

FOL0517m



1. Side air vent - 2. Right steering column stalk: windscreen, rear window wiper and trip computer controls - 3. Instrument panel and warning lights - 4. Left steering column stalk: external lights - 5. Central air vents - 6. Sound system - 7. Front passenger air bag - 8. Glovebox - 9. Heating/ventilation/climate controls - 10. Gearshift lever - 11. Cruise control lever - 12. Driver's knees air bag - 13. Driver's air bag - 14. Control unit access door - 15. Control plate.

INSTRUMENT PANEL



On versions 1.8 the end scale value of the engine speed indicator is 8000 rpm.

1.8 - 1.9 Multijet 8V versions with multifunctional display

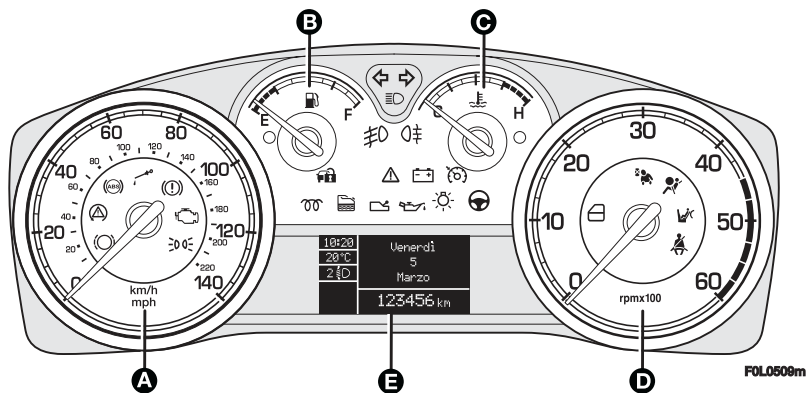

- A** Speedometer (speed indicator)
- B** Fuel level gauge with reserve warning light
- C** Engine coolant temperature gauge and excessive temperature warning light
- D** Rev counter
- E** multifunctional display
-  Warning lights fitted on Multijet versions
-  Warning light fitted on versions with automatic transmission



On versions 1.8 the end scale value of the engine speed indicator is 8000 rpm.

fig. 2

1.8 - 1.9 Multijet 8V with reconfigurable multifunctional display

- A** Speedometer (speed indicator)
- B** Fuel level gauge with reserve warning light
- C** Engine coolant temperature gauge and excessive temperature warning light
- D** Rev counter
- E** Reconfigurable multifunctional display
-  Warning lights fitted on Multijet versions
-  Warning light fitted on versions with automatic transmission

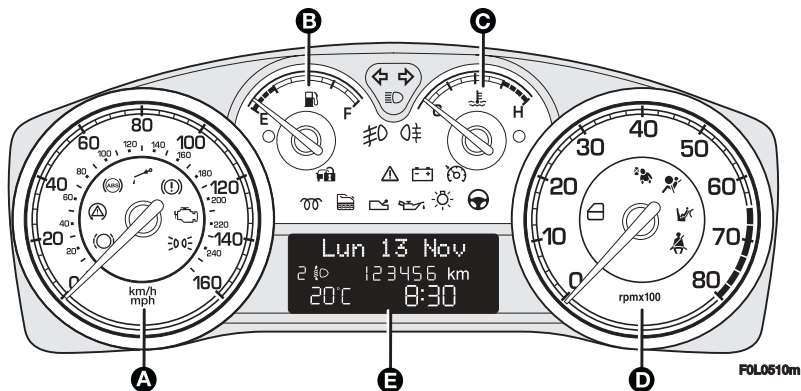

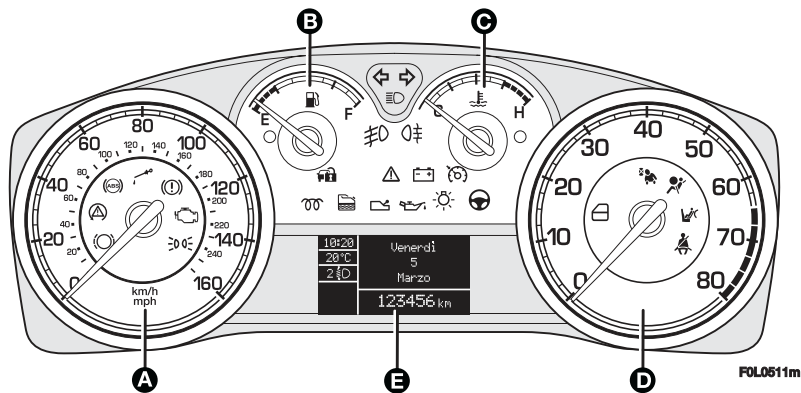

On Multijet versions the end scale value of the engine speed indicator is 6000 rpm.



On Multijet versions the end scale value of the engine speed indicator is 6000 rpm.

2.2 - 1.9 Multijet 16V versions - 2.4 Multijet 20V with multifunctional display

- A Speedometer (speed indicator)
- B Fuel level gauge with reserve warning light
- C Engine coolant temperature gauge and excessive temperature warning light
- D Rev counter
- E Multifunctional display
-   Warning lights fitted on Multijet versions
-  Warning light fitted on versions with automatic transmission

2.2 - 1.9 Multijet 16V - 2.4 Multijet 20V with reconfigurable multifunctional display



- A Speedometer (speed indicator)
- B Fuel level gauge with reserve warning light
- C Engine coolant temperature gauge and excessive temperature warning light
- D Rev counter
- E Reconfigurable multifunctional display
-   Warning lights fitted on Multijet versions
-  Warning light fitted on versions with automatic transmission

fig. 3

PROVISIONS FOR THE PROCESSING OF A VEHICLE AT THE END OF ITS LIFE-CYCLE

For years now Fiat has been developing its global commitment towards the safeguarding and protection of the Environment through the continuous improvement of its production processes and the making of increasingly more “eco friendly” products. With a view to guaranteeing the best possible service to clients in full observance of environmental standards and in response to the obligations imposed by European Directive 2000/53/EC on end-of-life vehicles, Fiat offers its clients the possibility to hand in their vehicle* at the end of its life span without additional costs.

The European Directive, in fact, provides for the take-back of the vehicle without the last holder or owner of the same incurring expenses due to the fact that the market value of the vehicle is zero or negative. In particular, in almost all of the countries of the European Union, up until 1st January 2007, take-back of the vehicle free of charge only applies to vehicles registered from 1 July 2002 on, while, from 2007 on, take-back will be carried out free of charge, independently of the year of registration, provided that the vehicle still contains all its essential component parts (especially engine and body) and is free from additional waste materials.

Our contracted network of authorised treatment facilities has been carefully selected in order to provide a quality service to our customers by de-polluting and recycling “End of Life Vehicles” to approved environmental standards. To find out the location of your nearest authorised treatment facility, offering free of charge take-back, simply contact one of our dealers or refer to the Fiat web site or call the toll free number 00800 3428 0000.

* Passenger transportation vehicles to seat a max. of nine persons, having a total admissible weight of 3.5 t



SELENIA[®]

At the heart of your engine.



Always ask your mechanic for **SELENIA[®]**

Oil change? The experts recommend Selenia.

*The engine of your car is factory filled with **Selenia**.
This is an engine oil range which satisfies the most advanced
international specifications. Its superior technical characteristics
allow **Selenia** to guarantee the **highest performance**
and **protection of your engine**.*

The Selenia range includes a number of technologically advanced products:

SELENIA PERFORMER MULTIPOWER

Particularly ideal for the protection of new generation petrol engines, very effective even in the most severe weather conditions. It guarantees a reduction in fuel consumption (Energy conserving) and it is also ideal for alternative engines.

SELENIA K

is the synthetic lubricant with innovative technology, which ensures improved cold starting for petrol engines and the utmost protection also under typically “urban” conditions of use. Owing to its 5W-40 viscosimetric grade and its special formulation it more effectively meets the emission limits required by new European regulations and exceeds the major international specifications.

SELENIA WR

Oil specifically designed for common rail Multijet engines. Particularly effective during cold starts, it guarantees maximum wear protection and hydraulic tappets control, reduction in consumption and stability at high temperatures.

SELENIA DIGITECH

Fully synthetic lubricant for petrol and diesel engines. Its advanced technology guarantees maximum protection, a reduction in consumption and reliability in extreme climate conditions.

The range also includes Selenia StAR, Selenia Racing, Selenia 20K Alfa Romeo, Selenia TD, Selenia Performer 5W-40
For further information on Selenia products visit the web site www.fl-selenia.com.

COLD TYRE INFLATION PRESSURE (bar)

Versions	Size	STANDARD TYRES				SPARE WHEEL
		Medium load		Full load		
		Front	Rear	Front	Rear	
1.8	205/55 R16 91V	2.4	2.4	2.7	2.6	4.2
	215/55 R16 93W	2.4	2.4	2.5	2.5	
	215/50 R17 91W	2.4	2.4	2.6	2.6	
2.2	205/55 R16 91V	2.4	2.4	2.8	2.7	4.2
	215/55 R16 93W	2.4	2.4	2.5	2.5	
	215/50 R17 91W	2.4	2.4	2.7	2.6	
	225/45 R18 95W	2.4	2.4	2.7	2.6	
2.2 a.t. 1.9 Multijet 8v	205/55 R16 91V	2.4	2.4	2.7	2.6	4.2
	215/55 R16 93W	2.4	2.4	2.5	2.5	
	215/50 R17 91W	2.4	2.4	2.6	2.5	
1.9 Multijet 16v	225/45 R18 95W	2.4	2.4	2.6	2.5	4.2
	205/55 R16 91V	2.4	2.4	2.8	2.7	
	215/55 R16 93W	2.4	2.4	2.5	2.5	
	215/50 R17 91W	2.4	2.4	2.7	2.6	
1.9 Multijet 16v a.t.	225/45 R18 95W	2.4	2.4	2.6	2.5	4.2
	205/55 R16 91V	2.4	2.4	2.7	2.6	
	215/55 R16 93W	2.4	2.4	2.5	2.5	
	215/50 R17 91W	2.4	2.4	2.7	2.6	
2.4 Multijet 20v a.t.	225/45 R18 95W	2.6	2.5	2.9	2.7	4.2
	215/50 R17 95W	2.6	2.5	2.8	2.6	

ENGINE OIL REPLACEMENT

	2.2		2.2 a.t.		1.9 Multijet 8v		1.9 Multijet 16v		1.9 Multijet 16v a.t.		2.4 Multijet 20v a.t.	
	litres	kg	litres	kg	litres	kg	litres	kg	litres	kg	litres	kg
Sump and filter	5	-	5	-	4.5	-	4.5	-	4.5	-	5.4	-

FUEL CAPACITY

Tank capacity: 62 litres

Reserve: 7 - 9 litres

Only refuel cars with petrol engines with unleaded petrol with octane rating (RON) not less than 95.

Only refuel cars with diesel engines with diesel fuel for motor vehicles conforming to the EN590 European Specification

The data contained in this publication is intended merely as a guide. FIAT reserves the right to modify the models and versions described in this booklet at any time for technical and commercial reasons.

If you have any further questions please consult your FIAT dealer.

Printed in recycled paper without chlorine.