



**FIAT**

*barchetta*

**OWNER  
HANDBOOK**

**D**ear Customer,

Thank you for selecting Fiat and congratulations on your choice of a Fiat barchetta.

**F**iat barchetta is a compact saloon with an original bodyline, designed to offer great driving satisfaction, ensure safety and be as friendly as possible to the environment.

We have written this handbook to help you get to know all your new Fiat barchetta's features and use it in the best possible way. You should read it right through before taking the road for the first time. You will find information, tips and important warnings regarding the driving of your car to help you derive the maximum from your Fiat barchetta's technological features. You will find very valuable tips for your own safety, the car's wellbeing and about how to protect the environment.

**W**hat's more every single component of the Fiat barchetta is fully recyclable. At the end of your car's useful lifespan any Fiat Dealer will be pleased to make arrangements for your car to be recycled and nature benefits in two ways: there's no pollution from waste disposal and the demand for raw materials is reduced.

**Y**ou are recommended to read carefully the warnings and indications, marked with the respective symbols, at the end of the page:



personal safety;



the car's wellbeing;



environmental protection.

**T**he enclosed FIAT WARRANTY BOOKLET lists the services that Fiat offers to its Customers:

- the Warranty Certificate with terms and conditions for maintaining its validity
- the range of additional services available to Fiat Customers

**B**est regards and good motoring!

# MUST BE READ!

## REFUELLING



Only refuel with unleaded petrol with octane rating (RON) no less than 95.

## ENGINE START-UP



Make sure the handbrake is pulled up; put the gear lever into neutral; press the clutch pedal down to the floor without touching the accelerator, then turn the ignition key to **AVV** and release it as soon as the engine starts.

## PARKING OVER INFLAMMABLE MATERIAL



When functioning normally, the catalytic converter reaches high temperatures. For this reason do not park the car over inflammable material, grass, dry leaves, pine needles, etc.: fire hazard.

## PROTECTING THE ENVIRONMENT



A system for continuously monitoring emission system components to ensure greater environmental protection is fitted in your car.

## ELECTRICAL ACCESSORIES



If, after buying the car, you decide to add electrical accessories (that will gradually drain the battery), visit a **Fi at Dealership**. They can calculate the overall electrical requirement and check that the car's electric system can support the required load.

## CODE card



Keep the code card in a safe place, not in the car. You should always keep the electronic code written on the CODE card with you in case you need to carry out an emergency start-up procedure.



## SCHEDULED SERVICING



Correct maintenance of the car is essential for ensuring it stays in tip-top condition and safeguards its safety features, its environmental friendliness and low running costs for a long time to come.

## THE OWNER HANDBOOK CONTAINS ...



... information, tips and important warnings regarding the safe, correct driving of your car, and its maintenance. Pay particular attention to the symbols  (personal safety)  (environmental protection)  (car well-being).



# CONTENTS

GETTING TO KNOW YOUR CAR

DRIVING YOUR CAR

IN AN EMERGENCY

CAR MAINTENANCE

TECHNICAL SPECIFICATIONS

ACCESSORY INSTALLATION

INDEX

# GETTING TO KNOW YOUR CAR

**Y**ou should read this chapter sitting comfortably in your new Fiat barchetta. This way you can see the parts described in the manual at a glance and immediately check what you have just read for yourself.

In short, you will become more familiar with your Fiat barchetta and its controls and other features. Later, when you start the engine and join the traffic you will make a host of other pleasant discoveries.

DASHBOARD .....	7
INSTRUMENT PANEL .....	8
SYMBOLS .....	9
THE FIAT CODE SYSTEM .....	11
ELECTRONIC ALARM .....	13
IGNITION SWITCH .....	17
INDIVIDUAL SETTINGS .....	18
SEAT BELTS .....	21
TRANSPORTING CHILDREN IN SAFETY .....	24
PRETENSIONERS .....	27
INSTRUMENTS .....	28

INDICATOR AND WARNING LIGHTS .....	30
HEATING AND VENTILATION .....	34
MANUAL CLIMATE CONTROL SYSTEM .....	36
STEERING COLUMN STALKS .....	38
CONTROLS .....	40
INTERIOR EQUIPMENT .....	42
DOORS .....	44
HOOD .....	46
HARD TOP .....	49
WIND STOP .....	51
BONNET .....	53
BOOT .....	55
HEADLIGHTS .....	55
ABS .....	56
AIRBAG .....	58
EOBD SYSTEM .....	62
CELLULAR PHONE SETUP .....	63
AT THE FILLING STATION .....	64
PROTECTING THE ENVIRONMENT .....	66

For more detailed information, see "Index".

# DASHBOARD

The presence and position of the instruments and warning and indicator lights may vary according to the version of the car.

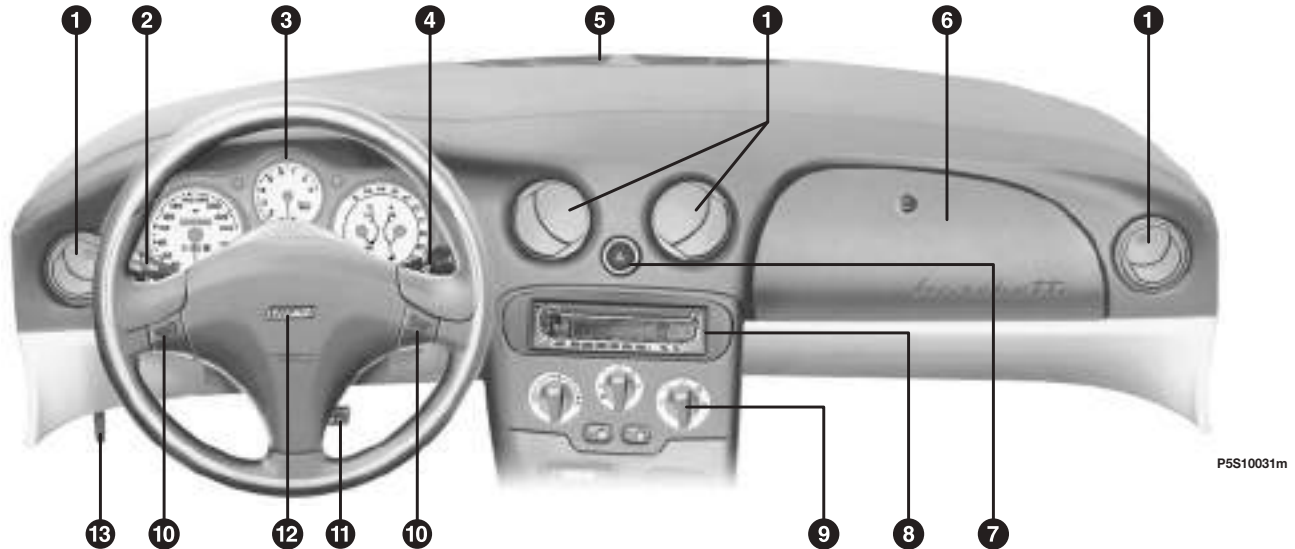

P5S10031m

fig. I

**1.** Directional air vents - **2.** Outside lights command stalk - **3.** Instrument, indicator and warning light panel - **4.** Windscreen washer and wiper stalk - **5.** Air vent for sending air to the windscreen - **6.** Glove compartment - **7.** Hazard light switch - **8.** Car radio - **9.** Heating, ventilation and climate control system - **10.** Horn - **11.** Lever for locking the steering wheel in place - **12.** Air bag for the driver - **13.** Lever for opening the bonnet



# INSTRUMENT PANEL

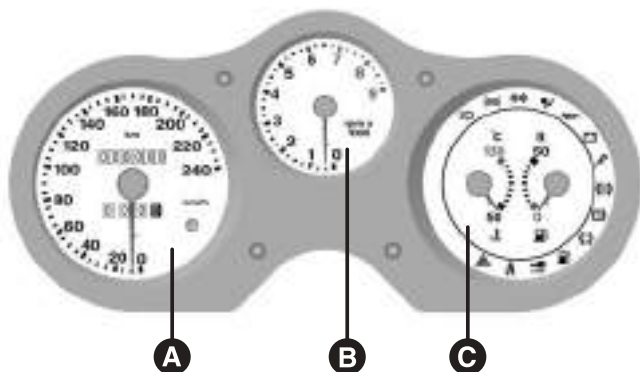

fig. 2

P5S10032m

## VERSION WITH KILOMETRE COUNTER

- A** - Speedometer and kilometre counter
- B** - Rev counter
- C** - Engine coolant temperature and fuel gauges.

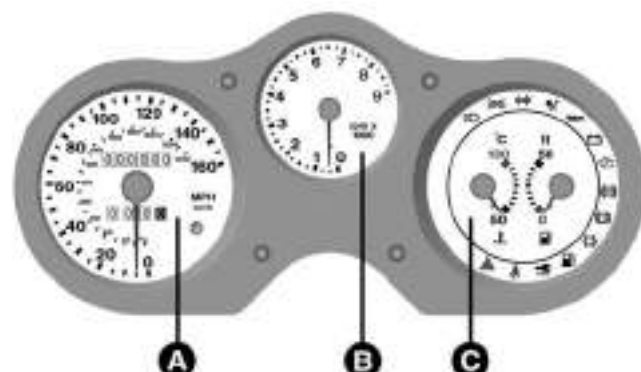

fig. 3

P5S10033m

## VERSION WITH MILEOMETRE

- A** - Speedometer and mileometre
- B** - Rev counter
- C** - Engine coolant temperature and fuel gauges.

# SYMBOLS

Special coloured labels have been attached near to or actually on some of the components making up your Fiat barchetta. These labels bear symbols that remind you of the precautions to be taken as regards that particular component.

A list of the symbols to be found on your Fiat barchetta is given below, with the name of the component to which it relates at the side of it.

These symbols are divided into the following four categories: danger, prohibition, warning and obligation.

## DANGER SYMBOLS



**Battery**  
Corrosive fluid.



**Battery**  
Explosion.



**Fan**  
May cut in automatically when the engine is off.



**Expansion tank**  
Do not remove the cap when the coolant is boiling.



**Coil**  
High voltage.



**Belts and pulleys**  
Moving parts; keep limbs and clothing away.



**Climate control tubing**  
Do not open.  
Gas under high pressure.

## PROHIBITION SYMBOLS



**Battery**  
Keep away from naked flames.



### Battery

Keep away from children.



### Heat shields - belts - pulleys - fan

Do not touch.



### Passenger's airbag

Do not install child safety seats facing backwards on the front passenger seat.

## WARNING SYMBOLS



### Catalytic converter

Do not park over inflammable materials. See the section "Protecting the emission control devices".



### Power steering

Do not exceed the maximum fluid level in the reservoir. Use only the fluid specified in the section "Capacities".



### Brake circuit

Do not exceed the maximum fluid level in the reservoir. Use only the fluid specified in the section "Capacities".



### Windscreen wiper

Use only the fluid specified in the section "Capacities".



### Engine

Use only the lubricant specified in the section "Capacities".



### Unleaded petrol vehicle

Use only unleaded petrol with RON 95.



### Expansion tank

Use only fluid of the type specified in the section "Capacities".

## OBLIGATION SYMBOLS



### Battery

Protect your eyes.



### Battery Jack

See the Owner Handbook.

# THE FIAT CODE SYSTEM

To further protect your car from attempted theft, it has been fitted with an electronic engine immobiliser system called Fiat CODE which is automatically activated when the ignition key is removed. The ignition keys, in fact, are fitted with an electronic device that transmits a coded signal to the Fiat CODE unit: only if this signal is recognised can the engine be started. The coded signal is the password with which the control unit recognises the key and enables engine ignition.



fig. 4

## KEYS fig. 4

The car comes with three types of the keys.

– key **A**, with a burgundy grip, is the “master” key. Only one of these keys is provided, and your **Fiat Dealership** needs it when it has to store the codes of new keys replacing ones that have been lost or damaged or when storing duplicate key codes. Given its importance, it should be kept in a safe place (not in the car) and only be used when absolutely necessary.

**Any repair operations to the Fiat CODE system and to the engine control unit cannot be carried out if this key is lost.**



fig. 5

– key **B** (supplied with a duplicate) with the blue grip, is the key which is normally used for: starting the engine; the doors; the glove compartment; the tunnel-mounted console; the lock on the boot opening lever.

– only one key **C** (with the blue grip) is provided. This key is only used to start the engine. It can be used by garage and workshop staff for vehicle handling.

A CODE card **fig. 5** bearing the following data is provided together with the keys:

**A** - the electronic code to be used for emergency starting (see “Emergency Start-up” in “In an emergency”);

**B** - the mechanical key code to be given to the **Fiat Dealership** when ordering duplicate keys;

**C** - the spaces for any remote control stickers when the car is fitted with the “Electronic alarm” option.

**U.K. Vehicle only** At the behest of the motor Insurance Companies the CODE card for the emergency starting and replacement of keys are not provided. If you need assistance please contact your nearest **Fiat Dealership**, or telephone **Free Phone 0800717000**.

The code numbers given on the CODE card and the key with the burgundy grip should be kept in a safe place.

You should always keep the electronic code written on the CODE card on you in case you need to perform an emergency startup.”



## OPERATION

Each time you remove the ignition key from the **STOP** or **PARK** position, the protection system blocks the engine.

When the key is turned to **MAR** at engine startup:



1) If the code is recognised, the warning lamp  on the instrument panel will flash briefly; this means that the protection system has recognised

the key code and disabled the engine immobiliser; turn the key to **AVV** to start.

2) If the code is not recognised, the warning lamp  will remain lit together with the warning lamp . Should this happen, turn the key back to **STOP** and then to **MAR**; if the engine remains immobilised, try using the other keys supplied with the car.

If you are still unable to start the engine, use the emergency starting procedure (see “In an emergency”), and take your car immediately to the nearest **Fiat Dealership**.

When travelling with the ignition key on **MAR**:

1) If the warning lamp  lights up while the car is moving, it means that the system is running a self-diagnosis (e.g. due to a voltage drop). The first time you stop you can test the system as follows: switch the engine off by turning the ignition key to **STOP**, then turn the key back to **MAR**: the warning lamp  will light up and should go out in the space of about one second.

If the warning lamp fails to go out, leave the key at **STOP** for more than 30 seconds and repeat the procedure described previously. If the problem persists, contact your nearest **Fiat Dealership**.

2) If the warning lamp  flashes it means that the car is not protected by the immobiliser. Contact your **Fiat Dealership** immediately and get them to store the codes of all the keys in the memory.



**The electronic components inside the key may be damaged if the key is subjected to sharp knocks.**

**IMPORTANT** Each key given with the car has its own code, different from all the others, which must be stored in the memory of the system’s control unit.

## DUPLICATING KEYS

If you ask for extra keys, remember that all the keys, both the new ones and those you already possess, must be stored in the memory (up to a maximum of 7). Go directly to your nearest **Fiat Dealership**, taking with you the key with the burgundy grip, all the other keys in your possession and the CODE card.

The codes of any keys that are not available when the new storage procedure is carried out will be deleted from the memory to prevent any lost or stolen keys being used to start the car.



**The burgundy key, plus all the other keys and the CODE card must be handed over to the new owner when the vehicle is sold.**

## ELECTRONIC ALARM (where fitted)

The electronic alarm has the following functions:

- remote central door locking/unlocking;
- peripheral surveillance, detecting any attempt to open the doors, the bonnet or the boot;
- passenger compartment surveillance.



fig. 6

## OPERATION

The electronic alarm fitted to the Fiat Barchetta is controlled by the receiver **fig. 6 (A button, B led)** located in the front ceiling light and is activated by the radio-frequency remote control.

The alarm can be turned on only when the ignition key has been turned to **STOP** or **PARK** and removed.

The electronic alarm control unit contains a self-supplied siren which can be deactivated.

**To switch the electronic alarm on:** press button **A-fig. 7** briefly on the remote control. You will hear a beep and the direction indicators will light up for approximately 3 seconds (in the countries where this is allowed). When the system is on, led **A-fig. 8** on the central tunnel will flash.

**To switch the electronic alarm off:** press button **A**-fig. 7 on the remote control again. You will hear two beeps and the direction indicators will flash twice (in the countries where this is allowed).

**Deactivating the volumetric surveillance function.** This function can be deactivated before turning the electronic alarm on: turn the ignition key from **STOP** to **MAR** and then back to **STOP** in rapid succession and remove the key.

Led **A**-fig 8 on the central tunnel will light up for approximately 2 seconds to confirm deactivation.

The passenger compartment protection function is reactivated (before turning on the electronic alarm) if the ignition key is turned to **MAR** for at least 30 seconds or when the alarm is turned on again.

To operate an ignition switch powered electronic device (e.g. electric window lifter) when the passenger compartment protection function is off, turn the key to **MAR**, operate the device and turn the key back to **STOP** within 30 seconds. The passenger compartment protection function will not be activated in this way.

**To exclude the siren:** press the remote control button for more than 4 seconds while turning the electronic alarm on, then release the button. Five beeps will confirm that the alarm is on and the siren off.

## ALARM SELF-TEST

When you turn the electronic alarm on you will hear a beep. If this beep is followed (after 1 second) by a second beep, check whether the doors, bonnet and boot are closed. Then turn the electronic alarm on again. If the situation persists, contact a **Fiat Dealership**.



fig. 7



fig. 8

## THE REMOTE CONTROL

The remote control has a button **A**-fig. 7 and a led **B**. The button activates the system. The led flashes while the signal is being transmitted to the receiver.

This a radio-frequency remote control and must be used close to the vehicle.

### Ministerial homologation

With respect to the legislation in force in each country on the use of radio frequencies:

- the market specific homologation codes are given in the chapter “Accessory installation”;
- the homologation code is printed on the remote control for the markets which require it.

## SYSTEM PROGRAMMING

When your new car is handed over to you, the electronic alarm has already been programmed by your **Fiat Dealership**. Any subsequent programming should also be carried out by a **Fiat Dealership**.

If, therefore, you ever need a new remote control, go to your nearest **Fiat Dealership**, taking with you the key with the burgundy grip, all the remote controls in your possession and the CODE card.

## REPLACING THE BATTERIES

Change the remote control batteries when led **B**-fig. 7 on the remote control flashes once only when pressed or when led **A**-fig. 8 on the central tunnel stays on when the alarm system is turned off. Change the batteries with a similar type as follows: open the plastic covers; insert the new batteries respecting the polarity shown; close the plastic covers fig. 9.



**Used batteries are an environmental hazard. Dispose of them in appropriate containers as prescribed by the law. Alternatively, take the batteries to a Fiat Dealership who will dispose of them correctly.**



fig. 9



## WHEN THE ALARM GOES OFF

When the car alarm is activated, the electronic alarm will be set off if:

- 1) One of the doors, the bonnet or the boot are opened.
- 2) The battery is disconnected or the electronic alarm power supply cables are cut.
- 3) When something enters the passenger compartment.
- 4) The outside of the car is knocked.
- 5) The key is turned to **MAR**.

A siren sounds for approximately 26 seconds (for a maximum of 3 cycles and 5-second pauses if the condition persists) when the electronic alarm is triggered. The direction indicators flash (in countries where this is allowed) for approximately 5 minutes.

Once the conditions cease, the system will continue its normal surveillance function.

To stop the electronic alarm, press the remote control button. If this does not work, turn the alarm off by turning the emergency key to **OFF** (see next paragraph “How to turn the alarm”).

## HOW TO TURN THE ALARM OFF fig. 10

Use the emergency key (two copies are provided) to deactivate the electronic alarm when the remote control batteries are flat or if there is a fault in the system. Lift the bonnet and find the control unit and siren (located in front of the battery). Lift the rubber protection cap **A**, insert the key and turn anticlockwise (**OFF** position). The system is thus deactivated.



fig. 10

“This key switch is not applicable for the U.K. market”.

Do not leave the emergency key in the switch. The keyhole must be covered with its rubber cap to prevent dust and humidity from getting in.



**The car alarm absorbs electricity. If you plan on not using the car for more than a month, you are advised to switch the system off with the remote control and to turn the emergency key to the “OFF” position.**

## HOW TO KNOW IF THE ALARM HAS GONE OFF

If the car alarm was triggered while you were away, led **A**-fig. 8 on the central tunnel will flash to identify the reason for it:

**Light on:** remote control battery flat.

**1 flash:** right door.

**2 flashes:** left door.

**5 flashes:** passenger compartment sensors (movement inside the passenger compartment).

**6 flashes:** bonnet.

**7 flashes:** boot.

**8 flashes:** ignition tampered with.

**9 flashes:** alarm power supply cables cut.

**10 flashes:** at least three different causes.

The led will go out when the ignition key is turned to **MAR** or after 2 minutes.

## IGNITION SWITCH

The key can turn through four different positions **fig. 11**:

– **STOP:** engine off, key can be removed and the steering column is locked. Some of the electrical devices (e.g. the radio) can be used.

– **MAR:** drive position. All electrical devices can be used.

– **AVV:** starting the engine.

– **PARK:** engine off, parking lights on, key can be removed and the steering column is locked. Press button **A** to turn the key to the **PARK** position.



fig. 11



### WARNING

*If the ignition switch has been tampered with (e.g. someone has tried to steal your car), get a Fiat Dealership to make sure it is still functioning properly before you start driving again.*



### WARNING

*Always remove the ignition key when you get out of the car. This will prevent anyone from accidentally working the controls. Remember to apply the handbrake and, if the car is pointing uphill, first gear. Put the car into reverse if it is pointing downhill. Never leave children in the car by themselves.*

## STEERING COLUMN LOCK

**To engage the lock:** remove the ignition key from either the **STOP** or **PARK** position, and turn the steering wheel until it locks.

**To release:** move the steering wheel slightly as you are turning the ignition key to **MAR.**



### WARNING

*Never remove the ignition key while the car is moving. The steering wheel would automatically lock as soon as you tried to turn it. This also applies when the vehicle is being towed.*

## INDIVIDUAL SETTINGS



### WARNING

*All seat adjustments must be made when the car is stationary.*

## SEATS fig. 12

### Moving the seat backwards or forwards

Lift lever **A** and push the seat forwards or backwards: you are in the correct position for driving when your hands are resting on the steering wheel rim and your arms are slightly bent.

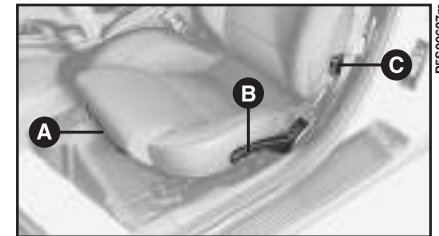

PSS00627m

fig. 12

Once you have let go of the lever, check the seat is firmly locked in the runners by trying to move it back and forth. Failure to lock the seat in place could result in the seat moving unexpectedly with obvious dangerous consequences.

### Adjusting the reclining seat back

Lift lever **B** and tilt the back into the position required. After releasing the lever, check that the back is locked properly into position by trying to tilt it backwards and forwards.

### Tipping the seat back forwards

To make it easier to get at the hood housing, the front seats can be tipped forwards

To tip the seat back, turn knob **C** towards the dashboard.

## HEAD RESTRAINTS fig. 13

These may be height adjusted by pulling them upwards or pushing them downwards.

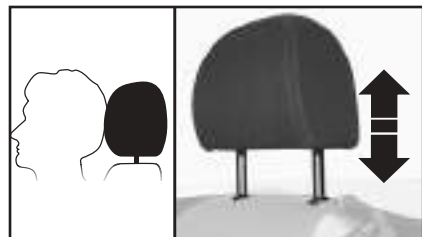
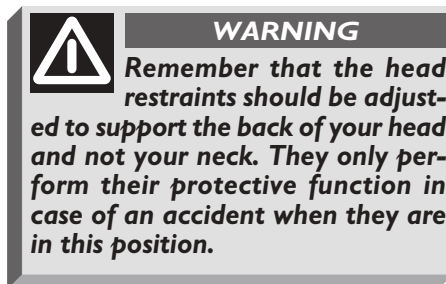
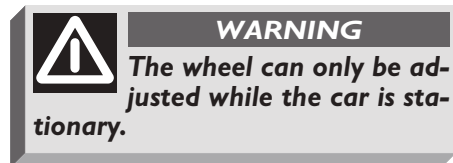

fig. 13

## STEERING WHEEL fig. 14



The steering wheel is height adjustable:

- 1) move lever **A** to position 1;
- 2) adjust the steering wheel;
- 3) return the lever to position 2 to lock the wheel in place again.

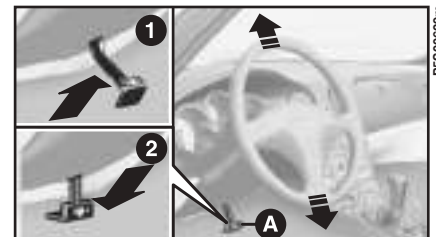

fig. 14

## DRIVING MIRROR fig. 15

You can adjust the mirror by moving lever **A**:

- 1) normal position
- 2) anti-dazzle position



fig. 15

## DOOR MIRRORS fig. 16

### Adjustment by hand

Move the mirror at the four points as shown in the figure to adjust its position.



If the mirror makes it difficult to get through narrow gaps, fold it from position 1 to position 2.

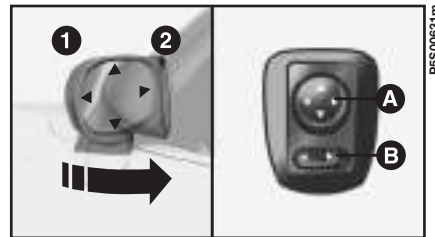

fig. 16

### Electric adjustment (where fitted)

The mirrors can only be adjusted electrically when the ignition key is at **MAR**.

All you need to do is press the four directions on switch **A** to perform this operation.

Switch **B** selects the mirror (right or left) to be adjusted.

You are advised to position the mirror when the car is stationary and the handbrake is on.

# SEAT BELTS

## HOW TO USE THE SEAT BELTS fig. 17



### WARNING

*Before fastening the seat belts, check they pass through the slots at the top of the seat back behind the shoulder.*

To fasten the seat belts, take the tongue of fastener **A** and push it into buckle **B** until you hear it click.

If the belt jams, let it rewind for a short stretch, then pull it out again without jerking.

When the driver's seat belt is not fastened, instrument panel indicator light  comes on when the ignition key is turned to **MAR**.

Press button **C** to unfasten the belts. Keep holding the belt as it rewinds to prevent it from getting twisted.



fig. 17

The seat belt retractor will adapt the belt to the body of the person wearing it to give him/her freedom of movement. The retractor could lock when the vehicle is parked on a steep slope, but this should be considered normal.

In addition, the reel mechanism blocks the belt when it is jerked or if the car brakes sharply, in a collision or when taking bends at high speed.



### WARNING

*For maximum safety, keep the back of your seat upright, lean back into it and make sure the seat belt fits closely across your chest and hips.*

## GENERAL INSTRUCTIONS FOR THE USE OF THE SEAT BELTS

All the occupants of the vehicle are obliged to respect the local traffic laws regarding the wearing of seat belts.



### WARNING

*Make sure the seat belts are fastened at all times. You increase the risk of serious injury or death in a collision if you travel with the belts unfastened.*



P5S00633m

fig. 18



### WARNING

*Never travel with children sitting on a passenger's lap with a single seat belt to protect them both.*



P5S00748

fig. 19



### WARNING

*The webbing must not be twisted. The upper section must pass across the shoulder and chest diagonally. The lower part must fit closely across the passengers' hips and not the abdomen, to prevent them sliding forward. Do not use devices (clips, clasps etc.) that prevent the belt adhering properly to the passenger's body.*



### WARNING

*SEVERE DANGER: if the car has a passenger airbag, do not place the child seat on the front seat.*

Seat belts must also be worn by expectant mothers: the risk of injury in the case of accident is much greater for them and their unborn child too if they do not have a seat belt on.

Of course they must position the lower part of the belt very low down so that it passes under the abdomen **fig. 20**.



fig. 20

## **HOW TO KEEP THE SEAT BELTS IN PROPER WORKING ORDER AT ALL TIMES**

1) When wearing your seat belt, always make sure it is not twisted and can wind/unwind freely without sticking.

2) Following a serious accident, replace the belt being worn at the time, even if it does not seem damaged. Replace the pretensioners even if they have not triggered.

3) When cleaning the belts, wash them by hand with water and neutral soap, rinse them and let them dry in the shade. Do not use industrial strength detergents, bleach, colouring or any other chemical substance that could weaken the fibres.

4) Do not allow the reels to get wet: they are only guaranteed to work properly if they remain dry.



# TRANSPORTING CHILDREN IN SAFETY

For optimal protection in the event of a crash, all passengers must be seated and wearing adequate restraint systems.

This is especially relevant for children.

A child's head is larger and heavier than an adult's head with respect to their body weight. Moreover, a child's muscular and bone structure is not fully developed. For these reasons, children require specific restraint systems, different from those required by adult passengers.

The results of research on the best child restraint systems are contained in the European Standard ECE-R44. This Standard enforces the use of restraint systems classified in four groups **fig. 21**:

Group 0 weight 0-10 kg

Group 1 weight 9-18 kg

Group 2 weight 15-25 kg

Group 3 weight 22-36 kg

The groups partially overlap. This is because there are systems which cover more than one weight group.

All restraint systems must show homologation data and control marking on a tag which is solidly fastened to the system and cannot be removed.

Children weighing more than 36 kg and taller than 1.5 m are, with reference to restraint systems, considered adults and can wear normal seat belts.

We recommend using Lineaccessori Fiat child restraint systems for each weight group. These systems were specifically designed and tested for Fiat vehicles.

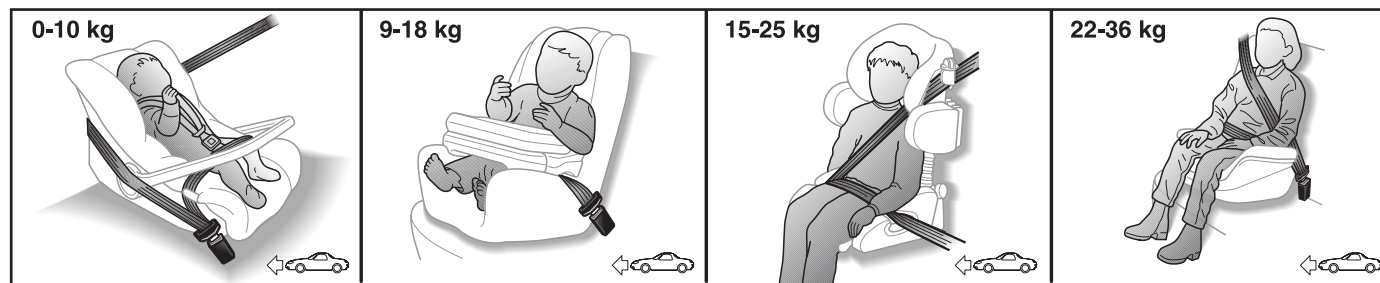

fig. 21



### WARNING

*Child restraint systems must never be positioned in the front passenger seat in vehicle's equipped with passenger side airbags. The inflated airbag could cause fatal injury, regardless of how severe the crash. Children can travel in the front seat only in cars equipped with an airbag deactivation device. In this case, make absolutely sure that the airbag has in fact been deactivated.*

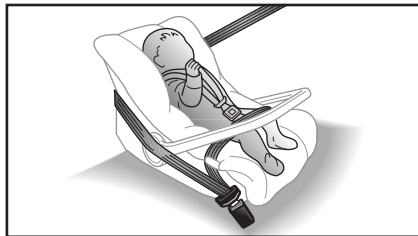

fig. 22

### GROUP 0 (fig. 22)

Babies up to 10 kg are to be seated in a cot type seat supporting the child's head facing backwards. This ensures there is no stress on the child's neck in sudden decelerations. The cot is secured with the seat belts. The child must be strapped to the carrier.



### WARNING

*The figure is only an example. Attain to the instructions for fastening the specific child restraint system you are using.*

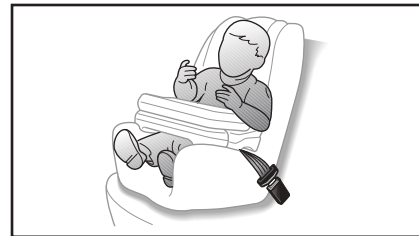

fig. 23

### GROUP I (fig. 23)

Children from 9 kg are to be seated facing forward in child seats with front cushions. The vehicle seat belt secures both seat and child.



### WARNING

*The figure is only an example. Attain to the instructions for fastening the specific child restraint system you are using. There are child restraints for Groups 0 and I which are fastened with the vehicle seat belts by means an attachment on the seat back. The child is then secured to the seat with specific straps. Due to their weight, child seats can be dangerous if they are fitted incorrectly (e.g. placing a cushion between the seat and the belts). Always attain carefully to the specific installation instructions for the child restraint system you are using.*

## GROUP 2 (fig. 24)

Children from 15 kg can be secured directly with the vehicle seat belts. The child seat has the purpose of positioning the child correctly with respect to the seat belt so that the diagonal section crosses the child's chest (never the child's throat) and the horizontal section fits snugly on the child's hips (and not the child's abdomen).

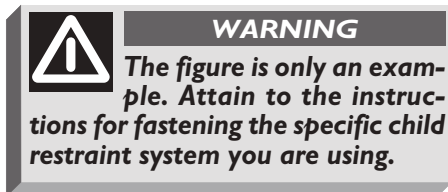

fig. 24

## GROUP 3 (fig. 25)

Children from 22 kg up only require a cushion to lift them. The size of the child's chest no longer requires a support to space the child's back from the seat back.

Children taller than 1.5 m can wear seat belts like adults.

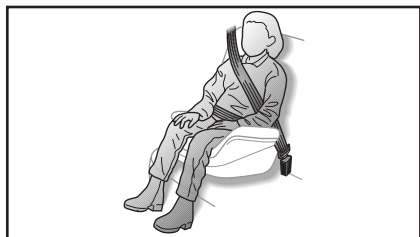
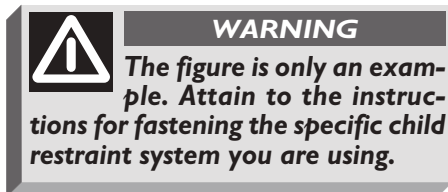

fig. 25

## To sum up the safety precautions to follow when transporting children:

1) Child restraint systems should be installed on the rear seat as this is the most protected area in the vehicle in the event of a crash.

2) Attain to the instructions for fastening the specific child restraint system you are using which must be provided by the manufacturer. Keep the child restraint system installation instructions with this the vehicle documents and with this Handbook. Never use a child restraint system without installation instructions.

3) Always check the seat belt is well fastened by pulling the webbing.

4) Only one child can be secured to a child restraint at a time. Never carry two children in one restraint system.

5) Always check the seat belts do not fit around the child's throat.

6) While travelling, do not let the child sit incorrectly or release the belts.

7) Passengers should never carry children or babies on their laps. No-one, however strong they are, can hold a child in the event of a crash.

8) Replace the child restraint system after an accident.

# PRETENSIONERS

To render the protective action of the seat belts even more effective, Fiat barchetta is fitted with pretensioners. These devices “feel” that a violent collision is in progress via a sensor, and pull back a few inches of webbing. In this way the pretensioner ensures that the belt is adhering perfectly to the body before the belt begins to hold back the wearer. When the pretensioner has been triggered the retractor will lock. The seat belt cannot be drawn back up even when guiding it manually.

When the pretensioner is triggered as small amount of smoke will be produced. This smoke is not harmful and does not indicate the principle of fire.

The pretensioner does not require any maintenance or lubrication. Any modification of its original state invalidates its efficiency. If, as the result of exceptional natural occurrences (floods, sea storms etc.), the device is soaked through with water and mud, it must be replaced.

The pretensioner will give maximum protection when the seat belt adheres snugly to the wearer’s chest and hips.



## WARNING

*The pretensioner can only be used once. After a collision that has triggered it, have it replaced at a Fiat Dealership. The device will last for 10 years from the date of production given on the adhesive label: the pretensioner must be replaced when this date is reached.*



## WARNING

*Pretensioners do not require lubrication or maintenance. Under no circumstances should the components of the pretensioner be tampered with as this could affect the correct operation of these devices. If any interventions are necessary, contact your Fiat Dealership.*



**Operations involving banging, vibrations or heating (exceeding 100°C for a maximum of 6 hours) in the area around the pretensioner may trigger or damage the device. Vibrations from rough road surfaces or accidental jolting caused by mounting pavements etc. do not have any effect on the pretensioner. If, however, you need any assistance, go to a Fiat Dealership.**

# INSTRUMENTS

## SPEEDOMETER

### Speedometer kilometre counter fig. 26

- A** - Kilometre counter
- B** - Speedometer
- C** - Trip counter
- D** - Reset button for the trip counter.  
Press to reset.

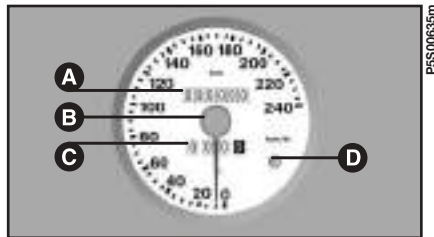

fig. 26

### Speedometer mileometre fig. 27

- A** - Mileometre
- B** - Speedometer
- C** - Trip counter
- D** - Reset button for the trip counter.  
Press to reset.

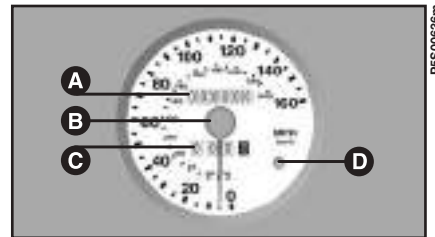

fig. 27

### REV COUNTER fig. 28

If the needle is in the zone with the red notches, it shows your car's engine is over-revving. This is only acceptable for a few moments.

**IMPORTANT** The electronic injection control system will progressively cut off the fuel supply when the engine is "overrevving" with consequent loss of engine power.



fig. 28

## COOLANT TEMPERATURE GAUGE A-fig. 29

Under normal conditions, the needle of the temperature gauge should hover around the middle of the scale. If it approaches the red section it means the engine is being overtaxed and you should reduce your demands on it.

Travelling too slowly when the outside temperature is very hot can also cause the needle to approach the red sector.

In this case it is better to stop and turn off the engine. After a few moments you can start the engine again and accelerate slightly.



**If the conditions persists even after the measures you have taken, turn off the engine and have the car seen to at a Fiat Dealership.**

## FUEL GAUGE B-fig. 29

The needle shows the number of litres of fuel probably in the tank.

When the  reserve warning light comes on, it means that about 5 litres of fuel are left in the tank.

Never travel with the fuel tank almost empty: any gaps in fuel supply could damage the catalytic converter.

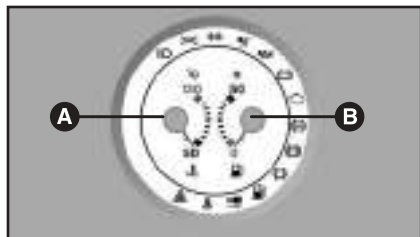

fig. 29

## DIGITAL CLOCK fig. 30

This a twenty-four hour clock. When the headlights are turned on the figures will automatically grow dim to make them easier to read.

To set the hours: press button **A**.

To set the minutes: press button **B**.

Press the button once to forward one unit at a time. Keep the button pressed to fast forward automatically. When you are close to the time you wish to set, release the button and press the button as many times as required.

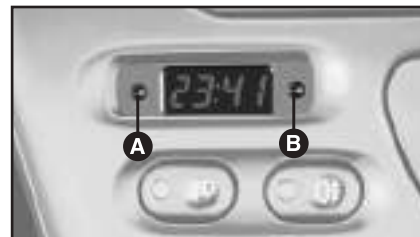

fig. 30

# INDICATOR AND WARNING LIGHTS

These light up in the following cases:



**ENGINE OIL PRESSURE TOO LOW (red)**

When the pressure of the oil in the engine falls below the normal level.

The light comes on when you turn the ignition key to **MAR** but it should go out when the engine starts.

A delay in the light going out is acceptable only when the engine is idling.

If the engine has been taxed heavily, the light might flash when idling but should go out on accelerating slightly.



## WARNING

*If the warning light comes on when the vehicle is moving, switch off the engine and contact a Fiat Dealership.*



**ENGINE CONTROL SYSTEM FAILURE (EOBD) (amber)**

In normal conditions, the warning light will come on when the ignition key is turned to **MAR** and should go out as soon as the engine is started. The initial lighting up shows that the warning light is working properly.

If the warning light either stays on or comes on while travelling:

1. Fixed light - warning of a fuel feed/ignition system failure which may increase emissions in exhaust or cause possible drops in performance, poor handling and high consumption. In such conditions, you can continue driving but you should not tax the engine and you should moderate the speed. Prolonged use with the warning light on can cause damage. Contact a **Fiat Dealership** as soon as possible.

The warning light will go out when the failure disappears. In any case, the system will store the error.

2. Flashing light - warning that the catalyser may be damaged (see "EOBD system" in this chapter). If the warning light starts flashing, release the accelerator pedal and slow the engine until the warning light stops flashing. Continue driving at moderate speed, preventing the warning light from coming on again. Contact a **Fiat Dealership** as soon as possible.



**Contact a Fiat Dealership as soon as possible if the  warning light either does not come on when the key is turned to **MAR** or comes on, with fixed or flashing light, when travelling.**



### HANDBRAKE ON/ BRAKE FLUID LEVEL LOW (red)

In two cases:

1. When the handbrake is applied.
2. When the brake fluid level falls below the minimum.



### BATTERY NOT RECHARGED PROPERLY (red)

When there is a malfunction in the current generating system.

The light comes on when you turn the ignition key to **MAR** but it should go out when the engine starts.



### ABS (ANTI-LOCK BRAKING SYSTEM) INEFFICIENT (amber) (where fitted)

When the ABS device is faulty.

The normal braking system continues to work but you should have the car seen to at a **Fiat Dealership**.

When the key is turned to **MAR** the warning light will come on but should go out after about 2 seconds.



#### WARNING

*If the  warning light comes on while travelling, check that the handbrake is not engaged. If the warning light stays on when the handbrake is disengaged, stop immediately and contact a Fiat Dealership.*





### FRONT BRAKE WEAR (red)

When the front brake pads have worn out. When having them replaced, have the rear brakes checked, too.



#### WARNING

*The car is fitted with an electronic braking device (EBD). If the  and  warning light turn on at the same time, this means that there is an EBD system fault. In this case violent braking may be accompanied by early rear wheel locking with the possibility of skidding. Drive the car extremely carefully to the nearest Fiat Dealership to have the system checked.*





### WARNING

*The lighting of warning light <sup>(ABS)</sup> when the engine is running normally indicates a fault in the ABS system only. In this case, the braking system will still be effective without the anti-lock device. In these conditions EBD system operation can be reduced. Also in this case we recommend immediately taking the car to a Fiat Dealership avoiding sudden braking to have the system checked.*



### CATALYTIC CONVERTER HOT (red) (where fitted)

When the temperature of the catalytic converter is extremely high: the warning light will go out as soon as the temperature drops to normal.



### AIRBAG OR PRETENSIONER FAILURE (red)

When the system is not working properly or has been triggered.



### WARNING

*When you turn the ignition key to the MAR position this light comes on. It should, however, go out after about four seconds. If the light stays on or comes on while the car is moving, stop at once and have the car seen to at a Fiat Dealership.*



### SEAT BELTS NOT FASTENED (red)

When the driver's seat belt is not fastened properly.



### HAZARD LIGHTS (red) (flashing)

When the hazard lights are on.



### **FIAT CODE (amber)**

In three cases (with ignition key at **MAR**):

1. A single flash - indicates that the key code has been recognised. The engine can be started.

2. A constant light - indicates that the key code has not been recognised. To start the engine, follow the emergency start-up procedure described in the "In an emergency" section.

3. A flashing light - indicates that the car is not protected by the immobiliser system. The engine can however be started.



### **PASSENGER SIDE AIRBAG DEACTIVATED (amber) (where fitted)**

When the passenger side airbag is deactivated.



### **FUEL RESERVE (amber)**

When about 5 litres of fuel are left in the fuel tank.

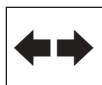

### **DIRECTION INDICATORS (green) (flashing)**

When the direction indicator control stalk is used.

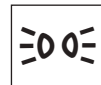

### **OUTSIDE LIGHTS (green)**

When the side and tail-lights are turned on.



### **MAIN-BEAM HEADLIGHTS (blue)**

When the main-beam headlights are turned on.

# HEATING AND VENTILATION

- A** - Directional side vents.
- B** - Windscreen defroster/ demister.
- C** - Directional centre vents
- D** - Side vents sending air toward the feet of the passengers.

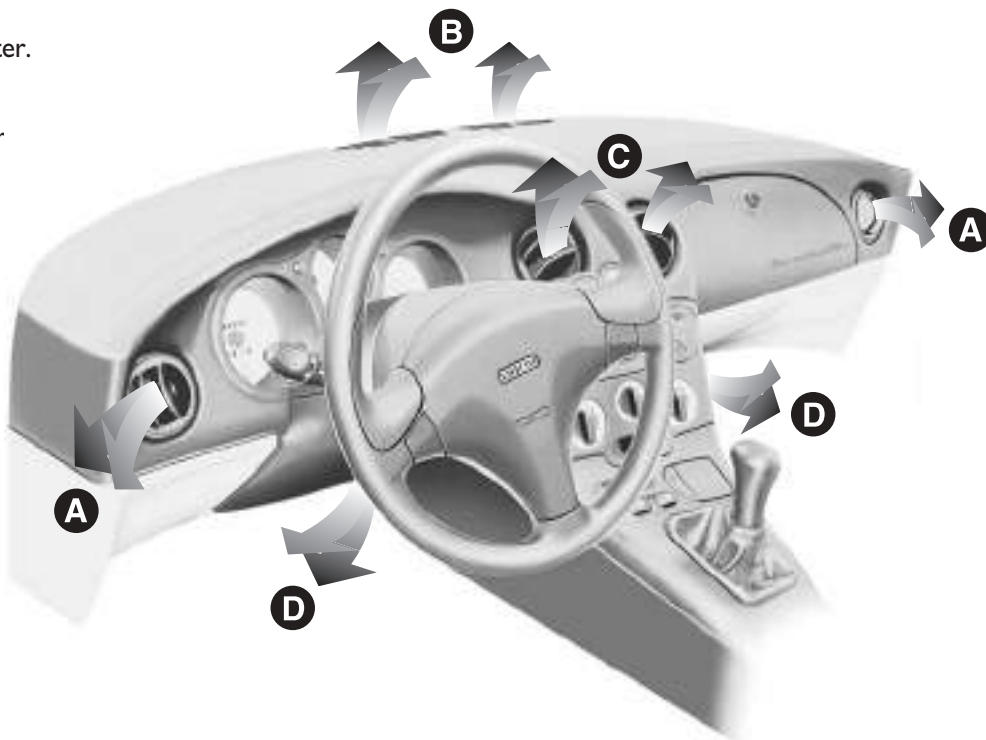

fig. 31

P5S00640m

## DIRECTIONAL AND ADJUSTABLE AIR VENTS fig. 32

Adjust the directional flaps **A** to regulate the air flow.

The vents can be rotated to the required position.

## CONTROLS fig. 33

**A** - Knob to regulate the air temperature (mixture of hot/cold air).

**B** - Knob for operating the fan.

**C** - Slider for setting the air recirculation function. This prevents air from being taken in from outside.

**D** - Knob for air distribution.

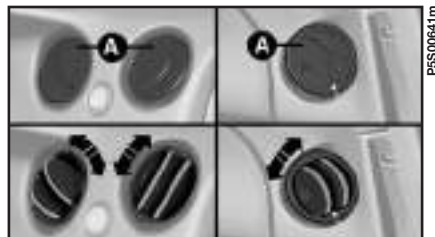



fig. 32

## HEATING

1) Knob to regulate the air temperature: pointer in the red sector.

2) Fan knob: pointer set at the speed required.

3) Air distribution knob: pointer set at

 to warm the feet and demist the windscreen at the same time

 to warm the inside of the car generally

 to warm the feet and keep the face cool (“bi-level” function)

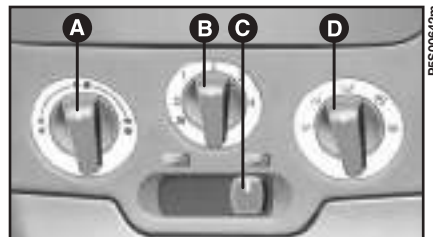



fig. 33

## FAST DEMISTING AND/OR DEFROSTING

### Windscreen and front side windows

1) Knob to regulate the air temperature: pointer in the red sector.

2) Fan knob: pointer set at the speed required.

3) Air distribution knob: pointer set at .



4) Side air vents completely open and aligning the white triangle on the adjustable part with the mark on the fixed part of the vents.

5) Air recirculation slider: set at .

When the windscreen and windows have been demisted adjust the controls to keep the windows as clear as possible.

**IMPORTANT** If the car has a manual climate control system, you are recommended to adjust the controls as described above and press button  to speed up the demisting process.

## VENTILATION

- 1) Centre and side vents: fully open.
- 2) Air temperature knob: pointer in the blue zone.
- 3) Fan knob: pointer set at the speed required.
- 4) Air distribution knob: pointer at 
- 5) Air recirculation slider: pointer set at , air is allowed to enter the car from the outside.

## RECIRCULATION

When the slider is in position , only the inside air is circulated.

**IMPORTANT** This function is particularly useful when the outside air is heavily polluted (in a traffic jam, tunnel etc.). You are advised against using this facility for long periods.

**IMPORTANT** Do not use the air recirculation function when the weather is wet/cold as this will make the inside of the windows mist up considerably.

## MANUAL CLIMATE CONTROL SYSTEM (where fitted)



The system uses refrigerating fluid R134a as it will not pollute the environment if it accidentally leaks. Under no circumstances use fluid R12, which is incompatible with the system's component parts.

## CONTROLS fig. 34

**A** - Knob for adjusting the air temperature (mixture of warm and cool air).

**B** - Switch for turning the manual climate control system on and off. When turned on, this switch automatically turns on the fan at first speed. The system is on when the light on the switch is on.

**C** - Fan knob.

**D** - Switch for turning the air recirculation option on, preventing air from being taken in from the outside. The recirculation function is on when the light on the switch is on.

**IMPORTANT** If you turn the air recirculation on when the outside temperature is particularly high, the air will cool more quickly. This function is particularly useful when the outside air is heavily polluted (in a traffic jam, tunnel etc.). You are advised against using this facility for long periods, however.

**E** - Air distribution knob.

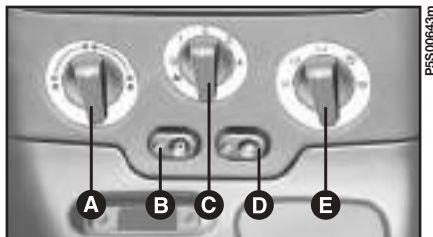





fig. 34

## CLIMATE CONTROL (COOLING)

1) Air temperature control knob: pointer in the blue sector.

2) Fan control knob: pointer set at the speed required.

3) Air distribution knob: pointer set at .

4) Manual climate control system: press switches  and .

If you wish to moderate the cooling effect: release switch , increase the temperature and reduce the speed of the fan.

Do not switch on the manual climate control system for heating and ventilation but use the ordinary heating and ventilation system (see the previous chapter).

**IMPORTANT** The manual climate control system is very useful for speeding up demisting because it dries the air. Simply adjust the controls for the demisting function and turn on the manual climate control system by pressing switch .

**IMPORTANT** Do not use the air recirculation function when the weather is wet/cold as this will make the inside of the windows mist up considerably.

# STEERING COLUMN STALKS



## LEFT-HAND STALK

The left-hand stalk brings together the outside light and direction indicator controls.



The outside lights can only come on if the ignition key is at **MAR**.

When the outside lights are turned on, the instrument panel and the various controls mounted on the dashboard light up.

## Side and taillights fig. 35

These come on when you turn knurled switch from  to . Instrument panel indicator light  comes on.

## Dipped beam headlights fig. 36

These come on when you turn the knurled switch from  to .

## Main-beam headlights fig. 37

These come on when you press the stalk towards the dashboard while the knurled switch is at .

Instrument panel indicator light  comes on.

To turn off the main-beam headlights, pull the stalk back towards the steering wheel

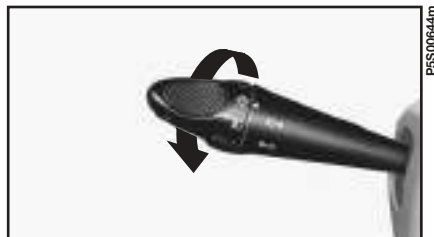

fig. 35



fig. 36

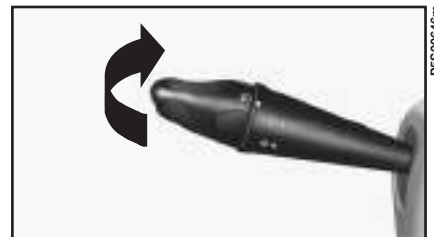

fig. 37

### Flashing the headlights fig. 38

To flash the headlights pull the stalk towards the steering wheel (temporary position).

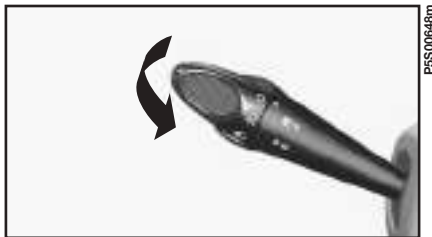



fig. 38

### Direction indicators fig. 39

Move the stalk as follows to turn on the direction indicators:

up - for the right indicator

down - for the left indicator.

Instrument panel indicator light  flashes.

The direction indicators turn off automatically when the car straightens up.

If you want the indicator to flash briefly, move the stalk up or down without it clicking into position. When you let it go it will return to its original position.

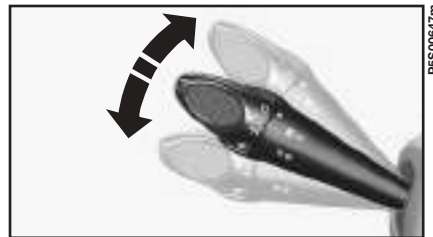

fig. 39

### RIGHT-HAND STALK

The right-hand stalk brings together all the windscreen cleaning controls.

### Windscreen wiper fig. 40

This feature can only work when the ignition key is at **MAR**.

**0** - Windscreen wiper off.

**1** - Flick wipe.

**2** - Slow continuous wipe.

**3** - Fast continuous wipe.

**4** - Temporary continuous slow wipe function: when you release the stalk, it returns to position **0** and automatically turns off the windscreen wiper.

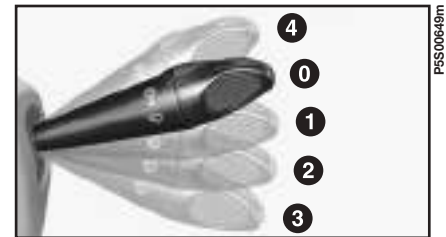

fig. 40



When you pull the lever towards the steering wheel **fig. 41** (temporary position), the windscreen washer jet is activated.



fig. 41

## CONTROLS

### HAZARD LIGHTS fig. 42

These come on when switch **A** is pressed. It does not matter what position the ignition key is in.

When these lights are on, indicator light r flashes on the instrument panel.

Press the switch again to turn the lights off.

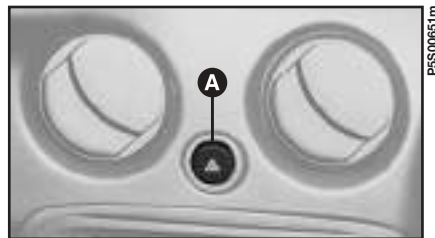

fig. 42



### WARNING

*The use of the hazard lights is governed by the traffic regulations of the country the car is driven in. These laws should be complied with.*

## FRONT AND REAR FOGLIGHTS fig. 43

The controls are situated on the centre tunnel.

They only function if the ignition key is at **MAR**.

When a button is pushed to turn the lights on, it lights up itself.

**A** - ON/OFF button for the front foglights (where fitted). The dipped beam headlights must be on to operate these lights.

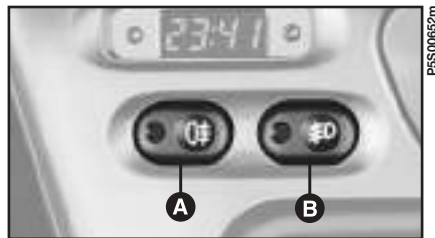

fig. 43

**B** - ON/OFF button for the rear foglights (where fitted). The dipped beam headlights or the front foglights must be on to operate these lights.

The rear foglights will be switched off when the ignition key is turned to **STOP**. If required, you will need to turn them on again the next time you start the engine.

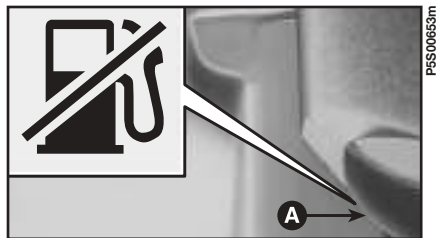



fig. 44

## FUEL CUT-OFF SWITCH fig. 44

This is a safety cut-out which comes into play in the case of an accident to block the fuel supply and thus stop the engine.



**WARNING**

*If, after an accident, you can smell petrol or see that the fuel feed system is leaking, to avoid the risk of fire, do not reset the switch.*

If you cannot see any fuel leaks and the car is in a fit state to continue its journey, press button **A** to reactivate the fuel supply system.

After an accident, remember to turn the ignition key to **STOP** to avoid the battery running down.

# INTERIOR EQUIPMENT

## GLOVE COMPARTMENT fig. 45

The glove compartment is fitted with a lock.

Position **1** - lock engaged

Position **2** - lock released

Press the button to open.

When the compartment is opened, an internal courtesy light comes on. There is an indent on the flap for standing a glass or can on while the car is stationary.



fig. 45

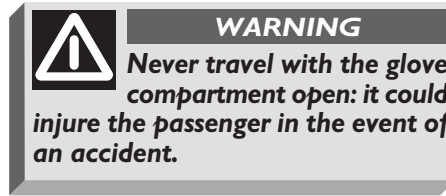

## ODDMENT BOX fig. 46

The oddment box is fitted with a lock.

Position **1** - lock engaged

Position **2** - lock released

Lift flap to open.



fig. 46

## CEILING LIGHT UNIT fig. 47

The light comes on automatically when one of the doors is opened.

When the doors are closed, the light can be turned on and off by pressing round indent on the lens.



fig. 47

## CIGAR LIGHTER fig. 48

The cigar lighter is situated inside the oddment box.

Press button **A**: after around 15 seconds the button pops back to its original position and the cigar lighter is ready for use.

**IMPORTANT** Make sure that the cigar lighter does in fact pop out after it has been pushed in.



### WARNING

*The cigar lighter gets very hot. Be careful how you handle it and make sure it is not used by children: danger of fire or burns.*

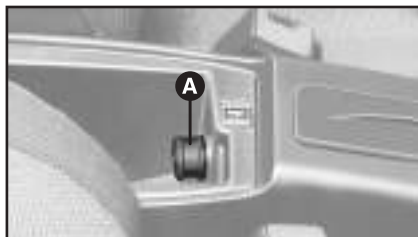

PSS00657m

fig. 48

## ASHTRAY fig. 49



### WARNING

*Do not use the ashtray as a waste paper basket: it could catch fire on contact with cigarette butts.*

It is protected by a flap. Press the two tabs **A**-fig. 49 and pull upwards to remove.

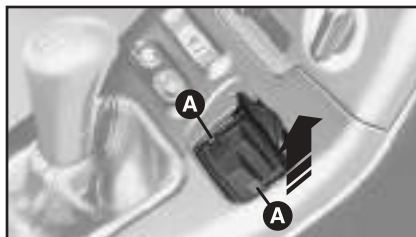

PSS10036m

fig. 49

## SUN VISORS fig. 50

These are positioned to the sides of the driving mirror. They can swing up or down.

There is a vanity mirror with protective flap on the back of the passenger's sun visor.



PSS00658m

fig. 50

# DOORS



## WARNING

*Make sure it is safe to open a door before opening it.*

### Opening by hand from the outside

Turn the key to position **1**-fig. 51 to release the lock. Opening lever **B** is raised by pressing button **A**. Take hold of it and pull.

### Closing by hand from the outside

Turn the key to position **2** to engage the lock.

### Manual locking/opening from the the inside

**Opening:** lift opening lever **A**-fig. 52.

**Locking:** close the door and press safety button **B**.

### CENTRAL DOOR LOCKING (where fitted) fig. 52

#### From the outside

When the doors are closed, insert and turn the key in the lock of one of the doors.

#### From the inside

When the doors are closed, press device **B**.

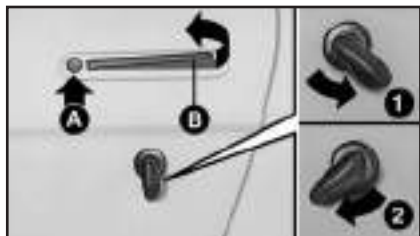

fig. 51

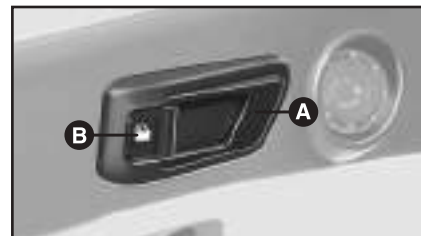

fig. 52

**IMPORTANT** If one of the doors is not shut properly or there is a failure in the system, the central locking feature will not work and, after some attempts, the device stops working for around two minutes. In these two minutes the doors can be locked or unlocked manually without the electrical system coming into play. After the two minutes the control unit is ready to receive commands once more.

If the reason for the malfunction has been removed, the device will start to work properly again. If not it will cut out once more.

## ELECTRIC WINDOWS fig. 53

Two push buttons are mounted on the central console. They control the following when the ignition key is at **MAR**:

- A** - left window opening
- B** - left window closing
- C** - right window closing
- D** - right window opening

If a button is pressed on the driver's side for around two seconds, the window works automatically: the window stops when it is fully opened or closed (or when the button is pushed again).



### WARNING

*Improper use of the electric windows can be dangerous. Before and during their operation, ensure that any passengers in the vehicle are not at risk either by personal objects getting caught or by being injured directly. Always remove the ignition key when you get out of the car to prevent the electric windows being operated accidentally and constituting a danger to the people left in the car.*

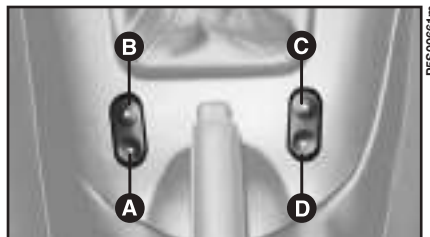

fig. 53

# HOOD

## USEFUL TIPS

Before opening the hood, make sure its housing is not obstructed by anything.

To prevent damage to the window seals, open and close the hood either with the windows right down or with the doors open.

Do not fold the hood when it is wet: it may get damaged if it is left in its housing for a long period.

Do not rest weights on the open or closed hood: the canvas and the frame could get damaged.

Do not open or close the hood when the outside temperature is very low.

Snow or ice must be removed with objects that do not leave scratches.

Take the car to a **Fiat Dealership** for any repairs or maintenance.



### WARNING

**Only open or close the hood while the car is stationary.**



**Make sure the boot lid is completely closed to avoid interference with the hood housing cover. (A beep will however warn you when you try to open the hood housing cover when the boot is not closed properly).**

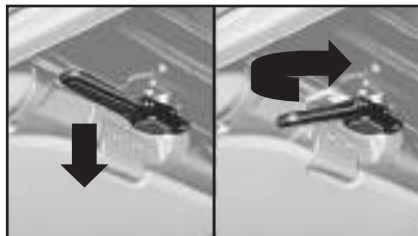

fig. 54

## OPENING

1) Lower the sun visors.

2) Grip the handles, lower them, turn them towards the inside of the car **fig. 54** and raise the front part of the hood from the windscreen transom.

3) Lower both the side windows or keep the doors open.

4) Working from the outside of the car on the driver's side, fold the hood back a little until you are able to raise the rear of the hood, as well. Make sure the rear window folds properly at the centre using the palm of your hand **fig. 55**.

**IMPORTANT** Make sure that no creases form in the rear window while you are doing this.



fig. 55

5) Keeping the rear of the hood raised make sure that the boot is closed properly, and pull lever **A** **fig. 56** (the lever nearest the seat) to release the hood housing cover. (A beep will however warn you when you try to open the hood housing cover when the boot is not closed properly). Lift it until it locks into the fully open position.

6) Fold the hood backwards into its housing, keeping it together with both hands and check that the visible part of the rear window has kept its rounded shape over its entire length, when you have finished.



fig. 56

7) With the whole hood folded inside the hood compartment, press the framework and turn the fastener from position **1**-**fig. 57** to position **2** so that it hooks onto the framework. Let the framework go and the hood will remain blocked in position. Do the same operation on both sides.

8) Close the hood compartment cover. Make sure that the catch has caught properly.

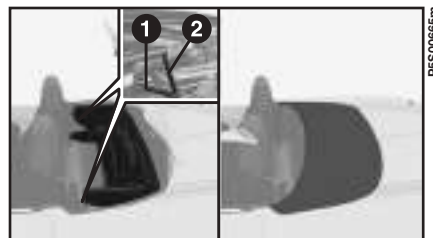

fig. 57

## CLOSING

1) Lower both side windows or keep the doors open.

2) Make sure that the boot is closed properly, then lift lever **A**-**fig. 58** (the lever nearest the seat) to release the hood housing cover. A beep, however, will inform you if the boot has not been closed properly.



fig. 58



3) Lift the hood housing cover until it locks into the completely open position.

4) Turn the hood fastener from position 2-fig. 58 to position 1 so that it rests in the appropriate recess. Do the same operation on both sides. Working from outside the car, lift hood with one hand until you can grip the rear part of the hood with the other hand. Keep the hood folded, and pull it right to the front of the car so you can close the hood compartment cover, fig. 59. Make sure the catch on the cover has caught properly.



fig. 59

5) Rest the rear of the hood on the hood compartment cover fig. 60.

6) Rest the front part of the hood on the windscreen transom.



fig. 60

7) From the inside of the car, swing the sun visors down, keep the hood lowered with one hand using the recess for the purpose fig. 61 and, with the other hand, lock it onto the windscreen transom by turning the handles.

8) Lift the sun visors.



fig. 61

## HARD TOP (where fitted)

The hard top is fitted with a heated rear window and should be used instead of the hood during the winter.

### USEFUL TIPS

Before fitting the hard top, fold the hood into its housing properly and anchor the hood housing cover to its safety devices.

Remove the seat belts from the slots in the seat backs and tip the seat backs forward.

Position and remove the hard top with the side windows fully lowered or the doors open. Get another person to help you to support the hard top on the right and left.

If repairs or maintenance are necessary, take the car to a **Fiat Dealership**.

### FITTING

1) Make sure the hard top's fitting handles on the windscreen transom are turned inwards.

2) Remove the side inner panels **A**-**fig. 62** from the hard top covering by unscrewing the fixing screws.

3) Lift the hard top and move it over the car.

4) Lower the hard top, and fit pins **A**-**fig. 63** into anchorage points **B** on the car (for the sole purpose of better showing anchorage points **B** in **fig. 63** the guard on the car has been removed).

5) Rest the front of the hard top on the windscreen transom.

6) Insert hooks **C** in holes **D** and secure the rear of the hard top to the car using levers **E**.

7) Fit side panels **A**-**fig. 62** by inserting tongue **B** into its position in the hard top upholstery and fix them into position with screw **C**.

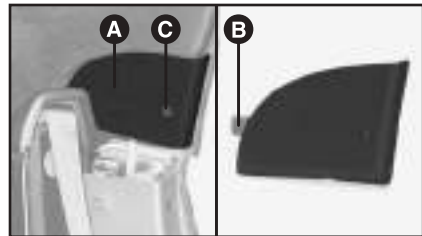

fig. 62

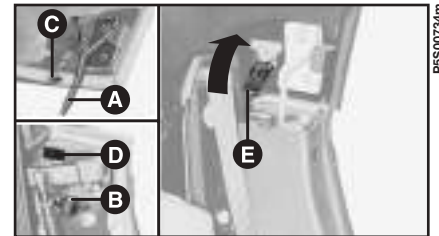

fig. 63

8) Connect the heated rear window's electrical connector to the connector located under the left side panel.

9) Working from inside the car, swing the sun visors down and lock the hard top in position on the windscreen transom by turning the handles **fig. 64**.

## REMOVAL

1) Working from inside the car, lower the sun visors and release the hard top from the windscreen transom by pulling down and turning the handles **fig. 65** towards the inside of the car.

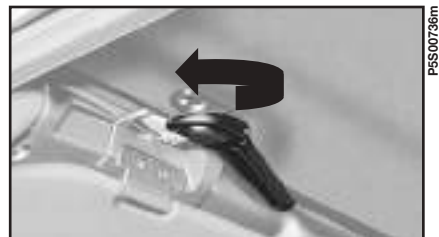

fig. 64

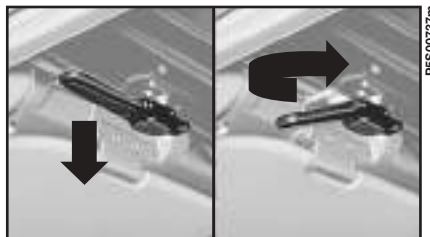

fig. 65

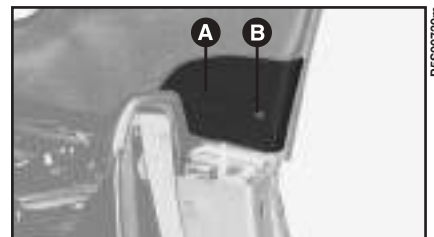

fig. 66

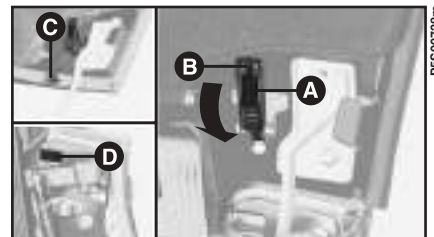

fig. 67

2) Remove the side panels **A-fig. 66** from the hard top's upholstery by undoing fixing screws **B**.

3) Disconnect the heated rear window's electrical connector from the connector located under the left side panel.

4) Push red safety buttons **A-fig. 67** upwards and release levers **B**.

5) Release hooks **C** from holes **D** (for the sole purpose of better showing anchorage points **D** in **fig. 67**, the guard on the car has been removed).

6) Working from outside the car, and with someone else to lend a hand, raise the hard top and move it backwards.

7) Refit side panels **A-fig. 66** over the hard top upholstery and fix them with screws **B**.

## STORAGE

- 1) Place the hard top on a suitable rack if possible.
- 2) Clean and protect the painted parts by applying protective wax.
- 3) Sprinkle talcum powder on the rubber weather-stripping.
- 4) Clean the interior upholstery, removing dust with a soft brush or vacuum cleaner.
- 5) Cover the hard top with a fabric or perforated plastic cover. Do not use imperforated plastic as it will not allow any moisture on the hard top to evaporate.

## HEATED REAR WINDOW

The device only works when the ignition key is at **MAR**. Press the button **A-fig. 68** on the hard top panel between the closing handles in central position to switch the device on and off.

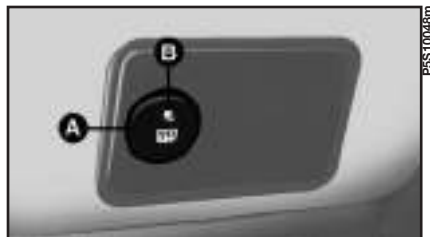

fig. 68

## WIND STOP

The wind stop is located behind the seats **fig. 70**. It increases driving comfort at all speeds by limiting the air turbulence created in the passenger compartment when travelling with the hood open.

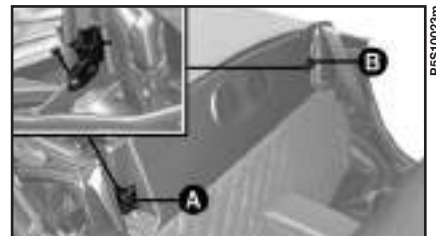

fig. 69

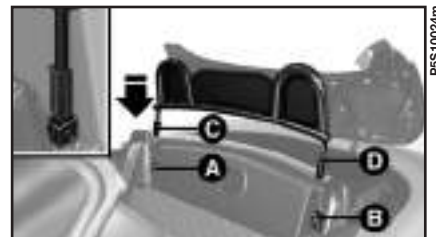

fig. 70

It allows to prolong the “open hood” season.



#### WARNING

*Fit and remove the wind stop with the hood folded away in the specific compartment and the hood compartment open.*

### FITTING THE WIND STOP (1<sup>st</sup> fitting)

1) Fit the side brackets **A** and **B** **fig. 69** in the holes on the internal sides of the car, on the right and on the left.

2) Fasten the side brackets **A** and **B** to the body with the nuts and screws provided. Insert the screws and the washers from the outside of the body side and fasten the brackets from the inside with the nuts, **fig. 69**.

3) Fit the ends of the wind spot **C** and **D** **fig. 70** inside the previously fitted brackets. Make sure that the wind stop cover is facing the rear part of the car.

4) Position the cover **E**-**fig. 71** on the brackets **A** and **B** as shown in the figure. Then fasten knobs **F** on the supporting bracket screw.

5) Fasten the knobs **F** so to lock the wind stop in position.

The wind stop will not prevent opening and closing the hood once it is fitted.

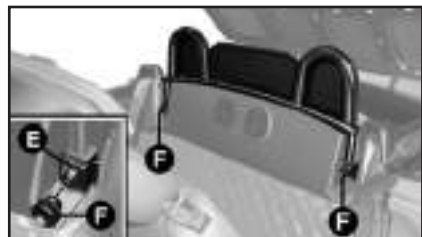

fig. 71

### REMOVING THE WIND STOP

Simply loosen the fastening knobs **F** by turning them anticlockwise. Remove the wind stop by pulling it upwards. After removing the wind stop, refasten the knobs **F** on the supporting brackets.

For refitting the wind stop, simply loosen the fastening knobs **F**, insert the wind stop and fasten it. Leave supporting brackets **A** and **B** fitted.



#### WARNING

*For safety reasons, do not store the removed wind stop in the passenger compartment.*



### WARNING

*Check the fasteners after the first 500 km. Repeat the check regularly.*



### WARNING

*We recommend removing the wind stop if you plan on using the car with the hood closed for a long time. Store the removed wind stop in the boot.*

## BONNET

To open the bonnet:

1) Pull lever **A**-fig. 72 in the direction of the arrow.



### WARNING

*Before lifting the bonnet, check the windscreen wiper arms are not lifted from the windscreen.*



### WARNING

*Perform the operation only when the vehicle is stationary.*

2) Press lever **A**-fig. 73.

3) Lift the bonnet gripping it in the centre of its front edge and, at the same time, release support rod **A**-fig. 74 from its clip.

4) Place the tip of the support rod in recess **B** of the bonnet.

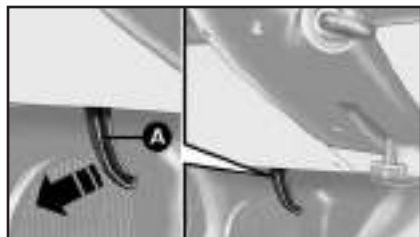

fig. 72

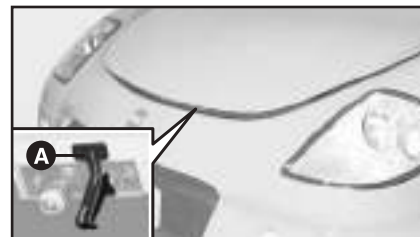

fig. 73



### WARNING

*Important. The bonnet might fall violently if the support rod is not positioned properly.*



### WARNING

*If repairs need to be carried out inside the engine compartment when this is still hot, be careful not to burn yourself and keep away from the electric fan as this may cut in at any time, even if the key is removed from the ignition switch. Wait until the engine has cooled.*

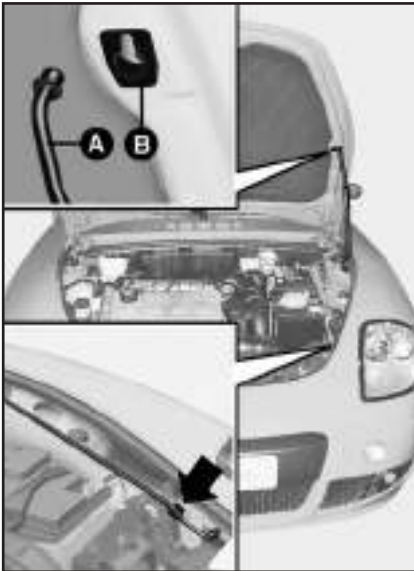

fig. 74



### WARNING

*Scarves, ties and other loose articles of clothing could easily get caught up in moving parts. This can be extremely dangerous.*

To close the bonnet:

- 1) Hold the bonnet up with one hand and, with the other, remove rod **A**-fig. 71 from recess **B** and replace it in its clip.
- 2) Lower the bonnet until it is about 20 cm (8 ins) above the engine compartment.
- 3) Let it fall: the bonnet locks automatically.



### WARNING

*Always make sure the bonnet is closed properly so it will not open while the vehicle is moving.*

## BOOT

To open the boot, open the driver's side door, release the lock using the ignition key and lift lever **A**-fig. 75 in the door frame:

1 = lever unlocked

2 = lever locked

To close the boot lid, use one hand to lower it completely, then press it with both hands at the points indicated by the arrows. Lock lever **A**.

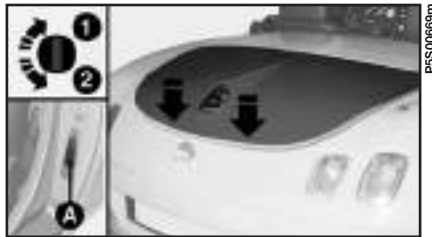

fig. 75

**IMPORTANT** The boot lid must be closed before opening or closing the hood.



**The addition of objects (speakers, spoilers, etc.) to the boot lid or to the rear window shelf (except when envisaged by the manufacturer) may prevent the gas-filled struts at the sides of the boot from working properly.**



### WARNING

**When using the boot, make sure the load you are carrying does not exceed the permitted weight (see the "Technical specifications" chapter).**

## HEADLIGHTS

### ADJUSTING THE HEADLIGHT BEAMS

The correct positioning of the headlight beams is very important for the comfort and safety, not only of the person driving the car but also all other road users. This is also covered by a specific law. To ensure you and other drivers have the best visibility conditions when travelling with the headlights on, the headlights must be set properly.

Have the headlight positioning checked at a **Fiat Dealership** and adjusted if necessary.

### ADJUSTING THE FRONT FOGLIGHTS

Have the lights checked at a **Fiat Dealership** and adjusted if necessary.



## **ABS (where fitted)**

The vehicle is fitted with an ABS braking system, which prevents the wheels from locking when braking, makes the most of road grip and gives the best control when emergency braking under difficult road conditions.

The driver can tell the ABS system has come into play when he feels the brake pedal pulsating slightly and the system gets noisier.

This should not be interpreted as a fault in the brakes; on the contrary it is a sign that the ABS system is working: it tells the driver that the vehicle is travelling at the limit of its road grip and that he should alter his speed to fit the type of road surface.

The ABS system is an addition to the basic braking system. If there is a malfunction, the system turns off automatically and only the ordinary brakes continue to work.

If a failure occurs, and consequently the anti-lock function is not effective, the braking system will continue to work as usual.

If you have never driven a vehicle with ABS before, you should practice using the system on slippery terrain, obviously with the necessary safety precautions and keeping to the Highway Code of the country you are in. It is also a good idea to read the following information carefully.

The advantage in using the ABS system is that it continues to give you maximum manoeuvrability even when braking hard in conditions of poor grip by preventing the wheels locking.

You should, however, not expect the braking distance to always decrease: for example surfaces with gravel or fresh snow on a slippery road will in fact increase the braking distance.

To exploit the ABS system to the full in the event of necessity, you should take heed of the following advice:



### **WARNING**

*The ABS exploits the tyre-road grip available to the full, but it cannot improve it; you should therefore take every care when driving on slippery surfaces, and not take unnecessary risks.*



### **WARNING**

*If the ABS system cuts in it is a sign that the grip between the tyre and the road surface has reached the limit: you must slow down to match the speed to the road grip available.*



### WARNING

*If there is a fault, the warning light  will light up on the dashboard. At this point, reduce speed and go to a Fiat Dealership to have your vehicle checked and put right immediately.*

Braking while cornering always requires extreme care even when using ABS.

The most important advice to follow is the following:



### WARNING

*When the ABS cuts in, and you feel the brake pedal pulsating, do not remove your foot, but keep it pressed. In doing so you will stop in the shortest amount of space possible under the current road conditions.*



If you follow these tips you will be able to brake better in any situation.

**IMPORTANT** Vehicles fitted with ABS may only be fitted with wheel rims, tyres and brake pads of the make and model approved by the vehicle manufacturer.

An Electronic Brake Distributor **EBD** integrates the **ABS** system and uses the control unit and sensors of the **ABS** system to increase performance of the brake system.



### WARNING

*The car is fitted with an electronic braking device (EBD). If the  and  warning light turn on at the same time, this means that there is an EBD system fault. In this case violent braking may be accompanied by early rear wheel locking with the possibility of skidding. Drive the car extremely carefully to the nearest Fiat Dealership to have the system checked.*



### WARNING

*The lighting of warning light  when the engine is running normally indicates a fault in the ABS system only. In this case, the braking system will still be effective without the anti-lock device. In these conditions EBD system operation can be reduced. Also in this case we recommend immediately taking the car to a Fiat Dealership avoiding sudden braking to have the system checked.*



### WARNING

*If the  brake fluid low warning light comes on, stop the vehicle immediately and contact the nearest Fiat Dealership. Fluid leaks from the hydraulic system, in fact, can compromise brake system operation, both traditional systems and systems with ABS.*

# AIR BAG

## Description and operation

The front airbag (driver and passenger) is a safety device which is immediately triggered in the event of a front impact.

It consists of an instantly inflatable bag housed in a special compartment located:

- in the centre of the steering wheel on the driver's side;
- in the dashboard on the passenger's side (larger bag).

The front airbag (driver and passenger) is a device which protects the occupants of the car during a head-on collision of a medium-high degree.

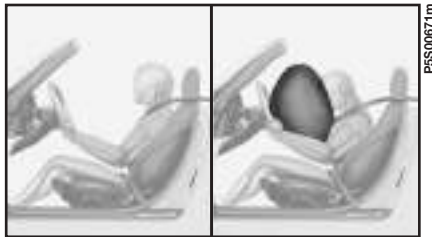

fig. 76

The system was designed to protect from injury caused by the body crashing to the steering wheel or the dashboard.

In a collision, an electronic control unit processes the signals from a deceleration sensor and, where required, inflates the airbag.

The bag inflates instantly and acts as a soft protective barrier between the front seat passengers and the structures in front of them that could cause injury. The bags deflate immediately afterwards.

A passenger not wearing the seat belt may crash into the bag before it is fully inflated. In this case, the protection is considerably decreased.

The airbag, as a consequence, is not a replacement for the use of seat belts but rather a complement. We recommend that seat belts are worn at all times as prescribed by legislation in Europe and most other countries worldwide.

In the event of front collisions at low speed, the restraining action of the seat belts is sufficient and the airbag is not inflated.

For impacts against very deformable or mobile objects (traffic sign poles, heaps of gravel or snow, parked vehicles), side impacts, wedging under other vehicles or barriers (e.g. under a truck or guard rail), the airbag is not necessary and may even be undesirable. In the event of frontal impacts involving, for example, the mudguard against a guard-rail, the airbags are not triggered as they would not offer additional protection with respect to the seat belts and may be undesirable.

The fact that the airbag is not triggered in these situations, this does not signify a malfunction.

## AIRBAG PASSENGER SIDE (where fitted)

The passenger side airbag was designed and calibrated to protect a person wearing seat belts.

When fully inflated, the bag will fill most of the space between the dashboard and the passenger.

## Manual deactivation

The passenger side airbag can be deactivated if it is absolutely necessary to carry a child in the front passenger seat.

Turn the specific switch **fig. 77** which can be reached by opening the passenger side door with the ignition key.

The switch has two positions:

**1** - Passenger side airbag on: (position **ON** ) instrument panel warning light off. Do not carry children on the front seat.

**2** - Passenger side airbag off: (position **OFF** ) instrument panel warning light on. A child can be carried on the front seat with a suitable restraint system.

The instrument panel warning light  will stay on until the passenger side airbag is reactivated.

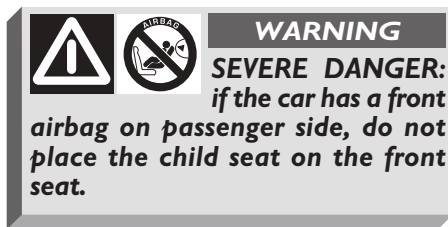

fig. 77

## GENERAL WARNINGS

The front airbags can be triggered if the car is subjected to considerable crashes or involved in an accident concerning the underbody areas, such as a violent impact against steps, kerbs or projecting objects fastened to the ground, falling into large holes or dips in the road surface.

A small amount of powder and smoke is freed when the airbags are triggered. This is not harmful and does not indicate the principle of a fire.

Go to a Fiat Dealership as soon as possible if the warning light comes on when travelling (to signal a fault) to have the problem repaired.

The airbag system is guaranteed for ten years. Contact a Fiat Dealership as the expiry data approaches.

After an accident which triggered the airbags, go to a Fiat Dealership to have the entire safety system, the electronic control unit, the seat belts and the

pretensioners replaced. The Dealership will also check the intactness of the electrical system.

Any diagnostic, repair or replacement operations concerning the airbag system must exclusively be carried out at a Fiat Dealership.

If you are having the car scrapped, have the airbag system deactivated at a Fiat Dealership first.

If the car changes hands, the new owner must be made aware of the indications given above and be given this Owner Handbook.

The pretensioners and front airbags are activated by the electronic control unit according to the type of impact. Consequently, missed activation of one or more system components does not indicate a fault in the system.



### WARNING

*The instrument panel warning light  should come on when the ignition key is turned to MAR and go out after approximately four seconds. Immediately, contact a Fiat Dealership if the warning light either does not come on or stays on or comes on when travelling.*



### WARNING

*When the passenger's front airbag is active (passenger front airbag deactivation switch at ON), the  warning light will come on for approximately four seconds and flash for other four seconds when the ignition key is turned to MAR to remind the driver than the passenger's front and side airbags (where fitted) will be fired in the event of a crash. The warning light should go out immediately afterwards.*



### WARNING

*Do not apply stickers or other objects to the steering wheel or to the dashboard on the passenger's side. Do not travel with objects on your lap or in front of you nor with a pipe, pencil or similar between your lips; you could seriously hurt yourself if the airbag inflates in a collision.*



### WARNING

*If an attempt has been made to steal the car, or if it has actually been stolen or has been vandalised in any way or subjected to flooding, have the airbag system checked over at a Fiat Dealership.*



### WARNING

*The correct operation of the front airbags and pretensioners is only ensured if the car is not overloaded.*



### WARNING

*Always drive with both hands on the rim of the steering wheel so that the airbag is free to inflate during a head-on collision, and protect you from serious injury. Do not drive with your body bending towards the steering wheel, but sit in an upright position with your back resting against the seat.*



### WARNING

*It is important to remember that when the ignition key is turned to MAR even if the engine is off, the air bag can be fired when the car is stationary if it hit by another vehicle travelling at suitable speed. As a consequence, Fiat recommends sitting children in their specific retainer system on the back seat, which is the most protected position possible. On the contrary, the air bags will not be fired in the car is crashed into when the key is not inserted or turned. Consequently, in this case, the fact that the system is not fired does not indicate a fault.*



### WARNING

*The airbag does not replace seat belts but rather increases their effectiveness. Furthermore, the front airbag is not fired in the event of low speed front collisions, side collisions, rear-end shunts and roll-overs. In these cases, the passengers are only protected by the seat belts which for this reason must always be fastened.*

## EOBD SYSTEM



The EOBD system (European On Board Diagnosis) performs a non-stop diagnosis of the components linked to the emissions, it also warns the user about the component current deterioration conditions, by turning on the pilot lamp  on the instrument panel.

Purpose of system is:

- keeping system efficiency under control;
- warning about emission increases due to car malfunction;
- warning about the necessity of replacing deteriorated components.

System also avails itself of a connector that can be interfaced with a proper instrumentation, enabling to read error codes stored in the control unit, together with a set of specific engine diagnosis and operation parameters. This inspection can be also carried out by traffic control agents.



**If the pilot lamp  does not turn on when the ignition key is turned to the MAR position, or if, when running, the fixed or blinking light turns on, please contact as soon as possible the Fiat Dealership. Pilot light  functionality can be inspected by the special equipment available with the traffic control agents. Comply with the regulations current in the Country where your are driving.**

**IMPORTANT** After eliminating the problem, your **Fiat Dealership** will run a bench test to fully check the system. In some cases, a long road test may be required.

## CELLULAR PHONE SETUP (where fitted)

Your vehicle may be equipped with an optional cellular phone system consisting of:

- a dual function speaker (sound system and cellular phone) located under the dashboard on the right-hand side;

- a dual function, electrically-operated aerial (sound system and cellular phone) **A**-fig. 78 located in the rear right-hand part of the vehicle;

- wiring and ten-pin connector **A**-fig. 79 (to power and connect to the dual function speaker) and connection to dual function aerial **B** located in the front part of the central tunnel. To access the components, remove the screws and flap **C**.

The wiring diagram is:

- N** electronic earth
- R** positive (+30) protected by 15A fuse no. 10 (in fuse carrier)
- GN** light positive (+), protected by 10A fuse no. 2 (in fuse carrier)
- AR** key positive (+), protected by 15A fuse no. 1 (in fuse carrier)
- LN** dual function speaker on right-hand door (-)
- BR** dual function speaker on right-hand door (+)



fig. 78

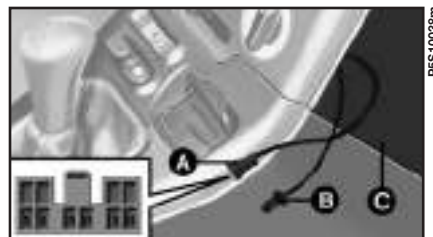

fig. 79



**IMPORTANT** The maximum power which can be applied to the aerial is 20W.

The microphone should be installed near the front ceiling light so that it does not interfere with driving visibility.

The recommended position to locate the telephone cradle is shown in **fig. 80**.

The cellular phone will work when the engine is off by turning the key to **MAR**.



**Have the cellular phone installed and connected to the provision system in the vehicle exclusively at a Fiat Dealership.**



**Have the cellular phone and the connections installed by a Fiat Dealership only. This will ensure the best results and avoid problems affecting car safety.**

## AT THE FILLING STATION

The Fiat barchetta's pollution control devices make it essential to use only unleaded petrol.

However, to avoid accidents, the hole for the petrol pump nozzle is too small to accommodate the nozzle of petrol pumps containing leaded petrol. The octane number (R.O.N.) must be at least 95.



fig. 80



fig. 81



**A catalytic converter that does not work properly leads to the emission of harmful gases and the consequent pollution of the atmosphere.**



**Never put even the tiniest amount of leaded petrol into the fuel tank, even in an emergency. You would damage the catalytic converter beyond repair.**

## FUEL FILLER CAP

The cap is provided with a strap **A**-**fig. 82** fastening it to the flap so that it cannot be lost..

**To open:** hold the cap still and turn the key anti-clockwise. Turn the cap by half a turn anti-clockwise and remove it.

The air-tight cap can cause a slight increase in pressure inside the fuel tank. A suction noise when removing the cap is, therefore, perfectly normal.



fig. 82

The cap can be positioned directly on the flap while refuelling as shown in **fig. 82**.

**To close:** insert the cap (with key) and turn it clockwise until it clicks once or twice. Hold the cap still, turn the key clockwise and remove it.



### WARNING

***Do not put naked flames or lighted cigarettes near the fuel filler hole as there is a danger of fire. Do not bend too close to the hole either so as not to breathe in harmful vapours.***

**IMPORTANT** If the fuel filler cap needs changing, use only genuine spares, otherwise you risk damaging the fuel vapour recovery system.

# PROTECTING THE ENVIRONMENT

Protecting the environment has been the guiding principle in the design of the Fiat barchetta right from the start. The result is the use of materials and creation of devices that can reduce or considerably curtail harmful influences on the environment.

The Fiat barchetta is ready to travel well ahead of the most stringent international pollution control standards.

## USE OF MATERIALS THAT DO NOT HARM THE ENVIRONMENT

None of the car's components contain asbestos. Padding and the climate control system do not contain CFI's (Chlorofluorocarbons) the gases considered responsible for the destruction of the ozone layer. Other substances which may pollute the air and water tables, such as cadmium used in bolt anti-rust coverings and the chromate used in some colourings, have been replaced entirely with environmentally-friendly substances.

## DEVICES FOR REDUCING PETROL ENGINE EMISSIONS

### Three-way catalytic converter (catalytic exhaust pipe)

Carbon monoxide, nitrogen oxides and unburned hydrocarbons are the main harmful components in exhaust gases.

The catalytic exhaust pipe and the devices connected to it are a "miniature laboratory" where a very high percentage of these components is converted into harmless substances.

The conversion is aided by minute particles of precious metals on the ceramic core enclosed in the stainless-steel container.

### Lambda Sensor

All petrol versions are fitted with this device. It ensures that air and fuel are constantly mixed in the correct proportions. This is a fundamental condition for the proper functioning of the engine and the catalytic converter.

### Anti-evaporation canister

As it is impossible to stop the build-up of petrol fumes even when the engine is not running, the system traps them in a special active carbon canister. They are sucked in from here and burnt while the engine is running.

# DRIVING YOUR CAR

**T**o help you handle your Fiat barchetta in the best and safest possible way, and above all use it to its fullest potential, we have given you some hints in this chapter on “what to do, what not to do and what to avoid” when at the wheel of your Fiat barchetta.

Most of the time, these suggestions apply to other cars as well. Sometimes, however, the tip may apply to an exclusive Fiat barchetta feature. You are therefore strongly recommended to pay the closest attention to this section for helpful hints on optimum driving practices and usage of the car that will help you get the most out of your Fiat barchetta.

STARTING THE ENGINE .....	68
PARKING .....	70
GEAR USE .....	71
SAFE DRIVING .....	71
CONTAINING RUNNING COSTS AND POLLUTION .....	76
CHEAP RUNNING THAT RESPECTS THE ENVIRONMENT .....	78
TOWING A TRAILER .....	79
SNOW CHAINS .....	80
VEHICLE STORAGE .....	81
REPEATED CHECKS AND CHECKS BEFORE LONG TRIPS .....	82
ACCESSORIES PURCHASED BY THE OWNER .....	82
USEFUL ACCESSORIES .....	82

# STARTING THE ENGINE



## WARNING

*It is dangerous to let the engine run in a garage or other closed area. The engine consumes oxygen and gives off carbon dioxide, carbon monoxide and other poisonous fumes.*



## WARNING



*Never touch the high tension cables (spark plug cables) when the engine is running.*

The engine may seem noisier than usual during the first seconds after startup, especially after a long period of inactivity. This phenomenon is characteristic of hydraulic tappets, and does not affect the functioning and reliability of the engine: this particular timing system has been selected for the Fiat barchetta engine to reduce the number of maintenance interventions necessary.

**IMPORTANT** It is important that the accelerator is never pressed until the engine is started.

- 1) Make sure the handbrake is on.
- 2) Put the gear lever in neutral.
- 3) Press the clutch pedal right down, without touching the accelerator pedal.
- 4) Turn the ignition key to **AVV** and let it go the moment the engine starts.

If the engine does not start at the first attempt, return the ignition key to **STOP** before trying to start the engine again.

If warning light  remains lit together with the warning light  when the ignition key is at **MAR**, turn the key to **STOP** and then to **MAR**; if the warning light still remains lit, try with the other keys provided with the car.

If you are still unable to start the engine, follow the emergency startup procedure (see “Emergency startup” in the section “In an emergency”) and go to the nearest **Fiat Dealership** immediately.

**IMPORTANT** Do not leave the ignition key at **MAR** when the engine is off.

## HOW TO WARM UP THE ENGINE AFTER IT HAS JUST STARTED

– Begin to move forward slowly, letting the engine turn over at medium revs. Do not floor the accelerator.

– Do not push the engine to its limit for the first few kilometres. You are recommended to wait until the water temperature has reached 50° to 60°C.

## EMERGENCY START-UP

If the Fiat CODE system fails to recognise the code transmitted by the ignition key (warning lamp  on instrument panel lit with a fixed light), you can start the engine by following the emergency procedure using the code written on the CODE card.

See the section “In an emergency”.



**Do not bump start by pushing, towing or coasting downhill. This way of starting could cause a rush of fuel into the catalytic exhaust pipe and damage it beyond repair.**



### WARNING

**Remember that as long as the engine is not running, the power brakes and power steering do not work. You therefore have to use considerably more effort on both the brake pedal and the steering wheel.**

## STOPPING THE ENGINE

Turn the ignition key to **STOP** while the engine is idling.



**A quick burst on the accelerator before turning off the engine serves absolutely no practical purpose and wastes fuel.**

**IMPORTANT** After a taxing drive it is better to allow the engine to “catch its breath” before turning it off by letting it idle to allow the temperature in the engine compartment to fall.

## PARKING

Turn off the engine, pull up the handbrake, put the car in gear (1st if the car is pointing uphill, reverse if downhill) and turn the wheels. If the car is on a steep incline, you should put a stone or wedge under the wheels to block them.

Do not leave the ignition key at **MAR** because it drains the battery.

Always remove the key when you leave the car.



### WARNING

*Do not leave children unsupervised in the car.*

## HANDBRAKE fig. 1

The handbrake lever is situated between the two front seats.

To operate the handbrake pull the lever upwards until the car is prevented from moving: pulling the lever through four or five “clicks” is generally enough on level ground while nine or ten might be necessary on a steep incline and with a load in the car.

**IMPORTANT** If this is not the case, have the handbrake adjusted at a **Fiat Dealership**.

When the hand brake is on and the ignition key is at **MAR**, panel indicator light (ⓘ) comes on.

To release the handbrake:

- 1) Slightly lift the handbrake and press release button **A**.
- 2) Keep the button pressed in and lower the lever. Instrument panel indicator light (ⓘ) will go out.
- 3) To prevent the vehicle accidentally moving, carry out this manoeuvre with the brake pedal pressed.

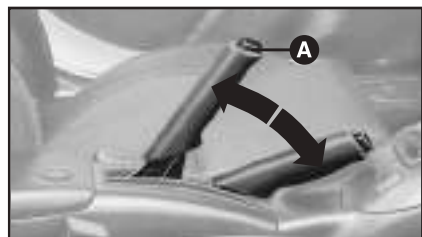

fig. 1

## GEAR USE

To engage the gears, press down the clutch and put the gear lever into one of the positions shown in the diagram in **fig. 2** (the diagram is also on the gear lever knob).

**IMPORTANT** The car can be put in reverse only when it has completely stopped moving. With engine running, before engaging the reverse, wait at least 2 seconds with clutch pedal completely pressed down to prevent damage and grating of gears.

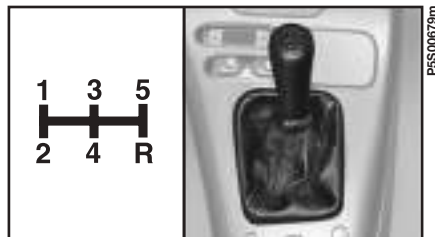

fig. 2



### WARNING

***You must push the clutch pedal fully down to change gear properly. It is therefore essential that there is nothing under the pedals: make sure mats are lying flat and do not get in the way.***



**Do not drive with your hand resting on the gear stick as the force exerted, even if only slight, could lead to premature wearing of the gear-box internal components.**

## SAFE DRIVING

In designing the Fiat barchetta, Fiat has made every effort to come up with a car able to provide driver and passenger with top-class levels of safety. Nevertheless it is always the behaviour of the person at the wheel that determines road safety.

Below you will find some simple tips to help you travel in safety under different conditions. You will no doubt be familiar with many of them already but it will be useful to read them all carefully.



## **BEFORE GETTING BEHIND THE WHEEL**

- Make sure all lights including the headlights are working properly.
- Adjust the position of the seats, steering wheel, driving and door mirrors properly for the best driving position.
- Carefully adjust head restraints so the back of the head and not the nape of the neck is supported.
- Make sure that nothing (mats etc.) gets in the way of the pedals when they are pushed down.
- Adjust the height of the seat belts, adapting them to your height (see indications given in the chapter “Getting to know your car - seat belts”).
- Make sure that any child restraint systems (child seats, carriers, etc.) are properly fixed.

– Stow objects in the luggage compartment with care to prevent them from being thrown forwards in the event of an accident.

– Make sure that any child restraint systems are properly fixed. If the child seat is installed when a passenger airbag is fitted, make sure it is facing forwards, and position the car seat as far back as possible.

– Do not eat a heavy meal before travelling. Light eating will help keep your reflexes prompt. Above all, do not have anything alcoholic to drink.

– Remember to check what is specified in the “Repeated checks and checks before long trips” in this section.

## **WHEN TRAVELLING**

– The first rule of safe driving is prudence.

– Prudence also means putting yourself into a position where you can predict wrong or imprudent behaviour of other drivers.

– Stick closely to the rules of the road in the particular country where the car is being driven and, above all, do not exceed speed limits.

– Do not drive with your foot resting on the clutch pedal as this will quickly wear the clutch out.

– Ensure that, besides yourself, all the other passengers in the car have their seat belts fastened, that children are sitting in the appropriate child seats and any animals are in special compartments.

– You should be physically fit and mentally alert before setting out on long journeys.



#### **WARNING**

*Driving while drunk or under the influence of drugs or certain medicines is dangerous for both you and other road users.*



#### **WARNING**

*Pay attention to assembly of extra spoilers, wheels in alloy or non standard wheel caps. These could reduce ventilation of the brakes and reduce their efficiency under conditions of violent or repeated braking or long downhill travel.*



#### **WARNING**

*Always fasten your seat belt and ensure your passenger does the same. Travelling with the seat belts unfastened increases the risk of injury or death if you are in a collision.*



#### **WARNING**

*Do not travel with objects on the floor in front of driver's seat: when braking they could block the pedals making acceleration or braking impossible.*



#### **WARNING**

*Water, ice or salt on road surfaces can deposit on brake disks, reducing braking efficiency on the first braking.*



#### **WARNING**

*Pay attention to the measurements of any carpets: any hindrance, even slight, to the braking system could result in a longer than normal pedal run.*

– Do not drive too many hours at a time but stop at intervals to stretch your legs and recoup your energies.

– Make sure the air in the car is being changed continuously.

– Never coast down steep slopes with the engine off: you lose the aid of engine brake, power brakes and power steering so that braking and steering require greater effort.

## **DRIVING AT NIGHT**

If you are driving at night these are the main rules to follow.

– Drive especially carefully: it is harder to drive at night.

– Slow down especially if the road is not lit.

– At the first signs of sleepiness, stop: continuing would be a risk for yourself and everybody else. Only start driving again when you have had enough rest.

– Keep a greater safety distance from the cars in front of you than during daylight hours: it is hard to judge how fast other cars are going when all you can see are their lights.

– Make sure the headlight beams are properly positioned: if they are too low, they reduce visibility and are hard on the eyes. If they are too high they can dazzle other drivers.

– Only use main-beam headlights when you are driving outside the city and when you are sure they do not annoy other drivers.

– If the headlights are on full, dip them in good time to prevent dazzling other drivers coming in the other direction.

– Keep all lights clean.

– Be careful of animals crossing the road when driving in the country.

## **DRIVING IN THE RAIN**

Rain and wet road surfaces spell danger.

All manoeuvres are more difficult on a wet road because the friction of the wheels on the tarmac is greatly reduced. This is why braking distances are much longer and roadholding is lower.

Here is some advice to follow if it is raining:

– Reduce speed and keep a greater safety distance from the cars in front.

– If it is raining particularly heavily, visibility is also reduced. In these cases, switch on the dipped headlights even if it is still daylight so you can be seen more clearly by other drivers.

– Do not drive through puddles at speed and hold on tightly to the wheel: a puddle taken at speed can make you lose control of the car (“aquaplaning”).

– Move the ventilation controls to the position for demisting the windows (see the “Getting to know your car” section), to avoid visibility problems.

– Periodically check the condition of the windscreen wiper blades.

## **DRIVING IN FOG**

– If the fog is thick, do not start out on a journey unless you absolutely have to.

If driving in mist, blanket fog or when there is the danger of patches of fog :

– Keep the speed down.

– Turn on the dipped headlights, rear foglights and front foglights, if fitted, even during the day. Do not drive with your headlights at full-beam.

**IMPORTANT** On stretches of road with good visibility, switch off your rear foglights; the brightness of these lights could annoy the people travelling in the cars behind.

– Remember that fog also means the tarmac is wet and therefore manoeuvres of all kinds are more difficult and stopping distances are longer.

– Keep a good distance from the cars in front of you.

– As far as possible, avoid spurts of speed or sudden deceleration.

– Do not overtake other vehicles if you can help it.

– If you are forced to stop your car (breakdown, limited visibility etc.) try to stop off the road. Then turn on the hazard lights and, if possible, the dipped headlights. Rhythmically sound the horn if you realise another car is coming.

## **DRIVING IN THE MOUNTAINS**

– When driving downhill, use the engine brake by engaging a low gear so as not to overheat the brakes.

– Under no circumstances should you drive downhill with the engine off or with the car in neutral, let alone with the ignition key out.

– Drive at a moderate speed without cutting corners.

– Remember that overtaking while going uphill is slower and therefore requires more free road. If you are being overtaken while driving uphill, make it easier for the other vehicle to pass.

## **DRIVING ON SNOW OR ICE**

Here are some tips for driving in these conditions:

– Keep your speed down.

– Use chains if the roads are covered in snow (refer to the “Snow chains” paragraph in this section).

– Mainly use the engine brake and under all circumstances avoid braking sharply.

– When braking in a car not fitted with ABS, avoid the wheels locking by varying the pressure you exert on the brake pedal.

– Do not accelerate suddenly and avoid swerving.

– In the winter, even apparently dry roads may have icy patches. Be careful therefore when driving over stretches that do not get much exposure to the sun or that are lined by trees and rocks where ice might not have melted.

– Keep a good distance from the vehicles in front.

– Do not remain for long periods in deep snow with the engine running as the snow could force the exhaust gases into the passenger compartment.

## **DRIVING WITH ABS**

ABS is a braking system that essentially offers two advantages:

1) It prevents wheel lock-up and consequent skidding in emergency stops, particularly when the road does not offer much grip.

2) It makes it possible to brake and steer at the same time so you can avoid unexpected obstacles and direct the car where you want while braking. The extent to which this can be done will depend on the physical limits of the tyre's sideways grip.

To get the most out of ABS:

– During emergency stops or when grip conditions are poor, you will feel a slight pulsation on the brake pedal. This is the sign that the ABS is in action. Do not release the brake pedal but continue to press so as not to interrupt the braking action.

– ABS prevents the wheels from locking but it does not increase actual grip conditions between tyre and road. Therefore, even if your car is fitted with ABS, respect the safety distance from the car in front of you and keep your speed down when driving into bends.

– ABS serves to increase the controllability of the car, not to enable you to go faster.

## **CONTAINING RUNNING COSTS AND POLLUTION**

Here are some suggestions which may help you to keep the running costs of your vehicle down and lower the amount of toxic emissions released into the atmosphere.

### **GENERAL CONSIDERATIONS**

#### **Car maintenance**

The overall state of the car is an important factor which has a marked influence over fuel consumption and driving comfort and on the life span of your car. For this reason care should be taken to maintain your car by carrying out the necessary checks and regulations in accordance with the specifications given in the Scheduled Maintenance Programme (see sections... spark plugs, idle, air filter, timing).

#### **Tyres**

Tyres should be checked at least every four weeks: if the pressure is too low fuel consumption increases as the resistance to the rolling movement of the tyre is greater. In this state, tyre wear is increased and car handling suffers which will affect safety.

#### **Unnecessary loads**

Do not travel with too much luggage stowed in the boot. The weight of the vehicle (especially when driving in town) and its trim greatly affects consumption and stability.

## Electric devices

Use the electrical devices for the necessary time only. The heated rear window, supplementary lights, wind-screen wipers, heating system blower require large amounts of energy and, increasing the request for power also increase fuel consumption (up to +25% when driving in towns).

## Air conditioner

The air conditioner is an additional load which greatly affects the engine leading to higher consumption (on average up to +20%). When the temperature outside the vehicle permits it, use the air vents.

## Spoilers

The use of aerodynamic optional extras which are not certified for specific use on the vehicle may reduce the aerodynamic penetration of the car and increase consumption.

## STYLE OF DRIVING

### Starting

Do not warm the engine when the vehicle is stationary or at high or low revs: in this way the engine will warm up gradually increasing consumption and emissions. You should drive off slowly straight away avoiding high revs, so that the engine will warm up more quickly.

### Unnecessary actions

Avoid revving the engine when stopped at traffic lights or before switching off the engine and avoid doubling the clutch as these actions have no purpose on modern cars and only increase consumption and pollution.

### Gear selection

As soon as the traffic and road conditions allow it, shift to a higher gear. Using a lower gear to liven up acceleration greatly increases consumption. In the same way, improper use of the higher gears will increase consumption, emissions and wear and tear on the engine.

## Top speeds

Fuel consumption increases considerably as speed increases. For example, when accelerating from 90 to 120 kph, fuel consumption increases by about +30%. Your speed should be kept as even as possible and superfluous braking and acceleration avoided as this increases both consumption and emissions. A “soft” way of driving should be adopted by attempting to anticipate manoeuvres to avoid imminent danger and to maintain a safe distance from the vehicle in front in order to avoid braking sharply.

## Acceleration

Accelerating violently increasing the revs will greatly affect consumption and emissions: acceleration should be gradual and should not exceed the maximum torque.

## CONDITIONS OF USE

### Cold starting

Frequent cold starting will not enable the engine to reach optimal running temperature. It follows therefore that consumption will be higher (from +15% to +30% in towns) as will the production of toxic emissions.

### Traffic and road conditions

Heavy traffic and higher consumption are synonymous; for example, when driving slowly with frequent use of the lower gears or in large towns where there are numerous traffic lights.

Winding roads, mountain roads and bumpy roads also have a negative effect on consumption.

### Enforced halts

During prolonged hold-ups (traffic lights, level crossings) the engine should be switched off.

## CHEAP RUNNING THAT RESPECTS THE ENVIRONMENT

Environmental protection has been one of the guiding principles in the production of the Fiat barchetta. It is no accident that its pollution control equipment is much more effective than that required by current legislation.

Nonetheless, the environment cannot get by without a concerted effort from everyone.

By following a few simple rules you can avoid harming the environment and often cut down fuel consumption at the same time.

On this subject, a few useful tips have been given below to supplement those marked by symbol , at various points of the handbook.

You are asked to read both the former and latter carefully.

## LOOKING AFTER EMISSION CONTROL DEVICES

The correct use of pollution control devices not only ensures respect for the environment but also has an effect on the car's performance.

Keeping these devices in good condition is therefore a fundamental rule for driving that is easy on your pocket and on the environment too.

The first step to take is to follow the Service Schedule to the letter.

Use only unleaded petrol in petrol engines.

If you have trouble starting, do not keep turning the ignition key for long periods. Be especially careful to avoid bump starting the car by pushing, towing or rolling down hill: these are all manoeuvres that can damage the catalytic exhaust. For emergency starts use only an auxiliary battery.

If the engine begins to “lose its smoothness” when travelling, continue your journey but reduce the demands you are making on the engine and have the car seen to at a **Fiat Dealership**.

When the instrument panel fuel reserve warning light  comes on, fill up as soon as possible. A low level of fuel can cause an uneven supply of fuel to the engine with the inevitable increase in the temperature of the exhaust gas and serious damage to the catalytic converter.

Never run the engine with one or more spark plugs disconnected, even for testing purposes.

Do not warm up the engine by letting it idle for a while before moving off unless the outside temperature is very low and, even in this case, only do so for less than thirty seconds.

Do not install other heat shields and do not remove those already fitted to the catalytic converter and exhaust pipe.

Do not allow anything to be sprayed onto the catalytic converter, lambda sensor and exhaust pipe.



#### **WARNING**

*When functioning normally the catalytic converter develops high temperatures. For this reason do not park the car over inflammable material (grass, dry leaves, pine needles, etc.): fire hazard.*



#### **WARNING**

*Failure to heed these precautions could cause a fire.*

## **TOWING A TRAILER**

### **IMPORTANT**

The car must be fitted with a homologated tow hitch and suitable electrical system for towing a caravan or trailer. Have the tow hitch fitted by an expert who will issue specific documentation for use on roads.

Fit special and/or additional rearview mirrors in accordance with the highway code.

Remember that towing a trailer makes it harder for the car to climb the maximum gradients specified, increases braking and overtaking distance, proportionally to the overall weight of the trailer.

The weight the trailer exerts on the car's tow hitch coupling reduces the car's loading capacity by the same amount.



In order to be sure you are not exceeding the maximum towing weight you have to take into account the trailer's fully laden weight, including accessories and personal luggage.

Do not exceed the speed limits for towing a trailer in the country you are driving in. In any case, do not exceed the top speed of 100 km/h.



#### **WARNING**

*The ABS system which may be fitted to the vehicle will not control the trailer braking system. Great care should therefore be taken when driving on slippery road surfaces.*



#### **WARNING**

*Under no circumstances modify the car's braking system for trailer braking control. The trailer's braking system must be completely independent of the car's hydraulic system.*

## **SNOW CHAINS**



**Keep your speed down when snow chains have been fitted to the wheels. Avoid potholes, steps and pavements, and do not drive for long stretches on snow-free roads, otherwise you risk damaging the tyres, suspension and steering.**

The use of snow chains is regulated by the legislation in force in the country the car is driven in.

The chains may only be applied to the drive wheel tyres (front wheels).

Check the tautness of the chains after driving some twenty to thirty metres.

Do not use snow chains with 195/55 R15 (84V) or 195/45 R16 (80V) tyres as the chains are likely to interfere with the plastic wheelarches.

Use only low-profile chains with 185/55 R15 (81H) tyres: maximum height off the wheel 12 mm

**IMPORTANT** As the spare wheel is small, it is not possible to fit snow chains to it. If a front tyre is punctured, first exchange a rear wheel with the spare tyre and then change the flat tyre with the rear wheel thus removed. This way there will be two ordinary wheels at the front and the snow chains can fitted.

## VEHICLE STORAGE

Do the following if the car is not to be used for several months:

- Park the car with the hood closed in covered, dry and if possible well-ventilated premises.
- Engage a gear.
- Make sure the handbrake is not engaged.
- Disconnect the terminals from the battery poles (negative pole first) and check the battery charge. When the vehicle is in storage, this check should be carried out once a month. If the no-load voltage is less than 12.5V, recharge the battery.

**IMPORTANT** If the car is fitted with an electronic car alarm, turn off the alarm with the remote control and deactivate the system by turning the emergency key to “**OFF**” (see the “Electronic alarm” in the “Getting to know your car” section).

- Clean and protect the painted parts using a protective wax.
- Clean and protect the shiny metal parts using special compounds available on the market.
- Sprinkle talcum powder on the rubber windscreen wiper blades and lift them off the glass.
- Open the windows slightly.
- Cover the car with a cloth or perforated plastic sheet. Do not use sheets of imperforated plastic as they do not allow moisture on the car body to evaporate.

– Inflate the tyres to 0.5 bar above the normal specified pressure and check it at intervals.

- Check battery charge once a month.
- Do not drain the engine cooling system.

## REPEATED CHECKS AND CHECKS BEFORE LONG TRIPS

- Remember to periodically check:
- tyre pressure and condition;
  - electrolyte level;
  - engine oil level;
  - coolant level and condition of the system;
  - brake fluid level;
  - windscreen washer liquid;
  - power steering fluid.

## ACCESSORIES PURCHASED BY THE OWNER



### RADIO TRANSMITTERS AND CELLULAR TELEPHONES

Cellphones and other radio transmitters (e.g. CB radios) cannot be used inside the vehicle, unless you use a separate aerial mounted outside the vehicle.

**IMPORTANT** The use of cellphones, CB radios or similar inside the passenger compartment (without an outside aerial) produces electromagnetic RF fields; if these are amplified by the resonance inside the passenger compartment, they may not only result in a potential health hazard, or poor functioning of the electronic systems fitted to the vehicle, but also put the safety of your vehicle in jeopardy.

The transmission and reception efficiency of this equipment may also be affected by the shielding effect of the vehicle's body.

## USEFUL ACCESSORIES

Apart from the legal obligations currently in force we suggest you keep in the car **fig. 3**:

- first aid kit containing non-alcoholic disinfectant, sterile gauze, a reel of gauze, plasters etc.
- fire extinguisher
- round-ended scissors
- working gloves.

The parts described and illustrated are available from Lineaccessori Fiat.



fig. 3

# IN AN EMERGENCY

**P**eople who find themselves in an emergency situation need immediate and concrete help.

The following pages have been written to help you if the need arises.



As you will see, a host of little snags have been taken into account and, for each of them, the measures you yourself can take are suggested. If the problems are more serious however, you should have the car seen to at a **Fiat Dealership**.

With regard to this, we would like to remind you that, in addition to the Owner Handbook, you have also been provided with the WARRANTY BOOKLET where you will find details of all the services Fiat can provide should you find yourself in difficulty.

We nevertheless recommend you read these pages. If in need you will be able to find the information you require much more quickly.

EMERGENCY START-UP .....	84
JUMP STARTING .....	85
BUMP STARTING .....	86
IF A TYRE IS PUNCTURED .....	86
IF A BULB BURNS OUT .....	91
IF AN EXTERIOR LIGHT BURNS OUT .....	93
IF AN INTERIOR LIGHT BURNS OUT .....	98
IF A FUSE BLOWS .....	98
IF THE BATTERY IS FLAT .....	105
IF THE CAR NEEDS TO BE RAISED .....	106
IF THE CAR NEEDS TO BE TOWED .....	108
IF AN ACCIDENT OCCURS .....	109



# EMERGENCY START-UP

If the Fiat CODE system cannot deactivate the engine immobiliser, the warning lights  and  will remain lit and the engine will not start. To start your car, follow the emergency startup procedure.

**Read the whole procedure carefully before trying to carry it out.** If you make a mistake in the emergency procedure you must turn the ignition key back to **STOP** and repeat the whole operation from the beginning, step 1).

1) Read the 5-figure electronic code given on the CODE card.

2) Turn the ignition key to **MAR**.

3) Press the accelerator pedal to the floor and keep it there. The injection warning lamp  will light up for about 8 seconds, and then go out. At this point release the accelerator pedal and get ready to count the flashes of warning lamp .

4) Count the number of flashes that corresponds to the first figure of the code on the CODE card, then press the accelerator pedal and keep it there until the warning lamp  lights up for four seconds and then goes out again. Release the accelerator pedal.

5) The warning lamp  will start flashing again: when the lamp has flashed the number of times that corresponds to the second figure on the CODE card, press the accelerator pedal to the floor and keep it there.

6) Do the same for the remaining figures on the CODE card.

7) Once the final figure has been entered, keep the accelerator pedal pressed. The warning lamp  will light up for 4 seconds and then go out. Release the accelerator pedal.

8) The warning lamp  will flash rapidly for about 4 seconds to indicate that the operation has been completed correctly.

9) Turn on the engine by turning the ignition key from the **MAR** to the **AVV** position.

If however indicator light  stays on, turn the ignition key to **STOP** and repeat the procedure starting from point 1).

**IMPORTANT** After emergency starting the car you should have it seen to at a **Fiat Dealership** because the emergency procedure will have to be repeated each time you start the engine otherwise.

# JUMP STARTING

If the battery is flat, you can use another battery to start the engine. Its capacity must be the same or slightly greater than the flat battery (see the chapter “Technical specifications”).

This is what to do **fig. 1**:

**1)** Connect positive terminals (signal **+** in proximity of the terminal) of the two batteries with a jump lead.

**2)** With a second lead, connect the negative terminal (**-**) of the auxiliary battery to an earth point **↓** on the engine or transmission of the vehicle to be started.

**IMPORTANT** Do not connect the two negative terminals directly: sparks could ignite the explosive gas output from the battery. If the other battery is fitted in a vehicle, prevent accidental contacts between the metal parts of the two vehicles.

**3)** Start the engine.

**4)** When the engine has been started, remove the leads in the reverse order.

If the engine fails to start after a few attempts, do not keep turning the key but have the car seen to at a **Fiat Dealership**.

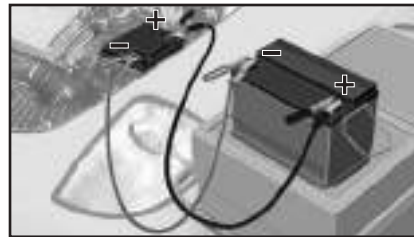

fig. 1



## WARNING

*Do not carry out this procedure if you lack experience; if it is not done correctly it can cause very intense electrical discharges. Furthermore, the fluid in the battery is poisonous and corrosive, avoid contact with your skin and eyes.  
Do not put naked flames or lighted cigarettes near the battery and do not cause sparks.*



**Under no circumstances should a battery charger be used to start the engine: it could damage the electronic systems and in particular the control units governing ignition and fuel feed.**

## BUMP STARTING



Do not bump start by pushing, towing or coasting downhill. This way of starting could cause a rush of fuel into the catalytic exhaust pipe and damage it beyond repair.



### WARNING

Remember that if the engine is not running, the brake booster will not work. You therefore have to use considerably more effort on the brake pedal.

## IF A TYRE IS PUNCTURED

### General instructions

Observe the instructions on this and the following pages to use the jack and space-saver spare wheel correctly.



### WARNING

Signal the presence of the stopped vehicle according to the laws in force (e.g. hazard lights, reflecting triangle, etc.). Any passengers on board should leave the vehicle, especially if it is heavily laden. Passengers should stay away from oncoming traffic while the wheel is being changed. If the wheel is being changed on a steep or badly surfaced road, place wedges or other suitable material under the wheels to stop the vehicle.



### WARNING

The space-saver spare wheel is vehicle-specific. Never use the wheel on other models. Never use other model spare wheels on your vehicle.

If you change the type of wheels (alloy rims instead of steel rims) you will have to change the entire set of fastening bolts with another set of suitably sized bolts.

Only use the spare-saver wheel for emergencies.

With the spare wheel do not exceed 80 kph.

An orange sticker is attached to the spare wheel giving the main instructions for its use and limitations. The sticker must never be removed or covered.

Do not fit the hub cap to the spare wheel.



### WARNING

The sticker gives the following information in four languages: CAUTION! FOR TEMPORARY USE ONLY. MAX. 80 KM/H! REPLACE BY NORMAL WHEEL AS SOON AS POSSIBLE. DO NOT COVER THIS LABEL IN USE. When driving with a space-saver spare wheel fitted the driving performance of your car may change. Avoid accelerating or braking suddenly, steering abruptly or driving fast on bends. The life span of a space-saver spare wheel is approximately 3000 km, after which it will need to be replaced with another spare wheel of the same type. Never fit a standard tyre on the spare-saver spare wheel rim. Have the wheel replaced and refitted as soon as possible. Never use two or more spare wheel at the same time. Do not lubricate the bolt threads before fitting them back: they could come loose. The jack should only be used to change a wheel on the car for which it was designed. It should not be put to other uses or employed to raise other models of car. Under no circumstances should it be used when carrying out repairs under the vehicle.



### WARNING

An incorrectly positioned jack may cause the vehicle to fall.  
Do not use the jack to lift loads exceeding that indicated on the label attached to the jack itself.  
Never start the engine when the car is jacked up.  
If you are towing a trailer, release the trailer before jacking up the car.  
Do not fit snow chains on space-saver spare wheels. If a front wheel (drive wheel) is punctured and you require snow chains to proceed, take a standard wheel from the rear axle and fit the space-saver spare wheel in its place. Having fitted two standard wheels on the drive axle, you can use snow chains, thus solving the emergency situation.



### WARNING

Torque the wheel cap correctly to prevent the wheel from coming free in motion.  
Never tamper with the inflation valve.  
Never place tools between the rim and tyre.  
Check the tyre and space-saver spare wheel pressure regularly. Tyre pressure is shown in the “Technical specifications” chapter.



## CHANGING A WHEEL

Please note:

- the jack weighs 1.85 kg;
- the jack requires no adjustments;
- the jack cannot be repaired. If it breaks it must be replaced with a new jack;
- no other tool, part from the handle shown in this chapter can be fitted to the jack.

### Change the wheel as follows:

1) Stop the vehicle so that it is not a hazard for other road users or yourself when changing the wheel. The ground should be as flat and firm as possible.

2) Stop the engine and engage the handbrake.

3) Engage first gear or reverse.

4) Lift the boot carpet.

5) Unscrew the locking device **A** **fig. 2**. Lift out the tool kit and place it near the wheel to be changed and take out the space-saver spare wheel.

6) Loosen the bolts on the wheel to be replaced by approximately half a turn. If alloy rims are fitted, shake the car to facilitate removing the rim from the wheel hub.

7) Turn the jack handle so the jack opens partially.

8) Place the jack near the wheel to be changed and make sure groove **A** **fig. 4** of the jack fits snugly into slot **B** of the long member.



fig. 2

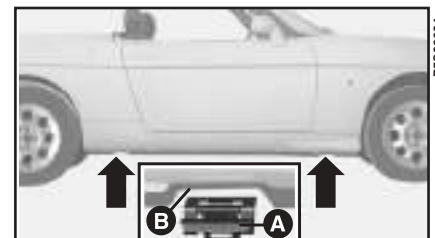

fig. 4

**9)** Warn anyone nearby that the vehicle is about to be lifted. They must stay clear and not touch the vehicle until it is back on the ground.

**10)** Turn the jack handle and raise the car until the wheel is a few centimetres above the ground.

The jack handle must turn freely, without touching the ground to avoid scraping your hands. Do not touch the moving parts of the jack as they can cause injuries. If you dirty your hands with grease, clean them carefully.

**11)** Fully unscrew the 4 bolts, remove the wheel and, where provided recover the wheel hub cap.

**12)** Make sure the surfaces of the space-saver spare wheel that come in contact with the hub are clean and free from any impurities which could result in the wheel bolts working loose.

**13)** Fit the spare wheel making sure that pegs **B** fit into holes **A**-fig. 5.

**14)** Tighten the four fastening bolts.

**15)** Lower the car by turning the jack handle and remove the jack.

**16)** Tighten up the wheel bolts completely in criss-cross fashion following the order shown in fig. 6.

**17)** Put the punctured tyre into the space-saver spare wheel housing.

Depending on whether the normal wheels are fitted with steel or light alloy rims, the spare wheel (always made of steel) differs in order to be compatible with the wheel bolts which are specific for each of the two types of rim.

If the type of wheel to be used is to be changed (alloy rims in place of steel rims and vice-versa) the bolts must also be changed and a specific spare wheel adopted.

Keep the bolts and the spare wheel as they are essential if the original wheels are to be refitted at some time in the future.



fig. 5



fig. 6

## REFITTING THE STANDARD WHEEL

1) Following the above procedure, raise the car and remove the space saver wheel.

2) Assemble the normal use wheel. If the wheel is fitted with a hub cap, it is necessary to add only one bolt first, then assemble the hub cap by aligning the hole **A**-fig. 7 with the already assembled bolt, screw on the other three bolts, using the extension **B** for fitting the fixing bolts.

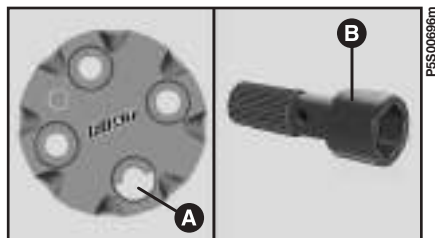

fig. 7

3) Screw up the bolts with the spanner provided.

4) Lower the vehicle and remove the jack.

5) Tighten up the bolts in the same order as shown above.

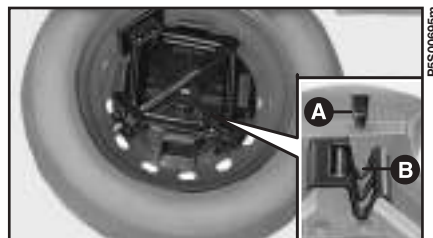

fig. 8

## When you have finished

1) Put the space-saver spare wheel back in the boot.

2) Put the jack back in its support making sure pin **A**-fig. 8 coincides with jack groove **B** then place the unit in the wheel that has been changed.

3) Put the tools you have used back in their support.

4) Position the support making slot **A**-fig. 9 coincide with the base of the jack.

5) Do up clamp **B**.

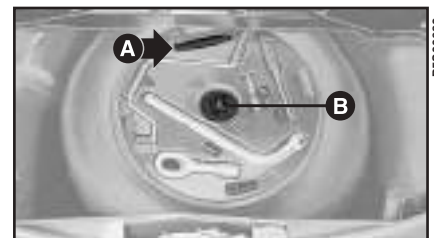

fig. 9

## IF A BULB BURNS OUT



### WARNING

*Modifications or repairs to the electrical system carried out incorrectly and without bearing the features of the system in mind can cause malfunctions with the risk of fire.*



You should, where possible, have your bulbs changed at a Fiat Dealership. Correct operation of external light beams are essential for safe driving and compliance with legal requirements.



Only touch the metal part when handling halogen bulbs. If the transparent bulb is touched it reduces the intensity of the light emitted and can also reduce the life of the bulb. If you touch the bulb accidentally, rub it with a cloth moistened with alcohol and leave it to dry.



### WARNING

*Halogen bulbs contain pressurised gas which, if broken, may cause small fragments of glass to be projected outwards.*

## GENERAL INSTRUCTIONS

- When a light is not working, check that it has not fused before changing the bulb.
- For the location of the fuses, refer to “If a fuse blows” in this section.
- Before replacing a bulb that does not work, check that the contacts are not oxidised.
- Burnt out bulbs must be replaced with ones of the same type.
- Always check the height of the headlight beam after changing a bulb for safety purposes.

## TYPES OF BULBS

Several types of bulbs are installed in the car (fig. 10):

### A Glass bulbs

Snapped into position. Pull to remove.

### B Bayonet connection bulbs

Remove from the bulb holder by pressing the bulb and rotating it anti-clockwise.

### C Cylindrical bulbs

Remove by pulling away from terminals.

### D Halogen bulbs

To remove the bulb, release the clip holding the bulb in place.

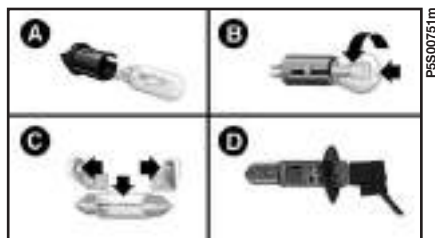

fig. 10

BULB	TYPE - fig. 10	POWER
Main beam	D	55W
Dipped-beam	D	55W
Front side lights	A	5W
Front direction indicators	B	21W
Side direction indicators	A	5W
Front fog light	D	55W
Taillights	B	5W
Brake lights	B	21W
Third brake light (supplementary brake light)	B	21W
Rear direction indicators	B	21W
Reverse light	B	21W
Rear fog light	B	21W
Number plate light	A	5W
Ceiling light	C	10W
Glove compartment	C	5W

# IF AN EXTERIOR LIGHT BURNS OUT

## FRONT SIDE LIGHTS fig. 11

To change the 12V-55W bulb:

1) Remove the protective cap by pulling tab **A** downwards.

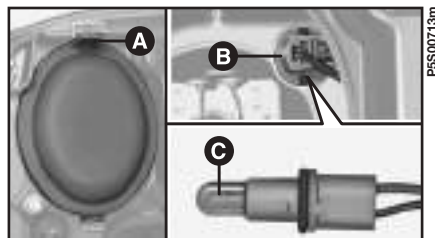

fig. 11

2) Remove the bulb holder **B**, rotating it slightly to uncouple it.

3) Pull out bulb **C**, change it and press fit the bulb holder back into position.

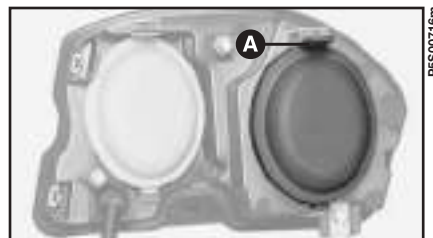

fig. 12

## DIPPED HEADLIGHTS

To change the halogen bulbs (H1 type, 12V-55W):

1) Remove the protective cap by pulling tab **A**-fig. 12 downwards.

2) Unhook retaining springlet **A**-fig. 13 and pull bulb **B** out.

3) Fit the new bulb making the fins of the metal part coincide with the special grooves in the headlight dish and rehook the retention springlet.

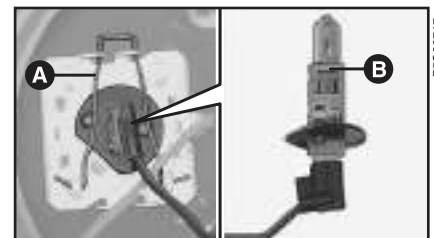

fig. 13

## FULL BEAM HEADLIGHTS

To change the halogen bulbs (H1 type, 12V-55W):

1) Remove the protective cap by pulling tab **A**-fig. 14 downwards.

2) Unhook retaining springlet **A**-fig. 15, pull bulb **B** out and replace it.

3) Fit the new bulb making the fins of the metal part coincide with the special grooves in the headlight dish and rehook the retention springlet.

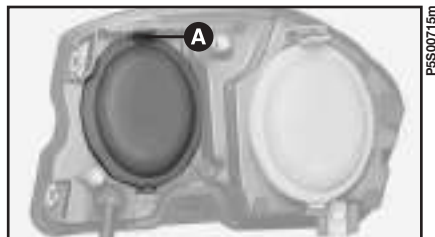

fig. 14

## FRONT FOGLIGHTS fig. 16

To replace the fog light lamps (type H3, 12V-55W) it is necessary to operate from below the car. It is hence suggested to have the lamps replaced by **Fiat Dealership**.

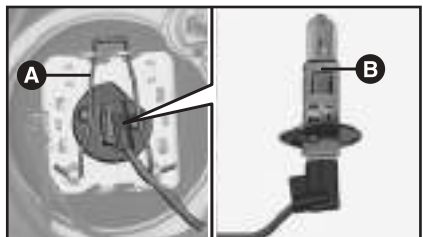
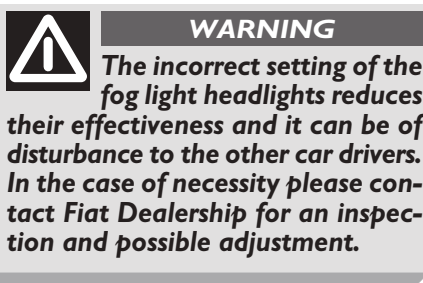

fig. 15

## FRONT DIRECTION INDICATORS

To replace front turn indicator lamps it is necessary to operate from below the car. It is hence suggested to have the lamps replaced by **Fiat Dealership**.



fig. 16



fig. 17

## DIRECTION REPEATERS fig. 18

To change the 12V-5W bulb:

- 1) Remove press-fit lens **A**, complete with bulb holder and rubber protection.
- 2) Pull back the rubber protection and remove the bulb holder from the lens assembly.

3) Remove bulb **B** by pressing it in slightly and turning it in an anti-clockwise direction.

4) Replace the bulb.

5) Fit the lens on the bulb holder until you hear it click into place, then reposition the rubber protection.

6) Then fit the whole assembly into the housing in the bodywork, turning it slightly to aid installation.

## REAR DIRECTION INDICATORS fig. 19

To change the 12V-21W bulb:

- 1) Unscrew knob **A** and remove the cover.
- 2) Turn bulb-holder **B** in an anti-clockwise direction and remove it.
- 3) Remove bulb **C** by pressing it in slightly and turning it in an anti-clockwise direction.

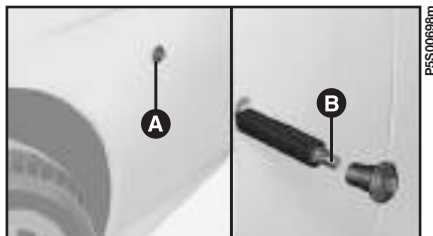

fig. 18

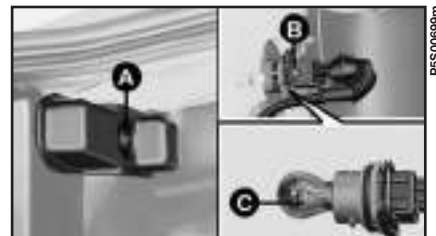

fig. 19



## TAIL- AND STOP LIGHTS

### fig. 20

To change the 12V-5/21W bulb:

- 1) Unscrew knob **A** and remove the cover.
- 2) Turn bulb holder **B** in an anti-clockwise direction and remove it.
- 3) Remove bulb **C** by pressing it in slightly and turning it in an anti-clockwise direction.

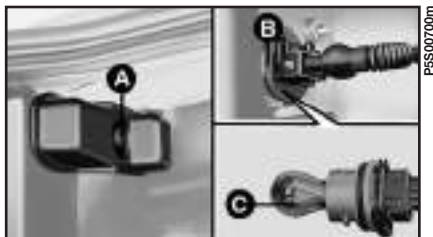

fig. 20

## THIRD BRAKE LIGHT

Proceed as follows to replace a 12V-P21W bulb:

- 1) Open the tailgate.
- 2) Loosen the two screws **A**-fig. 21 fastening the internal cover.

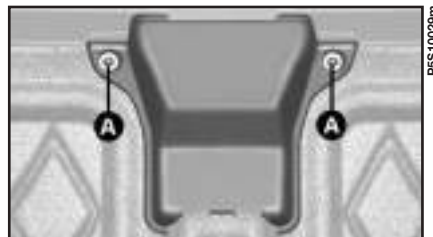

fig. 21

3) Turn the bulb holder **B**-fig. 22 anticlockwise by approximately 1/4 of a turn.

- 4) Pull out the bayonet fitted bulb **C**.
- 5) Refit by reversing the removal sequence.

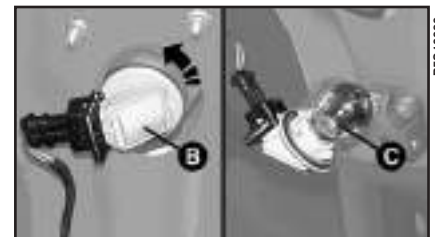

fig. 22

## REVERSING LIGHTS fig. 23

To change the 12V-21W bulb:

- 1) Undo screw **A** securing the lens assembly.
- 2) Turn bulb holder **B** in an anti-clockwise direction and remove it.
- 3) Remove the bulb by pressing it in slightly and turning it in an anti-clockwise direction.
- 4) When refitting the lens assembly, first insert tab **C** in its slot in the body work and then fix it in place with screw **A**.

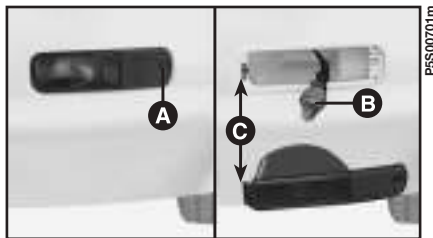

fig. 23

## REAR FOGLIGHTS fig. 24

1) Undo screw **A** securing the lens assembly.

2) Turn bulb holder **B** in an anti-clockwise direction and remove it.

3) Remove the bulb by pressing it in slightly and turning it in an anti-clockwise direction.

4) When refitting the lens assembly, first insert tab **C** in its seat in the body work and then fix it in place with screw **A**.

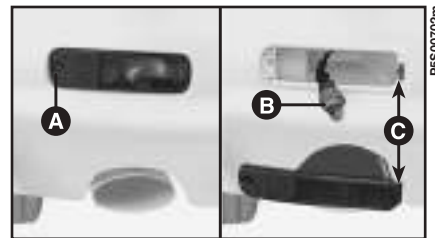

fig. 24

## NUMBER PLATE LIGHTS fig. 25

To change the 12V-5W bulb

1) Undo screw **A** securing the lens assembly.

2) Pull up lens weather-stripping **B** and remove press-fit bulb **C**.

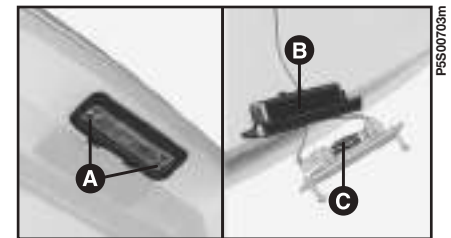

fig. 25

# IF AN INTERIOR LIGHT BURNS OUT

## CEILING LIGHT UNIT

To change 12V-10W tubular bulb **A**: pry off the ceiling light unit with a screwdriver at the points indicated in **fig. 26**.



fig. 26

## GLOVE COMPARTMENT LIGHT **fig. 27**

To replace the tubular 12V-5W bulb: remove the lens by pressing it on its two short sides and pulling it downwards.

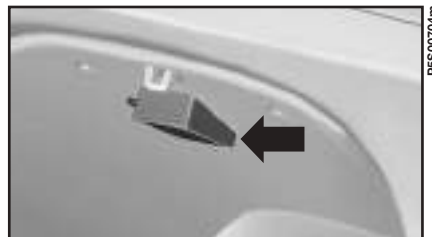

fig. 27

# IF A FUSE BLOWS

## GENERAL **fig. 28**

If an electrical device is not working, check whether the respective fuse is blown. The conductor **C** should not be broken. If it is, replace it with another with the same amperage (same colour).

**A** - Undamaged fuse

**B** - Fuse with broken filament.

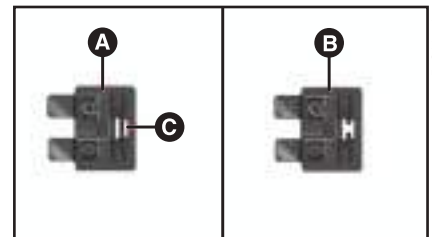

fig. 28



Never replace a broken fuse with anything other than a new fuse. Always use a fuse of the same colour.



#### WARNING

Before changing a fuse, check the ignition key has been removed and that all the other electrical devices have been turned off/disabled.

## POSITION OF THE FUSES

### Fuses in the fuse box fig. 30

The fuse box is situated under the dashboard to the left of the steering wheel.

To get at the fuses:

1) undo the fixing screws;

2) remove guard **A**-fig. 29. When you replace the guard, make sure it fits properly under the door weather-stripping.

The symbols identifying the main electrical elements corresponding to each fuse are shown on the inside of the guard.

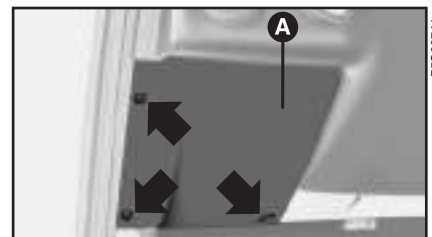

fig. 29



#### WARNING

Never, under any circumstances, replace a fuse with one of a higher amperage, this is **FIRE HAZARD!**



#### WARNING

If the fuse blows again, contact a Fiat Dealership.



#### WARNING

If a general protection fuse (MAXI-FUSE) blows, do not carry out any repairs. Take the vehicle to a Fiat Dealership.

To locate the fuse, refer to the table on the following pages.

## Fuses under the left side of the dashboard fig. 31

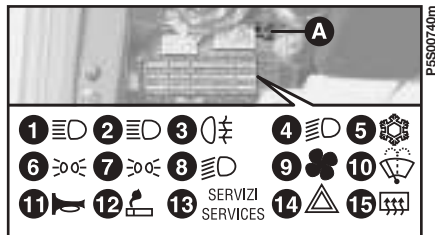

fig. 30



fig. 31

## Fuses in the engine bay (over the battery) fig. 32-33

To reach the fuses, open cover **A**, move clips **B** forwards and open the clipped-on cover **C**.

You will find tongs **D** for removing the fuses inside the fusebox.

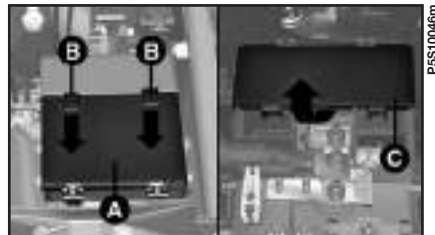

fig. 32

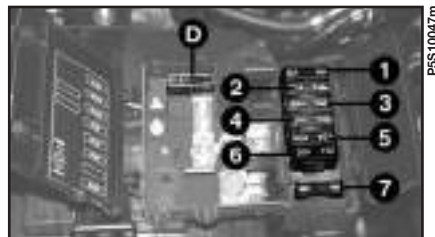

fig. 33

## Fuses in the engine bay (on the fire-break bulkhead) fig. 34

To reach the fuses, remove the plastic cover by unscrewing the three fixing screws.

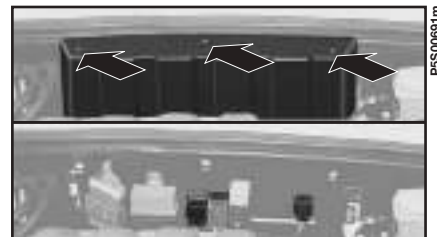

fig. 34

## FUSE LIST

### *Exterior lights*

<b>Protected device</b>	<b>Ampere</b>	<b>Fuse number - Location</b>
Direction indicators	15	13-fig. 30
Front right-hand side light	10	6-fig. 30
Front left-hand side light	10	7-fig. 30
Right-hand taillight	10	7-fig. 30
Left-hand taillight	10	6-fig. 30
Right-hand dipped beam headlight	10	4-fig. 30
Left-hand dipped beam headlight	10	8-fig. 30
Right-hand main beam headlight	10	1-fig. 30
Left-hand main beam headlight	10	2-fig. 30
Fog light	20	fig. 31
Fog light	40	5-fig. 33
Rear fog light	10	3-fig. 30
Reverse light	15	13-fig. 30
Hazard lights	10	14-fig. 30
Brake lights	15	13-fig. 30
Third brake light	15	13-fig. 30
Right-hand number plate light	10	6-fig. 30
Left-hand number plate light	10	7-fig. 30

## Interior lights

<b>Protected device</b>	<b>Ampere</b>	<b>Fuse number - Location</b>
Ceiling light	15	12-fig. 30
Glove compartment light	10	14-fig. 30
Glove compartment light	40	5-fig. 33
Side/taillight warning light	10	6-fig. 30
Main beam headlight warning light	10	2-fig. 30
Fog light warning light	20	fig. 31
Direction indicator warning light	15	13-fig. 30
Hazard light warning light	10	14-fig. 30
Rear fog light warning light	50	6-fig. 33
Instrument panel light	10	6-fig. 30
Digital clock light	10	6-fig. 30
Cigar lighter light	10	6-fig. 30
Window winder light	30	fig. 31
Fog light/rear fog light switch light	10	6-fig. 30
Hazard light control light	15	13-fig. 30
Heater control light	10	7-fig. 30
Manual climate control system light	10	7-fig. 30
Electric mirror control light	10	6-fig. 30

## Loads

Protected device	Ampere	Fuse number - Location
Ignition switch	50	6-fig. 33
Airbag	15	13-fig. 30
Fiat CODE	30	4-fig. 33
Fiat CODE	50	6-fig. 33
Door locking system	40	5-fig. 33
Door locking receiver	15	13-fig. 30
Door lock geared motors	20	fig. 31
Sound system power	15	12-fig. 30
ABS	60	7-fig. 33
Manual climate control system	30	5-fig. 30
Horn	20	11-fig. 30
Electric window winder system	40	5-fig. 33
Electric window winders	40	5-fig. 33
Electric window winder geared motors	30	fig. 31
Windscreen washer motor	20	10-fig. 30
Windscreen washer pump	20	10-fig. 30
Mirror adjustment device	15	13-fig. 30
Radiator fan (versions with heater)	30	3-fig. 33
Radiator fan (low speed) (versions with manual climate control system)	30	3-fig. 33
Radiator fan (high speed) (versions with manual climate control system)	30	2-fig. 33
Injection system	30	4-fig. 33



<b>Protected device</b>	<b>Ampere</b>	<b>Fuse - number - Location</b>
Instrument panel power	15	13-fig. 30
Digital clock power	15	12-fig. 30
Cigar lighter power	15	12-fig. 30
Hazard light repeater power	10	14-fig. 30
Hazard light repeater power	15	13-fig. 30
Window winder control unit power	30	fig. 31
Door locking receiver power	15	12-fig. 30
Door locking control unit power	20	fig. 31
Manual climate control system control unit power	20	9-fig. 30
Supplementary headlight relay power	40	5-fig. 33
Radiator fan relay	20	9-fig. 30
Manual climate control system compressor relay	20	9-fig. 30
Climate control system compressor relay energy	15	fig. 34
Phase variator solenoid valve	15	fig. 34
Radiator fan relay energy	7.5	fig. 34
Fuel pump relay energy	7.5	fig. 34
Lambda sensor	15	fig. 34
Cylinder position sensor	7.5	fig. 34
Interconnection control unit	60	1-fig. 33
Injection control unit	7.5	fig. 34
Injection control unit	7.5	fig. 34
Window winder control unit	15	13-fig. 30
Electronic alarm control unit	60	1-fig. 33
Fiat CODE control unit	7.5	fig. 34
Spare	-	15-fig. 30

## IF THE BATTERY IS FLAT

First of all, read the “Car maintenance” chapter for the steps to be taken to avoid the battery running down and to ensure it has a long life.

### RECHARGING THE BATTERY

You are advised to recharge the battery slowly for a period of approximately 24 hours at a very low amperage. Charging for too long could result in the battery being damaged.

Proceed as follows:

1) Disconnect the electrical system terminals from the battery posts.

**IMPORTANT** If the car is fitted with an electronic car alarm, use the remote control to turn the alarm off with the remote control and deactivate the system by turning the emergency key to “OFF” (see the “Electronic alarm” in the “Getting to know your car” section).

2) Connect the battery terminals to the charger.

3) Turn on the charger.

4) When you have finished, turn the charger off before disconnecting the battery.

5) Reconnect the cables to the battery posts. Make sure the polarity is correct.



#### WARNING

*The liquid in the battery is poisonous and corrosive. Do not let it touch the skin or eyes. Recharging the battery should be done in a well-ventilated area and away from naked flames or possible sources of sparks: explosion and fire risk.*

## JUMP STARTING

See “Jump starting” in this chapter.



#### WARNING

*Do not attempt to recharge a frozen battery. Thaw it first otherwise it could explode. If the battery froze, make sure the internal elements are not broken (short-circuit risk) and that the casing is not cracked (risk of spilling the poisonous and corrosive fluid).*



Under no circumstances should a battery charger be used to start the engine: it could damage the electronic systems and in particular, the control units governing ignition and fuel feed.

## IF THE CAR NEEDS TO BE RAISED

### WITH THE JACK

See “If a tyre is punctured”, in this chapter.



#### WARNING

*The jack is used solely for changing the wheels. It must not be used for any other purposes, for example lifting other cars. It must not be used for carrying out repairs under the car.*



#### WARNING

*The vehicle may fall if the jack is not positioned correctly. Do not use the jack to lift loads exceeding that indicated on the jack itself.*

Please note:

- the jack requires no adjustments;
- the jack cannot be repaired. If it breaks it must be replaced with a new jack;
- no tool, other than its handle, indicated in this chapter, can be fitted onto the jack.

## WITH A SHOP JACK

### Front end

The car may only be raised by placing the arm of the jack under the transaxle. Position a wooden or rubber block between them as shown in **fig. 35**.



fig. 35

## WITH AN ARM-TYPE HOIST

The car must be raised by placing the ends of the arms in the areas illustrated in **fig. 36**.

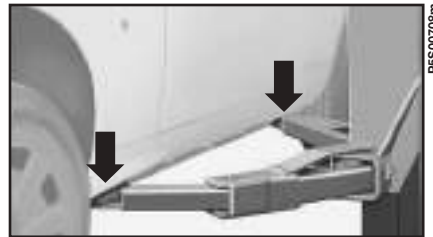

fig. 36



Be very careful that the arms of the jack do not force on the bodywork or the side trim. Adjust the jack arms correctly and if necessary insert a wooden or rubber block.

## IF THE CAR NEEDS TO BE TOWED

The tow ring supplied as an outfit together with the car is housed into the tool compartment under the luggage compartment coating carpet.

### Front tow

To fit the tow ring fully screw down the tow ring **fig. 37** into the threaded pin.

### Rear tow

To fit the tow ring proceed as follows:

- Take the tow ring from the tool compartment.



fig. 37

- Remove the small pressure fitted cover **A-fig. 38** on the rear bumper. Should the outfit flat tip screwdriver be used for this operation, it is necessary to protect the flat tip with a soft cloth, to avoid possible damage to the car.

- Fully screw down the tow ring on the threaded pin.



### WARNING

*Before screwing down the ring accurately clean the threaded pin. Before starting car towing, make sure whether the ring is fully screwed down.*



fig. 38



### WARNING

*Before starting to tow, turn the ignition key to **MAR** and back to **STOP** again without removing it. Removing the key automatically engages the steering lock resulting in the impossibility to steer the wheels. When towing remember that without the help of the engine brake and power steering greater effort is required on the pedal and steering wheel. Do not use flexible cables for towing and avoid jerks. During towing operations make sure that fastening the joint to the car does not damage the components in contact with it. When towing the car, it is compulsory to follow specific traffic regulations concerning both the towing device and behaviour on the road.*



### WARNING

*Do not start the engine when towing the car.*

## **IF AN ACCIDENT OCCURS**

- It is important to keep calm.
- If you are not directly involved in the accident stop at least ten metres away from the accident.
- If you are on a motorway, do not obstructing the emergency lane with your car.
- Turn off the engine and turn on the hazard lights.
- At night, illuminate the scene of the accident with your headlights.
- Act carefully, you must not risk being run over.
- Mark the accident by putting the red triangle at the prescribed distance from the car where it can be clearly seen.
- Call for rescue making the information you give as accurate as you can. On the motorway, use one of the special column-mounted emergency phones.

– In pile-ups on the motorway, particularly when the visibility is bad, there is a high risk of other vehicles running into those already immobile. Get out of the vehicle immediately and take refuge behind the guard rail.

– Remove the ignition keys of the vehicles involved.

– If you can smell petrol or other chemicals, do not smoke and make sure all cigarettes are extinguished.

– Use a fire extinguisher, blanket, sand or earth to put out fires no matter how small they are. Never use water.

## **IF ANYONE IS INJURED**

– Never leave the injured person alone. The obligation to provide assistance exists even for those not directly involved in the accident.

– Do not congregate around the injured person.

– Reassure the injured person that help is on its way and will arrive soon. Stay close by to calm him/her down should they panic.

– Unfasten or cut seat belts holding injured parties.

– Do not give an injured person anything to drink.

– Never move an injured person except in the following cases.

– Pull the injured person from the car only if it risks catching fire, is sinking in water, is likely to fall from a height or similar. Do not pull his/her arms or legs, do not bend the head and, as far as possible, keep the body flat.

## FIRST-AID KIT

The first-aid kit must at least contain **fig. 39**:

- sterile gauze for covering and cleansing wounds
- bandages of different widths
- antiseptic plasters of different sizes
- a roll of plaster
- a packet of cotton wool
- a bottle of disinfectant
- a packet of paper handkerchiefs
- a pair of scissors with rounded tips
- a pair of tweezers
- two haemostatic loops.

It is a good idea to keep a fire extinguisher and blanket in the car in addition to the first-aid kit.

The first-aid kit and the fire extinguisher are included in the Lineaccessori Fiat range.



fig. 39

# CAR MAINTENANCE

The Fiat barchetta is brand new throughout, even in its service schedule. For example: the first service schedule coupon is to be used at 20,000 km making the traditional check at 1,500 km unnecessary. You should however remember that your car needs routine maintenance such as systematic checking of the fluid level and tyre pressure, and any necessary topping up.

You should nonetheless bear in mind that proper car maintenance is certainly the best way to keep your car in tip-top condition for years to come and safeguard its safety features, its environmentally-friendly nature and its low running costs.

Also remember that following the servicing regulations marked with the symbol  $\triangle$  as specified might be essential to ensuring the warranty remains valid.

SCHEDULED SERVICING .....	112
SERVICE SCHEDULE .....	113
ANNUAL INSPECTION SCHEDULE .....	115
ADDITIONAL OPERATIONS .....	115
CHECKING FLUID LEVELS .....	117
AIR CLEANER .....	122
POLLEN FILTER .....	123
BATTERY .....	123
ELECTRONIC CONTROL UNITS .....	125
SPARK PLUGS .....	126
WHEELS AND TYRES .....	126
RUBBER TUBING .....	128
WINDSCREEN WIPER .....	128
MANUAL CLIMATE CONTROL SYSTEM .....	130
BODYWORK .....	130
HOOD .....	133
INTERIORS .....	133



## SCHEDULED SERVICING

Correct maintenance of the car is essential for ensuring it stays in tip-top condition for a long time to come.

For this reason, Fiat has designed a series of checks and maintenance interventions every 20,000 km.

**IMPORTANT** The Manufacturer requires the Service Schedule coupon-related checks to be carried out. Failure to do so could result in the warranty being cancelled.

Scheduled Servicing is performed at all **Fiat Dealerships** and at pre-established times.

If it is seen that further replacements or repairs are necessary in addition to the work being carried out, these will only be done after the Customer has given his/her consent.

**IMPORTANT** You are recommended to get in touch with the **Fiat Dealership** immediately if any small running problems crop up, without waiting for the next coupon.



**If the car is frequently used to tow trailers, increase the frequency of scheduled operations.**

# SERVICE SCHEDULE

Use these coupons either every 20,000 km.

Thousands of km	20	40	60	80	100	120	140	160	180
Check tyre conditions/wear and check pressure, if required	●	●	●	●	●	●	●	●	●
Check complete light system operation (headlights, direction indicators, hazard lights, boot lights, passenger compartment lights, oddment compartment lights, instrument panel warning lights, etc.)	●	●	●	●	●	●	●	●	●
Check windscreen wiper/washer system and adjust nozzles	●	●	●	●	●	●	●	●	●
Check front wiper blade wear	●	●	●	●	●	●	●	●	●
Check front disc brake wear indicator operation	●	●	●	●	●	●	●	●	●
Check rear disc brake conditions and wear		●		●		●		●	
Visually inspect: conditions of underbody protection, piping (exhaust - fuel feed - brakes), rubber parts (boots - sleeves - bushings, etc.), brake hoses and fuel lines	●	●	●	●	●	●	●	●	●
Visually inspect belt drives		●		●		●		●	
Check handbrake stroke		●		●		●		●	

Thousands of km	20	40	60	80	100	120	140	160	180
Check evaporation system				●				●	
Replace air cleaner cartridge		●		●		●		●	
Top up fluid level (engine coolant, brakes, windscreen washer, battery, etc.)	●	●	●	●	●	●	●	●	●
Check timing belt conditions			●						●
Replace timing belt (*)						●			
Replace spark plugs		●		●		●		●	
Check engine control systems (via diagnostic socket)		●		●		●		●	
Check gearbox/differential oil level				●				●	
Change engine oil	●	●	●	●	●	●	●	●	●
Replace engine oil filter	●	●	●	●	●	●	●	●	●
Change brake fluid (or every two years)			●			●			●
Replace pollen filter (or every year)	●	●	●	●	●	●	●	●	●
Top: check opening/closing operation and lubricate joints, visually inspect seals, check adherence of windows with top seal and adjust, if required	●	●	●	●	●	●	●	●	●

(\*) Or every 3 years for heavy duty uses (cold-hot climates, long idling urban use, use on roads that are specially dusty or covered with sand and/or salt)  
Or every 5 years independently from mileage.

## ANNUAL INSPECTION SCHEDULE

The following annual inspection schedule is required for cars travelling less than 20,000 km a year (e.g. approximately 10,000 km). The schedule includes the following operations:

- Check tyre condition and wear and adjust pressure, if required (including spare-saver spare wheel).
- Check operation of lights (headlights, direction indicators, hazard lights, boot light, passenger compartment ceiling light, glove compartment light, instrument panel lights, etc.).
- Check windscreen wiper/washer and adjust nozzles.
- Check position wear of windscreen window wiper blades.

- Check rear brake pad conditions and wear.

- Inspect conditions of engine, gearbox, transmission, piping (exhaust - fuel feed - brakes), rubber parts (boots - sleeves - bushings - etc.), brake and fuel line hoses.

- Check battery charge status.

- Check conditions of various control belts.

- Check and top up fluid levels (engine coolant, brakes, windscreen washer, battery, etc.).

- Change engine oil.

- Replace engine oil filter.

- Replace pollen filter (where fitted).

## ADDITIONAL OPERATIONS

**Every 1,000 km** or before long trips, check and top up as necessary:

- coolant level
- brake fluid level
- power steering fluid level
- electrolyte level
- windscreen washer liquid level
- tyre condition and pressure.

We advise you to use **FL Selenia** products, which have been designed and produced expressly for the Fiat vehicles (see the table “Capacities” given in the “Technical specifications” section).

**Every 3,000 km** check and top up as necessary: engine oil level.

## **IMPORTANT - Engine oil**

Change the engine oil more frequently than specified in the Service Schedule if the vehicle is mainly used under one of the following particularly severe conditions:

- towing a trailer or caravan
- on dirt roads
- short, repetitive trips (less than 7 or 8 kilometres) in outside temperatures below zero.
- engines that are frequently left to idle or drive slowly over long distances.

## **IMPORTANT - Air cleaner**

If you drive your car on dirt roads change the air cleaner more frequently than specified in the Service Schedule.

If you are in doubt about how often the engine oil or the air cleaner should be changed in relation to how you use the car, contact a **Fiat Dealership**.

## **IMPORTANT - Pollen filter**

If the car is often used in dusty or extremely polluted environments, you should change the filter element more frequently. It should be changed especially if the amount of air introduced into the passenger compartment is reduced.

## **IMPORTANT - Battery**

You should check the status of the battery charge preferably at the beginning of the cold season to avoid the possibility of the electrolyte freezing.

This check should be carried out more frequently if the vehicle is mainly used for short trips, or if it is fitted with accessories that permanently absorb electricity even with the ignition key removed, especially in the case of after market accessories.

You should check the battery fluid (electrolyte) level more frequently than shown in the Service Schedule if the car is used in hot climates or particularly demanding conditions.



**Maintenance of your car should be entrusted to a Fiat Dealership. For interventions of routine maintenance and small repairs you wish to carry out yourself, make sure you always have the proper equipment, genuine Fiat spare parts and fluids available. Do not, carry out these operations if you have no experience.**

# CHECKING FLUID LEVELS



## WARNING

*Do not smoke while working in the engine compartment: the presence of flammable gas and vapour could cause a fire.*



**Be careful not to mix up the various types of fluids when you are topping up: they are all mutually incompatible and could damage the vehicle.**

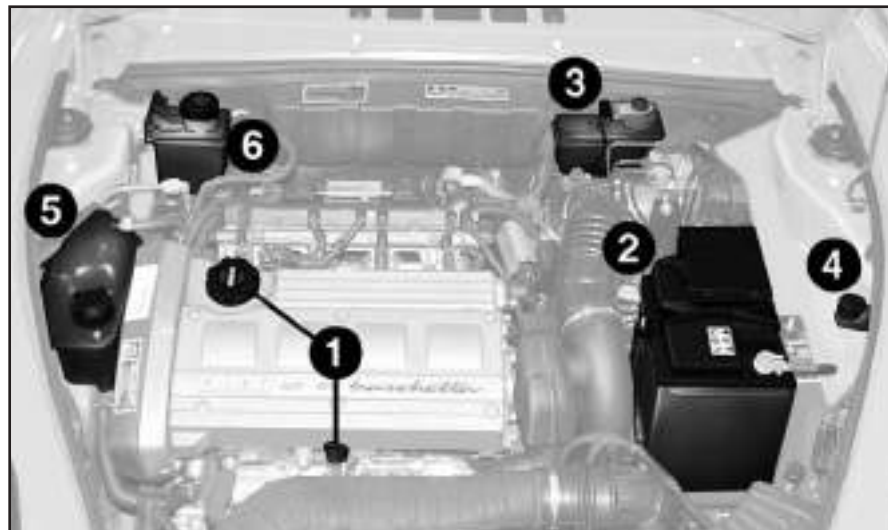

PST0099m

fig. 1 - 1. Engine oil - 2. Battery - 3. Brake fluid - 4. Windscreen washer fluid - 5. Engine coolant - 6. Power steering fluid.

## ENGINE OIL fig. 2

Check the oil level a few minutes (approx. 5) after the engine has stopped with the vehicle parked on level ground.

The oil level must be between the **MIN** and **MAX** marks on the dipstick.

The space between **MIN** and **MAX** corresponds approximately to half a litre of oil.



fig. 2



### WARNING

*If the engine is hot, be very careful when you put your hands under the bonnet as you risk burning yourself. Remember that while the engine is hot, the electric fan can start up and cause injury.*



### WARNING

*Scarves, ties and loose clothing may be caught in the moving parts.*

If the oil level is near or even below the **MIN** mark, pour in oil through the filler hole until it reaches the **MAX** mark.

The oil level must never exceed the **MAX** mark.

## ENGINE OIL CONSUMPTION

When the vehicle is new, the engine has to be run in; engine oil consumption can only be considered stable after travelling 5,000 to 6,000 km.

**IMPORTANT** Oil consumption depends on driving style and the conditions the car is driven in.



**Do not add oil with different specifications from the oil already in the engine.**

**IMPORTANT** After adding or changing the oil, let the engine turn over for a few seconds and wait a few minutes after turning it off before you check the level.



**Used engine oil and replaced oil filters contain substances that can harm the environment. We recommend you have the car seen to at a Fiat Dealership for the oil and filter change. It is suitably equipped for disposing of used oil and filters in an environmentally-friendly way that complies with the law.**

## ENGINE COOLANT SYSTEM fig. 3



### WARNING

***Do not take the cap of the reservoir off when the engine is very hot as you run the risk of scalding yourself.***

The coolant level must be checked while the engine is cold and must not be below the **MIN** mark on the reservoir.

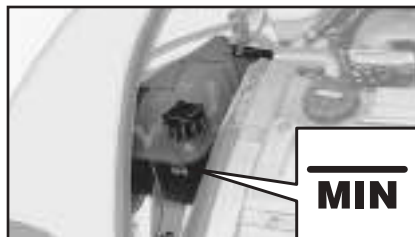

fig. 3

If there is not enough coolant, pour a 50-50 mixture of distilled water and a **PARAFLU<sup>II</sup>** liquid of **FL Selenia** slowly through the filler hole in the reservoir.

A 50-50 mixture of **PARAFLU<sup>II</sup>** and distilled water gives freeze protection to  $-35^{\circ}\text{C}$ .



### WARNING

***The cooling system is under pressure. When changing the cap, use only genuine spare parts to avoid damaging the system.***



## WINDSCREEN WASHER LIQUID fig. 4

To add liquid, take the cap off and pour in a mixture of water and **TUTELA PROFESSIONAL SC 35**, liquid in these proportions:

– 30% **TUTELA PROFESSIONAL SC 35** and 70% water in summer.

– 50% **TUTELA PROFESSIONAL SC 35** and 50% water in winter.

If the temperature falls below  $-20^{\circ}\text{C}$ , use **TUTELA PROFESSIONAL SC 35** undiluted.

**IMPORTANT** Do not travel with the windscreen washer bottle empty: using the windscreen washer is fundamental for improving visibility.



**WARNING**  
*Some windscreen washer additives on the market are flammable. The fluid could ignite if it comes into contact with hot parts in the engine compartment.*

## POWER STEERING FLUID fig. 5

Check the oil level is between the **MIN** and **MAX** marks on the dipstick attached to reservoir cap when the engine is cold and the car is on level ground.

Before checking, clean the dipstick, screw the cap tightly onto the reservoir, unscrew it again and check the level.

When the oil is hot the level may exceed the **MAX** mark.

If necessary, add oil making sure that it has the same specifications as the oil in the reservoir.

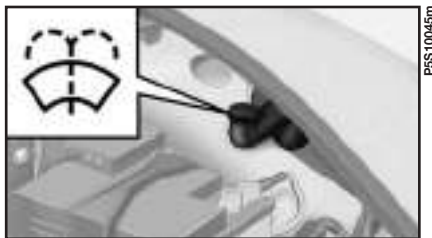

fig. 4

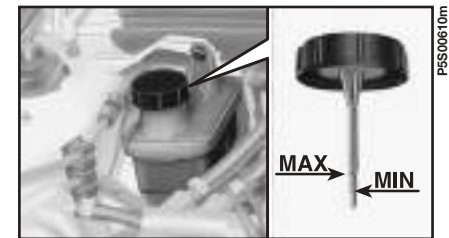

fig. 5



### WARNING

*Make sure the power steering fluid does not come in contact with the hot parts of the engine as it catches fire very easily.*



Oil consumption is extremely low: if it needs topping up after travelling only a short while, have the system checked for leaks at a Fiat Dealership.

### BRAKE FLUID fig. 6

From time to time check the instrument panel warning light by pressing the reservoir cover (with the ignition key at **MAR**): instrument warning panel light (Ⓢ) should come on.

On versions fitted with ABS, the brake fluid reservoir is positioned as shown in **fig. 6**; while on versions without ABS, the reservoir is positioned lengthwise.



fig. 6

The level of the fluid in the reservoir must not exceed the **MAX** mark.

If you need to add fluid, only use the type classified DOT 4. You are advised in particular to use **TUTELA TOP 4** with which the braking system was originally filled.



**Make sure the highly corrosive brake fluid does not drip onto the paintwork. If it does, wash it off immediately with water.**



### WARNING

*Brake fluid is poisonous and very corrosive. In the event of accidental contact, wash the effected part with water and mild soap and rinse. If the fluid is swallowed, call a doctor immediately.*



### WARNING

*The symbol  on the container indicates synthetic type brake fluid distinguishing it from the mineral kind. Using mineral type fluids damages the special rubber braking system gaskets beyond repair.*

**IMPORTANT** Brake fluid is hygroscopic (meaning it absorbs humidity). This is why the fluid should be changed more frequently than shown in the Service Schedule if the car is mainly driven in areas with a high percentage of humidity in the air.

## AIR CLEANER

### REPLACEMENT fig. 7

Unscrew knob **A**, remove the cap and pull out the filter element **B** to be replaced.

Have the filter element replaced at a **Fiat Dealership**.

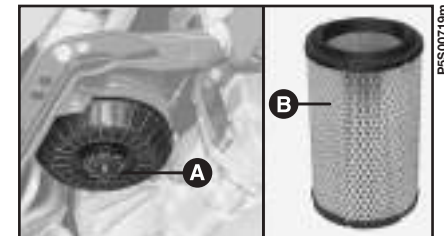

fig. 7

## POLLEN FILTER (where fitted)

Have the filter changed at the frequency specified in the Service Schedule.

Have the change made at a **Fiat Dealership**.

**IMPORTANT** If the car is often used in dusty or extremely polluted environments, you should change the filter more frequently. It should be changed especially if the amount of air introduced into the passenger compartment has decreased.

## BATTERY

The Fiat barchetta's battery is of the "Limited Maintenance" type: under normal conditions, it requires no topping up with distilled water.

The level of the battery liquid (electrolyte) should be between the two marks on the battery when the car is parked on level ground.

**If the level is lower than the MIN mark fig. 8 have the car seen to at a Fiat Dealership.**



**Running the battery on low electrolyte can damage the battery beyond repair, crack the casing and spill all the liquid.**

For the recharging of the battery, see the "In an emergency" section.



### WARNING

*The liquid in the battery is poisonous and corrosive. Do not let it touch the skin or eyes. Do not bring naked flames or possible sources of sparks near to the battery: fire and explosion risk.*



**If the vehicle is to stand for a long time in the cold, remove the battery and store it in a warm place to avoid it freezing.**

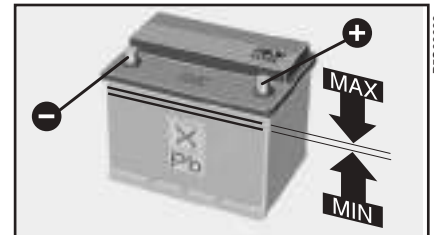

fig. 8



### WARNING

*Do not attempt to recharge a frozen battery. Thaw it first otherwise it could explode. If the battery froze, make sure the internal elements are not broken (short-circuit risk) and that the casing is not cracked (risk of spilling the poisonous and corrosive fluid).*



**Batteries contain substances that are very harmful for the environment. You are advised to have the battery changed at a Fiat Dealership. It is properly equipped for disposing of used batteries in an environmentally-friendly way that complies with the law.**



**Incorrect fitting of electrical and electronic accessories can seriously damage the car.**

### USEFUL ADVICE FOR LENGTHENING THE LIFE OF YOUR BATTERY

When you park the car, ensure the doors, boot and bonnet are closed properly. The courtesy light must be off.

Do not keep accessories (e.g. radio, hazard lights etc.) switched on for a long time when the engine is not running.

**IMPORTANT** A battery which is kept at a charge of less than 50% for any length of time will be damaged by sulphation leading to a reduction in cranking power and a higher risk of the battery electrolyte freezing (this may even occur at  $-10^{\circ}\text{C}$ ).

If the car is inactive for a long period of time, refer to “Storing the car” in the “Driving your car” chapter.

If, after purchasing your car you would like to add electrical accessories that require a permanent power supply (alarm systems, hands-free phone, radio navigator with satellite anti-theft system, etc.), visit a **Fiat Dealership**. The staff of experts, besides suggesting the most suitable accessories in the Lineaccessori range, will also check whether the car electrical system can support the required load or if a larger size battery needs to be installed.

These devices will, in fact, run off the battery even when the key is not inserted (car parked) and can deploy the battery.

The total intake of these systems (factory and after-market) must be less than  $0.6 \text{ mA} \times \text{Ah}$  (of the battery) as shown in the following table:

Battery	Maximum admitted stand-by intake
50Ah	30 mA

Furthermore, remember that high intake electric devices (such as baby bottle warmers, vacuum cleaners, cellular phones, mini-fridges, etc.) **powered when the engine is off** can run the battery down.

**IMPORTANT** If you need to install added systems to the car, improper wiring connections, in particular if they affect safety devices, are dangerous.

## ELECTRONIC CONTROL UNITS

When the car is being used normally, special measures are not necessary.

The following instructions must be followed very carefully however, if you work on the electrical system or in cases where starting with another battery is necessary:

- Never disconnect the battery from the electrical system while the engine is running.
- When recharging, disconnect the battery from the wiring system. The latest battery chargers can, in fact, generate voltages of up to 20V.
- Never start the engine with a battery charger. Always use another battery.
- Be particularly careful when connecting the battery to the electrical system. Ensure the battery posts are connected up to the right leads (the polarity is correct) and check that the connection has been made properly.

– Do not connect or disconnect the terminals of the electronic units while the ignition key is at **MAR**.

– Do not check polarity through sparking.

– Disconnect the electronic units if you are electrically welding the car body. Remove the units if temperatures exceed  $80^{\circ}\text{C}$ . (special operations on the bodywork etc.)

**IMPORTANT** If the radio or car alarm systems are not installed correctly, they can interfere with the working of the electronic control units.



### WARNING

**Modifications or repairs to the electrical system carried out incorrectly and without bearing the features of the system in mind can cause malfunctions with the risk of fire.**

## SPARK PLUGS

The cleanness and soundness of the spark plugs **fig. 9** are very important for keeping the engine efficient and polluting emissions down.

The appearance of the spark plug, if examined by an expert eye, is a good way of pin-pointing a malfunction even if it has nothing to do with the ignition system. Therefore, if the engine has problems, it is important to have the spark plugs checked at a **Fiat Dealership**.



fig. 9



The spark plugs must be changed at the times specified in the **Service Schedule**. **Only use the type of plugs indicated: if the heat ratio is less than required or the life specified is not guaranteed, problems can arise.**

	Spark plug (type)
Champion	RC10YCC
NGK	BKR6EZ

## WHEELS AND TYRES

### TYRES PRESSURE

Every two weeks and before long journeys, check the pressure of each tyre including the spare.

The pressure must be checked when the tyre is rested and cold.

It is normal for the pressure to rise when you are driving. If you have to check or restore the pressure when the tyres are warm remember that the pressure value must be 0.3 bar above the specified value.



### WARNING

**Tyre pressure must be correct to ensure good road holding.**

Wrong pressure causes uneven wear of the tyres **fig. 10**:

**A** - Correct pressure: tyre wears evenly.

**B** - Underinflated tyre: shoulder tread wear.

**C** - Overinflated tyre: centre tread wear.

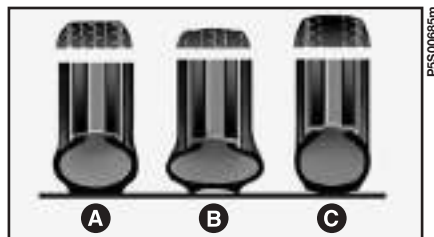
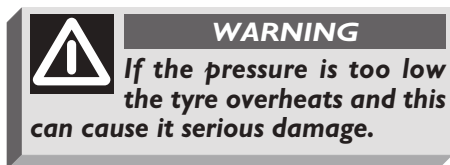

fig. 10

Tyres must be replaced when the tread wears down to 1.6 mm. Comply with the laws in the country where the car is being driven.

### IMPORTANT

As far as possible avoid sharp braking and screech starts.

Be careful not to hit the pavement, potholes or other obstacles hard. Driving for long stretches over bumpy roads can damage the tyres.

Periodically check that the tyres have no cuts in the side wall, abnormal swelling or irregular tyre wear. If any of these occur, have the car seen to at a **Fiat Dealership**.

Avoid travelling with an overloaded car: this can seriously damage wheels or tyres.

If you get a flat tyre, stop immediately and change it so as not to damage the tyre, the wheel, the suspension and the steering.

Tyres age even if they are not used very much. Cracking of the tread rubber and the side-walls are a sign of this ageing. In any case, if the tyres have been fitted for more than six years they should be examined by an expert who can judge whether they are still fit for use. Remember to check the spare tyre particularly carefully too.

If a replacement is necessary, always use new tyres and avoid using ones the origin of which you are not certain about.

The Fiat barchetta uses Tubeless tyres. Under no circumstances use an inner tube with these tyres.

If you replace a tyre it is a good idea to change the inflation valve, too.



To ensure the front and rear tyres all wear evenly, you are advised to change the tyres over every 10-15 thousand kilometres (6-10 thousand miles) keeping them on the same side of the car so as not to reverse the direction of rotation.



#### **WARNING**

*Do not change the tyres over in criss-cross fashion by moving a tyre from the left hand side of the car to the right and vice versa.*

## **RUBBER TUBING**

Follow the Service Schedule carefully in the case of the braking, power steering and fuel supply systems' rubber hoses. Ozone, high temperatures and long absence of liquid in the system can in fact cause the hardening and cracking of the hoses with possible losses of fluid. A careful check is therefore essential.

## **WINDSCREEN WIPER**

### **BLADES**

Periodically clean the rubber part with suitable liquid; **TUTELA PROFESSIONAL SC 35** is recommended.

Change the blades if the rubber edge is warped or worn out. You should in any case change them approximately once a year.



#### **WARNING**

*Travelling with worn wiper blades is dangerous because it reduces visibility in bad weather.*

Some simple steps can reduce potential damage to the blades:

– If the temperature falls to below zero, make sure the rubber blade is not frozen to the windscreen. If necessary, free it with a de-icing compound.

– Remove any snow that has settled on the glass: besides saving the blades you will avoid straining the electric windscreen wiper motor and causing it to overheat.

– Do not operate the windscreen wipers on dry glass.

### Changing the windscreen wiper blade fig. 11

1) Lift windscreen wiper arm **A** and position the blade to form a right angle with the arm.

2) Press tab **B** of the coupling spring and remove the blade to be replaced from the arm.

3) Fit the new blade by inserting the tab into the special hole in the arm. Make sure it is locked into place.

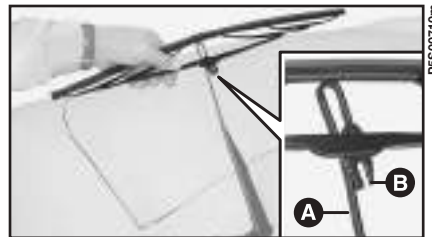

fig. 11

### SPRAY NOZZLES

If there is no jet of liquid, first make sure that there is liquid in the reservoir: see “Checking fluid levels” in this chapter.

Then make sure that the holes in the nozzles **fig. 12** are not clogged up. Use a pin for this if necessary.

The jets of the windscreen washer are directed by adjusting the nozzles in such a way that the jets are directed at the highest point reached by the wiper blades when operating.

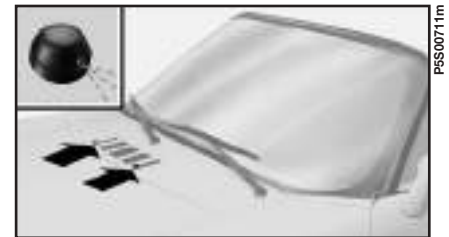

fig. 12

## MANUAL CLIMATE CONTROL SYSTEM (where fitted)

During the winter, the climate control system must be turned on at least once a month for about ten minutes.

Have the system checked at a **Fiat Dealership** before the summer.



**The system uses R134a refrigerating liquid. If it accidentally leaks it will not damage the environment. Under no circumstances should R12 fluid be used. Besides being incompatible with the system's components, it contains chlorofluorocarbides (CFC).**

## BODYWORK

### PROTECTING THE CAR FROM ATMOSPHERIC AGENTS

The main causes of rust are:

- atmospheric pollution
- salt and humidity in the atmosphere (seaside or very hot and humid areas)
- environmental conditions that are specific to the season.

In addition, the abrasiveness of dust in the atmosphere and sand carried by the wind as well as mud and stones kicked up by other vehicles must not be underestimated.

For your Fiat barchetta, Fiat has used leading-edge technological solutions to effectively protect the body from rust.

These are the main ones:

- Painting systems and products that make the car particularly resistant to rust and scratching.
- The use of zinc-plated (or pre-treated) sheet steel which is highly resistant to rust.
- The spraying of the underbody, engine compartment, inside the wheel-arches and other parts with wax-based products with a high protective capacity.
- Spraying plastic-coating materials for protecting the most exposed points: under the door, inside the wings, the edges etc.
- The use of “open” box sections to prevent condensation and water from building up and rusting the inside of the parts.

## BODY AND UNDERBODY GUARANTEE

The Fiat barchetta is covered guarantee against any original structural or body part being holed by rust. Refer to the “Warranty Booklet” for the general conditions of this guarantee.

## TIPS FOR KEEPING THE BODY IN GOOD CONDITION

### Paintwork

The paintwork is not only to make your car look attractive but also to protect the steel.

If your car is scuffed or scratched deeply you are therefore recommended to touch up the paintwork as necessary to prevent rust from forming.

Only use genuine products when touching up the paintwork (see the “Technical Specifications” chapter).

Ordinary maintenance of the paintwork consists in washing it. The frequency you should do this depends on the conditions and the environment the car is driven in. For example, if you drive in areas with a high level of air pollution or on roads sprinkled with road salt, it is a good idea to wash the car more often.



**Detergents pollute water. For this reason, the car must be washed in an area equipped for the collection and purification of the liquids used while washing.**

To wash the car properly:

- 1) Soak the body using a low pressure jet of water.
- 2) Wipe a sponge with a slightly soapy solution over the body, frequently rinsing the sponge.
- 3) Rinse well with water and dry with a jet of air or a chamois leather.

When drying the car, be careful to get at those parts which are not so easily seen e.g. the door frames, bonnet and around the headlights where water can most readily collect. You are advised not to take the car into a closed area immediately but to leave it out in the open so any water left can evaporate more easily.

Do not wash the car after it has been parked in the sun or while the bonnet is hot: it could take the shine off the paint.

Outside plastic parts must be cleaned following the usual car washing procedure.

Avoid parking your car under trees; the resinous substances that often drop will dull the paintwork and increase the possibility of corrosion.

**IMPORTANT** Bird droppings must be washed off immediately and with great care as their acid is particularly aggressive.

## Windows

Use specific window cleaners to clean the windows. Use very clean cloths to avoid scratching the glass or damaging its transparency.

## Engine compartment

At the end of each winter season, carefully clean the engine compartment. Have this done at a garage.



**Detergents pollute water. The car must therefore be washed in an area equipped for the collection and purification of the liquids used while washing.**

**IMPORTANT** The car should be washed while the engine is cold and with the ignition key at **STOP**. After washing the car, make sure that the various protections (e.g. rubber boots and various guards) have not been removed or damaged.

## HOOD

Normal maintenance of the hood consists in washing it.

Dust the hood off before washing it. Dirt must be removed using an appropriate cleaning compound; then rinse thoroughly using a low pressure hose.



You are advised to wash the hood by hand. When washing a car in an automatic car wash, the rotating brushes exert a strong pressure on the surface of the hood that could damage it and scratch the rear window. In addition, the cleaning compounds and additives could have a negative effect and spoil the hood's appearance.

**IMPORTANT** Do not use petrol, stain removers, benzol, paint thinners or solvents to remove dirt marks; only use products designed for the purpose. If the marks still will not come out, see a **Fiat Dealership**.

## REAR WINDOW

This window can be replaced; contact a **Fiat Dealership** to have this done.

When cleaning the rear window be particularly careful to avoid scratches or scuffs that could spoil its appearance.

## INTERIORS

From time to time, check that water has not collected under the mats (from dripping shoes, umbrellas etc.) which could cause the steel to rust.



### WARNING

*Never use flammable products (petroleum ether or petrol) to clean the inside of the car. Electrostatic charges generated by rubbing while cleaning could cause fires.*

## CLEANING THE SEATS AND FABRIC UPHOLSTERY

- Remove the dust with a soft brush or a vacuum cleaner.
- Rub the seats with a rag moistened in a solution of water and neutral detergent.

## CLEANING LEATHER SEATS

- Remove the dry dirt with a buckskin or very slightly moist cloth without exerting too much pressure.
- Remove liquid or grease stains with a dry absorbent cloth without rubbing. Then wipe with a buckskin or soft cloth moistened with water and neutral soap.

If the stain does not come out, use a special cleaning compound being particularly careful to follow the instructions for use.

**IMPORTANT** Never use alcohol or alcohol-base products.

## PLASTIC PARTS INSIDE THE CAR

Use special products designed not to alter the appearance of the components.

**IMPORTANT** Do not use alcohol or petrol for cleaning the glass of the instrument panel.



### WARNING

*Do not keep aerosol cans in the car. There is the risk they might explode. Aerosol cans must never be exposed to a temperature above 50°C. The temperature inside the car might go well beyond that figure if the car is exposed to the sun.*

# TECHNICAL SPECIFICATIONS

**M**otor and engineering enthusiasts as well as those “in the trade” will probably start reading from this point in the manual. This, in fact, is where a section jam-packed with facts, figures, formulae, measurements and tables begins. In a sense it is the Fiat barchetta’s identity card. A document that introduces the car and explains in technical jargon all the features that go together to make the Fiat barchetta a model designed to give you superlative driving satisfaction.

IDENTIFICATION DATA .....	136
ENGINE CODE - BODY VERSION .....	137
ENGINE .....	137
TRANSMISSION .....	139
BRAKES .....	139
SUSPENSIONS .....	140
STEERING .....	140
WHEEL GEOMETRY .....	140
PERFORMANCE .....	140
WHEELS .....	141
DIMENSIONS .....	142
WEIGHTS .....	143
CAPACITIES .....	144
FLUIDS AND LUBRICANTS .....	145
FUEL CONSUMPTION .....	147
CO <sub>2</sub> EMISSIONS .....	147
TYRES PRESSURE .....	148



# IDENTIFICATION DATA

## CHASSIS MARKING fig. 1

This is stamped on the passenger cabin floor pan near the right-hand front seat and includes:

- vehicle model ZFA 183000
- chassis serial number.

## ENGINE MARKING fig. 2

Marking **A** is stamped on the cylinder block and includes the model and serial number.

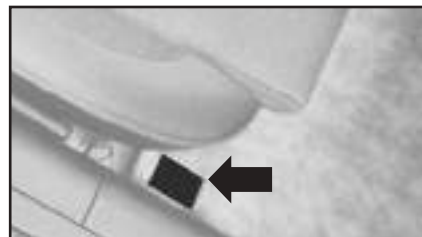

fig. 1

## MODEL PLATE fig. 3

The plate shows the following identification data:

- A** - Manufacturer's name
- B** - Homologation number
- C** - Vehicle ID code
- D** - Chassis serial number
- E** - Maximum vehicle weight fully laden
- F** - Maximum train weight (fully-laden vehicle plus trailer)
- G** - Maximum vehicle weight on first (front) axle
- H** - Maximum vehicle weight on second (rear) axle
- I** - Engine model code
- L** - Body version code
- M** - Number for spares
- N** - Smoke opacity index (for diesel engines)



fig. 2

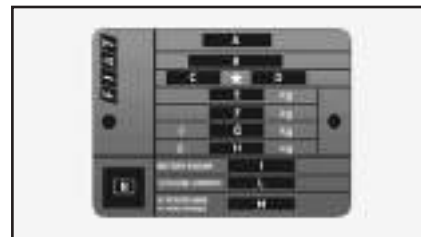

fig. 3

## PAINT IDENTIFICATION PLATE fig. 4

The plate is fastened to the inside of the hood seat cover.

It bears the following data:

- A** - Paint manufacturer
- B** - Colour name
- C** - Fiat colour code
- D** - Respray and touch-up code



fig. 4

## ENGINE CODE - BODY VERSION

Engine type code	Body version code
188A6.000	183SB1AA 01

## ENGINE

### GENERAL FEATURES

Engine Code		188A6.000
Cycle		Otto
Number and layout of cylinders		4 in line
Number of valves per cylinder		4
Bore x stroke	mm	82.0x82.7
Capacity	cm <sup>3</sup>	1747
Compression ratio		10.3 ± 0.15
Maximum power output (EEC)	kW	96
	HP	130
	at rpm	6300
Peak torque (EEC)	Nm	158
	m.kg	16.7
	at rpm	4300

## FUEL SUPPLY/IGNITION

Integrated electronic injection and ignition system: a single electronic control unit controls both functions. It processes both the time the injection lasts (for fuel metering) and the ignition's advance angle.

Type: Sequential in phase Multipoint

Air cleaner: dry-type with paper filter element; thermostatically controlled intake.

Petrol pump: in-tank.

Injection pressure: 3 bar

Method of measuring the amount of aspirated air by directly measuring the maximum rate of flow with a hot wire air flow meter.

“Closed loop” petrol metering (information about combustion provided by the Lambda sensor).

Firing order: 1-3-4-2

Spark plugs:

- Champion RC10YCC
- NGK BKR6EZ



## LUBRICATION

Forced-fed with gear pump with pressure relief valve incorporated.

Oil purification by means of full-flow-cartridge filter.

## COOLING

Cooling system with radiator, centrifugal pump and expansion tank.

“Controlled” by-pass type thermostat on the secondary circuit for the recirculation of water from the engine to the radiator.

Electric fan for radiator cooling with thermostatically-controlled on/off switch on the radiator.

## TRANSMISSION

### CLUTCH

Self-adjusting with no pedal free travel.

### GEARBOX

Five forward speeds and reverse with synchromesh for forward gear engagement.

## BRAKES



### WARNING

*Water, ice and salt sprinkled on the roads can deposit on the brake discs and reduce the effectiveness braking the first time they are used.*



### WARNING

*Be careful when fitting spoilers, alloy rims and after-market wheel caps: they could reduce ventilation and effectiveness in the event of abrupt and repeated braking or when driving down hill for a long time.*

## SERVICE AND EMERGENCY BRAKES

Front: disc, floating calliper type with a master cylinder for each wheel.

Rear: disc type with floating calliper.

Cross-over hydraulic circuit control.

8" vacuum servo brakes.

Four-channel, four-sensor ABS system (where fitted).

Automatic take up of clearance due to friction lining wear.

Electronic brake corrector (EBD system).

### HANDBRAKE

Controlled by a lever working mechanically on the rear brake callipers.

## SUSPENSIONS

### FRONT

Independent wheel, MacPherson-type with ferritic cast-iron wishbone anchored to an auxiliary cross-member.

Off-set coil springs and double-action telescopic gas dampers.

Anti-roll bar.

### REAR

Independent wheels with spheroidal cast-iron wishbones.

Coil springs and gas dampers with vulcanised bushings.

Anti-roll bar.

Auxiliary rigid H-shaped frame consisting of a tubular cross structure and two pressed steel long members welded to it.

## STEERING

Energy-absorbing jointed steering column with rake adjustment system.

Permanently lubricated rack and pinion control.

Hydraulic power steering.

Permanently lubricated joints.

Minimum turning circle: 10.5 metres.

Number of steering wheel turns lock to lock: approx. 2.5.

## WHEEL GEOMETRY

Wheel toe-in measured from rim to rim:  $0 \pm 1$  mm.

The figures refer to the car in full running order.

## PERFORMANCE

Maximum speeds after running in, in km/h:

1 <sup>st</sup>	2 <sup>nd</sup>	3 <sup>rd</sup>	4 <sup>th</sup>	5 <sup>th</sup>	Reverse
55	97	143	188	More than 200	55

# WHEELS

## RIMS AND TYRES

Pressed steel or alloy wheels (where applicable), specific bolts (of a different size and reciprocally incompatible) for each of the two types of rim.

Tubeless tyres with radial shell.

Rim	Tyre
6 1/2 J x15"	195/55 R15 (84V)
6 1/2 J x16"	195/45 R16 (80V)
6 J x15"	185/55 R15 (81H) specific for use with snow chains

## SPARE WHEEL

Pressed-steel rim.

Tubeless tyre.

Rim	Tyre
4.00 Bx14H	135/80 B14

All homologated tyres are listed in the Vehicle's Registration Papers. To ensure safe driving, make sure that the tyres are not only of the specified dimensions but that all four tyres are of the same type and make.

**IMPORTANT** Do not use an inner tube with Tubeless tyres. Do not secure light alloy wheels using bolts designed for steel wheels and vice-versa. For the compatibility between wheels and wheel bolts and between these and the spare wheel, refer to the detailed indications given in the paragraph "If a tyre is punctured".

## SNOW CHAINS

Do not use snow chains with 195/55 R15 (84V) or 195/45 R16 (80V) tyres as the chains are likely to interfere with the plastic wheelarches.

Use only low-profile chains with 185/55 R15 (81H) tyres: maximum height off the wheel 12 mm. Check the tautness of the chains after driving some twenty to thirty yards (twenty to thirty metres).

# DIMENSIONS

Boot volume (VDA standard): 165 dm<sup>3</sup>

Height is with the car unladen.

Dimensions in mm.

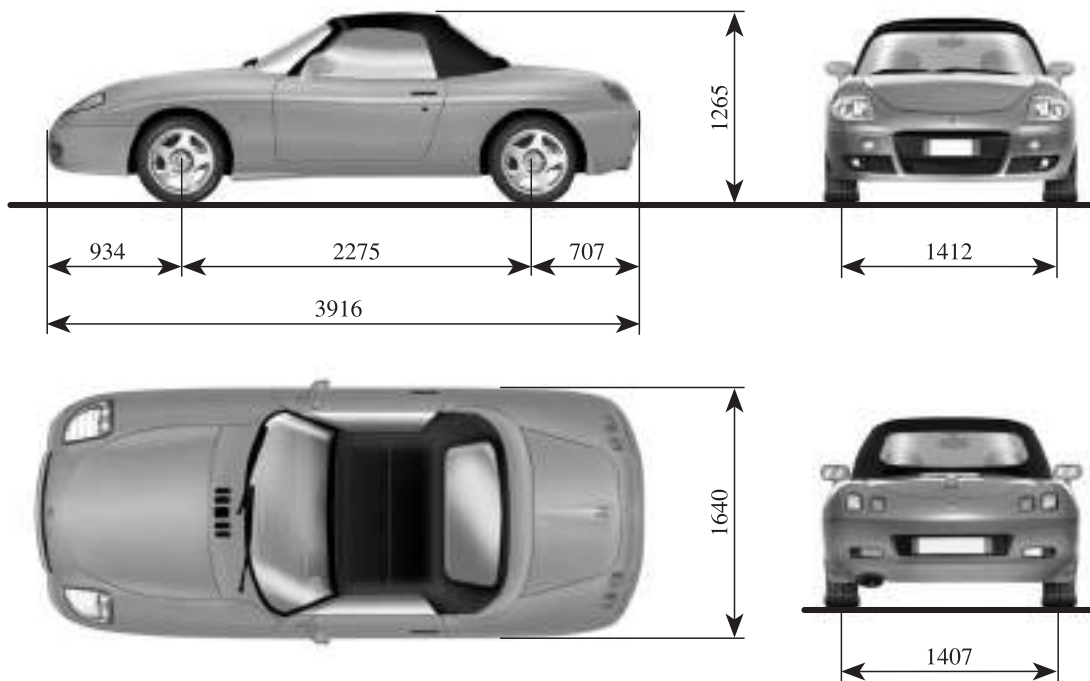

fig. 5

P5S00712m

# WEIGHTS

	Weights (kg)
Kerb weight (including fuel, space-saver spare wheel, tools and accessories):	1060
Payload (*) including the driver:	200
Maximum loads permitted (**)	
– front axle:	850
– rear axle:	700
– total:	1260
Towable weight	
– trailer with brakes:	450
– trailer without brakes:	400
Maximum load on the ball joint (trailer with brakes):	35

(\*) If special equipment is fitted (tow hitch etc.) the unladen weight increases, thus reducing the payload as specified in the maximum loads allowed.

(\*\*) Loads not to be exceeded: the driver must arrange the goods in the boot so that they comply with these limits.



# CAPACITIES

	litres	kg	Fuel required Recommended products
Fuel tank: including a reserve of:	50 about 5	– –	Premium unleaded petrol octane not less than 95 R.O.N
Engine cooling system:	6.2	–	50-50 mixture of distilled water and <b>PARAFLU</b> <sup>11</sup>
Engine sump:	3.7	3.3	<b>SELENIA 20K</b> (□)
Engine sump and filter:	4.0	3.6	
Engine sump, filter and lines (1 <sup>st</sup> in-factory filling):	4.7	4.2	
Transaxle:	1.98	1.8	<b>TUTELA CAR ZC 75 SYNTH</b>
Hydraulic power steering:	1.0	0.9	<b>TUTELA GI/A</b>
Front and rear hydraulic brake circuits:	–	0.55	<b>TUTELA TOP 4</b>
Windscreen liquid reservoir:	2.2	–	Mixture of water and <b>TUTELA PROFESSIONAL SC 35</b> liquid

(□) For temperatures lower than –20°C, we recommend using **SELENIA PERFORMER SAE 5W-30**.

# FLUIDS AND LUBRICANTS

## SUGGESTED PRODUCTS AND THEIR FEATURES

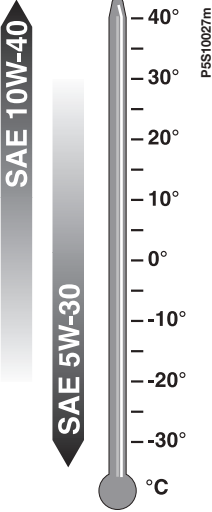
Use	Specifications of fluids and lubricants to use for best car operation	Recommended fluids and lubricants	Applications
Petrol engine lubricants	SAE 10W-40 synthetic-based multigrade oil exceeding ACEA A3-96, CCMC G5 and API SJ specifications	<b>SELENIA 20K</b>	 <p>SAE 10W-40</p> <p>SAE 5W-30</p> <p>°C</p> <p>PSS10027m</p>
	SAE 5W-30 synthetic-based multigrade oil exceeding ACEA A1 and API SJ specifications Recommended for temperatures lower than -20°C	<b>SELENIA PERFORMER</b>	

Use	Specifications of fluids and lubricants to use for best car operation	Recommended fluids and lubricants	Applications
Transmission lubricants and grease	Synthetic oil SAE 75W-80 EP. It complies with the specifications API GL5, MIL - L - 2105 D LEV.	<b>TUTELA CAR ZC 75 SYNTH</b>	Manual gearbox and differentials
	ATF DEXRON II D LEV, SAE 10W oil type	<b>TUTELA GI/A</b>	Hydraulic power steering
	Molybdenum disulphide, lithium-soap based grease, water resistant, NLGI = 2 consistency	<b>TUTELA MRM 2</b>	CV joints
Brake liquid	Synthetic fluid, NHTSA n° 116, DOT 4, ISO 4925 SAE J 1703, CUNA NC 956 - 01	<b>TUTELA TOP 4</b>	Hydraulic brake and clutch
Radiator antifreeze	Protective with anti-freeze action, for inhibited mono ethylene glycol based cooling systems, CUNA NC 956 - 16	<b>PARAFLU<sup>II</sup></b>	Proportion: 50-50 mix down to -35°C
Windscreen/ window washer fluid	Alcohol and surfactants mixture CUNA NC 956 - II	<b>TUTELA PROFESIONAL SC 35</b>	To be used pure or diluted in windshield wiper washing systems

## FUEL CONSUMPTION

The fuel consumption values, expressed in litres x 100 km, shown in the following tables, were defined on the basis of type-approval tests specified by European Directives.

Consumption values are defined by means of the following procedures:

- **an urban cycle** consisting of a cold start and a simulated drive in city streets;
- **an extra-urban cycle** consisting in frequent accelerations, in all gears, simulating normal conditions of use. Speed ranges from 0 to 120 km/h;
- **the combined consumption** is calculated as approximately 37% of the urban cycle and approximately 63% of the extra-urban cycle.

**IMPORTANT** Road and traffic conditions, weather, driving style, fittings and accessories, load, special devices and overall car conditions can penalise aerodynamic penetration and influence fuel consumption rates which can be different from the values shown in the table (see “Cheap running that respects the environment” in “Driving your car” chapter).

Consumption in accordance with Directive 999/100/CE	l/100 km
Urban	11.6
Extraurban	6.5
Combined	8.4

## CO<sub>2</sub> EMISSIONS

The CO<sub>2</sub> emissions in exhaust shown in the following tables refer to the average combined cycle.

CO <sub>2</sub> emissions in accordance with Directive 1999/100/CE	198
--	-----

# TYRES PRESSURE

## COLD TYRE PRESSURES (bar)

If the tyre is warm the pressure must be 0.3 bar above the pressure specified.

Tyre	Front	Rear	Spare wheel
195/55 R15 (84V)	2.4	2.0	2.8
195/45 R16 (80V)	2.4	2.0	2.8
185/55 R15 (81H)	2.4	2.0	2.8

# ACCESSORY INSTALLATION

**G**enuine Fiat accessories have been designed with the Fiat barchetta specifically in mind and have been selected and tested on the car. They are easy to use, reliable and practical, qualities that lead to enhanced comfort and safety under all driving conditions.

If you wish to give your Fiat barchetta a sportier look, Fiat has designed light alloy rims, leather panels, spoilers and sporty bumpers that are fully in keeping with the car's line making it more personal and aggressive.

To ensure child safety, the child safety seats offered by Lineaccessori Fiat meet the requirements of the European standards currently in force.

You can find accessories from the Fiat line described in a catalogue available from Fiat Branches, Dealers or Authorised Workshops. Just ask one of Fiat's staff to give you all the details.

The following pages show diagrams and give instructions for correctly fitting a number of accessories. Installation must always be entrusted to the experts. Fiat has specially trained its Dealership staff for work on the Fiat barchetta.

ELECTRONIC CAR ALARM .....	150
TOW HITCH INSTALLATION.....	152
HARD TOP .....	155
RADIO-FREQUENCY REMOTE CONTROL MINISTERIAL HOMOLOGATION .....	156

# ELECTRONIC ALARM

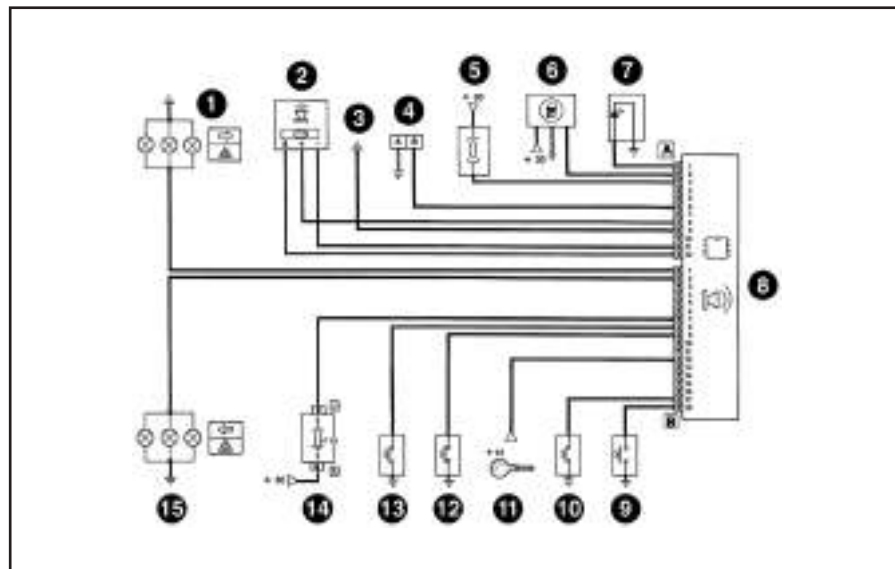

PSS00726m

5 - Optional device protection fuse-box

6 - Radio-frequency receiver

7 - "Electronic alarm on" led

8 - Electronic alarm control unit

9 - Bonnet switch

10 - Boot switch

11 - Ignition switch powering

12 - Right door switch

13 - Left door switch

14 - Indicator light 15A fuse and branch unit

15 - Left indicator/hazard lights branch.

fig. 1

## WIRING DIAGRAM AND ADDITIONAL BRANCHES fig. 1

1 - Right indicator/hazard lights branch

2 - Passenger compartment sensor

3 - Front right ground

4 - Diagnostic socket

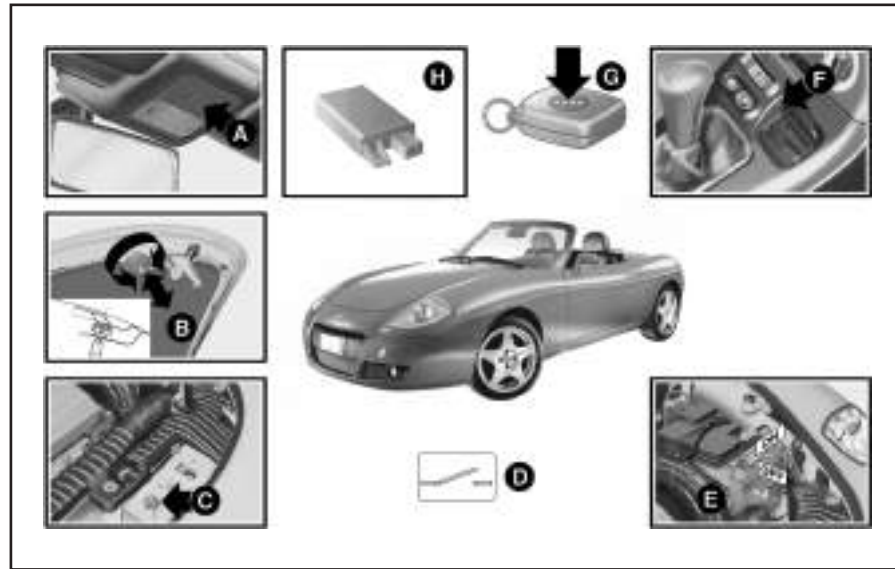

## LOCATION OF COMPONENTS IN THE VEHICLE fig. 2

**A** - Radio-frequency receiver in ceiling light

**B** - "Bonnet open" signal switch control (adjustable cap)

**C** - "Bonnet open" signal switch

**D** - "Right door open", "left door open" and "boot open" signal switch

**E** - Electronic alarm control unit (in the engine compartment)

**F** - "Electronic alarm on" warning led

**G** - Radio-frequency remote control

**H** - Passenger compartment protection sensor (located under the central tunnel).

fig. 2



# TOW HITCH INSTALLATION

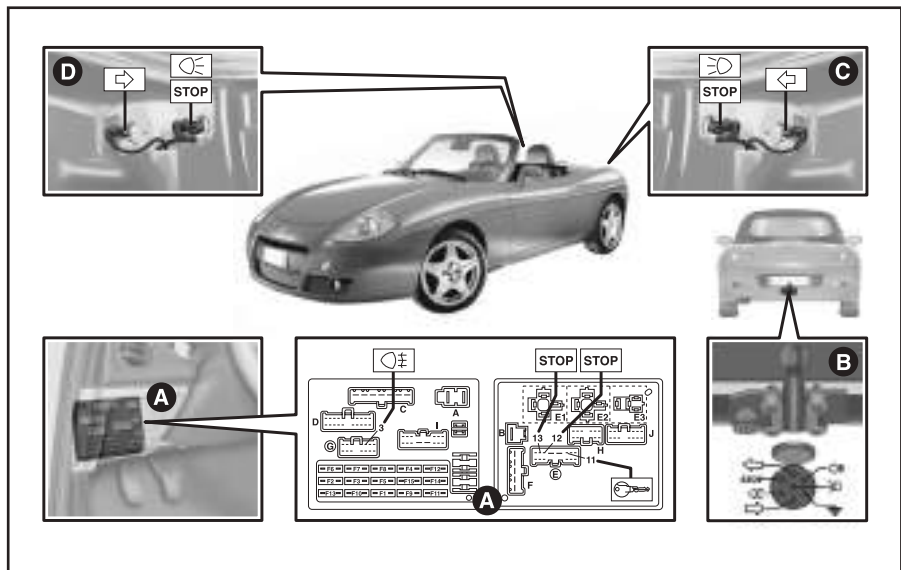

fig.3 - **A** - Fuse box- **B** - Seven pole socket - **C** - Left rear lighting cluster - **D** - Right rear lighting cluster

## TOW HITCH INSTALLATION

The device for towing a trailer (tow hitch) **fig. 3** must be fixed to the body by an expert in accordance with the following instructions.

The following must be used for the mechanical connection:

- “CUNA 501” 1<sup>st</sup> class ball coupling (CUNA NC 138-40 table);

- “CUNA 501” 1<sup>st</sup> class socket coupling (CUNA NC 438-40 table).

For the electric connection a 7-pole, 12-Volt coupling must be used (CUNA UNI 9128).

The electric coupling must be fixed on a special mount to be attached to the ball coupling.

The electrical functions for the coupling must be connected as illustrated in **fig. 5**.

In addition to the electrical connections (shown in the diagram that follows) only the lead for powering an electrical brake and the lead to power a light inside the trailer not exceeding 15W may be connected to the car's electrical system.

The electrical brake must be powered directly from the battery by means of a lead with a cross-section no less than 2.5 mm<sup>2</sup>.

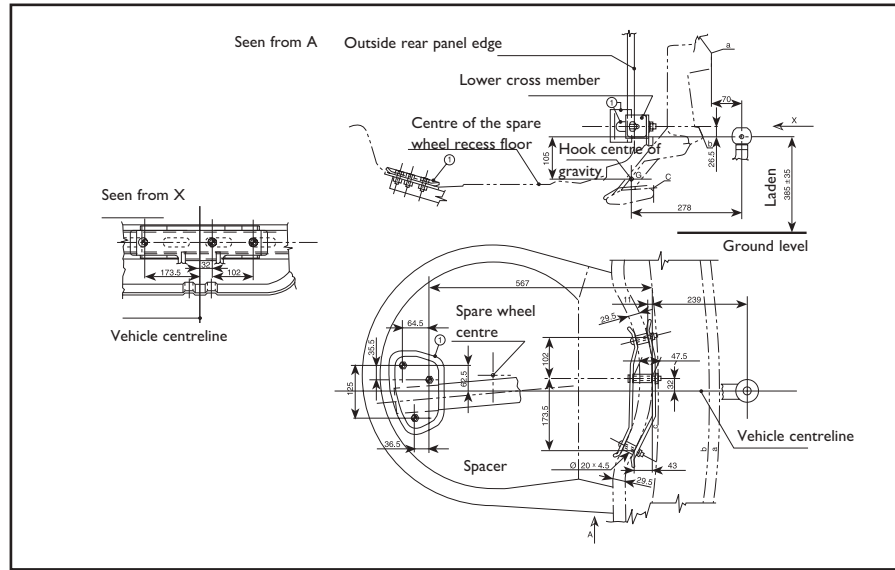



fig. 4

## ASSEMBLY DIAGRAM

The tow hitch structure **fig. 4** must be fixed using 6 M10 bolts at the points indicated .

All the anchorage points ① must have suitable internal 4 mm-thick steel reinforcements and diam. 20x4.5 mm

thick spacers. Dimensions as shown in the picture and turned up edges.

The underbody plate must be wider than the plate in the boot. Furthermore, the edge of the plate must be turned up to avoid sharp corners coming into contact with the body.

The tow hitch must be anchored to the body by trimming the grille in the centre part of the rear bumper.

**IMPORTANT** A clearly visible plate of a suitable size and made of suitable material saying:

**MAX LOAD ON BALL COUPLING**  
35 kg

must be fixed at the height of the ball coupling (for vehicles with maximum towable load of 450 kg).



## WARNING

After assembly, all holes must be adequately sealed to avoid exhaust fumes from filtering into the vehicle.

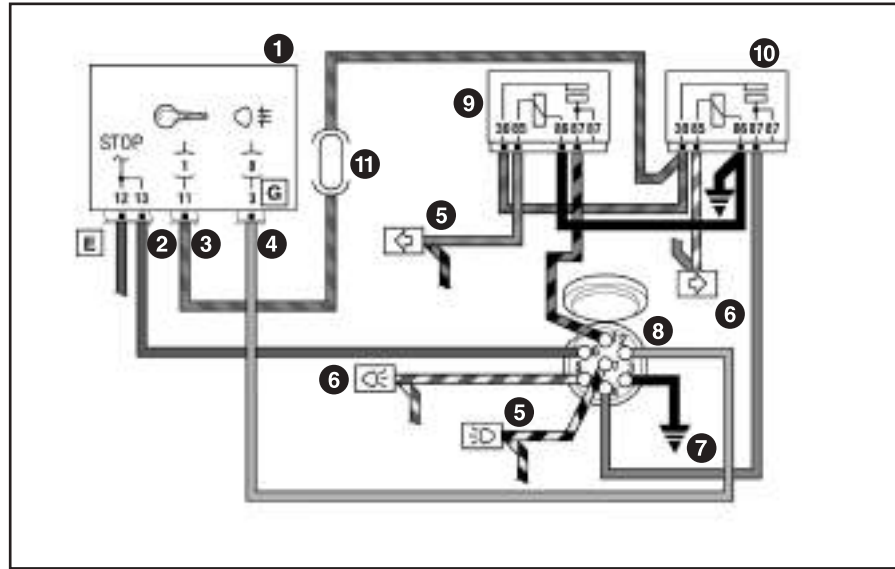

- 5 - Left-hand taillight
  - 6 - Right-hand taillight
  - 7 - Rear left earth point
  - 8 - Seven-pole socket
  - 9 - Relay for the power supply of the trailer's rear left-hand direction indicator
  - 10 - Relay for the power supply of the trailer's rear right-hand direction indicator
  - 11 - 7.5A fuse
- Devices 9 - 10 - 11 are not included in the car system and must be added by the owner.

fig. 5

### ELECTRICAL CONNECTION DIAGRAM fig. 5

- 1 - Fuse box
- 2 - Connection on the fuse box for powering the trailer's stop lights

3 - Connection on the fuse box for powering the relays

4 - Connection on the fuse box for powering the trailer's rear foglights

## HARD TOP

The hard top is fitted with a heated rear window and can be installed in place of the hood to provide maximum comfort during winter.

The hard top is not only on offer as an optional extra, but is also part of the Lineaccessori Fiat line, and is therefore available even after the car has been purchased.

When the hard top is bought from Lineaccessori Fiat, pin seats and fixing screws are also supplied.

The seats must be fixed to the rear pillars that have 2 threaded holes and can be left in place even when the hard top is no longer used.

When the hard top is mounted for the first time, it is necessary to adjust the rear tie rods.

You should have these operations carried out at a **Fiat Dealership**.

See the chapter “Getting to know your car” for instructions on how to fit and remove the hard top correctly.

# RADIO-FREQUENCY REMOTE CONTROL: MINISTERIAL HOMOLOGATION

International motoring abbreviation	Country	Homologation code
A	Austria	CEPTLPDD
B	Belgium	RTT/D/XI238
CH	Switzerland	BAKOM 96033I KP
D	Germany	GI27064H - GI2I483F
E	Spain	E0I960332 - E00950904
F	France	96 0186 PPL 0 - 95 0327 PPL 0
GB	Great Britain	I I699
GR	Greece	YIIME/ $\Delta$ TEE/EK399 - YIIME/ $\Delta$ TEE/EK40I
I	Italy	DGPGF/SEGR/2/03/338546/FO/00327/03/02/97
NL	Netherlands	NL 96040274
P	Portugal	ICP 016TC 96

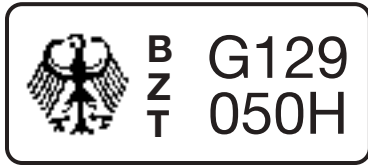

<p>Attesté</p> <p>Conforme</p>	<p>atc 960330 PPL 0</p> <p>date 31/07/96</p> <p>pres. TRW</p>
	<p><b>Radiocom Privées France</b></p> <p><b>Professionnel</b></p>

ministerie van verkeer en waterstaat  
NL 96080670

E	D.G.Tel.	E01960332
---	----------	-----------

E	D.G.Tel.	E00950904
---	----------	-----------

ministerie van verkeer en waterstaat	
NL 96040274	

<p>Attesté</p>  <p>ART</p> <p>Conforme</p>	atc 960186 PPL 0 date 17/04/96 pres. TRW
	<p><b>Radiocom Privées France</b></p> <p><b>Professionnel</b></p>

<p>Attesté</p>  <p>ART</p> <p>Conforme</p>	atc 950327 PPL 0 date 18/10/95 pres. TRW
	<p><b>Radiocom Privées France</b></p> <p><b>Professionnel</b></p>

# INDEX

- A**BS ..... 56  
Accessories purchased  
by the owner ..... 82  
**Accessory installation**..... 149  
Air cleaner..... 122  
Air recirculation..... 36  
Airbags  
– general information..... 60  
– switching the passenger side  
airbag off ..... 59  
Ashtray ..... 43
- B**attery  
– jump starting ..... 85-105  
– liquid level ..... 123  
– recharging..... 105  
Bodywork  
– maintenance..... 130  
– paint identification plate.... 137  
– versions ..... 137  
Bonnet..... 53  
Boot  
– opening/closing..... 55  
Brake fluid level..... 121  
Brake lights..... 96  
Brakes  
– fluid level..... 121  
– service and emergency  
brakes..... 139  
Bulb replacement..... 91
- C**ar maintenance..... 111  
Capacities ..... 64-144  
Catalytic converter ..... 66  
Ceiling light..... 42  
– bulb replacement ..... 98  
Cellular phone setup..... 63  
Central door locking..... 44  
Cheap running ..... 78  
Children (safety) ..... 24  
Cigar lighter ..... 43  
Climate control system..... 36  
– controls..... 36  
– maintenance..... 130  
Clutch ..... 139  
CO<sub>2</sub> emissions ..... 147  
Containing running costs  
and pollution ..... 76
- D**ashboard ..... 7  
Defrosting..... 35  
Demisting..... 35  
Digital clock ..... 29  
Dimensions ..... 142  
Dipped-beam headlights  
– controls ..... 38  
– bulb replacement ..... 93  
Direction indicators  
– controls ..... 39  
– front bulb replacement ..... 94  
– rear bulb replacement ..... 95  
– side bulb replacement ..... 95  
Doors ..... 44  
**Driving your car**..... 67
- E**lectric windows ..... 45  
Electronic alarm..... 13-150  
Electronic control units..... 125  
Engine  
– cooling..... 138  
– fuel feed/ignition ..... 138  
– identification code..... 136  
– lubrication ..... 138  
– specifications..... 137  
Engine compartment washing. 132



Engine coolant level.....	119
Engine coolant temperature gauge .....	29
Engine oil	
– checking the level .....	118
– engine oil consumption .....	118
– specifications.....	145
EOBD system .....	62
Evaporation system .....	66
<b>F</b> iat CODE system .....	11
First aid kit .....	110
Front fog lights	
– bulb replacement .....	94
– controls.....	41
Fuel	
– consumption .....	147
– fuel cut-off switch .....	41
– level gauge .....	29
– filler cap .....	65
Full-beam headlights	
– bulb replacement .....	94
– flashing.....	39
– controls.....	38
Fuses .....	98

<b>G</b> earbox	
– using the gearbox .....	71
<b>Getting to know your car</b> ..	6
Glove compartment light.....	98
Glove compartment.....	42
<b>H</b> andbrake.....	70-139
Hard top .....	49-155
Hazard lights .....	40
Head restraints.....	19
Headlights	
– beam slant .....	55
– front fog light slant.....	55
Heating and ventilation.....	34
Hood .....	46-133
<b>I</b> dentification data .....	136
If an accident occurs .....	109
<b>In an emergency</b> .....	83
Instrument panel.....	8
Instruments .....	28
<b>J</b> ack .....	88
Jacking the car .....	106

<b>K</b> eys .....	11
Kilometre counter.....	28
<b>L</b> ambda sensor .....	66
Lubricants .....	145
<b>M</b> ileometer .....	28
<b>N</b> umber plate lights.....	97
<b>O</b> ddment compartment.....	42
<b>P</b> aintwork .....	137
Parking lights (PARK).....	17
Parking.....	70
Performance.....	140
Plates	
– identification data .....	136
– paint identification.....	137
Pollen filter .....	123
Power steering fluid level .....	120
Pretensioners.....	27
<b>R</b> adio transmitters .....	82
Radio-frequency remote controls .....	15

– homologation codes.....	156	– maintenance .....	23	Steering column lock.....	18
Rear fog lights		– use .....	21	Steering column stalks	
– controls .....	41	Seats		– left-hand stalk .....	38
– bulb replacement .....	97	– adjustment.....	18	– right-hand stalk.....	39
Rear windowing (cleaning) .	133	– cleaning.....	134	Steering wheel .....	19
Rearview mirrors		Servicing.....	111	Steering.....	140
– electric.....	20	– additional operations ....	115	Storing the car .....	81
– external .....	20	– annual inspection schedule	115	Sun visors.....	43
– internal .....	20	– scheduled service.....	112	Suspensions .....	140
Rev counter.....	28	– Service Schedule .....	113	Symbols .....	9
Repeated checks .....	82	Side/taillights		<b>T</b> echnical specifications....	135
Reversing lights.....	97	– controls .....	38	Third brake light	
Rubber piping.....	128	– front bulb replacement	93	(bulb replacement) .....	96
<b>S</b> afe driving		– rear bulb replacement ..	96	Tools.....	88
– driving at night.....	73	Snow tyres.....	80-141	Top speeds.....	140
– driving in the rain.....	74	Spark plugs.....	126	Towing a trailer	
– before getting behind		Specifications.....	135	– tow hitch installation .....	152
the wheel.....	72	Speedometer.....	28	– warnings.....	79
– driving in fog .....	74	Starting the engine		Towing the car .....	108
– driving in the mountains	75	– jump starting .....	85	Transmission (ratios) .....	139
– driving on snow and ice	75	– bump starting.....	86	Transporting children	
– driving with ABS.....	75	– emergency start-up .....	84	in safety .....	24
– when travelling .....	72	– ignition switch.....	17	Tyre pressure .....	148
Seat belts		– stopping the engine .....	69	Tyres .....	126-148
– general information .....	22	– warming up a recently			
		started engine.....	69		

<b>V</b> entilation.....	36
Vehicle storage .....	81
<b>W</b> arning lights .....	30-31-32-33
Weights.....	143
Wheel geometry (toe-in).....	140
Wheel rims .....	141
Wheels	
– changing a wheel.....	88
– spare .....	141
Wind stop .....	51
Window cleaning.....	132
Windscreen washer	
– controls.....	40
– fluid level.....	120
Windscreen wipers	
– controls .....	39
– blades .....	128
– nozzles .....	129

# **OIL CHANGE? THE EXPERTS RECOMMEND SELENIA.**

The car you have just bought was built with the latest FL Group lubricant technology.

You will find Selenia at all FL Group appointed dealers the next time you need to change the oil in your car.

**35,000 motoring experts all over Europe recommend Selenia as being the best protection for your car's engine.**

**ASK YOUR SERVICE  
MANAGER FOR SELENIA.**



# SELENIA THE PERFECT CHOICE FOR YOUR CAR

The engine in your new car was developed with Selenia 20K, a synthetic-base oil which meets with the most advanced international specifications.

Selenia 20K enhances the characteristics of the engine guaranteeing optimum performance and maximum protection.

## SELENIA 20K

Top quality fuel economy API SJ specification oil, for normally aspirated, turbocharged or multi-valve petrol engines. It saves up to 2% on fuel and gives maximum stability at high temperatures.

## SELENIA PERFORMER

Specific oil for optimum petrol engine operation in particularly severe climate conditions (startup as low as  $-35^{\circ}\text{C}$ ).

## USED OIL ANALYSIS: INCREASE IN VISCOSITY AT $40^{\circ}\text{C}$ (\*)

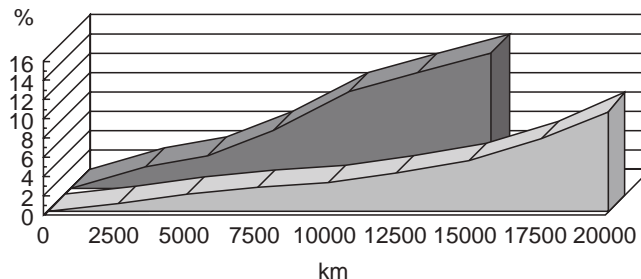

■ SELENIA 20K    ■ COMPARATIVE PRODUCT

(\*) ASTM D445

Dedicated to the new generation of engines, the high levels of chemical stability that are characteristic of Selenia 20K result in an extended oil change interval of **up to 20,000 km**, guaranteeing long lasting engine cleaning.

# SELENIA. FOR THE HEART THAT BEATS IN YOUR ENGINE









Fiat Auto S.p.A.  
B.U. After Sales - Assistenza Tecnica - Ingegneria Assistenziale  
Largo Senatore G. Agnelli, 5 - 10040 Volvera - Torino (Italia)  
Print no. 603.45.576 - III/2003 - 1<sup>st</sup> Edition - Printed by Satiz - Turin (Italy)  
**Coordinamento Editoriale Satiz - Torino**

The data contained in this publication is intended merely as a guide. FIAT reserves the right to modify the models and versions described in this booklet at any time for technical and commercial reasons. If you have any further questions please consult your FIAT dealer. Printed in recycled paper without chlorine.