

F I A T 6 0 0



O W N E R H A N D B O O K

Dear New Car Owner

Thank you for selecting Fiat and congratulations on your choice of a Fiat 600.

We have written this handbook to help you get to know all your new Fiat 600 features and use it in the best possible way.

You should read it right through before taking the road for the first time. You will find information, tips and important warnings regarding the driving of your car to help you derive the maximum from your Fiat 600's technological features.

You are recommended to read carefully the warnings and indications, marked with the respective symbols:



personal safety;



the car's wellbeing;



environmental protection.

The enclosed Fiat Warranty Booklet list the services that Fiat offers its Customers:

- the Warranty Certificate with terms and conditions for maintaining its validity
- the range of additional services available to Fiat Customers.

Best regards and good motoring.

This Owner Handbook describes all the Fiat 600 versions. As a consequence, you should consider only the information which is related to the engine and bodywork version of the car you purchased.

MUST BE READ!

REFUELLING



Refuel petrol engine vehicles with unleaded petrol, octane rating (RON) no lower than 95.

The use of other products or mixtures may irreparably damage the engine with invalidation of the warranty due to the damage caused.

ENGINE START-UP



Make sure the handbrake is pulled up; put the gear lever into neutral; press the clutch pedal down to the floor without touching the accelerator; turn the ignition key to **AVV** and release it as soon as the engine starts.

PARKING OVER INFLAMMABLE MATERIAL



When functioning normally, the catalytic converter reaches high temperatures. For this reason do not park the vehicle over inflammable material, grass, dry leaves, pine needles, etc.: fire hazard.

PROTECTING THE ENVIRONMENT

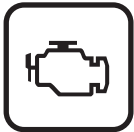

A system for continuously monitoring emission system components to ensure greater environmental protection is fitted in your vehicle.

ELECTRICAL ACCESSORIES



If, after buying the vehicle, you decide to add electrical accessories (that will gradually drain the battery), visit a **Fiat Dealership**. They can calculate the overall electrical requirement and check that the vehicle's electric system can support the required load.

CODE card



Keep the code card in a safe place, not in the vehicle. You should always keep the electronic code written on the CODE card with you in case you need to carry out an emergency start-up procedure.



SCHEDULED SERVICING



Correct maintenance of the vehicle is essential for ensuring it stays in tip-top condition and safeguards its safety features, its environmental friendliness and low running costs for a long time to come.

THE OWNER HANDBOOK CONTAINS ...



... information, tips and important warnings regarding the safe, correct driving of your vehicle, and its maintenance. Pay particular attention to the symbols  (personal safety)  (environmental protection)  (vehicle well-being).

GETTING TO KNOW YOUR CAR

SYMBOLS

Special coloured labels have been attached near or actually on some of the components of your Fiat 600. These labels bear symbols that remind you of the precautions to be taken as regards that particular component.

THE FIAT CODE SYSTEM

To further protect your car from attempted theft, it has been fitted with an electronic engine immobiliser system called "Fiat CODE", which is automatically activated when the ignition key is removed. The ignition keys, in fact, are fitted with an electronic device that transmits a coded signal to the Fiat CODE control unit; only if this signal is recognised can the engine be started.

The modulated signal is a password. Only if the control unit recognises the key can the engine be started.

The keys fig. 1

With the car, the following keys **A** are provided.

The key with a blue grip is used for:

- starting
- unlocking and locking the doors
- boot tailgate (VAN versions only)
- deactivating the passenger side airbag.



fig. 1

The CODE card (optional for versions / markets where applicable) **fig. 2** is also supplied with the keys and bears the following:

– front side:

A - the electronic code (optional for versions / markets where applicable);

B - the mechanical key code;

– reverse side:

C - the spaces for any remote control stickers.

Keep the CODE card in a safe place.

DUPLICATING KEYS

When you ask for extra keys, remember that all the keys, both the new ones and those you already possess, must be stored in the memory (up to a maximum of 7). Go to your **Fiat Dealership**, taking all the keys in your possession and the CODE card with you.

The **Fiat Dealership** may ask you to demonstrate that you own the car.

The codes of any keys that are not available when the new storage procedure is carried out will be deleted from the memory to prevent any lost or stolen keys being used to start the car.





fig. 2

OPERATION

Each time the ignition key is turned to **STOP**, or **PARK**, the protection system will automatically immobilise the engine.

When the key is turned to **MAR** to start the engine:

1) if the code is recognised the  warning light on the instrument panel will flash briefly; this means the protection system has recognised the key code and deactivates the immobiliser, turn the key to **AVV**, and the engine will start;

2) if the  warning light stays on, the code has not been recognised. In this case, turn the key to **STOP** position and then turn it back to **MAR**; if the engine remains immobilised, try with the other keys provided.

If you are still unable to start the engine, use the emergency starting procedure (see **IN AN EMERGENCY**) and take your car to the nearest **Fiat Dealership** as soon as possible.

When the car is travelling and the key is at **MAR**:

1) if the  warning light comes on while the car is moving, this means that the system is running a self-test (e.g. due to a voltage drop);

2) if the warning light  flashes when the key is in **MAR** the car is not protected by the Immobiliser. Contact your **Fiat Dealership** and get them to store the codes of all the keys in the memory.

IMPORTANT The electronic components inside the key may be damaged if the key is subjected to sharp knocks.

IMPORTANT Each key provided with the car has its own code, different from all the others, which must be stored in the memory of the system control unit.



All the keys (originals and duplicates) and the CODE card must be handed over to the new owner when selling the car.

SEAT BELTS

USING THE SEAT BELTS

The belt should be worn keeping the chest straight and rested against the seat back.

Take hold the tongue **B**-fig. 3 and insert it into the buckle **C**, until hearing the locking click.

If it jams, let it rewind for a short stretch, then pull it out again without jerking.

To unfasten the seat belts, press button **D**. Guide the seat belt with your hand while it is rewinding, to prevent it from twisting.



Do not press button D when running.

Through the reel, the belt automatically adapts to the body of the passenger wearing it, allowing freedom of movement.

When the car is parked on a steep slope the reel mechanism may block; this is normal. The reel mechanism prevents the webbing coming out when it is jerked or if the car brakes sharply, as in a collision or when cornering at high speed.

The rear seat is fitted with inertial seat belts with three anchor points and reel.

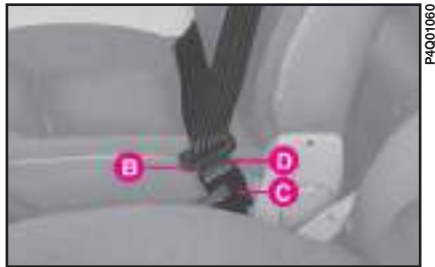

fig. 3

CENTRAL REAR SEAT

For versions /markets where applicable the centre seat, if any, is fitted with lap belt with two anchor points.

In order to ensure that the correct tabs are fitted into the corresponding buckle, the tabs of the side belt and the buckle of the centre seat (only abdominal) are incompatible.



The rear seat belts shall be worn as shown in fig. 4. Fig. 5 shows wrong seat belt fastening, not to be followed.



Remember that in the case of violent collision, back seat passengers not wearing seat belts also represent a serious danger to the front passengers.

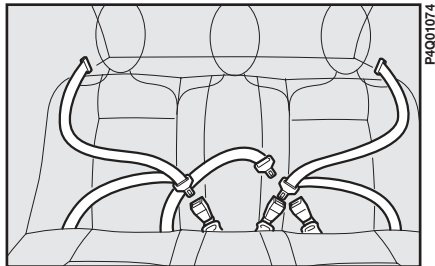

fig. 4

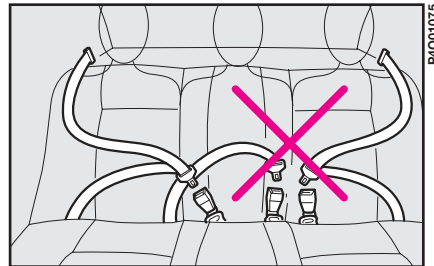

fig. 5

ADJUSTING THE SEAT BELT HEIGHT

There are two anchoring positions **A** and **B**-fig. 6 for front seat belts on the door post.

Before driving off for the first time, adjust the position of the seat belt anchoring point according to your height and favourite driving position. If required, have the anchoring point of the seat belt adjusted.

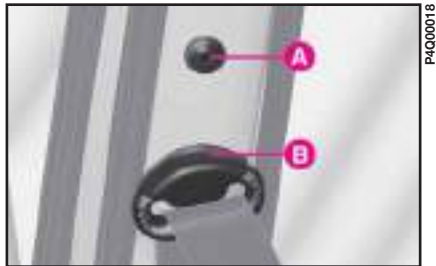

fig. 6

IMPORTANT Have this operation performed at a **Fiat Dealership** only as it involves passenger safety.

USING THE CENTRAL REAR SEAT BELT (For versions/markets)

To fasten the seat belt: push the fastener tongue **A**-fig. 7 into slot **B** of the buckle, until you hear it click.

To unfasten the seat belt: press button **C**.

To adjust the belt: slide the webbing through **D**, pulling length **E** to tighten and length **F** to loosen.

IMPORTANT The belt is adjusted properly when it fits closely across the hips.



fig. 7

PRETENSIONERS

In order to make the safety belt protective action even more efficient, vehicle is equipped with pretensioners on driver side and on front passenger side (if car is equipped with passenger side air bag option), that, in case of a violent front crash, recall the safety belt by a few cm, thus ensuring proper adherence of safety belt to passenger body, before the retaining action starts.

The seat belt locks to indicate that the device has intervened; the seat belt cannot be drawn back up even when guiding it manually.

IMPORTANT To obtain the highest degree of protection from the action of the pretensioning device, wear the seat belt keeping it firmly close to the chest and pelvis.

A small amount of smoke may be produced. This smoke is in no way toxic and presents no fire hazard.

The pretensioner does not require any maintenance or greasing. Anything that modifies its original conditions invalidates its efficiency. If due to unusual natural events (floods, sea storms, etc.) the device has been affected by water and mud, it must necessarily be replaced.



The pretensioner can only be used once.

After a collision that has triggered it, have it replaced at a Fiat Dealership. The validity of the device is written on the plate located on the front left door post. The pretensioners should be replaced at a Fiat Dealership as this date approaches.



Operations which lead to knocks, vibrations or localised heating (over 100°C for a maximum of 6 hours) in the area around the pretensioners may cause damage or trigger them. These devices are not affected by vibrations caused by irregularities of the road surface or low obstacles such as kerbs, etc. Contact a Fiat Dealership for any assistance.

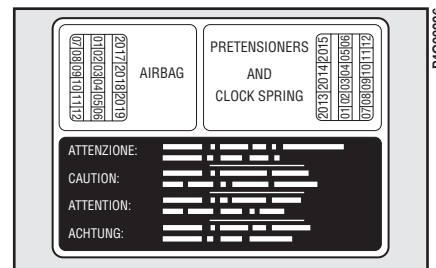

fig. 7a

GENERAL INSTRUCTIONS FOR USING THE SEAT BELTS

The driver must comply with (and have the vehicle occupants follow) all the local legal regulations concerning the use of seat belts.

Always fasten the seat belts before starting driving.



For maximum safety, keep the back of your seat upright, lean back into it and make sure the seat belt fits closely across your chest and hips.

Make sure that the seat belts of the front and rear passengers are fastened at all times! You increase the risk of serious injury or death in a collision if you travel with the belts unfastened.



The belt should not be twisted, make sure that it is taut and adheres to the passenger's body. The upper part should pass over the shoulder and cross the chest diagonally. The lower part should adhere to the pelvis and to the abdomen of the passenger, to prevent the risk of slipping forwards, fig. 8. Do not use any objects (pegs, stoppers, etc.) to keep the belts away from the body.



fig. 8



Under no circumstances should the components of the pretensioner be tampered with or removed. Any operation should be carried out by qualified and authorised personnel. Always contact a Fiat Dealership.



If the belt has been subjected to heavy stress, for example after an accident, it should be changed completely together with the anchors, anchor fastening screws and the pretensioners. In fact, even if the belt has no visible defects, it could have lost its resilience.



Never travel with a child sitting on the passenger's lap with a single belt to protect them both fig. 9 and do not fasten other objects.

Seat belts are also to be worn by expectant mothers: the risk of injury in the case of accident is greatly reduced for them and the unborn child if they are wearing a seat belt.

Of course they must position the lower part of the belt very low down so that it passes under the abdomen fig. 10.

HOW TO KEEP THE SEAT BELTS ALWAYS IN EFFICIENT CONDITIONS

1) Always use the belt with the tape taut and never twisted; make sure that it is free to run without impediments.

2) After a serious accident, replace the belt being worn at that time, even if it does not appear damaged. Always replace it in case of pretensioner activation.

3) To clean the belts, wash by hand with neutral soap, rinse and leave to dry in the shade. Never use strong detergents, bleach or dyes or other chemical substance that might weaken the fibres.

4) Prevent the reels from getting wet: their correct operation is only guaranteed if water does not get inside.

5) Replace seat belt if showing wear or cut signs.



fig. 9



fig. 10

CARRYING CHILDREN SAFELY

For optimal protection in the event of a crash, all passengers must be seated and wearing adequate restraint systems.

This is even more important for children.

According to 2003/20/EC Directive, this prescription is compulsory for all European Community countries.

Compared with adults, their head is proportionally larger and heavier than the rest of the body, while the muscles and bone structure are not completely developed. Therefore, correct restraint systems are necessary, other than adult seat belts.

The results of research on the best child restraint systems are contained in the European Standard ECE-R44. This Standard enforces the use of restraint systems classified in five groups:

- Group 0 - 0-10 kg in weight
- Group 0+ - 0-13 kg in weight
- Group 1 9-18 kg in weight
- Group 2 15-25 kg in weight
- Group 3 22-36 kg in weight

All restraint devices must bear the certification data, together with the control brand, on a solidly fixed label which must absolutely never be removed.

Over 1.50 m in height, from the point of view of restraint systems, children are considered as adults and wear the seat belts normally.

Lineaccessori Fiat offers seats for each weight group, which are the recommended choice, as they have been designed and experimented specifically for Fiat cars.

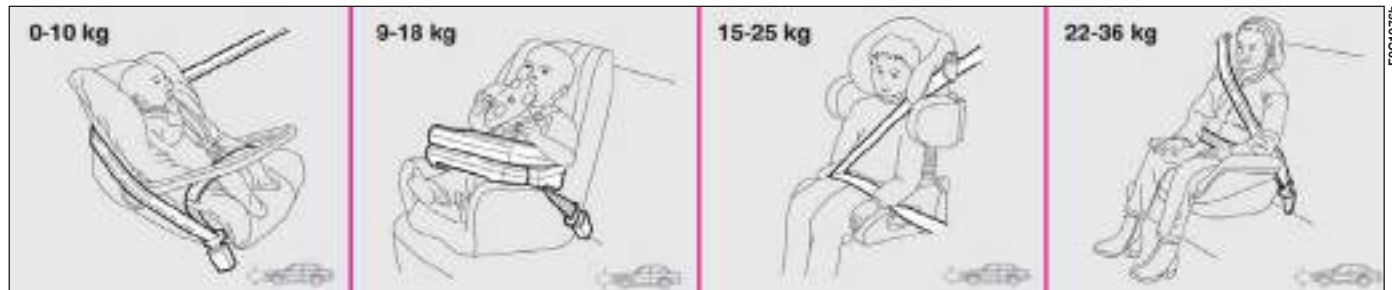



fig. 11

FOC10765



SERIOUS DANGER: Never place cradle child's seats on the front passenger seat of cars fitted with passenger's air bag. The air bag activation could cause serious injuries, even mortal. You are advised to carry children always on the rear seats, as this is the most protected position in the case of a crash. In any case, children's seats must absolutely not be fitted on the front seat of cars with passenger's air bag, which during inflation could cause serious injury, even mortal, regardless of the seriousness of the crash that triggered it. Children may be placed on the front seat of cars fitted with passenger's air bag deactivation. In this case, it is absolutely necessary to check the warning light  on the cluster to make sure that deactivation has actually taken place (see paragraph "Passenger's front air bag" at item "Front air bags"). The front passenger's seat shall be adjusted in the most backward position to prevent any contact between child's seat and dashboard.

GROUPS 0 and 0+

Babies up to 13 kg must be carried facing backwards on a cradle seat, which, supporting the head, does not induce stress on the neck in the event of sharp deceleration.

The cradle is restrained by the car seat belts, as shown in **fig. 12** and in turn it must restrain the child with its own belts.



The figure is only an example for mounting. **Attain to the instructions for fastening which must be enclosed with the specific child restraint system you are using.**



fig. 12

GROUP 1

Starting from 9 kg to 18 kg in weight, children may be carried facing forwards, with seats fitted with front cushion **fig. 13**, through which the car seat belt restrains both child and seat.



The figure is only an example for mounting. Attain to the instructions for fastening which must be enclosed with the specific child restraint system you are using.



fig. 13



Seats exist which are suitable for covering weight groups 0 and 1 with a rear connection to the car belts and their own belts to restrain the child. Due to their size, they can be dangerous if installed incorrectly fastened to the car belts with a cushion. Carefully follow the instructions for installation provided with the seat.

GROUP 2

Starting from 15 kg to 22 kg in weight, children may be restrained directly by the car belts. The only function of the seat is to position the child correctly in relation to the belts, so that the diagonal part adheres to the chest and not to the neck and that the horizontal part clings to the child's pelvis and not the abdomen **fig. 14**.



The figure is only an example for mounting. Attain to the instructions for fastening which must be enclosed with the specific child restraint system you are using.

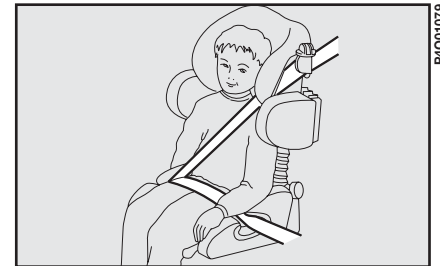

fig. 14

GROUP 3

Starting from 22 kg to 36 kg in weight, the size of the child's chest no longer requires a support to space the child's back from the seat back.

Fig. 15 shows an example of proper child positioning on the rear seat.

Children taller than 1.50 m can wear seat belts like adults.



fig. 15

PASSENGER SEATS COMPLIANCE WITH REGULATIONS ON CHILD'S SEAT USE

Fiat 600 complies with the new 2000/3/EC Directive regulating child's seat assembling on the different car seats according to the table on next page.

Key for the table on next page.

U = suitable for child restraint systems of the "Universal" category, according to European Standard ECE R44 for the specified "Groups".

(*) No child's seat can be installed on the rear seat with lap belt (without reel).

| Group | Range of weight | Front passenger | Rear side passenger | Central Rear side passenger (if any) |
|-------------|-----------------|-----------------|---------------------|--------------------------------------|
| Group 0, 0+ | up to 13 kg | U | U | (*) |
| Group 1 | 9-18 kg | U | U | (*) |
| Group 2 | 15-25 kg | U | U | (*) |
| Group 3 | 22-36 kg | U | U | (*) |

Below is a summary of the rules of safety to be followed for carrying children:

1) The recommended position for installing children's seat is on the rear seat, as it is the most protected in the case of a crash.



Never fit child restraint systems in the front passenger seat in cars with passenger airbag, children must never be seated on front seats.

2) If the passenger's air bag is deactivated always check the warning light  on the cluster to make sure that it has actually been deactivated.

3) Attain to the instructions for fastening the specific child restraint system which you are using. These instructions must be provided by the manufacturer. Keep the child restraint system installation instructions with the car documents and this Handbook. Never use a child restraint system without installation instructions.

4) Always check the seat belt is well fastened by pulling the webbing.

5) Only one child is to be strapped to each retaining system.

6) Always check the seat belts do not fit around the child's throat.

7) While travelling, do not let the child sit incorrectly or release the belts.

8) Passengers should never carry children on their laps. No-one, however strong they are, can hold a child in the event of a crash.

9) In case of an accident, replace the seat with a new one.

IGNITION SWITCH

The key can be turned to four different positions **fig. 16**.

- **STOP**: engine off, key can be removed and the steering column is locked mechanically. Some electrical devices can be used (e.g. sound system).
- **MAR**: drive position. All electrical devices can be used.
- **AVV**: engine ignition.
- **PARK**: engine off, parking lights on, steering column locked. Press button **A** and turn the key to **PARK**.



fig. 16



If the ignition switch has been tampered with (e.g. someone has tried to steal your car), get a Fiat Dealership to make sure it is still functioning properly before you start driving again.



Always remove the ignition key when you get out of the car. This will prevent anyone from accidentally working the controls. Remember to apply the handbrake and, if the car is faced down on a steep slope engage the first gear. If it is facing up, engage the reverse gear.

STEERING COLUMN LOCK

To engage the lock: remove the ignition key at **STOP** or **PARK** and turn the steering wheel until it locks.



To release the lock: rock the steering wheel slightly as you turn the ignition key to **MAR**.



Never remove the ignition key while the car is moving. The steering wheel would automatically lock as soon as you try to turn it. This also applies when the car is being towed.



It is absolutely forbidden to carry out whatever after-market operation involving steering system or steering column modifications (e.g.: installation of anti-theft Device) that could badly affect performance and safety, cause the lapse of warranty and also result in non-compliance of the car with homologation requirements.

DASHBOARD

Left-hand drive versions

The presence and position of the instruments and warning and indicator lights may vary according to the version of the car.



fig. 17

1. Left speaker housing - **2.** Side window defroster/demister vents - **3.** External light control stalk - **4.** Horn - **5.** Instrument panel - **6.** Steering wheel and airbag - **7.** Windscreen defroster/rear window wiper/washer control stalk - **8.** Central air vents - **10.** Windscreen defroster/demister vents - **11.** Oddment compartment - **12.** Right speaker housing - **13.** Side window defroster/demister vents - **14.** Oddment compartment under dashboard - **15.** Control buttons - **16.** Electric window controls - **17.** Heating and ventilation controls - **18.** Sound system housing/oddment compartment - **19.** Headlight adjustment control - **20.** Ignition switch - **21.** Fusebox.

INSTRUMENT PANEL



P4Q01004

fig. 18

- A. Clock setting button
- B. Speedometer
- C. Fuel level gauge
- D. Trip meter reset button
- E. Kilometre or mileage counter
- F. Clock.

INSTRUMENTS

SPEEDOMETER COUNTER

fig. 19

A - Kilometre counter.

B - Speedometer.

C - Trip meter reset button. Press to reset **fig. 20**.



fig. 19

Press briefly = switch from kilometre counter to trip meter and vice versa.

Press longer = reset trip meter.

D - Kilometre counter display **fig. 20**.



fig. 20

FUEL LEVEL GAUGE

When the reserve warning light comes on **A-fig. 21** there are still about 7 litres of fuel in the tank.

E - tank empty.

F - tank full (see the indications given in paragraph "At the filling station").

Do not travel with the fuel tank almost empty: the gaps in fuel delivery could damage the catalyser.



fig. 21

CLOCK

B-fig. 22 Clock display.

To adjust the time press **A-fig. 22**.



fig. 22

The clock will advance by one unit each time the button is pressed. Press the button and hold it down for a few seconds to rapidly advance the time automatically.

When the clock draws near to the correct time, release the button and complete the regulation manually.

CUT-OFF SWITCH ON DISPLAY fig. 23

The display shown appears automatically when the inertial fuel cut-off switch cuts in, following a crash of a certain magnitude.

The switch shuts off the supply of fuel.

IMPORTANT See the description in the CONTROLS paragraph under INERTIAL FUEL CUT-OFF SWITCH.



If after the display of the message the smell of fuel or leaks from the supply system are noted, do not re-engage the switch to avoid the risk of fire.

WARNING LIGHTS

These warning lights will come on in the following cases:



DIRECTION INDICATORS (flashing) (green)

When the direction indicator control stalk is operated.

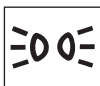

EXTERNAL LIGHTS (green)

When the side/taillights are switched on.



TRAILER DIRECTION INDICATORS (IF ANY) (green)

When the direction indicator control stalk is operated.



MAIN BEAM HEADLIGHTS (blue)

When the main beam headlights are turned on.





WHEEL ANTI-LOCKING SYSTEM (ABS) FAILURE (amber)

The normal braking system continues to work but you should have the car seen to at a **Fiat Dealership**. When the key is turned to **MAR** the warning light will come on but should go out after about 2 seconds.



fig. 23



The car is fitted with an electronic braking device (EBD). The  and  warning light will come on at the same time when the engine is running to indicate that there is an EBD system failure. In this case violent braking may be accompanied by early rear wheel locking with the possibility of skidding. Drive the car extremely carefully to the nearest Fiat Dealership to have the system checked.



Warning light  alone, with the engine running, normally indicates a fault in the ABS system only. In this case, the braking system is still efficient, though without the anti-locking device. Under these conditions, performance of the EBD system may be reduced. Also in this case, you are advised to go immediately to the nearest Fiat Dealership, driving in such a way to avoid sharp braking to have the system checked.



FUEL RESERVE (amber)

When there are about 7 litres of fuel left in the tank.







PASSENGER SIDE AIRBAG OFF (amber)

The warning light will come on when the passenger side airbag is switched off.

The light will flash when the engine is started: this signals the airbag is being activated and not a fault.



Warning light  indicates also **warning light**  failure. This is indicated by **intermittent flashing, over 4 seconds, of warning light** . In this event, **warning light**  could be not up to indicate **restraint system failures, if any. Stop the car and contact Fiat Dealership to have the system checked.**



ENGINE CONTROL SYSTEM FAILURE (EOBD) (amber)

In normal conditions, the warning light will come on when the ignition key is turned to **MAR** and should go out as soon as the engine is started. The initial lighting up shows that the warning light is working properly.

If the warning light either stays on or comes on while travelling:

1. Fixed light - warning of a fuel feed/ignition system failure which may increase emissions in exhaust or cause possible drops in performance, poor handling and high consumption.

In such conditions, you can continue driving but you should not tax the engine and you should moderate the speed. Prolonged use with the warning light on can cause damage. Contact a **Fiat Dealership** as soon as possible.

The warning light will go out when the failure disappears. In any case, the system will store the error.

2. Flashing - warning that the catalyser can be damaged (see EOBD SYSTEM in this chapter).

If the warning light starts flashing, release the accelerator pedal and slow the engine until the warning light stops flashing. Continue driving at moderate speed, preventing the warning light from coming on again. Contact a **Fiat Dealership** as soon as possible.



Contact a Fiat Dealership as soon as possible if the  warning light either does not come on when the key is turned to **MAR** or comes on, with fixed or flashing light, when travelling.



FIAT CODE (amber)

The warning light will come on the three cases when the key is at **MAR**:

1. Single flash - indicates that the key code has been recognised. The engine can be started.
2. Fixed light - the key code has not been recognised. Follow the emergency procedure to start the engine (see **IN AN EMERGENCY**).
3. Flashing light - indicates that the car is not protected by the immobiliser system. The engine can however be started.



HANDBRAKE ENGAGED / LOW BRAKE FLUID

LEVEL (red)

In three cases:

1. When the handbrake is engaged.
2. When the brake fluid level falls below the minimum
3. With the  warning light to indicate an **EBD** electronic brake force corrector failure.



If the  warning light comes on when travelling, check whether the handbrake is engaged. If the warning light stays on and the handbrake is not engaged, stop immediately and contact a Fiat Dealership.



AIRBAG FAILURE (red)

This warning light is found in cars fitting two airbags (driver's side and passenger's side) and in cars fitting an electronic driver's side airbag system. The warning light will come on to indicate a system failure.



If the  warning light does not turn on when turning the ignition key to **MAR** or if it stays on when travelling, this could indicate a failure in safety retaining systems; under this condition airbags or pretensioners could not trigger in the event of collision or, in a restricted number of cases, they could trigger accidentally. Stop the car and contact Fiat Dealership to have the system checked immediately.

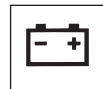

BATTERY NOT RECHARGING PROPERLY (red)

When there is a fault in the current generating system.

When the key is turned to **MAR** the light comes on but should go out the moment the engine is started.



ELECTRICAL POWER STEERING FAILURE (red)

In the following two cases:

1 - When the power steering electrical motor is overheated by repeated, complete steering. In this case, hold the steering wheel still and wait for the light to go out.

2 - When there is an electrical power steering system failure.

When the key is turned to **MAR** the warning light should come on for approximately four seconds only. If the warning lights stays on, the power steering system will not be working. The effort on the steering wheel will increase without compromising steerability. Contact a **Fiat Dealership**.



ENGINE COOLANT TOO HOT (Red)

Turning the ignition key to **MAR** the warning light turns on, but it should go off after four seconds.

If it turns on when travelling, stop the car, leaving the engine on and slightly accelerated to further activate the circulation of the coolant fluid.

If the warning light does not go off within the next 2 or 3 minutes, stop the engine and contact **Fiat Dealership**.



ENGINE OIL PRESSURE TOO LOW (red)

When the engine oil pressure drops under the normal value.

When the key is turned to **MAR**, the warning light should come on but should go out as soon as the engine is started.

A delay in the light going out is acceptable only when the engine is idling.

If the engine has been taxed heavily, the light might flash when idling but should go out on accelerating slightly.



If the warning light comes on while the car is moving, stop the engine and contact a Fiat Dealership.

INDIVIDUAL SETTINGS

FRONT SEATS



All adjustments must be made when the car is stationary.

Moving the seat backwards or forwards

Lift the lever **A**-fig. 25 and push the seat forwards or backwards. You are in the correct position for driving when your hands are resting on the steering wheel rim and your arms are slightly bent.



fig. 25



Once you have let go of the lever, check that the seat is firmly locked in the runners by trying to move it back and forth. Failure to lock the seat in place could result in the seat moving suddenly and dangerously.

Adjusting the reclining seat back

Turn knob **B**-fig. 26.



fig. 26

HEAD RESTRAINTS

Front seats fig. 27

The height of the front head restraints can be adjusted.

To adjust:

- press button **A** and move the head restraint vertically to the required position;
- after adjusting, release the button and make sure that the head restraint is locked in position by moving it up and down.



fig. 27

Rear seats fig. 28

Two fixed head restraints are provided for the rear seats.

Press the two buttons to remove.



Remember that the head restraints should be adjusted to support the back of your head and not your neck. Only if they are in this position will they be able to provide effective protection in the event of a rear-end shunt.



fig. 28

ACCESSING THE REAR SEATS

The rear seats can comfortably be accessed from both sides.

Pull lever **C**-fig. 29 upwards to tilt the seat forward.

Once you have let go of the lever, check that the seat is firmly locked in the runners by trying to move it back and forth.



fig. 29

DRIVING MIRROR

This mirror can be adjusted by means of lever **A**-fig. 30:

- 1) anti-dazzle position;
- 2) normal position.

Mirror slant can be adjusted in either positions.

The mirror is also fitted with a safety device that releases the mirror in the event of an impact.



fig. 30

DOOR MIRRORS

Manual adjustment

From inside the car, turn knob **B**-fig. 31.



If the mirror **A** makes it difficult to get through narrow gaps, fold it from position 1 to position 2.

An optional additional door mirror which can also be adjusted from inside the car on the other side is available.



fig. 31

HEATING AND VENTILATION

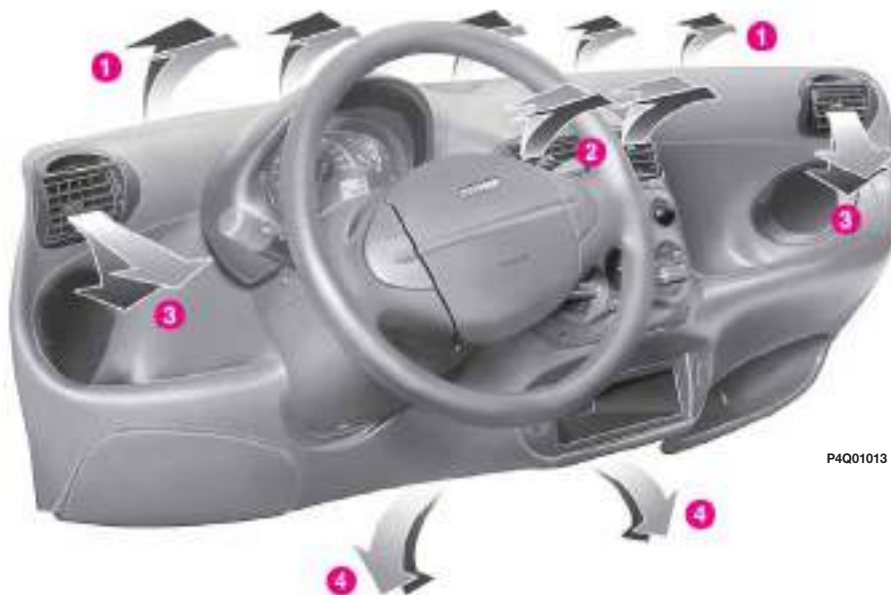

P4Q01013

fig. 32

1. Vent for defrosting or demisting the windscreen
2. Central adjustable vent
3. Side adjustable vent
4. Side vents conveying air to front footwell.

DIRECTIONAL AND ADJUSTABLE AIR VENTS fig. 33

The vents can be rotated upwards or downwards.

A - Control for adjusting air flow:

turned to ↗ vent open.

turned to ● vent closed.

B - Control for directing air flow.

C - Fixed vent for side windows.

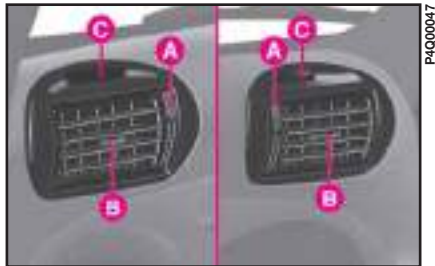

fig. 33

CONTROLS fig. 34

A - Air temperature knob (mixing hot and cold air).

B - Fan knob .

C - Air distribution knob.

D - Air recirculation slider. This prevents air from being taken in from the outside.





fig. 34

HEATING

1) Air temperature knob **A**-fig. 34: pointer in the red sector.

2) Fan knob **B**: pointer at required speed.

3) Air distribution knob **C**: pointer at:  to warm the feet and demist the windscreen at the same time;

 to direct air to the central and side vents;

 to warm the feet and keep the face cool (intermediate position);

 to heat when the outside temperature is especially low: to send most air to the footwell, close the central and side vents;

 to rapidly demist the windscreen.

IMPORTANT To speed up the heating procedure:

- close the vents on the dashboard;
- turn knob **A** to the red sector;
- turn knob **B** to top fan speed;
- turn knob **C** to .

REAR WINDOW DEMISTING AND/OR DEFROSTING

Press button .



We recommend you switch the device off as soon as the window is demisted.



Do not place stickers on the heated rear window filaments, this could generate a short-circuit with possible overheating and rear window explosion.



RAPID DEMISTING AND/OR DEFROSTING

Windscreen and side windows

- 1) Air temperature knob **A**-fig. 34: pointer in the red section.
- 2) Fan knob **B**: pointer at maximum speed.
- 3) Air distribution knob **C**: pointer at .
- 4) Recirculation slider **D** at .



When the windscreen and windows have been demisted, reset the required comfort conditions. To keep the windows as clear as possible follow the procedure described below:

IMPORTANT If the outside air is very damp, if it is raining and/or if there is a considerable difference between the inside and outside temperature, **prevent the windows from misting up** as follows:

- slider at .
- air temperature knob in the red sector;
- fan on 2nd speed or more;
- air distribution knob at . Turn it back to  if the windows do not mist up.

If the car has a manual climate control, adjust the controls as described above and press the  button.

VENTILATION

- 1) Central and side vents: completely open.
- 2) Air temperature knob **A**-fig. 34: pointer in the blue sector.
- 3) Slider **D** at .
- 4) Fan knob **B**: pointer at required speed.
- 5) Air distribution knob **C**: pointer at .

RECIRCULATION

When the slider **D** is in position  only air already inside the passenger compartment is recirculated.

IMPORTANT This function is particularly useful when the outside air is heavily polluted (in a traffic jam, tunnel etc.). You are advised against using this function for long periods however, especially if there are a lot of people in the car. Do not use the recirculation function during cold/wet weather as this will increase the likelihood of the windows misting up.

MANUAL CLIMATE CONTROL SYSTEM

The climate control system is adjusted manually.

CONTROLS fig. 35

Switch **E** automatically sets the fan to the 1st speed.

A - Air temperature knob (mixing hot and cold air).

B - Fan knob.

C - Air distribution knob.

D - Air recirculation slider.



fig. 35

IMPORTANT When the outside temperature is very high, the air will be cooled more quickly if the air recirculation function is turned on. This function is also particularly useful when the outside air is heavily polluted (in a traffic jam, tunnel etc.). You are advised against using this function for long periods however, especially if there are a lot of people in the car.

E - Climate control on/off switch.



The system uses refrigerating fluid R134a which will not pollute the environment if it accidentally leaks. Under no circumstances should fluid R12 be used as this is incompatible with the system's component parts.

CLIMATE CONTROL (Cooling)

1) Air temperature knob **A**-fig. 35: pointer in the blue sector.

2) Climate control: press button  **E**.

3) Slider **D**: at .

4) Fan knob **B**: pointer at required speed.

5) Air distribution knob **C**: pointer at .

To decrease cooling effects: set pointer to , increase temperature and decrease fan speed.

For normal **heating and ventilation**, do not use the manual climate control system. Use the normal heating and ventilation system instead (see following chapter).

IMPORTANT The manual climate control system is very useful for speeding up the demisting process because it dries the air. Simply adjust the controls for the **demisting** function (see previous section) and switch the manual climate control system on by pressing knob .

SYSTEM MAINTENANCE

During the winter, the climate control system must be turned on at least once a month for about ten minutes.

Have the system and pollen filter efficiency checked before the summer at a **Fiat Dealership**.



The system is filled with **R134a** refrigerant which will not pollute the environment in the event of leakage. Under no circumstances should **R12** fluid be used as it is incompatible with the system components and contains **CFC**.

STEERING COLUMN STALKS



LEFT-HAND STALK

This stalk groups together most of the outside lights.



The external lights can only be switched on when the ignition key is at **MAR**.

When the outside lights are turned on, the instrument panel and the various controls located on the dashboard light up.

Side/taillights fig. 36

These come on when you turn the ring from  to . Instrument panel warning light  will come on.

Dipped beam headlights fig. 37

Turn the ring from  to  to switch the lights on.

Main beam headlights fig. 38

Push the stalk from position  towards the dashboard to switch the headlights on.

Instrument panel warning light  will come on.

Pull the stalk towards the steering wheel to switch the lights off.



fig. 36



fig. 37



fig. 38

Flashing the headlights fig. 39

Pull the stalk towards the steering wheel (temporary position) to flash the lights.



fig. 39

Direction indicators fig. 40

Move the stalk as follows:

upwards - to turn the right-hand indicators on;

downwards - to turn the left-hand indicators on.

Instrument panel warning light \leftrightarrow will flash.

The direction indicators will automatically be switched off when the car is straightened out.

If you want the indicator to flash briefly to show that you are about to change lane, move the stalk up or down without clicking into position. When you let it go it will return to its original position.



fig. 40

RIGHT-HAND STALK

Windscreen wiper/washer fig. 41

The device will only work when the ignition key is at **MAR**.

Controls:

0 - Windscreen wiper off

1 - Flick wipe

2 - Continuous wipe

3 - Continuous fast wipe

4 - Temporary position: when released the stalk returns to **0** and automatically switches off the windscreen wiper.



fig. 41

Pulled towards the steering wheel
fig. 42:

– a jet of liquid shoots out from the
windscreen washer.



fig. 42



fig. 43

Rear window wiper/washer

This feature can only work when the
ignition key is at **MAR**.

Controls:

1) turn the control from  to 
fig. 43;

2) when you push the control stalk
forwards (temporary position) **fig. 44**,
a jet of liquid shoots out from the rear
window washer and the rear wind-
screen wiper comes on at the same
time; when the lever is released again
the rear window washer/wiper ceases
to function.



fig. 44

CEILING LIGHT

The light will come on automatically
when a front door is opened.

For versions/markets where pro-
vided, the lens **A-fig. 45** can be
switched to three positions:

- side 1 pressed: light always on
- side 2 pressed: light always off
- central position (neutral): the light
will come on and off when the door is
opened or closed.



fig. 45

CONTROLS

HAZARD LIGHTS

These come on when switch **A**-fig. 46, is pressed regardless of the position of the ignition key.

When these lights are on, the symbol on the switch flashes.

Press the switch again to switch the lights off.



fig. 46



The use of the hazard lights is governed by the traffic regulations of the country the car is driven in. These laws should be complied with.

SWITCHES AND CONTROL BUTTONS fig. 47

The buttons are located under the central air vents.

The controls can only be operated when the ignition key is at **MAR**.

The LED in the button will light up when the respective function is on.



fig. 47

A - Front foglight on/off button. The external lights must be on to switch the front foglights on.

B - Rear foglight on/off button. The external lights or the front foglights must be on to switch the rear foglights on. The rear foglights will be switched off when the ignition key is turned to **STOP**. If required, switch the rear foglights back on when you start the engine again.

C - Heated rear window on/off button.

D - Climate control system on/off button.

HORN

Press one of the two area on the steering wheel shown in **fig. 48**.

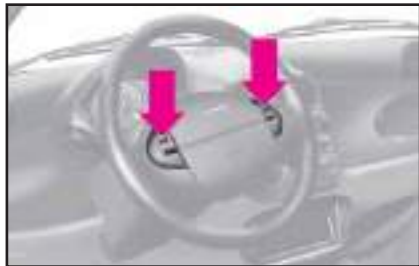

fig. 48

FUEL CUT-OFF SWITCH

This is a safety cut-off switch which comes into operation in the case of an accident to block the supply of fuel thereby stopping the engine.



If, after a crash, you can smell fuel or see leaks from the fuel system, no not reset the switch to avoid fire risk.

If you cannot see any fuel leaks and the car is in a fit state to continue its journey, press button **A-fig. 49** located in the engine compartment on the dashboard bulkhead to reactivate the fuel supply system, as illustrated.

Remember to turn the key to **STOP** to avoid deploying the battery.



fig. 49

INTERIOR EQUIPMENT

ASHTRAY AND CIGAR LIGHTER

Use:

1) press the **A** button; after about 15 seconds the button returns to its original position and the cigar lighter is ready for use.



fig. 50



Important. The cigar lighter gets very hot. Handle with care and do not let children use it: danger of fire or burns.



fig. 51

IMPORTANT Make sure that the cigar lighter does in fact pop out after it has been pushed in.

2) To open the ashtray slide flap **B-fig. 50**.

The ashtray can be removed.

Press the central tab in the ashtray down and pull the ashtray upwards **fig. 51**.



Do not put scraps of paper in the ashtray: they could catch fire if they come into contact with smouldering cigarette stubs.

SUN VISORS fig. 55

These are positioned to the sides of the rear-view mirror. They can swing up or down or be pivoted sideways.

On the back of the drivers sun visor there is a document pocket, while the passenger sun visor is fitted with a vanity mirror.



fig. 55

SUNROOF

ELECTRICAL

Opening and closing the canvas top



Do not attempt to open the roof if there is ice or snow on it as this may damage the top.

The car can be equipped with an optional electrically operated canvas top:

- **A-fig. 56** top closed
- **B-fig. 57** top open.



fig. 56

Press the button as follows to open the top:

- on the front side **A-fig. 58** to close the top;
- on the rear side **B** to open the top.



fig. 57

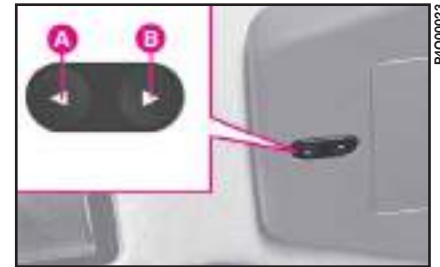

fig. 58

The top will stop as soon as the button is released. Consequently, hold button **A** pressed to open or close the top completely.

If the electrical device does not work, take the key **D-fig. 60** from the document pocket and open or close the roof by hand by inserting the key in hole **C** on the motor.

To access **C**, remove the clip-on cover **fig. 59** by inserting a screwdriver in the position shown.



Improper use of the electric top can be dangerous. Before and during its operation ensure that any passengers in the car are not at risk from the moving top either by personal objects getting caught in the mechanism or by being injured by it directly.



Always remove the ignition key when you get out of the car to prevent the electric top being operated accidentally and constituting a danger to the people left in the car.

IMPORTANT To prevent any noise, after closing the sunroof, keep button **A-fig. 58** depressed for more than 2 seconds.



fig. 59



fig. 60

DOORS

LOCKING - UNLOCKING



Before opening a door, make sure this can be done in safety.

From the outside

– To unlock: turn the key to position **2-fig. 61** and pull the handle upwards.

With centralised controls, the two doors are unlocked simultaneously and knobs **B-fig. 62** are both lifted when the key is turned.

– To lock: turn the key to position **1-fig. 61** when the doors are perfectly closed.

With centralised controls, both doors must be perfectly closed. If one of the doors is not closed they will not both be locked.

– if the door being locked is open the operation cannot be performed;

– if the door on the opposite side is open knobs **B-fig. 62** will move down and up again.

From the inside



Only open the doors with the car stationary.

– To open: pull lever **A-fig. 62** regardless of the position of the inside knob.

With centralised controls, when knob **B** is lifted, the knob on the opposite door is also lifted.



fig. 61

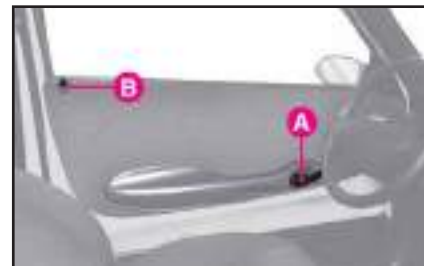



fig. 62

– To lock: lower knob **B** on the door.

With centralised controls, if both doors are perfectly closed, when one knob is lowered the other door is also simultaneously locked.

As for locking the doors with a key, if one of the knobs cannot be lowered the doors are not perfectly closed.

 Do not press a knob when a door is open: the locking device will not work and the lock could be damaged.

ELECTRIC WINDOWS

The electric window device will work normally when the ignition key is turned to **MAR**.

The two buttons **fig. 63** are located next to the sound system compartment (one for each side). Press these buttons to:

A - open/close the driver's side window;

B - open/close the passenger's side window.



fig. 63

 Improper use of the electric windows can be dangerous. Before and during their operation ensure that any passengers in the car are not at risk from the moving glass either by personal objects getting caught in the mechanism or by being injured by it directly.

 Always remove the ignition key when you get out of the car to prevent the electric windows being operated accidentally and constituting a danger to the people left in the car.

BOOT

OPENING/CLOSING THE TAILGATE

For sedan versions, the boot tailgate can only be opened from the passenger compartment using lever **A-fig. 66**.

To open the boot from the outside (VAN versions only), unlock it with the ignition key **fig. 64**.



Do not unlock the boot while the car is in motion.



fig. 64

To open it from inside the car, pull lever **A-fig. 66** at the side of the driver's seat.

The opening of the boot is made easier by the gas-filled struts on each side.

To close the boot, lower it and press the lock or the Fiat logo until it clicks.

A hole **fig. 65** in the inside of the tailgate is provided to offer an easy grip for closing the tailgate.



fig. 65



When using the boot, make sure that the load you are carrying does not exceed the permitted weight (see TECHNICAL SPECIFICATIONS). Also ensure that the items in the boot are arranged properly to prevent them being thrown forwards and injuring passengers should you brake sharply.



Never travel with the boot open: the exhaust fumes could enter the passenger compartment.



fig. 66



Adding things on the rear window shelf or the tailgate (speakers, spoiler, etc.) can interfere with the correct operation of the tailgate side gas-struts.



Follow the laws in force if you are travelling in areas where refuelling is difficult and you want to carry a can of petrol. Use a homologated can only and secure it to the load anchoring hooks. Even given these precautions, the risk of fire in the event of an accident is increased.

EXTENSION

How to extend the boot:

1) Remove the rear window shelf by releasing the two tie rod tips **A**-fig. 67 from their housings **B**.

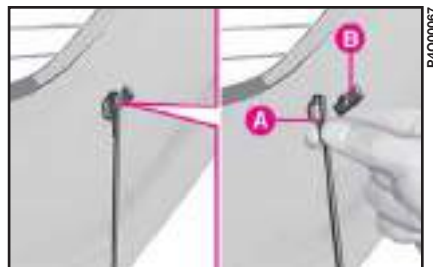

fig. 67



fig. 68

Pull the shelf outwards to release the pins **A**-fig. 68.

The rear window shelf can be positioned behind the rear seat backs while not in use.

2) Grip the back of the cushion and tilt it forward against the seat backs of the front seats **fig. 69**.

3) Raise the levers **A**-fig. 70 (two, on the outer side of the seat back) and tilt the seat back forward moving aside the side seat belt devices.

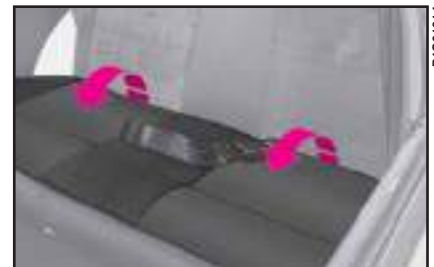

fig. 69

To bring the seat to its normal position again:

– Tip the seat back **fig. 71** backwards while holding the seat belts in front of the seat back. Ensure it clicks into place.

– Bring the cushion to a horizontal position making sure the seat belts do not remain underneath.

The car can be fitted with separate rear seats.

With separate seats the boot extension possibilities are various and can be decided according to the number of passengers and how much luggage is to be transported:

– all extended, by tilting both sides - left and right - of the rear seat as described above;

– partial extension with the left side of the rear seat tilted and a back seat for one passenger;

Anchoring the load

There are two brackets with holes **A-fig. 72** in the boot to fasten ropes for anchoring the load. These brackets are located at the base of the rear seat (one on each side).

Other luggage anchoring holes are located on the rear crossmember and are closed with rubber caps.

To use the holes, remove the caps.



fig. 70



fig. 71



fig. 72



Heavy loads which are not securely anchored could seriously injure passengers in the event of an accident.

IMPORTANT Check and adjust the height of the dipped headlight beam when travelling at night with a rather heavy load in the boot (see HEADLIGHTS in this chapter).



When refitting the rear window shelf, fasten the two side tie-rods fig. 67 passing them on the outside of the struts.

Some versions are fitted with rear speakers located on the rear window shelf.

When removing the rear window shelf disconnect also the connector between speakers and sound system.

Proceed as follows: disconnect connector **A**-fig. 73 from its seat **B** located on the side wall under the seat belt hole.

When refitting the rear window shelf, reconnect connector to **B**-fig. 73 to reset speaker operation.

IMPORTANT Proper radio operation is not impaired when the rear speakers (on the rear window shelf) are not connected.



fig. 73

PA001081

BONNET



This should only be done when the car is stationary.



Before opening the bonnet, check the windscreen wiper arms are not lifted from the windscreen.

To open the bonnet:

- 1) Pull the lever shown in **fig. 74** in the direction of the arrow.
- 2) Press tab B as shown in **fig. 75**.
- 3) Lift the bonnet and release the support rod **B-fig. 76** from its clip **A**.
- 4) Place the tip of the support rod in recess **C** of the bonnet.



Important. The bonnet might fall violently if the support rod is not positioned properly.



When the engine is hot, mind your hands when working inside the engine compartment to avoid burning yourself. Never put your hands near the fan: it could start up even without the key in the switch. Wait until the engine cools down.

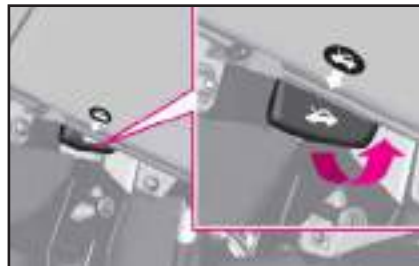

fig. 74



fig. 75



Take care that scarves, ties or loose clothing do not accidentally come near moving parts; they could become entangled with serious danger for the wearer.



fig. 76

To close the bonnet:

1) keep the bonnet lid raised with one hand and remove the rod **B**-fig. 76 from the recess with the other **C** then secure it in its clip **A**.

2) lower the bonnet until approx. 20 cm from the engine compartment and then let it drop, ensuring it is fully closed and not just held in position by the safety catch.

If the bonnet does not close properly do not push it down but open it again and repeat the above procedure.



For safety reasons the bonnet shall always be perfectly closed when travelling. Always check for proper bonnet locking. If the bonnet is left inadvertently open, stop the car immediately and close the bonnet.

ROOF RACK/ SKI RACK

ANCHORING ARRANGEMENT fig. 77

The anchoring seats for roof racks are shown in the illustration.

The rear clips are to be secured in the area immediately above the side window rubbers.

Specific roof/ski racks are available in the Fiat Lineaccessori range.



fig. 77



After travelling a few kilometres, check that the screws securing the attachments are tight.



Never exceed the permitted weight (see TECHNICAL SPECIFICATIONS).



Be careful not to knock objects on the roof rack when opening the tailgate.

HEADLIGHTS

ADJUSTING THE HEADLIGHT BEAM

The correct positioning of the headlight beams is very important for the comfort and safety, not only of the person driving the car but also all other road users.

This is also covered by a specific law.

To ensure you and other drivers have the best visibility conditions when travelling with the headlights on, the headlights must be set properly.

Have the headlight positioning checked at a **Fiat Dealership** and adjusted if necessary.

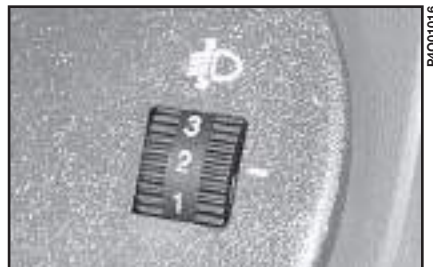

fig. 78

SLANT COMPENSATION

When the car is loaded, it slopes backwards. This means that the headlight beam rises. In this case, it is necessary to return it to the correct position.

The headlight beam adjuster is located inside the car on the right side of the steering column **fig. 78**.

Position **0** - one or two occupants in the front seats.

Position **1** - five occupants.

Position **2** - five occupants + load in boot.

Position **3** - driver + maximum permissible load stowed in boot.



Check the positioning of the headlight beams every time you change the load to be carried.

ADJUSTING THE FRONT FOGLIGHTS

The foglight beam can be adjusted by means of screw **A**-fig. 79.

Have the lights checked at a **Fiat Dealership** and adjusted if necessary.



fig. 79 Versione S and Active

ABS

The car is fitted with an ABS braking system, which prevents the wheels from locking when braking, makes the most of road grip and gives the best control when emergency braking under difficult road conditions.

The driver can tell the ABS system has come into play because the brake pedal pulsates slightly and the system gets noisier.

This should not be interpreted as a fault in the brakes; on the contrary it is a sign that the ABS system is working: it tells the driver that the car is travelling at the limit of its road grip and that the speed should be altered to fit the type of road surface.

The ABS is an addition to the basic braking system. If there is a malfunction, the system turns off automatically and only the ordinary brakes continue to work.

If a failure occurs, and, consequently, the wheel anti-locking system is not effective, the braking system will continue to work as usual.

If you have never driven a car with ABS before, you should practice using the system on slippery terrain, obviously with the necessary safety precautions and keeping to the Highway Code of the country you are in. It is also a good idea to read the following information carefully.

The advantage in using the ABS system is that it continues to give you maximum manoeuvrability even when braking hard in conditions of poor grip by preventing the wheels locking.

You should, however, not expect the braking distance to always decrease: for example surfaces with gravel or fresh snow on a slippery road will in fact increase the braking distance.

To exploit the ABS system to the full in the event of necessity, you should take heed of the following advice:



The **ABS** exploits the road hold available as much as possible but cannot increase it. You should always drive carefully on slippery surfaces and avoid any unnecessary risks.



If the **ABS** intervenes, it means that the grip between the tyre and the road is reduced with respect to the normal conditions. Reduce speed immediately to match the poor road conditions.



If there is a fault in the system and the instrument panel warning light  comes on, drive you car slowly to a Fiat Dealership, to have the system checked and put right.

Braking while cornering always requires extreme care even when using **ABS**.

The most important advice to follow is this:





When the **ABS** cuts in, and you feel the brake pedal pulsating, do not remove your foot, but keep it pressed. In doing so you will stop in the shortest amount of space possible under the current road conditions.

If you follow these tips you will be able to brake better in any situation.

IMPORTANT Cars with **ABS** may only be fitted with wheel rims, tyres and brake pads of the make and model approved by the manufacturer.

The system is completed with an electronic brake force distributor called **EBD** which improves braking system performance by means of the **ABS** system control unit and sensors.



The car is fitted with an electronic braking device (**EBD**). The  and  warning light will come on at the same time when the engine is running to indicate that there is an **EBD** system failure. In this case violent braking may be accompanied by early rear wheel locking with the possibility of skidding. Drive the car extremely carefully to the nearest Fiat Dealership to have the system checked.



Warning light (ABS) alone, with the engine running, normally indicates a fault in the ABS system only. In this case, the braking system is still efficient, though without the anti-locking device. Under these conditions, performance of the EBD system may be reduced. Also in this case, you are advised to go immediately to the nearest Fiat Dealership, driving in such a way to avoid sharp braking to have the system checked.



If the (ⓘ) brake fluid low warning light comes on, stop the vehicle immediately and contact the nearest Fiat Dealership. Fluid leaks from the hydraulic system, in fact, can compromise brake system operation, both traditional systems and systems with ABS.

FRONT AIRBAGS

The car is fitted with front air bags (for versions/markets where applicable) for the driver and the passenger.

FRONT AIR BAGS fig. 80

The front air bag (driver and passenger) has been designed to protect the occupants in the event of head-on crashes of medium-high severity, by placing the cushion between the occupant and the steering wheel or dashboard.

Front air bags are designed to protect car's occupants in front crashes and therefore non-activation in other types of collision (side collisions, rear shunts, roll-overs, etc.) is not a system malfunction.



fig. 80

In case of front crash, an electronic control unit, when required, triggers the inflation of the cushion.

The cushion immediately inflates, placing itself as a protection between the body of the front occupants and the structure that could cause injuries. Immediately after, the cushion deflates.

The front air bag (driver and passenger) is not a replacement of but complementary to the use of belts, which should always be worn, as specified by law in Europe and most non-European countries.

In case of crash, a person not wearing the seat belt moves forward and may come into contact with the cushion while it is still inflating. Under this circumstance the protection offered by the air bag is reduced.

Front air bag can be activated in the following situations:

- in collisions against highly deformable objects not affecting the vehicle front surface (e.g. bumper collision against guard rail);

– car wedging under other vehicles or protective barriers (for example under a truck or guard rail);

as it offers no additional protection compared with the seat belts, consequently, it would be pointless. Therefore, failure to come into action in the above circumstances does not mean that the system is not working properly.



Do not apply stickers or other objects to the steering wheel or to the passenger's air bag cover or on the side roof lining. Never apply objects on the dashboard on passenger side (e.g. mobile phones) since they could interfere with proper passenger air bag inflation and cause severe injuries.

FRONT AIRBAG PASSENGER SIDE



SERIOUS DANGER: Never place cradle child's seats on the front passenger seat of cars fitted with passenger air bag. Air bag activation could cause serious injuries, even mortal. In the case of need, always deactivate the passenger's air bag when a child's seat is placed on the front seat. The front passenger's seat shall be adjusted in the most backward position to prevent any contact between child's seat and dashboard. Even if not compulsory by law, you are recommended to reactivate the air bag immediately as soon as child transport is no longer necessary.

The passenger side airbag was designed and calibrated to protect a person wearing seat belts.

When fully inflated, the bag will fill most of the space between the dashboard and the passenger.

Manual deactivation

The passenger side airbag can be deactivated if it is absolutely necessary to carry a child in the front passenger seat.

Turn the specific control switch under the middle of the dashboard between the sound system compartment and the oddment compartment **fig. 81** with the ignition key to deactivate the airbag.



fig. 81

The switch has two positions:

1) Passenger side airbag activated: (position ON ) , instrument panel warning light off. Do not carry children on the front seat.

2) Passenger side airbag deactivated: (position OFF ) , instrument panel warning light on. A child can be carried on the front seat with a suitable restraint system.

The instrument panel warning light  will stay on until the passenger side airbag is reactivated.

GENERAL WARNINGS

The front airbags (on driver and passenger side, where fitted) can be triggered if the car is subjected to strong knocks or impacts underneath, e.g. violent crashes into steps, kerbs or fixed projections from the ground, falling to large holes or dips in the road.

When the airbag inflates it emits heat and a small amount of smoke. This is harmless and does not indicate the beginning of a fire.

The air bag system has a validity of 14 years as concerns the pyrotechnic charge and 10 years as concerns the coil contact (see the plate located on the front left door post near door hinges).

As these dates approach, contact **Fiat Dealership** to have them replaced.

After an accident which triggered the airbags, go to a **Fiat Dealership** to have the entire safety system, the electronic control unit, the seat belts and the pretensioners replaced. The **Fiat Dealership** will also check the intactness of the electrical system.

Any diagnostic, repair or replacement operations concerning the airbag system must exclusively be carried out at a **Fiat Dealership**.

If you are having the car scrapped, have the airbag system deactivated at a **Fiat Dealership** first.



If the car changes hands, the new owner must be made aware of the indications given above and be given this Owner Handbook.

Pretensioners and front airbags are triggered by the electronic control unit according to different types of impacts. Missed triggering of the system, consequently, does not indicate a fault in the system.



If the  warning light does not turn on when turning the ignition key to **MAR** or if it stays on when travelling, this could indicate a failure in safety retaining systems; under this condition air bags or pretensioners could not trigger in the event of collision or, in a restricted number of cases, they could trigger accidentally. Stop the car and contact Fiat Dealership to have the system checked immediately.



The failure of the  warning light is also indicated by the flashing for more than the normal 4 seconds of the passenger's front air bag deactivated warning light . In addition the air bag system will deactivate automatically the passenger's air bags (front and side where provided). In this event, warning light  could not indicate safety systems failures. Contact Fiat Dealership immediately to have the system checked.



The warning light  should come on for approximately four seconds and then flash for other four seconds when the passenger side airbag deactivation switch is turned to **ON** and the ignition key is turned to **MAR** to remind you that the passenger side airbag will be fired in the event of an accident. The warning light should then go out.



Do not travel with objects on your lap or in front of you. Do not hold a pipe, a pencil or similar between your lips. You could seriously hurt yourself if the airbag inflates in a collision.



Always drive with both hands on the rims of the steering wheel so that the airbag is free to inflate during a head-on collision and protection yourself from serious injury. Do not drive with your body bending towards the steering wheel but sit in an upright position with your back resting against the seat.



If an attempt has been made to steal the car or if it has actually been stolen or vandalised in any way or subjected to flooding, have the airbag system checked at a Fiat Dealership.



Please note that airbags can be triggered when the engine is running also if the car is stationary and another vehicle crashes into it at suitably high speed. As a consequence, never sit children in the front seat, also when the car is still. On the other hand, the airbags will not be fired if the car is stationary and the key is not turned. Missed operation in these circumstances does not indicate a fault.



Correct operation of the front airbags and the pretensioners is guaranteed as long as the car is not overloaded.



The airbag does not replace seat belts but rather increases their effectiveness. Furthermore, the front airbag is not fired in the event of low speed front collisions, side collisions, rear-end shunts and roll-overs. In these cases, the passengers are only protected by the seat belts which for this reason must be fastened at all times.

EOBD SYSTEM

The EOBD (European On Board Diagnosis) system continuously monitors the car emission system components. Furthermore, the system warns the driver of deterioration concerning the emission system components by means of the  warning light on the instrument panel. The objective is to:

- monitor system efficiency;
- warn when failures can increase emissions over the threshold established by the European regulations;
- warn of the need to replace deteriorated components.

Furthermore, the system is equipped with a connector for interfacing with specific tools used to read the error codes stored in the control unit memory along with a set of diagnostic and engine specific parameters.

This check can also be performed by traffic controller agents.



Contact a Fiat Dealership as soon as possible if the  warning light either does not come on when the key is turned to **MAR** or comes on, with fixed or flashing light, when travelling.

IMPORTANT After eliminating the problem, your **Fiat Dealership** will run a bench test to fully check the system. In some cases, a long road test may be required.

ELECTRICAL POWER STEERING SYSTEM

IMPORTANT The electrical power steering system only works when the ignition key is at **MAR**.

A new electrically controlled power steering system called EPAS (Electrical Power Assisted Steering) is fitted in the Fiat 600.

The EPAS system is operated by an electric motor and consists of only two parts: a steering column with built-in electric motor and an electronic control unit.

The control unit processes the data from the various sensors located in the car and converts the signals into commands for the power steering motor to reduce the effect on the steering wheel both when parking and when cornering.

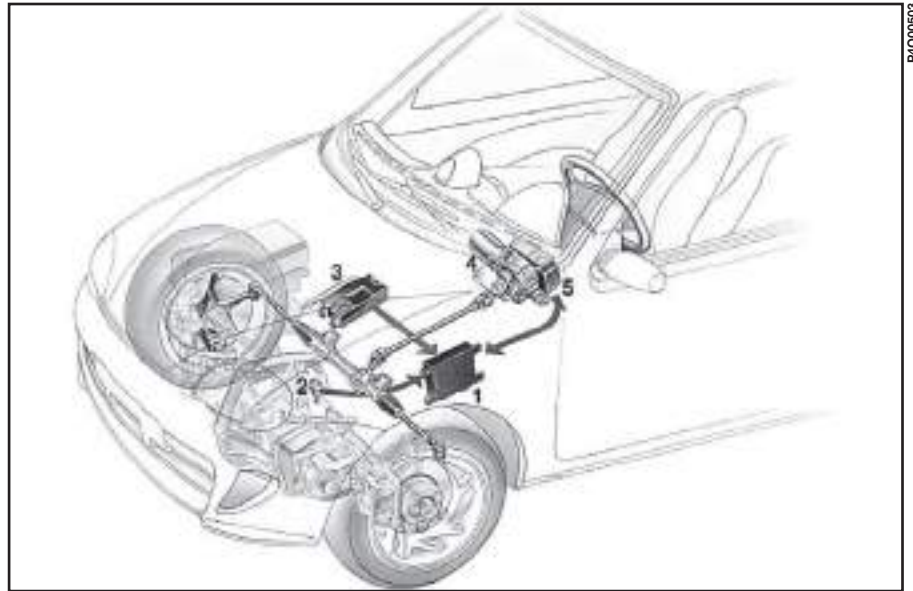

P4Q00503

fig. 82

- 1) Electronic power assisted steering control unit;
- 2) Car speed sensor;
- 3) Injection control unit;
- 4) Electric power steering motor;
- 5) Electrical power steering unit.

The system is programmed at the factory to ensure variable degrees of assistance according to the requirements. In other words, power is increased for parking and reduced as the car's speed increases.

The EPAS system only works when the engine is running to avoid deploying the battery accidentally. Furthermore, it is equipped with a self-test function to detect faults and incorrect signals.

IMPORTANT The steering wheel may stiffen slightly in parking manoeuvres requiring a great deal of steering: this is normal and caused by the power steering motor overheat protection system tripping. The problem does not require servicing and the electric power steering system will work normally the next time the car is used.

If the warning light comes on, see chapter GETTING TO KNOW YOUR CAR, paragraph WARNING LIGHTS.



It is absolutely forbidden to carry out whatever after-market operation involving steering system or steering column modifications (e.g.: installation of anti-theft Device) that could badly affect performance and safety, cause the lapse of warranty and also result in non-compliance of the car with homologation requirements.

FIAT 600 VAN

The version herein illustrated differs from Fiat 600 saloon described in this handbook for the different size of the boot and the availability of two front seats only.

Load recommendations

Fiat 600 Van has been designed and approved on the basis of several set maximum values:

- kerb weight
- payload
- gross vehicle weight
- total weight on the front axle
- total weight on the rear axle
- towable weight.

Each of these limits must be borne in mind and must never be exceeded under any circumstances.

IMPORTANT Sudden braking or collisions can cause sudden shifts of the load which could jeopardise the safety of the driver and the passengers: before you start off make sure the load is firmly secured.

Use metal cables, ropes or straps strong enough to support the weight of the load to be fixed.

In addition to these general precautions, some simple measures could enhance driving safety, comfort and the length of your vehicle's life:

- distribute the load evenly over the load floor: if you need to concentrate it all in one point choose the part between the axles;

- remember that the lower the load is, the lower the vehicle's centre of gravity will be, contributing to a safe drive; you should therefore always position the heavier goods at the bottom;

- finally, remember that the way in which the vehicle moves is influenced by the weight being carried. In particular, stopping distance lengthens particularly at high speed.



fig. 83

SOUND SYSTEM



Contact a Fiat Dealership if you want to install a sound system after purchasing your car. Their staff will advise you on how to safeguard the life of the battery. Excessive idle intake can damage the battery and invalid the battery warranty as well.

Large oddments compartments in the dashboard making the passenger compartment even more comfortable are found in cars not equipped with a SOUND SYSTEM SET-UP.

A specific SOUND SYSTEM SET-UP kit can be found in the Lineaccessori Fiat range.

STANDARD SYSTEM

Standard equipment includes car radio supply cables, car radio housing and front loudspeaker housing.

The car radio must be installed on specific housing occupied by the glove compartment that is removed by pressing on the two retaining tabs **A-fig. 84**.

Here, supply cables are available and, in case of car radio option provision, the loudspeaker and aerial connections as well.

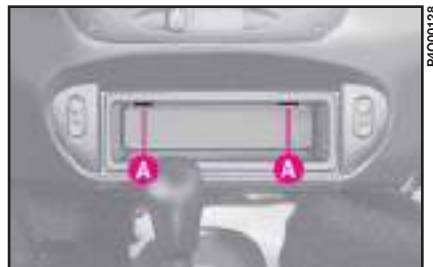

fig. 84

AERIAL

To install:

- 1) Remove the plastic cap **A-fig. 85** screwed onto the car roof.
- 2) Screw in the aerial.



fig. 85

WIRING DIAGRAM AND ADDITIONAL BRANCHES fig. 86

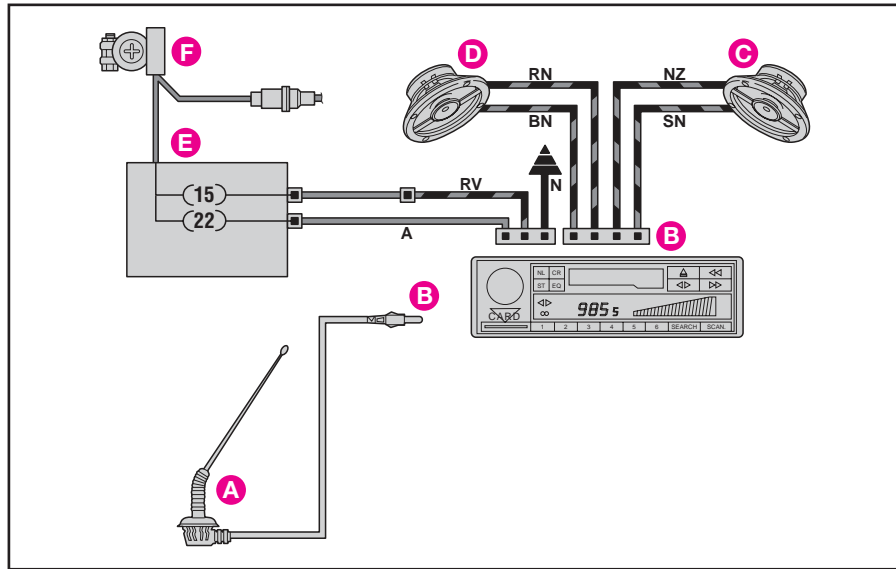

fig. 86

- A** - Aerial
- B** - Radio receiver unit connection
- C** - Speaker on right dashboard panel
- D** - Speaker on left dashboard panel
- E** - Power supply fuses
- F** - Power supply with extra fuse for amplifier installation only (for systems with 20 + 20W output or higher).

Wire colour coding:

A=light blue - **BN**=white/black - **N**=black -
NZ=black/purple - **RN**=red/black -
RV=red/green - **SN**=pink/black

SPEAKERS

Use the speaker housings on the two sides of the dashboard.

- **fig. 87** left speaker
- **fig. 88** right speaker.

1) Unscrew the four screws **B** and remove the supporting grid.



fig. 87



fig. 88

SET-UP SYSTEM

The vehicle is equipped with the following devices along with the standard system:

- 2 front speakers;
- an aerial to be applied to the roof.

SOUND SYSTEM

The complete system consists of the following:

- system provisions (see previous paragraph);
- stereo radio and cassette player with removable front control panel (for features and operation, see specific instruction booklet).

ACCESSORIES PURCHASED BY THE OWNER

If after buying the vehicle, you decide to install electrical accessories that require a permanent electric supply (alarm, satellite antitheft system, etc.) or accessories that in any case burden the electric supply, contact Fiat Dealership, whose qualified personnel, besides suggesting the most suitable devices belonging to Lineaccessori Fiat, will also evaluate the overall electric absorption, checking whether the vehicle electric system is able to withstand the load required, or whether it needs to be integrated with a more powerful battery.



Take care when fitting additional spoilers, alloy rims and non-standard wheel caps: they might reduce ventilation of the brakes, thus their efficiency, during abrupt and repeated braking, or long downhill slopes. Make sure that nothing (mats, etc.) gets in the way of the pedals when they are pushed down.

INSTALLATION OF ELECTRIC/ELECTRONIC DEVICES

Electric/electronic devices installed after buying the car or in aftermarket shall bear the and marking:



Fiat Auto S.p.A. authorizes the installation of transceivers provided that installation is carried out at a specialized shop, workmanlike performed and in compliance with manufacturer's specifications.

IMPORTANT Installation of devices resulting in modifications of car characteristics may cause driving license seizing by traffic agents and also the lapse of the warranty as concerns defects due to the abovementioned modification or traceable back to it directly or indirectly.

Fiat Auto S.p.A. declines all responsibility for damages caused by the installation of non-genuine accessories or not recommended by Fiat Auto S.p.A. and installed not in compliance with the specified requirements.

RADIO TRANSMITTERS AND CELLULAR TELEPHONES

Mobile phones and other radio transmitter equipment (e.g.: HAM radio systems and the like) shall not be used inside the car unless a separate aerial is mounted.

IMPORTANT The use of mobile phones, HAM radio systems or other similar devices inside the passenger compartment (without separate aerial) may cause electronic systems equipping the car to malfunction. This could compromise safety in addition to constituting a potential hazard for the passengers.

In addition, transmission and reception of these devices may be affected by the shielding effect of the car body.

As concerns EC-approved mobile phones (GSM, GPRS, UMTS), strictly comply with the instructions **CE**, for use provided by the mobile phone's manufacturer.

AT THE FILLING STATION

The Fiat 600's pollution control devices make it essential to use unleaded petrol only.

However, to avoid mistakes, the fuel filler is too small for the leaded petrol pump. Octane rating (R.O.N.) must not be lower than 95.



fig. 89



Never pour even the tiniest amount of leaded petrol in the tank, not even in an emergency; this would damage the catalytic exhaust beyond repair.



An inefficient catalytic exhaust causes harmful emissions with consequent environmental pollution.

REFUELLING

To guarantee full tank filling, carry out two refuelling operations after the first click of the fuel delivery gun. Avoid further topping up operations that could cause damages to the fuel system.

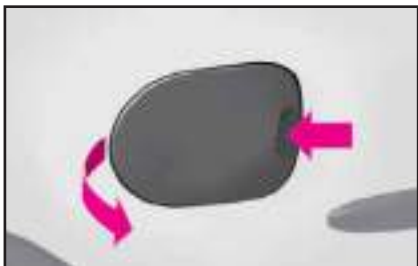

P4QC00076

fig. 90



P4QC01087

fig. 91



P4QC01088

fig. 92

FUEL TANK CAP

To open:

- 1) press on the point indicated and open the flap **fig. 90**;
- 2) turn the cap anticlockwise and remove it.

The cap is provided with a strap **A-fig. 92** fastening it to the flap so that it cannot be lost.

IMPORTANT The hermetic closure may cause a slight pressure in the tank: a slight hissing when turning the cap is quite normal.

To close:

- 1) the cap coupling is “bayonet” type. Insert the cap and turn it clockwise until it clicks;
- 2) holding still the cap, close the lid.

IMPORTANT If required, replace the fuel cap with another genuine cap to avoid affecting the efficiency of the fuel vapour recovery system.



Keep naked flames or lighted cigarettes away from the fuel filler hole as there is a danger of fire. Do not bend too close to the hole either so as not to breathe in harmful vapours.

PROTECTING THE ENVIRONMENT

Protecting the environment has been the guiding principle in the design of the Fiat 600 right from the start. The result is the use of materials and creation of devices that can reduce or considerably curtail harmful influences on the environment.

The devices for curtailing petrol engine emissions are:

- a three-way catalytic converter;
- a lambda sensor;
- a fuel evaporation system.

Consequently, the Fiat 600 is ready to travel well ahead of the most stringent international pollution control standards.

DRIVING YOUR CAR

STARTING THE ENGINE



It is dangerous to let the engine run in a garage or other closed area. The engine consumes oxygen and gives off carbon dioxide, carbon monoxide and other poisonous fumes.



Do not touch the high voltage cables (spark plug leads) when the engine is running.

IMPORTANT Do not press down the accelerator before starting the engine.

- 1) Ensure that the handbrake is up.
- 2) Put the gear lever into neutral.
- 3) Press the clutch pedal fully down, without pressing the accelerator.
- 4) Turn the ignition key to **AVV** and let it go the moment the engine starts.

If warning lights  stay on when the key is turned to **MAR** turn the key to **STOP** and then back to **MAR**. If the light does not go off, try with the other keys.

If you are still unable to start the engine, perform the emergency start-up procedure (see IN AN EMERGENCY) and call your **Fiat Dealership**.

IMPORTANT Do not leave the ignition key at **MAR** when the engine is off.

HOW TO WARM UP THE ENGINE AFTER IT HAS JUST STARTED

- Begin to move forward slowly letting the engine turn at medium revs. Do not accelerate abruptly.
- Do not push the engine to its limit for the first few kilometres.

EMERGENCY START-UP

If the Fiat CODE system fails to recognise that code transmitted by the ignition key (instrument panel warning light  on) the emergency start-up can be performed by using the CODE card code.

See the IN AN EMERGENCY.



Bump starting by pushing, towing or rolling downhill must be avoided at all costs. This way of starting could cause a rush of fuel into the catalytic exhaust pipe and damage it beyond repair.



Remember that as long as the engine is not running, the power brakes and power steering do not work. You therefore have to use considerably more effort on both the brake pedal and the steering wheel.

SWITCHING OFF THE ENGINE

Turn the key to **STOP** while the engine is idling.



A quick burst on the accelerator before turning off the engine serves absolutely no practical purpose and wastes fuel.

IMPORTANT After a taxing drive it is better to allow the engine to “catch its breath” before turning it off, by letting it idle to allow the temperature in the engine compartment to fall.

PARKING

Switch off the engine, pull up the handbrake and put the car in 1st gear if the car is pointing uphill, reverse if downhill.

If the car is parked on a steep gradient it is a good idea to use a stone or wedge to block the wheels.

Do not leave the ignition key at **MAR** because it drains the battery.

Always remove the key when you leave the car.



Never leave unsupervised children in the car.

HANDBRAKE

The handbrake lever is between the front seats.

Pull the handbrake lever upwards until the car cannot be moved. Four or five clicks are generally enough when the car is on level ground while nine or ten may be required if the car is on a steep slope or laden.



fig. 1

IMPORTANT If this is not the case, go to a **Fiat Dealership** to have the handbrake adjusted.

Instrument panel warning light (Ⓢ) will come on when the handbrake lever is pulled up and the ignition key is at **MAR.**

To release the handbrake:

1) Slightly lift the hand brake and press release button **A**-fig. 1;

2) keep the button pressed in and lower the lever. Warning light (Ⓢ) will go out;

3) to prevent accidental movement of the car, this procedure should be carried out with the brake pedal pressed down.

STEERING LOCK LEVER

Use the brake pedal to lock the bottom end.

HOW TO USE THE GEARS

The lever positions for the different gears are shown in **fig. 2** (this diagram is also on the gear knob).

Press the clutch fully.

To put the car in reverse (**R**), wait until the car has stopped and, from neutral: move the lever to the right and back.



fig. 2

IMPORTANT Reverse gear can only be engaged when the car is completely stationary. With the engine running, before engaging the reverse gear, wait for at least two seconds with the clutch pedal pressed fully down to avoid damaging or grating the gears.



To change the gear properly (with mechanical clutch) you must push the clutch pedal fully down. It is therefore essential that there is nothing under the pedals. Make sure mats are lying flat and do not get in the way of the pedals.

CONTAINING RUNNING COSTS AND POLLUTION

Some suggestions which may help you to keep the running costs of the vehicle down and lower the amount of toxic emissions released into the atmosphere are given below.

GENERAL CONSIDERATIONS

Car maintenance

The overall state of the car is an important factor which has a marked influence over fuel consumption and driving comfort and on the life span of your car. For this reason care should be taken to maintain your car by carrying out the necessary checks and regulations in accordance with the specifications given in the SERVICE SCHEDULE (see sections: SPARK PLUGS, IDLING, AIR CLEANERS, TIMING).

Tyres

Tyre pressure should be checked at least once every four weeks: if the pressure is too low fuel consumption increases as the resistance to the rolling movement of the tyre is greater. In this state, tyre wear is increased and vehicle handling suffers which will effect safety.

Unnecessary loads

Do not travel with too much luggage stowed in the boot. The weight of the vehicle and its trim greatly effects consumption and stability.

Roof rack/ski rack

Remove roof racks and ski racks from the roof of the car as soon as they are no longer needed. These accessories reduce the aerodynamic penetration of the vehicle and will increase consumption. When having to transport particularly large loads it is better to use a trailer.

Electric devices

Use electric devices for the necessary time only. The heated rear window, fog lights, windscreen wipers, heating system blower require large amounts of electricity, and as a consequence, the fuel consumption increases (up to +25% in town).

Climate control system

The climate control system is a further drag on the engine causing higher fuel consumption (on average, up to 20%). When outside temperatures permit, use the vents.

Aerodynamic accessories

The use of aerodynamic accessories not certified for that specific purpose can diminish the car's aerodynamic penetration and increase consumption.

BEHIND THE WHEEL

Starting-up

Do not warm up the engine when the car is stationary, neither by idling nor revving up. If you do, the engine will warm up much more slowly and increase fuel consumption and emissions. It is therefore better to start slowly and to keep the engine speed down.

Unnecessary manoeuvres

Do not give quick bursts on the accelerator when waiting at the traffic lights or before turning off the engine. This type of action, like the "double clutch" are absolutely useless on modern cars. They only increase fuel consumption and pollution.

Gear selection

As soon as traffic conditions allow, shift up to a higher gear. Using a low gear to have a sharp acceleration increases the consumption. Likewise, using a high gear when this is not called for increases consumption, emissions and wear on the engine.

Top speed

As speed increases, so does the fuel consumption: note that passing from 90 to 120 km/h increases consumption by about +30%. Keep your speed as steady as possible and avoid unnecessary braking and accelerations that cost fuel and increase emissions considerably. It is better to drive “smoothly” trying to foresee the manoeuvres to avoid imminent dangers and always respect the safety distance to avoid the need to slow down suddenly.

Acceleration

Sudden and sharp accelerations revving up the engine increase consumption and emissions; accelerate gradually and do not exceed the maximum torque.

USE

Cold start

Short journeys and frequent cold start-ups do not allow the engine to reach the best running temperature. As a result, consumption rises (from +15 to +30% in town) and so do the harmful emissions.

Traffic situations and road conditions

Consumption rises in heavy traffic, in traffic jams where it is constantly necessary to shift to low gears or in big cities with many traffic lights.

Also twisting roads, mountain roads and rough road surfaces pay a heavy toll on consumption.

Hold-ups in traffic

During hold-ups (e.g.: level crossings) switch off the engine.

CHEAP RUNNING THAT RESPECTS THE ENVIRONMENT

Environmental protection has been one of the guiding principles in the production of Fiat 600. It is no accident that its pollution control equipment is much more effective than that required by current legislation.

Nonetheless, the environment cannot get by without a concerted effort from everyone.

By following a few simple rules you can avoid harming the environment and often cut down fuel consumption at the same time.

On this subject, a few useful tips have been given below to supplement those marked by symbol , at various points of the handbook.

You are asked to read both the former and the latter carefully.

LOOKING AFTER EMISSION CONTROL DEVICES

The correct use of pollution control devices not only ensures respect for the environment but also has an effect on the car's performance. Keeping these devices in good condition is therefore a fundamental rule for driving that is easy on your pocket and on the environment too.

The first step to take is to follow the Service Schedule to the letter.

If your car has a petrol engine use only unleaded petrol.

If you have trouble starting, do not keep turning the ignition key for long periods. Be especially careful to avoid bump starting the car by pushing, towing or rolling down hill: these are all manoeuvres that can damage the catalytic exhaust. For emergency starts use only an auxiliary battery.

If the engine begins to “lose its smoothness” when travelling, continue your journey but reduce the demands you are making on the engine and go to a **Fiat Dealership** as soon as you can.

When the instrument panel fuel reserve warning light comes on, fill up as soon as possible. A low level of fuel can cause an uneven supply of fuel to the engine with the inevitable increase in the temperature of the exhaust gas and serious damage to the catalytic converter.

Never run the engine with one or more spark plugs disconnected, even for testing purposes.

Do not warm up the engine by letting it idle for a while before moving off unless the outside temperature is very low and, even in this case, only do so for less than 30 seconds.

Do not install other heat shields and do not remove those already fitted to the catalytic converter and exhaust pipe.



Do not allow anything to be sprayed onto the catalytic converter, Lambda sensor or exhaust pipe.



When functioning normally the catalytic converter reaches high temperatures. For this reason do not park the car over flammable material (grass, dry leaves, pine needles etc.): fire hazard.



Ignoring the above rules may lead to fire.

TOWING A TRAILER

IMPORTANT The car must be fitted with a homologated tow hitch and suitable electrical system for towing a caravan or trailer.

Installation must be carried out by skilled personnel who will provide specific documentation for authorising use on roads.

Fit special wing mirrors in accordance with the highway code.

Remember that towing a trailer makes it harder for the car to climb the maximum gradients specified.

Engage a low gear when driving downhill rather than constantly braking.

The weight that the trailer exerts on the car tow hitch coupling reduces the car carrying capacity by the same amount.

To ensure you do not exceed the maximum towable weight (indicated in the log book) you have to take into account the trailer's weight fully laden including the accessories and personal luggage.

Respect the speed limits enforced in the country where you are towing the trailer.



The ABS system, if fitted on the car, does not control the trailer braking system. Therefore be extra careful on slippery surfaces.



Under no circumstances modify the car braking system for trailer braking control. The trailer's braking system must be completely independent of the car's hydraulic system.

TOW HITCH INSTALLATION

The tow hitch must be fixed to the body by an expert in accordance with the following instructions and respecting the additional and/or integrative information provided by the tow hitch manufacturer. The tow hitch to be fitted must comply with the current regulations in force with reference to Directive 94/20/EEC and amendments. Use a tow hitch suited for the maximum towable load of the car version on which the tow hitch is to be fitted.

Use a unified coupling for the electrical connections. The coupling is generally fitted on a specific mount fastened to the tow hitch.

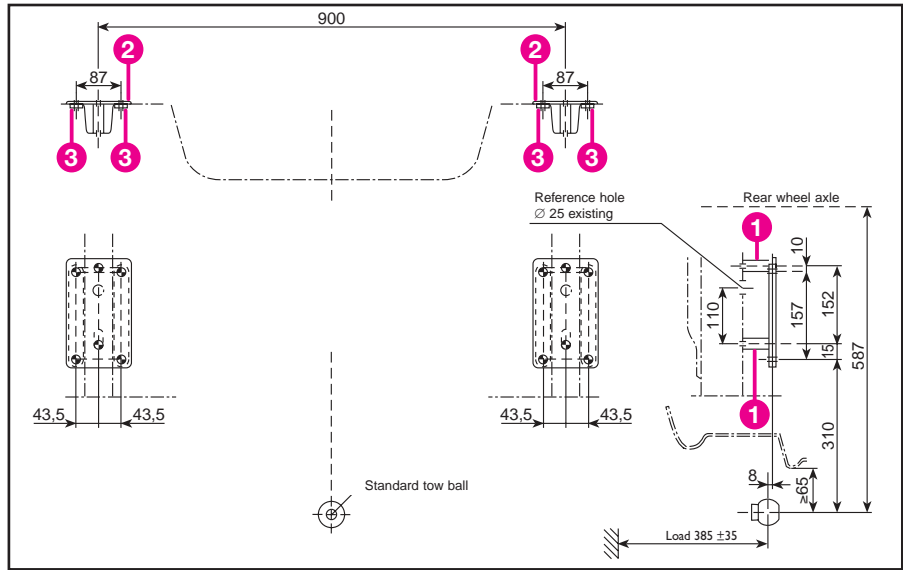

fig. 3

For electrical connection, a 7 or 13 pole 12VDC coupling must be used (CUNA/UNI and ISO/DIN standards). Follow the instructions provided by the manufacturer of the car and/or the tow hitch.

The electrical brake (where relevant) or other devices (electrical winch, etc.) must be powered directly from the battery by means of a lead with a cross-section area no smaller than 2.5 mm². In addition to the electrical connections, only the power wire for

an additional electrical brake and for internal trailer lighting with a power not exceeding 15W can be connected to the car's electrical system.

The coupling electrical connections are shown in fig. 4.

ASSEMBLY DIAGRAM fig. 3

The trailer tow hitch is to be fixed in the points indicated using 8 M8 screws and 4 M10 screws.

All anchorage points (1) are to have $\varnothing 20 \times 4.5$ spacers.

The internal counterplates (2) are to be at least 4 mm thick.

The internal counterplates (3) are to be at least 5 mm thick.

Fasten the tow hitch to the body without drilling or trimming the rear bumper that would be visible when the tow hitch is removed.

IMPORTANT A clearly visible plate of a suitable size and made of suitable material bearing the following:

MAX LOAD ON BALL COUPLING
70 kg.



After assembly, seal the holes to prevent exhaust fumes from entering the vehicle.

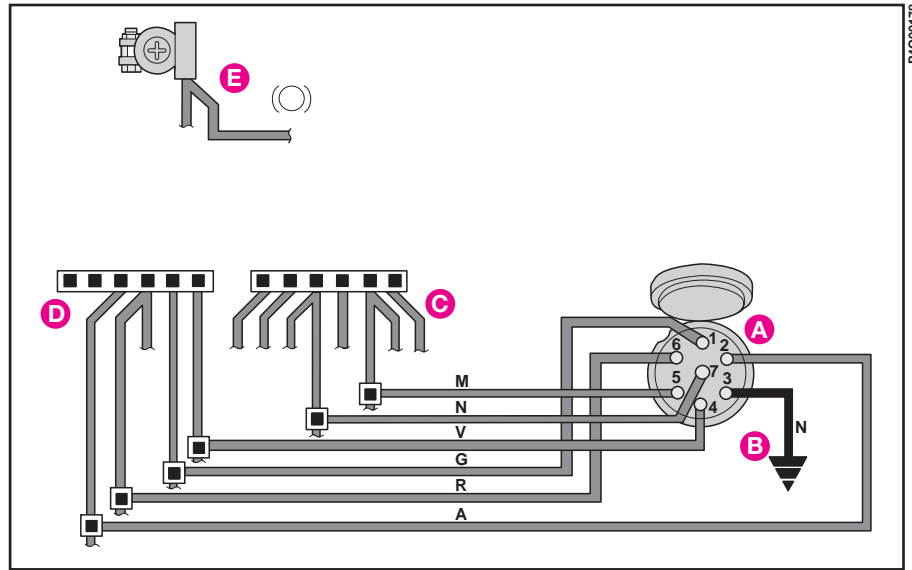

fig. 4

A=light blue - G=yellow - M=brown N=black - R=red - V=green

WIRING DIAGRAM fig. 4

- A - Seven pole coupling on tow hitch
- B - Rear earth wire connection
- C - Taillight power connection
- D - Rear foglight, brake light and direction indicator connection
- E - Electromagnetic brake power connection.

WINTER TYRES

These are tyres which have been specifically designed for use on snow and ice and should be fitted in place of the existing tyres.

Use winter tyres of the same size as the tyres provided with the car.

Fiat Dealerships will be glad to offer advice on the right type of tyres according to your needs.

For information on the tyres to be fitted, inflation pressure and winter tyre specifications, follow the prescriptions given in WHEELS, TECHNICAL SPECIFICATIONS.

The performance of winter tyres is greatly reduced when the depth of the tread is less than 4 mm. In this situation it would be safer to have them replaced.

The specific characteristics of the winter tyres mean that under normal driving conditions or when driving long distances on motorways, their performance is greatly reduced in comparison to those normally fitted to the car.

The use of these tyres should therefore be limited to the conditions for which they were designed.

IMPORTANT When using winter tyres with a maximum speed rating lower than the speed which can be reached by the car (plus 5%), place a suitable notice in the passenger compartment to inform the driver of the top speed which the winter tyre can run at (as per EC Directive).

All four tyres should be the same (brand and track) to ensure greater safety when driving, braking and cornering.

Remember not to invert the tyre direction of rotation.



The maximum speed for winter tyres with “Q” marking is 160 km/h. Respect the highway code speed limits.

SNOW CHAINS

The use of snow chains is regulated by the legislation in force in the country the car is driven in.

The chains may only be applied to the drive wheel tyres (front wheels).

Use only low profile chains (maximum height off the tyre: 12 mm).

We recommend using Lineaccessori Fiat snow chains.

Check the tautness of the chains after driving some ten metres.

IMPORTANT Do not fit snow chains on a space-saver spare wheel. If a front wheel (drive wheel) is punctured and you require snow chains to proceed, take a standard wheel from the rear axle and fit the space-saver spare wheel in its place. Having fitted two standard wheels on the front drive axle, you can use snow chains, thus solving the emergency situation.



Keep you speed down when snow chains have been fitted to the wheels. Avoid potholes, steps and pavements, and do not drive for long stretches on snow-free roads, otherwise you risk damaging the tyres, suspension and steering.

STORING THE CAR

The following precautions should be taken if the car will not be used for several months:

- Park the car in covered, dry and if possible well-ventilated premises.
- Engage a gear.
- Make sure the handbrake is not engaged.
- Remove the cables from the battery terminals (first remove the cable to the negative terminal), and check the battery charge. If the car is to be stored for long periods the charge of the battery should be checked every month and recharged if it falls below 12.5V.

- Clean and protect the shiny metal parts using special compounds readily available.



- Sprinkle talcum powder on the rubber windscreen and rear window wiper blades and lift them off the glass.
- Open the windows slightly.

- Cover the car with a cloth or perforated plastic sheet. Do not use sheets of non-perforated plastic as they do not allow moisture on the car body to evaporate.

- Inflate the tyres to +0.5 bar above the normal specified pressure and check it at intervals.
- Do not drain the engine cooling system.

IN AN EMERGENCY



EMERGENCY START-UP

If the Fiat CODE cannot deactivate the engine immobilising system, the  and  warning lights stay on and the engine will not start. Follow the emergency start-up procedure to start the engine.

Read the whole procedure carefully before trying to carry it out. If you make a mistake, you must turn the ignition key back to **STOP** and repeat the whole operation from the beginning (step 1).

1) Read the 5-figure electronic code given on the CODE card.

2) Turn the ignition key to **MAR**.

3) Press and hold down the accelerator pedal. The injection system warning light  will come on for about 8 seconds, and then go out. At this point release the accelerator pedal and get ready to count the flashes of warning light .

4) Count the number of flashes that corresponds to the first figure of the code on the CODE card, then press the accelerator pedal and keep it there until the  warning light comes on for four seconds and then goes out; release the accelerator pedal.

5) The  warning light will start flashing again: after it has flashed the number of times that corresponds to the second figure on the CODE card, press the accelerator pedal to the floor and keep it there.

6) Do the same for the remaining figures on the CODE card.

7) Once the final figure has been entered, keep the accelerator pedal pressed. The injection warning light  will light up for four seconds and then go out; release the accelerator pedal.

8) The  warning light will flash rapidly for about 4 seconds to indicate that the operation has been completed correctly.

9) Start the engine by turning the ignition key from **MAR** to **AVV**.

If, however, the  warning light stays on, turn the ignition key to **STOP** and repeat the procedure from step 1.

IMPORTANT After an emergency start, you should contact a **Fiat Dealership**, otherwise you will have to repeat the procedure described each time you want to start the engine.

JUMP STARTING

If the battery is flat, you can use another battery to start the engine. Its capacity must be the same or slightly greater than the flat battery (see the chapter TECHNICAL SPECIFICATIONS).

Proceed as follows:

1) connect positive terminals **A** and **B**-fig. 1 of the two batteries with a jump lead.

2) With a second lead, connect the negative terminal **C** of the auxiliary battery to an earth point **D** of the car.

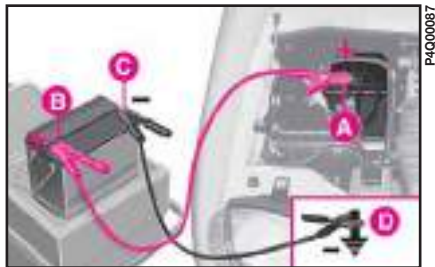

fig. 1

IMPORTANT Do not directly connect the two negative terminals: sparks could ignite the flammable gas from the battery.

If the auxiliary battery is fitted in another vehicle, prevent accidental contact of metallic parts.

3) Start the engine.

4) When the engine has been started, remove the leads in the reverse order: **D**, **C**, **B** and finally **A**.

If the engine fails to start after a few attempts, do not keep on but have the car seen to at a **Fiat Dealership**.



Do not carry out this procedure if you lack experience; if it is not done correctly it can cause very intense electrical discharges. In addition, the fluid contained in the battery is poisonous and corrosive. Avoid contact with skin and eyes.

You are also advised not to put naked flames or lighted cigarettes near the battery and not to cause sparks.



Under no circumstances should a battery charger be used to start the engine: it could damage the electronic systems and in particular the ignition and injection control units.

BUMP STARTING



Do not bump start by pushing, towing or coasting downhill. This way of starting could cause a rush of fuel into the catalytic exhaust pipe and damage it beyond repair.



Remember that until the engine has started the brake booster and power steering systems will not work and a greater effort will therefore be required to press the brake pedal or turn the steering wheel.

IF A TYRE IS PUNCTURED

General instructions

Observe the instructions on this and the following pages to use the jack and space-saver spare wheel correctly.



Alert other drivers that the car is stationary in compliance with local regulations: hazard warning lights, warning triangle etc.

Any passengers on board should leave the car, especially if it is heavily laden. Passengers should stay away from oncoming traffic while the wheel is being changed.

If the wheel is being changed on a steep or badly surfaced road, place wedges or other suitable material under the wheels to stop the car.



The space-saver spare wheel is vehicle-specific. Never use the wheel on other models. Never fit other model spare wheels on your car.

If you change the type of wheels (alloy rims instead of steel rims) you will have to change the entire set of fastening bolts with another set of suitably sized bolts.

Only use the spare-saver wheel for emergencies. Do not exceed 80 km/h with the spare wheel fitted. When driving with a space-saver spare wheel fitted, the driving performance of your car may change. Avoid accelerating or braking suddenly, steering abruptly or fast cornering.

A space-saver spare wheel has a maximum life of 3,000 km after which it must be replaced with a wheel of the same type.



Do not fit snow chains on a space-saver spare wheel. If a front wheel (drive wheel) is punctured and you require snow chains to proceed, take a standard wheel from the rear axle and fit the space-saver spare wheel in its place. Having fitted two standard wheels on the front drive axle, you can use snow chains, thus solving the emergency situation.



Never fit a traditional tyre on a space-saver spare wheel rim. Have the replace wheel repair and refitted as soon as possible.

Never use two or more spare wheels at the same time.

Do not lubricate the bolt threads before fitting them back: they could come loose.



The jack should only be used to change a wheel on the car for which it was designed. It should not be put to other uses or employed to raise other models of cars. Under no circumstances should it be used when carrying out repairs under the car.

An incorrectly positioned jack may cause the car to fall.

Do not use the jack for loads over the value indicated on the plate.

Fasten the wheel cap correctly to prevent the wheel from coming free in motion.

Never tamper with the inflation valve.

Never place tools between the rim and tyre.

Check the tyre and space-saver spare wheel pressure regularly. The tyre inflation pressure is shown in the TECHNICAL SPECIFICATIONS chapter.

TAKE OUT THE TOOLS, JACK AND SPARE WHEEL

These are in the boot.

- Lift the carpeting **fig. 2**.
- Take the tool bag and place it near the wheel to be changed.
- Take the tools out and lift strap **A-fig. 3** to remove the jack. Take the spare wheel by removing the nut screw securing it.



fig. 2

Please note:

- The jack requires no adjustments.
- The jack cannot be repaired. If it breaks it must be replaced with a new jack.
- No tool, other than its handle, indicated in this chapter, can be fitted onto the jack.



fig. 3



fig. 4

CHANGING THE WHEEL

1) Loosen the wheel bolts on the wheel to be changed by approximately one turn **fig. 4**.

2) Turn the jack handle so that the jack opens partially.

3) Position the jack near the wheel to be changed.

4) Ensure that grooves **A-fig. 5** in the jack fits properly into the side-member **B**.

5) Warn any people present that the vehicle is about to be raised; make sure they keep at a safe distance and do not touch the car until it is lowered once more.

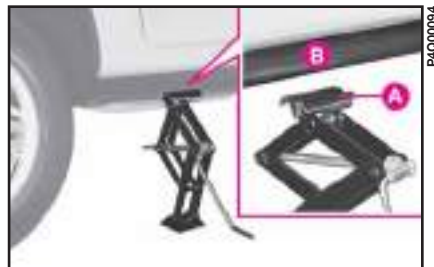

fig. 5

6) Insert the handle in the jack and turn it until the wheel to be changed lifts a few centimetres off the ground. When turning the handle make sure it rotates freely without danger of grazing your hands on the ground. Also the moving parts of the jack (screws and joints) can cause injury: do not touch them. Clean yourself up if you are soiled with lubricating grease.

7) Remove the wheel cap having removed the three bolts securing it. Then loosen the fourth bolt **A-fig. 6** and remove the wheel.

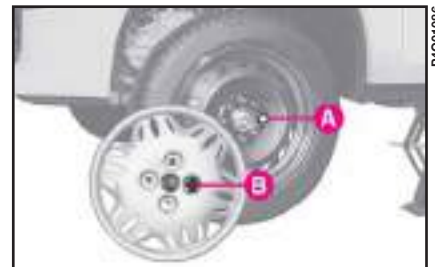

fig. 6

8) Ensure that the housings for the wheel bolts on the spare wheel are clean and free from dirt which could cause the wheel bolts to come loose.

9) Fit the space-saver spare wheel making peg **A-fig. 7** coincide with one of the holes **B** on the wheel.

10) Screw the four fastening bolts.

11) Wind down the jack to lower the car and remove the jack.

12) Fully tighten the bolts moving in a criss-cross fashion following the order shown in **fig. 8**.



fig. 7

REFITTING THE STANDARD WHEEL

1) Following the above procedure, raise the car and remove the space-saver wheel.

2) Refit a regular wheel inserting the first bolt **A-fig. 6** in the hole opposite the inflation valve.

3) Fit the wheel cap ensuring symbol  **A-fig. 9** corresponds with the inflation valve and the previously fixed bolt **B**.

4) Insert the other three bolts and screw them using the specific wrench.



fig. 8

5) Lower the car and remove the jack.

6) Torque the screws in the order described above **fig. 8**.

After refitting the wheel:

– place the spare wheel in its recess in the boot and fasten it with the ring nut **A-fig. 3**;

– put the jack in its bag and place this in the replaced wheel.

IMPORTANT Tubeless tyres are used.

Check the inflation pressure of the tyres and the spare wheel regularly.



fig. 9

IMPORTANT For cars equipped with optional alloy wheels, a specific spare wheel is required which differs from that used on cars equipped with steel rims. When fitting alloy rims to replace steel rims at a later date, the four original wheel bolts should be changed with a new set of adequately sized bolts and a specific spare wheel.

It is advised to keep the bolts and the spare wheel, which would become necessary if you should decide to return to the original type of wheels.

IF A BULB BURNS OUT



Modifications or repairs to the electrical system carried out incorrectly and without bearing the features of the system in mind can cause malfunctions with the risk of fire.



You should, where possible, have your bulbs changed at a Fiat Dealership. Correct operation of the external light beams are essential for safe driving and compliance with legal requirements.



Only touch the metal part when handling halogen bulbs. If the transparent bulb is touched it reduces the intensity of the light emitted and can also reduce the life of the bulb. If you touch the bulb accidentally, rub it with a cloth moistened with alcohol and leave it to dry.



Halogen bulbs contain pressurised gas which, if broken, may cause small fragments of glass to be projected outwards.

GENERAL INSTRUCTIONS

When a light is not working, check that it has not fused before changing the bulb.

For location of fuses, refer to IF A FUSE BLOWS in this chapter.

Before replacing a bulb that does not work, check that the contacts are not oxidised.

Burnt-out bulbs must be replaced with ones of the same type.

Always check the height of the headlight beam after changing a bulb.

IMPORTANT On the inside surface of the headlight there could appear a slight coat of fogging; this does not show a defect, since it is a natural occurrence due to low temperature and to the degree of humidity in the air; it will soon disappear as soon as the lights are turned on. The presence of drops inside the headlight shows water seepage, refer to the **Fiat Dealership**.



fig. 11

TYPES OF BULBS fig. 11

Several types of bulbs are installed in the car:

A. Glass bulbs Snapped into position. Pull to remove.

B. Bayonet connection bulbs Remove from the bulb holder by pressing the bulb and rotating it anti-clockwise.

C. Cylindrical bulbs Remove by pulling away from terminals.

D. Double filament halogen bulbs To remove the bulb release the clip holding the bulb in place.

E. Halogen bulb To remove the bulb, release the clip holding the bulb in place.

| BULB | (fig. 11) | TYPE | W |
|--|-----------|--------|-------|
| MAIN BEAM | D | H4 | 60/55 |
| DIPPED BEAM | D | H4 | 60/55 |
| FRONT SIDE LIGHTS | A | W5W | 5 |
| FRONT DIRECTION INDICATORS | B | P21W | 21 |
| SIDE DIRECTION INDICATORS | A | W5W | 5 |
| REAR DIRECTION INDICATORS | B | P21W | 21 |
| BRAKE/TAILLIGHTS | B | P21/5W | 21/5 |
| REVERSE LIGHT | B | P21W | 21 |
| REAR FOGLIGHT | B | P21W | 21 |
| CEILING LAMP | C | CW5 | 5 |
| NUMBER PLATE LIGHT | B | R5W | 5 |
| FRONT FOGLIGHT | E | H3 | 55 |
| ADDITIONAL BRAKE LIGHT (3 rd brake light) | A | W5W | 5 |

IF AN EXTERIOR LIGHT BURNS OUT



Modifications or repairs to the electrical system carried out incorrectly and without bearing the features of the system in mind can cause malfunctions with the risk of fire.

MAIN BEAM AND DIPPED BEAM HEADLIGHTS

To replace a halogen bulb:

- 1) take out the connector **A**-fig. 12 then the rubber protection **B**;
- 2) release the fastening clip **C**-fig. 13 and remove the bulb **D**;

3) fit a new bulb, making the tabs **E**-fig. 14 on the metal part coincide with the specific housings on the headlight dish;

4) refasten the clip, refit the rubber guard and refit the connector.

For bulb type and respective power, see IF A BULB BURNS OUT.

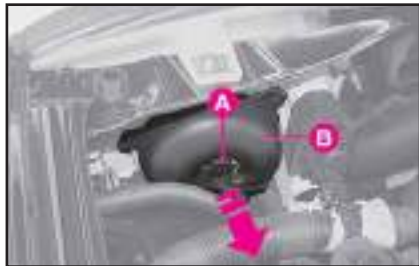

P44Q01023

fig. 12



P44Q01024

fig. 13



P44Q01025

fig. 14

FRONT SIDE LIGHTS

To replace the 12V-5W bulb:

- 1) take out the bulb holder **A**-fig. 15, turning slightly to release;
- 2) remove the bulb **B**-fig. 16;



fig. 15



fig. 16

- 3) replace the bulb and refit the bulb holder **A**.

Front direction indicators

To replace the 12V-21W bulb:

- 1) release the clip **A**-fig. 17, working in the direction of the arrow;
- 2) remove the lens unit **B**-fig. 18 from the front;
- 3) the bulb holder **C** is connected to the lens. Turn it slightly to remove;
- 4) remove the bulb **D**, pushing it in slightly and turning it anti-clockwise at the same time;



fig. 17

- 5) after changing the bulb, refit the bulb holder onto the lens;

6) replace the lens unit in its seating inserting the tabs **E**-fig. 19 in the guides **F** to the side of the light;

- 7) refasten the clip **A**-fig. 17.



fig. 18



fig. 19

SIDE DIRECTION INDICATORS

To replace the 12V-5W bulb:

1) turn the lens **A-fig. 20** towards the front of the car to position **2**;

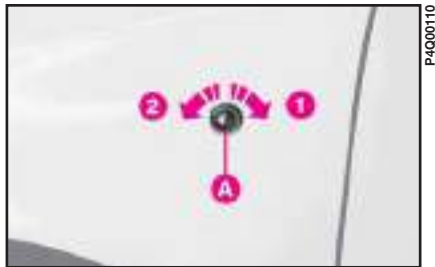

fig. 20



fig. 21

- 2) remove the lens;
- 3) remove bulb **B-fig. 21** and change it;
- 4) refit the lens and turn it to **1** to lock it.

FRONT FOGLIGHTS

To replace the halogen bulb (type H3, 12V-55W):

- 1) loosen the two screws **A-fig. 22** securing the fog light to the bumper;
- 2) loosen the two screws **B-fig. 23** and take out the rubber cover;



fig. 22



fig. 23



fig. 24

- 3) release the clip **C-fig. 24** and remove the bulb **D**;
- 4) to refit, follow the above operations in reverse order.

REAR LIGHT CLUSTER

To replace a bulb:

- 1) loosen the two screws **A-fig. 25** from the respective housings and tip the lens;
- 2) remove bulb holder **C-fig. 26** releasing clip **D**;



fig. 25



fig. 26

3) remove bulbs **fig. 27**, pushing them slightly and turning them anti-clockwise;

E - double filament bulb 12V-21/5W for brake and taillights;

F - 12V-21W bulb for direction indicators;

G - 12V-21W bulb for right light cluster reversing light; left light cluster rear foglight.

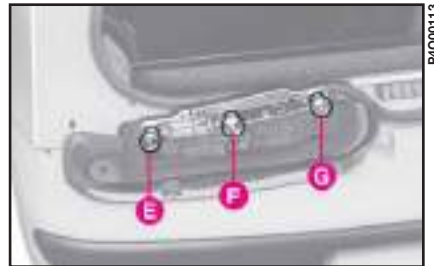

fig. 27

NUMBER PLATE LIGHTS

To replace a bulb:

1) with a screwdriver, press clip as shown in **fig. 28**;

2) remove the bulb holder **A-fig. 29** from the lens by turning it slightly;



fig. 28



fig. 29

3) change bulb **B-fig. 30** by pressing a 12V-5W bulb into the holder.



fig. 30



fig. 31

THIRD BRAKE LIGHT

To replace one or more 12V-5W bulbs:

1) loosen the five screws **A-fig. 31** and remove the complete covering;

2) disconnect the connection **B-fig. 32** and loosen the three screws **C** fastening the light cluster;

3) loosen the four screws **D-fig. 33** and separate the bulb unit from the lens;

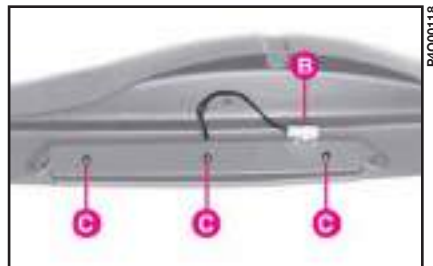

fig. 32

4) change the burnt bulb **E-fig. 34**. Press into place;

5) refit the unit reversing the operations described above.



fig. 33

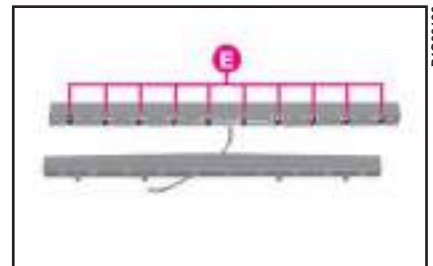

fig. 34

IF AN INTERIOR LIGHT BURNS OUT



Modifications or repairs to the electrical system carried out incorrectly and without bearing the features of the system in mind can cause malfunctions with the risk of fire.

COURTESY LIGHT

To replace the 12V-5W bulb use a screwdriver as a lever at the points indicated by the arrows and remove the complete pressure-fit light unit **fig. 35**.

BOOT LIGHT

To replace the 12V-5W ceiling light bulb, remove the clipped on lens with a screwdriver as shown in **fig. 36**.

IF A FUSE BLOWS

A fuse is an element for protecting the electrical system. A fuse will trip (i.e. it will blow) in the event of a failure or improper interventions in the electrical system.

If an electrical device is not working, check whether the respective fuse is blown. The conductor should be intact. If it is not, replace the fuse with another with the same amperage (same colour) **fig. 37**.

A - Undamaged fuse.

B - Fuse with broken filament.



fig. 35

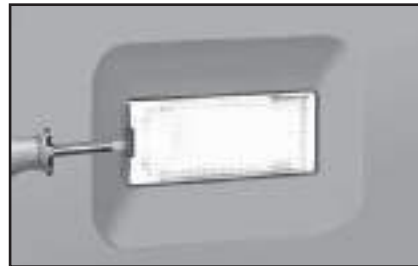

fig. 36



fig. 37

Remove the blown use with the tongs **C** which can be found in the fusebox.



Never replace a broken fuse with anything other than a new fuse. Always use a fuse of the same colour.



Before changing a fuse, check the ignition key has been removed and that all the other electric devices have been turned off/disabled.



Never change a fuse with another amperage: fire risk !



Do not attempt to repair a blown maxi fuse. Go to a Fiat Dealership.



If the fuse blows again, have the car inspected at a Fiat Dealership.

To locate the fuse, refer to the table on the following pages.



fig. 38

FUSE LOCATION

The fusebox is located to the left of the steering wheel. To reach the fusebox, loosen the screw **B**-fig. 38 fastening the cover **A**.

The numbers indicating the devices corresponding to the fuses are shown on the back of the cover **fig. 39**.



fig. 39

An additional 7.5A fuse is located by the side of the climate control system. It can be reached from inside the passenger compartment under the dashboard.

Fuses in the engine compartment

A fusebox is located on the left side of the engine compartment behind the battery. It contains four high amperage fuses **A-fig. 40** (MAXI FUSES) which act as additional fire protection in preventing high intensity cables from overheating the following :

- A** - 30A - injection control unit.
- B** - 40A - Ignition switch.
- C** - 30A - engine cooling fan.

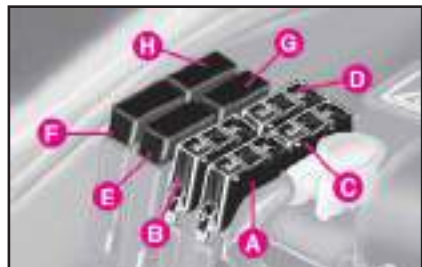

fig. 40

D - 60A - dashboard fusebox power.

IMPORTANT Go directly to a **Fiat Dealership** to have any one of these four fuses restored.

Other version-specific fuses are arranged next to the four MAXI fuses. They protect the following devices:

- E** - 30A - climate control system.
- F** - 30A - optional power circuits.
- G** - 40A - electrical power steering system.
- H** - 60A - ABS



fig. 41

A fusebox **B-fig. 41** containing other three fuses is located in the engine compartment on the right-hand side. To reach the fuses, loosen the two nuts **A** and remove the cover **B**.

Fuses **fig. 42** protect:

- 1** - 7.5A - Fiat CODE and control unit (+30)
- 2** - 15A - injection system auxiliary units and climate control system auxiliary units
- 3** - 7.5A - Fiat CODE and electronic injection control unit (15/54)



fig. 42

| System/Component | Fuse no. | Amperage | Location | System/Component | Fuse no. | Amperage | Location |
|---|----------|----------|----------|---|----------|----------|----------|
| Front left-hand sidelight | 5 | 10A | fig. 39 | Headlight beam adjuster | 6 | 10A | fig. 39 |
| Front right-hand sidelight | 4 | 10A | fig. 39 | Instrument panel (+15) | 22 | 10A | fig. 39 |
| Left-hand taillight | 4 | 10A | fig. 39 | Main beam headlight warning light | 9 | 10A | fig. 39 |
| Right-hand taillight | 5 | 10A | fig. 39 | Stalks: light control | 13 | 20A | fig. 39 |
| Left-hand dipped beam headlight | 6 | 10A | fig. 39 | Stalks: general | 20 | 20A | fig. 39 |
| Right-hand dipped beam headlight | 7 | 10A | fig. 39 | Sound system + battery | 15 | 15A | fig. 39 |
| Left-hand main beam headlight | 8 | 10A | fig. 39 | Sunroof | 11 | 20A | fig. 39 |
| Right-hand main beam headlight | 9 | 10A | fig. 39 | Airbag system | 23 | 10A | fig. 39 |
| Left-hand brake light | 21 | 10A | fig. 39 | ABS (+15) | 3 | 10A | fig. 39 |
| Right-hand brake light | 21 | 10A | fig. 39 | Fiat CODE system (+30) | 1 | 7,5A | fig. 42 |
| Additional brake light (3 rd brake light) | 21 | 10A | fig. 39 | Injection control unit (+30) | 1 | 7,5A | fig. 42 |
| Left-hand number plate light | 4 | 10A | fig. 39 | Climate control system | E | 30A | fig. 40 |
| Right-hand number plate light | 5 | 10A | fig. 39 | Engine cooler radiator fan | C | 30A | fig. 40 |
| Reversing light | 21 | 10A | fig. 39 | Passenger compartment fan | 24 | 25A | fig. 39 |
| Rear foglight | 18 | 10A | fig. 39 | Electronic ignition injection system (+15) | 3 | 7.5A | fig. 42 |
| Hazard lights | 16 | 10A | fig. 39 | Fiat CODE system (+15) | 3 | 7.5A | fig. 42 |
| Direction indicators | 22 | 10A | fig. 39 | Optional device power circuits | F | 30A | fig. 40 |
| Front foglights | 19 | 15A | fig. 39 | Electronic injection sensors | 2 | 15A | fig. 42 |
| Ceiling light | 15 | 15A | fig. 39 | Climate control system auxiliary units | 2 | 15A | fig. 42 |
| Windscreen wiper/washer | 25 | 20A | fig. 39 | Ignition switch | B | 40A | fig. 40 |
| Horn | 17 | 15A | fig. 39 | Relay coil power | 12 | 7.5A | fig. 39 |
| Electric windows | 2 | 25A | fig. 39 | Instrument panel (+30) | 15 | 15A | fig. 39 |
| Door locking system | 1 | 15A | fig. 39 | Electrical power steering system (+15) | 10 | 10A | fig. 39 |
| Heated rear window | 14 | 20A | fig. 39 | | | | |
| Cigar lighter | 24 | 25A | fig. 39 | | | | |

IF THE BATTERY IS FLAT

First of all, read the CAR MAINTENANCE chapter for the steps to be taken to avoid the battery running down and to ensure it has a long life.

RECHARGING THE BATTERY

You are advised to recharge the battery slowly for a period of approximately 24 hours at a low amperage. Charging for too long could damage the battery.

Proceed as follows:

1) Disconnect the electric system from the battery terminals.

IMPORTANT Where relevant, switch the electronic car alarm off with the remote control.

- 3) Turn on the charger.
- 4) When you have finished, turn the charger off before disconnecting the battery.
- 5) Reconnect the cables to the battery terminals. Make sure the polarity is correct.



The liquid in the battery is poisonous and corrosive. Do not let it touch the skin or eyes. Recharging the battery should be done in a well-ventilated area away from naked flames or possible sources of sparks: explosion and fire risk.



Do not attempt to recharge a frozen battery. Thaw it first otherwise it could explode. If the battery froze, make sure the internal elements are not broken (short-circuit risk) and that the casing is not cracked (risk of spilling the poisonous and corrosive liquid).

JUMP STARTING

See JUMP STARTING in this chapter.



Under no circumstances should a battery charger be used to start the engine: it could damage the electronic systems and in particular the ignition and injection control units.

JACKING THE CAR

WITH THE JACK

See IF A TYRE IS PUNCTURED in this chapter.



The jack should only be used to change a wheel on the car for which it was designed. It should not be put to other uses or employed to raise other models. Under no circumstances should it be used when carrying out repairs under the car.



An incorrectly positioned jack may cause the car to fall. Do not use the jack to lift loads exceeding that indicated on the label attached to the jack itself.

Please note:

- The jack requires no adjustments.
- The jack cannot be repaired. If it breaks it must be replaced with a new jack.
- Apart from the handle shown in this chapter no other tools should be installed on the jack.



Never start the engine when the car is jacked up. Detach the trailer, where relevant, before jacking up the car.

WITH A SHOP JACK

From the front

Jack up the car only by positioning the jack arm at the gearbox/differential and placing a rubber pad in between, as shown in **fig. 43**.

From the rear end

The car may only be raised by placing the jack arm under the suspension supports with a flat, compact piece of wood placed as shown in **fig. 44**.



fig. 43



fig. 44

From the side



The car can be lifted from the side providing the hydraulic jack arm is fitted with a special bracket in the plate housing.

WITH AN ARM HOIST

Jack up the car by arranging the ends of the arms in the areas shown in fig. 45.



fig. 45

IF THE CAR NEEDS TO BE TOWED

A tow hitch is provided with the car.

To fasten the tow hitch:

1) Take the tow eye from the spare wheel in the boot.



When towing the car, you must comply with the specific traffic regulations regarding the tow hitch and how to tow on the road.



Before starting to tow, turn the ignition key to **MAR** and then to **STOP**. Do not remove the key. If the key is removed, the steering lock engages automatically which prevents the wheels being turned.



While the car is being towed with the engine off, remember that the brake pedal and steering will require more effort as you no longer have the benefit of the power brakes and power steering. Do not use flexible cables to tow. Avoid jerking. Whilst towing, ensure that the coupling to the vehicle does not damage the surrounding components.

2) Remove the flap **A-fig. 46** on the bumper levering with a screwdriver.



fig. 46



fig. 47

3) Screw the ring **B-fig. 47** down fully onto the threaded pin that you will see when you remove the cover.

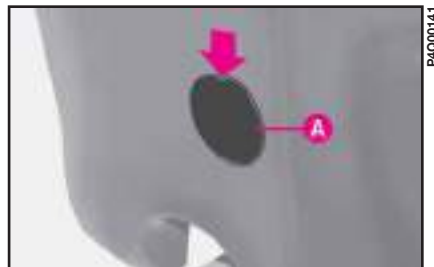

fig. 48

4) Remove the flap **A-fig. 48** on the rear bumper levering with a screwdriver in the point shown by the arrow and fasten the ring fully **B-fig. 49** on the threaded pin which appears when the cover is removed .

This device is used for towing another vehicle.

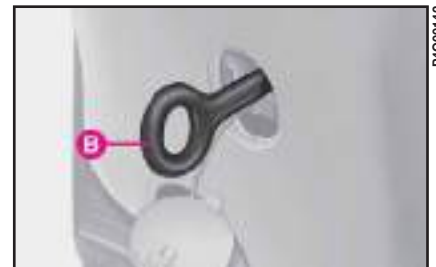

fig. 49

CAR MAINTENANCE

SCHEDULED SERVICING

Correct maintenance of the car is essential for ensuring it stays in tip-top condition for a long time to come.

This is why Fiat has programmed a number of service checks and operations every twenty thousand kilometres.

It is however important to remember that SCHEDULED SERVICING is not all your vehicle requires. Regular checked - also in the initial period before the 20,000 kilometre coupon and later between coupons - ordinary care is required, such as checking fluid levels and topping up, checking tyre inflation pressure, etc.

IMPORTANT The Manufacturer requires the Service Schedule coupon-related checks to be carried out. Failure to do so could result in the warranty being cancelled for those defects that can be attributed to such failure.

SCHEDULED SERVICING is performed at all **Fiat Dealerships**, and there is a set time scale for such operations.

If it is seen that further replacements or repairs are necessary in addition to the work being carried out, these will only be done after the customer has given his/her consent.

IMPORTANT You are recommended to get in touch with a **Fiat Dealership** immediately if any minor running problems crop up without waiting for the next coupon.



If the vehicle is often used for towing a trailer, the scheduled servicing will be required more frequently.

SERVICE SCHEDULE

These coupons are to be used every 20,000 km.

| | thousands of kilometres | | | | | | | | | |
|---|-------------------------|----|----|----|-----|-----|-----|-----|-----|---|
| | 20 | 40 | 60 | 80 | 100 | 120 | 140 | 160 | 180 | |
| Check tyre conditions and wear and adjust pressure, if required | ● | ● | ● | ● | ● | ● | ● | ● | ● | ● |
| Check lighting system operation (headlights, direction indicators, hazard lights, boot light, ceiling lights, glove compartment light, instrument panel warning lights, etc.) | ● | ● | ● | ● | ● | ● | ● | ● | ● | ● |
| Check windscreen washer/wiper system and adjust nozzles | ● | ● | ● | ● | ● | ● | ● | ● | ● | ● |
| Check windscreen/rear window wiper blade position/wear | ● | ● | ● | ● | ● | ● | ● | ● | ● | ● |
| Check front disc brake pad conditions and wear | ● | ● | ● | ● | ● | ● | ● | ● | ● | ● |
| Check rear drum brake linings and wear | | | ● | | | ● | | | | ● |
| Inspect: conditions of: outside bodywork, underbody protection, piping/hosing (exhaust - fuel lines - brake lines), rubber parts (boots, sleeves, bushings, etc.) | ● | ● | ● | ● | ● | ● | ● | ● | ● | ● |
| Check for bonnet and boot lock cleanness, lever cleanness and lubrication | ● | ● | ● | ● | ● | ● | ● | ● | ● | ● |
| Check tension of accessory drive belts and adjust, if required | ● | | | | | | | | | |
| Inspect accessory drive belt conditions | | ● | | ● | | ● | | ● | | |
| Check tappet clearance and adjust, if required | | ● | | ● | | ● | | ● | | |
| Check/adjust handbrake stroke | ● | ● | ● | ● | ● | ● | ● | ● | ● | ● |

| | thousands of kilometres | | | | | | | | | |
|--|-------------------------|----|----|----|-----|-----|-----|-----|-----|---|
| | 20 | 40 | 60 | 80 | 100 | 120 | 140 | 160 | 180 | |
| Check anti-evaporation system | | | | ● | | | | | ● | |
| Replace air cleaner cartridge | | ● | | ● | | ● | | ● | | |
| Top up fluids (engine coolant, brakes, windscreen washer, battery, etc.) | ● | ● | ● | ● | ● | ● | ● | ● | ● | ● |
| Check timing belt conditions | | | ● | | | | | | | ● |
| Replace timing belt (*) | | | | | | ● | | | | |
| Replace spark plugs | | ● | | ● | | ● | | ● | | |
| Check engine control systems via diagnostic socket | | ● | | ● | | ● | | ● | | |
| Check mechanical gearbox oil level | | | | ● | | | | ● | | |
| Change engine oil | ● | ● | ● | ● | ● | ● | ● | ● | ● | ● |
| Replace engine oil filter | ● | ● | ● | ● | ● | ● | ● | ● | ● | ● |
| Change brake fluid (or every two years) | | | ● | | | ● | | | | ● |

(*) or every 3 years for demanding use (cold climates, prolonged idling in city traffic)
or every 5 years, regardless of distance

ANNUAL INSPECTION SCHEDULE

The following annual inspection schedule is recommended for cars travelling less than 20,000 km a year (e.g. approximately 10,000 km). The schedule includes the following operations:

- Check tyre condition and wear and adjust pressure, if required (including spare wheel).
- Check operation of lights (headlights, direction indicators, hazard lights, boot light, passenger compartment ceiling light, glove compartment light, instrument panel lights, etc.).
- Check windscreen wiper/washer and adjust nozzles.
- Check position wear of windscreen/rear window wiper blades.
- Check front brake pad conditions and wear.

- Inspect conditions of engine, gearbox, transmission, piping (exhaust - fuel feed - brakes), rubber parts (boots - sleeves - bushings - etc.), brake and fuel line hoses.

- Check for bonnet and boot lock cleanness, lever cleanness and lubrication.

- Check battery charge status.

- Check conditions of various control belts.

- Check and top up fluid levels (engine coolant, brakes, windscreen washer, battery, etc.).

- Change engine oil.

- Replace engine oil filter.

- Replace pollen filter (where fitted).

ADDITIONAL CHECKS

Every 1,000 km or before long trips, check and top up as necessary:

- engine coolant level, brake fluid level, windscreen washer liquid level, tyre pressure and conditions.

Every 3,000 km check and top up as necessary: engine oil level.

We recommend using **FL Selenia** products which were specifically designed and made for use in Fiat vehicles (see CAPACITIES table in TECHNICAL SPECIFICATIONS).

IMPORTANT - Remote control

If when the remote control button is pressed the doors are not locked/unlocked or the performed operation signal (indicator lights on) does not appear, change the battery, using spare batteries of the same kind.

IMPORTANT - Engine oil

Should the prevailing use of the car be under one of the following specially heavy conditions:

- trailer towing
- dusty roads
- short distances (less than 7-8 km) repeated and with external temperatures below zero.
- frequently idling engines or long distance low speed driving (e.g. taxis or door-to-door deliveries) or in case of a long term inactivity replace engine oil more frequently than required on SCHEDULED MAINTENANCE PLAN.

IMPORTANT - Air cleaner

Replace the air cleaner more frequently if the car is used on dusty roads.

If you are in doubt about how often the engine oil or the air cleaner should be changed in relation to how you use the car, contact a **Fiat Dealership**.

IMPORTANT - Battery

The charge in your battery should be checked, where possible at the start of the winter, to limit the risk of the battery electrolyte freezing. This check should be carried out more frequently if the car is mainly used for short trips or if it is fitted with accessories that permanently take in electricity even when the ignition key is removed, especially in the case of after market accessories.

You should check the battery fluid (electrolyte) level more frequently than shown in the SERVICE SCHEDULE in this chapter if the vehicle is used in hot climates or particularly demanding conditions.



Maintenance of your car should be entrusted to a Fiat Dealership. For ordinary routine maintenance operations which you are able to carry out yourself, ensure that you have the necessary tools and original Fiat spare parts and fluids available. Do not carry out servicing operations if you have no experience.

CHECKING FLUID LEVELS



Do not smoke while working in the engine compartment: the presence of flammable gas and vapour could cause a fire.



Be very careful: scarves, ties and other loose articles of clothing could easily get caught up in moving parts. This can be extremely dangerous.



Be careful not to mix up the various types of fluids when you are topping up: they are all mutually incompatible and could damage the car.



fig. 1

1. Engine oil - 2. Battery - 3. Brake fluid - 4. Windscreen washer fluid - 5. Engine coolant.

ENGINE OIL

Check engine oil with the car on level ground and while the engine is still warm (approximately 5 minutes after stopping the engine).

The oil level must be between the **MIN** and **MAX** marks on the dipstick **B**-fig. 2.

The space between **MIN** and **MAX** equals about 1 litre of oil.

If the oil level is near or even below the **MIN** mark, pour in oil through the filler hole **A** until it reaches the **MAX** mark.

The level of the oil should never exceed the **MAX** mark.



Be very careful under the bonnet: you risk burning yourself. Remember that when the engine is hot, the fan can start up and cause injuries.

IMPORTANT After topping up or changing the oil, let the engine turn for a few seconds and wait a few minutes after stopping it before you check the level.



fig. 2



Do not add oil with different specifications from the oil already in the engine.

ENGINE OIL CONSUMPTION

Max. engine oil consumption is usually 400 grams every 1000 km.

During the beginning of the car's use, the engine is being run in. Engine oil consumption can be considered stabilised only after the first five-six thousand kilometres.

IMPORTANT Oil consumption depends on the driving style and the conditions of use.



Used engine oil and replaced oil filters contain substances which can harm the environment. We recommend you have the car seen to at a Fiat Dealership for the oil and filter change. It is suitably equipped for disposing of used oil and filters in an environmentally-friendly way that complies with the law.

ENGINE COOLANT fig. 3



Do not take the cap A of the reservoir off when the engine is very hot as you run the risk of scalding yourself.



The coolant system is under pressure. If the cap A requires changing, use only an original spare part, otherwise the system efficiency could be affected.



fig. 3

Check coolant level when the engine is cold. The level should be included between the **MIN** and **MAX** reference lines on the reservoir.

If the level is low, top up slowly through the filler on the reservoir with a 50-50 mixture of distilled water and **FL Selenia PARAFLU UP** fluid until the level approaches the **MAX** line. A 50-50 mixture of **PARAFLU UP** and distilled water gives freeze protection to -35°C .

For particularly hard climate conditions, we recommend use of a 60% **PARAFLU UP** and 40% demineralized water mixture.



The engine cooling system works with **PARAFLU UP**. Top up only with the same fluid contained in the cooling circuit. **PARAFLU UP** cannot be mixed with other fluids. Should this take place, do not start the engine and contact Fiat Dealership.

WINDSCREEN/REAR WINDOW WASHER LIQUID

To add liquid remove the cap **A** fig. 4.

Use a mixture of water and **TUTELA PROFESSIONAL SC35** fluid in the following concentrations:

30% of **TUTELA PROFESSIONAL SC35** and 70% of water in summer.

50% of **TUTELA PROFESSIONAL SC35** and 50% of water in winter.



Do not travel with the windscreen washer reservoir empty. The windscreen washer is fundamental for improving visibility.



fig. 4



Some windscreen wiper additives on the market are flammable. The engine compartment contains hot parts which could start a fire in the event of contact.

BRAKE FLUID fig. 5

Unscrew cap check that the fluid level in the reservoir is at maximum.

Fluid level in the reservoir shall not exceed the **MAX** mark.



fig. 5

If fluid has to be added, it is suggested to use the brake fluid in table "Fluids and lubricants" (see chapter "Technical characteristics").

NOTE Clean accurately the tank cap and the surrounding surface.

At plug opening, pay maximum attention in order to prevent any impurities from entering the tank.

For topping up, always use a funnel with integrated filter with mesh equal to or lower than 0.12 mm.

IMPORTANT Brake fluid absorbs moisture, for this reason, if the vehicle is mainly used in areas with a high degree of atmospheric humidity, the fluid should be replaced at more frequent intervals than specified in the "Service schedule".



Make sure that the highly corrosive brake fluid does not drip onto the paintwork. If it does, wash it off immediately with water.



The symbol © on the container indicates synthetic brake fluid distinguishing it from mineral fluid. Using mineral type fluid would damage the special rubber braking system gaskets beyond repair.



Brake fluid is poisonous and highly corrosive. Wash the concerned parts immediately with water and mild soap in the event of an accidental contact. Call a doctor immediately if swallowed.

From time to time check the instrument panel warning light by pressing the reservoir cover (with the ignition key at **MAR**) instrument panel warning light (⚠) should come on.

AIR CLEANER

REPLACEMENT

Loosen the screws **A**-fig. 6, remove the cover **B** and remove the filtering element **C**-fig. 7 to be replaced.



fig. 6



fig. 7

BATTERY

The car fits a low-maintenance battery: no top-ups with distilled water are needed in normal conditions of use.

INSPECTING THE CHARGE AND THE ELECTROLYTE LEVEL

Inspection operations must be carried out by specialised personnel, following the prescriptions contained in the Use and maintenance booklet. Any top-up operations must be carried out by specialised personnel and by Fiat Dealership.



Battery liquid is poisonous and corrosive. Avoid contact with the skin and eyes. Keep naked flames and sources of sparks away from the battery: risk of explosion and fire.



Running the battery with an excessively low liquid level will damage the battery beyond repair and even cause an explosion.

CHANGING THE BATTERY

If required, replace the battery with a genuine spare part having the same specifications.

If a battery with different specifications is fitted, the service intervals given in the “Service schedule” in this section will no longer be valid.

Refer therefore to the instructions provided by the battery manufacturer.



Incorrect assembly of electric and electronic devices may cause severe damage to your car. Go to a Fiat Dealership if you want to install accessories (alarms, mobile phone, etc.): they will suggest the most suitable devices and advise you if a higher capacity battery needs to be installed.



Batteries contain substances that can be very dangerous for the environment. It is advisable to have the battery changed by a Fiat Dealership where it will be disposed of according to the law.



If the vehicle must remain unused for a long time at very low temperature, remove the battery and carry it to a warm place, to avoid freezing.



When you must perform any operation on the battery or near it, always protect your eyes with the special goggles.

USEFUL ADVICE FOR LENGTHENING THE LIFE OF YOUR BATTERY

To avoid draining your battery and lengthen its life, observe the following indications:

- when you park the car, ensure the doors, tailgate and bonnet are closed properly;
- switch off all lights inside the car: the car is however equipped with a system which switches all internal lights off automatically;
- do not keep accessories (e.g. sound system, hazard lights, etc.) switched on for a long time when the engine is not running;
- before performing any operation on the electrical system, disconnect the battery negative cable;
- battery terminals shall always be perfectly tightened.

IMPORTANT If the charge level remains for a long time under 50%, the battery is damaged by sulphation, reducing its capacity and starting attitude.

The battery will also be more at risk of freezing (e.g. already at -10°C). Refer to the paragraph “Car inactivity” in “Starting and driving” if the car is left parked for a long time.

If after buying the car, you want to install electric accessories which require permanent electric supply (alarm, etc.) contact Fiat Dealership whose qualified personnel, in addition to suggesting the most suitable devices, will evaluate the overall electric absorption, checking whether the car’s electric system is capable of withstanding the load required, or whether it should be integrated with a more powerful battery.

Since these devices continue absorbing energy even when the ignition key is off, they gradually run down the battery.

ELECTRONIC CONTROL UNITS

When the car is being used normally, special measures are not necessary.

The following instructions must be followed very carefully, however, if you work on the electrical system or in cases where emergency starting is necessary:

- Never disconnect the battery from the electrical system while the engine is running.
- Disconnect the battery from the electrical system if you are recharging it.
- Never perform emergency starts with a battery charger. Always use an auxiliary battery.

– Be particularly careful when connecting the battery to the electrical system. Ensure the battery posts are connected up to the right leads (the polarity is correct) and check that the connection has been made properly.

– Do not connect or disconnect the terminals of the electronic units while the ignition key is at **MAR**.

– Do not check polarity through sparking.

– Disconnect the electronic units if you are electrically welding the car body. Remove the units if temperatures exceed 80°C (special operations on the bodywork etc.).

IMPORTANT If the sound system or car alarm systems are not installed correctly, they can interfere with the working of the electronic control units.



Modifications or repairs to the electrical system carried out incorrectly and without bearing the features of the system in mind can cause malfunctions with the risk of fire.

WHEELS AND TYRES

TYRE PRESSURE

Check the pressure of each tyre, including the spare, every two weeks and before long journeys.

The pressure must be checked when the tyre is rested and cold.

It is normal for the pressure to rise when you are driving. If you have to check or restore the pressure when the tyres are warm, remember that the pressure value must be 0.3 bar above the specified value.

See WHEELS in TECHNICAL SPECIFICATIONS for the correct tyre inflation pressure.



Tyre pressure must be correct to ensure good road holding.



If the pressure is too low the tyre overheats and this can cause it serious damage.

Wrong pressure causes uneven wear of the tyres **fig. 8**:

A - correct pressure: tyre wears evenly;

B - under inflated tyre: shoulder tread wear;

C - over inflated tyre: centre tread wear.

Tyres must be replaced when the tread wears down to 1.6 mm. In any case, comply with the laws in the country where the car is being driven.



fig. 8

IMPORTANT

As far as possible avoid sharp braking and screech starts.

Be careful not to hit the kerb, potholes or other obstacles hard. Driving for long stretches over bumpy roads can damage the tyres.

Periodically check that the tyres have no cuts in the sidewalls, abnormal swelling or irregular tyre wear. If any of these occur, have the car seen to at a **Fiat Dealership**.

Avoid overloading your car: this can seriously damage wheels or tyres.

If you get a flat tyre, stop immediately and change it so as not to damage the tyre, the wheel, the suspension and the steering.

Tyres age even if they are not used very much. Cracking of the tread rubber and the sidewalls are a sign of this ageing. In any case, if the tyres have been fitted for more than six years they should be examined by an expert who can judge whether they are still fit for use. Remember to check the spare tyre particularly carefully too.

If a replacement is necessary, always use new tyres and avoid using ones the origin of which you are not certain about.

The Fiat 600 fits tubeless tyres. Under no circumstances use an inner tube with these tyres.

If you replace a tyre it is a good idea to change the inflation valve, too.

To ensure the front and rear tyres all wear evenly, you are advised to change the tyres over every 10-15 thousand kilometres keeping them on the same side of the car so as not to reverse the direction of rotation.



Do not change the tyres over in criss-cross fashion by moving a tyre from the left hand side of the car to the right and vice versa.

RUBBER TUBING

Follow the SERVICE SCHEDULE to the letter as concerns braking, power steering and fuel line rubber tubing. Ozone, high temperatures and long absence of fluid in the system can in fact cause the hardening and cracking of the pipes with possible loss of fluid. A careful check is therefore essential.

WINDSCREEN AND REAR WINDOW WIPERS

BLADES

Periodically clean the rubber part with suitable products. We recommend **TUTELA PROFESSIONAL SC35**.

Change the blades if the rubber edge is warped or worn out. You should in any case change them approximately once a year.



Travelling with worn wiper blades is dangerous because it reduces visibility in bad weather.

In winter if the temperature falls below zero, make sure the blades are not frozen to the windscreen. If necessary, free them with a de-icing compound.



Never operate the windscreen wiper with blades locked to the windscreen: risk of windscreen wiper motor overheating / damaging.

Some simple steps can reduce potential damage to the blades:

– If the temperature falls to below zero, make sure the rubber blade is not frozen to the windscreen. If necessary, free it with a de-icing compound.

– Remove any snow that has settled on the glass: besides saving the blades you will avoid straining the electric windscreen wiper motor and causing it to overheat.

– Do not operate the windscreen or rear window wipers on dry glass.

Changing the windscreen wiper blade

1) Lift the windscreen wiper arm **A**-fig. 9 off the glass and position the blade so as to form a right angle with the arm.

2) Press tab **B** on the retainer and remove the blade to be replaced from arm **A**.

3) Fit the new blade by inserting the tab into the special slot in the arm. Make sure it is properly locked into place.

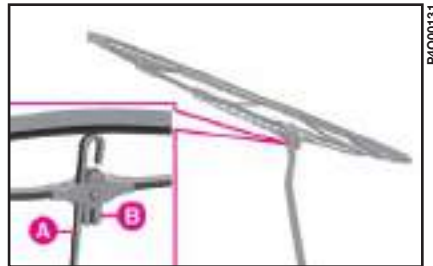

fig. 9

Changing the rear window wiper blade

1) Lift the cover **A**-fig. 10 and dismantle the arm from the vehicle by unscrewing the nut **B**-fig. 11 which holds it onto the knuckle.



fig. 10



fig. 11

2) Position the new arm correctly and fasten the nut **B**.

3) Replace the cover **A**.

NOZZLES fig. 12-13

If there is no jet of liquid, first make sure that there is liquid in the reservoir: see CHECKING FLUID LEVELS in this chapter.

Then make sure that the holes in the nozzles are not clogged up. Use a pin for this if necessary.



fig. 12

The windscreen washer jets can be directed by adjusting the inclination of the nozzles. Direct the spray so that it reaches the highest point reached by the blades.



fig. 13

BODYWORK

PROTECTING THE CAR FROM ATMOSPHERIC AGENTS

The main causes of rust are:

- atmospheric pollution;
- salt and humidity in the atmosphere (coastal or very hot and humid areas);
- environmental conditions that are specific to the season.

In addition, the abrasiveness of dust in the atmosphere and sand carried by the wind as well as mud and stones kicked up by other cars must not be underestimated.

For your Fiat 600, Fiat has used leading-edge technological solutions to effectively protect the body from rust.

These are the most important:

- painting systems and products that make the car particularly resistant to rust and scratching;

– the use of zinc-plated (or pre-treated) sheet steel which is highly resistant to rust;

– the spraying of the underbody, engine compartment, inside the wheel-arches and other parts with wax-based products with a high protective capacity;

– spraying plastic-coating materials to protect the most exposed points: under the door, inside the wings, the edges etc.;

– the use of “open” box sections to prevent condensation and water from building up and rusting the inside of the parts.

BODY AND UNDERBODY WARRANTY

Your Fiat 600 is covered by guarantee against any original structural or body part being holed by rust. Refer to the “Warranty Booklet” for the general conditions of this guarantee.

TIPS FOR KEEPING THE BODY IN GOOD CONDITIONS

Paintwork

The paintwork is not only to make your car look attractive but also to protect the steel.

If your car is scuffed or scratched deeply you are therefore advised to touch up the paintwork as necessary to prevent rust from forming.

Only use genuine products when touching up the paintwork (see the TECHNICAL SPECIFICATIONS chapter.

Ordinary maintenance of the paintwork means washing it. The frequency you should do this depends on the conditions and the environment the car is driven in. For example, in areas with a high level of air pollution, or on roads sprinkled with road saltwash the car more frequently.



Detergents pollute water. For this reason, the car must be washed in an area equipped for the collection and purification of the liquids used while washing.

To wash the car properly:

1) Remove the aerial from the roof to avoid damaging it in an automatic car wash.

2) Wash the body using a low pressure jet of water.

3) Wipe a sponge with a slightly soapy solution over the bodywork, frequently rinsing the sponge.

4) Rinse well with water and dry with a jet of air or a chamois leather.

When drying the car, be careful to get at those parts which are not so easily seen e.g. the door frames, bonnet and around the headlights where water can most readily collect.

Leave the car in the open so that the water can evaporate.

Do not wash the car after it has been parked in the sun or while the bonnet is hot: it could take the shine off the paint.

Outside plastic parts must be cleaned following the usual car washing procedure.

Where possible avoid parking the car under trees; the resinous substances that certain species of tree shed dull the paintwork and increase the possibility of rust forming.

IMPORTANT Bird droppings must be washed off immediately and with great care as their acid is particularly aggressive.

To better protect the paintwork, polish with specific protective wax.

When the paintwork tends to lose its shine because of the build-up of smog, use polish wax which has a slightly abrasive as well as protective action.

Windows

Use specific window cleaners to clean the windows. Use very clean cloths to avoid scratching the glass or damaging its transparency.

IMPORTANT To prevent damage to the electrical heater element, wipe the inside of the heated rear window gently in the same direction as the elements.

Engine compartment

At the end of each winter season, carefully clean the engine compartment. Have this done at a garage.



Detergents pollute water. The car must therefore be washed in an area equipped for the collection and purification of the liquids used while washing.

IMPORTANT The engine compartment should be washed while the engine is cold and with the ignition key at **STOP**. After washing, make sure that the various protections (e.g. rubber boots and various guards) have not be removed or damaged.

INTERIORS

From time to time check that water has not collected under the mats (from dripping shoes, umbrellas etc.) which could cause the steel to rust.



Never use inflammable products such as petroleum ether or petrol to clean inside the car. The electrostatic loads that are generated while rubbing to clean could become a fire risk.

CLEANING SEATS AND FABRICS

- Remove dust with a soft brush and vacuum cleaner.
- Brush the seats with a damp sponge with water and a neutral soap.
- Remove any grease stains with a specific product.

CLEANING LEATHER SEATS

- Remove the dry dirt with a chamois leather or very slightly moist cloth without exerting too much pressure.
- Remove liquid or grease stains with a dry absorbent cloth without rubbing. Then wipe with a chamois leather or soft cloth moistened with water and neutral soap.

If the stain does not come out, use a special cleaning compound being particularly careful to follow the instructions for use.

IMPORTANT Never use alcohol or alcohol-base products.

PLASTIC PARTS INSIDE THE CAR

Use special products designed not to alter the appearance of the components.

IMPORTANT Do not use alcohol or petrol to clean the instrument panel.



Do not keep aerosol cans in the car. There is the risk they might explode. Aerosol cans must never be exposed to a temperature above 50°C; when the weather starts to get hot the temperature inside the car might go well beyond that figure.

TECHNICAL SPECIFICATIONS

IDENTIFICATION DATA

CHASSIS MARKING

This is stamped on the bed plate in the boot, on the right **fig. 1**.

It can be seen by lifting the carpet and includes:

- vehicle model ZFA 187000
- chassis number.



fig. 1

ENGINE MARKING

The marking is stamped on the cylinder block and includes the model and the serial number.

MODEL PLATE

The plate **fig. 2** bears the following identification data:

- B** - Homologation number
- C** - Vehicle type code
- D** - Chassis number
- E** - Maximum vehicle weight fully loaded

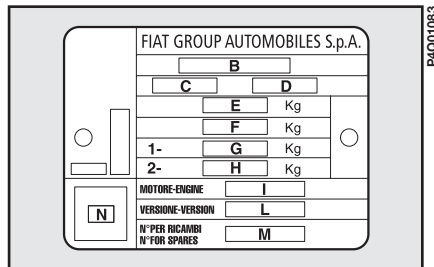

fig. 2

F - Maximum vehicle weight fully loaded with trailer

G - Maximum vehicle weight on front axle

H - Maximum vehicle weight on rear axle

I - Engine type

L - Body version code

M - Spare part code.

The plate is in the boot, on the left **fig. 3**.



fig. 3

BODYWORK PAINT IDENTIFICATION PLATE

This plate **fig. 4** is applied inside the tailgate.

It bears the following data:

A - Paint manufacturer

B - Colour name

C - Fiat colour code

D - Respray and touch up code.

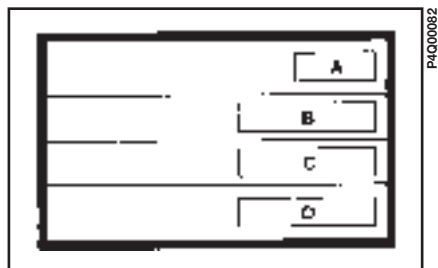

fig. 4

ENGINE CODES - BODYWORK VERSIONS

| Versions | Code engine type | Code bodywork version |
|-------------------|------------------|-----------------------|
| S - Active | 187A1.000 | 187AXCIA 02 |
| Van | 187A1.000 | 187CXCIA 1C |

ENGINE

GENERAL FEATURES

| | | |
|--------------------------------|-----------------|--------------------------------|
| Engine code | | 187A1.000 |
| Cycle | | Otto |
| Number and layout of cylinders | | 4 in line |
| Diameter x stroke | mm | 70 x 72 |
| Total capacity | cm ³ | 1108 |
| Compression ratio | | 9.6 |
| Max power (EEC): | kW | 40 |
| | HP | 54 |
| corresponding ratio | rpm | 5000 |
| Max torque (EEC): | Nm | 88 |
| | kgm | 9.0 |
| corresponding ratio | rpm | 2750 |
| Spark plugs | | NGK DCP7E-N-10 BOSCH YR7DEU |
| Fuel | | Unleaded petrol 95 RON |

FUEL SUPPLY IGNITION

Integrated multipoint electronic injection and ignition system: a single control unit controls both function processing injection time (for fuel metering) and spark advance angle at the same time.



Modifications or repairs to the fuel feed system that are not carried out properly or do not take the system's technical specifications into account can cause malfunctions leading to the risk of fire.

SPARK PLUGS

The cleanness and soundness of the spark plugs are very important for keeping the engine efficient and polluting emissions down.

The appearance of the spark plug, if examined by an expert eyes, is a good way of pinpointing a problem even if it has nothing to do with the ignition system. Therefore, if the engine has problems, it is important to have the spark plugs checked at a **Fiat Dealership**.



The spark plugs must be changed at the times specified in the SERVICE SCHEDULE. Only use the type of plugs indicated. If the heat ratio is less than required or the life specified is not guaranteed, problems can arise.

TRANSMISSION

CLUTCH

Mechanically controlled without travel-free pedal.

GEARBOX

Five forward gears and reverse with synchromesh for front gear engagement.

Cyclical gear reduction and differential assembly incorporated in the gearbox.

Drive transmission to the front wheels by means of drive shafts connected to the differential assembly and the wheels with CV joints.

BRAKES

SERVICE AND EMERGENCY BRAKES

Front:

– disc, floating caliper type with operating cylinder for each wheel.

Rear:

– drum type with self-centring shoes and operating cylinder for each wheel.

Crossed hydraulic circuit control.

7” vacuum brake booster.

ABS system with four sensors (where fitted).

Automatic take-up of friction liner wear.

Brake effort proportioning valves (2) intervening on hydraulic circuit of the rear brakes.

HANDBRAKE

Controlled by a lever, it works mechanically on the rear brakes.



Water, ice and salt sprinkled on the road deposit on the brake disc and reduce effectiveness when you brake.



Pay attention when installing extra spoilers, alloy wheels and non standard wheel caps: they could reduce the ventilation of the brakes, thus reducing their efficiency when braking suddenly and frequently, or on long downhill slopes.

SUSPENSION

Front:

Independent wheel type, lower wish-bones anchored to telescopic supports consisting of a cast iron riser rigidly connected to a hydraulic double action shock absorber. Leaf spring and coaxial pads with the shock absorbers. Permanently lubricated joints. Anti-roll bar anchored to the body acting on suspension arm.

Rear:

Independent wheel with coil springs. Jointed steel arms with bush and double action telescopic gas shock absorbers.

STEERING

Jointed steering column with two CV joints.

Permanently lubricated rack and pinion.

Number of steering wheel turns lock to lock (approximately) 3.9

Minimum steering circle: 10.5 metres (average between versions).

Electronically controlled power steering system optional.

WHEELS

RIMS AND TYRES

Printed steel or alloy rims. Specific wheel bolts (different in size and reciprocally incompatible) for each of the two types of rim.

Tubeless tyres with radial carcass.

The homologated tyres are listed in the log book.

IMPORTANT In the event of discrepancies between the information provided in this Owner Handbook and the Log Book, consider the specifications shown in the Log Book only.

To ensure safety of the car in movement, it must be fitted with tyres of specified size and of the same make and type on all wheels.

IMPORTANT Do not use inner tubes with tubeless tyres.

Do not fasten alloy wheels with the steel wheel bolts and vice versa. For details on the compatibility between rims and bolts - also with reference to the space-saver spare wheel - see IF A TYRE IS PUNCTURED.

WINTER TYRES

Use winter tyres as indicated in the WINTER TYRES chapter.

SMALL SPARE WHEEL

Printed steel rim.

Tubeless tyre.

SNOW CHAINS

Use only low profile chains, see the SNOW CHAIN CHAPTER.

WHEEL GEOMETRY

Front wheel toe-in measured from rim to rim: -1 ± 1 mm

The figures refer to the car in full running order.

UNDERSTANDING TYRE MARKINGS

The following are the necessary indications to understand the meaning of the markings on the tyre.

Example: **165/55 R 13 70 H**

- 165** = Nominal width (S, distance between side walls in mm).
- 55** = Height/width ratio (H/S, as a percentage).
- R** = Radial tyre.
- 13** = Rim nominal diameter in inches (\emptyset).
- 70** = Load rating (carrying capacity).
- H** = Maximum speed rating.

Maximum speed rating

- Q** = up to 160 km/h.
- R** = up to 170 km/h.
- S** = up to 180 km/h.
- T** = up to 190 km/h.
- U** = up to 200 km/h.
- H** = up to 210 km/h.
- V** = up to 240 km/h.

Maximum speed rating for snow tyres

- Q M+S** = up to 160 km/h
- T M+S** = up to 190 km/h
- H M+S** = up to 210 km/h

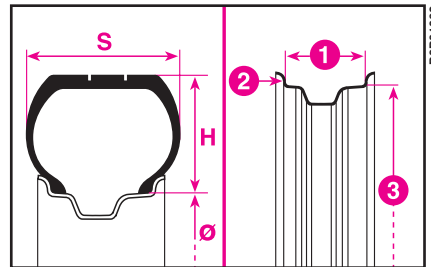

fig. 5

UNDERSTANDING RIM MARKINGS

The following are the necessary indications to understand the meaning of the markings on the rim.

Example: **5 1/2 B x 13 H2**

- 5 1/2** = rim width in inches (**1**)
- B** = rim drop centre outline (side projection where the tyre bead rests) (**2**)
- 13** = rim nominal diameter in inches (corresponds to diameter of the tyre to be mounted) (**3** = \emptyset)
- H2** = “hump” shape and number (relief on the circumference holding the tubeless tyre bead on the rim)

| Versions | Rim | Tyre | Snow tyre | Space-saver spare wheel | |
|-------------------|-------------------------|--|----------------------|---------------------------|------------------|
| | | | | rim | tyre |
| S - Active | 5Bx13 H 5 1/2Bx13 H2 | 155/65 R13 – 73T 155/70 R13 – 75T 165/55 R13 – 70H (*) | 145/70 R13 – 71Q M+S | 4 1/2x13 H | 135/70 R13 – 68T |
| Van | 5Bx13 H | 155/65 R13 – 73T | 145/70 R13 – 71Q M+S | Standard size spare wheel | |

(*) Optional tyres.

COLD TYRE PRESSURE (bar)

Add +0.3 bar to the prescribed inflation pressure when the tyres are warm.
Check again the correct pressure when the tyres are cold.

| Versions | Tyre | With average load | | With full load | | Space-saver spar wheel |
|-------------------|--|-------------------|------|----------------|------|---------------------------------|
| | | Front | Rear | Front | Rear | |
| S - Active | 155/65 R13 – 73T 155/70 R13 – 75T 165/55 R13 – 70H 145/70 R13 – 71Q M+S | 2.1 | 2.0 | 2.3 | 2.3 | 2.5 |
| Van | 155/65 R13 – 73T | 2.0 | 2.0 | 2.2 | 2.2 | Standard size spare wheel |
| | 145/70 R13 – 71Q M+S | 2.1 | 2.0 | 2.3 | 2.3 | |

DIMENSIONS

| | | | S - Active | Van |
|--|-------|-----------------|------------|------|
| Length | | mm | 3337 | 3337 |
| Width | | mm | 1508 | 1508 |
| Empty standing height | | mm | 1420 | 1440 |
| Projection | front | mm | 637 | 637 |
| | rear | mm | 500 | 500 |
| Wheelbase | | mm | 2200 | 2200 |
| Front track | front | mm | 1277 | 1275 |
| | rear | mm | 1270 | 1268 |
| Unladen boot volume (V.D.A. standards): | | dm ³ | 170 (*) | 810 |

Minor differences in dimensions may occur according to rims and/or versions.

- (*) Extending with load: - in line with windows 440 dm³
 - to the roof 810 dm³
 (requiring the use of two external rearview mirrors)

PERFORMANCE

Top permissible speed after running:
150 km/h.

WEIGHTS

| | | S - Active | Van |
|--|----|------------|------|
| Weight empty (including fluids, 90% fuel in the tank and no optional) | kg | 735 | 760 |
| Payload (4 occupants + 50 kg or driver + 330 kg) | kg | 465 | 450 |
| Maximum loads permitted (2): | | | |
| – front axle | kg | 610 | 610 |
| – rear axle | kg | 630 | 720 |
| – fully laden | kg | 1200 | 1210 |
| Towable weight: | | | |
| – trailer with brake | kg | 400 | 400 |
| – trailer without brake | kg | 350 | 200 |
| Weight on trailer ball joint | kg | 28 | 28 |
| Maximum weight on roof | kg | 30 | 30 |

- (1) If special equipment is fitted (sunroof, tow hitch etc.) the unladen weight increases, thus reducing the payload as specified in the maximum loads allowed.
- (2) The driver is responsible for arranging the load so that it complies with these limits.

CAPACITIES

| | litres | kg | Prescribed fuel Recommended products |
|--|------------|------------|--|
| Fuel tank: including a reserve about: | 38 7 | – – | Unleaded petrol with no less than 95 R.O.N. |
| Engine cooling system: | 4 | – | Mixture of distilled water and PARAFU UP at 50% (☐) |
| Engine sump: Engine sump and filter: | 3.1 3.5 | 2.8 3.1 | SELENIA 20 K |
| Gearbox/differential casing: | 2.4 | 2.15 | TUTELA CAR TECHNIX |
| CV joint cavities and boots (each): | – | 0.08 | TUTELA ALL STAR |
| Front and rear brakes hydraulic circuit: | 0.4 | – | TUTELA TOP 4 |
| Windscreen and rear window washer liquid reservoir: | 1.8 | – | Mixture of water and TUTELA PROFESSIONAL SC35 fluid |

(☐) For particularly hard climate conditions, we recommend use of a 60% PARAFU UP and 40% demineralized water mixture.

FLUIDS AND LUBRICANTS

PRODUCTS WHICH MAY BE USED AND THEIR CHARACTERISTICS

| Use | Specifications of the lubricants and fluids to use for best car operation | Original fluids and lubricants | Change |
|--------------------------|---|--|-------------------------------|
| Petrol engine lubricants | SAE 10W-40 grade synthetic-based oil exceeding Qualification FIAT | SELENIA 20K Contractual Technical Reference N.° F405.N04 | According to Service Schedale |

In case of use of non original SAE 10W-40 products, lubricants complying with ACEA A3 minimal performances required are acceptable. Using products with characteristics not even meeting ACEA A3 technical specifications for gasoline engines may cause serious damages to the engine, which are not covered by warranty.

For very cold climate conditions, ask Fiat Dealership for the appropriate Selenia product to use.

| Use | Fluid and lubricant specifications for correct car operation | Original fluids and lubricants | Change |
|---|--|--|--|
| Lubricants and greases for transmission | Lubricant with synthetic basis complying with SAE 75W-85. Performance exceeds by far the API GL-4 PLUS and FIAT 9.55550 standards required. | TETELA CAR TECHNIX Contractual Technical Reference N.° F010.B05 | Mechanical gear and differential gear. |
| | Grease containing Molybdenum bisulphide for high temperature appliances. NLGI 1-2 consistency. | TUTELA ALL STAR Contractual Technical Reference N.° F702.G07 | Constant-velocity joints on wheel side. |
| Brake fluids | Synthetic fluid, F.M.V.S.S. no. 116, DOT 4, ISO 4925, SAE J-1704, CUNA NC 956-01 | TUTELA TOP 4 Contractual Technical Reference N.° F001.A93 | Hydraulic brakes and clutch hydraulic controls. |
| Protective agent for radiatore | Anti-freezing safety liquid (red colour) containing monoethylene glycol inhibited with organic formula. Antifreeze complying with CUNA NC 956-16, ASTM D 3306 standards. | PARAFLU UP Contractual Technical Reference N.° F101.M01 | Radiator antifreeze proportion: 50% water and 50% PARAFLU UP (□) |
| Windscreen/ rear window washer fluid | Mixture of alcohols, water and surfactants (CUNA NC 956-11). | TUTELA PROFESSIONAL SC 35 Contractual Technical Reference N.° F201.D02 | To be used diluted or undiluted in windscreen/ rear window washer/ wiper systems |

IMPORTANT Do not top up or mix with fluids having characteristics different from those specified.

(□) For particularly hard climate conditions, we recommend use of a 60% PARAFLU UP and 40% demineralized water mixture.

FUEL CONSUMPTION

The fuel consumption values shown in the table below were defined according to the type-approval specifications in European Directives.

Consumption values are defined by means of the following procedures:

- **an urban cycle**: consisting of a cold start and a simulated drive in city streets;

- **an extra-urban cycle**: consisting in frequent accelerations, in all gears, simulating normal conditions of use. Speed ranges from 0 to 120 km/h;

- **average combined cycle** consisting of 37% urban cycle and 63% extra-urban cycle.

IMPORTANT Road and traffic conditions, weather, general conditions of the car, driving style, fittings and accessories, use of the climate control system, load, roof racks and other situations penalising aerodynamic penetration and effecting rolling resistance will influence fuel consumption rates which can be different from the values shown in the table (see CHEAP RUNNING THAT RESPECTS THE ENVIRONMENT IN DRIVING YOUR CAR chapter).

CO₂ EMISSIONS

The maximum CO₂ emission values shown in the following table refer to the average combined cycle.

| Versions | CO ₂ emission in accordance with Directive 1999/100/EC (g/km) |
|------------|--|
| S - Active | 143 |

Consumption in accordance with Directive 1999/100/EC (litres x 100 km)

| | S - Active |
|-------------|------------|
| Urban | 8.3 |
| Extra-urban | 4.7 |
| Combined | 6.0 |

INDEX

| | | | | | |
|---|--------|-----------------------------------|-----|----------------------------------|-----|
| A BS | 54 | Brake fluid level | 112 | – controls | 39 |
| Accessories purchased by the owner | 66 | Brake lights | 95 | Central locking | 45 |
| – Installation of electrical/ electronic devices | 67 | Brakes | | Cigar lighter | 42 |
| – Radio transmitters and mobile phones | 67 | – fluid level | 112 | Clock..... | 24 |
| Air filter | 113 | – service and emergency | 126 | Clutch | 127 |
| Air recirculation | 35 | Bulbs | | CO ₂ emissions | 136 |
| Ashtray | 42 | – bulb replacement | 89 | Control buttons | 40 |
| | | – exterior bulb replacement .. | 92 | Correct use of the vehicle | 70 |
| | | – general information | 90 | Courtesy (ceiling) lights | |
| | | – interior bulb replacement .. | 107 | – bulb replacement | 97 |
| | | – types | 91 | – controls | 39 |
| | | | | Courtesy light | |
| B attery | | C apacities | 133 | – bulb replacement | 97 |
| – checking fluid level | 114 | Car maintenance | | – controls | 39 |
| – jump starting | 84-101 | – additional operations | 108 | | |
| – recharging | 101 | – annual inspection plan | 108 | D ashboard | 19 |
| – replacing the battery | 114 | – scheduled servicing | 105 | Dimensions | 131 |
| – useful advice | 115 | – service schedule | 106 | Dipped beam headlights | |
| – warning light for check | 115 | Car parked | 71 | – bulb replacement | 92 |
| Bodywork | 124 | Car radio | 64 | – controls | 37 |
| Bonnet | 51 | Carrying children in safety | 13 | Directable, adjustable air vents | 33 |
| Boot | | Ceiling (courtesy) light | | Direction indicators | |
| – extension | 48 | – bulb replacement | 97 | – controls | 38 |
| – opening | 47 | | | | |
| – securing the load | 49 | | | | |

| | |
|--|-----|
| – front bulb replacement | 93 |
| – rear bulb replacement | 95 |
| – side bulb replacement | 94 |
| Display of fuel cut off activated | 22 |
| Doors | 45 |
| Driving style | 74 |
| E conomical driving | 75 |
| Electric power assisted steering | 61 |
| Electric windows | 46 |
| Electronic control units | 116 |
| Engine | |
| Engine compartment (washing) | 122 |
| Engine coolant level | 111 |
| Engine oil | |
| Engine oil consumption | 111 |
| Engine oil level | 110 |
| – consumption | 111 |
| – level check | 110 |
| – Technical specifications | 125 |
| – cooling | 111 |
| – features | 126 |
| – fluid level check | 110 |
| – identification code | 124 |
| – on/power supply | 127 |
| EOBD (System) | 60 |
| EOBD system | 60 |

| | |
|---|-------|
| F iat Code (The system) | 4 |
| Fiat CODE system | 4 |
| Filling the tank | 68 |
| Fog lights | |
| – control | 40 |
| – direction | 54 |
| Front air bags | 56 |
| – front air bags | 56 |
| – general information | 58 |
| – passenger front air bag | 57 |
| Front fog lights | |
| – bulb replacement | 94 |
| – on/off button | 40 |
| Fuel | 68 |
| – consumption | 136 |
| – fuel cut off switch | 41 |
| – gauge | 21 |
| Fuel consumption | 136 |
| Fuel cut off switch | 22-41 |
| Fuel gauge | 21 |
| Fuses | 100 |
| G earbox | |
| – type | 127 |
| – use of the gearbox | 72 |
| Government homologation (remote control) | 9-139 |

| | |
|--|--------|
| H andbrake | 72-126 |
| Hazard warning lights | |
| – controls | 40 |
| Head restraints | 30 |
| Headlights | |
| – angle compensation | 53 |
| – light beam direction | 53 |
| Heated rear window | 40 |
| Heater controls | 33 |
| Heating | 33 |
| Horn | 41 |
| I dentification data | 124 |
| Ignition switch | 18 |
| In an emergency | 83 |
| Instrument panel | 20 |
| J ack | |
| – usage | 87-102 |
| – warnings | 86 |
| K eys | 4 |
| – duplication | 7 |
| Knowing your car | 6 |
| L ubricants (specifications) | 136 |
| Luggage compartment | 47 |

| | | | |
|--|--------|--|--|
| M ain beam headlights | | | |
| – bulb replacement | 92 | | |
| – controls | 37 | | |
| – flashing | 38 | | |
| Manual climate control system | | | |
| – climate control (cooling) | 36 | | |
| – controls | 35 | | |
| – maintenance | 36 | | |
| Milometer | 21 | | |
| N umber plate lights | 95 | | |
| O n board instruments | 21 | | |
| P aint | 121 | | |
| Performance | 131 | | |
| Personalized adjustments | 29 | | |
| Pretensioners | 10 | | |
| Protecting devices that reduce emissions | 76 | | |
| R aising the vehicle | 102 | | |
| Rear fog lamps | | | |
| – bulb replacement | 95 | | |
| – on/off button | 40 | | |
| Rear screen washer | | | |
| – controls | 39 | | |
| – fluid level | 112 | | |
| Rear view mirrors | | | |
| – exterior | 31 | | |
| – interior | 31 | | |
| Rearscreen wiper | | | |
| – blades | 118 | | |
| – controls | 39 | | |
| – jets | 120 | | |
| Restricting management expenses | 73 | | |
| Reversing lights | 95 | | |
| Roof rack/ski rack | 52 | | |
| Rubber hoses | 118 | | |
| S eat belts | | | |
| – general information | 11 | | |
| – maintenance | 12 | | |
| – pretensioners | 10 | | |
| – transporting children safely | 13 | | |
| – usage | 7 | | |
| Seats | | | |
| – access to rear seats | 31 | | |
| – backrest adjustment | 30 | | |
| – children (transporting) | 13 | | |
| – cleaning | 123 | | |
| – lengthwise adjustment | 29 | | |
| Side lights | | | |
| – controls | 37 | | |
| – front bulb replacement | 93 | | |
| – rear bulb replacement | 95 | | |
| Signals for correct driving | 5 | | |
| Snow chains | 81 | | |
| Spark plugs | 126 | | |
| Speedometer | 21 | | |
| Starting the engine | | | |
| – emergency starting | 71-83 | | |
| – ignition switch | 18 | | |
| – jump starting | 84-101 | | |
| – procedure for starting | 70 | | |
| – to switch off the engine | 71 | | |
| – warming up the engine once started | 70 | | |
| Steering | 61-129 | | |
| Steering lock | 18-72 | | |
| Steering wheel levers | | | |
| – left lever | 37 | | |

| | | | | | |
|----------------------------------|-----|---------------------------------|-----|--------------------------|-----|
| – right lever | 38 | – inflation pressure | 130 | – fluid level | 112 |
| Storing the car | 82 | – maintenance | 117 | Windscreen wiper | |
| Sun roof | | – snow tyres | 80 | – blades | 118 |
| – electrically operated | 43 | – types | 130 | – controls | 38 |
| Sun visors | 43 | U sage conditions | 75 | – jets | 120 |
| Suspension | 127 | V an | 62 | Windscreen/rearscreen | |
| Symbols | 4 | Various controls | 40 | washer fluid level | 112 |
| T ank cap | | Vehicle inactivity | 82 | | |
| Technical specifications | 124 | Ventilation | 35 | | |
| Third brake lights | 96 | W arning lights | 23 | | |
| To the service station | 67 | Weights | 132 | | |
| Tools | 86 | Wheel | | | |
| Top speed | 133 | – maintenance | 117 | | |
| Towing the car | 103 | – replacement | 87 | | |
| Towing trailers | | – spare wheel | 128 | | |
| – fitting diagram | 78 | – types | 130 | | |
| – installation of tow hook | 77 | Wheel geometry | 128 | | |
| – warnings | 77 | Windows (cleaning) | 122 | | |
| Transmission | 126 | Windscreen and rearscreen wiper | | | |
| Travelling safely and in harmony | | blades | 118 | | |
| with nature | 4 | Windscreen washer | | | |
| Tyre inflation pressure | 130 | – controls | 38 | | |
| Tyres | | | | | |
| – changing a wheel | 87 | | | | |

PROVISIONS FOR THE PROCESSING OF A VEHICLE AT THE END OF ITS LIFE-CYCLE

For years now Fiat has been developing its global commitment towards the safeguarding and protection of the Environment through the continuous improvement of its production processes and the making of increasingly more “eco friendly” products. With a view to guaranteeing the best possible service to clients in full observance of environmental standards and in response to the obligations imposed by European Directive 2000/53/EC on end-of-life vehicles, Fiat offers its clients the possibility to hand in their vehicle* at the end of its life span without additional costs.

The European Directive, in fact, provides for the take-back of the vehicle without the last holder or owner of the same incurring expenses due to the fact that the market value of the vehicle is zero or negative. In particular, in almost all of the countries of the European Union, up until 1st January 2007, take-back of the vehicle free of charge only applies to vehicles registered from 1 July 2002 on, while, from 2007 on, take-back will be carried out free of charge, independently of the year of registration, provided that the vehicle still contains all its essential component parts (especially engine and body) and is free from additional waste materials.

Our contracted network of authorised treatment facilities has been carefully selected in order to provide a quality service to our customers by de-polluting and recycling “End of Life Vehicles” to approved environmental standards. To find out the location of your nearest authorised treatment facility, offering free of charge take-back, simply contact one of our dealers or refer to the Fiat web site or call the toll free number 00800 3428 0000.

* Passenger transportation vehicles to seat a max. of nine persons, having a total admissible weight of 3.5 t

SELENIA®

At the heart of your engine.



Always ask your mechanic for **SELENIA®**

Oil change? The experts recommend Selenia.

*The engine of your car is factory filled with **Selenia**. This is an engine oil range which satisfies the most advanced international specifications. Its superior technical characteristics allow **Selenia** to guarantee the **highest performance** and **protection of your engine**.*

The Selenia range includes a number of technologically advanced products:

SELENIA PERFORMER MULTIPOWER

Particularly ideal for the protection of new generation petrol engines, very effective even in the most severe weather conditions. It guarantees a reduction in fuel consumption (Energy conserving) and it is also ideal for alternative engines.

SELENIA K

is the synthetic lubricant with innovative technology, which ensures improved cold starting for petrol engines and the utmost protection also under typically “urban” conditions of use. Owing to its 5W-40 viscosimetric grade and its special formulation it more effectively meets the emission limits required by new European regulations and exceeds the major international specifications.

SELENIA WR

Oil specifically designed for common rail Multijet engines. Particularly effective during cold starts, it guarantees maximum wear protection and hydraulic tappets control, reduction in consumption and stability at high temperatures.

SELENIA DIGITECH

Fully synthetic lubricant for petrol and diesel engines. Its advanced technology guarantees maximum protection, a reduction in consumption and reliability in extreme climate conditions.

The range also includes Selenia StAR, Selenia Racing, Selenia 20K Alfa Romeo, Selenia TD, Selenia Performer 5W-40
For further information on Selenia products visit the web site www.fliselenia.com.

COLD TYRE INFLATION PRESSURE (bar)

| Versions | Tyre | Medium load | | Full load | | Space-saver spare |
|-------------------|--|-------------|------|-----------|------|---------------------------|
| | | Front | Rear | Front | Rear | |
| S - Active | 155/65 R13 – 73T | 2.1 | 2.0 | 2.3 | 2.3 | 2.5 |
| | 155/70 R13 – 75T | | | | | |
| | 165/55 R13 – 70H 145/70 R13 – 71Q M+S | | | | | |
| Van | 155/65 R13 – 73T | 2.0 | 2.0 | 2.2 | 2.2 | Standard size spare wheel |
| | 145/70 R13 – 71Q M+S | 2.1 | 2.0 | 2.3 | 2.3 | |

0.3 bar should be added to the values given if the pressure is measured while the tyre is hot.
Check again the correct pressure when the tyres are cold.

ENGINE OIL REPLACEMENT

| | litres | kg |
|-----------------|--------|-----|
| Sump | 3.1 | 2.8 |
| Sump and filter | 3.5 | 3.1 |

Dispose of waste oil properly.

FUEL CAPACITY

| | litres |
|---------------|---------|
| Tank capacity | 38 |
| Reserve | about 7 |

Refuel petrol engine vehicles with unleaded petrol, octane rating (RON) no lower than 95.

The data contained in this publication is intended merely as a guide. FIAT reserves the right to modify the models and versions described in this booklet at any time for technical and commercial reasons.

If you have any further questions please consult your FIAT dealer.

Printed in recycled paper without chlorine.