



SHOGUN - EN-UK - 0VWX17E1

SHOGUN - EN-UK - 0VWX17E1

# SHOGUN

## OWNER'S MANUAL

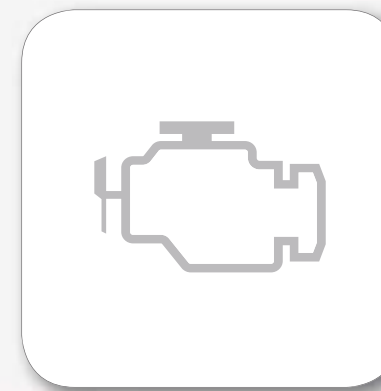

## Foreword

E09200106777

Thank you for selecting a SHOGUN as your new vehicle. This owner's manual will add to your understanding and full enjoyment of the many fine features of this vehicle. It contains information prepared to acquaint you with the proper way to operate and maintain your vehicle for the utmost in driving pleasure.

MITSUBISHI MOTORS Europe B.V. reserves the right to make changes in design and specifications and/or to make additions to or improvements in this product without obligation to install them on products previously manufactured.

It is an absolute requirement for the driver to strictly observe all laws and regulations concerning vehicles.

This owner's manual has been written in compliance with such laws and regulations, but some of the contents may become contradictory with later amendment of the laws and regulations.

Please leave this owner's manual in this vehicle at time of resale. The next owner will appreciate having access to the information contained in this owner's manual.

Repairs to your vehicle:  
Vehicles in the warranty period:  
All warranty repairs must be carried out by a MITSUBISHI MOTORS Authorized Service Point.

Vehicles outside the warranty period:  
Where the vehicle is repaired is at the discretion of the owner.

Throughout this owner's manual the words **WARNING** and **CAUTION** appear.

These serve as reminders to be especially careful. Failure to follow instructions could result in personal injury or damage to your vehicle.

### **WARNING**

**indicates a strong possibility of severe personal injury or death if instructions are not followed.**

### **CAUTION**

**means hazards or unsafe practices that could cause minor personal injury or damage to your vehicle.**

You will see another important symbol:

**NOTE: gives helpful information.**

**\*: indicates optional equipment.**

It may differ according to the sales classification; refer to the sales catalogue.

Abbreviations used in this owner's manual:

**LHD: Left-Hand Drive**

**RHD: Right-Hand Drive**

**M/T: Manual transmission**

**A/T: Automatic Transmission**

The symbol used on the vehicles:



. See owner's manual

## Information for station service

E09300104338

	Capacity	3-door models	69 litres
		5-door models	88 litres
Fuel	Fuel requirements	<b>Petrol-powered vehicles</b> Unleaded petrol octane number (EN228) 90 RON or higher If the "PREMIUM FUEL ONLY" label is attached to the fuel tank filler door, fill it up with premium fuel. <b>Diesel-powered vehicles</b> Cetane number (EN590) 51 or higher Refer to "General information" section for the fuel selection.	
Engine oil		Refer to the "Maintenance" section for the selection of engine oil.	
Tyre inflation pressure		Refer to the "Maintenance" section for the tyre inflation pressure.	

**Mitsubishi Motors Europe B.V.**

© 2016 Mitsubishi Motors Corporation

OVWX17E1  
BLO-16-000629

17

# Table of contents

<b>Overview</b>	<b>1</b>
<b>General information</b>	<b>2</b>
<b>Locking and unlocking</b>	<b>3</b>
<b>Seat and seat belts</b>	<b>4</b>
<b>Instruments and controls</b>	<b>5</b>
<b>Starting and driving</b>	<b>6</b>
<b>For pleasant driving</b>	<b>7</b>
<b>For emergencies</b>	<b>8</b>
<b>Vehicle care</b>	<b>9</b>
<b>Maintenance</b>	<b>10</b>
<b>Specifications</b>	<b>11</b>
<b>Alphabetical index</b>	<b>12</b>
<b>Declaration of Conformity</b>	<b>13</b>

# Instruments and Controls (Driver's area)

E00100108432

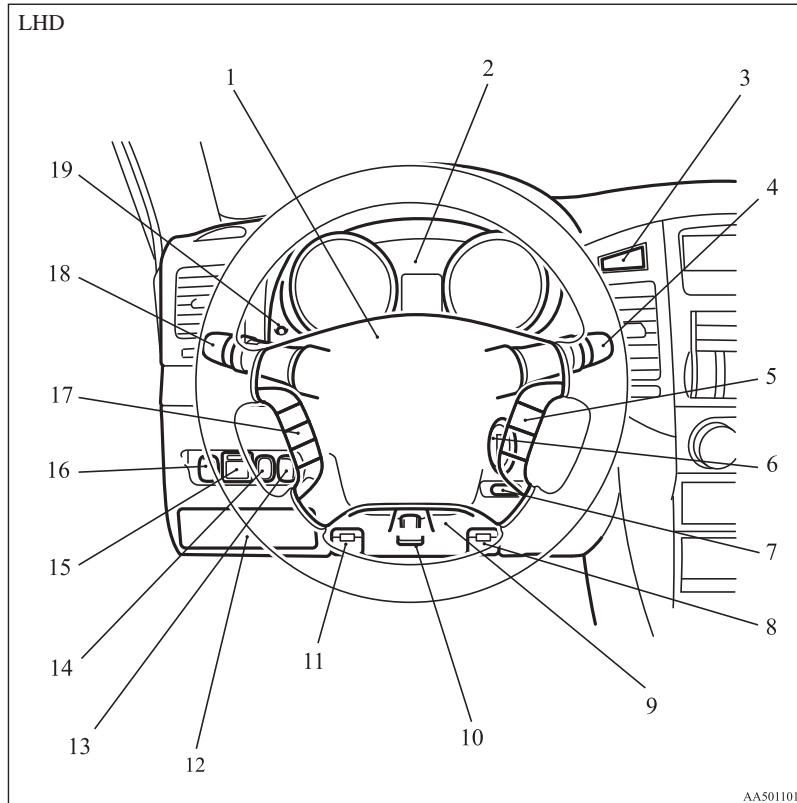

1. Supplemental restraint system - airbag (for driver's seat) p. 4-36  
Horn switch p. 5-50
2. Instruments p. 5-02
3. Hazard warning flasher switch p. 5-42
4. Windscreen wiper and washer switch p. 5-44  
Rear window wiper and washer switch p. 5-48
5. Cruise control switch\* p. 6-44
6. Ignition switch p. 6-10
7. Active Stability Control switch p. 6-40
8. Fuel tank filler door release lever p. 2-03
9. Steering control switch (for Bluetooth® 2.0 interface)\* p. 7-51
10. Steering wheel height adjustment p. 6-06
11. Bonnet release lever p. 10-03
12. Fuse block lid p. 10-18
13. Sonar cancel switch\* p. 6-52
14. Headlamp levelling switch\* p. 5-40  
Automatic high-beam switch\* p. 5-36
15. Electric remote-controlled outside rear-view mirror switch p. 6-08
16. Front fog lamp switch\* p. 5-43  
Rear fog lamp switch p. 5-43
17. Audio switch\* p. 7-24
18. Combination headlamps and dipper switch p. 5-34  
Turn-signal lever p. 5-42  
Headlamp washer switch\* p. 5-48
19. Daytime dipper button (meter illumination control) p. 5-07

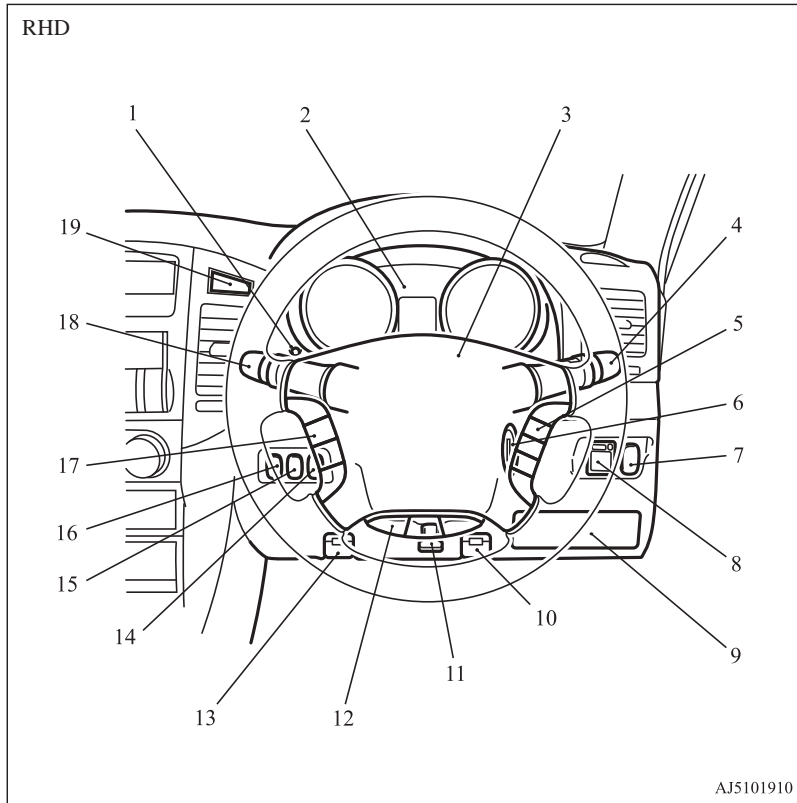

1. Daytime dipper button (meter illumination control) p. 5-07
2. Instruments p. 5-02
3. Supplemental restraint system - airbag (for driver's seat) p. 4-36  
Horn switch p. 5-50
4. Windscreen wiper and washer switch p. 5-44  
Rear window wiper and washer switch p. 5-48
5. Cruise control switch\* p. 6-44
6. Ignition switch p. 6-10
7. Front fog lamp switch\* p. 5-43  
Rear fog lamp switch p. 5-43
8. Electric remote-controlled outside rear-view mirror switch  
p. 6-08
9. Fuse block lid p. 10-18
10. Bonnet release lever p. 10-03
11. Steering wheel height adjustment p. 6-06
12. Steering control switch (for Bluetooth<sup>®</sup> 2.0 interface)\* p. 7-51
13. Fuel tank filler door release lever p. 2-03
14. Headlamp levelling switch\* p. 5-40  
Automatic high-beam switch\* p. 5-36
15. Sonar cancel switch\* p. 6-52
16. Active stability control switch p. 6-40
17. Audio switch\* p. 7-24
18. Combination headlamps and dipper switch p. 5-34  
Turn-signal lever p. 5-42  
Headlamp washer switch\* p. 5-48
19. Hazard warning flasher switch p. 5-42

# Instruments and Controls (Instrument panel)

E00100108982

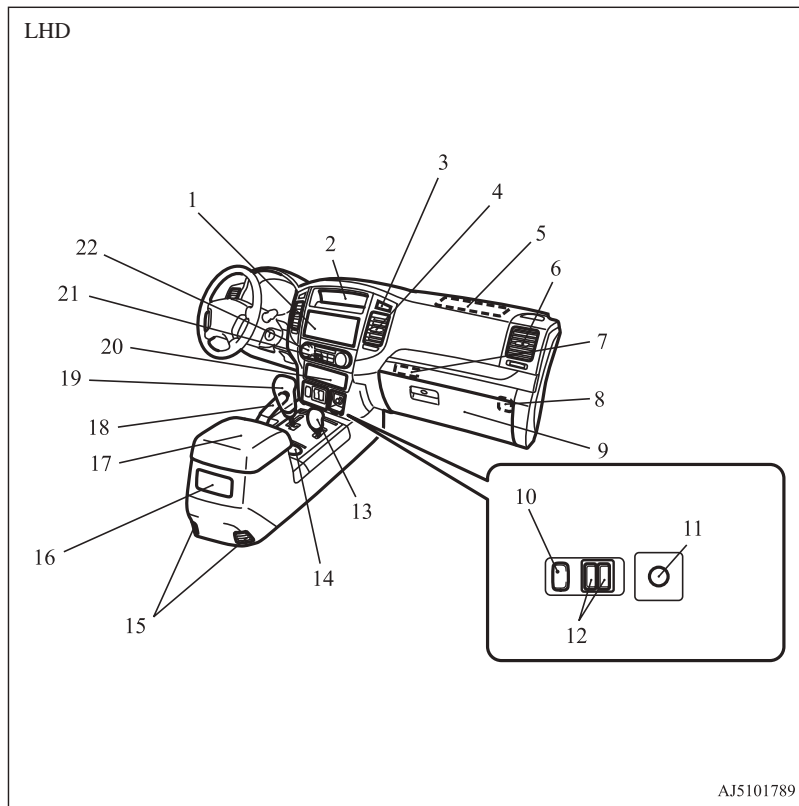

1. Audio\* p. 7-12  
DISPLAY AUDIO\*/Smartphone Link Display Audio\*/  
MITSUBISHI Multi-Communication System (MMCS)\*  
[Refer to the separate owner's manual]
2. Centre information display p. 5-12
3. Front passenger's airbag OFF indication lamp p. 4-40
4. Centre ventilators p. 7-02
5. Supplemental restraint system - airbag (for front passenger's seat)  
p. 4-36
6. Side ventilators p. 7-02
7. Auxiliary Video connector (RCA)\* p. 7-39  
USB port\* p. 7-71  
HDMI port\* p. 7-74
8. Front passenger's airbag ON-OFF switch p. 4-39
9. Glove box p. 7-82
10. Rear differential lock switch\* p. 6-26
11. Cigarette lighter\* p. 7-76  
Accessory socket\* p. 7-77
12. Heated seat switch\* p. 4-09
13. Transfer shift lever p. 6-21
14. Cup holder (for front seats) p. 7-85
15. Floor ventilators\* p. 7-02
16. Rear air conditioning\* p. 7-09
17. Armrest (for front seats) p. 4-08  
Centre console box p. 7-83  
Accessory socket p. 7-77
18. Parking brake lever p. 6-04
19. Selector lever p. 6-15
20. Centre accessory box\* p. 7-83
21. Rear window demister switch p. 5-50
22. Front automatic air conditioning p. 7-03

RHD

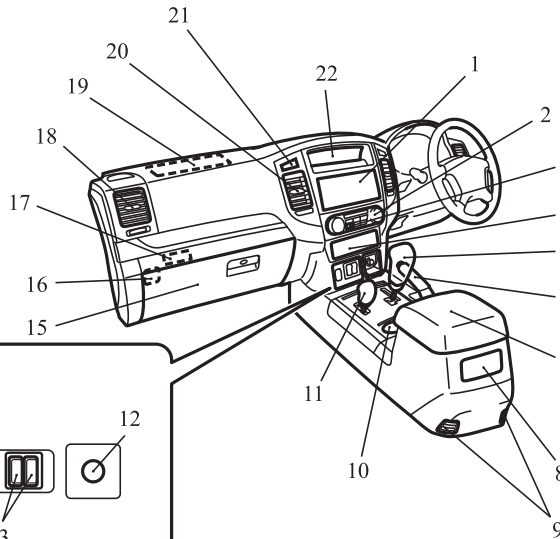

AJ5101792

1. Audio\* p. 7-12  
DISPLAY AUDIO\*/Smartphone Link Display Audio\*/  
MITSUBISHI Multi-Communication System (MMCS)\*  
[Refer to the separate owner's manual]
2. Front automatic air conditioning p. 7-03
3. Rear window demister switch p. 5-50
4. Centre accessory box\* p. 7-83
5. Selector lever p. 6-15
6. Parking brake lever p. 6-04
7. Armrest (for front seats) p. 4-08  
Centre console box p. 7-83  
Accessory socket p. 7-77
8. Rear air conditioning\* p. 7-09
9. Floor ventilators\* p. 7-02
10. Cup holder (for front seats) p. 7-85
11. Transfer shift lever p. 6-21
12. Cigarette lighter\* p. 7-76  
Accessory socket\* p. 7-77
13. Heated seat switch\* p. 4-09
14. Rear differential lock switch\* p. 6-26
15. Glove box p. 7-82
16. Front passenger's airbag ON-OFF switch p. 4-39
17. Auxiliary Video connector (RCA)\* p. 7-39  
USB port\* p. 7-71  
HDMI port\* p. 7-74
18. Side ventilators p. 7-02
19. Supplemental restraint system - airbag (for front passenger's seat)  
p. 4-36
20. Centre ventilators p. 7-02
21. Front passenger's airbag OFF indication lamp p. 4-40
22. Centre information display p. 5-12

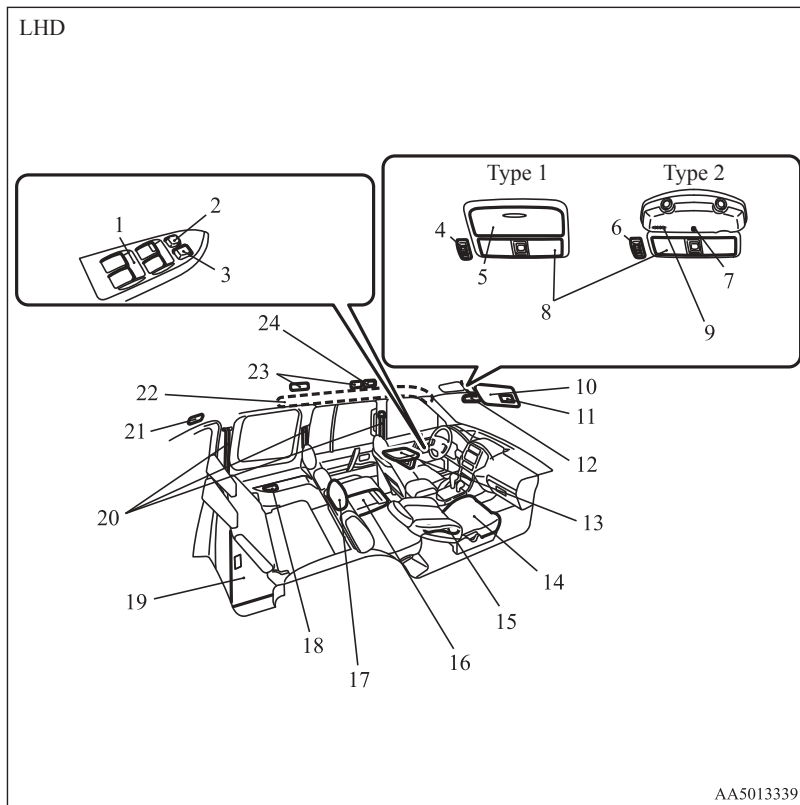

1. Electric window control p. 3-16
2. Electric window lock switch p. 3-17
3. Central door lock switch p. 3-07
4. Sunroof switch\* p. 3-19
5. Sunglasses holder\* p. 7-84
6. Sunroof switch\* p. 3-19
7. Ceiling lamp p. 7-78
8. Room & map lamp p. 7-79, 10-25, 10-30  
Interior lamp switch p. 7-78
9. Microphone (for Hands-free & voice recognition)\* p. 7-51
10. Sun visors p. 7-74
11. Vanity mirror p. 7-74
12. Inside rear-view mirror p. 6-07
13. Video Entertainment System\*  
Refer to the separate "Video Entertainment System owner's manual"
14. Seat p. 4-02
15. Supplemental restraint system - side airbag (for front seats)\*  
p. 4-36
16. Armrest (for rear/second seat) p. 4-10  
Cup holder (for rear/second seat) p. 7-85
17. Head restraints p. 4-12
18. Cup holder (for third seat)\* p. 7-86
19. Luggage floor box p. 7-84
20. Seat belts p. 4-21  
Adjustable seat belt anchor (front seats) p. 4-23
21. Luggage compartment lamp p. 7-80, 10-25, 10-31
22. Supplemental restraint system - curtain airbag\* p. 4-36
23. Roof ventilators (5-door models)\* p. 7-02
24. Rear personal lamps p. 7-79, 10-25, 10-30



RHD

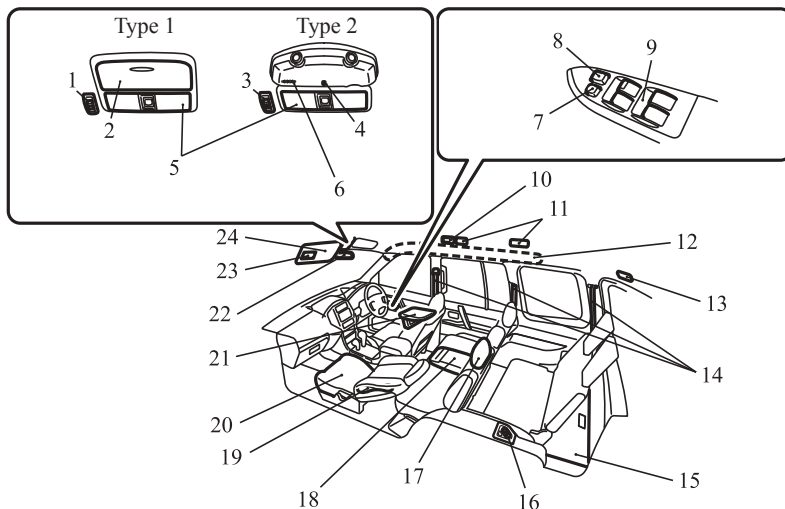

AA5013342

1. Sunroof switch\* p. 3-19
2. Sunglasses holder\* p. 7-84
3. Room & map lamp p. 7-79, 10-25, 10-30  
Interior lamp switch p. 7-78
4. Sunroof switch\* p. 3-19
5. Microphone (for Hands-free & voice recognition)\* p. 7-51
6. Ceiling lamp p. 7-78
7. Electric window lock switch p. 3-17
8. Central door lock switch p. 3-07
9. Electric window control p. 3-16
10. Rear personal lamps p. 7-79, 10-25, 10-30
11. Roof ventilators (5-door models)\* p. 7-02
12. Supplemental restraint system - curtain airbag\* p. 4-36
13. Luggage compartment lamp p. 7-80, 10-25, 10-31
14. Seat belts p. 4-21  
Adjustable seat belt anchor (front seats) p. 4-23
15. Luggage floor box p. 7-84
16. Cup holder (for third seat)\* p. 7-86
17. Head restraints p. 4-12
18. Armrest (for rear/second seat) p. 4-10  
Cup holder (for rear/second seat) p. 7-85
19. Supplemental restraint system - side airbag (for front seats)\* p. 4-36
20. Seat p. 4-02
21. Video Entertainment System\*  
Refer to the separate "Video Entertainment System owner's manual"
22. Inside rear-view mirror p. 6-07
23. Vanity mirror p. 7-74
24. Sun visors p. 7-74

# 1 Luggage area

E00100401351

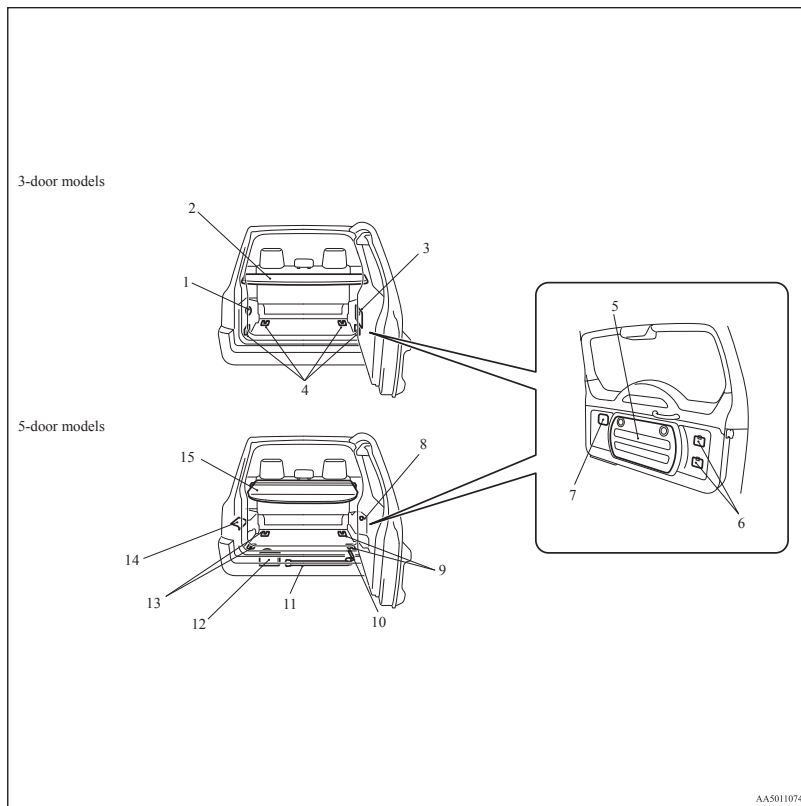

1. Accessory socket p. 7-77
2. Rear shelf\* p. 7-86
3. Jack p. 8-07  
Jack handle p. 8-07  
Tool p. 8-07
4. Luggage hooks p. 7-88
5. Securing bands of warning triangle p. 7-88
6. Securing bolts of spare wheel garnish p. 8-10
7. Rear window washer fluid container p. 10-08
8. Accessory socket p. 7-77
9. Luggage hooks p. 7-88
10. Tool p. 8-07
11. Jack handle p. 8-07
12. Jack p. 8-07
13. Luggage hooks p. 7-88
14. Side box\* p. 7-84
15. Cargo area cover\* p. 7-86

## Outside (Front)

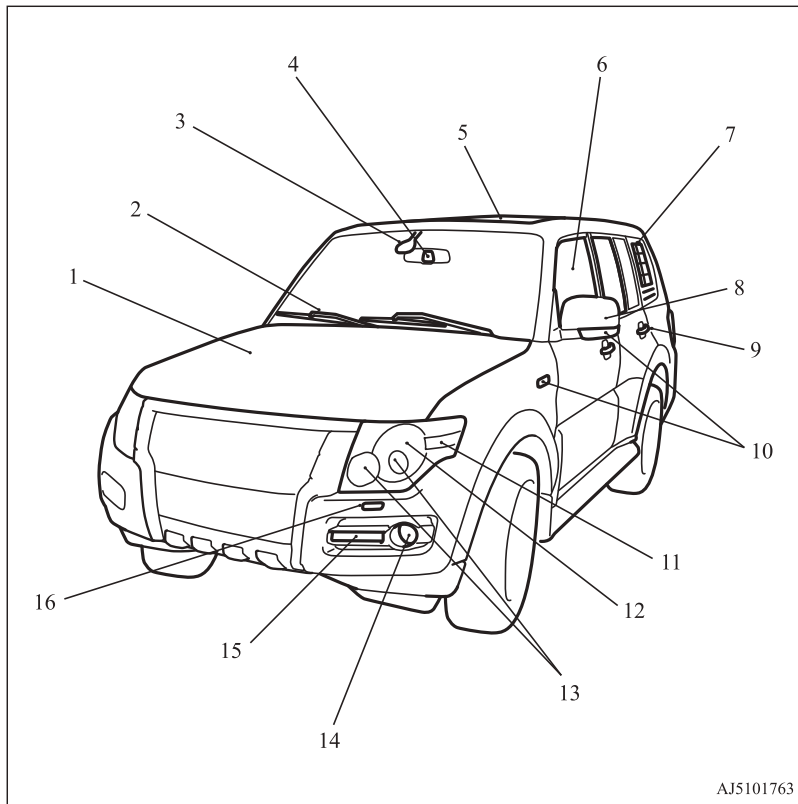

1. Engine compartment p. 11-14  
Bonnet p. 10-03
2. Windscreen wiper and washer p. 5-44
3. Rain sensor\* p. 5-45
4. Camera (for Automatic high-beam system)\* p. 5-36
5. Sunroof\* p. 3-19
6. Electric window control p. 3-16
7. Rear side/quarter window p. 3-18  
Antenna p. 7-50
8. Outside rear-view mirrors p. 6-08  
Approach lamps\* p. 3-08
9. Locking and unlocking p. 3-06  
Keyless entry system\* p. 3-04
10. Side turn-signal lamps\* p. 5-42, 10-23
11. Front turn-signal lamps p. 5-42, 10-23, 10-26
12. Position lamps\* p. 5-34, 10-23, 10-26
13. Headlamps p. 5-34, 10-23, 10-25
14. Front fog lamps\* p. 5-43, 10-23, 10-27
15. Position and Daytime running lamps\* p. 5-34, 5-35, 10-23
16. Headlamp washer\* p. 5-48

# 1 Outside (Rear)

E00100507224

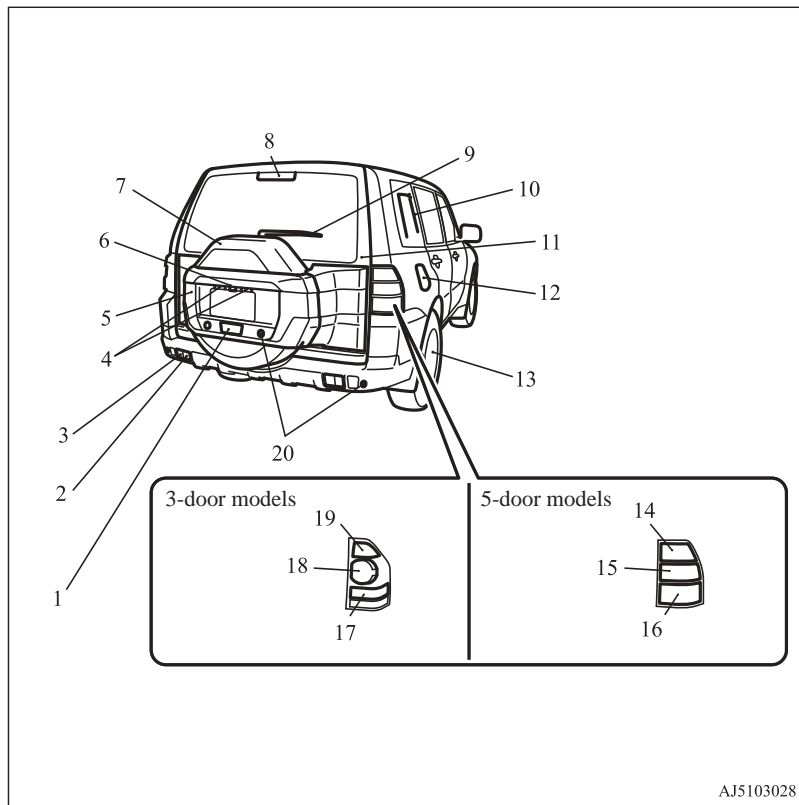

1. Rear fog lamp p. 5-43, 10-23, 10-29
2. Rear turn-signal lamps\* p. 5-42, 10-23, 10-28
3. Tail lamps\* p. 5-34, 10-23, 10-28
4. Licence plate lamps p. 5-34, 10-23, 10-29
5. Spare wheel garnish p. 8-10
6. Rear-view camera\* p. 6-56
7. Spare wheel p. 8-10
8. High-mounted stop lamp p. 10-23, 10-29
9. Rear window wiper and washer p. 5-48
10. Antenna\* p. 7-50
11. Backdoor p. 3-09
12. Fuel tank filler p. 2-03
13. Tyre inflation pressure p. 10-11  
Tyre pressure monitoring system\* p. 6-48  
Changing tyres p. 8-09  
Tyre rotation p. 10-13  
Tyre chains p. 10-14
14. Corner and back sensor\* p. 6-53
15. Rear turn-signal lamps\* p. 5-42, 10-23, 10-28
16. Stop and tail lamps p. 5-34, 10-23, 10-28  
Stop lamps\* p. 10-23, 10-28
17. Reversing lamps p. 10-23, 10-28
18. Rear turn-signal lamps\* p. 5-42, 10-23, 10-28
19. Reversing lamps p. 10-23, 10-28
20. Stop and tail lamps p. 5-34, 10-23, 10-28  
Stop lamps\* p. 10-23, 10-28

## *General information*

Fuel selection.....	2-02
Filling the fuel tank.....	2-03
Installation of accessories.....	2-04
Modification/alterations to the electrical or fuel systems.....	2-05
Genuine parts.....	2-05
Used engine oils safety instructions and disposal information.....	2-06
Disposal information for used batteries.....	2-06

## Fuel selection

E00200104901

Recom-  
mended  
fuel

### Petrol-powered vehicles

Unleaded petrol octane number (EN228)

90 RON or higher

If the “PREMIUM FUEL ONLY” label is attached to the fuel tank filler door, fill it up with premium fuel.

### Diesel-powered vehicles

Cetane number (EN590)

51 or higher

## ⚠ CAUTION

- For petrol-powered vehicles, the use of leaded fuel can result in serious damage to the engine and catalytic converter. Do not use leaded fuel.
- Diesel-powered vehicles are designed to use only diesel fuel that meets the EN 590 standard. Use of any other type of diesel fuel would adversely affect the engine’s performance and durability.

## ⚠ CAUTION

- For diesel-powered vehicles, if proper “winter” fuel is not used in winter, the diesel preheat indication lamp may blink and the engine speed may not rise above the idling speed because of fuel freezing. In this case, keep the engine idling for about ten minutes, then turn off the ignition switch and immediately turn it on again to confirm that the diesel preheat indication lamp is off. (Refer to “Diesel preheat indication lamp” on page 5-09.)

## 📖 NOTE

- It is advisable to sufficiently warm up the engine after starting it when the outside temperature is below zero °C.
- Due to the separation of paraffin, the fluidity of the fuel decreases considerably as the temperature falls. Because of this fact there are two kinds of fuel: “summer” and “winter”. This must be considered in winter use. Select either of the two kinds of fuel in accordance with ambient temperature.
  - Above -5 °C: “Summer” diesel
  - Below -5 °C: “Winter” diesel
 When travelling abroad, find out in advance about the fuels served in local service stations.

## 📖 NOTE

- In petrol-powered vehicles, repeatedly driving short distances at low speeds can cause deposits to form in the fuel system and engine, resulting in poor starting and poor acceleration. If these problems occur, you are advised to add a detergent additive to the gasoline when you refuel the vehicle. The additive will remove the deposits, thereby returning the engine to a normal condition. Be sure to use a MITSUBISHI MOTORS GENUINE FUEL SYSTEM CLEANER. Using an unsuitable additive could make the engine malfunction. For details, please contact your MITSUBISHI MOTORS Authorized Service Point.
- Poor quality petrol can cause problems such as difficult starting, stalling, engine noise and hesitation. If you experience these problems, try another brand and/or grade of petrol. If the check engine warning lamp flashes, have the system checked as soon as possible at a MITSUBISHI MOTORS Authorized Service Point.

**NOTE**

- In diesel-powered vehicles, poor-quality diesel fuel can cause deposits form in the injector, resulting in black smoke and rough idling. If these problems occur, you are advised to add a cleaning additive to the diesel fuel when you refuel the vehicle. The additive will break up and remove the deposits, thereby returning the engine to a normal condition. Be sure to use a MITSUBISHI MOTORS GENUINE DIESEL FUEL SYSTEM CLEANER. Using an unsuitable additive could make the engine malfunction. For details, please contact your MITSUBISHI MOTORS Authorized Service Point.

**E10 type petrol**

E00203200019

The petrol engines are compatible with E10 type petrol (containing 10 % ethanol) conforming to European standards EN 228.

**CAUTION**

- Do not use more than 10 % concentration of ethanol (grain alcohol) by volume. Use of more than 10 % concentration may lead to damage to your vehicle fuel system, engine, engine sensors and exhaust system.

**Filling the fuel tank**

E00200204087

**WARNING**

- When handling fuel, comply with the safety regulations displayed by garages and filling stations.
- Before removing the fuel tank filler tube cap, be sure to get rid of your body's static electricity by touching a metal part of the car or fuel pump. Any static electricity on your body could create a spark that ignites fuel vapour.
- Perform the whole refueling process (opening the fuel tank filler door, removing the fuel tank filler tube cap, etc.) by yourself. Do not let any other person come near the fuel tank filler. If you allowed a person to help you and that person was carrying static electricity, fuel vapour could be ignited.
- Do not move away from the fuel tank filler door until refueling is finished. If you moved away and did something else (for example, cleaning your windscreen) part-way through the refueling process, you could pick up a fresh charge of static electricity.
- If the fuel tank filler tube cap must be replaced, use only a MITSUBISHI MOTORS genuine part.

**Fuel tank capacity**

3-door models: 69 litres

5-door models: 88 litres

**Refueling**

1. Before filling with fuel, stop the engine.
2. The fuel tank filler is located on the rear right side of your vehicle. Open the fuel tank filler door with the release lever located below the instrument panel.

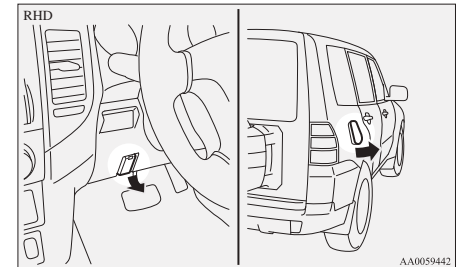
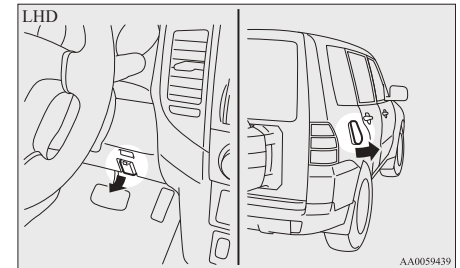

2

3. Open the fuel tank filler tube by slowly turning the cap anticlockwise.

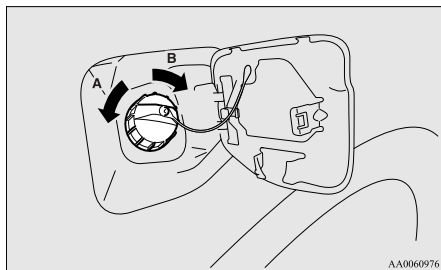

- A- Remove  
B- Close

**CAUTION**

- Since the fuel system may be under pressure, remove the fuel tank filler tube cap slowly. This relieves any pressure or vacuum that might have built up in the fuel tank. If you hear a hissing sound, wait until it stops before removing the cap. Otherwise, fuel may spray out, injuring you or others.

4. Insert the gun in the tank port as far as it goes.

**CAUTION**

- Do not tilt the gun.

5. When the gun stops automatically, do not fill with fuel any more.
6. To close, turn the fuel tank filler tube cap slowly clockwise until you hear clicking sounds, then gently push the fuel tank filler door closed.

**Installation of accessories**

E00200302345

We recommend you to consult your MITSUBISHI MOTORS Authorized Service Point.

**CAUTION**

- Your vehicle is equipped with a diagnosis connector for checking and servicing the electronic control system. Do not connect a device other than a diagnosis tool for inspections and service to this connector. Otherwise, the battery could be discharged, the electronic devices of the vehicle could malfunction, or other unexpected problems could result. In addition, malfunctions caused by connecting a device other than a diagnosis tool may not be covered under warranty.

- The installation of accessories, optional parts, should only be carried out within the limits prescribed by law in your country, and in accordance with the guidelines fitting instructions and warnings contained within the documents accompanying the parts or accessories.
- Improper installation of electrical components may cause an electrical fire if incorrectly fitted. Please refer to the Modification/alteration to the electrical or fuel systems section within this owner's manual.
- When installing the radio, for the required information (frequency, transmission output, installing procedure), consult a MITSUBISHI MOTORS Authorized Service Point. If the frequency, transmission output and installing condition are not appropriate, it can adversely affect the electronic devices and could lead to unsafe vehicle operation.
- Using a cellular phone or radio set inside the vehicle without an external antenna may cause electrical system interference, which could lead to unsafe vehicle operation.
- Tyres and wheels which do not meet specifications must not be used. Refer to the "Specifications" section for information regarding wheel and tyre sizes.



- When fitting accessories, ensure that maximum gross vehicle weight and maximum axle weight are not exceeded.

### Important points!

Due to large number of accessory and replacement parts of different manufactures available in the market, it is not possible, not only for MITSUBISHI MOTORS, but also for a MITSUBISHI MOTORS Authorized Service Point, to check whether the attachment or installation of such parts affects the overall safety of your MITSUBISHI-vehicle.

Even when such parts are officially authorized, for example by a “general operators permit” (an appraisal for the part) or through the execution of the part in an officially approved manner of construction, or when a single operation permit following the attachment or installation of such parts, it cannot be deduced from that alone, that the driving safety of your vehicles has not been affected.

Consider also that there basically exists no liability on the part of the appraiser or the official. Only in the case of parts (MITSUBISHI MOTORS original replacement or exchange parts as well as MITSUBISHI MOTORS genuine accessories) that are recommended and released by a MITSUBISHI MOTORS Authorized Service Point and that are attached or installed by a MITSUBISHI MOTORS Authorized Service Point can you assume, that optimal safety has been provided. The same also pertains to modifications of MITSUBISHI vehicles with respect to the production specifications. For your own safety, in such cases, you should only undertake modifications according to the recommendations of a MITSUBISHI MOTORS Authorized Service Point.

### Modification/alterations to the electrical or fuel systems

E00200400254

MITSUBISHI MOTORS has always manufactured safe, high quality vehicles. In order to maintain this safety and quality, it is important that any accessory that is to be fitted, or any modifications carried out which involve the electrical or fuel systems, should be carried out in accordance with MITSUBISHI MOTORS guidelines.

### CAUTION

- If the wiring interferes with any part of the vehicle bodywork or improper installation methods are used, i.e. protective fuses not installed, etc.), electronic devices may be adversely affected, possibly resulting in an electrical fire or other failures that may cause an accident.

### Genuine parts

E00200500617

MITSUBISHI MOTORS has gone to great lengths to bring you a superbly crafted automobile offering the highest quality and dependability.

Use MITSUBISHI MOTORS genuine parts, designed and manufactured to maintain your MITSUBISHI MOTORS automobile at top performance. MITSUBISHI MOTORS genuine parts are identified by this mark and are available at all MITSUBISHI MOTORS Authorized Service Points.

**MITSUBISHI MOTORS  
GENUINE PARTS**

## Used engine oils safety instructions and disposal information

E0020060025

### WARNING

- Prolonged and repeated contact may cause serious skin disorders, including dermatitis and cancer.
- Avoid contact with the skin as far as possible and wash thoroughly after any contact.
- Keep used engine oils out of reach of children.

## Protect the environment

It is illegal to pollute drains, water courses and soil. Use authorized waste collection facilities, including civic amenity sites and garages providing facilities for disposal of used oil and used oil filters. If in doubt, contact your local authority for advice on disposal.

## Disposal information for used batteries

E00201300016



Your vehicle contains batteries and/or accumulators.

Do not mix with general household waste.

For proper treatment, recovery and recycling of used batteries, please take them to applicable collection points, in accordance with your national legislation and the Directives 2006/66/EC.

By disposing of these batteries correctly, you will help to save valuable resources and prevent any potential negative effects on human health and the environment which could otherwise arise from inappropriate waste handling.

## *Locking and unlocking*

Keys.....	3-02
Electronic immobilizer (Anti-theft starting system).....	3-03
Keyless entry system*.....	3-04
Doors.....	3-06
Central door locks.....	3-07
“Child-protection” rear doors (5-door models).....	3-08
Approach lamps*.....	3-08
Backdoor.....	3-09
Security alarm system*.....	3-11
Electric window control.....	3-16
Rear side/quarter window.....	3-18
Sunroof*.....	3-19

## Keys

E00300103631

The key fits all locks.

3

Type 1

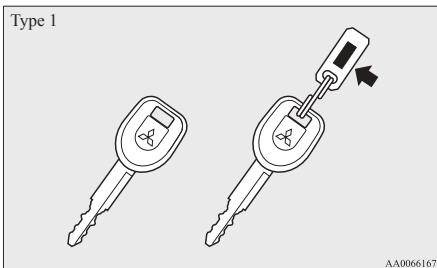

Type 2

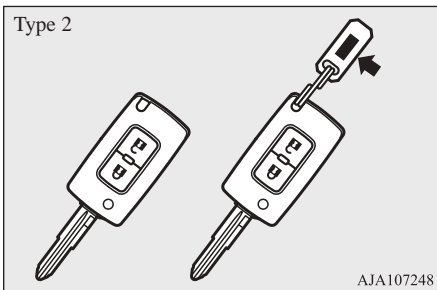
 **WARNING**

- When taking a key on flights, do not press any switches on the key while on the plane. If a switch is pressed on the plane, the key emits electromagnetic waves, which could adversely affect the plane's flight operation. When carrying a key in a bag, be careful that no switches on the key can be easily pressed by mistake.

 **NOTE**

- The key number is stamped on the tag as indicated in the illustration. Make a record of the key number and store the key and key number tag in separate places, so that you can order a key in the event the original keys are lost.
- The key is a precision electronic device with a built-in signal transmitter. Please observe the following in order to prevent damage.
  - Do not leave where it may be exposed to heat caused by direct sunlight, such as on top of the dashboard.
  - Do not take the remote control transmitter apart.
  - Do not excessively bend the key or subject it to strong impacts.
  - Keep the remote control transmitter dry.
  - Keep away from magnetic objects such as key rings.
  - Keep away from devices that produce magnetism, such as audio systems, computers and televisions.

 **NOTE**

- Do not clean with ultrasonic cleaners.
- Do not leave the key where it may be exposed to high temperature or high humidity.
- The engine is designed so that it will not start if the ID code registered in the immobilizer computer and the key's ID code do not match. Refer to the section entitled "Electronic immobilizer" section for details and key usage.

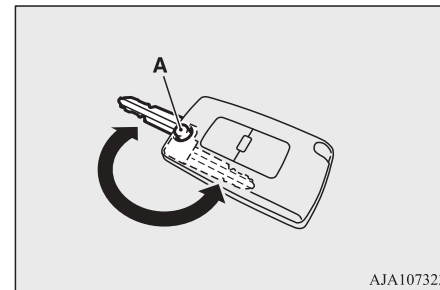
**To use and carry the key (Type 2)**

When using the key, press the button (A) on the body.

When carrying the key, fold the key while pressing the button.

## Electronic immobilizer (Anti-theft starting system)

E00300203472

The electronic immobilizer is designed to significantly reduce the possibility of vehicle theft. The purpose of the system is to immobilize the vehicle if an invalid start is attempted. A valid start attempt can only be achieved by using a key "registered" to the immobilizer system.

### NOTE

- In the following cases, the vehicle may not be able to receive the registered ID code from the registered key and the engine may not start.
  - When the key contacts a key ring or other metallic or magnetic object



### NOTE

- When the key grip contacts metal of another key

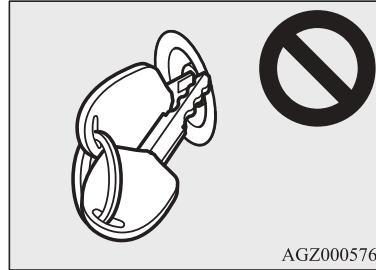

- When the key contacts or is close to other immobilizing keys (including keys of other vehicles)



In cases like these, remove the object or additional key from the vehicle key. Then try again to start the engine. If the engine does

### NOTE

not start, we recommend you to contact your MITSUBISHI MOTORS Authorized Service Point.

- Electronic immobilizer is not compatible with remote starting systems. Use of these systems may result in vehicle starting problems and a loss of security protection.
- If you lose your key, order a key from your MITSUBISHI MOTORS Authorized Service Point as soon as possible. To obtain a replacement or extra spare key, take your vehicle and all remaining keys to your MITSUBISHI MOTORS Authorized Service Point. All the keys have to be re-registered in the immobilizer computer unit. The immobilizer can register up to 8 different keys for use.

### CAUTION

- Don't make any alterations or additions to the immobilizer system; alterations or additions could cause failure of the immobilizer.

## Keyless entry system\*

E00300303789

3 Press the remote control switch, and all doors (including the backdoor) will be locked or unlocked as desired. It is also possible to operate the outside rear-view mirrors.

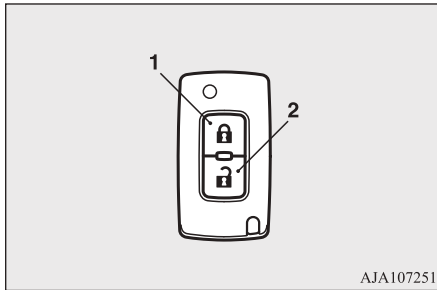

AJA107251

- 1- LOCK switch
- 2- UNLOCK switch

### To lock

Press the LOCK switch (1), and all doors (including the backdoor) will be locked. When they are locked with the room lamp switch at the middle position (DOOR), the room lamp and the turn-signal lamps blink once.

### To unlock

Press the UNLOCK switch (2), and all doors (including the backdoor) will be unlocked. When they are unlocked with the room lamp switch at the middle position (DOOR), the room lamp will be turned on for approximately 15 seconds and the turn-signal lamps will blink twice.

#### NOTE

- If the UNLOCK switch (2) is pressed and no door (including the backdoor) is opened within approximately 30 seconds: relocking will automatically occur.
- It is possible to modify functions as follows: For further information, please contact your MITSUBISHI MOTORS Authorized Service Point.
  - The time for automatic relocking can be changed.
  - The confirmation function (blinking of the turn-signal lamps) can be set to operate only when the doors and backdoor are locked or only when the doors and backdoor are unlocked.
  - The confirmation function (this indicates locking or unlocking of the doors and backdoor with the blink of the turn-signal lamps) can be deactivated.
  - The number of times the turn-signal lamps are flashed by the confirmation function can be changed.

### Operation of the outside rear-view mirrors

#### To fold

Within 30 seconds of locking the doors and backdoor using the LOCK switch (1), press the LOCK switch twice rapidly to fold the outside rear-view mirrors.

#### To extend

Within 30 seconds of unlocking the doors and backdoor using the UNLOCK switch (2), press the UNLOCK switch twice rapidly to return the outside rear-view mirrors to their extended positions.

#### NOTE

- The keyless entry system does not operate in the following conditions:
  - The key is left in the key cylinder.
  - The door (including the backdoor) is open.
- The remote control switch will operate within approximately 4 m from the vehicle. However, the operating range of the remote control switch may change if the vehicle is located near a power station, or radio/TV broadcasting station.

**NOTE**

- If the remote control switch is operated at the correct distance from the vehicle, but the doors (including the backdoor) are not locked/unlocked in response, the battery may be exhausted.

For further information, please consult your MITSUBISHI MOTORS Authorized Service Point.

If you replace the battery yourself, refer to "Procedure for replacing the remote control switch battery" on page 3-05.

- If your remote control switch is lost or damaged, please contact your MITSUBISHI MOTORS Authorized Service Point for a replacement remote control switch.
- If you wish to add a remote control switch, we recommend you to contact your MITSUBISHI MOTORS Authorized Service Point.

A maximum of 4 remote control switches are available for your vehicle.

**Procedure for replacing the remote control switch battery**

E00309501298

**WARNING**

- **Danger of explosion if battery is incorrectly replaced.**  
Replace only with the same battery or an equivalent type.

**CAUTION**

- Never disassemble or remove any inside parts of the keyless entry key other than described below.  
Because there is a possibility that it may become impossible to reassemble.
- When the remote control switch case is opened, be careful to keep water, dust, etc. out.

**NOTE**

- You may purchase a replacement battery at an electric appliance store.
- A MITSUBISHI MOTORS Authorized Service Point can replace the battery for you if you prefer.

1. Before replacing the battery, remove static electricity from your body by touching a metal part such as doorknob of the room.
2. With the MITSUBISHI mark facing you, insert the cloth-covered tip of a straight blade (or minus) screwdriver in-

to the notch in the remote control switch case and use it to open the case.

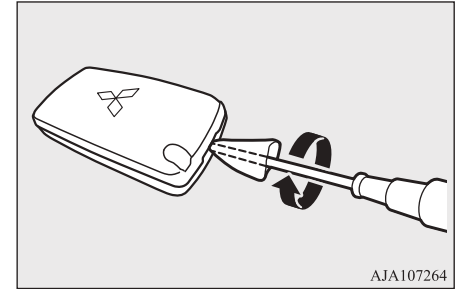

AJA107264

**NOTE**

- Be sure to perform the procedure with the MITSUBISHI mark facing you. If the MITSUBISHI mark is not facing you when you open the remote control switch case, the switches may come out.

3. Remove the remote control transmitter from the remote control switch case.

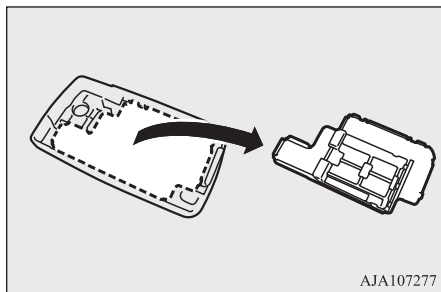

4. Open the remote control transmitter by using a minus screwdriver as shown in the illustration.

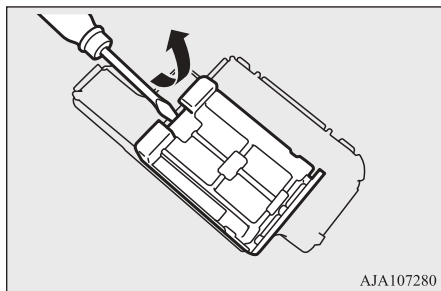

5. Remove the old battery.

6. Install a new battery with the + side (A) down.

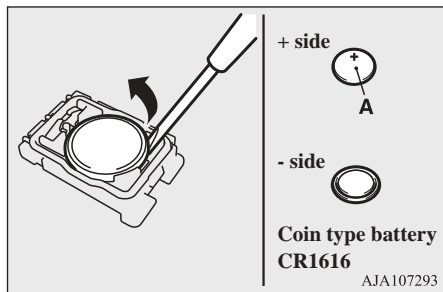

7. Close the remote control transmitter firmly.
8. Place the remote control transmitter in the remote control switch case, then securely close the remote control switch case.
9. Check the keyless entry system to see that it works.

## Doors

E00300401177

### ! CAUTION

- Make sure the doors are closed: driving with doors not completely closed is dangerous.
- Never leave children in the vehicle unattended.

### ! CAUTION

- Be careful not to lock the doors while the key is inside the vehicle.

### To lock or unlock with the key

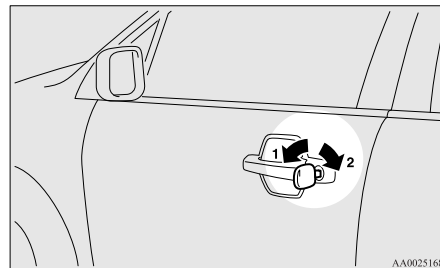

- 1- Lock
- 2- Unlock



## Central door locks

E00300801692

### NOTE

- Each of the doors can be locked or unlocked independently by using the inside lock knob.
- Repeated continuous operation between lock and unlock could activate the central door locking systems built-in protection circuit and prevent the system from operating. If this occurs, wait approximately 1 minute before operating the central door lock switch or the key.

### Driver's door with key (except for vehicles with keyless entry system)

Using the key on the driver's door locks or unlocks all doors (including the backdoor).

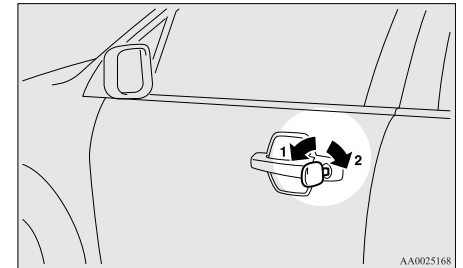

- 1- Lock  
2- Unlock

### To lock or unlock from inside the vehicle

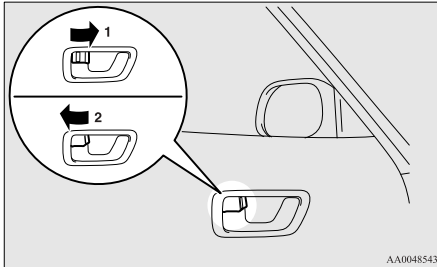

- 1- Lock  
2- Unlock

Pull the inside door handle towards you to open the door.

### To lock without using the key

#### Front door

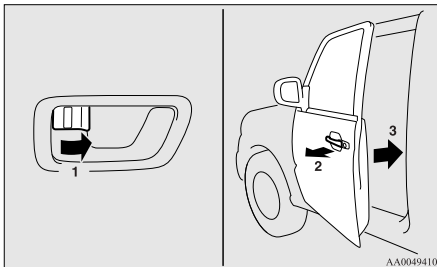

Set the inside lock knob (1) to the locked position, and while pulling the outside handle up (2), close the door (3).

#### Rear door (5-door models)

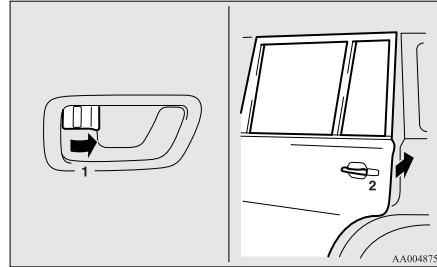

Set the inside lock knob (1) to the locked position, and close the door (2).

### “Forgotten-key-prevention” mechanism

E00300600273

If the key is in the ignition switch when you push the lock knob forward with the driver's door open, the lock knob will automatically return to the unlocked position.

## “Child-protection” rear doors (5-door models)

### Driver’s door with central door lock switch

3

Using the central door lock switch locks or unlocks all doors (including the backdoor).

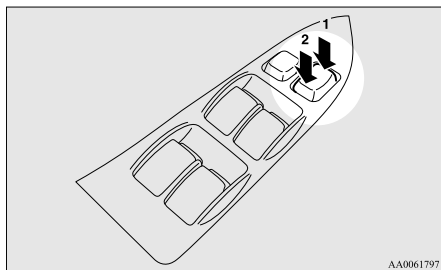

- 1- Lock
- 2- Unlock

### “Child-protection” rear doors (5-door models)

E00300900869

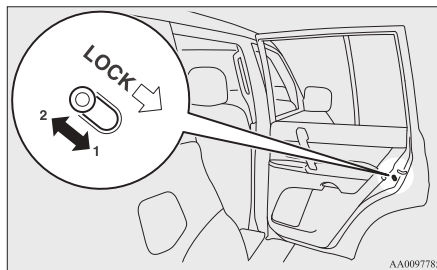

- 1- Lock
- 2- Unlock

Child protection helps prevent the rear doors from being opened accidentally from the inside.

If the lever is set to the locked position, the rear door cannot be opened using the inside handle, but only with the outside handle.

If the lever is set to the “Unlock” position, the child protection mechanism does not function.

### ⚠ CAUTION

- When driving with a child in the rear seat, please use the child protection to prevent accidental door opening which may cause an accident.

### Approach lamps\*

E00306100195

The lamps (A) in the bottom of each mirror come on to illuminate road surface while people are entering or exiting the vehicle.

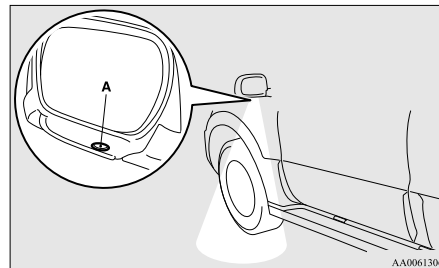

These lamps turn on/off as follows:

- The lamps come on for approximately 15 seconds when all of the doors (including the backdoor) are unlocked using the central door lock function or the keyless entry system (if so equipped).

- When any door or the backdoor is opened, the lamp comes on for approximately 2 minutes.  
If all of the doors (including the backdoor) are closed while the lamps are on, the lamps go off 30 seconds later.

### NOTE

- The lamps go off immediately if any of the following actions is taken while the lamps are on.
  - The ignition switch is turned to the “ON” position.
  - All of the doors (including the backdoor) are locked using the central door lock function.
  - All of the doors (including the backdoor) are locked using the keyless entry system (if so equipped).

## Backdoor

E00301300424

### WARNING

- **It is dangerous to drive with the backdoor open since carbon monoxide (CO) gas can enter the cabin. You cannot see or smell CO. It can cause unconsciousness and even death.**

### CAUTION

- When the backdoor is open, the rear-right combination lamp is obscured by the spare wheel.  
If the backdoor is opened while the vehicle is parked on the road, alert other road users to the vehicle’s presence using a warning triangle or other device as required by local legislation.
- When closing the backdoor, always ensure your or other person’s fingers cannot be caught by the backdoor.

### NOTE

- The backdoor is equipped with an oil damper type backdoor stopper, enabling you to hold the backdoor at a desired position.
- While opening or closing the backdoor, you may feel slight resistance. This is a structural feature of the backdoor stopper that supports the backdoor and does not indicate any abnormality.

## To lock or unlock from outside the vehicle (Except for vehicles with keyless entry system)

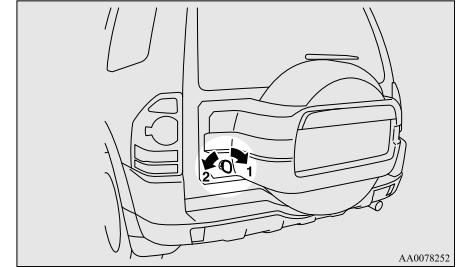

- 1- Lock
- 2- Unlock

## To lock or unlock from inside the vehicle

3

The backdoor can be locked or unlocked by using the central door lock switch.

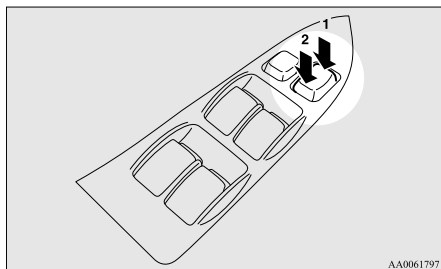

- 1- Lock
- 2- Unlock

Vehicles without keyless entry system, if the backdoor is locked or unlocked by using the central door lock switch, it can still be locked or unlocked with the key.

### NOTE

- Repeated continuous operating between lock and unlock could cause the central door lock's built-in protection circuit to prevent the system from operating. If this occurs, wait approximately 1 minute before operating the central door lock switch.

### NOTE

- When the luggage compartment lamp is set to the [•] position, the luggage compartment lamp illuminates when the backdoor is opened and turns off when it is closed.

## To open

Pull the outside handle towards you to open the backdoor.

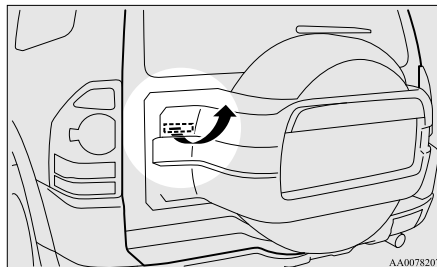

## Backdoor stopper

Open the backdoor fully and then move the locking tube (A) to the LOCK position (B); this will ensure that the backdoor remains in the fully opened position. To subsequently release the stopper, move the locking tube back to the UNLOCK position (C).

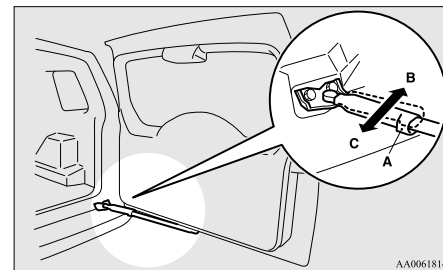

### CAUTION

- When closing the backdoor, be careful not to trap your hands.
- Before closing the backdoor, make sure that the locking tube (A) is in the UNLOCK position (C). Closing the backdoor with the locking tube (A) in the LOCK position (B) may damage the backdoor stopper, rendering the backdoor unable to be closed.

## Security alarm system\*

E00301500657

The security alarm system is designed to prevent unlawful entry into the vehicle. It will alert people nearby if a door, the backdoor, or the bonnet is opened when the vehicle has not been unlocked using the keyless entry system.

Also, the alarm will be activated if any of the following occur.

- Attempt an unlawful moving of the vehicle. (the vehicle inclination detection function)
- Detect a motion in the vehicle. (the interior intrusion detection function)
- Disconnect the battery terminal.

The security alarm system is set to “active” when the vehicle leaves the factory.

When making changes to the settings, please follow the procedure listed in the section titled “Changing the system settings” on page 3-12.

### CAUTION

- Do not modify or add parts to the security alarm system.  
Doing so could cause the security alarm to malfunction.

### NOTE

- The alarm system will not be activated if the doors (including the backdoor) have been locked using a key or the central door lock switch (instead of the keyless entry system).
- If the turn-signal lamps do not blink after the locking and unlocking operation using the keyless entry system, the security alarm system may be malfunctioning.  
Have the vehicle inspected at a MITSUBISHI MOTORS Authorized Service Point.
- In the following situations, the security alarm system could be more likely to be accidentally activated.
  - Using a car wash
  - Taking the vehicle on a ferry
  - Parking in an automated car park
  - Leaving someone or a pet in the vehicle
  - Leaving a window, door, or the sunroof open
  - Leaving an unstable object such as a stuffed toy or accessory in the vehicle
  - Suffering a continuous impact or vibration by hail, thunder, etc.
- The sensitivity of the vehicle inclination detection function and the interior intrusion detection function can be adjusted. For details, please contact a MITSUBISHI MOTORS Authorized Service Point.

## The security alarm has four modes:

### System preparation mode (approx. 20 seconds)

(The buzzer sounds intermittently, and the security alarm indicator (A) blinks)

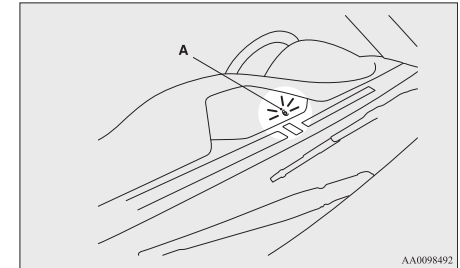

The system preparation time extends from the point at which all of the doors (including the backdoor) are locked by the keyless entry switch to the point at which the system activation mode goes into effect.

During this time, it is possible to temporarily open a door without using the keyless entry system and without causing the alarm to sound (for example, when you forget something inside the vehicle or realize that a window is open).

## System armed mode

(The buzzer stops, and the security alarm indicator continues to blink slowly)

3

Once the system preparation mode has ended, the system armed mode starts. If an unlawful opening of any of the doors (including the backdoor) or the bonnet is detected during the system armed mode, the alarm will be activated to warn people around the vehicle of an abnormal condition.

Also, if unlawful moving of the vehicle is attempted or a vehicle intrusion is detected, the alarm will be activated.

## Alarm activation

The turn-signal lamps blink and the siren sounds for approximately 30 seconds. Refer to “Alarm activation” on page 3-15.

### NOTE

- The alarm will resume if unlawful actions are taken again, even if the alarm has stopped.

## System cancellation

It is possible to cancel the system activation during the system preparation mode or the system armed mode.

In addition, it is possible to cancel the alarm once it has been activated.

Refer to “Cancelling the system” on page 3-15, “Cancelling the alarm” on page 3-16.

### NOTE

- When lending the vehicle to another person or allowing the vehicle to be driven by someone who is unfamiliar with the security alarm system, be sure to give the person a proper explanation of the security alarm system or set the security alarm system to the “inactive” mode.

If a person who is unfamiliar with the security alarm system accidentally unlocked the vehicle, causing the alarm to sound, the alarm would be a nuisance to people nearby.

## Changing the security alarm settings

E00301601378

It is possible to set the security alarm to the “active” mode or “inactive” mode.

Follow the procedure below.

1. Remove the key from the ignition switch.
2. Place the lamp switch in the “OFF” position, and leave the driver’s door open.

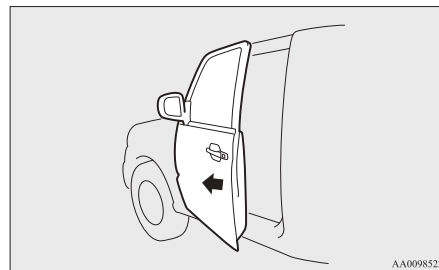
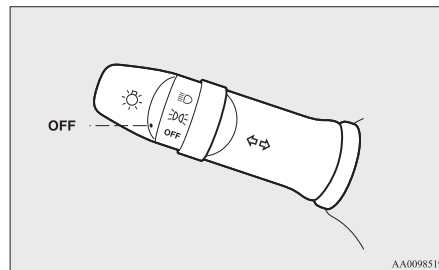

3. Pull the windscreen wiper and washer switch towards you and hold it there.

(Since the ignition switch is in the “LOCK” position, washer fluid will not be sprayed.)

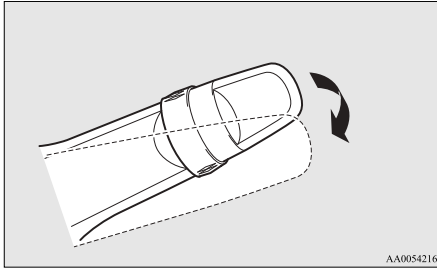

4. After approximately 10 seconds, the buzzer will make a sound. Keep the windshield wiper and washer switch pulled towards you. (If the windshield wiper and washer switch was released, the setting change mode would be cancelled. To start over, perform the procedure again from step 3.)
5. When the buzzer stops, with the windshield wiper and washer switch still pulled towards you, press the UNLOCK switch (A) on the keyless entry switch to select the security alarm settings mode.

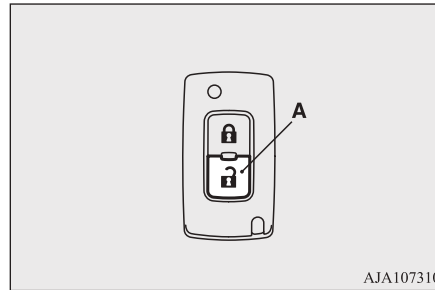

The settings mode can be toggled by pressing the UNLOCK switch. The mode can be confirmed from the number of times the buzzer sounds.

Number of times the buzzer sounds	Security alarm settings mode
1	Alarm inactive
3	Alarm active

6. Any of the following operations can be used to terminate the system settings change mode.
  - Releasing the windshield wiper and washer switch.
  - Closing the driver's door.
  - Inserting the key into the ignition switch.

- Placing the lamp switch in any position other than “OFF”.
- Allowing 30 seconds to pass without making any changes to the settings.

### NOTE

- If anything with regard to making changes to the security alarm system settings is hard to understand, please consult a MITSUBISHI MOTORS Authorized Service Point.
- Avoid leaving valuable items inside the vehicle even when the security alarm system has been set to the “active” mode.

## Setting the system

E00301702028

Once the security alarm system has been set to the “active” mode, follow the procedure below to set the system to the system armed mode.

1. Remove the key from the ignition switch.
2. Exit the vehicle and close all of the doors (including the backdoor) and the bonnet.
3. Press the LOCK switch (A) on the keyless entry switch in order to lock all the doors (including the backdoor).

3

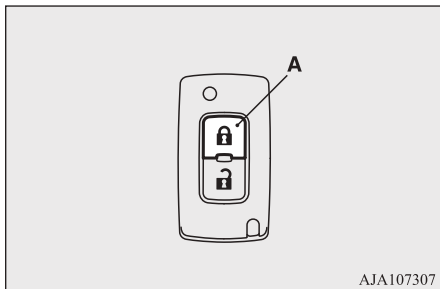

By locking the vehicle using the keyless entry system, the system preparation mode is activated. The buzzer sounds intermittently for confirmation, and the security alarm indicator (B) on the instrument panel blinks.

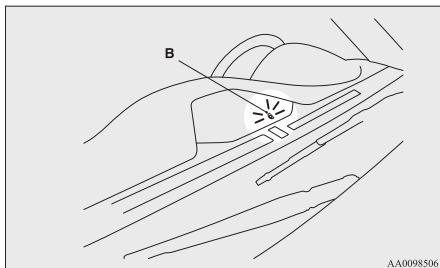

**NOTE**

- The system preparation mode is not activated when all of the doors (including the backdoor) have been locked using a method other than the keyless entry system (namely a key or the central door lock switch).
- If the bonnet is open, the security alarm indicator illuminates, and the system does not enter the system armed mode. When the bonnet is closed, the system enters the system preparation mode, and after approximately 20 seconds the system enters the system armed mode.

4. The buzzer stops after approximately 20 seconds, and when the blinking of the security alarm indicator starts to slow down, the system armed mode goes into effect. The security alarm indicator continues to blink during the system armed mode.

**NOTE**

- The security alarm system can be activated when people are riding inside the vehicle or when the windows are open. To prevent accidental activation of the alarm, do not set the system to the system armed mode while people are riding in the vehicle.

**NOTE**

- With the system in the system armed mode, if any method other than the keyless entry system is used (namely a key or the central door lock switch) to unlock the vehicle and open any of the doors (including the backdoor), the room lamp does not illuminate.

**To deactivate the vehicle inclination detection function and the interior intrusion detection function**

E00312100204

The vehicle inclination detection function and the interior intrusion detection function can be deactivated when parking in automated car parks, when leaving pets in the vehicle or when leaving the vehicle with the windows slightly open.

1. Remove the key from the ignition switch.
2. Raise and hold the wiper and washer switch to the “MIST” position for approximately 3 seconds. The buzzer will sound once and the function will be deactivated.

To activate the function again, raise and hold the wiper and washer switch to the “MIST” position for approximately 3 seconds.



The buzzer will sound twice and the function will be activated.

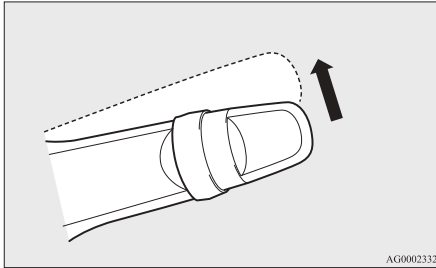

### NOTE

- The function will be activated again using one of the following methods.
  - Unlock the doors (including the backdoor) using the keyless entry system.
  - Turn the ignition switch to the “ON” or “ACC” position.

## Cancelling the system

E00301800399

The following methods can be used to cancel the system when it is in the system preparation mode or the system armed mode.

- Pressing the UNLOCK switch on the keyless entry switch.
- Turning the ignition switch to the “ON” or “ACC” position.

- Opening any of the doors (including the backdoor) when the system is in the system preparation mode, or inserting the key into the ignition switch.

### NOTE

- If the bonnet is opened during the system preparation mode, the system preparation mode is suspended. The system returns to the system preparation mode when the bonnet is closed.
- If the battery terminals are disconnected while the system is in the system preparation mode, the memory will be erased.
- It is possible to register up to 4 remote control switches. As long as they are registered, any of the 4 remote control switches, other than the one used to activate the system, can be used to cancel the system. If you want to register additional remote control switches, please contact a MITSUBISHI MOTORS Authorized Service Point.

### NOTE

- The activation distance for the keyless entry system is approximately 4 m. If it is not possible to lock or unlock the vehicle by pressing the switch at the correct distance or the security alarm system cannot be set or cancelled using the switch, the battery may need to be replaced. For further information, please consult a MITSUBISHI MOTORS Authorized Service Point. If you replace the battery yourself, refer to “Procedure for replacing the remote control switch battery” on page 3-05.
- If the UNLOCK switch is pressed and no door is (including the backdoor) opened within 30 seconds, the doors will automatically relock. In this case as well, the system preparation mode will go into effect. The time between pressing the UNLOCK switch and automatic locking can be adjusted. Consult a MITSUBISHI MOTORS Authorized Service Point.

## Alarm activation

E00301900840

When the system is in the system armed mode, the alarm will be activated as follows if the vehicle is unlocked and any of the doors (including the backdoor) or bonnet is opened using a method other than pressing the UNLOCK switch on the keyless entry switch.

## Electric window control

1. The alarm will be activated for approximately 30 seconds. The turn-signal lamps will flash, and the siren will sound intermittently.

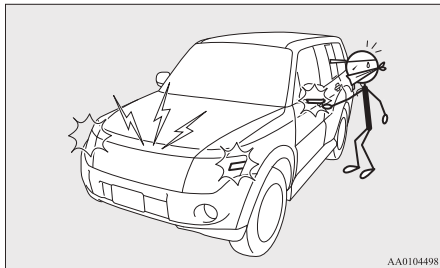

2. The alarm will resume if unlawful actions are taken again, even if the alarm has stopped.

### NOTE

- The interior lamp will not come on while the alarm is sounding.

## Cancelling the alarm

E00302000356

It is possible to halt the activation of an alarm using the following methods:

- Pressing the LOCK or UNLOCK switch on the keyless entry switch.  
(After pressing the LOCK switch, the vehicle will lock if all the doors (including the backdoor) are closed, after which the system preparation mode will once again go into effect.)
- Turning the ignition switch to the “ON” or “ACC” position.

### NOTE

- When the ignition switch is turned to the “ON” position, the buzzer sounds 4 times. This operation indicates that the alarm was activated while the vehicle was parked. Please check the inside of the vehicle to confirm that nothing was stolen.
- Even if the battery is disconnected, the alarm activation memory will not be erased.

## Electric window control

E00302200185

The electric windows can only be operated with the ignition switch in the “ON” position.

## Electric window control switch

E00302301226

Each door window opens or closes while the corresponding switch is operated.

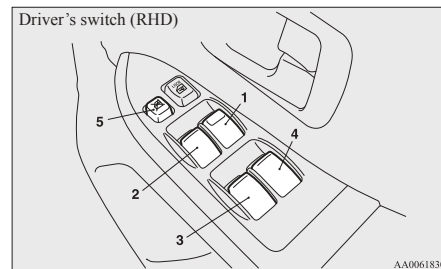
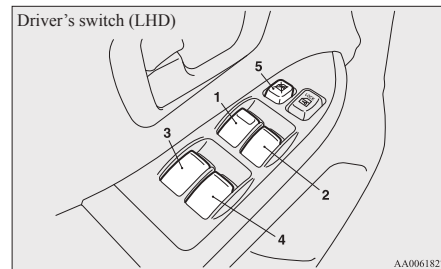

- 1- Driver's door window
- 2- Front passenger's door window
- 3- Rear left door window (5-door models)
- 4- Rear right door window (5-door models)
- 5- Lock switch

**⚠ WARNING**

- Before operating the electric window control, make sure that nothing can get trapped (head, hand, finger, etc.).
- Never leave the vehicle without removing the key.
- Never leave a child (or other person who might not be capable of safe operation of the electric window control) in the vehicle alone.
- The child may tamper with the switch at the risk of its hands or head being trapped in the window.

**📖 NOTE**

- Repeated operation with the engine stopped will run down the battery. Operate the window switches only while the engine is running.

**Driver's switches**

The driver's switches can be used to operate all door windows.

A window can be opened or closed by operating the corresponding switch.

Press the switch down to open the window, and pull up the switch to close it.

If the switch for the driver's window is fully pressed down/pulled up, the door window automatically opens/closes completely.

If you want to stop the window movement, operate the switch lightly.

**Passenger's switches**

The passenger's switches can be used to operate the corresponding passenger's door windows.

Press the switch down for opening the window, and pull up the switch for closing it.

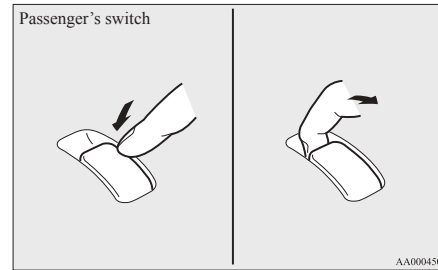
**📖 NOTE**

- The rear door windows only open halfway.

**Lock switch**

E00303100501

When this switch is operated, the passenger's switches cannot be used to open or close the door windows.

To unlock, press it once again.

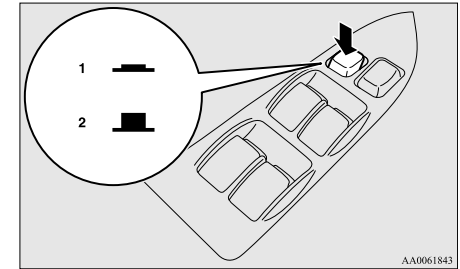

- 1- Lock
- 2- Unlock

**📖 NOTE**

- The driver's switch can always open or close any door windows.

**⚠ WARNING**

- A child may tamper with the switch at the risk of its hands or head being trapped in the window. When driving with a child in the vehicle, please press the window lock switch to disable the passenger's switches.

**NOTE**

- It is possible to prevent the driver's door switches from being used to open and close the front passenger's door window and rear door windows (5-door models) while the lock switch is pressed in the "LOCK" position.

For details, we recommend you to consult a MITSUBISHI MOTORS Authorized Service Point.

**Timer function**

E00302400712

The door windows can be opened or closed for 30 seconds after the ignition switch is turned from the "ON" position to the "ACC" or "LOCK" position. If the driver's door is opened during this period, the door window can be opened or closed for another 30 seconds.

However, once the driver's door is closed, the windows cannot be operated.

**Safety mechanism**

E00302500218

If a hand or head is trapped in the closing window, it will lower automatically.

Nonetheless, make sure that nobody puts their head or hand out of the window when closing a window.

The lowered window will become operational after a few seconds.

**WARNING**

- **If the safety mechanism is activated three or more times successively, the safety mechanism will be temporarily cancelled. If a hand or head got trapped, a serious injury could result.**

**CAUTION**

- The safety mechanism is cancelled just before the window is fully closed. This allows the window to close completely. Therefore be especially careful that no fingers are trapped in the window.

**NOTE**

- The safety mechanism can be activated if the driving conditions or other circumstances cause the door windows to be subjected to a physical shock similar to that caused by a trapped hand or head.

**NOTE**

- If the safety mechanism is activated three or more times in a row, the safety mechanism will be cancelled and the door window will not close correctly.

In such a case, the following procedure should be implemented to rectify this situation. If the window is open, repeatedly raise the appropriate window switch until that window has been fully closed. Following this, release the switch, raise the switch once again and hold it in this condition for at least 1 second, then release it. You should now be able to operate all windows in the normal fashion.

**Rear side/quarter window**

E00302600091

**To open**

1. Pull the lever towards you.

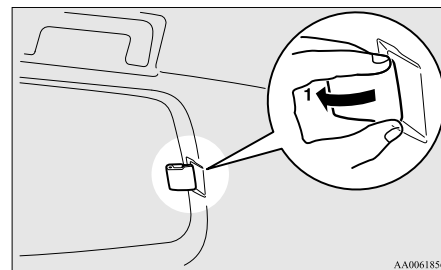

AA0061856

2. Push the lever towards the outside of the vehicle.
3. Push the lever towards the rear of the vehicle to secure it in place.

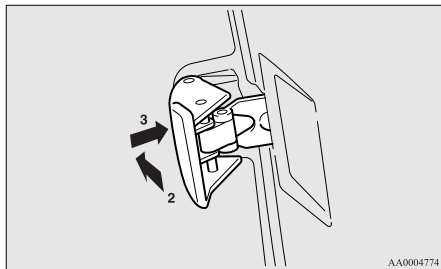

## To close

Pull the lever, returning it to its original position and securing it in place.

## Sunroof\*

E00302701015

The sunroof can only be operated with the ignition switch in the “ON” position.

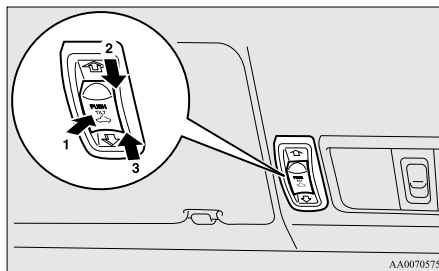

- 1- Tilt up
- 2- Close, Tilt down
- 3- Open

To open, press the switch (3).  
To stop the moving sunroof, press the switch (1) or (2).

## NOTE

- The sunroof automatically stops just before reaching the fully open position. Press the switch again to fully open it.

To close, press the switch (2).  
To stop the moving sunroof, press the switch (1) or (3).

To tilt up, press the switch (1).  
The rear sunroof raises for ventilation.

## NOTE

- When the sunroof is tilted up, the sunshade is automatically opened slightly.

To tilt down, press the switch (2).

## WARNING

- Do not put head, hands or anything else out of the sunroof opening while driving the vehicle.
- Never leave a child (or other person who might not be capable of safe operation of the sunroof switch) in the vehicle alone.
- Before operating the sunroof, make sure that nothing is capable of being trapped (head, hand, finger, etc.).

## Lock switch

E00308900025

When this switch is operated, the sunroof switch cannot be used to open or close the sunroof.

To unlock, press it once again.

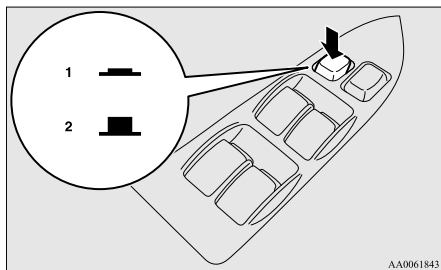

- 1- Lock  
2- Unlock

### NOTE

- If the sunroof switch is operated with the lock switch pressed, a buzzer sounds to indicate the sunroof cannot be opened or closed.
- With the lock switch pressed, operation of the electric window control with switches other than the driver's door switches is also prevented.

### Safety mechanism

E0030380090

If a hand or head is trapped in the closing sunroof, it will reopen automatically.

Nonetheless, make sure that nobody puts their head or hand out of the sunroof when opening or closing.

The opened sunroof will become operational after a few seconds.

3-20 Locking and unlocking

If the safety mechanism should be activated 5 or more times consecutively, normal closing of the sunroof will be aborted. In such an event, the following steps should be taken:

1. Press the switch (2) repeatedly, setting the sunroof in the tilt up condition.
2. Once the tilt up condition has been reached, press and hold the switch (2) for a period of at least 3 seconds.
3. Press the switch (2) once again to fully close the sunroof.
4. After pressing the switch (3) to perform full opening, press the switch (2) to fully close the sunroof.

### NOTE

- The safety mechanism can be activated if the driving conditions or other circumstances cause the sunroof to be subjected to a physical shock similar to that caused by a trapped hand or head.
- Avoid stopping the sunroof before it reaches the opening or closing end during operations in steps 3 and 4 above. If this should accidentally happen, repeat the process from step 1.

5. Following this action, it should be possible to operate the sunroof in the normal manner.

### CAUTION

- The safety mechanism is cancelled just before the sunroof is fully closed. This allows the sunroof to close completely. Therefore be especially careful that no fingers are trapped in the sunroof.

### NOTE

- The sunroof stops just before reaching the fully open position. If the vehicle is driven with the sunroof in this position, wind throb is lower than with the sunroof fully open.
- When leaving the vehicle unattended, make sure you close the sunroof and remove the ignition key.
- Do not try to operate the sunroof if it is frozen closed (after snow fall or during extreme cold).
- Do not sit or place heavy luggage on the sunroof or roof opening edge.
- Release the switch as soon as the sunroof reaches the fully open or fully closed position.
- If the sunroof does not operate when the sunroof switch is operated, release the switch and check whether something is trapped by the sunroof. If nothing is trapped, we recommend you to have the sunroof checked.

**NOTE**

- Depending on the model of ski carriers or roof carriers, the sunroof may make contact with the carrier when the sunroof is tilted up. Be careful when tilting up the sunroof if such a ski carrier or a roof carrier is installed.
- Be sure to close the sunroof completely when washing the vehicle or when leaving the vehicle.
- Be careful, not to put any wax on the weatherstrip (black rubber) around the sunroof opening. If stained with wax, the weatherstrip cannot maintain a weatherproof seal with the sunroof.
- After washing the vehicle or after it has rained, wipe off any water that is on the sunroof before operating it.
- Operating the sunroof repeatedly with the engine stationary will run down the battery. Operate the sunroof while the engine is running.

**Sunshade**

E00307900103

Slide the sunshade manually to open and close it.

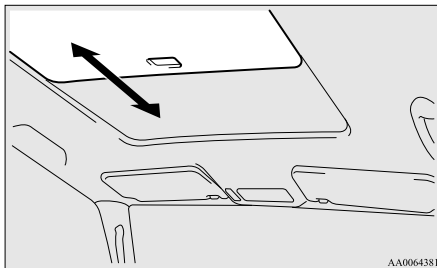

AA0064381

**CAUTION**

- Be careful that hands are not trapped when closing the sunshade.

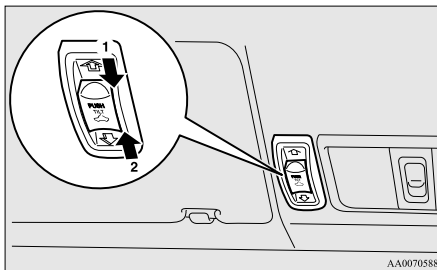

AA0070588

**To open**

When switch (2) is pressed, the sunshade and the sunroof open together.

**To close**

When switch (1) is pressed, the sunshade and the sunroof close together.

If the sunroof is stopped midway, the sunshade will no longer be able to close together with the sunroof. In such a situation, press switch (2) to fully open the sunroof and then press switch (1).

**NOTE**

- When the sunroof is tilted up, the sunshade is automatically opened slightly.
- Be sure to tilt down the sunroof before closing the sunshade.
- The sunshade cannot be closed with the sunroof opened.  
Do not attempt to close the sunshade when the sunroof is opened.

A series of 15 horizontal dashed lines spanning the width of the page, intended for writing or drawing.



## *Seat and seat belts*

Seats.....	4-02
Seat arrangement.....	4-03
Seat adjustment.....	4-05
Front seats.....	4-05
Rear seats (3-door models)*/Second seats (5-door models)*.....	4-09
Third seat (5-door models)*.....	4-11
Head restraints.....	4-12
Making a luggage area.....	4-13
Making a flat seat (Except for 3-door models equipped with the power seat).....	4-20
Seat belts.....	4-21
Pregnant women restraint.....	4-25
Seat belt pretensioner system and force limiter system.....	4-25
Child restraint.....	4-26
Seat belt inspection.....	4-36
Supplemental restraint system (SRS) - airbag.....	4-36

4

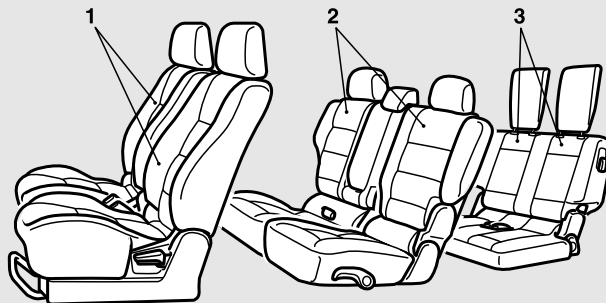

AA1003976

## 1- Front seats

- To adjust forward or backward → p. 4-05
- To recline the seatback → p. 4-06
- To adjust seat cushion height → p. 4-07
- Lumbar support adjustment (Power type, driver's seat) → p. 4-08
- Armrest → p. 4-08
- To get in and out of the rear seat (3-door models, passenger's seat) → p. 4-08
- Heated seats\* → p. 4-09

## 2- Rear seats (3-door models)\*/Second seats (5-door models)\*

- To recline the seatback → p. 4-10
- Armrest → p. 4-10
- To get in and out of the third seat (5-door models) → p. 4-11



## 3-Third seat (5-door models)\*



- To recline the seatback → p. 4-11

## Seat arrangement

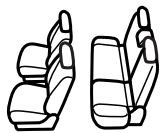
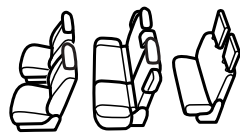
E00400200687

By operating the front, rear/second or third seat select the desired seat arrangement.

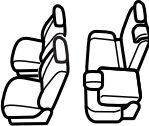
	3-door models	5-door models
Normal usage		
Flat seat (Except for 3-door models equipped with the power seat) → p. 4-20		

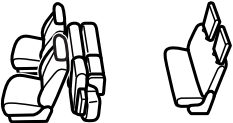
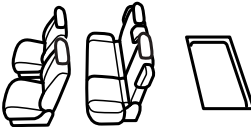
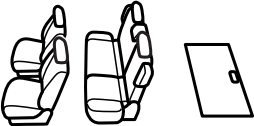
		3-door models	5-door models
How to stow large articles	Folding the rear seatbacks forward (3-door models) / Folding the second seatbacks forward (5-door models) → p. 4-13		
	Folding the rear seats (3-door models) / Folding the second seats (5-door models) → p. 4-14		
	Storage of the third seat → p. 4-15	—	
	Removing the third seat → p. 4-17	—	

## Seat adjustment

E00400301988

Adjust the driver's seat so that you are comfortable and that you can reach the pedals, steering wheel, switches etc. while retaining a clear field of vision.

### ⚠ WARNING

- Do not attempt to adjust the seat while driving. This can cause loss of vehicle control and result in an accident. After adjustments are made, ensure the seating is locked in position by attempting to move the seat forward and rearward without using the adjusting mechanism.
- Do not allow people or children to ride in any area of your vehicle that is not equipped with seats and seat belts, and make sure that everyone travelling in your vehicle is in a seat and wearing a seat belt, or in the case of a child is strapped in a child restraint.
- To minimize the risk of personal injury in the event of a collision or sudden braking, the seatbacks should always be in the almost upright position while the vehicle is in motion. The protection provided by the seat belts may be reduced significantly when the seatback is reclined. There is greater risk that the passenger will slide under the seat belt, resulting in serious injury, when the seatback is reclined.

### ⚠ WARNING

- Do not place objects under the seats. This could prevent the seat from locking securely, and it could lead to an accident. It may also cause damage to the seat or other parts.

### ⚠ CAUTION

- Make sure the seat is adjusted by an adult or with adult supervision for correct and safe operation.
- Do not place a cushion or the like between your back and the seatback while driving. The effectiveness of the head restraints will be reduced in the event of an accident.
- When sliding the seats, be careful not to catch your hand or foot.

## Front seats

E00400400100

### To adjust forward or backward

E00400500055

#### Manual type

Pull the seat adjusting lever and adjust the seat forward or backward to the desired position, and release the adjusting lever.

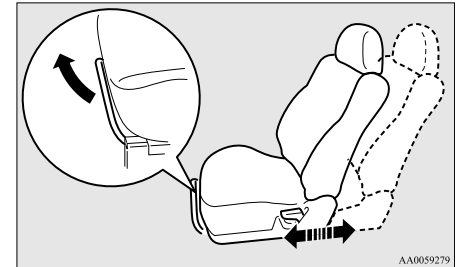

### ⚠ WARNING

- To ensure the seat is locked securely, try to move the seat forward or backward without using the adjusting lever.

## Power type

Adjust the seat by operating the switch as indicated by the arrows.

4

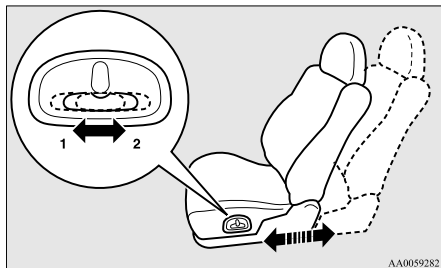

- 1- Adjustment forward
- 2- Adjustment backward

### NOTE

- To prevent the battery from running down, operate the power seat with the engine running.

## To recline the seatback

E00400600056

### Manual type

In order to recline the seatback, lean forward slightly, pull the seatback lock lever up, and then lean backward to the desired position and release the lever. The seatback will lock in that position.

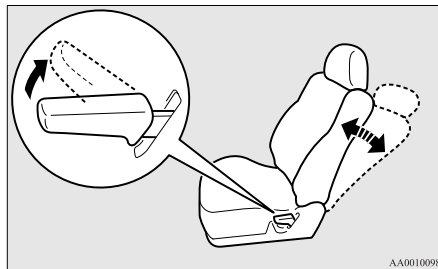

### CAUTION

- The reclining mechanism of the seatback is spring loaded, causing it to return to the vertical position when the lock lever is operated. When using the lever, sit close to the seatback or hold it with your hand to control its return motion.

## Power type

Adjust the seatback angle by operating the switch as indicated by the arrows.

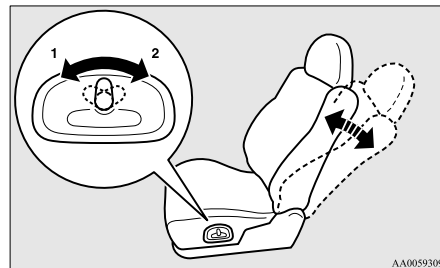

- 1- To move to forward direction
- 2- To recline rearward

### NOTE

- To prevent the battery from running down, operate the power type seat with the engine running.

## To adjust seat cushion height

E00400700451

### Manual type

To adjust the seat cushion height, turn the dial as shown in the illustration.

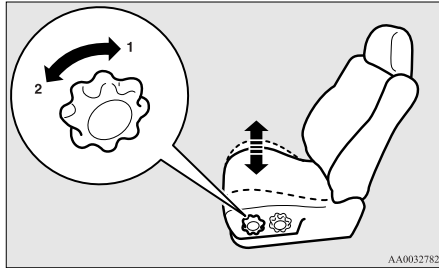

- 1- To move the front of the seat cushion up
- 2- To move the front of the seat cushion down

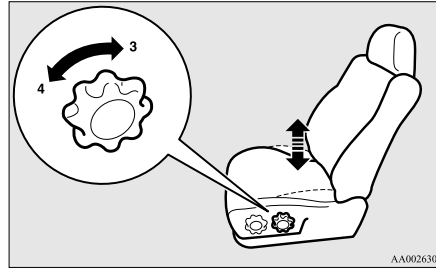

- 3- To move the rear of the seat cushion up
- 4- To move the rear of the seat cushion down

### Power type

To adjust the seat cushion height, operate the switch as indicated by arrows.

#### NOTE

- To prevent the battery from running down, operate the power seat with the engine running.

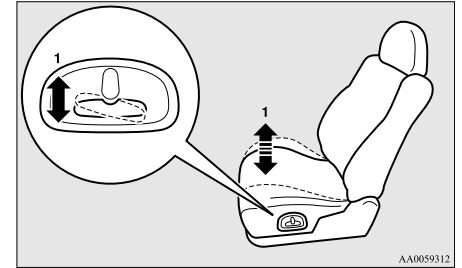

- 1- To move the front of the seat cushion up and down

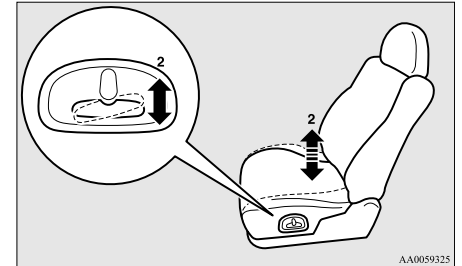

- 2- To move the rear of the seat cushion up and down

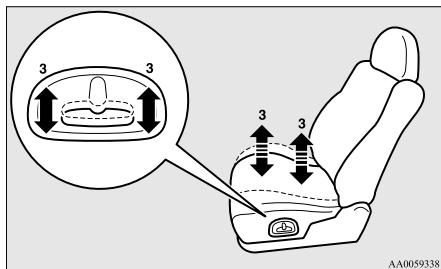

3- To move the whole seat cushion up and down

### Lumbar support adjustment (Power type, driver's seat)

E0040080032

A lumbar support adjustment is located in the seatback of the driver's seat. To adjust the lumbar support, operate the switch as indicated by arrows.

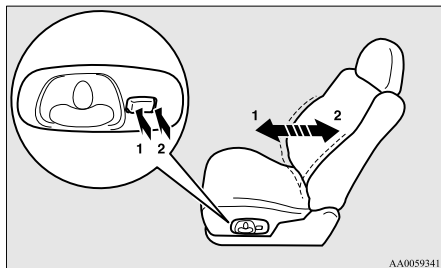

- 1- Strong
- 2- Weak

**NOTE**

- To prevent the battery from running down, operate the power seat with the engine running.

### Armrest

E00400900118

Slide forward the centre console lid while pressing the right upper lever (A).

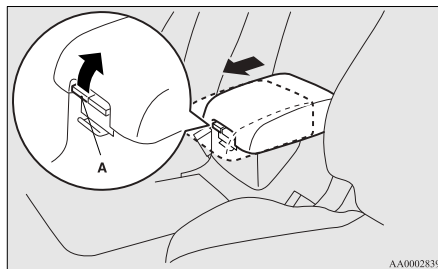

### To get in and out of the rear seat (3-door models, passenger's seat)

E00401000044

The lever can be used to make getting in and out easier.

Pull up the lever (A) or depress the pedal (B), tilt the seatback forward. Then slide the entire seat forward. To return the seat, raise the seatback, then slide the entire seat backward until there is a "click" in a locked position. Adjust the seat position.

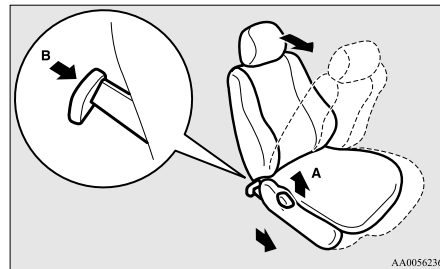

**WARNING**

- Do not drive the vehicle with the seatback folded forward. The seat is not retained with the seatback in this position, so serious injuries could be suffered in the event of hard braking or a collision.



**⚠ CAUTION**

- The reclining mechanism of the seatback is spring loaded, causing it to return to the vertical position when the lock lever is operated. When using the lever, sit close to the seatback or hold it with your hand to control its return motion.

**Heated seats\***

E00401102384

The heated seats can be operated with the ignition switch in the “ON” position. Operate the switch as indicated by arrows.

The indication lamp (A) will illuminate while the heater is on.

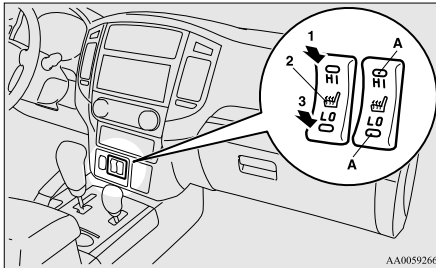

- 1 (HI)- Heater high (for quick heating).
- 2 (neutral position)- Heater off.
- 3 (LO)-

3 (LO)- Heater low (to keep the seat warm).

**⚠ CAUTION**

- Switch off seat heaters when not in use.
- Operate in the high position for quick heating. Once the seat is warm, set the heater to low to keep it warm. Slight variations in seat temperature may be felt while using the heated seats. This is caused by the operation of the heater’s internal thermostat and does not indicate a malfunction.
- If the following types of persons use the heated seats, they might become too hot or receive minor burns (red skin, heat blisters, etc.):
  - Children, elderly or ill people
  - People with sensitive skin
  - Excessively tired people
  - People under the influence of alcohol or sleep inducing medication (cold medicine, etc.)
- Do not place heavy objects on the seat or stick pins, needles, or other pointed objects into it.
- Do not use a blanket, cushion, or other material with high heat insulation properties on the seat while using the heater; this might cause the heater element to overheat.
- When cleaning the seat, do not use benzene, kerosene, petrol, alcohol, or other organic solvents; these might damage the surface of the seat and also the heater element.

**⚠ CAUTION**

- If water or any other liquid is spilled on the seat, allow it to dry thoroughly before attempting to use the heater.
- Turn the heater off immediately if it appears to be malfunctioning during use.

**Rear seats (3-door models)\*/  
Second seats (5-door models)\***

E00402000184

**⚠ WARNING**

- When a person is sitting in the middle seating position of the rear seats (3-door models)/second seats (5-door models), pull up the head restraint to a height at which it locks in position. Be sure to make this adjustment before starting to drive. Serious injuries could otherwise be suffered as the result of an impact. Refer to “Head restraints” on page 4-12.

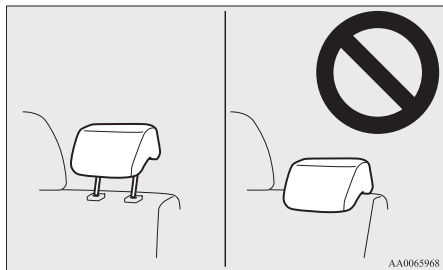

### To recline the seatback

E00402201297

In order to recline the seatback, lean forward slightly, pull the seatback lock lever up, and then lean backward to the desired position and release the lever. The seatback will lock in that position.

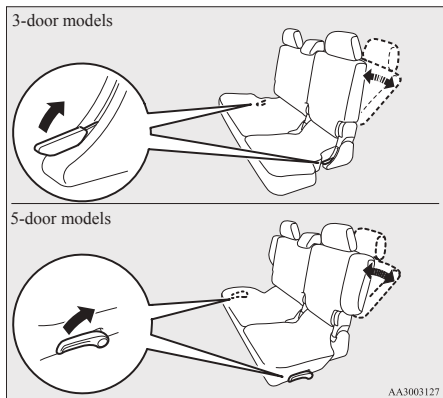

### CAUTION

- The reclining mechanism of the seatback is spring loaded, causing it to return to the vertical position when the lock lever is operated. When using the lever, sit close to the seatback or hold it with your hand to control its return motion.

### NOTE

- Each seatback can be adjusted by the lever on its side.
- On 5-door models, each of the second seat's sidebacks (A) is foldable. When either side of the seatback is reclined to a new position, its sideback automatically folds inward accordingly.

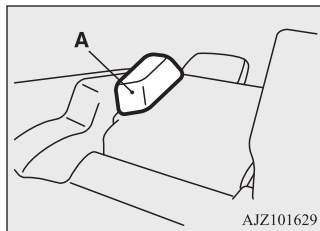

### Armrest

E00402400218

### For rear seats (3-door models)

Press the button (A) at the top of the armrest and allow the armrest to drop down.

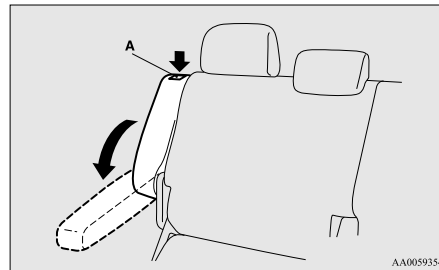

## For second seats (5-door models)

Lift the centre head restraint and then tilt the armrest for use as illustrated.

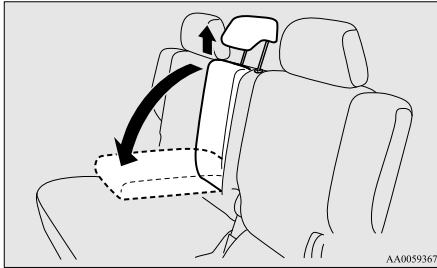

### CAUTION

- When storing the armrest, push the armrest securely to prevent it from falling down while driving the vehicle.

### NOTE

- Do not stand or sit on the armrest. It could break.

## To get in and out of the third seat (5-door models)

E00402500163

Getting in and out of the third seat can be made easily by folding the second seat. Refer to “Folding the rear seats (3-door models) / Folding the second seats (5-door models)” on page 4-14.

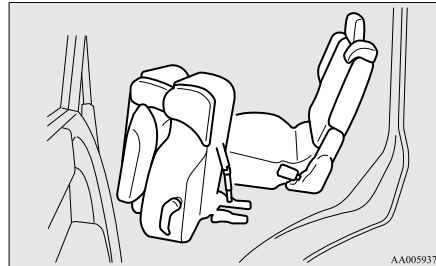

## Third seat (5-door models)\*

E00402700149

### To recline the seatback

E00402800124

In order to recline the seatback, lean forward slightly, pull the seatback lock lever as shown in the illustration, and then lean backward to the desired position and release the lever. The seatback will lock in that position.

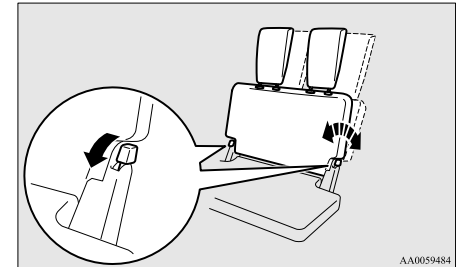

### CAUTION

- The reclining mechanism of the seatback is spring loaded, causing it to return to the vertical position when the lock lever is operated. When using the lever, sit close to the seatback or hold it with your hand to control its return motion.

## Head restraints

E00403301585

### WARNING

- Driving without the head restraints in place can cause you and your passengers serious injury or death in an accident. To reduce the risk of injury in an accident, always make sure the head restraints are installed and properly positioned when the seat is occupied.
- Never place a cushion or similar device on the seatback. This can adversely affect head restraint performance by increasing the distance between your head and the restraint.

### To adjust height

Adjust the head restraint height so that the centre of the head restraint is as close as possible to eye level to reduce the chances of injury in the event of collision. Any person too tall for the head restraint to reach their seated eye level, should adjust the restraint as high as possible.

To raise the head restraint, move it upward. To lower the restraint, move it downward while pushing the height adjusting knob (A) in the direction of the arrow. After adjustment, push the head restraint downward and make sure that it is locked.

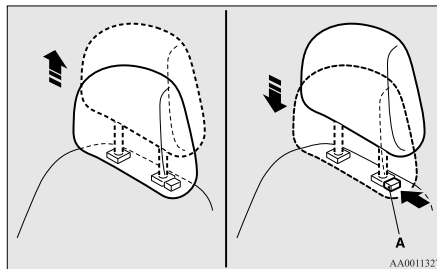

### To remove

Lift the head restraint with the height adjusting knob (A) pushed in.

### To install

Confirm that the head restraint is facing the correct direction, and then insert it into the seatback while pressing the height adjusting knob (A) in the direction indicated by the arrow.

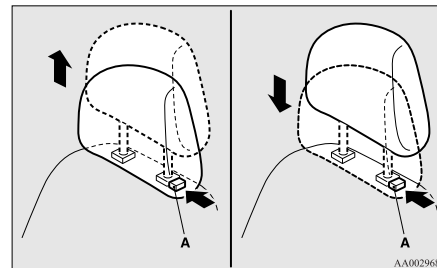

### CAUTION

- Confirm that the height adjusting knob (A) is correctly adjusted as shown in the illustration, and also lift the head restraints to ensure that they do not come out of the seatback.

## To fold

1. If your vehicle is equipped with a rear shelf (3-door models) / cargo area cover (5-door models), remove it before performing the following steps. Refer to “Rear shelf (3-door models)” on page 7-86 and “Cargo area cover (5-door models)” on page 7-86.
2. Lift up the knob (A) behind the seatback, then tilt the seatback forward.

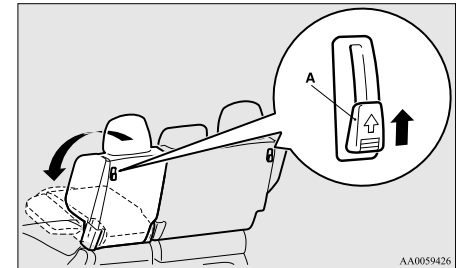

4

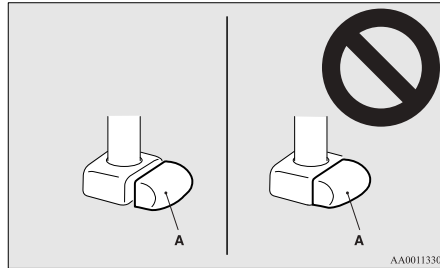

## Making a luggage area

E00403400013

### CAUTION

- Do not stack luggage above the seatback height. Secure the luggage firmly. Serious accidents could result due to unrestrained objects entering the passenger compartment during sudden braking.
- When folding, storing or removing the seat, be sure not to catch your hand or leg.

## Folding the rear seatbacks forward (3-door models) / Folding the second seatbacks forward (5-door models)

E00403500232

The passenger and luggage compartments can be joined by folding the rear (3-door models) / second (5-door models) seatback forward. This is useful for carrying long objects.

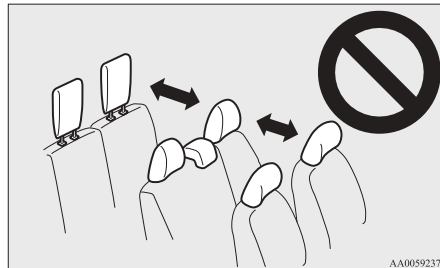

### CAUTION

- The head restraints for the seats differ in shape and size. When installing head restraints, make sure the head restraints are fitted in their respective seats.

### NOTE

- Each seatback can be folded forward using the knob on its side.

## Making a luggage area

3. Push the seat until you hear a “click” and the seat locks securely.

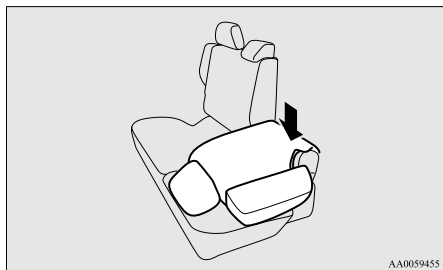

### To replace

Raise the seatback until it locks securely into place.

Push lightly on the seatback to confirm that it has actually been secured.

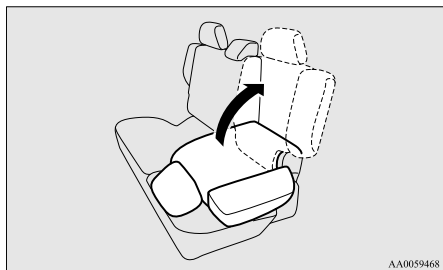

### Folding the rear seats (3-door models) / Folding the second seats (5-door models)

E00403700221

To create luggage space, you can fold the rear (3-door models) / second (5-door models) seats.

If your vehicle is equipped with the third seat, by folding the second seat, you can get in and out easier.

#### WARNING

- When driving the vehicle, do not allow anyone to sit on the third seat if the second seat is in the folded-down position. The second seat could tip rearward in the event of hard braking or a collision, resulting in serious injuries.

### To fold

1. If your vehicle is equipped with a rear shelf (3-door models) / cargo area cover (5-door models), remove it before performing the following steps. Refer to “Rear shelf (3-door models)” on page 7-86 and “Cargo area cover (5-door models)” on page 7-86.

2. Lift up the knob (A) behind the seatback, then tilt the seatback forward.

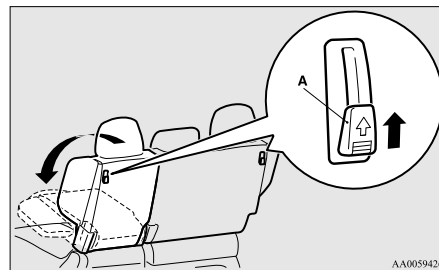

3. Lift the seat until you hear a “click”.

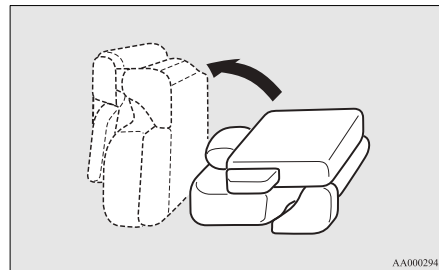

## To replace

1. Hold the seat with your hand, then return the seat to its original position while pushing the stopper (A).

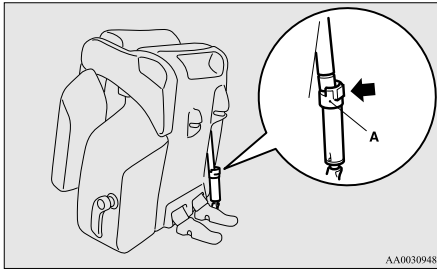

2. Push the seat until you hear a “click” and the seat locks securely.

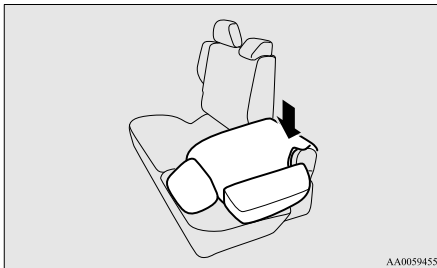

3. Raise the seatback until it locks securely into place.

Push lightly on the seatback to confirm that it has actually been secured.

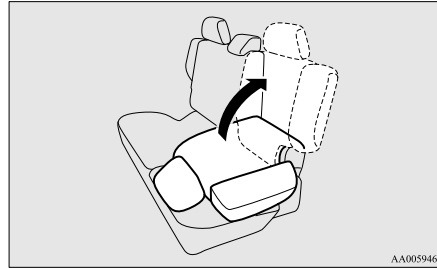

## Storage of the third seat

E00404101287

By folding the third seat into the luggage floor box, large articles can be stored in the vehicle.

## To store

1. Remove the luggage floor board (A) and the head restraints (B).

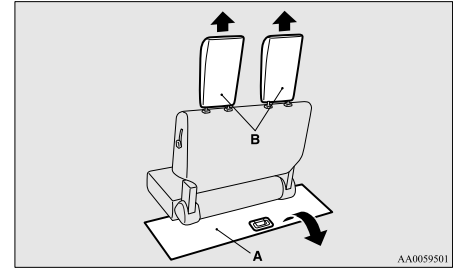

2. Stow the removed head restraints in the luggage floor box with their front faces facing upward.

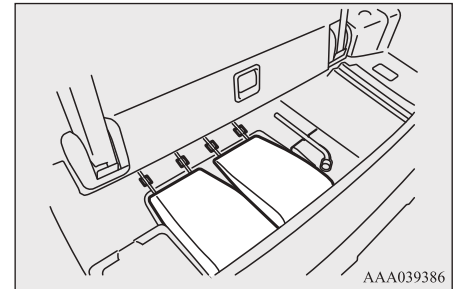

**NOTE**

- Stowing the head restraints with their front faces facing downward would prevent the third seat from being stowed.

4

3. Pull up knob (C) on the side of the seatback, then tilt the seatback forward.

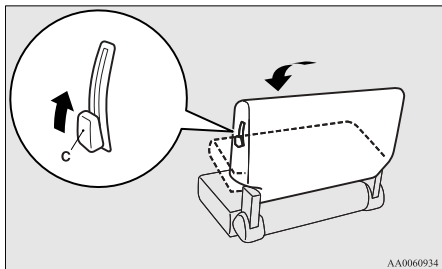

4. Push lever (D) forward, then tilt the seatback forward until the seatback touches the seat cushion.

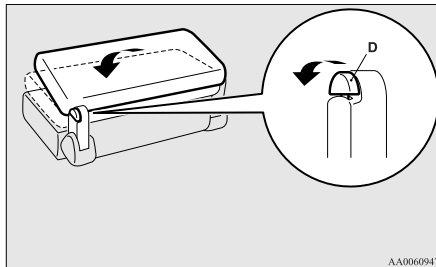

**CAUTION**

- Do not drive with luggage placed on the forward-folded seatback.

5. Pull lever (E), fold the seat backward, and store it into the luggage floor box.

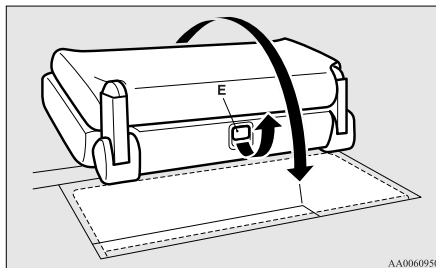

**CAUTION**

- Ensure that lever (E) is not operated while the seat is occupied. The folding action of the seat in such a situation could result in an unexpected accident.
- When folding the seat, be sure not to catch your hands between seat and luggage floor box.
- When folding the seat away into the luggage floor box, hold the seat by hand and fold it slowly. If the seat is not held properly, it might fall under its own weight during folding and pinch your hand.

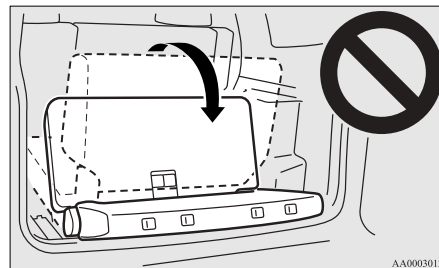



6. Fold down the stands (F).

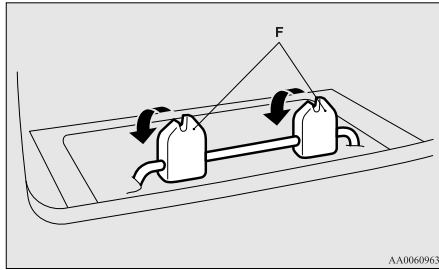

7. Refit the luggage floor board.

### To replace

1. Remove the luggage floor board. And then raise the stands.
2. Raise the seat forward until you hear a “click” and the seat locks securely.

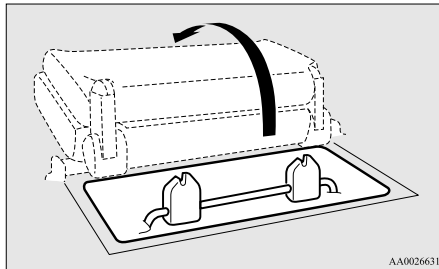

3. Push knob (A) forward, and raise the seatback until it locks securely into place. After the operation, push lightly on the seatback to confirm that it has actually been secured.

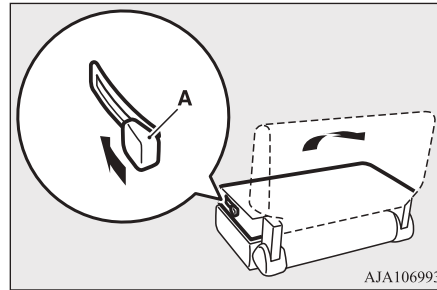

4. Refit the luggage floor board and head restraints.

### Removing the third seat

E00404201220

To create more luggage space, you can remove the third seat.

### CAUTION

- For safety, do not allow children to remove or refit the seat.

### CAUTION

- Be careful not to trap your hands or feet when removing or refitting the seat. Also, be careful not to drop or trip over the seat. If necessary, have someone help you remove it.

### To remove

1. Remove the head restraints. Refer to “Head restraints” on page 4-12.
2. Pull up the knob (A) on the side of the seatback, then tilt the seatback forward.

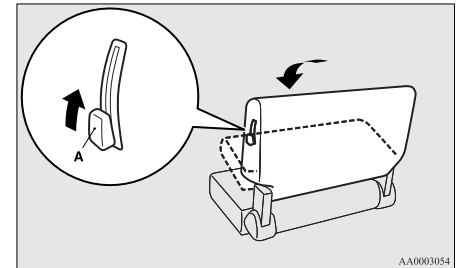

## Making a luggage area

3. Push lever (B) forward, then tilt the seat-back forward until the seatback touches the seat cushion.

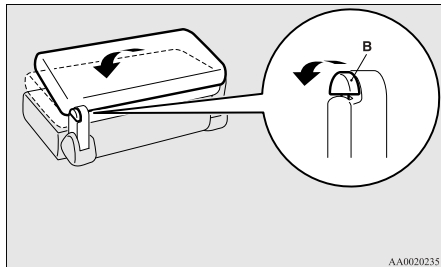

4. Pull the seat lock lever (C).

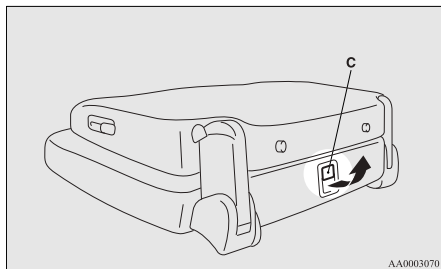

5. Fold the stands (D) towards you from the seat side, while lifting the front end of the seat.

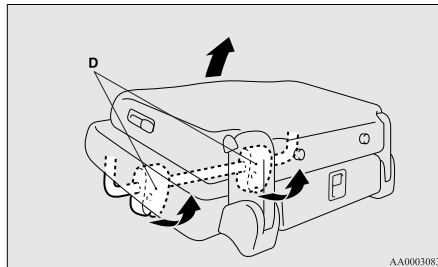

6. Put down the front end of the seat to the floor. In this situation, the seat locking system is unlocked automatically.

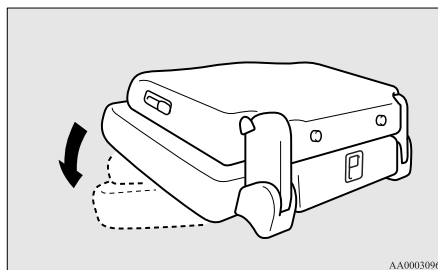

7. Remove the covers (E) by turning the knobs (F) anticlockwise.

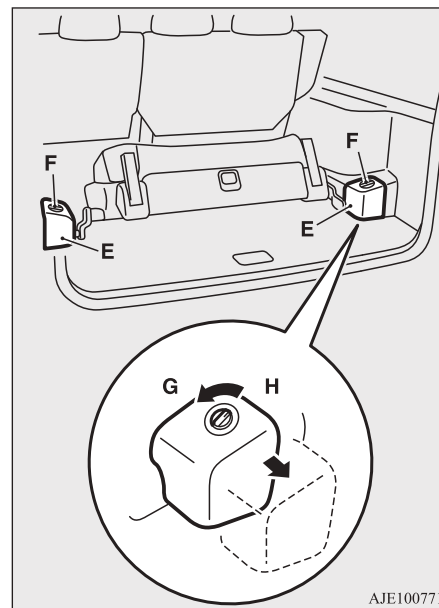

G- Unlock  
H- Lock

- Hold the seat as shown in the illustration, remove the seat by sliding it backward.

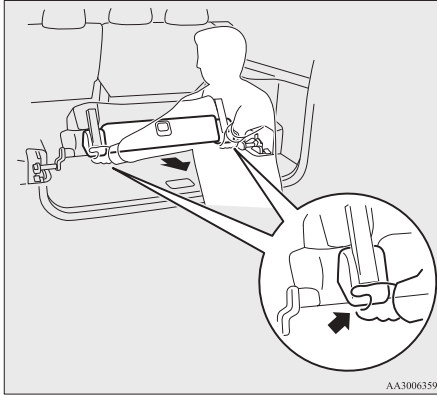

**CAUTION**

- Do not sit or place luggage on the removed seat. Any weight placed on the folded seat could deform the seat mountings, preventing the seat from being locked securely onto the floor.

**NOTE**

- During the removal procedure, ensure that both ends of the seat are moved evenly while the seat is being pulled out. If this procedure is not followed, the seat could catch on its securing fixtures, making it difficult to remove.

**To refit**

- Push the seat's mounting arms into the luggage compartment's fixtures.

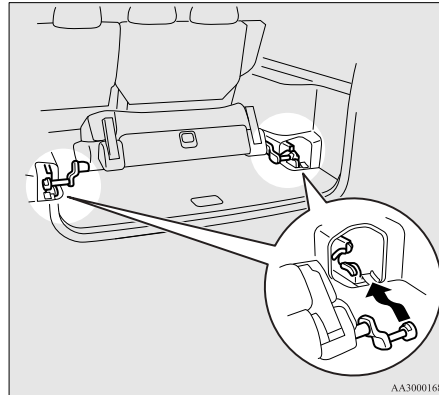

- Confirm that the seat's mounting arms are secured by the hooks (A).

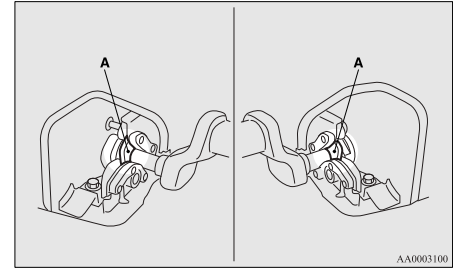

- Fold the stands forward from the seat side, while lifting the front end of the seat.
- Refit the covers on both sides of the luggage room.
- Push the knob (B) forward, raise the seatback until it locks securely into place.

## Making a flat seat (Except for 3-door models equipped with the power seat)

After the operation, push the seatback lightly to confirm that it has actually been secured.

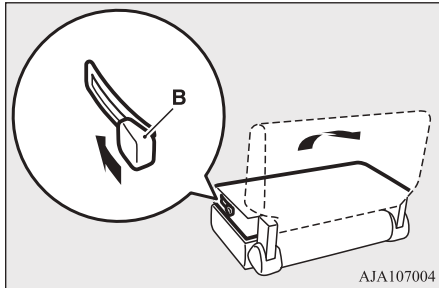

6. Refit the head restraints.

### Making a flat seat (Except for 3-door models equipped with the power seat)

E00404301960

By removing the head restraints and fully reclining the seatbacks of the seats, one large flat seat is achieved.

### ⚠ WARNING

- Never drive with passengers on the flat seat. This is highly dangerous.

### ⚠ CAUTION

- To make a flat seat, stop the vehicle in a safe place.
- Make sure the seat is adjusted by an adult or with adult supervision for correct and safe operation.
- When sliding the seat, be sure not to catch your hand or leg.
- Do not walk around on top of the seats after they have been laid flat.
- To ensure the seats are locked securely, attempt to move them back and forth.
- Do not jump on, or impact the seatbacks heavily.
- To raise the seatback, put a hand on the seatback and raise slowly. Never have a child do this operation, or an unexpected accident may result.

1. If your vehicle is equipped with a rear shelf (3-door models) / cargo area cover (5-door models), remove it before performing the following steps. Refer to “Rear shelf (3-door models)” on page 7-86 and “Cargo area cover (5-door models)” on page 7-86.

2. Remove the head restraints from the front seats.

If your vehicle is equipped with the third seat (5-door models), store the third seat into the luggage floor box.

Refer to “Head restraints” on page 4-12 and “Storage of the third seat” on page 4-15.

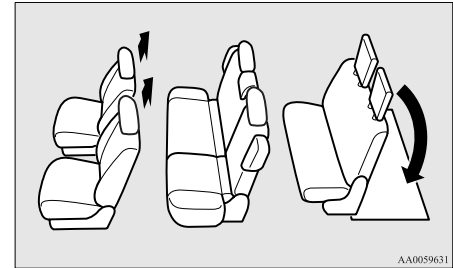

3. Slide the front seats fully forward, then tip their seatbacks backward.  
On 5-door models, slide the front seats backward until their seatbacks touch the second seat.

Refer to “To adjust forward or backward” on page 4-05 and “To recline the seatback” on page 4-06.

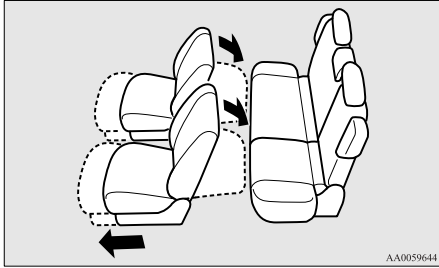

- On 3-door models, remove the head restraints from the rear seat. Recline the rear (3-door models) / second (5-door models) seatback backward. Refer to “To recline the seatback” on page 4-10.

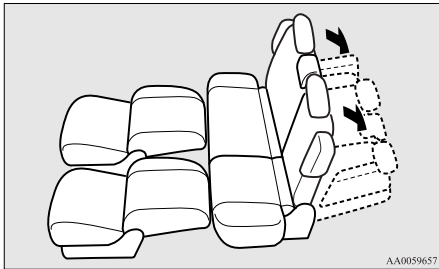

**NOTE**

- On 5-door models, each of the second seat’s sidebacks (A) is foldable. When either side of the seatback is reclined to a new position, its sideback automatically folds inward accordingly.

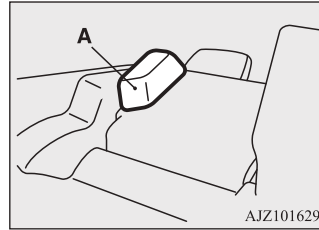

- On 3-door models, store the front head restraints and rear centre head restraint between the front seats. And store the rear outboard head restraints on the side of the rear seat. On 5-door models, store the front head restraints between the front seats. The flat seat configuration is now complete.

Reverse the above procedure when returning the seat to the normal position.

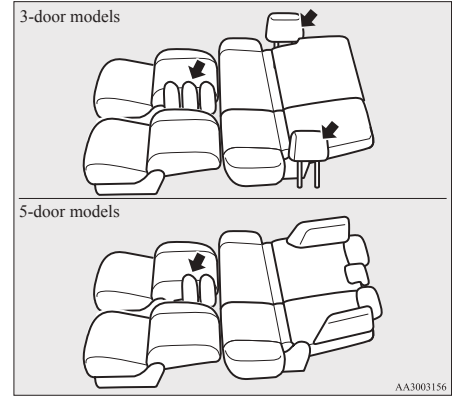

**Seat belts**

E00404800072

To protect you and your passengers in the event of an accident, it is most important that the seat belts are worn correctly while driving.

The front seat belts have a pretensioner system. These belts are used the same way as a conventional seat belt. Refer to “Seat belt pretensioner system and force limiter system” on page 4-25.

**⚠ WARNING**

- Always place the shoulder belt over your shoulder and across your chest. Never put it behind you or under your arm.
- One seat belt should be used by only one person. Doing otherwise can be dangerous.
- The seat belt will provide its wearer with maximum protection if the recliner seatback is placed in fully upright position. When the seatback is reclined, there is greater risk that the passenger will slide under the belt, especially in a forward impact accident, and may be injured by the belt or by striking the instrument panel or seatbacks.
- Seat belts should always be worn by every adult who drives or rides in this vehicle, and by all children who are tall enough to wear seat belts properly. Other children should always use proper child restraint systems.
- Remove any twists when using the belt.
- No modifications or additions should be made by the user which will either prevent the seat belt adjusting devices from operating to remove slack, or prevent the seat belt assembly from being adjusted to remove slack.
- Never hold a child in your arms or on your lap when riding in this vehicle, even if you are wearing your seat belt. To do so risks severe or fatal injury to the child in a collision or sudden stop.
- Always adjust the belt to a snug fit.

**⚠ WARNING**

- Always wear the lap portion of the belt over your hips.

**3-point type seat belt (with emergency locking mechanism)**

E00404902934

This type of belt requires no length adjustment. Once worn, the belt adjusts itself to the movement of the wearer, but in the event of a sudden or strong shock, the belt automatically locks to hold the wearer's body.

**📖 NOTE**

- You can check if the belt locks by pulling it forward quickly.

**To fasten**

1. Pull the seat belt out slowly while holding the latch plate.

**📖 NOTE**

- When the seat belts cannot be pulled out in a locked condition, pull the belts once forcefully and then return them. After that, pull the belts out slowly once again.

2. Insert the latch plate into the buckle until a “click” is heard.

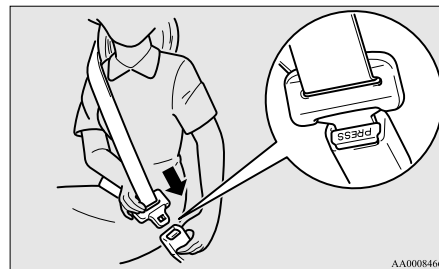
**⚠ WARNING**

- Never wear the lap portion of the belt across your abdomen. During accidents it can press sharply against the abdomen and increase the risk of injury.
- The seat belts must not be twisted when worn.

3. Pull the belt slightly to adjust slackness as desired.

## To unfasten

Hold the latch plate and push the button on the buckle.

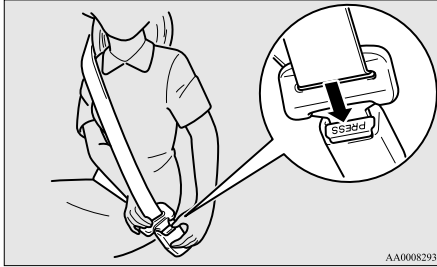

AA0008293

## NOTE

- As the belt retracts automatically, keep holding the latch plate while retracting so that the belt stows slowly. Failure to do this could damage the vehicle.
- If the seat belt (A) or ring (B) becomes dirty, the belt may not retract smoothly. If the seat belt and ring are dirty, clean them with a mild soap or detergent solution.

## NOTE

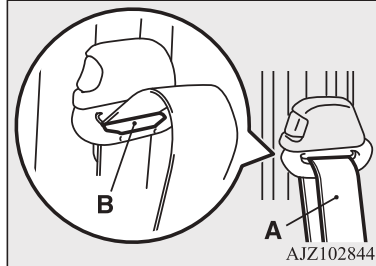

## Seat belt reminder/warning lamp

E00409800338

The seat belt warning lamp is located on the instrument panel. A tone and warning lamp are used to remind the driver to fasten the seat belt.

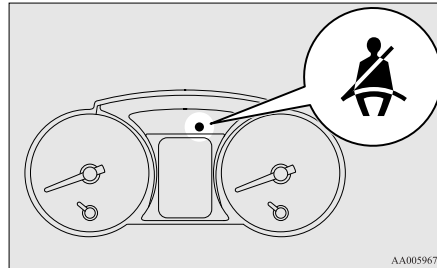

When the ignition key is turned to the “ON” position, the warning lamp will come on and a tone will sound for about 6 seconds. If the driver’s seat belt remains unfastened for approximately 1 minute later, the warning lamp will flash and the tone sound intermittently (each 12 times) when the vehicle is driven. If the driver subsequently unfastens the seat belt while driving, the warning lamp and tone will issue further warnings. And if the seat belt remains unfastened, the warning lamp and tone will issue further warnings each time the vehicle starts moving from a stop. When the seat belt is fastened, the warnings will stop.

## Adjustable seat belt anchor (front seats)

E00405000286

The seat belt anchor height can be adjusted.

## Seat belts

Move the seat belt anchor down with the lock knob (A) depressed. To move the anchor up, slide it without depressing the lock knob (A).

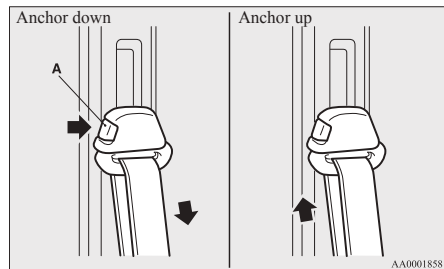

### **WARNING**

- When adjusting the seat belt anchor, set it at a position that is sufficiently high so that the belt will make full contact with your shoulder but will not touch your neck.

## Rear/second, third seat belt storage\*

E00405300029

When the seat belt is not in use, store it as shown in the illustration.

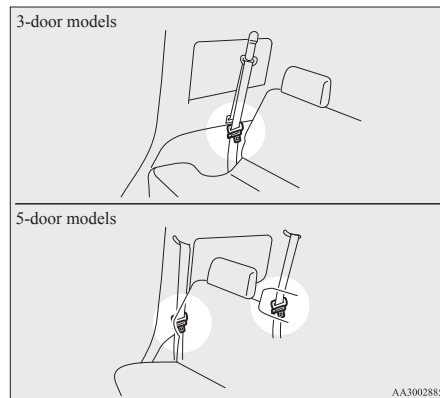

## Seat belt plate storage

After passing the belt through the rear notch (A), insert the plate into the front notch (B).

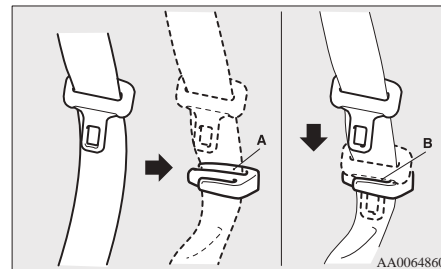



## Seat belt buckle storage

Store the seat belt buckle in the storage pocket.

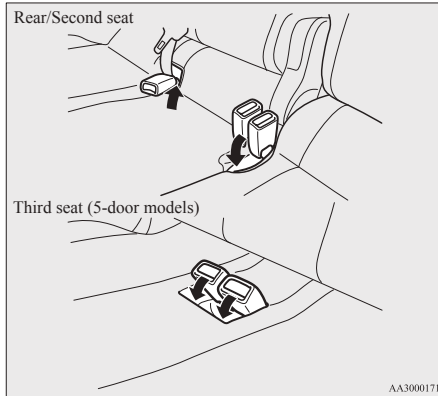

## Pregnant women restraint

E00405600064

### ⚠ WARNING

- Seat belts work for everyone, including pregnant women. Pregnant women should use the available seat belts. This will reduce the likelihood of injury to both the woman and the unborn child. The lap belt should be worn across the thighs and as snug against the hips as possible, but not across the waist. Consult your doctor if you have any additional questions or concerns.

## Seat belt pretensioner system and force limiter system

E00405701323

The driver's seat and front passenger's seat each have a seat belt equipped with a pretensioner system and force limiter system.

### Pretensioner system

E00405800747

The pretensioner system will retract their respective seat belts instantaneously, thus maximizing the seat belt's effectiveness, if there is a frontal impact severe enough to injure the driver and/or front passenger and the ignition switch is in the "ON" or "START" position.

### ⚠ WARNING

- To obtain the best results from your pretensioner seat belt, make sure you have adjusted your seat correctly and wear your seat belt properly.

### ⚠ CAUTION

- Installation of audio equipment or repairs in the vicinity of the pretensioner seat belts or floor console must be performed in line with MITSUBISHI MOTORS guidelines. It is important to do so because the work could affect the pretensioner systems.
- If you need to scrap the vehicle, please consult a MITSUBISHI MOTORS Authorized Service Point.  
It is important to do so because unexpected activation of the pretensioner seat belts could cause injuries.

### 📖 NOTE

- The pretensioner seat belts will be activated if the vehicle suffers a severe frontal impact, even if the seat belts are not worn.
- The pretensioner seat belts are designed to work only once. After the pretensioner seat belts have been activated, we recommend you to have them replaced by a MITSUBISHI MOTORS Authorized Service Point.

## SRS warning lamp

E0040590083

This warning lamp is shared by the SRS airbags and the pretensioner seat belts. Refer to “SRS warning lamp” on page 4-47.

## 4 Force limiter system

E00406000153

In the event of a collision, each force limiter system will effectively absorb the load applied to the seat belt to minimize the impact to the passenger.

## Child restraint

E00406403233

When transporting children in your vehicle, some type of child restraint system should always be used according to the size of the child. This is required by law in most countries.

The regulations concerning driving with children in the front seat may differ from country to country. You are advised to comply with the relevant regulations.

**⚠ WARNING**

- When possible, put children in the rear seat. Accident statistics indicate that children of all sizes and ages are safer when properly restrained in the rear seat rather than in the front seat.

**⚠ WARNING**

- Holding a child in your arms is no substitute for a restraint system. Failure to use a proper restraint system can result in severe or fatal injury to the child.
- Each child restraint device or fixing is to be used only by one child.
- When attaching a child restraint system to the rear seat, prevent the front seat-backs from touching the child restraint system. Otherwise, the child could be seriously injured in the event of hard braking or a collision.

## Caution for installing the child restraint on vehicle with front passenger’s airbag

The label shown here is attached on vehicles with a front passenger’s airbag.

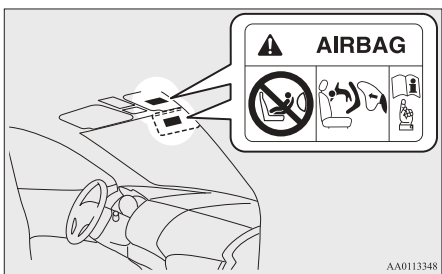

**⚠ WARNING**

- Extreme Hazard!  
NEVER use a rearward facing child restraint on a seat protected by an ACTIVE AIRBAG in front of it, DEATH or SERIOUS INJURY to the CHILD can occur.

**📖 NOTE**

- The labels may be in different positions depending on the vehicle model.

Use rearward facing child restraints in the rear seat or turn off the front passenger’s airbag ON-OFF switch. (Refer to “To turn an airbag off” on page 4-40.)



**⚠ WARNING**

- A **REARWARD FACING CHILD RESTRAINT** must **NOT** be used in the front passenger seat if the front passenger's airbag has not been deactivated. The force of an inflating airbag could kill or cause serious injuries to the child. A rearward facing child restraint must only be used in the rear seat.
- A **FORWARD FACING CHILD RESTRAINT** should be used in the rear seat whenever possible; if used in the front seat, adjust the seat to the most rearward position.

**Infants and small children**

E00406602166

When transporting infants and small children in your vehicle, follow the instruction given below.

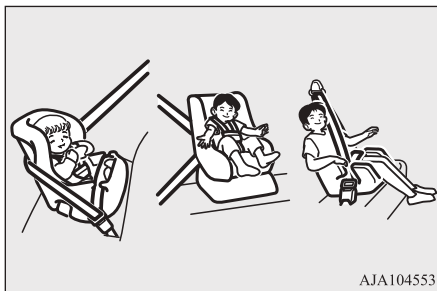
**Instruction:**

- For small infants, an infant carrier should be used. For small children whose height when seated allows the shoulder belt to lie in contact with the face or the throat, a child seat should be used.
- The child restraint system should be appropriate for the child's weight and height and properly fit in the vehicle. For a higher degree of safety: **THE CHILD RESTRAINT SYSTEM SHOULD BE INSTALLED IN THE REAR SEAT.**

- Before purchasing a child restraint system, try installing it in the rear seat to make sure there is a good fit. Because of the location of the seat belt buckles and the shape of the seat cushion, it may be difficult to securely install some manufacturer's child restraint systems. If the child restraint system can be pulled forward or to either side easily on the seat cushion after the seat belt has been tightened, choose another manufacturer's child restraint system.

**⚠ WARNING**

- When installing a child restraint system, refer to the instructions provided by the manufacturer of the restraint system. Failure to do so can result in severe or fatal injury to the child.
- After installation, push and pull the child restraint system back and forth, and side to side, to see that it is properly secured. If the child restraint system is not installed securely, it may cause injury to the child or other occupants in the case of accident or sudden stops.
- When the child restraint system is not in use, keep your child restraint system secured with the seat belt or remove it from the vehicle in order to prevent it from being thrown around inside the vehicle during an accident.

### NOTE

- Depending on the seating position in the vehicle and the child restraint system that you have, the child restraint can be attached using one of the following two ways:
  - Use the lower anchorage in the rear seat (3-door models) / second seat (5-door models) ONLY if the child restraint has ISOFIX mountings (See page 4-34).
  - Using the seat belt (See page 4-35).

### Older children

E00406700147

Children who have outgrown the child restraint system should be seated in the rear seat and wear combination lap shoulder belt. The lap portion of the belt should be snug and positioned low on the abdomen so that it is below the top of the hip-bone. Otherwise, the belt could intrude into the child's abdomen during an accident and cause injury.

## Suitability for various ISOFIX positions

E00411402058

Mass group	Size class	Fixture	Vehicle ISOFIX positions	
			Rear/second Outboard	
			Left side	Right side
Carrycot	F	ISO/L1	X	X
	G	ISO/L2	X	X
0 - Up to 10 kg	E	ISO/R1	X	X
0+ - Up to 13 kg	E	ISO/R1	X	IL*1
	D	ISO/R2	X	X
	C	ISO/R3	X	X
I - 9 to 18 kg	D	ISO/R2	X	X
	C	ISO/R3	X	X
	B	ISO/F2	IUF	IUF
	B1	ISO/F2X	IUF, IL*2	IUF, IL*2
	A	ISO/F3	IUF	IUF
II - 15 to 25 kg			X	X
III - 22 to 36 kg			X	X

### CAUTION

- When installing a child restraint system, remove the head restraint from the seat.
- Do not sit in the middle seating position of those seats when installing a child restraint system to the rear outboard (3-door models) or the second outboard (5-door models).

**Key of letters to be inserted in the table above:**

- IUF- Suitable for ISOFIX forward child restraints systems of universal category approved for use in the mass group.
- IL- Suitable for particular ISOFIX child restraint systems given in the following list (MITSUBISHI MOTORS genuine parts).
- X- ISOFIX position not suitable for ISOFIX child restraint systems in this mass group and/or this size class.

**4****IL (Genuine part information)**

	Genuine part No.	UN-R44 Approval No.
*1	MZ314393 (Child restraint system), MZ314394 (ISOFIX base)	E1-04301146
*2	MZ313045	E1-04301133

 **NOTE**

- MITSUBISHI MOTORS Europe B.V. reserves the right to changes without any prior announcement.  
For detailed information, consult your MITSUBISHI MOTORS Authorized Service Point.

**Suitability for various seating positions**

E00406802823

**3-door models**

Mass group	Seating position				
	Front passenger		Rear outboard		Rear centre
	Activated air-bag	Deactivated AirBag <sup>#1</sup>	Left side	Right side	
0 - Up to 10 kg	X	X	X	X	X
0+ - Up to 13 kg	X	L* <sup>1</sup>	L* <sup>1</sup>	L* <sup>1</sup>	L* <sup>1</sup>

Mass group	Seating position				
	Front passenger		Rear outboard		Rear centre
	Activated air-bag	Deactivated AirBag <sup>#1</sup>	Left side	Right side	
I -9 to 18 kg	L*2	L*2	L*2	L*2	L*2
II & III -15 to 36 kg	L*3	L*3	L*3	L*3	L*3

#1: With front passenger's airbag deactivated by means of front passenger's airbag ON-OFF switch.

### CAUTION

- When installing a child restraint system, remove the head restraint from the seat.
- Do not sit in the middle seating position of the rear seat when installing a child restraint system to the right side of the rear outboard.

### Key of letters to be inserted in the table above:

- L- Suitable for particular child restraints given in the following list (MITSUBISHI MOTORS genuine parts).
- X- Seat position not suitable for children in this mass group.

#### L (Genuine part information)

	Genuine parts No.	UN-R44 Approval No.
*1	MZ314393	E1-04301146
*2	MZ313045	E1-04301133
*3	MZ314250	E1-04301169

 **NOTE**

- There is no applicable MITSUBISHI MOTORS Genuine Parts to the Mass Group “0-Up to 10 kg”.
- MITSUBISHI MOTORS Europe B.V. reserves the right to changes without any prior announcement.  
For detailed information, consult your MITSUBISHI MOTORS Authorized Service Point.

**4****5-door models**

Mass group		Seating position					
		Front Passenger		Rear out-board	Intermediate Outboard		Intermediate Centre
		Activated air-bag	Deactivated AirBag <sup>#1</sup>		Left side	Right side	
0	- Up to 10 kg	X	X	X	U	U	X
0+	- Up to 13 kg	X	L* <sup>1</sup>	L* <sup>1</sup>	U, L* <sup>1</sup>	U, L* <sup>1</sup>	L* <sup>1</sup>
I	-9 to 18 kg	L* <sup>2</sup>	L* <sup>2</sup>	L* <sup>2</sup>	U, L* <sup>2</sup>	U, L* <sup>2</sup>	L* <sup>2</sup>
II & III	-15 to 36 kg	L* <sup>3</sup>	L* <sup>3</sup>	L* <sup>3</sup>	U, L* <sup>3</sup>	U, L* <sup>3</sup>	L* <sup>3</sup>

<sup>#1</sup>: With front passenger’s airbag deactivated by means of front passenger’s airbag ON-OFF switch.

 **CAUTION**

- When installing a child restraint system, remove the head restraint from the seat.
- When installing a “universal” category child restraint system on the intermediate outboard seat, adjust the seatback of the intermediate seat to its most upright position.
- When installing a child restraint system that’s a MITSUBISHI MOTORS genuine part for the mass group “0+ up to 13 kg” in a rear outboard seating position, remove the head restraint from the rear outboard seating position and tip the rear outboard seatback fully rearward.
- Do not sit in the middle seating position of the second seat when installing a child restraint system to the right side of the second outboard.



**Key of letters to be inserted in the table above:**

- U- Suitable for “universal” category restraints approved for use in this mass group.
- L- Suitable for particular child restraints given in the following list (MITSUBISHI MOTORS genuine parts).
- X- Seat position not suitable for children in this mass group.

**L (Genuine part information)**

	<b>Genuine parts No.</b>	<b>UN-R44 Approval No.</b>
*1	MZ314393	E1-04301146
*2	MZ313045	E1-04301133
*3	MZ314250	E1-04301169

 **NOTE**

- There is no applicable MITSUBISHI MOTORS Genuine Parts to the Mass Group “0-Up to 10 kg”.
- MITSUBISHI MOTORS Europe B.V. reserves the right to changes without any prior announcement.  
For detailed information, consult your MITSUBISHI MOTORS Authorized Service Point.

## Installing a child restraint system to the lower anchorage (ISOFIX child restraint mountings) and tether anchorage\*

E00408901980

### Lower anchorage location

Your vehicle's rear seat (3-door models)/second seat (5-door models) is fitted with lower anchorages for attaching a child restraint system with ISOFIX mountings.

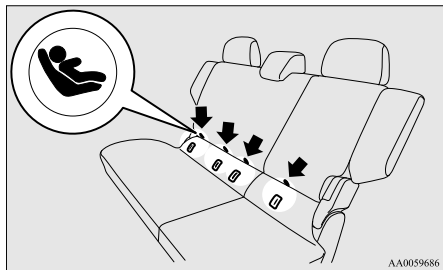

### Tether anchorage locations

There are 2 attachment points on the floor, located behind the rear seat (3-door models)/second seat (5-door models). These are for securing a child restraint system tether strap to both of the 2 rear (3-door models)/second (5-door models) seating positions in your vehicle.

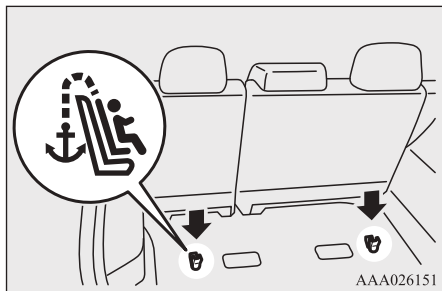

### **⚠ WARNING**

- Child restraint anchorages are designed to withstand only those loads imposed by correctly fitted child restraints. Under no circumstances are they to be used for adult seat belts, harnesses, or for attaching other items or equipment to the vehicle.

### Child restraint system with ISOFIX mountings

The child restraint system is designed only for seats that incorporate lower anchorages. Retain the child restraint system using the lower anchorages.

It is not necessary to retain the child restraint system using the vehicle's seat belts.

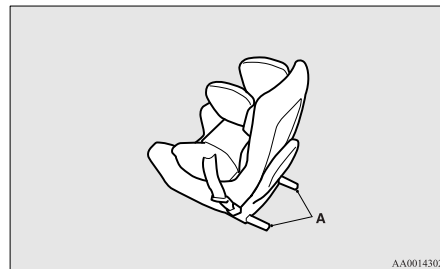

A: Child restraint System connectors

### To install

1. Remove any foreign material in or around the connectors and ensure the vehicle seat belt is in its normal storage position.
2. Remove the head restraint from the location in which you wish to install a child restraint.  
Refer to "Head restraints" on page 4-12.

3. Push the child restraint system's connectors (A) into the slits (B) in accordance with the instructions provided by the child restraint system's manufacturer.

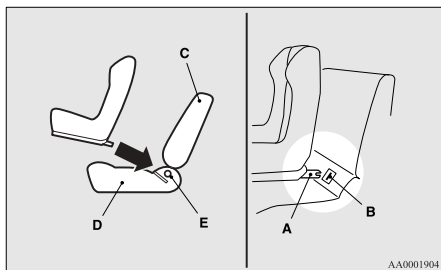

- A- Connector  
B- Slit  
C- Vehicle seatback  
D- Vehicle seat cushion  
E- Lower anchorage

If your child restraint system requires the use of a tether strap, fasten the tether strap in accordance with steps 4 through 5.

4. Open the cover from the tether anchorage installation point by pulling it back with your hand as illustrated.
5. Latch the top tether strap hook (F) of the child restraint system to the tether anchorage bracket (G) and tighten the top tether strap so that it is securely fastened.

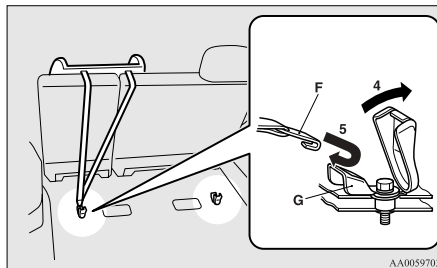

### ⚠ WARNING

- Do not latch the top tether strap hook to any place, for example the luggage hook (H), other than the tether anchorage bracket (I), or the child restraint system could not be fastened securely, resulting in serious injury in the event of a collision.

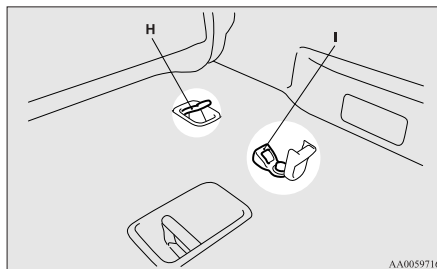

6. Push and pull the child restraint system in all directions to be sure it is firmly fastened.

### To remove

Remove the child restraint in accordance with the instructions provided by the child restraint system's manufacturer.

## Installing a child restraint system to a 3-point type seat belt

E00408701887

4

### 3-door models

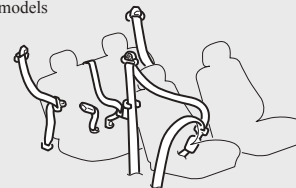

### 5-door models

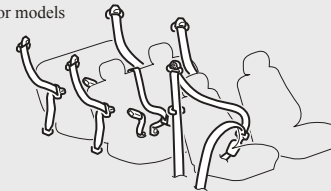

AA3004922

### Installation:

- Put a child restraint system on the seat in which you wish to install it, and remove the head restraint from the seat. Refer to "Head restraints" on page 4-12.

2. Fasten the seat belt to secure the child restraint system. Make sure you hear a “click” when you insert the latch plate in the buckle.
3. Remove all slack by using the locking clip.
4. Push and pull the child restraint in all directions to be sure it is secure.

4

### ⚠ WARNING

- For some types of child restraint, the locking clip (A) should be used to help avoid personal injury during a collision or sudden manoeuvre. It must be fitted and used in accordance with the child restraint manufacturer’s instructions. The locking clip must be removed when the child restraint is removed.

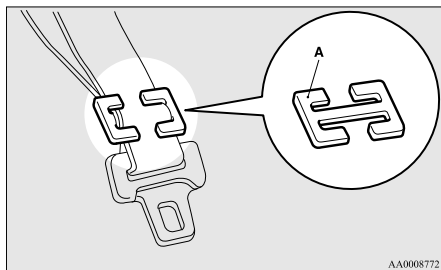

## Seat belt inspection

E00406301690

Check the belts for cuts, worn or frayed webbing and for cracked or deformed metallic parts. Replace the belt assembly if it is defective.

### ⚠ WARNING

- We recommend you to have all seat belt assemblies including retractors and attaching hardware inspected after any collision. We recommend that seat belt assemblies in use during a collision be replaced unless the collision was minor and the belts show no damage and continue to operate properly.
- Do not attempt to repair or replace any part of the seat belt assemblies; we recommend you to have this work done by a MITSUBISHI MOTORS Authorized Service Point. Incorrect repair or replacement could reduce the effectiveness of the belts and could result in serious injury in the event of a collision.
- Once the pretensioner has been activated, it cannot be re-used. It must be replaced together with the retractor.

### ⚠ WARNING

- Do not insert any foreign objects (pieces of plastic, paper clips, buttons, etc.) in the buckle or retractor mechanism. In addition, do not modify, remove or install the seat belt. Otherwise, the seat belt may not be able to provide adequate protection in a collision or other situation.



- A dirty belt should be cleaned with neutral detergent in warm water. After rinsing in water, let it dry in the shade. Do not attempt to bleach or re-dye the belts because this will affect their characteristics.

## Supplemental restraint system (SRS) - airbag

E00407203397

The information written in this Supplemental Restraint System (SRS) section contains important points concerning the driver, front passenger, side and curtain airbags.

The SRS driver's and front passenger's airbags are designed to supplement the primary protection of the driver and front passenger side seat belt systems by providing those occupants with protection against head and chest injuries in certain moderate-to-severe frontal collisions.

The SRS driver's and front passenger's airbags employ a dual stage airbag system. The SRS driver's and front passenger's airbag is controlled by the impact sensors (at the front of the vehicle) and the control unit (near the centre of the vehicle at floor level).

The SRS side airbag (if so equipped) is designed to supplement properly worn seat belts and provide the driver and front passenger with protection against chest injury in certain moderate-to-severe side impact collisions.

The SRS curtain airbags (if so equipped) are designed to supplement properly worn seat belts and provide the driver and passenger with protection against head injuries in certain moderate-to-severe side impact collisions.

The SRS is NOT a substitute for the seat belts; for maximum protection in all types of crashes and accidents, seat belts should ALWAYS be worn by everyone who drives or rides in this vehicle.

## How the Supplemental Restraint System works

E00407302939

The SRS includes the following components:

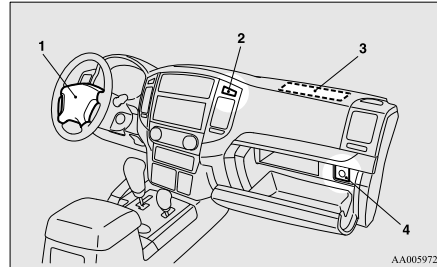

- 1- Airbag module (Driver)
- 2- Front passenger's airbag OFF indication lamp
- 3- Airbag module (Passenger)
- 4- Front passenger's airbag ON-OFF switch

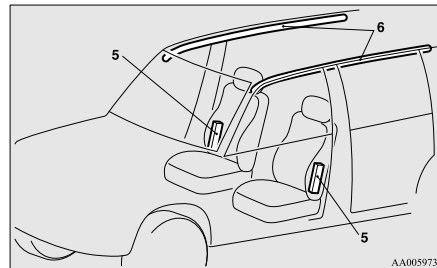

- 5- Side airbag modules\*
- 6- Curtain airbag modules\*

The airbags will operate only when the ignition switch is in the "ON" or "START" position.

The airbags deployment produces a sudden, loud noise, and releases some smoke and powder, but these conditions are not injurious, and do not indicate a fire in the vehicle. People with respiratory problems may feel some temporary irritation from chemicals used to produce the deployment; open the windows after airbag deployment, if safe to do so.

The airbags deflate very rapidly after deployment, so there is little danger of obscured vision.

### **CAUTION**

- Airbags inflate at an extremely rapid speed. In certain situations, contact with inflating airbags can result in abrasions, light cuts, bruises, and the like.

**⚠ WARNING**

- **IT IS VERY IMPORTANT TO BE PROPERLY SEATED.**  
A driver or front passenger too close to the steering wheel or instrument panel during airbag deployment can be killed or seriously injured.  
Airbags inflate very fast, and with great force.  
If the driver and passengers are not properly seated and restrained, the airbags may not protect you properly, and could cause serious or fatal injuries when it inflates.
- Do not sit on the edge of the seat, or lean head or chest close to the steering wheel or instrument panel. Do not put feet or legs on or against the instrument panel.
- Place all infants and small children in the rear seat and properly restrained using an appropriate child restraint system. The rear seat is the safest place for infants and children.



**⚠ WARNING**

- Infants and small children should never be unrestrained, stand up against the instrument panel or be held in your arms or on your lap. They could be seriously injured or killed in a collision, including when the airbag inflates. They should be properly seated in the rear seat in an appropriate child restraint system. See the “Child restraint” section of this owner’s manual.



Use rearward facing child restraints in the rear seat or turn off the front passenger’s airbag ON-OFF switch. (Refer to “To turn an airbag off” on page 4-40.)

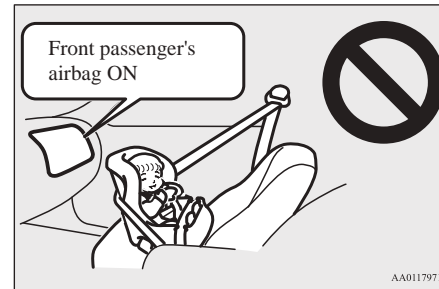

**⚠ WARNING**

- A **REARWARD FACING CHILD RESTRAINT** must **NOT** be used in the front passenger seat if the front passenger’s airbag has not been deactivated. The force of an inflating airbag could kill or cause serious injuries to the child.  
A rearward facing child restraint must only be used in the rear seat.
- A **FORWARD FACING CHILD RESTRAINT** should be used in the rear seat whenever possible; if it must be used in the front passenger seat, adjust the seat to the most rearward position. Failure to do so could kill or cause serious injuries to the child.



AHA100591

### ⚠ WARNING

- Older children should be seated in the rear seat, properly wearing the seat belt, with an appropriate booster seat if needed.

## Caution for installing the child restraint on vehicle with a front passenger's airbag

E00408801947

The label shown here is attached on vehicles with front passenger's airbag.

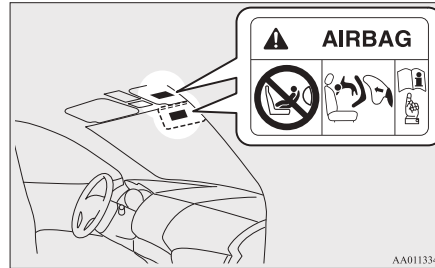

AA0113348

### ⚠ WARNING

- **Extreme Hazard!**  
NEVER use a rearward facing child restraint on a seat protected by an ACTIVE AIRBAG in front of it, DEATH or SERIOUS INJURY to the CHILD can occur.

### 📖 NOTE

- The labels may be in different positions depending on the vehicle model.

## Front passenger's airbag ON-OFF switch

E00410100344

The front passenger's airbag ON-OFF switch can be used to disable the front passenger's airbag. If you have a rearward facing child restraint system that cannot be fitted to any seat other than the front passenger seat, be sure to turn OFF the front passenger's airbag ON-OFF switch before using it. (Refer to "To turn an airbag off" on page 4-40.)

The front passenger's airbag ON-OFF switch is located in the glove box.

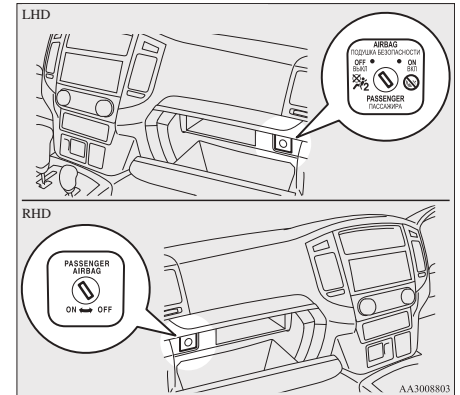

AA3008803

## Front passenger's airbag OFF indication lamp

E00411500068

The front passenger's airbag OFF indication lamp is located in the instrument panel.

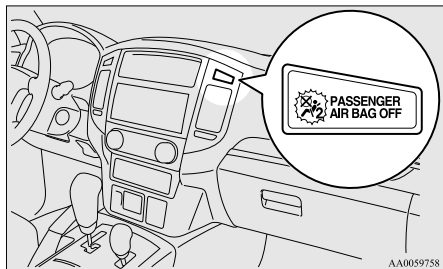

The indication lamp normally comes on when the ignition switch is turned to the “ON” position, and goes off a few seconds later.

When the front passenger's airbag ON-OFF switch is turned OFF, the indication lamp will stay on to show that the front passenger's airbag is not operational. When the front passenger's airbag ON-OFF switch is turned ON, the indication lamp goes off to show that the front passenger's airbag is operational.

### **⚠ WARNING**

- Do not fit any accessory that makes the indication lamp impossible to see, and do not cover the indication lamp with a sticker. You would not be able to verify the status of the passenger airbag system.

## To turn an airbag off

E00410600453

### **⚠ WARNING**

- To reduce risk of serious or fatal injury:
  - Always remove the key from the ignition switch before operating a front passenger's airbag ON-OFF switch. Failure to do so could adversely affect the airbag performance.
  - Wait at least 60 seconds to operate the front passenger's airbag ON-OFF switch after turning the ignition switch from “ON” position to “LOCK” position.  
The SRS airbag system is designed to retain enough voltage to deploy the airbag.
  - Always remove the key from the front passenger's airbag ON-OFF switch after operating that switch. Failure to do so could lead to improper position of the front passenger's airbag ON-OFF switch.

### **⚠ WARNING**

- Do not turn OFF the front passenger's airbag ON-OFF switch except when a rearward facing child restraint system is fitted to the front passenger seat.
- If the indication lamp does not come on when the front passenger's airbag ON-OFF switch is turned OFF, do not fit a rearward facing child restraint system to the front passenger seat. We recommend you to have the system inspected by a MITSUBISHI MOTORS Authorized Service Point.
- If the indication lamp remains on when the front passenger's airbag ON-OFF switch is turned ON, do not allow anyone to sit on the front passenger seat. We recommend you to have the system inspected by a MITSUBISHI MOTORS Authorized Service Point.

To turn an airbag off, follow these steps:

1. Insert the key into the front passenger's airbag ON-OFF switch, and turn it to the “OFF” position.
2. Remove the key from the key opening of the front passenger's airbag ON-OFF switch.



3. Insert the key into the ignition switch, and turn the ignition to the “ON” position. The front passenger’s airbag OFF indication lamp will stay on.

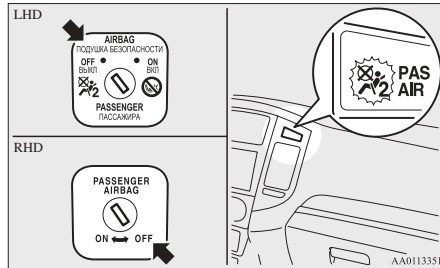

The front passenger’s airbag is now deactivated and will not deploy until switched on again.

## Driver’s and passenger’s front airbag system

E00407400372

The driver’s airbag is located under the padded cover in the middle of the steering wheel. The front passenger’s airbag is contained in the instrument panel above the glove box. The driver’s airbag inflates at two different rates according to the severity of the impact.

The front passenger’s airbag deploys at the same time as the driver’s airbag, even if the passenger seat is not occupied, and inflates at two different rates according to the severity of the impact.

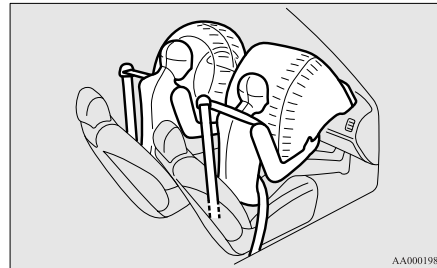

## Deployment of front airbags

E00407501279

### The front airbags ARE DESIGNED TO DEPLOY when...

The front airbags are designed to deploy when the vehicle suffers a moderate to severe frontal impact. A typical condition is shown in the illustration.

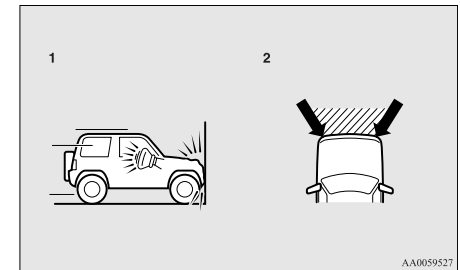

- 1- Head-on collision with a solid wall at a speed of approximately 25 km/h (16 mph) or higher
- 2- Moderate-to-severe frontal impact within the shaded area between the arrows

The front airbags will deploy if the severity of impact is above the designed threshold level, comparable to an approximately 25 km/h (16 mph) collision when impacting straight into a solid wall that does not move or deform. If the severity of the impact is below the above threshold level, the front airbags may not deploy. However, this threshold speed will be considerably higher if the vehicle strikes an object that absorbs the impact by either deforming or moving (for example, another stationary vehicle, pole or a guard rail).

Because frontal collisions can easily move you out of position, it is important to always properly wear your seat belts. Your seat belts will help keep you in a safe distance from the steering wheel and instrument panel during the initial stages of airbag deployment. The initial stage of airbag inflation is the most forceful, and can possibly cause serious or fatal injuries. Moreover, the seat belts in your vehicle are your primary means of protection in a collision. The SRS airbags are designed to provide additional protection. Therefore, for your safety and the safety of all occupants, be sure to always properly wear your seat belts.

### **The front airbags MAY NOT DEPLOY when...**

With certain types of frontal collisions, the vehicle's body structure is designed to absorb the shock to help protect the occupants from harm. (The vehicle body's front area may deform significantly as it absorbs the impact.) Under such circumstances, the front airbags may not deploy irrespective of the deformation and damage to the vehicle body. Examples of some typical conditions are shown in the illustration.

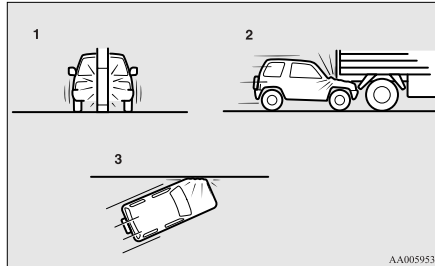

- 1- Collision with a utility pole, tree or other narrow objects
- 2- Vehicle slides under the rear body of a truck
- 3- Oblique frontal impacts

Because the front airbags do not protect the occupant in all types of frontal collisions, be sure to always properly wear your seat belts.

### **The front airbags ARE NOT DESIGNED TO DEPLOY when...**

The front airbags are not designed to deploy in conditions where they cannot typically provide protection to the occupant. Such conditions are shown in the illustration.

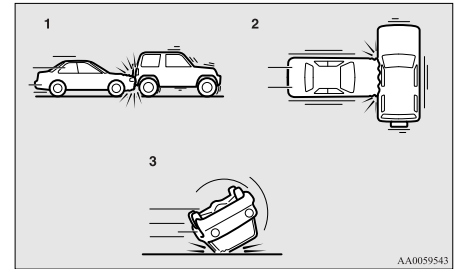

- 1- Rear end collisions
- 2- Side collisions
- 3- Vehicle rolls onto its side or roof

Because the front airbags do not protect the occupant in all types of collisions, be sure to always properly wear your seat belts.

## The front airbags MAY DEPLOY when...

The front airbags may deploy if the bottom of the vehicle suffers a moderate-to-severe impact (undercarriage damage). Examples of some typical conditions are shown in the illustration.

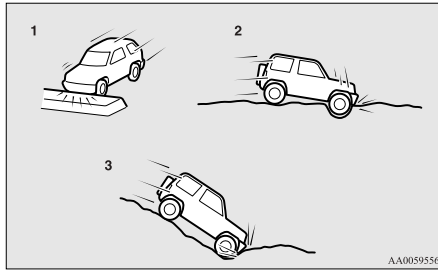

- 1- Collision with an elevated median/island or kerb
- 2- Vehicle travels over a deep hole/pothole
- 3- Vehicle drives down a steep slope and hits the ground

Because the front airbags may deploy in certain types of unexpected impacts as shown in the illustration that can easily move you out of position, it is important to always properly wear your seat belts. Your seat belts will help keep you a safe distance from the steering wheel and instrument panel during the initial stages of airbag deployment. The initial stage of airbag inflation is the most forceful and can possibly cause serious or fatal injuries if you contact it at this stage.

### WARNING

- Do not attach anything to the steering wheel padded cover, such as trim material, badges, etc. It might strike and injure an occupant if the airbag inflates.
- Do not set anything on, or attach anything to, the instrument panel above the glove box. It might strike and injure an occupant if the airbag inflates.

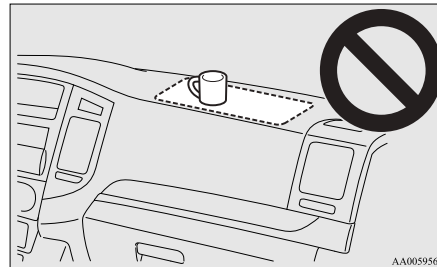

### WARNING

- Do not attach accessories to, or put them in front of, the windscreen. These objects could restrict the airbag inflation, or strike and injure an occupant if the airbags inflate.
- Do not put packages, pets or other objects between the airbags and the driver or front passenger. It could affect airbag performance, or could cause injury when the airbag inflates.
- Right after the airbag inflation, several airbag system components will be hot. Do not touch them; you could be burned.
- The airbag system is designed to work only once. Once the airbags have deployed, they will not work again. They must promptly be replaced, and we recommend you to have the entire airbag system inspected by a MITSUBISHI MOTORS Authorized Service Point.

### Side airbag system\*

The side airbags (A) are contained in the driver and front passenger seatbacks.

E00407600198

## Supplemental restraint system (SRS) - airbag

The side airbag is designed to inflate only on the side of the vehicle that is impacted, even with no passenger in the front seat.

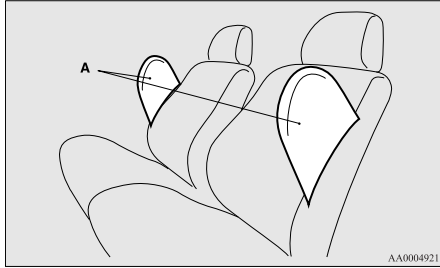

The label shown here is attached to the seat-backs with a side airbag.

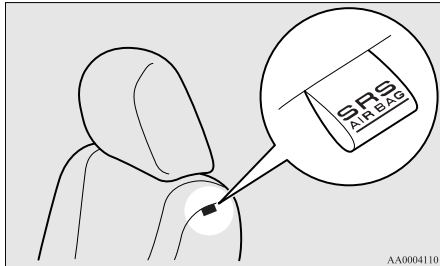

### Curtain airbag system\*

E00409100243

The curtain airbags are contained in the front pillars and roof side rail. The curtain airbag is designed to inflate only on the side of the vehicle that is impacted, even with no passenger in the front seat or rear (3-door models)/second (5-door models) seat.

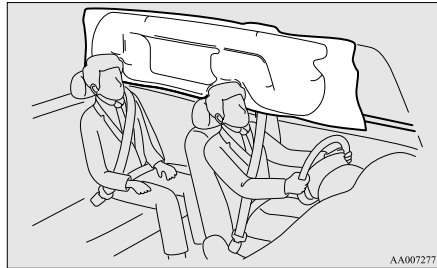

### Deployment of side airbags and curtain airbags

E00407701301

**The side airbags and curtain airbags ARE DESIGNED TO DEPLOY when...**

The side airbags and curtain airbags are designed to deploy when the vehicle suffers a moderate-to-severe side impact to the middle of the passenger compartment.

The typical condition is shown in the illustration.

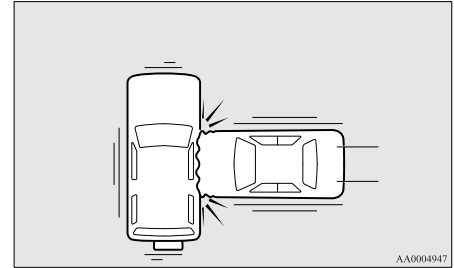

The seat belts in your vehicle are your primary means of protection in a collision. The side airbags and curtain airbags are designed to provide additional protection. Therefore, for your safety and the safety of all occupants, be sure to always properly wear your seat belts.

## The side airbags and curtain airbags MAY NOT DEPLOY when...

With certain types of side collisions, the vehicle's body structure is designed to absorb the shock to help protect the occupants from harm. (The vehicle body's side area may deform significantly as it absorbs the impact.) Under such circumstances, the side airbags and curtain airbags may not deploy irrespective of the deformation and damage to the vehicle body. Also, depending on the location of the impact, the side airbags and curtain airbags may not deploy simultaneously.

Examples of some typical conditions are shown in the illustration.

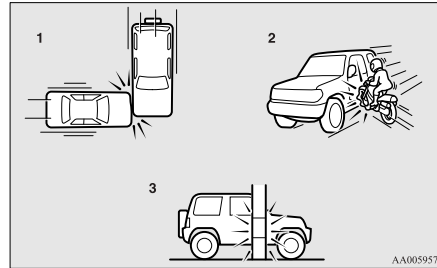

- 1- Side impacts in an area away from the passenger compartment
- 2- Motorcycle or other similar small vehicle collides with the side of vehicle
- 3- Collision with a utility pole, tree or other narrow object

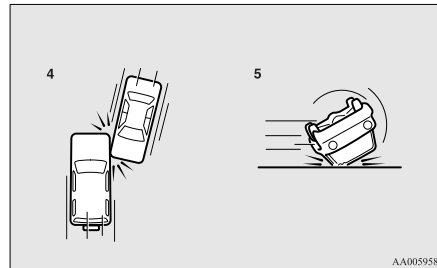

- 4- Oblique side impacts
- 5- Vehicle rolls onto its side or roof

Because the side airbags and curtain airbags do not protect the occupant in all types of side collisions, be sure to always properly wear your seat belts.

## The side airbags and curtain airbags ARE NOT DESIGNED TO DEPLOY when...

The side airbags and curtain airbags are not designed to deploy in conditions where they cannot usually provide protection to the occupant. Typical conditions are shown in the illustration.

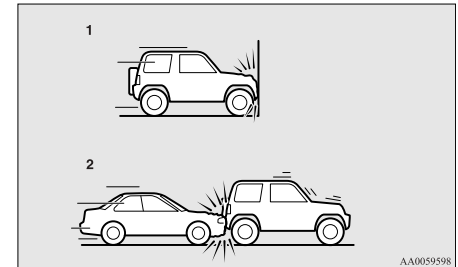

- 1- Head-on collisions
- 2- Rear end collisions

Because the side airbags and curtain airbags do not protect the occupant in all types of collisions, be sure to always properly wear your seat belts.

**⚠ WARNING**

- The side airbags and curtain airbags are designed to supplement the driver and passenger seat belts in certain side impacts. Seat belts should always be worn properly, and the driver and passenger should sit well back and upright without leaning against the window or door.
- The side airbag and curtain airbag inflate with great force. The driver and passenger should not put their arms out of the window, and should not lean against the door, in order to reduce the risk of serious or possible fatal injury from the deploying side airbag and curtain airbag.



**⚠ WARNING**

- Do not allow any rear seat occupant to hold onto the seatback of either front seat, in order to reduce the risk of injury from a deploying side airbag. Special care should be taken with children.

**⚠ WARNING**

- Do not place any objects near or in front of the seatback of either front seat. They could interfere with proper side airbag inflation, and also could cause injury if thrown free by side airbag deployment.
- Do not place stickers, labels or additional trim on the seatback of either front seat. They could interfere with proper side airbag inflation.
- Do not install seat covers on seats with side airbags. Do not re-cover the seats with side airbags. They could interfere with proper side airbag inflation.
- Do not attach a microphone (A) or any other device or object around the part where the curtain airbags activate such as on the windscreen, side door glass, front and rear pillars and roof side or assist grips. When the curtain airbags inflate, the microphone or other device or object will be hurled with great force or the curtain airbags may not activate correctly, resulting in death or serious injury.

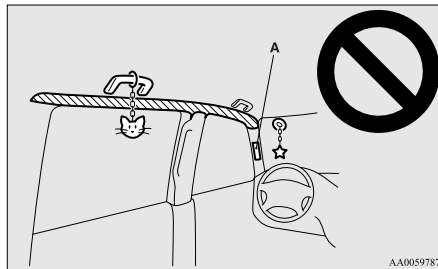

**⚠ WARNING**

- Do not put a hanger or any heavy or pointed object on the coat hook. If the curtain airbag was activated, any such item could be propelled away with great force and could prevent the curtain airbag from inflating correctly. Hang clothes directly on the coat hook (without using a hanger). Make sure there are no heavy or sharp objects in the pockets of clothes that you hang on the coat hook.
- Do not allow a child to lean against or close to the front door even if the child is seated in a child restraint system. The child's head should also not lean against or be close to the area where the side airbag and curtain airbag are located. It is dangerous if the side airbag and curtain airbag inflate. Failure to follow all of these instructions could lead to serious or fatal injury to the child.
- We recommend work around and on the side airbags and curtain airbags system to be done by a MITSUBISHI MOTORS Authorized Service Point.

## SRS warning lamp

E00407801706

There is a Supplemental Restraint System (“SRS”) warning lamp on the instrument panel. The system checks itself every time the ignition switch is turned to the “ON” position. The SRS warning lamp will come on for several seconds and then go out. This is normal and means the system is working properly. If there is a problem involving one or more of the SRS components, the warning lamp will come on and stay on.

The SRS warning lamp is shared by the SRS airbag and the seat belt pretensioner system.

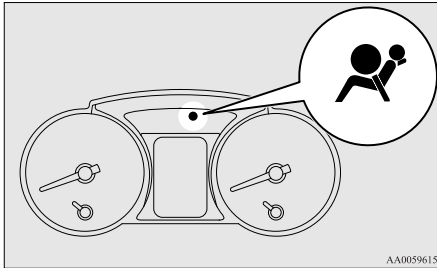

AA0059615

### ⚠ WARNING

- If any of the following conditions occur, there may be a problem with the SRS airbags and/or seat belt pretensioners, and they may not function properly in a collision

### ⚠ WARNING

sion or may suddenly activate without a collision:

- Even when the ignition switch is in “ON” position, the SRS warning lamp does not come on or it remains on.
- The SRS warning lamp comes on while driving.

The SRS airbags and seat belt pretensioners are designed to help reduce the risk of serious injury or death in certain collisions. If either of the above conditions occurs, immediately have your vehicle checked by a MITSUBISHI MOTORS Authorized Service Point.

## SRS servicing

E00407901390

### ⚠ WARNING

- We recommend any maintenance performed on or near the components of the SRS to be performed by a MITSUBISHI MOTORS Authorized Service Point. Improper work on the SRS components or wiring could result in inadvertent deployment of the airbags, or could render the SRS inoperative; either situation could result in serious injury.

### ⚠ WARNING

- Do not modify your steering wheel, seat belt retractor or any other SRS components. For example, replacement of the steering wheel, or modifications to the front bumper or body structure can adversely affect SRS performance and lead to possible injury.
- If your vehicle has sustained any damage, we recommend you to have the SRS inspected to ensure it is in proper working order.
- On vehicles equipped with side airbags, do not modify your front seats, centre pillar and centre console. It can adversely affect SRS performance and lead to possible injury. If you found any tear, scratch, crack or damage to the seat fabric near the side airbag, the portion of the front and rear pillars and roof side rail, you should have the SRS inspected by a MITSUBISHI MOTORS Authorized Service Point.

### 📖 NOTE

- When you transfer ownership of the vehicle to some other person, we urge you to alert the new owner that it is equipped with the SRS and refer the new owner to the applicable section in this owner’s manual.

 **NOTE**

- If your vehicle has to be scrapped, do this in line with local legislation and contact a MITSUBISHI MOTORS Authorized Service Point to safely dismantle the airbag system.



## *Instruments and controls*

Instruments.....	5-02
Indication and warning lamps.....	5-08
Indication lamps.....	5-09
Warning lamps.....	5-10
Centre information display.....	5-12
Combination headlamps and dipper switch.....	5-34
Headlamp levelling.....	5-40
Turn-signal lever.....	5-42
Hazard warning flasher switch.....	5-42
Fog lamp switch.....	5-43
Wiper and washer switch.....	5-44
Wiper de-icer switch*.....	5-49
Rear window demister switch.....	5-50
Horn switch.....	5-50

## Instruments

E00500102896

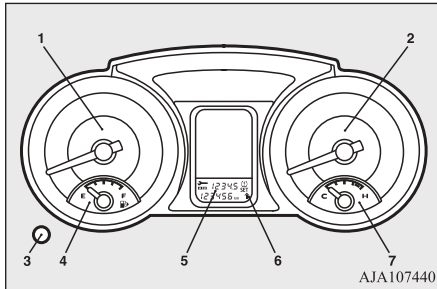

AJA107440

- 1- Speedometer (km/h or mph + km/h)
- 2- Tachometer
- 3- Tripmeter reset button/Daytime dipper button
- 4- Fuel gauge
- 5- Odometer/Tripmeter/Service reminder/ Tyre pressure monitoring system\*
- 6- Gearshift indicator → p. 6-17
- 7- Water temperature gauge

## Tachometer

E00500300458

The tachometer indicates the engine speed (r/min). The tachometer helps you to obtain more economical driving and also warns you of excessive engine speeds (Red zone).

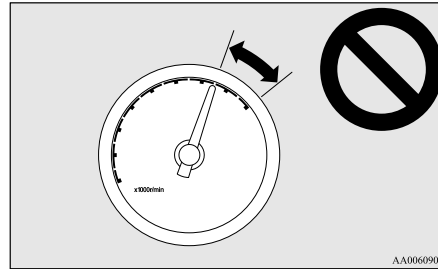

AA0060905

 **CAUTION**

- When driving, watch the tachometer to make sure that the engine speed indication does not rise into the red zone (excessive engine rpm).

**Odometer/Tripmeter/Service reminder/Tyre pressure monitoring system\***

E00500602237

With the ignition switch in the “ON” position, odometer, tripmeter, service reminder and tyre pressure monitoring system indications are given.

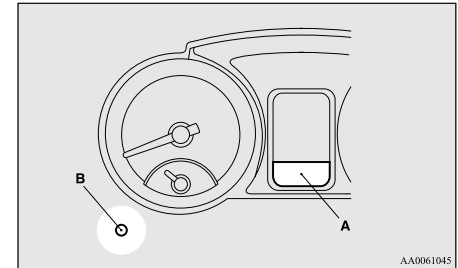

AA0061045

- A- Odometer/Tripmeter/Service reminder/ Tyre pressure monitoring system\*
- B- Reset button

Each time you press the reset button (B) less than 1 second, the display switches in the following order.

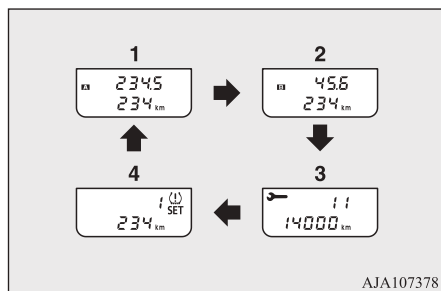

- 1- Odometer/Tripmeter **A**
- 2- Odometer/Tripmeter **B**
- 3- Service reminder
- 4- Tyre pressure monitoring system\*  
→ p. 6-48

### NOTE

- When the ignition switch is in the “ACC” or “LOCK” position or while driving, the tyre pressure monitoring system is not displayed even if you operate the reset button (B).

## Odometer

The odometer indicates the total distance the vehicle has travelled.

## Tripmeter

The tripmeter indicates the distance travelled during a particular trip or period.

There are two tripmeter displays: **A** and **B**. Tripmeter **A** can be used to measure the distance travelled since the current trip began. At the same time, Tripmeter **B** can be used to measure the distance from an intermediate location.

### NOTE

- If you do not push the button for about 10 seconds while the service reminder is showing, the display will return to the odometer indication.
- The odometer, tripmeter, and service reminder indications are given for 30 seconds after the ignition switch has been turned to the “ACC” or “LOCK” position.
- After the odometer, tripmeter, and service reminder indications have gone off, they come back on for about 30 seconds if either of the following actions takes place.
  - The driver’s door is opened.
  - The reset button is pressed.

### To reset the tripmeter

To return the display to “0”, press the reset button (B) for more than 2 seconds. Only the currently displayed value will be reset.

### NOTE

- When disconnecting the battery terminal for a long time, the memory of tripmeter display **A** and **B** are cleared, and the display returns to “0”.

## Service reminder

E00517701187

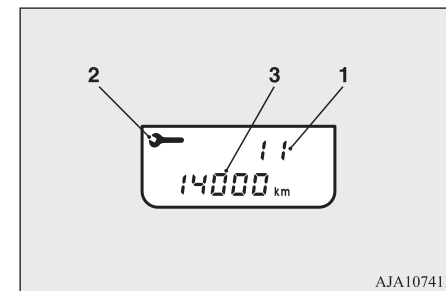

The service reminder shows the number of months (1) and driving distance (3) remaining until the next 12-monthly (15,000 km or 9,000 miles) inspection. When the next inspection is nearly due, the display shows “----”. At this time, a spanner mark (2) is shown for a few seconds whenever the ignition switch is turned from the “OFF” position to the “ON” position.

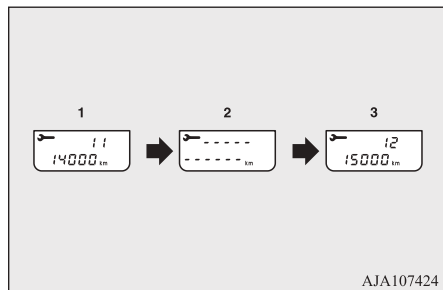

1. The display shows the number of months and driving distance remaining until the next inspection.
2. When the next inspection is nearly due, the display shows “-----”.

For further information, we recommend you to consult a MITSUBISHI MOTORS Authorized Service Point.

At this time, a spanner mark is shown for a few seconds whenever the ignition

switch is turned from the “OFF” position to the “ON” position.

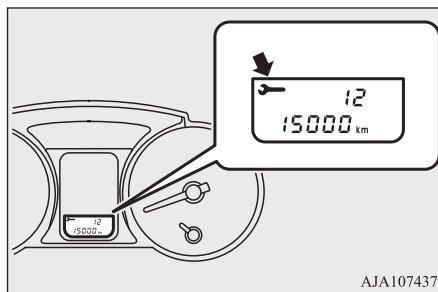

3. When the vehicle is inspected at a MITSUBISHI MOTORS Authorized Service Point, the number of months and driving distance remaining until the next inspection will be shown.

### Resetting the service reminder

With the ignition switch in the “OFF” position, it is possible to reset the spanner mark (A) and “-----” indication (B). When they have been reset, the number of months and driving distance remaining until the next inspection are shown and the spanner mark (A) is no longer shown every time the ignition switch is turned from the “OFF” position to the “ON” position.

### NOTE

- The indicated distance decreases in steps of 100 km or (100 miles). The indicated number of months decreases in steps of one month.
- It is possible to change the settings for the service reminder.

For further information, we recommend you to consult a MITSUBISHI MOTORS Authorized Service Point.

## Fuel gauge

E00500700856

The fuel gauge indicates the fuel level in the fuel tank when the ignition switch is in the “ON” position.

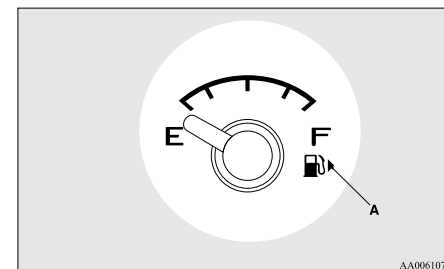

AA0061074

F- Full  
E- Empty

### CAUTION

- For petrol-powered vehicles, do not drive with an extremely low fuel level; running out of fuel could cause damage to the catalytic converter.
- For diesel-powered vehicles, do not drive with an extremely low fuel level; running out of fuel could cause damage to the fuel system.

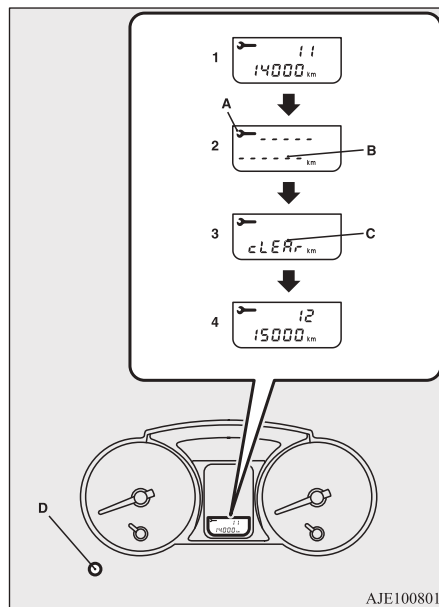

AJE100801

1. Push the reset button (D) to view the number of months and driving distance remaining until the next inspection.
2. Give the reset button (D) a long push (at least two seconds) to make the spanner mark (A) start flashing. (If you do not touch the reset button for 10 seconds while the spanner mark is flashing, the display will revert to its original indication.)

3. Give the reset button (D) a gentle push while the spanner mark is flashing. The “-----” indication (B) will change to “cLEAR” (C).
4. The number of months and driving distance remaining until the next inspection will be shown.

### CAUTION

- Daily and periodic inspections and maintenance are your responsibility. Be sure to perform them to help prevent accidents and breakdowns.

### NOTE

- It is not possible to reset the “-----” indication (B) with the ignition switch in the “ON” position.
- When a certain distance has been driven and a certain period has elapsed after appearance of the “-----” indication (B), the indication is automatically reset and the number of months until the next periodic inspection is shown.
- If you accidentally reset the display, consult a MITSUBISHI MOTORS Authorized Service Point.

## NOTE

- When the vehicle has been refuelled, the pointer in the fuel gauge takes a short while to stabilize.
- The fuel gauge will not give an accurate indication if the vehicle is refuelled with the ignition switch in the “ON” position.
- When the engine on diesel-powered vehicles fails to operate due to running out of fuel, it may sometimes be difficult to start after refueling. This is due to air entering the fuel system. Therefore, air must be bled from the system. (Refer to “Bleeding the fuel system” on page 8-06.)

## Fuel lid mark

The fuel lid mark (A) indicates that the fuel tank filler door is located on the right side of the vehicle.

## Low fuel warning lamp

E00508101778

The warning lamp (A) comes on when the fuel level is getting low (approx. 10 litres) with the ignition switch in the “ON” position. Refuel as soon as possible.

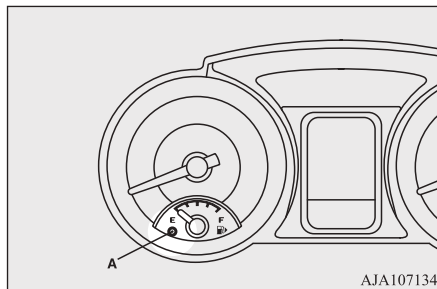

AJA107134

## NOTE

- On inclines or curves, due to the movement of fuel in the tank, the low fuel warning lamp may indicate incorrectly.

## Water temperature gauge

E00500801519

The water temperature gauge indicates the engine coolant temperature when the ignition switch is in the “ON” position.

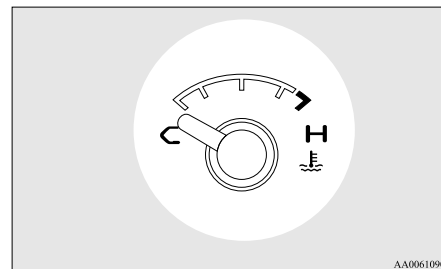

AA0061090

## CAUTION

- If the indication needle enters the H zone while the engine is running, it indicates that the engine is possibly overheating. Immediately park your vehicle in a safe place and make the necessary corrections. (Refer to “Engine overheating” on page 8-04.) While driving, care should always be taken to maintain the normal operating temperature.

## Daytime dipper button (meter illumination control)

E00508801674

Turn the dial to adjust the illumination (meter, centre information display, audio system's control panel, heater control panel, etc.) to the desired brightness.

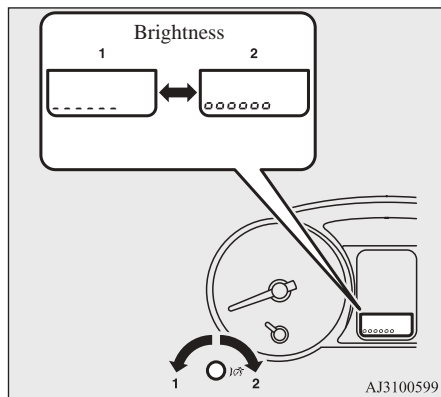

- 1- To reduce brightness
- 2- To increase brightness

### NOTE

- The meter brightness stays memorized.





- 25- Rear differential lock indication lamp\*  
→ p. 6-26
- 26- Door ajar warning lamp → p. 5-12
- 27- Odometer/Tripmeter/Service reminder/  
Tyre pressure monitoring system\*  
→ p. 5-02

- 28- Gearshift indicator\* → p. 6-17
- 29- “SONAR OFF” indication lamp\*  
→ p. 6-56
- 30- Tyre pressure monitoring system warn-  
ing lamp\* → p. 6-48

- 31- Sports mode indicator → p. 6-19
- 32- Selector lever position indication lamps  
 (“N” indication lamp is also used as A/T  
warning lamp) → p. 6-17

## Indication lamps

E00501600012

### Turn-signal indication lamps/ Hazard warning indication lamps

E00501700068

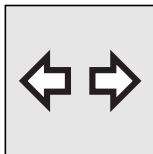

These indication lamps blink on and off when a turn-signal lamp is operating.



#### NOTE

- If the blinking is too fast, the cause may be a blown lamp bulb or a faulty turn-signal connection.

When the hazard warning lamp switch is pressed, all turn-signal lamps will flash on and off continuously.

### High-beam indication lamp

E00501800072

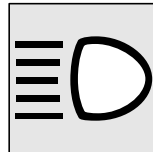

This indication lamp illuminates when the high-beam is used.

### Front fog lamp indication lamp\*

E00501901533



This indication lamp illuminates while the front fog lamps are on.

### Rear fog lamp indication lamp

E00502001254

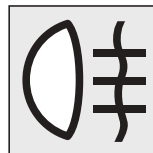



This indication lamp illuminates while the rear fog lamp is on.

### Position lamp indication lamp

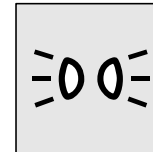
E00508900102



This lamp illuminates with the lamp switch at “” or “” position

### Diesel preheat indication lamp (diesel-powered vehicles)

E00502300146

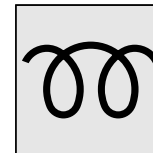

This indication lamp illuminates when the ignition switch is placed in the “ON” position. As the glow plug becomes hot, the lamp goes out and the engine can be

started.

**⚠ CAUTION**

- If the diesel preheat indication lamp comes on after the engine is started, the engine speed may not rise above the idling speed because of fuel freezing. In this case, keep the engine idling for about ten minutes, then turn off the ignition switch and immediately turn it on again to confirm that the diesel preheat indication lamp is off.

**📖 NOTE**

- If the engine is cold, the diesel preheat indication lamp is on for a longer time.
- When the engine has not been started within about 5 seconds after the diesel preheat indication lamp went out, return the ignition switch to the “LOCK” position. Then, turn the switch to the “ON” position to preheat the engine again.
- When the engine is warm, the diesel preheat indication lamp does not come on even if the ignition switch is placed in the “ON” position.

**Fuel filter indication lamp (diesel-powered vehicles)**

E00509901337



This indication lamp illuminates when the ignition switch is turned to the “ON” position and goes off after the engine has started. If it lights up while the engine is running, it indicates that water has accumulated inside the fuel filter; if this happens, remove the water from the fuel filter. Refer to “Removal of water from the fuel filter (diesel-powered vehicles only)” on page 8-06. When the lamp goes out, you can resume driving. If it either does not go out or comes on from time to time, we recommend you to have the vehicle inspected.

**Warning lamps**

E00502400017

**Brake warning lamp (brake warning buzzer)**

E00502501712



This lamp illuminates when the ignition switch is turned to the “ON” position, and goes off after a few seconds. Always make sure that the lamp goes off before driving.

With the ignition switch in the “ON” position, the brake warning lamp illuminates under the following conditions:

- When the parking brake lever has been engaged.
- When the brake fluid level in the reservoir falls to a low level.
- When the brake force distribution function or the brake system is not operating correctly.

**Brake warning buzzer**

When there is a danger of brake performance becoming compromised, a buzzer will sound to alert the driver. If this buzzer should continue to sound, park your vehicle in a safe place and we recommend you to have it checked.

**📖 NOTE**

- Depressing the brake pedal repeatedly may turn on the brake warning lamp, ABS warning lamp and brake warning buzzer. It is normal if the lamp goes out and the buzzer stops sounding after a few seconds.

**⚠ CAUTION**

- In the situations listed below, brake performance may be compromised or the vehicle may become unstable if brakes are applied

**CAUTION**

suddenly; consequently, avoid driving at high speeds or applying the brakes suddenly. Furthermore, the vehicle should be brought to a stop in a safe location and to have it checked.

- The brake warning lamp does not illuminate when the parking brake is applied or does not turn off when the parking brake is released.
- The ABS warning lamp and brake warning lamp illuminate at the same time. For details, refer to “ABS warning lamp” on page 6-38.
- The brake warning lamp remains illuminated during driving.
- The brake warning buzzer does not turn off.
- The vehicle should be brought to a halt in the following manner when brake performance has deteriorated.
  - Depress the brake pedal harder than usual. Even if the brake pedal moves down to the very end of its possible stroke, keep it pressed down hard.
  - Should the brakes fail, use engine braking to reduce your speed and pull the parking brake lever.
 Depress the brake pedal to operate the stop lamp to alert the vehicles behind you.

**NOTE**

- In certain cases immediately after the engine has been started or when the brake pedal is depressed repeatedly, a noise generated by operation of brake devices may be heard coming from the engine compartment. At this time, you may feel a shock from the brake pedal if you depress it. This type of noise or shock is normal and there is no need for concern. In fact, they indicate that the corresponding devices are operating normally.
- The brake system uses brake fluid pressurized by the pump. Please refer to “Braking” on page 6-35.

**Check engine warning lamp**

E00502603052

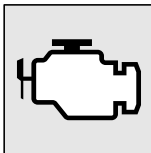

This lamp is a part of an on-board diagnostic system which monitors the emissions, engine control system or automatic transmission control systems.

If a problem is detected in one of these systems, this lamp illuminates. Although your vehicle will usually be drivable and not need towing, we recommend you to have the system checked as soon as possible.

[Vehicles to comply with the Euro 4 regulation]

This lamp will also illuminate for a few seconds when the ignition switch is turned to the “ON” position. If it does not go off after a few seconds, we recommend you to have the vehicle checked.

[Vehicles to comply with the Euro 5 and Euro 6]

This lamp will also illuminate when the ignition switch is turned “ON”, and goes off after the engine has started. If it does not go off after the engine has started, we recommend you to have the system checked.

**CAUTION**

- Prolonged driving with this lamp on may cause further damage to the emission control system. It could also affect fuel economy and drivability.
- If the lamp does not illuminate when the ignition switch is turned to the “ON” position, we recommend you to have the system checked.
- If the lamp illuminates while the engine is running, avoid driving at high speeds and we recommend you to have the system checked. Accelerator pedal and brake pedal response may be negatively influenced under these conditions.

**NOTE**

- The engine electronic control module accommodating the onboard diagnostic system has various fault data (especially about the exhaust emission) stored. This data will be erased if a battery cable is disconnected which will make a rapid diagnosis difficult. Do not disconnect a battery cable when the check engine warning lamp is ON.

**Charge warning display**

E00502700472

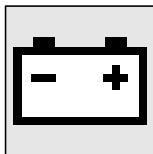

This lamp illuminates when the ignition switch is turned to the “ON” position, and goes off after the engine has started.

**CAUTION**

- If it illuminates while the engine is running, there is a problem in the charging system. In this case, immediately park your vehicle in a safe place and we recommend you to have it checked.

**Oil pressure warning lamp**

E00502800529



This lamp illuminates when the ignition switch is turned to the “ON” position, and goes off after the engine has started. If it illuminates while the engine is running,

the oil pressure is too low. Turn the engine off and have it inspected.

**CAUTION**

- This warning lamp does not indicate the amount of oil level in the engine. This must be determined by checking the oil level on the dipstick, while the engine is switched off.
- If this lamp illuminates when the engine oil level is not low, have it inspected.
- If you continue driving with low engine oil level or with this warning lamp illuminated, engine seizure may occur.

**Door ajar warning lamp**

E00503300635

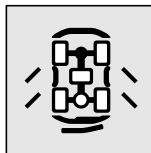

This lamp illuminates when a door or the backdoor is either open or incompletely closed.

If the vehicle speed reaches approximately 8 km/h (5 mph) with a door or the backdoor open or incompletely closed, the warning lamp flashes 8 times and a buzzer simultaneously sounds 8 times as a warning.

**CAUTION**

- Before moving your vehicle, check that the warning lamp is OFF.

**NOTE**

- On vehicles with keyless entry system, the lamp remains illuminated for a certain period and then goes out automatically.
- Buzzer settings can be changed at a your MITSUBISHI MOTORS Authorized Service Point to:
  - No buzzer operation (buzzer disabled)
  - Continuous buzzer operation

**Centre information display**

E00517801423

**CAUTION**

- The driver should not operate the display while the vehicle is in motion.

When the ignition switch is turned to the “ACC” position, the screen switches on automatically.

 **NOTE**

- Placing a cellular phone in the monitor's small storage compartment may weaken the phone's reception. This does not indicate a fault with the system.
- Use of wireless devices such as transceivers or a cellular phone near the monitor may

 **NOTE**

- make the following condition on the display. This does not indicate a fault with the system.
- The screen goes dark temporarily.
  - The compass may not show the correct direction.

 **NOTE**

- Depending on the angle of view, you may see reddish horizontal lines on the monitor. The lines are a characteristic of the vacuum fluorescent display (VFD) used in the monitor. They do not indicate a fault.

Type 1

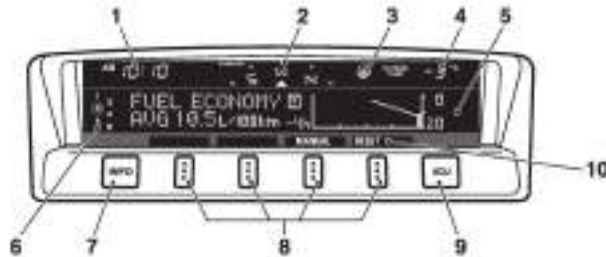

Type 2

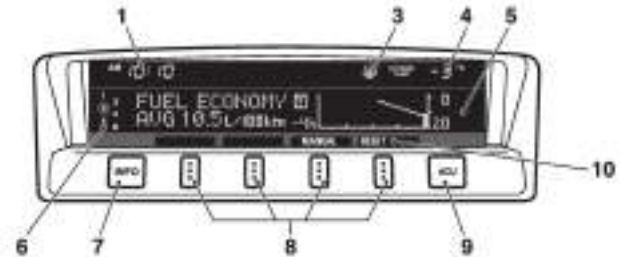

1- Digital clock → p. 5-22  
Indicates the time.

2- Electronic compass\*  
This display shows the direction of the vehicle.

3- Frozen road warning → p. 5-18  
Gives an indication when the outside temperature is 3 °C or lower.

4- Outside temperature → p. 5-18

5- Centre information display indications  
Indicates details of each display.

6- Disc number\*  
Shows the disc number. When no disc is inserted, it does not show a disc number.

7- "INFO" button  
Used to select various kinds of information for display.

8- Function buttons  
Press this button to select options shown in the display.

9- "ADJ" button  
Used for adjusting the clock and for selecting settings displays.

10- Display for function buttons  
This display shows the options available for each function button.

## Changing the information display

E00517901394

Every time the “INFO” button is pressed lightly, the display can be changed to the following:

5

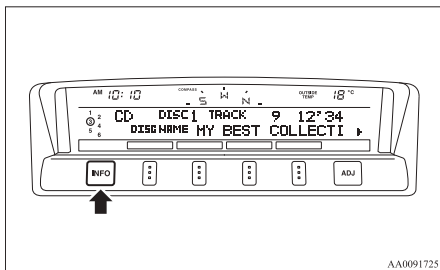

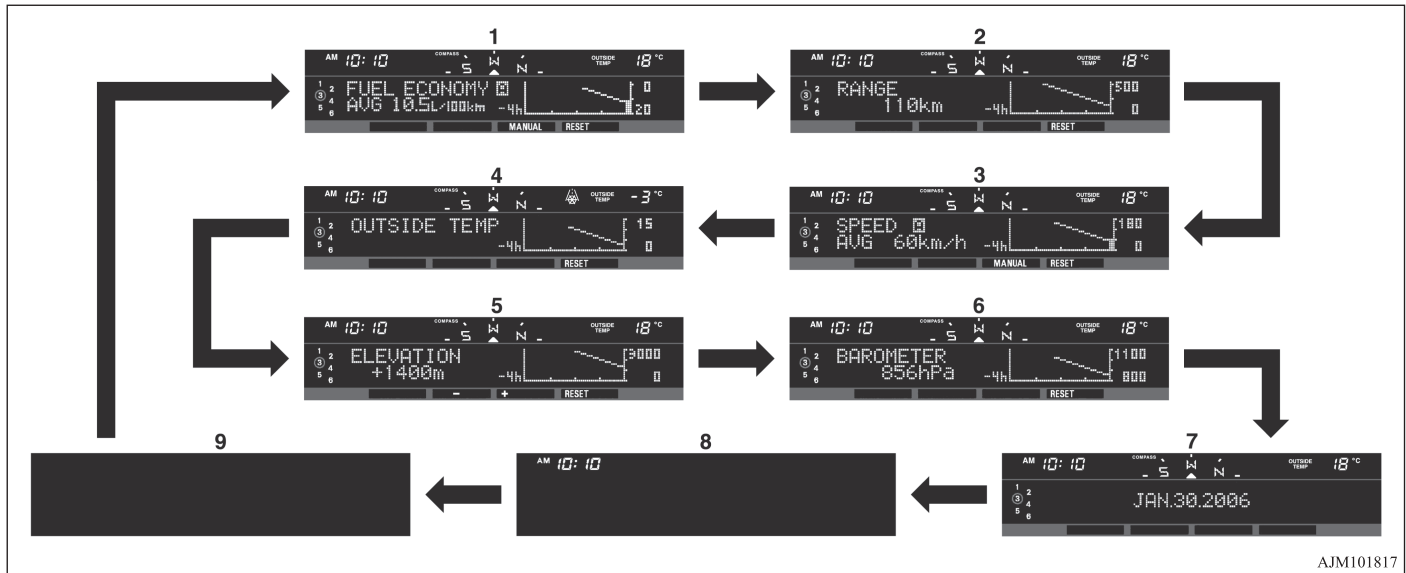

- 1- Average fuel consumption → p. 5-16
- 2- Driving range → p. 5-16
- 3- Average speed → p. 5-17
- 4- Outside temperature → p. 5-18
- 5- Altimeter → p. 5-19
- 6- Barometer → p. 5-20
- 7- Calendar → p. 5-20
- 8- Clock-only → p. 5-21
- 9- Blank → p. 5-21

## Average fuel consumption

E00518200238

The average fuel consumption during the period since the last reset is shown in (A) and the momentary fuel consumption in (C). The average value of the fuel consumption is graphed every 5 minutes and the data for up to 4 hours are shown in (B). When you press the “MANUAL” function button in the auto reset mode, the mode will be changed to the manual reset mode. When you press the “AUTO” function button in the manual reset mode, the mode will be changed to the auto reset mode.

5

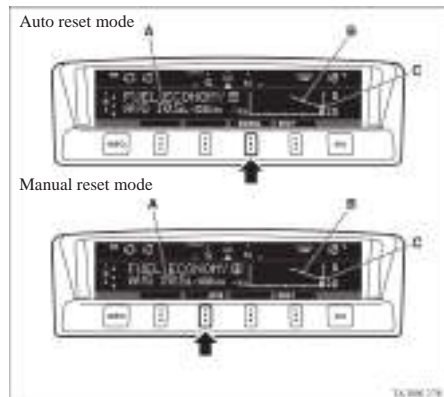

## NOTE

- When you turn the ignition switch to the “ON” position after turning it from the “ON” position to the “ACC” or “LOCK” position in the manual reset mode, the auto reset mode will automatically be selected.
- When the average fuel consumption cannot be calculated, “--.” will be shown.
- The average and momentary fuel consumption change depending on the driving condition (road condition, driving behavior, etc.). The indications may differ from the actual fuel consumption. Therefore, it is recommended to use the indications as reference.
- The unit indication can be changed to your desired setting {km/L, L/100 km, mpg (UK GALLON), or mpg (US GALLON)}. Refer to “User customization” on page 5-28.

## Resetting the average fuel consumption

Press the “RESET” function button to reset the average fuel consumption indication.



## NOTE

- The average fuel consumption can be reset separately for the auto reset mode and for the manual reset mode.
- When you turn the ignition switch to the “ON” position about 4 hours (or more) after turning it from the “ON” position to the “ACC” or “LOCK” position in the auto reset mode, the average fuel consumption indication will automatically be reset.

## Driving range

E00518300066

This value (A) shows the distance (in km or miles) that can be driven on the fuel remaining in the fuel tank. The driving range is graphed every 5 minutes and the data for up to 4 hours are shown in (B).

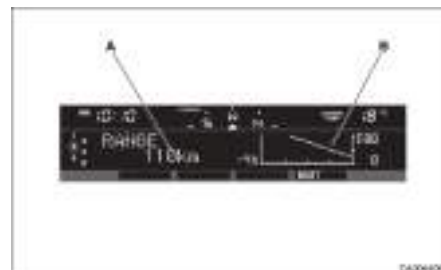



## NOTE

- When the driving range is 50 km (30 miles) or less, the display shows “----”. When it is 3,000 km (2,000 miles) or more, “3,000 km” or “2,000 miles” will be shown.
- When the driving range cannot be measured, the display shows “----”.
- The driving range is shown based on the accumulated fuel consumption data, however, may be changed depending on the driving condition (road condition, driving behavior, etc.). If the battery terminals are disconnected, the accumulated fuel consumption data will be erased. It is recommended to use the indication as reference.
- When the vehicle is fueled, the driving range will be updated. However, if the amount of fueling is small, the indication may not be correct. Therefore, fill up the tank as much as possible in case of fueling.
- When the vehicle is stopped on a steep slope, the value of the driving range may increase. This is caused by the fuel movement inside the tank on the slope and is not deemed as a failure.

## Resetting the driving range

Press the “RESET” function button to reset the driving range plotted in graph.

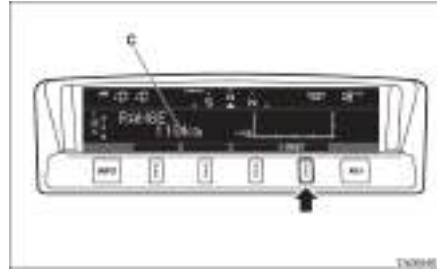

## NOTE

- Pressing the “RESET” function button will not reset the indication (C).
- It is possible to set the display unit to km or miles. Refer to “User customization” on page 5-28.

## Average speed

E00518400139

The average speed during the period since the last reset is shown in (A) and the momentary speed in (C). The average value of the vehicle speed is graphed every 5 minutes and the data for up to 4 hours are shown in (B).

When you press the “MANUAL” function button in the auto reset mode, the mode will be changed to the manual reset mode. When you press the “AUTO” function button in the manual reset mode, the mode will be changed to the auto reset mode.

Auto reset mode

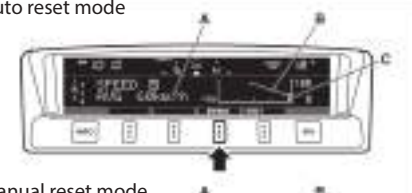

Manual reset mode

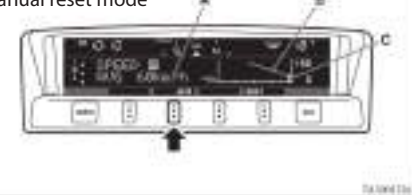

## NOTE

- When you turn the ignition switch to the “ON” position after turning it from the “ON” position to the “ACC” or “LOCK” position in the manual reset mode, the auto reset mode will automatically be selected.
- When the average speed cannot be calculated, “--” will be shown.

**NOTE**

- The average and momentary speed change depending on the driving condition (road condition, driving behavior, etc.). The indications may differ from the actual speed. Therefore, it is recommended to use the indications as reference.
- The unit indication can be changed to your desired setting (km/h or mph). Refer to “User customization” on page 5-28.

**Resetting the average speed**

Press the “RESET” function button to reset the average vehicle speed.

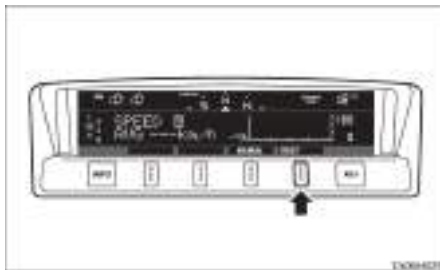

**NOTE**

- The average speed can be reset separately for the auto reset mode and for the manual reset mode.

**NOTE**

- When you turn the ignition switch to the “ON” position about 4 hours (or more) after turning it from the “ON” position to the “ACC” or “LOCK” position in the auto reset mode, the average speed indication will automatically be reset.

**Outside temperature**

E00518501111

The outside temperature is graphed every 5 minutes and the data for up to 4 hours are shown in (A). The current outside temperature is shown in (B).

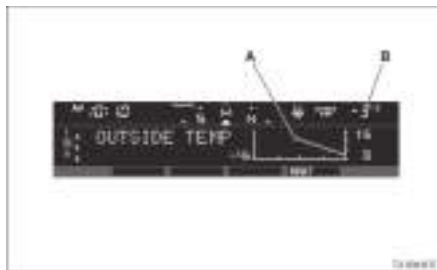

**Resetting the outside temperature**

Press the “RESET” function button to reset the graph of the outside temperature.



**NOTE**

- Depending on factors such as the driving conditions, the displayed temperature may vary from the actual outside temperature.
- It is possible to set the display unit to °C or °F. Refer to “User customization” on page 5-28.

**Frozen road warning**

E00537100034

This shows the temperature outside the vehicle.

When the outside air temperature drops below about 3 °C (37 °F), the alarm sounds and the outside air temperature warning symbol (A) flashes for about 10 seconds.

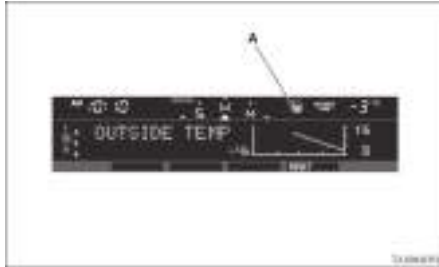

### CAUTION

- There is a danger the road might be icy, even when this symbol is not flashing, so please take care when driving.

## Altimeter

E00518600056

The current elevation in units of 50 m (200 ft) is shown in (A). The elevation is graphed every 5 minutes and the data for up to 4 hours are shown in (B).

### To adjust the elevation

It is possible to adjust the currently indicated elevation using the following function buttons:

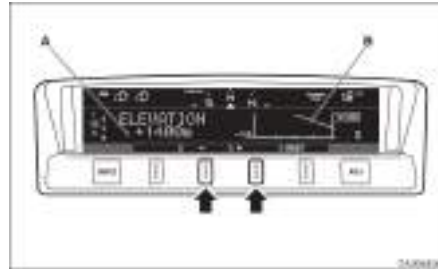

“+”-

#### Adjustment of elevation

The elevation increases by 50 m (200 ft) every time you lightly push the “+” button.

If you continue pressing the button for about 2 seconds or more, the elevation indication is fast-forwarded. Then the setting is changed to the elevation selected.

“-”-

#### Adjustment of elevation

The elevation decreases by 50 m (200 ft) every time you lightly push the “-” button.

If you continue pressing the button for about 2 seconds or more, the elevation indication is fast-forwarded. Then the setting is changed to the elevation selected.

### NOTE

- The elevation is determined from changes in atmospheric pressure. Depending on weather conditions, the indicated elevation may differ from the actual elevation. Variations in atmospheric pressure can cause different elevations to be shown even in the same location. This behavior does not indicate a fault. Use the indication as a guide only.

### Resetting the elevation

Press the “RESET” function button to reset the elevation plotted in graph.

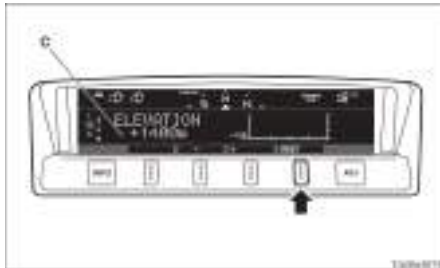

### NOTE

- Pressing the “RESET” function button will not reset the indication (C).
- It is possible to set the display unit to m or ft. Refer to “User customization” on page 5-28.

### Barometer

E00518700031

This display shows the atmospheric pressure at the present location in (A). The atmospheric pressure values are graphed every 5 minutes and the data for up to 4 hours are shown in (B).

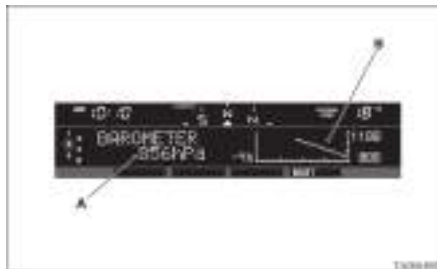

### Resetting the atmospheric pressure

Press the “RESET” function button to reset the atmospheric pressure plotted in graph.

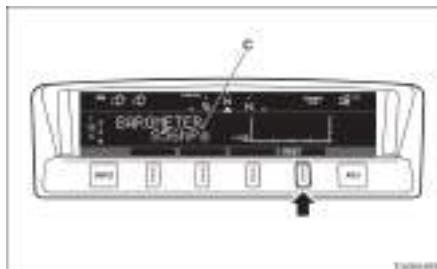

### NOTE

- Pressing the “RESET” function button will not reset the indication (C).
- It is possible to set the display unit to hPa, mb, kPa, or inHg. Refer to “User customization” on page 5-28.

### Calendar

E00518800029

The date is shown. The calendar pattern can be changed to your desired setting. Refer to “Changing the calendar setting” on page 5-26.



## Clock-only

E00518900017

Only the clock is shown. The time notation can be changed to your desired setting. (12 hour/24 hour) Refer to “User customization” on page 5-28.



## Blank

E00519001054

The whole display can be turned into blank. In this case, buttons remain illuminated.



## Selecting settings displays

E00519100061

Every time the “ADJ” button is pressed lightly, the display can be changed to the following:

### CAUTION

- The driver should not operate the display while the vehicle is in motion.
- When operating the system, stop the vehicle in a safe area.

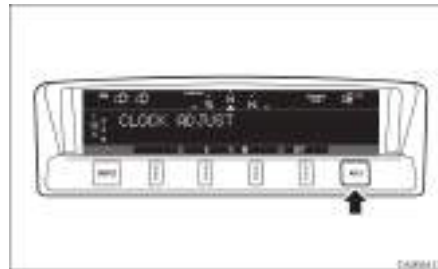

- 1- Changing the clock settings → p. 5-22
- 2- Adjusting the display brightness  
→ p. 5-22
- 3- Correcting the compass\* → p. 5-24
- 4- Changing the calendar setting  
→ p. 5-26
- 5- User customization → p. 5-28
- 6- Adjusting the barometer → p. 5-32

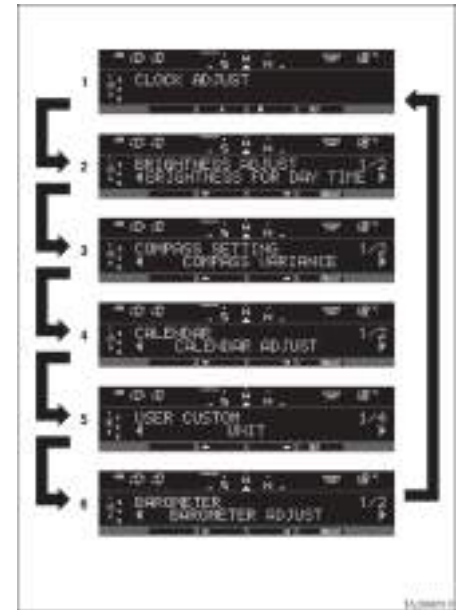

## Changing the clock settings

E00519201160

1. Press the “ADJ” button to select the clock setting display.

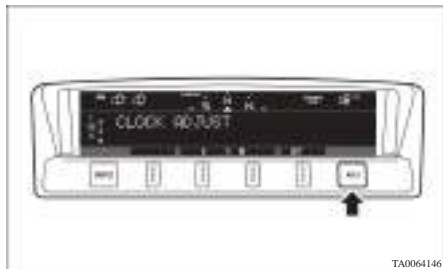

2. It is possible to adjust the clock using the function buttons.

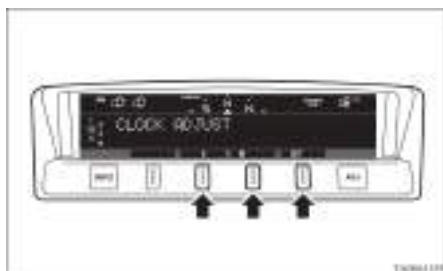

“H”- Adjust “hour”.  
The indication increases by one hour, every time you lightly press the “H” function button. If you continue pressing the button for about 2 seconds or more, the indication is fast-forwarded, and then the setting is changed to the hour selected.

“M”- Adjust “minute”.  
The indication increases by one minute, every time you lightly press the “M” function button. If you continue pressing the button for about 2 seconds or more, the indication is fast-forwarded, and then the setting is changed to the minute selected.

“SET” To reset the minutes to zero.  
- The time is adjusted as described below by pressing the function button “SET”.  
● 10:30-11:29 . . . . change to 11:00  
● 11:30-12:29 . . . . change to 12:00

In this occasion, the display flashes twice and then the setting is changed.

3. After making the adjustment, press the “INFO” button to select the information display.



 **NOTE**

- The time shown by the audio system may differ from that shown by the centre information display.

## Adjusting the display brightness

E00519300021

The display brightness can be adjusted at 13 levels for both daytime and nighttime.

- **BRIGHTNESS FOR DAY TIME**  
The display brightness is adjusted when the light switch is in the “OFF” position.
- **BRIGHTNESS FOR NIGHT TIME**  
The display brightness is adjusted when the light switch is in the “☰” or “☷” position.

1. Press the “ADJ” button to show the brightness adjusting display.

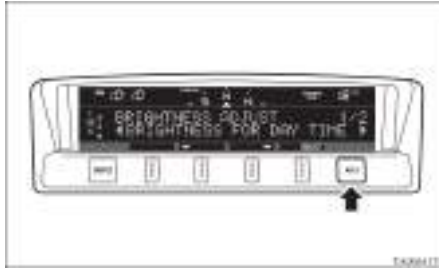

2. Press the “←” or “→” function button to select the setting you wish to adjust (daytime or nighttime). Then press the “SELECT” function button.

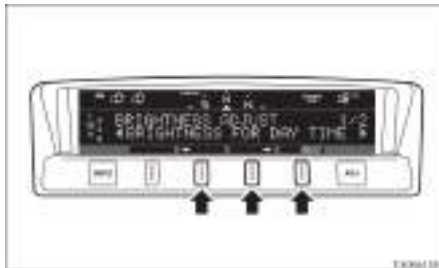

3. Use the function buttons to adjust the brightness.



- “+”- To make the display brighter  
The display becomes brighter by one step, every time you lightly press the “+” function button. If you continue pressing the button for about 2 seconds or more, the indication is fast-forwarded.

- “-”- To make the display darker  
The display becomes darker by one step, every time you lightly press the “-” function button. If you continue pressing the button for about 2 seconds or more, the indication is fast-forwarded.

“SET” To set the brightness

- Press function button “SET” to set the new brightness. The display will flash twice.

## NOTE

- If you next wish to adjust the other adjustment setting (daytime or nighttime), press the “ADJ” button or “BACK” function button.

4. After adjustment, press the “INFO” button to select the information display.



## NOTE

- As the display brightness can be adjusted in the center information display only, the brightness inside the meter cannot be changed.

## Correcting the compass\*

E00519401322

This compass shows the direction of the vehicle by the 8 azimuth system.



### NOTE

- This system uses the earth's magnetic field, and so may not show the correct direction depending on the traffic condition or in the following places where the earth's magnetic field is disrupted.
  - Car parks located in buildings and tunnels
  - Expressways and underground cables
  - Area over the subway
  - Transforming station
  - Areas along the railroad

In these cases, the correct direction will be displayed once the vehicle returns to a place where the earth's magnetic field is stable.

### NOTE

- Do not install ski racks, antennas, etc. which are attached to the vehicle by means of a magnet. They affect the operation of the compass.
- On vehicles equipped with the MITSUBISHI Multi Communication System (MMCS), even though the compass setting display is shown, correcting the compass of the MITSUBISHI Multi Communication System (MMCS) will not be possible.

### Setting the declination

The declination is the difference between true north (the direction of the geographic north pole) and where a compass needle points to. Since the declination varies from place to place, it needs to be set for each region. Otherwise the compass will not show the correct direction.

Set the declination by the following steps:

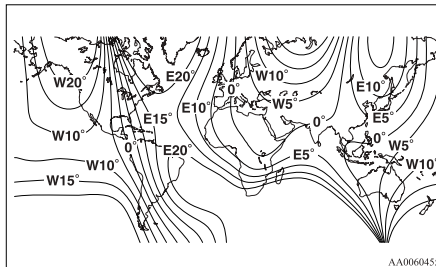

### NOTE

- The illustration above shows a correction value to input to the centre information display, it does not indicate the declination of the geomagnetic field.
- The default declination setting is 0 degrees. In accordance with the illustration, set the declination setting to the declination contour nearest to a region where you drive the vehicle.
- The declination can be set at intervals of 1 degrees, from 28 degrees west (W28) to 28 degrees east (E28).

With a settings display showing, press the "ADJ" button and select "COMPASS VARIANCE".

1. Press the function button for "SELECT".

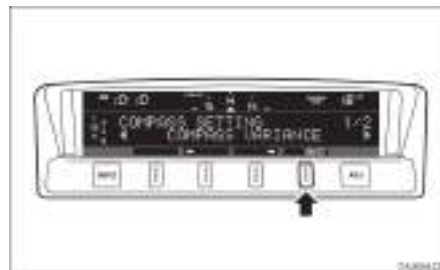

2. Press the function button for "←" or "→" to set the desired declination.



Pressing “←” or “→” for more than 1 second makes the value change rapidly.



3. When the declination adjustment has been completed, press the “SET” function button.



### Setting the compass

The compass is usually calibrated automatically when the vehicle is moving. At times when complete calibration is not possible, no compass indications are given. Manually set the compass using the following procedure.



### NOTE

- If your vehicle has a sunroof, keep the sunroof closed when calibrating the compass. Having the sunroof open when calibrating the compass could render the compass unable to correctly show directions.

With a settings display showing, press the “ADJ” button and select “COMPASS CALIBRATION”.

1. Press the function button for “SELECT”.



2. Press the function button for “SELECT”.



3. Turn the vehicle slowly through 360 degrees in a safe, open area with no buildings and other vehicles.



**NOTE**

- If you wish to stop calibrating the compass part-way through the procedure, press the "INFO" button or "ADJ" button.



**NOTE**

- The "Completed the calibration." message may be displayed even if you terminate the turn before it is complete and return to the vehicle's original direction. The compass may not be properly calibrated in this case, so you must turn the vehicle through at least 360 degrees.

4. The compass setting will finish automatically and the words "COMPASS CALIBRATION COMPLETE" will appear on the screen.



**NOTE**

- If your vehicle has a sunroof, do not open the sunroof when checking the indicated direction after completing the turn. Opening the sunroof could cause the azimuth bar shown on the centre information display to freeze because of electromagnetic interference. Be sure to check the indicated direction with the sunroof closed. If the azimuth bar freezes, perform the compass calibration procedure again.

**Changing the calendar setting**

E00519500023

The date and the calendar indication patterns can be changed.

**Date setting**

1. Press the "ADJ" button to select the calendar setting display.



2. Press the “←” or “→” function button to select “CALENDAR ADJUST”. Then press the “SELECT” function button.



3. Use the function buttons to set the calendar.



“→”- Select “YEAR”, “MONTH”, “DAY” you wish to change. “YEAR”, “MONTH”, and “DAY” are changed over by turns every time you lightly press the “→” function button.

“+”- Change “YEAR”, “MONTH”, “DAY” you have selected. The indication is changed to your desired date every time you lightly press the “+” function button. If you continue pressing the button for about 2 seconds or more, the indication is forwarded.

“SET”- Determine the date. Press the “SET” function button. Then the display flashes twice and the setting is changed.

#### NOTE

- The year changes in the following sequence: 2006 → 2007 → ... 2099 → 2006.
- You can return to the previous display by pressing the “BACK” function button.

4. After setting the date, press the “INFO” button to return to the information display.



#### Changing the calendar pattern

1. Press the “ADJ” button to select the calendar setting display. Press the “←” or “→” function button to select “CALENDAR PATTERN SELECT”. Then press the “SELECT” function button.

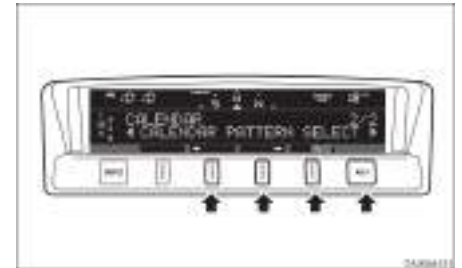

- Press function button “←” or “→” to select your desired indication pattern.

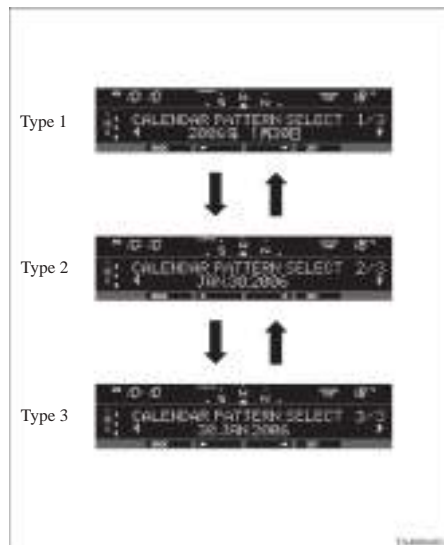

- Press the function button “SET”. The display will flash twice, and the indication pattern will be updated.



**NOTE**

- You can return to the previous display by pressing the “BACK” function button.

- After setting the calendar pattern, press the “INFO” button to return to the information display.

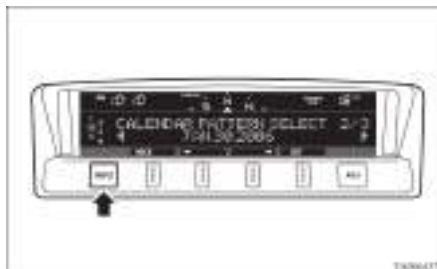

## User customization

E00519600196

You can set the indication of unit, language, and the time notation.

In addition, you can return these settings to the factory default settings.

### Selecting the item to set

- Press the “ADJ” button to select the user customization display.

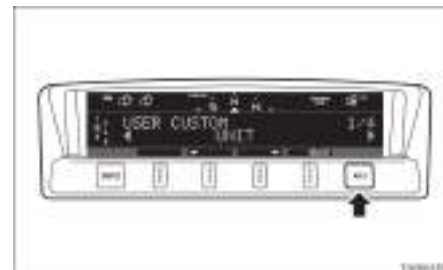

- Press the function button “←” or “→” to select the item you wish to set.
  - “UNIT”: Changing the unit
  - “LANGUAGE”: Changing the language
  - “12h ↔ 24h”: Changing the time format
  - “DEFAULT”: Resetting to factory settings

Push the function button “SELECT”.  
The setting display for your selected item will appear.



### Changing display units

It is possible to change the display units for the fuel consumption, driving range, average speed, outside temperature, elevation, and atmospheric pressure as shown below.

FUEL ECONOMY	km/L → L/100 km → mpg (UK GALLON) → mpg (US GALLON)
RANGE	km → miles
SPEED	km/h → mph
OUTSIDE TEMPERATURE	°C → °F
ELEVATION	m → ft
BAROMETER	hPa → mb → kPa → inHg

- Changing the display unit for fuel consumption

1. Press the “←” or “→” function button to select “FUEL ECONOMY”. Then press the “SELECT” function button.



2. Press the “←” or “→” function button to select “km/L”. Then press the “SET” function button. The display will flash twice, and the display unit will be updated to the selected one.



### NOTE

- You can return to the previous display by pressing the “BACK” function button.

3. After setting, press the “INFO” button to return to the information display.



### Changing the language

It is possible to set the display language of the centre information display.

- To change the display language to English

1. Press the “←” or “→” function button to select “ENGLISH”. Then press the “SET” function button. The display will flash twice, and then the setting is completed to the language selected.



### NOTE

- You can return to the previous display by pressing the “BACK” function button.

2. After setting the language, press the “INFO” button to return to the information display.



### Changing the time notation

It is possible to set the time notation to 12-hour or 24-hour.

1. Press the “←” or “→” function button to select “12h TIME NOTATION” or “24h TIME NOTATION”. Then press the “SET” function button. The display will flash twice, and the display time notation will be updated to the selected one.

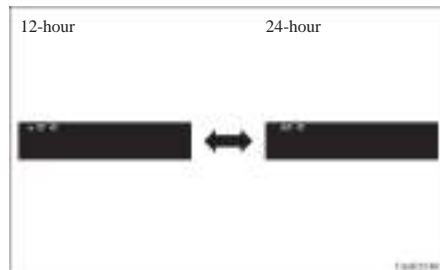

### NOTE

- You can return to the previous display by pressing the “BACK” function button.

2. After setting the time notation, press the “INFO” button to return to the information display.



### Returning display items to their factory settings

You can return the setting of each item to the factory default settings.

#### NOTE

- The factory settings are as follows:
  - Fuel consumption: L/100 km
  - Driving range: km
  - Average speed: km/h
  - Outside temperature: °C
  - Elevation: m
  - Atmospheric pressure: hPa
  - Display language: English
  - Time notation: 12-hour

1. Push the “SELECT” function button.



2. Press the “←” function button to select “YES”.



3. Press the “SELECT” function button.



4. Once more press the “←” function button to select “YES”.

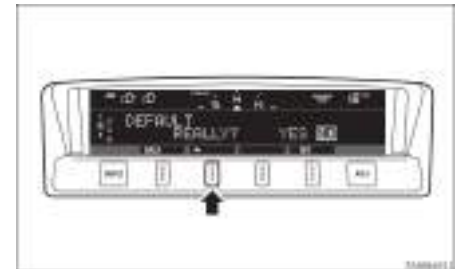

5. Press the “SET” function button.

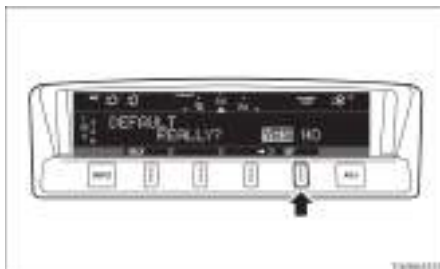

6. The display shown below will appear, and the display items will return to their factory settings.



### NOTE

- If the battery terminals are disconnected, the settings for the date and time may be erased. If this happens, please set the date and time again.

## Adjusting the barometer

E0052440020

It is possible to adjust the barometer indication and return it to the factory setting.

### NOTE

- It is not necessary to adjust the barometer because it has been adjusted at the factory. However, if you wish, adjust it using an accurate barometer.

### To adjust the barometer

1. Press the “ADJ” button to select the barometer adjustment display.



2. Press the “←” or “→” function button to select the “BAROMETER ADJUST” display. Then press the “SELECT” function button.



3. Adjust the barometer by pressing the function buttons.

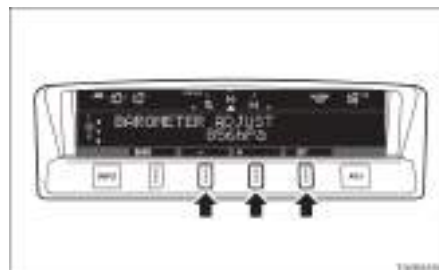



“+”- To adjust the barometer  
Each gentle press of the “+” function button will increase the indicated barometer by 2 hPa. If you continue pressing the button for about 2 seconds or longer, the indication is fast-forwarded.

“-”- To adjust the barometer  
Each gentle press of the “-” function button will decrease the indicated barometer by 2 hPa. If you continue pressing the button for about 2 seconds or longer, the indication is fast-forwarded.

“SET” To set the barometer  
- Press the “SET” function button. The display will flash twice, and the new setting will be established.

#### NOTE

- You can return to the previous display by pressing the “BACK” function button.

4. After setting the barometer adjust, press the “INFO” button to return to the information display.



#### Resetting to the factory setting

1. Press the “ADJ” button to select the barometer adjustment display. Press the “←” or “→” function button to select the “BAROMETER DEFAULT” display. Then press the “SELECT” function button.



2. Press the “SET” function button. The display will flash twice and the barometer indication will return to the factory settings.

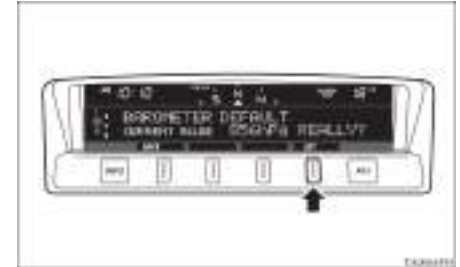

#### NOTE

- Although the barometer value is changed to the factory setting, a barometer unit you have selected is unchanged.
- You can return to the previous display by pressing the “BACK” function button.

## Combination headlamps and dipper switch

3. After setting the barometer default, press the “INFO” button to return to the information display.



### Care of the monitor

E0051970012

If the monitor becomes covered in fingerprints or otherwise dirty, clean it with a soft and dry cloth.

#### NOTE

- Don't use a wet cloth or abrasive cleaner as this may cause damage.

## Combination headlamps and dipper switch

E00506003621

### Headlamps

#### NOTE



- Do not leave the lights on for a long time while the engine is stationary (not running). A rundown battery could result.
- When it rains, or when the vehicle has been washed, the inside of the lens sometimes becomes foggy, but this does not indicate a functional problem. When the lamp is switched on, the heat will remove the fog. However, if water gathers inside the lamp, we recommend you to have it checked.

### Type 1

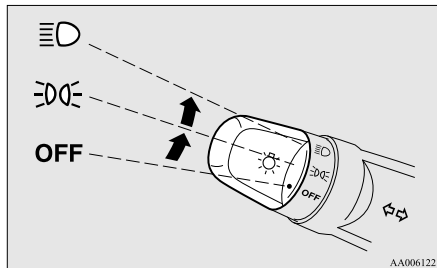
Rotate the switch to turn on the lamps.



AA0061221

OFF	All lamps off {except day-time running lamps (if so equipped)}
	Position, tail, licence plate and instrument panel lamps on
	Headlamps and other lamps go on

### Type 2

Rotate the switch to turn on the lamps.

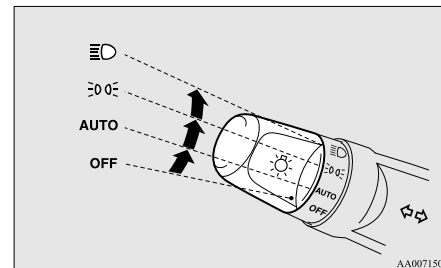

AA0071501

OFF	All lamps off {except day-time running lamps (if so equipped)}
-----	--

## Daytime running lamps\*

E00530601109

The daytime running lamps come on when the engine is running and the lamp switch is in the “OFF” or “AUTO” position and the tail lamps are off.

### NOTE



- If the lamp switch is in the “OFF” or “AUTO” position, or if the tail lamps are on when the lamp switch is in the “AUTO” position, the daytime running lamps come on as position lamps.

## Lamps (headlamps, fog lamp, etc.) auto-cutout function

E00532700178

- If the ignition key is turned to the “LOCK” or “ACC” position or removed from the ignition switch, and without opening the driver’s door for 3 minutes with the lamp switch in the “AUTO” position, the lamps will turn off automatically.
- If the ignition key is turned to the “LOCK” or “ACC” position or removed from the ignition switch and the driver’s door is opened within 3 minutes with the lamp switch in the “AUTO” position, a buzzer will sound to warn the driver that the lamps have not been turned off, and these lamps will automatically turn off.

Instruments and controls 5-35

AUTO	With the ignition switch in the “ON” position, headlamps, position, tail, licence plate, and instrument panel lamps turn on and off automatically in accordance with outside light level. {Daytime running lamps (if so equipped) will be turned on while the tail lamps are off.} All lamps turn off automatically when the ignition switch is turned to the “OFF” position.
	Position, tail, licence plate and instrument panel lamps on
	Headlamps and other lamps on

### NOTE

- The sensitivity of the automatic on/off control can be adjusted.  
For further information, we recommend you to consult a MITSUBISHI MOTORS Authorized Service Point.

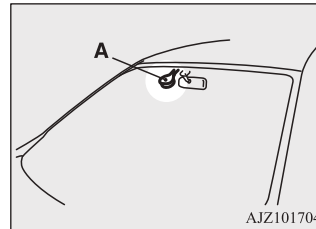

### NOTE

- When the headlamps are turned off by the automatic on/off control with the ignition switch in the “ON” position, the front fog lamps (if so equipped) and rear fog lamp also go off. When the headlamps are subsequently turned back on by the automatic on/off control, the front fog lamps also come on but the rear fog lamp stays off. If you wish to turn the rear fog lamp back on, operate the switch again.
- Do not cover the sensor (A) for the automatic on/off control by affixing a sticker or label to the windscreen.





- If the lamps do not turn on or off with the switch in the “AUTO” position, manually operate the switch and we recommend you to have your vehicle checked.

**NOTE**

- The lamp auto-cutout will not function when the lamp switch is in the “” position
- When the ignition key has been turned to either the “LOCK” or “ACC” position or removed from the ignition switch with the lamp switch in the “” position, and the lamp switch is returned to the “OFF” within approximately 3 minutes, the auto-cutout function will not be activated.

**When you want to keep the lamps on**

- Turn the lamp switch in the “OFF” position while the ignition switch is in the “LOCK” or “ACC” position.
- Turn on the lamps with the switch in the “” or “” position again, then the lamps will remain on.
- Remove the ignition key.

**NOTE**

- For further information, we recommend you to consult a MITSUBISHI MOTORS Authorized Service Point.

**Lamp monitor buzzer**

E00506100256

If the driver’s door is opened when the key is in the “LOCK” or “ACC” position or removed from the ignition switch while the lamps are on, a buzzer will sound to remind the driver to turn off the lamps.

When the lamp auto-cutout function acts, the buzzer will stop automatically.

**Dipper (High/Low beam change)**

E00506201586

When the lamp switch is in the “” position, the beam changes from high to low (or low to high) each time the lever is pulled fully (1). While the high-beam is on, the high-beam indication lamp in the instrument cluster will also illuminate.

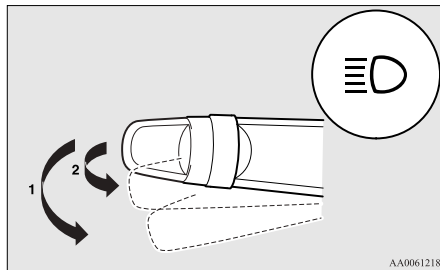

**NOTE**

- On vehicles equipped with the automatic high-beam system, if you press the ON side of the automatic high-beam system switch when high-beam is on, automatic high-beam system will be activated.

**Automatic high-beam system\***

E00538200074

The system switches the headlamp beams (high/low) when the automatic high-beam system camera (A) senses a illuminant such as lights of a vehicle in front or oncoming vehicle or a street lamp.

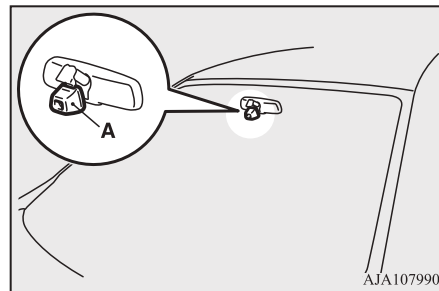

**⚠ WARNING**

- The headlamp beams (high/low) may not be switched automatically under certain circumstances. Do not overestimate the system. It is the responsibility of the driver to switch the headlamp beams (high/low) manually to suit each driving condition. Refer to “Dipper (High/Low beam change)” on page 5-36.

**How to use the automatic high-beam system**

1. Press the ON side (1) on the automatic high-beam system switch.

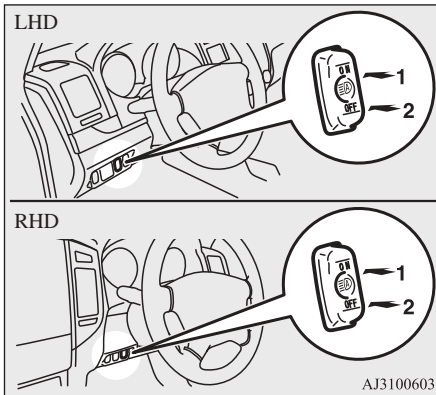

1- ON

2- OFF

2. Rotate the lamp switch to “ ” position or “AUTO” (vehicles with the automatic lamp control) position.

**📖 NOTE**

- The automatic high-beam system works only when the headlamps are on with the lamp switch in the “AUTO” position. (Vehicles with automatic lamp control)

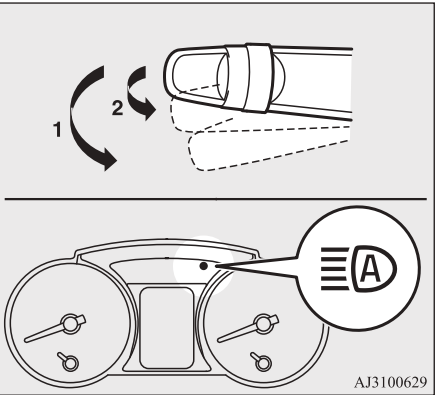

4. The system switches the headlamp beams (high/low) automatically to suit each driving condition.

**📖 NOTE**

- The high-beam indication lamp illuminates when the high-beam is on. Refer to “High-beam indication lamp” on page 5-09.

## NOTE

- You can switch the headlamp beams (high/low) manually by operating the lever even if the automatic high-beam system is working. Refer to “Dipper (High/Low beam change)” on page 5-36.
- If the lever is operated manually, the automatic high-beam system indication lamp will go off and the automatic high-beam system will be deactivated.
- The automatic high-beam system is not deactivated when you pull the lever slightly (2).

5. To deactivate the automatic high-beam system, press the OFF side (2) on the automatic high-beam system switch.

## Automatic switching conditions

The high-beam headlamps illuminate when all of the following conditions are met:

- Your vehicle speed exceeds approximately 40 km/h (25 mph).
- It is dark ahead of your vehicle.
- There are no vehicles in front or oncoming vehicles, or none of their exterior lamps are illuminated.

The low beam headlamps illuminate when any of the following conditions occur:

- Your vehicle speed does not exceed approximately 30 km/h (19 mph).
- It is bright ahead of your vehicle.
- An exterior lamp of a vehicle in front or oncoming vehicle is illuminating.

## NOTE

- The headlamps may not be switched from high-beam to low beam under the following circumstances:
  - A vehicle in front or oncoming vehicle is hindered by any object such as continuous bends, elevated median/island, traffic signs, roadside trees.
  - Your vehicle passes an oncoming vehicle suddenly on a bend with poor visibility.
  - Another vehicle crosses ahead of your vehicle
- The headlamps may remain at low beam (or be switched from high-beam to low beam) when a reflective object (e.g. street lamp, traffic signal, noticeboard and signboard) reflects light.
- Any of the following factors may influence the headlamp beam switching timing:
  - How brightly the exterior lamps of a vehicle in front or oncoming vehicle illuminate.
  - Movement or direction of a vehicle in front or oncoming vehicle.
  - Only right or left exterior lamp of a vehicle in front or oncoming vehicle is illuminating.

## NOTE

- A vehicle in front or oncoming vehicle is a motorcycle.
- Road conditions (gradient, bends and road surface).
- The number of occupants and luggage load.
- The automatic high-beam system recognises environmental conditions by sensing a light source ahead of your vehicle. Therefore, you may feel like something is not quite right when the headlamp beams are switched automatically.
- The system may not detect a light vehicle such as a bicycle.
- The system may not detect an ambient brightness precisely. This causes the traffic to be dazzled by high-beam or the low beam to be maintained. In such cases, you should switch the headlamp beams manually.
  - In bad weather (heavy rain, fog, snow or sandstorm).
  - The windscreen is dirty or fogged up.
  - The windscreen is cracked or broken.
- The inside rear view mirror or the camera is deformed or dirty.
- A light, which is similar to the headlamps or tail lamps, is shining around your vehicle
- A vehicle in front or oncoming vehicle is driven without lights, the exterior lamps are dirty or discoloured, or the direction of the headlamp beams is adjusted improperly

**NOTE**

- It becomes dark and bright suddenly and continuously around your vehicle.
- Your vehicle is driven on uneven surfaces.
- Your vehicle is driven on a winding road.
- A reflective object such as a noticeboard or a mirror reflects a light ahead of your vehicle
- The rear end of a vehicle in front (such as a container truck) reflect a strong light.
- Your vehicle's headlamp is broken or dirty.
- Your vehicle is inclined due to a flat tyre or towing.
- The automatic high-beam system warning lamp comes on.
- Observe the precautions below to maintain good usage conditions:
  - Do not touch the camera lens.
  - Do not subject the inside rear view mirror and the camera to strong impact. Do not spill any liquid over them.
  - Do not attempt to disassemble the camera.
  - Do not affix a sticker or label on the windscreen near the camera.
  - Do not place any objects on the instrument panel.
  - Do no hang any accessories around the inside rear view mirror or the camera.
  - Avoid overload.
  - Do not modify your vehicle.
  - When the windscreen is replaced, use the MITSUBISHI MOTORS genuine parts.

**Automatic high-beam system warning lamp**

E00538300046

The automatic high-beam system warning lamp (yellow) will illuminate when the automatic high-beam system detects any fault when the ignition switch is in the "ON" position.

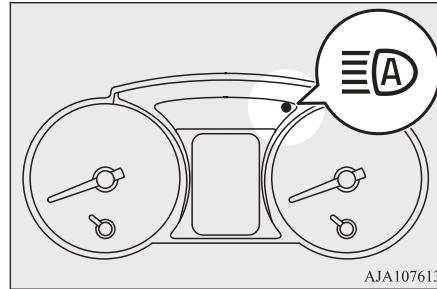

AJA107613

**CAUTION**

- If the warning lamp comes on, we recommend you to have the system checked.

**NOTE**

- If the warning lamp comes on, press the OFF side (2) on the automatic high-beam system switch to deactivate the system. It is the responsibility of the driver to switch the headlamp beams (high/low) manually to suit each driving condition. Refer to "Dipper (High/Low beam change)" on page 5-36.

**Headlamp flasher**

E00506300128

The high-beams flash when the lever is pulled slightly (2), and will go off when it is released.

When the high-beam is on, the high-beam indication lamp in the instrument cluster will illuminate.

**NOTE**

- The high-beams can also flash when the lamp switch is OFF.
- If you turn the lamps off with the headlamps set to high-beam, the headlamps are automatically returned to their low-beam setting when the lamp switch is next turned to the "☰" position.

## Headlamp levelling

E0051740015

## Headlamp levelling switch\*

E00517501970

### Except for vehicles with discharge headlamps

The angle of the headlamp beam varies depending on the load carried by the vehicle.

The headlamp levelling dial can be used to adjust the headlamp illumination distance (when the lower beam is illuminated) so that the headlamps' glare does not distract other drivers.

Set the dial according to the following table.

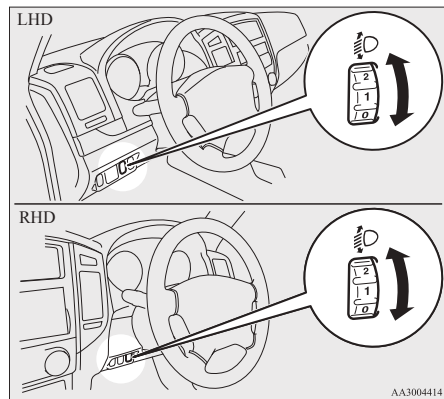

### CAUTION

- Always perform adjustments before driving. Do not attempt to adjust while driving, as it could cause an accident.

### NOTE

- When adjusting the beam position, first put the dial in the "0" position (the highest beam position).

### 3-door models

Vehicle condition	Switch position
	"0"
	"0"
	"2"
	"3"

Vehicle condition	Switch position
	"4"

- : 1 person
- : Full luggage loading

Switch position 0- Driver only/ Driver + 1 front passenger

Switch position 2- 5 passengers (including driver)

Switch position 3- 5 passengers (including driver) + Full luggage loading





Switch position 4- Driver + Full luggage loading

### 5-door models

Except for vehicles with only the front seats

Vehicle condition	Switch position
	"0"



Vehicle condition	Switch position
	“0”
	“1”
	“2”
	“3”
	“3” or “4”

●: 1 person

▨: Full luggage loading

Switch position 0- Driver only/ Driver + 1 front passenger

Switch position 1- Driver + 1 front passenger + 2 passengers on third seat

Switch position 2- 7 passengers (including driver)

Switch position 3- 7 passengers (including driver) + Full luggage loading/ Driver + Full luggage loading  
{Vehicles except for Russia, Kazakhstan, Belarus, Ukraine and Azerbaijan}

Switch position 4- Driver + Full luggage loading  
{Vehicles for Russia, Kazakhstan, Belarus, Ukraine and Azerbaijan}

Switch position 0- Driver only

Switch position 4- Driver + Full luggage loading



### Automatic headlamp levelling\*

E00517601577

This function automatically adjusts the illumination distance of the headlamps according to the number of people and the load in the vehicle.

When the ignition switch is in the “ON” position and the lamp switch is in the “” position, the illumination distance of the headlamps is automatically adjusted when the vehicle is stopped.

#### Vehicles with only the front seats

Vehicle condition	Switch position
	“0”
	“4”

●: 1 person

▨: Full luggage loading

## Automatic headlamp levelling warning lamp

E00525901045

The automatic headlamp levelling warning lamp should illuminate when the ignition switch is turned “ON”, and should go off in a few seconds.

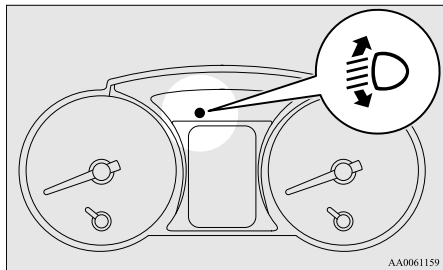

AA0061159

### ⚠ CAUTION

- If the warning lamp stays on or does not illuminate when the ignition switch is turned “ON”, it indicates that the automatic headlamp levelling device is not functioning. We recommend you to have your vehicle inspected.

## Turn-signal lever

E00506500928

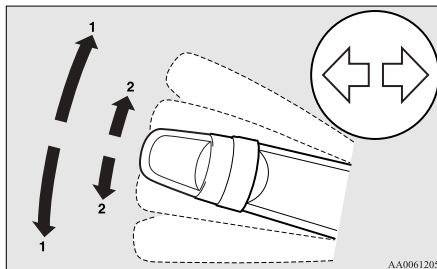

AA0061205

### 1- Turn-signals

When making a normal turn, use position (1). The lever will return automatically when cornering is completed.

### 2- Lane-change signals

When changing lanes, use position (2). It will return to the neutral position when released.

Also, when you move the lever to (2) slightly then release it, the turn-signal lamps and indication lamp in the instrument cluster will flash 3 times.

### 📖 NOTE

- If the lamp flashes unusually quickly, the bulb in a turn-signal lamp may have burned out. We recommend you to have the vehicle inspected.

### 📖 NOTE

- It is possible to activate the following functions. For further information, we recommend you to consult a MITSUBISHI MOTORS Authorized Service Point.
  - Sounding of a buzzer as the turn-signal lamps flash.
  - Flashing of the turn-signal lamps when the lever is operated with the ignition switch in the “ACC” position.
  - The turn-signal lamps 3-flash function for lane changes can be deactivated.
  - The time required to operate the lever for the 3-flash function can be adjusted.

## Hazard warning flasher switch

E00506600440

Use the hazard warning flasher switch when the vehicle has to be parked on the road for any emergency.

The hazard warning flashers can always be operated, regardless of the position of the ignition key.

Push the switch to turn on the hazard warning flashers, all turn-signal lamps flash continuously.

To turn them off, push the switch again.

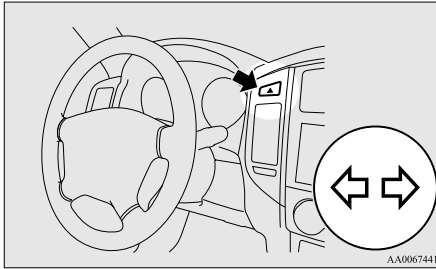

### NOTE

- It is possible for a buzzer to sound with flashing of the turn-signal lamps. For further information, we recommend you to consult a MITSUBISHI MOTORS Authorized Service Point.

## Fog lamp switch

E00506700047

### Front fog lamp switch\*

E00508301839

The front fog lamps illuminate only when the headlamps or tail lamps are on. Push the switch to turn on the front fog lamps, and push the switch again to turn them off.

The indication lamp in the instrument cluster will illuminate while the front fog lamps are on.

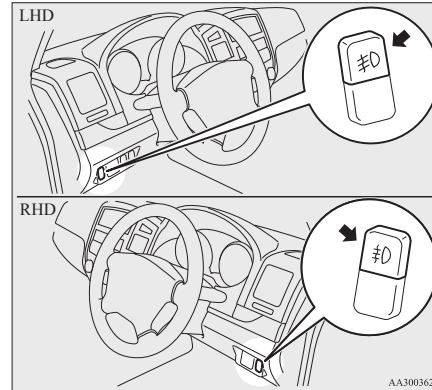

### NOTE

- The front fog lamps are automatically turned off when the headlamps or tail lamps are turned off. To turn on the front fog lamps again, push the switch again when the headlamps or tail lamps turn on.
- Do not use fog lamps except in conditions of fog, otherwise excessive lamp glare may temporarily blind oncoming vehicle drivers.

## Rear fog lamp switch

E00508401856

The rear fog lamp illuminates only when the headlamps or front fog lamps (if so equipped) are on.

Push the switch to turn on the rear fog lamp, and push the switch again to turn it off.

The indication lamp in the instrument cluster will illuminate while the rear fog lamp is on.

### Type 1

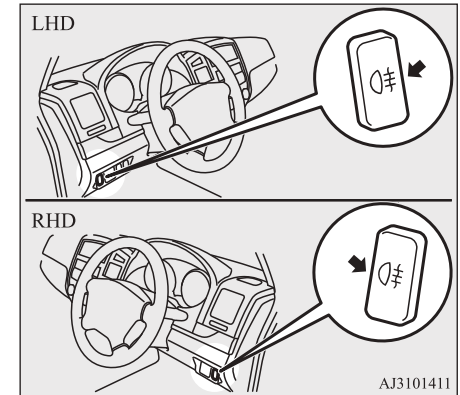

## Type 2

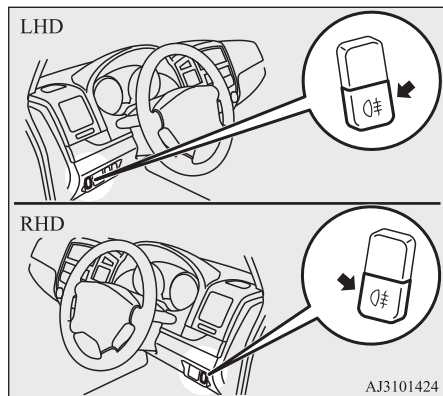

5

### NOTE

- The rear fog lamp is automatically turned off when the headlamps or front fog lamps (if so equipped) are turned off. To turn on the rear fog lamp again, push the switch again when the headlamps or front fog lamps (if so equipped) turn on.

## Wiper and washer switch

E00507101191

### CAUTION

- If the washer is used in cold weather, the washer fluid sprayed against the glass may freeze, which may hinder visibility. Warm the glass with the defroster or rear window demister before using the washer.

## Windscreen wipers

E00516900273

### Except for vehicles with rain sensor

The windscreen wipers can be operated with the ignition switch in the “ON” or “ACC” position.

If the blades are frozen to the windscreen or rear window, do not operate the wipers until the ice has melted and the blades are freed, otherwise the wiper motor may be damaged.

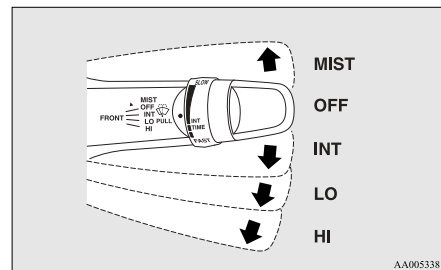

- MIST- Misting function  
The wipers will operate once.
- OFF- Off
- INT- Intermittent (Speed sensitive)
- LO- Slow
- HI- Fast

### To adjust intermittent intervals

With the lever in the “INT” (speed-sensitive) position, the intermittent intervals can be adjusted by turning the knob (A).

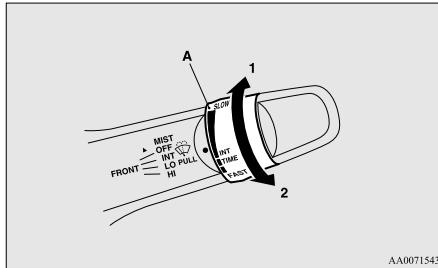

- 1- Fast
- 2- Slow

### NOTE

- The speed-sensitive-operation function of the windscreen wipers can be deactivated. For further information, we recommend you to consult a MITSUBISHI MOTORS Authorized Service Point.

### Misting function

The misting function can be used when the ignition switch is in the “ON” or “ACC” position.

The wipers will operate once if the wiper lever is raised to the “MIST” position and released. This operation is useful when it is drizzling, etc. The wipers will continue to operate while the lever is held in the “MIST” position.

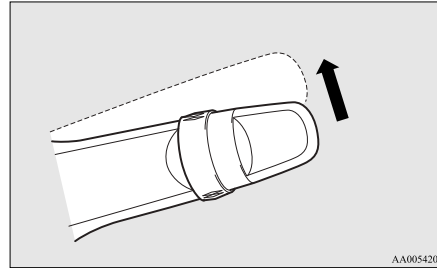

### Vehicles with rain sensor

E00526401773

The windscreen wipers can be operated with the ignition switch in the “ON” or “ACC” position.

If the blades are frozen to the windscreen or rear window, do not operate the wipers until the ice has melted and the blades are freed, otherwise the wiper motor may be damaged.

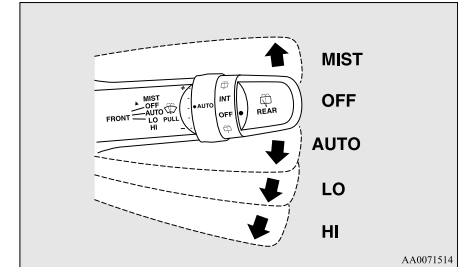

MIST- Misting function

The wipers will operate once.

OFF- Off

AUTO- Auto-wiper control

Rain sensor

The wipers will automatically operate depending on the degree of wetness on the windscreen.

LO- Slow

HI- Fast

### Rain sensor

Can only be used when the ignition switch is in the “ON” position.

## Wiper and washer switch

If the lever is put in the “AUTO” position, the rain sensor (A) will detect the extent of rain (or snow, other moisture, dust, etc.) and the wipers will operate automatically.

Keep the lever in the “OFF” position if the windscreen is dirty and the weather is dry.

Wiper operation under these conditions can scratch the windscreen and damage the wipers.

5

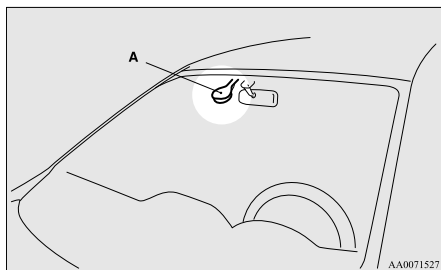

### ⚠ CAUTION

- With the ignition switch in the “ON” position and the lever in the “AUTO” position, the wipers may automatically operate in the situations described below.

If your hands get trapped, you could suffer injuries or the wipers could malfunction. Be sure to turn the ignition switch to the “OFF” position or move the lever to the “OFF” position to deactivate the rain sensor.

- When cleaning the outside surface of the windscreen, if you touch the rain sensor.
- When cleaning the outside surface of the windscreen, if you wipe with a cloth the rain sensor.
- When using an automatic car wash.
- A physical shock is applied to the windscreen.
- A physical shock is applied to the rain sensor.

### 📖 NOTE

- To protect the rubber parts of the wipers, this operation of the wipers does not take place even if the lever is put in the “AUTO” position when the vehicle is stationary and the ambient temperature is about 0 °C or lower.
- Do not cover the sensor by affixing a sticker or label to the windscreen. Also, do not put any water-repellent coating on the windscreen. The rain sensor would not be able to detect the extent of rain, and the wipers might stop working normally.

### 📖 NOTE

- In the following cases, the rain sensor may be malfunctioning.  
Have the vehicle inspected at a MITSUBISHI MOTORS Authorized Service Point.
  - When the wipers operate at a constant interval despite changes in the extent of rain.
  - When the wipers do not operate even though it is raining.
- The wipers may automatically operate when things such as insects or foreign objects are affixed to the windscreen on top of the rain sensor or when the windscreen is frozen. Objects affixed to the windscreen will stop the wipers when the wipers cannot remove them. To make the wipers operate again, place the lever in the “LO” or “HI” position. Also, the wipers may operate automatically due to strong direct sunlight or electromagnetic wave. To stop the wipers, place the lever in the “OFF” position.
- Contact a MITSUBISHI MOTORS Authorized Service Point when replacing the windscreen or reinforcing the glass around the sensor.

With the ignition switch in the “ON” position, if the lever is moved to the AUTO position and pulled towards you a little, the wipers operate once.

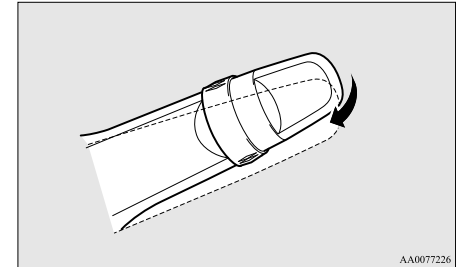

The wipers will operate once if the lever is moved to the “AUTO” position and the knob (A) is turned in the “+” direction when the ignition switch is in the “ON” position.

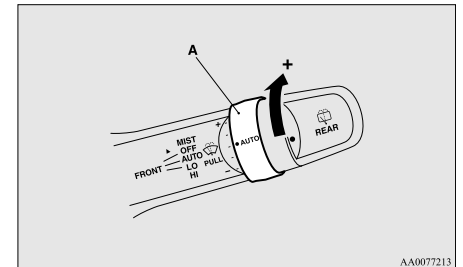

### To adjust the sensitivity of the rain sensor

With the lever in the “AUTO” (rain sensor) position, it is possible to adjust the sensitivity of the rain sensor by turning the knob (A).

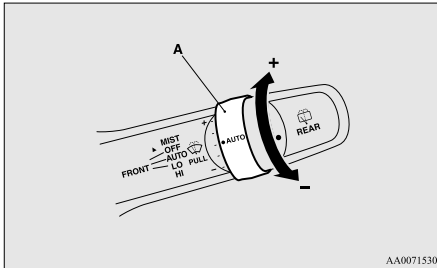

“+”- Higher sensitivity to rain

“-”- Lower sensitivity to rain

### Misting function

Move the lever in the direction of the arrow and release, to operate the wipers once. Use this function when you are driving in mist or drizzle.

The wipers will operate once if the lever is raised to the “MIST” position and released when the ignition switch is in the “ON” or “ACC” position. The wipers will continue to operate while the lever is held in the “MIST” position.

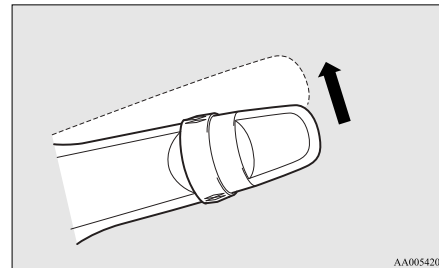

### NOTE

- It is possible to activate the following functions. For further information, we recommend you to consult a MITSUBISHI MOTORS Authorized Service Point.
  - Automatic operation (rain droplet sensitive) can be changed to intermittent operation (vehicle-speed sensitive).
  - Automatic operation (rain droplet sensitive) can be changed to intermittent operation (except vehicle-speed sensitive).

## Windscreen washer

E00507200528

The washer fluid will be sprayed onto the windscreen by pulling the lever towards you. The wipers operate automatically several times while the washer fluid is being sprayed. On a vehicle equipped with the headlamp washer, the headlamp washer operates together with the windscreen washer the first time the windscreen washer is used if the headlamps are on.

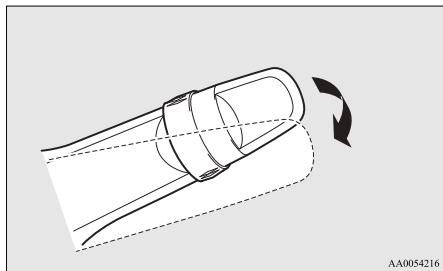

### CAUTION

- If the washer is used in cold weather, the washer fluid sprayed against the glass may freeze resulting in poor visibility. Heat the glass with the defroster or demister before using the washer.

## Rear window wiper and washer

E00507300994

The rear window wiper and washer switch can be operated with the ignition switch in the “ON” or “ACC” position.

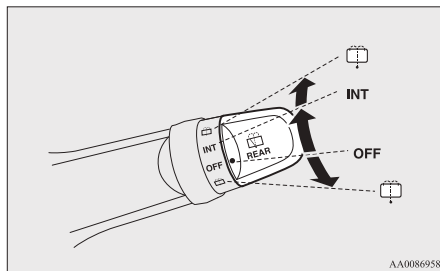

**INT-** The wiper operates continuously for several seconds then operates intermittently at intervals of about every 8 seconds.

**OFF-** Off



The washer fluid will be sprayed onto the rear window when the knob is turned fully in either direction.

The wipers operate automatically several times while the washer fluid is being sprayed.

## NOTE

- To ensure a clear rearward view, the wiper performs several continuous operations when the reverse gear is engaged while the switch is in the “INT” position. Following this continuous operation, the wiper will automatically switch to intermittent operation.
- It is possible to activate the following functions. For further information, we recommend you to consult a MITSUBISHI MOTORS Authorized Service Point.
  - Adjustment of the interval for intermittent operation
  - The wipers can be changed to continuous operation by turning the knob at the end of the lever twice to the --- (intermittent operation) position. (Continuous operation mode)
  - Changing intermittent wiper operation to continuous wiper operation

## Headlamp washer switch\*

E00510100231

The headlamp washer can be operated when the ignition switch is in the “ON” or “ACC” position and the headlamps are on.



Push the button once and the washer fluid will be sprayed on to the headlamps.

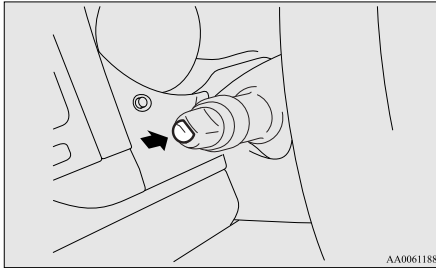

### NOTE

- If the ignition switch is in the “ON” or “ACC” position and the headlamps are on, the headlamp washer operates together with the windscreen washer the first time the windscreen washer lever is pulled.

## Precautions to observe when using wipers and washers

E00507601558

- If the moving wipers become blocked partway through a sweep by ice or other deposits on the glass, the wipers may temporarily stop operating to prevent the motor from overheating. In this case, park the vehicle in a safe place and turn the ignition switch to the “LOCK” position, and then remove the ice or other deposits.

The wipers will start operating again after the wiper motor cools down, so check that the wipers operate before using them.

- Do not use the wipers when the glass is dry. They may scratch the glass surface and the blades wear out prematurely.
- Before using the wipers in cold weather, check that the wiper blades are not frozen onto the glass. The motor may burn out if the wipers are used with the blades frozen onto the glass.
- Avoid using the washer continuously for more than 20 seconds. Do not operate the washer when the fluid reservoir is empty. Otherwise, the motor may burn out.

- Periodically check the level of washer fluid in the reservoir and refill if required.

During cold weather, add a recommended washer solution that will not freeze in the washer reservoir. Failure to do so could result in loss of washer function and frost damage to the system components.

## Wiper de-icer switch\*

E00507700103

The wiper de-icer switch can be operated with the ignition switch in the “ON” position. When the front wipers have frozen to the windscreen at the parked positions, turning on this switch will heat the windscreen to make the wipers operable. Press the switch and the deicer will operate and turn on the indication lamp (A).

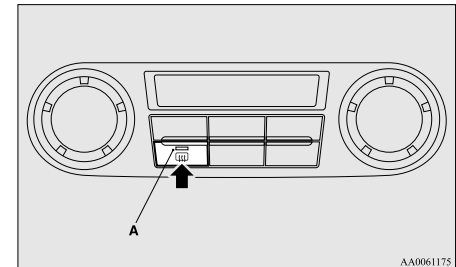

### NOTE

- The switch is automatically turned off after operating for approximately 20 minutes. To turn off the switch while it is operating, press the switch again.

## 5 Rear window demister switch

E00507901030

The rear window demister switch can be operated with the ignition switch in the “ON” position.

Push the switch to turn on the rear window demister. It will be turned off automatically in about 20 minutes. To turn off the demister within 20 minutes, push the switch again.

The indication lamp (A) will illuminate while the demister is on.

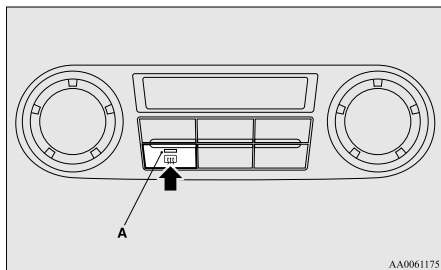

### NOTE

- If your vehicle is equipped with wiper de-icer, when the rear window demister switch is pushed, the window glass becomes warm and the wipers become operable. Refer to “Wiper de-icer switch” on page 5-49.
- If your vehicle is equipped with heated mirrors, when the rear window demister switch is pressed, the outside rear-view mirrors are defogged or defrosted. Refer to “Heated mirror” on page 6-10.
- The demister switch is not to melt snow but to clear mist. Remove snow before use of the demister switch.
- To avoid unnecessary discharge of the battery, do not use the rear window demister during starting of the engine or when the engine is not running. Turn the demister off immediately after the window is clear.
- When cleaning the inside of the rear window, use a soft cloth and wipe gently along the heater wires, being careful not to damage the wires.
- Do not allow objects to touch the inside of the rear window glass, damaged or broken wires may result.

## Horn switch

E00508000347

Press the steering wheel on or around the “” mark.

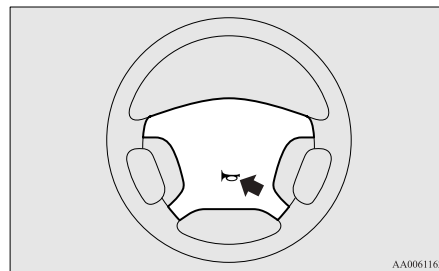

## *Starting and driving*

Economical driving.....	6-02	Rear-view camera*.....	6-56
Driving, alcohol and drugs.....	6-02	Cargo loads.....	6-59
Safe driving techniques.....	6-03	Trailer towing.....	6-60
Running-in recommendations.....	6-04		
Parking brake.....	6-04		
Parking.....	6-05		
Steering wheel height adjustment.....	6-06		
Inside rear-view mirror.....	6-07		
Outside rear-view mirrors.....	6-08		
Ignition switch.....	6-10		
Steering wheel lock.....	6-12		
Starting.....	6-12		
NOx trap catalyst (dieselpowered vehicles)*.....	6-14		
Diesel particulate filter (DPF)*.....	6-14		
Automatic transmission INVECS-II Sports Mode 5A/T (Intelligent & Innovative Vehicle Electronic Control System II).....	6-15		
Super select 4WD II (SS4 II).....	6-21		
Rear differential lock*.....	6-26		
4-wheel drive operation.....	6-30		
Inspection and maintenance following rough road operation.....	6-33		
Cautions on handling of 4-wheel drive vehicles.....	6-33		
Braking.....	6-35		
Brake assist system.....	6-36		
Anti-lock brake system (ABS).....	6-37		
Power steering system.....	6-39		
Active stability & traction control (ASTC).....	6-40		
Cruise control*.....	6-44		
Tyre pressure monitoring system (TPMS)*.....	6-48		
Reversing sensor system*.....	6-52		

### Economical driving

E00600100561

For economical driving, there are some technical requirements that have to be met. The prerequisite for low fuel consumption is a properly adjusted engine. In order to achieve longer life of the vehicle and the most economical operation, we recommend you to have the vehicle checked at regular intervals in accordance with the service standards.

Fuel economy and generation of exhaust gas and noise are highly influenced by personal driving habits as well as the particular operating conditions. The following points should be observed in order to minimize wear of brakes, tyres and engine as well as to reduce environmental pollution.

### Starting

Avoid rapid acceleration and sudden starts; such operation will result in higher fuel consumption.

### Shifting

Shift only at an appropriate speed and engine speed. Always use the highest gear possible. The transfer shift lever should be set to “2H” when driving on normal roads and express ways to obtain best possible fuel economy.

### City traffic

Frequent starting and stopping increases the average fuel consumption. Use roads with smooth traffic flow whenever possible. When driving on congested roads, avoid use of a low gear at high engine speeds.

### Idling

The vehicle consumes fuel even during idling. Avoid extended idling whenever possible.

### Speed

At higher vehicle speed, more fuel is consumed. Avoid driving at full speed. Even a slight release of the accelerator pedal will save a significant amount of fuel.

### Tyre inflation pressure

Check the tyre inflation pressures at regular intervals. Low tyre inflation pressure increases road resistance and fuel consumption. In addition, low tyre pressures adversely affect tyre wear and driving stability.

### Load

Do not drive with unnecessary articles in the luggage compartment. Especially during city driving where frequent starting and stopping is necessary, the increased weight of the vehicle will greatly affect fuel consumption. Also avoid driving with unnecessary luggage or carriers, etc., on the roof; the increased air resistance will increase fuel consumption.

### Cold engine starting

Starting of a cold engine consumes more fuel.

Unnecessary fuel consumption is also caused by keeping a hot engine running. After the engine is started, commence driving as soon as possible.

### Air conditioning

The use of the air conditioning will increase the fuel consumption.

### Driving, alcohol and drugs

E00600200067

Driving after drinking alcohol is one of the most frequent causes of accidents.

Your driving ability can be seriously impaired even with blood alcohol levels far below the legal minimum. If you have been drinking, don't drive. Ride with a designated non-drinking driver, call a cab or a friend, or use public transportation. Drinking coffee or taking a cold shower will not make you sober.

Similarly, prescription and nonprescription drugs affect your alertness, perception and reaction time. Consult with your doctor or pharmacist before driving while under the influence of any of these medications.

### WARNING

#### ● NEVER DRINK AND DRIVE.

Your perceptions are less accurate, your reflexes are slower and your judgment is impaired.

## Safe driving techniques

E00600300488

Driving safety and protection against injury cannot be fully ensured. However, we recommend that you pay extra attention to the following:

### Seat belts

Before starting the vehicle, make sure that you and your passengers have fastened your seat belts.

### Floor mats

#### WARNING

- Keep floor mats clear of the pedals by correctly laying floor mats that are suitable for the vehicle.

To prevent the floor mats from slipping out of position, securely retain them using the hook etc.

Note that laying a floor mat over a pedal or laying one floor mat on top of another can obstruct pedal operation and lead to a serious accident.

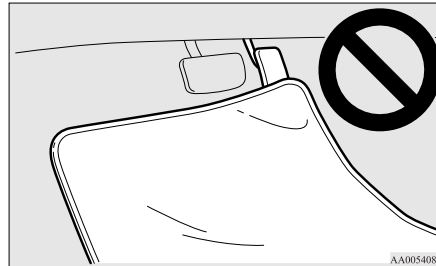

### Carrying children in the vehicle

- Never leave your vehicle unattended with the key in the ignition and children inside the vehicle. Children may play with the driving controls and this could lead to an accident.
- Make sure that infants and small children are properly restrained in accordance with the laws and regulations, and for maximum protection in case of an accident.
- Prevent children from playing in the luggage compartment. It is quite dangerous to allow them to play there while the vehicle is moving.

6

## Running-in recommendations

E00600404155

During the running-in period for the first 1,000 km (620 miles), it is advisable to drive your new vehicle using the following precautions as a guideline to aid long life as well as future economy and performance.

- Do not race the engine at high speeds.
- Avoid rapid starting, accelerating, braking and prolonged high-speed running.
- Keep to the running-in speed limit shown below.  
Please note that the legal speed limits must be adhered to.
- Do not exceed loading limits.
- Refrain from towing a trailer.

6

Shift point	Speed limit			
	3000 models		3200 models	
	2H, 4H, 4HLc	4LLc	2H, 4H, 4HLc	4LLc
1 <sup>st</sup> gear	25 km/h (16 mph)	10 km/h (6 mph)	25 km/h (16 mph)	10 km/h (6 mph)
2 <sup>nd</sup> gear	50 km/h (30 mph)	25 km/h (16 mph)	45 km/h (28 mph)	25 km/h (16 mph)
3 <sup>rd</sup> gear	80 km/h (50 mph)	40 km/h (25 mph)	70 km/h (43 mph)	35 km/h (22 mph)
4 <sup>th</sup> gear	115 km/h (71 mph)	45 km/h (28 mph)	100 km/h (62 mph)	45 km/h (28 mph)
5 <sup>th</sup> gear	115 km/h (71 mph)	45 km/h (28 mph)	120 km/h (74 mph)	45 km/h (28 mph)

## Parking brake

E00600501360

To park the vehicle, first bring it to a complete stop, fully apply the parking brake lever sufficiently to hold the vehicle.

## To apply the parking brake

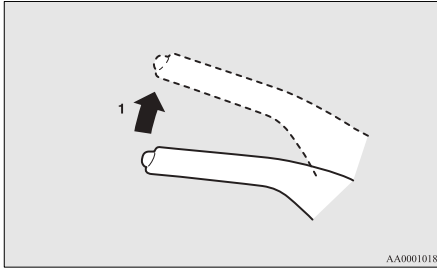

- 1- Firmly depress and hold the brake pedal, then pull the lever up without pushing the button at the end of hand grip.

### CAUTION

- When you intend to apply the parking brake, firmly press the brake pedal to bring the vehicle to a complete stop before pulling the parking brake lever. Pulling the parking brake lever with the vehicle moving could make the rear wheels lock up, thereby making the vehicle unstable. It could also make the parking brake malfunction.

### NOTE

- Apply sufficient force to the parking brake lever to hold the vehicle stationary after the foot brake is released.

### NOTE

- If the parking brake does not hold the vehicle stationary after the foot brake is released, have your vehicle checked immediately.

## To release the parking brake

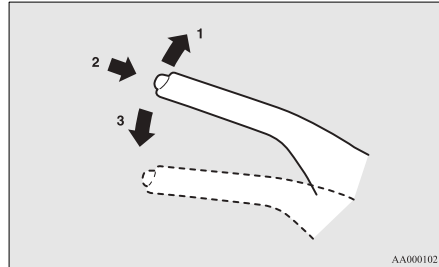

- 1- Firmly depress and hold the brake pedal, then pull the lever up slightly.
- 2- Push the button at the end of hand grip.
- 3- Lower the lever fully.

### CAUTION

- Before driving, be sure that the parking brake is fully released and brake warning lamp is off. If a vehicle is driven without releasing the parking brake, the brake will be overheated, resulting in ineffective braking and possible brake failure.

### CAUTION

- If the brake warning lamp does not extinguish when the parking brake is fully released, the brake system may be abnormal. Have your vehicle checked immediately. For details, refer to “Brake warning lamp” on page 5-10.

## Parking

E00600602791

To park the vehicle, fully engage the parking brake, and then set the selector lever to the “P” (PARK) position.

### Parking on a hill

To prevent the vehicle from rolling, follow these procedures:

#### Parking on a downhill slope

Turn the front wheels towards the kerb and move the vehicle forward until the kerb side wheel gently touches the kerb. Apply the parking brake and place the selector lever into the “P” (PARK) position. If necessary, apply chocks to wheels.

#### Parking on an uphill slope

Turn the front wheels away from the kerb and move the vehicle back until the kerb side wheel gently touches the kerb.

## Steering wheel height adjustment

Apply the parking brake and place the selector lever into the “P” (PARK) position.

If necessary, apply chocks to wheels.

### NOTE

- Be sure to apply the parking brake before moving the selector lever to the “P” (PARK) position. If you move the selector lever to the “P” (Park) position before applying the parking brake, it may be difficult to disengage the selector lever from the “P” (Park) position when next you drive the vehicle, requiring application of a strong force to the selector lever to move from the “P” (Park) position.

## Parking with the engine running

Never leave the engine running while you take a short sleep/rest, or you open or close a gate or garage door, etc. Also, never leave the engine running in a closed or poorly ventilated place.

### WARNING

- Leaving the engine running risks injury or death from accidentally moving the selector lever or the accumulation of toxic exhaust fumes in the passenger compartment.

## Where you park

### WARNING

- Do not park your vehicle in areas where combustible materials such as dry grass or leaves can come in contact with a hot exhaust, since a fire could occur.

## When leaving the vehicle

Always remove the key from the ignition switch and lock all doors (including the back-door) when leaving the vehicle unattended.

Always try to park your vehicle in a well lit area.

## Steering wheel height adjustment

E00600700222

1. Release the tilt lock lever while holding the steering wheel up.
2. Adjust the steering wheel to the desired height.
3. Securely lock the steering wheel by pulling the tilt lock lever fully upward.

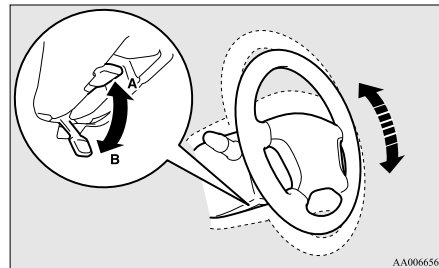

A- Locked

B- Release

### WARNING

- Do not attempt to adjust the steering wheel while you are driving the vehicle.



## Inside rear-view mirror

E00600801943

Adjust the rear-view mirror only after making any seat adjustments so you have a clear view to the rear of the vehicle.

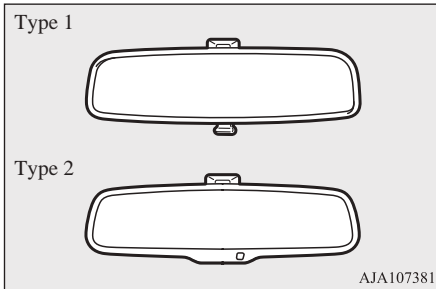

### WARNING

- Do not attempt to adjust the rear-view mirror while driving. This can be dangerous. Always adjust the mirror before driving.

Adjust the rear-view mirror to maximize the view through the rear window.

## To adjust the vertical mirror position

It is possible to move the mirror up and down to adjust its position.

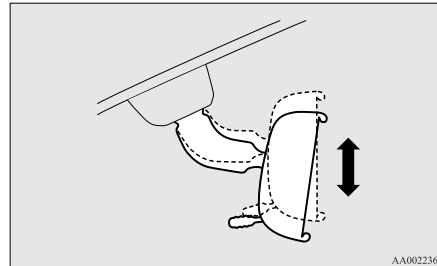

## To adjust the mirror position

It is possible to move the mirror up/down and left/right to adjust its position.

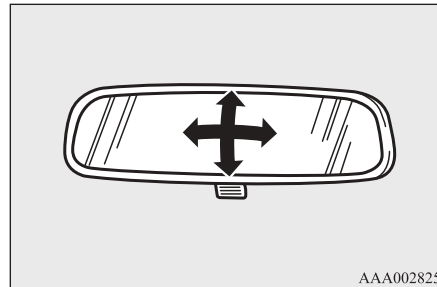

## To reduce the glare

### Type 1

The lever (A) at the bottom of the mirror can be used to adjust the mirror to reduce the glare from the headlamps of vehicles behind you during night driving.

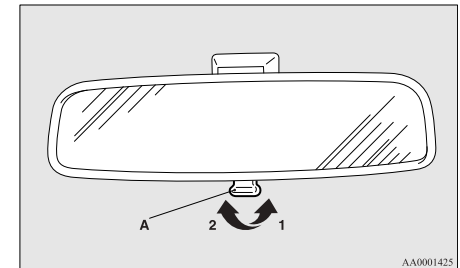

- 1- Normal
- 2- Anti-glare

## Type 2

When the headlamps of the vehicles behind you are very bright, the reflection factor of the rear-view mirror is automatically changed to reduce the glare.

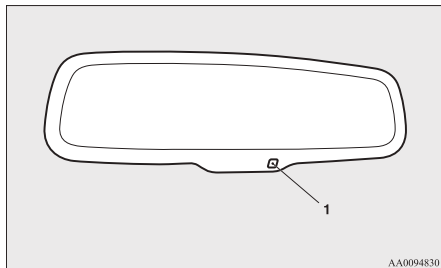

When the ignition switch is turned to the “ON” position, the reflection factor of the mirror is automatically changed.

### NOTE

- Do not hang items on, or spray glass cleaner on the sensor (1), as reduced sensitivity could result.

## Outside rear-view mirrors

E00600900484

### Compound curved-surface mirror\*

On the driver’s side, a compound curved-surface mirror is used, while on the front passenger’s side, a single curved-surface mirror is used.

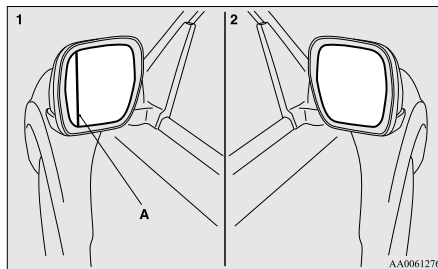

- 1- Compound curved-surface mirror
- 2- Single curved-surface mirror

While the single curved-surface mirror has a fixed curvature, the compound curved-surface mirror has different curvatures between the inner and outer sides of the boundary line (A).

The inner side of the boundary line provides the same vision as that available from an ordinary door mirror.

However, the outer side of the boundary line provides a wider angle of vision compared to an ordinary door mirror.

### WARNING

- The sense of distance that you get from an object you see on the inner side of the mirror boundary line differs from the sense of distance that you get from an object you see on the outer side. An object you see on the outer side of the boundary line of the mirror will look farther away than actually is as compared with an object you see on the inner side.

### To adjust the mirror position

E00601000105

The outside rear-view mirrors can be operated when the ignition switch is in the “ON” or “ACC” position.

### WARNING

- Do not attempt to adjust the rear-view mirrors while driving. This can be dangerous. Always adjust the mirrors before driving.

**⚠ WARNING**

- Your vehicle is equipped with convex type mirrors. Please take into consideration, that objects you see in the mirror will look smaller and farther away compared to a normal flat mirror. Do not use this mirror to estimate distance of following vehicles when changing lanes.

1. Place the lever (A) to the same side as the mirror whose adjustment is desired.

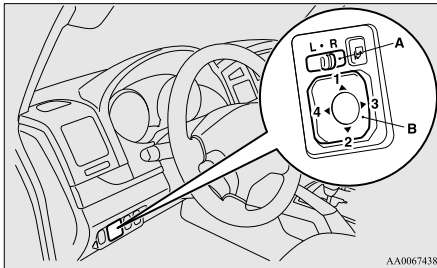

L- Left outside mirror adjustment  
R- Right outside mirror adjustment

2. Press the switch (B) to the left, right, up or down to adjust the mirror position.
  - 1- Up
  - 2- Down
  - 3- Right
  - 4- Left

3. Return the lever (A) back to the middle position (•).

**Retracting and extending the outside mirrors**

E00618200011

The outside mirrors can be folded in towards the side window to prevent damage when parking in narrow areas.

**⚠ CAUTION**

- Do not drive the vehicle with the mirror folded in. The lack of rearward visibility normally provided the mirror could lead to an accident.

**Retracting and extending the mirrors using the mirror retractor switch**

With the ignition switch in the “ON” or “ACC” position, push the mirror retractor switch to retract the mirrors. Push it again to extend the mirrors to their original positions.

After placing the ignition switch in the “LOCK” position, it is possible to retract and extend the mirrors using the mirror retractor switch for about 30 seconds.

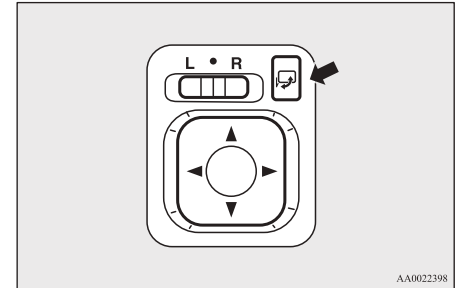

AA0022398

**⚠ CAUTION**

- It is possible to retract and extend the mirrors by hand. After retracting a mirror using the mirror retractor switch, however, you should extend it by using the switch again, not by hand. If you extended the mirror by hand after retracting it using the switch, it would not properly lock in position. As a result, it could move because of the wind or vibration while you are driving, taking away your rearward visibility.

**NOTE**

- Be careful not to get your hands trapped while a mirror is moving.
- If you move a mirror by hand or it moves after hitting a person or object, you may not be able to return it to its original position using the mirror retractor switch. If this happens, push the mirror retractor switch to place the mirror in its retracted position and then push the switch again to return the mirror to its original position.
- If the battery voltage is low and you start the engine while extending the mirrors, the mirrors may stop part-way. If this happens, push the mirror retractor switch to retract the mirrors and then push the switch again to extend them.
- When freezing has occurred and mirrors fail to operate as intended, please refrain from repeated pushing of the retractor switch as this action can result in burn-out of the mirror motor circuits.

**Automatic extension of mirrors**

If the engine is stopped and started with the mirrors retracted, the mirrors automatically extend for safety when the vehicle speed reaches 30 km/h (19 mph).

**Heated mirror\***

E00601200312

To demist or defrost the outside rear-view mirrors, press the rear window demister switch.

The indication lamp (C) will illuminate while the demister is on.

The heater will be turned off automatically in about 20 minutes.

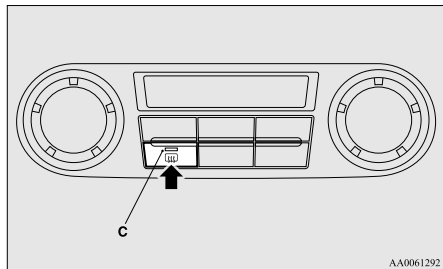

**Ignition switch**

E00601403399

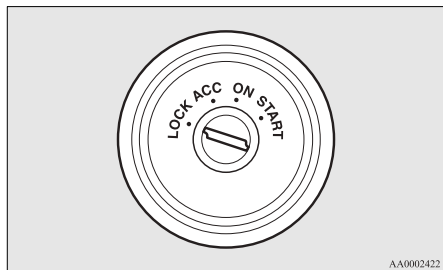

**LOCK**

The engine is stopped and the steering wheel locked. The key can only be inserted and removed in this position.

**ACC**

The engine is stopped, but the electrical devices such as the radio and cigarette lighter can be operated.

**ON**

The engine is running, and all the vehicle's electrical devices can be operated.

**START**

The starter motor operates. After the engine has started, release the key and it will automatically return to the "ON" position.

**NOTE**

- Your vehicle is equipped with an electronic immobilizer. To start the engine, the ID code transmitted by the transponder inside the key must match the code registered in the immobilizer computer. Refer to "Electronic immobilizer" on page 3-03.

## Ignition switch illumination

In the situations listed below, the ignition switch illumination comes on to facilitate insertion or removal of the ignition key.

- When any door or the backdoor is opened, the ignition switch illumination comes on. When it is closed, the ignition switch illumination becomes steadily dimmer until completely going off about 15 seconds later.
- When the ignition key is removed with all the doors and the backdoor closed, the ignition switch illumination comes on and stays on for about 15 seconds.

The ignition switch illumination immediately goes off if any of the following actions is taken while it is on.

- All of the doors and the backdoor are closed, and the ignition switch is turned to the “ON” position.
- All of the doors and the backdoor are locked using the central door lock function.
- All of the doors and the backdoor are locked using the keyless entry system (if so equipped).

## NOTE

- If the interior lamp switch is in the “(○)” position, the ignition switch illumination will not come on.
- It is possible to adjust the period of ignition switch illumination (the period until the ignition switch illumination goes off). For details, we recommend you to consult a MITSUBISHI MOTORS Authorized Service Point.
- If the illumination period of the room & map lamps or rear personal lamps (the period until these lamps go off) is adjusted, the period of ignition switch illumination (the period until the ignition switch illumination goes off) will automatically be changed at the same time.

If the illumination period of the room & map lamps or rear personal lamps is set to zero (in other words, the illumination keep-on function is deactivated), the ignition switch illumination will not come on when the ignition switch is removed.  
For information, we recommend you to consult a MITSUBISHI MOTORS Authorized Service Point.

## To remove the key

When removing the key, first set the selector lever to the “P” (PARK) position, and then turn the key to the “LOCK” position and remove it.

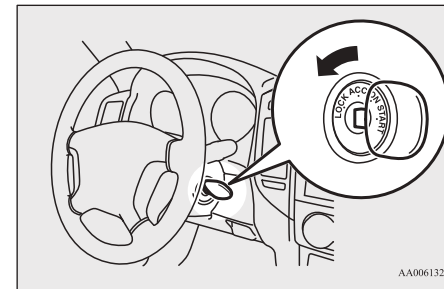

## CAUTION

- If the engine is stopped while driving, the brake servomechanism will cease to function and braking efficiency will deteriorate. Also, the power steering system will not function and it will require greater manual effort to operate the steering.
- Do not leave the key in the “ON” position for a long time when the engine is not running, doing so will cause the battery to be discharged.
- Do not turn the key to the “START” position when the engine is running, doing so could damage the starter motor.

## Steering wheel lock

E00601500298

### To lock

Remove the key at the “LOCK” position. Turn the steering wheel until it is locked.

### To unlock

Turn the key to the “ACC” position while moving the steering wheel slightly right and left.

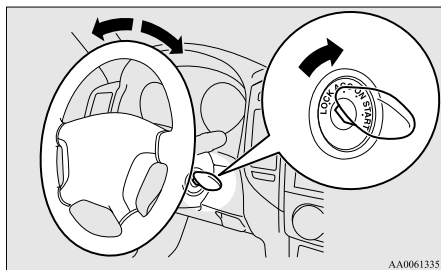

AA0061335

### CAUTION

- Remove the key when leaving the vehicle. In some countries, it is prohibited to leave the key in the vehicle when parked.

## Starting

E00601600811

### Tips for starting

- Do not operate the starter motor continuously longer than 10 seconds; doing so could run down the battery. If the engine does not start, turn the ignition key back to “LOCK” position, wait a few seconds, and then try again. Trying repeatedly with the starter motor still turning will damage the starter mechanism.

### WARNING

- Never run the engine in a closed or poorly ventilated area any longer than is needed to move your vehicle in or out of the area. Carbon monoxide gases are odourless and can be fatal.

### CAUTION

- Never attempt to start the engine by pushing or pulling the vehicle.
- Do not run the engine at high rpm or drive the vehicle at high speed until the engine has had a chance to warm up.
- Release the ignition key as soon as the engine starts to avoid damaging the starter motor.

### CAUTION

- If your vehicle is equipped with a turbocharger, do not stop the engine immediately after high-speed or uphill driving. First allow the engine to idle to give the turbocharger a chance to cool down.

## Starting the engine (petrol-powered vehicles)

E00601703682

The starting procedure is as follows:

1. Insert the ignition key and fasten the seat belt.
2. Make sure the parking brake is applied.
3. Depress and hold the brake pedal.
4. Make sure the selector lever is in the “P” (PARK) position.

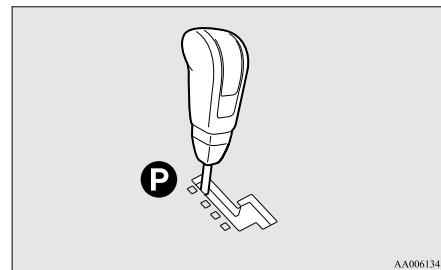

AA0061348

- After turning the ignition key to the “ON” position, make certain that all warning lamps are functioning properly before starting the engine.
- Turn the ignition key to the “START” position without depressing the accelerator pedal, and release it when the engine starts.

### NOTE

- A ticking noise may be heard after starting the engine. This is not an abnormal condition. The noise will disappear after a short time of engine running. If the ticking noise continues after the engine is warmed up, we recommend you to have your vehicle checked.

## When it is difficult to start the engine

After several attempts, you may experience that the engine still does not start.

- Make sure that all electric devices, such as lamps, air conditioning blower and rear window demister, are turned off.
- While depressing the brake pedal, press the accelerator pedal halfway and hold it there, then crank the engine. Release the accelerator pedal, immediately after the engine starts.

- If the engine still will not start, the engine could be flooded with too much petrol. While depressing the brake pedal, push the accelerator pedal all the way down and hold it there, then crank the engine for 5 to 6 seconds. Return the ignition switch to the “LOCK” position and release the accelerator pedal. Wait a few seconds, and then crank the engine again for 5 to 6 seconds while depressing the brake pedal, but do not push the accelerator pedal. Release the ignition key if the engine starts. If the engine fails to start, repeat these procedures. If the engine still will not start, we recommend you to have the vehicle checked.

## Using the MIVEC engine

The MIVEC engine automatically switches its intake-valve control between a low-speed mode and a high-speed mode in accordance with the driving conditions for maximum engine performance.

### NOTE

- To protect the engine, the high-speed mode may not be selected while the engine coolant temperature is low. In such a case, the engine revolutions do not rise to over 5,000 rpm even if the accelerator pedal is depressed.

## Starting the engine (diesel-powered vehicles)

E00601801331

- Insert the ignition key and fasten the seat belt.
- Make sure the parking brake is applied.
- Depress and hold the brake pedal.
- Make sure the selector lever is in the “P” (PARK) position.

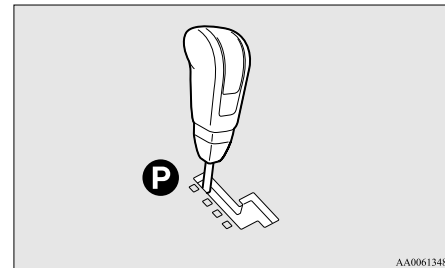

- Turn the ignition key to the “ON” position. The diesel preheat indication lamp will first illuminate, and then after a short time go out, indicating that preheating is completed.

### NOTE

- If the engine is cold, the diesel preheat indication lamp is on for a longer time.

 **NOTE**

- When the engine has not been started within about 5 seconds after the diesel preheat indication lamp went out, return the ignition key to the “LOCK” position. Then, turn the key to the “ON” position to preheat the engine again.
- When the engine is warm, the diesel preheat indication lamp does not come on even if the ignition key is placed in the “ON” position. Start the engine by turning the ignition key right to the “START” position.

6. Turn the ignition key to the “START” position without depressing the accelerator pedal, and release it when the engine starts.

**Fuel injection amount learning process (diesel-powered vehicles)**

E0061600044

To keep exhaust emissions and engine noise low, the engine very occasionally performs a learning process for the fuel injection amount.

The engine sounds slightly different from usual while the learning process is taking place. The change in the engine sound does not indicate a fault.

**NOx trap catalyst (dieselpowered vehicles)\***

E00649200020

A NOx (nitrogen oxide) trap catalyst absorbs the NOx contained in the exhaust gas of the diesel engine.

To maintain the NOx absorbing function, the fuel is supplied regularly to the catalyst while driving, and the catalyst reduces NOx to harmless N<sub>2</sub> (nitrogen).

The bar graph of momentary fuel consumption in the centre information display and engine sound change while NOx is being purged automatically by the catalyst. These do not indicate a fault.

**Diesel particulate filter (DPF)\***

E00619801460

The diesel particulate filter (DPF) is a device that captures most of the particulate matter (PM) in the exhaust emissions of the diesel engine. The DPF automatically burns away trapped PM during vehicle operation. Under certain driving conditions, however, the DPF is not able to burn away all of the trapped PM and, as a result, an excessive amount of PM accumulates inside it.

 **WARNING**

- The DPF reaches very high temperatures. **Do not park your vehicle in areas where combustible materials such as dry grass or leaves can come in contact with a hot exhaust system since a fire could occur.**

 **CAUTION**

- Do not use any type of fuel or engine oil that is not specified for your vehicle. Also, do not use any moisture-removing agent or other fuel additive. Such substances could have a detrimental effect on the DPF. Refer to “Fuel selection” on page 2-02 and “Engine oil” on page 10-04.

 **NOTE**

- To minimize the likelihood of excessive accumulation of PM, try to avoid driving for long periods at low speeds and repeatedly driving short distances, and try to keep high engine speed driving as much as possible.



## DPF warning lamp

The DPF warning lamp comes on or flashes in the event of an abnormality in the DPF system. Provided the DPF system is working normally, the DPF warning lamp comes on when the ignition switch is turned to the “ON” position and goes off a few seconds later.

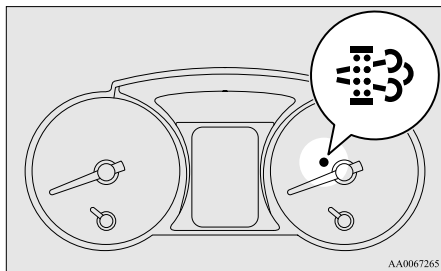

## If the DPF warning lamp comes on during vehicle operation

Steady illumination of the DPF warning lamp shows that the DPF has not been able to burn away all of the trapped PM and that, as a result, an excessive amount of PM has accumulated inside it. To enable the DPF to burn away the PM, try to drive the vehicle as follows:

- With the needle of the water temperature gauge stabilized in roughly the middle of the scale, drive for about 20 minutes at a speed of at least 40 km/h (24 mph).

If the DPF warning lamp subsequently stays on, contact your MITSUBISHI MOTORS Authorized Service Point.

### CAUTION

- You do not have to continuously drive exactly as indicated above. Always strive to drive safely in accordance with road conditions.

## If the DPF warning lamp flashes during vehicle operation

Flashing of the DPF warning lamp indicates an abnormality in the DPF system. Have the system inspected at a MITSUBISHI MOTORS Authorized Service Point.

### CAUTION

- Continuing to drive with the DPF warning lamp flashing could result in engine trouble and DPF damage.

## Automatic transmission INVECS-II Sports Mode 5A/T (Intelligent & Innovative Vehicle Electronic Control System II)

E00603200736

6

Automatic transmission will automatically change its gear depending on road and driving conditions. This helps achieve smooth driving and excellent fuel efficiency.

Also you can manually shift up and shift down the transmission. Refer to “Sports mode” on page 6-17.

### NOTE

- During running-in period or immediately after reconnection of the battery cable, there may be a case where gear shifts are not made smoothly. This does not indicate a faulty transmission. Gear shifts will become smooth after the transmission has been shifted several times by the electronic control system.

## Selector lever operation

E00603300522

The transmission has 5 forward gears and 1 reverse gear.

The individual gears are selected automatically, depending on the position of the gear selector lever, the speed of the vehicle and the position of the accelerator pedal.

The selector lever has 2 gates; the main gate (1) and the manual gate (2).

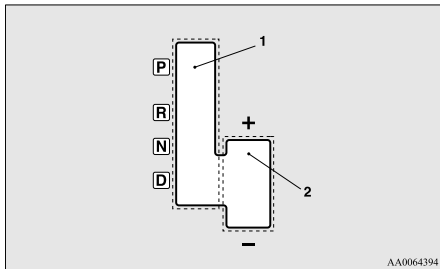

In the main gate, the selector lever has 4 positions, and is equipped with a lock button (A) to avoid inadvertent selection of the wrong gear.

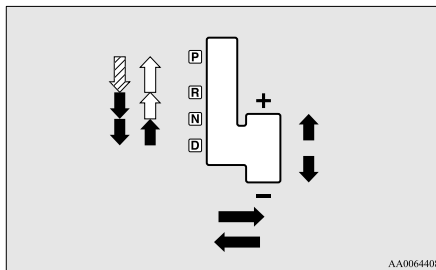
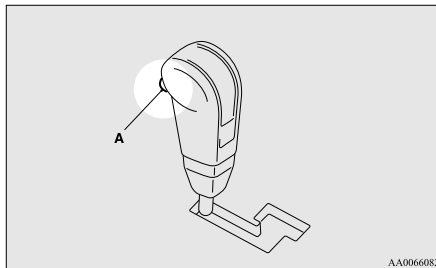

	The lock button must be pushed while the brake pedal is depressed to move the selector lever.
	The lock button must be pushed to move the selector lever.

	The lock button need not be pushed to move the selector lever.
--	--

**⚠ WARNING**

- If the lock button is always pushed to operate the selector lever, the lever may be accidentally shifted into the “P” (PARK) or “R” (REVERSE) position. Be sure not to push the lock button when performing the operations indicated by ↓ in the illustration.
- Always depress the brake pedal when shifting the selector lever into a gear from the “P” (PARK) or “N” (NEUTRAL) position. Never put your foot on the accelerator pedal while shifting the selector lever from the “P” (PARK) or “N” (NEUTRAL) position.

**📖 NOTE**

- If the brake pedal is not depressed and held, the shift-lock device activates to prevent the selector lever from being moved from the “P” (PARK) position.

## Selector lever position indication lamps

E00603500247

When the ignition switch is turned to the "ON" position, the indication lamps in the instrument panel illuminate to show the position of the selector lever (i.e. "PARK", "DRIVE", "REVERSE", etc.).

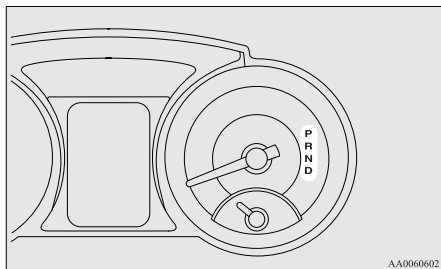

AA0060602

## Selector lever positions (Main gate)

E00603800699

### "P" PARK

This position locks the transmission to prevent the vehicle from moving. The engine can be started in this position.

### "R" REVERSE

This position is to back up.

## ⚠ CAUTION

- Never shift into the "P" (PARK) or "R" (REVERSE) position while the vehicle is in motion to avoid transmission damage.

## "N" NEUTRAL

At this position the transmission is disengaged. It is the same as the neutral position on a M/T, and should only be used when the vehicle is stationary for an extended length of time during driving, such as in a traffic jam.

## ⚠ WARNING

- Never move the selector lever to the "N" (NEUTRAL) position while driving. A serious accident could occur since you could accidentally move the lever into the "P" (PARK) or "R" (REVERSE) position or you will lose engine braking.
- On a gradient the engine should be started in the "P" (PARK) position, not in the "N" (NEUTRAL) position.
- To prevent rolling, always keep your foot on the brake pedal when the vehicle is in "N" (NEUTRAL) position, or when shifting into or out of "N" (NEUTRAL) position.

## "D" DRIVE

This position is used for most city and highway driving. The transmission will automatically change its gear depending on road and driving conditions.

## ⚠ CAUTION

- To prevent transmission damage, never shift into the "D" (DRIVE) position from the "R" (REVERSE) position while the vehicle is in motion.

6

## Sports mode

E00603902678

Whether the vehicle is stationary or in motion, sports mode is selected by gently pushing the selector lever from the "D" (DRIVE) position into the manual gate (A). To return to "D" range operation, gently push the selector lever back into the main gate (B).

In sports mode, gear shifts can be made rapidly simply by moving the selector lever backward and forward. In contrast to a manual transmission, the sports mode allows gear shifts with the accelerator pedal depressed.

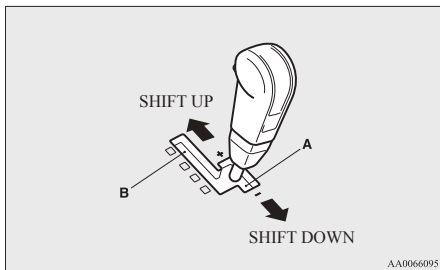

**+ (SHIFT UP)**

Push the lever forward once to shift up one gear.

**- (SHIFT DOWN)**

Pull the lever backward once to shift down one gear.

**⚠ CAUTION**

- In sports mode, the driver must execute upward shifts in accordance with prevailing road conditions, taking care to keep the engine speed below the red zone.

**⚠ CAUTION**

- By rapidly moving the selector lever backward (SHIFT DOWN) twice, it is possible to skip one gear, i.e., 3<sup>rd</sup> to 1<sup>st</sup>, 4<sup>th</sup> to 2<sup>nd</sup> or 5<sup>th</sup> to 3<sup>rd</sup>. Since sudden engine braking and/or rapid acceleration can cause a loss of traction, however, downshifts must be made carefully in accordance with the vehicle's speed.

**📖 NOTE**

- In sports mode, only the 5 forward gears can be selected. To reverse or park the vehicle, move the selector lever to the "R" (Reverse) or "P" (Park) position as required.
- To maintain good running performance, the transmission may refuse to perform an upshift when the selector lever is moved to the "+ (SHIFT UP)" position at certain vehicle speeds. Also, to prevent over-revving of the engine, the transmission may refuse to perform a downshift when the lever is moved to the "- (SHIFT DOWN)" position at certain vehicle speeds.
- In sports mode, downward shifts are made automatically when the vehicle slows down. When the vehicle stops, 1<sup>st</sup> gear is automatically selected.

**📖 NOTE**

- When driving away on a slippery road, push the selector lever forward into the "+ (SHIFT UP)" position. This causes the transmission to shift into the 2<sup>nd</sup> gear which is better for smooth driving away on a slippery road. Push the selector lever to the "- (SHIFT DOWN)" side to shift back to the 1<sup>st</sup> gear.
- If the A/T fluid temperature is high, the protection function operates. In this case, the transmission may refuse to perform an upshift when the selector lever is operated to the "+ (SHIFT UP)" position in sports mode, or it may automatically downshift.
- For vehicles equipped with the gearshift indicator, the gearshift indicator shows recommended gearshift points for fuel-efficient driving. It shows a "↑" when an upshift is recommended. When the transfer shift lever is in the 4LLc position, the gearshift indicator does not show recommended gearshift points.

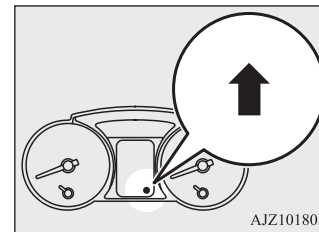

## Sports mode indicator

E00612300254

In sports mode, the currently selected position is indicated by the indicator (A) shown on the instrument panel.

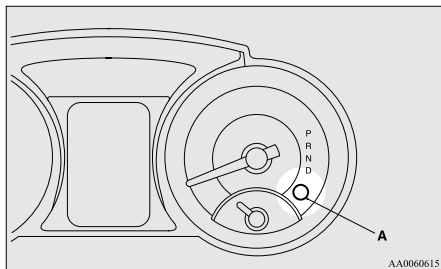

### NOTE

- When sports mode is selected, the “D” indicator goes off.

## When a malfunction occurs in the A/T

E00615100035

### When the “N” indication lamp blinks

E00615201323

When the “N” indication lamp (A) blinks with the “D” (DRIVE) position or “Sports mode” being selected, the A/T may be malfunctioning.

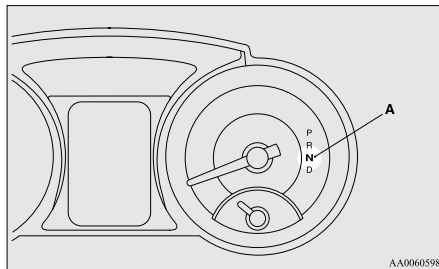

### CAUTION

- If the “N” indication lamp blinks while driving in the “D” (DRIVE) position or “Sports Mode”, the A/T safety device may be operating due to a malfunction. We recommend you to have your vehicle inspected immediately.

## When the A/T fluid temperature warning lamp comes on

E00615301177

When the A/T fluid temperature warning lamp comes on, a buzzer may sound when the automatic transmission fluid temperature becomes abnormally high. Normally the warning lamp comes on when the ignition switch is turned to the “ON” position, and then will go out after a few seconds.

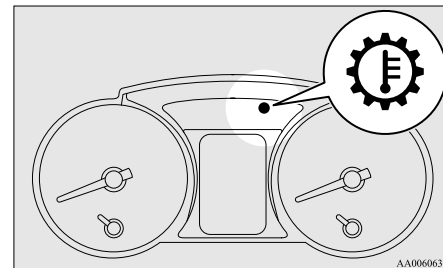

### CAUTION

- If the lamp comes on, reduce the engine speed and stop the vehicle in a safe area. Then set the selector lever to “P” (PARK) position and idle the engine until the warning lamp goes off. When the warning lamp goes off, resume normal driving. If the warning lamp does not go off, we recommend you to have your vehicle inspected.

## Operation of the A/T

E00604200560

### CAUTION

- Before selecting a gear with the engine running and the vehicle stationary, fully depress the brake pedal to prevent the vehicle from creeping.  
The vehicle will begin to move as soon as the gear is engaged, especially when the engine speed is high, at fast idle or with the air conditioning operating, the brakes should only be released when you are ready to drive away.
- Depress the brake pedal with the right foot at all times.  
Using the left foot could cause driver movement delay in case of an emergency.
- Operating the accelerator pedal while the other foot is resting on the brake pedal will affect braking efficiency and may cause premature wear of brake pads.
- To prevent sudden acceleration, never race the engine when shifting from the “P” (PARK) or “N” (NEUTRAL) position.
- Use the selector lever in the correct shift position in accordance with driving conditions.  
Never coast downhill backward with the selector lever in the “D” (DRIVE) or sports mode position or coast forward with the selector lever in the “R” (REVERSE) position.  
The engine may stop and the unexpected increase in brake pedal effort and steering wheel weight could lead to an accident.

### CAUTION

- Do not race the engine with brake pedal pressed when the vehicle is stationary.  
This can damage the A/T.  
Also, when you depress the accelerator pedal while holding down the brake pedal with the selector lever in the “P” (PARK), “N” (NEUTRAL) or “D” (DRIVE) position, the increase in engine revolutions may be limited.

### Passing acceleration

E00604500156

To gain extra acceleration in “D” (DRIVE) position, push the accelerator to the floor. The automatic transmission will automatically downshift.

### NOTE

- In “Sports mode”, downshifts do not take place when the accelerator is depressed all the way to the floor.

### Uphill/downhill driving

E00610500177

#### DRIVING UPHILL

The transmission prevents unnecessary upshifts even when the accelerator pedal is released and ensures smooth driving.

#### DRIVING DOWNHILL

According to the conditions, the transmission will automatically shift to a lower gear ratio to achieve stronger engine braking. This may help reduce your need to use the service brake.

### Waiting

E00604600245

For short waiting periods, such as at traffic signals, the vehicle can be left in gear and held stationary with the service brake.

For longer waiting periods with the engine running, place the selector lever in the “N” (NEUTRAL) position and apply the parking brake, while holding the vehicle stationary with the service brake.

### CAUTION

- Never hold the vehicle stationary on a hill using the accelerator pedal (without using the brake pedal). Always apply the parking brake and/or service brakes.

### Parking

E00604700161

To park the vehicle, first bring it to a complete stop, fully engage the parking brake, and then move the selector lever to the “P” (PARK) position.

If you are going to leave the vehicle unattended, always switch off the engine and remove the ignition key.

**NOTE**

- On a slope, be sure to apply the parking brake before moving the selector lever to the “P” (PARK) position. If you move the selector lever to the “P” (PARK) position before applying the parking brake, it may be difficult to disengage the selector lever from the “P” (PARK) position when next you drive the vehicle, requiring application of a strong force to the selector lever to move from the “P” (PARK) position.

**When the A/T makes no speed change**

E00604801879

If the transmission does not change speeds while driving, or your vehicle does not pick up enough speed when starting on an uphill slope, it may be that there is something unusual happening in the transmission, causing a safety device to activate. We recommend you to have your vehicle checked immediately.

1. If your vehicle has difficulty moving uphill, shift the selector lever into 2<sup>nd</sup> gear of the “Sports mode”.

This method might not work depending on the transmission malfunction.

2. Once the vehicle is moving on a level road, move the selector lever back to “D” (DRIVE).

**Super select 4WD II (SS4 II)**

E00605701325

Shifting to rear-wheel drive or 4-wheel drive can be made by operating the transfer shift lever (A). Shift the transfer shift lever to an appropriate position according to the road surface conditions. In addition, the 2WD/4WD operation indication lamp indicates the transfer shift lever shifting state. Refer to “2WD/4WD operation indication lamp” on page 6-23.

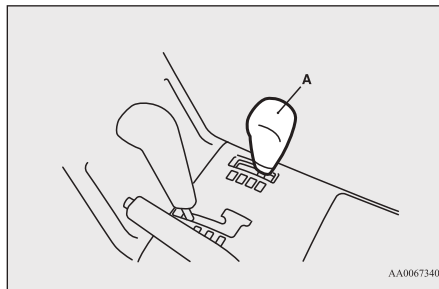

**Shift lever position and 2WD/4WD operation indication lamp**

E00605801401

Transfer shift lever position		2WD/4WD operation indication lamp	Driving conditions
2H	Rear-wheel drive	4L	When driving on dry paved road.
4H	Full-time 4-wheel drive	4L	The basic position for super select 4WD II. When driving on dry paved or slippery roads.
4HLc	Centre differential lock engaged 4-wheel drive	4L	When driving on rough, sand or snow covered roads.

: Illuminate

: Remain off

Transfer shift lever position		2WD/4WD operation indication lamp	Driving conditions
4LLc	Low range differential lock engaged 4-wheel drive		When driving up or down steep hills, on rough or muddy roads (especially when increased torque is required).

 : Illuminate

 : Remain off

### CAUTION

- The “4LLc” range gives maximum torque for low-speed driving on steep slopes, as well as sandy, muddy, and other difficult surfaces. Do not exceed speeds of approximately 70 km/h (43 mph) in “4LLc” range.
- Do not drive your vehicle in the “4HLc” or “4LLc” position on dry paved roads and highways. Doing so may result in excessive tyre wear, increased fuel consumption, and possible noise generation. It may also increase the differential oil temperature, which may damage the drive system. Further, the drive train will be subjected to excessive loading, resulting in oil leakage, component seizure, or other serious problems. On dry paved roads and highways, drive the vehicle in “2H” or “4H” only.

## Transfer shift lever operation

E00605901444

The transfer shift lever is operated by pushing it down and sliding it to the desired position.

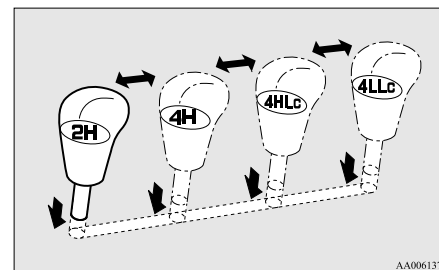

AA0061377

To shift from	To	Procedure
2H	4H	The transfer shift lever can be operated while the vehicle is either moving or stationary.
4H	2H or 4HLc	
4HLc	4H	When the vehicle is not in motion, shift the selector lever to the “N” (NEUTRAL) position before operating the transfer shift lever.
4HLc	4LLc	When the vehicle is moving, and only while it can be steered straight ahead, shift the selector lever to the “D” (DRIVE) position, and release the accelerator pedal before operating the transfer shift lever.
4LLc	4HLc	Stop the vehicle, shift the selector lever to the “N” (NEUTRAL) position, and operate the transfer shift lever.



**NOTE**

- Shifting of the lever among “2H” ↔ “4H” ↔ “4HLc” should only be done at speeds below 100 km/h (62 mph).
- When shifting from “2H” to “4H” in cold weather while the vehicle is in motion, the transmission gear may make some noise. In cold weather, try to shift the gear while the vehicle is stopped.
- When the lever is shifted between “2H” ↔ “4H” or “4H” ↔ “4HLc” while the vehicle is stopped, the 2WD/4WD operation indication lamp blinks while the selection is in process. Drive slowly and normally after confirming that the lamp is illuminated. Refer to “2WD/4WD operation indication lamp” on page 6-23.
- Do not move the selector lever while the 2WD/4WD operation indication lamp is blinking.
- On vehicles with cruise control, when the lever is shifted among “2H” ↔ “4H” ↔ “4HLc” while the cruise control is activated, the transfer gear may make some noise.

**CAUTION**

- Do not operate the transfer shift lever while the rear wheels of the vehicle are slipping on snow or ice.

**2WD/4WD operation indication lamp**

E00606001413

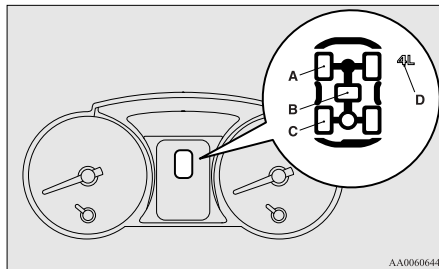

- A- Front wheel lamp
- B- Centre differential lock lamp
- C- Rear wheel lamp
- D- Low-range centre differential lock lamp



When the ignition switch is in the “ON” position, the 2WD/4WD operation indication lamp shows the shifting condition. The 2WD/4WD operation indication lamp illuminates at each transfer shift lever position as follows:



**“2H” ↔ “4H”**

Transfer shift lever position	2WD/4WD operation indication lamp
2H	
Drive mode switching in progress	
4H	



- : Blink
- : Illuminate
- : Remain off



“2H” ↔ “4HLc”

Transfer shift lever position	2WD/4WD operation indication lamp
2H	
Drive mode switching in progress	
	

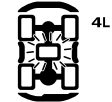









: Blink  
: Illuminate  
: Remain off



“4H” ↔ “4HLc”

Transfer shift lever position	2WD/4WD operation indication lamp
4H	
Drive mode switching in progress	
	

: Blink  
: Illuminate  
: Remain off

“4HLc” ↔ “4LLc”

Transfer shift lever position	2WD/4WD operation indication lamp	
4HLc		
		
Drive mode switching in progress		
		
4LLc		

: Blink  
: Illuminate  
: Remain off

6

**NOTE**

- The 2WD/4WD operation indication lamp blinks while the selection is in process. Take the following precautions when the indication lamp is blinking.
  - Keep the steering wheel in the straight ahead position while making range selections. If you attempt to drive forward with the steering wheel turned, gear rattling may occur and the desired range may not actually be selected.
  - If the front wheel and/or centre differential lock lamps continue blinking after a “2H” ↔ “4H” ↔ “4HLC” selection has been made with the vehicle moving, hold the steering wheel in the straight ahead position and slowly depress the accelerator pedal several times.
  - If, after a “4HLC” ↔ “4LLC” selection has been made, the front and rear wheel lamps continue blinking and the desired range is not actually selected, return the transfer shift lever to its previous position. Place the steering wheel in the straight ahead position, drive the vehicle forward, and release the accelerator pedal. Next, place the selector lever in the “N” (NEUTRAL) position and make the range selection again.

**NOTE**

- If the front and rear wheel lamps blink rapidly (twice per second) when you attempt to make a “4HLC” ↔ “4LLC” selection, the selection cannot be made. Stop the vehicle and release the accelerator pedal. Next, place the selector lever in the “N” (NEUTRAL) position and make the range selection again.

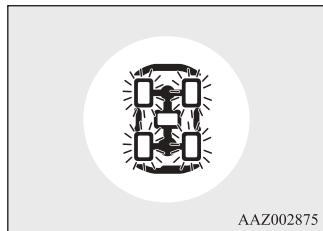
**CAUTION**

- If a problem is detected in the transfer system, a safety device will activate. The front and rear wheel lamps will go out, the centre differential lock lamp will blink, and transfer shifting will become impossible. Park your vehicle in a safe place, turn off the engine for a few moments. Restart the engine. The lamps should resume normal operation. If the lamps continue to blink, we recommend you to have the vehicle checked as soon as possible.



## Rear differential lock\*

E0060620043

If one wheel starts to spin freely and the vehicle becomes stuck and cannot be freed even using 4-wheel drive, the rear differential lock switch (A) can be used to activate the rear differential lock for extra traction.

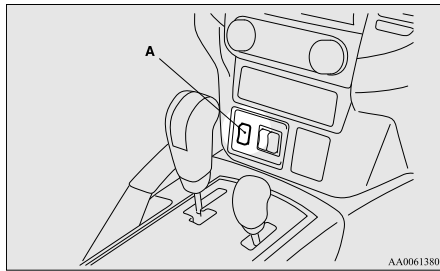

### Operating the rear differential lock

1. Move the transfer shift lever to “4LLc” or “4HLc” position.
2. To activate the rear differential lock, press the rear differential lock switch (1).

3. To deactivate the rear differential lock, press the rear differential lock switch (2).

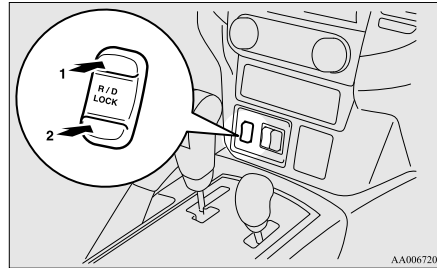

### CAUTION

- Operate the rear differential lock switch after the wheels are stopped. Operating the switch with the wheels turning may cause the vehicle to dart in unexpected directions.

### NOTE

- The rear differential lock does not operate when the transfer shift lever is in “4H” or “2H” position.
- When the rear differential is locked with the transfer shift lever in “4LLc” or “4HLc” position, changing the shift lever to “4H” or “2H” position makes the rear differential unlock automatically.

## The rear differential lock indication lamp

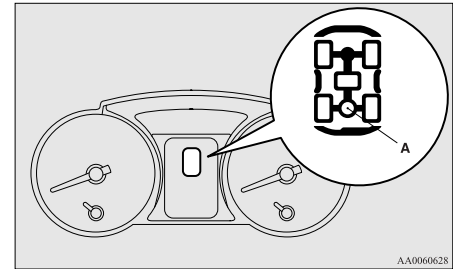

E00606300233

When the ignition switch is turned to the “ON” position, the rear differential lock indication lamp (A) in the meter cluster illuminates for a few seconds then indicates the rear differential lock’s operating status (activated or deactivated).



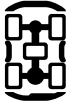

**NOTE**

- The 2WD/4WD operation indication lamp also illuminates for a few seconds when the ignition switch is turned to the “ON” position. Refer to “2WD/4WD operation indication lamp” on page 6-23. The status of the rear differential lock (resulting from depression of the rear differential lock switch) is shown by blinking or steady illumination of the rear differential lock indication lamp.

The operation state of rear differential lock	2WD/4WD operation indication lamp
Rear differential lock deactivated	
	↑↓
Switching in progress	

The operation state of rear differential lock	2WD/4WD operation indication lamp
	↑↓
Rear differential lock activated	

: Blink  
: Illuminate (steady)  
: Remain off

**NOTE**

- The indication lamp blinks while the rear differential lock is being switched between its activated and deactivated conditions. When the switching operation is complete, the indication lamp is either illuminated steadily or not illuminated.

**NOTE**

- The active stability & traction control (ASTC) and anti-lock brake system (ABS) functions are suspended while the rear differential lock is activated. ASTC indication lamp, Active Stability Control function OFF indication lamp, ABS warning lamp and brake warning lamp are illuminated while these functions are suspended. It does not indicate a problem. When the rear differential lock is disengaged, these lamps go out and function again. Refer to “Brake warning lamp” on page 5-10, “ABS warning lamp” on page 6-38, “ASTC indication lamp” on page 6-40, “Active stability control function OFF indication lamp” on page 6-42.
- If the indication lamp continues blinking after the switch has been pressed to deactivate the rear differential lock, hold the steering wheel in the straight ahead position then slowly depress and release the accelerator pedal several times.
- If the indication lamp continues blinking after the switch has been pressed to activate the rear differential lock, bear in mind the following instructions:
  - If the vehicle speed is 12 km/h (7 mph) or higher, decelerate to a speed of 6 km/h (4 mph) or lower. The switching operation will be completed and the indication lamp will illuminate steadily.

**NOTE**

- If the vehicle speed is 12 km/h (7 mph) or lower, turn the steering wheel from side to side until the indication lamp illuminates steadily. If the vehicle is stuck in soft ground, make sure the area around the vehicle is clear then repeatedly attempt to drive forward and backward. The switching operation will be completed and the indication lamp will illuminate steadily.



AA0092096

**Examples of effective use of the rear differential lock**

E00606400045

**CAUTION**

- If a problem is detected in the rear differential lock system, a safety device will activate. The centre differential lock lamp, front and rear wheel lamps will go out, the rear differential lock indication lamp will blink, and the rear differential lock will deactivate. Park your vehicle in a safe place, turn off the engine for a few moments. Restart the engine. It is safe to continue driving if the lamps resume normal operation. If the rear differential lock indication lamp blinks when the rear differential lock is reactivated, we recommend you to have the vehicle checked as soon as possible.

**CAUTION**

- Use the rear differential lock only as an emergency measure when the vehicle is stuck and cannot be freed with the transfer shift lever in “4LLc” or “4HLC” position. Deactivate the rear differential lock immediately after using it.

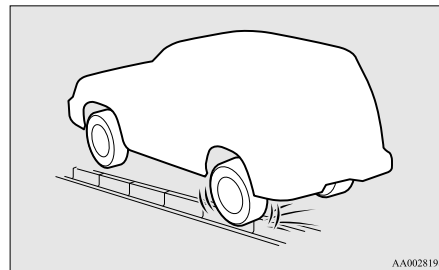
**When one of the wheels has fallen in a ditch**

AA0028198

**When driving on rocky roads**

When the vehicle is unable to move because one of the wheels is suspended in the air.

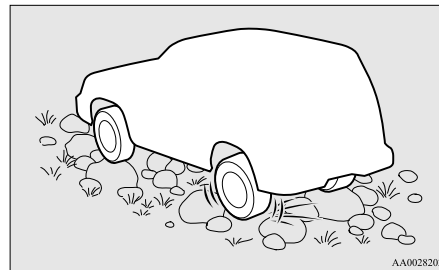

AA0028202

## When getting out of snow

When the vehicle is unable to get going because one of the wheels is on the snow and the other on a paved road.

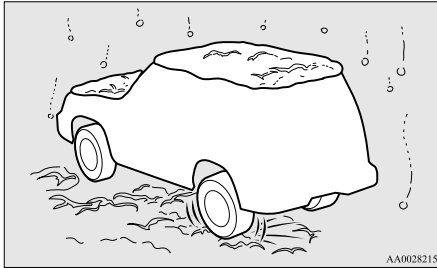

## Examples of incorrect use of the rear differential lock

E00606500046

### ⚠ WARNING

- If the "4LLc" or "4HLc" position is selected along with the rear differential lock, the following phenomena appear and it is very dangerous.  
Please be sure to release the rear differential lock on normal roads.

### ⚠ WARNING

- If the rear differential lock is used by mistake when driving on a paved road: With the rear differential lock on, the power to drive the vehicle straight ahead becomes very strong, which may make it difficult to turn the steering wheel.

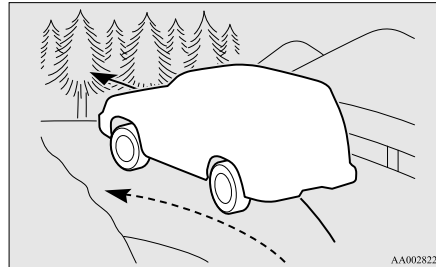

### ⚠ WARNING

- If the rear differential lock is used by mistake when turning a curve or making a right or left turn at a crossing or the like: The vehicle is unable to make a turn and may go straight ahead.

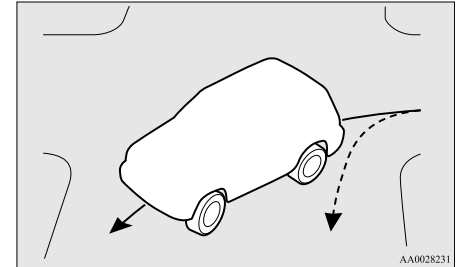

### ⚠ WARNING

- If the rear differential lock is used by mistake except when making an emergency escape on snow or frozen road: It becomes difficult to make a steady turn.
- In the case where the condition of the road is different for the right tyre to drive from the left tyre (such as one tyre on a paved road and the other on ice), direction of the vehicle may change abruptly when engine braking or accelerating.  
Do not use the rear differential lock except when making an emergency escape on a snow or frozen road, but drive with 4WD.

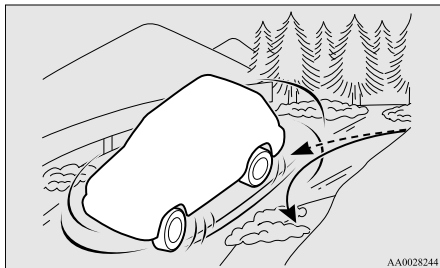

AA0028244

### 4-wheel drive operation

E00606602344

By selecting 4-wheel drive, both axles of the vehicle are rigidly connected with each other. This improves the traction characteristics. When turning sharp corners or moving forward and backward repeatedly, however, the drive line is stressed, which is felt as a braking effect. A 4-wheel drive vehicle can accelerate more quickly and smoothly.

However, note that the braking distance is not shorter than that of a rear-wheel drive vehicle.

When using 4-wheel drive on rough roads (snow, mud, sand, etc.), it is important to operate the vehicle correctly.

### NOTE

- The driving posture should be more upright and closer to the wheel than usual; adjust the seat to a good position for easy steering and pedal operation. Be sure to wear the seat belt.
- After driving on rough roads, check each part of the vehicle and wash it thoroughly with water. Refer to the “Vehicle care” section and “Inspection and maintenance following rough road operation” on page 6-33.

### Driving on dry paved road and highway

Select the “2H” or “4H” position to drive on the dry paved road. Especially on dry highway, never select the “4HLc” or “4LLc” position.

### CAUTION

- Selecting the “4HLc” or “4LLc” position to drive on dry paved road will increase the fuel consumption with possible noise generation and early tyre wear. It may also increase the differential oil temperature, resulting in possible damage to the driving system. Further, the drive train will be subjected to excessive loading, possibly leading to oil leakage, component seizure, or other serious faults.

### Driving on snowy or icy roads

Set the transfer shift lever to the “4H” or “4HLc” position in accordance with the road conditions, and then gradually depress the accelerator pedal for a smooth start.

### NOTE

- The use of snow tyres and/or tyre chains is recommended.
- In order to ensure that the anti-lock brake system (ABS) will operate correctly in situations where tyre chains have been fitted, drive in the “4H”, “4HLc” or “4LLc” position.
- Maintain a safe distance between vehicles, avoid sudden braking, and use engine braking (downshifting).



**⚠ CAUTION**

- Avoid sudden braking, sudden acceleration, and sharp turning; such operations could cause skidding and spinouts.

**Driving on sandy or muddy roads**

Set the transfer shift lever to the “4HLc” or “4LLc” position and then gradually depress the accelerator pedal for a smooth start. Keep the pressure on the accelerator pedal as constant as possible, and drive at low speed.

**⚠ CAUTION**

- Do not force the vehicle or drive recklessly on sandy surfaces. In comparison with normal road surfaces, the engine and other drive-system components are put under excessive strain when driving on such a surface, and this could lead to accidents.
- If any of following conditions occur while the vehicle is being driven, immediately park your vehicle in a safe place and follow these procedures:
  - The needle in the temperature gauge approaches the overheating zone. Refer to “Engine overheating” on page 8-04.

**⚠ CAUTION**

- A/T fluid temperature warning lamp illuminates. Refer to “When the A/T fluid temperature warning lamp comes on” on page 6-19.

**⚠ WARNING**

- **When attempting to rock your vehicle out of a stuck position, be sure that the area around the vehicle is clear of people and physical objects. The rocking motion may cause the vehicle to suddenly launch forward or backward, causing injury or damage to nearby people or objects.**

**📖 NOTE**

- Avoid sudden braking, acceleration, and turning; such operations could result in the vehicle becoming stuck.
- If the vehicle becomes stuck in sandy or muddy roads, it can often be moved with a rocking motion. Move the selector lever rhythmically between the “D” (DRIVE) and “R” (REVERSE) position, while applying slight pressure to the accelerator pedal.
- It is recommended to start the vehicle with parking brake partially, but not completely, applied by slightly pulling the parking brake lever. After the vehicle has become free, do not forget to release the parking brake.

**📖 NOTE**

- If it is necessary to drive in extremely muddy conditions, the use of tyre chains is recommended. Because the extent of muddy conditions is difficult to judge and the vehicle could become bogged down very deeply, operation should be at a low speed. If possible, get out of the vehicle and check the conditions ahead before proceeding.
- Driving over roads in coastal areas or roads on which anti-skid preparations have been spread can cause rust on the vehicle; wash the vehicle thoroughly as soon as possible after such use.

**6****Climbing sharp grades**

Set the transfer shift lever to the “4LLc” position to maximize the engine torque.

**⚠ WARNING**

- **Go straight up. Do not try to traverse across a steep slope.**
- **If you begin to lose traction, ease off the accelerator pedal and gently turn the steering wheel alternatively left and right to regain adequate traction again.**

**📖 NOTE**

- Choose as smooth a slope as possible with few stones or other obstacles.

### NOTE

- Before attempting to drive up the slope, walk it up to confirm that the vehicle can handle the grade.

### Descending sharp grades

Set the transfer shift lever to the “4LLc” position, use the engine brake (downshifting) and descend slowly.

### WARNING

- Avoid snaking down a sharp grade. Descend the grade as straight as possible.

### NOTE

- When descending a sharp grade, if the brakes are applied suddenly because of an obstacle encountered, control of the vehicle could be lost. Before descending the slope, walk it down and confirm the path.
- Before descending a grade, it is necessary to choose the appropriate gear. Avoid changing gears or depressing the clutch while descending the grade.

### NOTE

- MITSUBISHI MOTORS is not responsible to the operator for any damage or injury caused or liability incurred by improper and negligent operation of a vehicle. All techniques of vehicle operation described herein depend on the skill and experience of the operator and other participating parties and any deviation from the recommended operation instructions above is at their own risk.

### Turning sharp corners

When turning a sharp corner in the “4HLc” or “4LLc” position at low speed, a slight difference in steering may be experienced similar to as if the brakes were applied. This is called tight corner braking and results from each of the 4 tyres being at a different distance from the corner.

The phenomenon is peculiar to 4-wheel drive vehicles. If this occurs, either straighten the steering wheel, or change to rear-wheel drive.

### Crossing a stream

4-wheel drive vehicles are not necessarily waterproof. If the electrical circuits become wet, further operation of the vehicle will be impossible; therefore, avoid crossing streams unless absolutely necessary. If crossing a stream is unavoidable, use the following procedure:

1. Check depths of a stream and geographical features before attempting to cross a stream and ford the stream where the water is as shallow as practicable.
2. Cross at a place where the water is less than 70 cm deep.
3. Set the transfer shift lever to the “4LLc” position.
4. Drive slowly at a speed of approximately 5 km/h (3 mph) to avoid splashing too much water.

### CAUTION

- Do not attempt to cross a stream at a place where the water is more than 70 cm deep.
- Cross a stream temporarily for emergencies and avoid doing so for a long period of time.
- After crossing a stream, apply the brakes to be sure they are functioning properly. If the brakes are wet and not functioning properly, dry them out by driving slowly while lightly depressing the brake pedal. Inspect each part of the vehicle carefully.

### NOTE

- Because the inside of the vehicle is flooded with water when crossing at a place where the water is more than 50 cm deep, we recommend you to have your vehicle inspected.

 **NOTE**

- Frequent crossing of streams can adversely affect the life span of the vehicle; we recommend you to take the necessary measures to prepare, inspect, and repair the vehicle.

## Inspection and maintenance following rough road operation

E00606700048

After operating the vehicle in rough road conditions, be sure to perform the following inspection and maintenance procedures:

- Check that the vehicle has not been damaged by rocks, gravel, etc.
- Carefully wash the vehicle with water. After washing, drive the vehicle slowly while lightly depressing the brake pedal in order to dry out the brakes. If the brakes still do not function properly, we recommend you to have the brakes checked as soon as possible
- Remove the insects, dried grass, etc. clogging the radiator core.
- After crossing a stream, be sure to have the following items inspected at a MITSUBISHI MOTORS Authorized Service Point and take the necessary measures.

- Check the brake system and, if necessary, have it serviced.
- Check the engine, transmission, transfer, and differential oil or grease level and turbidity. If the oil or grease is milky, it indicates water contamination. Replace it with new oil or grease.
- Grease the propeller shaft.
- Check the inside of the vehicle. If ingress of water is found, dry the carpet etc.
- Inspect the headlamps. If the headlamp bulb is flooded with water, we recommend you to have it drained.

### Cautions on handling of 4-wheel drive vehicles

E00606802144

#### Tyres and wheels

Since the driving torque can be applied to the 4 wheels, the performance of the vehicle when operating in 4-wheel drive is greatly affected by the condition of the tyres.

Pay close attention to the tyres.

- Install specified tyres on all wheels. Refer to “Tyres and wheels” on page 11-11.

- Be sure to fit all 4 tyres and wheels of the same size and type. When replacement of any of the tyres or wheels is necessary, replace all of them.
- All tyres should be rotated whenever the wear difference between the front and rear tyres is recognizable.

Good vehicle performance cannot be expected if there is a difference in wear between tyres. Refer to “Tyre rotation” on page 10-13.

- Check the tyre inflation pressure regularly.
- If the tyre inflation pressure is inappropriate, the transfer gear may make some noise and shock while changing the drive mode.

#### CAUTION

- Always use tyres of the same size, same type, and same brand, and which have no wear differences. Using tyres which differ in size, type, brand or the degree of wear will cause excessive loading, resulting in possible damage to the drive system.

## Towing

If towing is necessary, we recommend you to have it done by your MITSUBISHI MOTORS Authorized Service Point or a commercial tow truck service.

In the following cases, transport the vehicle using a tow truck.

- The engine runs but the vehicle does not move or abnormal noise is produced.
- Inspection of the vehicle's underside reveals that oil or some other fluid is leaking.

Only when you cannot receive a towing service from a MITSUBISHI MOTORS Authorized Service Point or commercial tow truck service, tow your vehicle carefully in accordance with the instructions given in "Towing" on page 8-16.

### CAUTION

- Be sure to shift the transfer shift lever to the "2H" position. Never try to tow with the transfer shift lever in the "4H", "4HLc" or "4LLc" positions and with any of the wheels on the ground (Type A or B). This could result in damage to the vehicle's driving system, or the vehicle could become separated from the tow truck and unexpected accident might result.  
If you cannot shift the transfer shift lever to "2H" position or the transmission is malfunctioning or damaged, transport the vehicle with all the wheels on a carriage (Type C or D) as illustrated.

If you can shift the transfer shift lever to the "2H" position.

A



B



If you cannot shift the transfer shift lever to the "2H" position.

C

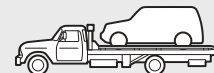

D



AA2001328

## Jacking up a 4-wheel drive vehicle

### WARNING

- Do not crank the engine while jacking up the vehicle.  
The tyre on the ground may turn and the vehicle may roll off the jack.

## Braking

E00607001524

All the parts of the brake system are critical to safety. We recommend you to have the vehicle checked at regular intervals according to the service booklet.

### CAUTION

- Avoid driving habits that cause heavy braking and never “ride” the brakes by resting your foot on the brake pedal while driving. It causes brake overheating and fade.

## Brake system

The service brake is divided into two brake circuits so that when one brake circuit fails, the other is available to stop the vehicle. In this situation, even if the brake pedal moves down to the very end of its possible stroke, keep depressing the brake pedal down harder than usual; stop driving as soon as possible and have the brake system repaired. For details, refer to “Brake warning lamp” on page 5-10.

## Power brakes

The power brakes use brake fluid pressurized by the pump to power-assist the brake. If the brake system fails during driving, the brake warning lamp comes on and a buzzer sounds continuously. In this case, the brake may not work properly.

If this buzzer should continue to sound, park your vehicle in a safe place and have the system checked.

Refer to “Brake warning lamp” on page 5-10.

### CAUTION

- Bring the vehicle to halt in a safe location by applying the brakes gently. Applying the brakes rapidly or driving at high speed may make the vehicle unstable.

### NOTE

- Depressing the brake pedal repeatedly may turn on the brake warning lamp, ABS warning lamp and brake warning buzzer. (The ASTC indication lamp and Active Stability Control function OFF indication lamp also turn on.) It is normal if the lamp goes out and the buzzer stops sounding after a few seconds.

### NOTE

- In certain cases immediately after the engine has been started or when the brake pedal is depressed repeatedly, a noise generated by operation of brake devices may be heard coming from the engine compartment, or the brake pedal vibration may be felt. This type of noise or vibration is normal and there is no need for concern. In fact, it indicates that the corresponding devices are operating normal.

### WARNING

- **Do not turn off the engine while your vehicle is in motion. If you turn off the engine while driving, the power assistance for the braking system will stop working and your brakes will not work effectively.**
- **If the power assist is lost or if either brake hydraulic system stops working properly, have your vehicle checked immediately.**

## Warning lamp

- The brake warning lamp illuminates to indicate a fault in the braking system. Read “Brake warning lamp” on page 5-10.

- On vehicles with the rear differential lock, the active stability & traction control (ASTC) and anti-lock brake system (ABS) functions are suspended while the rear differential lock is activated. ASTC indication lamp, Active Stability Control function OFF indication lamp, ABS warning lamp and brake warning lamp are illuminated while these functions are suspended. It does not indicate a problem. When the rear differential lock is disengaged, these lamps go out and function again.

Refer to “Brake warning lamp” on page 5-10, “ABS warning lamp” on page 6-38, “ASTC indication lamp” on page 6-40, “Active stability control function OFF indication lamp” on page 6-42.

### When brakes are wet

Check the brake system while driving at a low speed immediately after starting, especially when the brakes are wet, to confirm they work normally.

A film of water can be formed on the brake discs and prevent normal braking after driving in heavy rain or through large puddles, or after the vehicle is washed. If this occurs, dry the brakes out by driving slowly while lightly depressing the brake pedal.

### When driving downhill

It is important to take advantage of the engine braking by shifting to a lower shift position while driving on steep downhill roads in order to prevent the brakes from overheating.

#### WARNING

- **Do not leave any objects near the brake pedal or let a floor mat slide under it; doing so could prevent the full pedal stroke that would be necessary in an emergency. Make sure that the pedal can be operated freely at all times. Make sure the floor mat is securely held in place.**

### Brake pads

- Avoid hard braking situations. New brakes need to be broken-in by moderate use for the first 200 km (125 miles).
- The disc brakes are provided with a warning device which emits a shrieking metallic sound while braking if the brake pads have reached their wear limit. If you hear this sound, have the brake pads replaced immediately.

#### WARNING

- **Driving with worn brake pads will make it harder to stop, and can cause an accident.**

### Brake assist system

E00627001852

The brake assist system is a device assisting drivers who cannot depress the brake pedal firmly when it is necessary to do so (such as in emergency stop situations) and provides greater braking force.

If the brake pedal is depressed suddenly, the brakes will be applied with more force than usual.

#### CAUTION

- The brake assist system is not a device designed to exercise braking force greater than its capacity. Make sure to always keep a sufficient distance between your vehicle and a vehicle in front of you without relying too much on the brake assist system.

 **NOTE**

- Once the brake assist system is operational, it maintains great braking force even if the brake pedal is lightly released. To stop its operation, completely remove your foot from the brake pedal.
- When the brake assist system is in use while driving, you may feel the brake pedal attempt to resist, the pedal moves in small motions in conjunction with the operation noise, or the vehicle body and the steering wheel vibrate. This occurs when the brake assist system is operating normally and does not indicate faulty operation. Continue to firmly depress the brake pedal.
- When the anti-lock brake system warning lamp is illuminated, the brake assist system is not functioning.

## Anti-lock brake system (ABS)

E00607101248

Environmental conditions can have an effect on braking. During sudden braking when there is snow, ice, oil, water etc. on the road surface, a skid may occur. In this situation, steering control and braking effectiveness is reduced and the stopping distance is increased. The vehicle may also go into an uncontrolled spin.

The ABS helps prevent the wheels from locking during braking, thus maintaining directional stability, ensuring controllability and providing optimum braking force.

### Driving hints

- Always maintain the same distance from the vehicle in front of you as you would for a vehicle not equipped with ABS. Compared with vehicles not fitted with ABS, your vehicle may require a longer stopping distance in the following cases:
  - Driving on gravel or snow-covered roads.
  - Driving with tyre chains installed.
  - Driving on roads where the road surface is pitted or has other differences in surface height.
  - Driving on bumpy roads or other poor driving surfaces.
- In order to ensure that the ABS will operate correctly in situations where tyre chains have been fitted, drive in the “4H”, “4HLc”, or “4LLc” position.

- Operation of ABS is not restricted to situations where brakes are applied suddenly. This system may also operate to prevent wheel lock when you are driving over manholes, steel road-work plates, or the vehicle is driven over steps or level differences in the road, road markings, or other surfaces which are difficult for the wheels to grip.
- When the ABS is activated, you may feel the brake pedal pulsation and the vibrations of the vehicle body and steering wheel. You may also hear a characteristic noise. At this time, you may feel as if the pedal attempts to resist being depressed. This is a normal result of the ABS operation, and does not indicate a problem. **In this situation, to let the ABS work for you, just hold the brake pedal down more firmly. Do not pump the brake. This will result in reduced braking performance.**
- When the engine starts and after starting to drive, you might hear operation noise from the engine compartment or feel a shock from the brake pedal. This is normal. The ABS is performing self-check.
- The ABS will operate after the vehicle has accelerated to a speed in excess of approximately 10 km/h (6 mph). It stops operating when the vehicle decelerates to a speed below about 5 km/h (3 mph).

### CAUTION

- Even the ABS cannot prevent the natural laws of physics from acting on the vehicle. It cannot for instance avoid accidents that may result from excessive speed on bends or following another vehicle too closely or aquaplaning. It should remain the driver's task to observe safety precautions to judge speeds and brake applications correctly in such conditions.
- Be sure to use tyres of the same type and size on 4 wheels.  
If tyre types or sizes are mixed, ABS may not function normally.
- Never install a limited-slip differential, which is not a MITSUBISHI MOTORS genuine part, as the ABS may not function normally.  
We recommend you to consult a MITSUBISHI MOTORS Authorized Service Point.

### ABS warning lamp

E00607200532

The ABS warning lamp should illuminate when the ignition switch is turned "ON", and should go off in a few seconds.

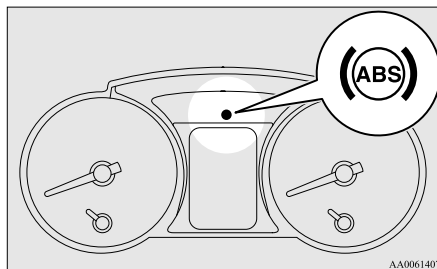

### CAUTION

- If the warning lamp stays on or does not illuminate when you start the vehicle, it indicates that the ABS is not functioning and that only the standard brake system is in operation. (In this condition the standard hydraulic brake system will still function.) We recommend you to have your vehicle inspected as soon as possible.

### NOTE

- Depressing the brake pedal repeatedly may turn on the brake warning lamp, ABS warning lamp and brake warning buzzer. (The ASTC indication lamp and Active Stability Control function OFF indication lamp also turn on.) It is normal if the lamp goes out and the buzzer stops sounding after a few seconds.
- On vehicles with the rear differential lock, the active stability & traction control (ASTC) and anti-lock brake system (ABS) functions are suspended while the rear differential lock is activated. ASTC indication lamp, Active Stability Control function OFF indication lamp, ABS warning lamp and brake warning lamp are illuminated while these functions are suspended. It does not indicate a problem. When the rear differential lock is disengaged, these lamps go out and function again.  
Refer to "Brake warning lamp" on page 5-10, "ASTC indication lamp" on page 6-40, "Active stability control function OFF indication lamp" on page 6-42.



## If the warning lamp illuminates while driving

E00607300416

## If only the ABS warning lamp illuminates

- Avoid hard braking and high-speed driving. Stop the vehicle in a safe place. Restart the engine and check to see whether the lamp goes out after a few minutes driving; if it then remains off during driving, there is no problem. However, if the lamp does not go out, or if it lights up again when the vehicle is driven, we recommend you to have the vehicle checked as soon as possible.
- The ABS warning lamp can illuminate if the battery voltage is insufficient when the engine is started. In this case, it does not indicate an ABS fault. Charge the battery by allowing the engine to idle for a while. If the battery has been charged but the ABS warning lamp continues to illuminate or illuminates intermittently, we recommend you to have the vehicle inspected.

## If the ABS warning lamp and brake warning lamp illuminate at the same time

- The ABS and brake force distribution function will not work, so hard braking could make the vehicle unstable. Avoid hard braking and high-speed driving. Stop the vehicle in a safe place and we recommend you to have it checked.

## Inspection following snowy road operation

E00618300012

After driving on snowy roads, remove any snow and ice which may have become adhered to the wheel areas.

When doing this, be careful not to damage the wheel speed sensors (A) and cables located at each wheel on vehicles equipped with an ABS.

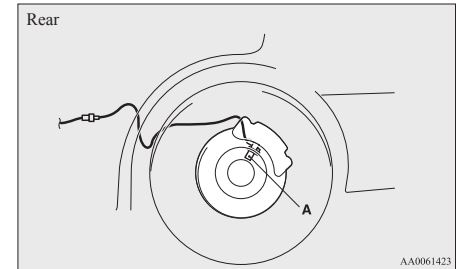
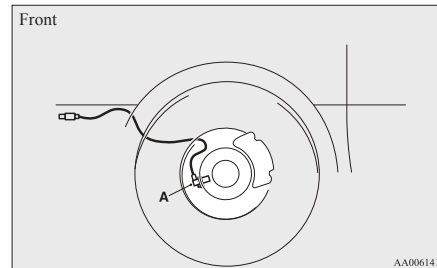

## Power steering system

E00607401528

The power steering system operates while the engine is running. It helps reduce the effort needed to turn the steering wheel.

The power steering system has mechanical steering capability in case the power assist is lost. If the power assist is lost for some reason, you will still be able to steer your vehicle, but you will notice it takes much more effort to steer. If this happens, have your vehicle inspected at a MITSUBISHI MOTORS Authorized Service Point.

### ⚠ WARNING

- Do not stop the engine while the vehicle is moving. Stopping the engine would make the steering wheel extremely hard to turn, possibly resulting in an accident.

### CAUTION

- Do not leave the steering wheel turned all the way in one direction. This can cause damage to the power steering system.

## Active stability & traction control (ASTC)

E00613800230

The active stability & traction control (ASTC) takes overall control of the anti-lock brake system, Active Stability Control function and active traction control function to maintain the vehicle's stability and traction. Please read this section in conjunction with the pages on the anti-lock brake system, Active Stability Control function and active traction control function.

Anti-lock brake system (ABS) → p. 6-37  
Active stability control function → p. 6-42  
Active traction control function → p. 6-43

### CAUTION

- Do not over-rely on the ASTC. Even when the ASTC is operating, there are limits to how far it can ensure vehicle stability; reckless driving may lead to accidents. Always drive carefully, taking account of the road conditions.

### CAUTION

- Be sure to use the same specified type and size of tyre on all 4 wheels. Otherwise, there is a possibility that the ASTC will not work properly.

### NOTE

- An operation noise may be emitted from the engine compartment in the following situations. The sound is associated with checking the operations of the ASTC. At this time, you may feel a shock from the brake pedal if you depress it. These do not indicate a malfunction.
  - When the ignition switch is set to the "ON" position.
  - When the vehicle is driven for a while after the engine is turned on.
- When the ASTC is activated, you may feel a vibration in the vehicle body or hear a whining sound from the engine compartment. This indicates that the system is operating normally. It does not indicate a malfunction.
- When the anti-lock brake system warning lamp is illuminated, the ASTC is not active.

### NOTE

- On vehicles with the rear differential lock, the ASTC and ABS functions are suspended while the rear differential lock is activated. ASTC indication lamp, Active Stability Control function OFF indication lamp, ABS warning lamp and brake warning lamp are illuminated while these functions are suspended. It does not indicate a problem. When the rear differential lock is disengaged, these lamps go out and function again. Refer to "Brake warning lamp" on page 5-10, "ABS warning lamp" on page 6-38, "Active stability control function OFF indication lamp" on page 6-42.

## ASTC indication lamp

E00618000035

The ASTC indication lamp shows the operating status of the Active Stability Control function and active traction control function. For details, see these sections of this owner's manual:

Active stability control function indication lamp → p. 6-42

Active traction control function indication lamp → p. 6-43

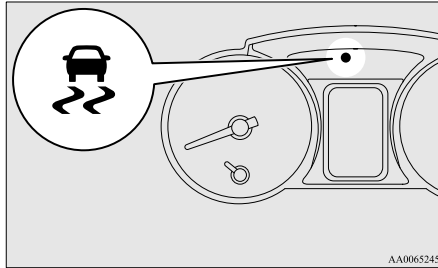

## ASC OFF switch

E00620500095

The Active Stability Control function is automatically activated when the ignition switch is turned to the “ON” position. You can deactivate the system by pressing the ASC OFF switch when the vehicle is stationary.

To reactivate the Active Stability Control function, press the ASC OFF switch again. It is strongly recommended that the Active Stability Control function normally be kept activated.

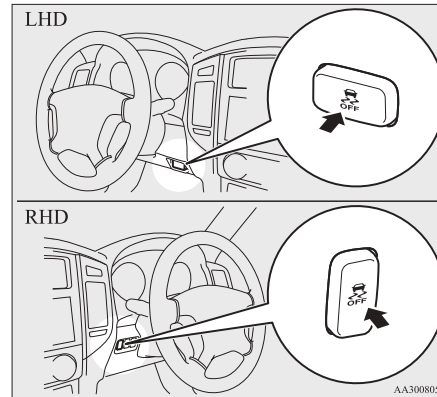

## ⚠ CAUTION

- For safety, operate the ASC OFF switch with the vehicle stationary.

## Driving hints

E00618100036

When extricating the vehicle from mud, sand or fresh snow with the transfer shift lever in the “2H”, “4H”, or “4HLc” position, you may find that operation of the ASTC prevents the engine speed from increasing in response to depression of the accelerator pedal. If this happens and the vehicle remains stuck as a result, place the transfer shift lever in the “4LLc” position or turn the Active Stability Control switch OFF. The vehicle will then be easier to extricate. (Brake control of the active traction control function is still working to prevent wheel spins when ASC OFF switch “OFF” or “4LLc” position selected.)

## 📖 NOTE

- If the vehicle speed increases to about 120 km/h (75 mph) with the Active Stability Control function deactivated, the Active Stability Control function automatically starts operating. To subsequently stop the Active Stability Control function, stop the vehicle and press the ASC OFF switch again.

## Active stability control function

E0061390097

The Active Stability Control function is designed to help maintain the vehicle's control in slippery conditions, or during rapid steering manoeuvres. It works by controlling the engine output and brake on each wheel.

### NOTE

- The Active Stability Control function does not operate when the transfer shift lever is in the "4LLc" position. When the Active Stability Control function is operating with the transfer shift lever in the "2H", "4H" or "4HLc" position, moving the shift lever to the "4LLc" position makes the Active Stability Control function deactivate automatically.
- On vehicles with rear differential lock, the Active Stability Control function does not operate when the rear differential lock is activated.

## Active stability control function indication lamp

E00614000183

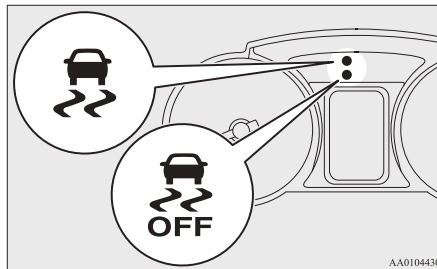



Active stability control function indication lamp



Active stability control function OFF indication lamp







The indication lamps should illuminate when the ignition switch is turned to the "ON" position and should go off after a few seconds. If the indication lamps stay on or do not illuminate when the ignition switch is turned to the "ON" position, we recommend you to have your vehicle inspected.

 indication lamp blinks when the Active Stability Control function is operating.



 indication lamp illuminates when the Active Stability Control function is deactivated by either of the following operations:

- The ASC OFF switch is pressed to deactivate the system.
- The transfer shift lever is placed in the "4LLc" position.

### CAUTION

- When  indication lamp blinks, the Active Stability Control function is operating, which means that the road is slippery or that your vehicle's wheels are spinning excessively. If this happens, drive slower with less accelerator input.
- If a fault occurs in the device, the ABS warning lamp or  and  indication lamps illuminate as warning. Park your vehicle in a safe place and stop the engine. Then, start the engine again and check whether the ABS warning lamp or  and  indication lamps go out. If the ABS warning lamp or  and  indication lamps remains lit even after the engine has been started, we recommend you to have your vehicle checked.

**NOTE**

- Immediately after reconnection of the battery cable, the  indication lamp will illuminate and the Active Stability Control function will stop operating. If the vehicle is driven and the  indication lamp goes off, the Active Stability Control function will again start operating. If the indication lamp illuminates again or illuminates even though the battery has not been disconnected, an insufficient battery voltage or other problems may be the reason. We recommend you to have your vehicle inspected.



**Active traction control function**

E00614100041

The active traction control function maintains traction on slippery road surfaces by automatically controlling the engine output and applying the brakes so the driving wheels are prevented from spinning.

The active traction control function automatically turns ON when the ignition switch is turned to the “ON” position.

**CAUTION**

- If the temperature in the braking system increases excessively due to continuous brake control on a slippery road surface, a warning buzzer will sound intermittently to warn the driver. If driving continues in spite of the buzzer and the temperature in the braking system increases further, the  indication lamp will illuminate, the warning buzzer will sound continuously for approximately 3 seconds, and active traction control function will be suspended to protect the braking system. (Normal operation of the vehicle will not be affected.) If the vehicle is stopped and the  indication lamp goes off, the active traction control function will start operating again.

**Active traction control function indication lamp**

E00614200127

The  indication lamp (1) should illuminate when the ignition switch is turned to the “ON” position and should go off after a few seconds.

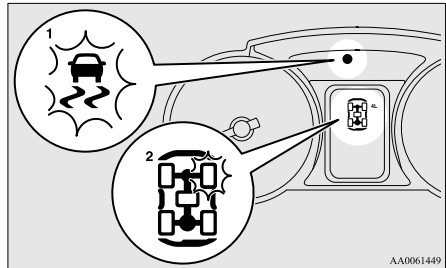

If the indication lamp stays on or does not illuminate when the ignition switch is turned to the “ON” position, we recommend you to have your vehicle inspected.

When the active Traction Control System operates, the active traction control function indication lamp (1) blinks and the indication lamp for the wheel (2) being subjected to antispin control also blinks.



Example indication: Active traction control function controlling front-right wheel

**NOTE**

- In the event of a fault in the Active Stability Control function, the  and  indication lamps illuminate. As a result, an indication of the active traction control function is limited to flashing of the indication lamp for the wheel (2) being subjected to antispin control.

## ⚠ CAUTION

- If the vehicle is towed with the ignition switch in the “ON” position and only the front wheels or only the rear wheels raised off the ground, the active traction control function may operate, resulting in an accident. When towing the vehicle with the front wheels raised, keep the ignition switch in the “LOCK” or “ACC” position. When towing the vehicle with the rear wheels raised, keep the ignition switch in the “ACC” position. Refer to “Towing” on page 8-16.

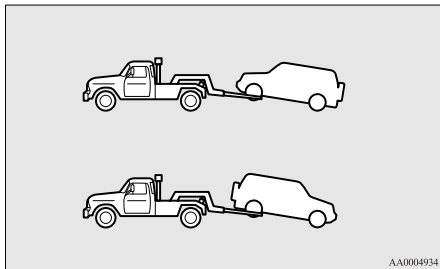

## Cruise control\*

E00609102382

Cruise control is an automatic speed control system that keeps a set speed. It can be activated at about 40 km/h (25 mph) or more.

## ⚠ CAUTION

- When you do not wish to drive at a set speed, turn off the cruise control for safety.
- Do not use cruise control when driving conditions will not allow you to stay at the same speed, such as in heavy traffic or on roads that are winding, icy, snow-covered, wet, slippery, on a steep downhill slope.

## 📖 NOTE

- Cruise control may not be able to keep your speed on uphill or downhill.
- Your speed may decrease on a steep uphill. You may use the accelerator pedal if you want to stay at your set speed.
- Your speed may increase to more than the set speed on a steep downhill. You must use the brake to control your speed. As a result, the set speed driving is deactivated.

## Cruise control switches

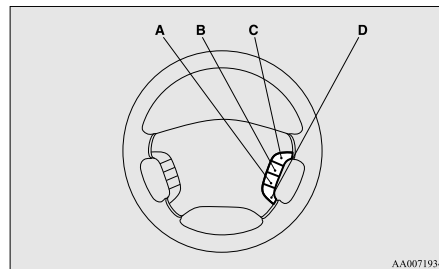

### A- “ON OFF” switch

Used to turn on and off the cruise control.

### B- “COAST SET” switch

Used to reduce the set speed and to set the desired speed.

### C- “ACC RES” switch

Used to increase the set speed and to return to the original set speed.

### D- “CANCEL” switch

Used to deactivate the set speed driving.

**NOTE**

- When operating the cruise control switches, press the cruise control switches correctly. The set speed driving may be deactivated automatically if two or more switches of the cruise control are pressed at the same time.

**To activate**

E00609300553

1. With the ignition switch in the “ON” position, press the “ON OFF” switch (A) to turn on the cruise control. The “CRUISE” indication lamp in the meter cluster will come on.

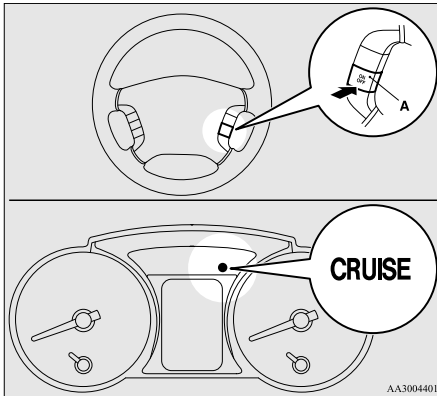
**NOTE**

- If the cruise control is on when the ignition switch is turned to the “LOCK” or “ACC” position, cruise control will be on automatically the next time you start the engine. The “CRUISE” indication lamp will also be on.
- If the battery voltage is insufficient, the memory data for the cruise control may be erased. As a result, the “CRUISE” indication lamp may not come on when you restart the engine. If this happens, press the “ON OFF” switch once again to turn on the cruise control.

2. Accelerate or decelerate to your desired speed, then press and release the “COAST SET” switch (B) when the “CRUISE” indication lamp is illuminated. The vehicle will then maintain the desired speed.

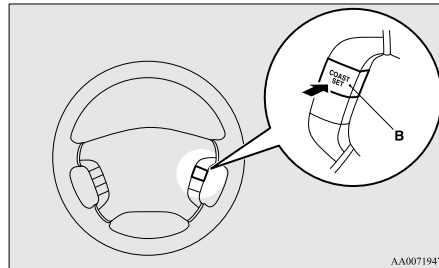
**NOTE**

- When you release the “COAST SET” switch, the vehicle speed will be set.

**To increase the set speed**

E00609400482

There are 2 ways to increase the set speed.

**“ACC RES” switch**

Press and hold the “ACC RES” switch (C) while driving at the set speed, and your speed will then gradually increase.

When you reach your desired speed, release the switch. Your new cruising speed is now set.

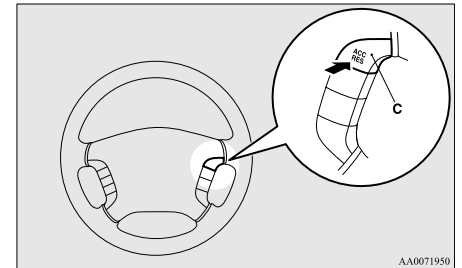

To increase your speed in small amounts, press the “ACC RES” switch for less than about 1 second and release it.

## Cruise control\*

Each time you press the “ACC RES” switch, your vehicle will go about 1.6 km/h (1 mph) faster.

### Accelerator pedal

While driving at the set speed, use the accelerator pedal to reach your desired speed and then press the “COAST SET” switch (B) and release the switch momentarily to set a new desired cruising speed.

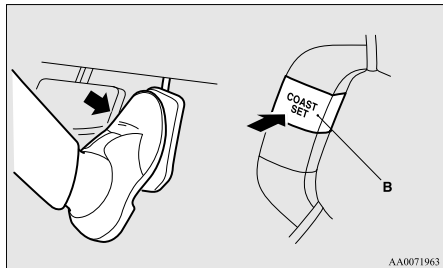

### To decrease the set speed

E00609500412

There are 2 ways to decrease the set speed.

### “COAST SET” switch

Press and hold the “COAST SET” switch (B) while driving at the set speed, and your speed will slow down gradually.

When you reach your desired speed, release the switch. Your new cruising speed is now set.

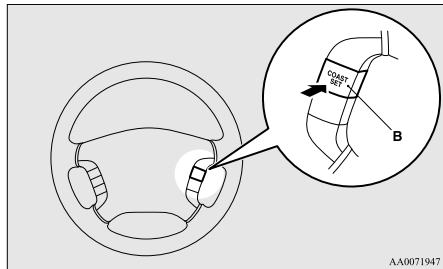

To slow down your speed in small amounts, press the “COAST SET” switch for less than about 1 second and release it.

Each time you press the “COAST SET” switch, your vehicle will slow down by about 1.6 km/h (1 mph).

### Brake pedal

While driving at the set speed, use the brake pedal, which disengages the cruise control, then press the “COAST SET” switch (B) and release the switch momentarily to set a new desired cruising speed.

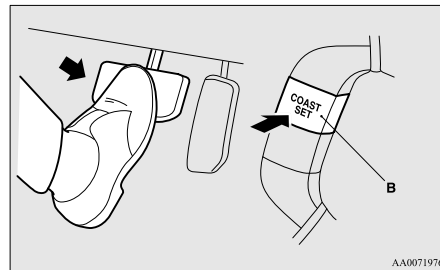



## To temporarily increase or decrease the speed

E00619500037

## To temporarily increase the speed

Depress the accelerator pedal as you would normally. When you release the pedal, you will return to your set speed.

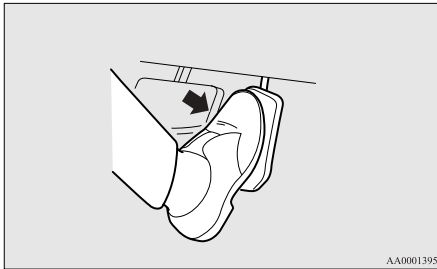

AA0001395

## To temporarily decrease the speed

Depress the brake pedal to decrease the speed. To return to the previously set speed, press the “ACC RES” switch (C). Refer to “To resume the set speed” on page 6-48.

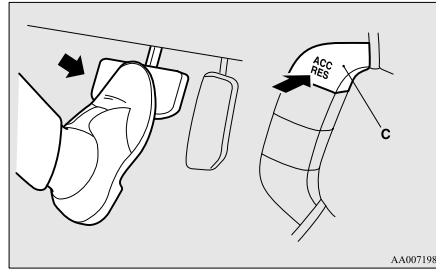

AA0071989

## To deactivate

E00609702782

The set speed driving can be deactivated as follows:

- Press the “ON OFF” switch (A) (Cruise control will be turned off)
- Press the “CANCEL” switch (D).

- Depress the brake pedal.

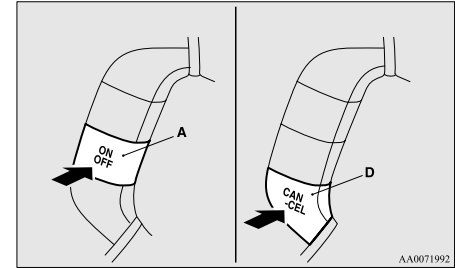

AA0071992

The set speed driving is deactivated automatically in any of the following ways.

- When your speed slows to about 15 km/h (9 mph) or more below the set speed because of a hill, etc.
- When your speed slows to about 40 km/h (25 mph) or less.
- When the active stability & traction control (ASTC) starts operating. Refer to “Active Stability & Traction Control (ASTC)” on page 6-40.

## ⚠ WARNING

- Although the set speed driving will be deactivated when shifting to the “N” (NEUTRAL) position, never move the selector lever to the “N” (NEUTRAL) position while driving. You would have no engine braking and could cause a serious accident.

## To resume the set speed

E00609800460

If the set speed driving is deactivated by the condition described in “To deactivate” on page 6-47, you can resume the previously set speed by pressing the “ACC RES” switch (C) while driving at a speed of about 40 km/h (25 mph) or higher.

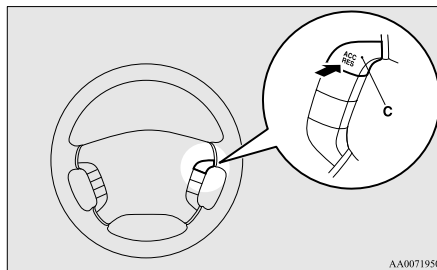

AA0071950

## Tyre pressure monitoring system (TPMS)\*

E00637100077

The tyre pressure monitoring system (TPMS) uses tyre inflation pressure sensors (A) on the wheels to monitor the tyre inflation pressures. The system only indicates when a tyre is significantly under-inflated.

The base tyre pressure can be set at desired value by the driver with the reset function execution. (The low pressure warning threshold is set based on the reset.)

The tyre inflation pressure sensor IDs for two sets of tyres can be registered by a MITSUBISHI MOTORS Authorized Service Point, and the valid ID set can be switched by the multi-information display switch. (It's beneficial in case of seasonal tyre change between summer tyre and winter tyre.)

6 Also, the set speed driving may be deactivated as follows:

- When the engine speed rises and approaches the tachometer's red zone (the red-coloured part of the tachometer dial).

## ⚠ CAUTION

- When the set speed driving is deactivated automatically in any situation other than those listed above, there may be a system malfunction. Press the “ON-OFF” switch to turn off the cruise control and have your vehicle inspected by a MITSUBISHI MOTORS Authorized Service Point.

Under either of the following conditions, however, using the switch does not allow you to resume the previously set speed. In these situations, repeat the speed setting procedure:

- The “ON OFF” switch is pressed.
- The ignition switch is turned OFF.
- “CRUISE” indication lamp is turned OFF.

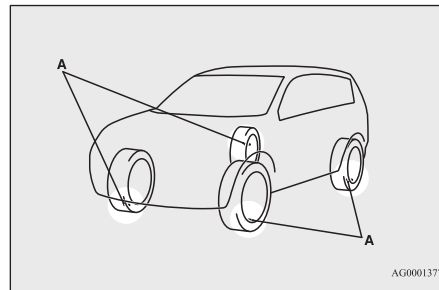

AG0001377

## NOTE

- The tyre pressure monitoring system (TPMS) is not a substitute for regularly checking tyre inflation pressures. Be sure to check the tyre inflation pressures as described in “Tyres” on page 10-11.
- The tyre inflation pressure sensor (B) is installed in the illustrated location. Replace rubber air valve (C) with a new one when the tyre is replaced. For details, please contact your MITSUBISHI MOTORS Authorized Service Point.

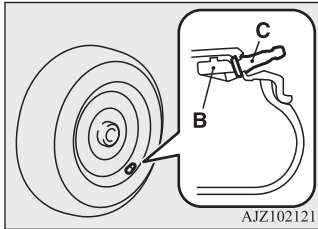

- The spare tyre also has tyre inflation pressure sensor, so it can be used for tyre rotation.

## Tyre pressure monitoring system warning lamp

E00637200052

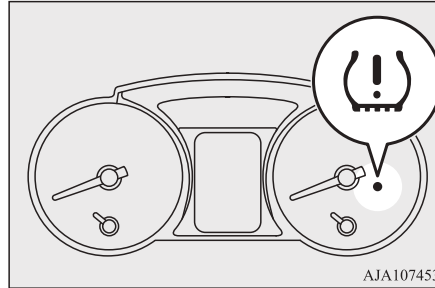

When the ignition switch is turned to the “ON” position the tyre pressure monitoring system warning lamp normally illuminates and goes off a few seconds later.

If one or more of the vehicle tyres is significantly under-inflated, the warning lamp will remain illuminated while the ignition switch is in ON.

Refer to “If the warning lamp illuminates while driving” on page 6-39 and take the necessary measures.

## CAUTION

- If the warning lamp does not illuminate when the ignition switch is turned to the “ON” position it means that the tyre pressure monitoring system (TPMS) is not working properly. Have the system inspected at a MITSUBISHI MOTORS Authorized Service Point.
- If a malfunction is detected in the tyre pressure monitoring system (TPMS), the warning lamp will blink for approximately 1 minute and then remain continuously illuminated.

In such situations, a malfunctioning of the system may be preventing the monitoring of the tyre pressure. Avoid sudden braking, sharp turning and high-speed driving.

The warning lamp will issue further warnings each time the engine is restarted as long as the malfunction exists.

Check to see whether the warning lamp goes off after few minutes driving.

If it then goes off during driving, there is no problem.

However, if the warning lamp does not go off, or if it blinks again when the engine is restarted, have the vehicle inspected by a MITSUBISHI MOTORS Authorized Service Point.

In such situations, a malfunctioning of the system may be preventing the monitoring of the tyre pressure. For safety reasons, when the warning lamp appears while driving, avoid sudden braking, sharp turning and high-speed driving.

## Tyre pressure monitoring system (TPMS)\*

Each tyre, including the spare, should be checked monthly when cold and inflated to the inflation pressure recommended by the vehicle manufacturer on the tyre inflation pressure label. (If your vehicle has tyres of a different size than the size indicated on the tyre inflation pressure label, you should determine the proper tyre inflation pressure for those tyres.)

As an added safety feature, your vehicle has been equipped with the tyre pressure monitoring system (TPMS) that illuminates a low tyre pressure telltale when one or more of your tyres is significantly under-inflated.

Accordingly, when the low tyre pressure telltale illuminates, you should stop and check your tyres as soon as possible, and inflate them to the proper pressure. Driving on a significantly under-inflated tyre causes the tyre to overheat and can lead to tyre failure.

Under-inflation also reduces fuel efficiency and tyre tread life, and may affect the vehicle's handling and stopping ability.

Please note that the tyre pressure monitoring system (TPMS) is not a substitute for proper tyre maintenance, and it is the driver's responsibility to maintain correct tyre pressure, even if under-inflation has not reached the level to trigger illumination of the tyre pressure monitoring system (TPMS) low tyre pressure telltale.

Your vehicle has also been equipped with a warning lamp to indicate when the system is not operating properly.

The warning lamp is combined with the low tyre pressure telltale.

When the system detects a malfunction, the telltale will flash for approximately one minute and then remain continuously illuminated. This sequence will continue upon subsequent vehicle start-ups as long as the malfunction exists.

When the warning lamp is illuminated, the system may not be able to detect or signal low tyre pressure as intended.

The tyre pressure monitoring system (TPMS) malfunctions may occur for a variety of reasons, including the installation of replacement or alternate tyres or wheels on the vehicle that prevent the tyre pressure monitoring system (TPMS) from functioning properly. Always check the tyre pressure monitoring system (TPMS) malfunction telltale after replacing one or more tyres or wheels on your vehicle to ensure that the replacement or alternate tyres and wheels allow the tyre pressure monitoring system (TPMS) to continue to function properly.

### **If the warning lamp illuminates while driving**

1. If the warning lamp illuminates, avoid hard braking, sharp steering manoeuvres

and high speeds. You should stop and adjust the tyres to the proper inflation pressure as soon as possible. Refer to "Tyres" on page 10-11.

### **NOTE**

- When inspecting or adjusting the tyre pressure, do not apply excessive force to the valve stem to avoid breakage.
- After inspecting or adjusting the tyre pressure, always reinstall the valve cap on the valve stem.  
Without the valve cap, dirt or moisture could get into the valve, resulting in damage to the tyre inflation pressure sensor.
- Do not use metal valve caps, which may cause a metal reaction, resulting in corrosion and damage of the tyre inflation pressure sensors.
- Once adjustments have been made, the warning lamp will go off after a few minutes of driving.

2. If the warning lamp remains illuminated after you have been driving for about 10 minutes after you adjust the tyre inflation pressure, one or more of the tyres may have a puncture. Inspect the tyre and if it has a puncture, have it repaired by a MITSUBISHI MOTORS Authorized Service Point as soon as possible.

E00637300082

**⚠ WARNING**

- If the warning lamp illuminates while you are driving, avoid hard braking, sharp steering manoeuvres and high speeds. Driving with an under-inflated tyre adversely affects vehicle performance and can result in an accident.

**⚠ CAUTION**

- The warning lamp may not illuminate immediately in the event of a tyre blowout or rapid leak.

**📖 NOTE**

- To avoid the risk of damage to the tyre inflation pressure sensors, have any punctured tyre repaired by a MITSUBISHI MOTORS Authorized Service Point. If the tyre repair is not done by a MITSUBISHI MOTORS Authorized Service Point, damage to the tyre inflation pressure sensor is not covered by your warranty.
- Do not use an aerosol puncture-repair spray on any tyre. Such a spray could damage the tyre inflation pressure sensors. Have any puncture repaired by a MITSUBISHI MOTORS Authorized Service Point.

The tyre pressure monitoring system (TPMS) may not work normally in the following circumstances:

- A wireless facility or device using the same frequency is near the vehicle.
- Snow or ice is stuck inside the fenders and/or on the wheels.
- The tyre inflation pressure sensor's battery is dead.
- Wheels other than MITSUBISHI MOTORS GENUINE wheels are being used.
- Wheels that are not fitted with tyre inflation pressure sensors are being used.
- Wheels whose ID codes are not memorized by the vehicle are used.
- A window tint that affects the radio wave signals is installed.

**📖 NOTE**

- Tyre inflation pressures vary with the ambient temperature. If the vehicle is subjected to large variations in ambient temperature, the tyre inflation pressures may be underinflated (causing the warning lamp come on) when the ambient temperature is relatively low. If the warning lamp comes on, adjust the tyre inflation pressure.

**Whenever the tyres and wheels are replaced with new ones**

E0063740025

If new wheels with new tyre inflation pressure sensors are installed, their ID codes must be programmed into the tyre pressure monitoring system. Have tyre and wheel replacement performed by a MITSUBISHI MOTORS Authorized Service Point to avoid the risk of damaging the tyre inflation pressure sensors. If the wheel replacement is not done by a MITSUBISHI MOTORS Authorized Service Point, it is not covered by your warranty.

**⚠ CAUTION**

- The use of non-genuine wheels will prevent the proper fit of the tyre inflation pressure sensors, resulting air leakage or damage of the sensors.

**Reset of low tyre pressure warning threshold**

E00637500055

The threshold is set based on the tyre pressure which the reset function is executed by following procedure.

1. Transit the display by the button (A) until the tyre pressure monitoring system (TPMS) SET indicator is displayed.

## Reversing sensor system\*

2. Hold down the button (A) for 3 seconds or more.

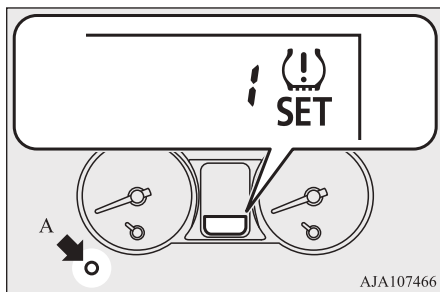

3. The warning lamp start flashing slowly.
4. Drive for a while. The reset is completed if the warning lamp goes out.

### NOTE

- The reset function should be executed every time when the tyre pressure or tyre rotation is adjusted.
- The reset function should be executed when the tyre is cold. If it is executed when the tyre is warm (e.g. after driving), there may be a low tyre pressure warning earlier than usual.

## Tyre ID set change

E0063760056

In case that 2 sets of tyre inflation pressure sensor ID are registered in the receiver, the valid tyre ID set can be changed by following procedure.

1. Transit the display by the button (A) until the tyre pressure monitoring system (TPMS) SET indicator is displayed.
2. Hold down the button (A) for 10 seconds or more.  
(Although the reset execution starts at holding down the button for 3 seconds, keep holding down the button continuously.)

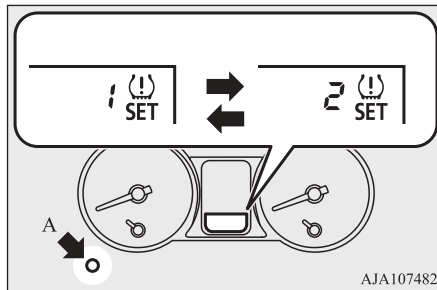

3. The valid tyre ID set is changed, and the number of the tyre pressure monitoring system (TPMS) SET indicator is changed.

### NOTE

- Each time this procedure is done, the tyre ID set is changed. (1 - 2 - 1 - 2 ...)
- The tyre ID set is NOT changed, in case that only 1 set of ID is registered.
- When changing the tyre ID set, the reset function of low tyre pressure warning threshold is automatically started. (The warning lamp start flashing slowly.) If the tyre is warm at this time, the reset function should be executed again when the tyre is cold.

## Reversing sensor system\*

E0061550055

This system operates when you are backing the vehicle. It uses corner and back sensors to detect an obstacle and sounds a buzzer to inform you of the approximate distance to the obstacle.

**CAUTION**

- The reversing sensor system assists you in determining the approximate distance between the vehicle and an obstacle located behind the vehicle. It has limitations in terms of detectable areas and objects, and may not properly detect some objects. Therefore, do not place excessive confidence in the reversing sensor system and operate the vehicle as carefully as you would do with a vehicle not equipped with this system.
- Make sure to check the surroundings with your own eyes to ensure safety. Do not operate the vehicle by relying on the reversing sensor system alone.

**Corner and back sensor locations**

E00618500014

There are two corner sensors (A) at the corners of the rear bumper, and two back sensors (B) in the spare wheel garnish.

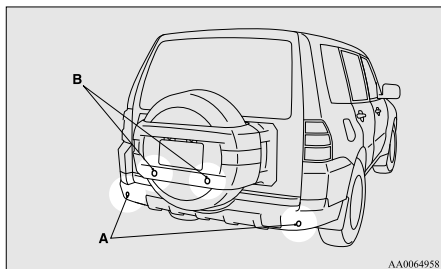
**Obstacle detection areas**

E00615600261

The detection areas of the corner and back sensors are limited to those shown in the illustration. Because the back sensors are built in the overhanging area of the vehicle (spare wheel garnish), the sensors are unable to detect low or thin obstacles, or obstacles on the bottom of the spare wheel garnish or the bottom of the centre of the rear bumper. Thus, make sure to check the surroundings as you operate the vehicle in a safe manner.

**Reversing sensor system detection areas**

Depending on whether the vehicle is equipped with a towing bar, you can change the reversing sensor system between the standard mode and the towing bar mode. The towing bar mode changes the system to exclude the area in which the towing bar is mounted from the detection areas.

**Vehicles without a towing bar**

The detection areas are within approximately 50 cm (A) from the corner sensors, 150 cm (B) from the back sensors.

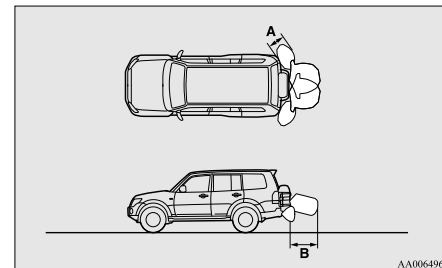
**Vehicles with a towing bar**

The detection areas are within approximately 50 cm (A) from the corner sensors, 150 cm (B) from the back sensors. The non-detection areas (C) are within approximately 20 cm (D) from the bumper.

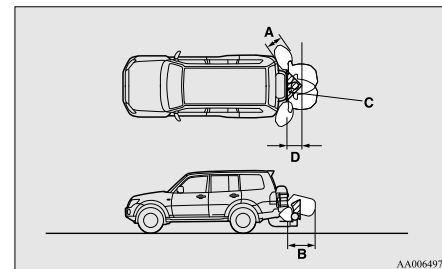

## NOTE

- If the rear bumper or the spare wheel garnish has been exposed to an impact, the corner or back sensors may fail and prevent the system from functioning properly. We recommend you to have your vehicle inspected.
- The sensors do not detect objects located in the area directly below or near the bumper. If the height of an object is lower than the mounted position of the corner or back sensors, the sensors may not continue detecting it even if they detected it initially.

For information on how to change the detection areas, please refer to “Changing the detection areas” on page 6-56.

## CAUTION

- The reversing sensor system may not operate properly under the following conditions:
  - The sensors or surroundings are covered with ice, snow, or mud.
  - The sensors are frozen.
  - The system receives ultrasonic noise from other sources (the horns of other vehicles, motorcycle engines, brakes, radios, pouring rain, splashing water, tyre chains, etc.).
  - The sensors are extremely hot or cold (while the vehicle is parked for a long period of time under a blazing sun or in cold weather).
  - The vehicle tilts significantly.

## CAUTION

- The vehicle is driven on a rough road (with a bumpy, gravel, hilly, or grassy surface).
- The vehicle is too close to an obstacle.
- The sensors or surroundings have been wiped by hand, or stickers or accessories have been attached.
- The reversing sensor system may not properly detect the following:
  - Objects that are thin, such as wire nets or ropes.
  - Objects that absorb sound waves, such as snow.
  - Objects that are shaped with a sharp angle.
  - Objects with a smooth surface, such as glass.
  - Objects that are low, such as kerbstones.

## NOTE

- The buzzer may sound lower than the normal warning sound when the reversing sensor system is receiving ultrasonic noise from other sources, but this is not a malfunction. The buzzer will stop sounding and the system will return to normal operation after the noise is no longer received.

## To operate

E00615702035

To operate the system, move the selector lever to the “R” (REVERSE) position while the ignition switch is in the “ON” position. To stop the operation, push the “SONAR” switch.

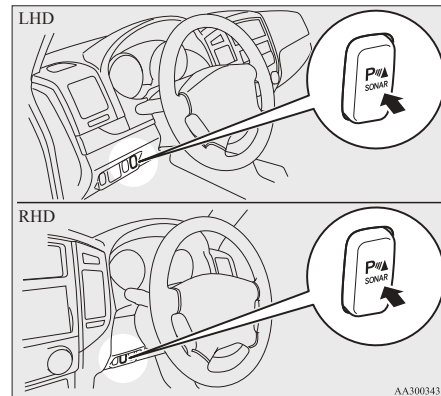

The “SONAR OFF” indication lamp will illuminate to indicate that the system has stopped operating.



It will flash in case there is a malfunction in the system. For details, refer to “SONAR OFF indication lamp” on page 6-56.

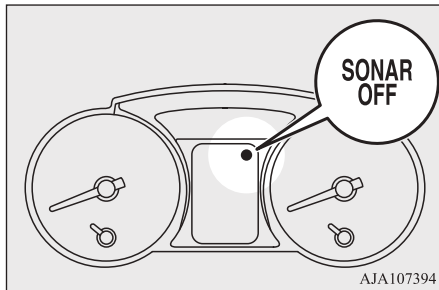

To return the system to the operating state, push the “SONAR” switch again. When the system returns to the operating state, the buzzer sounds once and the “SONAR OFF” indication lamp turns off.

### NOTE

- The “SONAR OFF” indication lamp flashes once when the ignition switch is turned to the “ON” position.

The warning buzzer sounds when the system detects an obstacle during operation.

### NOTE

- After pushing the “SONAR” switch, reversing sensor system operation differs according to the detection area setting.
  - Setting when towing bar is not equipped  
When the selector lever is moved to the “R” (REVERSE) position, the reversing sensor system will operate even if the corner sensor operation was stopped by pushing the “SONAR” switch.
  - Setting when towing bar is equipped  
When reversing sensor system operation was stopped by pushing the “SONAR” switch, the reversing sensor system will not operate until the engine has been stopped even if the selector lever is moved to the “R” (REVERSE) position.  
To resume reversing sensor system operation, push the “SONAR” switch or stop and restart the engine, and then move the gearshift lever or selector lever to the “R” position.

### Warning for obstacles

If there is an obstacle behind the vehicle, a warning buzzer sounds to indicate the distance between the vehicle and the obstacle.

#### Corner sensor

Vehicle to obstacle distance	Warning sound cycle
Approx. 50 to 40 cm	Intermittent

Vehicle to obstacle distance	Warning sound cycle
Approx. 40 to 20 cm	Fast intermittent
Within approx. 20 cm	Continuous

#### Back sensor (vehicles without a towing bar)

Vehicle to obstacle distance	Warning sound cycle
Approx. 150 to 80 cm	Intermittent
Approx. 80 to 40 cm	Fast intermittent
Within approx. 40 cm	Continuous

#### Back sensor (vehicles with a towing bar)

Vehicle to obstacle distance	Warning sound cycle
Approx. 150 to 120 cm	Intermittent
Approx. 120 to 60 cm	Fast intermittent
Within approx. 60 cm	Continuous

**⚠ CAUTION**

- The distances given are to be used for reference only, as errors may be caused by various factors, such as temperature, humidity, or the shape of the obstacles.

**Changing the detection areas**

E0061580032

The detection areas can be changed as follows:

**Vehicles with a towing bar**

While the operation of the system is stopped at the “SONAR” switch, push the “SONAR” switch approximately 3 seconds or more, and release it. The buzzer sounds twice to indicate that the detection area has been changed.

**Vehicles without a towing bar**

While the operation of the system is stopped at the “SONAR” switch, push the “SONAR” switch approximately 3 seconds or more, and release it. The buzzer sounds once to indicate that the detection area has been changed.

**📖 NOTE**

- The detection area will not change if you keep the “SONAR” switch pushed for 10 seconds or more.

**“SONAR OFF” indication lamp**

E00615901362

In case there is a malfunction in the reversing sensor system, the “SONAR OFF” indication lamp will flash and the warning buzzer will sound for approximately 5 seconds. Even after the buzzer has stopped sounding, the indication lamp will continue flashing until the system reverts to the normal state. We recommend you to have your vehicle inspection.

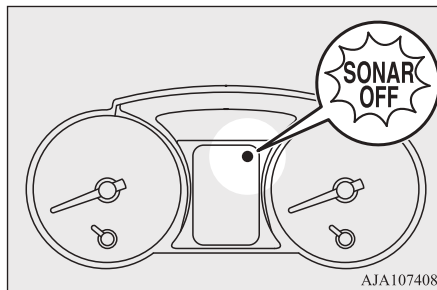

AJA107408

**Rear-view camera\***

E00618402277

The rear-view camera is a system that shows the view behind the vehicle on a screen of the MITSUBISHI Multi Communication System (MMCS), the DISPLAY AUDIO or the Smartphone Link Display Audio.

**⚠ CAUTION**

- The rear-view camera is an assistance system that enables the driver to check for obstacles behind the vehicle. Its range of view is limited, so you should not overly depend on it. Please drive just as carefully as you would if the vehicle did not have the rear-view camera.
- Be sure to visually confirm safety around the vehicle with your own eyes. Do not depend entirely on the rear-view camera.

**Range of view of rear-view camera**

The range of view of the rear-view camera is limited to the area shown in the illustrations. Because the camera is built in the overhanging area of the vehicle (spare wheel garnish), it cannot show the bottom of the spare wheel garnish and the right behind the vehicle (rear bumper and backdoor).

When reversing, be sure to visually confirm safety around the vehicle.

## Location of rear-view camera

The rear-view camera (A) is integrated into the spare wheel garnish.

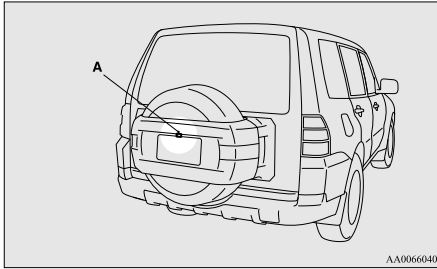

## Range of view of rear-view camera

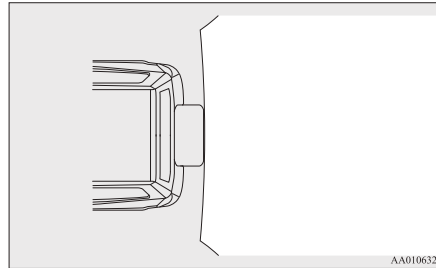
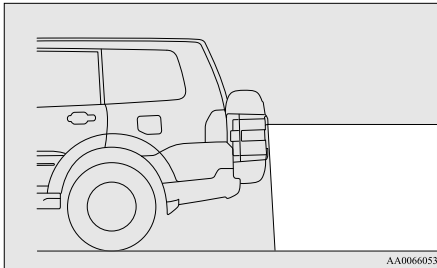

## How to use the rear-view camera

When you place the selector lever in the “R” (REVERSE) position with the ignition switch in the “ON” position, the view behind the vehicle will automatically appear on the screen of the MITSUBISHI Multi Communication System (MMCS), the DISPLAY AUDIO or the Smartphone Link Display Audio. When you move the selector lever to any other position, the screen will return to its original indication.

### ⚠ CAUTION

- The rear-view camera has a special lens that can make objects shown on the screen appear to be closer or further away than they actually are.

### ⚠ CAUTION

- The line (red) shows the point approximately 50 cm behind the rear extremity of the rear bumper.  
Be careful because the spare wheel garnish overhangs for approximately 30 cm behind the rear extremity of the rear bumper.

### 📖 NOTE

- Because the rear-view camera has a special lens, the lines on the ground between parking spaces may not look parallel on the screen.
- In the following situations, the screen indication may be difficult to see. There is no abnormality.
  - Low light (night time)
  - When the light of the sun or the light from a vehicle's headlamps shines directly into the lens
- If the camera is hot and is then cooled by rain or a car wash, the lens can mist up. This phenomenon does not indicate a malfunction.
- It is not possible to fully see obstacles when the lens is dirty. If the lens becomes contaminated by water droplets, snow, mud or oil, wipe off the contamination, taking care not to scratch the lens.
- Please observe the following cautions. Ignoring them could lead to a camera malfunction.
  - Do not subject the camera to physical shock.

**NOTE**

- Do not apply wax to the camera.
- Do not splash the camera with boiling water.
- Do not disassemble the camera.

**Reference lines on the screen**

Reference lines and upper surface of the rear bumper (A) are displayed on the screen.

- Red line (B) indicates approximately 50 cm behind the rear bumper.
- Two Green lines (C) indicate approximately 20 cm outside of the vehicle body.
- Short transverse lines (1 to 3) indicate distance from the rear bumper.

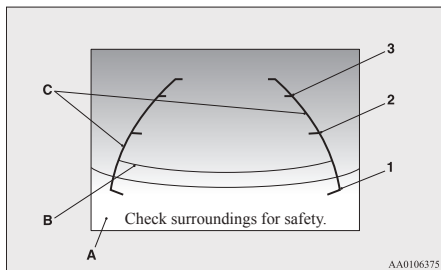

- 1- Approximately at the rear edge of the rear bumper
- 2- Approximately 100 cm
- 3- Approximately 200 cm

**NOTE**

- When the vehicle is tilting because of the number of people in the vehicle, the weight and positioning of luggage, and/or the condition of the road surface, the lines in the view from the rear-view camera may not be accurately positioned relative to the actual road.
- The reference lines for distance and vehicle width are based on a level, flat road surface. In the following cases, objects shown on the screen will appear to be farther off than they actually are.
  - When the rear of the vehicle is weighed down with the weight of passengers and luggage in the vehicle.

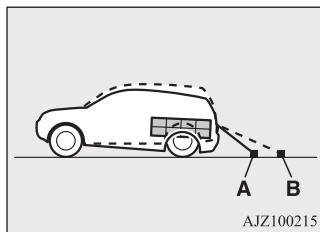

- A- Actual objects
- B- Objects shown on the screen
- When there is an upward slope at the back.

**NOTE**

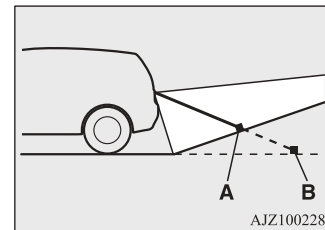

- A- Actual objects
- B- Objects shown on the screen

## NOTE

- The reference lines for distance and vehicle width are intended to indicate the distance to a flat object such as a level, flat road surface. This may make the distance to a projecting object shown on the screen differ from the actual distance to the projecting object. Do not use them as a guide for distances to solid objects.

Example: On the screen the point B appears the nearest, then the point C and A in order of distance. The points A and B actually are the same distances from the vehicle, and the point C is farther off than the points A and B.

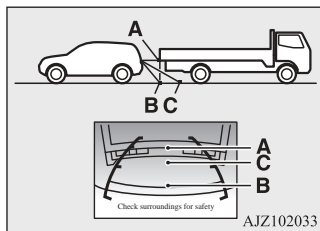

## Cargo loads

E00609901224

### Cargo loads precautions

#### CAUTION

- When loading luggage, be careful to the following.
  - Stow cargo and luggage in the luggage compartment whenever possible.
  - Distribute cargo or luggage evenly not to be unbalanced in weight.
  - Do not place cargo or luggage on the instrument panel.

Also, do not stack up cargo or luggage on the front passenger's seat or the rear seats. Having the driver's vision blocked, and your cargo being thrown inside the cabin if you suddenly have to brake can cause a serious accident or injury.

### Loading a roof carrier

#### CAUTION

- Use a roof carrier that properly fits your vehicle. Do not load luggage directly onto the roof. For installation, refer to the instruction manual accompanying the roof carrier.

## Roof carrier mounting brackets\*

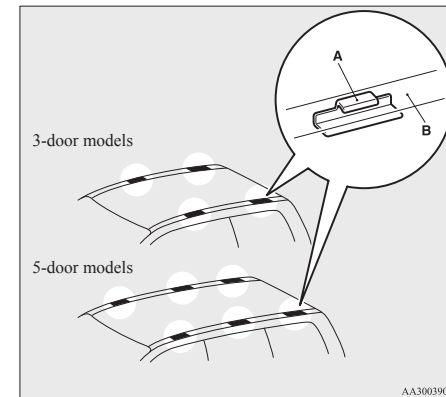

When installing the roof carrier, use the brackets (A). The brackets (A) are located under each roof drip moulding (B).

## NOTE

- We recommend you to use a genuine MITSUBISHI roof carrier, since the brackets to be used have a special shape. For details, we recommend you to consult a MITSUBISHI MOTORS Authorized Service Point.

## Roof carrier precaution

### CAUTION

- Make sure that the weight of the luggage does not exceed the allowable roof load. If the allowable roof load is exceeded, this may cause damage to the vehicle. The roof load is the total allowable load on the roof (the weight of the roof carrier plus the weight of luggage placed on the roof carrier). For specific figures, please refer to “Maximum roof load” on page 11-06 .
- When luggage is loaded onto the vehicle, please make sure to drive slowly and avoid excessive manoeuvres such as sudden braking or quick turning. In addition, place the luggage on the carrier so that its weight is distributed evenly with the heaviest items on the bottom. Do not load items that are wider than the roof carrier. The additional weight on the roof could raise the vehicle’s centre of gravity and affect vehicle handling characteristics. As a result, driving errors or emergency manoeuvres could lead to a loss of control and result in an accident.
- Before driving and after travelling a short distance, always check the load to make sure it is securely fastened to the roof carrier. Check periodically during your travel that the load remains secure.

### NOTE

- To prevent wind noise or reduction in fuel economy, remove the roof carrier when not in use.
- Before using an automatic car wash, remove the roof carrier.
- Be sure that adequate clearance is maintained for raising the sunroof (if so equipped) when installing a roof carrier.

## Trailer towing

E00610001850

In order to tow a trailer with your vehicle, when having a trailer towing device mounted that meets all relevant regulations in your area, consult a MITSUBISHI MOTORS Authorized Service Point.

The regulations concerning the towing of a trailer may differ from country to country. You are advised to obey the regulations in each area.

### CAUTION

- Danger of Accident!  
A towing bar should be fitted according to MITSUBISHI MOTORS guidelines. When you are going to tow a trailer, move the transfer shift lever to “4H” position. Selecting the “2H” drive may increase the differential oil temperature, resulting in possible damage to the driving system. Further, the drive train will be subjected to excessive loading possibly leading to oil leakage, component seizure, or other serious faults.

## Maximum towable weight with brake and maximum trailer-nose weight

Never exceed the maximum towable weight with brake and the maximum trailer-nose weight as listed in the specifications. (Refer to “Vehicle weight” on page 11-06 .) If you tow a trailer at an altitude of more than 1,000 m above sea-level, reduce your weight by 10 % of the gross combination weight for every increase of 1,000 m above sea-level, as the engine output is lowered owing to decrease in atmospheric pressure.

## Towing bar mounting specifications

See the following table for fixing points (A) for the towing bar.

6

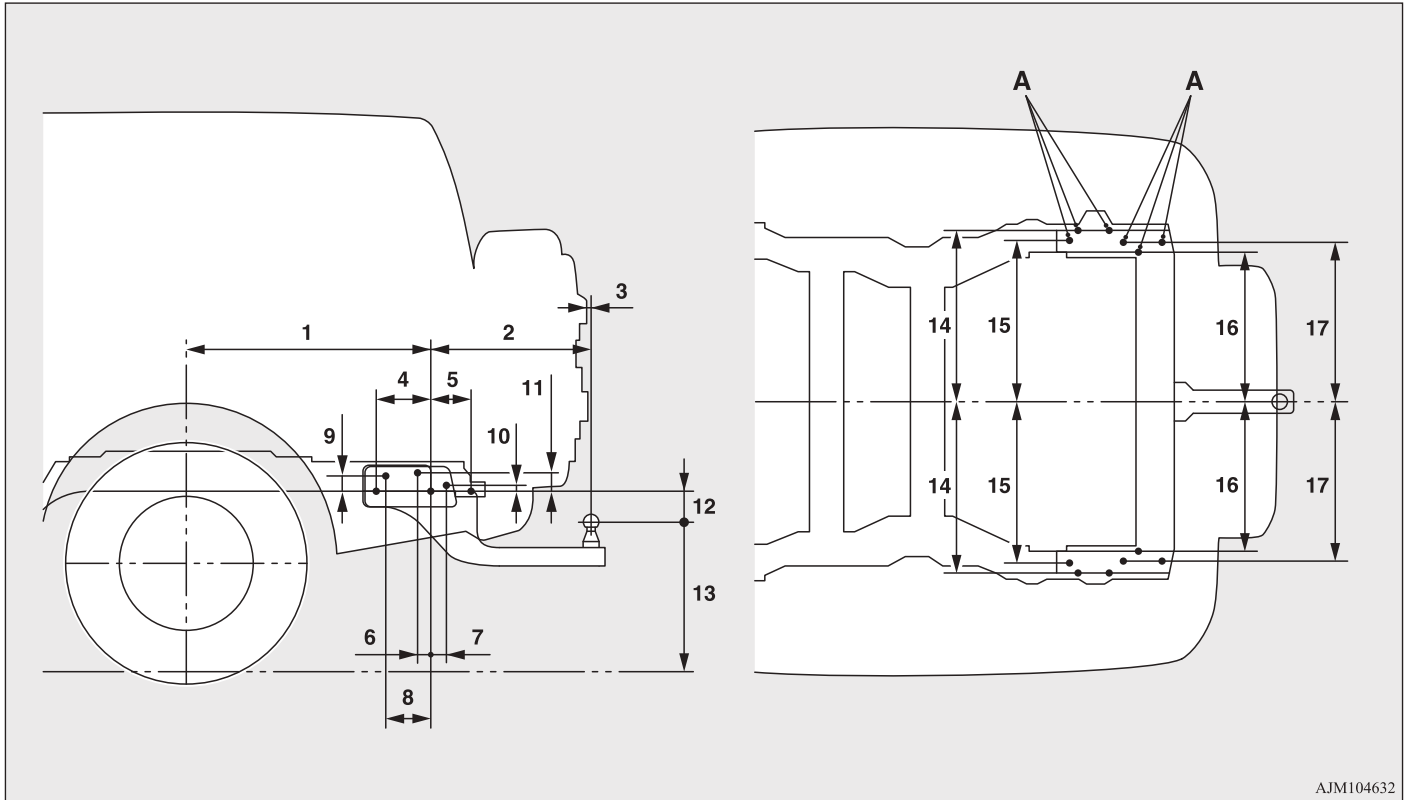

AJM104632



## Additional precautions for vehicles equipped with A/T

The 2<sup>nd</sup> gear (in sports mode) is recommended on slopes or at low speed. Use the 1<sup>st</sup> gear (in sports mode) in mountainous areas in order to make better use of engine braking and to assist the brake system. However, be sure that the speed does not exceed the maximum speed limit for the selected gear.

	3-door models	5-door models
1	512.5 mm	797 mm
2	564 mm	564 mm
3	8 mm	8 mm
4	124 mm	179 mm
5	131 mm	131 mm
6	44 mm	44 mm
7	55 mm	55 mm
8	—	149 mm
9	55 mm	55 mm
10	20 mm	20 mm
11	63 mm	63 mm
12	139 mm	138 mm
13	473 mm	491 mm, 513 mm*
14	576.3 mm	576.3 mm
15	—	547 mm
16	499.7 mm	499.7 mm
17	538 mm	538 mm

\*: Vehicles with only front seats and second seats

Item 8, 15: 5-door models only

Item 13: at kerb weight

### NOTE

- The values under item 13 are applicable to unladen vehicles. These values can also be varied depending on the tyre size, optional equipment and suspension conditions.

### Operating hints

- Do not increase the engine speed more than necessary when starting.
- Be sure that the driving speed does not exceed 100 km/h (62 mph)\* for trailer operation.

\*: For vehicles with only front seats or vehicles with only front seats and second seats (5-door models), 80 km/h (50 mph) should be applied instead of 100 km/h (62 mph).

It is also recommended that you obey the local regulations in case driving speed with a trailer is limited to less than 100 km/h (62 mph).

- To prevent shocks from the overrun brake, depress the brake pedal lightly at first and then more strongly.
- To make full use of engine braking, change to a lower gear before descending a slope.

A series of 15 horizontal dashed lines spanning the width of the page, providing a template for handwriting practice.

## *For pleasant driving*

Ventilators.....	7-02	Bluetooth® 2.0 interface*.....	7-50
Front automatic air conditioning.....	7-03	USB port*.....	7-71
Rear air conditioning*.....	7-09	HDMI port*.....	7-74
Important operation tips for the air conditioning.....	7-11	Sun visors.....	7-74
Air purifier (with deodorizing function).....	7-11	Ashtray*.....	7-75
LW/MW/FM radio/CD player*.....	7-12	Cigarette lighter*.....	7-76
Handling of Discs.....	7-16	Accessory socket.....	7-77
Audio Files (MP3/WMA/AAC).....	7-17	Interior lamps.....	7-78
Important Points on Safety for the Customer.....	7-21	Storage spaces.....	7-82
Operation Keys.....	7-21	Cup holder.....	7-85
Listen to Radio.....	7-24	Rear shelf (3-door models)*.....	7-86
Listen to DAB*.....	7-25	Cargo area cover (5-door models)*.....	7-86
Listen to Traffic Messages.....	7-27	Convenient hooks (5-door models)*.....	7-87
Listen to CDs.....	7-27	Luggage hooks.....	7-88
Listen to MP3s.....	7-28	Coat hooks.....	7-88
Listen to an iPod.....	7-29	Installation position for warning triangle.....	7-88
Listen to Audio Files on a USB Device.....	7-31		
To play iPod/USB memory device tracks via voice operation (vehicles with Bluetooth® 2.0 interface).....	7-34		
Listen to Bluetooth Audio*.....	7-36		
Use AUX*.....	7-38		
To listen to a disc in the Video Entertainment System (vehicles with Video Entertainment System).....	7-39		
Display Indicator.....	7-40		
Audio Quality and Volume Balance Adjustment.....	7-41		
System Settings.....	7-42		
Troubleshooting.....	7-47		
Antenna.....	7-50		
Link System*.....	7-50		

## Ventilators

E00700100373

### Front ventilators

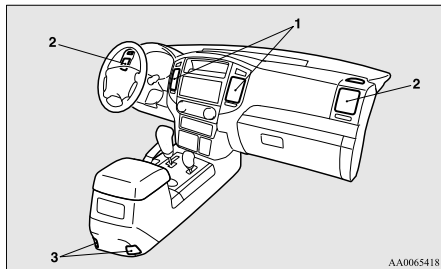

- 1- Centre ventilators
- 2- Side ventilators
- 3- Floor ventilators\*  
(from the centre console box)

### NOTE

- Do not place beverages on top of the instrument panel. If they splash into the air conditioning ventilators, they could damage the system.

### Rear ventilators (5-door models)\*

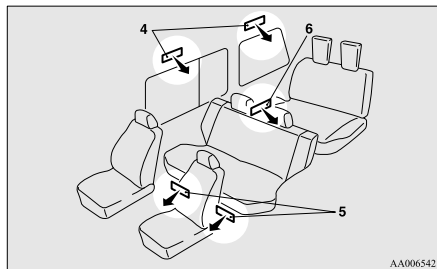



- 4- Roof ventilators
- 5- Rear floor ventilators  
(from under the second seat)
- 6- Rear floor ventilators  
(from side of the third seat)

### Air flow and direction adjustments

E00700200619

### Front ventilators

The ventilator can be opened and closed with the dial (A).

-  - Open
-  - Close

Adjust the direction of the air flow by moving the knob (B).

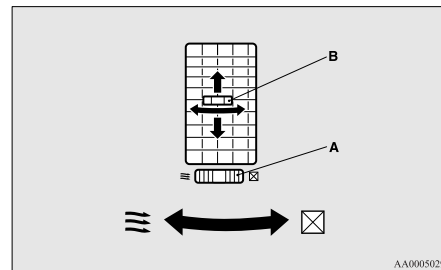

### Roof ventilators

Adjust the direction of the air flow by moving the knob (C) either left or right.

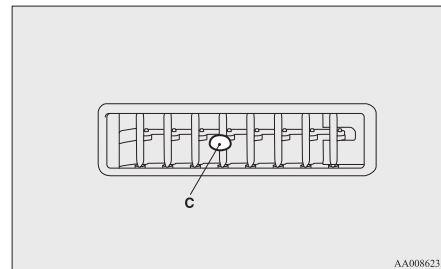

**NOTE**

- The cool air from the ventilators may appear as a mist.  
This is due to moist air being suddenly cooled by the air conditioning. This will clear after a few moments.

**Front automatic air conditioning**

E00702400165

The front air conditioning can only be used while the engine is running.

**Control panel**

E00702502610

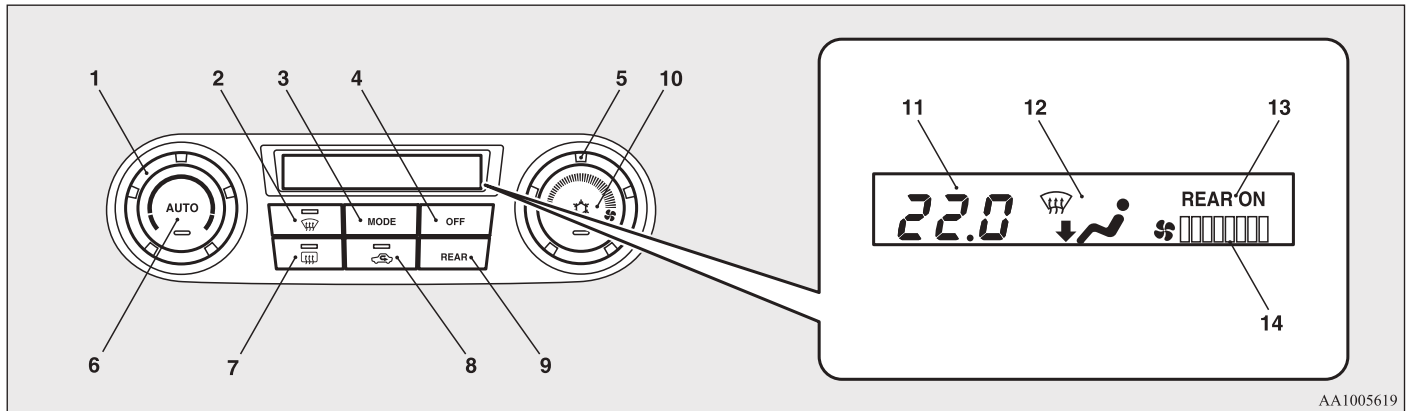

AA1005619

- |  |                                   |
|--|-----------------------------------|
| 1- Temperature control dial              | 11- Temperature display           |
| 2- Demister switch                       | 12- Mode selection display        |
| 3- MODE switch                           | 13- Rear blower operation display |
| 4- OFF switch                            | 14- Front blower speed display    |
| 5- Blower speed selection dial           |                                   |
| 6- AUTO switch                           |                                   |
| 7- Rear window demister switch → p. 5-50 |                                   |
| 8- Air selection switch                  |                                   |
| 9- Rear fan switch* → p. 7-10            |                                   |
| 10- Air conditioning switch              |                                   |

**NOTE**

- There is an interior air temperature sensor (A) in the illustrated position.  
Never place anything on top of the sensor, since doing so will prevent it from functioning properly.

 **NOTE**

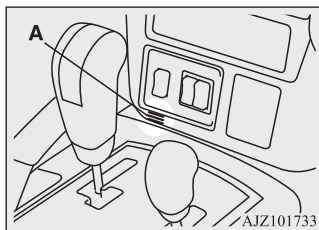

The selected blower speed will be shown by the front blower speed display (A).

The selected temperature will be shown by the temperature display (A).

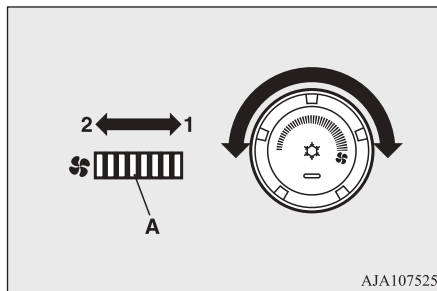

- 1- Increase
- 2- Decrease

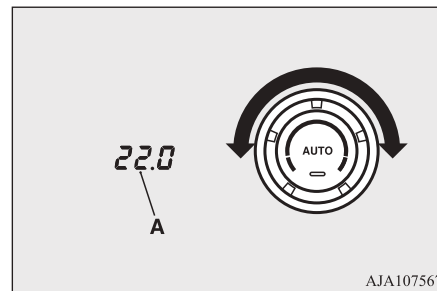

 **NOTE**

- While the engine coolant temperature is low, the temperature of the air from the heater will be cool/cold until the engine warms up, even if you have selected warm air with the dial.

**7** **Blower speed selection dial**

E00702801384

Select the blower speed by turning the blower speed selection dial clockwise or anticlockwise. The blower speed will gradually increase as the dial is turned to the right.

**Temperature control dial**

E00703001729

Turn the temperature control dial clockwise or anticlockwise.

**Air selection switch**

E00703400436

To change the air selection, simply press the air selection switch.

- Outside air: Indication lamp (A) is OFF  
Outside air is introduced into the passenger compartment.

- Recirculated air: Indication lamp (A) is ON  
Air is recirculated inside the passenger compartment.

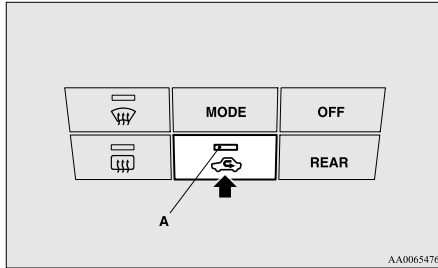

### ⚠ CAUTION

- Normally, use the outside position to keep the windscreen and side windows clear and quickly remove fog or frost from the windscreen.  
If high cooling performance is desired, or if the outside air is dusty or otherwise contaminated use the recirculation position.  
Switch to the outside position periodically to increase ventilation so that the windows do not become fogged up.
- Use of the recirculation position for extended time may cause the windows to fog up.

### 📖 NOTE

- If you press the AUTO switch to select automatic control after manually switching between outside air and recirculated air, the air selection will also be automatically controlled.

### AUTO switch

E00702601050

When the AUTO switch is pressed, the operation indication lamp (A) comes on and the mode selection, blower speed adjustment, recirculated/outside air selection, temperature adjustment, and air conditioner ON/OFF status are all controlled automatically.

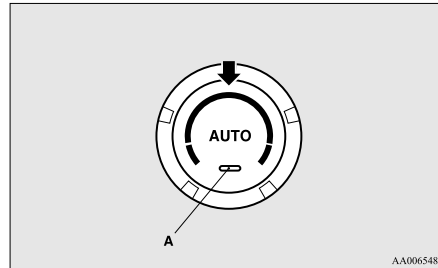

### Air conditioning switch

E00703502587

Push the switch to turn the air conditioning on, indication lamp (A) will come on.

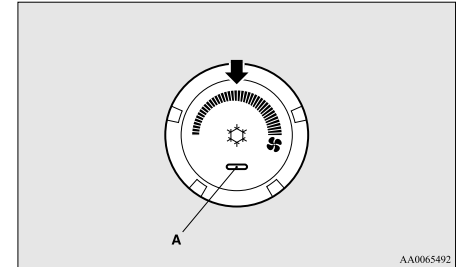

Push the switch again to switch it off.

### ⚠ CAUTION

- When using the air conditioning, the idling speed may slightly increase as the air conditioning compressor is switched on/off automatically. While the vehicle is stationary, fully depress the brake pedal to prevent the vehicle from creeping.

**NOTE**

- If a problem is detected in the air conditioning compressor, the air conditioning operation indication lamp (A) blinks. Stop the vehicle in a safe place, turn off the engine, then restart the engine. If the air conditioning operation indication lamp does not blink, there is no problem. If it does blink, we recommend you to have it checked.
- Sometimes, for example after using a high-pressure car wash, the condenser can get wet, and the operation indication lamp (A) blinks temporarily. In this case there is nothing wrong. Stop the vehicle in a safe place, stop the engine, then restart the engine. Once the water evaporates, the blinking will stop.

**OFF switch**

E00702700012

Push the switch to turn off the air conditioning system.

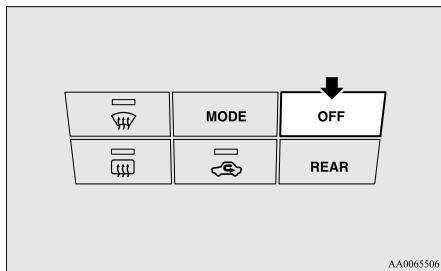

AA0065506

**MODE switch**

E00703300015

Each time the MODE switch is pressed, the mode changes to the next one in the following sequence: “” → “” → “” → “” → “”. The selected mode is shown by the mode selection display (A). (Refer to “Changing the front mode selection” on page 7-07.)

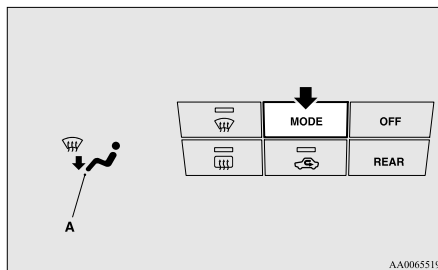

AA0065519

**Demister switch**

E00703900037

When this switch is pressed, the mode changes to the “” mode. The indication lamp (A) will come on. The selected mode is shown by the mode selection display (B). (Refer to “Changing the front mode selection” on page 7-07.)

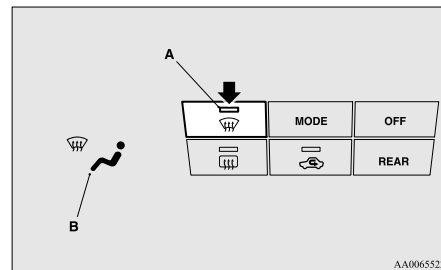

AA0065522

**NOTE**

- When the demister switch is pressed, the air conditioning system automatically operates and outside air (as opposed to recirculated air) is selected. (Refer to “Demisting of the windscreen and door windows” on page 7-08.)



## Changing the front mode selection

E00727100017

To change the position and amount of air flowing from the ventilators, push the MODE switch or demister switch. (Refer to “MODE switch” on page 7-06 and “Demister switch” on page 7-06.)

These symbols are used in the next several illustrations to demonstrate the quantity of air coming from the ventilators.

→: Small amount of air from the ventilators

➔: Medium amount of air from the ventilators

➡: Large amount of air from the ventilators

### Face position

Air flows only to the upper part of the passenger compartment.

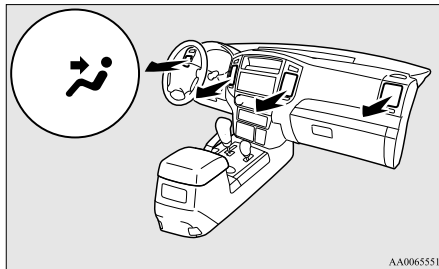

### Foot/Face position

Air flows to the upper part of the passenger compartment, and flows to the leg area.

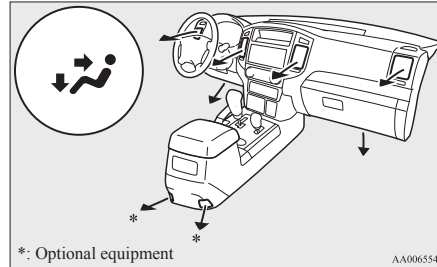

### Foot position

Air flows mainly to the leg area.

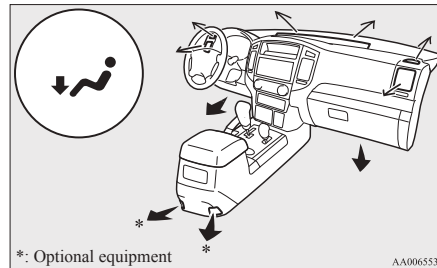

### Foot/Demister position

Air flows to the leg area, the windscreen and the door windows.

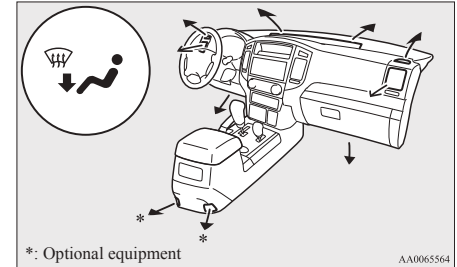

### Demister position

Air flows mainly to the windscreen and the door windows.

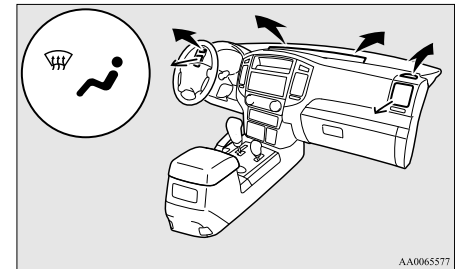

## Operating the system in auto- matic mode

E00704102506

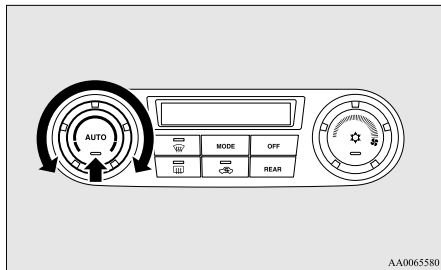

In normal conditions, use the system in the AUTO mode and follow these procedures:

1. Push the AUTO switch.
2. Select the temperature control dial to the desired temperature.

The mode selection, blower speed adjustment, recirculated/outside air selection, temperature adjustment, and air conditioner ON/OFF status are all controlled automatically.

### CAUTION

- While the vehicle is stationary, fully depress the brake pedal to prevent the vehicle from creeping caused by slightly increased idling speed when the air conditioning compressor is switched on automatically.

### NOTE

- When the temperature is set to the highest or the lowest setting under the AUTO operation, the air selection and the air conditioning will be automatically changed as follows.  
Also, if the air selection is operated manually after an automatic changeover, manual operation will be selected.
  - Quick Heating (When the temperature is set to the highest setting)  
Outside air will be introduced.
  - Quick Cooling (When the temperature is set to the lowest setting)  
Inside air will be recirculated and the air conditioning will operate.

## Operating the system in manual mode



E00704200154

Blower speed and ventilator mode may be controlled manually by setting the blower speed selection dial and the MODE switch to the desired positions.

To return to automatic operation, set the AUTO operation.

## Demisting of the windscreen and door windows

E00704301992

To remove frost or mist from the windscreen and door windows, use the MODE switch or Demister switch (“” or “”).

### CAUTION

- For safety, make sure you have a clear view through all the windows.

## Rear air conditioning\*

E0070460073

The rear air conditioning can only be used while the engine is running and the front air conditioning is switched on. When the front air conditioning is not switched on, only blower operation without cooling is possible.

### Control panel

E00704700058

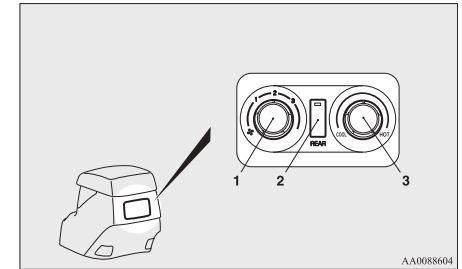

- 1- Blower speed selection dial
- 2- Main switch
- 3- Temperature control dial

7

### For ordinary demisting

Use this setting to keep the windscreen and door windows clear of mist, and to keep the leg area heated.

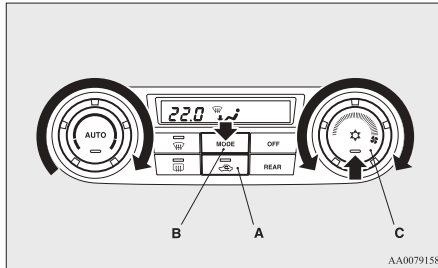

1. Set the air selection switch (A) to the outside position.
2. Set the MODE switch (B) to the “” position.
3. Select your desired blower speed by turning the blower speed selection dial.
4. Select your desired temperature by turning the temperature control dial.
5. Push the air conditioning switch (C).

### For quick demisting

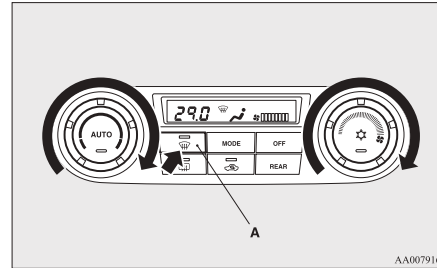

1. Push the demister switch (A) to change to the “” position.
2. Set the blower to the maximum speed.
3. Set the temperature to the highest position.

### NOTE

- When the demister switch is pressed, the air conditioning will operate automatically and the outside air position will also be selected automatically. (In this case, the air conditioning indication lamp will not change.)
- To demist effectively, direct the air flow from the side ventilators towards the door windows.
- Do not set the temperature control dial to the max. cool position. Cool air will blow against the window glasses and prevent demisting.

## Rear fan switch for the front seat

E0070500029

When the rear fan switch is pressed, the rear blower comes on, the rear blower operation display (A) shows “REAR ON”. When the rear fan switch is pressed again, the rear blower goes off.

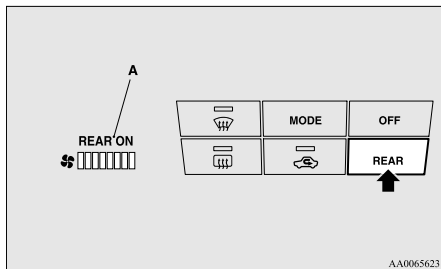

### NOTE

- Check whether or not the rear blower is operating by looking at the operation display (A). The operation display shows when the rear blower is operating.

## Main switch for the rear seat

E00704900021

Push the main switch, and the rear blower will operate, turning the operation indication lamp (A) on. Push the main switch again, and the rear blower will stop.

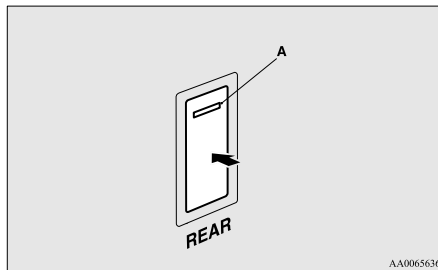

### NOTE

- Either the rear fan switch or the main switch can be used to switch the power of the rear blower ON and OFF.

## Blower speed selection dial

E00705301029

The blower has 3 different speeds. Select the best speed to fit your needs.

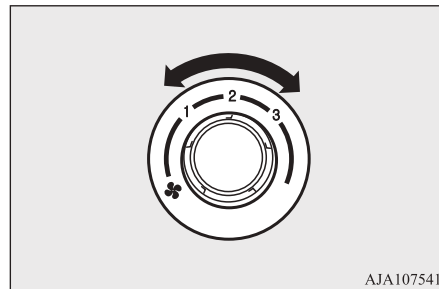

## Temperature control dial

E00705501106

Select the desired temperature level by turning clockwise or anticlockwise.

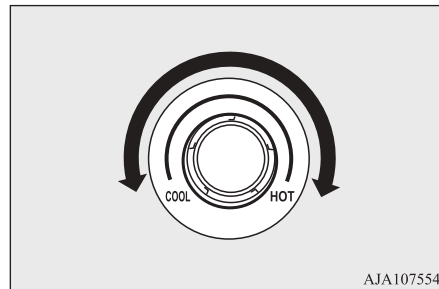

 **NOTE**

- The rear air conditioning will not operate unless the front air conditioning compressor is operating. Always switch the front air conditioning compressor on before using the rear air conditioning. If the front air conditioning compressor is not operating, the system will just operate as a blower.

**Important operation tips for the air conditioning**

E00708302261

- Park the vehicle in the shade. Parking in the hot sun will make the vehicle inside extremely hot, and it will require more time to cool the interior. If it is necessary to park in the sun, open the windows for the first few minutes of air conditioning operation to expel the hot air.
- Close the windows when the air conditioning is in use. The entry of outside air through open windows will reduce the cooling efficiency.
- Too much cooling is not good for the health. The inside air temperature should only be 5 to 6 °C below the outside air temperature.

- When operating the system, make sure the air intake, which is located in front of the windscreen, is free of obstructions such as leaves and snow. Leaves collected in the air-intake plenum may reduce air flow and plug the plenum water drains.

**Air conditioning system refrigerant and lubricant recommendations**

If the air conditioning seems less effective than usual, the cause might be a refrigerant leak. We recommend you to have the system inspected.

[Except for vehicles equipped with air conditioning refrigerant (HFO-1234yf) label]

The air conditioning system in your vehicle must be charged with the refrigerant HFC-134a and the lubricant ND-OIL8.

[Vehicles equipped with air conditioning refrigerant (HFO-1234yf) label]

The air conditioning system in your vehicle must be charged with the refrigerant HFO-1234yf and the lubricant ND-OIL12.

Refer to “Refill capacities” on page 11-14. For details, we recommend you to consult a MITSUBISHI MOTORS Authorized Service Point.

**During a long period of disuse**

The air conditioning should be operated for at least five minutes each week, even in cold weather. This is to prevent the compressor from seizing and to maintain the air conditioning in the best operating condition.

**Air purifier (with deodorizing function)**

E00708400183

7

An air filter is incorporated into the air conditioning system to remove pollen, dust, tobacco smells and exhaust smells.

The air filter’s ability to collect pollen and dirt is reduced as it becomes dirty, so replace it periodically. For the maintenance interval, refer to the “SERVICE BOOKLET”.

 **NOTE**

- Operation in certain conditions such as driving on a dusty road and frequent use of the air conditioning can lead to reduction of service life of the filter. When the air flow rate suddenly drops or when the windscreen or windows start to fog up easily, the air filter requires replacement. We recommend you to have it checked.

## LW/MW/FM radio/CD player\*

E00708503518

The audio system can only be used when the ignition switch is in the “ON” or “ACC” position.

### NOTE

- To listen to the audio system while the engine is stopped, turn the ignition switch to the “ACC” position.
- If a cellular phone is used inside the vehicle, it may create noise from the audio equipment. This does not mean that anything is wrong with your audio equipment. In such a case, use the cellular phone at a place as far away as possible from the audio equipment.
- If foreign objects or water get into the audio equipment, or if smoke or a strange odour comes from it, immediately turn off the audio system. We recommend you to have it checked. Never try to repair it by yourself. Avoid continuous usage without inspection by a qualified person.

## Important Points on Usage

E00735500023

### iPod/iPhone Playback Function\*

- This product supports audio playback from iPod/iPhone devices, however differing versions mean that playback cannot be guaranteed.
- Please be aware that depending on the iPod/iPhone model or version, operation may differ.

## How to Clean

E00735700025

- If the product becomes dirty, wipe with a soft cloth.
- If very dirty, use a soft cloth dipped in neutral detergent diluted in water, and then wrung out. Do not use benzene, thinners, or other chemical wipes. This may harm the surface.

## Trademarks

E00735801225

- Product names and other proper names are the trademarks or registered trademarks of their respective owners.
- Furthermore, even if there is no specific denotation of trademarks or registered trademarks, these are to be observed in their entirety.

Made for



iPod



iPhone

“Made for iPod,” “Made for iPhone” mean that an electronic accessory has been designed to connect specifically to iPod or iPhone, respectively, and has been certified by the developer to meet Apple performance standards.

iPhone, iPod, iPod classic, iPod nano, and iPod touch are trademarks of Apple Inc., registered in the U.S. and other countries.

Apple is not responsible for the operation of this device or its compliance with safety and regulatory standards.

### NOTE

- iPod and iTunes licensing allows individual users to privately reproduce and play back non- copyrighted material as well as material that may be legally copied and reproduced. Infringement of copyright is prohibited.

 **NOTE**

- For vehicles with a Bluetooth® 2.0 interface, the types of devices that can be connected may vary.  
For details, access the MITSUBISHI MOTORS website.  
Please read and agree to the “Warning about Links to the Web Sites of Other Companies”.  
The websites mentioned above may connect you to websites other than the MITSUBISHI MOTORS website.  
<http://www.mitsubishi-motors.com/en/products/index.html>

iPod



**iPod**  
5th generation  
(video)  
60GB 80GB



**iPod**  
5th generation  
(video)  
30GB

iPod classic



**iPod classic**  
160GB (2009)



**iPod classic**  
160GB (2007)



**iPod classic**  
80GB

iPod nano



**iPod nano**  
6th generation  
8GB 16GB



**iPod nano**  
5th generation  
(video camera)  
8GB 16GB



**iPod nano**  
4th generation (video)  
8GB 16GB



**iPod nano**  
3rd generation  
(video)  
4GB 8GB



**iPod nano**  
2nd generation  
(aluminium)  
2GB 4GB 8GB



**iPod nano**  
1st generation  
1GB 2GB 4GB



iPod touch



**iPod touch**  
4th generation  
8GB 32GB 64GB



**iPod touch**  
3rd generation  
32GB 64GB



**iPod touch**  
2nd generation  
8GB 16GB 32GB



**iPod touch**  
1st generation  
8GB 16GB 32GB

iPhone



**iPhone 4S**  
16GB 32GB 64GB



**iPhone 4**  
16GB 32GB



**iPhone 3GS**  
8GB 16GB 32GB



**iPhone 3G**  
8GB 16GB

## Handling of Discs

E00735901040

This explains care that should be taken in the handling of discs.

## Important Points on Handling

- Fingerprints or other marks on the read surface of the disc may result in its content being more difficult to read. When holding the disc, grip both edges, or one edge and the centre hole, in order that the read surface is not touched.
- Do not affix paper or stickers, or otherwise damage the disc.
- Do not forcefully insert a disc if another is already within the device. This can result in damage to discs, or malfunction.

## Cleaning

- Periodically clean the read surface of the disc. When cleaning, do not wipe in a circular motion. Instead, wipe gently outwards from the centre of the disc to the outer edge.
- New discs may have burring around the outer edge or in the hole in the centre. Ensure you check for these. If there are burrs, these may lead to faulty operation, therefore ensure these are removed.

## Important Points on Storage

- When not using discs, ensure these are kept in cases, and stored out of direct sunlight.
- If discs are not going to be used for a long period of time, remove these from the product.

## Disc Playback Environment

In cold environments such as in mid-winter when the interior of the vehicle is cold, turning the heater on and immediately trying to use the product may cause condensation (water droplets) to form on the disc and internal optical components, and this may prevent the product from operating correctly.

In these conditions, remove the disc, and wait a short time before use.





## Copyright

Actions such as unauthorized reproduction, broadcast, public performance, or rental of discs that comprise other than personal use are prohibited by law.

## Types of Disc That Can Be Played Back

E00736001035

The following marks are printed on the disc label, package, or jacket.

Type	Size	Maximum playback time	Comments
CD-DA 	12 cm	74 minutes	—
CD-TEXT 	12 cm	74 minutes	—
CD-R/RW  	12 cm	—	•Disc containing MP3 files

## Discs That May Not Be Played Back

- Playback of discs other than those described in “Types of Disc That Can Be Played Back” is not guaranteed.
- 8 cm discs may not be used.

- Do not insert irregularly-shaped discs (for example, heart-shaped), as these may result in malfunction. Additionally, discs that have transparent portions may not be played back.
  - Discs that have not been finalized cannot be played back.
  - Even if recorded using the correct format on a recorder or computer, application software settings and environments; disc peculiarities, damage, or marking; or dirt or condensation on the lens inside the product may render the disc unplayable.
  - Depending on the disc, some functions may not be used, or the disc may not play back.
  - Do not use discs with cracks or warps.
  - If the disc has stickers affixed, remains from removed stickers, or affixed adhesive, then do not use the disc.
  - Discs that have decorative labels or stickers may not be used.
- Playback of other than standard CDs is not guaranteed. Even if the audio can be played back, the audio quality cannot be guaranteed.
  - When playing back other than standard CDs, the following may occur.
    - There may be noise during playback.
    - There may be jumping in the audio.
    - The disc may not be recognized.
    - The first track may not be played back.
    - It may take longer than usual until start of playback of tracks.
    - Playback may start from within the track.
    - Some parts may not be played back.
    - Tracks may freeze during playback.
    - Tracks may be displayed erroneously.

## Audio Files (MP3/WMA/AAC)

E00736100026

This product can play back MP3/WMA/AAC format audio files recorded on CD-ROM, CD-R/RW, and USB devices.

There are limitations on the files and media that can be used, therefore read the following prior to recording MP3/WMA/AAC format audio files on discs or USB devices.

Additionally, ensure you read the user manuals for your CD-R/RW drive and the writing software, and ensure these are used correctly. If the MP3/WMA/AAC format audio files includes title information or other data, then this can be displayed.

### CAUTION

- CD-ROM and CD-R/RW media can only play back MP3 format audio files.
- Actions such as copying audio CDs or files and either distributing these to others for free or for charge, or uploading files via the Internet or other means to servers is an infringement of the law.
- Do not append the file extensions “.mp3”, “.wma”, or “.m4a”, to other than MP3/WMA/AAC format files. Playing back discs with these types of files recorded upon them may cause the files to be incorrectly identified for playback, which may lead to loud noise, resulting in speaker damage or accident.

### NOTE

- Depending on the condition of the disc recorder or recording software used, correct playback may not be possible. In these cases, refer to the user manual for your product or software.

## Nonstandard CDs

This product will play back audio CDs, however please be aware of the following points regarding CD standards.

- Ensure that you use discs with  on the label surface.

**NOTE**

- Depending on your computer's operating system, version, software, or settings, files may not have a file extension appended. In these cases, append the file extensions ".mp3", ".wma", or ".m4a" when copying the files.
- Files larger than 2GB in size cannot be played back.

You can create a folder structure as in Genre - Artist - Album - Track (MP3/WMA/AAC format audio files) for management of tracks.

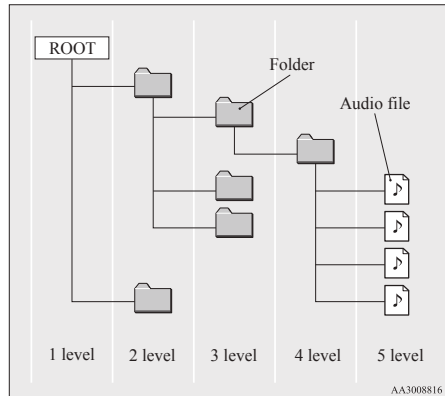

**7 Data Formats That Can Be Played Back**

E00736200027

Data formats that can be played on discs (CD-ROM, CDR/RW) and USB devices differ.

Data format	DISC	USB device
MP3	○	○
WMA	X	○
AAC	X	○

**Folder Structure**

E00736300031

Up to 8 folder levels can be recognized.

Name	Specification	Explanation	
Format specifications	ISO9660	Level 1	Maximum 8 character file name, and 3 character file extension. (single-byte alphanumeric capital letters, numerals, “_” may be used)

Name	Specification	Explanation	
	ISO9660 extension	Joliet	Files names up to a maximum 64 characters can be used.
Multisession	Not supported (only first session supported)		
Maximum number of levels	8 levels (if the root is the 1 <sup>st</sup> level)		
Maximum folder number	700 folders (including root)		
Maximum file number*	65,535 files (total number on media. Other than MP3, WMA, and AAC files not included)		
File name and folder name restrictions	Maximum 64 bytes (for Unicode, 32 characters), files/folders with file/folder names longer than this will not be displayed or played back.		
USB supported formats	The recommended file system is FAT32. 1 partition only		

\*: Do not include other than MP3/WMA/AAC files. However, if storing many tracks within the same folder, these may not be recognized even if less than the maximum number of tracks. In these cases, divide the tracks up into multiple folders.

 **NOTE**

- The order in which folders and audio files are displayed on this product may be different to how they are displayed on a computer.

### What Is MP3?

E00736400029  
MP3 is the abbreviation of “MPEG-1 Audio Layer 3”. MPEG is an abbreviation of “Motion Picture Experts Group”, and this is a video compression standard used in video CDs, etc.

MP3 is one of the audio compression methods contained in the MPEG audio standard, and reduces the quality of sounds that are beyond the auditory resolution of the human ear and that are hidden by louder sounds, thus creating high-quality data with a lower data size.

This can compress CD audio to approximately 1/10 its original data size without perceptible loss, approximately 10 CDs can be written to a single CD-R/RW disc.

 **CAUTION**

- MP3 files different to the standards at right may not play back correctly, or file/folder names may not be displayed correctly.

### Standards for MP3 Files That Can Be Played Back

Specifications for MP3 files that can be played are as shown below.

Item	Details
Specification	MPEG-1 AUDIO LAYER3
	MPEG-2 AUDIO LAYER3
Sampling frequency [kHz]	MPEG-1: 32/44.1/48
	MPEG-2: 16/22.05/24
Bit rate [kbps]	MPEG-1: 32 to 320
	MPEG-2: 8 to 160
VBR (variable bit rate)	Support
Channel mode	Stereo/ Joint stereo/ Dual channel/ Monaural
File extension	mp3

Item	Details
Supported tag information	ID3 tag Ver. 1.0, Ver. 1.1, Ver. 2.2, Ver. 2.3, Ver. 2.4 (ISO-8859-1, UTF-16 (Unicode)), Titles, Artist name, Album name
Maximum number of characters that can be indicated on the display	64 characters

### What Is WMA?

E00736601031  
WMA is the abbreviation of Windows Media Audio, and this is an audio compression format from Microsoft. This is a compression format that has a higher compression ratio than MP3.

 **NOTE**

- Microsoft, Windows Media, and Windows are registered trademarks of Microsoft Corporation (USA) and in other countries.

 **CAUTION**

- WMA supports digital rights management (DRM). This product cannot play back WMA files protected using this system.

**⚠ CAUTION**

- WMA files different to the standards at right may not play back correctly, or file/folder names may not be displayed correctly.
- “Pro”, “Lossless”, and “Voice” are not supported.

**Standards for WMA Files That Can Be Played Back**

Specifications for WMA files that can be played are as shown below.

Item	Details
Specification	Windows Media Audio Version7.0/8.0/9.0
Sampling frequency [kHz]	32/44.1/48
Bit rate [kbps]	48 to 320
VBR (variable bit rate)	Support
Channel mode	Stereo/Monaural
File extension	wma
Supported tag information	WMA tags Title name, Artist name, Album name

Item	Details
Maximum number of characters that can be indicated on the display	64 characters

**What is AAC?**

E00736801033

AAC is the abbreviation of Advanced Audio Coding, and this is an audio compression standard used in “MPEG-2” and “MPEG-4”. This features 1.4x the compression of MP3, with comparable audio quality.

**⚠ CAUTION**

- AAC supports digital rights management (DRM). This product cannot play back AAC files protected using this system.
- AAC files different to the standards at right may not play back correctly, or file/folder names may not be displayed correctly.

**Standards for AAC Files That Can Be Played Back**

Specifications for AAC files that can be played are as shown below.

Item	Details	
Specification	Advanced Audio Coding MPEG4/AAC-LC MPEG2/AAC-LC	
Sampling frequency [kHz]	MPEG4	8/11.025/12/16/22.05/24/32/44.1/48
	MPEG2	8/11.025/12/16/22.05/24/32/44.1/48
Bit rate [kbps]	MPEG4	8 to 320
	MPEG2	8 to 320
VBR (variable bit rate)	Support	
Channel mode	Stereo/Monaural	
File extension	m4a	
Supported tag information	AAC tags or ID3 tags Title, Artist name, Album name	
Maximum number of characters that can be indicated on the display	64 characters	

## Important Points on Safety for the Customer

E0073700035

This product features a number of pictorial indications as well as points concerning handling so that you can use the product correctly and in a safe manner, as well as prevent injury or damage to yourself, other users, or property.

### ⚠ WARNING

- The driver should not pay close attention to the display while driving.  
This may prevent the driver looking where they are going, and cause an accident.
- The driver should not perform complicated operations while driving.  
Performing complicated operations while driving may prevent the driver looking where they are going, and cause an accident.  
Therefore stop the vehicle in a safe location before performing such operations.
- Do not use during malfunctions, such as when no sound is audible.  
This may lead to accident, fire, or electric shock.
- Ensure water or other foreign objects do not enter the product.  
This may lead to smoking, fire, electric shock, or malfunction.

### ⚠ WARNING

- Do not insert foreign objects into the disc slot.  
This may lead to fire, electric shock, or malfunction.
- In the event of abnormalities occurring when foreign objects or water enter the product, resulting in smoke or a strange smell, immediately stop using the product, and consult a MITSUBISHI MOTORS Authorized Service Point.  
Continuing to use the product may result in accident, fire, or electric shock.
- Do not disassemble or modify the product.  
This may lead to malfunction, fire, or electric shock.
- During thunderstorms, do not touch the antenna or the front panel.  
This may lead to electrical shock from lightning.

### ⚠ CAUTION

- Do not block ventilation holes or heat sinks on the product.  
Blocking ventilation holes or heat sinks may prevent heat from escaping from within the product, leading to fire or malfunction.

### ⚠ CAUTION

- Do not turn the volume up to the extent that you cannot hear sounds from outside the vehicle while driving.  
Driving without being able to hear sounds from outside the vehicle may result in an accident.
- Do not insert your hand or fingers into the disc slot.  
This may result in injury.

## Operation Keys

E00737100023

### Turn the Power ON/ OFF

E00737200024

1. Press the PWR/VOL key.

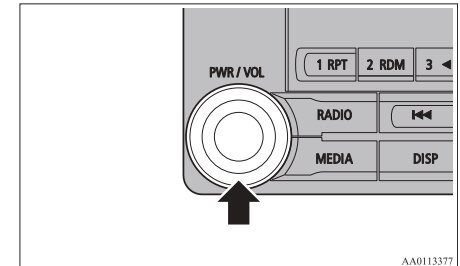

AA0113377

Turn the power on, and resume playback from the previous status.

## Operation Keys

2. Press the PWR/VOL key.  
Turn the power OFF.

### NOTE

- Hold down the steering MODE key to also turn the audio function ON/OFF.

## Adjust Volume

E00737300025

1. Turn the PWR/VOL key to adjust the volume.

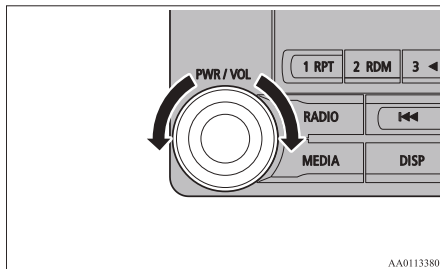

Turn the PWR/VOL key clockwise to increase, and counter-clockwise to decrease the volume.

### NOTE

- The maximum value for volume is 45, and the minimum is 0.

### NOTE

- The initial setting for volume is “17”.

## Insert/Eject Discs

E00737400026

1. Insert the disc into the disc slot with the label surface up.

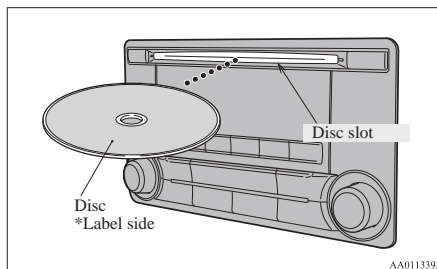

Push the disc in a certain amount, and the product will pull the disc in, and playback will start.

2. Press the ▲ key.  
This will eject the disc from the product, so remove the disc.

### CAUTION

- When replacing discs, first ensure that the vehicle is stopped in an area in which stopping is permitted.
- Do not insert your hand, fingers, or foreign objects into the disc slot. This may lead to injury, smoking, or fire.
- 8 cm CDs are not supported.



## Explanation of Buttons

E00737501226

This explains names and functions of each part.

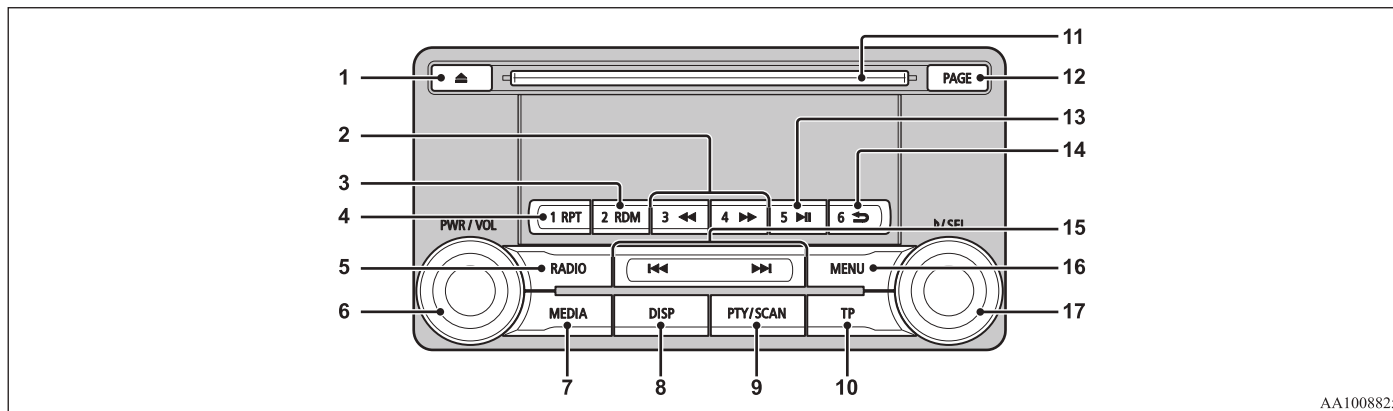

AA100825

- |  |   |   |
|--|---|---|
| <p>1- ▲ key<br/>Use to eject a disc.</p> <p>2- 3◀◀ key/4▶▶ key<br/>For audio, rewind/fast forward.<br/>For radio, use as preset keys 3 and 4.</p> <p>3- 2RDM key<br/>For radio, play random playback; for radio, use as preset key 2.</p> <p>4- 1RPT key<br/>For audio, play repeat playback; for radio, use as preset key 1.</p> <p>5- RADIO key<br/>Switch the radio and the band.</p> | <p>6- PWR/VOL key<br/>Adjust the volume, and turn the power ON/OFF.</p> <p>7- MEDIA key<br/>Switch between CD and other sources.<br/>Hold down the key to switch to AUX.</p> <p>8- DISP key<br/>Switch the content of the display.</p> <p>9- PTY/SCAN key<br/>For audio, play scan playback; for radio, search PTY.</p> <p>10- TP key<br/>Receive traffic messages.</p> | <p>11- Disc slot</p> <p>12- PAGE key<br/>Display indicator page advance.</p> <p>13- 5 ▶   key<br/>Play/Pause Bluetooth Audio*, and use as preset key 5 for radio.</p> <p>14- 6 ↶ key<br/>Return during audio track search, and stop Bluetooth Audio*.<br/>For radio, use as preset key 6.</p> |
|--|---|---|

## Listen to Radio

### 15- ◀◀key/▶▶key

For audio, select audio track/file; for radio, perform automatic station selection or ensemble/service station selection.

### 16- MENU key

Switch to Menu mode.

### 17- ▶/SEL key

Adjust audio quality and select items.  
For radio, manually select stations.

\*: Requires a separately-purchased Bluetooth-capable audio device in equipment by type (vehicles with a Bluetooth® 2.0 interface).

## Steering wheel audio remote control switches\*

E00737601214

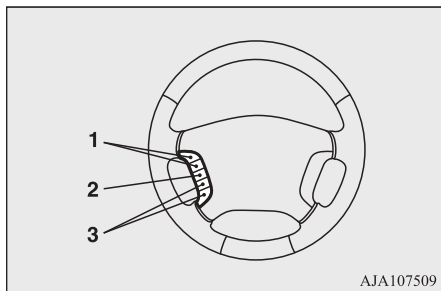

AJA107509

### 1- Vol + key, - key

Adjust audio functions and the mobile phone function volume.

### 2- CH ▾ key, ▲ key

Select CD and other audio source tracks and radio stations.

Hold down to skip up and down through tracks.

### 3- MODE Key

Hold down to turn the audio function ON/OFF. Additionally, each time this is pressed, this switches the audio source.

The order of switching is as shown below.

If devices are not connected, then these are to be skipped, and the next source selected.

\*2: Requires a separately-purchased Bluetooth-capable audio device (vehicles with a Bluetooth® 2.0 interface).

\*3: Requires DAB tuner connection.

## Listen to Radio

E00737700032

This explains how to listen to FM, MW, and LW radio broadcasts.

## To Listen to the Radio

Press the RADIO key to switch the band.

Switch between FM1, FM2, FM3, MW, and LW bands.

The selected band is indicated on the display.



AA0114084

\*1: An iPod cable (available separately) is required.

**NOTE**

- This switches in the order FM1, FM2, FM3, DAB1\*, DAB2\*, DAB3\*, MW, and LW.  
\*:When a DAB tuner is connected.

**Manual/Seek Station Selection**

Turn the **▷/SEL** key to the frequency to listen to.

<b>▷/SEL</b> key (counter-clockwise)	Reduces the frequency being received.
<b>▷/SEL</b> key (clockwise)	Increases the frequency being received.
<b>▶▶ </b> key (hold down)	Release the button to start seek station selection, and when a station is received, scanning stops.
<b> ◀◀</b> key (hold down)	

**Preset Memory**

Register the broadcast station in advance, and select this at a later time.

1. Tune in to the frequency to register.

2. Hold down any of the keys from the 1RPT key to the 6 **⇒** key.

A “Beep” sounds, and the preset key is registered.

**NOTE**

- The preset memory can register a maximum of 6 stations for each band (FM1, FM2, FM3).
- If a preset key that already has a station registered is selected, then this is overwritten with the new preset.
- Pressing the preset key will select the previously registered frequency.

**Auto Memory (Auto Store)**

The top 6 stations with a strong signal can be automatically registered in order with preset keys.

Hold down the RADIO key.

After completion of auto store operations, the product will receive the station registered in the preset key [1].

**CAUTION**

- Please be aware that the formerly-registered frequency in the memory will be overwritten.

**NOTE**

- Using auto store for FM1 and FM2 switches to FM3.

**PTY Search**

Select PTY (program content), and automatically scan for stations.

1. During FM reception, press the PTY/SCAN key.  
This switches to the PTY selection mode.
2. Turn the **▷/SEL** key to select PTY.  
The PTY (program content) indicator will flash, and station selection will automatically start. When a station is received, the station name is displayed.

**NOTE**

- This receives the station detected first.
- 10 seconds after reception, PTY search mode will be cancelled.

**Listen to DAB\***

E00739100014

This explains how to listen to DAB.

## To listen to DAB

1. Press the RADIO key to switch the band.  
Switch between DAB1, DAB2, and DAB3 bands.  
The selected band is indicated on the display.

### NOTE

- This switches in the order FM1, FM2, FM3, DAB1, DAB2, DAB3, MW, and LW.

## Select a Service

1. Hold down the ◀◀ key or the ▶▶ key.  
Receives the lead services of the ensembles that can be received.
2. Press the ◀◀ key or the ▶▶ key to select the service.

◀◀ key (hold down)	Automatically receives lower lead services within ensembles that can be received.
▶▶ key (hold down)	Automatically receives higher lead services within ensembles that can be received.
◀◀ key	Switches to lower services.
▶▶ key	Switches to higher services.

### NOTE

- Going to the first service or last service within the ensemble switches to the next ensemble.

## Register the Service

Register the service in advance, and select this at a later time.

1. Tune in to the service to register.
2. Hold down any of the keys from the IRPT key to the 6 ➡ key.  
A “Beep” sounds, and the preset key is registered.

### NOTE

- If a preset key that already has a service registered is selected, then this is overwritten with the new preset.
- Pressing the preset key will select the previously registered service.

## Search for a Service

Search for ensembles and services that can be received.

1. Turn the ▶/SEL key to select the ensemble.
2. Press the ▶/SEL key.  
The service name within the selected ensemble is displayed.

3. Turn the ▶/SEL key to select the service.
4. Press the ▶/SEL key.  
Receive the selected service.

### NOTE

- If the text information for the service name cannot be obtained, then nothing is displayed.
- If there is no operation for 10 seconds, then service search mode will be cancelled.

## PTY Search

Select PTY (program content), and automatically scan for services.

1. Press the PTY/SCAN key.  
This switches to the PTY selection mode.
2. Turn the ▶/SEL key to select PTY.
3. Press the ◀◀ key or ▶▶ key.  
This starts PTY search.

◀◀ key	Lower PTY search starts.
▶▶ key	Higher PTY search starts.

 **NOTE**

- When selecting PTY, press any of the keys from the 1RPT key to the 6 ➡ key to switch to the PTY registered as a preset.
- When selecting PTY, select the PTY to register, and hold down any of the keys from the 1RPT key to the 6 ➡ key to register the PTY as a preset.
- While in PTY select status, if there is no operation for 2 seconds, then an upwards search within the selected PTY will start.

**Listen to Traffic Messages**

E00739200015

This explains how to listen to traffic messages.

**To Listen to Traffic Messages**

1. When not in MW or LW mode, press the TP key.  
If traffic messages are being broadcast, these are received.

 **CAUTION**

- When receiving a MW or LW signal, traffic messages cannot be received.

 **NOTE**

- Receiving traffic messages will indicate “TRAF INF” on the display, and if text information can be received, the station name is displayed.
- If traffic messages are received, then this will switch to the volume of the previously received traffic messages or emergency broadcasts. The volume when receiving traffic messages or emergency broadcasts is that at which subsequent broadcasts will be received.

**Traffic Message Standby Mode**

When the broadcast of traffic messages starts, this automatically switches to the station that is broadcasting traffic messages.

1. When not in MW or LW mode, press the TP key.  
“TP” is indicated on the display, and the product switches to standby mode.  
If traffic messages are being broadcast, these are received.
2. When not in MW or LW mode, press the TP key.  
“TP” disappears from the display, and standby mode will be cancelled.

 **CAUTION**

- When receiving a MW or LW signal, traffic message standby mode will be cancelled.

**Listen to CDs**

E00737800059

This explains how to listen to audio CDs (CD-DA/CD-TEXT).

**Play CDs**

Insert the disc.

Insert a disc to automatically start playback.  
→ “Insert/Eject Discs” on page 7-22  
If a disc is already within the product, press the MEDIA key to switch to CD as the source.

**Select the Track**

Press the ◀◀ key or ▶▶ key to select the track.

This enables selection of the next or previous track.

**Fast Forward or Rewind**

Hold down the 3◀◀ key or the 4▶▶ key.

Fast forward/rewind is possible.

## Listen to MP3s

### Switch Playback Mode

Repeat playback, random playback, and scan playback are possible.

### Repeat Playback (RPT)

Press the 1RPT key.

Repeat playback of the track currently being played.

#### NOTE

- Pressing again will cancel.
- Selecting a track, ejecting, fast forwarding, or rewinding will cancel.

### Random Playback (RDM)

Press the 2RDM key.

Play the tracks on the disc in a random order.

#### NOTE

- Pressing again will cancel.
- Ejecting will cancel this.

### Scan Playback (SCAN)

Press the PTY/SCAN key.

Play the first 10 seconds of each of the tracks on the whole disc in order.

#### NOTE

- Press this button again during playback if you wish to hear that track, and that track will play normally.

## Listen to MP3s

E0073790034

This explains how to listen to audio files on a disc.

#### CAUTION

- CD-ROM and CD-R/RW media can only play back MP3 format audio files.

### To Listen to MP3s

Insert the disc.

Insert a disc to automatically start playback.

→ “Insert/Eject Discs” on page 7-22

If a disc is already within the product, press the MEDIA key to switch to CD as the source.

#### NOTE

- Depending on the file structure, it may take some time to read the contents of the disc.

### Select the Track (File)

Press the ◀◀ key or ▶▶ key to select the track.

This enables selection of the next or previous track.

### Fast Forward or Rewind

Hold down the 3◀◀ key or the 4▶▶ key.

Fast forward/rewind is possible.

### Switch Playback Mode

Repeat playback, random playback, and scan playback are possible.

### Repeat Playback (RPT)

Press the 1RPT key.

Repeat playback of the track currently being played.

 **NOTE**

- Pressing again will cancel.
- Selecting a file, ejecting, fast forwarding, or rewinding will cancel.

**Folder Repeat Playback**

Hold down the 1RPT key.

Repeat playback of the tracks within the folder currently being played.

 **NOTE**

- Pressing again will cancel.
- Even if the file is selected, folder repeat playback will not be cancelled.

**Random Playback (RDM)**

Press the 2RDM key.

Play the tracks in the folder in a random order.

 **NOTE**

- Pressing again will cancel.

**Folder Random Playback**

Hold down the 2RDM key.

Play all tracks in folders on the disc in a random order.

 **NOTE**

- Pressing again will cancel.

**Scan Playback (SCAN)**

Press the SCAN key.

Play the first 10 seconds of each of the tracks in the folder currently being played in order.

**Search Tracks**

Search folders and files, and select a track.

1. Turn the **▶/SEL** key to select the folder.
2. Press the **▶/SEL** key.

Files within the selected folder are displayed.

3. Turn the **▶/SEL** key to select the file.
4. Press the **▶/SEL** key.

This plays the selected file (track).

 **NOTE**

- While the folder is selected, press the 6 **➡** key to cancel track search mode.

 **NOTE**

- If there is no operation for 10 seconds after selecting the folder, then track search mode will be cancelled.
- Select the folder, and hold down the **▶/SEL** key to start playback from the first track in that folder.
- While the file is selected, press the 6 **➡** key to return to the previous operation.
- While the file is selected, hold down the 6 **➡** key to cancel track search mode.
- If there is no operation for five seconds after selecting the file, that file is played back.
- Disc operations such as selecting a track will cancel track search mode.

**Listen to an iPod**

E00738001143

By connecting commercially-available iPod/iPhone devices to this product, you can play back tracks on these through the product.

 **CAUTION**

- Do not leave the iPod/iPhone unattended in the vehicle.
- Never hold these devices in your hand to operate while driving, as this is dangerous.
- No indemnification for data loss resulting when the iPod/iPhone is connected to the product will be possible.

**⚠ CAUTION**

- Depending on how the devices are handled, audio files being damaged or lost, therefore it is recommended that data be backed up.

**📖 NOTE**

- Depending on the generation, model, or software version of the iPod/iPhone, playback on this product may not be possible. (→7-12) Additionally, playback as explained in this document may not be possible.
- For vehicles with a Bluetooth® 2.0 interface, the types of devices that can be connected may vary.  
For details, access the MITSUBISHI MOTORS website.  
Please read and agree to the “Warning about Links to the Web Sites of Other Companies”.  
The websites mentioned above may connect you to websites other than the MITSUBISHI MOTORS website.  
<http://www.mitsubishi-motors.com/en/products/index.html>
- Usage of iPod/iPhone hardware with the latest software version is recommended.
- Regarding how to connect the iPod/iPhone, refer to “How to connect an iPod” on page 7-72.
- When connecting the iPod/iPhone, use a commercially available iPod connection cable.

**📖 NOTE**

- Set up the device in order that no unsafe actions, such as plugging in the connection cable are taken while driving.
- When inserting and removing the iPod/iPhone, for safety’s sake first stop the vehicle.
- Depending on the status of the iPod/iPhone, it may take some time until the device is recognized, or playback starts.
- Buttons on the product may not operate while the iPod/iPhone is connected.
- iPod/iPhone specifications and settings may mean that connection is not possible, or result in differences in operation or display.
- Depending on audio data in the iPod/iPhone, track information may not be displayed correctly.
- Depending on the status of the vehicle and device, the iPod/iPhone may not play back after starting the engine.
- Data containing copyright information may not play back.
- It is recommended that the iPod/iPhone equaliser settings be set to flat.
- Operate the iPod/iPhone while connected to this product.
- If the iPod/iPhone is connected via Bluetooth as a Bluetooth-capable audio device, then do not connect the iPod/iPhone using an iPod connection cable. Connection using both methods will result in erroneous operation.

**📖 NOTE**

- If an iPod/iPhone does not operate correctly, then remove the iPod/iPhone from the product, reset, then reconnect.

**Play iPod**

Press the MEDIA key to set the iPod as the source.

The selected source is indicated on the display.

**Select the Track (File)**

Press the ◀◀ key or ▶▶ key to select the track.

This enables selection of the next or previous track.

**Fast Forward or Rewind**

Hold down the 3◀◀ key or the 4▶▶ key.

Fast forward/rewind is possible.

**Switch Playback Mode**

Repeat playback and shuffle playback are possible.



## Repeat Playback (RPT)

Press the 1RPT key.

Repeat playback of the track currently being played.

### NOTE

- Pressing again will cancel.

## Shuffle Playback (RDM)

Press the 2RDM key.

Play tracks in the category currently being played in a random order.

### NOTE

- Pressing again will cancel.

## Album Shuffle Playback

Hold down the 2RDM key.

Play back the album in a random order (tracks in any order on the album).

### NOTE

- Pressing again will cancel.

## Search Tracks

Search categories or track names, and select a track.

1. Turn the **▶** /SEL key to select the category.
2. Press the **▶** /SEL key. Categories or tracks within the selected category are displayed.
3. Turn the **▶** /SEL key to select the category or track.
4. Press the **▶** /SEL key.  
Repeat steps 1 to 4, and search for tracks.  
Select the track, and press the **▶** /SEL key to play.

### NOTE

- While the category (1<sup>st</sup> level) is selected, press the 6 **➔** key to cancel track search mode.
- If there is no operation for 10 seconds after selecting the category, then track search mode will be cancelled.
- Select the category, and hold down the **▶** /SEL key to start playback from the first track in that category.
- While the track is selected, press the 6 **➔** key to return to the previous operation.
- While the track is selected, hold down the 6 **➔** key to cancel track search mode.

### NOTE

- If there is no operation for five seconds after selecting the track, that file is played back.
- iPod operations such as selecting a track will cancel track search mode.

## Listen to Audio Files on a USB Device

E00736501199

By connecting commercially-available USB devices such as USB memory to this product, you can play back audio files on these through the product.

### CAUTION

- Do not leave the USB device unattended in the vehicle.
- Never hold these devices in your hand to operate while driving, as this is dangerous.
- Do not use hard discs, card readers, or memory readers, as damage may occur to these or to the data contained therein. If these are erroneously connected, turn the ignition switch to the “LOCK” position, then remove.
- Because of the risk of data loss, it is recommended that files be backed up.
- No guarantee is made as regards damage to the USB device, nor regarding loss or damage to data contained therein.

### CAUTION

- Depending on how the devices are handled, audio files being damaged or lost, therefore it is recommended that data be backed up.

### NOTE

- Digital audio players that support the mass storage class specifications can be connected.
- For details regarding the types of USB devices that can be connected and the types of files that can be played back in vehicles with a Bluetooth® 2.0 interface, refer to “Types of connectable devices and supported file specifications” on page 7-72.
- Regarding how to connect USB devices, refer to “How to connect a USB memory device” on page 7-71.
- When connecting a USB device, use a connection cable. Failure to use a connection cable when connecting may place undue load on, or damage the USB connector.
- Set up the device in order that no unsafe actions, such as plugging in the connection cable are taken while driving.
- When inserting and removing the USB device, for safety’s sake first stop the vehicle.
- Do not insert other than audio devices into the USB port. Damage to the device or equipment may result.
- Depending on the status of the USB device, it may take some time until the device is recognized, or playback starts.

### NOTE

- Depending on the USB device, the button functions on the product may not operate while the USB device is connected.
- USB device specifications and settings may mean that connection is not possible, or result in differences in operation or display.
- Depending on audio data in the USB device, track information may not be displayed correctly.
- Depending on the status of the vehicle and device, the iPod/iPhone may not play back after starting the engine.
- Data containing copyright information may not play back.
- This product can play back MP3, WMA, and AAC format audio files.
- Depending on the type of USB device, usage may not be possible, or functions that can be used may be restricted.
- The recommended file system for USB memory is FAT32.
- The maximum supported capacity for USB memory is 32GB.
- Operate the USB device containing recorded audio files while connected to this product.

### Play Back of Audio Files on a USB Device

Press the MEDIA key to set

USB as the source. The selected source is indicated on the display.

### Select the Track (File)

Press the ◀◀ key or ▶▶ key to select the track.

This enables selection of the next or previous track.

### Fast Forward or Rewind

Hold down the 3◀◀ key or the 4▶▶ key.

Fast forward/rewind is possible.

### Switch Playback Mode

Repeat playback, random playback, and scan playback are possible.

### Repeat Playback (RPT)

Press the 1RPT key.

Repeat playback of the track currently being played.

### NOTE

- Pressing again will cancel.
- Selecting a file will cancel this.

### Folder Repeat Playback

Hold down the 1RPT key.

Repeat playback of the tracks within the folder currently being played.

### NOTE

- Pressing again will cancel.
- Even if the file is selected, folder repeat playback will not be cancelled.

## Folder Random Playback (RDM)

Press the 2RDM key.

Play tracks in the folder currently being played in a random order.

### NOTE

- Pressing again will cancel.
- Even if the file is selected, folder random playback will not be cancelled.

## All Folder Random Playback

Hold down the 2RDM key.

Play the tracks in all folders in a random order.

### NOTE

- Pressing again will cancel.

### NOTE

- Even if the file is selected, all folder random playback will not be cancelled.

## Scan Playback (SCAN)

Press the PTY/SCAN key.

Play the first 10 seconds of each of the tracks on the whole USB device in order.

### NOTE

- Press this button again during playback if you wish to hear that track, and that track will play normally.

## Folder Scan Playback

Hold down the PTY/SCAN key.

Play the first 10 seconds of the first track in each folder on the USB device in order.

### NOTE

- Press this button again during playback if you wish to hear that track, and that track will play normally.



## Search Tracks

Search folders and files, and select a track.

1. Turn the /SEL key to select the folder.





2. Press the /SEL key.

Files within the selected folder are displayed.

3. Turn the /SEL key to select the file.
4. Press the /SEL key.

This plays the selected file (track).

### NOTE

- While the folder is selected, press the 6  key to cancel track search mode.
- If there is no operation for 10 seconds after selecting the folder, then track search mode will be cancelled.
- Select the folder, and hold down the /SEL key to start playback from the first track in that folder.
- While the file is selected, press the 6  key to return to the previous operation.
- While the file is selected, hold down the 6  key to cancel track search mode.
- If there is no operation for five seconds after selecting the file, that file is played back.
- Operations such as selecting a track will cancel track search mode.

To play iPod/USB memory device tracks via voice operation (vehicles with Bluetooth® 2.0 interface)

## To play iPod/USB memory device tracks via voice operation (vehicles with Bluetooth® 2.0 interface)

E00748700045

Desired tracks on the iPod/USB memory device which is connected to the USB port can be selected and played via voice operation.

For information concerning the voice recognition function or speaker registration function, refer to “Bluetooth® 2.0 interface” on page 7-50.

The following explains how to prepare for voice operation and play the tracks.

### Preparation for voice operation

E00748800046

To use the voice operation, press the SPEECH button (1) first.

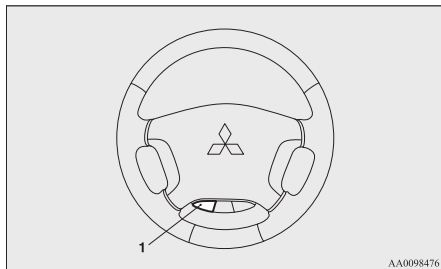

AA0098476

## To search by artist name

E00748900021

1. Say “Play” on the main menu.

### NOTE

- The Bluetooth® 2.0 interface starts recognizing the connected device. If the connected device cannot be recognized or a connection error occurs, the Bluetooth® 2.0 interface starts an appropriate voice guide. Follow the voice guide.

2. After the voice guide says “Would you like to play by Artist, Album, Playlist or Genre?,” say “Artist”.

### NOTE

- If you say “Artist <name>,” you can skip step 3.

3. After the voice guide says “What Artist would you like to play?,” say the artist name.

4. If there is only one match, the system proceeds to step 6.

5. If there are two or more matches, the voice guide will say “More than one match was found, would you like to play <artist name>?” If you say “Yes,” the system proceeds to step 6.

If you say “No,” the next matching artist is uttered by the system.

### NOTE

- If you say “No” to three or all artist names uttered by the system, the voice guide will say “Artist not found, please try again” and the system returns to step 2.
- Search time is dependant on the number of songs on your connected device. Devices containing a large number of songs may take longer to return search results.

6. After the voice guide says “Playing <artist name>,” the system creates a playlist index for the artist.

### NOTE

- If the confirmation function is active, the voice guide confirms if the artist name is correct. If the artist name is correct, say “Yes”. If not, say “No”. After the voice guide says “Artist not found, please try again,” the system returns to step 2.

7. The system exits the voice recognition mode and starts playback.

## To search by album title

E00749000029

1. Say “Play” on the main menu.

 **NOTE**

- The Bluetooth® 2.0 interface starts recognizing the connected device.  
If the connected device cannot be recognized or a connection error occurs, the Bluetooth® 2.0 interface starts an appropriate voice guide. Follow the voice guide.

2. After the voice guide says “Would you like to play by Artist, Album, Playlist or Genre?,” say “Album”.

 **NOTE**

- If you say “Album <title>,” you can skip step 3.

3. After the voice guide says “What Album would you like to play?” say the album title.
4. If there is only one match, the system proceeds to step 6.
5. If there are two or more matches, the voice guide will say “More than one match was found, would you like to play <album title>?” If you say “Yes,” the system proceeds to step 6.  
If you say “No,” the next matching album is uttered by the system.

 **NOTE**

- If you say “No” to three or all album titles uttered by the system, the voice guide will say “Album not found, please try again” and the system returns to step 2.

6. After the voice guide says “Playing <album title>,” the system creates a playlist index for the album title.

 **NOTE**

- If the confirmation function is active, the voice guide confirms if the album title is correct. If the album title is correct, say “Yes”. If not, say “No”. After the voice guide says “Album not found, please try again,” the system returns to step 2.

7. The system exits the voice recognition mode and starts playback.

**To search by playlist**

E00749100020

1. Say “Play” on the main menu.

 **NOTE**

- The Bluetooth® 2.0 interface starts recognizing the connected device.  
If the connected device cannot be recognized or a connection error occurs, the Bluetooth® 2.0 interface starts an appropriate voice guide. Follow the voice guide.

2. After the voice guide says “Would you like to play by Artist, Album, Playlist or Genre?,” say “Playlist”.

 **NOTE**

- If you say “Playlist <playlist>,” you can skip step 3.  
If the device has no playlist, the voice guide will say “There are no playlists stored on device” and the system returns to step 2.

3. After the voice guide says “What Playlist would you like to play?,” say the playlist name.
4. If there is only one match, the system proceeds to step 6.
5. If there are two or more matches, the voice guide will say “More than one match was found, would you like to play <playlist>?” If you say “Yes,” the system proceeds to step 6.  
If you say “No,” the next matching playlist name is uttered by the system.

 **NOTE**

- If you say “No” to three or all playlist names uttered by the system, the voice guide will say “Playlist not found, please try again” and the system returns to step 2.

6. After the voice guide says “Playing <playlist>,” the system creates an index for the playlist.

**7**  **NOTE**

- If the confirmation function is active, the voice guide confirms if the playlist name is correct. If the playlist name is correct, say “Yes”. If not, say “No”. After the voice guide says “Playlist not found, please try again,” the system returns to step 2. Refer to “Confirmation function setting” on page 7-53.

7. The system exits the voice recognition mode and starts playback.

**To search by genre**

E00749200021

1. Say “Play” on the main menu.

 **NOTE**

- The Bluetooth® 2.0 interface starts recognizing the connected device. If the connected device cannot be recognized or a connection error occurs, the Bluetooth® 2.0 interface starts an appropriate voice guide. Follow the voice guide.

2. After the voice guide says “Would you like to play by Artist, Album, Playlist or Genre?,” say “Genre”.

 **NOTE**

- If you say “Genre <type>,” you can skip step 3.

3. After the voice guide says “What Genre would you like to play?,” say the music type.

4. If there is only one match, the system proceeds to step 6.

5. If there are two or more matches, the voice guide will say “More than one match was found, would you like to play <genre>?” If you say “Yes,” the system proceeds to step 6.

If you say “No,” the next matching genre is uttered by the system.

 **NOTE**

- If you say “No” to three or all genres uttered by the system, the voice guide will say “Genre not found, please try again” and the system returns to step 2.

6. After the voice guide says “Playing <genre>,” the system creates an index for the genre.

 **NOTE**

- If the confirmation function is active, the voice guide confirms if the genre is correct. If the genre is correct, say “Yes”. If not, say “No”. After the voice guide says “Genre not found, please try again,” the system returns to step 2. Refer to “Confirmation function setting” on page 7-53.

7. The system exits the voice recognition mode and starts playback.

**Listen to Bluetooth Audio\***

E00736701117

This product can play back tracks on commercially-available Bluetooth-capable audio devices.

**CAUTION**

- Never hold these devices in your hand to operate while driving, as this is dangerous.
- Do not leave the Bluetooth audio device unattended in the vehicle.
- Depending on how the devices are handled, audio files being damaged or lost, therefore it is recommended that data be backed up.

**NOTE**

- Depending on the type of Bluetooth-capable audio devices, usage may not be possible, or functions that can be used may be restricted.
- Confirm together with the user manuals for the commercially- available Bluetooth-capable audio devices.
- Depending on the type of Bluetooth-capable audio devices, volume levels may differ. There is the danger of loud volumes, so prior to use, it is recommended that you turn the volume down.  
→ “Adjust Volume” on page 7-22
- Depending on the status of the Bluetooth audio device, it may take some time until the device is recognized, or playback starts.
- Bluetooth audio device specifications and settings may mean that connection is not possible, or result in differences in operation or display.
- Depending on audio data in the Bluetooth audio device, track information may not be displayed correctly.

**NOTE**

- Depending on the status of the vehicle and device, the iPod/iPhone may not play back after starting the engine.

**Connect a Bluetooth-capable Audio Device**

Regarding how to connect your Bluetooth device, refer to “Connecting the Bluetooth® 2.0 interface and Bluetooth® device” on page 7-56.

Operation methods below describe situations once connection has been completed.

**NOTE**

- If the iPod/iPhone is connected via Bluetooth as a Bluetooth- capable audio device, then do not connect the iPod/iPhone using an iPod cable. Connection using both methods will result in erroneous operation.

**Play Bluetooth Audio**

1. Press the MEDIA key to set Bluetooth Audio as the source.

The selected source is indicated on the display.

2. Press the 5 **▶** key. Bluetooth Audio playback starts.

**NOTE**

- Hold down the 5 **▶** key to pause.
- Press the 6 **⏪** key to stop.

**Select the Track (File)**

Press the **◀◀** key or **▶▶** key to select the track.

This enables selection of the next or previous track.

**Fast Forward or Rewind**

Hold down the 3 **◀◀** key or the 4 **▶▶** key.

Fast forward/rewind is possible.

**Switch Playback Mode**

Repeat playback, random playback, and scan playback are possible.

**Repeat Playback (RPT)**

Press the 1RPT key.

Repeat playback of the track currently being played.

**NOTE**

- Each time the IRPT key is pressed, this switches in the order Repeat OFF, 1 track repeat, All track repeat, and Repeat OFF.

**Random Playback (RDM)**

Press the 2RDM key.

Play the tracks in the Bluetooth Audio device in a random order.

**NOTE**

- Pressing again will cancel.

**Scan Playback (SCAN)**

Press the PTY/SCAN key.

Play the first 10 seconds of each of the tracks on the whole Bluetooth Audio device in order.

**NOTE**

- Press this button again during playback if you wish to hear that track, and that track will play normally.

**Use AUX\***

E00736901135

By connecting external input cables and AUX devices to this product, you can play back tracks on these devices through the product.

Hold down the MEDIA key.

Switch to the AUX mode, and “AUX” is displayed.

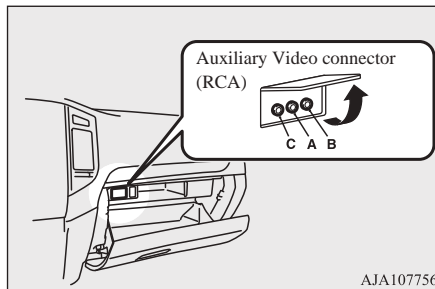

AJA107756

- Auxiliary Video connector (RCA)
- A- Left audio input connector (white)
  - B- Right audio input connector (red)
  - C- Video input connector (yellow)

**CAUTION**

- Connect an audio device with external sound input mode cancelled, or with the sound turned down.
- Even if not inserted, the product will switch to AUX, therefore take care with volume levels when not inserted.

**NOTE**

- For information on using the Auxiliary Video connector (RCA), refer to the separate owner’s manual for the Video Entertainment System.
- Depending on the audio device to be connected, noise may be emitted.
- For power, use the battery power source included in the audio device to be connected. Using the connected audio device while charging through the cigarette lighter socket in the vehicle may lead to noise being emitted through the speakers.
- If no audio devices are connected, then do not select the external sound input mode. If external sound input mode is selected while no audio devices are connected, then sound may be emitted through the speakers.



## To listen to a disc in the Video Entertainment System (vehicles with Video Entertainment System)

E00755101181

It is possible to listen to the audio from the Video Entertainment System using the vehicle's speakers.

Hold down the MEDIA key.

Switch to the AUX mode, and "AUX" is displayed.



### NOTE

- For more details about the Video Entertainment System, refer to the separate owner's manual.

## Display Indicator

E00738100033

This explains content of the display indicator.



### Change the Display Mode

E00738501089

You can change the content of the display indicator.

Press the DISP key to switch the display content.

Each time the DISP key is pressed, the display content changes.

### CAUTION

- The operation of changing display contents may impede safe driving, therefore check safety before operation.

### NOTE

- Up to 11 characters may be displayed at one time. To display 12 or more characters, press the PAGE key, and subsequent characters will be displayed.

### During DAB Reception\*

This switches in the order “Service name”, “Ensemble name”, and “CH no. (CH ID)”.

 **NOTE**

- If the text information for the service name and ensemble name cannot be obtained, then nothing is displayed.

**During CD-DA playback**

This switches in the order “Disc title”, “Track title”, and “Operating status”.

 **NOTE**

- If there is no text information to display, then “NO TITLE” is displayed.

**During MP3/WMA/AAC Playback**

This switches in the order “Folder title”, “File title”, and “Operating status”.

 **NOTE**

- If there is no text information to display, then “NO TITLE” is displayed.

**Display the ID3tag**

Hold down the DISP key.

This switches the ID3tag display.

[DISP] Each time the key is pressed, this switches in the order “Album name”, “Track name”, “Artist name”, “Genre name”\*, and “Operating status”.

\*: Displayed when playing back audio files on a USB device (vehicles with a Bluetooth® 2.0 interface).

 **NOTE**

- During display of the ID3tag, hold down the DISP key to switch to the folder title display.
- The genre name display may not be possible.

**During iPod Playback**

This switches in the order “Albums”, “Track name”, “Artist name”, “Genre name”\*, and “Operating status”.

 **NOTE**

- If there is no text information to display, then “NO TITLE” is displayed.
- Displayed genre name in equipment by type (vehicles with a Bluetooth® 2.0 interface).
- The genre name display may not be possible.

**During Bluetooth® 2.0 Audio Playback\***

E0073900013

Operating details are the same as in “During iPod Playback” on page 7-41.

**Audio Quality and Volume Balance Adjustment**

E00738200021

Change audio quality settings.

**Adjust Audio Quality and Volume Balance**

1. Press the  /SEL key to select settings items.

Each time the  /SEL key is pressed, this switches in the order BASS, TREBLE, FADER, BALANCE, SCV, and Cancel.

2. Turn the  /SEL key to adjust.

Adjustment items	Turn counter-clockwise	Turn clockwise
BASS	-6 to 0 (low low-pass volume)	0 to +6 (high low-pass volume)

Adjustment items	Turn counter-clockwise	Turn clockwise
TREBLE	-6 to 0 (Low high-pass volume)	0 to +6 (High high-pass volume)
FADER	CENTER to REAR 11 (emphasise REAR)	FRONT 11 to CENTER (emphasise FRONT)
BALANCE	LEFT 11 to CENTER (emphasise LEFT)	CENTER to RIGHT 11 (emphasise RIGHT)
SCV	OFF, LOW (Low vehicle compensated volume effect)	MID, HIGH (High vehicle compensated volume effect)

## System Settings

E00738301250

Change system settings such as product time.

1. Press the MENU key.

2. Press the **▶**/SEL key to select settings items.

Each time the **▶**/SEL key is pressed, this switches in the order DAB setting\*<sup>1</sup>, Gracenote DB\*<sup>2</sup>, AF, REG, TP-S, PI-S, PTY language settings, PHONE settings, CT, Adjust time, and Cancel.

3. Turn the **▶**/SEL key to set.
4. Press the **▶**/SEL key to determine.

This completes settings, and displays the next settings item.

\*1: Displayed when a DAB tuner is connected.

\*2: Displayed when playing back audio files (vehicles with a Bluetooth® 2.0 interface).

### DAB Setting\*

#### Change DAB settings

(“Set value” bold typeface indicates factory default settings.)

Settings name	Settings value	Settings content
<b>DAB-DAB Link settings</b>	OFF	If low reception sensitivity, switch to another service.
	<b>ON</b>	If low reception sensitivity, switch to another service.
<b>DAB Band settings</b>	<b>BAND III</b>	Set used broadcast band to 174 to 239 MHz.
	L-BAND	Set used broadcast band to 1452 to 1490 MHz.
	BOTH	Set used broadcast band to Band III and L-Band.

## RDS Setting

### Change RDS settings

("Set value" bold typeface indicates factory default settings.)

Settings name	Settings value	Settings content
<b>AF</b>	<b>AF ON</b>	Automatically track the same station as the program being received.
	AF OFF	Do not automatically track the same station as the program being received.
<b>REG</b>	REG ON	Do not automatically track the local station for the program being received.

Settings name	Settings value	Settings content
<b>REG</b>	<b>REG OFF</b>	Automatically track the local station for the program being received.
<b>TP-S</b>	TP-S ON	Automatically search for traffic messages (TP stations).
	<b>TP-S OFF</b>	Do not automatically search for traffic messages (TP stations).
<b>PI-S</b>	<b>PI-S ON</b>	Search for the same station or local station for that registered in the preset channel.

Settings name	Settings value	Settings content
<b>PI-S</b>	PI-S OFF	Do not search for the same station or local station for that registered in the preset channel.
<b>PTY</b>	<b>ENGLISH</b>	Set the display language for the program content search (PTY search) to English.
	FRANÇAIS	Set the display language for the program content search (PTY search) to French.

Settings name	Settings value	Settings content
PTY	DEUTSCH	Set the display language for the program content search (PTY search) to German.
	SVENSK	Set the display language for the program content search (PTY search) to Swedish.
	ESPAÑOL	Set the display language for the program content search (PTY search) to Spanish.
	ITALIANO	Set the display language for the program content search (PTY search) to Italian.

Settings name	Settings value	Settings content
CT	CT ON	Update the time if time data is received.
	CT OFF	Do not update the time even if time data is received.

\*: It is necessary to press the [TP] key and turn traffic message standby mode “ON”.

### Time Setting

Turning the RDS setting CT setting “CT OFF” enables manual setting of the time.

1. Select “YES” at the “Adjust time” screen, and press the **▶/SEL** key.

The hour can be adjusted. Press the **▶/SEL** key again to adjust the minutes.

2. Turn the **▶/SEL** key to adjust the time.
3. Press the **▶/SEL** key.

This completes the adjustment.

### NOTE

- In order to finish adjusting the time, hold down the **▶/SEL** key until the seconds are reset to “00”.

### PHONE Settings

Change the mobile phone voice cut- in settings and the Bluetooth® 2.0 interface language.

Depending on the vehicle, PHONE settings may not be possible.

### NOTE

- Cancel functions such as the mobile phone “dial lock”, and connect while on the standby screen.
- While connected, mobile phone (receiving calls, etc.) operations may not function correctly.
- Depending on the distance between the product and the mobile phone, the conditions within the vehicle, and types of screening, connection may not be possible. In these cases, situate the mobile phone as close as possible to the product.
- Even though a Bluetooth-capable mobile phone, characteristics and specifications may mean that correct operation may not be possible.

 **NOTE**

- For safety's sake, do not operate the mobile phone while driving. When operating the mobile phone, first stop the vehicle in a safe location.
- Even though a Bluetooth-capable mobile phone, phone specifications and settings may result in differences in display, or prevent correct operation.
- Some models may not be confirmed as connected, or may not connect.

**Supported profiles**

<b>Hands-free</b>	HFP(v1.5)
<b>Phone book transfer</b>	OPP(v1.1), PBAP(v1.0)

**Vehicles without a Bluetooth® 2.0 Interface**

A hands-free kit (available separately) is required.

("Set value" bold typeface indicates factory default settings.)

Settings value	Settings content
<b>PHONE OFF</b>	Do not use mobile phone voice cut-in.
PHONE MUTE	During mobile phone voice cut-in, mute the audio.

Settings value	Settings content
PHONE ATT	During mobile phone voice cut-in, output audio from all speakers.
PHONE IN-L	During mobile phone voice cut-in, output sound from the left front speaker.
PHONE IN-R	During mobile phone voice cut-in, output sound from the right front speaker.
PHONE IN-LR	During mobile phone voice cut-in, output sound from the left and right front speakers.

**Vehicles with a Bluetooth® 2.0 Interface**

("Set value" bold typeface indicates factory default settings.)

Settings name	Settings value	Settings content
<b>PHONE IN settings</b>	<b>PHONE IN-R</b>	During mobile phone voice cut-in, output sound from the right front speaker.

Settings name	Settings value	Settings content
<b>PHONE IN settings</b>	PHONE IN-L	During mobile phone voice cut-in, output sound from the left front speaker.
<b>HFM voice language settings</b>	<b>ENGLISH</b>	Change the hands free module voice language.
	FRENCH	
	GERMAN	
	SPANISH	
	ITALIAN	
	DUTCH	
	PORTUGUESE	
	RUSSIAN	

 **NOTE**

- Depending on the vehicle model, this may not display.

## **Gracenote DB (Vehicles with a Bluetooth® 2.0 interface)**

The version number can be confirmed.

1. Select “Gracenote DB” and press the **▶**/SEL key.
2. Turn the **▶**/SEL key and select “DB Version”.
3. Press the **▶**/SEL key.  
The DB Version is displayed.



# Troubleshooting

E00738401075

Please check these items if a message appears on the display, or if you think something is not working properly.

## If This Message Appears...

A message is displayed on this product according to the situation.

Mode	Message	Cause	Response
CD	CHECK DISC	The disc is inserted upside down.	Insert with the label side up.
		The disc has condensation on it.	Wait a while before inserting again.
	DISC ERROR	The disc is damaged.	Clean the read surface of the disc.
		The disc is dirty.	
	INTERNAL E	The drive has malfunctioned for some reason.	Check that there is no problem with the disc, and insert the disc again. If the problem persists, consult a MITSUBISHI MOTORS Authorized Service Point.
HEAT ERROR	The temperature inside the product is high.	Remove the disc, and wait for the internal temperature to return to normal.	
USB	FILE ERROR	Files that cannot be played are selected.	Select files that can be played. → “Audio Files (MP3/WMA/AAC)” on page 7-17.
	USB BUS PWR	There is high or low electrical current or voltage.	Turn the power OFF and wait a short while. If the problem persists, consult a MITSUBISHI MOTORS Authorized Service Point.
	LSI ERROR	There is an internal malfunction for some reason.	
	UNSUPPORTED FORMAT	Unsupported audio files have been played.	Confirm audio files that can be played. → “Audio Files (MP3/WMA/AAC)” on page 7-17.
	UNSUPPORTED DEVICE	An unsupported USB device has been connected.	Please connect a USB memory device.
iPod	NO SONG	An iPod/iPhone not containing any tracks has been connected.	Connect an iPod/iPhone containing tracks.

## Troubleshooting

<b>Mode</b>	<b>Message</b>	<b>Cause</b>	<b>Response</b>
	VER ERROR	This iPod/iPhone software version is not supported.	Please change to a supported software version.
Other	ERROR DC	An abnormal direct voltage has been sent to the speakers.	Turn the power OFF and wait a short while. If the problem persists, consult a MITSUBISHI MOTORS Authorized Service Point.

7

## If You Think Something Is Not Working Properly...

Here is a list of symptoms, causes and responses if you think something is not working properly.

Symptoms	Cause	Response
There is no sound or quiet sound.	The volume is turned to its minimum.	Adjust the volume. → “Adjust Volume” on page 7-22.
	The balance or fader is turned to one side.	Adjust the balance or fader. → “Adjust Audio Quality and Volume Balance” on page 7-41.
The disc cannot be inserted.	A disc is already in the product.	Eject the disc. → “Insert/Eject Discs” on page 7-22.
	There is no disc in the product, but the product says it is loading.	Press the eject button once. → “Insert/Eject Discs” on page 7-22.
The disc cannot be played.	The disc is inserted upside down.	Insert with the label side up.
	The disc has condensation on it.	Wait a while before inserting.
	The disc is dirty.	Clean the read surface of the disc.
The sound skips in the same place.	The disc is damaged or dirty.	Check the disc.
There is no sound, even if the disc is inserted.	Damage to or dirt on the disc means that its data cannot be read.	Check the disc. Additionally, if using CD-R/RW discs, their characteristics may render them unable to be played.

## Antenna

E00710501771

Antenna leads (1) are printed on the inside of the rear side window (3-door models)/quarter window (5-door models) glass.

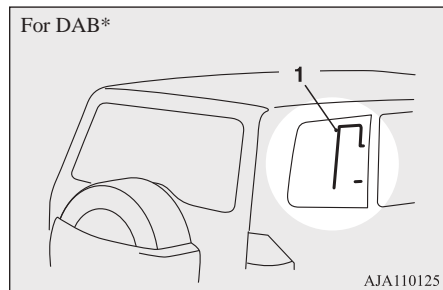
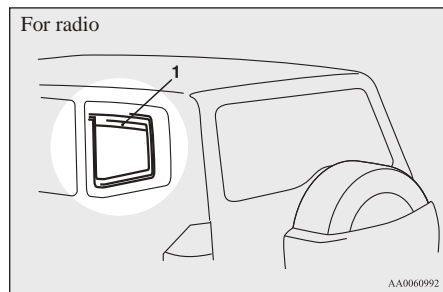

## NOTE

- When the rear side/quarter window glass is cleaned, wipe the glass with a soft cloth by moving the cloth along the antenna so as not to damage it.

## Link System\*

E00764501530

The Link System takes overall control of the devices connected via the USB port, HDMI port or the Bluetooth® 2.0 interface allowing the connected devices to be operated by using the switches in the vehicle or voice commands.

See the following section for details on how to operate.

Refer to “Bluetooth® 2.0 interface” on page 7-50.

Refer to “USB input terminal” on page 7-71.

Refer to “HDMI port” on page 7-74.

Bluetooth® is a registered trademark of BLUETOOTH SIG, INC.

## Link System End User Licence Agreement

E00764601166

You have acquired a device that includes software licensed by MITSUBISHI MOTORS CORPORATION from JOHN-SON CONTROLS Inc (the automotive experience business unit), and their subsequent 3<sup>rd</sup> party suppliers. For a complete list of these 3<sup>rd</sup> party products and their end user licence agreements, please go to the following website.

<http://www.jcibblueconnect.com/faq/fulldisclosure.pdf>

## Bluetooth® 2.0 interface\*

E00726000732

The Bluetooth® 2.0 interface allows for making/receiving hands-free calls in the vehicle using a Bluetooth® compatible cellular phone based on the wireless communication technology commonly known as Bluetooth®. It also allows the user to play music, saved in a Bluetooth® music player, from the vehicle’s speakers.

The system is equipped with a voice recognition function, which allows you to make hands-free calls by simple switch operations and voice command operations using a defined voice tree.

The Bluetooth® 2.0 interface can be used when the ignition switch is in the “ON” or “ACC” position.

Before you can use the Bluetooth® 2.0 interface, you must pair the Bluetooth® device and Bluetooth® 2.0 interface. Refer to “Connecting the Bluetooth® 2.0 interface and Bluetooth® device” on page 7-56.

Bluetooth® is a registered trademark of BLUETOOTH SIG, INC.

### **⚠ WARNING**

- Although the Bluetooth® 2.0 interface allows you to make hands-free calls, if you choose to use the cellular phone while driving, you must not allow yourself to be distracted from the safe operation of your vehicle. Anything, including cellular phone usage, that distracts you from the safe operation of your vehicle increases your risk of an accident.
- Refer to and comply with all state and local laws in your area regarding cellular phone usage while driving.

### **NOTE**

- The Bluetooth® 2.0 interface cannot be used if the Bluetooth® device has a flat battery or the device power is turned off.
- Hands-free calls will not be possible if your phone does not have service available.
- If you place the Bluetooth® device in the vehicle’s third seat or luggage compartment, you may not be able to use the Bluetooth® 2.0 interface.
- Some Bluetooth® devices are not compatible with the Bluetooth® 2.0 interface.
- You can confirm the Link System software version by pressing the HANG-UP button 3 times (press and hold 2 times and then press briefly) within 10 seconds.
- For details on the Bluetooth® 2.0 interface, you can see them by accessing the MITSUBISHI MOTORS website. Please read and agree on the “Warning about Links to the Web Sites of Other Companies” because it connects to other than MITSUBISHI MOTORS website. <http://www.mitsubishi-motors.com/en/products/index.html>
- Software updates by cellular phone/digital audio device manufacturers may change/alter device connectivity.

“Steering control switch and microphone” on page 7-51

Voice recognition function → p. 7-52

Useful voice commands → p. 7-53

Speaker enrollment function → p. 7-55

Connecting the Bluetooth® 2.0 interface and Bluetooth® device → p. 7-56

Operating a music player connected via Bluetooth® → p. 7-61

How to make or receive hands-free calls → p. 7-61

Phone book function → p. 7-64

## **Steering control switch and microphone**

E00727200265

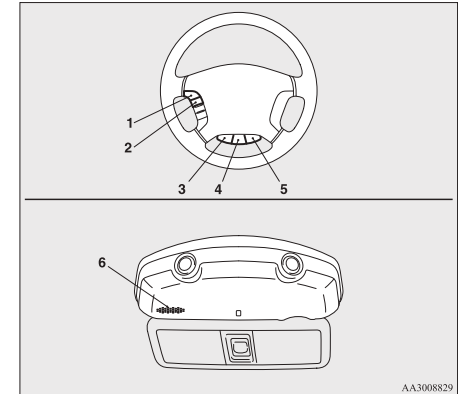

- 1- Volume up button
- 2- Volume down button
- 3- SPEECH button
- 4- PICK-UP button
- 5- HANG-UP button
- 6- Microphone

AA3008829

## Volume up button

Press this button to increase the volume.

## Volume down button

Press this button to decrease the volume.

## SPEECH button

- Press this button to change to voice recognition mode.  
While the system is in voice recognition mode, “Listening” will appear on the audio display.
- If you press the button briefly while in voice recognition mode, it will interrupt prompting and allow voice command input.  
Pressing the button longer will deactivate the voice recognition mode.
- Pressing this button briefly during a call will enable voice recognition and allow voice command input.

## PICK-UP button

- Press this button when an incoming call is received to answer the telephone.
- When another call is received during a call, press this button to put the first caller on hold and talk to the new caller.

- In such circumstances, you can press the button briefly to switch between callers. You will switch to the first caller and the other caller will be put on hold.
- To establish a three-way call in such situations, press the SPEECH button to enter voice recognition mode and then say “Join calls”.

## HANG-UP button

- Press this button when an incoming call is received to refuse the call.
- Press this button during a call to end the current call.  
When another call is on hold, you will switch to that call.
- If this button is pressed in the voice recognition mode, the voice recognition mode will be deactivated.

### NOTE

- When you press the SPEECH button to enter voice recognition mode with a cellular phone paired to the system, current information on the cellular phone, such as “remaining battery life,” “signal strength” or “roaming,” will be displayed on the audio display.\*  
\*: Some cellular phones will not send this information to the Bluetooth® 2.0 interface.

### NOTE

- Call waiting and three-way calls can be used by the Bluetooth® 2.0 interface, only if it is possible to use those services with your cellular phone.

## Microphone

Your voice will be recognized by a microphone in the overhead console, allowing you to make hands-free calls with voice commands.

### NOTE

- If a cellular phone is brought close to the microphone, it may create noise in the voice on the phone. In such a case, take the cellular phone at a place as far as possible from the microphone.

## Voice recognition function

E00727300527

The Bluetooth® 2.0 interface is equipped with a voice recognition function. Simply say voice commands and you can perform various operations and make or receive hands-free calls.

With the Bluetooth® 2.0 interface, voice recognition is possible for English, French, Spanish, Italian, German, Dutch, Portuguese and Russian. The factory setting is English or “Russian.”

 **NOTE**

- If the voice command that you say differs from the predefined command or cannot be recognised due to ambient noise or some other reason, the Bluetooth® 2.0 interface will ask you for the voice command again up to 3 times.
- For best performance and further reduction of ambient noise, close the vehicle windows, lower the blower speed and refrain from conversation with your passengers while engaging the voice recognition function.
- Depending on the selected language, some functions may not be available.

## Selecting the Language

1. Press the SPEECH button.
2. Say “Setup”.
3. Say “Language.”
4. The voice guide will say “Select a language: English, French, Spanish, Italian, German, Dutch, Portuguese or Russian” Say the desired language. (Example: Say “English.”)
5. The voice guide will say “English (French, Spanish, Italian, German, Dutch, Portuguese or Russian) selected. Is this correct?” Say “Yes.” Answer “No” to return to Step 4.

 **NOTE**

- The voice guide will repeat the same message twice. The first message is in the current language, and the second message is in the selected language.
- If many entries are registered in the vehicle phone book, changing the language will take longer.
- Changing the language deletes the mobile phone book imported to the Bluetooth® 2.0 interface. If you wish to use it, you will have to import it again.

6. When the voice guide says “English (French, Spanish, Italian, German, Dutch, Portuguese or Russian) selected,” the language change process will be completed and the system will return to the main menu.

## Useful voice commands

E00760000019

## Help function

E00760100010

The Bluetooth® 2.0 interface is equipped with a help function. If you say “Help” when the system is waiting for a voice command input, the system will tell you a list of the commands that can be used under the circumstances.

## Cancelling

E00760201021

There are two cancel functions.

If you are at the main menu, say “Cancel” to exit from the Bluetooth® 2.0 interface.

If you are anywhere else within the system, say “Cancel” to return to the main menu.

 **NOTE**

- You can return to the previous menu by saying “Go Back.” (if so equipped)

7

## Confirmation function setting

E00760400013

The Bluetooth® 2.0 interface is equipped with a confirmation function.

With the confirmation function activated, you are given more opportunities than normal to confirm a command when making various settings to the Bluetooth® 2.0 interface. This allows you to decrease the possibility that a setting is accidentally changed.

The confirmation function can be turned on or off by following the steps below.

1. Press the SPEECH button.
2. Say “Setup”.
3. Say “Confirmation prompts”.

- The voice guide will say “Confirmation prompts are <on/off>. Would you like to turn confirmation prompts <off/on>”. Answer “Yes” to change the setting or answer “No” to keep the current setting.
- The voice guide will say “Confirmation prompts are <off/on>” and then the system will return to the main menu.

### Security function

E00760500131

It is possible to use a password as a security function by setting a password of your choice for the Bluetooth® 2.0 interface.

When the security function is turned on, it is necessary to make a voice input of a 4-digit password in order to use all functions of the Bluetooth® 2.0 interface, except for reception.

#### Setting the password

Use the following procedure to turn on the security function by setting a password.

- Press the SPEECH button.
- Say “Setup”.
- Say “Password.”
- The voice guide will say “Password is disabled. Would you like to enable it?” Answer “Yes.”  
Answer “No” to cancel the setting of the password and return to the main menu.

- The voice guide will say “Please say a 4-digit password. Remember this password. It will be required to use this system”.  
Say a 4-digit number which you want to set as a password.
- For confirmation purposes, the voice guide will say “Password <4-digit password>. Is this correct?” Answer “Yes.”  
Answer “No” to return to the password input in Step 5.
- When the registration of the password is completed, the voice guide will say “Password is enabled” and the system will return to the main menu.

#### NOTE

- Password will be required to access the system after the next ignition cycle.
- It is required for a little time after engine stop that the entered password is actually recorded in the system.  
If the ignition switch is made to “ACC” or “ON” or the engine is started immediately after engine stop, there is a case when the entered password is not recorded in the system. At this time, please try to enter the password again.

#### Entering the password

If a password has been set and the security function is enabled, the voice guide will say “Hands-free system is locked. State the password to continue” when the SPEECH button is pressed to enter voice recognition mode. Say the 4-digit password number to enter the password.

If the entered password is wrong, the voice guide will say “<4- digit password>, Incorrect password. Please try again”. Enter the correct password.

#### NOTE

- You can re-enter the password as many times as you want.
- If you have forgotten your password, say “Cancel” to quit the voice input mode and then check with a MITSUBISHI MOTORS Authorized Service Point.

#### Disabling the password

Use the following procedure to turn off the security function by disabling the password.

#### NOTE

- System must be unlocked to disable the password.

- Press the SPEECH button.
- Say “Setup”.



3. Say “Password.”
4. The voice guide will say “Password is enabled. Would you like to disable it?” Answer “Yes.” Answer “No” to cancel the disabling of the password and return to the main menu.
5. When the disabling of the password is completed, the voice guide will say “Password is disabled” and the system will return to the main menu.

## Speaker enrollment function

E00727400209

The Bluetooth® 2.0 interface can use the speaker enrollment function to create a voice model for one person per language.

This makes it easier for the Bluetooth® 2.0 interface to recognise voice commands said by you.

You can turn a voice model registered with the speaker enrollment function on and off whenever you want.

## Speaker enrollment

E00727501425

It takes about 2 to 3 minutes to complete the speaker enrollment process.

To ensure the best results, run through the process while in the driver’s seat, in an environment that is as quiet as possible (when there is no rain or strong winds and the vehicle windows are closed). Please turn off your phone while in speaker enrollment to prevent interruption of the process.

Use the following procedure for speaker enrollment.

1. Stop your vehicle in a safe area, put the selector lever in the “P” (PARK) position, and pull the parking brake lever.



### NOTE

- Speaker enrollment is not possible unless the vehicle is parked. Make sure you park the vehicle in a safe area before attempting speaker enrollment.

2. Press the SPEECH button.
3. Say “Voice training”.
4. The voice guide will say “This operation must be performed in a quiet environment while the vehicle is stopped. See the owner’s manual for the list of required training phrases. Press and release the SPEECH button when you are ready to begin. Press the HANG-UP button to cancel at any time”. Press the SPEECH button to start the speaker enrollment process.



### NOTE

- If you do not start the speaker enrollment process within 3 minutes of pressing the SPEECH button, the speaker enrollment function will time out. The voice guide will say “Speaker Enrollment has timed out”. The system will then beep and the voice recognition mode will be deactivated.

5. The voice guide will prompt for phrase 1. Repeat the corresponding phrase listed in table “Enrollment commands” on page 7-71.

The system will register your voice and then move on to the registration of the next command. Continue the process until all phrases have been registered.



### NOTE

- To repeat the most recent voice training command, press and release the SPEECH button.
- If you press the HANG-UP button anytime during the process, the system will beep and stop the speaker enrollment process.

6. When all enrollment commands have been read out, the voice guide will say “Speaker enrollment is complete”.

The system will then end the speaker enrollment process and return to the main menu.

### NOTE

- Completing the speaker enrollment process will turn on the voice model automatically.
- The commands “Help” and “Cancel” will not work in this mode.

4. When enrollment is “enabled”, the voice model is on; when enrollment is “disabled”, the voice model is off. Say the command that fits your needs. Say “Retrain” to start the speaker enrollment process and recreate a new voice model. (Refer to “Speaker enrollment” on page 7-55.)

## Connecting the Bluetooth® 2.0 interface and Bluetooth® device

E00727600096

You can turn a voice model registered with the speaker enrollment function on and off whenever you want.

You can also retrain the system.

Use the following procedure to perform these actions.

1. Press the SPEECH button.
2. Say “Voice training”.
3. If you have completed a speaker enrollment process once already, the voice guide will say either “Enrollment is enabled. Would you like to disable or retrain?” or “Enrollment is disabled. Would you like to enable or retrain?”

Before you can make or receive hands-free calls or play music using the Bluetooth® 2.0 interface function, you must pair the Bluetooth® device and Bluetooth® 2.0 interface.

E00760601852

### NOTE

- Pairing is required only when the device is used for the first time. Once the device has been paired with the Bluetooth® 2.0 interface, all you need is to bring the device into the vehicle next time and the device will connect to the Bluetooth® 2.0 interface automatically (if supported by the device).

Up to 7 Bluetooth® devices can be paired with the Bluetooth® 2.0 interface.

If multiple paired Bluetooth® devices are available in the vehicle, the cellular phone or music player most recently connected is automatically connected to the Bluetooth® 2.0 interface.

You can also change a Bluetooth® device to be connected.

## To pair

To pair a Bluetooth® device with the Bluetooth® 2.0 interface, use either one of the following 2 methods (Type 1 or Type 2).

### Pairing procedure- Type 1\*

1. Stop your vehicle in a safe area, put the selector lever in the “P” (PARK) position, and pull the parking brake lever.

### NOTE

- You cannot pair any Bluetooth® device with the Bluetooth® 2.0 interface unless the vehicle is parked. Before pairing a Bluetooth® device with the Bluetooth® 2.0 interface, confirm that the vehicle is parked in a safe location.

2. Press the SPEECH button.
3. Say “Setup.”
4. Say “Pairing options.”

5. The voice guide will say “Select one of the following: pair, edit, delete, or list.” Say “Pair.”

 **NOTE**

- If 7 devices have already been paired, the voice guide will say “Maximum devices paired” and then the system will end the pairing process. To register a new device, delete one device and then repeat the pairing process. (Refer to “Deleting a device” on page 7-59.)

6. The voice guide will say “Please say a 4-digit pairing code.” Say a 4-digit number. When the confirmation function is on, the system will confirm whether the number said is acceptable. Answer “Yes.” Answer “No” to return to pairing code selection.

 **NOTE**

- Some Bluetooth® devices require a specific pairing code. Please refer to the device manual for pairing code requirements.

 **NOTE**

- The pairing code entered here is only used for the Bluetooth® connection certification. It is any 4-digit number the user would like to select. Remember the pairing code as it needs to be keyed into the Bluetooth® device later in the pairing process. Depending on the connection settings of the Bluetooth® device, this code may have to be entered each time you connect the Bluetooth® device to the Bluetooth® 2.0 interface. For the default connection settings, refer to the instructions for the device.

7. The voice guide will say “Start pairing procedure on the device. See the device manual for instructions.” Enter in the Bluetooth® device the 4-digit number you have registered in Step 6.

 **NOTE**

- According to the corresponding device to Bluetooth®, it might take a few minute to pair the Bluetooth® device with the Bluetooth® 2.0 interface.
- If the Bluetooth® 2.0 interface cannot recognize the Bluetooth® device, the voice guide will say “Pairing has timed out” and the pairing process will be cancelled. Confirm that the device you are pairing supports Bluetooth®, and try pairing it again.

 **NOTE**

- If you enter the wrong number, the voice guide will say “Pairing failed” and the pairing process will be cancelled. Confirm the number is right, and try pairing it again.

8. The voice guide will say “Please say the name of the device after the beep.” You can assign a desired name for the Bluetooth® device and register it as a device tag. Say the name you want to register after the beep.

 **NOTE**

- When the confirmation function is on, after repeating the device tag you have said, the voice guide will ask “Is this correct?” Answer “Yes.” To change the device tag, answer “No” and then say the device tag again.

9. The voice guide will say “Pairing complete,” and the pairing process will end.

**Pairing procedure - Type 2\***

1. Stop your vehicle in a safe area, put the selector lever in the “P” (PARK) position, and pull the parking brake lever.

 **NOTE**

- You cannot pair any Bluetooth® device with the Bluetooth® 2.0 interface unless the vehicle is parked. Before pairing a Bluetooth® device with the Bluetooth® 2.0 interface, confirm that the vehicle is parked in a safe location.

2. Press the SPEECH button.
3. Say “Pair Device.”

 **NOTE**

- The following procedure ( ① to ③ ) can also be used instead of saying “Pair Device.” Replace this step 3 with the following procedure if you prefer.
  - ① Say “Setup.”
  - ② Say “Pairing Options.”
  - ③ The voice guide will say “Select one of the following: pair, edit, delete, or list.” Say “Pair.”
- If 7 devices have already been paired, the voice guide will say “Maximum devices paired” and then the system will end the pairing process. To register a new device, delete one device and then repeat the pairing process. (Refer to “Deleting a device” on page 7-59.)

4. The voice guide will say “Start pairing procedure on the device. See the device

manual for instructions.” and then will say “The pairing code is <pairing code>.”

 **NOTE**

- Some Bluetooth® devices require a specific pairing code. Please refer to the device manual for pairing code requirements and read the next section “If your device requires a specific pairing code” on page 7-56 to set the pairing code.
- The pairing code entered here is only used for the Bluetooth® connection certification. Depending on the connection settings of the Bluetooth® device, this code may have to be entered each time you connect the Bluetooth® device to the Bluetooth® 2.0 interface. For the default connection settings, refer to the instructions for the device.

5. Enter in the Bluetooth® device the 4-digit number that has been read out in Step 4.

 **NOTE**

- According to the corresponding device to Bluetooth®, it might take a few minute to pair the Bluetooth® device with the Bluetooth® 2.0 interface.

 **NOTE**

- If the Bluetooth® 2.0 interface cannot recognize the Bluetooth® device, the voice guide will say “Pairing has timed out” and the pairing process will be cancelled. Confirm that the device you are pairing supports Bluetooth®, and try pairing it again.
- If you enter the wrong number, the voice guide will say “Pairing failed” and the pairing process will be cancelled. Confirm the number is right, and try pairing it again. If your device requires a specific pairing code, you need to set the pairing code. Refer to the device manual for pairing code requirements and read the next section “If your device requires a specific pairing code” on page 7-56.

6. The voice guide will say “Please say the name of the device after the beep.” You can assign a desired name for the Bluetooth® device and register it as a device tag. Say the name you want to register after the beep.

 **NOTE**

- When the confirmation function is on, after repeating the device tag you have said, the voice guide will ask “Is this correct?” Answer “Yes.” To change the device tag, answer “No” and then say the device tag again.

- The voice guide will say “Pairing Complete. Would you like to import the contacts from your mobile device now?” Answer “Yes,” and the voice guide will say “Please wait while the contacts are imported. This may take several minutes.” Answer “No” to end the pairing process.

#### **If your device requires a specific pairing code**

If your device requires a specific pairing code, you need to set the pairing code. Follow the procedures below.

- Press the SPEECH button.
- Say “Setup.”
- Say “Pairing Options.”
- Say “Set Code.”
- The voice guide will say “Do you want the pairing code to be random or fixed?” Say “Fixed.”
- The voice guide will say “Please say a 4-digit pairing code.” Say a 4-digit number.
- The voice guide will say “Pairing code set to <pairing code>.”  
When the confirmation function is on, the system will confirm whether the number said is acceptable. Answer “Yes.”  
Answer “No” to return to Step 6.

- The voice guide will say “Do you want to pair a device now?” Answer “Yes,” the system will proceed to Step 3 in the pairing process. Refer to the “Pairing procedure- Type 2.”

## Selecting a device

E00760700016

If multiple paired Bluetooth® devices are available in the vehicle, the cellular phone or music player most recently connected is automatically connected to the Bluetooth® 2.0 interface.

You can connect to the other cellular phone or music player by following setting change procedures.

#### **To select a cellular phone**

- Press the SPEECH button.
- Say “Setup.”
- Say “Select phone.”
- After the voice guide says “Please say,” the numbers of the cellular phones and device tags of corresponding cellular phones will be read out in order, starting with the cellular phone that has been most recently connected.  
Say the number of the cellular phone that you want to connect to.  
When the confirmation function is on, the system will ask you again whether the phone that you want to connect to is

correct. Answer “Yes” to continue and connect to the cellular phone.  
Answer “No,” and the voice guide will say “Please say.”  
Say the number of the phone that you want to connect to.

#### **NOTE**

- You can connect to a phone at any time by pressing the SPEECH button and saying the number, even before all of the paired numbers and device tags of corresponding cellular phones are read out by the system.

- The selected phone will be connected to the Bluetooth® 2.0 interface. The voice guide will say “<device tag> selected” and then the system will return to the main menu.

#### **To select a music player**

- Press the SPEECH button.
- Say “Setup.”
- Say “Select music player.”
- After the voice guide says “Please say,” the numbers of the music players and device tags of corresponding music players will be read out in order, starting with the music player that has been most recently connected.  
Say the number of the music player that you want to connect to.

When the confirmation function is on, the system will ask you again whether the music player that you want to connect to is correct. Answer “Yes” to continue and connect to the music player.

Answer “No,” and the voice guide will say “Please say.”

Say the number of the music player that you want to connect to.

### NOTE

- You can connect to a music player at any time by pressing the SPEECH button and saying the number, even before all of the paired numbers and device tags of corresponding music players are read out by the system.

5. The selected music player will be connected to the Bluetooth® 2.0 interface. The voice guide will say “<device tag> selected” and then the system will return to the main menu.

### Deleting a device

Use the following procedure to delete a paired Bluetooth® device from the Bluetooth® 2.0 interface.

1. Press the SPEECH button.
2. Say “Setup.”
3. Say “Pairing Options.”

4. The voice guide will say “Select one of the following: pair, edit, delete, or list.” Say “Delete.”

5. After the voice guide says “Please say,” the numbers of the devices and device tags of corresponding devices will be read out in order, starting with the device that has been most recently connected. After it completes reading all pairs, the voice guide will say “or all.”

Say the number of the device that you want to delete from the system.

If you want to delete all paired phones from the system, say “All.”

6. For confirmation purposes, the voice guide will say “Deleting <device tag> <number>. Is this correct?” or “Deleting all devices. Is this correct?”

Answer “Yes” to delete the phone(s).

Answer “No,” the system will return to Step 4.

7. The voice guide will say “Deleted,” and then the system will end the device deletion process.

### NOTE

- If the device deletion process fails for some reason, the voice guide will say “Delete failed” and then the system will cancel deleting the device.

## To check a paired Bluetooth® device

E00760800017

You can check a paired Bluetooth® device by following the steps below.

1. Press the SPEECH button.
2. Say “Setup.”
3. Say “Pairing Options.”
4. The voice guide will say “Select one of the following: pair, edit, delete, or list.” Say “List.”
5. The voice guide will read out device tags of corresponding devices in order, starting with the Bluetooth® device that has been most recently connected.
6. After the device tags of all paired Bluetooth® devices have been read, the system will say “End of list, would you like to start from the beginning?” To hear the list again from the beginning, answer “Yes.” When you are done, answer “No” to return to the main menu.

 **NOTE**

- If you press and release the SPEECH button and say “Continue” or “Previous” while the list is being read, the system will advance or rewind the list.  
Say “Continue” to proceed to the device with the next highest number or “Previous” to return to the phone with the previous number.
- You can change the device tag by pressing and releasing the SPEECH button and then saying “Edit” while the list is being read.
- You can change the phone to be connected by pressing and releasing the SPEECH button and then saying “Select phone” while the list is being read.
- You can change the music player to be connected by pressing and releasing the SPEECH button and then saying “Select music player” while the list is being read.

## Changing a device tag

E0076090018

You can change the device tag of a paired cellular phone or music player.

Follow the steps below to change a device tag.

1. Press the SPEECH button.
2. Say “Setup.”
3. Say “Pairing Options.”
4. The voice guide will say “Select one of the following: pair, edit, delete, or list.” Say “Edit.”

5. The voice guide will say “Please say,” and read out the numbers of the Bluetooth® devices and device tags of corresponding devices in order, starting with the Bluetooth® that has been most recently connected.

After all paired device tags have been read, the voice guide will say “Which device, please?” Say the number of the device tag you want to change.

 **NOTE**

- You can press and release the SPEECH button while the list is being read, and immediately say the number of the device tag you want to change.

6. The voice guide will say “New name, please.” Say the name you want to register as a new device tag.

When the confirmation function is on, the voice guide will say “<New device tag>. Is this correct?” Answer “Yes.”

Answer “No,” you can say the new device tag you want to register again.

7. The device tag is changed.

When the change is complete, the voice guide will say “New name saved” and then the system will return to the main menu.

## Operating a music player connected via Bluetooth®

E00761001345

For the operation of a music player connected via Bluetooth®, refer to “Listen to Bluetooth Audio” on page 7-36. On vehicles equipped with MITSUBISHI Multi-Communication System (MMCS), DISPLAY AUDIO or Smartphone Link Display Audio, refer to separate owner’s manual.

## How to make or receive hands-free calls

E00761100020

You can make or receive hands-free calls using a Bluetooth® compatible cellular phone connected to the Bluetooth® 2.0 interface.

You can also use the phone books in the Bluetooth® 2.0 interface to make calls without dialling telephone numbers.

To make a call → p. 7-62

SEND function → p. 7-63

Receiving calls → p. 7-63

MUTE function → p. 7-63

Switching between hands-free mode and private mode → p. 7-64

 **NOTE**

- The hands-free calls might not be operated correctly when it makes calling or receiving by operating the cellular phone directly.

## To make a call

E00761200122

You can make a call in the following 3 ways using the Bluetooth® 2.0 interface:

Making a call by saying a telephone number, making a call using the Bluetooth® 2.0 interface's phone book, and making a call by re-dialing.

### Making a call by using the telephone number

You can make a call by saying the telephone number.

1. Press the SPEECH button.
2. Say "Dial."
3. After the voice guide says "Number please," say the telephone number.
4. The voice guide will say "Dialing <number recognised>."

The Bluetooth® 2.0 interface will then make the call.

When the confirmation function is on, the system will confirm again the telephone number. To continue with that number, answer "Yes."

To change the telephone number, answer "No." The system will say "Number please" then say the telephone number again.

 **NOTE**

- In the case of English, the system will recognise both "zero" and "oh" (Letter "o") for the number "0."
- The Bluetooth® 2.0 interface supports numbers (0 to 9) and characters (+, # and \*).
- The maximum supported telephone number length is as follows:
  - International telephone number: + and telephone numbers (to 18 digits).
  - Except for international telephone number: telephone numbers (to 19 digits).

### Making a call using a phone book

You can make calls using the vehicle phone book or mobile phone book of the Bluetooth® 2.0 interface.

For details on the phone books, refer to "Phone book function" on page 7-64.

1. Press the SPEECH button.
2. Say "Call."

 **NOTE**

- If you say "Call" when the vehicle phone book and the mobile phone book are empty, the voice guide will say "The vehicle phone book is empty. Would you like to add a new entry now?" Answer "Yes," and the voice guide will say "Entering the phone book - new entry menu." You can now create data in the vehicle phone book. Answer "No," to return to the main menu.

3. After the voice guide says "Name please," say the name you want to call, from those registered in the phone book.
4. If there is only one match, the system proceeds to Step 5.

If there are two or more matches, the voice guide will say "More than one match was found, would you like to call <returned name>." If that person is the one you want to call, answer "Yes."

Answer "No," and the name of the next matching person will be uttered by the voice guide.

 **NOTE**

- If you say "No" to all names read by the system, the voice guide will say "Name not found, returning to main menu" and the system will return to the main menu.



5. If only one telephone number is registered under the name you just said, the voice guide proceeds to Step 6.

If two or more telephone numbers are registered that match the name you just said, the voice guide will say “Would you like to call <name> at [home], [work], [mobile], or [other]?” Select the location to call.

### NOTE

- If the name you selected has matching data in the vehicle phone book but no telephone number is registered under the selected location, the voice guide will say “{home/work/mobile/other} not found for <name>. Would you like to add location or try again?”  
Say “Try again,” and the system will return to Step 3.  
Say “Add location” and you can register an additional telephone number under the selected location.
- If the name you selected has matching data in the mobile phone book but no telephone number is registered under the selected location, the voice guide will say “{home/work/mobile/other} not found for <name>. Would you like to try again?”  
Answer “Yes,” and the system will return to Step 3.  
Answer “No,” and the call will be cancelled. Start over again from Step 1.

6. The voice guide will say “Calling <name> <location>” and then the system will dial the telephone number.

### NOTE

- When the confirmation function is on, the system will ask if the name and location of the receiver are correct.  
If the name is correct, answer “Yes.”  
If you want to change the name or location to call, answer “No.” The system will return to Step 3.

### Redialing

You can redial the last number called, based on the history of dialed calls in the paired cellular phone.

Use the following procedure to redial.

1. Press the SPEECH button.
2. Say “Redial.”

### SEND function

E00761300035

During a call, press the SPEECH button to enter voice recognition mode, then say “<numbers> SEND” to generate DTMF tones.

For example, if during a call you need to simulate the press of a phone button as a response to an automated system, press the SPEECH button and speak “1 2 3 4 pound SEND” and the 1234# will be sent on your cellular phone.

### Receiving calls

E00761600012

If an incoming phone call is received while the ignition switch is in the “ACC” or “ON” position, the audio system will be automatically turned on and switched to the incoming call, even when the audio system was originally off.

The voice guide announcement for the incoming call will be output from the front passenger’s seat speaker.

If the CD player or radio was playing when the incoming call was received, the audio system will mute the sound from the CD player or radio and output only the incoming call.

To receive the call, press the PICK-UP button on the steering wheel control switch.

When the call is over, the audio system will return to its previous state.

### MUTE function

E00760301077

At any time during a call, you can mute the vehicle microphone.

## Bluetooth® 2.0 interface\*

Pressing the SPEECH button and then saying “Mute” during a call will turn on the mute function and mute the microphone.

Saying “Mute off” in the same way will turn off the mute function and cancel the mute on the microphone.

### Switching between hands-free mode and private mode

E00761400036

The Bluetooth® 2.0 interface can switch between Hands-free mode (Hands-free calls) and private mode (calls using cellular phone). If you press the SPEECH button and say “Transfer call” during a Hands-free call, you can stop the Hands-free mode and talk in private mode.

To return to Hands-free mode, press the SPEECH button again and say “Transfer call”.

### Phone book function

E00763700017

The Bluetooth® 2.0 interface has 2 types of unique phone books that are different from the phone book stored in the cellular phone. They are the vehicle phone book and the mobile phone book.

These phone books are used to register telephone numbers and to make calls to desired numbers via the voice recognition function.

#### NOTE

- Disconnecting the battery cable will not delete information registered in the phone book.

### Vehicle phone book

E00763801275

This phone book is used when making calls with the voice recognition function.

Up to 32 names can be registered in the vehicle phone book per language.

Also, each entry has 4 locations associated with: home, work, mobile and other. You can register one telephone number for each location.

You can register a desired name as a name for any phone book entry registered in the vehicle phone book.

Names and telephone numbers can be changed later on.

The vehicle phone book can be used with all paired cellular phones.

#### To register a telephone number in the vehicle phone book

You can register a telephone number in the vehicle phone book in the following 2 ways: Reading out a telephone number, or selecting and transferring 1 phone book entry from the phone book of the cellular phone.

#### To register by reading out a telephone number

1. Press the SPEECH button.
2. Say “Phone book.”
3. The voice guide will say “Select one of the following: new entry, edit number, edit name, list names, delete, erase all, or import contact.” Say “New entry.”
4. The voice guide will say “Name please.” Say your preferred name to register it.

#### NOTE

- If the maximum number of entries are already registered, the voice guide will say “The phone book is full. Would you like to delete a name?” Say “Yes” if you want to delete a registered name. Say “No,” to return to the main menu.

5. When the name has been registered, the voice guide will say “home, work, mobile, or other?” Say the location for which you want to register a telephone number.

 **NOTE**

- When the confirmation function is on, the voice guide will say “<Location>. Is this correct?” Answer “Yes.”  
Answer “No” to return to location selection in Step 5.  
If a telephone number has been registered for the selected location, the voice guide will say “The current number is <telephone number>, number please.”  
If you do not want to change the telephone number, say “cancel!” or the original number to keep it registered.

6. The voice guide will say “Number please.” Say the telephone number to register it.

 **NOTE**

- In the case of English, the system will recognize both “zero” and “oh” (Letter “o”) for the number “0.”

7. The voice guide will repeat the telephone number you have just read, and then register the number.  
When the telephone number has been registered, the voice guide will say “Number saved. Would you like to add another number for this entry?”  
To add another telephone number for a new location for the current entry, an-

swer “Yes.” The system will return to location selection in Step 5.  
Answer “No” to end the registration process and return to the main menu.

 **NOTE**

- When the confirmation function is on, after repeating the telephone number you have read, the voice guide will ask “Is this correct?” Answer “Yes.”  
Answer “No” to return to telephone number registration in step 6.

**To select and transfer one phone book entry from the phone book of the cellular phone**

You can select 1 phone book entry from the phone book of the cellular phone and register it in the vehicle phone book.

 **NOTE**

- Transfer is not permitted unless the vehicle is parked.  
Before transferring, make sure that the vehicle is parked in a safe location.
- All or part of data may not be transferred, even when the cellular phone supports Bluetooth®, depending on the compatibility of the device.

 **NOTE**

- The maximum supported telephone number length is 19 digits. Any telephone number of 20 digits or more will be truncated to the first 19 digits.
- If telephone numbers contain characters other than 0 to 9, \*, # or +, these characters are deleted before the transfer.
- For the connection settings on the cellular phone side, refer to the instructions for the cellular phone.

1. Press the SPEECH button.
2. Say “Phone book.”
3. The voice guide will say “Select one of the following: new entry, edit number, edit name, list names, delete, erase all, or import contact.” Say “Import contact.”
4. The voice guide will say “Would you like to import a single entry or all contacts?” Say “Single entry.”

The Bluetooth® 2.0 interface will become ready to receive transferred phone book data.

 **NOTE**

- If the maximum number of entries are already registered, the voice guide will say “The phone book is full. Would you like to delete a name?” Say “Yes” if you want to delete a registered name.  
Say “No,” to return to the main menu.

5. After the voice guide says “Ready to receive a contact from the phone. Only a home, a work, and a mobile number can be imported, the Bluetooth® 2.0 interface will receive the phone book data from the Bluetooth® compatible cellular phone.
6. Operate the Bluetooth® compatible cellular phone to set it up so that the phone book entry you want to register in the vehicle phone book can be transferred to the Bluetooth® 2.0 interface.

 **NOTE**

- If the Bluetooth® 2.0 interface cannot recognise the Bluetooth® compatible cellular phone or the connection takes too much time, the voice guide will say “Import contact has timed out” and then the system will cancel the registration. In such case, start over again from Step 1.
- Pressing the HANG-UP button or pressing and holding the SPEECH button will cancel the registration.

7. When the reception is complete, the voice guide will say “<Number of telephone numbers that had been registered in the import source> numbers have been imported. What name would you like to use for these numbers?”

Say the name you want to register for this phone book entry.

 **NOTE**

- If the entered name is already used for other phone book entry or similar to a name used for other phone book entry, that name cannot be registered.

8. The voice guide will say “Adding <name>.”

When the confirmation function is on, the system will ask if the name is correct. Answer “Yes.”

Answer “No,” and the voice guide will say “Name please.”

Register a different name.

9. The voice guide will say “Numbers saved.”

10. The voice guide will say “Would you like to import another contact?”

Answer “Yes” if you want to continue with the registration. You can continue to register a new phone book entry from Step 5.

Answer “No,” to return to the main menu.

**To change the content registered in the vehicle phone book**

E0073980037

You can change or delete a name or telephone number registered in the vehicle phone book.

You can also listen to the list of names registered in the vehicle phone book.

 **NOTE**

- The system must have at least one entry.

**[Editing a telephone number]**

1. Press the SPEECH button.
2. Say “Phone book.”
3. The voice guide will say “Select one of the following: new entry, edit number, edit name, list names, delete, erase all, or import contact.” Say “Edit number.”
4. The voice guide will say “Please say the name of the entry you would like to edit, or say list names.” Say the name of the phone book entry you want to edit.

 **NOTE**

- Say “List names,” and the names registered in the phone book will be read out in order. Refer to “Listening to the list of registered names” on page 7-67.

5. The voice guide will say “Home, work, mobile or other?”

Select and say the location where the telephone number you want to change or add is registered.

When the confirmation function is on, the system will check the target name and location again. Answer “Yes” if you want to continue with the editing.

Answer “No” to return to Step 3.

6. The voice guide will say “Number please.” Say the telephone number you want to register.

#### NOTE

- If the telephone number is already registered in the selected location, the voice guide will say “The current number is <current number>. New number, please.” Say a new telephone number to change the current number.

7. The voice guide will repeat the telephone number.

When the confirmation function is on, the system will ask if the number is correct. Answer “Yes.”

Answer “No” to return to Step 3.

8. Once the telephone number is registered, the voice guide will say “Number saved” and then the system will return to the main menu.

#### NOTE

- If the location where a telephone number was already registered has been overwritten with a new number, the voice guide will say “Number changed” and then the system will return to the main menu.

#### [Editing a name]

1. Press the SPEECH button.
2. Say “Phone book.”
3. The voice guide will say “Select one of the following: new entry, edit number, edit name, list names, delete, erase all, or import contact.” Say “Edit name.”
4. The voice guide will say “Please say the name of the entry you would like to edit, or say list names.” Say the name you want to edit.

#### NOTE

- Say “List names,” and the names registered in the phone book will be read out in order. Refer to “Listening to the list of registered names” on page 7-67.

5. The voice guide will say “Changing <name>.”

When the confirmation function is on, the system will ask if the name is correct. Answer “Yes” if you want to continue with the editing based on this information.

Answer “No” to return to Step 4.

6. The voice guide will say “Name please.” Say the new name you want to register.
7. The registered name will be changed. When the change is complete, the system will return to the main menu.

#### Listening to the list of registered names

E0073990038

1. Press the SPEECH button.
2. Say “Phone book.”
3. The voice guide will say “Select one of the following: new entry, edit number, edit name, list names, delete, erase all, or import contact.” Say “List names.”
4. Bluetooth® 2.0 interface will read out the entries in the phone book in order.
5. When the voice guide is done reading the list, it will say “End of list, would you like to start from the beginning?” When you want to check the list again from the beginning, answer “Yes.” When you are done, answer “No” to return to the previous or main menu.

 **NOTE**

- You can call, edit or delete a name that is being read out.  
Press the SPEECH button and say “Call” to call the name, “Edit name” to edit it, or “Delete” to delete it.  
The system will beep and then execute your command.
- If you press the SPEECH button and say “Continue” or “Previous” while the list is being read, the system will advance or rewind the list. Say “Continue” to proceed to the next entry or “Previous” to return to the previous entry.

**Deleting a telephone number**

E0074000039

1. Press the SPEECH button.
2. Say “Phone book.”
3. The voice guide will say “Select one of the following: new entry, edit number, edit name, list names, delete, erase all, or import contact.” Say “Delete.”
4. The voice guide will say “Please say the name of the entry you would like to delete, or say list names.” Say the name of the phone book entry in which the telephone number you want to delete is registered.

 **NOTE**

- Say “List names,” and the names registered in the phone book will be read out in order. Refer to “Listening to the list of registered names” on page 7-67.

5. If only one telephone number is registered in the selected phone book entry, the voice guide will say “Deleting <name> <location>.”

If multiple telephone numbers are registered in the selected phone book entry, the voice guide will say “Would you like to delete [home], [work], [mobile], [other], or all?”

Select the location to delete, and the voice guide will say “Deleting <name> <location>.”

 **NOTE**

- To delete the telephone numbers from all locations, say “All.”

6. The system will ask if you really want to delete the selected telephone number(s) to go ahead with the deletion, answer “Yes.”

Answer “No,” the system will cancel deleting the telephone number(s) and then return to Step 4.

7. When the deletion of the telephone number is completed, the voice guide will say “<name> <location> deleted” and then the system will return to the main menu.

If all locations are deleted, the system will say “<name> and all locations deleted” and the name will be removed from the phone book. If numbers still remain under the entry, the name will retain the other associated numbers.

**Erasing the phone book**

E00740100030

You can delete all registered information from the vehicle phone book.

1. Press the SPEECH button.
2. Say “Phone book.”
3. The voice guide will say “Select one of the following: new entry, edit number, edit name, list names, delete, erase all, or import contact.” Say “Erase all.”
4. For confirmation purposes, the voice guide will ask “Are you sure you want to erase everything from your hands-free system phone book?” Answer “Yes.”  
Answer “No” to cancel the deletion of all registered information in the phone book and return to the main menu.

5. The voice guide will say “You are about to delete everything from your hands-free system phone book. Do you want to continue?” Answer “Yes” to continue. Answer “No” to cancel the deletion of all registered information in the phone book and return to the main menu.
6. The voice guide will say “Please wait, erasing the handsfree system phone book” and then the system will delete all data in the phone book.  
When the deletion is complete, the voice guide will say “Hands-free system phone book erased” and then the system will return to the main menu.

## Mobile phone book

E00763900051

All entries in the phone book stored in the cellular phone can be transferred in a batch and registered in the mobile phone book. Up to 7 mobile phone books, each containing up to 1,000 names, can be registered.

The Bluetooth® 2.0 interface automatically converts from text to voice the names registered in the transferred phone book entries, and creates names.



### NOTE

- Only the mobile phone book transferred from the connected cellular phone can be used with that cellular phone.
- You cannot change the names and telephone numbers in the phone book entries registered in the mobile phone book. You cannot select and delete specific phone book entries, either.  
To change or delete any of the above, change the applicable information in the source phone book of the cellular phone and then transfer the phone book again.

### To import a devices phone book

Follow the steps below to transfer to the mobile phone book the phone book stored in the cellular phone.



### NOTE

- Transfer should be completed while the vehicle is parked.  
Before transferring, make sure that the vehicle is parked in a safe location.
- The already stored phone book in the mobile phone book is overwritten by the stored phone book in the cellular phone.
- All or part of data may not be transferred, even when the cellular phone supports Bluetooth®, depending on the compatibility of the device.



### NOTE

- Only a home, a work, and a mobile number can be imported.
- The maximum supported telephone number length is 19 digits. Any telephone number of 20 digits or more will be truncated to the first 19 digits.
- If telephone numbers contain characters other than 0 to 9, \*, # or +, these characters are deleted before the transfer.
- For the connection settings on the cellular phone side, refer to the instructions for the cellular phone.

1. Press the SPEECH button.
2. Say “Phone book.”
3. The voice guide will say “Select one of the following: new entry, edit number, edit name, list names, delete, erase all, or import contact.” Say “Import contact.”
4. The voice guide will say “Would you like to import a single entry or all contacts?” Say “All contacts.”
5. The voice guide will say “Importing the contact list from the mobile phone book. This may take several minutes to complete. Would you like to continue?” Answer “Yes,” transferring to the mobile phone book the phone book stored in the cellular phone will start.  
Answer “No,” to return to the main menu.

 **NOTE**

- The transfer may take some time to complete depending on the number of contacts.
- If the Bluetooth® 2.0 interface could not be connected to the Bluetooth® compatible cellular phone, the voice guide will say “Unable to transfer contact list from phone” and then the system will return to the main menu.
- If you press the HANG-UP button or press and hold the SPEECH button during the data transfer, the transfer will be cancelled and the system will return to the main menu.
- If an error occurs during the data transfer, all transfer will be cancelled and the voice guide will say “Unable to complete the phone book import” and then the system will return to the main menu.
- If there are no contacts in the phone book, the voice guide will say “There are no contacts on the connected phone.”

6. When the transfer is complete, the voice guide will say “Import complete” and then the system will return to the main menu.



## Enrollment commands

E00732400249

Phrase	English	French	Spanish	Italian	German	Dutch	Portuguese	Russian
1	123456789	123456789	123456789	123456789	123456789	123456789	123456789	123456789
2	888 555 1212	888 555 1212	888 555 1212	888 555 1212	888 555 1212	888 555 1212	888 555 1212	888 555 1212
3	Call	Appeler	Llamar	Chiama	Anrufen	Bellen	Ligar	Вызов
4	Dial	Composer	Marcar	Componi	Wählen	Nummer keuze	Marcar	Набор
5	Setup	Configurer	Configuración	Configura	Einrichtung	Setup	Configurar	Настройка
6	Cancel	Annuler	Cancelar	Annulla	Abbrechen	Annuleren	Cancelar	Отмена
7	Continue	Continuer	Continuar	Continua	Weiter	Doorgaan	Continuar	Продолжить
8	Help	Aide	Ayuda	Aiuto	Hilfe	Help	Ajuda	Справка

7

## USB port\*

E00761901461

You can connect your USB memory device or iPod\* to play music files stored in the USB memory device or iPod.

\*: “iPod” is a registered trademark of Apple Inc. in the United States and other countries.

The USB port (A) is located in the indicated position.

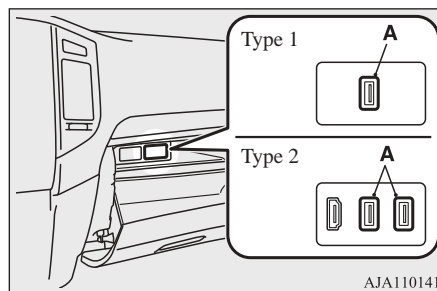

AJA110141

## How to connect a USB memory device

E00762001472

1. Park your vehicle in a safe place and turn the ignition switch to the “LOCK” position.
2. Open the glove box.

## USB port\*

3. Connect a commercially available USB connector cable (A) to the USB memory device (B).

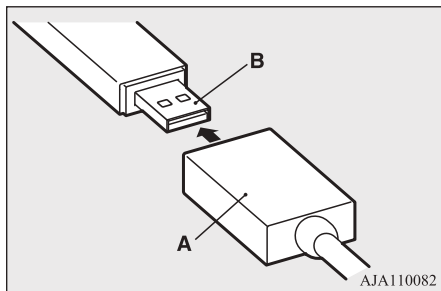

4. Connect the USB connector cable (A) to the USB port (C).

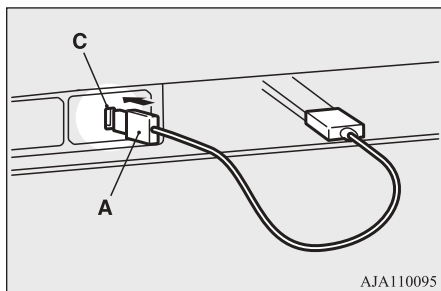

### CAUTION

- Keep the lid of the glove box closed while driving the vehicle. A lid or the contents of the glove box could otherwise cause injuries.

### NOTE

- Do not connect the USB memory device to the USB port directly. The USB memory device may be damaged.
- When closing the glove box, be careful not to trap the USB connector cable.

5. To remove the USB connector cable, turn the ignition switch to the “LOCK” position first and perform the installation steps in reverse.

## How to connect an iPod

E00762101646

1. Park your vehicle in a safe place and turn the ignition switch to the “LOCK” position.
2. Open the glove box.
3. Connect the connector cable to the iPod.

### NOTE

- Use a genuine connector cable from Apple Inc.

4. Connect the connector cable to the USB port.

### CAUTION

- Keep the lid of the glove box closed while driving the vehicle. A lid or the contents of the glove box could otherwise cause injuries.

### NOTE

- When closing the glove box, be careful not to trap the connector cable.

5. To remove the connector cable, turn the ignition switch to the “LOCK” position first and perform the installation steps in reverse.

## Types of connectable devices and supported file specifications

E00762201269

### Except for vehicles equipped with the Bluetooth® 2.0 interface

For details about the types of connectable devices and supported file specifications, refer to the following pages and manuals.

[For vehicles equipped with the LW/MW/FM radio/CD player]

Refer to “Listen to an iPod” on page 7-29, “Listen to Audio Files on a USB Device” on page 7-31 and “Audio Files (MP3/WMA/AAC)” on page 7-17.

### [For vehicles equipped with the DISPLAY AUDIO/Smartphone Link Display Audio]

Refer to the separate owner’s manual.

### For vehicles equipped with the Bluetooth® 2.0 interface

For details about the types of connectable devices and supported file specifications, refer to the following section.

## Device types

E00762301563

Devices of the following types can be connected.

Model name	Condition
USB memory device	Storage capacity of 256 Mbytes or more
Models other than USB memory devices and iPods	Digital audio player supporting mass storage class

For connectable device type for “iPod\*,” “iPod classic\*,” “iPod nano\*,” “iPod touch\*” and “iPhone\*,” access the MITSUBISHI MOTORS website.

Please read and agree to the “Warning about Links to the Web Sites of Other Companies”. The websites mentioned above may connect you to websites other than the MITSUBISHI MOTORS website.

<http://www.mitsubishi-motors.com/en/products/index.html>

\*: “iPod,” “iPod classic,” “iPod nano,” “iPod touch” and “iPhone” are registered trademarks of Apple Inc. in the United States and other countries.

### NOTE

- Depending on the type of the USB memory device or other device connected, the connected device may not function properly or the available functions may be limited.
- It is recommended to use an iPod with firmware updated to the latest version.
- You can charge your iPod by connecting it to the USB port when the ignition switch is in the “ACC” or “ON” position.
- Do not keep your USB memory device or iPod in your vehicle.
- It is recommended that you back up files in case of data damage.

### NOTE

- Do not connect to the USB port any device (hard disk, card reader, memory reader, etc.) other than the connectable devices specified in the previous section. The device and/or data may be damaged. If any of these devices was connected by mistake, remove it after turning the ignition switch to the “LOCK” position.

## File specifications

E00762401056

You can play music files of the following specifications that are saved in a USB memory device or other device supporting mass storage class. When you connect your iPod, playable file specifications depend on the connected iPod.

Item	Condition
File format	MP3, WMA, AAC, WAV
Maximum number of levels (including the root)	Level 8
Number of folders	700
Number of files	65,535

## HDMI port\*

### HDMI port\*

E0077140039

You can connect a commercially available HDMI device such as a video camera and a smart phone to the HDMI port (A).

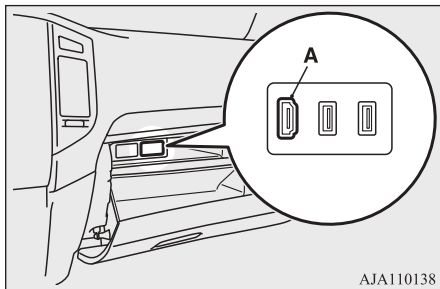

### NOTE

- For details, refer to the separate owner's manual for Smartphone Link Display Audio.

### To connect

1. Park your vehicle in a safe place and turn the ignition switch to the "LOCK" position.
2. Open the glove box.
3. Connect a commercially available HDMI cable to the HDMI device.
4. Connect the HDMI cable to the HDMI port in the glove box.

7-74 For pleasant driving

### CAUTION

- Keep the lid of the glove box closed while driving the vehicle. A lid or the contents of the glove box could otherwise cause injuries.

### NOTE

- When closing the glove box, be careful not to trap the HDMI cable.

5. To remove the HDMI cable, turn the ignition switch to the "LOCK" position first and perform the installation steps in reverse.

### Sun visors

E00711200811

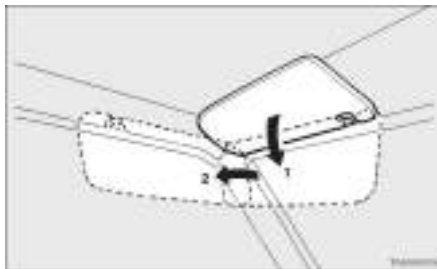

- 1- To eliminate front glare
- 2- To eliminate side glare

## Vanity mirror

E00731900191

### Type 1

A vanity mirror is fitted to the back of the sun visor.

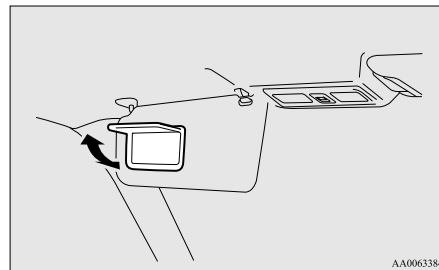

### Type 2

A vanity mirror is fitted to the back of the sun visor.

Operating the lid of the vanity mirror will automatically turn on the mirror lamp (A).

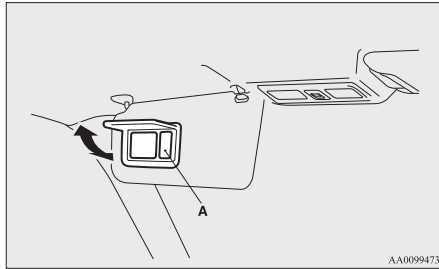

### ⚠ CAUTION

- If the lid of vanity mirror with lamp is kept open for prolonged periods of time, the vehicle's battery will be discharged.

## Card holder

E00732000203

Cards can be slipped into the holder (A) on the back of the sun visor.

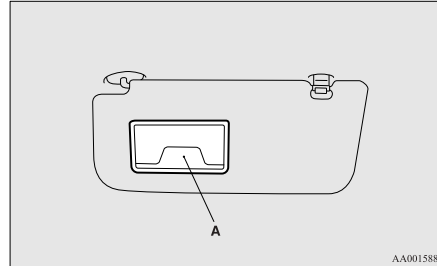

## Slide plate\*

E00732100086

To block out the glare of the sunlight from behind the inside rear-view mirror, swing down the sun visor, and then pull out the slide plate (B).

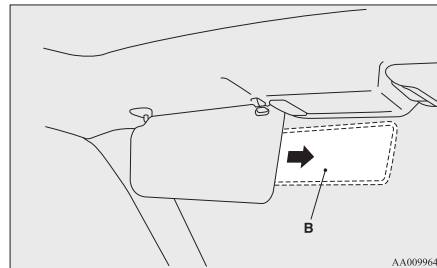

To block out a broader range of glare from your side, swing the sun visor sideways and pull out the slide plate (B).

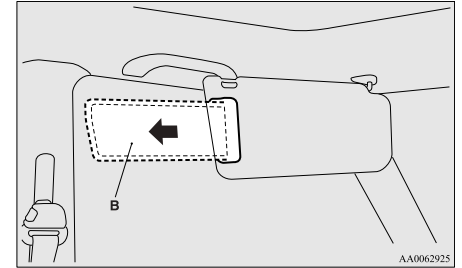

7

## Ashtray\*

E00711400640

### ⚠ CAUTION

- Put out matches and cigarettes before they are placed in the ashtray.
- Don't put papers and other things that burn into your ashtrays. If you do, cigarettes or other smoking materials could set them on fire, causing damage.
- Always close the ashtray. If left open, other cigarette butts in the ashtray may be rekindled.

## Cigarette lighter\*

To use the ashtray, open the lid.

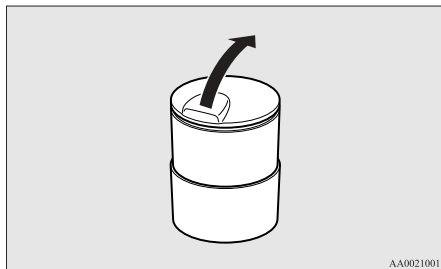

### 7 Mounting position for moveable ashtray

There is a mounting position on the front console box.

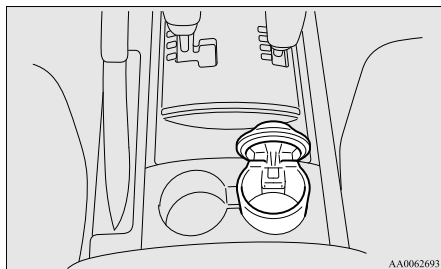

### NOTE

- The moveable ashtray can also be fitted in the cup holder for the rear seat (3-door models) and in the cup holder for the third seat (5-door models). Refer to “Cup holder” on page 7-85.

### Cigarette lighter\*

E00711501042

The cigarette lighter can be used while the ignition switch is in the “ON” or “ACC” position.

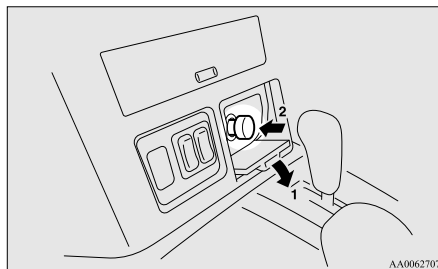

- 1- Open the lid
- 2- Push all the way in.

The cigarette lighter will automatically return to its original position with a “click” when ready. Pull it out for use.

After use, insert the cigarette lighter to its original position in the socket.

### NOTE

- Do not leave the cigarette lighter removed from its socket, because the socket might become clogged by foreign material and be short-circuited.

### CAUTION

- Do not touch the heating element or the cigarette lighter housing, hold the knob only to prevent burns.
- Do not allow children to operate or play with the cigarette lighter as burns may occur.
- Something is wrong with the cigarette lighter if it does not pop back out within approximately 30 seconds of being pushed in. We recommend you to have it checked.
- Do not use any electric appliance that is not approved by MITSUBISHI MOTORS. Doing so could damage the socket. If you used the cigarette lighter after damaging the socket, the cigarette lighter might pop out or fail to come out after being pushed in.
- When the cigarette lighter socket is used as a power source for an electric appliance, be sure that the electric appliance operates at 12 V and has an electric capacity of 120 W or less. In addition, long use of the electric appliance without running the engine may run down the battery.

## Accessory socket

E00711600987

The accessory socket can be used while the ignition switch is in the “ON” or “ACC” position.

### ⚠ CAUTION

- Be aware that using electronic equipment with the engine off may run the battery down.
- When you connect an electrical device, make sure it is rated at 12 V and its electrical capacity does not exceed 120 W. When using some sockets at the same time, make sure the total power consumption of the electrical accessories does not exceed 120 W at 12 V.
- When the accessory socket is not in use, be sure to close the cap or plug, because the socket might become clogged by foreign material and be short-circuited.

### 📖 NOTE

- The two or more accessory sockets can be used simultaneously.

## Type 1

Pull out the plug (A) in the instrument panel to uncover the socket. Use it to plug in an electrical device.

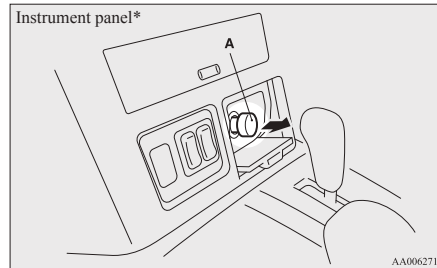

## Type 2

Open the cap (B) on the centre console box and the side wall of the luggage compartment to uncover the socket. Use it to plug in an electrical device.

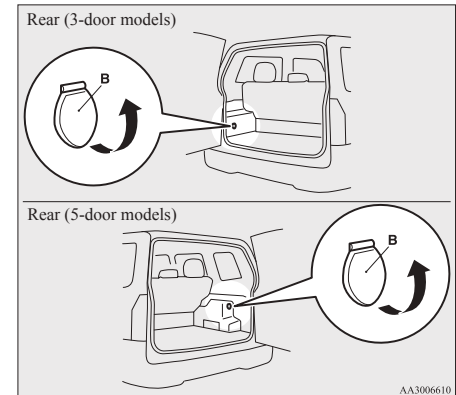
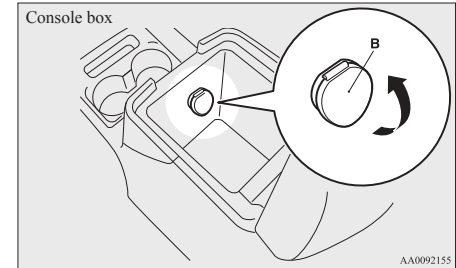

## Interior lamps

E00712001015

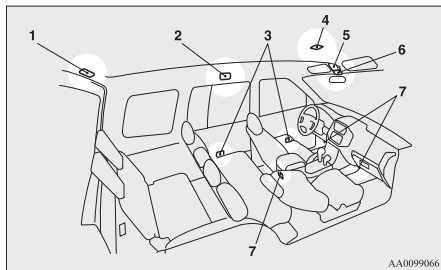

AA00699066

- 1- Luggage compartment lamp
- 2- Rear personal lamps
- 3- Door courtesy lamps
- 4- Ceiling lamp (Type 1)\*
- 5- Ceiling lamp (Type 2)\*
- 6- Interior lamp switch  
Room & map lamps
- 7- Foot lamps\*

### NOTE

- If you leave the interior lamps on without running the engine, you will run down the battery. Before you leave the vehicle, make sure that all the interior lamps are off.

## Interior lamp switch

E00717301811

The interior lamp switch can be used to turn the room & map lamps and rear personal lamps on and off.

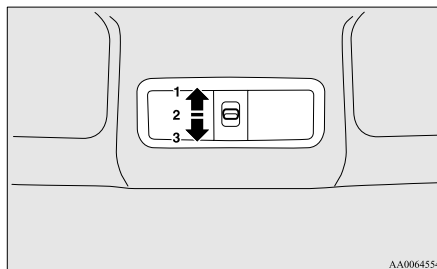

AA0064554

- 1 (☞) - The room & map lamps and rear personal lamps go on regardless of opening and closing of the doors and backdoor.

### NOTE

- The luggage compartment lamp goes on with the luggage compartment lamp switch in “○” position, using the interior lamp switch.

- 2 (DOOR) The room & map lamps and rear personal lamps go on when any of the doors or the backdoor is opened. They go off about 15 seconds after all doors and backdoor are closed.

However, the lamps go off immediately without being dimmed in the following cases:

- The doors and backdoor are closed and the ignition switch is turned to the “ON” position.
- All doors and the backdoor are locked using the central door lock function or the keyless entry system (if so equipped).

### NOTE

- On vehicles with the keyless entry system, if the ignition key is removed with the doors and backdoor closed, the room & map lamps and rear personal lamps are illuminated for 15 seconds and then go off. The dimming period is also adjustable. For further information, we recommend you to consult a MITSUBISHI MOTORS Authorized Service Point.



**NOTE**

- When the room & map lamp switch is in the “ON” position, closing the doors and backdoor does not cause the room & map lamps to go off.

- 3 (○) - The room & map lamps, rear personal lamps and luggage compartment lamp are off regardless of opening and closing of the doors and backdoor.

**NOTE**

- When the room & map lamp switch is in the “ON” position, the interior lamp switch cannot be used to turn off the room & map lamps.
- When the luggage compartment lamp switch is in the “” position, the interior lamp switch cannot be used to turn off the luggage compartment lamp.

**Room & map lamps**

E00717400062

With the doors and backdoor closed and the interior lamp switch in the “DOOR” or “○” position, pressing the lens (A) illuminates the room & map lamps and pressing the lens again turns them off.

If any of the doors or the backdoor is opened with the interior lamp switch in the “DOOR” position, the room & map lamps illuminate. When it is closed, the room & map lamps are dimmed gradually for 15 seconds and then go off.

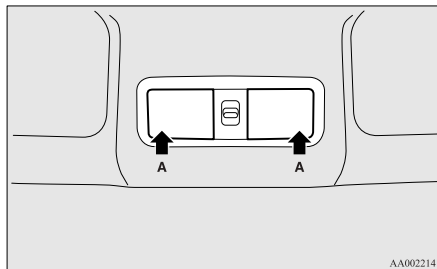

AA0022141

**NOTE**

- When any of the doors or the backdoor is opened and the interior lamp switch in the “” position, the room & map lamps remain on even when the lens is pressed.

**Rear personal lamps**

E00712600290

With the doors and backdoor closed and the interior lamp switch in the “DOOR” position, pressing the lens (A) makes the lamp go on and pressing the lens again makes it go off.

If any of the doors or the backdoor is opened, the lamps go on. When it is subsequently closed, the lamps are dimmed gradually for 15 seconds then go off.

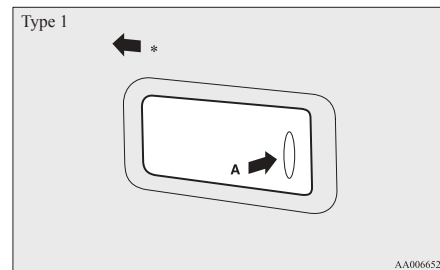

AA0066529

\*: Front of the vehicle

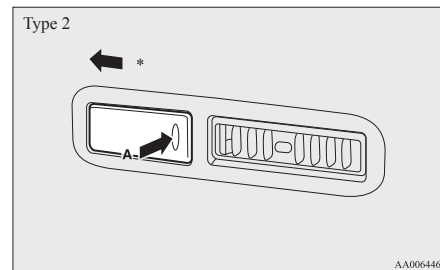

AA0064466

\*: Front of the vehicle

**NOTE**

- When the interior lamp switch is in the “○” position, the lamp remains off even when the lens (A) is pressed and any of the doors or the backdoor is opened.

**Luggage compartment lamp**

E00712701748

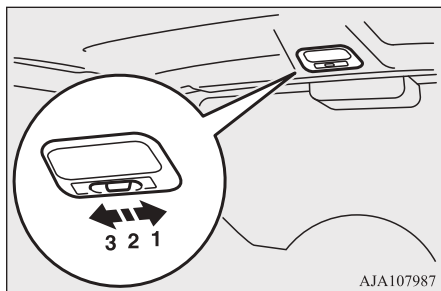

AJA107987

1 (☞) - The lamp illuminates.

2 (○) -

With the interior lamp switch in “DOOR” position, the lamp goes on when any of the doors or the backdoor is opened. When all the doors and the backdoor are closed, the lamp is illuminated for 15 seconds, then goes off.

However, the lamp goes off immediately without being dimmed in case of the followings:

- The ignition switch is turned to the “ON” position.
- All the doors and the backdoor are locked using the central door lock function or the keyless entry system (if so equipped).

**NOTE**

- When the interior lamp switch is in the “○” position, the luggage compartment lamp will not come on.

**NOTE**

- On vehicles with keyless entry system, when the ignition key is removed with the doors and the backdoor closed, the lamp is illuminated for 15 seconds, then goes off. The dimming period is also adjustable. For further information, we recommend you to consult a MITSUBISHI MOTORS Authorized Service Point.

3 (○) - The lamp goes off.

**Foot lamps and ceiling lamp**

E00726601344

The front foot lamps (A), rear foot lamp (B) and ceiling lamp (C) illuminate when the lamp switch in the “DOOR”, “☞”, or “AUTO” position (vehicles with automatic lamp control).

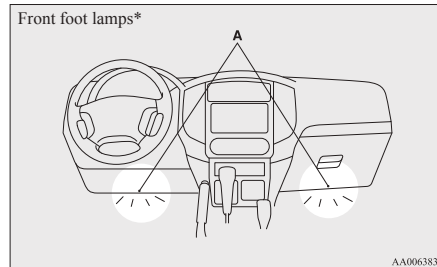

AA0063834

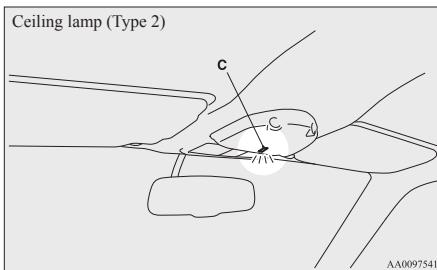
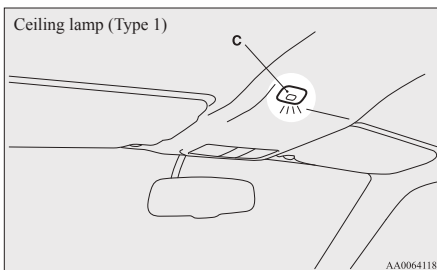
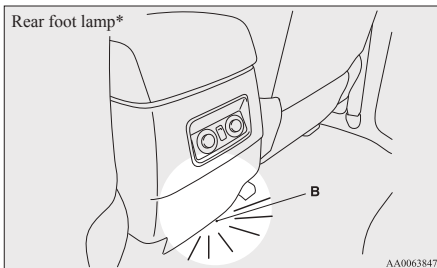

## Door courtesy lamps

E00717500047

Each door courtesy lamp illuminates when the relevant door is opened and goes off when the door is closed.

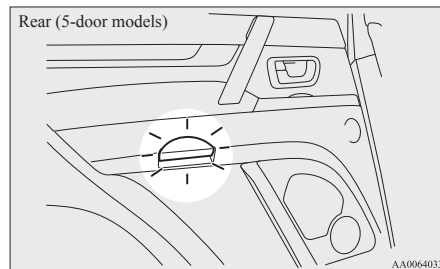
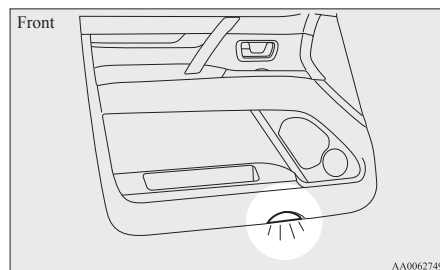

## Interior lamp\* auto-cutout function (Vehicles with keyless entry system)

E00712902428

\*: Room & map lamps, rear personal lamps and luggage compartment lamp

If any of the interior lamps are left switched on with the ignition switch in any position other than "ON" or "ACC", it goes off automatically after approximately 30 minutes.

The lamp comes on again if the ignition switch is turned to the "ON" or "ACC" position, any door or backdoor is opened and closed, or the keyless entry remote control is operated.

### NOTE

- The interior lamp auto-cut function period can be adjusted or deactivated. We recommend you to consult a MITSUBISHI MOTORS Authorized Service Point for detailed information and assistance.

## Storage spaces

E00713103088

### CAUTION

- Never leave lighters, cans of carbonated drink, and spectacles in the cabin when parking the vehicle in hot sunshine. The cabin will become extremely hot, so lighters and other flammable items may catch fire and unopened drink cans (including beer cans) may rupture. The heat may also deform or crack plastic spectacle lenses and other spectacle parts that are made of plastic.
- Keep the lids of storage spaces closed while driving the vehicle. A lid or the contents of a storage space could otherwise cause injuries.

### NOTE

- Do not leave valuables in any storage space when leaving the vehicle.

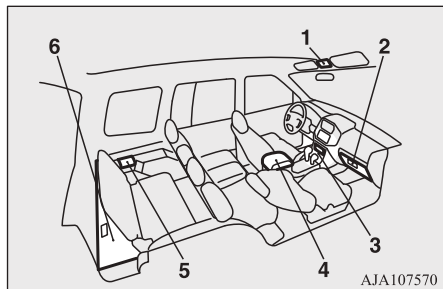

- 1- Sunglasses holder\*
- 2- Glove box
- 3- Accessory box\*
- 4- Centre console box
- 5- Side box\*
- 6- Luggage floor box

## Glove box

E00717602824

The glove box can be locked and unlocked using the key.

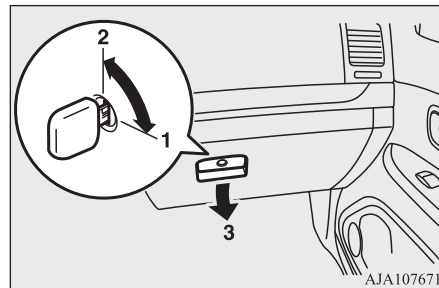

- 1- To lock
- 2- To unlock
- 3- To open, pull the lever

### NOTE

- When the lamp switch is in the “☀” or “☾” position, the lower glove box lamp illuminates.
- The Auxiliary Video connector (RCA) (A) is located in the glove box (if so equipped).
- The USB port (B) is located in the glove box (if so equipped). For details, refer to “USB port\*” on page 7-71.

**NOTE**

- Small articles can be stored in the upper area (C) of the glove box.

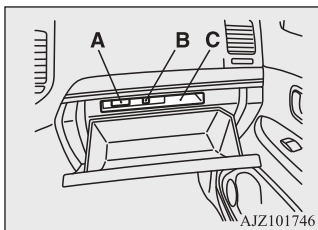
**Centre console box**

E00722600105

Upper and lower boxes are located inside the centre console box.

The centre console box can also be used as an armrest. Refer to "Armrest" on page 4-08.

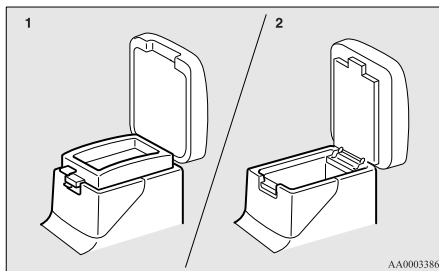

- 1- Upper box
- 2- Lower box

**Upper box**

To open the upper box, lift the left upper release lever (A) and raise the lid.

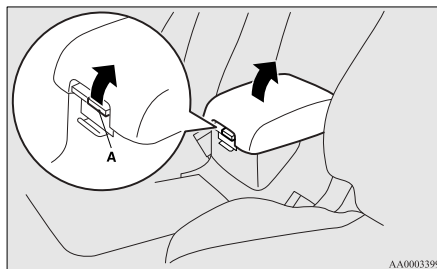
**Lower box**

To open the lower box, lift the lower release lever (B) and raise the lid.

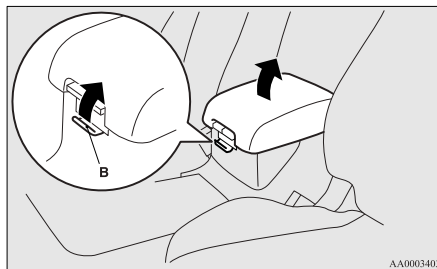
**Accessory box\***

E00717900168

To open, push the lid.

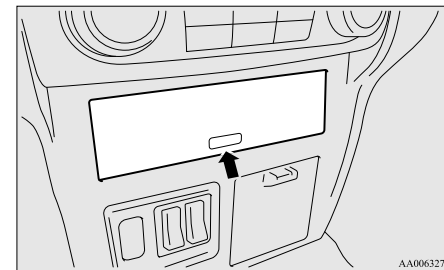
**Card holder**

Insert the card all the way in to keep it in the card holder (A). Pull out the card to remove it from the holder.

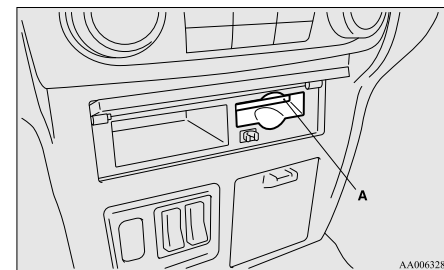

## NOTE

- The card holder can hold up to 3 cards.
- Do not insert receipts and other thin pieces of paper.

## Side box\*

E0072270092

The box for storing articles is located inside the luggage compartment.

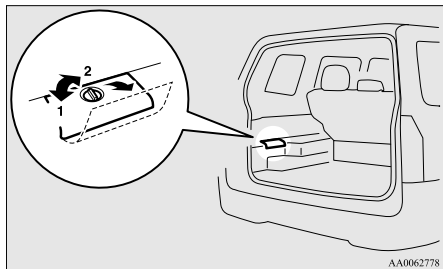

- 1- To open
- 2- To close

## Luggage floor box

E00718700280

The box for storing articles is located inside the luggage compartment.

## 3-door models

To use the box, raise the luggage floor board by pulling up on the strap (A).

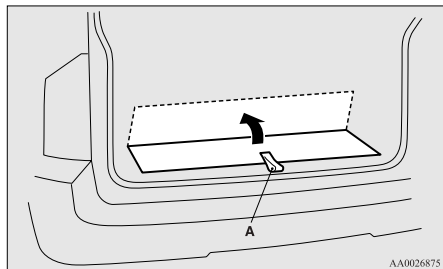

## 5-door models

To use the box, raise the luggage floor board.

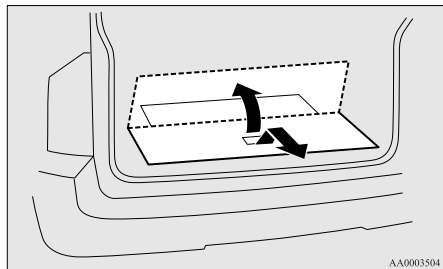

## NOTE

- On 5-door models, the luggage floor board can be removed. This is useful for storing large articles.

## Sunglasses holder\*

E00718600322

To open, push the lid.

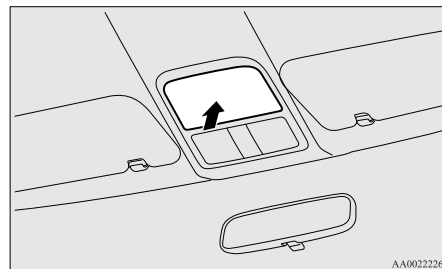

## CAUTION

- The holder should not be used to store anything heavier than sunglasses. These objects could drop out.

## NOTE

- The holder may not be able to accommodate every possible size and shape of sunglasses; it is advisable to check compatibility before use.

## Cup holder

E00714502314

### WARNING

- Do not spray water or spill beverages inside the vehicle. If the switches, wires or electrical components become wet, they could malfunction or cause a vehicle fire. If you accidentally spill a beverage, wipe up as much liquid as possible and immediately consult a MITSUBISHI MOTORS Authorized Service Point.

### CAUTION

- Do not drink beverages while driving the vehicle; doing so could distract you and result in an accident.

## For the front seat

The cup holder is located in front of the centre console box.

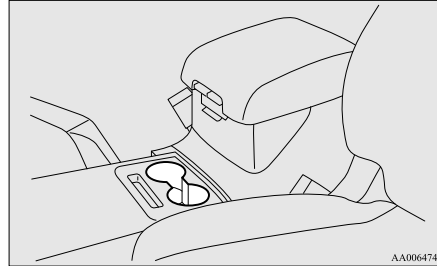

## For the rear seat/second seat

E00716900321

### 3-door models

To use the cup holder, press the button (A) at the top of the armrest and allow the armrest to drop down.

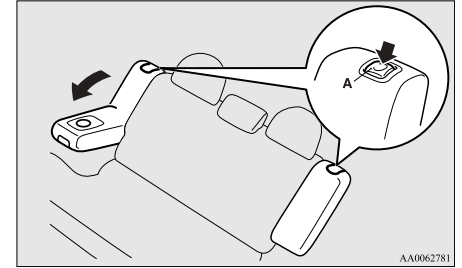

7

## Rear shelf (3-door models)\*

### 5-door models

1. Lift the head restraint (B) and tilt the armrest.

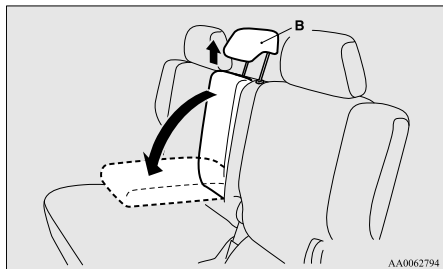

2. Open the lid (C) while holding the side face of the lid with your hand.

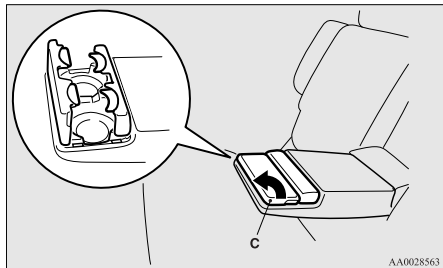

### For the third seat\*

E0071900075

The cup holder is located at the left side of the third seat.

7-86 For pleasant driving

The cup holder is designed for holding cups or drink-cans securely in its holes.

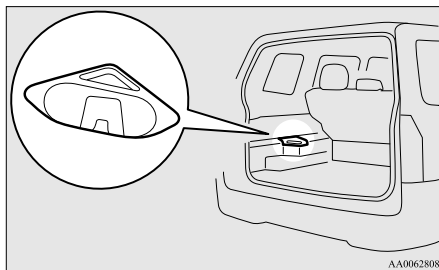

### Rear shelf (3-door models)\*

E00722800064

The rear shelf divides the passenger compartment and luggage area.

#### NOTE

- Do not place luggage or other items on the rear shelf.

Remove the rear shelf when loading large items of luggage.

### To remove

Raise the rear shelf, then pull it upward to remove it from the groove (A) on each side of the luggage area.

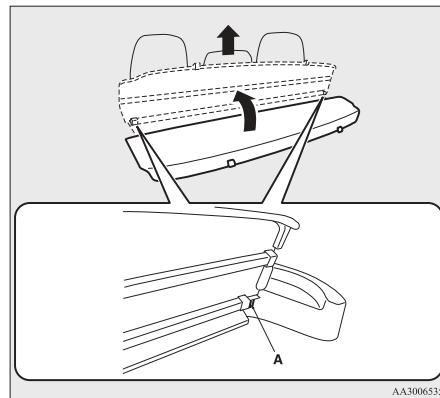

### To refit

Refit the rear shelf by performing the removal steps in reverse.

### Cargo area cover (5-door models)\*

E00715500421

The cargo area cover divides the passenger compartment and cargo area.



**NOTE**

- Do not put luggage on the cover.

**To remove**

1. Unhook the hooks (A) on the cover from the mounting grooves (B) on the side of the cargo area, and the cover will be rolled back into the retracted position.

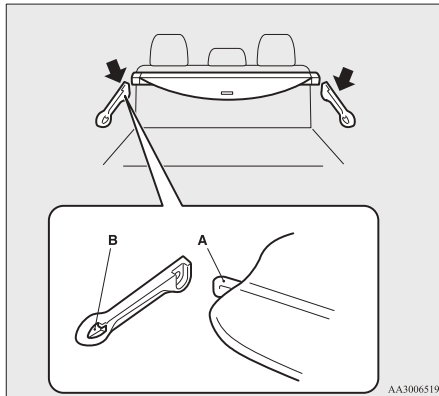

2. Pull up the cargo area cover (C) from the mounting grooves (D).

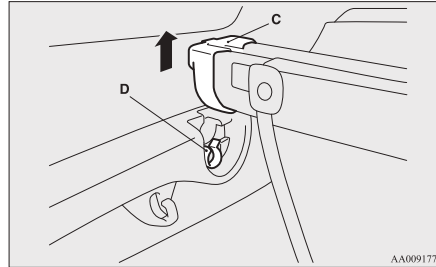

**To refit**

Refit the cover by performing the removal steps in reverse.

**NOTE**

- Gently shake the entire cover after fitting it to make sure it is securely retained.

**Convenient hooks (5-door models)\***

E00715600129

There are four hooks (A) on the side of the luggage compartment.

Light items of luggage can be hung from the hook.

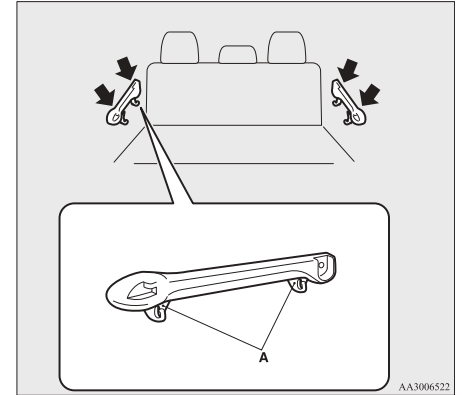

**NOTE**

- Do not hang heavy luggage (more than about 4 kg) on the hook. Doing so could cause damage to the hook.

## Luggage hooks

E00715700306

There are hooks on the floor and the side of the luggage compartment. Use the hooks on the floor for securing the luggage.

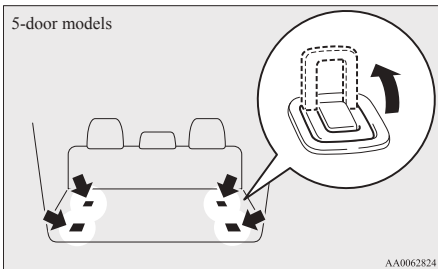
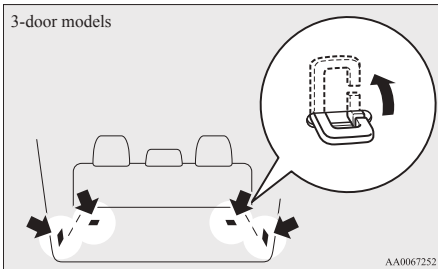

## CAUTION

- Do not pile up the luggage beyond the seat-back height. Secure the luggage firmly. Otherwise, serious accidents could result due to hindered rearward view or flying objects during sudden braking.

## Coat hooks

E00725600366

There are two hooks on the rear/second assist grips for use in hanging clothes.

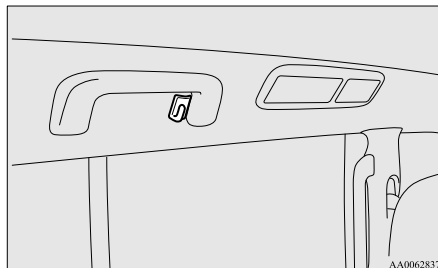

## WARNING

- Do not put a hanger or any heavy or pointed object on the coat hook. If the curtain airbag was activated, any such item could be propelled away with great force and could prevent the curtain airbag from inflating correctly. Hang clothes directly on the coat hook (without using a hanger). Make sure there are no heavy or sharp objects in the pockets of clothes that you hang on the coat hook.

## Installation position for warning triangle

E00718400102

There are securing bands (A) for the warning triangle on the backdoor.

To remove or install the warning triangle, turn the lock knobs (B) anticlockwise, then remove the backdoor lid (C).

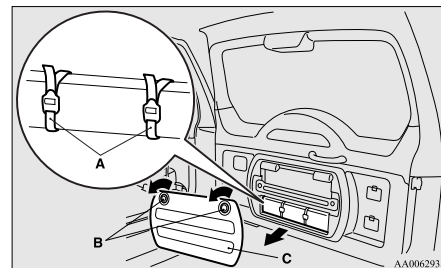

 **NOTE**

- The warning triangle shown in the illustration is not supplied with the vehicle. It is recommended one be obtained and carried for use if required.

A series of 15 horizontal dashed lines spanning the width of the page, intended for writing.

## *For emergencies*

If the vehicle breaks down.....	8-02
Emergency starting.....	8-02
Engine overheating.....	8-04
Bleeding the fuel system (diesel-powered vehicles only).....	8-06
Removal of water from the fuel filter (diesel-powered vehicles only).....	8-06
Tool, jack and jack handle.....	8-07
How to change a tyre.....	8-09
Towing.....	8-16
Operation under adverse driving conditions.....	8-19

## If the vehicle breaks down

E00800101179

If the vehicle breaks down on the road, move it to the shoulder and use the hazard warning flashers and/or the warning triangle etc. Refer to “Hazard warning flasher switch” on page 5-42.

## If the engine stops/fails

Vehicle operation and control are affected if the engine stops. Before moving the vehicle to a safe area, be aware of the following:

- The brake booster becomes inoperative and the pedal effort will increase. Press down the brake pedal harder than usual.
- Since the power steering pump is no longer operative, the steering wheel feels heavy when turning it.

## Emergency starting

E008000504318

If the engine cannot be started because the battery is weak or dead, the battery from another vehicle can be used with jumper cables to start the engine.

### WARNING

- **To start the engine using jumper cables connected from another vehicle, perform the correct procedures according to the instruction below. Incorrect procedures could result in a fire or explosion or damage to the vehicles.**

### CAUTION

- Do not attempt to start the engine by pulling or pushing the vehicle. It could damage your vehicle.
- Always wear protective eye goggles when working near the battery.
- Keep the battery out of the reach of children.

1. Get the vehicles close enough so the jumper cables can reach, but be sure the vehicles aren't touching each other.

### CAUTION

- Check the other vehicle. It must have a 12-volt battery. If the other system isn't 12-volt, shorting can damage both vehicles.

2. Set the parking brake firmly on each vehicle. Put an A/T in “P” (PARK) or an

M/T in “N” (Neutral). Turn off the ignition switch.

### WARNING

- **Turn off the ignition on both vehicles beforehand. Make sure that the cables or your clothes cannot be caught by the fan or drive belt. Personal injury could result.**

3. Turn off all lamps, heater and other electrical loads.
4. Make sure battery electrolyte is at the proper level. Refer to “Battery” on page 10-09.

### WARNING

- **If electrolyte fluid is not visible, or appears to be frozen, Do Not Attempt Jump Starting! A battery might rupture or explode if the temperature is below the freezing point or if it is not filled to the proper level.**

5. Connect one end of one jumper cable to the positive (+) terminal of the discharged battery (A or B), and the other end to the positive (+) terminal of the booster battery (C).

3000 models

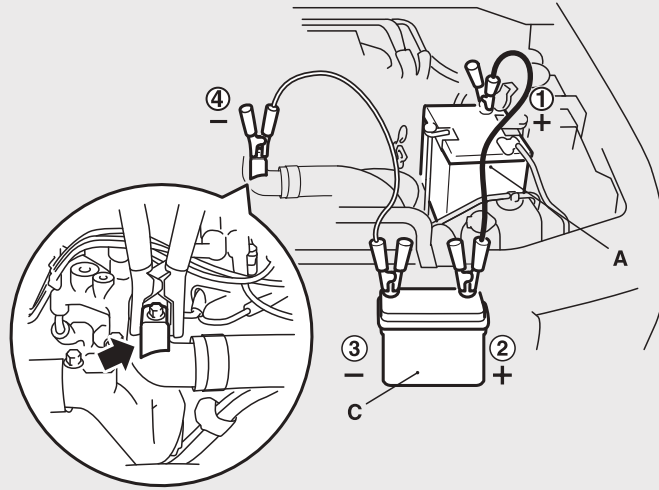

3200 models

LHD\*

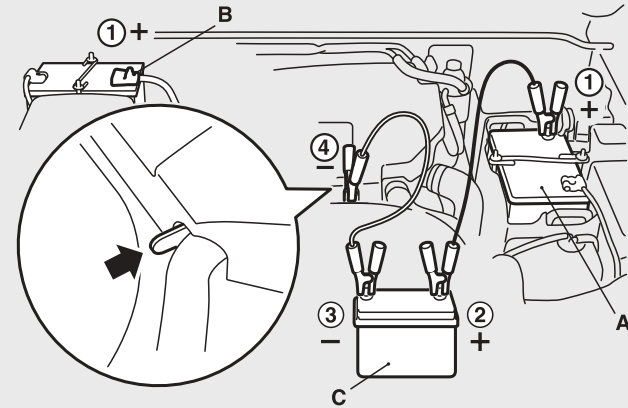

AJM101686

\*: Optional equipment

6. Connect one end of the other jumper cable to the negative (-) terminal of the booster battery (C), and the other end to the engine block of the vehicle with the discharged battery.

### ⚠ WARNING

- Be sure to observe the connecting sequence of ① → ② → ③ → ④.
- Make sure that the connection ④ is made to the appointed position (shown in the illustration). If the connection is made directly to the negative side of the battery, the inflammable gasses generated from the battery might catch fire and explode.

### ⚠ WARNING

- When connecting the jumper cable, do not connect the positive (+) cable to the negative (-) terminal. Otherwise sparks might cause explosion of the battery.

### CAUTION

- Take care not to get the jumper cable caught in the cooling fan or other rotating part in the engine compartment.
- Use the proper cables suitable for the battery size to prevent overheating of the cables.
- Check the jumper cables for damage and corrosion before use.

7. Start the engine in the vehicle which has the booster battery, let the engine idle a few minutes, then start the engine in the vehicle with the discharged battery.

### CAUTION

- Keep the engine of the vehicle giving assistance running.

8. After the engine is started, disconnect the cables in the reverse order and keep the engine running for several minutes.

### WARNING

- If the battery has to be charged while fitted in the vehicle, disconnect the vehicle side negative (-) terminal connected to the battery.
- Keep sparks, cigarettes and flames away from the battery because the battery may produce an explosion.

### WARNING

- Use adequate ventilation when charging or using the battery in an enclosed space.
- Remove all the caps before charging the battery.
- Electrolyte is corrosive diluted sulphuric acid.  
If electrolyte (battery acid) comes into contact with your hands, eyes, clothes and the painted surface of your vehicle, it should be thoroughly flushed with water. If electrolyte gets in your eyes, flush them with water immediately and thoroughly, and get prompt medical attention.

### NOTE

- If the vehicle is put in motion without fully charging the battery, it might cause the loss of smooth engine operation and the anti-lock brake warning lamp to illuminate. Refer to “Anti-lock brake system (ABS)” on page 6-37.

## Engine overheating

E00800603875

If the water temperature gauge indication remains in the overheating zone for a long time, the engine may be overheating. If this occurs, take the following corrective measures:

1. Stop the vehicle in a safe place.

2. Check whether steam is coming from the engine compartment.

[If steam does not come from the engine compartment]

With the engine still running, raise the bonnet to ventilate the engine compartment.

[If steam is coming from the engine compartment]

Stop the engine, and when the steam stops, raise the bonnet to ventilate the engine compartment. Restart the engine.

### WARNING

- Do not open the bonnet while steam is coming from the engine compartment. It could cause steam or hot water to spurt out, causing burns. Hot water could spurt out even when there is no steam coming out, and some parts will be very hot. Be very careful when opening the bonnet.
- Be careful of hot steam, which could be blowing off the reserve tank cap.
- Do not attempt to remove the radiator cap while the engine is hot.





AJA107916

3. Confirm that the cooling fan is turning. If the fan is not turning, stop the engine immediately and have it checked.

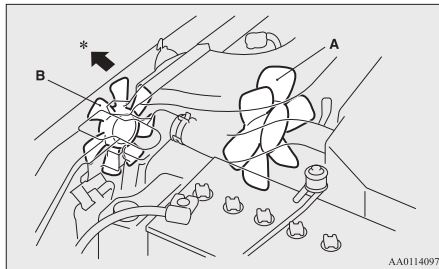

AA0114097

- A- Radiator fan
- B- Air conditioning condenser fan (if so equipped)
- \*: Front of the vehicle

### ⚠ WARNING

- Be careful not to get your hands or clothes caught in the cooling fan.

4. After the engine coolant temperature has dropped to the normal temperature, stop the engine.

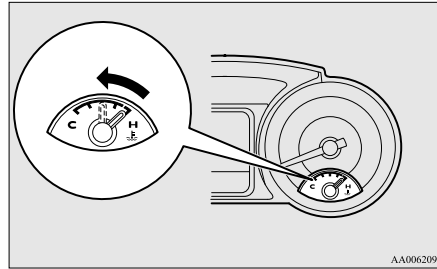

AA0062097

5. Check the coolant level in the reserve tank (C).

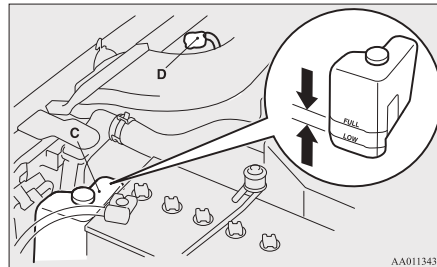

AA0113436

### ⚠ WARNING

- If there is none, make sure that the engine has cooled down before removing the radiator cap (D), because hot steam or boiling water otherwise will gush from the filler port and may scald you.

6. Add coolant to the radiator and/or reserve tank if necessary. (Refer to the "Maintenance" section.)

### ⚠ CAUTION

- Do not add coolant while the engine is hot. Suddenly adding cold coolant could damage the engine. Wait for the engine to cool down, then add coolant a little at a time.

7. Examine the radiator hoses for coolant leakage and the drive belt for looseness or damage.

If there is anything wrong with the cooling system or drive belt, we recommend you to have it checked and repaired.

## Bleeding the fuel system (diesel-powered vehicles only)

E00800700149

The fuel system should be bled to remove air as described below if the fuel supply is exhausted during travel.

Pump the hand pump (A) at the top of the fuel filter until the hand pump becomes stiff. Then try again to start the engine.

If the engine does not start, repeat the process above.

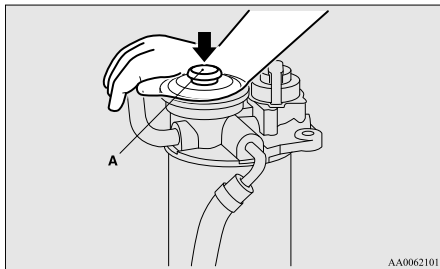

## Removal of water from the fuel filter (diesel-powered vehicles only)

E00800800140

If the fuel filter indication lamp in the instrument panel illuminates during driving, it indicates that water has accumulated in the fuel filter. If this occurs, remove the water as described below.

1. Loosen the drain plug (A) at the bottom of the fuel filter.

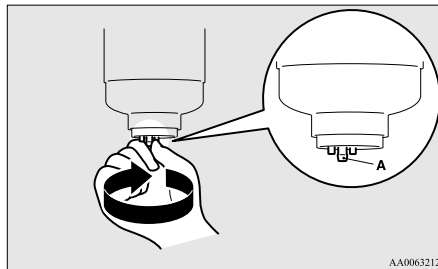

2. Operate the hand pump (B) slowly 6 or 7 times in order to force the water out through the drain plug.

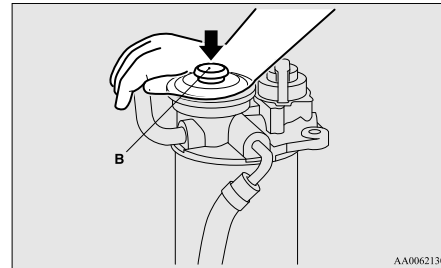

3. Tighten the drain plug when water no longer comes out.
4. Bleed the air in the fuel system. (Refer to “Bleeding the fuel system” on page 8-06.)
5. Check to be sure that the fuel filter indication lamp illuminates when the ignition switch is turned to “ON”, and that it goes off when the engine is started. If in doubt, we recommend you to have your vehicle inspected.

### CAUTION

- Do not smoke or have any other open flame near the vehicle while bleeding the fuel system.

**CAUTION**

- Be sure to carefully clean away any water drained out because any fuel mixed with the water could ignite and cause a fire.

**Tool, jack and jack handle**

E00800900659

**Storage**

The storage location of the tool, jack and jack handle should be remembered in case of an emergency.

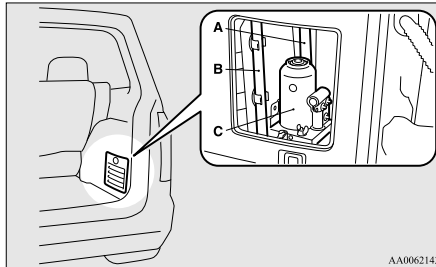
**3-door models**

- A- Jack handle
- B- Tool (wheel nut wrench)
- C- Jack

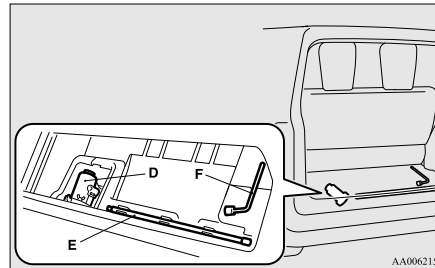
**5-door models**

- D- Jack
- E- Jack handle
- F- Tool (wheel nut wrench)

**Tool**

E00801900483

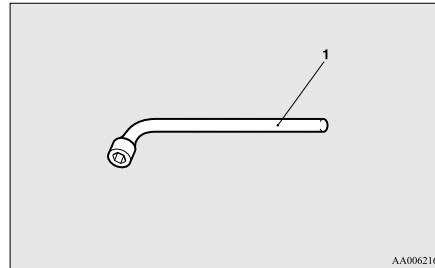

- 1- Wheel nut wrench

**Jack**

E00802001707

The jack is used only for the purpose of changing a tyre when a tyre is punctured.

**NOTE**

- The jack is maintenance-free.
- The jack is in conformity with EC law as approximated by the Machinery Directive 2006/42/EC.
- The EC declaration of conformity is attached to the section "Declaration of Conformity" in the end of this owner's manual.
  - The business name, full address of the manufacturer and of his authorized representative and the designation of the jack are described in the EC declaration of conformity.

**Removing and storing the tool, jack and jack handle**

E00802300178

**3-door models**

Tool, jack and jack handle are in the storage compartment at the rear of the vehicle, on the right side.

## Tool, jack and jack handle

1. Loosen the knob (A), and remove the lid (B).

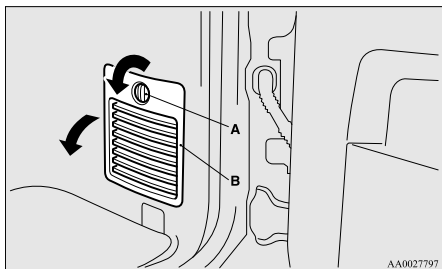

2. Remove the securing bolt (C), and then take out the jack.

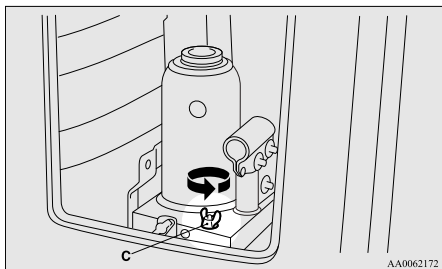

3. Remove the tool and the jack handle from the holder (D), and take it out.

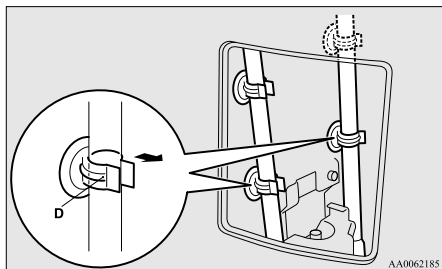

4. Reverse the removing procedure when storing the tool, jack and jack handle.

### **⚠ CAUTION**

- When removing and storing the items in the storage compartment, be careful not to injure your hands or fingers.

### **5-door models**

Tool, jack and jack handle are located in the luggage floor box.

1. When the third seat is folded into the luggage floor box, raise the seat forward and return it to the original position. Refer to “Storage of the third seat” on page 4-15.

2. Remove the lid.

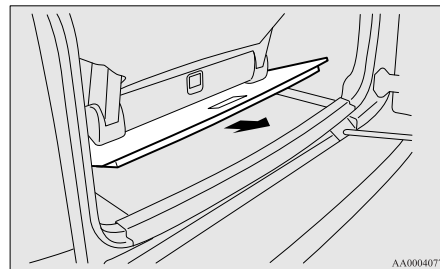

3. Remove the tool and the jack handle from the holder (A), and take it out.

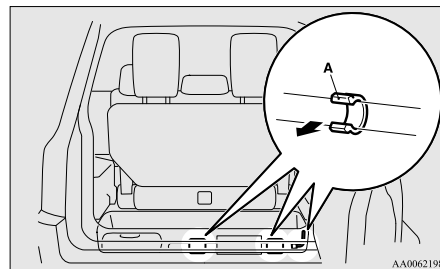

4. Pull the lid to remove it.

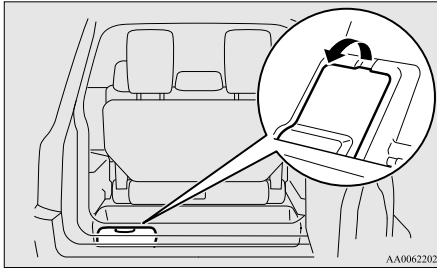

5. Remove the securing bolt (B), and then take out the jack.

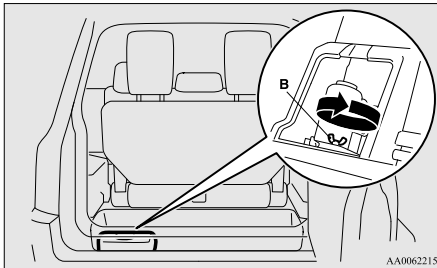

6. Reverse the removing procedure when storing the tool, jack and jack handle.

## To use the jack handle

E00802400023

1. While pushing the snap pin (A), remove the inside handle (B).

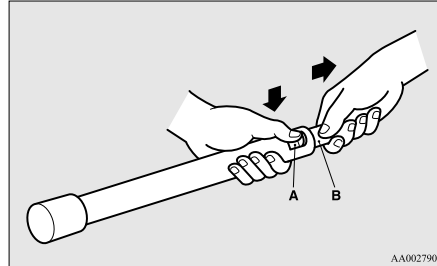

2. With the snap pin (C) pushed, insert the inside handle until it is locked.

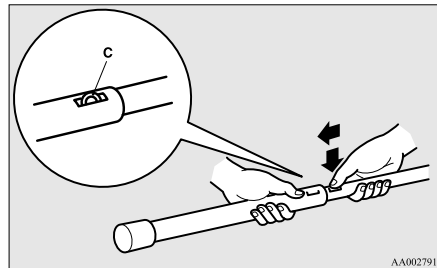

## How to change a tyre

E00801204194

Before changing a tyre, first stop your vehicle in a safe, flat location.

1. Park the vehicle on level and stable ground.
2. Set the parking brake firmly.
3. Move the selector lever to the “P” (PARK) position, turn the ignition key to the “LOCK” position.
4. Turn on the hazard warning flashers and set up a warning triangle, flashing signal lamp, etc., at an adequate distance from the vehicle, and have all your passengers leave the vehicle.
5. To prevent the vehicle from rolling when it is raised on the jack, place chocks or blocks (A) at the tyre that is diagonally opposite from the tyre (B) you are changing.

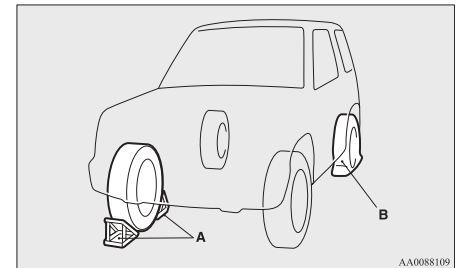

### **⚠ WARNING**

- Be sure to apply chocks or blocks to the correct tyre when jacking up the vehicle. If the vehicle moves while jacked up, the jack could slip out of position, leading to an accident.

### **📖 NOTE**

- The chocks shown in the illustration do not come with your vehicle. It is recommended that you keep one in the vehicle for use if needed.
- If chocks are not available, use stones or any other objects that are large enough to hold the wheel in position.

6. Get the spare wheel, jack, jack handle and wheel nut wrench ready.  
Refer to “Tool, jack and jack handle” on page 8-07.

## Spare wheel information

E00803600266

Check the air pressure of the spare tyre frequently and make sure it is ready for emergency use at any time.

Maintaining the spare wheel at the highest specified air pressure will ensure that it can always be used under any conditions (city/high-speed driving, varying load weight, etc.).

The spare wheel is stored on the outside of the backdoor. (Refer to “To remove the spare wheel” on page 8-10).

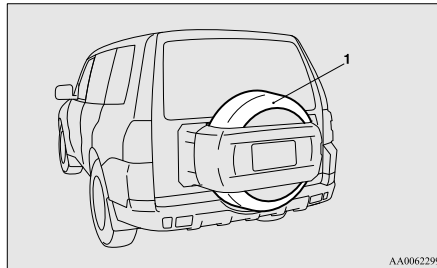

1- Spare wheel

### **⚠ CAUTION**

- The tyre pressure should be periodically checked and maintained at the specified pressure while the tyre is stowed. Driving with an insufficient tyre pressure can lead to an accident. If you have no choice but to drive with an insufficient tyre pressure, keep your speed down and inflate the tyre to the correct pressure as soon as possible. (Refer to “Tyre inflation pressures” on page 10-11.)

## To remove the spare wheel

E00803500177

### **⚠ CAUTION**

- Grasp the spare wheel firmly when removing or attaching it.
- When removing the spare wheel, put on gloves. Removing the spare wheel with your bare hands may cause injury to the fingers.

1. Open the backdoor.
2. Open the lids (A) inside of the backdoor.

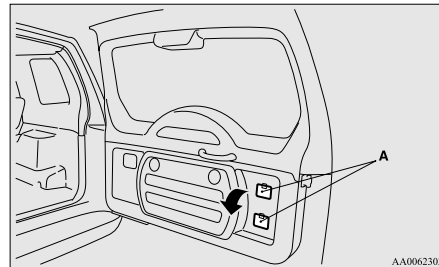

- Remove the bolts (B) by turning them anticlockwise with the wheel nut wrench.

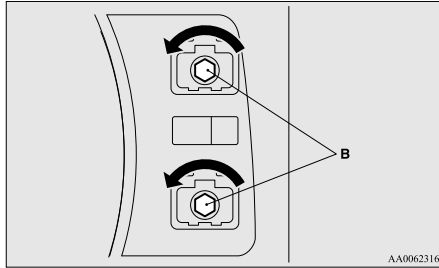

- Close the backdoor.

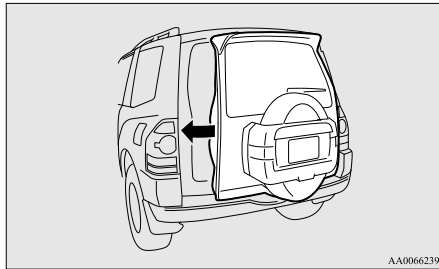

- Open the spare wheel garnish (C).

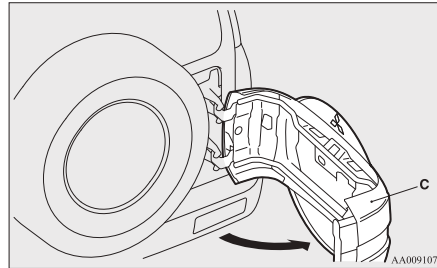

**CAUTION**

- Do not open the backdoor with the spare wheel garnish open. The spare wheel garnish could swing out to the right of the vehicle, resulting in an accident.

- Loosen the spare wheel bolts with the wheel nut wrench (D), then remove the spare wheel.

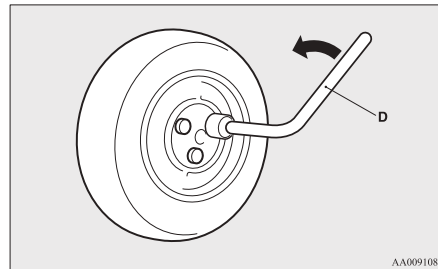

**NOTE**

- Put the spare wheel under the vehicle body near the flat tyre. This makes it safer if the jack slips out of position.

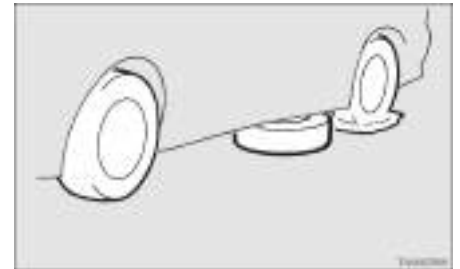

**To change a tyre**

E00803202543

- Loosen the wheel nuts a quarter turn with the wheel nut wrench. Do not remove the wheel nuts yet.

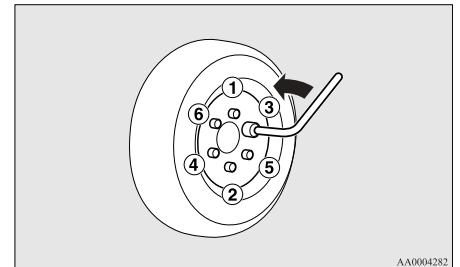

## How to change a tyre

- Using the jack handle, turn the release valve (A) clockwise until it stops.

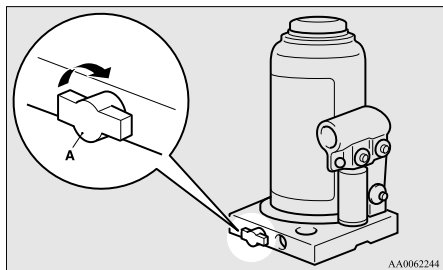

- Insert the jack handle in the bracket of the jack and hook the notch (B) on the jack handle end to the claw (C) of the bracket.

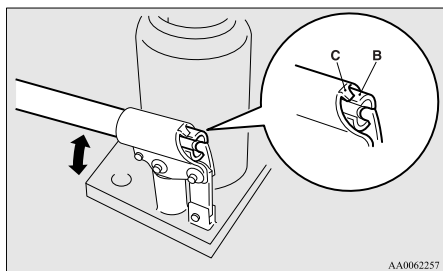

- Place the jack under one of the jacking points shown in the illustration. Use the

jacking point closest to the tyre you wish to change.

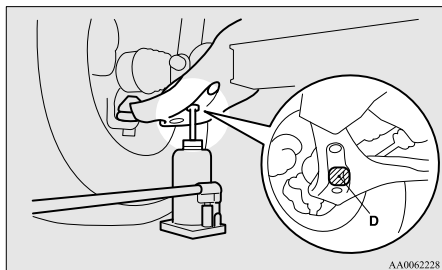

D- Front jacking point

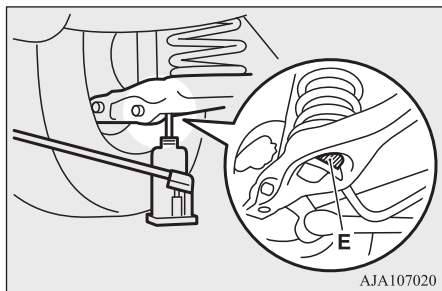

E- Rear jacking point

### **⚠ WARNING**

- Set the jack only at the positions shown here. If the jack is set at a wrong position, it could dent your vehicle or the jack might fall over and cause personal injury.
- Do not use the jack on a tilted or soft surface. Otherwise, the jack might slip and cause personal injury. Always use the jack on a flat, hard surface. Before setting the jack, make sure there are no sand or pebbles under the jack base.

- Move the jack handle up and down to raise the ram until just before the jack contacts the jacking point of the vehicle. Ensure that the jack will properly contact the vehicle jacking point.

### **📖 NOTE**

- This jack is a 3 stage expansion type.

- Raise the vehicle until the tyre is slightly off the ground.

### **⚠ WARNING**

- Stop jacking up the vehicle as soon as the tyre is raised off the ground. It is dangerous to raise the vehicle any higher.
- Do not get under your vehicle while using the jack.



**! WARNING**

- Do not bump the raised vehicle or leave it sitting on the jack for a long time. Both are very dangerous.
- Do not use a jack except the one that came with your vehicle.
- The jack should not be used for any purpose other than to change a tyre.
- No one should be in your vehicle when using the jack.
- Do not start or run the engine while your vehicle is on the jack.
- Do not turn the raised wheel. The tyres still on the ground could turn and make your vehicle fall off the jack.

7. Remove the wheel nuts with the wheel nut wrench, then take the wheel off.

**! CAUTION**

- Handle the wheel carefully when changing the tyre, to avoid scratching the wheel surface.

8. Clean out any mud, etc. on the hub surface (F), hub bolts (G) or in the installation holes (H) in the wheel, and then mount the spare wheel.

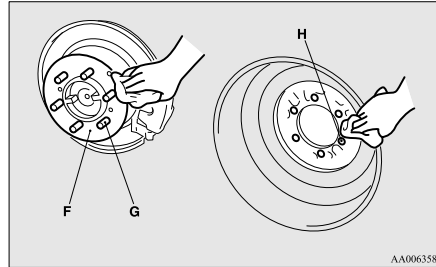

**! WARNING**

- Mount the spare wheel with the valve stem (I) facing outboard. If you cannot see the valve stem, you have installed the wheel backwards. Operating the vehicle with the spare wheel installed backwards can cause vehicle damage and result in an accident.

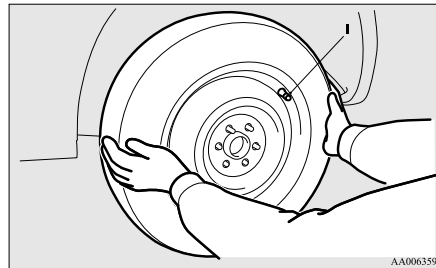

9. Finger-tighten the wheel nuts. (Turn them clockwise.)

Tighten the wheel nuts (flange nuts) until their flange section comes in contact with the wheel and is no longer loose.

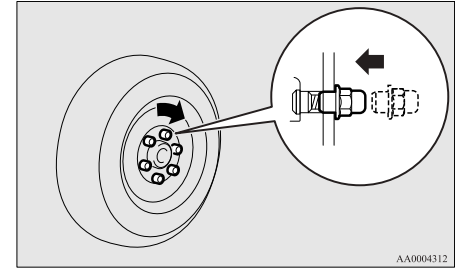

**! CAUTION**

- Never apply oil to either the wheel bolts or the nuts, or they will tighten too much.

10. Put the notch (J) provided on the jack handle end on the valve (K) of the jack.

## How to change a tyre

Using the jack handle, turn the release valve anticlockwise slowly to lower the vehicle until the tyre touches the ground.

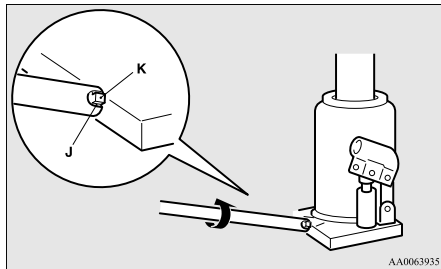

### ⚠ WARNING

- Be sure to open the release valve slowly. If it is opened quickly, the vehicle will drop abruptly and the jack may come out of position, causing a serious accident.

11. Tighten the nuts crisscross in 2 or 3 steps until each nut has been tightened securely.

Tightening torque  
105 to 125 N•m  
(Achieved by applying a force of 390 to 460 N at the end of the wheel nut wrench supplied with the vehicle.)

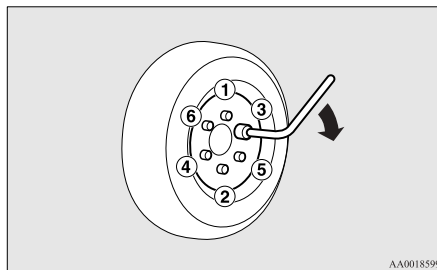

### ⚠ CAUTION

- Never use your foot or a pipe extension for extra force in the wheel nut wrench. If you do so, you will tighten the nut too much.

12. Lower the jack all the way and remove it.

### ⚠ CAUTION

- If the release valve is loosened too much (2 or more turns) in the anticlockwise direction, the jack's oil will leak and the jack cannot be used.

### ⚠ CAUTION

- Close the release valve slowly when lowering the vehicle, or the valve may be damaged.

### 📖 NOTE

- Occasionally when the vehicle is jacked up, the grooved portion of the designated point will not come off. When this happens, rock the vehicle to lower the ram.
- If the jack is difficult to remove by hand, insert the jack handle (L) into the bracket (M). Then using the handle, remove the jack.

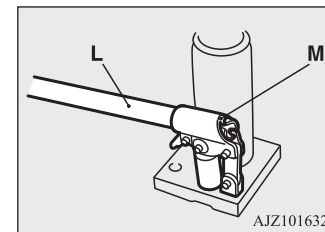

13. Press the piston down all the way, and turn the release valve clockwise as far as possible.

- Check your tyre inflation pressure at the next gasstation. The correct pressures are shown on the driver's door label. See the illustration.

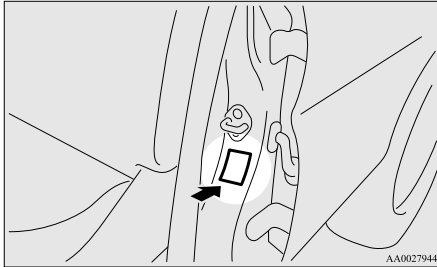

- On vehicles with tyre pressure monitoring system (TPMS), after filling your tyres to the correct pressure, reset the tyre pressure monitoring system (TPMS).

Refer to “Tyre pressure monitoring system (TPMS): Reset of low tyre pressure warning threshold” on page 6-51.

### **⚠ CAUTION**

- After changing the tyre and driving the vehicle about 1,000 km (620 miles), retighten the wheel nuts to make sure that they have not come loose.
- If the steering wheel vibrates when driving after changing the tyre, we recommend you to have the tyres checked for balance.

### **⚠ CAUTION**

- Do not mix one type of tyre with another or use a different size from the one listed. This would cause early wear and poor handling.

### **To store the flat tyre or spare tyre**

E00803400192

- Attach the wheel to the spare wheel hanger (A) while aligning the holes in the wheel with the bolts on the spare wheel hanger. Using the wheel nut wrench, tighten the spare wheel bolts firmly.

Tightening torque

37 to 54 Nm

(Achieved by applying a force of 140 to 200 N at the end of the wheel nut wrench supplied with the vehicle.)

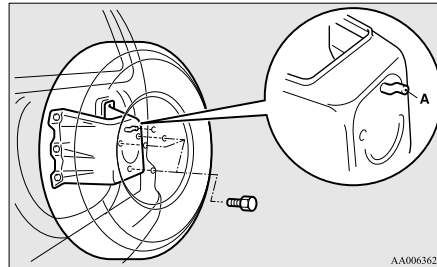

- Reverse the opening procedure when closing the spare wheel garnish.

Tightening torque for spare wheel garnish mounting bolt

11 to 25 Nm

(Achieved by applying a force of 40 to 92 N at the end of the wheel nut wrench supplied with the vehicle.)

### **⚠ CAUTION**

- The spare wheel should always be secured during vehicle operation. If a flat tyre is changed, put the flat tyre in the spare wheel mounting position, and use the wheel nut wrench to secure it firmly.

### **📖 NOTE**

- Have your damaged tyre repaired as soon as possible.

## Towing

E00801505888

### If your vehicle needs to be towed

If towing is necessary, we recommend you to have it done by your MITSUBISHI MOTORS Authorized Service Point or a commercial tow truck service.

In the following cases, transport the vehicle using a tow truck.

- The engine runs but the vehicle does not move or abnormal noise is produced.
- Inspection of the vehicle's underside reveals that oil or some other fluid is leaking.

If a wheel gets stuck in a ditch, do not try to tow the vehicle. Please contact your authorized MITSUBISHI MOTORS dealer or a commercial tow truck service for assistance.

Only when you cannot receive a towing service from a MITSUBISHI MOTORS Authorized Service Point or commercial tow truck service, tow your vehicle carefully in accordance with the instructions given in "Emergency towing" in this part.

The regulations concerning towing may differ from country to country. It is recommended that you obey the regulations of the area where you are driving your vehicle.

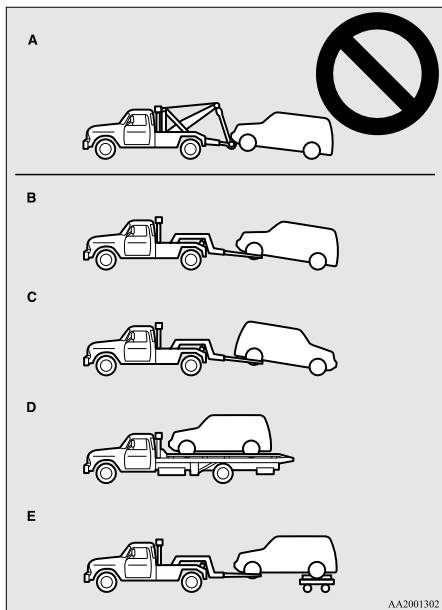

## Towing the vehicle by a tow truck

### ⚠ CAUTION

- This vehicle must not be towed by a tow truck using sling lift type equipment (Type A) as illustrated. Using a sling lift will damage the bumper and front end.
- Be sure to shift the transfer shift lever to "2H" position and transport the vehicle with the driving wheels on a carriage (Type C, D or E) as illustrated. Never try to tow with the transfer shift lever in "4H", "4HLc" or "4LLc" positions and with the front or rear wheels on the ground (Type B or Type C) as illustrated. This could result in driving system damage or the vehicle may jump at the carriage. If you cannot shift the transfer shift lever to the "2H" position or the transmission is malfunctioning or damaged, transport the vehicle with all wheels on a carriage (Type D or E) as illustrated.
- As your vehicle equipped with the Active Stability & Traction Control system (ASTC), if the vehicle is towed with the ignition switch in the "ON" position and only the front wheels or only the rear wheels raised off the ground, the active Traction Control System may operate, resulting in an accident.

**⚠ CAUTION**

- If you tow the vehicles with the driving wheels on the ground (Type B) as illustrated, make sure that the towing speed and distance given below are never exceeded, causing damage to the transmission.

Petrol-powered vehicles

Towing speed: 50 km/h (31 mph)

Towing distance: 50 km (31 miles)

Diesel-powered vehicles

Towing speed: 30 km/h (19 mph)

Towing distance: 80 km (50 miles)

For the towing speed and the towing distance, follow the local driving laws and regulations.

**Towing with front wheels off the ground (Type B)**

Place the selector lever in the “N” (NEUTRAL) position.

Release the parking brake.

**⚠ CAUTION**

- Never tow an A/T vehicle with the front wheels up (and the rear wheels on the ground) (Type B) when the A/T fluid level is low. This may cause serious and expensive damage to the transmission.

**Towing with rear wheels off the ground (Type C)**

Place the selector lever in the “N” (NEUTRAL) position. Turn the ignition key to the “ACC” position and secure the steering wheel in a straight-ahead position with a rope or tiedown strap. Never place the ignition switch in the “LOCK” position when towing.

**Emergency towing**

If towing service is not available in an emergency, your vehicle may be temporarily towed by a rope secured to the towing hook.

If your vehicle is to be towed by another vehicle or if your vehicle tows another vehicle, pay careful attention to the following points:

**If your vehicle is to be towed by another vehicle**

1. The front towing hooks (A) and rear towing hooks (B) are located as shown in the illustrations. Secure the tow rope to the towing hook.

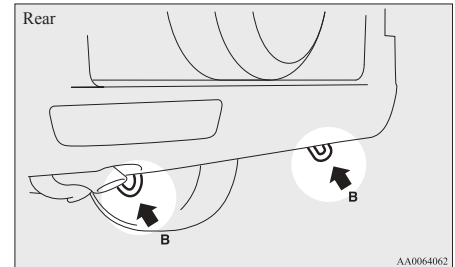
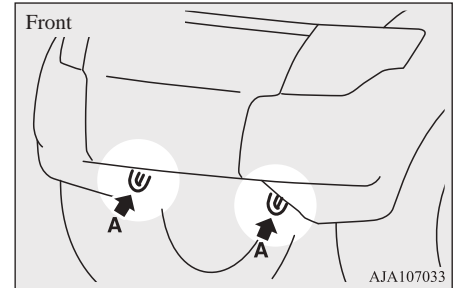
**NOTE**

- Using a wire rope or metal chain can result in damage to the vehicle body. It is best to use a non-metallic rope. If you use a wire rope or metal chain, wrap it with cloth at any point where it touches the vehicle body.
- Take care that the tow rope is kept as horizontal as possible. An angled tow rope can damage the vehicle body.

**NOTE**

- Secure the tow rope to the same side towing hook, to keep the tow rope as straight as possible.

## 2. Keep the engine running.

If the engine is not running, turn the ignition switch to the “ACC” or “ON” position to unlock the steering wheel.

**CAUTION**

- When the engine is not running, the brake booster and power steering pump do not operate. This means higher brake depression force and higher steering effort are required. Therefore, vehicle operation is more difficult than usual.
- Do not leave the key in the “LOCK” position. The steering wheel will lock, causing loss of control.

3. Place the selector lever in the “N” (NEUTRAL) position.
4. Shift the transfer shift lever to “2H” position.
5. Turn on the hazard warning lamps if required by law. (Follow the local driving laws and regulations.)
6. During towing make sure that close contact is maintained between the drivers of both vehicles, and that the vehicles travel at low speed.

**CAUTION**

- Avoid sudden braking, sudden acceleration and sharp turning; such operation could cause damage to the towing hooks or the tow rope. People in the vicinity could be injured as a result.
- When towing or being towed down a long slope, the brakes may overheat reducing the effectiveness. In this situation, have your vehicle transported by a tow truck.
- When the vehicle is to be towed by another vehicle with all the wheels on the ground, make sure that the towing speed and distance given below are never exceeded, avoiding damage to the transmission.

Petrol-powered vehicles  
Towing speed: 50 km/h (31 mph)  
Towing distance: 50 km (31 miles)

Diesel-powered vehicles  
Towing speed: 30 km/h (19 mph)  
Towing distance: 80 km (50 miles)

For the towing speed and the towing distance, follow the local driving laws and regulations.

**If your vehicle tows another vehicle**

Only use the rear towing hook as shown in the illustration. Secure the tow rope to the rear towing hook.

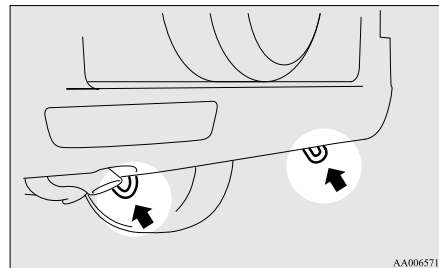
**CAUTION**

- When you are going to tow another vehicle, move the transfer shift lever to “4H” position. Selecting “2H” drive may increase the differential oil temperature, resulting in possible damage to the driving system. Further, the drive train will be subjected to excessive loading possibly leading to oil leakage, component seizure, or other serious faults.

**NOTE**

- Do not tow a vehicle heavier than your own vehicle.



**Operation under adverse driving conditions**

E00801704160

**If your vehicle becomes stuck in sand, mud or snow**

If the vehicle becomes stuck in snow, sand, or mud, it can often be moved with a rocking motion. Move the selector lever alternately between the Sports mode and “R” (REVERSE) position, while applying slight pressure to the accelerator pedal.

Avoid racing the engine or spinning the wheels. Prolonged efforts to free a stuck vehicle may result in overheating, transmission and drivetrain failure. Allow the engine to idle for a few minutes to let the transmission cool between rocking attempts. If the vehicle remains stuck after several rocking attempts, seek other assistance.

**WARNING**

- When attempting to rock your vehicle out of a stuck position, be sure that the area around the vehicle is clear of people and physical objects. The rocking motion may cause the vehicle to suddenly launch forward or backward, causing injury or damage to nearby people or objects.

**On a flooded road**

- Avoid flooded roads. In the event driving flooded roads, doing so may cause the following serious damage to the vehicle.
  - Engine stalling
  - Short in electrical components
  - Engine damage caused by water immersion

After driving on flooded roads, be sure to have an inspection at an Authorized MITSUBISHI MOTORS dealer and take the necessary measures or repair.

- When driving in rain, or water-covered roads, or through a car wash, water could enter the brake discs, resulting in temporarily ineffective brakes. In such cases, lightly depress the brake pedal to see if the brakes operate properly. If they do not, lightly depress the pedal several times while driving in order to dry the brake pads.
- When driving in rain or on a road with many puddles a layer of water may form between the tyres and the road surface. This reduces a tyre’s frictional resistance on the road, resulting in loss of steering stability and braking capability.

To cope with this, observe the following items:

- (a) Drive your vehicle at slow speed.
- (b) Do not drive on worn tyres.
- (c) Always maintain the specified tyre inflation pressures.

**On a snow-covered or frozen road**

- When driving on a snow-covered or frozen road, it is recommended that you use snow tyres or tyre chains.

Refer to the “Snow tyres” and “Tyre chains” sections.

### CAUTION

- Avoid sudden braking, sudden acceleration, and sharp turning; such operations could cause skidding and spinouts. Also, doing so could cause damage to the drivetrain.

- Depressing the brake pedal during travel on snowy or icy roads may cause tyre slippage and skidding. When traction between the tyres and the road is reduced the wheels may skid and the vehicle cannot readily be brought to a stop by conventional braking techniques. Braking will differ, depending upon whether you have anti-lock brake system (ABS). As your vehicle is equipped with ABS, brake by pressing the brake pedal hard, and keeping it pressed.
- Allow extra distance between your vehicle and the vehicle in front of you, and avoid sudden braking.
- Accumulation of ice on the braking system can cause the wheels to lock. Pull away from a standstill slowly after confirming safety around the vehicle.

### CAUTION

- Do not press the accelerator pedal rapidly. If the wheels break free of the ice, the vehicle could suddenly start moving and possibly cause an accident.

## On a bumpy or rutted road

Drive as slow as possible when driving on bumpy or rutted roads.

### CAUTION

- The impact on tyres and/or wheels when driving on a bumpy or rutted road can damage the tyre and/or wheel.



## *Vehicle care*

Vehicle care precautions.....	9-02
Cleaning the interior of your vehicle.....	9-02
Cleaning the exterior of your vehicle.....	9-03

## Vehicle care precautions

E00900100825

In order to maintain the value of your vehicle, it is necessary to perform regular maintenance using the proper procedures. Always maintain your vehicle in compliance with environmental pollution control regulations. Carefully select the materials used for washing, etc., to be sure that they do not contain corrosives. If in doubt, we recommend you to consult a specialist for selection of these materials.

### CAUTION

- Cleaning products can be dangerous. Always follow the instructions of the cleaning product supplier.
- To avoid damage, never use the following to clean your vehicle:
  - Petrol
  - Paint Thinner
  - Benzine
  - Kerosene
  - Turpentine
  - Naphtha
  - Lacquer Thinner
  - Carbon Tetrachloride
  - Nail Polish Remover
  - Acetone

## Cleaning the interior of your vehicle

E00900200464

After cleaning the interior of your vehicle with water, cleaner or similar, wipe and dry in a shady, well-ventilated area.

### CAUTION

- Do not use organic substances (solvents, benzine, kerosene, alcohol, petrol, etc.) or alkaline or acidic solutions. These chemicals can cause discolouring, staining or cracking of the surface. If you use cleaners or polishing agents, make sure their ingredients do not include the substances mentioned above.

## Plastic, vinyl leather, fabric and flocked parts

E00900300377

1. Gently wipe off with gauze or other soft cloth soaked with a 3 % aqueous solution of neutral detergent.
2. Dip cloth in fresh water and wring out well. Using this cloth, wipe off the detergent thoroughly.

## NOTE

- Do not use cleaners, conditioners, and protectants containing silicons or wax. Such products, when applied to the instrument panels or other parts, may cause reflections on the windscreen and obscure vision. Also, if such products get on the switches of the electrical accessories, it may lead to failure of these accessories.

## Upholstery

E00900500063

1. To maintain the value of your new vehicle, handle the upholstery carefully and keep the interior clean. Use a vacuum cleaner and brush to clean the seats. If stained, vinyl and synthetic leather should be cleaned with an appropriate cleaner, and cloth fabrics can be cleaned with either upholstery cleaner or a 3 % solution of neutral detergent in lukewarm water.
2. Clean the carpeting with a vacuum cleaner and remove any stains with carpet cleaner. Oil and grease can be removed by lightly dabbing with a clean colourfast cloth and stain remover.

Use a mild car washing soap if necessary. Rinse thoroughly and wipe dry with a soft cloth. After washing the vehicle, carefully clean the joints and flanges of the doors, bonnet, etc., where dirt is likely to remain.

## Genuine leather\*

E00900600716

1. Gently wipe off with gauze or other soft cloth soaked with a 5 % aqueous solution of neutral detergent.
2. Dip cloth in fresh water and wring it out well. Using this cloth, wipe off the detergent thoroughly.
3. Apply leather protecting agent to the genuine leather surface.

## NOTE

- If genuine leather is wet with water or is washed in water, wipe off water as quickly as possible with a dry, soft cloth. If left damp, mildew may grow.
- The genuine leather surface may be damaged if a nylon brush or synthetic fibre is rubbed hard against it.
- Organic solvents such as benzene, kerosene, alcohol and petrol, acid or alkaline solvents may discolour the genuine leather surface. Be sure to use neutral detergents.
- Remove dirty patches or oil substances quickly as they can stain genuine leather.
- The genuine leather surface may harden and shrink if it is exposed to direct sun for long hours. When your vehicle is parked, place it in the shade as much as possible.
- When the temperature of the vehicle interior rises in summer, vinyl products left on the genuine leather seat may deteriorate and stick to the seat.

## Cleaning the exterior of your vehicle

E00900700195

If the following is left on your vehicle, it may cause corrosion, discolouration and stains, wash the vehicle as soon as possible.

- Seawater, road deicing products.
- Soot and dust, iron powder from factories, chemical substance (acids, alkalis, coal-tar, etc.).
- Droppings from birds, carcasses of insects, tree sap, etc.

## Washing

E00900903895

Chemicals contained in the dirt and dust picked up from the road surface can damage the paint coat and body of your vehicle if left in prolonged contact.

Frequent washing and waxing is the best way to protect your vehicle from this damage. This will also be effective in protecting it from environmental elements such as rain, snow, salt air, etc.

Do not wash the vehicle in direct sunlight. Park the vehicle in the shade and spray it with water to remove dust. Next, using an ample amount of clean water and a car washing brush or sponge, wash the vehicle from top to bottom.

## CAUTION

- When washing the under side of your vehicle or wheel, be careful not to injure your hands.
- If your vehicle has a rain sensor, place the wiper switch lever in the “OFF” position to deactivate the rain sensor before washing the vehicle. Otherwise, the wipers will operate in the presence of water spray on the windshield and may get damaged as a result.
- Refrain from excessively using a car wash as its brushes may scratch the paint surface, causing it to lose its gloss. Scratches will be especially visible on darker coloured vehicles.
- Never spray or splash water on the electrical components in the engine compartment, as this may adversely affect engine starting. Exercise caution also when washing the underbody; be careful not to spray water into the engine compartment.
- Some types of hot water washing equipment apply high pressure and heat to the vehicle. They may cause heat distortion and damage to the vehicle resin parts and may result in flooding of the vehicle interior. Therefore:

## CAUTION

- Maintain a distance of approx. 50 cm or more between the vehicle body and the washing nozzle.
- When washing around the door glass, hold the nozzle at a distance of more than 50 cm and at right angles to the glass surface.
- After washing the vehicle, drive the vehicle slowly while lightly depressing the brake pedal several times in order to dry out the brakes.  
Leaving the brakes wet could result in reduced braking performance. Also, there is a possibility that they could freeze up or become inoperative due to rust, rendering the vehicle unable to move.
- When using an automatic car wash, pay attention to the following items, referring to the operation manual or consulting a car wash operator. If the following procedure is not followed, it could result in damage to your vehicle.
  - The outside mirrors are retracted.
  - The wiper arm assembly is taped.
  - If your vehicle is equipped with a rear deflector or roof rails, consult a car wash operator before using the car wash.
  - If your vehicle has a rain sensor, place the wiper switch lever in the “OFF” position to deactivate the rain sensor.

## During cold weather

Salt and other chemicals spread on the roads in some areas in winter can have a harmful effect on the vehicle body. You should therefore wash the vehicle as often as possible in accordance with our care-instructions. It is recommended to have a preservative applied and the underfloor protection checked before and after the cold weather season.

After washing your vehicle, wipe off all waterdrops from the rubber parts around the doors to prevent the doors from freezing.

## NOTE

- To prevent freezing of the weatherstripping on the doors, bonnet, etc., they should be treated with silicone spray.

## Waxing

E00901000560

Waxing the vehicle will help prevent the adherence of dust and road chemicals to the paintwork. Apply a wax solution after washing the vehicle, or at least once every three months to assist displacing of water. Do not wax your vehicle in direct sunlight. You should wax after the surfaces have cooled.

## CAUTION

- Waxes containing high abrasive compounds should not be used. Such waxes remove rust and stains effectively from the paintwork but they are harmful to the lustre on the painted surface and the plated surface.  
Further, they are harmful to glossy surfaces such as grille, garnish, mouldings, etc.
- Do not use petrol or paint thinners to remove road tar or other contamination to the vehicle surface.
- Do not apply wax on the areas having black mat coating as it can cause uneven discolouration, patches, blurs, etc. If stained with wax, immediately wipe off with a piece of soft cloth and warm water.
- On vehicles with a sunroof, be careful when waxing the area around the sunroof opening, not to put any wax on the weatherstrip (black rubber). If stained with wax, the weatherstrip cannot maintain a weatherproof seal with the sunroof.

## Polishing

E00901100024

The vehicle should only be polished if the paintwork has become stained or lost its lustre. Matt-finish parts and plastic bumpers must not be polished, polishing these parts will stain them or damage their finish.

## Damaged paint

E00901201237

Small cracks and scratches in the paint coat should be touched up as soon as possible with MITSUBISHI MOTORS GENUINE touch-up paint to prevent corrosion.

Check body areas facing the road or the tyres carefully for damage to the paint coat caused by flying stones, etc. The paint code number for your vehicle can be found on the vehicle information code plate. (Refer to “Vehicle information code plate” on page 11-02.)

## Cleaning plastic parts

E00901300619

Use a sponge or chamois leather.

If a car wax adheres on a grey or black rough surface of the bumper, moulding or lamps, the surface becomes white. In such a case, wipe it off using lukewarm water and soft cloth or chamois leather.

### ⚠ CAUTION

- Do not use a scrubbing brush or other hard tools as they may damage the plastic part surface.
- Do not use wax containing compound (polishing powder) which may damage the plastic part surface.

### ⚠ CAUTION

- Do not bring the plastic parts into contact with petrol, light oil, brake fluids, engine oils, greases, paint thinners, and sulphuric acid (battery electrolyte) which may crack, stain or discolour the plastic parts. If they touch the plastic parts, wipe them off with soft cloth, chamois or the like and an aqueous solution of neutral detergent then immediately rinse the affected parts with water.

## Chrome parts

E00901400115

In order to prevent spots and corrosion of chrome parts, wash with water, dry thoroughly, and apply a special protective coating. This should be done more frequently in winter.

## Aluminium wheels

E00901501663

1. Remove dirt using a sponge while sprinkling water on the wheels.
2. Use neutral detergent on any dirt that cannot be removed easily with water. Rinse off the neutral detergent after washing the wheels.
3. Dry the wheels thoroughly using a chamois leather or a soft cloth.

### ⚠ CAUTION

- Do not use a brush or other hard implement on the wheels. Doing so could scratch the wheels.
- Do not use any cleaner that contains an abrasive substance or is acidic or alkaline. Doing so could cause the coating on the wheels to peel or become discoloured or stained.
- Do not directly apply hot water using a steam cleaner or by any other means.
- Contact with seawater and road deicer can cause corrosion. Rinse off such substances as soon as possible.

## Window glass

E00901600032

The window glass can normally be cleaned using only a sponge and water.

Glass cleaner can be used to remove oil, grease, dead insects, etc. After washing the glass, wipe dry with a clean, dry, soft cloth. Never use the same cloth to wipe the window glass as would be used to wipe the paintwork; wax from the painted surfaces could adhere to the glass and reduce its transparency and visibility.

 **NOTE**

- To clean the inside of the backdoor window, always use a soft cloth and wipe the window glass along the demister heater element so as not to cause damage.

## Wiper blades

E00901700059

Use a soft cloth and glass cleaner to remove grease, dead insects, etc., from the wiper blades. Replace the wiper blades when they no longer wipe properly. (Refer to page 10-15.)

## 9 Cleaning the sunroof\*

E00901800180

Clean the inside of the sunroof with a soft cloth. Hard deposits should be wiped away with a cloth dipped in warm, neutral detergent solution. Wipe away the solution with a sponge dipped in fresh water.

 **NOTE**

- The surface treatment on the inside of the glass may be removed if hard cloth or organic solvent (benzine, kerosene, thinner, etc.) is used.

## Engine compartment

E00902100311

Clean the engine compartment at the beginning and end of winter. Pay particular attention to flanges, crevices and peripheral parts where dust containing road chemicals and other corrosive materials might collect.

If salt and other chemicals are used on the roads in your area, clean the engine compartment at least every three months.

Never spray or splash water on the electrical components in the engine compartment, as this may cause damage.

Do not bring the nearby parts, the plastic parts and so on into contact with sulphuric acid (battery electrolyte) which may crack, stain or discolour them.

If they are in contact, wipe off with soft cloth, chamois or the like and an aqueous solution of neutral detergent then immediately rinse the affected parts with plenty of water.

## *Maintenance*

Service precautions.....	10-02
Catalytic converter.....	10-02
Bonnet.....	10-03
Engine oil.....	10-04
Engine coolant.....	10-06
Washer fluid.....	10-07
Brake fluid.....	10-08
Power steering fluid.....	10-09
Battery.....	10-09
Tyres.....	10-11
Parking brake break-in.....	10-15
Wiper blade rubber replacement.....	10-15
General maintenance.....	10-17
For cold and snowy weather.....	10-17
Fusible links.....	10-18
Fuses.....	10-18
Replacement of lamp bulbs.....	10-23

## Service precautions

E01000102696

Adequate care of your vehicle at regular intervals serves to preserve the value and appearance as long as possible.

Maintenance items as described in this owner's manual can be performed by the owner.

We recommend you to have the periodic inspection and maintenance performed by a MITSUBISHI MOTORS Authorized Service Point or another specialist. In the event a malfunction or other problem is discovered, we recommend you to have it checked and repaired. This section contains information on inspection maintenance procedures that you can do yourself. Follow the instructions and cautions for each of the various procedures.

### ⚠ WARNING

- When checking or servicing the inside of the engine compartment, make sure the engine is switched off and has had a chance to cool down.
- If it is necessary to do work in the engine compartment with the engine running, be especially careful that your clothing, hair, etc., does not become caught by the fans, drive belts, or other moving parts.

### ⚠ WARNING

- After performing the maintenance, make sure that no tools or cloths are left behind in the engine compartment. If they are left behind, a fire or damage to the vehicle may occur.
- The air conditioning condenser fan (if so equipped) can turn on automatically even if the engine is not running. Turn the ignition switch to the "LOCK" position to be safe while you work in the engine compartment.

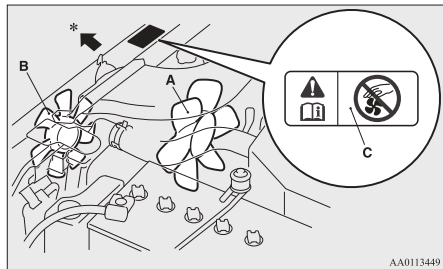

- A- Radiator fan  
 B- Air conditioning condenser fan (if so equipped)  
 C- Caution label (Vehicle with air conditioning condenser fan)  
 \*: Front of the vehicle

### ⚠ WARNING

- Do not smoke, cause sparks or allow open flames around fuel or battery. The fumes are flammable.
- Be extremely cautious when working around the battery. It contains poisonous and corrosive sulphuric acid.
- Do not get under your vehicle with just the body jack supporting it. Always use automotive jack stands.
- Improper handling of components and materials used in the vehicle can endanger your personal safety. We recommend you to consult a specialist for necessary information.

## Catalytic converter

E01000201355

For ordinary use, there are no particular precautions except that of using unleaded petrol. The exhaust gas scavenging devices used with the catalytic converter are extremely efficient for the reduction of noxious gases. The catalytic converter is installed in the exhaust system.

It is important to keep the engine properly tuned to ensure proper catalyst operation and prevent possible catalyst damage.



**⚠ WARNING**

- As with any vehicle, do not park or operate this vehicle in areas where combustible materials such as dry grass or leaves can come in contact with a hot exhaust since a fire could occur.
- Paint should not be applied to the catalytic converter.

**📖 NOTE**

- In case of the petrol-powered vehicles, use UNLEADED PETROL ONLY of the type recommended in "Fuel selection" on page 2-02.

**Bonnet**

E01000304445

**To open**

1. Pull the release lever towards you to unlock the bonnet.

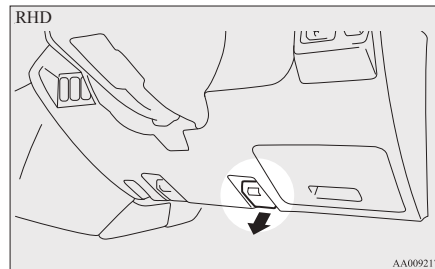
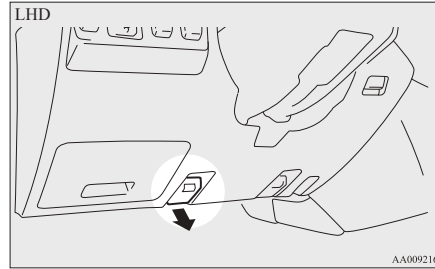

2. Raise the bonnet while pressing the safety lock.

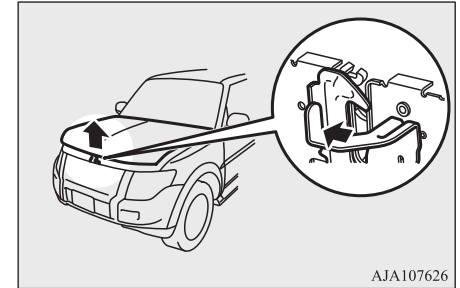
**📖 NOTE**

- Only open the bonnet when the wipers are in the original position. Failure to do so may cause damage to the bonnet, wiper arms or windscreen.

3. Support the bonnet by inserting the support bar in its slot.

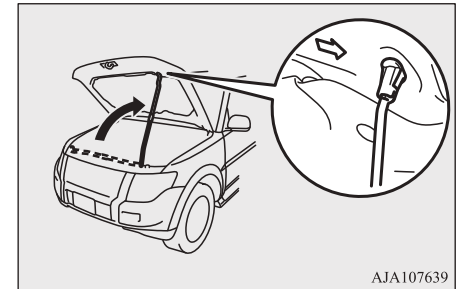

## Engine oil

### CAUTION

- Note that the support bar may disengage the bonnet if the open bonnet is lifted by a strong wind.
- After inserting the support bar into the slot, make sure the bar supports the bonnet securely from falling down on to your head or body.

### To close

1. Unlatch the support bar and clip it in its holder.

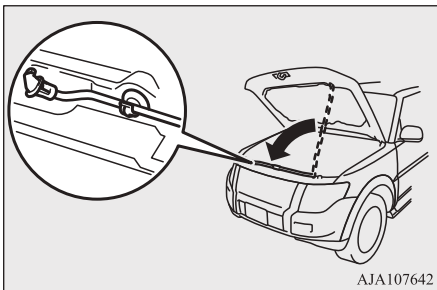

2. Slowly lower the bonnet to a position about 20 cm above the closed position, then let it drop.
3. Make sure the bonnet is securely locked by softly lifting the centre of the bonnet.

### NOTE

- If this does not close the bonnet, release it from a slightly higher position.
- Do not press down the bonnet hard with a hand as it may damage the bonnet.

### CAUTION

- Be careful that hands or fingers are not trapped when closing the bonnet.

## Engine oil

E01000404680

### To check and refill engine oil

- A- Minimum level
- B- Maximum level
- C- Oil replacement indication mark

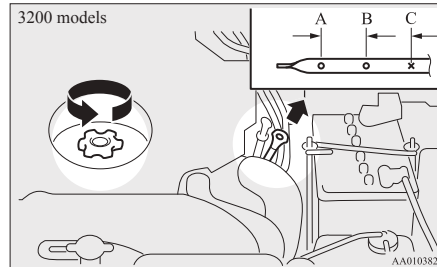
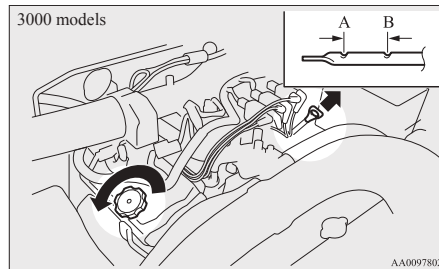

The engine oil used has a significant effect on the engine's performance, service life and startability. Be sure to use oil of the recommended quality and appropriate viscosity.

All engines consume a certain amount of oil during normal operation. Therefore, it is important to check the oil level at regular intervals or before starting a long trip.

1. Park the vehicle on a horizontal surface.
2. Switch off the engine.
3. Wait a few minutes.
4. Remove the dipstick and wipe it with a clean cloth.
5. Reinsert the dipstick as far as it goes.
6. Remove the dipstick and read the oil level, which should always be within the range indicated.

7. If the oil level is below the specified limit, remove the cap located on the cylinder head cover and add enough oil to raise the level to within the specified range. Do not overfill to avoid engine damage. Be sure to use the specified engine oil and do not mix various types of oil.
8. After adding oil, close the cap securely.
9. Confirm the oil level by repeating step 4 to 6.

Use only the recommended oils with an ACEA or API classification as specified in this manual.

### NOTE

- For 3200 models, check or refill the oil according to the following manner.
  - When the oil level is checked in step 6 above, check it on a low side of the dipstick because it is different in appearance of oil level in the two sides of the dipstick.
  - The oil level should be within the range (A) to (C) (oil replacement indication mark) on the dipstick.  
If the oil level is beyond the oil replacement indication mark (C), replace the oil as soon as possible.  
Then, the oil should be refilled to the maximum level (B).

### NOTE

- The engine oil will increase due to a little fuel getting mixed in the engine oil when the DPF regenerates to burn away the PM (particulate matter). It does not indicate a malfunction.  
In the following conditions, the engine oil level may increase easily. We recommend you to have it checked frequently.
  - frequent driving at uphill and downhill
  - frequent driving at high altitudes
  - frequent and extended idling
  - frequent driving through a traffic jam
- The engine oil will deteriorate rapidly if the vehicle is subjected to severe conditions, requiring earlier oil replacement. Please refer to the maintenance schedule.
- For handling of used engine oils, refer to page 2-06.

## Selection of engine oil

### Petrol-powered vehicles

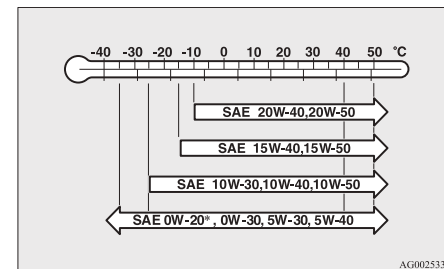

- Select engine oil of the proper SAE viscosity number according to the atmospheric temperature.
 

SAE 0W-20\*, 0W-30, 5W-30, and 5W-40 engine oils can only be used if they meet ACEA A3/B3, A3/B4 or A5/B5 and API SM (or higher) specifications.

\*: Only the vehicles complying with the Euro 5 regulation
- Use engine oil conforming to the following classification:
  - API classification: “For service SM” or higher
  - ILSAC certificated oil
  - ACEA classification: “For service A1/B1, A3/B3, A3/B4 or A5/B5”

**NOTE**

- Use of additives is not recommended since they may reduce the effectiveness of additives already included in the engine oil. It may result in failure of the mechanical assembly.

**Diesel-powered vehicles**

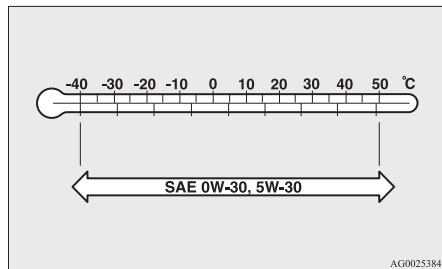

AG0025384

- Select engine oil of the proper SAE viscosity number according to the atmospheric temperature.
- Use engine oil conforming to the following classification:
  - ACEA classification: "For service C1, C2, C3 or C4"
  - JASO classification: "For service DL-1"

If those classifications are not available, contact a MITSUBISHI MOTORS Authorized Service Point.

**NOTE**

- Use of additives is not recommended since they may reduce the effectiveness of additives already included in the engine oil. It may result in failure of the mechanical assembly.

**Engine coolant**

E01000503222

**To check the coolant level**

A translucent coolant reserve tank is located in the engine compartment.

The coolant level in this tank should be kept between the "LOW" and "FULL" marks when measured while the engine is cold.

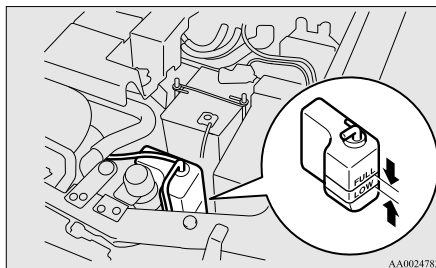

AA0024783

**To add coolant**

The cooling system is a closed system and normally the loss of coolant should be very slight. A noticeable drop in the coolant level could indicate leakage. If this occurs, we recommend you to have the system checked as soon as possible.

If the level should drop below the "LOW" level on the reserve tank, open the lid and add coolant.

Also, if the reserve tank is completely empty, remove the radiator cap and add coolant until the level reaches the filler neck.

**WARNING**

- Do not open the radiator cap while the engine is hot. The coolant system is under pressure and any hot coolant escaping could cause severe burns.



AJA107916

## Anti-freeze

The engine coolant contains an ethylene glycol anti-corrosion agent. The cylinder head and water pump housing are cast aluminium alloy, and periodic changing of the engine coolant is necessary to prevent corrosion of these parts.

Use “MITSUBISHI MOTORS GENUINE SUPER LONG LIFE COOLANT” or equivalent.

MITSUBISHI MOTORS GENUINE Coolant has excellent protection against corrosion and rust formation of all metals including aluminium and can avoid blockages in the radiator, heater, cylinder head, engine block, etc.

Because of the necessity of this anti-corrosion agent, the coolant must not be replaced with plain water even in summer. The required concentration of anti-freeze differs depending on the expected ambient temperature.

Ambient temperature (minimum)°C	-15	-20	-25	-30	-35	-50
Anti-freeze concentration %	30	35	40	45	50	60

### ⚠ CAUTION

- Do not use alcohol or methanol anti-freeze or any engine coolants mixed with alcohol or methanol anti-freeze. The use of an improper anti-freeze can cause corrosion of the aluminium components.
- For effective anti-corrosion and anti-freeze performance, keep the anti-freeze concentration within the range of 30 to 60 %. Concentrations exceeding 60 % will result in a reduction of both the anti-freeze and cooling performance thus adversely affecting the engine.
- Do not top up with water only.

### During cold weather

The concentration should be checked before the start of cold weather and anti-freeze added to the system if necessary to prevent damage to engine and radiator due to freezing.

## Washer fluid

E01000700656

### Windscreen washer fluid

The windscreen washer fluid reservoir is in the engine compartment.

Check the washer fluid level at regular intervals and add washer fluid to reservoir if necessary.

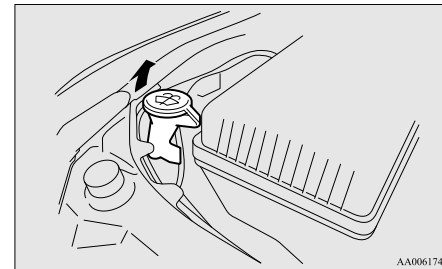

AA0061742

### 📖 NOTE

- The washer fluid container serves the windscreen and headlamps (if so equipped).

10

## Rear window washer fluid

E0100650063

1. Remove the rear window washer fluid reservoir filler port lid (A) on the back-door.

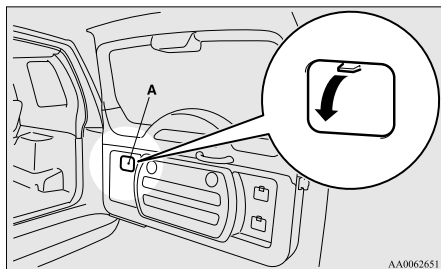

2. Pull out the rear window washer fluid reservoir filler port (B) and check the washer fluid level.

If the level is low, replenish the container with washer fluid.

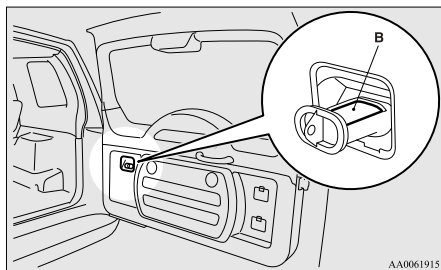

## During cold weather

E0100660019

To ensure proper operation of the washers at low temperatures, use a fluid containing an anti-freezing agent.

## Brake fluid

E01000900847

## To check the fluid level

The brake fluid level is monitored by a float. When the brake fluid level falls below the “MIN” mark, the brake fluid warning lamp lights up.

The brake fluid level must be between the “MAX” and “MIN” marks on the reservoir.

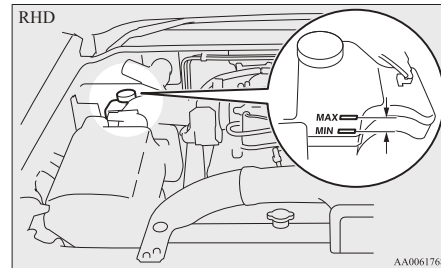
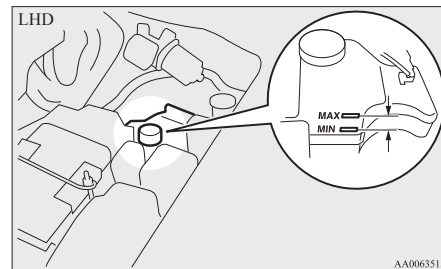

If the level is below the “MIN” mark, check according to the following procedure:

1. Turn the ignition switch to the “LOCK” or “ACC” position.
2. Repeatedly depress the brake pedal until significant resistance is felt (normally after about 40 times).

3. Check the brake fluid level in the reservoir.

The brake fluid level must be between the “MAX” and “MIN” marks on the reservoir.

The fluid level falls slightly with wear of the brake pads, but this does not indicate any abnormality.

If the brake fluid level falls markedly in a short length of time, it indicates leaks from the brake system.

If this occurs, we recommend you to have the vehicle checked.

### Fluid type

Use brake fluid conforming to DOT3 or DOT4 from a sealed container. The brake fluid is hygroscopic. Too much moisture in the brake fluid will adversely affect the brake system, reducing the brake performance.

### CAUTION

- Take care in handling brake fluid as it is harmful to the eyes, may irritate your skin and also damage painted surfaces.

### CAUTION

- Use only the specified brake fluid. Do not mix or add different brands of brake fluid to prevent chemical reactions. Do not let any petroleum-based fluid touch, mix with, or get into the brake fluid. This will damage the seals.
- Keep the reservoir tank cap closed to prevent the brake fluid from deteriorating except maintenance.
- Clean the filler cap before removing and close the cap securely after maintenance.

### Power steering fluid

E01001102459

### To check the fluid level

Check the fluid level in the reservoir while the engine is idling.

Check to make certain that the power steering fluid level is always between the “MAX” and “MIN” level markings on the fluid reservoir and top up the fluid, if necessary.

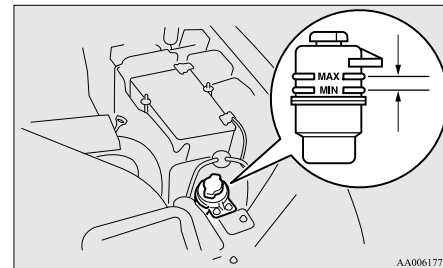

AA0061771

### Fluid type

Use “MITSUBISHI MOTORS GENUINE PSF (Power Steering Fluid)”.

### Battery

E01001201772

The condition of the battery is very important for quick starting of the engine and proper functioning of the vehicle’s electrical system. Regular inspection and care are especially important in cold weather.

**NOTE**

- On vehicles equipped with 2 batteries, when the batteries are replaced, the 2 batteries should be replaced at the same time. If only a battery is replaced, it will cause shortening of the batteries life.

**Checking battery electrolyte level**

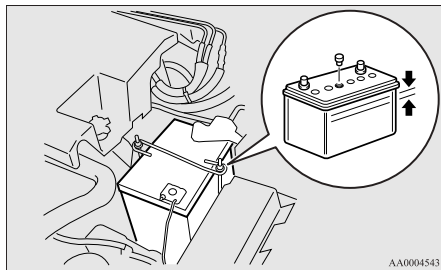

The electrolyte level must be between the specified limit on the outside of the battery. Replenish with distilled water as necessary. The inside of the battery is divided into several compartments; remove the cap from each compartment and fill to the upper mark. Do not top up beyond the upper mark because spillage during driving could cause damage. Check the electrolyte level at least once every 4 weeks, depending on the operating conditions.

If the battery is not used, it will discharge by itself with time.

Check it once every 4 weeks and charge with low current as necessary.

**During cold weather**

The capacity of the battery is reduced at low temperatures. This is an inevitable result of its chemical and physical properties.

This is why a very cold battery, particularly one that is not fully charged, will only deliver a fraction of the starter current which is normally available.

We recommend you to have the battery checked before the start of cold weather and, if necessary, have it charged or replaced.

This does not only ensure reliable starting, but a battery which is kept fully charged also has a longer life.

**Disconnection and connection**

To disconnect the battery cable, stop the engine, first disconnect the negative (-) terminal and then the positive (+) terminal.

When connecting the battery, first connect the positive (+) terminal and then the negative (-) terminal.

**WARNING**

- Keep sparks, cigarettes, and flames away from the battery because the battery could explode.
- The battery electrolyte is extremely caustic. Do not allow it to come in contact with your eyes, skin, clothing, or the painted surfaces of the vehicle. Spilt electrolyte should be flushed immediately with ample amounts of water. Irritation to eyes or skin from contact with electrolyte requires immediate medical attention.
- Ventilate when charging or using the battery in an enclosed space.

**CAUTION**

- Keep it out of reach of children.
- Never disconnect the battery with the ignition switch in the "ON" position; doing so could damage the vehicle's electrical components.
- Never short-circuit the battery; doing so could cause it to overheat and be damaged.
- If the battery is to be quick-charged, first disconnect the battery cables.
- In order to prevent a short circuit, be sure to disconnect the negative (-) terminal first.
- Always wear protective eye goggles when working near the battery.



**⚠ CAUTION**

- Do not bring nearby parts, plastic parts and so on into contact with sulphuric acid (battery electrolyte) which may crack, stain or discolour them.

If they are in contact, wipe off with soft cloth, chamois or the like and an aqueous solution of neutral detergent then immediately rinse the affected parts with plenty of water.

**📖 NOTE**

- Keep the terminals clean. After the battery is connected, apply terminal protection grease. To clean the terminals, use lukewarm water.
- Check to see if the battery is securely installed and cannot be moved during travel. Also check each terminal for tightness.
- When the vehicle is to be left unused for a long period of time, remove the battery and store it in a place where the battery fluid will not freeze. The battery should be stored only in a fully charged condition.

**Tyres**

E01001300239

**⚠ WARNING**

- **Driving with tyres that are worn, damaged or improperly inflated can lead to a loss of control or blow out of the tyres which can result in a collision with serious or fatal injury.**

**Tyre inflation pressures**

E01001404254

**Except for vehicles for Russia, Kazakhstan, Belarus and Ukraine**

Tyre size	Up to 5 passengers		Up to max. load		At trailer towing	
	Front	Rear	Front	Rear	Front	Rear
265/65R17 112H	2.2 bar (220 kPa)	2.4 bar (240 kPa)	2.4 bar (240 kPa)	2.8 bar (280 kPa)	2.6 bar (260 kPa)	3.0 bar (300 kPa)
265/65R17 112S	2.4 bar (240 kPa)	2.6 bar (260 kPa)	2.6 bar (260 kPa)	3.0 bar (300 kPa)	2.6 bar (260 kPa)	3.0 bar (300 kPa)
265/60R18 110H	2.2 bar (220 kPa)	2.4 bar (240 kPa)	2.4 bar (240 kPa)	2.8 bar (280 kPa)	2.6 bar (260 kPa) 3.2 bar (320 kPa) *	3.0 bar (300 kPa) 3.5 bar (350 kPa) *

\*: 5 door models

## Vehicles for Russia, Kazakhstan, Belarus and Ukraine

Tyre size	Up to 5 passengers		Up to max. load		At trailer towing	
	Front	Rear	Front	Rear	Front	Rear
265/65R17 112H	2.0 bar (200 kPa) * 2.2 bar (220 kPa)	2.2 bar (220 kPa) * 2.4 bar (240 kPa)	2.4 bar (240 kPa)	2.8 bar (280 kPa)	2.6 bar (260 kPa)	3.0 bar (300 kPa)
265/60R18 110H	2.0 bar (200 kPa) * 2.2 bar (220 kPa)	2.2 bar (220 kPa) * 2.4 bar (240 kPa)	2.4 bar (240 kPa)	2.8 bar (280 kPa)	2.6 bar (260 kPa)	3.0 bar (300 kPa)

\*: Vehicles for 3000 models

Check the tyre inflation pressure of all the tyres while they are cold; if insufficient or excessive, adjust to the specified value. After the tyre inflation pressure has been adjusted, check the tyres for damage and air leaks. Be sure to put caps on the valves.

### Wheel condition

E01001800478

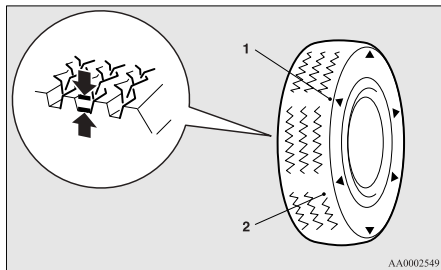

- 1- Location of the tread wear indicator
- 2- Tread wear indicator

Check the tyres for cuts, cracks and other damage. Replace the tyres if there are deep cuts or cracks. Also check each tyre for pieces of metal or pebbles.

The use of worn tyres can be very dangerous because of the greater chance of skidding or hydroplaning. The tread depth of the tyres must exceed 1.6 mm in order for the tyres to meet the minimum requirement for use.

Tread wear indicators will appear on the surface of the tyre as the tyre wears, thereby indicating that the tyre no longer meets the minimum requirement for use. When these wear indicators appear, the tyres must be replaced with new ones.

When replacement of any of the tyres is necessary, replace all of them.

### CAUTION

- Always use tyres of the same size, same type, and same brand, and which have no wear differences.

Using tyres of different size, type, brands or degree of wear, will increase the differential oil temperature, resulting in possible damage to the driving system. Further, the drive train will be subjected to excessive loading, possibly leading to oil leakage, component seizure, or other serious faults.

## Replacing tyres and wheels

E01007201530

### ⚠ CAUTION

- Avoid using different size tyres from the one listed and the combined use of different types of tyres, as this can affect driving safety. Refer to “Tyres and wheels” on page 11-11.
- Even if a wheel has the same rim size and offset as the specified type of wheel, its shape may prevent it from being fitted correctly. We recommend you to consult a specialist before using wheels that you have.
- If your vehicle is equipped with a tyre pressure monitoring system, only MITSUBISHI MOTORS genuine wheels should be used. Use of another type of wheel risks air leaks and sensor damage, as it will not be possible to install the tyre pressure sensor properly. Refer to “Tyre pressure monitoring system (TPMS)” on page 6-48.

## Wheel balance

On vehicles equipped with 17x7 1/2J size aluminium wheels (round rim type), if you need to balance a wheel, put the balance weight (A) on the specified position which is spoke side from the notch (B) on the inner surface of the wheel.

There is a possibility that the balance weight is interfered the related brake part if it is put any place other than the specified position. For details, we recommend you to consult a MITSUBISHI MOTORS Authorized Service Point.

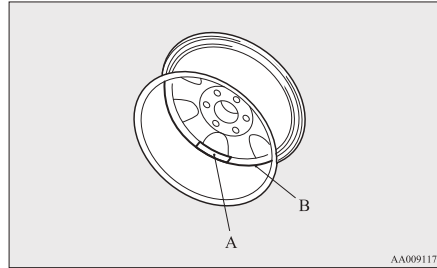

## Tyre rotation

E01001901203

Tyre wear varies with vehicle conditions, road surface conditions and individual driver's driving habits. To equalize the wear and help extend tyre life, it is recommended to rotate the tyres immediately after discovery of abnormal wear, or whenever the wear difference between the front and rear tyres is recognizable.

When rotating tyres, check for uneven wear and damage. Abnormal wear is usually caused by incorrect tyre pressure, improper wheel alignment, out of balance wheel, or severe braking. We recommend you to have it checked to determine the cause of irregular tread wear.

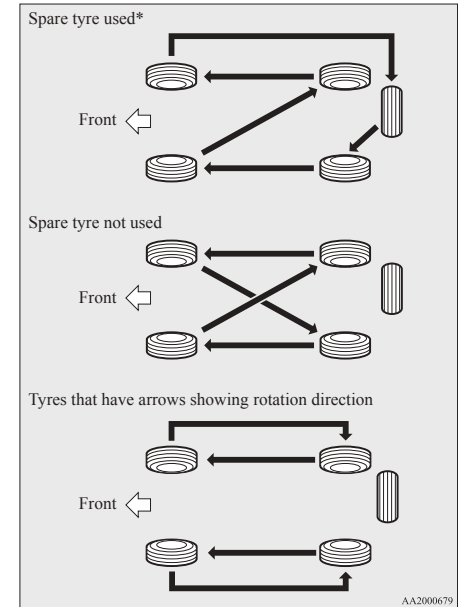

## Tyres

\*- If the spare tyre wheel differs from the standard tyre wheel, do not perform tyre rotation using a spare wheel.

### CAUTION

- If the tyres have arrows (A) indicating the correct direction of rotation, swap the front and rear wheels on the left hand side of the vehicle and the front and rear wheels on the right hand side of the vehicle separately. Keep each tyre on its original side of the vehicle. When fitting the tyres, make sure the arrows point in the direction in which the wheels will turn when the vehicle moves forward. Any tyre whose arrow points in the wrong direction will not perform to its full potential.

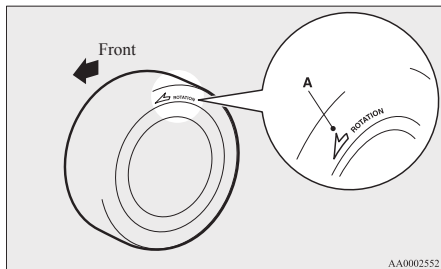

### CAUTION

- Avoid the combined use of different types of tyres.  
Using different types of tyres can affect vehicle performance and safety.

### Snow tyres

E01002001894

The use of snow tyres is recommended for driving on snow and ice. To preserve driving stability, mount snow tyres of the same size and tread pattern on all 4 wheels. Snow tyres worn more than 50% are no longer suitable for use as snow tyres. Snow tyres which do not meet specifications must not be used.

### CAUTION

- Observe permissible maximum speed for your snow tyres and the legal speed limit.
- If your vehicle is equipped with a tyre pressure monitoring system, only MITSUBISHI MOTORS genuine wheels should be used. Use of another type of wheel risks air leaks and sensor damage, as it will not be possible to install the tyre pressure sensor properly. Refer to “Tyre pressure monitoring system (TPMS)” on page 6-48.

### NOTE

- The laws and regulations concerning snow tyres (driving speed, required use, type, etc.) vary. Find out and follow the laws and regulations in the area you intend to drive.
- If flange nuts are used on your vehicle, change to tapered nuts when steel wheels are used.

### Tyre chains

E01002101794

On 4WD vehicles in which the driving power is distributed preferentially to the rear wheels, ensure that the tyre chains are fitted on the rear in accordance with the manufacturer's instructions.

Use only tyre chains which are designed for use with the tyres mounted on the vehicle: use of the incorrect size or type of chain could result in damage to the vehicle body. Before fitting tyre chains, we recommend you to consult a MITSUBISHI MOTORS Authorized Service Point. The max. chain height is as follows.

Tyre size	Wheel size	Max. chain height [mm]
265/65R17 112H 265/65R17 112S	17 x 7 1/2 J	22

Tyre size	Wheel size	Max. chain height [mm]
265/60R18 110H	18 x 7 1/2 J	

The speed limit for tyre chain is 50 km/h (30 mph) and remove the tyre chains as soon as possible on snow free roads.

### ⚠ CAUTION

- As your vehicle is equipped with anti-lock brake system (ABS), in order to ensure that the anti-lock brake system (ABS) will operate correctly in situations where tyre chains have been fitted, drive in “4H”, “4HLc” or “4LLc”.
- Practice fitting the chains before you need them.  
Don't expect help from other people in the cold.
- Choose a clear straight stretch of road where you can pull over and still be seen while you are fitting the chains.
- Do not fit chains before you need them. This will wear out your tyres and the road surface.
- After driving around 100-300 metres, stop and retighten the chains.
- Drive carefully and do not exceed 50 km/h (30 mph). Remember, fitting chains is not going to stop accidents from happening.
- When tyre chains are installed, take care that they do not damage the disc wheel or body.

### ⚠ CAUTION

- An aluminium wheel can be damaged by a tyre chain while driving. When fitting a tyre chain on an aluminium wheel, take care that any part of the chain and fitting cannot be brought into contact with the wheel.
- When installing or removing the tyre chains, take care that hands and other parts of your body are not injured by the sharp edges of the vehicle body.

### 📖 NOTE

- The laws and regulations concerning the use of tyre chains vary. Always follow local laws and regulations.  
In most countries, it is prohibited by law to use tyre chains on roads without snow.

### Parking brake break-in

E01008300010

Break-in the parking brake linings whenever the brake performance of the parking brake is insufficient or whenever the parking brake linings and/or discs are replaced, in order to assure the best brake performance. This procedure is described in the vehicle service manual and can be carried out by a MITSUBISHI MOTORS Authorized Service Point.

### Wiper blade rubber replacement

E01008200208

1. Lift the wiper arm off the windscreen.
2. Pull the wiper blade until its stopper (A) disengages from the hook (B). Then, pull the wiper blade further to remove it.

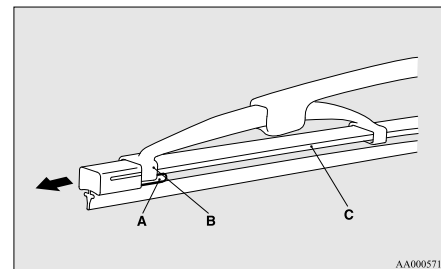

10

### 📖 NOTE

- Do not allow the wiper arm to fall onto the windscreen; it could damage the glass.

3. Attach the retainers (C) to a new wiper blade.

## Wiper blade rubber replacement

Refer to the illustration to ensure that the retainers are correctly aligned as you attach them.

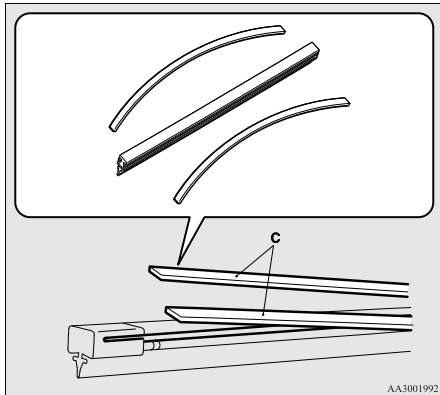

4. Insert the wiper blade into the arm, starting with the opposite end of the blade from the stopper. Make sure the hook (B) is fitted correctly in the grooves in the blade.

### NOTE

- If retainers are not supplied with the new wiper blade, use the retainers from the old blade.

5. Push the wiper blade until the hook (B) engages securely with the stopper (A).

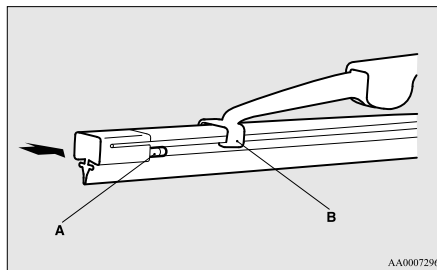

## Rear window wiper blade

1. Lift the wiper arm off the window glass.
2. Pull the wiper blade downward to disengage it from the stopper (A) at the end of the wiper arm. Pull the wiper blade further to remove it.

3. Slide a new wiper blade through the hook (B) on the wiper arm.

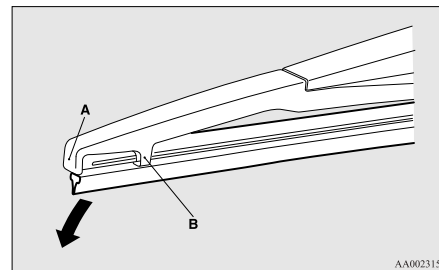

### NOTE

- Do not allow the wiper arm to fall onto the window glass; it could damage the glass.
4. Firmly insert the retainer (C) into the groove (D) in the wiper blade.

Refer to the illustration to ensure that the retainers are correctly aligned as you insert them into the groove.

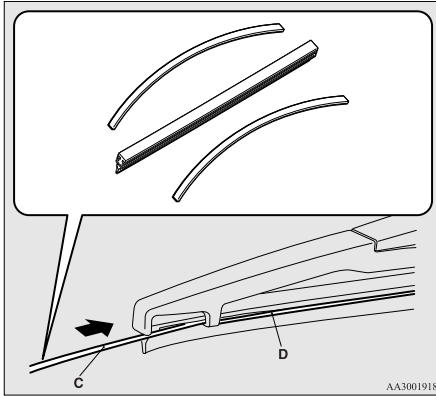

### NOTE

- If a retainer is not supplied with the new wiper blade, use the retainer from the old blade.

## General maintenance

E01002700360

### Fuel, engine coolant, oil and exhaust gas leakage

Look under the body of your vehicle to check for fuel, engine coolant, oil and exhaust gas leaks.

### WARNING

- If you see a suspicious fuel leak or if you smell fuel, do not operate the vehicle; we recommend you to call for assistance.

### Exterior and interior lamp operation

Operate the combination lamp switch to check that all lamps are functioning properly. If the lamps do not illuminate, the probable cause is a blown fuse or defective lamp bulb. Check the fuses first. If there is no blown fuses, check the lamp bulbs.

For information regarding the inspection and replacement of the fuses and the lamp bulbs, refer to “Fuses” on page 10-18 and “Replacement of lamp bulbs” on page 10-23.

If the fuses and bulbs are all OK, we recommend you to have your vehicle checked and repaired.

### Meter, gauge and indicator/warning lamps operation

Run the engine to check the operation of all meters, gauges, and indicator/warning lamps. If there is anything wrong, we recommend you to have your vehicle inspected.

### Hinges and latches lubrication

Check all latches and hinges, and, if necessary, have them lubricated.

### For cold and snowy weather

E01002800299

### Ventilation slots

The ventilation slots in front of the windscreen should be kept clear of leaves or brushed clear after heavy snowfall, so that the operation of the heating and ventilation systems will not be impaired.

### Weatherstripping

To prevent freezing of the weatherstripping on the doors, bonnet, etc., they should be treated with silicone grease.

## Additional equipment

It is a good idea to carry a shovel or a short-handled spade in the vehicle during the winter so that you can clear away snow if you get stranded. A small hand-brush for sweeping snow off the vehicle and a plastic scraper for the windscreen and rear window are also useful.

## Fusible links

E01002900434

The fusible links will melt to prevent a fire if a large current attempts to flow through certain electrical systems.

In case of a melted fusible link, we recommend you to have your vehicle inspected.

For the fusible links, please refer to “Fuse load capacity” on page 10-18.

### WARNING

- **Fusible links must not be replaced by any other device. Failing to fit the correct fusible link may result in fire in the vehicle, property destruction and serious or fatal injuries at any time.**

## Fuses

E01003000849

### Fuse block location

E01007601521

To prevent damage to the electrical system due to short-circuiting or overloading, each individual circuit is provided with a fuse. There are fuse blocks in the passenger compartment and in the engine compartment.

### Passenger compartment

The fuse block in the passenger compartment is located in front of the driver’s seat at the position shown in the illustration.

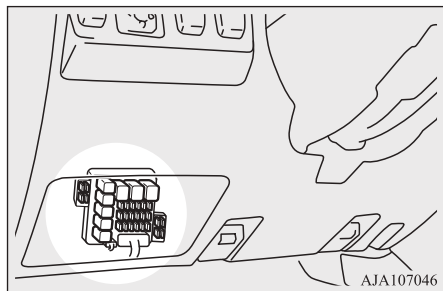

## Engine compartment

In the engine compartment, the fuse blocks are located as shown in the illustration.

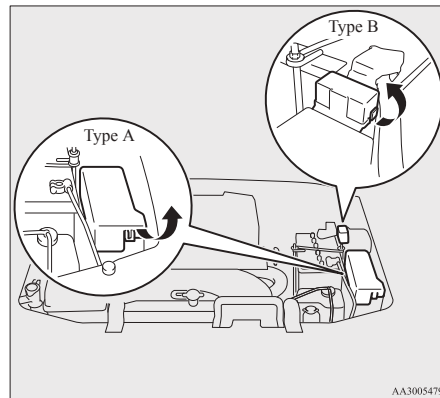

## Fuse load capacity

E01007700105

The fuse capacity and the name of the electrical systems protected by the fuses are indicated on the inside of the lid located at the driver’s leg area and on the inside of the fuse block cover for fuses located in the engine compartment.



## Passenger compartment fuse location table

E01007901957

### NOTE

- Spare fuses are contained in the fuse block lid. Always use a fuse of the same capacity for replacement.

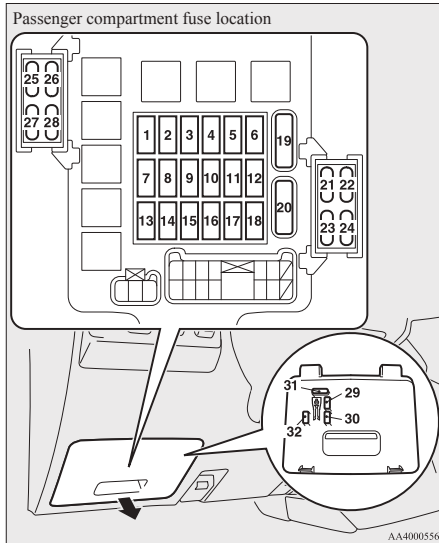

No.	Symbol	Electrical system	Capacity
1		Ignition coil	10 A
2		Gauge	7.5 A
3		Reversing lamp	7.5 A
4		Daytime running lamps	7.5 A
5		Relay	7.5 A
6		Heated door mirror	7.5 A
7	—	—	30 A
8		Engine control	7.5 A
9		Cigarette lighter	15 A
10	—	—	—
11		Outside rear-view mirrors	7.5 A
12		Engine control	7.5 A
13	—	—	—
14		Rear window wiper	15 A

No.	Symbol	Electrical system	Capacity
15		Central door locks	15 A
16		Rear fog lamp	10 A
17	—	—	—
18	—	—	—
19		Heater	30 A
20		Rear window demister	30 A
21		Sunroof	20 A
22		Anti-lock brake system	10 A
23		Heated seat	20 A
24		Approach lamps	10 A
25		Transfer control	10 A
26		ENG/ POWER	10 A
27		Starter motor	10 A
28	—	—	—
29	—	Spare fuse	10 A
30	—	Spare fuse	20 A

No.	Symbol	Electrical system	Capacity
31	—	Spare fuse	30 A
32	—	Spare fuse	25 A

- Some fuses may not be installed on your vehicle, depending on the vehicle model or specifications.
- The table above shows the main equipment corresponding to each fuse.

The fuse block does not contain spare 7.5 A and 15 A fuses. If a fuse of one of these capacities blows, replace it temporarily by borrowing the one that matches from:

**7.5 A: Outside rear-view mirrors**

**15 A: Cigarette lighter**

Replace the borrowed fuse as soon as possible.

## Engine compartment fuse location table

E01008001913

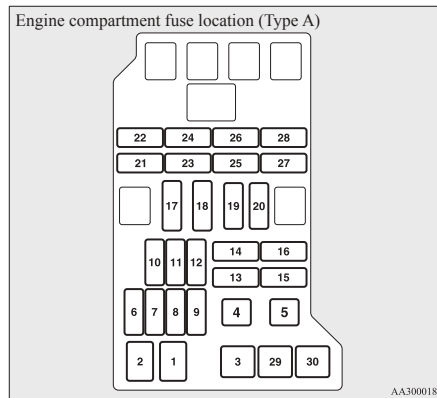

No.	Symbol	Electrical system	Capacity
1		Alternator	140 A *1
2		Fuse (+B)	60 A *1
3		Ignition switch	40 A *1

\*1: Fusible link

\*2: Vehicles without discharge headlamps

\*3: Vehicles with discharge headlamps

No.	Symbol	Electrical system	Capacity
4		Electric window control	30 A *1
5		Engine control	20 A *1
6		Fuel pump	20 A
7		Rear heater	25 A
8		Accessory socket	25 A
9		Fuel line heater	25 A
10		Condenser fan motor	25 A
11		Rear air conditioning	20 A
12		Horn (Theft-alarm system)	15 A
		Wiper de-icer	
13		Horn	10 A
14	A/T	Automatic transmission	20 A

\*1: Fusible link

\*2: Vehicles without discharge headlamps

\*3: Vehicles with discharge headlamps

No.	Symbol	Electrical system	Capacity
15		Hazard warning flasher	10 A
16	STOP	Stop lamps	15 A
17		Radio	10 A
18		Room lamp	15 A
19		Air conditioning	10 A
20		Front fog lamps	15 A
21	—	—	—
22		Windscreen wiper	20 A
23		Tail lamp (right)	7.5 A
24		Tail lamp (left)	7.5 A
25		Headlamp low beam (right)	10 A* <sup>2</sup>
			20 A* <sup>3</sup>
26		Headlamp low beam (left)	10 A* <sup>2</sup>

\*1: Fusible link

\*2: Vehicles without discharge headlamps

\*3: Vehicles with discharge headlamps

No.	Symbol	Electrical system	Capacity
			20 A* <sup>3</sup>
27		Headlamp high-beam (right)	10 A
28		Headlamp high-beam (left)	10 A
29		Audio	40 A* <sup>1</sup>
30		Heater	50 A* <sup>1</sup>

\*1: Fusible link

\*2: Vehicles without discharge headlamps

\*3: Vehicles with discharge headlamps

- Some fuses may not be installed on your vehicle, depending on the vehicle model or specifications.

- The table above shows the main equipment corresponding to each fuse.

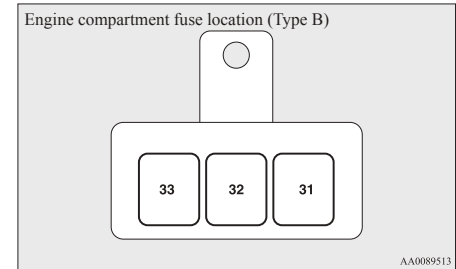

No.	Symbol	Electrical system	Capacity
31		Anti-lock brake system	60 A*
32		Brake system	40 A*
33		Glow relay	80 A*

\*: Fusible link

- Some fuses may not be installed on your vehicle, depending on the vehicle model or specifications.
- The table above shows the main equipment corresponding to each fuse.

## Identification of fuse

E01008100164

Capacity	Colour
7.5 A	Brown
10 A	Red
15 A	Blue
20 A	Yellow (fuse type)/Light blue (fusible link type)
25 A	Transparent
30 A	Green (fuse type)/ Pink (fusible link type)
40 A	Green
50 A	Red
60 A	Yellow
80 A	Black
140 A	Reddish brown

## Fuse replacement

E01007801901

1. Before replacing a fuse, always turn off the electrical circuit concerned and place the ignition switch in the "LOCK" position.
2. Pull the fuse block lid (A) to remove it.

3. Remove the fuse puller (B) from the fuse block lid.

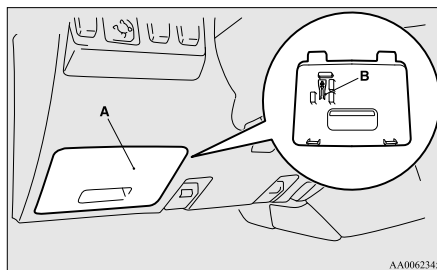

4. The replacement of fuses located in the driver's seat leg area should be performed from the hole of the fuse block lid.

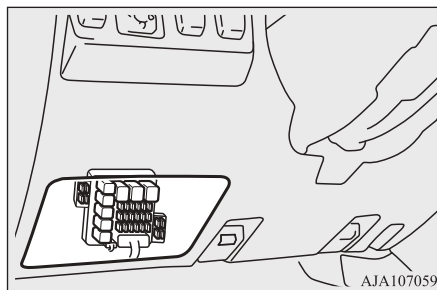

5. Referring to the fuse load capacity table, check the fuse pertaining to the problem.

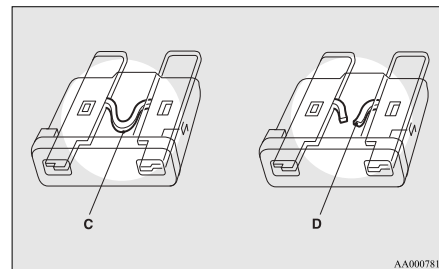

- C- Fuse is OK  
D- Blown fuse

## NOTE

- If any system does not function but the fuse corresponding to that system is normal, there may be a fault in the system elsewhere. We recommend you to have your vehicle checked.

6. Insert a new fuse of the same capacity by using the fuse puller into the same place at the fuse block.

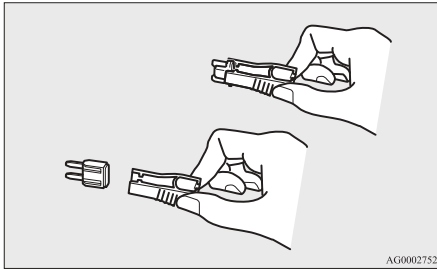

AG0002752

**CAUTION**

- If the newly inserted fuse blows again after a short time, we recommend you to have the electrical system checked to find the cause and rectify it.
- Never use a fuse with a capacity larger than that specified or any substitute, such as wire, foil, etc.; doing so will cause the circuit wiring to heat up and could cause a fire.

**Replacement of lamp bulbs**

E01003102118

Before replacing a bulb, ensure the lamp is off. Do not touch the glass part of the new bulb with your bare fingers; the skin oil left on the glass will evaporate when the bulb gets hot and the vapour will condense on the reflector and dim the surface.

**CAUTION**

- Bulbs are extremely hot immediately after being turned off. When replacing a bulb, wait for it to cool sufficiently before touching it. You could otherwise be burnt.
- Do not install commercially available LED-type bulbs. Commercially available LED-type bulbs could adversely affect the operation of the vehicle, such as by preventing the lights and other vehicle equipment from operating properly.

**NOTE**

- Do not attempt to repair or replace the lamp bulbs other than described in this owner's manual. For repair or replacement, contact a MITSUBISHI MOTORS Authorized Service Point.
- If you are unsure of how to carry out the work as required, we recommend you to consult a specialist.
- Be careful not to scratch the vehicle body when removing a lamp or lens.

**NOTE**

- When it rains or when the vehicle has been washed, the inside of the lens sometimes becomes foggy. This is the same phenomenon as when window glass mists up on a humid day, and does not indicate a functional problem. When the lamp is switched on, the heat will remove the fog. However, if water gathers inside the lamp, we recommend you to have it checked.

**Bulb capacity**

E01003200014

When replacing a bulb, use a new bulb with the same wattage and colour.

**Outside**

E01003304316

**10**

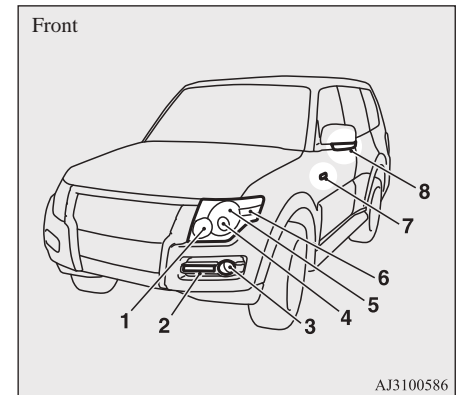

AJ3100586

## Replacement of lamp bulbs

- 1- Headlamps, high-beam: 65 W (H9)
  - 2- Position and Daytime running lamps\*
  - 3- Front fog lamps\*: 55 W (H11)
  - 4- Headlamps, low beam with discharge lamp: 35 W  
Headlamps, low beam without discharge lamp: 55 W (H11)
  - 5- Position lamps\*: 5 W (W5W)
  - 6- Front turn-signal lamps: 21 W (WY21W)
  - 7- Side turn-signal lamps (on fender)\*: 5 W
  - 8- Side turn-signal lamps (on outside rear-view mirror)\*
- Codes in parentheses indicate bulb types.

10

### ⚠ CAUTION

- On vehicles with discharge headlamps, do not attempt to disassemble or repair discharge headlamps, and do not attempt to replace their bulbs. A high voltage is present in the power circuit and in the bulbs and bulb terminals. To avoid the risk of an electric shock, contact by a MITSUBISHI MOTORS Authorized Service Point whenever repair or replacement is necessary.

### 📖 NOTE

- The following lamps are not possible to repair or replace only the bulb.

### 📖 NOTE

If you need to repair or replace these lamp bulbs, contact a MITSUBISHI MOTORS Authorized Service Point.

- Position and Daytime running lamps
- Side turn-signal lamps (on fender)
- Side turn-signal lamps (on outside rear-view mirror)

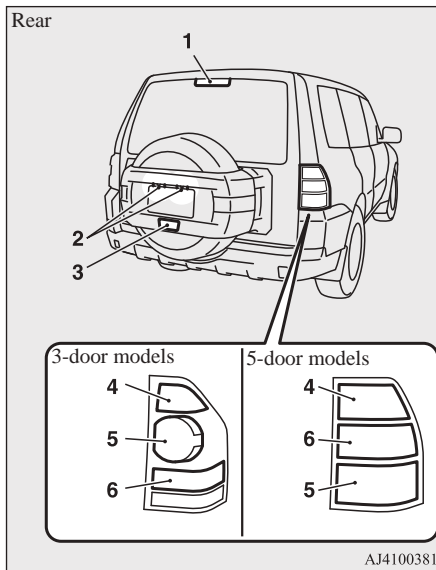

- 1- High-mounted stop lamp (bulb type)\*: 16 W (W16W)

- 2- Licence plate lamps: 5 W (W5W)
- 3- Rear fog lamp: 21 W (W21W)
- 4- Tail lamps\*: 5 W (W5W)
- 5- Rear turn-signal lamps\*: 21 W (WY21W)
- 6- Rear turn-signal lamps\*: 21 W (WY21W)
- 7- Stop and tail lamps\*: 21/5 W (W21/5W)  
Stop lamps\*: 21/5 W (W21/5W)
- 8- Reversing lamps: 21 W (W21W)  
Codes in parentheses indicate bulb types.

### 📖 NOTE

- On vehicles with LED type high-mounted stop lamp, do not attempt to repair or replace it.  
For repair and replacement, contact a MITSUBISHI MOTORS Authorized Service Point.

## Inside

E01003403118

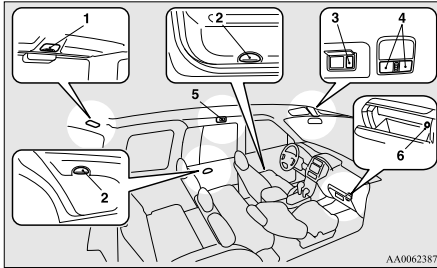

AA0062387

- 1- Luggage compartment lamp: 8 W
- 2- Door courtesy lamps: 3.4 W
- 3- Vanity mirror lamps\* 2 W
- 4- Room & map lamps: 8 W
- 5- Rear personal lamps: 8 W
- 6- Glove box lamp: 1.4 W

## Headlamps

E01003501199

### Replacement of high-beam

1. Remove the bulb and connector assembly (A) by turning it anticlockwise.

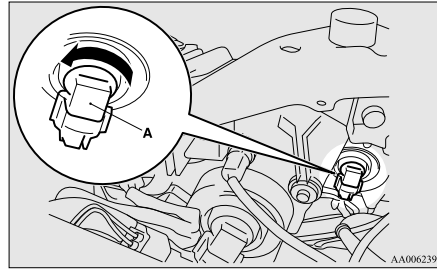

AA0062390

2. Depress the tab (B) on the harness connector and pull the harness connector (C) to remove it.

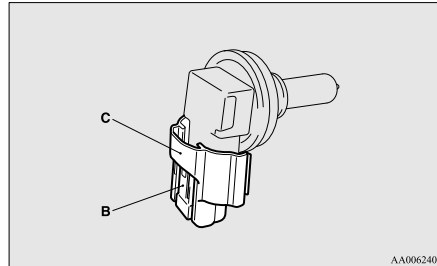

AA0062404

3. To install the bulb, perform the removal steps in reverse.

### Replacement of low beam (except for vehicles with discharge headlamps)

1. Remove the bulb and connector assembly (A) by turning it anticlockwise.

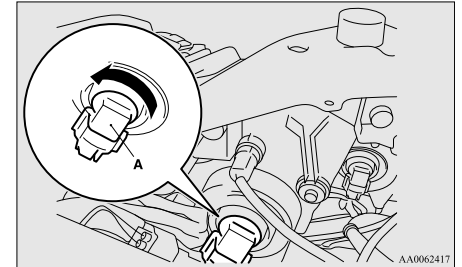

AA0062417

## Replacement of lamp bulbs

2. Depress the tab (B) on the harness connector and pull the harness connector (C) to remove it.

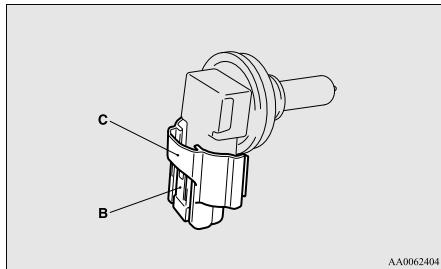

3. To install the bulb, perform the removal steps in reverse.

### CAUTION

- Handle halogen lamp bulbs with care. The gas inside halogen lamp bulbs is highly pressurized, so dropping, knocking, or scratching a halogen lamp bulb can cause it to shatter.
- Never hold the halogen lamp bulb with a bare hand, dirty glove, etc. The oil from your hand could cause the bulb to break the next time the headlamps are operated. If the glass surface is dirty, it must be cleaned with alcohol, paint thinner, etc., and refit it after drying it thoroughly.

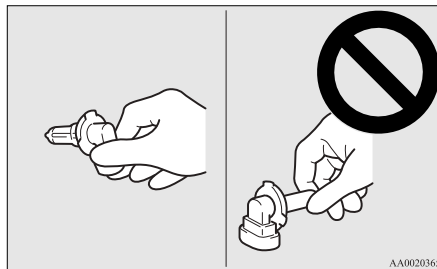

### Position lamps (except for vehicles with discharge headlamps)

1. Turn the bulb socket anticlockwise to remove it.
2. Remove the bulb from the socket by pulling out.

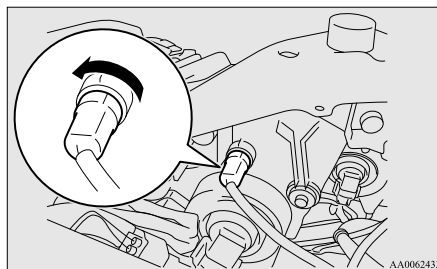

3. To install the bulb, perform the removal steps in reverse.

## Front turn-signal lamps

E01003800733

1. Turn the bulb socket anticlockwise to remove it.
2. Remove the bulb from the socket by pulling out.

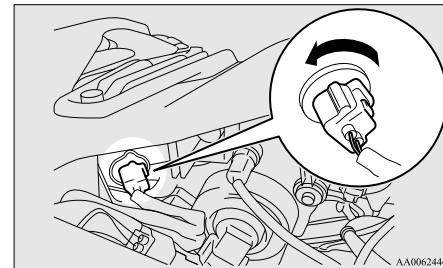

3. To install the bulb, perform the removal steps in reverse.



## Front fog lamps\*

E01004002983

1. Remove the 5 clips (A, C) and screw (B) by following procedures then turn up the cover (D).

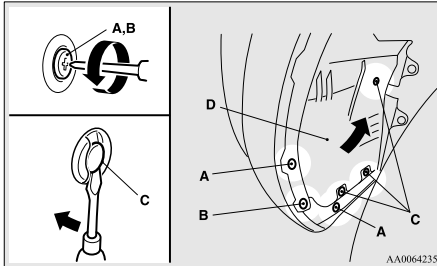

2. Depress the tab (E) on the harness connector (F) and pull the harness connector to remove it.

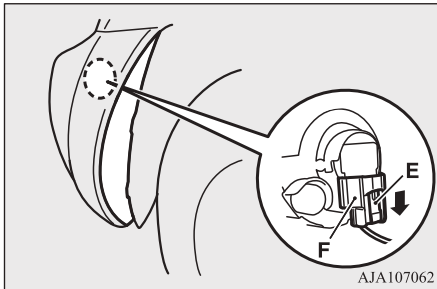

3. Remove the entire socket and bulb assembly (G) by turning it anticlockwise.

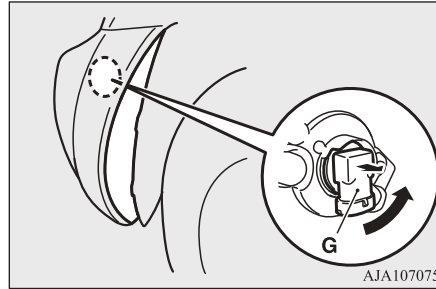

### CAUTION

- Handle halogen lamp bulbs with care. The gas inside halogen lamp bulbs is highly pressurized, so dropping, knocking, or scratching a halogen lamp bulb can cause it to shatter.
- Never hold the halogen lamp bulb with a bare hand, dirty glove, etc. The oil from your hand could cause the bulb to break the next time the fog lamps are operated. If the glass surface is dirty, it must be cleaned with alcohol, paint thinner, etc., and refit it after drying thoroughly.

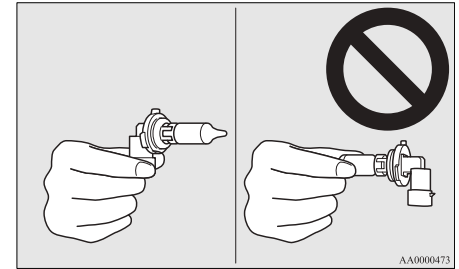

4. To install the bulb, perform the removal steps in reverse.

### NOTE

- When refitting the clips (H and I) of the cover, push the pin (J).

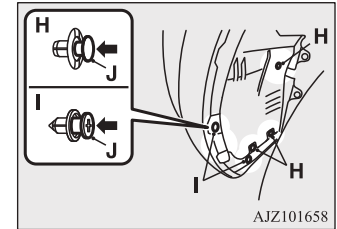

10

## Rear combination lamps

E01004200659

### On corner side

1. Remove the screws that hold the lamp unit.
2. Slide the lamp unit out sideways to remove it.

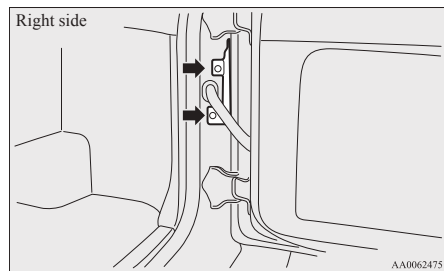
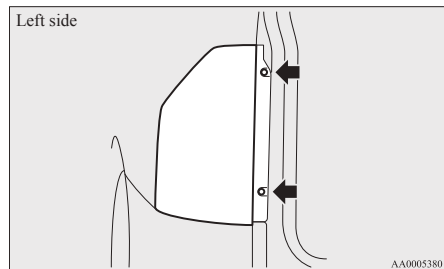

3. Remove the socket and bulb assemblies by turning them anticlockwise. Remove the bulb by pulling it out.

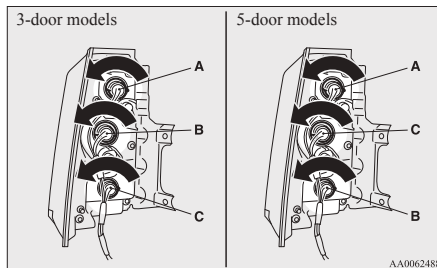

- A- Rear turn-signal lamp\*  
B- Stop and tail lamp\*  
Stop lamp\*  
C- Reversing lamp

4. To install the bulb, perform the removal steps in reverse.

### On bumper\*

1. Remove the lens mounting screws.

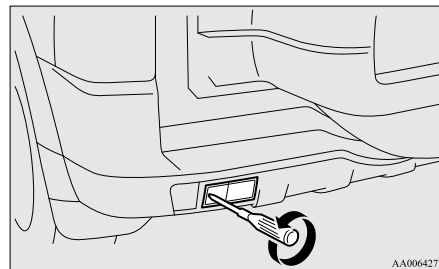

2. Remove the socket and bulb assembly together by turning it anticlockwise, and then remove the bulb by pulling it out.

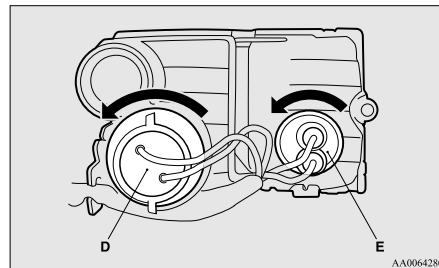

- D- Rear turn-signal lamp  
E- Tail lamp

3. To install the bulb, perform the removal steps in reverse.

## Rear fog lamp

E01004100371

1. Open the spare wheel garnish (A). (Refer to “To remove the spare wheel!” on page 8-10).

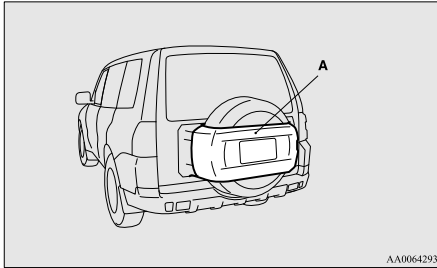

2. Remove the socket and bulb assembly (B) by turning it anticlockwise, and then remove the bulb by pulling it out.

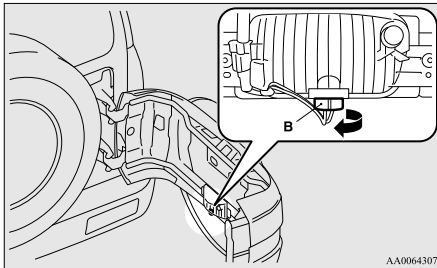

3. To install the bulb, perform the removal steps in reverse.

## High-mounted stop lamp (bulb type)\*

E01004500535

1. Insert a straight blade (or minus) screwdriver with a cloth over at the edge of the cover and pry gently to remove the cover.

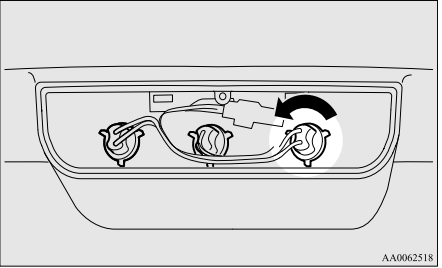
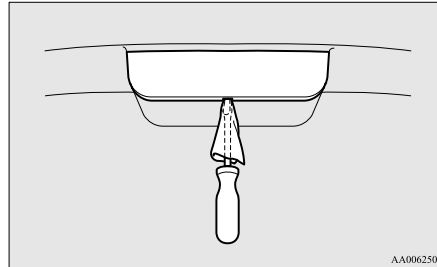

3. To install the bulb, perform the removal steps in reverse.

## Licence plate lamps

E01004602136

1. Remove the mounting screws and remove the lamp unit.

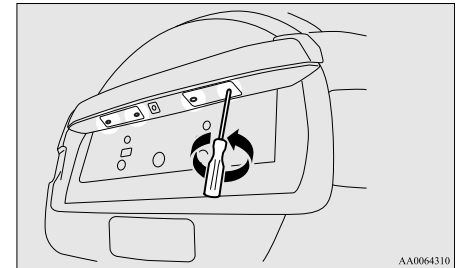

## Replacement of lamp bulbs

2. Remove the socket and bulb assembly (A) together by turning it anticlockwise and then remove the bulb by pulling it out.

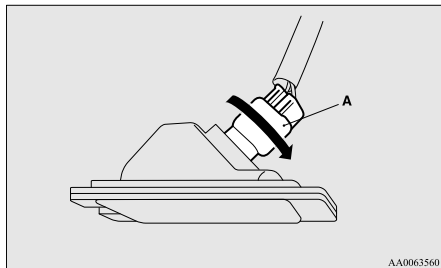

3. To install the bulb, perform the removal steps in reverse.

### NOTE

- When installing the lamp unit, make sure the direction of the lens is installed as shown in the illustration.

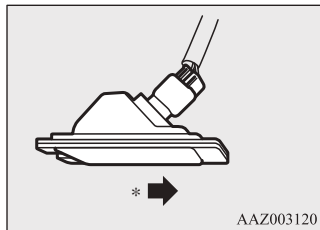

\*: Right side of the vehicle

## Room & map lamps

E01009500093

1. Insert a straight blade (or minus) screwdriver with a cloth over its tip into the lens and pry gently to remove it.

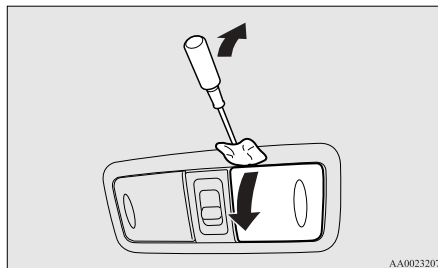

2. Remove the bulb from the lamp holder.
3. To install the bulb, perform the removal steps in reverse.

### NOTE

- When installing the lens, align the tab on the lens with the hole on the vehicle side.

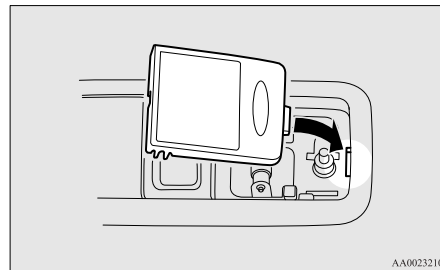

## Rear personal lamps

E01005200252

When replacing a bulb, keep the interior lamp switch in the "O" (OFF) position.

1. Insert a straight blade (or minus) screwdriver with a cloth over its tip into the notch of the lens and pry gently to remove it.

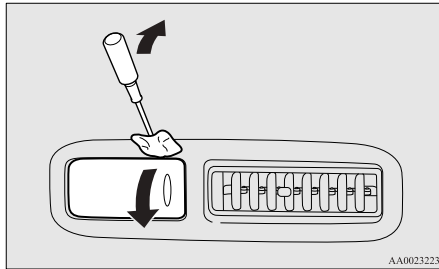

2. Remove the bulb from the lamp holder.
3. To install the bulb, perform the removal steps in reverse.

### NOTE

- When installing the lens, align the tab on the lens with the hole on the vehicle side.

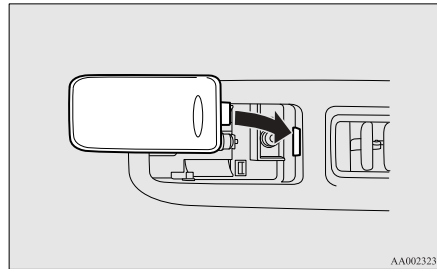

### Luggage compartment lamp

E01005300439

1. Insert a straight blade (or minus) screwdriver with a cloth over its tip into the notch of the lens and pry gently to remove the lens.

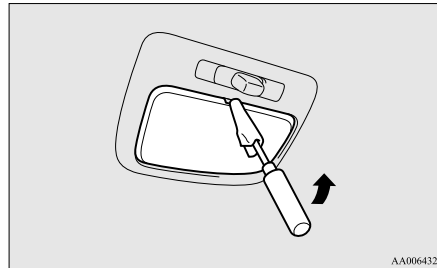

2. Remove the bulb from the lamp holder.
3. To install the bulb, perform the removal steps in reverse.

### NOTE

- When installing the lens, align the tabs on the lens with the holes on the vehicle side.

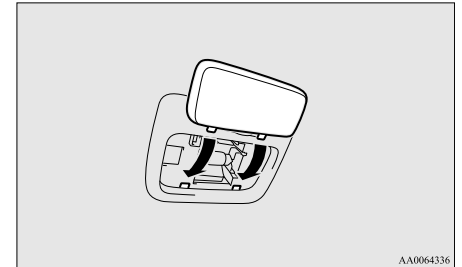

### Door courtesy lamps

E01005400339

1. Insert a straight blade (or minus) screwdriver with a cloth over its tip into the edge of the lens, pry gently to remove the lens.

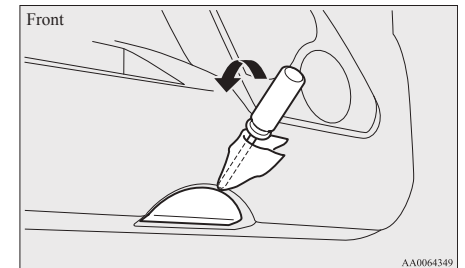

## Replacement of lamp bulbs

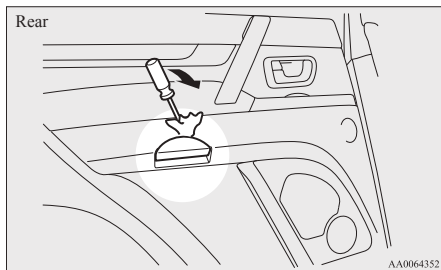

2. Remove the bulb from the lamp holder.
3. To install the bulb, perform the removal steps in reverse.

### NOTE

- When installing the lens, align the 2 tabs on the lens with the notches on the vehicle side.

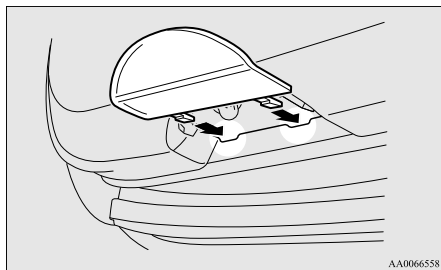

## Glove box lamp

E01006100232

1. Pull out the bulb.

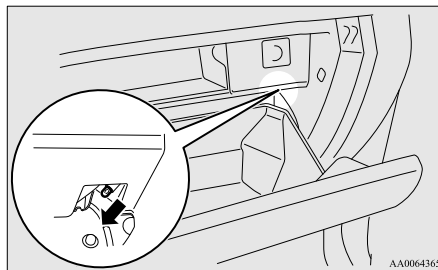

2. To install the bulb, perform the removal steps in reverse.

## Vanity mirror lamps\*

E01006200262

1. Insert a straight blade (or minus) screwdriver with a cloth over its tip into the

notch of the lens and pry gently to remove it.

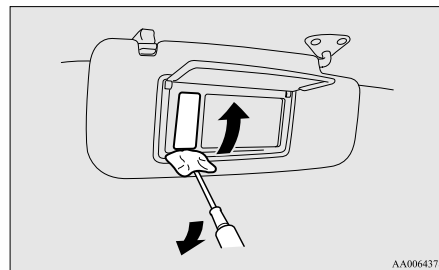

2. Remove the bulb from the lamp holder.
3. To install the bulb, perform the removal steps in reverse.

# *Specifications*

Vehicle labeling.....	11-02
Vehicle dimensions.....	11-04
Vehicle performance.....	11-06
Vehicle weight.....	11-06
Engine specifications.....	11-10
Electrical system.....	11-11
Tyres and wheels.....	11-11
Fuel consumption.....	11-12
Refill capacities.....	11-14

## Vehicle labeling

E01100105180

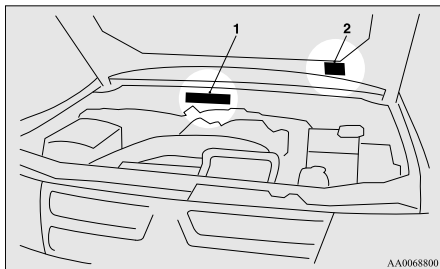

### 1. Vehicle identification number

The vehicle identification number is stamped on the bulkhead as shown in the illustration.

### 2. Vehicle information code plate

The vehicle information code plate is clipped as shown in the illustration.

The plate shows model code, engine model, transmission model and body colour code, etc.

Please use this number when ordering replacement parts.

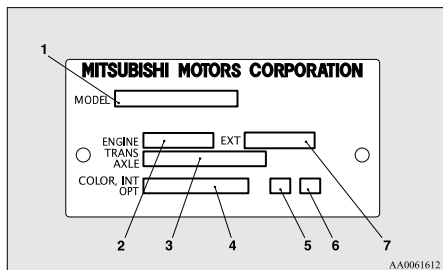

- 1- Model code
- 2- Engine model code
- 3- Transmission model code
- 4- Body colour code
- 5- Interior code
- 6- Option code
- 7- Exterior code

## Vehicle identification number plate (RHD vehicles only)

The vehicle identification number is stamped on the plate riveted to the left front corner of the instrument panel pad. It is visible from outside of the vehicle through the wind-screen.

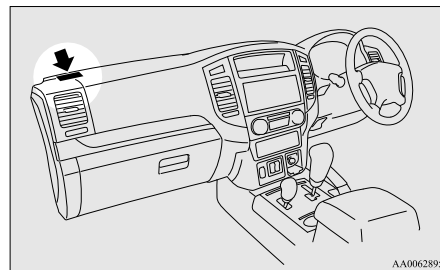



## Engine model/number

The engine model and number are stamped on the engine cylinder block as shown in the illustrations.

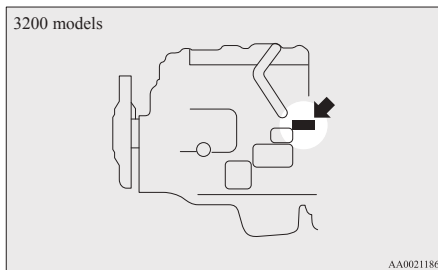
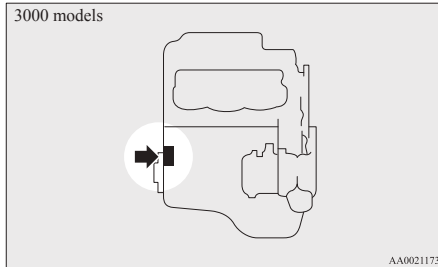

# Vehicle dimensions

E01100204780

## 3-door models

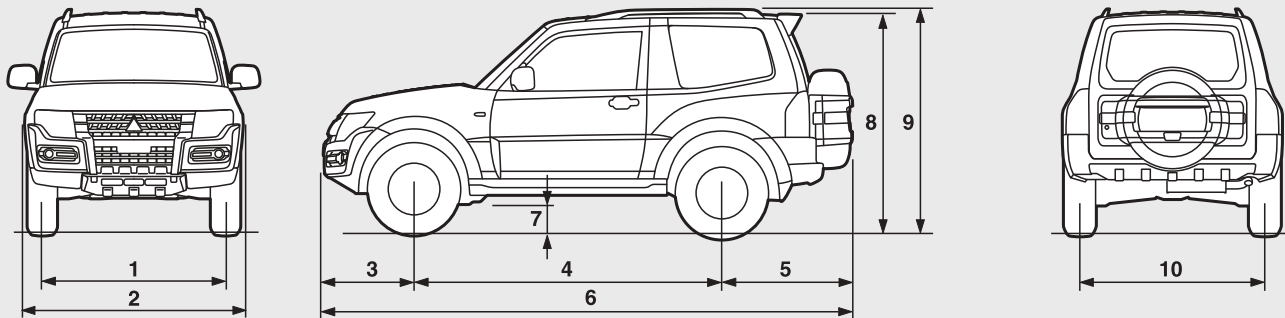

11

## 5-door models

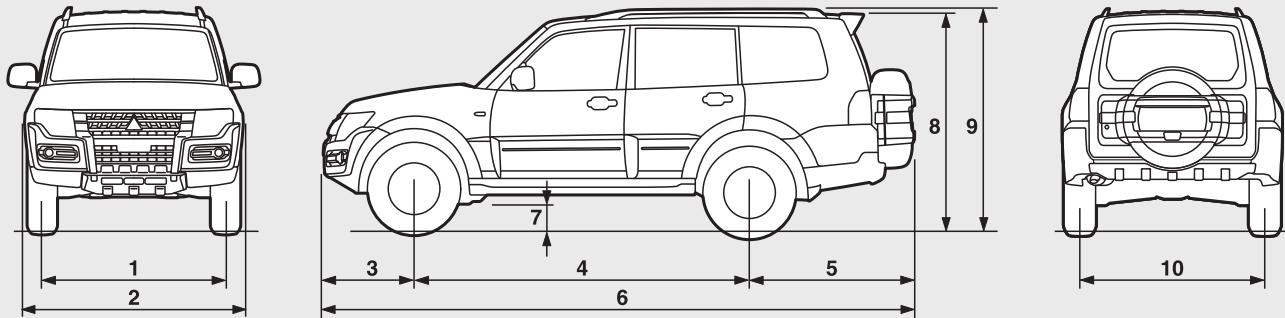

Item			3-door models	5-door models
1	Front track		3000 models	—
			3200 models	1,560 mm
2	Overall width	Without wheelhouse moulding	1,845 mm	
		With wheelhouse moulding	1,875 mm	
3	Front overhang		765 mm	
4	Wheel base		2,545 mm	2,780 mm
5	Rear overhang		1,075 mm	1,355 mm
6	Overall length		4,385 mm	4,900 mm
7	Ground clearance (unladen)		3000 models	—
			3200 models	210 mm
8	Overall height	Without roof rails	3000 models	—
			3200 models	1,840 mm
9	Overall height	With roof rails	3000 models	1,860 mm, 1,870 mm <sup>*1</sup> , 1,880 mm <sup>*2</sup>
			3200 models	1,890 mm, 1,900 mm <sup>*1</sup> , 1,910 mm <sup>*2</sup>
10	Rear track		3000 models	—
			3200 models	1,560 mm

\*1: Vehicles for Russia, Kazakhstan, Belarus and Ukraine

\*2: Vehicles with only front seats or vehicles with only front seats and second seats

Item		3-door models	5-door models
Minimum turning radius	Body	5.7 m	6.1 m

## Vehicle performance

Item	3-door models	5-door models
Wheel	5.3 m	5.7 m

## Vehicle performance

E01100304101

Item	3000 models	3200 models
Maximum speed	175 km/h	180 km/h
Maximum climbing ability (in 1 <sup>st</sup> gear)	35 °	

## Vehicle weight

E01100408344

### 3-door models

11

Kerb weight	Without optional parts	2,085 kg
	With full optional parts	2,185 kg
Maximum gross vehicle weight		2,665 kg, 2,765 kg* <sup>1</sup>
Maximum axle weight	Front	1,250 kg
	Rear	1,600 kg
Maximum towable weight	With brake	2,800 kg, 3,000 kg* <sup>2</sup>

\*1: In case of trailer towing

\*2: Vehicles with 265/60R18 size tyre

	Without brake	750 kg
Maximum trailer-nose weight		120 kg
Maximum roof load	With roof rails	100 kg
	Without roof rails	100 kg, 80 kg* <sup>2</sup>
Seating capacity		5 persons

\*1: In case of trailer towing

\*2: Vehicles with 265/60R18 size tyre

### NOTE

- Trailer specifications indicate the manufacturer's recommendation.

## 5-door models

Item		3000 models	3200 models	
			Vehicles except for Russia, Kazakhstan, Belarus and Ukraine	Vehicles for Russia, Kazakhstan, Belarus and Ukraine
Kerb weight	Without optional parts	2,120 kg	2,265 kg, 2,170 kg <sup>*1</sup> , 2,230 kg <sup>*2</sup> , 2,275 kg <sup>*3</sup>	2,275 kg
	With full optional parts	2,205 kg	2,375 kg, 2,280 kg <sup>*1</sup> , 2,340 kg <sup>*2</sup> , 2,375 kg <sup>*3</sup>	2,380 kg
Maximum gross vehicle weight		2,810 kg, 2,835 kg <sup>*4</sup>	3,030 kg, 3,130 kg <sup>*4</sup>	3,030 kg, 3,120 kg <sup>*4</sup>
Maximum axle weight	Front	1,250 kg	1,330 kg	
	Rear	1,650 kg, 1,765 kg <sup>*4</sup>	1,780 kg, 1,925 kg <sup>*4</sup>	1,780 kg, 1,925 kg <sup>*4</sup>
Maximum towable weight	With brake	1,800 kg	3,300 kg <sup>*5</sup> , 3,500 kg <sup>*6</sup>	3,300 kg
	Without brake	750 kg		
Maximum trailer-nose weight		75 kg	140 kg	135 kg

\*1: Vehicles with only front seats

\*2: Vehicles with only front seats and second seats

\*3: Vehicles complying with the Euro 5 regulation

\*4: In case of trailer towing

\*5: Vehicles with 265/65R17 size tyre

\*6: Vehicles with 265/60R18 size tyre

Item	3000 models	3200 models	
		Vehicles except for Russia, Kazakhstan, Belarus and Ukraine	Vehicles for Russia, Kazakhstan, Belarus and Ukraine
Maximum permissible mass of the coupling device*1*2	—	34 kg	—
Maximum roof load	With roof rails	100 kg	
	Without roof rails	100 kg*5, 80 kg*6	
Seating capacity	7 persons, 2 persons*1, 5 persons*2		

\*1: Vehicles with only front seats

\*2: Vehicles with only front seats and second seats

\*3: Vehicles complying with the Euro 5 regulation

\*4: In case of trailer towing

\*5: Vehicles with 265/65R17 size tyre

\*6: Vehicles with 265/60R18 size tyre

## NOTE

- Trailer specifications indicate the manufacturer's recommendation.

## Engine specifications

E01100604579

Item	3000 models	3200 models	
		Vehicles except for Russia, Kazakhstan, Belarus and Ukraine	Vehicles for Russia, Kazakhstan, Belarus and Ukraine
Engine model	6G72	4M41	
No. of cylinders	6-V (60 °)	4 in line	
Total displacement	2,972 cc	3,200 cc	
Bore	91.1 mm	98.5 mm	
Stroke	76.0 mm	105.0 mm	
Camshaft	Single overhead	Double overhead	
Mixture preparation	Electronic injection	Electronic injection	
Maximum output (EEC net)	128 kW/5,250 r/min <sup>*1</sup> , 130 kW/5,250 r/min <sup>*2</sup>	140 kW/3,500 r/min	138 kW/3,800 r/min
Maximum torque (EEC net)	255 N•m/4,000 r/min <sup>*1</sup> , 259 N•m/4,000 r/min <sup>*2</sup>	441 N•m/2,000 r/min	

\*1: Vehicles complying with the Euro 5 regulation

\*2: Vehicles complying with the Euro 4 regulation



## Electrical system

E01100804441

Item		3000 models	3200 models
Voltage		12 V	
Battery	Type (JIS)	75D23L, 80D26L*	80D26L
	Capacity (5HR)	52 Ah, 55 Ah*	55 Ah
Alternator capacity		120 A	130 A
Spark plug type	NGK	DIFR6C11	—

\*: Optional equipment

## Tyres and wheels

E01100902897

Tyre		265/65R17 112H, 265/65R17 112S	265/60R18 110H
Wheel	Size	17x7 1/2J	18x7 1/2J
	Offset	46 mm	

### NOTE

- Contact your MITSUBISHI MOTORS Authorized Service Point for details on the combination used on your vehicle.

## Fuel consumption

E01101102001

### 3-door models

Model	Combined		Urban conditions		Extra-urban conditions	
	CO <sub>2</sub> (g/km)	Fuel consumption (L/100 km)	CO <sub>2</sub> (g/km)	Fuel consumption (L/100 km)	CO <sub>2</sub> (g/km)	Fuel consumption (L/100 km)
A/T*1	238	9.0	271	10.3	219	8.3
A/T*2	216	8.2	263	10.0	189	7.2

\*1: Vehicles complying with the Euro 6 regulation

\*2: Vehicles complying with the Euro 5 regulation

### 5-door models

#### Vehicles except for Russia, Kazakhstan, Belarus and Ukraine

Model	Combined		Urban conditions		Extra-urban conditions	
	CO <sub>2</sub> (g/km)	Fuel consumption (L/100 km)	CO <sub>2</sub> (g/km)	Fuel consumption (L/100 km)	CO <sub>2</sub> (g/km)	Fuel consumption (L/100 km)
A/T*1	245	9.3	277	10.5	226	8.6
A/T*2	224	8.5	267	10.1	199	7.5
A/T*3	224	8.6	264	10.0	204	7.7

\*1: Vehicles complying with the Euro 6 regulation

\*2: Vehicles complying with the Euro 5 regulation

\*3: Vehicles with only front seat or vehicles with only front seats and second seats

## Vehicles for Russia, Kazakhstan, Belarus and Ukraine

Model	Combined		Urban conditions		Extra-urban conditions	
	CO <sub>2</sub> (g/km)	Fuel consumption (L/100 km)	CO <sub>2</sub> (g/km)	Fuel consumption (L/100 km)	CO <sub>2</sub> (g/km)	Fuel consumption (L/100 km)
3000 models	293	12.7	391	17.0	236	10.2
3200 models	231	8.8	273	10.4	206	7.8

### NOTE

- The values shown above apply to a vehicle on which optional equipment has not been fitted.
- The results given do not express or imply any guarantee of the fuel consumption of the particular vehicle. The vehicle itself has not been tested and there are inevitably differences between individual vehicles of the same model. In addition, this vehicle may incorporate particular modifications. Furthermore, the driver's style and road and traffic conditions, as well as the extent to which the vehicle has been driven and the standard of maintenance, will all affect its fuel consumption.

## Refill capacities

E01101306838

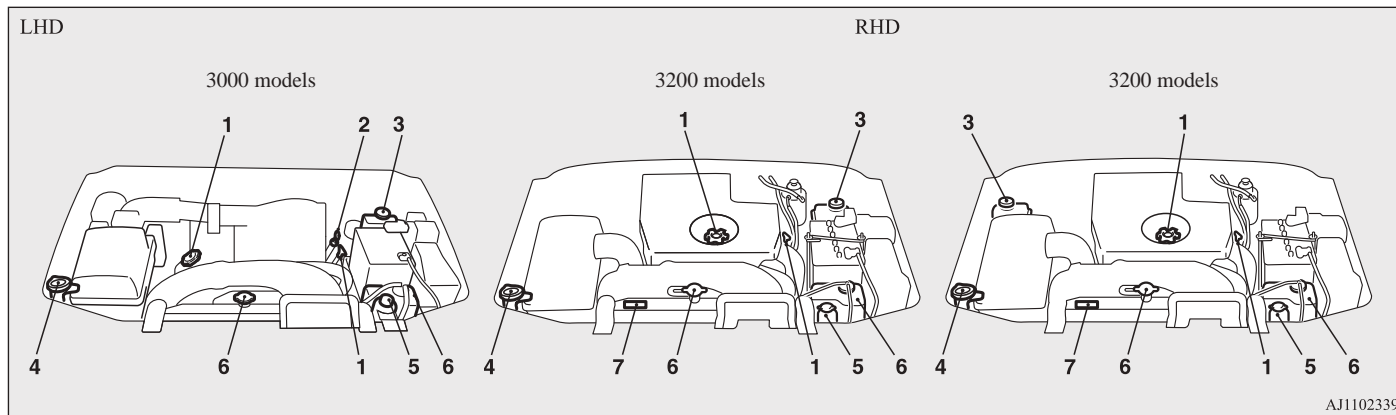

AJ1102339

11

No.	Item		Quantity	Lubricants	
1	Engine oil	3000 models	Oil pan	4.3 litres	Refer to page 10-04.
			Oil filter	0.3 litre	
		3200 models	Oil pan	7.5 litres	
			Oil filter	1.0 litre	
2	Automatic transmission fluid	3000 models	9.7 litres	MITSUBISHI MOTORS GENUINE ATF SPIII	
		3200 models*1	10.9 litres	MITSUBISHI MOTORS GENUINE ATF-PA	

\*1: 3200 models do not have a dipstick.

 **CAUTION**

- For the automatic transmission fluid, use only the MITSUBISHI MOTORS GENUINE ATF. Use of a different fluid could damage the transmission.

No.	Item		Quantity	Lubricants
3	Brake fluid		As required	Brake fluid DOT3 or DOT4
4	Washer fluid	Front	5.1 litres	—
		Rear* <sup>1</sup>	1.4 litres	
5	Power steering fluid		As required	MITSUBISHI MOTORS GENUINE PSF (Power Steering Fluid)
6	Engine coolant (Includes 0.65 litre in the reserve tank)	Without rear air conditioning	9.0 litres	MITSUBISHI MOTORS GENUINE SUPER LONG LIFE COOLANT or equivalent
		With rear air conditioning	10.5 litres	
7	Refrigerant (air conditioning)	Without rear air conditioning	530 - 570 g	HFC-134a, HFO-1234yf* <sup>2</sup>
		With rear air conditioning	850 - 890 g	
8	Transfer oil		2.8 litres	MITSUBISHI MOTORS GENUINE MTF API classification GL-3 SAE 75W-85 or MITSUBISHI MOTORS GENUINE Multi Gear Oil API classification GL-4 SAE 75W-85
9	Differential oil	Front	1.15 litres	MITSUBISHI MOTORS GENUINE Super Hypoid Gear Oil API classification GL-5 SAE 80
		Rear	1.6 litres	

\*<sup>1</sup>: Rear washer fluid container is located on the backdoor. (Refer to “Rear window washer fluid” on page 10-08.)

\*<sup>2</sup>: Vehicles equipped with air conditioning refrigerant (HFO-1234yf) label.

A series of 15 horizontal dashed lines spanning the width of the page, providing a template for handwriting practice.

<hr/>		<hr/>	
<b>A</b>			
Accessory (Installation).....	2-04	Selector lever operation.....	6-15
Accessory socket.....	7-77	Selector lever position.....	6-17
Active stability & traction control (ASTC).....	6-40	Sports mode.....	6-17
Additional equipment.....	10-18	<hr/>	
Air conditioning		<b>B</b>	
Front automatic air conditioning.....	7-03	Backdoor.....	3-09
Important operation tips for the air conditioning.....	7-11	Battery.....	10-09
Rear air conditioning.....	7-09	Charge warning display.....	5-12
Air purifier (with deodorizing function).....	7-11	Discharged battery (Emergency starting).....	8-02
Airbag.....	4-36	Specifications.....	11-11
Caution for installing the child restraint on vehicle with a front passenger's airbag.....	4-25,4-39	Bleeding the fuel system.....	8-06
Antenna.....	7-50	Bluetooth® 2.0 interface.....	7-50
Anti-lock brake system (ABS).....	6-37	Bonnet.....	10-03
Warning lamp.....	6-38	Brake	
Approach lamps.....	3-08	Anti-lock brake.....	6-37
Armrest.....	4-08,4-10	Brake assist system.....	6-36
Ashtray.....	7-75	Braking.....	6-35
Audio		Fluid.....	10-08,11-14
LW/MW/FM radio/CD player.....	7-12	Parking brake.....	6-04
To listen to a disc in the Video Entertainment System.....	7-39	Power brakes.....	6-35
Troubleshooting.....	7-47	Warning lamp.....	5-10
Auto-cutout function.....	7-81	Bulb capacity.....	10-23,10-25
Automatic headlamp levelling.....	5-41	<hr/>	
Automatic high-beam system.....	5-36	<b>C</b>	
Automatic high-beam system warning lamp.....	5-39	Card holder.....	7-75,7-83
Automatic transmission		Cargo loads.....	6-59
Fluid.....	11-14	Catalytic converter.....	10-02
		Cautions on handling of 4-wheel drive vehicles.....	6-33
		Central door locks.....	3-07
		Centre console box.....	7-83
		Centre information display.....	5-12
		<hr/>	
		<b>D</b>	
		Changing a fuse.....	10-22
		Charge warning display.....	5-12
		Check engine warning lamp.....	5-11
		Child restraint.....	4-26
		Caution for installing the child restraint on vehicle with a front passenger's airbag.....	4-25,4-39
		Child-protection rear doors.....	3-08
		Cigarette lighter.....	7-76
		Cleaning	
		Aluminium wheels.....	9-05
		Chrome parts.....	9-05
		Exterior of your vehicle.....	9-03
		Genuine leather.....	9-03
		Interior of your vehicle.....	9-02
		Plastic, vinyl leather, etc.....	9-02
		Polishing.....	9-04
		Sunroof.....	9-06
		Washing.....	9-03
		Waxing.....	9-04
		Coat hooks.....	7-88
		Combination headlamps and dipper switch.....	5-34
		Convenient hook.....	7-87
		Coolant (engine).....	10-06,11-14
		Cruise control.....	6-44
		Cup holder.....	7-85
		Curtain airbag system.....	4-44
		<hr/>	
		<b>D</b>	
		Daytime dipper button.....	5-07
		Daytime running lamps.....	5-35
		Demister (rear window).....	5-50
		Diesel particulate filter (DPF).....	6-14

## Alphabetical index

Diesel preheat indication lamp.....	5-09
Digital clock	
Time Setting.....	7-44
Dimensions.....	11-04
Dipper (High/Low beam change).....	5-36
Door ajar warning lamp.....	5-12
Door courtesy lamps.....	7-81,10-25
Bulb capacity.....	10-25
Replacement.....	10-31
Doors	
Central door locks.....	3-07
Child-protection.....	3-08
Lock and unlock.....	3-06
Driving, alcohol and drugs.....	6-02

## E

Economical driving.....	6-02
Electric window control.....	3-16
Switch.....	3-16
Timer function.....	3-18
Electrical system.....	11-11
Electronic immobilizer (Anti-theft starting system).....	3-03
Emergency starting.....	8-02
Engine	
Coolant.....	10-06,11-14
MIVEC.....	6-13
Number.....	11-03
Oil.....	10-04,11-14
Overheating.....	8-04
Specifications.....	11-10
Used engine oils safety instructions and disposal information.....	2-06
Water temperature gauge.....	5-06

Exterior and interior lamp operation.....	10-17
---	-------

## F

Fluid	
Automatic transmission fluid.....	11-14
Brake fluid.....	10-08,11-14
Engine coolant.....	10-06,11-14
Power steering fluid.....	10-09,11-14
Washer fluid.....	10-07,11-14
Fog lamp switch.....	5-43
Foot lamps and ceiling lamp.....	7-80
For cold and snowy weather.....	10-17
Front automatic air conditioning.....	7-03
Front fog lamps	
Bulb capacity.....	10-23
Indication lamp.....	5-09
Replacement.....	10-27
Switch.....	5-43
Front passenger's airbag OFF indication lamp.....	4-40
Front seats.....	4-05
Front turn-signal lamps	
Bulb capacity.....	10-23
Replacement.....	10-26
Fuel consumption.....	11-12
Fuel	
Filling the fuel tank.....	2-03
Fuel filter indication lamp.....	5-10
Fuel gauge.....	5-05
Fuel selection.....	2-02
Low fuel warning lamp.....	5-06
Modification/alterations to the electrical or fuel systems.....	2-05
Tank capacity.....	2-03
Fuses.....	10-18

Fusible links.....	10-18
--------------------	-------

## G

Gauges.....	5-02,5-08
General maintenance.....	10-17
General vehicle data.....	11-04
Genuine parts.....	2-05
Glove box.....	7-82
Glove box lamp	
Bulb capacity.....	10-25
Replacement.....	10-32

## H

Hazard warning flasher switch.....	5-42
Hazard warning indication lamps.....	5-09
HDMI port.....	7-74
Head restraints.....	4-12
Headlamp levelling.....	5-40
Headlamp washer switch.....	5-48
Headlamps	
Bulb capacity.....	10-23
Headlamp flasher.....	5-39
Replacement.....	10-25
Switch.....	5-34
Heated mirror.....	6-10
Heated seats.....	4-09
High-beam indication lamp.....	5-09
High-mounted stop lamp (bulb type)	
Bulb capacity.....	10-23
Replacement.....	10-29
Hinges and latches lubrication.....	10-17



Horn switch..... 5-50

**I**

If the vehicle breaks down..... 8-02

Ignition switch..... 6-10

Indication and warning lamps..... 5-08

Indication lamps..... 5-09

Inside rear-view mirror..... 6-07

Inspection and maintenance following  
rough road operation..... 6-33

Installation of accessories..... 2-04

Installation position for warning triangle..... 7-88

Instruments..... 5-02

Interior lamp switch..... 7-78

Interior lamps..... 7-78

**J**

Jack handle..... 8-09

Storage..... 8-09

Jack..... 8-07

Storage..... 8-07

Jump starting (Emergency starting)..... 8-02

**K**

Keyless entry system..... 3-04

Keys..... 3-02

**L**

Labeling..... 11-02

Lamp monitor buzzer..... 5-36

Lamps (headlamps, fog lamp, etc.)  
auto-cutout function..... 5-35

Leakage (Fuel, engine coolant, oil  
and exhaust gas)..... 10-17

Licence plate lamps  
Bulb capacity..... 10-23  
Replacement..... 10-29

Link System..... 7-50

Low fuel warning lamp..... 5-06

Lubricants..... 11-14

Luggage compartment lamp..... 7-80  
Bulb capacity..... 10-25  
Replacement..... 10-31

Luggage floor box..... 7-84

Luggage hooks..... 7-88

**M**

Making a flat seat..... 4-20

Making a luggage area..... 4-13

Mirror  
Inside rear-view mirror..... 6-07  
Outside rear-view mirrors..... 6-08

MIVEC engine..... 6-13

Modification/alterations to the electrical  
or fuel systems..... 2-05

**N**

NOx trap catalyst..... 6-14

**O**

Odometer..... 5-02

Oil pressure warning lamp..... 5-12

Oil  
Differential oil..... 11-14  
Engine oil..... 10-04  
Transfer oil..... 11-14  
Operation under adverse driving conditions..... 8-19  
Outside rear-view mirrors..... 6-08  
Overheating..... 8-04

**P**

Parking..... 6-05

Parking brake..... 6-04

Position lamps  
Bulb capacity..... 10-23  
Indication lamp..... 5-09  
Replacement..... 10-26

Power brakes..... 6-35

Power steering  
Fluid..... 10-09, 11-14  
System..... 6-39

Precautions to observe when using  
wipers and washers..... 5-49

Pregnant women restraint..... 4-25

Puncture (Tyre changing)..... 8-09

**R**

Rear air conditioning..... 7-09

Rear combination lamps  
Bulb capacity..... 10-23  
Replacement..... 10-28

Rear differential lock..... 6-26

Rear fog lamp

## Alphabetical index

Bulb capacity.....	10-23
Indication lamp.....	5-09
Replacement.....	10-29
Switch.....	5-43
Rear personal lamp	
Bulb capacity.....	10-25
Replacement.....	10-30
Rear personal lamps.....	7-79
Rear shelf (3-door models).....	7-86
Rear side/quarter window.....	3-18
Rear turn-signal lamps	
Bulb capacity.....	10-23
Replacement.....	10-28
Rear window demister switch.....	5-50
Rear-view camera.....	6-56
Rear-view mirror	
Inside.....	6-07
Outside.....	6-08
Refill capacities.....	11-14
Removal of water from the fuel filter.....	8-06
Replacement of lamp bulbs.....	10-23
Reversing lamps	
Bulb capacity.....	10-23
Replacement.....	10-28
Reversing sensor system.....	6-52
Roof carrier precaution.....	6-60
Room & map lamps.....	7-79
Bulb capacity.....	10-25
Replacement.....	10-30
Running-in recommendations.....	6-04

---

## S

---

Safe driving techniques.....	6-03
------------------------------	------

Seat belt.....	4-21
Adjustable seat belt anchor.....	4-23
Child restraint.....	4-26
Force limiter system.....	4-26
Inspection.....	4-36
Pregnant women restraint.....	4-25
Pretensioner.....	4-25
Rear/second, third seat belt storage.....	4-24
Seat belt reminder/warning lamp.....	4-23
Seats	
Adjustment.....	4-05
Armrest.....	4-08,4-10
Front seats.....	4-05
Head restraints.....	4-12
Heated seats.....	4-09
Lumbar support.....	4-08
Making a flat seat.....	4-20
Making a luggage area.....	4-13
Rear seats.....	4-09
Seat arrangement.....	4-03
Second seats.....	4-09
Third seat.....	4-11
Security alarm system.....	3-11
Service precaution.....	10-02
Service reminder.....	5-02,5-03
Side airbag system.....	4-43
Side box.....	7-84
Snow tyres.....	10-14
Spark plug.....	11-11
Specifications.....	11-02
Starting.....	6-12
Steering	
Power steering fluid.....	10-09,11-14
Power steering system.....	6-39
Steering wheel height adjustment.....	6-06

Steering wheel lock.....	6-12
Stop lamps	
Bulb capacity.....	10-23
Replacement.....	10-28
Storage spaces.....	7-82
Sun visors.....	7-74
Sunglasses holder.....	7-84
Sunroof.....	3-19
Lock switch.....	3-19
Safety mechanism.....	3-20
Sunshade.....	3-21
Super select 4WD II.....	6-21
Supplemental restraint system.....	4-36
Caution for installing the child restraint on vehicle with a front passenger's airbag.....	4-25,4-39
How the Supplemental Restraint System works.....	4-37
Servicing.....	4-47
Warning lamp.....	4-47

---

## T

---

Tachometer.....	5-02
Tail lamps	
Bulb capacity.....	10-23
Replacement.....	10-28
Tank capacity.....	2-03
Third seat.....	4-11
Time Setting.....	7-44
Tools.....	8-07
Storage.....	8-07
Towing.....	8-16
Trailer towing.....	6-60

---

Transfer oil.....	11-14
Transmission	
Automatic transmission.....	6-15
Tripmeter.....	5-02
Turn-signal indication lamps.....	5-09
Turn-signal lever.....	5-42
Tyre pressure monitoring system.....	6-48
Tyres.....	10-11
How to change a tyre.....	8-09
Inflation pressures.....	10-11
Rotation.....	10-13
Size (tyre and wheel).....	11-11
Snow tyres.....	10-14
Spare wheel information.....	8-10
Tyre chains.....	10-14

---

**U**

---

USB port.....	7-71
Used engine oils safety instructions and disposal information.....	2-06

---

**V**

---

Vanity mirror.....	7-74
Vanity mirror lamps	
Bulb capacity.....	10-25
Replacement.....	10-32
Vehicle care precautions.....	9-02
Vehicle dimensions.....	11-04
Vehicle identification number.....	11-02
Vehicle identification number plate.....	11-02
Vehicle information code plate.....	11-02
Vehicle labeling.....	11-02

Vehicle performance.....	11-06
Vehicle weight.....	11-06
Ventilators.....	7-02

---

**W**

---

Warning lamps.....	5-10
Washer	
Fluid.....	10-07,11-14
Switch.....	5-41,5-44,5-48
Washing.....	9-03
Water temperature gauge.....	5-06
Waxing.....	9-04
Weatherstripping.....	10-17
Weight.....	11-06
Wheel condition.....	10-12
Wheel	
Specification.....	11-11
Wiper de-icer switch.....	5-49
Wiper	
Rear window.....	5-48
Switch.....	5-44
Wiper blades.....	10-15



## EC-Declaration of Conformity

Manufacturer / responsible person Johnson Controls Interior Experience  
Address: 915 E. 32nd Street  
Holland Michigan USA 49423

Declares that the product:  
type: BlueTooth Hands Free for Automotive  
model: 1872669\_1872721  
intended use/: Hands Free cellphone interface to vehicle audio system

complies with the essential requirements of Article 3 of the R&TTE 1999/5/EC Directive, if used as intended and that the following standards has been applied:

- 1 Safety (Article 3.1.a of the R&TTE Directive)  
applied standard(s) EN 60 950-1 issue 2001  
± A 11 issue 2004  
EN 50371 issue 2008
- 2 Electromagnetic compatibility (Article 3.1.b of the R&TTE Directive)  
applied standard(s) ETSI EN 301 489-1 V1.6.1 issue 2005-09  
ETSI EN 301 489-17 V1.2.1 issue 2002-08
- 3 Efficient use of the radio frequency spectrum (Article 3.2 of the R&TTE Directive)  
applied standard(s) ETSI EN 300 328 V1.7.1 issue 2006-10

Holland, MI USA 8/30/2009  
(Place and date of the declaration of conformity)

John D. Spencer  
(Name and signature)

Česky [Czech]:	Toto zařízení je v souladu se základními požadavky a ostatními odpovídajícími ustanoveními Směrnice 1999/5/EC.
Dansk	Denne udstyr er i overensstemmelse med de væsentlige krav og andre relevante bestemmelser i Direktiv 1999/5/EF.
Deutsch	Dieses Gerät entspricht den grundlegenden Anforderungen und den weiteren entsprechenden Vorgaben der Richtlinie 1999/5/EU.
[German]:	See seade vastab direktiivi 1999/5/EU olulistele nõuetele ja teistele asjakohastele sätetele.
[Estonian]:	This equipment is in compliance with the essential requirements and other relevant provisions of Directive 1999/5/EC.
English:	
Español	Este equipo cumple con los requisitos esenciales así como con otras disposiciones de la Directiva 1999/5/CE.
[Spanish]:	Αυτός ο εξοπλισμός είναι σε συμμόρφωση με τις ουσιώδεις απαιτήσεις και άλλες σχετικές διατάξεις της Οδηγίας 1999/5/ΕΚ.
[Greek]:	Cet appareil est conforme aux exigences essentielles et aux autres dispositions pertinentes de la Directive 1999/5/EC.
[French]:	Þetta tæki er samkvæmt grunnkröfum og öðrum viðeigandi ákvæðum Tilskipunar 1999/5/EC.
[Icelandic]:	Questo apparato è conforme ai requisiti essenziali ed agli altri principi sanciti dalla Direttiva 1999/5/CE.
[Italian]:	Sī iekārta atbilst Direktīvas 1999/5/EK būtiskajām prasībām un citiem ar to saistītajiem noteikumiem.
[Latvian]:	Šis įrenginys tenkina 1999/5/EB Direktyvos esminius reikalavimus ir kitas šios direktyvos nuostatas.
[Lithuanian]:	Dit apparaat voldoet aan de essentiële eisen en andere van toepassing zijnde bepalingen van de Richtlijn 1999/5/EC.
Nederlands	Dan I-apparatet huva konformi mal-higiðjet essenzjali u I-provedimentini I-ohra rilevanti tad-Direttiva 1999/5/EC.
[Dutch]:	[Maltese]:
Malti	Ez a készülék teljesíti az alapvető követelményeket és más 1999/5/EK irányelvben meghatározott vonatkozó rendelkezéseket.
[Hungarian]:	Denne udstyret er i samsvar med de grundlæggende krav og andre relevante bestemmelser i EU-direktiv 1999/5/EF.
Norsk	Urządzenie jest zgodne z ogólnymi wymaganiami oraz szczególnymi warunkami określonymi Dyrektywą UE: 1999/5/EC.
[Norwegian]:	Este equipamento está em conformidade com os requisitos essenciais e outras provisões relevantes da Directiva 1999/5/EC.
Português	Ta naprava je skladna z bistvenimi zahtevami in ostalimi relevantnimi pogoji Direktive 1999/5/EC.
[Portuguese]:	[Slovenian]:
Slovensko	Toto zariadenie je v zhode so základnými požiadavkami a inými príslušnými nariadeniami direktív: 1999/5/EC.
[Slovak]:	Tämä laite täyttää direktiivin 1999/5/EY olematset vaatimukset ja on siinä asetettujen muiden laitteita koskevien määräysten mukainen.
Suomi	Denna utrustning är i överensstämmelse med de väsentliga kraven och andra relevanta bestämmelser i Direktiv 1999/5/EC.
[Finnish]:	[Swedish]:
Svenska	

# OMRON

OMRON Automotive Electronics Co., Ltd.

6348 NENJO-ZAKA, OKUSA, KOMAKI-CITY,

AICHI 465-0802 JAPAN

PHONE: +81-565-78-6139

FAX: +81-565-78-7059

## DECLARATION of CONFORMITY

We, OMRON Automotive Electronics Co. Ltd. hereby declare, at our sole responsibility, that the following product conforms to the Essential Requirements of the Radio and Telecommunications Terminal Equipment Directive 1999/5/EC in accordance with the tests conducted to the appropriate requirements of the relevant standards, as listed herewith.

**Product** : Transmitter / Receiver / TPMS Receiver  
**Model/ Type Number** : **G8D-635M-A**  
: Receiver : G8C-527M  
: TPMS Receiver : GGM-M002

Directive and Standards used as appropriate:  
Model

Standard used for conformity

**G8D-635M-A**  
R&TTE Directive EN 60065: 2002 + Amd.1: 2006 + Amd.11: 2008 +  
(Article 3.1(a) Safety) Amd.2:2010 + Amd.12:2011

R&TTE Directive EN 301 489-1 V1.9.2:2011-09  
(Article 3.1(b) EMC) EN 301 489-3 V1.6.1:2013-08

R&TTE Directive EN 300 220-1 V2.4.1:2012-05  
(Article 3.2 Spectrum) EN 300 220-2 V2.4.1:2012-05

**G8C-527M**  
R&TTE Directive EN 60065: 2002 + Amd.1: 2006 + Amd.11: 2008 +  
(Article 3.1(a) Safety) Amd.2:2010 + Amd.12:2011

R&TTE Directive EN 301 489-1 V1.9.2:2011-09  
(Article 3.1(b) EMC) EN 301 489-3 V1.6.1:2013-08

R&TTE Directive EN 300 220-1 V2.4.1:2012-05  
(Article 3.2 Spectrum) EN 300 220-2 V2.4.1:2012-05

**GGM-M002**  
R&TTE Directive EN 60065: 2002 + Amd.1: 2006 + Amd.11: 2008 +  
(Article 3.1(a) Safety) Amd.2:2010 + Amd.12:2011

R&TTE Directive EN 301 489-1 V1.9.2:2011-09  
(Article 3.1(b) EMC) EN 301 489-3 V1.6.1:2013-08

R&TTE Directive EN 300 220-1 V2.4.1:2012-05  
(Article 3.2 Spectrum) EN 300 220-2 V2.4.1:2012-05

Receiver Category of this radio equipment is Category 3, which is referred to EN 300 220-1.

Signature : *Kanako Tennoko*

Name : Kanako Tennoko

Title and position : Manager  
Development Management Section  
Development Strategy Department

Date : April 20, 2016

CE 1731

CE 0891

[Czech]	OMRON Automotive Electronics Co. Ltd. tímto prohlašuje, že tento [ G8C-930M*, G8C-931M*, G8C-932M*, G8C-937M*, GHR-M004*, G8D-640M-KEY-E*, G8D-649M*, G8D-640M-RAM-E*, G8D-640M-ECU* ] G8D-841M-ECU-E*, G8D-841M-WCM-E*, G8D-841M-WCM-PD*, GHR-M001*, G8D-640M-KEY-E*, G8D-649M*, G8D-640M-RAM-E*, G8D-640M-ECU* ] je ve shodě se základními požadavky a dalšími příslušnými ustanoveními směrnice 1999/5/ES.
[Danish]	Undertegnede OMRON Automotive Electronics Co. Ltd. erklærer herved, at følgende udstyr [ G8C-930M*, G8C-931M*, G8C-932M*, G8C-937M*, GHR-M004*, G8D-640M-KEY-E*, G8D-649M*, G8D-640M-RAM-E*, G8D-640M-ECU* ] G8D-841M-ECU-E*, G8D-841M-WCM-E*, G8D-841M-WCM-PD*, GHR-M001*, G8D-640M-KEY-E*, G8D-649M*, G8D-640M-RAM-E*, G8D-640M-ECU* ] overholder de væsentligste krav og øvrige relevante krav i direktiv 1999/5/EF.
[German]	Hiermit erklärt OMRON Automotive Electronics Co. Ltd., dass sich das Gerät [ G8C-930M*, G8C-931M*, G8C-932M*, G8C-937M*, GHR-M004*, G8D-640M-KEY-E*, G8D-649M*, G8D-640M-RAM-E*, G8D-640M-ECU* ] G8D-841M-ECU-E*, G8D-841M-WCM-E*, G8D-841M-WCM-PD*, GHR-M001*, G8D-640M-KEY-E*, G8D-649M*, G8D-640M-RAM-E*, G8D-640M-ECU* ] in Übereinstimmung mit den grundlegenden Anforderungen und den übrigen einschlägigen Bestimmungen der Richtlinie 1999/5/EG befindet.
[Estonian]	Käesolevaga kinnitab OMRON Automotive Electronics Co. Ltd. esmalt, [ G8C-930M*, G8C-931M*, G8C-932M*, G8C-937M*, GHR-M004*, G8D-640M-KEY-E*, G8D-649M*, G8D-640M-RAM-E*, G8D-640M-ECU* ] G8D-841M-ECU-E*, G8D-841M-WCM-E*, G8D-841M-WCM-PD*, GHR-M001*, G8D-640M-KEY-E*, G8D-649M*, G8D-640M-RAM-E*, G8D-640M-ECU* ] vastavust direktiivi 1999/5/EE põhiolemetele ja nimetatud direktiivis tulenevatele leiastele asjakohastele sätetele.
[English]	Hereby OMRON Automotive Electronics Co. Ltd., declares that this [ G8C-930M*, G8C-931M*, G8C-932M*, G8C-937M*, GHR-M004*, G8D-640M-KEY-E*, G8D-649M*, G8D-640M-RAM-E*, G8D-640M-ECU* ] G8D-841M-ECU-E*, G8D-841M-WCM-E*, G8D-841M-WCM-PD*, GHR-M001*, G8D-640M-KEY-E*, G8D-649M*, G8D-640M-RAM-E*, G8D-640M-ECU* ] is in compliance with the essential requirements and other relevant provisions of Directive 1999/5/EC.
[Spanish]	Por medio de la presente OMRON Automotive Electronics Co. Ltd. declara que el [ G8C-930M*, G8C-931M*, G8C-932M*, G8C-937M*, GHR-M004*, G8D-640M-KEY-E*, G8D-649M*, G8D-640M-RAM-E*, G8D-640M-ECU* ] G8D-841M-ECU-E*, G8D-841M-WCM-E*, G8D-841M-WCM-PD*, GHR-M001*, G8D-640M-KEY-E*, G8D-649M*, G8D-640M-RAM-E*, G8D-640M-ECU* ] cumple con los requisitos esenciales y cualesquiera otras disposiciones aplicables o exigibles de la Directiva 1999/5/CE.
[Greek]	ΜΕ ΤΗΝ ΠΑΡΟΥΣΑ ΟΜΡΟΝ Automotive Electronics Co. Ltd. ΔΗΛΩΝΕΙ ΟΤΙ [ G8C-930M*, G8C-931M*, G8C-932M*, G8C-937M*, GHR-M004*, G8D-640M-KEY-E*, G8D-649M*, G8D-640M-RAM-E*, G8D-640M-ECU* ] G8D-841M-ECU-E*, G8D-841M-WCM-E*, G8D-841M-WCM-PD*, GHR-M001*, G8D-640M-KEY-E*, G8D-649M*, G8D-640M-RAM-E*, G8D-640M-ECU* ] ΣΥΜΜΟΡΦΩΝΕΤΑΙ ΠΡΟΣ ΤΙΣ ΟΥΣΙΩΔΕΙΣ ΑΠΑΙΤΗΣΕΙΣ ΚΑΙ ΤΙΣ ΛΟΠΙΤΕΣ ΣΥΝΤΙΚΕΣ ΔΙΑΤΑΞΕΙΣ ΤΗΣ ΟΔΗΓΙΑΣ 1999/5/ΕΚ.
[French]	Par la présente OMRON Automotive Electronics Co. Ltd. déclare que l'appareil [ G8C-930M*, G8C-931M*, G8C-932M*, G8C-937M*, GHR-M004*, G8D-640M-KEY-E*, G8D-649M*, G8D-640M-RAM-E*, G8D-640M-ECU* ] G8D-841M-ECU-E*, G8D-841M-WCM-E*, G8D-841M-WCM-PD*, GHR-M001*, G8D-640M-KEY-E*, G8D-649M*, G8D-640M-RAM-E*, G8D-640M-ECU* ] est conforme aux exigences essentielles et aux autres dispositions pertinentes de la directive 1999/5/CE.
[Italian]	Con la presente OMRON Automotive Electronics Co. Ltd. dichiara che questo [ G8C-930M*, G8C-931M*, G8C-932M*, G8C-937M*, GHR-M004*, G8D-640M-KEY-E*, G8D-649M*, G8D-640M-RAM-E*, G8D-640M-ECU* ] G8D-841M-ECU-E*, G8D-841M-WCM-E*, G8D-841M-WCM-PD*, GHR-M001*, G8D-640M-KEY-E*, G8D-649M*, G8D-640M-RAM-E*, G8D-640M-ECU* ] è conforme ai requisiti essenziali ed alle altre disposizioni pertinenti stabilite dalla direttiva 1999/5/CE.
[Latvian]	Ar šo OMRON Automotive Electronics Co. Ltd. deklarē, ka [ G8C-930M*, G8C-931M*, G8C-932M*, G8C-937M*, GHR-M004*, G8D-640M-KEY-E*, G8D-649M*, G8D-640M-RAM-E*, G8D-640M-ECU* ] G8D-841M-ECU-E*, G8D-841M-WCM-E*, G8D-841M-WCM-PD*, GHR-M001*, G8D-640M-KEY-E*, G8D-649M*, G8D-640M-RAM-E*, G8D-640M-ECU* ] atbilst Direktīvas 1999/5/EK būtiskajām prasībām un citiem ar to saistītajiem noteikumiem.
[Lithuanian]	Suo OMRON Automotive Electronics Co. Ltd. deklaruoją, kad šis [ G8C-930M*, G8C-931M*, G8C-932M*, G8C-937M*, GHR-M004*, G8D-640M-KEY-E*, G8D-649M*, G8D-640M-RAM-E*, G8D-640M-ECU* ] G8D-841M-ECU-E*, G8D-841M-WCM-E*, G8D-841M-WCM-PD*, GHR-M001*, G8D-640M-KEY-E*, G8D-649M*, G8D-640M-RAM-E*, G8D-640M-ECU* ] atitinka esminius reikalavimus ir kitas 1999/5/EE Direktivos nuostatas.
[Dutch]	Hierbij verklaart OMRON Automotive Electronics Co. Ltd. dat het toestel [ G8C-930M*, G8C-931M*, G8C-932M*, G8C-937M*, GHR-M004*, G8D-640M-KEY-E*, G8D-649M*, G8D-640M-RAM-E*, G8D-640M-ECU* ] G8D-841M-ECU-E*, G8D-841M-WCM-E*, G8D-841M-WCM-PD*, GHR-M001*, G8D-640M-KEY-E*, G8D-649M*, G8D-640M-RAM-E*, G8D-640M-ECU* ] in overeenstemming is met de essentiële eisen en de andere relevante bepalingen van richtlijn 1999/5/EG.
[Maltese]	Hejnhekk, OMRON Automotive Electronics Co. Ltd., jiddeklara li dan [ G8C-930M*, G8C-931M*, G8C-932M*, G8C-937M*, GHR-M004*, G8D-640M-KEY-E*, G8D-649M*, G8D-640M-RAM-E*, G8D-640M-ECU* ] G8D-841M-ECU-E*, G8D-841M-WCM-E*, G8D-841M-WCM-PD*, GHR-M001*, G8D-640M-KEY-E*, G8D-649M*, G8D-640M-RAM-E*, G8D-640M-ECU* ] jikkonforma mal-hiġġiet essenzjali u ma provvedimenti oħrajn relevanti li hemm fid-Direttiva 1999/5/EC.
[Hungarian]	Az alírott: OMRON Automotive Electronics Co. Ltd. nyilatkozik, hogy a [ G8C-930M*, G8C-931M*, G8C-932M*, G8C-937M*, GHR-M004*, G8D-640M-KEY-E*, G8D-649M*, G8D-640M-RAM-E*, G8D-640M-ECU* ] G8D-841M-ECU-E*, G8D-841M-WCM-E*, G8D-841M-WCM-PD*, GHR-M001*, G8D-640M-KEY-E*, G8D-649M*, G8D-640M-RAM-E*, G8D-640M-ECU* ] megfelel a vonatkozó alapvető követelményeknek és az 1999/5/EC irányelv egyéb előírásainak.
[Polish]	[OMRON Automotive Electronics Co. Ltd.] niniejszym oświadcza, że [ G8C-930M*, G8C-931M*, G8C-932M*, G8C-937M*, GHR-M004*, G8D-640M-KEY-E*, G8D-649M*, G8D-640M-RAM-E*, G8D-640M-ECU* ] G8D-841M-ECU-E*, G8D-841M-WCM-E*, G8D-841M-WCM-PD*, GHR-M001*, G8D-640M-KEY-E*, G8D-649M*, G8D-640M-RAM-E*, G8D-640M-ECU* ] spełnia zasadnicze wymogi oraz inne istotne postanowienia dyrektywy 1999/5/EC.



[Portuguese]	OMRON Automotive Electronics Co. Ltd. declara que este [ G8C-930M*, G8C-9311M*, G8C-932M*, G8C-937M*, GHR-M004*, GGM-M006*, G8D-644M-KEY-E*, G8D-646M*, G8D-649M*, G8D-640M-RAM-E*, G8D-640M-ECU*, G8D-841M-WCM-E*, G8D-841M-WCM-PD*, GHR-M001*, GGM-M002*, GGM-M003*, J166E, G8D-635M-A*, G8C-527M* ] está conforme com os requisitos essenciais e outras disposições da Directiva 1999/5/CE.
[Slovenian]	OMRON Automotive Electronics Co. Ltd. izjavlja, da je ta [ G8C-930M*, G8C-9311M*, G8C-932M*, G8C-937M*, GHR-M004*, GGM-M006*, G8D-644M-KEY-E*, G8D-646M*, G8D-649M*, G8D-640M-RAM-E*, G8D-640M-ECU*, G8D-841M-WCM-E*, G8D-841M-WCM-PD*, GHR-M001*, GGM-M002*, J166E, G8D-635M-A*, G8C-527M* ] v skladu z bistvenimi zahtevami in ostalimi relevantnimi določili direktive 1999/5/ES.
[Slovak]	OMRON Automotive Electronics Co. Ltd. týmto vyhlasuje, že [ G8C-930M*, G8C-9311M*, G8C-932M*, G8C-937M*, GHR-M004*, GGM-M006*, G8D-644M-KEY-E*, G8D-646M*, G8D-649M*, G8D-640M-RAM-E*, G8D-640M-ECU*, G8D-841M-WCM-E*, G8D-841M-WCM-PD*, GHR-M001*, GGM-M002*, J166E, G8D-635M-A*, G8C-527M* ] typickým ľahostojným výrobkom, ktorý spĺňa požiadavky a všetky príslušné ustanovenia Smernice 1999/5/ES.
[Finnish]	OMRON Automotive Electronics Co. Ltd. vakuuttaa täten että [ G8C-930M*, G8C-9311M*, G8C-932M*, G8C-937M*, GHR-M004*, GGM-M006*, G8D-644M-KEY-E*, G8D-646M*, G8D-649M*, G8D-640M-RAM-E*, G8D-640M-ECU*, G8D-841M-WCM-E*, G8D-841M-WCM-PD*, GHR-M001*, GGM-M002*, J166E, G8D-635M-A*, G8C-527M* ] tyypillinen laite on direktiivin 1999/5/EY oheislistan vaatimusten ja sitä koskevien direktiivin muiden ehtojen mukainen.
[Swedish]	Härmed intygar OMRON Automotive Electronics Co. Ltd. att denna [ G8C-930M*, G8C-9311M*, G8C-932M*, G8C-937M*, GHR-M004*, GGM-M006*, G8D-644M-KEY-E*, G8D-646M*, G8D-649M*, G8D-640M-RAM-E*, G8D-640M-ECU*, G8D-841M-WCM-E*, G8D-841M-WCM-PD*, GHR-M001*, GGM-M002*, J166E, G8D-635M-A*, G8C-527M* ] står i överensstämmelse med de väsentliga egenskapskrav och övriga relevanta bestämmelser som framgår av direktiv 1999/5/EG.
[Icelandic]	Hér með lýsir OMRON Automotive Electronics Co. Ltd. yfir því að [ G8C-930M*, G8C-9311M*, G8C-932M*, G8C-937M*, GHR-M004*, GGM-M006*, G8D-644M-KEY-E*, G8D-646M*, G8D-649M*, G8D-640M-RAM-E*, G8D-640M-ECU*, G8D-841M-WCM-E*, G8D-841M-WCM-PD*, GHR-M001*, GGM-M002*, J166E, G8D-635M-A*, G8C-527M* ] er í samræmi við grunnkröfur og aðrar kröfur, sem gefnar eru í liðskapnum 1999/5/EC.
[Norwegian]	OMRON Automotive Electronics Co. Ltd. erklærer herved at utstyret [ G8C-930M*, G8C-9311M*, G8C-932M*, G8C-937M*, GHR-M004*, GGM-M006*, G8D-644M-KEY-E*, G8D-646M*, G8D-649M*, G8D-640M-RAM-E*, G8D-640M-ECU*, G8D-841M-WCM-E*, G8D-841M-WCM-PD*, GHR-M001*, GGM-M002*, J166E, G8D-635M-A*, G8C-527M* ] er i samsvar med de grunnleggende krav og øvrige relevante krav i direktiv 1999/5/EF.
[Turkish]	İşbu belge ile OMRON Automotive Electronics Co. Ltd., bu [ G8C-930M*, G8C-9311M*, G8C-932M*, G8C-937M*, GHR-M004*, GGM-M006*, G8D-644M-KEY-E*, G8D-646M*, G8D-649M*, G8D-640M-RAM-E*, G8D-640M-ECU*, G8D-841M-WCM-E*, G8D-841M-WCM-PD*, GHR-M001*, GGM-M002*, J166E, G8D-635M-A*, G8C-527M* ] in 1999/5/EC Yönetmeliği esas gereksinimlerine ve diğer şartlarına uygun olduğunu beyan eder.
[Romanian]	Noi OMRON Automotive Electronics Co. Ltd. declaram că aparatul [ G8C-930M*, G8C-9311M*, G8C-932M*, G8C-937M*, GHR-M004*, GGM-M006*, G8D-644M-KEY-E*, G8D-646M*, G8D-649M*, G8D-640M-RAM-E*, G8D-640M-ECU*, G8D-841M-WCM-E*, G8D-841M-WCM-PD*, GHR-M001*, GGM-M002*, J166E, G8D-635M-A*, G8C-527M* ] este în conformitate cu cerințele esențiale și cu alte prevederi relevante ale Hotărârii Guvernului nr.881/2003 și Directivei 1999/5/EC.
[Bulgarian]	С настоящия документ OMRON Automotive Electronics Co. Ltd. декларира, че [ G8C-930M*, G8C-9311M*, G8C-932M*, G8C-937M*, GHR-M004*, GGM-M006*, G8D-644M-KEY-E*, G8D-646M*, G8D-649M*, G8D-640M-RAM-E*, G8D-640M-ECU*, G8D-841M-WCM-E*, G8D-841M-WCM-PD*, GHR-M001*, GGM-M002*, J166E, G8D-635M-A*, G8C-527M* ] е в съгласие с основните изисквания и съответните положения на Директива 1999/5/EC.
[Croatian]	Ovime, OMRON Automotive Electronics Co. Ltd. izjavljuje da je ovaj [ G8C-930M*, G8C-9311M*, G8C-932M*, G8C-937M*, GHR-M004*, GGM-M006*, G8D-644M-KEY-E*, G8D-646M*, G8D-649M*, G8D-640M-RAM-E*, G8D-640M-ECU*, G8D-841M-WCM-E*, G8D-841M-WCM-PD*, GHR-M001*, GGM-M002*, J166E, G8D-635M-A*, G8C-527M* ] sukladno s bitnim zahtjevima i drugim relevantnim odredbama direktive 1999/5/EZ.
[Macedonian]	Co ova, OMRON Automotive Electronics Co. Ltd. objavljuje leka ovoj [ G8C-930M*, G8C-9311M*, G8C-932M*, G8C-937M*, GHR-M004*, GGM-M006*, G8D-644M-KEY-E*, G8D-646M*, G8D-649M*, G8D-640M-RAM-E*, G8D-640M-ECU*, G8D-841M-WCM-E*, G8D-841M-WCM-PD*, GHR-M001*, GGM-M002*, J166E, G8D-635M-A*, G8C-527M* ] je u skladu sa osnovnim zahtjevima i drugim relevantnim odredbama Direktive 1999/5/EC.
[Georgian]	ამით, OMRON Automotive Electronics Co.Ltd. აცხადებს, რომ არჩენს [ G8C-930M*, G8C-9311M*, G8C-932M*, G8C-937M*, GHR-M004*, GGM-M006*, G8D-644M-KEY-E*, G8D-646M*, G8D-649M*, G8D-640M-RAM-E*, G8D-640M-ECU*, G8D-841M-WCM-E*, G8D-841M-WCM-PD*, GHR-M001*, GGM-M002*, J166E, G8D-635M-A*, G8C-527M* ] შესაბამისად 1999/5/EC დირექტივს განსაკუთრებით იმ მომენტებზე, სადა მოხდა შესაბამისი პრობები.
[Albanian]	Nëpërmjet kësaj, OMRON Automotive Electronics Co.Ltd., deklaron se kjo [ G8C-930M*, G8C-9311M*, G8C-932M*, G8C-937M*, GHR-M004*, GGM-M006*, G8D-644M-KEY-E*, G8D-646M*, G8D-649M*, G8D-640M-RAM-E*, G8D-640M-ECU*, G8D-841M-WCM-E*, G8D-841M-WCM-PD*, GHR-M001*, GGM-M002*, J166E, G8D-635M-A*, G8C-527M* ] është në përputhje me kërkesat themelore dhe dispozitat e tjera përkatesë të Direktivës 1999/5/EC.
[Montenegrin]	Ovim, OMRON Automotive Electronics Co.Ltd. izjavljuje da je ova [ G8C-930M*, G8C-9311M*, G8C-932M*, G8C-937M*, GHR-M004*, GGM-M006*, G8D-644M-KEY-E*, G8D-646M*, G8D-649M*, G8D-640M-RAM-E*, G8D-640M-ECU*, G8D-841M-WCM-E*, G8D-841M-WCM-PD*, GHR-M001*, GGM-M002*, J166E, G8D-635M-A*, G8C-527M* ] u skladu sa osnovnim zahtjevima i drugim relevantnim odredbama Direktive 1999/5/EZ.

Наименование изделия и модель:

передатчик, система отпирания дверей автомобиля без ключа, G8D-635M-A



Модуль управления беспроводной, G8D-646M

Изготовитель и марка изделия: OMRON Automotive Electronics. Co. Ltd. , OMRON

Страна изготовления: Япония

Справки об изделии:

Название компании: OMRON Automotive Electronics Co. Ltd.

Адрес: 6368 Narijizaka, Okusa, Komaki-city, Aichi-Prefecture 485-0802 Japan

Подразделение: Development Management Section, Development Strategy Department

е-мейл: oae\_depaninsho@oae.omron.co.jp

ТЕЛ.: +81(568) 78 6159 ФАКС: +81(568) 78 7159

0VWX17E1

Представительство в России по сертификации:

ООО ЮниСервис (UniServices LLC)

111123, г. Москва, улица 1-я Владимирская 20А, 1-й этаж, стр. 1,  
кабинет 17

ИНН7718832495 , ОКПО 69691874

Тел/факс: +7 (495) 517 93 95

сведения об ограничениях в использовании технического средства с учетом его предназначения для работы в жилых, коммерческих и производственных зонах: Ничего особенного

## Чтобы узнать месяц и год производства изделия:

МОДЕЛЬ: G8D-635M-A

Открыть ключ и вынуть модуль передатчика. Серийный номер изготовителя (7 цифр) указан на его обратной стороне.

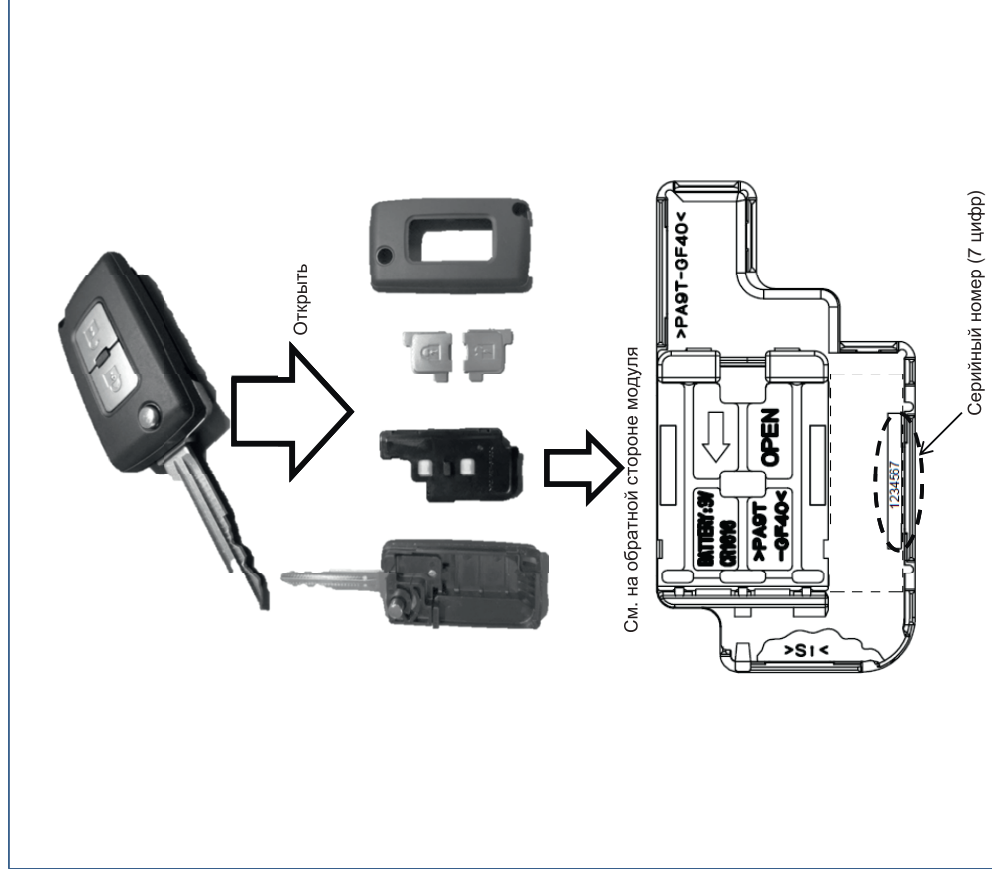

Внешний вид ключа и модуля передатчика могут слегка отличаться от указанных на фотографиях и рисунке.

## МОДЕЛЬ: G8D-646M

Покалуйста, обратитесь этикетку оборудования и прочитать номер под штрих-кодом. Пятый и шестой номера из слева указывают производство месяцев и следующие две цифры обозначают две последние цифры выпуска Год. (например '1013' указывать Октябрь 2013)

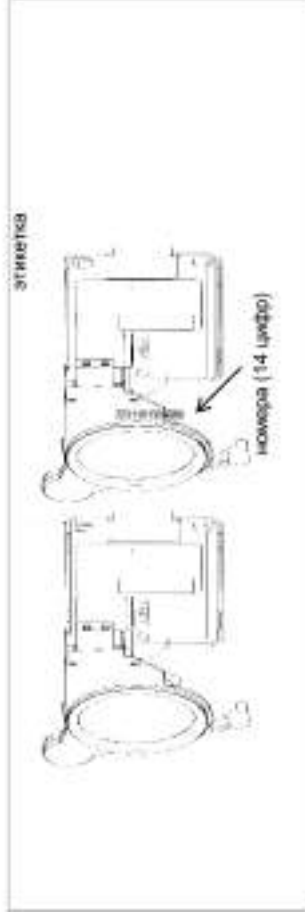

(ответственность за содержание данной статьи: ONRON Automotive Electronics, Co. Ltd.)

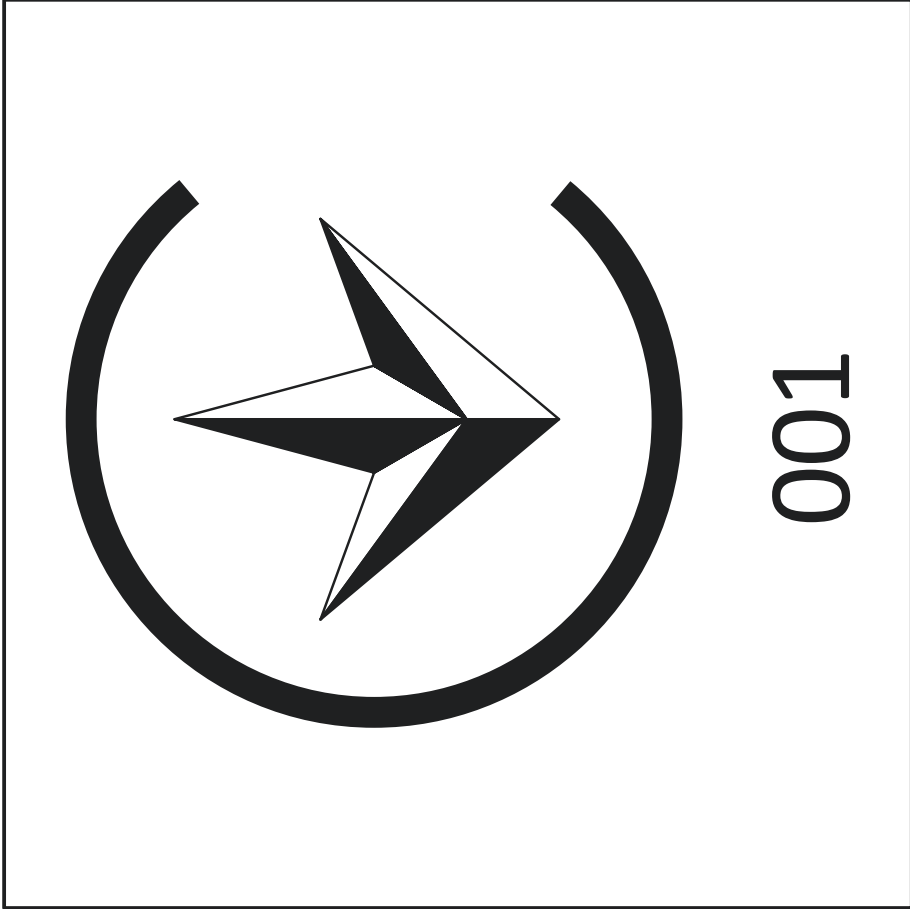

AJM104687



Continental Automotive GmbH - Postfach 100 853 - 35009 Hagenbach

Josef Lohr  
I BS 703 CFRF WM  
Phone +49 (941) 790-8942  
Fax +49 (941) 790-998942  
josef.lohr@continental-corporation.com

Date	Your message dated	Our Reference	Your reference
June 06, 2012	TGID MMC		

**Declaration of Conformity in accordance with Directive 1999/5/EC (R&TE Directive)**

Manufacturer: Continental Automotive GmbH  
Address: Siemensstrasse 12  
D-93056 Regensburg  
Germany

Product type designation: S180150004

Intended use: Tire Pressure Monitoring Sensor

The product mentioned above complies with the essential requirements and other relevant provisions of Directive 1999/5/EC, when used for its intended purpose.

Health and safety pursuant to Art. 3(1)(a):

Applied standard(s):  
EN 60 950-1:2006 + A11:2009  
+ A1:2010 + A12:2011  
EN 62 479:2010

Electromagnetic compatibility pursuant to Art. 3(1)(b):

Applied standard(s):  
EN 301 489-1 V1.8.1 (2008-04)  
EN 301 489-3 V1.4.1 (2002-08)

Efficient use of spectrum pursuant to Art. 3(2):

Applied standard(s):  
EN 300 220-1 V2.3.1 (2010-02)  
EN 300 220-2 V2.3.1 (2010-02)

The following marking applies to the above mentioned product:



Continental Automotive GmbH  
Regensburg, 2012-06-06

Andreas Wolf  
Executive Vice President  
Body & Security

Konrad Müller  
Director Product Group 1  
Body & Security

Continental Automotive GmbH  
Postfach 100 853  
93056 Regensburg  
Postfach 100 853  
93052 Regensburg

Registered Office  
Amberg-Weiden  
Amberg-Weiden  
94114

General Manager  
Responsible for  
Product Approval  
Internal Business

TCAM agreed that it is sufficient to add the following statement as part of the user information:

[CZ]Česky [Czech]	Continental tímto prohlašuje, že tento <i>Radio Transmitter</i> je ve shodě se základními požadavky a dalšími příslušnými ustanoveními směrnice 1999/5/ES.
[DA]Dansk [Danish]	Undertegnede <i>Continental</i> erklærer herved, at følgende udstyr <i>Radio Transmitter</i> overholder de væsentlige krav og øvrige relevante krav i direktiv 1999/5/EF.
[DE]Deutsch [German]	Hiermit erklärt <i>Continental</i> , dass sich das Gerät <i>Radio Transmitter</i> in Übereinstimmung mit den grundlegenden Anforderungen und den übrigen einschlägigen Bestimmungen der Richtlinie 1999/5/EG befindet.
[ET]Eesti [Estonian]	Käesolevaga kinnitab <i>Continental</i> seadme <i>Radio Transmitter</i> vastavust direktiivi 1999/5/EE põhivõttele ja nimetatud direktiivist tulenevatele teistele asjakohastele sätetele.
[EN]English	Hereby, <i>Continental</i> declares that this <i>Radio Transmitter</i> is in compliance with the essential requirements and other relevant provisions of Directive 1999/5/EC.
[ES]Español [Spanish]	Por medio de la presente <i>Continental</i> declara que el <i>Radio Transmitter</i> cumple con los requisitos esenciales y cualesquiera otras disposiciones aplicables o exigibles de la Directiva 1999/5/CE.
[EL]Ελληνικά [Greek]	ΜΕ ΤΗΝ ΠΑΡΟΥΣΑ <i>Continental</i> ΔΗΛΩΝΕΙ ΟΤΙ <i>Radio Transmitter</i> ΣΥΜΜΟΡΦΩΝΕΤΑΙ ΠΡΟΣ ΤΙΣ ΟΥΣΙΩΔΕΙΣ ΑΠΑΙΤΗΣΕΙΣ ΚΑΙ ΤΙΣ ΛΟΙΠΕΣ ΣΧΕΤΙΚΕΣ ΔΙΑΤΑΞΕΙΣ ΤΗΣ ΟΔΗΓΙΑΣ 1999/5/ΕΚ.
[FR]Français [French]	Par la présente <i>Continental</i> déclare que l'appareil <i>Radio Transmitter</i> est conforme aux exigences essentielles et aux autres dispositions pertinentes de la directive 1999/5/CE.
[IT]Italiano [Italian]	Con la presente <i>Continental</i> dichiara che questo <i>Radio Transmitter</i> è conforme ai requisiti essenziali ed alle altre disposizioni pertinenti stabilite dalla direttiva 1999/5/CE.
[LV]Latviski [Latvian]	Ar šo <i>Continental</i> deklarē, ka <i>Radio Transmitter</i> atbilst Direktīvas 1999/5/EEK būtiskajām prasībām un citiem ar to saistītajiem noteikumiem.
[LT]Lietuvių [Lithuanian]	Šiuo <i>Continental</i> deklaruoju, kad šis <i>Radio Transmitter</i> atitinka esminius reikalavimus ir kitas 1999/5/EB Direktyvos nuostatas.
[NL]Nederlands [Dutch]	Hierbij verklaart <i>Continental</i> dat het toestel <i>Radio Transmitter</i> in overeenstemming is met de essentiële eisen en de andere relevante bepalingen van richtlijn 1999/5/EG.

<input checked="" type="checkbox"/> [Malti [Maltese]]	Hawn hekk, <i>Continental</i> , jiddikjara li dan <i>Radio Transmitter</i> jikkonforma mal- <i>htigijiet essenzjali</i> u ma provvedimenti oħrajn relevanti li hemm fid- <i>Dirrettiva 1999/5/EC</i> .
<input checked="" type="checkbox"/> [Magyar [Hungarian]]	A <i>lullrott</i> , <i>Continental</i> nyilatkozik, hogy a <i>Radio Transmitter</i> megfelel a vonatkozó alapvető követelményeknek és az <i>1999/5/EC</i> irányelv egyéb előírásainak.
<input checked="" type="checkbox"/> [Polski [Polish]]	Niniejszym <i>Continental</i> oświadcza, że <i>Radio Transmitter</i> jest zgodny z zasadniczymi wymogami oraz pozostałymi stosownymi postanowieniami <i>Dyrektywy 1999/5/EC</i> .
<input checked="" type="checkbox"/> [Português [Portuguese]]	<i>Continental</i> declara que este <i>Radio Transmitter</i> está conforme com os requisitos essenciais e outras disposições da <i>Diretiva 1999/5/CE</i> .
<input checked="" type="checkbox"/> [Slovensko [Slovenian]]	<i>Continental</i> izjavlja, da je ta <i>Radio Transmitter</i> v skladu z bistvenimi zahtevami in ostalimi relevantnimi določili direktive <i>1999/5/ES</i> .
<input checked="" type="checkbox"/> [Slovenský [Slovak]]	<i>Continental</i> týmto vyhlasuje, že <i>Radio Transmitter</i> spĺňa základné požiadavky a všetky príslušné ustanovenia <i>Smernice 1999/5/ES</i> .
<input checked="" type="checkbox"/> [Suomi [Finnish]]	<i>Continental</i> vakuuttaa täten että <i>Radio Transmitter</i> täyttää kaikkiin <i>1999/5/EY</i> oleellisiin vaatimuksiin ja sitä koskeviin direktiivin muiden ehtojen mukainen.
<input checked="" type="checkbox"/> [Svenska [Swedish]]	Härmed intygar <i>Continental</i> att denna <i>Radio Transmitter</i> står i överensstämmelse med de väsentliga egenskapskrav och övriga relevanta bestämmelser som framgår av direktiv <i>1999/5/EG</i> .
Íslenska [Icelandic]]	Hér með lýsir <i>Continental</i> yfir því að <i>Radio Transmitter</i> er í samræmi við grunnkröfur og aðrar kröfur, sem gerðar eru í tilskipun <i>1999/5/EC</i> .
<input checked="" type="checkbox"/> [Norsk [Norwegian]]	<i>Continental</i> erklærer herved at utstyret <i>Radio Transmitter</i> er i samsvar med de grunnleggende krav og øvrige relevante krav i direktiv <i>1999/5/EF</i> .



**MANUFACTURERS DECLARATION  
OF CONFORMITY**



For



**Hydraulic Car Jack  
Model HPT-1.5 Hydraulic Jack, rated 1.5 Tonnes**

**Manufactured by**

Masada Seisakusho Co.,Ltd.  
1-1, Ninomiyahigashi,  
2-Chome, Akiruno-shi,  
Tokyo, 197-0815  
Japan

**Technical File compiled and held in the  
EU, on behalf of the manufacturer by**

TRaC EMC & Safety Ltd  
100 Frobisher Business Park,  
Leigh Sinton Road, Malvern,  
Worcestershire, WR14 1BX  
United Kingdom

**Standards used as guidance  
Machinery Directive**

**Annex I of 2006/42/EC with reference to :  
EN 1494:2000/A1:2008**

**Means of Conformity**

The Product is in conformity with EC law as approximated by the Machinery Directive 2006/42/EC,  
As detailed in Technical Documentation File No 2135 Revision 3, **September 2011**

**Signature of Responsible Person:**

後藤 祥爾

**Mr. Shouji Gotou**  
President  
Masada Seisakusho Co.,Ltd.

**Signature of the person in the EU holding  
the Technical File:**

NRoche

**Mr Neil Roche**  
EMC Product Manager  
TRaC EMC & Safety Ltd

**MACHINE SERIAL No.**

**Date:**

**27<sup>th</sup> September 2011**

**Certificate No. 17-0074 DoFC Issue 3**

Deutsch (German)	Français (French)	Italiano (Italian)
<p>KONFORMITÄTSERLÄRUNG DES HERSTELLERS Für Hydraulischer Wagenheber Modell HPT-1.5 Hydraulikheber, Einstufung 1,5 Tonnen</p> <p>Hergestellt von Masada Seisakusho Co., Ltd. 1-1, Ninomiyahigashi, 2-Chome, Akiruno-shi, Tokio, 197-0815 Japan</p> <p>Technische Dokumentation zusammengestellt und bereitgehalten in der EU, im Namen des Herstellers durch TRaC EMC &amp; Safety Ltd 100 Frobisher Business Park, Leigh Sinton Road, Malvern, Worcestershire, WR14 1BX Vereinigtes Königreich</p> <p>Als Leitlinie der Maschinenrichtlinie verwendete Normen Anhang I der 2006/42/EG mit Bezug auf: EN 1494:2000/A1:2008</p> <p>Konformität Das Produkt steht in Übereinstimmung mit den der Maschinenrichtlinie 2006/42/EG angelegenen EG-Gesetzen,</p> <p>Entsprechend der Technischen Dokumentation Akte Nr. 2135.3. Revision, September 2011</p> <p>Unterschrift der verantwortlichen Person: Herr Shouji Gotou Präsident Masada Seisakusho Co., Ltd.</p> <p>Unterschrift der Person, die die technische Dokumentation in der EU bereithält: Herr Neil Roche EMV-Produktmanager TRaC EMC &amp; Safety Ltd.</p> <p>MASCHINENSERIENN. Datum: 27. September 2011 Zertifikatsnr. 14-0074 DofC 3. Ausgabe</p>	<p>DECLARATION DE CONFORMITE DU FABRICANT Pour Prise hydraulique modèle cric de voiture hydraulique HPT-1.5, taux à 1,5 tonnes</p> <p>Fabriqué par Masada Seisakusho Co., Ltd. 1-1, Ninomiyahigashi, 2-Chome, Akiruno-shi, Tokyo, 197-0815 Japon</p> <p>Fichier technique compilé et maintenu dans l'UE, au nom du fabricant en TRaC EMC &amp; Safety Ltd 100 Frobisher Business Park, Leigh Sinton Road, Malvern, Worcestershire, WR14 1BX Royaume-Uni</p> <p>Normes utilisées pour le guide de l'appareil Annexe I de 2006/42/EC en se reportant à la section : EN 1494:2000/A1:2008</p> <p>Moyens de conformité Le produit est en conformité avec la loi CE comme approximativement par la directive sur la machinerie 2006/42/CE, Comme décrit dans le fichier de la documentation technique n°2135 révision 3, septembre 2011</p> <p>Signature de la personne responsable : M. Shouji Gotou Président Masada Seisakusho Co., Ltd.</p> <p>Signature de la personne dans l'UE gardant le fichier technique : M. Neil Roche Chef de produit EMC TRaC EMC &amp; Safety Ltd.</p> <p>N° DE SERIE DE LA MACHINE Date : 27 septembre 2011 N° de certificate 14-0074 DofC Edition 3</p>	<p>DICHIARAZIONE DI CONFORMITÀ DEL PRODUTTORE Per Cric idraulico modello HPT-1.5 martinetto idraulico, nominale 1,5 tonnellate</p> <p>Prodotto da Masada Seisakusho Co., Ltd. 1-1, Ninomiyahigashi, 2-Chome, Akiruno-shi, Tokyo, 197-0815 Giappone</p> <p>File tecnico compilato e detenuto nell'UE per conto del produttore da TRaC EMC &amp; Safety Ltd 100 Frobisher Business Park, Leigh Sinton Road, Malvern, Worcestershire, WR14 1BX Regno Unito</p> <p>Standard utilizzati come guida della direttiva macchine Appendice I di 2006/42/CE con riferimento a: EN 1494:2000/A1:2008</p> <p>Certificato di conformità Il prodotto è conforme alle leggi della CE poiché rispetta la direttiva macchine 2006/42/CE,</p> <p>Come dettagliato nel file della documentazione tecnica N. 2135, revisione 3 settembre 2011</p> <p>Firma del responsabile: Shouji Gotou Presidente Masada Seisakusho Co., Ltd.</p> <p>Firma della persona che detiene il file tecnico nell'UE: Neil Roche EMC Product Manager TRaC EMC &amp; Safety Ltd.</p> <p>N. SERIALE DELLA MACCHINA Data: 27 settembre 2011 Certificato N. 14-0074 DofC Issue 3</p>

<b>Nederland (Dutch)</b>	<b>Dansk (Danish)</b>	<b>Ελληνικά (Greek)</b>
<p>FABRIKANTENVERKLARING VAN CONFORMITEIT Voor Hydraulische Autokrik Model HPT-1.5 Hydraulische Krik met een capaciteit van 1,5 ton</p> <p>Geproduceerd door Masada Seisakusho Co., Ltd. 1-1, Ninomiyahigashi, 2-Chome, Akiruno-shi, Tokyo, 197-0815 Japan</p> <p>Technisch Dossier samengesteld en gehouden in de EU, namens de fabrikant door TRaC EMC &amp; Safety Ltd 100 Frobisher Business Park, Leigh Sinton Road, Malvern, Worcestershire, WR14 1BX United Kingdom</p> <p>Normen als leidraad Machinerichtlijn</p> <p>Bijlage I van 2006/42/EG met betrekking tot: EN 1494:2000 / A1: 2008</p> <p>Middel van conformiteit Het product is in overeenstemming met het EG-recht zoals benaderd door de Machinerichtlijn 2006/42/EG, Zoals beschreven in Technische Documentatie Dossier nr. 2135 Revisie 3, september 2011</p> <p>Handtekening van de bevoegde persoon: De heer Shouji Gotou President Masada Seisakusho Co., Ltd.</p> <p>Handtekening van de persoon in de EU die het Technisch Dossier: De heer Neil Roche EMC Product Manager TRaC EMC &amp; Safety Ltd.</p> <p>MACHINE Serienummer Datum: 27 september 2011 Certificaat nr. 14-0074 DoFC Uitgave 3</p>	<p>PRODUCENTENS OVERENSSTEMMELSESERKLÆRING for Hydraulisk donkraft i model HPT-1.5 Hydraulisk donkraft, nominel 1,5 ton</p> <p>Fremstillet af Masada Seisakusho Co., Ltd. 1-1, Ninomiyahigashi, 2-Chome, Akiruno-shi, Tokyo, 197-0815 Japan</p> <p>Teknisk fil kompileret og holdt inden for EU på vegne af producenten TRaC EMC &amp; Safety Ltd 100 Frobisher Business Park, Leigh Sinton Road, Malvern, Worcestershire, WR14 1BX England</p> <p>Standarder anvendt som vejledende maskindirektiv</p> <p>Bilag I i 2006/42/EU med reference til: EN 1494:2000/A1:2008</p> <p>Overensstemmelseserklæringens betydning Produktet er i overensstemmelse med EU-lovgivningen defineret af Maskindirektivet 2006/42/EF, Som beskrevet i fil med teknisk dokumentation nr. 2135 Revidering 3, september 2011</p> <p>Signatur for ansvarlig: Hr. Shouji Gotou Formand Masada Seisakusho Co., Ltd.</p> <p>Signatur fra personen i EU, der besidder den tekniske fil: Hr. Neil Roche EMC-produktchef TRaC EMC &amp; Safety Ltd.</p> <p>MASKINENS SERIENR. Dato: 27. september 2011 Certifikatnr. 14-0074 DoFC Problemstilling 3</p>	<p>ΔΗΛΩΣΗ ΣΥΜΜΟΡΦΩΣΗΣ ΤΩΝ ΚΑΤΑΣΚΕΥΑΣΤΩΝ Για Υδραυλικός Γρύλος Αυτοκινήτου Μοντέλο HPT-1,5 Υδραυλικός Γρύλος, 1,5 Τόνου ονομαστικά</p> <p>Κατασκευάστηκε από την Masada Seisakusho Co., Ltd. 1-1, Ninomiyahigashi, 2-Chome, Akiruno-shi, Τόκιο, 197-0815 Ιαπωνία</p> <p>Τεχνικό Αρχείο συντασσόμενο και διατηρούμενο στην ΕΕ, εξ ονόματος του κατασκευαστή από την TRaC EMC &amp; Safety Ltd 100 Frobisher Business Park, Leigh Sinton Road, Malvern, Worcestershire, WR14 1BX Ηνωμένο Βασίλειο</p> <p>Πρότυπα που χρησιμοποιούνται ως κατευθυντήρια Οδηγία περί Μηχανημάτων Παράρτημα Ι της 2006/42/EK με αναφορά στη: EN 1494:2000/A1:2008</p> <p>Μέσα Συμμόρφωσης Το Προϊόν είναι σύμφωνο με την κοινοτική νομοθεσία, όπως προσεγγίζεται από την Οδηγία για τα Μηχανήματα 2006/42/EK, όπως αναφέρεται λεπτομερώς στην Τεχνική Τεκμηρίωση με Αρ. Αρχείου 2135 Αναθεώρηση 3, Σεπτέμβριος 2011</p> <p>Υπογραφή του Υπεύθυνου Ατόμου: κ. Shouji Gotou Πρόεδρος Masada Seisakusho Co., Ltd.</p> <p>Υπογραφή του ατόμου στην ΕΕ που διατηρεί το Τεχνικό Αρχείο: κ. Neil Roche Διευθυντής Προϊόντων Ηλεκτρομαγνητικής Συμβατότητας TRaC EMC &amp; Safety Ltd.</p> <p>ΣΕΙΡΙΑΚΟΣ ΑΡ. ΣΥΣΚΕΥΗΣ Ημερομηνία: 27 Σεπτεμβρίου 2011 Αρ. Πιστοποιητικού 14-0074 DoFC Έκδοση 3</p>

<b>Español (Spanish)</b>	<b>Português (Portuguese)</b>	<b>Svenska (Swedish)</b>
<p>DECLARACIÓN DE CONFORMIDAD DEL FABRICANTE Para Gato hidráulico para coche modelo HPT-1.5 Gato hidráulico, con capacidad nominal de 1,5 toneladas</p> <p>Fabricado por Masada Seisakusho Co., Ltd. 1-1, Ninomiyahigashi, 2-Chome, Akiruno-shi, Tokio, 197-0815 Japón</p> <p>Archivo técnico compilado y mantenido en la UE, en nombre del fabricante por TRaC EMC &amp; Safety Ltd 100 Frobisher Business Park, Leigh Sinton Road, Malvern, Worcestershire, WR14 1BX Reino Unido</p> <p>Estándares usados como guía Directiva sobre maquinaria Anexo I de 2006/42/CE con referencia a: EN 1494:2000/A1:2008</p> <p>Medidas de conformidad El producto se encuentra en conformidad con la ley de la CE según se aproxima por la Directiva de máquinas 2006/42/CE,</p> <p>Como se detalla en el Archivo de documentación técnica Núm. 2135 Revisión 3, septiembre de 2011</p> <p>Firma de la persona responsable: Sr. Shouji Gotou Presidente Masada Seisakusho Co., Ltd.</p> <p>Firma de la persona en la UE que sostiene el Archivo técnico: Sr. Neil Roche Gestor de producto EMC TRaC EMC &amp; Safety Ltd.</p> <p>NÚM. DE SERIE DE LA MÁQUINA Fecha: 27 de septiembre de 2011 Núm. de certificado 14-0074 DoFC Edición 3</p>	<p>DECLARAÇÃO DE CONFORMIDADE DOS FABRICANTES Para Macaco Hidráulico para Carro, Modelo HPT-1.5, classificado para 1,5 Toneladas</p> <p>Fabricado por Masada Seisakusho Co., Ltd. 1-1, Ninomiyahigashi, 2-Chome, Akiruno-shi, Tóquio, 197-0815 Japão</p> <p>Ficha Técnica compilada e mantida na UE, em nome do fabricante por TRaC EMC &amp; Safety Ltd 100 Frobisher Business Park, Leigh Sinton Road, Malvern, Worcestershire, WR14 1BX Reino Unido</p> <p>Normas usadas como orientação da Diretiva de Maquinaria Anexo I da 2006/42/EC com referência a: EN 1494:2000/A1:2008</p> <p>Meios de Conformidade O Produto está em conformidade com a lei CE como aproximado através da Diretiva Relativa a Máquinas 2006/42/CE, Como detalhado na Ficha de Documentação Técnica N.º 2135 Revisão 3, de setembro de 2011</p> <p>Assinatura da Pessoa Responsável: Sr. Shouji Gotou Presidente Masada Seisakusho Co., Ltd.</p> <p>Assinatura da pessoa que detém a Ficha Técnica na UE: Sr. Neil Roche Gestor de Produto EMC TRaC EMC &amp; Safety Ltd.</p> <p>N.º DE SÉRIE DA MÁQUINA Data: 27 de Setembro de 2011 Certificado N.º 14-0074 DoFC Edição 3</p>	<p>TILLVERKARENS FÖRSÄKRAN OM ÖVERENSSTÄMMELSE För Hydraulisk domkraft för bil, modell HPT-1.5 hydraulisk domkraft, klassad för 1,5 ton</p> <p>Tillverkad av Masada Seisakusho Co., Ltd. 1-1, Ninomiyahigashi, 2-Chome, Akiruno-shi, Tokyo, 197-0815 Japan</p> <p>Teknisk fil sammanställd och förvarad i EU, å tillverkarens vägnar genom TRaC EMC &amp; Safety Ltd 100 Frobisher Business Park, Leigh Sinton Road, Malvern, Worcestershire, WR14 1BX Storbritannien</p> <p>Standarder som används som vägledning för maskindirektiv Bilaga I i 2006/42/EG med avseende på: EN 1494:2000/A1:2008</p> <p>Överensstämmelse Produkten överensstämmer med EG-lagstiftningen som approximeras av Maskindirektivet 2006/42/EG,</p> <p>I enlighet med Teknisk dokumentationsfil nr. 2135 revision 3, september 2011</p> <p>Signatur av ansvarig person: Mr. Shouji Gotou Ordförande Masada Seisakusho Co., Ltd.</p> <p>Signatur av den person i EU som förvarar den tekniska filen: Mr Neil Roche EMC Produktchef TRaC EMC &amp; Safety Ltd.</p> <p>MASKINENS SERIENUMMER Datum: 27 september 2011 Certifikat nr. 14-0074 DoFC Utgåva 3</p>

Suomi/Suomen kieli (Finnish)	Čeština (Czech)	Magyar (Hungarian)
<p>VALMISTAJAN VAATIMUSTENMUKAISUUSVAKUUTUS Malleille Hydraulinen autonosturi, malli HPT-1.5, Hydraulinen nosturi, kapasiteetti 1,5 tonnia</p> <p>Valmistaja Masada Seisakusho Co., Ltd. 1-1, Ninomiyahigashi, 2-Chome, Akiruno-shi, Tokyo, 197-0815 Japan</p> <p>Teknisen asiakirjan on laatinut ja sitä säilyttää EU:ssa valmistajan puolesta TRaC EMC &amp; Safety Ltd 100 Frobisher Business Park, Leigh Sinton Road, Malvern, Worcestershire, WR14 1BX United Kingdom</p> <p>Ohjeena käytetyt standardit Konedirektiivi 2006/42/EY:n liite I viitaten standardiin: EN 1494:2000/A1:2008</p> <p>Vaatimustenmukaisuuden sisältö Tuote on EY:n lain mukainen konedirektiivin 2006/42/EY mukaisesti, Kuten on selitetty teknisessä asiakirjassa nro 2135 versio 3, syyskuu 2011</p> <p>Vastuuhenkilön allekirjoitus: Mr. Shouji Gotou Puheenjohtaja Masada Seisakusho Co., Ltd.</p> <p>Teknisestä asiakirjasta EU:ssa vastaavan henkilön allekirjoitus: Mr Neil Roche EMC-tuotepäällikkö TRaC EMC &amp; Safety Ltd.</p> <p>KONEEN SARJANRO Päivämäärä: 27. syyskuuta 2011 Sertifikaatin nro 14-0074 DofC-numero 3</p>	<p>PROHLÁŠENÍ VÝROBCE O SHODĚ Pro Hydraulický automobilový zvedák model HPT-1.5 hydraulický zvedák, jmenovitá hodnota 1,5 tuny</p> <p>Výrobeno společností Masada Seisakusho Co., Ltd. 1-1, Ninomiyahigashi, 2-Chome, Akiruno-shi, Tokyo, 197-0815 Japonsko</p> <p>Technický soubor sestaven a uložen v EU, jménem výrobce v TRaC EMC &amp; Safety Ltd 100 Frobisher Business Park, Leigh Sinton Road, Malvern, Worcestershire, WR14 1BX Velká Británie</p> <p>Doporučené normy k použití Směrnice o strojních zařízeních Dodatek I k 2006/42/EC s odkazem na: EN 1494:2000/A1:2008</p> <p>Prostředky pro shodu Výrobek vyhovuje předpisům ES vyjádřeným ve směrnici o strojních zařízeních 2006/42/ES, Jak je podrobně uvedeno ve Složce technické dokumentace č. 2135 revize 3, září 2011</p> <p>Podpis odpovědné osoby: p. Shouji Gotou Předseda Masada Seisakusho Co., Ltd.</p> <p>Podpis osoby v EU uchovávající Technickou složku: p. Neil Roche EMC Výrobní manažer TRaC EMC &amp; Safety Ltd.</p> <p>SÉRIOVÉ Č. STROJE Datum: 27. září 2011 Certifikát č. 14-0074 DofC vydání 3</p>	<p>GYÁRTÓI MEGFELELŐSÉGI NYILATKOZAT A Hidraulikus autómelő HPT-1.5 Hidraulikus emelő modell, névleges 1,5 tonnás</p> <p>Gyártó Masada Seisakusho Co., Ltd. 1-1, Ninomiyahigashi, 2-Chome, Akiruno-shi, Tokyo, 197-0815 Japan</p> <p>Az EU-ban összeállított és megtartott Műszaki Akta, a gyártó részéről TRaC EMC &amp; Safety Ltd 100 Frobisher Business Park, Leigh Sinton Road, Malvern, Worcestershire, WR14 1BX United Kingdom</p> <p>Az irányadó Gépészeti irányelveknek használt szabványok A 2006/42/EC I. melléklete, az EN 1494:2000/A1:2008-ra hivatkozva</p> <p>A megfelelőség eszközei A Termék megfelel az EK törvényeinek, a Gépi berendezésekre vonatkozó 2006/42/EK irányelvek alapján, A 2135. számú Műszaki Dokumentációs Akta 3., 2011. szeptemberi javított kiadásában részletezettek szerint</p> <p>Felelős személy aláírása: Mr. Shouji Gotou Elnök Masada Seisakusho Co., Ltd.</p> <p>A Műszaki Aktát az EU-ban betartó személy aláírása: Mr Neil Roche EMC Termékmenedzser TRaC EMC &amp; Safety Ltd.</p> <p>GÉP SOROZATSZÁMA Datum: 2011. szeptember 27. Tanúsítvány sz. 14-0074 DofC 3. kiadás</p>

<b>Polski (Polish)</b>	<b>Slovenský (Slovak)</b>	<b>Eesti (Estonian)</b>
<p>DEKLARACJA ZGODNOŚCI PRODUCENTA</p> <p>Dotycząca</p> <p>Hydrauliczny podnośnik samochodowy model HPT-1.5, podnośnik hydrauliczny, udźwig znamionowy 1,5 tony</p> <p>Wyprodukowane przez</p> <p>Masada Seisakusho Co., Ltd.</p> <p>1-1, Ninomiyahigashi, 2-Chome, Akiruno-shi, Tokio, 197-0815 Japonia</p> <p>Dokumentacja techniczna sporządzona i przechowywana w UE w imieniu producenta przez</p> <p>TRaC EMC &amp; Safety Ltd</p> <p>100 Frobisher Business Park, Leigh Sinton Road, Malvern, Worcestershire, WR14 1BX Wielka Brytania</p> <p>Normy stosowane zgodnie z zaleceniami dyrektywy maszynowej Załącznik I dyrektywy 2006/42WE w odniesieniu do: EN 1494:2000/A1:2008</p> <p>Zgodność z przepisami</p> <p>Produkt spełnia wymogi prawa WE zgodnie z Dyrektywą Maszynową 2006/42/WE,</p> <p>Zgodnie ze szczegółowym opisem w dokumentacji technicznej nr 2135 rewizja 3, wrzesień 2011 r.</p> <p>Podpis osoby odpowiedzialnej:</p> <p>Pan Shouji Gotou</p> <p>Prezes</p> <p>Masada Seisakusho Co., Ltd.</p> <p>Podpis osoby w UE pozostającej w posiadaniu dokumentacji technicznej:</p> <p>Pan Neil Roche</p> <p>Menedżer Produktów EMC</p> <p>TRaC EMC &amp; Safety Ltd.</p> <p>Nr SERYJNY MASZYNY</p> <p>Data:</p> <p>27 września 2011 r.</p> <p>Nr certyfikatu</p> <p>14-0074 DoFC wyd. 3</p>	<p>VYHLÁSENIE VÝROBCU O ZHODE</p> <p>pre</p> <p>Automobilový hydraulický zdvíhák model HPT-1,5 hydraulický zdvíhák, menovitá hmotnosť 1,5 tony</p> <p>Výrobca</p> <p>Masada Seisakusho Co., Ltd.</p> <p>1-1, Ninomiyahigashi, 2-Chome, Akiruno-shi, Tokyo, 197-0815 Japonsko</p> <p>Technický súbor zostavený a uložený v EÚ v zastúpení výrobcu</p> <p>TRaC EMC &amp; Safety Ltd</p> <p>100 Frobisher Business Park, Leigh Sinton Road, Malvern, Worcestershire, WR14 1BX Veľká Británia</p> <p>Normy použité podľa smerníc o strojových zariadeniach Príloha I 2006/42/ES s odkazom na: EN 1494:2000/A1:2008</p> <p>Prostriedky pre zhodu</p> <p>Tento výrobok je v súlade so zákonmi EÚ podľa smernice o strojových zariadeniach 2006/42/ES,</p> <p>Ako je uvedené v technickej dokumentácii č. 2135 revízia č. 3, september 2011</p> <p>Podpis zodpovednej osoby:</p> <p>Mr. Shouji Gotou</p> <p>Riaditeľ</p> <p>Masada Seisakusho Co., Ltd.</p> <p>Podpis osoby v EÚ držiacej technickú dokumentáciu:</p> <p>Mr Neil Roche</p> <p>Produktový manažér EMC</p> <p>TRaC EMC &amp; Safety Ltd.</p> <p>VÝROBNÉ ČÍSLO ZARIADENIA</p> <p>Dátum:</p> <p>27. september 2011</p> <p>Certifikát č.</p> <p>14-0074 Výhl. o zhode 3. vydanie</p>	<p>TOOTJATE VASTAVUSDEKLARATSIOON</p> <p>toodetele</p> <p>Hüdrauliline autotungraud mudel HPT-1.5 hüdrauliline tungraud, nimivõime 1,5 tonni</p> <p>Tootja</p> <p>Masada Seisakusho Co., Ltd.</p> <p>1-1, Ninomiyahigashi, 2-Chome, Akiruno-shi, Tokyo, 197-0815 Japan (Jaapan)</p> <p>Tehnilise toimiku koostaja ja selle hoidja tootja nimel Elis</p> <p>TRaC EMC &amp; Safety Ltd</p> <p>100 Frobisher Business Park, Leigh Sinton Road, Malvern, Worcestershire, WR14 1BX United Kingdom (Ühendkuningriik)</p> <p>Suunistena kasutatud standardid Masinate direktiiv 2006/42/EC lisa I viitematerjaliga standardist EN 1494:2000/A1:2008</p> <p>Vastavusnormatiivid</p> <p>Antud toode on vastavuses EÜ seadustega, mis on ühtlustatud masinate direktiiviga 2006/42/EÜ,</p> <p>Vastavalt üksikasjalisele kirjeldusele tehnilise dokumentatsiooni toimikus nr 2135, redaktsioon 3, september 2011</p> <p>Vastutava isiku allkiri:</p> <p>Mr. Shouji Gotou</p> <p>President</p> <p>Masada Seisakusho Co., Ltd.</p> <p>Tehnilise dokumentatsiooni hoidja allkiri ELIS:</p> <p>Mr Neil Roche</p> <p>EMC tootejuht</p> <p>TRaC EMC &amp; Safety Ltd.</p> <p>MASINA SEERIANUMBER</p> <p>Kuupäev:</p> <p>27. september 2011</p> <p>Sertifikaat nr</p> <p>14-0074 DoFC, väljaanne 3</p>

Lietuvių kalba (Lithuanian)	Latviešu valoda (Latvian)	Slovenščina (Slovenian)
<p><b>GAMINTOJO ATITIKTIES DEKLARACIJA</b> Skirta šiems modeliams Hidraulinis automobilinis domkratas, modelis HPT-1.5 hidraulinis domkratas, nominali galia 1,5 tonos</p> <p>Pagaminta Masada Seisakusho Co., Ltd. 1-1, Ninomiyahigashi, 2-Chome, Akiruno-shi, Tokijas, 197-0815 Japonija</p> <p>Techninė byla sudaryta ir laikoma ES, gamintojo vardu</p> <p>TRaC EMC &amp; Safety Ltd 100 Frobisher Business Park, Leigh Sinton Road, Malvern, Worcestershire, WR14 1BX Jungtinė Karalystė</p> <p>Naudojami Mašinų direktyvoje nurodyti standartai Direktyvos 2006/42/EB I priedas su nuoroda [ EN 1494:2000/A1:2008</p> <p>Atitikties apibūdinimas Šis gaminytis atitinka EB įstatymus, apibrėžtus Mašinų direktyvoje 2006/42/EB, Kaip nurodyta Techninės dokumentacijos byloje Nr. 2135, 3-iojoje pataisoje, 2011 m. rugsėjo mėn.</p> <p>Atsakingo asmens parašas: P. Shouji Gotou Prezidentas Masada Seisakusho Co., Ltd.</p> <p>Asmens, kuriam ES priklauso Techninė dokumentacija, parašas: P. Neil Roche EMC gamybos vadovas TRaC EMC &amp; Safety Ltd.</p> <p>MAŠINOS SERIJOS Nr. Data: 2011 m. rugsėjo 27 d. Sertifikato Nr. 14-0074 DofC, 3-iasis leidimas</p>	<p><b>RAŽOTĀJA ATBILSTĪBAS DEKLARĀCIJA</b> Izstrādājums Hidrauliskais automobiļu domkrats, modelis HPT-1.5, hidrauliskais domkrats, nominālā celtpēja 1,5 tonnas</p> <p>Ražotājs Masada Seisakusho Co., Ltd. 1-1, Ninomiyahigashi, 2-Chome, Akiruno-shi, Tokyo, 197-0815 Japan</p> <p>Tehniskais fails ir kompilēts un to uzglabā ES ražotāja vārdā</p> <p>TRaC EMC &amp; Safety Ltd 100 Frobisher Business Park, Leigh Sinton Road, Malvern, Worcestershire, WR14 1BX United Kingdom</p> <p>Standarti, kas izmantoti kā Mehānismu direktīvas vadlīnijas direktīvas 2006/42/EK Pielikums I ar atsauci uz EN 1494:2000/A1:2008</p> <p>Atbilstības nodrošināšanas līdzekļi Izstrādājums atbilst EK likumiem, kas tuvināti ar Mašīnu direktīvu 2006/42/EK, Kā detalizēti norādīts Tehniskās dokumentācijas failā Nr. 2135, 3. pārstrādātais izdevums, 2011. g. septembris</p> <p>Atbildīgās personas paraksts: Shouji Gotou k-gs Prezidents Masada Seisakusho Co., Ltd.</p> <p>Personas, kas glabā tehnisko failu ES, paraksts: Neil Roche k-gs EMC produktu menedžeris TRaC EMC &amp; Safety Ltd.</p> <p>MEHĀNISMA SĒRIJAS Nr. Datums: 2011. gada 27. septembris Sertifikāta Nr. 14-0074 DofC, 3. izdevums</p>	<p><b>IZJAVA PROIZVAJALCEV O SKLADNOSTI</b> Za Model hidravlične dvigalke HPT-1.5 Hidravlična dvigalka z nosilnostjo 1,5 tone</p> <p>Proizvaja Masada Seisakusho Co., Ltd. 1-1, Ninomiyahigashi, 2-Chome, Akiruno-shi, Tokio 197-0815, Japonska</p> <p>Tehnično dokumentacija se, v imenu proizvajalca, za EU zbira in hrani na TRaC EMC &amp; Safety Ltd 100 Frobisher Business Park, Leigh Sinton Road, Malvern, Worcestershire, WR14 1BX Združeno kraljestvo</p> <p>Standarti se uporabljajo kot vodilo Direktive o strojih Aneks I k 2006/42/ES s sklicem na: EN 1494:2000/A1:2008</p> <p>Skladnost Proizvod je v skladu z zakonodajo ES, kot navaja Direktiva o strojih 2006/42/ES, Kot je podrobno opisano v Tehnični dokumentaciji številka dokumenta 2135 revizija 3, september 2011</p> <p>Podpis odgovorne osebe: G. Shouji Gotou Predsednik Masada Seisakusho Co., Ltd.</p> <p>Podpis osebe v EU, ki hrani tehnično dokumentacijo: G. Neil Roche EMC Produktivni vodja TRaC EMC &amp; Safety Ltd.</p> <p>SERIJSKA ŠT. STROJA Datum: 27. september 2011 Št. certifikata 14-0074 DofC Izdaja 3</p>

<b>Български (Bulgarian)</b>	<b>Român (Romanian)</b>	<b>Hrvatski (Croatian)</b>
<p>ДЕКЛАРАЦИЯ ЗА СЪОТВЕТСТВИЕ НА ПРОИЗВОДИТЕЛЯ За Хидравличен авто крик модел HPT-1.5 хидравличен крик, номинален 1,5 тона</p> <p>Произведено от Masada Seisakusho Co., Ltd. 1-1, Ninomiyahigashi, 2-Chome, Akiruno-shi, Tokyo, 197-0815 Japan</p> <p>Техническото досие е изготвено и се съхранява в ЕС от името на производителя от TRaC EMC &amp; Safety Ltd 100 Frobisher Business Park, Leigh Sinton Road, Malvern, Worcestershire, WR14 1BX United Kingdom</p> <p>Стандартите, използвани като ръководство за директива за машините Приложение I от 2006/42/ЕС с позоваване на: EN 1494:2000/A1:2008</p> <p>Съответствие с изискванията Продуктът отговаря на законодателството на ЕО, съгласно Директива за машините 2006/42/ЕС, Както е описано подробно в Папка с техническа документация No. 2135 редакция 3, септември 2011</p> <p>Подпис на отговорното лице: Г-н Шоуджи Гото Президент Masada Seisakusho Co., Ltd.</p> <p>Подпис на лицето в ЕС, притежаващо техническото досие: Г-н Нийл Рош Продуктов мениджър за EMC TRaC EMC &amp; Safety Ltd.</p> <p>СЕРИЕН No. НА МАШИНАТА Дата: 27 септември 2011г. Сертификат No. 14-0074 DoF издание 3</p>	<p>DECLARAȚIA DE CONFORMITATE A PRODUCĂTORULUI Pentru Cric hidraulic pentru automobile, cric hidraulic modelul HPT-1.5, capacitate nominală 1,5 tone</p> <p>Produs de Masada Seisakusho Co., Ltd. 1-1, Ninomiyahigashi, 2-Chome, Akiruno-shi, Tokyo, 197-0815 Japonia</p> <p>Dosarul tehnic elaborat și păstrat în UE în numele producătorului de către TRaC EMC &amp; Safety Ltd 100 Frobisher Business Park, Leigh Sinton Road, Malvern, Worcestershire, WR14 1BX Regatul Unit</p> <p>Standarde utilizate ca linii directoare în Directiva privind echipamentele tehnice Anexa I la Directiva 2006/42/CE cu trimitere la: EN 1494:2000/A1:2008</p> <p>Mijloace de asigurare a conformității Produsul respectă legislația CE, astfel cum este aproximată de Directiva Mașini 2006/42/CE și cum este detaliată în Dosarul de documentație tehnică nr. 2135, revizia 3, septembrie 2011</p> <p>Semnătura persoanei responsabile: DI. Shouji Gotou Președinte Masada Seisakusho Co., Ltd.</p> <p>Semnătura persoanei din UE care păstrează Dosarul tehnic: DI. Neil Roche Manager Produs EMC TRaC EMC &amp; Safety Ltd.</p> <p>NR. DE SERIE ECHIPAMENT Data: 27 septembrie 2011 Certificat nr. 14-0074 DoF Ediția 3</p>	<p>PROIZVOĐAČEVA IZJAVA O SUKLADNOSTI За Hidraulična automobilska dizalica model HPT-1,5 hidraulična dizalica, procijenjena na 1,5 tonu</p> <p>Proizvodi Masada Seisakusho Co., Ltd. 1-1, Ninomiyahigashi, 2-Chome, Akiruno-shi, Tokio, 197-0815 Japan</p> <p>Tehnički dokument sastavljen i držan u EU, u ime proizvođača</p> <p>TRaC EMC &amp; Safety Ltd 100 Frobisher Business Park, Leigh Sinton Road, Malvern, Worcestershire, WR14 1BX Ujedinjeno Kraljevstvo</p> <p>Standardi korišteni kao smjernice Direktive o strojevima</p> <p>Dodatak I iz 2006/42/EC s povezivanjem s: EN 1494:2000/A1:2008</p> <p>Značenje sukladnosti Proizvod je sukladan sa zakonima EK po Direktivi o strojevima 2006/42/EC, Kao što je navedeno u Tehničkoj dokumentaciji dokument broj 2135 revizija 3, rujna 2011.</p> <p>Potpis ovlaštene osobe: G. Shouji Gotou Predsjednik Masada Seisakusho Co., Ltd.</p> <p>Potpis osobe iz EU koja posjeduje Tehnički dokument: G. Neil Roche EMC Menadžer proizvoda TRaC EMC &amp; Safety Ltd.</p> <p>SERIJSKI BROJ UREĐAJA Datum: 27. rujna 2011. Certifikat br. 14-0074 DoF Broj 3</p>



Norsk (Norwegian)	Türk (Turkish)	Íslenska (Icelandic)
<p>PRODUSENTENS ERKLÆRING OM OVERENSSTEMMELSE For</p> <p>Hydraulisk biljekk modell HPT-1.5 hydraulisk jekk klassifisert for 1,5 tonn</p> <p>Produsert av Masada Seisakusho Co., Ltd. 1-1, Ninomiyahigashi, 2-Chome, Akiruno-shi, Tokyo, 197-0815 Japan</p> <p>Teknisk fil er satt sammen og lagret i EU, på vegne av produsenten av TRaC EMC &amp; Safety Ltd 100 Frobisher Business Park, Leigh Sinton Road, Malvern, Worcestershire, WR14 1BX, Storbritannia</p> <p>Veiledende standarder, brukt av maskindirektivet Tillegg 1 for 2006/42/EU med henvisning til: EN 1494:2000/A1:2008</p> <p>Betydningen av overensstemmelse Apparatet er i overensstemmelse med EU-lovverket, slik det er tilnærmet i maskindirektiv 2006/42/EU, Som beskrevet i teknisk dokumentasjonsfil nr. 2135, revisjon 3, fra september 2011</p> <p>Signatur fra ansvarlig person: Hr. Shouji Gotou Direktør Masada Seisakusho Co., Ltd.</p> <p>Signatur til person i EU som oppbevarer teknisk fil: Hr. Neil Roche EMC produksjef TRaC EMC &amp; Safety Ltd.</p> <p>MASKINENS SERIENR. Dato: 27. september 2011 Sertifikat nr. 14-0074 DoFC utgave 3</p>	<p>AŞAĞIDAKI ÜRÜNLER İÇİN İMALATÇI UYGUNLUK BEYANI</p> <p>Hidrolik Araba Krikosu Model HPT-1.5 Hidrolik Kriko, nominal 1,5 Ton</p> <p>Üretici : Masada Seisakusho Co., Ltd. 1-1, Ninomiyahigashi, 2-Chome, Akiruno-shi, Tokyo, 197-0815 Japonya</p> <p>İmalatçı adına Teknik Dosyayı derleyen ve AB'de muhafaza eden kuruluş TRaC EMC &amp; Safety Ltd 100 Frobisher Business Park, Leigh Sinton Road, Malvern, Worcestershire, WR14 1BX Birleşik Krallık</p> <p>Yol Gösterici Makine Yönetmeliği olarak kullanılan standartlar EN 1494:2000/A1:2008 no.lu standarda atıfta bulunan 2006/42/EC no.lu Ek I</p> <p>Uyumluluk Aracı Ürün, 2006/42/EC no.lu Makine Yönetmeliği tarafından öngörüldüğü şekilde Avrupa Topluluğu yasalarına uyumludur, 2135 No.lu 3. Revizyon, 2011 Eylül tarihli Teknik Dokümantasyon Dosyasında detaylandırıldığı şekilde</p> <p>Sorumlu Kişinin İmzası: Sayın Shouji Gotou Başkan Masada Seisakusho Co., Ltd.</p> <p>Teknik Dosyayı AB'de muhafaza eden kişinin imzası: Sayın Neil Roche EMC Ürün Müdürü TRaC EMC &amp; Safety Ltd.</p> <p>MAKİNE SERİ No. Tarih: 27 Eylül 2011 Sertifika No. 14-0074 no.lu Uyum Beyanı Yayın 3</p>	<p>YFIRLÝSING FRAMLEIÐANDA UM SAMRÆMI</p> <p>Fyrir Bíla-Vökvatjakkur Gerð HPT-1.5 Vökvatjakkur, hámarksþyngd 1,5 Tonn</p> <p>Framleitt af Masada Seisakusho Co., Ltd. 1-1, Ninomiyahigashi, 2-Chome, Akiruno-shi, Tókýó, 197-0815 Japan</p> <p>Tækniskjal tekið saman og notað í ESB, fyrir hönd framleiðanda</p> <p>TRaC EMC &amp; Safety Ltd 100 Frobisher Business Park, Leigh Sinton Road, Malvern, Worcestershire, WR14 1BX, Bretland</p> <p>Staðlar notaðir sem leiðsögn Tilskipun Vélbúnaðar Viðauki 1 frá 2006/42/EC með tilvísun til: EN 1494:2000/A1:2008</p> <p>Uppfylling skilyrða Varan uppfyllir lög ESB eins og mælt er fyrir í tilskipun 2006/42/EC um vélarbúnað, Sem tekið er fram í tækniskjali nr. 2135 3. Endurskoðun, September 2011</p> <p>Undirskrift ábyrgðarmanns: Hr. Shouji Gotou Forstjóri Masada Seisakusho Co., Ltd.</p> <p>Undirskrift einstaklings í ESB sem heldur um tækniskjalið: Hr. Neil Roche EMC Framleiðslustjóri TRaC EMC &amp; Safety Ltd.</p> <p>RÆÐNÚMER TÆKIS Dagsetning: 27. september 2011 Númer vottorðs 14-0074 DoFC útgáfa 3</p>



AJM104397