



LANCER EVOLUTION - ENGLISH - OCZE14E3

LANCER EVOLUTION - ENGLISH - OCZE14E3

LANCER EVOLUTION

OWNER'S MANUAL

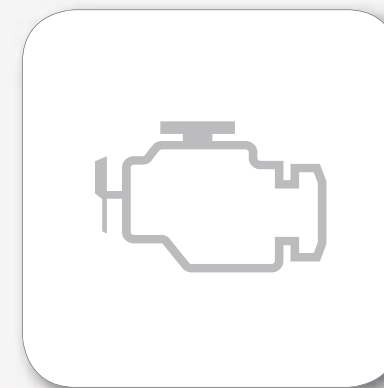

Foreword

E09200104542

Thank you for selecting a LANCER EVOLUTION as your new vehicle. This owner's manual will add to your understanding and full enjoyment of the many fine features of this vehicle. It contains information prepared to acquaint you with the proper way to operate and maintain your vehicle for the utmost in driving pleasure.

mitsubishi motors Europe B.V. reserves the right to make changes in design and specifications and/or to make additions to or improvements in this product without obligation to install them on products previously manufactured.

It is an absolute requirement for the driver to strictly observe all laws and regulations concerning vehicles.

This owner's manual has been written in compliance with such laws and regulations, but some of the contents may become contradictory with later amendment of the laws and regulations.

Please leave this owner's manual in this vehicle at time of resale. The next owner will appreciate having access to the information contained in this owner's manual.

Repairs to your vehicle:

Vehicles in the warranty period:

All warranty repairs must be carried out by a MITSUBISHI MOTORS Authorized Service Point.

Vehicles outside the warranty period:

Where the vehicle is repaired is at the discretion of the owner.

Throughout this owner's manual the words **WARNING** and **CAUTION** appear.

These serve as reminders to be especially careful. Failure to follow instructions could result in personal injury or damage to your vehicle.

WARNING

indicates a strong possibility of severe personal injury or death if instructions are not followed.

CAUTION

means hazards or unsafe practices that could cause minor personal injury or damage to your vehicle.

You will see another important symbol:

NOTE: gives helpful information.

***: indicates optional equipment.**

It may differ according to the sales classification; refer to the sales catalogue.

Abbreviations used in this owner's manual:

LHD: Left-Hand Drive

RHD: Right-Hand Drive

M/T: Manual Transmission

The symbol used on the vehicles:

: See owner's manual

Information for station service

E09300101630

Fuel	Fuel tank capacity	55 litres
	Fuel requirements	Unleaded petrol octane number (EN228) 98 RON or higher Refer to the "General information" section for the fuel selection.
Engine oil		Refer to the "Maintenance" section for the selection of engine oil.
Tyre inflation pressure		Refer to the "Maintenance" section for the tyre inflation pressure.

Mitsubishi Motors Europe B.V.

© 2013 Mitsubishi Motors Corporation

OCZE14E3
BLC-14-000800

14

Table of contents

<i>Overview</i>	
<i>General information</i>	
<i>Locking and unlocking</i>	1
<i>Seat and seat belts</i>	2
<i>Instruments and controls</i>	3
<i>Starting and driving</i>	4
<i>For pleasant driving</i>	5
<i>For emergencies</i>	6
<i>Vehicle care</i>	7
<i>Maintenance</i>	8
<i>Specifications</i>	9

Instruments and Controls (Driver's area)

E00100107145

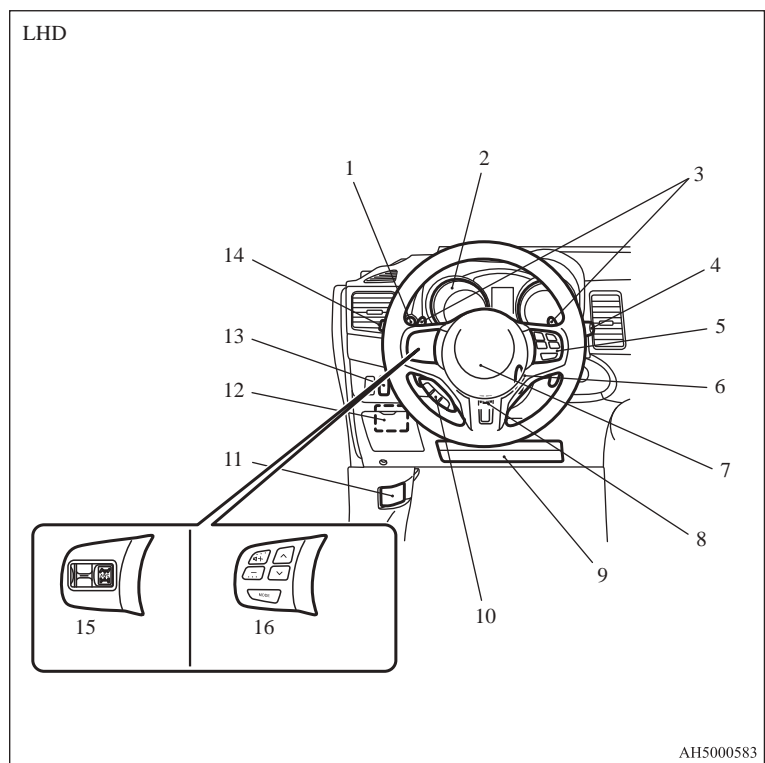

1. Multi-information meter switch p. 3-05
2. Instruments p. 3-02
3. Shift paddles* p. 4-21, 4-22
4. Wiper and washer switch p. 3-44
5. Cruise control switches* p. 4-38
6. Ignition switch p. 1-11, 1-16, 4-09
7. Supplemental restraint system - airbag (for driver's seat) p. 2-18, 2-22
8. Horn switch p. 3-48
9. Steering wheel height adjustment lever p. 4-06
10. Supplemental restraint system - driver's knee airbag p. 2-23
11. Bluetooth® 2.0 interface* p. 5-40
12. Bonnet release lever p. 8-03
13. Fuses p. 8-16
14. ASC OFF switch p. 4-34
15. Combination headlamps and dipper switch p. 3-37
 - Turn-signal lever p. 3-41
 - Front fog lamp switch p. 3-43
 - Rear fog lamp switch p. 3-43
 - Headlamp washer switch p. 3-47
16. AWC switch* p. 4-29
17. Steering wheel audio remote control switches* p. 5-21

RHD

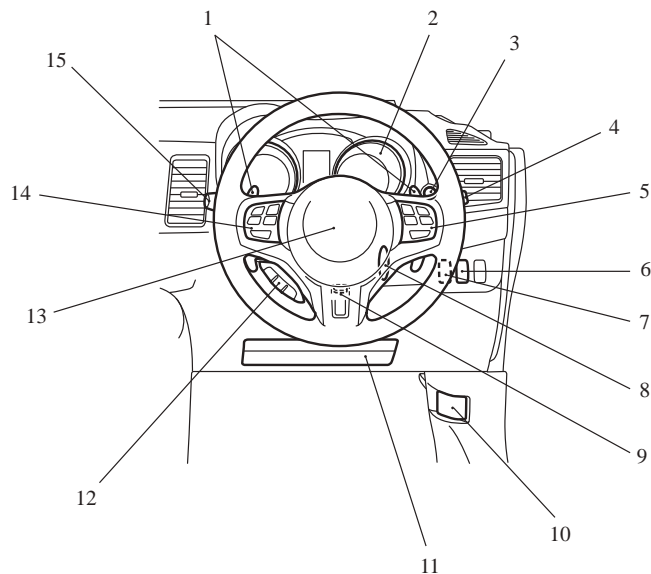

AH5000945

1. Shift paddles p. 4-21, 4-22
 2. Instruments p. 3-02
 3. Multi-information meter switch p. 3-05
 4. Wiper and washer switch p. 3-44
 5. Cruise control switches p. 4-38
 6. ASC OFF switch p. 4-34
 7. Trunk lid opener switch p. 1-26
 8. Ignition switch p. 1-11, 1-16, 4-09
 9. Steering wheel height adjustment lever p. 4-06
 10. Bonnet release lever p. 8-03
 11. Supplemental restraint system - driver's knee airbag p. 2-23
 12. Bluetooth® 2.0 interface* p. 5-40
 13. Steering wheel audio remote control switches p. 5-21
 14. Supplemental restraint system - airbag (for driver's seat) p. 2-18, 2-22
 15. Combination headlamps and dipper switch p. 3-37
- Turn-signal lever p. 3-41
 - Front fog lamp switch p. 3-43
 - Rear fog lamp switch p. 3-43
 - Headlamp washer switch p. 3-47

Instruments and Controls (Instrument panel)

E00100107158

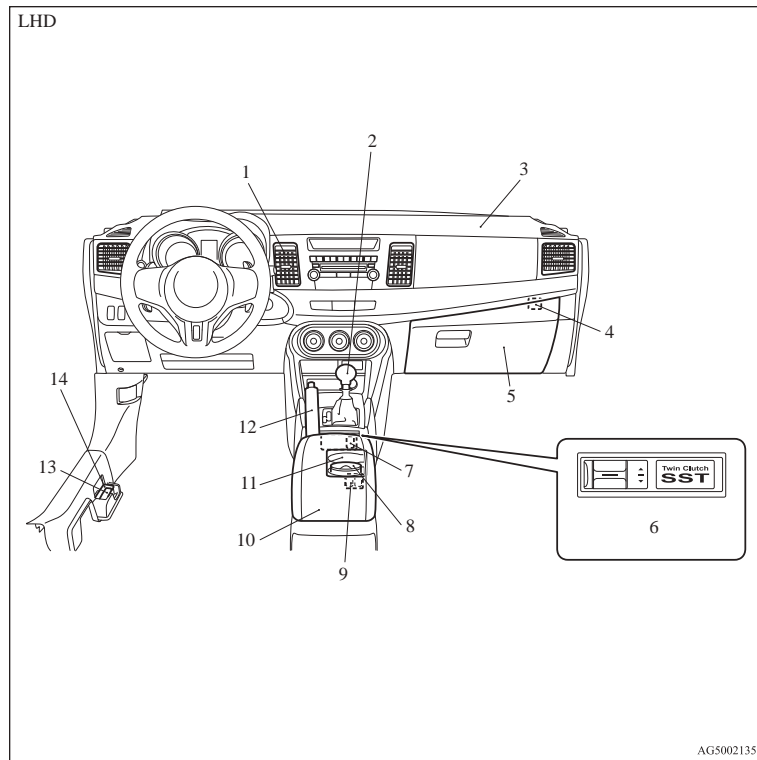

1. Ventilators p. 5-02
2. Gearshift lever p. 4-14, 4-17
3. Supplemental restraint system - airbag (for front passenger's seat) p. 2-18, 2-22
4. Front passenger's airbag ON-OFF switch p. 2-18, 2-21
5. Glove box p. 5-63
USB input terminal* p. 5-56
6. Twin Clutch SST control mode switch* p. 4-20
7. AWC switch* p. 4-29
8. Moveable ashtray* p. 5-59
9. Heated seat switch* p. 2-04
10. Floor console box p. 5-63
11. Cup holder p. 5-64
12. Parking brake lever p. 4-04
13. Fuel tank filler door release lever p. 03
14. Trunk lid release lever p. 1-26

RHD

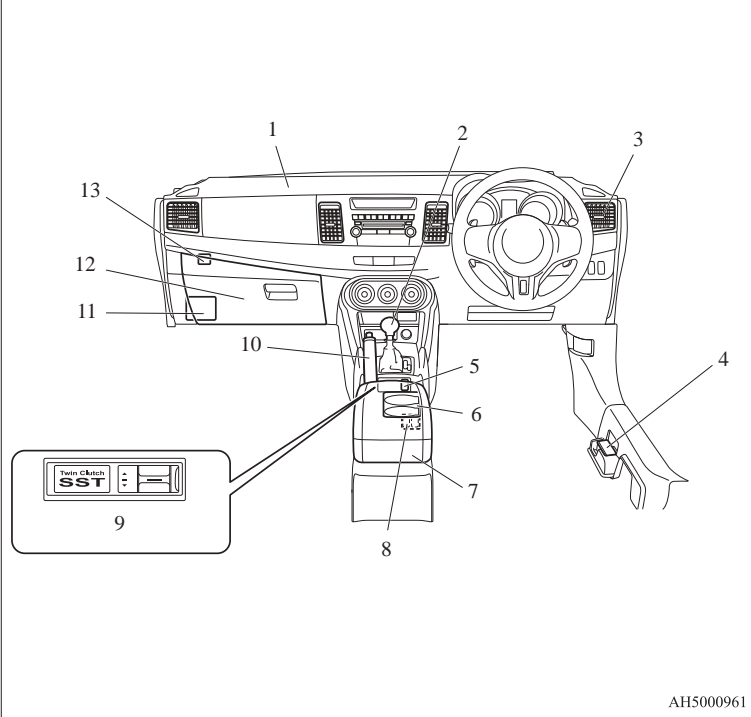

AH5000961

1. Supplemental restraint system - airbag (for front passenger's seat) p. 2-18, 2-22
2. Gearshift lever p. 4-14, 4-17
3. Ventilators p. 5-02
4. Fuel tank filler door release lever p. 03
5. AWC switch p. 4-29
6. Cup holder p. 5-64
7. Floor console box p. 5-63
8. Heated seat switch p. 2-04
9. Twin Clutch SST control mode switch p. 4-20
10. Parking brake lever p. 4-04
11. Fuses p. 8-16
12. Glove box p. 5-63
USB input terminal* p. 5-56
13. Front passenger's airbag ON-OFF switch p. 2-18, 2-21

Centre panel

E00100600590

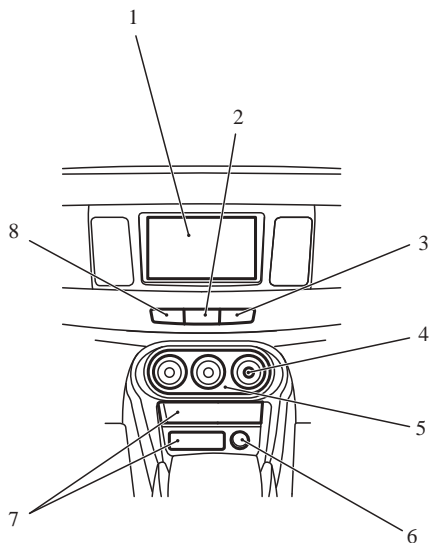

AH5000974

1. Audio* p. 5-09
 DISPLAY AUDIO*
 MITSUBISHI Multi-Communication System*
 Refer to the separate owner's manual
2. Hazard warning flasher switch p. 3-43
3. Front passenger seat belt warning lamp p. 2-08
4. Rear window demister switch p. 3-47
5. Air conditioning p. 5-04
6. Cigarette lighter* p. 5-59
 Accessory socket* p. 5-60
7. Front console box p. 5-63
8. Front passenger's airbag OFF indication lamp p. 2-18, 2-21

Interior

LHD

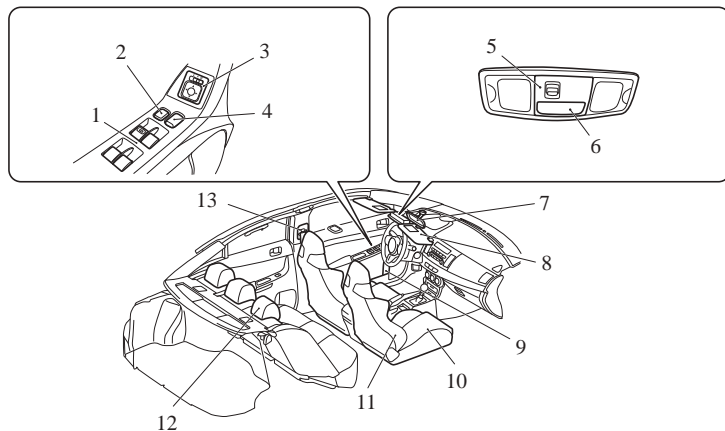

AH5000987

1. Electric window control switches p. 1-34
2. Lock switch p. 1-35
3. Electric remote-controlled outside rear-view mirrors switch p. 4-07
4. Central door lock switch p. 1-23
5. Front room & map lamp p. 5-60, 8-23, 8-28
6. Microphone (for Bluetooth® 2.0 interface)* p. 5-41
7. Inside rear-view mirror p. 4-06
8. Sun visors p. 5-58
Vanity mirror p. 5-58
Card holder p. 5-58
9. Bottle holder (for front seats) p. 5-65
10. Front seats p. 2-03
11. Supplemental restraint system - side airbag (for front seats) p. 2-25
12. Head restraints p. 2-05
13. Adjustable seat belt anchor (front seats) p. 2-08
Seat belts p. 2-06

RHD

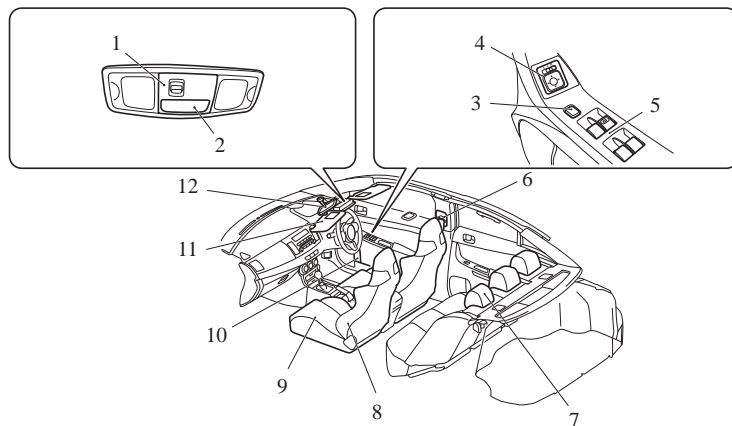

AH5000990

1. Front room & map lamp p. 5-60, 8-23, 8-28
2. Microphone (for Bluetooth® 2.0 interface)* p. 5-41
3. Lock switch p. 1-35
4. Electric remote-controlled outside rear-view mirrors switch p. 4-07
5. Electric window control switches p. 1-34
6. Adjustable seat belt anchor (front seats) p. 2-08
Seat belts p. 2-06
7. Head restraints p. 2-05
8. Supplemental restraint system - side airbag (for front seats) p. 2-25
9. Front seats p. 2-03
10. Bottle holder (for front seats) p. 5-65
11. Sun visors p. 5-58
Vanity mirror p. 5-58
Card holder p. 5-58
12. Inside rear-view mirror p. 4-06

Interior

LHD

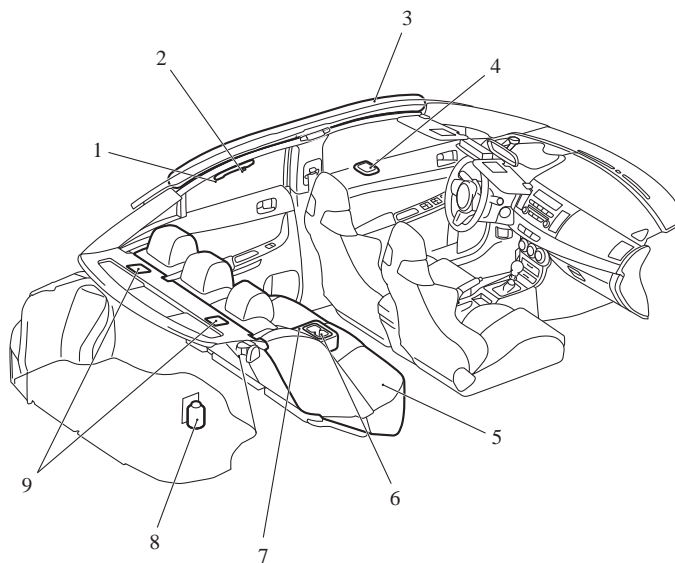

AH5001245

1. Assist grip p. 5-65
2. Coat hook p. 5-66
3. Supplemental restraint system - curtain airbag p. 2-26
4. Rear room lamp p. 5-61, 8-23, 8-28
5. Rear seat p. 2-05
6. Cup holder p. 5-65
7. Armrest p. 2-05
8. AWC control fluid tank p. 8-06, 9-11
9. Tether anchorages for child restraint system p. 2-16

RHD

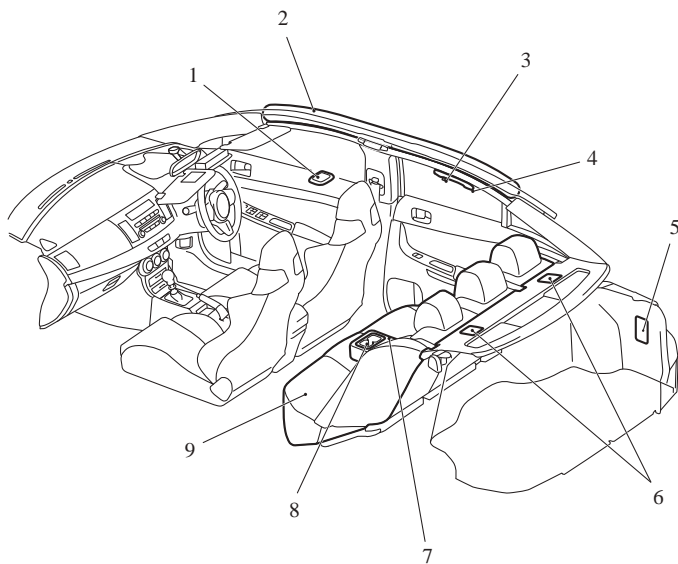

AH5001258

1. Rear room lamp p. 5-61, 8-23, 8-28
2. Supplemental restraint system - curtain airbag p. 2-26
3. Coat hook p. 5-66
4. Assist grip p. 5-65
5. AWC control fluid tank p. 8-06, 9-11
6. Tether anchorages for child restraint system p. 2-16
7. Armrest p. 2-05
8. Cup holder p. 5-65
9. Rear seat p. 2-05

Trunk area (Except for vehicle with spare wheel)

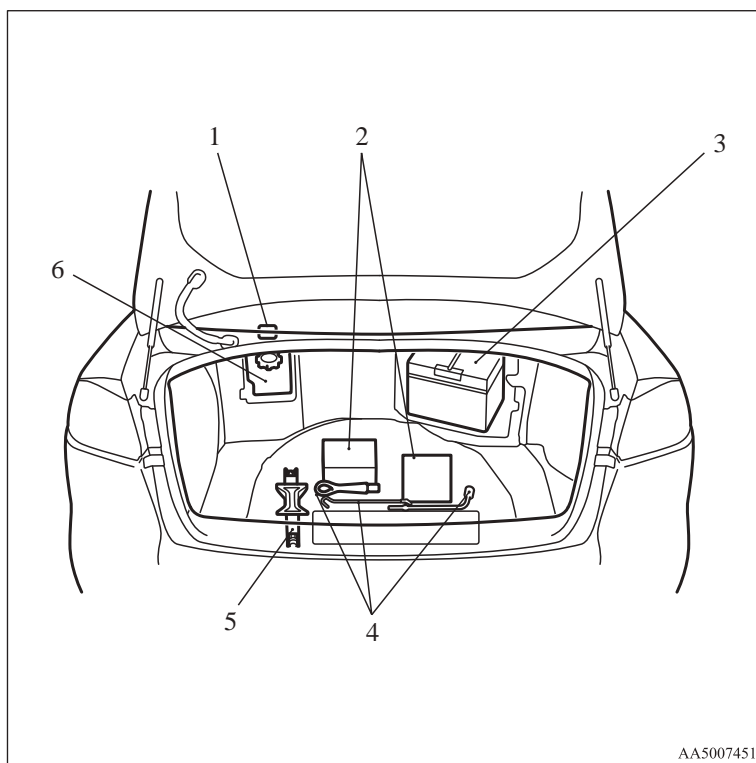

AA5007451

1. Trunk room lamp p. 8-23, 8-29
2. Tyre repair kit p. 6-05
3. Battery p. 6-02, 8-08
4. Tools p. 6-06
5. Jack p. 6-06
6. Front washer fluid reservoir p. 8-07

Trunk area (Vehicle with full size spare wheel)

E00100300760

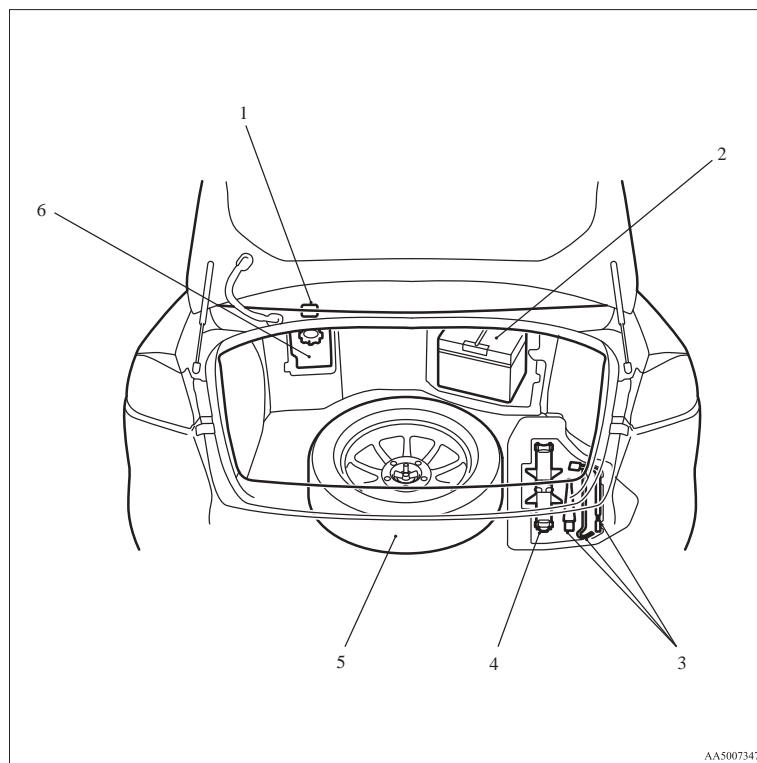

1. Trunk room lamp p. 8-23, 8-29
2. Battery p. 6-02, 8-08
3. Tools p. 6-06
4. Jack p. 6-06
5. Spare wheel p. 6-12, 6-13
6. Front washer fluid reservoir p. 8-07

AA5007347

Trunk area (Vehicle with compact spare wheel)

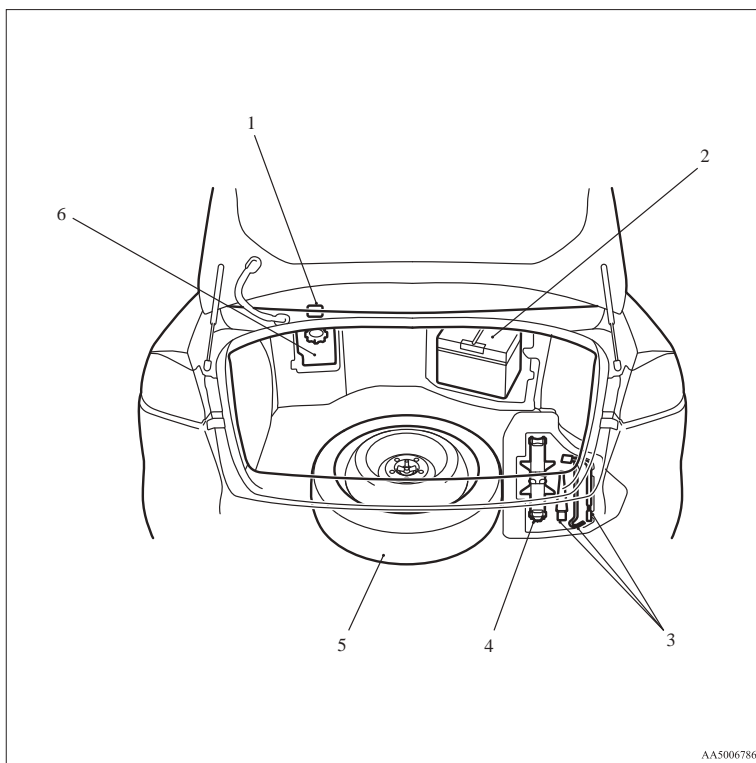

AA5006786

1. Trunk room lamp p. 8-23, 8-29
2. Battery p. 6-02, 8-08
3. Tools p. 6-06
4. Jack p. 6-06
5. Spare wheel p. 6-12, 6-13
6. Front washer fluid reservoir p. 8-07

Outside (Front)

E00100505738

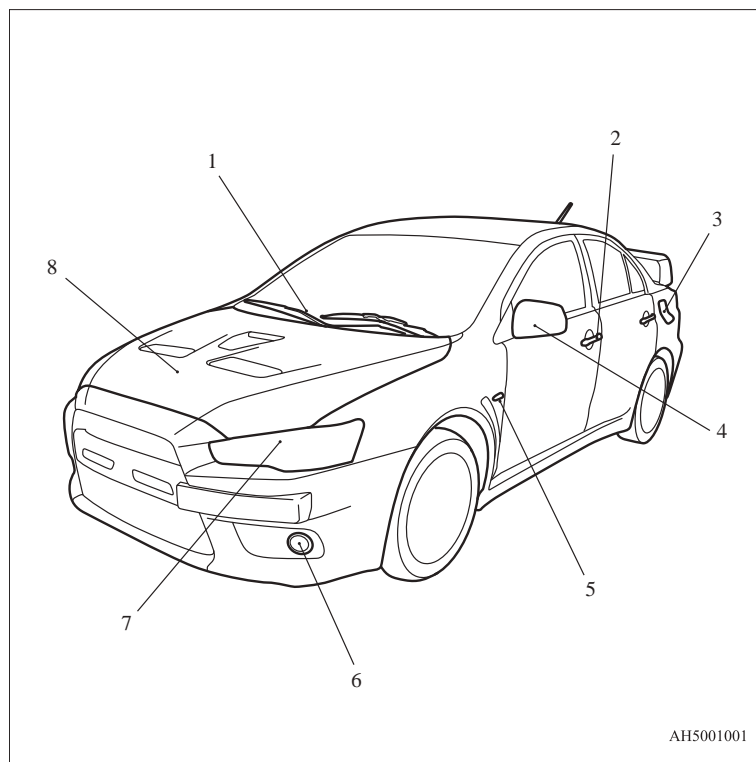

AH5001001

- 1. Windscreen wipers and washer p. 3-44, 8-14
- 2. Keyless entry system* p. 1-04
Keyless operation system* p. 1-07
Locking and unlocking p. 1-22
- 3. Fuel tank filler p. 03
- 4. Outside rear-view mirrors p. 4-07
- 5. Side turn-signal lamps p. 3-41, 8-22
- 6. Front fog lamps p. 3-43, 8-22, 8-25
- 7. Headlamps, high/low beam p. 3-37, 8-22, 8-23
Front turn-signal lamps p. 3-41, 8-22, 8-25
Position lamps p. 3-37, 8-22, 8-24
Bending lamps (Adaptive Front lighting System (AFS) p. 3-41, 8-22, 8-23
- 8. Bonnet p. 8-03

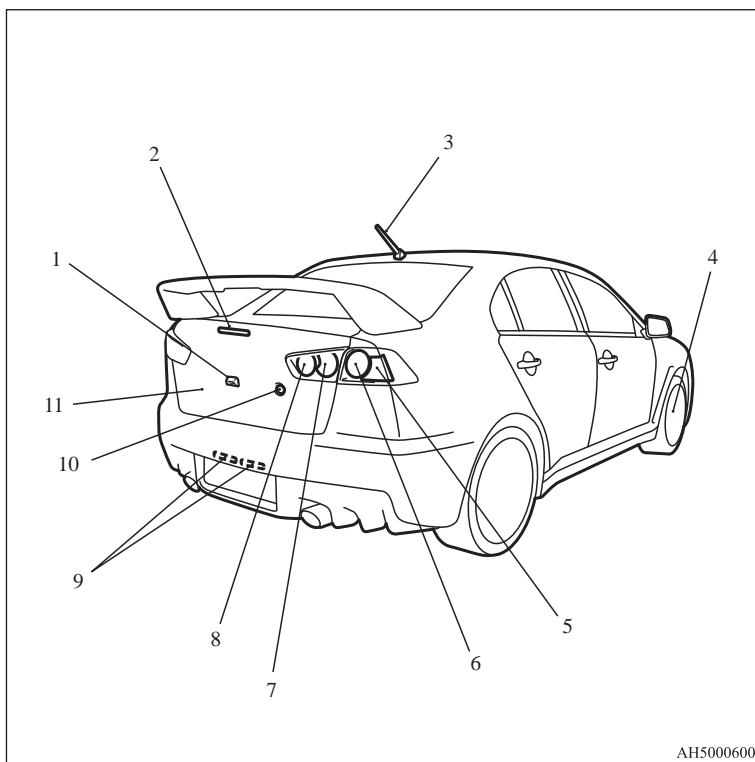
Outside (Rear)

AH5000600

1. Rear-view camera* p. 4-43
2. High-mounted stop lamp p. 8-22
3. Antenna p. 5-39
4. Tyre inflation pressures p. 8-10
Changing tyres p. 6-12
Tyre rotation p. 8-11
Tyre chains p. 8-12
5. Rear turn-signal lamps p. 3-41, 8-22, 8-26
6. Tail and stop lamps p. 3-37, 8-22, 8-26
7. Tail lamps p. 3-37, 8-22, 8-26
8. Reversing lamp (Passenger's side only) p. 8-22, 8-26
Rear fog lamp (Driver's side only) p. 3-43, 8-22, 8-26
9. Licence plate lamps p. 3-37, 8-22, 8-27
10. Trunk lid OPEN switch* p. 1-09
11. Trunk lid p. 1-26

A series of 15 horizontal dashed lines spanning the width of the page, providing a template for handwriting practice.

General information

Fuel selection.....	02
Filling the fuel tank.....	03
Installation of accessories.....	04
Modification/alterations to the electrical or fuel systems.....	05
Genuine parts.....	05
Used engine oils safety instructions and disposal information.....	05
Disposal information for used batteries.....	06

General information

Fuel selection

E00200103047

Recommended fuel	Unleaded petrol octane number (EN228) 98 RON or higher
------------------	---

Your engine is designed to provide satisfactory performance by using unleaded petrol octane number 98 RON or higher. In order to maintain engine performance and exhaust system durability, use unleaded petrol octane number 98 RON or higher.

CAUTION

- **The use of leaded fuel can result in serious damage to the engine and catalytic converter. Do not use leaded fuel.**

NOTE

- Your vehicles have the knock control system so that you can use unleaded petrol 95 RON as an emergent measure in case unleaded petrol 98 RON or higher is not available on journey, etc. In such a case, you don't need to adjust the engine specially.
In case of using unleaded petrol 95 RON, the engine performance level is reduced.

- Repeatedly driving short distances at low speeds can cause deposits to form in the fuel system and engine, resulting in poor starting and poor acceleration. If these problems occur, you are advised to add a detergent additive to the gasoline when you refuel the vehicle. The additive will remove the deposits, thereby returning the engine to a normal condition. Be sure to use a MITSUBISHI MOTORS GENUINE FUEL SYSTEM CLEANER. Using an unsuitable additive could make the engine malfunction. For details, please contact a MITSUBISHI MOTORS Authorized Service Point.

- Poor quality petrol can cause problems such as difficult starting, stalling, engine noise and hesitation. If you experience these problems, try another brand and/or grade of petrol.

If the check engine warning lamp flashes, have the system checked as soon as possible at a MITSUBISHI MOTORS Authorized Service Point.

E10 type petrol

E00203200019

The petrol engines are compatible with the E10 type petrol (containing 10 % ethanol) conforming to European standards EN 228.

CAUTION

- **Do not use more than 10 % concentration of ethanol (grain alcohol) by volume. Use of more than 10 % concentration may lead to damage to your vehicle fuel system, engine, engine sensors and exhaust system.**

Filling the fuel tank

E00200202100

⚠ WARNING

- When handling fuel, comply with the safety regulations displayed by garages and filling stations.
- Before removing the fuel cap, be sure to get rid of your body's static electricity by touching a metal part of either the car or the fuel pump. Any static electricity on your body could create a spark that ignites fuel vapour.
- Perform the whole refueling process (opening the fuel tank filler door, removing the fuel cap, etc.) by yourself. Do not let any other person come near the fuel tank filler. If you allowed a person to help you and that person was carrying static electricity, fuel vapour could be ignited.
- Do not move away from the fuel tank filler until refueling is finished. If you moved away and did something else (for example, cleaning your windscreen) part-way through the refueling process, you could pick up a fresh charge of static electricity.
- If the tank cap must be replaced, use only a MITSUBISHI MOTORS original part.

Fuel tank capacity

55 litres

Refueling

1. Before filling with fuel, stop the engine.

2. The fuel tank filler is located on the rear left side of your vehicle.
Open the fuel tank filler door with the release lever located on the side of the driver's seat.

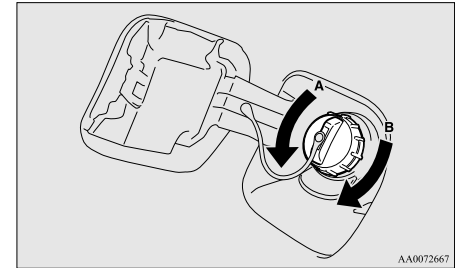
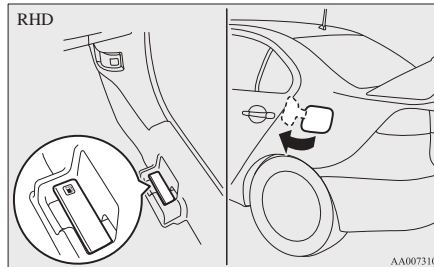
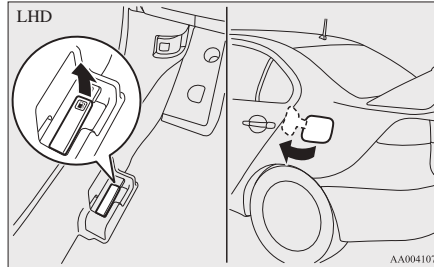

- A- Remove
- B- Close

⚠ CAUTION

- Since the fuel system may be under pressure, remove the fuel tank filler tube cap slowly. This relieves any pressure or vacuum that might have built up in the fuel tank. If you hear a hissing sound, wait until it stops before removing the cap. Otherwise, fuel may spray out, injuring you or others.

3. Open the fuel tank filler tube by slowly turning the cap anticlockwise.

General information

4. While filling with fuel, store the cap in the capholder located on the inside of the fuel tank filler door.

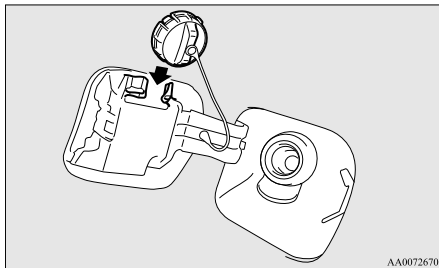

5. Insert the gun in the tank port as far as it goes.

⚠ CAUTION

- Do not tilt the gun.

6. When the gun stops automatically, do not fill with fuel any more.
7. To close, turn the fuel tank filler tube cap slowly clockwise until you hear clicking sounds, then gently push the fuel tank filler door closed.

Installation of accessories

E00200300703

We recommend you to consult your MITSUBISHI MOTORS Authorized Service Point.

- The installation of accessories, optional parts, should only be carried out within the limits prescribed by law in your country, and in accordance with the guidelines fitting instructions and warnings contained within the documents accompanying the parts or accessories.
- Improper installation of electrical components may cause an electrical fire if incorrectly fitted. Please refer to the Modification/alteration to the electrical or fuel systems section within this owner's manual.
- Using a cellular phone or radio set inside the vehicle without an external antenna may cause electrical system interference, which could lead to unsafe vehicle operation.
- Tyres and wheels which do not meet specifications must not be used.

Refer to the "Specifications" section for information regarding wheel and tyre sizes.

Important points!

Due to large number of accessory and replacement parts of different manufactures available in the market, it is not possible, not only for MITSUBISHI MOTORS, but also a MITSUBISHI MOTORS Authorized Service Point, to check whether the attachment or installation of such parts affects the overall safety of your MITSUBISHI-vehicle.

Even when such parts are officially authorized, for example by a "general operators permit" (an appraisal for the part) or through the execution of the part in an officially approved manner of construction, or when a single operation permit following the attachment or installation of such parts, it cannot be deduced from that alone, that the driving safety of your vehicles has not been affected.

Consider also that there basically exists no liability on the part of the appraiser or the official. Only in the case of parts (MITSUBISHI MOTORS original replacement or exchange parts as well as MITSUBISHI MOTORS genuine accessories) that are recommended and released by a MITSUBISHI MOTORS Authorized Service Point and that are attached or installed by a MITSUBISHI MOTORS Authorized Service Point can you assume, that optimal safety has been provided. The same also pertains to modifications of MITSUBISHI vehicle with respect to the production specifications. For your own safety, in such cases, you should only undertake modifications according to the recommendations of a MITSUBISHI MOTORS Authorized Service Point.

Modification/alterations to the electrical or fuel systems

E00200400195

MITSUBISHI MOTORS has always manufactured safe, high quality vehicles. In order to maintain this safety and quality, it is important that any accessory that is to be fitted, or any modifications carried out which involve the electrical or fuel systems, should be carried out in accordance with MITSUBISHI MOTORS guidelines.

⚠ CAUTION

- If the wiring interferes with any part of the vehicle bodywork or improper installation methods are used, i.e. protective fuses not installed, etc.), electronic devices may be adversely affected, possibly resulting in an electrical fire or other failures that may cause an accident.

Genuine parts

E00200500545

MITSUBISHI MOTORS has gone to great lengths to bring you a superbly crafted automobile offering the highest quality and dependability.

Use MITSUBISHI MOTORS Genuine Parts, designed and manufactured to maintain your MITSUBISHI MOTORS automobile at top performance. MITSUBISHI MOTORS Genuine Parts are identified by this mark and are available at all MITSUBISHI MOTORS Authorized Service Points.

**MITSUBISHI MOTORS
GENUINE PARTS**

Used engine oils safety instructions and disposal information

E00200600025

⚠ WARNING

- Prolonged and repeated contact may cause serious skin disorders, including dermatitis and cancer.
- Avoid contact with the skin as far as possible and wash thoroughly after any contact.
- Keep used engine oils out of reach of children.

Protect the environment

It is illegal to pollute drains, water courses and soil. Use authorized waste collection facilities, including civic amenity sites and garages providing facilities for disposal of used oil and used oil filters. If in doubt, contact your local authority for advice on disposal.

Disposal information for used batteries

E00201300016



Your vehicle contains batteries and/or accumulators.

Do not be mixed with general household waste.

For proper treatment, recovery and recycling of used batteries, please take them to applicable collection points, in accordance with your national legislation and the Directives 2006/66/EC.

By disposing of these batteries correctly, you will help to save valuable resources and prevent any potential negative effects on human health and the environment which could otherwise arise from inappropriate waste handling.

Locking and unlocking

Keys.....	1-02
Electronic immobilizer (Anti-theft starting system).....	1-03
Keyless entry system*.....	1-04
Keyless operation system*.....	1-07
Doors.....	1-22
Central door locks.....	1-23
Dead Lock System*.....	1-24
“Child-protection” rear doors.....	1-26
Trunk lid.....	1-26
Security alarm system (except for vehicles for Israel).....	1-28
Electric window control.....	1-34

Locking and unlocking

Keys

E00300102360

Type 1

The key fits all locks.

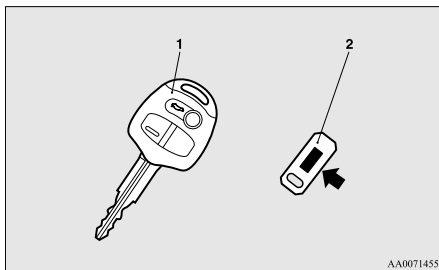

- 1- Keyless entry key (with electronic immobilizer)
- 2- Key number tag

Type 2

The emergency key fits all locks.

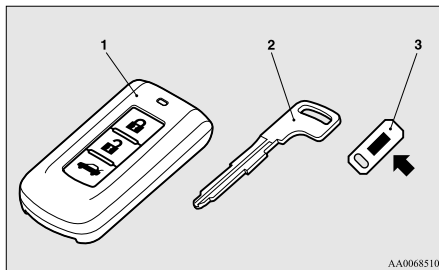

- 1- Keyless operation key (with electronic immobilizer and keyless entry system function)
- 2- Emergency key
- 3- Key number tag

⚠ WARNING

- When taking a key on flights, do not press any switches on the key while on the plane. If a switch is pressed on the plane, the key emits electromagnetic waves, which could adversely affect the plane's flight operation. When carrying a key in a bag, be careful that no switches on the key can be easily pressed by mistake.

NOTE

- The key number is stamped on the tag as indicated in the illustration. Make a record of the key number and store the key and key number tag in separate places, so that you can order a key in the event the original keys are lost.
- The key is a precision electronic device with a built-in signal transmitter. Please observe the following in order to prevent a malfunction.
 - Do not leave in a place that is exposed to direct sunlight, for example on the dashboard.
 - Do not disassemble or modify.
 - Do not excessively bend the key or subject it to strong impacts.
 - Do not expose to water.
 - Keep away from magnetic key rings.
 - Keep away from audio systems, personal computers, TVs, and other equipment that generates a magnetic field.
 - Keep away from devices that emit strong electromagnetic waves, such as cellular phones, wireless devices and high frequency equipment (including medical devices).
 - Do not clean with ultrasonic cleaners or similar equipment.
 - Do not leave the key where it may be exposed to high temperature or high humidity.
- The engine is designed so that it will not start if the ID code registered in the immobilizer computer and the key's ID code do not match. Refer to the "Electronic immobilizer" section for details and key usage.

- Pay attention to the following if the security alarm is set to “Active”. Refer to “Security alarm system” on page 1-28.
 - If the security alarm system is in the system armed mode, the alarm will sound if the doors are opened after being unlocked with the key, the inside lock knob or the central door lock switch (vehicles equipped with the central door lock switch).
 - Even if the security alarm is set to “Active”, the system preparation mode is not entered if the keyless entry system or the keyless operation function was not used to lock the vehicle.

Electronic immobilizer (Anti-theft starting system)

E00300201898

[For vehicles equipped with the keyless operation system]

For information on operations for vehicles equipped with the keyless operation system, refer to “Keyless operation system: Electronic immobilizer (Anti-theft starting system)” on pages 1-11, 1-15.

[Except for vehicles equipped with the keyless operation system]

The electronic immobilizer is designed to reduce significantly the possibility of vehicle theft. The purpose of the system is to immobilize the vehicle if an invalid start is attempted. A valid start attempt can only be achieved, using a key “registered” to the immobilizer system.

NOTE

- In the following cases, the vehicle may not be able to receive the registered ID code from the registered key and the engine may not start.
 - When the key contacts a key ring or other metallic or magnetic object (Type A)
 - When the key grip contacts metal of another key (Type B)

- When the key contacts or is close to other immobilizing keys (including keys of other vehicles) (Type C)

In cases like these, remove the object or additional key from the vehicle key. Then try again to start the engine. If the engine does not start, we recommend you to contact your MITSUBISHI MOTORS Authorized Service Point.

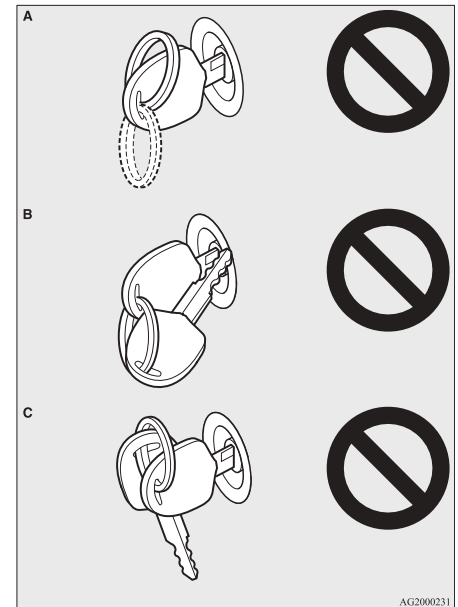

Locking and unlocking

NOTE

- If you lose your key, contact your MITSUBISHI MOTORS Authorized Service Point as soon as possible.

To obtain a replacement or extra spare key, take your vehicle and all remaining keys to your MITSUBISHI MOTORS Authorized Service Point. All the keys have to be re-registered in the immobilizer computer unit. The immobilizer can register up to 8 different keys.

CAUTION

- Don't make any alterations or additions to the immobilizer system; alterations or additions could cause failure of the immobilizer.

Keyless entry system*

E00300302737

Press the remote control switch to lock or unlock the doors and to open the trunk lid.

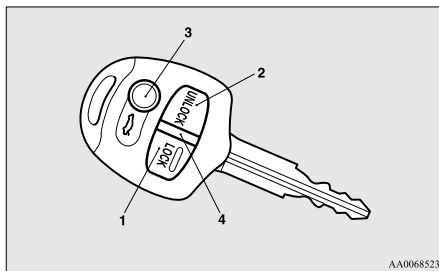

- 1- LOCK switch
- 2- UNLOCK switch
- 3- Electric trunk lid (≡) switch
- 4- Indication lamp

To lock

Press the LOCK switch (1). All the doors will be locked. The turn-signal lamps will blink once.

To unlock

Press the UNLOCK switch (2). All the doors will be unlocked. If the front room lamp switch is in the "DOOR" position or the rear room lamp switch is in the middle (•) position, the room lamp will come on for approximately 15 seconds and the turn-signal lamps will blink twice.

The position and tail lamps will also turn on for about 30 seconds.

Refer to "Instruments and controls: Welcome light" on page 3-39.

NOTE

- For vehicles equipped with the central door lock switch, the door unlock function can be set so that only the driver's door unlocks when the UNLOCK switch (2) is pressed once.

If the door unlock function is set to work as described above, all the doors unlock when the UNLOCK switch is pressed two times in succession.

Refer to "Setting of door unlock function" on page 1-05.

To open the trunk lid

Press the electric trunk lid switch (3) twice within about 5 seconds and the trunk lid will be opened. The trunk lid must be closed manually after it has been opened.

NOTE

- The remote control switch does not operate in the following conditions:
 - The key is left in the ignition switch.
 - A door is open or ajar. (Only the unlock function operates.)
- The indication lamp (4) comes on each time a switch is pressed.
- If the UNLOCK switch (2) is pressed and no door is opened within approximately 30 seconds, relocking will automatically occur.
- It is possible to modify functions as follows:

For further information, please contact your MITSUBISHI MOTORS Authorized Service Point.

 - The time for automatic relocking can be changed.

- Activating the operation confirmation function (blinking of the turn-signal lamps) only during locking, or only during unlocking.
- The confirmation function (this indicates locking or unlocking of the doors with the blink of the turn-signal lamps) can be deactivated.
- The number of times the turn-signal lamps are flashed by the confirmation function can be changed.
- The keyless entry system does not operate in the following conditions:
 - The key is left in the ignition switch.
 - The door is open.
- The remote control switch will operate within approximately 4 m from the vehicle. However, the operating range of the remote control switch may change if the vehicle is located near a power station, or radio/TV broadcasting station.
- If either of the following problems occurs, the battery may be exhausted.
 - The remote control switch is operated at the correct distance from the vehicle, but the doors are not locked/unlocked in response.
 - The trunk lid cannot be opened.
 - The indication lamp (4) is dim or does not come on.

For further information, please contact your MITSUBISHI MOTORS Authorized Service Point.

If you replace the battery yourself, refer to “Procedure for replacing the remote control switch battery” on page 1-05.

- If your remote control switch is lost or damaged, please contact your MITSUBISHI MOTORS Authorized Service Point for a replacement remote control switch.
- If you wish to add a remote control switch, please contact your MITSUBISHI MOTORS Authorized Service Point. A maximum of 8 remote control switches are available for your vehicle.

Setting of door unlock function (vehicles equipped with the central door lock switch)

E00310300228

The door unlock function can be set to the following two conditions.

Each time the door unlock function is set, a chime will sound to tell you the condition of the door unlock function.

Number of chimes	Condition
One chime	All doors unlock
Two chimes	Driver’s door unlock only

1. Remove the key from the ignition switch.
2. Place the combination headlamps and dipper switch in the “OFF” position, and leave the driver’s door open.
3. Press the LOCK switch (1) for 4 to 10 seconds and press the UNLOCK switch (2) during this time.
4. Release in sequence the LOCK and UNLOCK switches within 10 seconds of pressing the LOCK switch in step 3.

Procedure for replacing the remote control switch battery

E00309500174

1. Before replacing the battery, remove static electricity from your body by touching a metal grounded object.
2. Remove the screw (A) from the remote control switch.

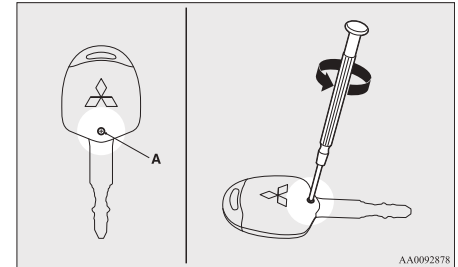

3. With the MITSUBISHI mark facing you, insert the clothcovered tip of a straight blade (or minus) screwdriver into the notch in the

Locking and unlocking

remote control switch case and use it to open the case.

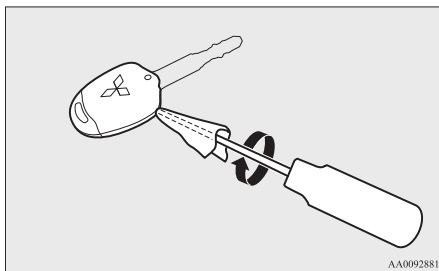

NOTE

- Be sure to perform the procedure with the MITSUBISHI mark facing you. If the MITSUBISHI mark is not facing you when you open the remote control switch case, the switches may come out.

4. Remove the remote control transmitter from the remote control switch case. Then, open the remote control transmitter using the method described in step 3.

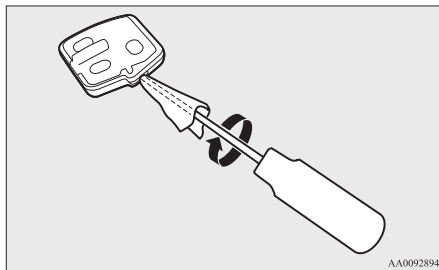

5. Remove the old battery.
6. Install a new battery with the + side (B) down.

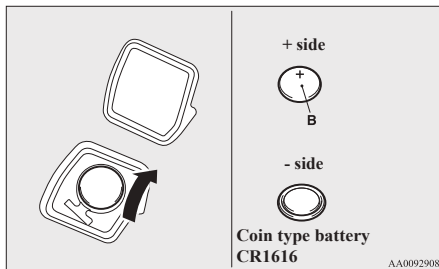

7. Close the remote control transmitter firmly.
8. Place the remote control transmitter in the remote control switch case, then securely close the remote control switch case.

9. Attach the screw (A) removed in step 2.
10. Check the keyless entry system to see that it works.

NOTE

- You may purchase a replacement battery at an electric appliance store.
- A MITSUBISHI MOTORS Authorized Service Point can replace the battery for you if you prefer.

⚠ CAUTION

- When the remote control switch case is opened, be careful to keep water, dust, etc. out. Also, do not touch the internal components.

Keyless operation system*

E00305600409

The keyless operation system allows you to lock and unlock the doors, to open the trunk lid, and start the engine simply by carrying the keyless operation key with you.

The keyless operation key can also be used as the keyless entry system remote control switch.

Refer to “Keyless operation system: Keyless entry system” on page 1-19.

The driver should always carry the keyless operation key. This key is necessary for locking and unlocking the doors, opening the trunk lid, starting the engine and otherwise operating the vehicle, so before locking and leaving the vehicle, be sure to check that you have the keyless operation key.

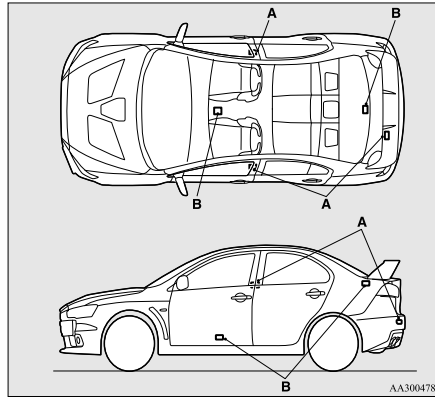

⚠ WARNING

- People with implantable cardiac pacemakers or implantable cardiovascular-defibrillators should not go near the exterior transmitters (A) or the interior transmitters (B). The radio waves used by the keyless operation system could adversely affect implantable cardiac pacemakers or implantable cardiovascular-defibrillators.

⚠ WARNING

- When using electromedical devices other than implantable cardiac pacemakers or implantable cardiovascular-defibrillators, contact the electromedical device manufacturer ahead of time to determine the affects of radio waves on the devices. Electromedical device operations could be affected by radio waves.

You can limit the possible operations of the keyless operation system in the following ways. (The keyless operation system can be used as a keyless entry system.) Please consult a MITSUBISHI MOTORS Authorized Service Point.

- You can limit operations to locking and unlocking of the doors and to opening of the trunk lid.

- You can limit operations to starting the engine.
- The keyless operation system can be disabled.

When keyless operation system operations are modified, the transmitters operate as follows.

- Only locking and unlocking of the doors and opening of the trunk lid: exterior transmitter and interior transmitter
- Only starting the engine: interior transmitter

NOTE

- The keyless operation key uses an ultra-weak electromagnetic wave. In the following cases, the keyless operation system may not operate properly or may be unstable.
 - When there is equipment nearby that emits strong radio waves, such as: a power station, a radio/TV broadcasting station or an airport.
 - The keyless operation system is carried together with a communications device such as a cellular phone or radio set, or with an electronic device such as a personal computer.
 - The keyless operation key is touching or covered by a metal object.
 - A keyless entry system is being used nearby.
 - When the keyless operation key battery is worn out.

Locking and unlocking

- When the keyless operation key is set down in an area with strong radio waves or noise.

In such cases, use the emergency key.

Refer to “To operate without using the keyless operation function” on page 1-15.

- Because the keyless operation key receives signals in order to communicate with the transmitters in the vehicle, the battery continually wears down regardless of keyless operation key use. The battery life is 1 to 3 years, depending on usage conditions. When the battery wears out, have it replaced at your MITSUBISHI MOTORS Authorized Service Point.
- Because the keyless operation key continually receives signals, strong radio wave reception could affect battery wear. Do not leave the key near a TV, personal computer, or other electronic device.

Operating range of the keyless operation system

E00305700468

If you are carrying the keyless operation key, enter the operating range of the keyless operation system, and press the driver's or front passenger's door lock/unlock switch or trunk lid switch, the ID code for your key is verified.

You can only lock and unlock the doors, open the trunk lid and start the engine if the ID codes of your keyless operation key and the vehicle match.

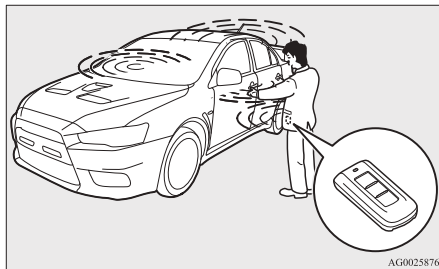

AG0025876

NOTE

- If the keyless operation key battery is wearing out or there are strong electromagnetic waves or noise present, the operating range may become smaller and operation may become unstable.

Operating range for locking and unlocking the doors and for opening the trunk lid

E00306200431

The operating range is about 70 cm from the driver's and front passenger's door lock/unlock switches and centre of the trunk lid.

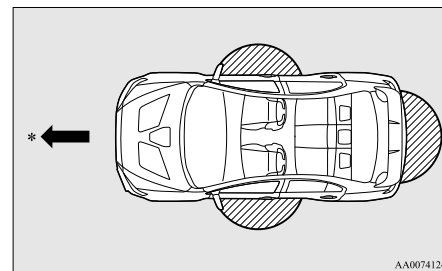

AA0074124

*: Forward direction

: Operating range

NOTE

- Locking and unlocking are only possible when the door is operated while the keyless operation key is being detected.
- Operation may not be possible if you are too close to the front door, door window or trunk lid.
- Even if the keyless operation key is within 70 cm of the driver's or front passenger's door lock/unlock switch or centre of the trunk lid, if the key is near to the ground or high up, the system may not operate.

- If the keyless operation key is within the operating range, even someone not carrying the key can lock and unlock the doors or open the trunk lid by pressing the driver's or front passenger's door lock/unlock switch or the trunk lid switch.

Operating range for starting the engine

E00306300096

The operating range is the interior of the vehicle.

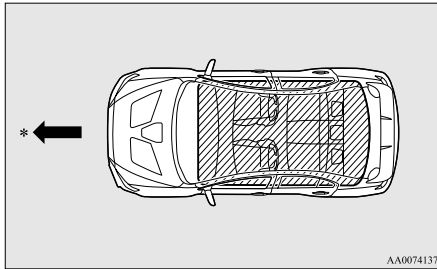

*: Forward direction

 Operating range

NOTE

- Even if it is within the operating range, if the keyless operation key is in a small item holder such as the glove box, on top of the instrument panel, door pocket or in the trunk compartment, it may be impossible to start the engine.

- If you are too close to the door or door window, the engine may be able to be started even though the keyless operation key is outside the vehicle.

To operate using the keyless operation function

E00305800993

Locking the doors

When you are carrying the keyless operation key, if you press the driver's or front passenger's door lock/unlock switch (A) within the operating range, the doors are locked.

The turn-signal lamps will blink once.

Also refer to "Locking and unlocking: Doors, Central door locks" on pages 1-22 and 1-23.

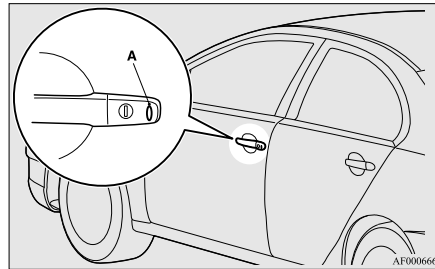

NOTE

- For vehicles equipped with the mirror retractor switch, the outside rear-view mirrors automatically retract when all the doors are locked using the keyless operation function. Refer to "Starting and driving: Outside rear-view mirrors" on page 4-07.

- With a vehicle that has a Dead Lock System, pressing the driver's or front passenger's door lock/unlock switch (A) two times in succession causes the Dead Lock System to be set. (Refer to "Setting the system" on page 1-24.)
- The keyless operation function does not operate under the following conditions:
 - The keyless operation key is inside the vehicle.
 - A door is open or ajar.
 - The ignition switch is not in the "LOCK" position.
 - The emergency key is in the ignition switch.

Unlocking the doors

When you are carrying the keyless operation key, if you press the driver's or front passenger's door lock/unlock switch (A) within the operating range, all the doors are unlocked. If the front room lamp switch is in the "DOOR" position or the rear room lamp switch is in the middle (•) position, at this time, the room lamp will turn on for 15 seconds. The turn-signal lamps will blink twice.

If the driver's or front passenger's door lock/unlock switch is pressed and any of the doors is not opened within approximately 30 seconds, relocking will automatically occur.

Locking and unlocking

Refer to “Locking and unlocking: Doors, Central door locks” on pages 1-22 and 1-23.

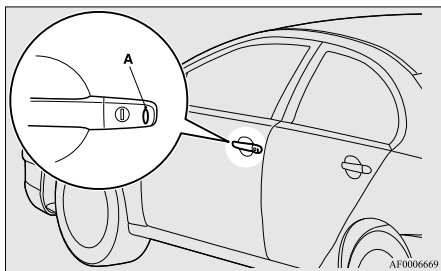

NOTE

- For vehicles equipped with the mirror retractor switch, the outside rear-view mirrors automatically retract when all the doors are locked using the keyless operation function. Refer to “Starting and driving: Outside rear-view mirrors” on page 4-07.
- For vehicles equipped with the central door lock switch, the keyless operation function can be set so that only the driver’s door unlocks when the driver’s door lock/unlock switch is pressed. If the keyless operation function is set to work as described above, all the doors unlock when the driver’s door lock/unlock switch is pressed two times in succession. Refer to “Setting of door unlock function” on page 1-21.
- The keyless operation function does not operate under the following conditions:
 - A door is open or ajar.

- The ignition switch is not in the “LOCK” position.
- The emergency key is in the ignition switch.
- The time between unlocking and automatic locking can be adjusted. Consult a MITSUBISHI MOTORS Authorized Service Point.

Operation confirmation when locking and unlocking

Operation can be confirmed as shown below. However, the room lamp will illuminate only if the front room lamp switch is in the “DOOR” position or the rear room lamp switch is in the middle (●) position.

When locking:	The turn-signal lamps will blink once.
When unlocking:	The room lamp will illuminate for about 15 seconds, the turn-signal lamps will blink twice.

NOTE

- Functions can be modified as stated below. For further information, please contact your MITSUBISHI MOTORS Authorized Service Point.
 - Activating the operation confirmation function (blinking of the turn-signal lamps) only during locking, or only during unlocking.
 - Disabling the operation confirmation function (blinking of the turn-signal lamps).

- Changing the number of blinks for the operation confirmation function (blinking of the turn-signal lamps).

Operation of the Dead Lock System

With a vehicle that has a Dead Lock System, it is possible to set the Dead Lock System using the driver’s or front passenger’s door lock/open switch.

(Refer to “Dead Lock System” on page 1-24.)

To open the trunk lid

While carrying the keyless operation key within the operating range to open the trunk lid, press and hold down the OPEN switch (A) until the trunk lid opens.

Also refer to “Trunk lid” on page 1-26.

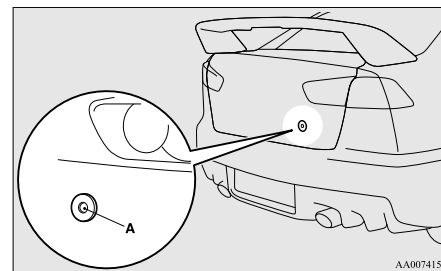

NOTE

- The keyless operation function does not operate when the trunk lid is open.

Electronic immobilizer (Anti-theft starting system)

E00306400475

The electronic immobilizer has been designed to significantly reduce the possibility of vehicle theft. The purpose of the system is to immobilize the vehicle if an invalid start is attempted. A valid start attempt can only be achieved (subject to certain conditions) using a keyless operation system “registered” to the immobilizer system. All of the keys provided with your new vehicle have been programmed into the vehicle’s electronics. Refer to “Keyless operation system: Ignition switch” on pages 1-11 and 1-16.

NOTE

- If you lose one of the keyless operation keys, contact a MITSUBISHI MOTORS Authorized Service Point as soon as possible. To obtain a replacement or extra spare key, take your vehicle and all remaining keys to your MITSUBISHI MOTORS Authorized Service Point. All the keys have to be re-registered in the immobilizer computer unit. The immobilizer can register up to 4 different keys.

Ignition switch

E00306500737

In order to prevent theft, the engine will not start unless a preregistered keyless operation key is used. (Engine immobilizer function) Provided you are carrying the keyless operation key, you can start the engine by turning the ignition switch.

Also refer to “Starting and driving: Starting the engine” on page 4-11.

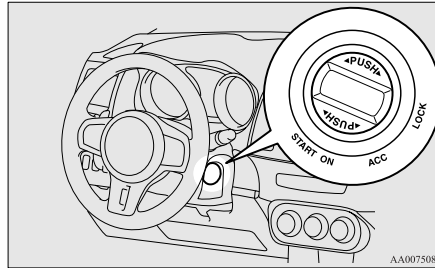

LOCK (PUSH OFF)

The position in which the steering wheel is locked.

LOCK (PUSH ON)

When the ID code verification inside the vehicle produces a match, the steering wheel lock is released and the ignition switch can be turned.

ACC

The engine is stopped, but the electrical devices such as the audio system, accessory socket and cigarette lighter can be operated.

ON

The engine is running, and all the vehicle’s electrical devices can be operated.

START

The starter motor operates. After the engine has started, release the key and it will automatically return to the “ON” position.

NOTE

- The keyless operation key is equipped with an electronic immobilizer. To start the engine, the ID code transmitted by the transponder inside the key must match the code registered in the immobilizer computer. Refer to “Electronic immobilizer (Anti-theft starting system)” on page 1-11.

When turning from “LOCK” (PUSH OFF) to “ACC”

Push the ignition switch and turn it slowly.

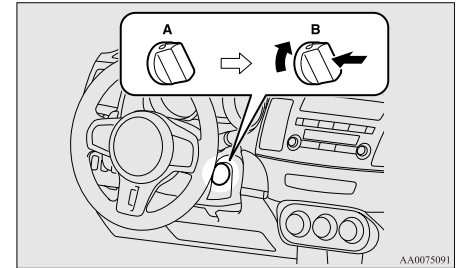

- A- Steering wheel locked
- B- Steering wheel released

NOTE

- If the ignition switch does not turn from “LOCK” (PUSH OFF) to “ACC”, press the ignition switch again, slightly move the steering wheel left and right, and then turn the ignition switch.
- The ignition switch cannot be turned if the keyless operation key is not in the vehicle. Refer to “Operating range for starting the engine” on page 1-09.

Locking and unlocking

When turning from “ACC” to “LOCK”

First, set the gearshift lever to the “P” (PARK) position, and then slowly turn the ignition switch to the “LOCK” position while pressing it.

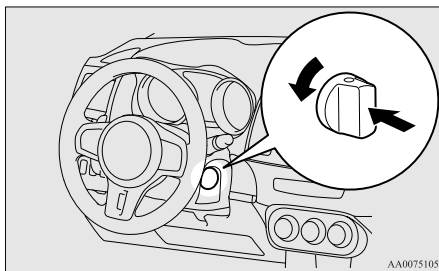

NOTE

- The ignition switch cannot be turned to the “LOCK” position unless the gearshift lever is in the “P” (PARK) position.

⚠ CAUTION

- Do not turn the ignition switch to the “LOCK” position while driving. The steering wheel will be locked, causing loss of control.
- If the engine is stopped while driving, the brake servomechanism will cease to function and braking efficiency will deteriorate. Also, the power steering system will not function and it will require greater manual effort to operate the steering.

⚠ CAUTION

- Do not leave the ignition switch in the “ON” or “ACC” position for a long time when the engine is not running, doing so will cause the battery to be discharged.
- Do not turn the ignition switch to the “START” position when the engine is running, doing so could damage the starter motor.



Warning activation

E00305900587

In order to prevent vehicle theft or the accidental operation of the keyless operation system, the buzzer and the display on the information screen in the multi-information display are used to alert the driver.



If a warning is activated, always check the vehicle and the keyless operation key. The warning is also displayed if there is a fault in the keyless operation system.

If any of the following warnings are activated, please contact a MITSUBISHI MOTORS Authorized Service Point.



	There is a fault in the keyless operation system.
	The battery in the keyless operation key has worn out.

In the following cases, a warning is activated, but it can be cancelled if the correct actions are followed.

- The ID codes for the keyless operation key and the vehicle do not match.

	You could be carrying another keyless operation key with a different code, or the keyless operation key could be outside the operating range.
	Refer to “Keyless operation key take-out monitoring system” on page 1-12.

- Even though you press the driver’s or front passenger’s door lock/unlock switch, the doors are not locked.

	Refer to “Key lock-in prevention system” on page 1-13.
	Refer to “Door ajar prevention system” on page 1-13.
	Refer to “Ignition switch turn-off reminder system” on page 1-13.

Keyless operation key take-out monitoring system

E00308000286

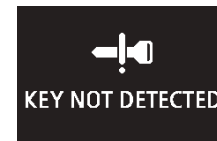

When the vehicle is parked with the ignition switch in any position other than “LOCK” (PUSH OFF), if you close the door after opening any of the doors and taking the keyless operation key out of the vehicle, a warning displays and the buzzer sounds 4 times.

NOTE

- If you take the keyless operation key out of the vehicle through a window without opening a door, the keyless operation key take-out monitoring system does not operate.
- It is possible to change the setting to make the keyless operation key take-out monitoring system operate if you take the keyless operation key out from the vehicle through a window without opening a door. For further information, please contact your MITSUBISHI MOTORS Authorized Service Point.
- Even if you have the keyless operation key within the engine start operating range, if the keyless operation key and vehicle ID codes cannot be matched, for example due to the ambient environment or electromagnetic conditions, the warning may be activated.

Key lock-in prevention system

E00308100492



When the ignition switch is in the “LOCK” (PUSH OFF) position, if you close all the doors with the keyless operation key left in the vehicle and you try to lock the doors by pressing the driver’s or front passenger’s door lock/unlock switch, a warning is issued with the warning display and the buzzer buzzing for about 3 seconds and you cannot lock the doors.

NOTE

- Make sure you have the keyless operation key with you before locking the doors. Even if you leave the keyless operation key inside the vehicle, it is possible that the doors will lock depending on the surrounding environment and wireless signal conditions.

Door ajar prevention system

E00308200448



When the ignition switch is in the “LOCK” (PUSH OFF) position, if you try to lock the doors by pressing the driver’s or front passenger’s door lock/unlock switch when one of the doors is not completely closed, a warning is issued with the warning display and the buzzer buzzing for about 3 seconds and you cannot lock the doors.

Ignition switch turn-off reminder system

E00308300449



When the ignition switch is in any position other than the “LOCK” (PUSH OFF) position, if you close all the doors then try to lock the doors by pressing the driver’s or front passenger’s door lock/unlock switch, a warning is issued with the warning display and the buzzer buzzing for about 3 seconds and you cannot lock the doors.

Steering wheel lock

E00306800105

To lock

Turn the steering wheel until it is locked.

To unlock

Turn the ignition switch to the “ACC” position while moving the steering wheel slightly right and left.

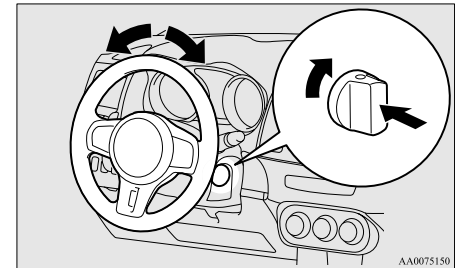

Locking and unlocking

A CAUTION

- Carry the key with you when leaving the vehicle.
If your vehicle needs to be towed, turn the ignition switch to the “ACC” position to unlock the steering wheel.

1

Starting

E00306900500

Tips for starting

- Do not operate the starter motor continuously longer than 10 seconds; doing so could run down the battery. If the engine does not start, turn the ignition switch back to “LOCK”, wait a few seconds, and then try again.
Trying repeatedly with the starter motor still turning will damage the starter mechanism.
- After starting the engine in cold weather, drive in a way that keeps the engine speed low until the bar graph of engine coolant temperature display starts to move (the engine speed decreases). Otherwise, the engine will not rev smoothly and the vehicle will move jerkily.
- The following may occur after the engine is started, but they do not indicate an abnormality.
 - You may hear operational sounds of the Twin Clutch SST and you may feel vibration in the vehicle body.
 - If you shift the gearshift lever into the “N” (NEUTRAL) position and depress the accelerator pedal, increases in the engine speed will be limited.

A WARNING

- Never run the engine in a closed or poorly ventilated area any longer than is needed to move your vehicle in or out of the area. Carbon monoxide gases are odourless and can be fatal.

A CAUTION

- Never attempt to start the engine by pushing or pulling the vehicle.
- Do not run the engine at high rpm or drive the vehicle at high speed until the engine has had a chance to warm up.
- Release the ignition switch as soon as the engine starts to avoid damaging the starter motor.

Starting the engine

E00307000973

The starting procedure is as follows:

1. Insert the ignition key and fasten the seat belt.
2. Make sure the parking brake is applied.
3. Depress and hold the brake pedal.
4. Make sure the selector lever is in the “P” (PARK) position.

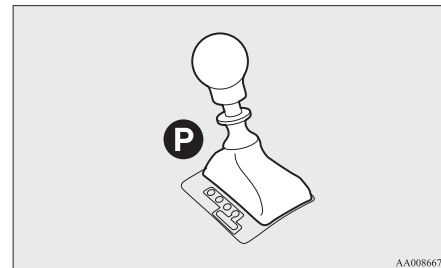

NOTE

- The starter will not operate unless the gearshift lever is in the “P” (PARK) position or the lever is in the “N” (NEUTRAL) position with the brake pedal depressed.
For safety reasons, start the engine in the “P” (PARK) position so that the wheels are locked.
5. After turning the ignition switch to the “ON” position, make certain that all warning lamps are functioning properly before starting the engine.
 6. Turn the ignition switch to the “START” position without depressing the accelerator pedal, and release it when the engine starts.

When it is difficult to start the engine

After several attempts, you may experience that the engine still does not start.

1. Make sure that all electric devices, such as lamps, air conditioning blower and rear window demister, are turned off.

2. While depressing the brake pedal, press the accelerator pedal halfway and hold it there, then crank the engine. Release the accelerator pedal, immediately after the engine starts.
3. If the engine still will not start, the engine could be flooded with too much petrol. While depressing the brake pedal, push the accelerator pedal all the way down and hold it there, then crank the engine for 5 to 6 seconds. Return the ignition switch to the "LOCK" position and release the accelerator pedal. Wait a few seconds, and then crank the engine again for 5 to 6 seconds while depressing the brake pedal, but do not push the accelerator pedal. Release the ignition key if the engine starts. If the engine fails to start, repeat these procedures. If the engine still will not start, we recommend you to have the vehicle checked.

To operate without using the keyless operation function

E00306000077

Emergency key

E00307200340

The emergency key is built into the keyless operation key. If the keyless operation function cannot be used, for example because the keyless operation key battery has worn out or the vehicle battery is flat, you can lock and unlock the driver's door (RHD vehicles) or all the doors (LHD vehicles) and start the engine with the emergency key. To use the emergency key (1), unlock the lock knob (2) and remove it from the keyless operation key (3).

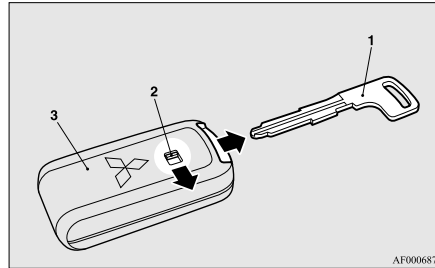

NOTE

- Only use the emergency key for emergencies. If the keyless operation key battery wears out, replace it as quickly as possible so that you can use the keyless operation key.
- After using the emergency key, always return it into the keyless operation key.

Locking and unlocking the door

Turning the emergency key in the forward direction locks the door, and turning it in the rear direction unlocks the door. Also refer to "Locking and unlocking: Doors" on page 1-22.

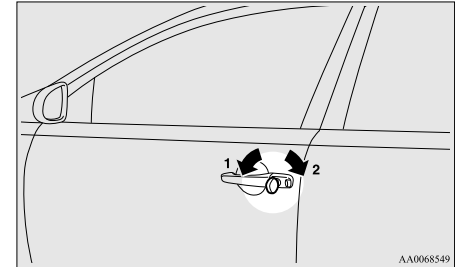

- 1- Lock
- 2- Unlock

Electronic immobilizer (Anti-theft starting system)

E00307300396

The electronic immobilizer is designed to significantly reduce the possibility of vehicle theft. The purpose of the system is to immobilize the vehicle if an invalid start is attempted. A valid start attempt can only be achieved (subject to certain conditions) using a keyless operation system "registered" to the immobilizer system.

All of the keys provided with your new vehicle have been programmed to the vehicle's electronics. Refer to "Keyless operation system: Ignition switch" on pages 1-11 and 1-16.

Locking and unlocking

NOTE

- If you lose one of the keyless operation keys, contact your MITSUBISHI MOTORS Authorized Service Point as soon as possible. To obtain a replacement or extra spare key, take your vehicle and all remaining keys to your MITSUBISHI MOTORS Authorized Service Point. All the keys have to be re-registered in the immobilizer computer unit. The immobilizer can register up to 4 different keys.

Ignition switch

E00307400661

To prevent vehicle theft, only the emergency key with the preregistered keyless operation key inserted can start the engine. (Electronic immobilizer function)

Also refer to “Starting and driving: Starting the engine” on page 4-11.

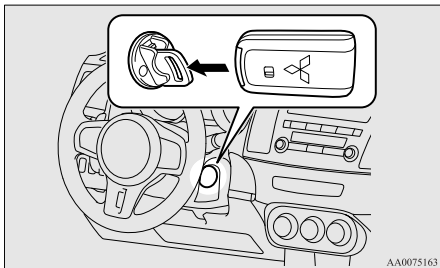

LOCK

The engine is stopped and the steering wheel locked. The emergency key can be inserted and removed in this position.

ACC

The engine is stopped, but the electrical devices such as the audio system, accessory socket and cigarette lighter can be operated.

ON

The engine is running, and all the vehicle’s electrical devices can be operated.

START

The starter motor operates. After the engine has started, release the emergency key and it will automatically return to the “ON” position.

NOTE

- The keyless operation key is equipped with an electronic immobilizer. To start the engine, the ID code transmitted by the transponder inside the key must match the code registered in the immobilizer computer. Refer to “Electronic immobilizer (Anti-theft starting system)” on page 1-15.

When turning from “LOCK” to “ACC”

1. Take the emergency key out of the keyless operation key. Refer to “Emergency key” on page 1-15.

2. Remove the ignition switch cover while pressing the lock release button (A).

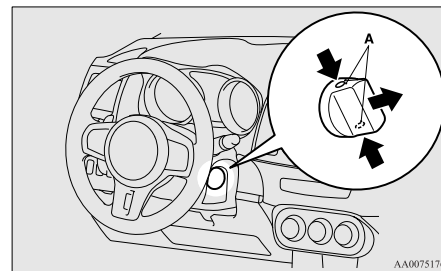

3. Insert the emergency key into the ignition switch and turn slowly while pushing.

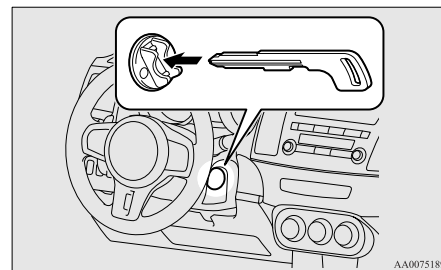

NOTE

- If the ignition switch will not turn from the “LOCK” to the “ACC” position, lightly turn the steering wheel right and left while turning the ignition switch.

To turn from “ACC” to “LOCK”

1. First, set the gearshift lever to the “P” (PARK) position, and then push the emergency key in at the “ACC” position and keep it depressed until it is turned to the “LOCK” position, and remove.
2. Install the cover of the ignition switch.
3. Reinsert the emergency key into the keyless operation key.

NOTE

- The emergency key cannot be removed unless the gearshift lever is set to the “P” (PARK) position.
- When not using the emergency key, always install the ignition switch cover. Otherwise, there is a danger of dirt or dust getting into the keyhole of the ignition switch and causing a malfunction.

⚠ CAUTION

- Do not remove the emergency key from the ignition switch while driving. The steering wheel will be locked, causing loss of control.
- If the engine is stopped while driving, the brake servomechanism will cease to function and braking efficiency will deteriorate. Also, the power steering system will not function and it will require greater manual effort to operate the steering.
- Do not leave the ignition switch in the “ON” or “ACC” position for a long time when the engine is not running, doing so will cause the battery to be discharged.

⚠ CAUTION

- Do not turn the ignition switch to the “START” position when the engine is running, doing so could damage the starter motor.

Steering wheel lock

E00307500138

To lock

Turn the emergency key to the “LOCK” position. Turn the steering wheel until it is locked.

To unlock

Turn the emergency key to the “ACC” position while moving the steering wheel slightly right and left.

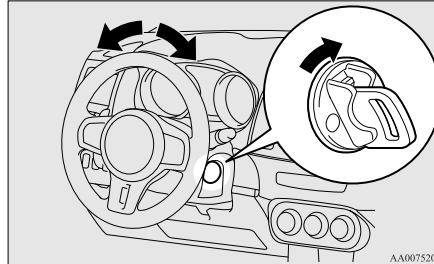
**⚠ CAUTION**

- Remove the emergency key when leaving the vehicle. In some countries, it is prohibited to leave the key on the vehicle when parked.

Starting

E00307600461

Tips for starting

- Do not operate the starter motor continuously longer than 10 seconds; doing so could run down the battery. If the engine does not start, turn the ignition switch back to “LOCK”, wait a few seconds, and then try again. Trying repeatedly with the starter motor still turning will damage the starter mechanism.
- After starting the engine in cold weather, drive in a way that keeps the engine speed low until the bar graph of engine coolant temperature display starts to move (the engine speed decreases). Otherwise, the engine will not rev smoothly and the vehicle will move jerkily.
- The following may occur after the engine is started, but they do not indicate an abnormality.
 - You may hear operational sounds of the Twin Clutch SST and you may feel vibration in the vehicle body.
 - If you shift the gearshift lever into the “N” (NEUTRAL) position and depress the accelerator pedal, increases in the engine speed will be limited.

Locking and unlocking

⚠ WARNING

- Never run the engine in a closed or poorly ventilated area any longer than is needed to move your vehicle in or out of the area. Carbon monoxide gases are odourless and can be fatal.

⚠ CAUTION

- Never attempt to start the engine by pushing or pulling the vehicle.
- Do not run the engine at high rpm or drive the vehicle at high speed until the engine has had a chance to warm up.
- Release the emergency key as soon as the engine starts to avoid damaging the starter motor.

Starting the engine

E00307800838

The starting procedure is as follows:

1. Insert the ignition key and fasten the seat belt.
2. Make sure the parking brake is applied.
3. Depress and hold the brake pedal.
4. Make sure the selector lever is in the “P” (PARK) position.

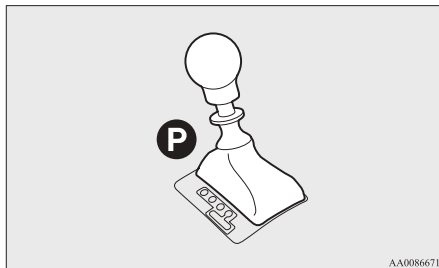

NOTE

- The starter will not operate unless the gear-shift lever is in the “P” (PARK) position or the lever is in the “N” (NEUTRAL) position with the brake pedal depressed. For safety reasons, start the engine in the “P” (PARK) position so that the wheels are locked.

5. While pushing the lock release button (A), remove the cover of the ignition switch.

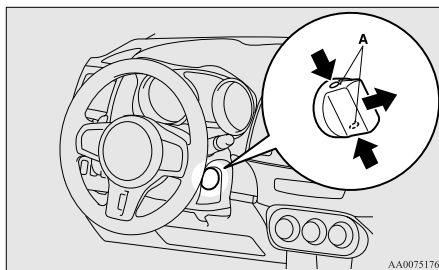

6. Insert the emergency key into the ignition switch.

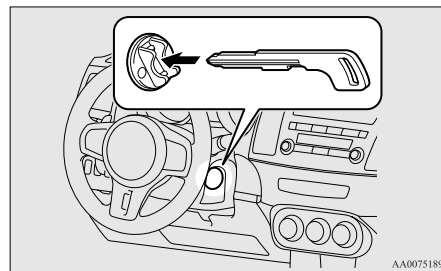

7. Insert the keyless operation key into the emergency key.

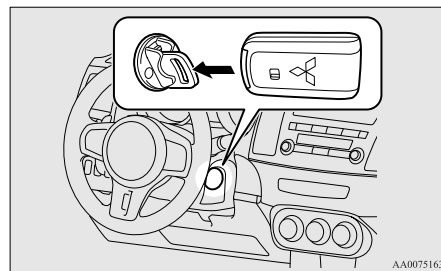

8. After turning the emergency key with the keyless operation key to the “ON” position, make sure that all warning lamps are functioning properly before starting the engine.

- Turn the emergency key with the keyless operation key to the “START” position without depressing the accelerator pedal, and release it when the engine starts.
- Remove the keyless operation key from the emergency key.

Locking and unlocking

(Vehicles equipped with the mirror retractor switch)

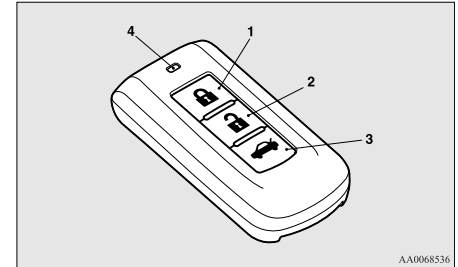

- 1- LOCK (🔒) switch
- 2- UNLOCK (🔓) switch
- 3- Electric trunk lid (🚗) switch
- 4- Indication lamp

⚠️ WARNING

- Make sure to remove the keyless operation key from the emergency key after the engine is started.

If not removed, the keyless operation key could fall to the floor, which could disturb the pedal operation. Furthermore, the keyless operation key could prevent the driver's knee airbag from inflating normally or could be propelled to cause serious injury if the airbag inflates.

- While depressing the brake pedal, press the accelerator pedal halfway and hold it there, then crank the engine. Release the accelerator pedal, immediately after the engine starts.
- If the engine still will not start, the engine could be flooded with too much petrol. While depressing the brake pedal, push the accelerator pedal all the way down and hold it there, then crank the engine for 5 to 6 seconds. Return the ignition switch to the “LOCK” position and release the accelerator pedal. Wait a few seconds, and then crank the engine again for 5 to 6 seconds while depressing the brake pedal, but do not push the accelerator pedal. Release the ignition key if the engine starts. If the engine fails to start, repeat these procedures. If the engine still will not start, we recommend you to have the vehicle checked.

Keyless entry system

E00307701010

Press the remote control switch to lock or unlock the doors and to open the trunk lid. It is also possible to operate the outside rear-view mirrors.

To lock

Press the LOCK switch (1). All the doors will be locked. The turn-signal lamps will blink once.

NOTE

- With a vehicle that has a Dead Lock System, pressing the LOCK switch (1) two times in succession causes the Dead Lock System to be set. (Refer to “Setting the system” on page 1-24.)

To unlock

Press the UNLOCK switch (2). All the doors will be unlocked. If the front room lamp switch is in the “DOOR” position or the rear room lamp switch is in the middle (•) position, the room lamp will come on for approximately 15 seconds and the turn-signal lamps will blink twice.

NOTE

- If the emergency key is attached to a key holder, it may become impossible to insert the keyless operation key into the emergency key, and it may prevent the engine from being started. When using the emergency key to start the engine, first remove the key from the key ring.

When it is difficult to start the engine

After several attempts, you may experience that the engine still does not start.

- Make sure that all electric devices, such as lamps, air conditioning blower and rear window demister, are turned off.

Locking and unlocking

The position and tail lamps will also turn on for about 30 seconds.

Refer to “Instruments and controls: Welcome light” on page 3-39.

NOTE

- For vehicles equipped with the central door lock switch, the door unlock function can be set so that only the driver’s door unlocks when the UNLOCK switch (2) is pressed once.

If the door lock function is set to work as described above, all the doors unlock when the UNLOCK switch is pressed two times in succession.

Refer to “Setting of door unlock function” on page 1-05.

To open the trunk lid

Press the electric trunk lid switch (3) twice within about 5 seconds and the trunk lid will be opened. The trunk lid must be closed manually after it has been opened.

Operation of the Dead Lock System

In a vehicle that has a Dead Lock System, it is possible to set the Dead Lock System using the remote controller. (Refer to “Dead Lock System” on page 1-24.)

Operation of the outside rear-view mirrors (Vehicles equipped with mirror retractor switch)

E00311200295

To fold

Within 30 seconds of locking the doors using the LOCK switch (1), press the LOCK switch twice rapidly to fold the door mirrors.

To extend

Within 30 seconds of unlocking the doors using the UNLOCK switch (2), press the UNLOCK switch twice rapidly to return the door mirrors to their extended positions.

The outside rear-view mirrors are not initially set to work as described above. If you want them to work as described above, you need to set them so that they do not retract/extend when the doors are locked/unlocked using the keyless entry system or keyless operation system.

Refer to “Starting and driving: Outside rear-view mirrors” on page 4-07.

For details, please consult a MITSUBISHI MOTORS Authorized Service Point.

NOTE

- The remote control switch does not operate in the following conditions:
 - The key is left in the ignition switch.
 - A door is open or ajar. (Only the unlock function operates.)
- The indication lamp (4) comes on each time a switch is pressed.
- For vehicles equipped with the mirror retractor switch, the outside rear-view mirrors automatically retract or extend when all the doors are locked or unlocked using the remote control switches of the keyless entry system. Refer to “Starting and driving: Outside rear-view mirrors” on page 4-07.
- If the UNLOCK switch (2) is pressed and no door is opened within approximately 30 seconds, relocking will automatically occur.
- It is possible to modify functions as follows:

For further information, please contact your MITSUBISHI MOTORS Authorized Service Point.

- The time for automatic relocking can be changed.
- Activating the operation confirmation function (blinking of the turn-signal lamps) only during locking, or only during unlocking.
- The confirmation function (this indicates locking or unlocking of the doors with the blink of the turn-signal lamps) can be deactivated.
- The number of times the turn-signal lamps are flashed by the confirmation function can be changed.
- The remote control switch will operate within approximately 4 m from the vehicle. However, the operating range of the remote control switch may change if the vehicle is located near a power station, or radio/TV broadcasting station.
- If either of the following problems occurs, the battery may be exhausted.
 - The remote control switch is operated at the correct distance from the vehicle, but the doors are not locked/unlocked in response.
 - The trunk lid cannot be opened.
 - The indication lamp (4) is dim or does not come on.

For further information, please contact your MITSUBISHI MOTORS Authorized Service Point.

If you replace the battery yourself, refer to “Procedure for replacing the remote control switch battery” on page 1-21.

- If your remote control switch is lost or damaged, please contact your MITSUBISHI MOTORS Authorized Service Point for a replacement remote control switch.
- If you wish to add a remote control switch, please contact your MITSUBISHI MOTORS Authorized Service Point. A maximum of 4 remote control switches are available for your vehicle.

Setting of door unlock function (vehicles equipped with the central door lock switch)

E00310400014

The door unlock function can be set to the following two conditions. Each time the door unlock function is set, a chime will sound to tell you the condition of the door unlock function.

Number of chimes	Condition
One chime	All doors unlock
Two chimes	Driver's door unlock only

1. Turn the ignition switch to the "LOCK" position. If you started the engine with the key, remove the key from the ignition switch.
2. Place the combination headlamps and dipper switch in the "OFF" position, and leave the driver's door open.
3. Press the LOCK switch (1) for 4 to 10 seconds and press the UNLOCK switch (2) during this time.
4. Release in sequence the LOCK and UNLOCK switches within 10 seconds of pressing the LOCK switch in step 3.

Procedure for replacing the remote control switch battery

E00309600016

1. Before replacing the battery, remove static electricity from your body by touching a metal grounded object.
2. With the MITSUBISHI mark facing you, insert the cloth-covered tip of a straight blade (or minus) screwdriver into the notch in the case and use it to open the case.

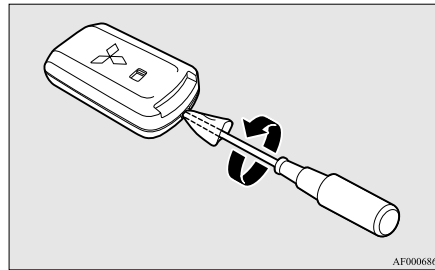

AF0006861

NOTE

- Be sure to perform the procedure with the MITSUBISHI mark facing you. If the MITSUBISHI mark is not facing you when you open the case, the transmitter may come out.
3. Remove the old battery.

4. Install a new battery with the + side (A) up.

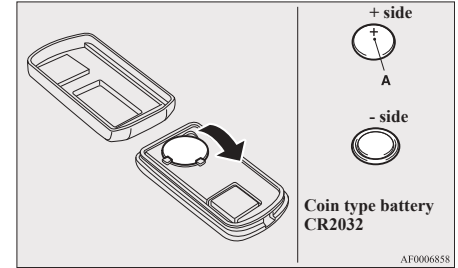

AF0006858

5. Close the case firmly.
6. Check the keyless operation function to see that it works.

NOTE

- You may purchase a replacement battery at an electric appliance store.
- A MITSUBISHI MOTORS Authorized Service Point can replace the battery for you if you prefer.

CAUTION

- When the remote control switch case is opened, be careful to keep water, dust, etc. out. Also, do not touch the internal components.

Locking and unlocking

Doors

E00300402161

CAUTION

- Make sure the doors are closed: driving with doors not completely closed is dangerous.
- Never leave children in the vehicle unattended.
- Be careful not to lock the doors while the key is inside the vehicle.

NOTE

- To prevent the key from being locked inside the vehicle, neither the inside lock knob on the driver's door nor the key or the central door lock switch (vehicles equipped with the central door lock switch) can be used to lock the driver's door when it is open.

To lock or unlock with the key

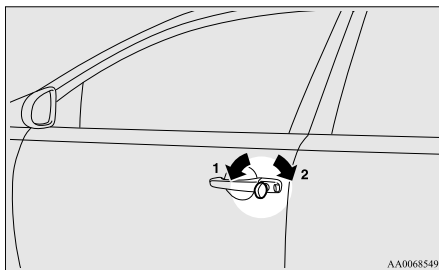

- 1- Lock
- 2- Unlock

NOTE

- On LHD vehicles, when locking or unlocking with the key, only the driver's door will be locked or unlocked. To lock or unlock all doors, use the central door lock switch, the keyless entry system or the keyless operation function. Refer to "Central door locks" on pages 1-23, "Keyless entry system" on pages 1-04 and 1-19, and "To operate using keyless operation function" on page 1-09.
- If the vehicle is equipped with the keyless operation system, the door can be locked or unlocked with the emergency key. Refer to "Emergency key" on page 1-15.

To lock or unlock from inside the vehicle

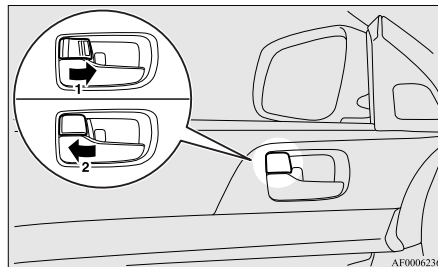

- 1- Lock
- 2- Unlock

Pull the inside door handle towards you to open the door.

NOTE

- The driver's door can be opened without using the inside lock knob by pulling on the inside door handle. On RHD vehicles, all other doors are unlocked at the same time.
- In a vehicle that has a Dead Lock System, it is not possible to unlock the door by pushing the inside lock knob to the unlock side while the Dead Lock System is set. (Refer to "Dead Lock System" on page 1-24.)

To lock without using the key

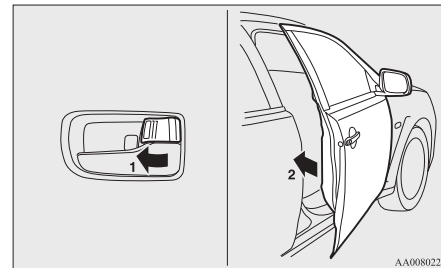

Set the inside lock knob (1) to the locked position and close the door (2).

NOTE

- The driver's door cannot be locked using the inside lock knob while the driver's door is opened.

Ignition switch on reminder system*

E00310100356

When the engine was started using the keyless operation function



If the driver's door is opened with the ignition switch in any position other than "LOCK" (PUSH OFF) after turning off the engine, the ignition switch on reminder buzzer sounds intermittently to remind you to turn off the ignition switch.

In addition, the warning display will be displayed on the information screen in the multi-information display.

Central door locks

E00300801517

Type 1 (LHD vehicles)

E0031140082

NOTE

- Each of the doors can be locked or unlocked independently by using the inside lock knob.
- When locking or unlocking with the key on the driver's door, only the driver's door will lock or unlock.
- Repeated continuous operation between lock and unlock could activate the central door locking systems built-in protection circuit and prevent the system from operating. If this occurs, wait about 1 minute before operating the central door lock switch.
- When the driver's door is open, the central door lock switch cannot be used to lock it.

To lock and unlock the doors

E00311500054

Using the central door lock switch

All of the doors can be locked or unlocked by pressing the central door lock switch on the driver's door.

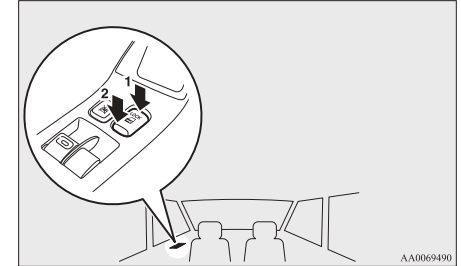

- 1- Lock
2- Unlock

AA006940

Type 2 (RHD vehicles)

E00311600042

NOTE

- Each of the doors can be locked or unlocked independently by using the inside lock knob. (except for the driver's door)
- Repeated continuous operation between lock and unlock could activate the central door locking systems built-in protection circuit and prevent the system from operating. If this occurs, wait about 1 minute before operating the inside lock knob or the key.

Locking and unlocking

To lock and unlock the doors

E0031170069

Using the key on the driver's door

Using the key on the driver's door locks or unlocks all doors.

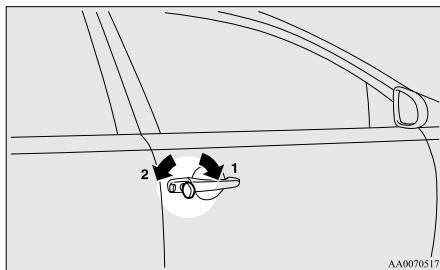

- 1- Lock
- 2- Unlock

Using the inside lock knob on the driver's door

Using the inside lock knob on the driver's door locks or unlocks all doors.

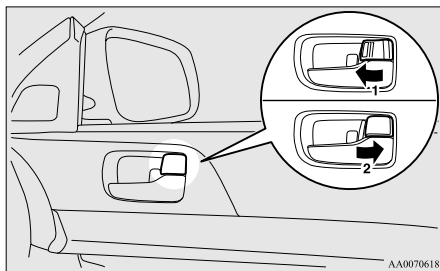

- 1- Lock
- 2- Unlock

To unlock the doors

E00308700368

You can select the functions to unlock the doors either using the ignition switch position or using the gearshift lever (Twin Clutch SST) position.

These functions are not activated when the vehicle is shipped from the factory. To activate or deactivate these functions, please contact a MITSUBISHI MOTORS Authorized Service Point.

Using the ignition switch position

All doors will unlock whenever the ignition switch is turned to the "LOCK" position.

Using the gearshift lever (Twin Clutch SST) position

All doors will unlock whenever the gearshift lever (Twin Clutch SST) is moved to the "P" (PARK) position with the ignition switch in the "ON" position.

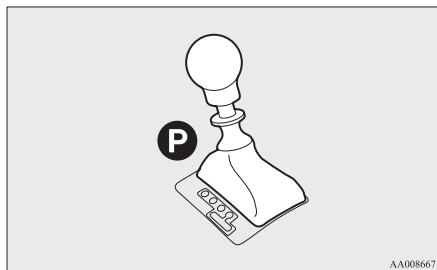

AA0086671

Dead Lock System*

E00305100172

The Dead Lock System helps to prevent theft. When the keyless operation system has been used to lock all of the doors, the Dead Lock System makes it impossible to unlock the doors using the inside lock knobs.

CAUTION

- Do not set the Dead Lock System when someone is inside the vehicle. With the Dead Lock System set, it is not possible to unlock the doors using the inside lock knobs. If you erroneously set the Dead Lock System, unlock the doors using the UNLOCK switch on the keyless operation key or the keyless operation function.

Setting the system

E00305200203

1. Turn the ignition switch to the "LOCK" position.
Also, if an emergency key was used to start the engine, remove the key from the ignition switch.
2. Get out of the vehicle. Close all of the doors.
3. Press the LOCK switch (A) on the keyless operation key, or the driver or front passenger's door lock/unlock switch (B) to lock all of the doors. The turn-signal lamps will blink once.

- Press the LOCK switch (A) on the keyless operation key, or the driver or front passenger's door lock/unlock switch (B) again within two seconds.
The turn-signal lamps will blink three times to show that the Dead Lock System has been set.

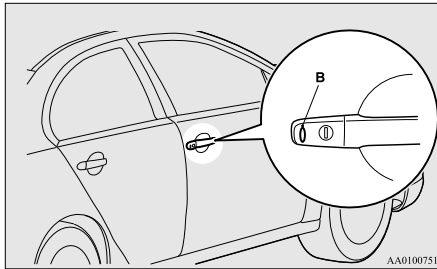
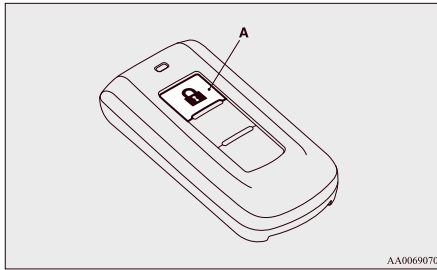

NOTE

- Pressing the LOCK switch (A) once while the Dead Lock System is set causes the turn-signal lamps to blink three times, so it is possible to confirm that the Dead Lock System is set.

Cancelling the system

E00305300275

When the UNLOCK switch (C) on the keyless operation key, or the driver's or front passenger's door lock/unlock switch (B) is pressed, the doors will unlock, and the Dead Lock System will be simultaneously cancelled.

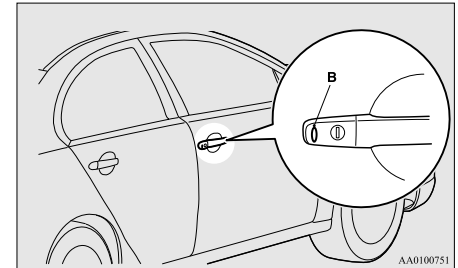
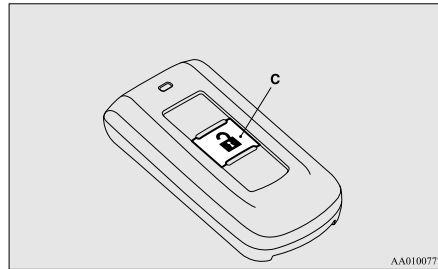

NOTE

- If no door is opened within 30 seconds of unlocking, the doors are automatically relocked and the Dead Lock System is simultaneously set again.
- Even when it is not possible to use the keyless operation system to unlock the doors, it is possible to use the key to unlock the driver's door. When the key is used to unlock the driver's door, the Dead Lock System is cancelled for only the driver's door. If you wish to subsequently unlock all other doors, turn the ignition switch to the "ON" or "ACC" position.
- It is also possible to adjust the time between pressing the UNLOCK switch (C), or the driver's or front passenger's door lock/unlock switch (B) and automatic relocking. For details, please contact a MITSUBISHI MOTORS Authorized Service Point.

Locking and unlocking

- It is possible to lock the doors and set the Dead Lock System at the same time with a single push of the LOCK switch (A), or the driver's or front passenger's door lock/unlock switch (B). For details, please contact a MITSUBISHI MOTORS Authorized Service Point.

1

Testing the system

E00305400146

Open all of the door windows, then set the Dead Lock System. (Refer to "Setting the system" on page 1-24.)

After setting the Dead Lock System, reach into the vehicle through the windows and confirm that you cannot unlock the doors using the inside lock knobs.

NOTE

- If you need advice on how to set the Dead Lock System, please contact a MITSUBISHI MOTORS Authorized Service Point.

"Child-protection" rear doors

E00300900856

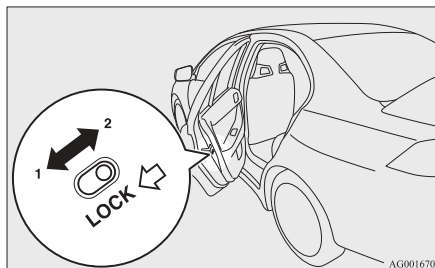

- 1- Lock
2- Unlock

Child protection helps prevent the rear doors from being opened accidentally from the inside.

If the lever is set to the locked position, the rear door cannot be opened using the inside handle, but only with the outside handle.

If the lever is set to the "Unlock" position, the child protection mechanism does not function.

⚠ CAUTION

- When driving with a child in the rear seat, please use the child protection to prevent accidental door opening which may cause an accident.

Trunk lid

E00301200625

⚠ WARNING

- The trunk cannot be opened from the inside. Do not allow children to get inside the trunk. If a child got trapped inside the trunk, a serious accident could result.
- It can be dangerous to drive with the trunk lid open since carbon monoxide (CO) gas can enter the cabin. You cannot see or smell CO. It can cause unconsciousness and even death.

⚠ CAUTION

- Do not stand behind the exhaust pipe when loading and unloading luggage. Heat from the exhaust could lead to burns.
- Do not place tools or other items in the battery (A) space inside the trunk. They could knock the battery and damage it during vehicle operation.

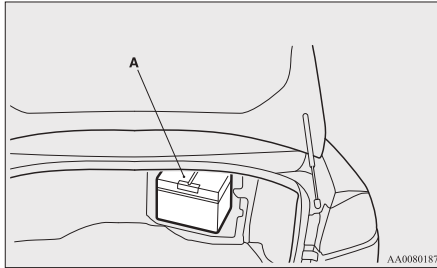

To open

Operation from inside the vehicle (LHD vehicles)
Pull the release lever located beside the driver's seat.

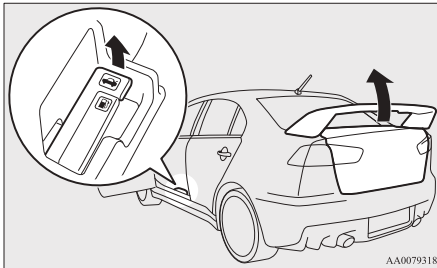

Operation from inside the vehicle (RHD vehicles)
1. Bring the vehicle to a complete stop.

2. Press the trunk lid opener switch to open the trunk lid. The trunk lid will pop up slightly. Lift it to open the trunk.

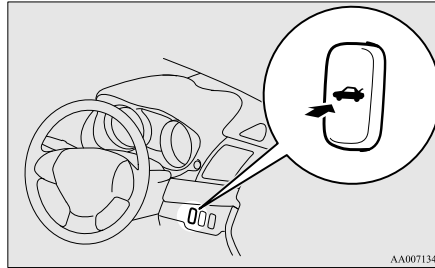

NOTE

- When the LOCK switch of the keyless entry system has been used to lock all of the doors, pushing the trunk lid opener switch does not make the trunk lid open. Before using the trunk lid opener switch, you must press the UNLOCK switch of the keyless entry system. Refer to "Keyless entry system" on pages 1-04 and 1-19.

Using the remote control switch

Press the electric trunk lid switch or the OPEN switch on the trunk lid. (See "Keyless entry system" on pages 1-04, 1-19 or "Keyless operation system" on page 1-07.)
The trunk lid will pop up slightly. Lift it to open the trunk.

To close

Pull the trunk lid downward as illustrated. Gently slam the trunk lid from the outside so that it is completely closed. Always ensure the trunk lid is securely closed.

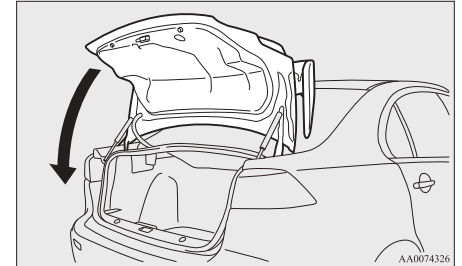

CAUTION

- When closing the trunk lid, always ensure your or another person's fingers cannot be caught by the trunk lid.
- Before starting the vehicle, be sure to confirm that the trunk lid is closed. If the trunk lid opens while driving the vehicle, objects stored in the trunk could fall out onto the road.

NOTE

- Gas struts (A) are installed to support the trunk lid. To prevent damage or faulty operation,
 - Do not touch, push or pull the gas struts when closing the trunk lid.

Locking and unlocking

- Do not attach any plastic material, tape, etc., to the gas struts.
- Do not tie string, etc., around the gas struts.
- Do not hang any object on the gas struts.

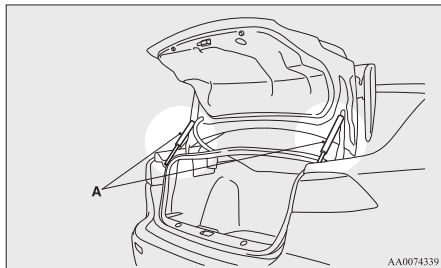

NOTE

- The trunk room lamp illuminates when the lid is opened, and turns off when it is closed.
- The trunk room lamp remains illuminated for a certain period and then goes off automatically to prevent complete discharge of the battery. Refer to “Lamps (room lamps, etc.) auto-cutout function” on page 5-62.

Security alarm system (except for vehicles for Israel)

E00301500963

The security alarm system is for alerting the surrounding area of suspicious behaviour to prevent unlawful entry into the vehicle by operating an alarm if a door, the trunk lid or the bonnet is opened when the vehicle has not been unlocked using the keyless entry system or the keyless operation function.

Also, for vehicles equipped with the interior alarm sensor, the alarm will be activated if any of the following occur.

- Attempt an unlawful moving of the vehicle. (the vehicle inclination detection function)
- Detect a motion in the vehicle. (the interior intrusion detection function)
- Disconnect the battery terminal.

The security alarm system is set to “active”.

When making changes to the settings, please follow the procedure listed in the section titled “Changing the security alarm settings” on page 1-29.

CAUTION

- **Do not modify or add parts to the security alarm system. Doing so could cause the security alarm to malfunction.**

NOTE

- The alarm system will not be activated if the doors have been locked using a key, the inside lock knob or the central door lock switch (if so equipped) (instead of the keyless entry system or the keyless operation function).
- For vehicles equipped with the interior alarm sensor, if the turn-signal lamps do not blink after the locking and unlocking operation using the keyless entry system or the keyless operation function, the security alarm system may be malfunctioning. Have the vehicle inspected at a MITSUBISHI MOTORS Authorized Service Point. If the confirmation function (blinking of the turn-signal lamps by locking and unlocking the doors) is deactivated, the turn-signal lamps do not blink after the locking and unlocking operation. For information on the confirmation function, refer to “Keyless entry system” on page 1-04, “Keyless entry system” on page 1-19 and “To operate using the keyless operation function” on page 1-09.
- For vehicles equipped with the interior alarm sensor, the security alarm system could be activated in the following situations.
 - Using a car wash.
 - Taking the vehicle on a ferry
 - Parking in an automated car park
 - Leaving someone or a pet in the vehicle
 - Leaving a window open.
 - Leaving an unstable object such as a stuffed toy or accessory in the vehicle
 - Suffering a continuous impact or vibration by hail, thunder, etc.

According to the situations, deactivate the vehicle inclination detection function and the interior intrusion detection function.

Refer to “To deactivate the vehicle inclination detection function and the interior intrusion detection function” on page 1-32.

- For vehicles equipped with the interior alarm sensor, the sensitivity of the interior intrusion detection function can be adjusted. For further details, please contact your MITSUBISHI MOTORS Authorized Service Point.

The security alarm has four modes:

System preparation mode (approx. 20 seconds)

(The buzzer sounds intermittently and the security indicator (A) blinks.)

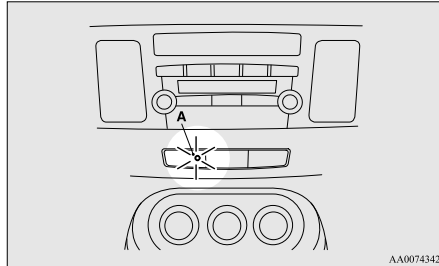

The system preparation time extends from the point at which all of the doors are locked by pressing the LOCK switch on the remote control switch or by using the keyless operation function to the point at which the system armed mode goes into effect.

During this time, it is possible to temporarily open a door or the trunk lid without using the keyless entry system or the keyless operation function and without causing the alarm to sound (for example, when you forget something inside the vehicle or realize that a window is open).

System armed mode

(The buzzer stops and the security indicator continues to blink with the indicator’s reduced lit-up duration time.)

Once the system preparation mode has ended, the system armed mode starts.

If an unlawful opening of any of the doors, trunk lid or bonnet is detected during the system armed mode, the alarm will be activated to warn people around the vehicle of an abnormal condition.

Also, for vehicles equipped with the interior alarm sensor, if unlawful moving of the vehicle is attempted or a vehicle intrusion is detected, the alarm will be activated.

Alarm activation

Inside alarm (approx. 10 seconds):

The buzzer sounds, warning those inside the vehicle of an abnormal condition. (except for vehicles equipped with the interior alarm sensor)

Outside alarm (approx. 30 seconds):

The turn-signal lamps blink and the horn (the siren for vehicles equipped with the interior alarm sensor) sounds, warning people around the vehicle of an abnormal condition.

Refer to “Alarm activation” on page 1-33.

NOTE

- The alarm will resume if unlawful actions are taken again, even if the alarm has stopped.

System cancellation

It is possible to cancel the system activation during the system preparation mode or the system armed mode.

In addition, it is possible to cancel the alarm once it has been activated.

Refer to “Cancelling the system” on page 1-32, “Cancelling the alarm” on page 1-33.

NOTE

- When lending the vehicle to another person or allowing the vehicle to be driven by someone who is unfamiliar with the security alarm system, be sure to give the person a proper explanation of the security alarm system.

If a person who is unfamiliar with the security alarm system accidentally unlocked the vehicle, causing the alarm to sound, the alarm would be a nuisance to people nearby.

Changing the security alarm settings

E00301600283

It is possible to set the security alarm to the “active” mode or “inactive” mode.

Follow the procedure below.

1. Turn the ignition switch to the “LOCK” position. If you started the engine with the key, remove the key from the ignition switch.
2. Place the lamp switch in the “OFF” position, and leave the driver’s door open.

Locking and unlocking

1

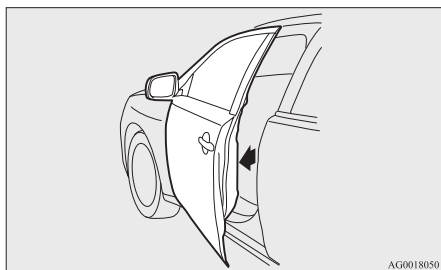
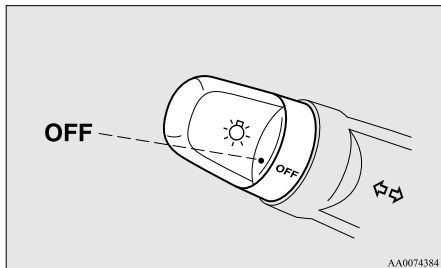

3. Pull the windscreen wiper and washer switch towards you and hold it there.

(Since the ignition switch is in the “LOCK” position, washer fluid will not be sprayed.)

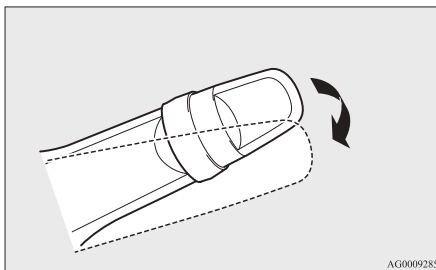

4. After approximately 10 seconds, the buzzer will make a sound. Keep the windscreen wiper and washer switch pulled towards you. (If the windscreen wiper and washer switch was released, the setting change mode would be cancelled. To start over, perform the procedure again from step 3.)
5. When the buzzer stops, with the windscreen wiper and washer switch still pulled towards you, press the UNLOCK switch (A) on the remote control switch to select the security alarm settings mode.

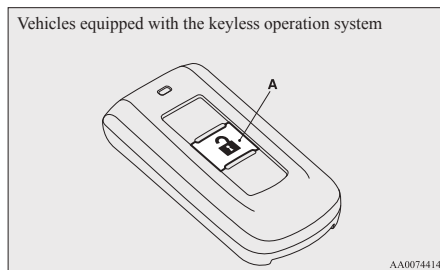
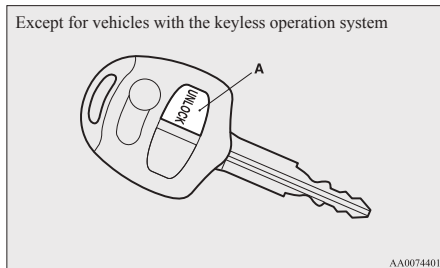

The settings mode can be toggled by pressing the UNLOCK switch. The mode can be confirmed from the number of times the buzzer sounds.

Number of times the buzzer sounds	Security alarm settings mode
1	Alarm inactive
2	Alarm active

6. Any of the following operations can be used to terminate the system settings change mode.

- Releasing the windscreen wiper and washer switch.
- Closing the driver's door.
- Inserting the key into the ignition switch.
- Placing the lamp switch in any position other than "OFF".
- Allowing 30 seconds to pass without making any changes to the settings.
- The ignition switch is put into the "LOCK" (PUSH OFF) position. (vehicles with the keyless operation system)

NOTE

- If anything with regard to making changes to the security alarm system settings is hard to understand, please consult your MITSUBISHI MOTORS Authorized Service Point.
- Avoid leaving valuable items inside the vehicle even when the security alarm system has been set to the "active" mode.

Setting the system

E00301700721

Follow the procedure below to set the system to the system armed mode.

1. Turn the ignition switch to the "LOCK" position. If you started the engine with the key, remove the key from the ignition switch.
2. Exit the vehicle and close all of the doors, the trunk lid and the bonnet.
3. Press the LOCK switch (A) on the remote control switch of the keyless entry system or the keyless operation system, the driver's or

front passenger's door lock/unlock switch (B) in order to lock all the doors.

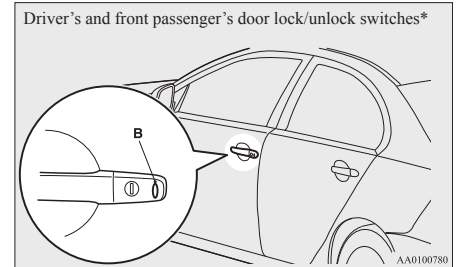
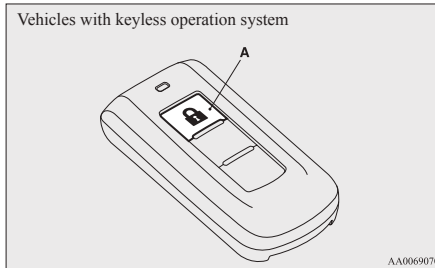
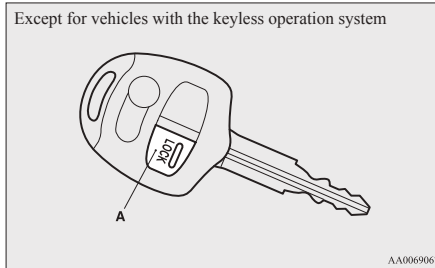

By locking the vehicle using the keyless entry system or the keyless operation function, the system preparation mode is activated. The buzzer makes an intermittent beeping sound and the security indicator (C) in the audio panel blinks for confirmation.

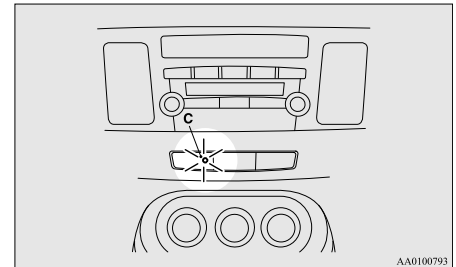

Locking and unlocking

NOTE

- The system preparation mode is not activated when the doors have been locked using a method other than the keyless entry system or the keyless operation function {namely a key, the inside lock knob or the central door lock switch (if so equipped)}.
- If the bonnet or the trunk lid is open, the security indicator illuminates, and the system does not enter the system preparation mode. When the bonnet or the trunk lid is closed, the system enters the system preparation mode, and after approximately 20 seconds the system enters the system armed mode.
- 4. After approximately 20 seconds, the buzzer stops, and when the blinking of the security indicator starts to slow down, the system armed mode goes into effect. The security indicator continues to blink during the system armed mode.

NOTE

- The security alarm system can be activated when people are riding inside the vehicle or when the windows are open. To prevent accidental activation of the alarm, do not set the system to the system armed mode while people are riding in the vehicle.
- Avoid leaving valuable items inside the vehicle even when the security alarm system has been set to the “active” mode.

*To deactivate the vehicle inclination detection function and the interior intrusion detection function**

E00312100233

The vehicle inclination detection function and the interior intrusion detection function can be deactivated when parking in automated car parks or leaving pets in the vehicle or leaving the vehicle with the windows slightly open.

1. Turn the ignition switch to the “LOCK” position. Also, if a key was used to start the engine, remove the key from the ignition switch.
2. Raise and hold the wiper and washer switch to the “MIST” position for approximately 3 seconds. The buzzer will sound once and the function will be deactivated.

To activate the function again, raise and hold the wiper and washer switch to the “MIST” position for approximately 3 seconds. The buzzer will sound twice and the function will be activated.

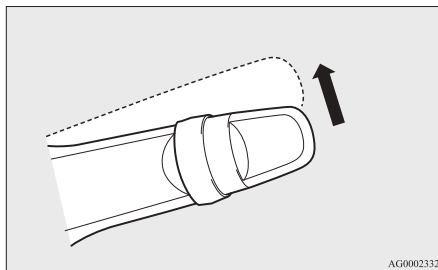

NOTE

- The function will be activated again if the following operation is performed.
 - If the doors are unlocked using the keyless entry system or the keyless operation function.
 - If the ignition switch is turned to the “ON” or “ACC” position.

Cancelling the system

E00301800793

The following methods can be used to cancel the system when it is in the system preparation mode or the system armed mode.

- Pressing the UNLOCK switch on the remote control switch.
- Turning the ignition switch to the “ON” position.
- Opening any one of the doors or inserting the key into the ignition switch when the system is in the system preparation mode.
- Holding the keyless operation key and pressing the driver’s or front passenger’s door lock/unlock switch to unlock the doors (vehicles equipped with the keyless operation system).

NOTE

- If the bonnet or the trunk lid is opened during the system preparation mode, the system preparation mode is suspended. The system returns to the system preparation mode when the bonnet or the trunk lid is closed.
- If the battery terminals are disconnected while the system is in the system preparation mode, the memory will be erased.

- It is possible to register up to 8 remote control switches for the keyless entry system and 4 remote control switches for the keyless operation system. As long as they are registered, any of the remote control switches, other than the one used to activate the system, can be used to cancel the system. If you want to register additional remote control switches, please contact a MITSUBISHI MOTORS Authorized Service Point.
- The activation distance for the keyless entry system is approximately 4 m. If it is not possible to lock or unlock the vehicle by pressing the switch at the correct distance or the security alarm system cannot be set or cancelled using the switch, the battery may need to be replaced. Replace the battery at a MITSUBISHI MOTORS Authorized Service Point.
- If the UNLOCK switch on the remote control switch, or the driver's or front passenger's door lock/unlock switch is pressed and no door is opened within 30 seconds, the doors will automatically relock. In this case as well, the system preparation mode will go into effect.
- The time between pressing the UNLOCK switch on the remote control switch, or the driver's or front passenger's door lock/unlock switch and automatic locking can be adjusted. Please consult your MITSUBISHI MOTORS Authorized Service Point for details.

Alarm activation

E00301901023

When the system is in the system armed mode, the alarm will be activated as follows if the vehicle is unlocked or if any of the doors, trunk lid or bonnet is opened using a method other than the keyless entry system or the keyless operation function.

1. The inside alarm will be activated for approximately 10 seconds. (except for vehicles equipped with the interior alarm sensor)

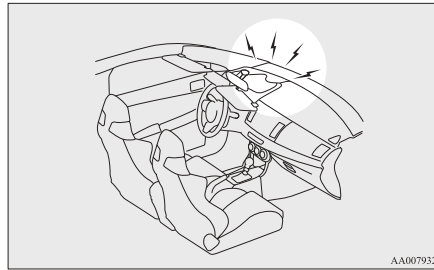

NOTE

- If the bonnet or the trunk lid is opened during the system armed mode, the vehicle outside alarm operates immediately, without the vehicle inside alarm operating.
- The trunk lid can only be opened by the keyless entry system or the keyless operation function without triggering or disarming the system even after the system has been armed. When it is closed, the system will be rearmed.
- The time for the vehicle inside alarm can be adjusted. Consult a MITSUBISHI MOTORS Authorized Service Point.

2. The alarm will be activated for approximately 30 seconds. The turn-signal lamps will blink, and the horn (the siren for vehicles equipped with the interior alarm sensor) will sound intermittently.

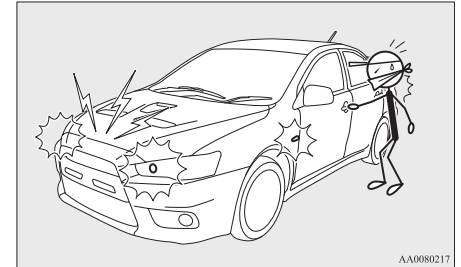

3. The alarm will resume if unlawful actions are taken again, even if the alarm has stopped.

NOTE

- During an alarm operation, the alarm is displayed on the information screen in the multi-information display.



Cancelling the alarm

E00302000532

It is possible to halt the activation of an alarm using the following methods:

Locking and unlocking

- Pressing one of the switches on the remote control switch. (After pressing the LOCK switch, the vehicle will lock if all the doors are closed, after which the system preparation mode will once again go into effect.)
- Turning the ignition switch to the “ON” position.
- Holding the keyless operation key and locking or unlocking the doors using the keyless operation function (vehicles equipped with the keyless operation system).

1

NOTE

- Even if a door or the trunk lid is closed while the inside alarm is activating, this will not cancel the alarm activation. (except for vehicles equipped with the interior alarm sensor)
- When the ignition switch is turned to the “ON” position, the buzzer sounds 4 times. This operation indicates that the alarm was activated while the vehicle was parked. Please check the inside of the vehicle to confirm that nothing was stolen.
- Even if the battery is disconnected, the alarm activation memory will not be erased.

Electric window control

E00302200390

The electric windows can only be operated with the ignition switch in the “ON” position.

Electric window control switch

E00302301662

Each door window opens or closes while the corresponding switch is operated.

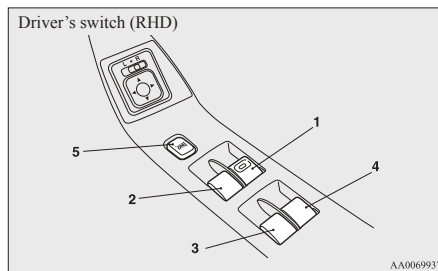
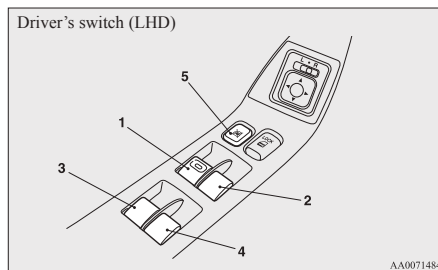

- 1- Driver's door window
- 2- Front passenger's door window
- 3- Rear left door window
- 4- Rear right door window
- 5- Lock switch

⚠ WARNING

- Before operating the electric window control, make sure that nothing is capable of being trapped (head, hand, finger, etc.).
- Never leave the vehicle without removing the key.
- Never leave a child (or other person who might not be capable of safe operation of the electric window control) in the vehicle alone.
- The child may tamper with the switch at the risk of its hands or head being trapped in the window.

NOTE

- Repeated operation with the engine stopped will run down the battery. Operate the window switches only while the engine is running.

Driver's switches

The driver's switches can be used to operate all door windows.

A window can be opened or closed by operating the corresponding switch.

Press the switch down to open the window, and pull up the switch to close it.

If the switch for the driver's window is fully pressed down/pulled up, the door window automatically opens/closes completely.

If you want to stop the window movement, operate the switch lightly in the reverse direction.

Passenger's switches

The passenger's switches can be used to operate the corresponding passenger's door windows.

Press the switch down for opening the window, and pull up the switch for closing.

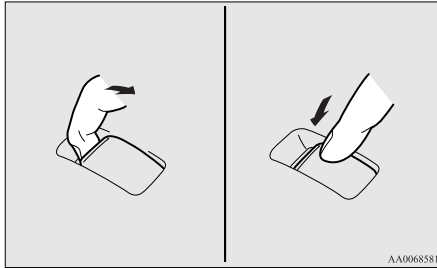

Lock switch

E00303101120

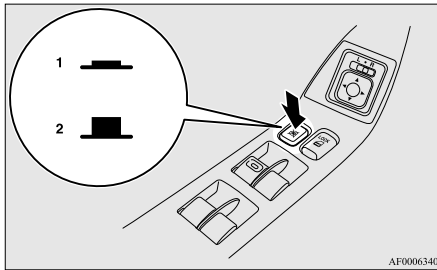

- 1- Lock
- 2- Unlock

When this switch is operated, the passenger's switches cannot be used to open or close the door windows and the driver's switch cannot open or close any windows other than the driver's door window.

To unlock, press it once again.

⚠ WARNING

- A child may tamper with the switch at the risk of its hands or head being trapped in the window. When driving with a child in the vehicle, please press the window lock switch to disable the passenger's switches.

Timer function

E00302400897

The door windows can be opened or closed for 30 seconds after the ignition switch is turned from the "ON" position to the "ACC" or "LOCK" position. However, once the driver's door or the front passenger's door is opened, the windows cannot be operated.

Safety mechanism (Driver's door window only)

E00302500713

If a hand or head is trapped in the closing window, it will lower automatically. Nonetheless, make sure that nobody puts their head or hand out of the window when closing the driver's door window. The lowered window will become operational after a few seconds.

⚠ WARNING

- If the safety mechanism is activated three or more times successively, the safety mechanism will be temporarily cancelled. If a hand or head got trapped, a serious injury could result.

⚠ CAUTION

- The safety mechanism is cancelled just before the window is fully closed. This allows the window to close completely. Therefore be especially careful that no fingers are trapped in the window.
- The safety mechanism is deactivated while the switch is pulled up. Therefore be especially careful that fingers are not trapped in the door window opening.

NOTE

- The safety mechanism can be activated if the driving conditions or other circumstances cause the driver's door window to be subjected to a physical shock similar to that caused by a trapped hand or head.

Locking and unlocking

- If the safety mechanism is activated three or more times in a row, the safety mechanism will be cancelled and the door window will not close correctly.

In such a case, the following procedure should be implemented to rectify this situation. If the window is open, repeatedly raise the driver's door window switch until the window has been fully closed. Following this, release the switch, raise the switch once again and hold it in this condition for at least 1 second, then release it. You should now be able to operate the driver's door window in the normal fashion.

1

Seat and seat belts

Seat.....	2-02
Seat adjustment.....	2-03
Front seat.....	2-03
Rear seat.....	2-05
Head restraints (Rear seat only).....	2-05
Seat belts.....	2-06
Pregnant women restraint.....	2-08
Seat belt pretensioner system and force limiter system.....	2-09
Child restraint.....	2-09
Seat belt inspection.....	2-18
Supplemental restraint system (SRS) - airbag.....	2-18

Seat

E00400101074

2

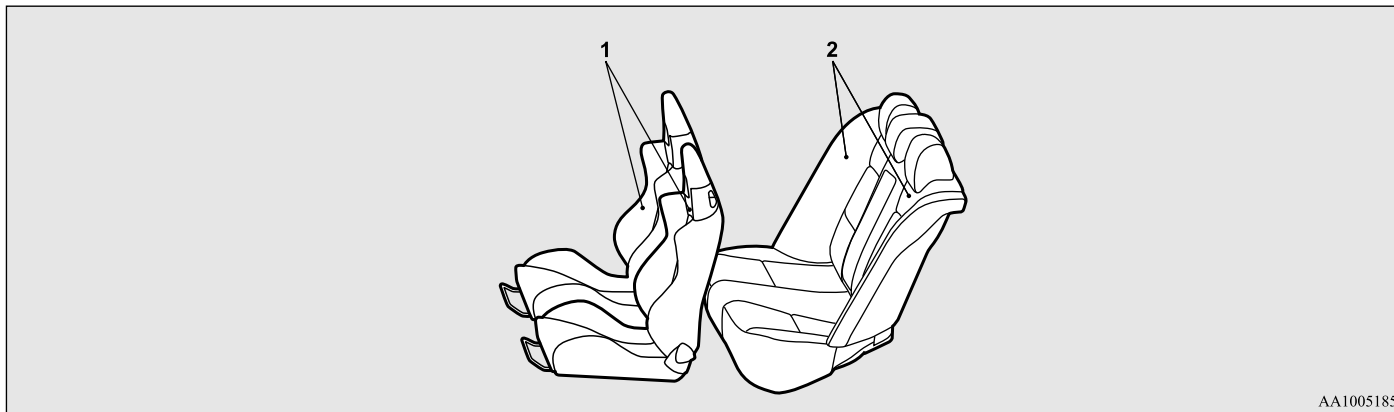

AA1005185

1-Front seat

- To adjust forward or backward → p. 2-03
- To recline the seatback → p. 2-04
- Heated seats* → p. 2-04

2-Rear seat

- Armrest → p. 2-05

Seat adjustment

E00400300428

Adjust the driver's seat so that you are comfortable and that you can reach the pedals, steering wheel, switches etc. while retaining a clear field of vision.

⚠ WARNING

- Do not attempt to adjust the seat while driving. This can cause loss of vehicle control and result in an accident. After adjustments are made, ensure the seating is locked in position by attempting to move the seat forward and rearward without using the adjusting mechanism.
- Do not allow people or children to ride in any area of your vehicle that is not equipped with seats and seat belts, and make sure that everyone travelling in your vehicle is in a seat and wearing a seat belt, or in the case of a child is strapped in a child restraint.
- To minimize the risk of personal injury in the event of a collision or sudden braking, the seatbacks should always be in the almost upright position while the vehicle is in motion. The protection provided by the seat belts may be reduced significantly when the seatback is reclined. There is greater risk that the passenger will slide under the seat belt, resulting in serious injury, when the seatback is reclined.

⚠ CAUTION

- Make sure the seat is adjusted by an adult or with adult supervision for correct and safe operation.
- Do not place a cushion or the like between your back and the seatback while driving. The effectiveness of the head restraints will be reduced in the event of an accident.
- When sliding the seats, be careful not to catch your hand or foot.

Front seat

E00400400012

To adjust forward or backward

E00400500589

Pull the seat adjusting lever and adjust the seat forward or backward to the desired position, and release the adjusting lever.

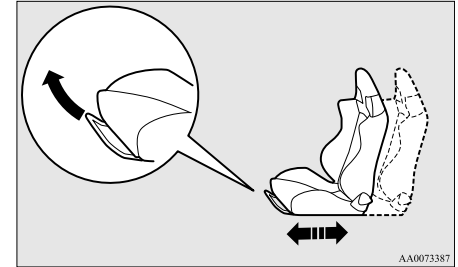

AA0073387

⚠ WARNING

- To ensure the seat is locked securely, try to move the seat forward or backward without using the adjusting lever.

Seat and seat belts

To recline the seatback

E00400600708

Adjust the seatback angle by turning the knob.

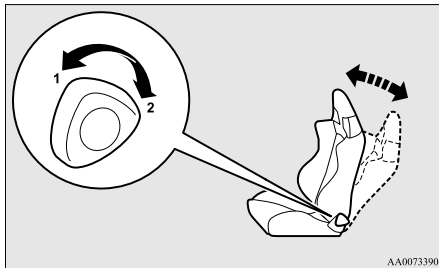

AA0073390

- 1- To move to forward direction
- 2- To recline backward

Heated seats*

E00401100814

The heated seats can be operated with the ignition switch in the “ON” position. Operate the switch as indicated by arrows.

The indication lamp (A) will illuminate while the heater is on.

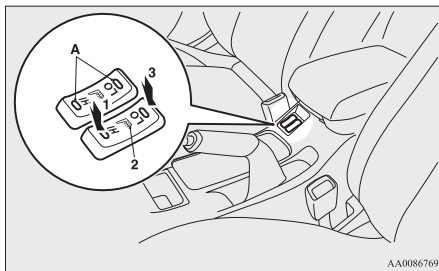

AA0086769

- 1 (HI)- Heater high (for quick heating).
- 2- Heater off.
- 3 (LO)- Heater low (to keep the seat warm).

⚠ CAUTION

- Switch off seat heaters when not in use.
- Operate in the “HI” position for quick heating. Once the seat is warm, set the heater switch to the “LO” position to keep it warm. Slight variations in seat temperature may be felt while using the heated seats. This is caused by the operation of the heater’s internal thermostat and does not indicate a malfunction.
- If the following types of persons use the heated seats, they might become too hot or receive minor burns (red skin, heat blisters, etc.):
 - Children, elderly or ill people
 - People with sensitive skin
 - Excessively tired people
 - People under the influence of alcohol or sleep inducing medication (cold medicine, etc.)
- Do not place heavy objects on the seat or stick pins, needles, or other pointed objects into it.
- Do not use a blanket, cushion, or other material with high heat insulation properties on the seat while using the heater; this might cause the heater element to overheat.

⚠ CAUTION

- When cleaning the seat, do not use benzene, kerosene, petrol, alcohol, or other organic solvents; these might damage the surface of the seat and also the heater element.
- If water or any other liquid is spilled on the seat, allow it to dry thoroughly before attempting to use the heater.
- Turn the heater off immediately if it appears to be malfunctioning during use.

Rear seat

E00401300018

Armrest

E00401700517

To use the armrest, fold it down.
To return to the original position, push it backward until it is flush with the seat.

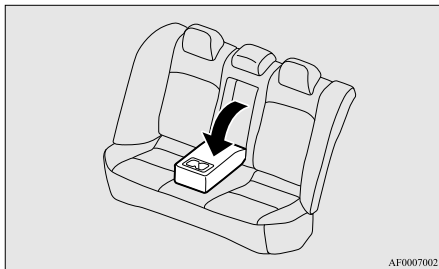

AF0007002

NOTE

- The top surface of the armrest contains a cup holder for rear seat occupants. Refer to “Cup holder” on page 5-65.

Head restraints (Rear seat only)

E00403301035

WARNING

- Driving without the head restraints in place can cause your passengers serious injury or death in an accident. To reduce the risk of injury in an accident, always make sure the head restraints are installed and properly positioned when the seat is occupied.
- Never place a cushion or similar device on the seatback. This can adversely affect head restraint performance by increasing the distance between passenger’s head and the restraint.

To adjust height

Adjust the head restraint height so that the centre of the restraint is as close as possible to eye level to reduce the chances of injury in the event of collision. Any person too tall for the restraint to reach their seated eye level, should adjust the restraint as high as possible.

Seat and seat belts

To raise the head restraint, move it upward. To lower the restraint, move it downward while pushing the height adjusting knob (A) in the direction of the arrow. After adjustment, push the head restraint downward and make sure that it is locked.

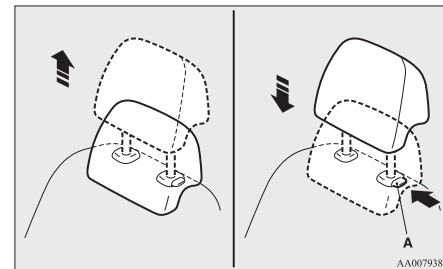

To remove

Lift the head restraint with the height adjusting knob (A) pushed in.

Seat and seat belts

To install

Confirm that the head restraint is facing the correct direction, and then insert it into the seatback while pressing the height adjusting knob (A) in the direction indicated by the arrow.

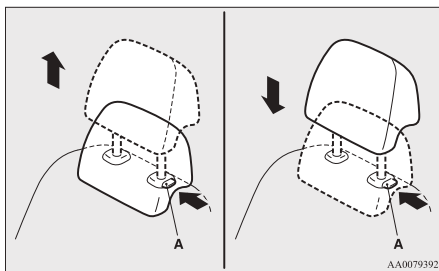

CAUTION

- Confirm that the height adjusting knob (A) is correctly adjusted as shown in the illustration, and also lift the head restraints to ensure that they do not come out of the seatback.

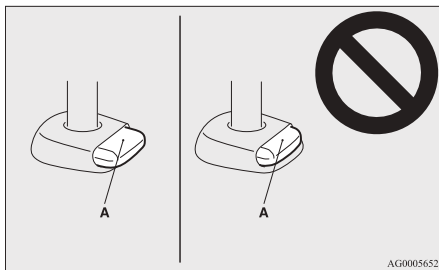

Seat belts

E00404800577

To protect you and your passengers in the event of an accident, it is the most important that the seat belts be worn correctly while driving.

The front seat belts have a pretensioner system. These belts are used the same way as a conventional seat belt.

Refer to "Seat belt pretensioner system and force limiter system" on page 2-09.

WARNING

- Always place the shoulder belt over your shoulder and across your chest. Never put it behind you or under your arm.
- One seat belt should be used by only one person. Doing otherwise can be dangerous.
- The seat belt will provide its wearer with maximum protection if the recliner seatback is placed in fully upright position. When the seatback is reclined, there is greater risk that the passenger will slide under the belt, especially in a forward impact accident, and may be injured by the belt or by striking the instrument panel or seatbacks.
- Seat belts should always be worn by every adult who drives or rides in this vehicle, and by all children who are large enough to wear seat belts properly. Other children should always use proper child restraint systems.
- Remove any twists when using the belt.

WARNING

- No modifications or additions should be made by the user which will either prevent the seat belt adjusting devices from operating to remove slack, or prevent the seat belt assembly from being adjusted to remove slack.
- Never hold a child in your arms or on your lap when riding in this vehicle, even if you are wearing your seat belt. To do so risks severe or fatal injury to your child in a collision or sudden stop.
- Always adjust the belt to a snug fit.
- Always wear the lap portion of the belt over your hips.



3-point type seat belt (with emergency locking mechanism)

E00404901328

This type of belt requires no length adjustment. Once worn, the belt adjusts itself to the movement of wearer, but in the event of a sudden or strong shock, the belt automatically locks to hold the wearer's body.

NOTE

- You can check if the belt locks by pulling it forward quickly.

To fasten

1. Pull the seat belt out slowly while holding the latch plate.

NOTE

- When the seat belts cannot be pulled out in a locked condition, pull the belts once forcefully and then return them. After that, pull the belts out slowly once again.

2. Insert the latch plate into the buckle until a “click” is heard.

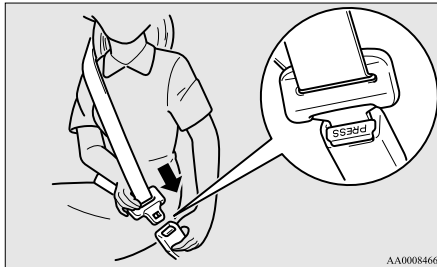

⚠ WARNING

- Never wear the lap portion of the belt across your abdomen. During accidents it can press sharply against abdomen and increase the risk of injury.

⚠ WARNING

- The seat belts must not be twisted when worn.

3. Pull the belt slightly to adjust slackness as desired.

To unfasten

Hold the latch plate and push the button on the buckle.

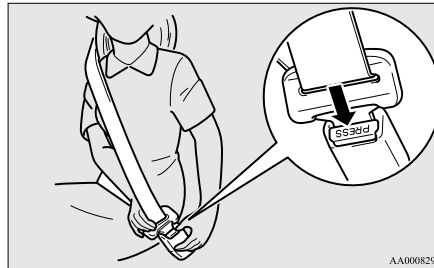

NOTE

- As the belt retracts automatically, keep the latch plate held while retracting so that the belt stows slowly. Failure to do this could damage the vehicle.

Driver's seat belt reminder/warning lamp and display

E00409800686

Warning lamp



Warning display



A tone and warning lamp are used to remind the driver to fasten the seat belt.

If the ignition switch is set to the “ON” position without the driver’s seat belt being fastened, a warning lamp will come on and a tone will sound for approximately 6 seconds to remind you to fasten your seat belt.

If you then drive with the seat belt unfastened for longer than a minute from when the ignition switch was turned to the “ON” position, the warning lamp will come on and blink repeatedly and the tone will sound intermittently.

The warning lamp and the tone will stop after approximately 90 seconds.

If you then repeatedly stop and start your vehicle with the seat belt unfastened, the warning lamp/display and tone will remind you to fasten your seat belt every time the vehicle starts moving. You will also be reminded to fasten your seat belt in this way when you remove your seat belt while driving. The warning lamp and the tone go off when the seat belt is fastened.

Seat and seat belts

NOTE

- At the same time, “FASTEN SEAT BELT” will be displayed on the information screen in the multi-information display.

Front passenger seat belt warning lamp

E00411600274

The front passenger seat belt warning lamp is located on the instrument panel.

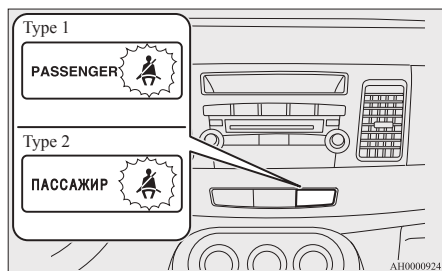

The lamp comes on when a person sits on the front passenger seat but does not fasten the seat belt. It goes off when the seat belt is subsequently fastened.

⚠ WARNING

- Do not install any accessory or sticker that makes the lamp difficult to see.

Adjustable seat belt anchor (front seats)

E00405000420

The seat belt anchor height can be adjusted. Move the seat belt anchor down with the lock knob (A) depressed. To move the anchor up, slide it without depressing the lock knob (A).

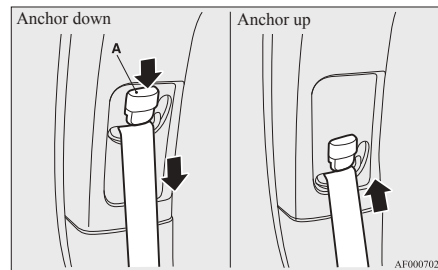

⚠ WARNING

- When adjusting the seat belt anchor, set it at a position that is sufficiently high so that the belt will make full contact with your shoulder but will not touch your neck.

Pregnant women restraint

E00405600064

⚠ WARNING

- Seat belts work for everyone, including pregnant women. Pregnant women should use the available seat belts. This will reduce the likelihood of injury to both the woman and the unborn child. The lap belt should be worn across the thighs and as snug against the hips as possible, but not across the waist. Consult your doctor if you have any additional questions or concerns.

Seat belt pretensioner system and force limiter system

E00405700081

The driver's seat and front passenger's seat each have a seat belt equipped with a pretensioner system.

Pretensioner system

E00405800747

The pretensioner system will retract their respective seat belts instantaneously, thus maximizing the seat belt's effectiveness, if there is a frontal impact severe enough to injure the driver and/or front passenger and the ignition switch is in the "ON" or "START" position.

WARNING

- To obtain the best results from your pretensioner seat belt, make sure you have adjusted your seat correctly and wear your seat belt properly.

CAUTION

- Installation of audio equipment or repairs in the vicinity of the pretensioner seat belts or floor console must be performed in line with MITSUBISHI MOTORS guidelines. It is important to do so because the work could affect the pretensioner systems.

CAUTION

- If you need to scrap the vehicle, please consult a MITSUBISHI MOTORS Authorized Service Point. It is important to do so because unexpected activation of the pretensioner seat belts could cause injuries.

NOTE

- The pretensioner seat belts will be activated if the vehicle suffers a severe frontal impact, even if the seat belts are not worn.
- The pretensioner seat belts are designed to work only once. After the pretensioner seat belts have been activated, we recommend you have it replaced by a MITSUBISHI MOTORS Authorized Service Point.

SRS warning

E00405900302

This warning lamp/display is shared by the SRS airbags and the pretensioner seat belts. Refer to "SRS warning lamp/display" on page 2-28.

Force limiter system

E00406000153

In the event of a collision, each force limiter system will effectively absorb the load applied to the seat belt to minimize the impact to the passenger.

Child restraint

E00406401200

When transporting children in your vehicle, some type of child restraint system should always be used according to the size of the child. This is required by law in most countries.

The regulations concerning driving with children in the front seat may differ from country to country. You are advised to comply with the relevant regulations.

WARNING

- When possible, put children in the rear seat. Accident statistics indicate that children of all sizes and ages are safer when properly restrained in the rear seat rather than in the front seat.
- Holding a child in your arms is no substitute for a restraint system. Failure to use a proper restraint system can result in severe or fatal injury to your child.
- Each child restraint device or fixing is to be used only by one child.
- When attaching a child restraint to the rear seat, place the front seatbacks in the upright position. Otherwise, the child could be seriously injured in the event of hard braking or a collision.

Seat and seat belts

Caution for installing the child restraint on vehicles with a front passenger airbag

E00406500549

The label shown here is attached on vehicles with a front passenger airbag.

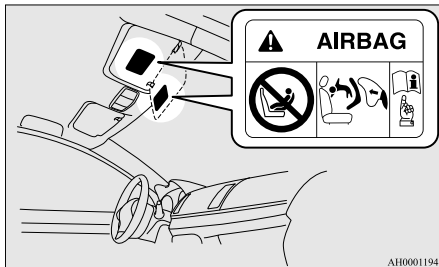

2

⚠ WARNING

- **Extreme Hazard!**
NEVER use a rearward facing child restraint on a seat protected by an ACTIVE AIRBAG in front of it, DEATH or SERIOUS INJURY to the CHILD can occur.

Use rearward facing child restraints in the rear seat or turn off the front passenger's airbag ON-OFF switch. (Refer to "To turn an airbag off" on page 2-22.)

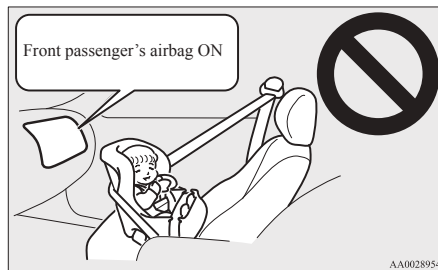

⚠ WARNING

- A REARWARD FACING CHILD RESTRAINT must NOT be used in the front passenger seat if the front passenger's airbag has not been deactivated. The force of an inflating airbag could kill or cause serious injuries to the child. A rearward facing child restraint must only be used in the rear seat.
- A FORWARD FACING CHILD RESTRAINT should be used in the rear seat whenever possible; if used in the front seat, adjust the seat to the most rearward position.



Infants and small children

E00406600902

When transporting infants and small children in your vehicle, follow the instruction given below.

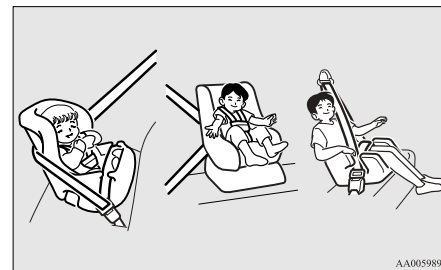

Instruction:

- For small infants, an infant carrier should be used. For small children whose height when seated allows the shoulder belt to lie in contact with the face or the throat, a child seat should be used.

- The child restraint system should be appropriate for your child's weight and height and properly fit the vehicle. For a higher degree of safety: **THE CHILD RESTRAINT SYSTEM SHOULD BE INSTALLED IN THE REAR SEAT.**
- Before purchasing a child restraint system, try installing it in the rear seat to make sure there is a good fit. Because of the location of the seat belt buckles and the shape of the seat cushion, it may be difficult to securely install some manufacturer's child restraint systems. If the child restraint system can be pulled forward or to either side easily on the seat cushion after the seat belt has been tightened, choose another manufacturer's child restraint system.

⚠ WARNING

- **When installing a child restraint system, refer to the instructions provided by the manufacturer of the restraint system. Failure to do so can result in severe or fatal injury to your child.**
- **After installation, push and pull the child restraint system back and forth, and side to side, to see that it is positively secured. If the child restraint system is not installed securely, it may cause injury to the child or other occupants in the case of accident or sudden stops.**

⚠ WARNING

- **When the child restraint system is not in use, keep your child restraint system secured with the seat belt or remove it from the vehicle in order to prevent it from being thrown around inside the vehicle during an accident.**

NOTE

- Depending on the seating position in the vehicle and the child restraint system that you have, the child restraint can be attached using one of following two locations:
 - To the lower anchorage in the rear seat, ONLY if the child restraint has ISOFIX mountings (See page 2-16).
 - To the seat belt (See page 2-17).

Older children

E00406700134

Children who have outgrown the child restraint system should be seated in the rear seat and wear combination lap shoulder belt.

The lap portion of the belt should be snug and positioned low on the abdomen so that it is below the top of the hip-bone. Otherwise, the belt could intrude into the child's abdomen during an accident and cause injury.

Suitability for various ISOFIX positions

E00411400706

Mass group	Size class	Fixture	Vehicle ISOFIX positions
			Rear outboard
Carycot	F	ISO/L1	X
	G	ISO/L2	X
0 - Up to 10 kg	E	ISO/R1	X
0+ - Up to 13 kg	E	ISO/R1	IL* ¹
	D	ISO/R2	X
	C	ISO/R3	X
I - 9 to 18 kg	D	ISO/R2	X
	C	ISO/R3	X
	B	ISO/F2	IUF
	B1	ISO/F2X	IUF, IL* ²
	A	ISO/F3	IUF
II & III - 15 to 36 kg			X

 **CAUTION**

- When installing a child restraint system, remove the head restraint from the seat.

Key of characters to be inserted in the table above:

- IUF- Suitable for ISOFIX forward child restraints systems of universal category approved for use in the mass group.
- IL- Suitable for particular ISOFIX child restraint systems given in the following list (MITSUBISHI MOTORS GENUINE parts).
- X- ISOFIX position not suitable for ISOFIX child restraint systems in this mass group.

II. (Genuine part information)

	Genuine part No.	UN-R44 Approval No.
*1	MZ314393 (Child restraint system), MZ314394 (ISOFIX base)	E1-04301146
*2	MZ313045	E1-04301133

NOTE

- MITSUBISHI MOTORS Europe B.V. reserves the right to changes without any prior announcement.
For further information, please contact a MITSUBISHI MOTORS Authorized Service Point.

Suitability for various seating positions

E00406801392

Mass group	Seating position			
	Front passenger		Rear outboard	Rear centre
	Activated airbag	Deactivated Airbag ^{#1}		
0 - Up to 10 kg	X	U	X	U
0+ - Up to 13 kg	X	U, L* ¹	L* ¹	U, L* ¹
I -9 to 18 kg	UF, L* ² , L* ³	U, L* ² , L* ³	L* ² , L* ³	U, L* ² , L* ³
II & III -15 to 36 kg	UF	U	L* ⁴	U

#1: With front passenger's airbag deactivated by means of front passenger's airbag ON-OFF switch

CAUTION

- When installing a child restraint system, remove the head restraint from the seat.

Key of characters to be inserted in the table above:

- U- Suitable for “universal” category restraints approved for use in this mass group.
- UF- Suitable for forward-facing “universal” category restraints approved for use in this mass group.
- L- Suitable for particular child restraints in the following list (MITSUBISHI MOTORS genuine parts).
- X- Seat position not suitable for children in this mass group.

L (Genuine part information)

	Genuine part No.	UN-R44 Approval No.
*1	MZ314393	E1-04301146
*2	MZ314451	E1-04301203
*3	MZ313045	E1-04301133
*4	MZ314250	E1-04301169

NOTE

- There is no applicable MITSUBISHI MOTORS Genuine Parts to the Mass Group “0-Up to 10 kg”.

MITSUBISHI MOTORS Europe B.V. reserves the right to changes without any prior announcement.
For further information, please contact a MITSUBISHI MOTORS Authorized Service Point.

Seat and seat belts

Installing a child restraint system to the lower anchorage (ISOFIX child restraint mountings) and tether anchorage

E00408900912

Lower anchorage location

Your vehicle's rear seat is fitted with lower anchorages for attaching a child restraint system with ISOFIX mountings.

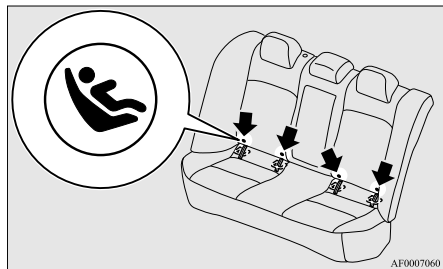

Tether anchorage locations

There are 2 attachment points on the rear shelf, located behind the top of your rear seat. These are for securing a child restraint system tether strap to each of the 2 rear seating positions in your vehicle.

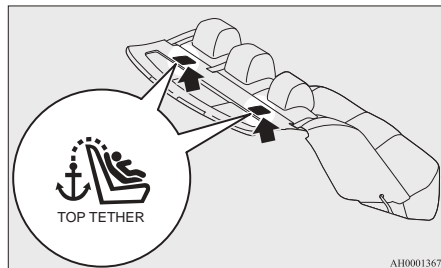

⚠ WARNING

- Child restraint anchorages are designed to withstand only those loads imposed by correctly fitted child restraints. Under no circumstances are they to be used for adult seat belts, harnesses, or for attaching other items or equipment to the vehicle.

Child restraint system with ISOFIX mountings

The child restraint system is designed only for seats that incorporate lower anchorages. Retain the child restraint system using the lower anchorages.

It is not necessary to retain the child restraint system using the vehicle's seat belts.

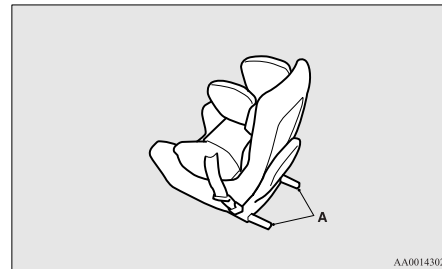

A- Child restraint system connectors

To install

1. Remove any foreign material in or around the connectors and ensure the vehicle seat belt is in its normal storage position.
2. Remove the head restraint from the location in which you wish to install a child restraint. Refer to "Head restraints" on page 2-05.
3. Push the child restraint system's connectors (A) into the slit (B) in accordance with the instructions provided by the child restraint system's manufacturer.

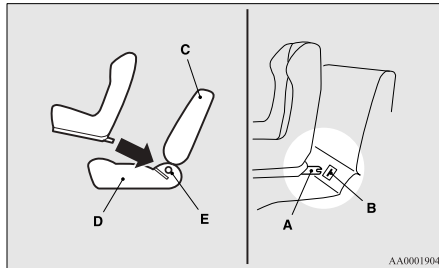

- A- Connector
- B- Slit
- C- Vehicle seatback
- D- Vehicle seat cushion
- E- Lower anchorage

If your child restraint system requires the use of a tether strap, fasten the tether strap in accordance with steps 4 through 5.

4. Open the cover from the tether anchorage installation point by pulling it back with your hand as illustrated.

5. Latch the top tether strap hook (F) of the child restraint system to the tether anchorage bracket (G) and tighten the top tether strap so that it is securely fastened.

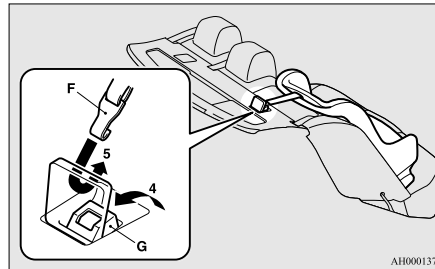

6. Push and pull the child restraint system in all directions to be sure it is firmly secured.

To remove

Remove the child restraint in accordance with the instructions provided by the child restraint system's manufacturer.

Installing a child restraint system to a 3-point type seat belt (with emergency locking mechanism)

E00407100731

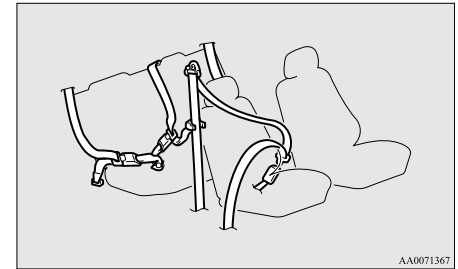

Installation:

1. Put a child restraint system on the seat in which you wish to install it, and remove the head restraint from the seat. Refer to "Head restraints" on page 2-05.
2. Fasten the seat belt to secure the child restraint system. Make sure you hear a "click" when you insert the latch plate in the buckle.
3. Remove all slack by using the locking clip.
4. Push and pull the child restraint in all directions to be sure it is secure.

⚠ WARNING

- For some types of child restraint, the locking clip (A) should be used to help avoid personal injury during a collision or sudden manoeuvre. It must be fitted and used in accordance with the child restraint manufacturer's instructions. The locking clip must be removed when the child restraint is removed.

2

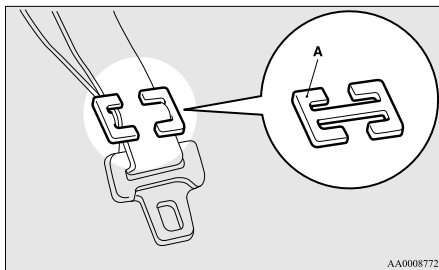

Seat belt inspection

E00406300475

- Check the belts for cuts, worn or frayed webbing and for cracked or deformed metallic parts. Replace the belt assembly if defective.
- A dirty belt should be cleaned with neutral detergent in warm water. After rinsing in water, let it dry in the shade. Do not attempt to bleach or re-dye the belts because this affects their characteristics.

⚠ WARNING

- We recommend you to have all seat belt assemblies including retractors and attaching hardware inspected after any collision. We recommend that seat belt assemblies in use during a collision be replaced unless the collision was minor and the belts show no damage and continue to operate properly.
- Do not attempt to repair or replace any part of the seat belt assemblies; we recommend you to have this work done by a MITSUBISHI MOTORS Authorized Service Point. Incorrect repair or replacement could reduce the effectiveness of the belts and could result in serious injury in the event of a collision.
- Once the pretensioner has activated, it cannot be re-used. It must be replaced together with the retractor.

Supplemental restraint system (SRS) - airbag

E00407201843

The information written in this Supplemental Restraint System (SRS) section contains important points concerning the driver, front passenger, driver's knee, side and curtain airbags.

The SRS driver and front passenger airbags are designed to supplement the primary protection of the driver and front passenger side seat belt systems by providing those occupants with protection against head and chest injuries in certain moderate- to-severe frontal collisions.

The SRS driver and front passenger airbags employ a dual stage airbag system. The SRS driver and front passenger airbag is controlled by the impact sensors (at the front of the vehicle) and the control unit (near the centre of the vehicle at floor level).

The SRS driver's knee airbag is designed to supplement the primary protection of the driver's seat belt system. It can reduce the forward movement of the driver's lower legs and provide increased overall body protection in certain moderate-to-severe frontal collisions.

The SRS side airbags are designed to supplement properly worn seat belts and provide the driver and front passenger with protection against chest and abdomen injuries in certain moderate-to-severe side impact collisions.

The SRS curtain airbags are designed to supplement properly worn seat belts and provide the driver and passenger with protection against head injuries in certain moderate-to-severe side impact collisions.

The SRS is NOT a substitute for the seat belts; for maximum protection in all types of crashes and accidents, seat belts should ALWAYS be worn by everyone who drives or rides in this vehicle.

How the Supplemental Restraint System works

E00407301424

The SRS includes the following components:

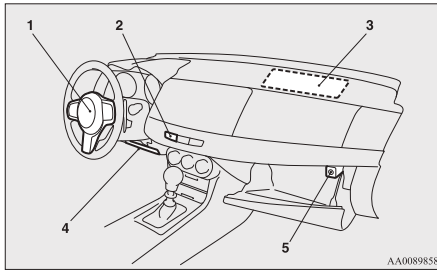

- 1- Airbag module (Driver)
- 2- Front passenger's airbag OFF indication lamp
- 3- Airbag module (Passenger)
- 4- Driver's knee airbag module

5- Front passenger's airbag ON-OFF switch

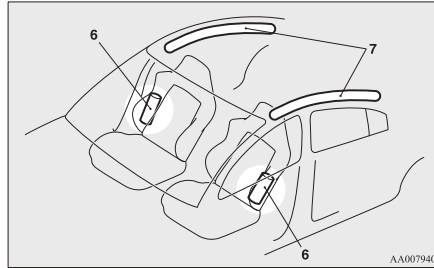

- 6- Side airbag modules
- 7- Curtain airbag modules

The airbags will operate only when the ignition switch is in the "ON" or "START" position.

The airbags deployment produces a sudden, loud noise, and releases some smoke and powder, but these conditions are not injurious, and do not indicate a fire in the vehicle. People with respiratory problems may feel some temporary irritation from chemicals used to produce the deployment; open the windows after airbag deployment, if safe to do so.

The airbags deflate very rapidly after deployment, so there is little danger of obscured vision.

CAUTION

- Airbags inflate at an extremely rapid speed. In certain situations, contact with inflating airbags can result in abrasions, light cuts, bruises, and the like.

WARNING

- IT IS VERY IMPORTANT TO BE PROPERLY SEATED.

A driver or front passenger too close to the steering wheel or instrument panel during airbag deployment can be killed or seriously injured.

Airbags inflate very fast, and with great force.

If the driver and passengers are not properly seated and restrained, the airbags may not protect you properly, and could cause serious or fatal injuries when it inflates.

- Do not sit on the edge of the seat or sit with your lower legs too close to the instrument panel, or lean head or chest close to the steering wheel or instrument panel. Do not put feet or legs on or against the instrument panel.
- Place all infants and small children in the rear seat and properly restrained using an appropriate child restraint system. The rear seat is the safest place for infants and children.

Seat and seat belts

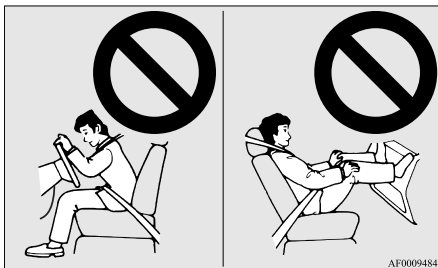

2

⚠ WARNING

- Infants and small children should never be unrestrained, stand up against the instrument panel or be held in your arms or on your lap. They could be seriously injured or killed in a collision, including when the airbag inflates. They should be properly seated in the rear seat in an appropriate child restraint system. See the “Child restraint” section of this owner’s manual.



Use rearward facing child restraints in the rear seat or turn off the front passenger’s airbag ON-OFF switch. (Refer to “To turn an airbag off” on page 2-22.)

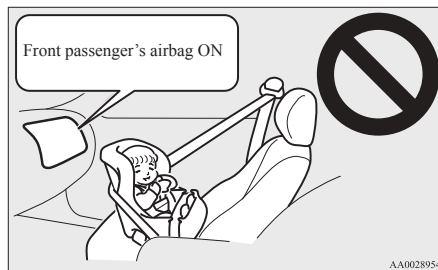

⚠ WARNING

- A REARWARD FACING CHILD RESTRAINT must NOT be used in the front passenger seat if the front passenger’s airbag has not been deactivated. The force of an inflating airbag could kill or cause serious injuries to the child. A rearward facing child restraint must only be used in the rear seat.
- A FORWARD FACING CHILD RESTRAINT should be used in the rear seat whenever possible; if it must be used in the front passenger seat, adjust the seat to the most rearward position. Failure to do so could kill or cause serious injuries to the child.



⚠ WARNING

- Older children should be seated in the rear seat, properly wearing the seat belt, with an appropriate booster seat if needed.

Caution for installing the child restraint on vehicles with a front passenger airbag

E00408800823

The label shown here is attached on vehicles with a front passenger airbag.

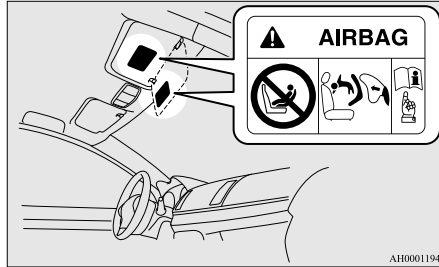

AH0001194

⚠ WARNING

- **Extreme Hazard!**
NEVER use a rearward facing child restraint on a seat protected by an ACTIVE AIRBAG in front of it, DEATH or SERIOUS INJURY to the CHILD can occur.

Front passenger's airbag ON-OFF switch

E00410100302

The front passenger's airbag ON-OFF switch can be used to disable the front passenger's airbag. If you have a rearward facing child restraint system that cannot be fitted to any seat other than the front passenger seat, be sure to turn OFF the front passenger's airbag ON-OFF switch before using it. (Refer to "To turn an airbag off" on page 2-22.) The front passenger's airbag ON-OFF switch is located in the glove box.

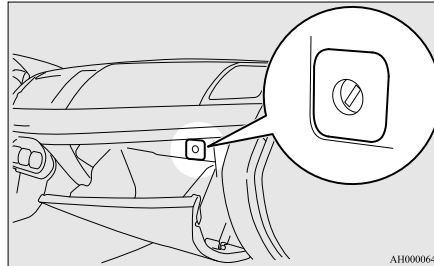

AH0000647

Front passenger's airbag OFF indication lamp

E00411500172

The front passenger's airbag OFF indication lamp is located in the instrument panel.

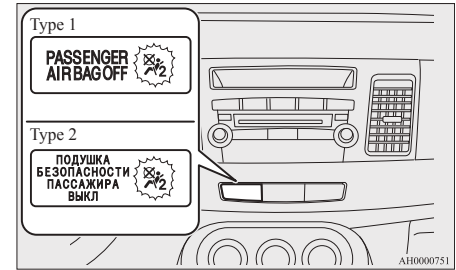

AH0000751

The indication lamp normally comes on when the ignition switch is turned to the "ON" position, and goes off a few seconds later.

When the front passenger's airbag ON-OFF switch is turned OFF, the indication lamp will stay on to show that the front passenger's airbag is not operational.

When the front passenger's airbag ON-OFF switch is turned ON, the indication lamp goes off to show that the front passenger's airbag is operational.

⚠ WARNING

- Do not fit any accessory that makes the indication lamp impossible to see, and do not cover the indication lamp with a sticker. You would not be able to verify the status of the passenger airbag system.

Seat and seat belts

To turn an airbag off

E00410600411

⚠ WARNING

- To reduce risk of serious or fatal injury:
 - Always remove the key from the ignition switch before operating a front passenger's airbag ON-OFF switch. Failure to do so could adversely affect the airbag performance.
 - Wait at least 60 seconds to operate the front passenger's airbag ON-OFF switch after turning the ignition switch from "ON" position to "LOCK" position.
The SRS airbag system is designed to retain enough voltage to deploy the airbag.
 - Always remove the key from the front passenger's airbag ON-OFF switch after operating that switch. Failure to do so could lead to improper position of the front passenger's airbag ON-OFF switch.
 - Do not turn OFF the front passenger's airbag ON-OFF switch except when a rearward facing child restraint system is fitted to the front passenger seat.

⚠ WARNING

- If the indication lamp does not come on when the front passenger's airbag ON-OFF switch is turned OFF, do not fit a rearward facing child restraint system to the front passenger seat. We recommend you to have the system inspected by a MITSUBISHI MOTORS Authorized Service Point.
- If the indication lamp remains on when the front passenger's airbag ON-OFF switch is turned ON, do not allow anyone to sit on the front passenger seat. We recommend you to have the system inspected by a MITSUBISHI MOTORS Authorized Service Point.

To turn an airbag off, follow these steps:

1. Insert the key into the front passenger's airbag ON-OFF switch, and turn it to the "OFF" position.
2. Remove the key from the key opening of the front passenger's airbag ON-OFF switch.

3. Insert the key into the ignition switch, and turn the ignition to the "ON" position. The front passenger's airbag OFF indication lamp will stay on.

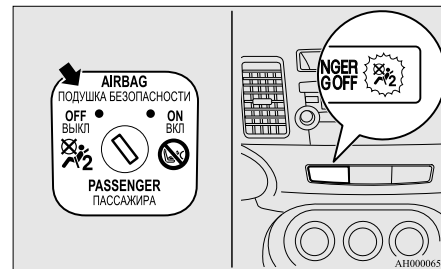

The front passenger's airbag is now deactivated and will not deploy until switched on again.

Driver's and front passenger's airbag system

E00407400721

The driver's airbag is located under the padded cover in the middle of the steering wheel. The front passenger's airbag is contained in the instrument panel above the glove box.

The driver's airbag inflates at two different rates according to the severity of the impact.

The front passenger's airbag deploys at the same time as the driver's airbag, even if the passenger seat is not occupied, and inflates at two different rates according to the severity of the impact.

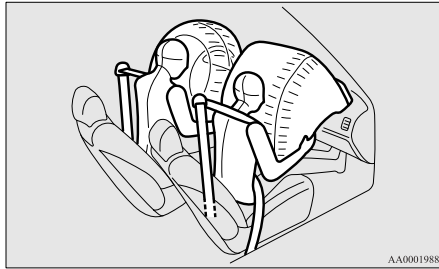

AA0001988

Driver's knee airbag system

E00412400051

The driver's knee airbag is located under the steering wheel. The driver's knee airbag is designed to deploy at the same time as the driver's front airbag.

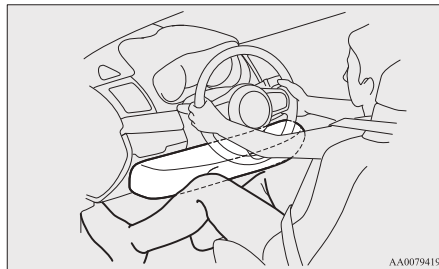

AA0079419

Deployment of front airbags and driver's knee airbag

E00412500270

The front airbags and driver's knee airbag ARE DESIGNED TO DEPLOY when...

The front airbags and driver's knee airbag are designed to deploy when the vehicle suffers a moderate to severe frontal impact. A typical condition is shown in the illustration.

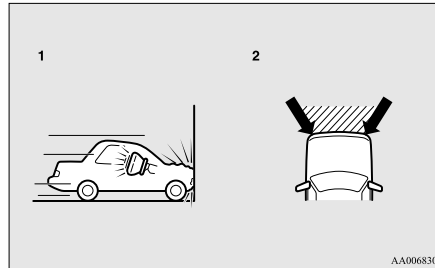

AA0068305

- 1- Head-on collision with a solid wall at a speed of approximately 25 km/h (16 mph) or higher
- 2- Moderate to severe frontal impact within the shaded area between the arrows

The front airbags and driver's knee airbag will deploy if the severity of the impact is above the designed threshold level, comparable to an approximately 25 km/h (16 mph) collision when impacting straight into a solid wall that does not move or deform. If the severity of the impact is below the above threshold level, the front airbags and driver's knee airbag may not deploy. However, this threshold speed will be considerably higher if the vehicle strikes an object that absorbs the impact by either deforming or moving (for example, another stationary vehicle, pole or a guard rail).

Because frontal collisions can easily move you out of position, it is important to always properly wear your seat belts. Your seat belts will help keep you at a safe distance from the steering wheel and instrument panel during the initial stages of airbag deployment. The initial stage of airbag inflation is the most forceful, and can possibly cause serious or fatal injuries. Moreover, the seat belts in your vehicle are your primary means of protection in a collision. The SRS airbags are designed to provide additional protection. Therefore, for your safety and the safety of all occupants, be sure to always properly wear your seat belts.

The front airbags and driver's knee airbag MAY NOT DEPLOY when...

With certain types of frontal collisions, the vehicle's body structure is designed to absorb the shock to help protect the occupants from harm. (The vehicle body's front area may deform significantly as it absorbs the impact.) Under such circumstances, the front airbags and driver's knee airbag may not deploy irrespective of the deformation and damage to the vehicle body.

Seat and seat belts

Examples of some typical conditions are shown in the illustration.

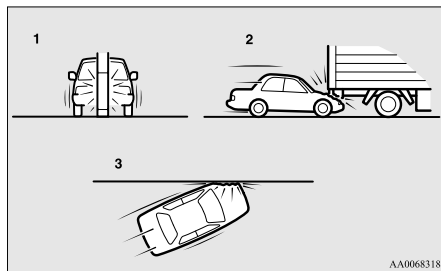

- 1- Collision with a utility pole, tree or other narrow objects
- 2- Vehicle slides under the rear body of a truck
- 3- Oblique frontal impacts

Because the front airbags and driver's knee airbag do not protect the occupant in all types of frontal collisions, be sure to always properly wear your seat belts.

The front airbags and driver's knee airbag ARE NOT DESIGNED TO DEPLOY when...

The front airbags and driver's knee airbag are not designed to deploy in conditions where they cannot typically provide protection to the occupant.

Such conditions are shown in the illustration.

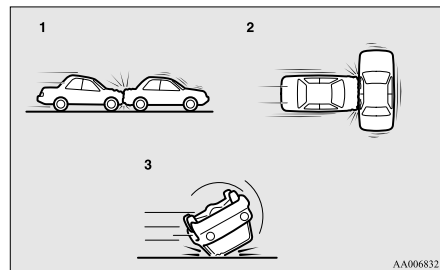

- 1- Rear end collisions
- 2- Side collisions
- 3- Vehicle rolls onto its side or roof

Because the front airbags and driver's knee airbag do not protect the occupant in all types of collisions, be sure to always properly wear your seat belts.

The front airbags and driver's knee airbag MAY DEPLOY when...

The front airbags and driver's knee airbag may deploy if the bottom of the vehicle suffers a moderate to severe impact (undercarriage damage).

Examples of some typical conditions are shown in the illustration.

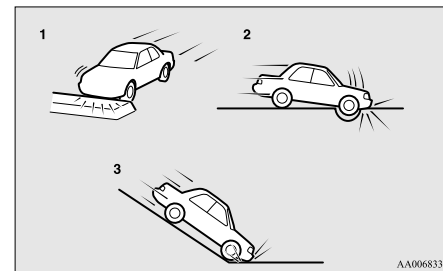

- 1- Collision with an elevated median/island or kerb
- 2- Vehicle travels over a deep hole/pothole
- 3- Vehicle drives down a steep slope and hits the ground

Because the front airbags and driver's knee airbag may deploy in certain types of unexpected impacts as shown in the illustration that can easily move you out of position, it is important to always properly wear your seat belts. Your seat belts will help keep you in a safe distance from the steering wheel and instrument panel during the initial stages of airbag deployment. The initial stage of airbag inflation is the most forceful and can possibly cause serious or fatal injuries if you contact it at this stage.

WARNING

- Do not attach anything to the steering wheel padded cover, such as trim material, badges, etc. It might strike and injure an occupant if the airbag inflates.

⚠ WARNING

- Do not set anything on, or attach anything to, the instrument panel above the glove box. It might strike and injure an occupant if the airbag inflates.

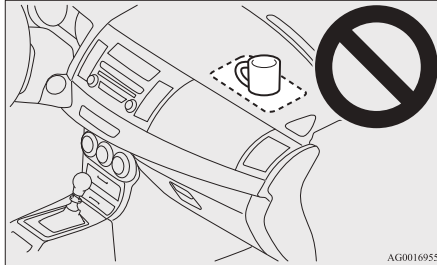

⚠ WARNING

- Do not attach accessories to, or put them in front of, the windscreen. These objects could restrict the airbag inflation, or strike and injure an occupant if the airbags inflate.
- Do not attach additional keys or accessories (hard, pointed or heavy objects) to the ignition key. Such objects could prevent the driver's knee airbag from inflating normally or could be propelled and cause serious injury if the airbag inflates.

⚠ WARNING

- Do not attach accessories to the lower portion of the driver's side instrument panel. Such objects could prevent the driver's knee airbag from inflating normally or could be propelled and cause serious injury if the airbag inflates.

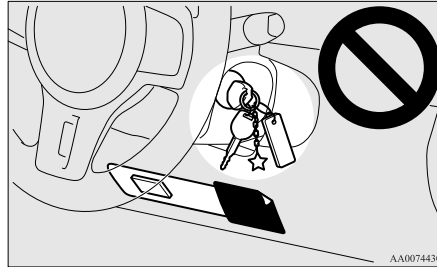

⚠ WARNING

- Do not put packages, pets or other objects between the airbags and the driver or front passenger. It could affect airbag performance, or could cause injury when the airbag inflates.
- Right after the airbag inflation, several airbag system components will be hot. Do not touch them; you could be burned.

⚠ WARNING

- The airbag system is designed to work only once. Once the airbags have deployed, they will not work again. They must promptly be replaced and we recommend you to have the entire airbag system inspected by a MITSUBISHI MITSUBISHI MOTORS Authorized Service Point.

Side airbag system

E00407600345

The side airbags (A) are contained in the driver and front passenger seatbacks. The side airbag is designed to inflate only on the side of the vehicle that is impacted, even with no passenger in the front seat.

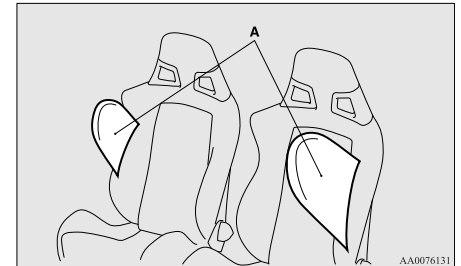

Seat and seat belts

The label shown here is attached to the seatbacks with a side airbag.

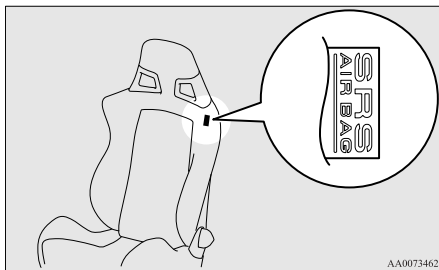

2

Curtain airbag system

E00409100315

The curtain airbags are contained in the front and rear pillars and roof side rail. The curtain airbag is designed to inflate only on the side of the vehicle that is impacted, even with no passenger in the front seat or rear seat.

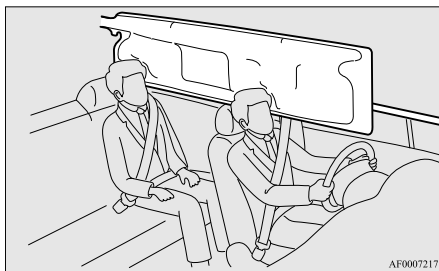

Deployment of side airbags and curtain airbags

E00407701327

The side airbags and curtain airbags ARE DESIGNED TO DEPLOY when...

The side airbags and curtain airbags are designed to deploy when the vehicle suffers a moderate to severe side impact to the middle of the passenger compartment.

The typical condition is shown in the illustration.

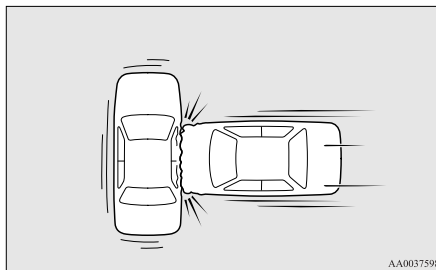

The seat belts in your vehicle are your primary means of protection in a collision. The SRS side airbags and curtain airbags are designed to provide additional protection. Therefore, for your safety and the safety of all occupants, be sure to always properly wear your seat belts.

The side airbags and curtain airbags MAY NOT DEPLOY when...

With certain types of side collisions, the vehicle's body structure is designed to absorb the shock to help protect the occupants from harm. (The vehicle body's side area may deform significantly as it absorbs the impact.) Under such circumstances, the side airbags and curtain airbags may not deploy irrespective of the deformation and damage to the vehicle body.

Examples of some typical conditions are shown in the illustration.

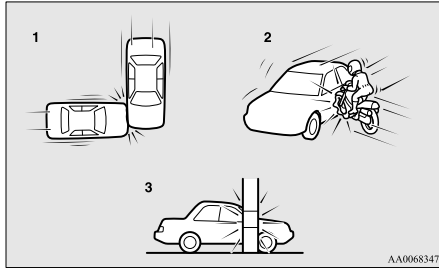

- 1- Side impacts in an area away from the passenger compartment
- 2- Motorcycle or other similar small vehicle collides with the side of vehicle
- 3- Collision with a utility pole, tree or other narrow object

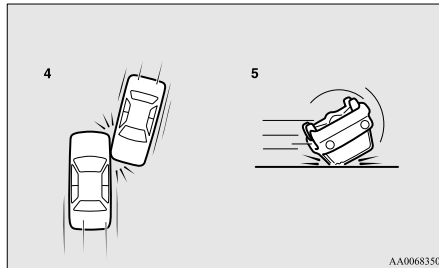

- 4- Oblique side impacts
- 5- Vehicle rolls onto its side or roof

Because the side airbags and curtain airbags do not protect the occupant in all types of side collisions, be sure to always properly wear your seat belts.

The side airbags and curtain airbags ARE NOT DESIGNED TO DEPLOY when...

The side airbags and curtain airbags are not designed to deploy in conditions where they cannot usually provide protection to the occupant. Typical conditions are shown in the illustration.

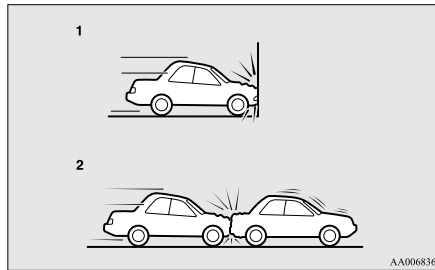

- 1- Head-on collisions
- 2- Rear end collisions

Because the side airbags and curtain airbags do not protect the occupant in all types of collisions, be sure to always properly wear your seat belts.

⚠ WARNING

- The side airbags and curtain airbags are designed to supplement the driver and passenger seat belts in certain side impacts. Seat belts should always be worn properly, and the driver and passenger should sit well back and upright without leaning against the window or door.
- The side airbag and curtain airbag inflate with great force. The driver and passenger should not put their arms out the window, and should not lean against the door, in order to reduce risk of serious or possible fatal injury from the deploying side airbag and curtain airbag.

2



⚠ WARNING

- Do not allow any rear seat occupant to hold onto the seatback of either front seat, in order to reduce risk of injury from a deploying side airbag. Special care should be taken with children.
- Do not place any objects near or in front of the seatback of either front seat. They could interfere with proper side airbag inflation, and also could cause injury if thrown free by side airbag deployment.
- Do not place stickers, labels or additional trim on the seatback of either front seat. They could interfere with proper side airbag inflation.
- Do not install seat covers on seats with side airbags. Do not re-cover the seats with side airbags. They could interfere with proper side airbag inflation.
- Do not attach a microphone (A) or any other device or object around the part where the curtain airbags (B) activate such as on the windscreen, side door glass, front and rear pillars and roof side or assist grips. When the curtain airbags inflate, the microphone or other device or object will be hurled with great force or the curtain airbags may not activate correctly, resulting in death or serious injury.

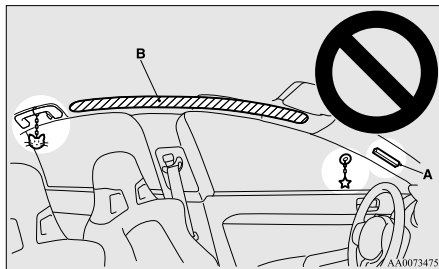

⚠ WARNING

- Do not put a hanger or any heavy or pointed object on the coat hook. If the curtain airbag was activated, any such item could be propelled away with great force and could prevent the curtain airbag from inflating correctly. Hang clothes directly on the coat hook (without using a hanger). Make sure there are no heavy or sharp objects in the pockets of clothes that you hang on the coat hook.
- When loading luggage, do not stack luggage near the side windows. They could interfere with proper curtain airbag inflation.

⚠ WARNING

- Do not allow the child to lean against or close to the front door even if the child is seated in a child restraint system. The child's head should also not be leaned against or be close to the area where the side airbag and curtain airbag are located. It is dangerous if the side airbag and curtain airbag inflate. Failure to follow all of these instructions could lead to serious or fatal injury to the child.
- We recommend work around and on the side airbags and curtain airbags system to be done by a MITSUBISHI MOTORS Authorized Service Point.

SRS warning lamp/display

E00407801474

Warning lamp



Warning display



If there is an error in the system, the warning lamp will come on and the warning display will appear on the information screen in the multi-information display.

Under normal conditions, the warning lamp comes on when the ignition switch is turned to the “ON” position and goes off a few seconds later.

The warning lamp will also come on and remain on when the SRS airbags and the seat belt pretensioner system have been activated.

The warning lamp/display is used for both SRS airbag warnings and seat belt pretensioner system warnings.

WARNING

- There may be a system error if the warning lamp/display appears as indicated. In such cases, an SRS airbag or a seat belt pretensioner system may not function properly in a collision. Have your vehicle checked by a MITSUBISHI MOTORS Authorized Service Point:
 - Even when the ignition switch is in the “ON” position, the warning lamp does not come on or it remains on a few seconds later
 - When warning lamp comes on while driving
 - When warning display appears while driving

SRS servicing

E00407901156

WARNING

- We recommend any maintenance performed on or near the components of the SRS to be performed by a MITSUBISHI MOTORS Authorized Service Point. Improper work on the SRS components or wiring could result in inadvertent deployment of the airbags, or could render the SRS inoperative; either situation could result in serious injury.
- Do not modify your steering wheel, seat belt retractor or any other SRS components. For example, replacement of the steering wheel, or modifications to the front bumper or body structure can adversely affect SRS performance and lead to possible injury.
- If your vehicle has received any damage, we recommend you to have the SRS inspected to ensure it is in proper working order.
- Do not modify your front seats, centre pillar and centre console. It can adversely affect SRS performance and lead to possible injury. If you found any tear scratch, crack or damage to the seat fabric near the side airbag, the portion of the front and rear pillars and roof side rail, you should have the SRS inspected by a MITSUBISHI MOTORS Authorized Service Point.

NOTE

- When you transfer ownership of the vehicle to some other person, we urge you to alert the new owner that it is equipped with the SRS and refer that owner to the applicable section in this owner’s manual.
- If your vehicle has to be scrapped, do this in line with local legislation and contact a MITSUBISHI MOTORS Authorized Service Point to safely dismantle the airbag system.

A series of 15 horizontal dashed lines spanning the width of the page, providing a template for handwriting practice.

Instruments and controls

Instruments.....	3-02
Multi-information display.....	3-03
Indication lamp, warning lamp, and information screen display list.....	3-21
Indication lamps.....	3-33
Warning lamps.....	3-33
Information screen display.....	3-35
Combination headlamps and dipper switch.....	3-37
Headlamp levelling.....	3-40
Turn-signal lever.....	3-41
Adaptive Front lighting System (AFS).....	3-41
Hazard warning flasher switch.....	3-43
Fog lamp switch.....	3-43
Wiper and washer switch.....	3-44
Headlamp washer switch.....	3-47
Rear window demister switch.....	3-47
Horn switch.....	3-48

Instruments

E00500101466

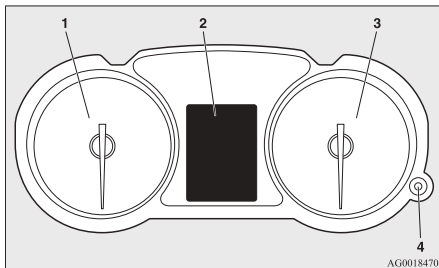

AG0018470

- 1- Tachometer → p. 3-02
- 2- Multi-information display → p. 3-03
Information screen display list → p. 3-22
- 3- Speedometer (km/h or mph + km/h)
- 4- Daytime dipper button (meter illumination control) → p. 3-02

3

Tachometer

E00500300065

The tachometer indicates the engine speed (r/min). The tachometer can help you obtain more economical driving and also warns you of excessive engine speeds (Red zone).

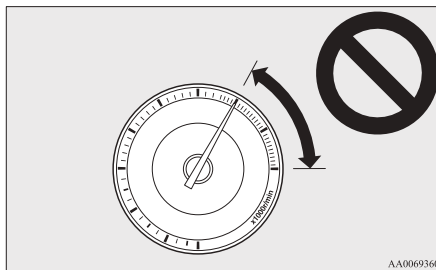

AA0069360

CAUTION

- When driving, watch the tachometer to make sure that the engine speed indication does not rise into the red zone (excessive engine rpm).

Daytime dipper button (meter illumination control)

E00508800518

Each time you press this button, there is a sound and the brightness of the instruments changes.

NOTE

- You can adjust to 8 different levels for when the position lamps are illuminated and 8 for when they are not.
- When the lamp switch is in a position other than the “OFF” position, the meter illumination switches automatically to the adjusted brightness, depending on the brightness outside the vehicle.
- The brightness level of the instruments is stored when the ignition switch is turned off.
- If you press and hold the button for longer than about 1 second when the position lamps are illuminated, the brightness level changes to the maximum level. Pressing and holding the button for longer than about 1 second again returns the brightness level to the previous level.

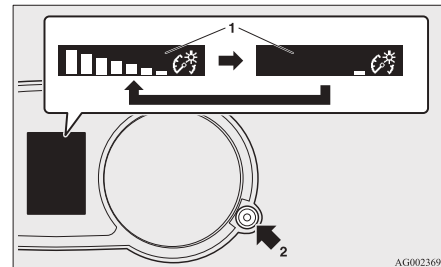

AG0023696

- 1- Brightness display
- 2- Rheostat illumination button

Multi-information display

E00519900812

The following information is included on the multi-information display: warnings, odometer, tripmeter, service reminder, engine coolant temperature, fuel remaining, outside temperature, Twin Clutch SST control mode, S-AWC (Super-All Wheel Control) control mode, shift lever position, average and momentary fuel consumption, driving range, average speed, S-AWC (Super-All Wheel Control) operation display, and meter illumination.

It is also possible to change elements such as the language and units used on the multi-information display.

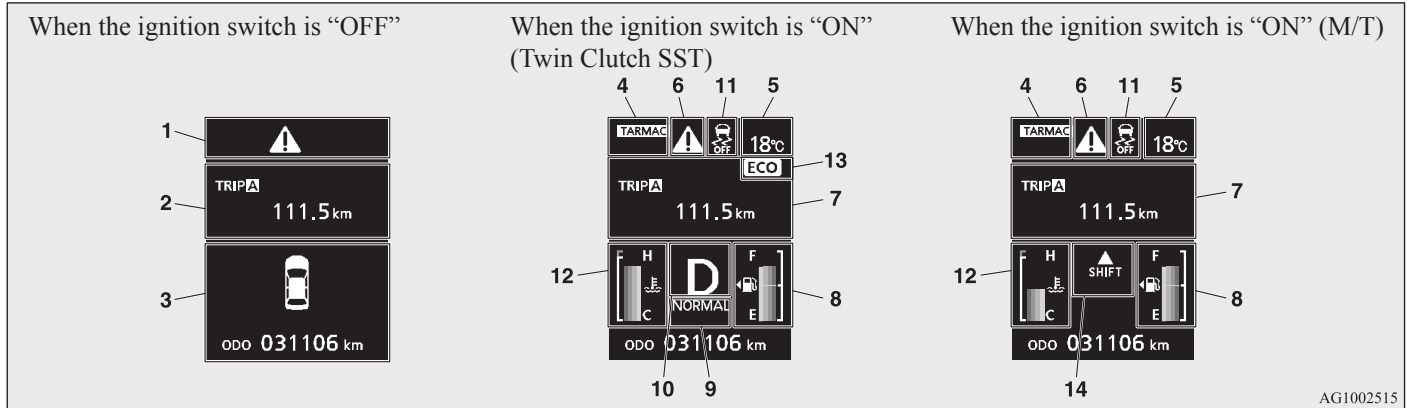

3

AG1002515

- 1- "!" mark display screen (when the ignition switch is "OFF") → p. 3-05
- 2- Information screen (when the ignition switch is "OFF") → p. 3-05
Interrupt display screen (when the ignition switch is "OFF") → p. 3-06
- 3- Door ajar warning display screen (when the ignition switch is "OFF")
→ p. 3-07
- 4- S-AWC (Super-All Wheel Control) control mode display screen
→ p. 3-08
- 5- Outside temperature display screen → p. 3-12
- 6- "!" mark display screen (when the ignition switch is "ON") → p. 3-08

- 7- Information screen (when the ignition switch is "ON") → p. 3-08
Interrupt display screen (when the ignition switch is "ON") → p. 3-11
- 8- Fuel remaining display screen → p. 3-12
- 9- Twin Clutch SST control mode display screen* → p. 3-12
- 10- Gearshift lever position display screen* → p. 3-12
- 11- Active Stability Control (ASC) OFF display screen → p. 3-08
- 12- Engine coolant temperature display → p. 3-09
- 13- ECO mode indicator* → p. 3-12
- 14- Gearshift indicator display screen* → p. 4-15

NOTE

- The trip computer function fuel units, temperature units, display language, and other settings can be changed. Refer to “Changing the function settings (when the ignition switch is “ON”)” on page 3-15.
- The display screen is different depending on whether the ignition switch is “OFF” or “ON”.
 - Refer to “Information screen (when the ignition switch is “OFF”)” on page 3-05.
 - Refer to “Warning display list (when the ignition switch is “OFF”)” on page 3-23.
 - Refer to “Information screen (when the ignition switch is turned from “OFF” to “ON”)” on page 3-07.
 - Refer to “Information screen (when the ignition switch is “ON”)” on page 3-08.
 - Refer to “Warning display list (when the ignition switch is “ON”)” on page 3-25.

Multi-information meter switch

E00520000480

Each time the multi-information meter switch is operated, a sound is emitted and the multi-information display changes between information such as warnings, service reminder, average and momentary fuel consumption, driving range, average speed, and S-AWC (Super-All Wheel Control) operation display.

It is also possible to change elements such as the language and units used on the multi-information display by operating the multi-information meter switch.

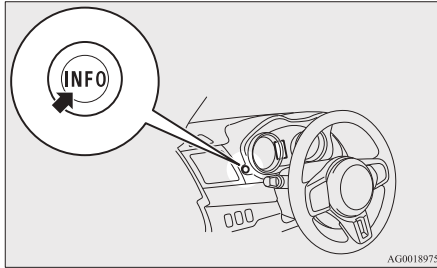

AG0018975



“!” mark display screen (when the ignition switch is “OFF”)

E00520100465

If you press the multi-information meter switch and return from the warning display screen to the previous screen, the “!” mark is displayed.

Refer to “To return to the screen displayed before the warning display” on page 3-06.

This mark is also displayed if there is another warning other than the one displayed. When the cause of the warning display is eliminated, the “!” mark goes out automatically.

NOTE

- When the “!” mark is displayed, the warning display screen can be redisplayed on the information screen.

Refer to “Information screen (when the ignition switch is “OFF”)” on page 3-05.

Refer to “Information screen (when the ignition switch is “ON”)” on page 3-08.

Information screen (when the ignition switch is “OFF”)

E00520200671

Each time you lightly press the multi-information meter switch, the display screen switches in the following order.

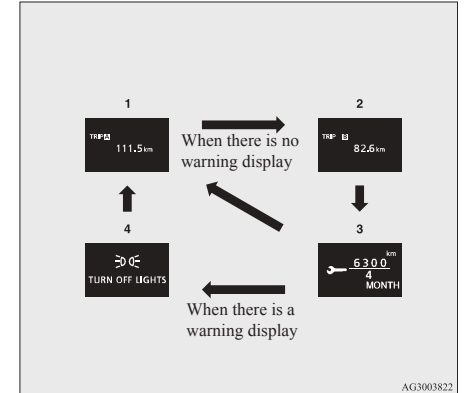

AG3003822

- 1- Tripmeter **A**
- 2- Tripmeter **B**
- 3- Service reminder
- 4- Redisplay of a warning display screen

Odometer/Tripmeter

E00521201617

Each time you lightly press the multi-information meter switch, the display screen switches.

Odometer/Tripmeter **A** → Odometer/Tripmeter **B** → Service reminder → Redisplay of a warning display screen → Odometer/Tripmeter **A**

Instruments and controls

Odometer

The odometer indicates the distance travelled.

Tripmeter

The tripmeter indicates the distance travelled between two points.

Example usage of tripmeter **A** and tripmeter **B**

It is possible to measure two currently travelled distances, from home using tripmeter **A** and from a particular point on the way using tripmeter **B**.

To reset the tripmeter

To return the display to 0, hold down the multi-information meter switch for about 2 seconds or more. Only the currently displayed value will be reset.

Example

If tripmeter **A** is displayed, only tripmeter **A** will be reset.



NOTE

- If there is no warning display, the switching sequence is: Odometer/Tripmeter **A** → Odometer/Tripmeter **B** → Service reminder → Odometer/Tripmeter **A**.
- Both tripmeters **A** and **B** can count up to 9999.9 km (9999.9 miles). When a tripmeter goes past 9999.9 km (9999.9 miles), it returns to 0.0 km (0.0 miles).
- When disconnecting the battery terminal, the memories of tripmeter display **A** and display **B** are erased, and their displays return to 0.0 km (0.0 miles).



Service reminder

E00521300901

This displays the distance and number of months until the next periodic inspection.

Refer to “Service reminder” on page 3-13

Interrupt display screen (when the ignition switch is “OFF”)

E00520500704

When there is information to be announced, such as lamp reminders, the buzzer sounds and the multi-information display switches to the warning display screen. Refer to the appropriate page and take the necessary measures.

When the cause of the warning display is eliminated, the warning display goes out automatically.

Refer to “Warning display list (when the ignition switch is “OFF”)” on page 3-23.

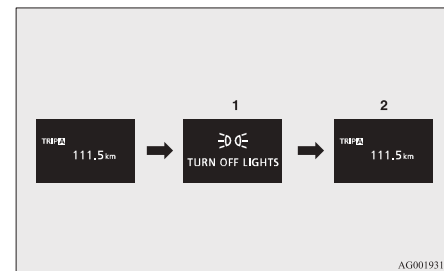

- 1- Information generated
- 2- Cause eliminated

To return to the screen displayed before the warning display

Even if the cause of the warning display is not eliminated, you can return to the screen that was displayed before the warning display.

If you press the multi-information meter switch, the display screen switches to the screen that was displayed before the warning display and the “!” mark (A) is displayed.

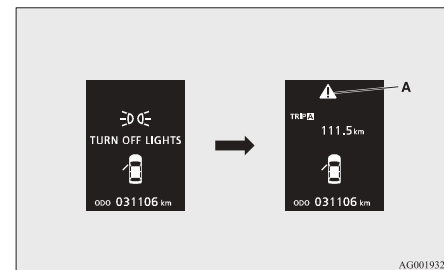

NOTE

- Warning display screens with a or mark displayed in the upper right of the screen can be switched. If you want to switch the display, press the multi-information meter switch as follows.
: Press lightly.
: Press for about 2 seconds or more.

Redisplay of a warning display screen

When the “!” mark is displayed, if you lightly press the multi-information meter switch a few times, the warning display screen you switched from is redisplayed.
 Refer to “Information screen (when the ignition switch is “OFF”)” on page 3-05.

Door ajar warning display screen (when the ignition switch is “OFF”)

E00520600369

If any of the doors or the trunk lid is not completely closed, this displays the open door or trunk lid.

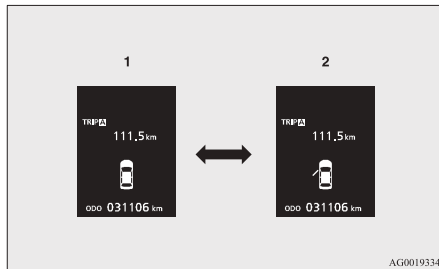

- 1- Doors and trunk lid are closed
- 2- Doors or trunk lid is open

Information screen (when the ignition switch is turned from “OFF” to “ON”)

E00520700722

When the ignition switch is turned to the “ON” position, the display screen switches in the following order.

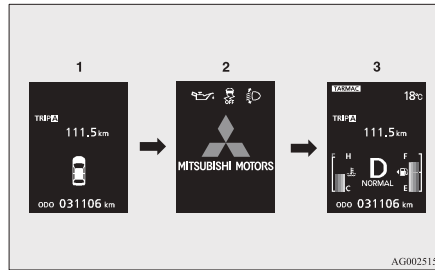

- 1- Screen when the ignition switch is “OFF”
- 2- System check screen
- 3- Screen when the ignition switch is “ON”

System check screen

When the ignition switch is turned to the “ON” position, the system check screen is displayed for about 4 seconds. If there is no fault, information screen (when the ignition switch is “ON”) is displayed.
 If there is a fault, the screen changes to warning display.

Refer to “Warning display list (when the ignition switch is “ON”)” on page 3-25.

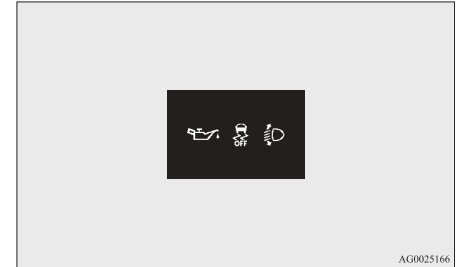

AG0025166

NOTE

- The system check screen display varies depending on the customer’s equipment.

Service reminder

When the time for periodic inspection arrives, the warning display is displayed for a few seconds after the ignition switch “ON”. Refer to “Service reminder” on page 3-06.



AG0019044



S-AWC (Super-All Wheel Control) control mode display screen

E00526100018

The S-AWC operation status is displayed. Refer to “S-AWC (Super-All Wheel Control) control mode” on page 4-29.



“!” mark display screen (when the ignition switch is “ON”)

E00520900014

This is displayed when you press the multi-information meter switch and switch the warning display screen.

This mark is also displayed if there is another warning other than the one displayed.

When the cause of the warning display is eliminated, the “!” mark goes out automatically.

NOTE

- When the “!” mark is displayed, the warning display screen can be redisplayed on the information screen. Refer to “Information screen (when the ignition switch is “OFF”)” on page 3-05. Refer to “Information screen (when the ignition switch is “ON”)” on page 3-08.



Active Stability Control (ASC) OFF display screen

E00521000474

This is displayed when the Active Stability Control (ASC) is turned off with the ASC OFF switch.

If there is a fault with the ASC, the ASC OFF display is shown.

Refer to ““ASC OFF” switch” on page 4-34.

Information screen (when the ignition switch is “ON”)

E00521100648

Each time you lightly press the multi-information meter switch, the display screen switches in the following order.

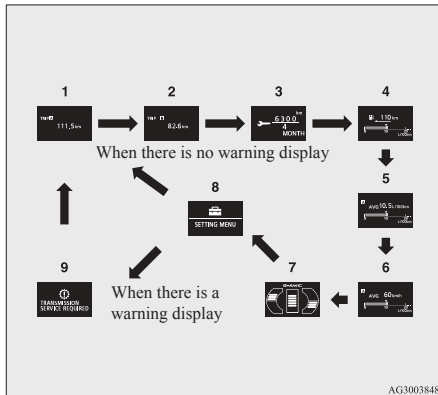

- 1- Tripmeter **A**
- 2- Tripmeter **B**
- 3- Service reminder

- 4- Driving range display, momentary fuel consumption display
- 5- Average fuel consumption display, momentary fuel consumption display
- 6- Average speed display, momentary fuel consumption display
- 7- S-AWC (Super-All Wheel Control) operation display
- 8- Function setting screen
- 9- Redisplay of a warning display screen

NOTE

- While driving, the function setting screen is not displayed even if you operate the multi-information meter switch. Always stop the vehicle in a safe place before operating. Refer to “Changing the function settings (when the ignition switch is “ON”)” on page 3-15.
- When there is information to be announced, such as a system fault, the buzzer sounds and the screen display is switched. Refer to “Interrupt display screen (when the ignition switch is “ON”)” on page 3-11.

Odometer/Tripmeter

E00524500148

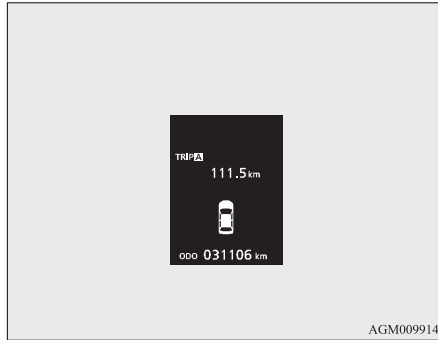

AGM009914

The operation method is the same as when the ignition switch is "OFF". Refer to "Odometer/Tripmeter" on page 3-05 for further details.



Service reminder

E00521300914

This displays the distance and number of months until the next periodic inspection. Refer to "Service reminder" on page 3-13.



Engine coolant temperature display

E00521400410

This indicates the engine coolant temperature. If the coolant becomes hot, "H" will blink.

Pay careful attention to the engine coolant temperature display while you are driving.

CAUTION

- If the engine is overheating, "H" will blink. In this case, the bar graph is on the red zone. Immediately park the vehicle in a safe place and take the required measures. Refer to "Engine overheating" on page 6-04.



Driving range display

E00521500697

This displays the approximate driving range (how many more kilometres or miles you can drive). When the driving range falls below approximately 50 km (30 miles), "---" is displayed. Refuel as soon as possible.

NOTE

- The driving range is determined based on the fuel consumption data. This may vary depending on the driving conditions and habits. Treat the distance displayed as just a rough guideline.



Average speed display

E00521600757

This displays the average speed from the last reset to the present time. There are the following 2 mode settings. For the method for changing the average speed display setting, refer to "Changing the function settings (when the ignition switch is "ON")" on page 3-15.

Manual reset mode

- When the average speed is being displayed, if you hold down the multi-information meter switch, the average speed displayed at that time is reset.

Instruments and controls

- When the ignition switch is switched from “ACC” or “LOCK” to “ON”, the mode setting is automatically switched from manual to auto. Switching to auto occurs automatically. If switching to manual mode is done, however, the data from the last reset is displayed.

Auto reset mode

- When the average speed is being displayed, if you hold down the multi-information meter switch, the average speed displayed at that time is reset.
- If the ignition switch is at “ACC” or “LOCK” for about 4 hours or longer, the average speed display is automatically reset.

NOTE

- The average speed display and the average fuel consumption display can be reset separately in both auto reset mode and manual reset mode.
- “---” is displayed when the average speed cannot be measured.
- The initial (default) setting is “Auto reset mode”.

- The display setting can be changed to the preferred units (km/h or mph). Refer to “Changing the function settings (when the ignition switch is “ON”)” on page 3-15.
- The average speed display memories for auto reset mode and manual reset mode are erased if the battery is disconnected.

Average fuel consumption display

E00521700732

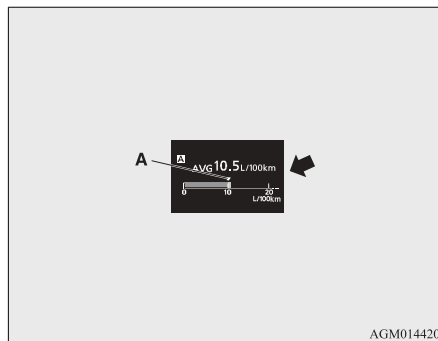

This displays the average fuel consumption from the last reset to the present time. There are the following 2 mode settings. For information on how to change the average fuel consumption display setting, refer to “Changing the function settings (when the ignition switch is “ON”)” on page 3-15.

The “” mark (A) in the momentary fuel gauge shows the average fuel consumption.

Manual reset mode

- When the average fuel consumption is being displayed, if you hold down the multi-information meter switch, the average fuel consumption displayed at that time is reset.
- When the ignition switch is switched from “ACC” or “LOCK” to “ON”, the mode setting is automatically switched from manual to auto. Switching to auto occurs automatically. If switching to manual mode is done, however, the data from the last reset is displayed.

Auto reset mode

- When the average fuel consumption is being displayed, if you hold down the multi-information meter switch, the average fuel consumption displayed at that time is reset.
- If the ignition switch is at “ACC” or “LOCK” for about 4 hours or longer, the average fuel consumption display is automatically reset.

NOTE

- The average speed display and the average fuel consumption display can be reset separately in both auto reset mode and manual reset mode.
- “---” is displayed when the average fuel consumption cannot be measured.
- The initial (default) setting is “Auto reset mode”.

- The average fuel consumption will depend on the driving conditions (road conditions, how you drive, etc.). The displayed fuel consumption may vary from the actual fuel consumption. Treat the fuel consumption displayed as just a rough guideline.
- The average fuel consumption display memories for auto reset mode and manual reset mode are erased if the battery is disconnected.
- The display setting can be changed to the preferred units {km/L, mpg (US), mpg (UK) or L/100 km}. Refer to “Changing the function settings (when the ignition switch is “ON”)” on page 3-15.

Momentary fuel consumption display

E00521800704

While driving, this displays the momentary fuel consumption, using a bar graph.

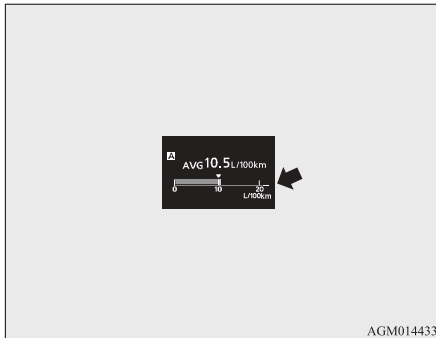

When the value of momentary fuel consumption surpasses the value of average fuel consumption, the momentary fuel consumption is displayed with a white bar graph.

Be conscious of maintaining the value of momentary fuel consumption below the value of average fuel consumption, it can help you drive with the better fuel consumption.

NOTE

- When the momentary fuel consumption cannot be measured, the bar graph is not displayed.
- The display setting can be changed to the preferred units {km/L, mpg (US), mpg (UK) or L/100 km}. Refer to “Changing the function settings (when the ignition switch is “ON”)” on page 3-15.
- It is possible to cancel the green bar graph. Refer to “Changing the function settings (when the ignition switch is “ON”)” on page 3-15.



S-AWC (Super-All Wheel Control) operation display

E00526200022

The S-AWC operation status is displayed.

For further details, refer to “S-AWC (Super-All Wheel Control) operation display” on page 4-30.

WARNING

- **Always concentrate on your driving first. Keep your eyes and mind on the road. Distractions while driving can lead to an accident.**



Function setting screen

E00521900170

The “Display language”, “Temperature unit”, “Fuel consumption unit”, and “Average fuel consumption and speed reset method” etc. settings can be modified as desired.

Refer to “Changing the function settings (when the ignition switch is “ON”)” on page 3-15 for further details.

Interrupt display screen (when the ignition switch is “ON”)

E00522000787

Warning display

When there is information to be announced, such as a system fault, a sound is emitted and the information screen is switched to the warning display screen.

Refer to the warning list and take the necessary measures.

Refer to “Warning display list (when the ignition switch is “ON”)” on page 3-25.

When the cause of the warning display is eliminated, the warning display goes out automatically.

Instruments and controls

To return to the screen displayed before the warning display

Even if the cause of the warning display is not eliminated, you can return to the screen that was displayed before the warning display.

If you press the multi-information meter switch, the display screen switches to the screen that was displayed before the warning display and the “!” mark (A) is displayed.

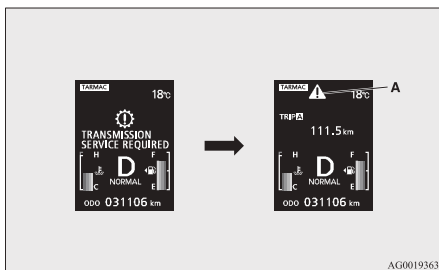

3

NOTE

- Warning display screens with a “!” or “!” mark displayed in the upper right of the screen can be switched. If you want to switch the display, press the multi-information meter switch as follows.
“!”: Press lightly.
“!”: Press for about 2 seconds or more.

Redisplay of a warning display screen

When the “!” mark is displayed, if you lightly press the multi-information meter switch a few times, the warning display screen you switched from is redisplayed.

Other interrupt displays

The operation status of each system is displayed on the information screen.

Refer to the appropriate page in the warning display list for further details.

Refer to “Other interrupt displays (when the ignition switch is “ON”)” on page 3-31.



Gearshift lever position display screen*

E00527100031

Shows the position of the gearshift lever. Refer to “Gearshift lever position display” on page 4-18.



Outside temperature display screen

E00522100414

This displays the temperature outside the vehicle

NOTE

- The display setting can be changed to the preferred units (°C or °F). Refer to “Changing the function settings (when the ignition switch is “ON”)” on page 3-15.
- Depending on factors such as the driving conditions, the displayed temperature may vary from the actual outside temperature.

NORMAL

Twin Clutch SST control mode display screen*

E00526500025

The operation status of the Twin Clutch SST control mode is displayed.

Refer to “Twin Clutch SST control mode” on page 4-19.

ECO

ECO mode indicator (for vehicles equipped with Twin Clutch SST)

E00529300196

Except for vehicles for Russia, Kazakhstan and Ukraine, this indicator will be displayed when fuel-efficient driving is achieved.

Fuel remaining display screen

E00522200297

This displays the amount of fuel remaining.

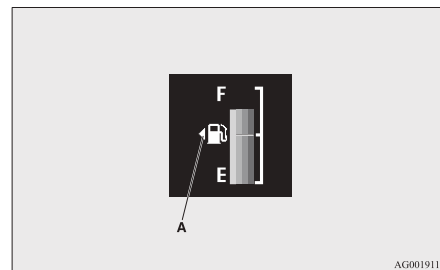

CAUTION

- Do not run out of fuel, or the catalytic converter may be adversely affected. If the warning display appears, refuel as soon as possible.

NOTE

- It may take several seconds to stabilise the display after refilling the tank.
- If fuel is added with the ignition switch in the “ON” position, the fuel gauge may incorrectly indicate the fuel level.

Fuel lid mark

E00522300184

The arrow (A) indicates that the fuel tank filler is located on the left side of the body. (Refer to “Filling the fuel tank” on page 03)

Fuel remaining warning display

E00522400387

When the fuel is reduced to about 8 litres, the information screen switches to the interrupt display of the fuel remaining warning display, and the “” mark (B) on the fuel remaining display flashes slowly (about once per second). After a few seconds, the information screen returns from the fuel remaining warning display to the previous screen.

When the fuel is reduced further to about 5 litres, the information screen switches to the fuel remaining warning display and the “” mark (B) on the fuel remaining display flashes quickly (about twice per second).

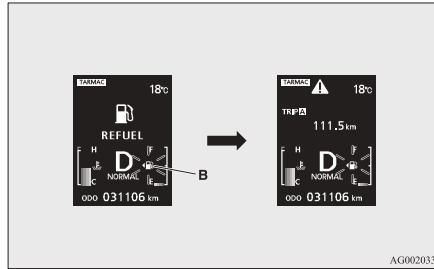

NOTE

- On inclines or curves, the display may be incorrect due to the movement of fuel in the tank.

Service reminder

E00522500825

Displays the approximate time until the next periodic inspection that MITSUBISHI MOTORS recommends. “---” is displayed when the inspection time has arrived.

NOTE

- Depending on the vehicle specifications, the displayed time until the next periodic inspection may differ from that of MITSUBISHI MOTORS recommends. In addition, the display settings for the next periodic inspection time can be modified. To modify the display settings, have it adjusted at a MITSUBISHI MOTORS Authorized Service Point. For more details, consult a MITSUBISHI MOTORS Authorized Service Point.

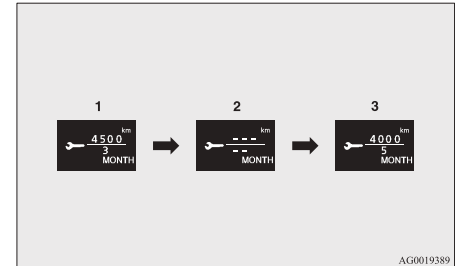

1. Displays the time until the next periodic inspection.

NOTE

- The distance is shown in units of 100 km (100 miles). The time is shown in units of months.
2. This informs you that a periodic inspection is due. We recommend you to consult a MITSUBISHI MOTORS Authorized Service Point.

Instruments and controls

At that time, when the ignition switch is switched from “OFF” to “ON”, the warning display is displayed for a few seconds on the information screen.

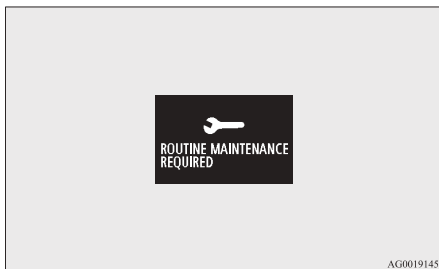

3. After your vehicle is inspected at a MITSUBISHI MOTORS Authorized Service Point, it displays the time until the next periodic inspection.

To reset

The “---” display can be reset while the ignition switch is “OFF”. When the display is reset, the time until the next periodic inspection is displayed and the warning display is no longer displayed when the ignition switch is switched from “OFF” to “ON”.

1. When you lightly press the multi-information meter switch a few times, the information screen switches to the service reminder display screen.



2. Press and hold the multi-information meter switch for about 2 seconds or more to display “---” and make it flash. (If there is no operation for about 10 seconds with flashing, the display returns to the previous screen.)

3. Lightly press the multi-information meter switch while the icon is flashing to change the display from “---” to “CLEAR”. After this, the time until the next periodic inspection will be displayed.

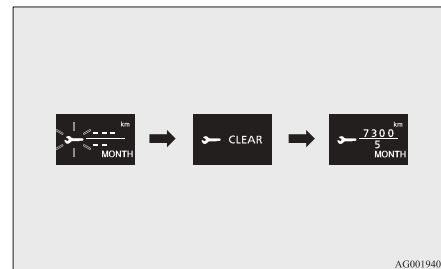

CAUTION

- The customer is responsible for making sure that periodic inspection and maintenance are performed. Inspections and maintenance must be performed to prevent accidents and malfunctions.

NOTE

- “---” display cannot be reset when the ignition switch is “ON”.
- When “---” is displayed, after a certain distance and a certain period of time, the display is reset and the time until the next periodic inspection is displayed.
- If you accidentally reset the display, we recommend you to consult a MITSUBISHI MOTORS Authorized Service Point.

Door ajar warning display screen (when the ignition switch is “ON”)

E00522600477

If any of the doors or the trunk lid is not completely closed, this displays the open door or trunk lid. If the vehicle speed exceeds approximately 8 km/h (5 mph) while a door is ajar, a buzzer sounds 4 times. This notifies the driver that a door is ajar.

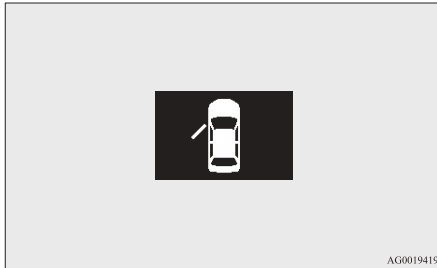

CAUTION

- Before moving your vehicle, check that the warning lamp is OFF.

NOTE

- In order to prevent the battery from running down, if you leave the door open a long time, the lamp goes out automatically. Refer to “Lamps (room lamps, etc.) auto-cut-out function” on page 5-62.

Changing the function settings (when the ignition switch is “ON”)

E00522700670

1. Stop the vehicle in a safe place. Firmly apply the parking brake and put the gearshift lever into the “N” (Neutral) position (M/T) or the shift lever into the “P” (Park) position (Twin Clutch SST).
2. Lightly press the multi-information meter switch a few times to switch the information screen to the function setting screen. Refer to “Information screen (when the ignition switch is “ON”)” on page 3-08.



CAUTION

- For safety, stop the vehicle before operating. While driving, even if you operate the multi-information meter switch, the function setting screen is not displayed.

3. Press and hold the multi-information meter switch for about 2 seconds or more to switch

from the setting mode screen to the menu screen.

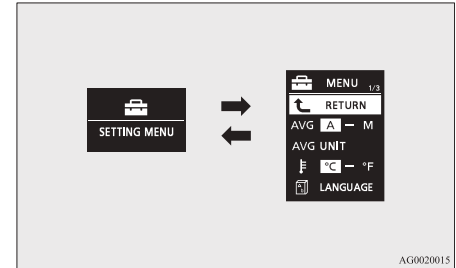

NOTE

- To return the menu screen to the function setting screen, press and hold the multi-information meter switch for about 2 seconds or more.
- If no operations are made within about 15 seconds of the menu screen being displayed, the display returns to the function setting screen.

Instruments and controls

4. Select the item to change on the menu screen and change to the desired setting. Refer to the following items for further details on the operation methods.

Refer to “Changing the reset mode for average fuel consumption and average speed” on page 3-16.

Refer to “Changing the fuel consumption display unit” on page 3-16.

Refer to “Changing the temperature unit” on page 3-17.

Refer to “Changing the display language” on page 3-17.

Refer to “Operation sound setting” on page 3-18.

Refer to “Changing the time until “REST REMINDER” is displayed” on page 3-18.

Refer to “Changing the turn-signal sound” on page 3-19.

Refer to “Changing the momentary fuel consumption display” on page 3-19.

Refer to “Returning to the factory settings” on page 3-19.

Changing the reset mode for average fuel consumption and average speed

E00522900890

The mode conditions for the average fuel consumption and average speed display can be switched between “Auto reset” and “Manual reset”.

1. Press and hold the multi-information meter switch for about 2 seconds or more to switch from the setting mode screen to the menu screen.
Refer to “Changing the function settings (when the ignition switch is “ON”)” on page 3-15.

2. Lightly press the multi-information meter switch to select “AVG (average fuel consumption and average speed setting)”.

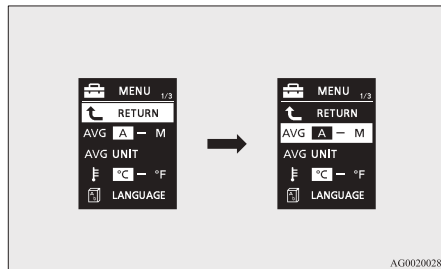

3. Press and hold the multi-information meter switch for about 2 seconds or more to switch in sequence from A or I (Auto reset mode) → M, 2 or P (Manual reset mode) → A or I (Auto reset mode).
The setting is changed to the selected mode condition.

Manual reset mode

- When the average fuel consumption and average speed are being displayed, if you hold down the multi-information meter switch, the average fuel consumption and average speed displayed at that time are reset.
- When the ignition switch is switched from “ACC” or “LOCK” to “ON”, the mode setting is automatically switched from manual to auto.
Switching to auto occurs automatically. If switching to manual mode is done, however, the data from the last reset is displayed.

Auto reset mode

- When the average fuel consumption and average speed are being displayed, if you hold down the multi-information meter switch, the average fuel consumption and average speed displayed at that time are reset.
- If the ignition switch is at “ACC” or “LOCK” for about 4 hours or longer, the average fuel consumption display and average speed display are automatically reset.

NOTE

- The average speed display and the average fuel consumption display can be reset individually for the auto reset mode and manual reset mode.
- The average speed display memories and average fuel consumption memories for auto reset mode and manual reset mode are erased if the battery is disconnected.
- The initial (default) setting is “Auto reset mode”.

Changing the fuel consumption display unit

E00523000641

The display unit for fuel consumption can be switched. The distance, speed, and amount units are also switched to match the selected fuel consumption unit.

1. Press and hold the multi-information meter switch for about 2 seconds or more to switch from the setting mode screen to the menu screen.
Refer to “Changing the function settings (when the ignition switch is “ON”)” on page 3-15.

- Lightly press the multi-information meter switch to select “AVG UNIT (fuel consumption display setting)”.

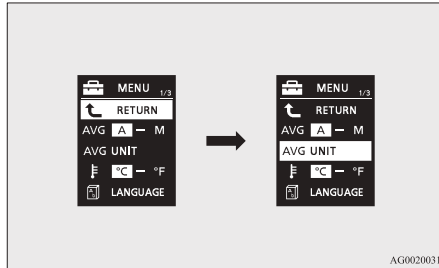

- Press and hold the multi-information meter switch for about 2 seconds or more to display “AVG UNIT” (fuel consumption display unit setting).
- Lightly press the multi-information meter switch to switch in sequence from km/L → L/100 km → mpg (US) → mpg (UK) → RETURN → km/L.

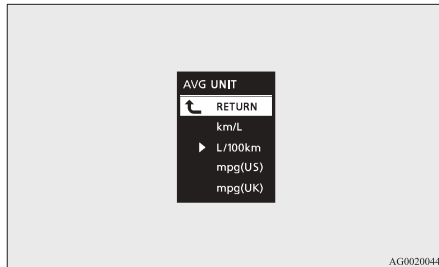

- Press and hold the multi-information meter switch for about 2 seconds or more to change the setting to the selected unit.

NOTE

- The display units for the driving range, the average fuel consumption, the average speed and the momentary fuel consumption are switched, but the units for the indicating needle (speedometer), the odometer and the trip-meter will remain unchanged.
- The memory of the unit setting is erased if the battery is disconnected, and it returns automatically to L/100 km.

The distance and speed units are also switched in the following combinations to match the selected fuel consumption unit.

Fuel consumption	Distance (driving range)	Speed (average speed)
L/100 km	km	km/h
mpg (UK)	mile (s)	mph
mpg (US)	mile (s)	mph
km/L	km	km/h

Changing the temperature unit

E00523100567

The display unit for temperature can be switched.

- Press and hold the multi-information meter switch for about 2 seconds or more to switch from the setting mode screen to the menu screen.
Refer to “Changing the function settings (when the ignition switch is “ON”)” on page 3-15.

- Lightly press the multi-information meter switch to select “” (temperature unit setting).

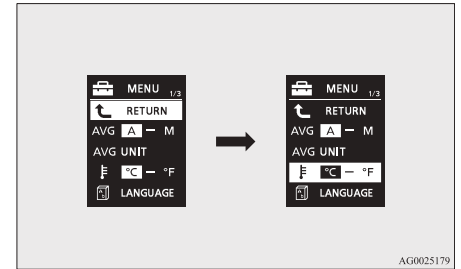

- Press and hold the multi-information meter switch for about 2 seconds or more to switch in sequence from °C → °F → °C.
The setting is changed to the selected temperature unit.

NOTE

- If the battery is disconnected, the unit setting is erased from memory and is automatically set to °C.

Changing the display language

E00523200630

The language of the multi-information display can be switched.

- Press and hold the multi-information meter switch for about 2 seconds or more to switch from the setting mode screen to the menu screen.
Refer to “Changing the function settings (when the ignition switch is “ON”)” on page 3-15.

Instruments and controls

2. Lightly press the multi-information meter switch to select “LANGUAGE” (language setting).

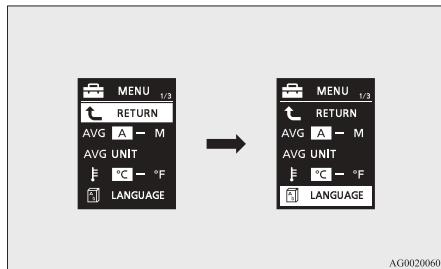

3. Press and hold the multi-information meter switch for about 2 seconds or more to display “LANGUAGE” (language setting).
4. Lightly press the multi-information meter switch to select the desired language.
5. If you hold down the multi-information meter switch for about 2 seconds or more, the setting is changed to the selected language.

NOTE

- The memory of the language setting is erased if the battery is disconnected, and it returns automatically to ENGLISH or RUSSIAN.
- If “---” is selected in the language setting, a warning message is not displayed when there is a warning display or interrupt display.

Operation sound setting

E00523400616

You can turn off the operation sounds of the multi-information meter switch and daytime dipper button.

1. Press and hold the multi-information meter switch for about 2 seconds or more to switch from the setting mode screen to the menu screen.

Refer to “Changing the function settings (when the ignition switch is “ON”)” on page 3-15.

2. Lightly press the multi-information meter switch to select “” (operation sound setting).

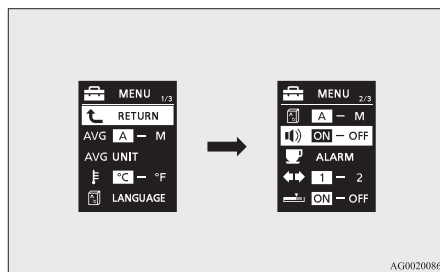

3. Press and hold the multi-information meter switch for about 2 seconds or more to switch in sequence from ON (operation sound on) → OFF (operation sound off) → ON (operation sound on).

The setting is changed to the selected condition.

NOTE

- The memory of the operation sound setting is erased if the battery is disconnected, and it returns automatically to ON (operation sound on).

- The operation sound setting only deactivates the operation sound of the multi-information meter switch and daytime dipper button. The warning display and other sounds cannot be deactivated.

Changing the time until “REST REMINDER” is displayed

E00523500617

The time until the display appears can be changed.

1. Press and hold the multi-information meter switch for about 2 seconds or more to switch from the setting mode screen to the menu screen.

Refer to “Changing the function settings (when the ignition switch is “ON”)” on page 3-15.

2. Lightly press the multi-information meter switch to select “ALARM” (rest time setting).

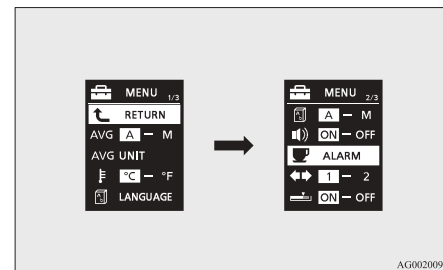

- Press and hold the multi-information meter switch for about 2 seconds or more to display “ALARM” (rest time setting).

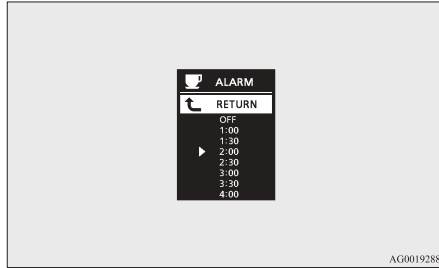

- Lightly press the multi-information meter switch to select (changing the turn-signal sound).

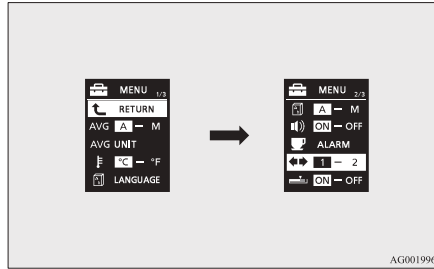

- Lightly press the multi-information meter switch to select (changing the momentary fuel consumption display).

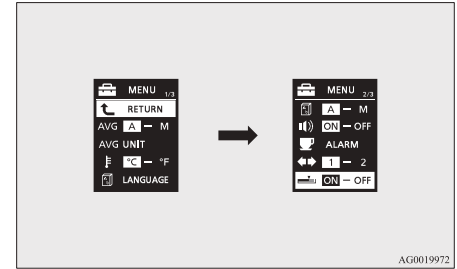

- Lightly press the multi-information meter switch to select the time until the display.
- Press and hold the multi-information meter switch for about 2 seconds or more, the setting is changed to the selected time.

- Press and hold the multi-information meter switch for about 2 seconds or more to switch in sequence from 1 (turn-signal sound 1) → 2 (turn-signal sound 2) → 1 (turn-signal sound 1).
The setting changes to the selected turn-signal sound.

- Press and hold the multi-information meter switch for about 2 seconds or more to switch in sequence from ON (with the green bar graph) → OFF (without the green bar graph) → ON (with the green bar graph).
The setting changes to the selected bar graph setting.

NOTE

- If the battery is disconnected, the unit setting is erased from memory and is automatically set to OFF.
- The drive time is reset when the ignition switch is turned off.

Changing the turn-signal sound

E00529100312

It is possible to change the turn-signal sound.

- Press and hold the multi-information meter switch for about 2 seconds or more to switch from the setting mode screen to the menu screen.
Refer to “Changing function settings (when the ignition switch is “ON”)” on page 3-15.

Changing the momentary fuel consumption display

E00529200241

It is possible to change the bar graph setting of the momentary fuel consumption display.

- Press and hold the multi-information meter switch for about 2 seconds or more to switch from the setting mode screen to the menu screen.
Refer to “Changing the function settings (when the ignition switch is “ON”)” on page 3-15.

Returning to the factory settings

E00523600777

All of the function settings can be returned to their factory settings.

- Press and hold the multi-information meter switch for about 2 seconds or more to switch from the setting mode screen to the menu screen.
Refer to “Changing the function settings (when the ignition switch is “ON”)” on page 3-15.

Instruments and controls

2. Lightly press the multi-information meter switch to select “RESET” (returning to the factory settings).

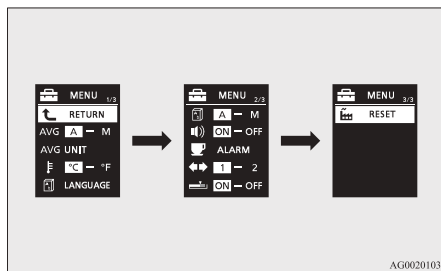

3. When you press and hold the multi-information meter switch for about 5 seconds or more, the buzzer sounds and all of the function settings are returned to the factory settings.

NOTE

- The factory settings are as follows.
 - Average fuel consumption and average speed reset mode: A (Auto reset)
 - Fuel consumption display unit: L/100 km
 - Temperature unit: °C (Celsius)
 - Display language: ENGLISH or RUSSIAN
 - Cooperative language setting: A
 - Operation sounds: ON (Operation sounds on)
 - “REST REMINDER” display: OFF
 - Turn-signal sound: Turn-signal sound 1
 - Momentary fuel consumption with the green bar graph: ON

Indication lamp, warning lamp, and information screen display list

E00523700013

E00523800913

Indication and warning lamp list

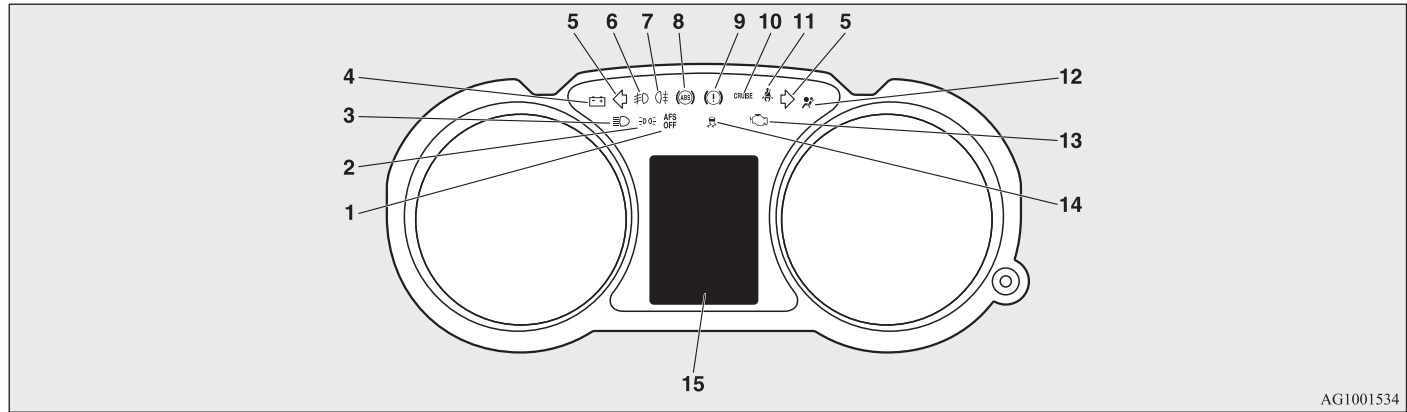

AG1001534

3

- 1- Adaptive Front lighting System (AFS) warning lamp → p. 3-42
- 2- Position lamp indication lamp → p. 3-33
- 3- High-beam indication lamp → p. 3-33
- 4- Charge warning lamp → p. 3-34
- 5- Turn-signal indication lamps/Hazard warning indication lamps → p. 3-33
- 6- Front fog lamp indication lamp → p. 3-33
- 7- Rear fog lamp indication lamp → p. 3-33

- 8- Anti-lock brake system (ABS) warning lamp → p. 4-32
- 9- Brake warning lamp → p. 3-33
- 10- Cruise control indication lamp* → p. 4-38
- 11- Driver's seat belt reminder/warning lamp → p. 2-07
- 12- Supplemental Restraint System (SRS) warning lamp → p. 2-28
- 13- Check engine warning lamp → p. 3-34
- 14- Active Stability Control (ASC) indicator → p. 4-35
- 15- Information screen display list → p. 3-22

Information screen display list

E00523900288

When there is information to be announced, such as lamp reminders, a sound is emitted and the screen switches to the displays shown below. Refer to the appropriate page and take the necessary measures.

When the cause of the warning display is eliminated, the warning display goes out automatically.

Refer to “Warning display list (when the ignition switch is “OFF”)” on page 3-23.

Refer to “Warning display list (when the ignition switch is “ON”)” on page 3-25.



Refer to “Other interrupt displays (when the ignition switch is “ON”)” on page 3-31.

NOTE





- A warning may be displayed on the information screen and the buzzer may sound in the following rare cases.
This is caused by the system picking up interference such as noise or strong electromagnetic waves, and is not a functional problem.
 - An extremely strong electromagnetic wave is received from a source such as an illegal radio set, a spark from a wire, or a radar station.
 - Abnormal voltage or a static electricity discharge is generated by the operation of installed electrical equipment (including after-market parts).

If the warning display appears many times, we recommend you to consult a MITSUBISHI MOTORS Authorized Service Point.

Warning display list (when the ignition switch is “OFF”)





Screen	Cause	Solution (Reference)
	<ul style="list-style-type: none"> You have forgotten to turn off the lamps. 	Refer to “Lamps (headlamps, fog lamp, etc.) auto-cutout function” on page 3-38.
	<ul style="list-style-type: none"> The security alarm system is operating. 	Refer to “Security alarm system” on page 1-28.
	<ul style="list-style-type: none"> After turning off the engine, an attempt was made to open the driver’s door with the ignition switch in any position other than “LOCK” (PUSH OFF). 	<ul style="list-style-type: none"> Turn the ignition switch to the “LOCK” (PUSH OFF) position. Refer to “Ignition switch on reminder system” on page 1-23.
	<ul style="list-style-type: none"> An attempt was made to lock all the doors and the trunk lid with the ignition switch in any position other than “LOCK” (PUSH OFF). 	<ul style="list-style-type: none"> Turn the ignition switch to the “LOCK” (PUSH OFF) position. Refer to “Ignition switch turn-off reminder system” on page 1-13.

Instruments and controls





Screen	Cause	Solution (Reference)
<div data-bbox="204 153 414 293">  <p>KEY BATTERY LOW</p> </div> <div data-bbox="204 293 414 433">  <p>KEY NOT DETECTED</p> </div> <div data-bbox="204 433 414 574">  <p>KEY STILL IN VEHICLE</p> </div> <div data-bbox="204 574 414 714">  <p>CHECK DOORS</p> </div> <div data-bbox="204 714 414 854">  <p>KEYLESS OPERATION SYSTEM SERVICE REQUIRED</p> </div>	<ul style="list-style-type: none"> ● There is a fault in the keyless operation system. 	<p>Refer to “Keyless operation system” on page 1-07.</p>





Warning display list (when the ignition switch is “ON”)

E00524101167





Screen	Cause	Solution (Reference)
 <p>KEY BATTERY LOW</p>  <p>KEY NOT DETECTED</p>  <p>KEY STILL IN VEHICLE</p>  <p>CHECK DOORS</p>  <p>KEYLESS OPERATION SYSTEM SERVICE REQUIRED</p>	<ul style="list-style-type: none"> ● There is a fault in the keyless operation system. 	<p>Refer to “Keyless operation system” on page 1-07.</p>





Instruments and controls

Screen	Cause	Solution (Reference)
 <p>BRAKE SYSTEM SERVICE REQUIRED</p>	<ul style="list-style-type: none"> ● The brake fluid level in the reservoir has fallen to a low level. ● There is a fault in the brake system. 	<ul style="list-style-type: none"> ● Immediately stop the vehicle in a safe place. We recommend you to consult a MITSUBISHI MOTORS Authorized Service Point. Refer to “Brake warning display” on page 3-33.
 <p>ABS SERVICE REQUIRED</p>	<ul style="list-style-type: none"> ● There is a fault in the ABS. 	<ul style="list-style-type: none"> ● Avoid sudden braking and high-speed driving, stop the vehicle in a safe place, and take corrective measures. Refer to “ABS warning” on page 4-32.
	<ul style="list-style-type: none"> ● One of the doors or the trunk lid is not completely closed. The open door is displayed. 	<ul style="list-style-type: none"> ● Close the door or trunk lid. Refer to “Door ajar warning display screen (when the ignition switch is “ON”)” on page 3-15.
 <p>CLOSE HOOD</p>	<ul style="list-style-type: none"> ● The bonnet is open. 	<ul style="list-style-type: none"> ● Close the bonnet. Refer to “Bonnet” on page 8-03.
 <p>ENGINE OVERHEATING STOP SAFELY</p>	<ul style="list-style-type: none"> ● The engine is overheated. 	<ul style="list-style-type: none"> ● Stop the vehicle in a safe place and take corrective measures. Refer to “Engine overheating” on page 6-04.

Screen	Cause	Solution (Reference)
 <p>TRANSMISSION OVERHEATING SLOW DOWN</p>	<ul style="list-style-type: none"> ● Twin Clutch SST fluid temperature is too high. 	<p>Refer to “Twin Clutch SST” on page 4-17.</p>
 <p>FASTEN SEAT BELT</p>	<ul style="list-style-type: none"> ● You turned the ignition switch to the “ON” position without fastening your seat belt. 	<ul style="list-style-type: none"> ● Fasten your seat belt properly. Refer to “Driver’s seat belt warning” on page 2-07.
 <p>FUEL SYSTEM SERVICE REQUIRED</p>	<ul style="list-style-type: none"> ● There is a fault in the fuel system. 	<ul style="list-style-type: none"> ● We recommend you to consult a MITSUBISHI MOTORS Authorized Service Point.
 <p>RELEASE PARKING BRAKE</p>	<ul style="list-style-type: none"> ● You are driving with the parking brake still applied. 	<ul style="list-style-type: none"> ● Release the parking brake. Refer to “Brake warning display” on page 3-35.
 <p>LOW OIL PRESSURE</p>	<ul style="list-style-type: none"> ● There is a fault in the engine oil circulation system. 	<ul style="list-style-type: none"> ● Immediately stop the vehicle in a safe place. We recommend you to have it checked. Refer to “Oil pressure warning display” on page 3-36.

Instruments and controls

Screen	Cause	Solution (Reference)
 <p>CHARGING SYSTEM SERVICE REQUIRED</p>	<ul style="list-style-type: none"> ● There is a fault in the charging system. 	<ul style="list-style-type: none"> ● Immediately stop the vehicle in a safe place. We recommend you to consult a MITSUBISHI MOTORS Authorized Service Point. Refer to “Charge warning display” on page 3-36.
 <p>AIRBAG SYSTEM SERVICE REQUIRED</p>	<ul style="list-style-type: none"> ● There is a fault in the SRS airbag or the pretensioner system. 	<ul style="list-style-type: none"> ● We recommend you to have it checked. Refer to “SRS warning lamp” on page 2-28.
 <p>HEADLAMP LEVELLING SERVICE REQUIRED</p>	<ul style="list-style-type: none"> ● There is a fault in the automatic headlamp levelling. 	<ul style="list-style-type: none"> ● We recommend you to have it checked. Refer to “Automatic headlamp levelling” on page 3-40.
 <p>ASC SYSTEM SERVICE REQUIRED</p>	<ul style="list-style-type: none"> ● There is a fault in the Active Stability Control (ASC). 	<ul style="list-style-type: none"> ● We recommend you to have it checked. Refer to “Active stability control (ASC)” on page 4-33.
 <p>AFS! ADAPTIVE FRONT LIGHTING SERVICE REQUIRED</p>	<ul style="list-style-type: none"> ● There is a fault in the Adaptive Front lighting System (AFS). 	<ul style="list-style-type: none"> ● We recommend you to have it checked. Refer to “Adaptive Front lighting System (AFS)” on page 3-41.



Screen	Cause	Solution (Reference)
 <p>4WD SYSTEM SERVICE REQUIRED</p>	<ul style="list-style-type: none"> ● There is a fault in the S-AWC (Super- All Wheel Control) system. 	<ul style="list-style-type: none"> ● We recommend you to have it checked. Refer to “S-AWC (Super-All Wheel Control)” on page 4-29.
 <p>TRANSMISSION SERVICE REQUIRED</p>	<ul style="list-style-type: none"> ● A safety device in the Twin Clutch SST has been activated due to a possible malfunction in the Twin Clutch SST or in the engine electronic control module. 	<ul style="list-style-type: none"> ● We recommend you to have it checked. Refer to “Twin Clutch SST” on page 4-17.
 <p>REFUEL</p>	<ul style="list-style-type: none"> ● The fuel is running low. 	<ul style="list-style-type: none"> ● Refuel as soon as possible. Refer to “Fuel remaining warning display” on page 3-13.
 <p>CHECK ENGINE OIL LEVEL</p>	<ul style="list-style-type: none"> ● The engine oil is running low. 	<ul style="list-style-type: none"> ● Stop the vehicle in a safe place, turn off the engine, and check the engine oil level. Refer to “Engine oil level warning display” on page 3-36.
 <p>POSSIBLE ICY ROADS</p>	<ul style="list-style-type: none"> ● The outside temperature is 3 °C (37 °F) or less. 	<ul style="list-style-type: none"> ● Be careful of ice on the road. ● The road can be icy even when this warning is not displayed, so drive carefully.

Instruments and controls

Screen	Cause	Solution (Reference)
 The image shows a black rectangular warning icon. At the top center is a white triangle with an exclamation mark inside. Below the triangle, the text "ENGINE SYSTEM SERVICE REQUIRED" is written in white, uppercase, sans-serif font, arranged in three lines: "ENGINE SYSTEM", "SERVICE", and "REQUIRED".	<ul style="list-style-type: none">● The timing chain may be worn.	<ul style="list-style-type: none">● Have the vehicle inspected at a MITSUBISHI MOTORS Authorized Service Point.

Other interrupt displays (when the ignition switch is “ON”)

The operation status of each system is displayed on the information screen. Refer to the appropriate page for the system for further details.

Screen	System operation status	Reference
	<ul style="list-style-type: none"> ● When the Active stability control (ASC) and the braking control of the Active yaw control system (AYC) are turned off with the “ASC OFF” switch. 	Refer to “Active stability control (ASC)” on page 4-33.
	<ul style="list-style-type: none"> ● When the Active Stability Control (ASC) is operating 	Refer to “Active stability control (ASC)” on page 4-33.

This informs you that a periodic inspection is due.

Screen	Solution
	We recommend you to have it checked. Refer to “Service reminder” on page 3-13 for further details.

The setting for rest interval can be changed.

Screen	Solution
	<p>Stop the vehicle in a safe place, turn off the engine, and take a rest. Use this display as rough guide for taking rests during a long drive. The interval from the start of your trip until this message is displayed can be set. Refer to “Changing the function settings (when the ignition switch is “ON”)” on page 3-15.</p> <p>The display and buzzer alert the driver when the set time is reached. If you continue to drive without having a rest, the buzzer sounds about every 5 minutes to encourage you to take a rest.</p> <ul style="list-style-type: none"> ● In the following cases, the time driven is reset and the display returns to the previous display screen. After this, when the set time is reached again, the buzzer and display encourage you to take a rest. <ul style="list-style-type: none"> • The buzzer sounds 3 times. • The ignition switch is turned to the “OFF” position. • The multi-information meter switch is held for about 2 seconds or more.

Indication lamps

E00501600100



Turn-signal indication lamps/ Hazard warning indication lamps

E00501700172

These indication lamps blink on and off when a turn-signal lamp is operating.

NOTE

- If the blinking is too fast, the cause may be a blown lamp bulb or a faulty turn-signal connection.

When the hazard warning lamp switch is pressed, all turn-signal lamps will flash on and off continuously.



High-beam indication lamp

E00501800160

This indication lamp illuminates when the high-beam is used.



Front fog lamp indication lamp

E00501900321

This lamp illuminates while the front fog lamps are on.



Rear fog lamp indication lamp

E00502000101

This lamp illuminates while the rear fog lamp is on.



Position lamp indication lamp

E00508900160

This indication lamp illuminates while the position lamps are on.



Warning lamps

E00502400147

Brake warning lamp

E00502502100

This lamp illuminates when the ignition switch is turned to the "ON" position, and goes off after a few seconds.

Always make sure that the lamp goes off before driving.

With the ignition switch in the "ON" position, the brake warning lamp illuminates under the following conditions:

- When the parking brake has been applied.
- When the brake fluid level in the reservoir falls to a low level.
- When the brake force distribution function is not operating correctly.



CAUTION

- In the situations listed below, brake performance may be compromised or the vehicle may become unstable if brakes are applied suddenly; consequently, avoid driving at high speeds or applying the brakes suddenly. Furthermore, immediately the vehicle should be brought to a stop in a safe location and we recommend you to have it checked.

CAUTION

- The brake warning lamp does not illuminate when the parking brake is applied or does not turn off when the parking brake is released.
- The brake warning lamp and the ABS warning lamp illuminate at the same time. For details, refer to “ABS warning lamp” on page 4-32.
- The brake warning lamp remains illuminated while driving.
- The vehicle should be brought to a halt in the following manner when brake performance has deteriorated.
 - Depress the brake pedal harder than usual. Even if the brake pedal moves down to the very end of its possible stroke, keep it pressed down hard.
 - Should the brakes fail, use engine braking to reduce your speed and carefully pull the parking brake lever. Depress the brake pedal to operate the stop lamp to alert the vehicles behind you.

NOTE

- Under conditions such as sporty driving, the brake fluid in the tank may move and the warning lamp may come on temporarily. If the warning lamp goes out after a while, there is not a problem with the brake system and the vehicle can be driven normally.



Check engine warning lamp

E00502601029

This lamp is a part of an onboard diagnostic system which monitors the emissions, engine control system or Twin Clutch SST control system.

If a problem is detected in one of these systems, this lamp illuminates or flashes. Although your vehicle will usually be drivable and not need towing, we recommend you to have the system checked as soon as possible.

This lamp will also illuminate when the ignition switch is turned “ON”, and goes off after the engine has started. If it does not go off after the engine has started, we recommend you to have the vehicle checked.

CAUTION

- Prolonged driving with this lamp on may cause further damage to the emission control system. It could also affect fuel economy and drivability.

CAUTION

- If the lamp does not illuminate when the ignition switch is turned to the “ON” position, we recommend you to have the system checked.
- If the lamp illuminates while the engine is running, avoid driving at high speeds and we recommend you to have the system checked. Accelerator pedal and brake pedal response may be negatively influenced under these conditions.

NOTE

- The engine electronic control module accommodating the onboard diagnostic system has various fault data (especially about the exhaust emission) stored. This data will be erased if a battery cable is disconnected which will make a rapid diagnosis difficult. Do not disconnect a battery cable when the check engine warning lamp is ON.



Charge warning lamp

E00502700456

This lamp illuminates when the ignition switch is turned “ON”, and goes off after the engine has started.

A warning is also displayed on the multi-information display.

CAUTION

- If it illuminates while the engine is running, there is a problem in the charging system. Immediately park your vehicle in a safe place and we recommend you to have it checked.

Information screen display

E00524600022

Brake warning display

E00524700238



This warning is displayed if you drive with the parking brake still applied. The warning lamp in the instrument cluster only illuminates when the parking brake is applied.

CAUTION

- If a vehicle is driven without releasing the parking brake, the brake will be overheated, resulting in ineffective braking and possible brake failure. If this warning is displayed, release the parking brake.



When the ignition switch is turned to the “ON” position, if the brake fluid is low, this warning is displayed.

The warning lamp in the instrument cluster also illuminates.

CAUTION

- If this warning stays illuminated and does not go out while driving, there is a danger of ineffective braking. If this happens, immediately park your vehicle in a safe place and we recommend you to have it checked.
- If the brake warning display is displayed and the brake warning lamp and the ABS warning lamp are illuminated at the same time, the braking force distribution function will not operate, so the vehicle may be destabilised during sudden braking. Avoid sudden braking and high-speed driving, stop the vehicle in a safe place, and we recommend you to have it checked.
- The vehicle should be brought to a halt in the following manner when brake performance has deteriorated.
 - Depress the brake pedal harder than usual. Even if the brake pedal moves down to the very end of its possible stroke, keep it pressed down hard.
 - Should the brakes fail, use engine braking to reduce your speed and carefully pull the parking brake lever. Depress the brake pedal to operate the stop lamp to alert the vehicles behind you.

Instruments and controls

NOTE

- Under conditions such as sporty driving, the brake fluid in the tank may move and the warning display may appear temporarily. If the warning display goes out after a while, there is not a problem with the brake system and the vehicle can be driven normally.

Charge warning display

E00524800167



If there is a fault with the charging system, the warning display is displayed on the information screen in the multi-information display. The warning lamp in the instrument cluster also illuminates.

CAUTION

- If the warning is displayed while the engine is running, immediately park your vehicle in a safe place and we recommend you to have it checked.

Oil pressure warning display

E00524900171



If the engine oil pressure drops while the engine is running, the warning display is displayed on the information screen in the multi-information display.

CAUTION

- If the vehicle is driven while the engine oil is low, or the oil level is normal but the warning is displayed, the engine may burn out and be damaged.
- If the warning is displayed while the engine is running, immediately park your vehicle in a safe place and check the engine oil level.
- If the warning is displayed while the engine oil level is normal, have it inspected.

Engine oil level warning display

E00526700030



When the ignition switch is “ON”, if the engine oil level is below the specified limit, the warning display is displayed on the information screen in the multi-information display.

CAUTION

- If this warning is displayed while driving, stop the vehicle in a safe place, turn off the engine, and check the engine oil level. Refer to “Engine oil” on page 8-04.

Combination headlamps and dipper switch

E00506002291

Headlamps

NOTE

- Do not leave the lamps on for a long time while the engine is stationary (not running). A rundown battery could result.
- When it rains, or when the vehicle has been washed, the inside of the lens sometimes becomes foggy, but this does not indicate a functional problem. When the lamp is switched on, the heat will remove the fog. However, if water gathers inside the lamp, we recommend you to have it checked.

Rotate the switch to turn on the lamps.

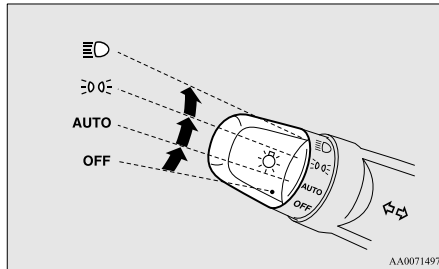

OFF	All lamps off
-----	---------------

AUTO	With the ignition switch in the "ON" position, headlamps, position, tail, licence plate, and instrument panel lamps turn on and off automatically in accordance with outside light level. All lamps turn off automatically when the ignition switch is turned to the "OFF" position.
	Position, tail, licence plate and instrument panel lamps on
	Headlamps and other lamps go on

NOTE

- The sensitivity of the automatic on/off control can be adjusted. For further information, contact a MITSUBISHI MOTORS Authorized Service Point.
- When the headlamps are turned off by the automatic on/off control with the ignition switch in the "ON" position, the front fog lamps and rear fog lamp also go off. When the headlamps are subsequently turned back on by the automatic on/off control, the front fog lamps also come on but the rear fog lamp stays off. If you wish to turn the rear fog lamp back on, operate the switch again.
- Do not cover the sensor (A) for the automatic on/off control by affixing a sticker or label to the windscreen.

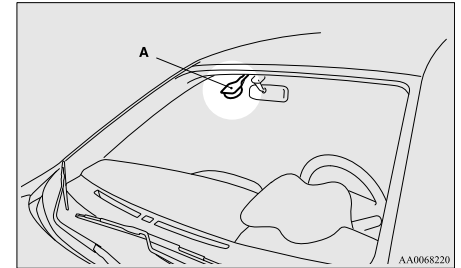

- If the lamps do not turn on or off with the switch in the "AUTO" position, manually operate the switch and we recommend you to have your vehicle checked.

Vehicles with Daytime Running Lamp*

When the engine is running and the lamp switch is set to the "AUTO" or "OFF" position, the low beam of the headlamps, tail lamp etc., will illuminate.

NOTE

- The daytime running lamp can be deactivated. For further information, we recommend you to consult a MITSUBISHI MOTORS Authorized Service Point. The regulations concerning daytime running lamp may differ from country to country. Find out and follow the laws and regulations of the area you're driving in.

Lamps (headlamps, fog lamp, etc.) auto-cutout function

E00532700497

- If, while the lamp switch is in the “

[When the engine was started using the key]

- If the key is removed and the driver’s door is opened, a buzzer sounds at a high pitch intermittently to remind the driver to turn off the lamps.

[When the engine was started using the keyless operation function]

- If the ignition switch is turned to the “LOCK” position and the driver’s door is opened, a buzzer sounds at a high pitch intermittently to remind the driver to turn off the lamps.
- If the ignition switch is turned to the “LOCK” position or “ACC” position, or the key is removed from the ignition switch, while the lamp switch is in the “

NOTE

- The lamp auto-cutout will not function when the lamp switch is in the “
 - The lamp auto-cutout function can also be disabled.

For further information, we recommend you to consult a MITSUBISHI MOTORS Authorized Service Point.

When you want to keep the lamps on:

1. Turn the lamp switch in the “OFF” position while the ignition switch is in the “LOCK” or “ACC” position.
2. Turn on the lamps with the switch in the “

NOTE

- When the engine was started using the key, if the driver’s door is opened and the key is removed, the lamp monitor buzzer sounds at a high pitch intermittently. The buzzer stops when the driver’s door is closed. (The warning is also displayed on the multi-information display.) The buzzer stops in the following manner.
 - Turn the lamp switch to the “OFF” position.
 - Close the driver’s door.
- When the engine was started using the keyless operation function, if the driver’s door is opened and the ignition switch is in the “LOCK” position, the lamp monitor buzzer sounds at a high pitch intermittently. The buzzer stops when the driver’s door is closed. (The warning is also displayed on the multi-information display.) The buzzer stops in the following manner.
 - Turn the lamp switch to the “OFF” position.
 - Close the driver’s door.

Lamp monitor buzzer

E00506100096

[When the engine was started using the key]

If the driver’s door is opened when the key is in the “LOCK” or “ACC” position or removed from the ignition switch while the lamps are on, a buzzer will sound to remind the driver to turn off the lamps.

[When the engine was started using the keyless operation function]

If, while the lamps are illuminated, the ignition switch is set to the “LOCK” or “ACC” position, or the driver’s door is opened with the ignition switch set to the “LOCK” position, a buzzer will sound to remind the driver to turn off the lamps.

In both cases, the buzzer will automatically stop if the auto-cutoff function is activated, the lamp switch is turned off, or the door is closed.

Dipper (High/Low beam change)

E00506200374

When the lamp switch is in the “” position, the beam changes from high to low (or low to high) each time the lever is pulled fully (1). While the high-beam is on, the high-beam indication lamp in the instrument cluster will also illuminate.

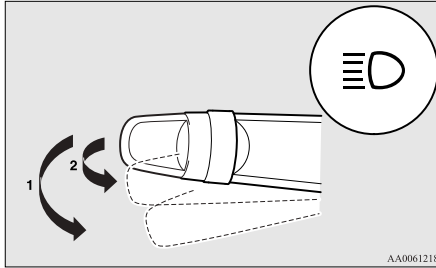

AA0061218

Headlamp flasher

E00506300199

The high-beams flash when the lever is pulled slightly (2), and will go off when it is released. When the high-beam is on, the high-beam indication lamp in the instrument cluster will illuminate.

NOTE

- The high-beams can also flash when the lamp switch is OFF.
- If you turn the lamps off with the headlamps set to high-beam, the headlamps are automatically returned to their low-beam setting when the lamp switch is next turned to the “” position.

Welcome light

E00528900544

This function turns on the position and tail lamps for about 30 seconds after the UNLOCK switch (A) on the remote control transmitter is pressed when the combination headlamps and dipper switch is in the “OFF” or “AUTO” position. The welcome light function will operate only when it is dark outside the vehicle.

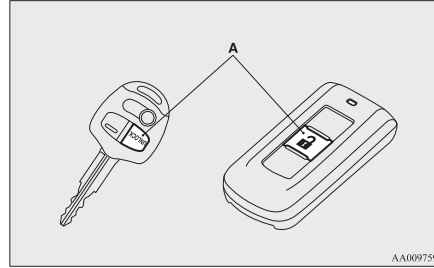



AA0097596

NOTE

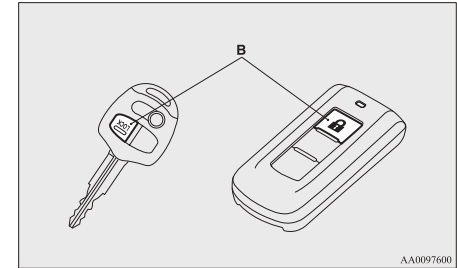
- While the welcome light function is operating, perform one of the following operations to cancel the function.
 - Push the LOCK switch (B) on the remote control transmitter.



AA0097600

- Turn the combination headlamps and dipper switch to the “” or “” position.
- Turn the ignition switch to the “ON” position.
- It is possible to modify functions as follows:
 - The headlamps can be set to come on in the low beam setting.
 - The welcome light function can be deactivated.

For further information, please contact your MITSUBISHI MOTORS Authorized Service Point.

Coming home light

E00529000513

This function turns on the headlamps in the low beam setting for about 30 seconds after the ignition switch is turned to the “LOCK” position.

1. Turn the combination headlamps and dipper switch to the “OFF” or “AUTO” position.
2. Turn the ignition switch to the “LOCK” position. Also, if a key was used to start the engine, remove the key from the ignition switch.

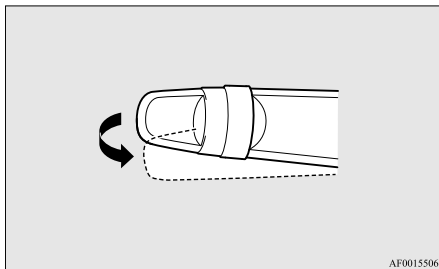

Instruments and controls

3. Within 60 seconds of turning the ignition switch to the “LOCK” position, pull the turn signal lever towards you.



4. The headlamps will come on in the low-beam setting for about 30 seconds. After the headlamps go off, the headlamps can be turned on again in the low beam setting for about 30 seconds by pulling the turn signal lever towards you within 60 seconds of turning the ignition switch to the “LOCK” position. To turn on the headlamps again after 60 seconds of turning the ignition switch to the “LOCK” position, repeat the process from step 1.

NOTE

- While the coming home light function is operating, perform one of the following operations to cancel the function.
 - Pull the lever towards you.
 - Turn the combination headlamps and dipper switch to the “” or “” position.
 - Turn the ignition switch to the “ON” position.

- It is possible to modify functions as follows:
 - The time that the headlamps remain on can be changed.
 - The coming home light function can be deactivated.

For further information, please contact your MITSUBISHI MOTORS Authorized Service Point.

Headlamp levelling

E00517400086

Automatic headlamp levelling

E00517600352

This mechanism automatically adjusts the direction of the headlamps (beam position) depending on changes in the condition of the vehicle, such as the number of occupants or luggage weight. When the headlamps are illuminated with the ignition switch in the “ON” position, the beam position of the headlamps is automatically adjusted when the vehicle is stopped.

Headlamp automatic levelling system warning display



If there is a fault in the automatic headlamp levelling system, the warning display is displayed on the information screen in the multi-information display.

CAUTION

- If the warning is displayed, the system may be malfunctioning. Have the vehicle inspected by a MITSUBISHI MOTORS Authorized Service Point.

Turn-signal lever

E00506501589

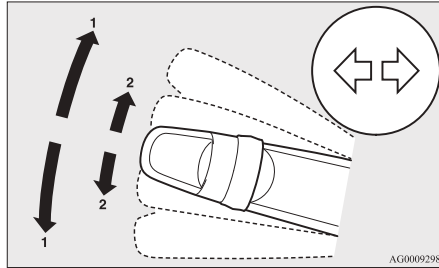

1- Turn-signals

When making a normal turn, use position (1). The lever will return automatically when cornering is completed.

2- Lane-change signals

When moving the lever to (2) slightly to change a lane, the turn-signal lamps and indication lamp in the instrument cluster will only flash while the lever is operated.

Also, when you move the lever to (2) slightly then release it, the turn-signal lamps and indication lamp in the instrument cluster will flash 3 times.

NOTE

- If the lamp flashes unusually quickly, the bulb in a turn-signal lamp may have burned out. We recommend you to have the vehicle inspected.
- It is possible to activate the following functions.

- Flashing of the turn-signal lamps when the lever is operated with the ignition switch in the “ACC” position.
- Deactivate the turn-signal lamp 3-flash function for lane changes
- The time required to operate the lever for the 3-flash function can be adjusted.

For further information, we recommend you to consult a MITSUBISHI MOTORS Authorized Service Point.

Adaptive Front lighting System (AFS)

E00525100398

The AFS makes it easier for the driver to see ahead at night. While the lamp switch is in the “ ” or “AUTO” position (with the headlamps on), turning the steering wheel causes a bending lamp to automatically come on and illuminate the road in the direction in which the vehicle is being turned, thereby expanding the illuminated area of the road.

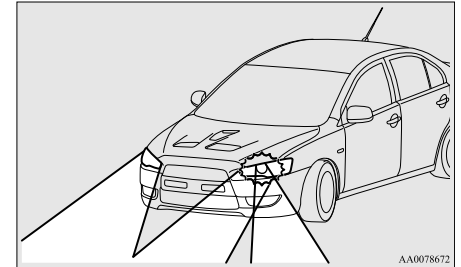

Instruments and controls

When the steering wheel is turned (on a curve, for example), the road ahead in the direction in which the vehicle is being turned is illuminated. (The left bending lamp comes on when the vehicle is turned leftward, and the right bending lamp comes on when the vehicle is turned rightward.)

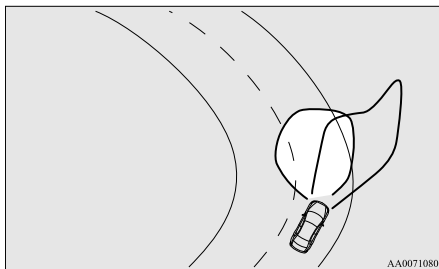

3

CAUTION

- If either bending lamp is kept on for about 15 minutes, it automatically goes off. If you wish to make it come on again, first turn the steering wheel back from its turned position to the straight-ahead position.

NOTE

- The amount of steering wheel operation necessary to illuminate the bending lamps changes according to the vehicle speed. (The lower the vehicle speed, the more steering wheel operation is necessary.) However, the lamps can be set before driving to illuminate with just a small amount of steering wheel operation.
- The AFS does not work in any of the following circumstances:
 - The shift lever is in the “R” position.
 - The lamp switch is in the “ Σ OFF” or “OFF” position.
 - The vehicle speed is 100 km/h (62 mph) or higher.

Adaptive Front lighting System (AFS) indications

E00525300404

Warning lamp



Warning display



In the event of an abnormality in the AFS, a warning display appears in the information window of the multi information display and the “AFS OFF” warning lamp in the meter cluster flashes.

CAUTION

- If the warning display is displayed, the system may be malfunctioning. We recommend you to consult a MITSUBISHI MOTORS Authorized Service Point.

NOTE

- If the AFS warning lamp flashes while you are driving, stop the car in a safe place, turn the ignition switch to the “ACC” or “OFF” position, then restart the engine. If the AFS warning lamp stays off, the AFS is normal.
- When the emergency spare wheel is fitted on the vehicle, the AFS may not work normally. Fit a standard wheel on the vehicle instead of the emergency spare wheel as soon as possible.

Hazard warning flasher switch

E00506600596

Use the hazard warning flasher switch when the vehicle has to be parked on the road for any emergency.

The hazard warning flashers can always be operated, regardless of the position of the ignition switch.

Push the switch to turn on the hazard warning flashers, all turn signal lamps flash continuously. To turn them off, push the switch again.

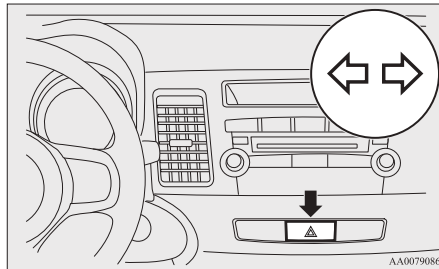

AA0079086

Fog lamp switch

E00506700034

Front fog lamp switch

E00508300366

The front fog lamps can be operated while the headlamps or tail lamps are on. Turn the knob in the “ON” direction to turn on the front fog lamps. An indication lamp in the instrument cluster will also come on. Turn the knob in the “OFF” direction to turn off the front fog lamps. The knob will automatically return to its original position when you release it.

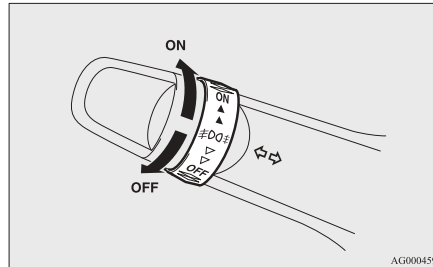

AG0004596

NOTE

- The front fog lamps are automatically turned off when the headlamps or tail lamps are turned off. To turn the front fog lamps on again, turn the knob in the “ON” direction after turning on the headlamps or tail lamps.
- Do not use fog lamps except in conditions of fog, otherwise excessive lamp glare may temporarily blind oncoming vehicle drivers.

- In case of vehicles with Daytime Running Lamp, the front fog lamps can be operated even if the lamp switch is set to the “OFF” position.

Rear fog lamp switch

E00508400338

The rear fog lamp can be operated when the headlamps or front fog lamps turn on.

An indication lamp in the instrument cluster comes on when the rear fog lamp is turned on.

Turn the knob once in the “ON” direction to turn on the front fog lamps. Turn the knob once more in the “ON” direction to turn on the rear fog lamp. To turn the rear fog lamp off, turn the knob once in the “OFF” direction. Turn the knob once more in the “OFF” direction to turn off the front fog lamps. The knob will automatically return to its original position when you release it.

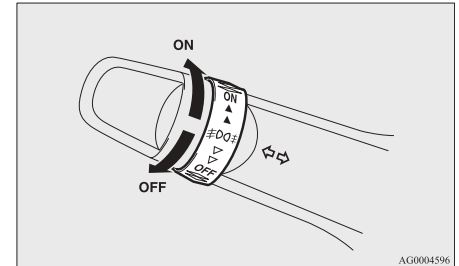

AG0004596

NOTE

- The rear fog lamp is automatically turned off when the headlamps or front fog lamps are turned off.
- To turn the rear fog lamp on again, turn the knob twice in the “ON” direction after turning on the headlamps.
- In case of vehicles with Daytime Running Lamp, the rear fog lamp can be operated even if the lamp switch is set to the “OFF” position.

Wiper and washer switch

E00507101726

CAUTION

- If the washer is used in cold weather, the washer fluid sprayed against the glass may freeze, which may hinder visibility. Warm the glass with the defroster before using the washer.

Windscreen wipers

The windscreen wipers can be operated with the ignition switch in the “ON” or “ACC” position. If the blades are frozen to the windscreen, do not operate the wipers until the ice has melted and the blades are freed, otherwise the wiper motor may be damaged.

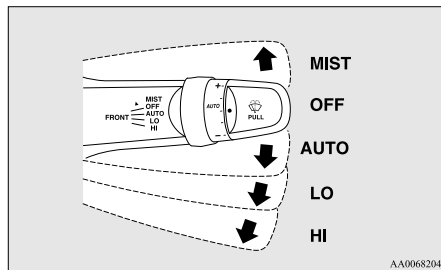

AA0068204

MIST- Misting function
The wipers will operate once.

OFF- Off

AUTO- Auto-wiper control
Rain sensor
The wipers will automatically operate depending on the degree of wetness on the windscreen.

LO- Slow

HI- Fast

Rain sensor

Can only be used when the ignition switch is in the “ON” position.

If the lever is put in the “AUTO” position, the rain sensor (A) will detect the extent of rain (or snow, other moisture, dust, etc.) and the wipers will operate automatically.

Keep the lever in the “OFF” position if the windscreen is dirty and the weather is dry.

Wiper operation under these conditions can scratch the windscreen and damage the wipers.

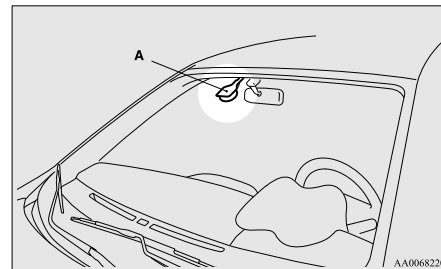

AA0068220

⚠ CAUTION

- With the ignition switch in the “ON” position and the lever in the “AUTO” position, the wipers may automatically operate in the situations described below. If your hands get trapped, you could suffer injuries or the wipers could malfunction. Be sure to turn the ignition switch to the “OFF” position or move the lever to the “OFF” position to deactivate the rain sensor.
 - When cleaning the outside surface of the windscreen, if you touch the rain sensor.
 - When cleaning the outside surface of the windscreen, if you wipe with a cloth the rain sensor.
 - When using an automatic car wash.
 - A physical shock is applied to the windscreen.
 - A physical shock is applied to the rain sensor.

NOTE

- To protect the rubber parts of the wipers, this operation of the wipers does not take place when the vehicle is stationary and the ambient temperature is about 0 °C or lower.
- Do not cover the sensor by affixing a sticker or label to the windscreen. Also, do not put any water-repellent coating on the windscreen. The rain sensor would not be able to detect the extent of rain, and the wipers might stop working normally.
- In the following cases, the rain sensor may be malfunctioning. For further information,

we recommend you to consult a MITSUBISHI MOTORS Authorized Service Point.

- When the wipers operate at a constant interval despite changes in the extent of rain.
 - When the wipers do not operate even though it is raining.
- The wipers may automatically operate when things such as insects or foreign objects are affixed to the windscreen on top of the rain sensor or when the windscreen is frozen. Objects affixed to the windscreen will stop the wipers when the wipers cannot remove them. To operate the wipers again, move the lever to the “LO” or “HI” position. Also, the wipers may operate automatically due to strong direct sunlight or electromagnetic wave. To stop the wipers, move the lever to the “OFF” position.
 - Contact a MITSUBISHI MOTORS Authorized Service Point when replacing the windscreen or reinforcing the glass around the sensor.

To adjust the sensitivity of the rain sensor
With the lever in the “AUTO” (rain sensor) position, it is possible to adjust the sensitivity of the rain sensor by turning the knob (B).

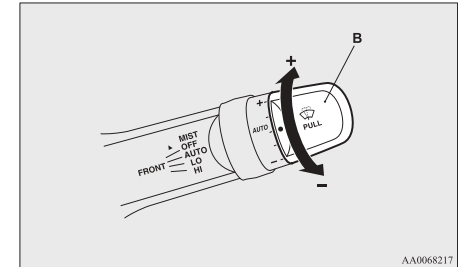

“+”- Higher sensitivity to rain

“-”- Lower sensitivity to rain

NOTE

- It is possible to activate the following functions.
 - Automatic operation (rain droplet sensitive) can be changed to intermittent operation (vehicle-speed sensitive).
 - Automatic operation (rain droplet sensitive) can be changed to intermittent operation (except vehicle-speed sensitive).

For further information, please contact your MITSUBISHI MOTORS Authorized Service Point.

Misting function

Move the lever in the direction of the arrow and release, to operate the wipers once.

Use this function when you are driving in mist or drizzle.

Instruments and controls

The wipers will operate once if the lever is raised to the “MIST” position and released when the ignition switch is in the “ON” or “ACC” position. The wipers will continue to operate while the lever is held in the “MIST” position.

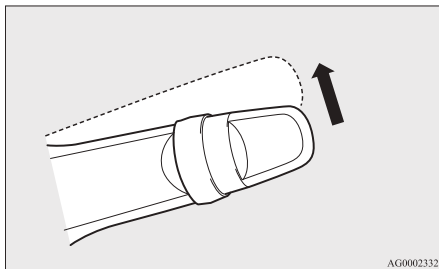

3

The wipers will operate once if the lever is moved to the “AUTO” position and the knob (C) is turned in the “+” direction when the ignition switch is in the “ON” position.

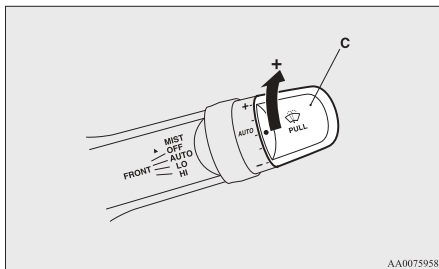

Windscreen washer

E00507201280

The windscreen washer can be operated with the ignition switch in the “ON” or “ACC” position.

The washer fluid will be sprayed onto the windscreen by pulling the lever towards you.

When the wipers are not in operation or in intermittent operation, by pulling the lever towards you, the wipers will operate several times while the washer fluid is being sprayed.

Except for vehicles for Russia and Ukraine, then about 6 seconds later, wipers operate once more.

While the headlamps are on, the headlamp washer will operate once together with the windscreen washer.

Also, except for vehicles for Russia and Ukraine, by releasing the lever soon after pulling it towards you, the washer fluids will be sprayed several times while the wipers are operating several times. (Comfort washer) Then about 6 seconds later, wipers operate once more.

Comfort washer will stop operating with any operation of the lever.

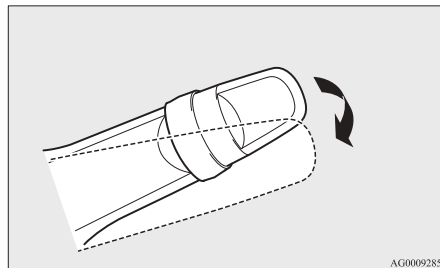

CAUTION

- If the washer is used in cold weather, the washer fluid sprayed against the glass may freeze resulting in poor visibility. Heat the glass with the defroster or demister before using the washer.

NOTE

- It is possible to modify functions as follows:
 - Causing the wiper never to operate when washer fluid is sprayed.
 - Except for vehicles for Russia and Ukraine, deactivating the comfort washer.
 - Except for vehicles for Russia and Ukraine, deactivating the function that operates the wipers once more about 6 seconds later.
 - Vehicles for Russia and Ukraine, activating the comfort washer.
 - Vehicles for Russia and Ukraine, the wipers can be set to operate again after about 6 seconds.

For further information, we recommend you to consult a MITSUBISHI MOTORS Authorized Service Point.

Headlamp washer switch

E00507800205

The headlamp washer can be operated with the ignition switch in the “ON” or “ACC” position and the headlamps are on.

Push the button once and the washer fluid will be sprayed on to the headlamps.

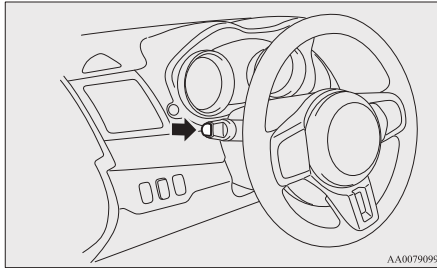

AA0079099

NOTE

- If the ignition switch is in the “ON” or “ACC” position and the headlamps are on, the headlamp washer operates together with the windscreen washer the first time the windscreen washer lever is pulled.

Precautions to observe when using wipers and washers

E0051000025

- If the moving wipers become blocked by ice or other deposits on the glass, the motor may burn out even if the wiper switch is turned to OFF. If obstruction occurs, park your vehicle in a safe place, turn off the ignition, and clean the deposits from the glass so that the wipers operate smoothly.
- Do not use the wipers when the glass is dry. They may scratch the glass surface and the blades wear out prematurely.
- Before using the wipers in cold weather, check that the wiper blades are not frozen onto the glass. The motor may burn out if the wipers are used with the blades frozen onto the glass.
- Avoid using the washer continuously for more than 20 seconds. Do not operate the washer when the fluid reservoir is empty. Otherwise, the motor may burn out.
- Periodically check the level of washer fluid in the reservoir and refill if required. During cold weather, add a recommended washer solution that will not freeze in the washer reservoir. Failure to do so could result in loss of washer function and frost damage to the system components.

Rear window demister switch

E00507901115

The rear window demister switch can be operated when the engine is running.

Push the switch to turn on the rear window demister. It will be turned off automatically in about 20 minutes. To turn off the demister within about 20 minutes, push the switch again.

The indication lamp (A) will illuminate while the demister is on.

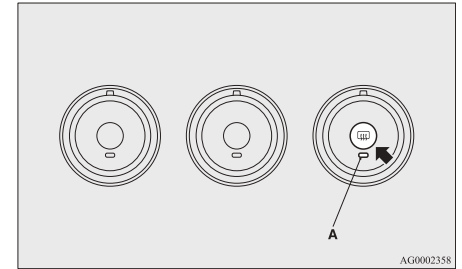

AG0002358

NOTE

- If your vehicle is equipped with heated mirrors, when the rear window demister switch is pressed, the outside rear-view mirrors are defogged or defrosted. Refer to “Heated mirror” on page 4-09.
- The demister switch is not to melt snow but to clear mist. Remove snow before use of the demister switch.
- To avoid unnecessary discharge of the battery, do not use the rear window demister during starting of the engine or when the engine is not running. Turn the demister off immediately after the window is clear.

Instruments and controls

- When cleaning the inside of the rear window, use a soft cloth and wipe lightly along the heater wires, being careful not to damage the wires.
- Do not allow objects to touch the inside of the rear window glass, damaged or broken wires may result.

Horn switch

E00508000448

Press the steering wheel on or around the “” mark.

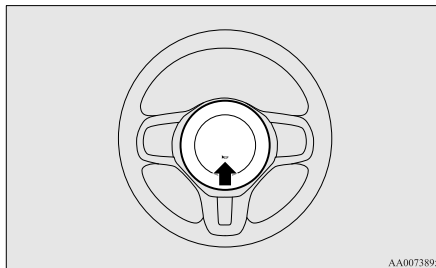

Starting and driving

Economical driving.....	4-02
Driving, alcohol and drugs.....	4-02
Safe driving techniques.....	4-03
Running-in recommendations.....	4-03
Parking brake.....	4-04
Parking.....	4-05
Steering wheel height adjustment.....	4-06
Inside rear-view mirror.....	4-06
Outside rear-view mirrors.....	4-07
Ignition switch.....	4-09
Steering wheel lock.....	4-10
Starting and stopping the engine.....	4-11
Turbocharger operation.....	4-13
Clutch pedal operation.....	4-14
Manual transmission*.....	4-14
Twin Clutch SST (Sport Shift Transmission)*.....	4-17
Full-time 4WD.....	4-27
Cautions on handling of 4-wheel drive vehicles.....	4-28
S-AWC (Super-All Wheel Control).....	4-29
Anti-lock brake system (ABS).....	4-32
Active stability control (ASC).....	4-33
Braking.....	4-35
Brake assist system.....	4-36
Power steering system.....	4-37
Cruise control*.....	4-37
Cargo loads.....	4-41
Rear-view camera*.....	4-43
Trailer towing.....	4-45

Starting and driving

Economical driving

E00600100819

For economical driving, there are some technical requirements that have to be met. The prerequisite for low fuel consumption is a properly adjusted engine. In order to achieve longer life of the vehicle and the most economical operation, we recommend you to have the vehicle checked at regular intervals in accordance with the service standards.

Fuel economy and generation of exhaust gas and noise are highly influenced by personal driving habits as well as the particular operating conditions. The following points should be observed in order to minimize wear of brakes, tyres and engine as well as to reduce environmental pollution.

Starting

Avoid rapid acceleration and sudden starts; such operation will result in higher fuel consumption.

Shifting

Shift only at an appropriate speed and engine speed. Always use the highest gear possible.

City traffic

Frequent starting and stopping increases the average fuel consumption. Use roads with smooth traffic flow whenever possible. When driving on congested roads, avoid use of a low gear at high engine speeds.

Idling

The vehicle consumes fuel even during idling. Avoid extended idling whenever possible.

Speed

At higher the vehicle speed, more fuel is consumed. Avoid driving at full speed. Even a slight release of the accelerator pedal will save a significant amount of fuel.

Tyre inflation pressure

Check the tyre inflation pressures at regular intervals. Low tyre inflation pressure increases road resistance and fuel consumption. In addition, low tyre pressures adversely affect tyre wear and driving stability.

Load

Do not drive with unnecessary articles in the luggage compartment. Especially during city driving where frequent starting and stopping is necessary, the increased weight of the vehicle will greatly affect fuel consumption.

Cold engine starting

Starting of a cold engine consumes more fuel. Unnecessary fuel consumption is also caused by keeping a hot engine running. After the engine is started, commence driving as soon as possible.

Air conditioning

The use of the air conditioning will increase the fuel consumption.

Driving, alcohol and drugs

E00600200067

Driving after drinking alcohol is one of the most frequent causes of accidents.

Your driving ability can be seriously impaired even with blood alcohol levels far below the legal minimum. If you have been drinking, don't drive. Ride with a designated non-drinking driver, call a cab or a friend, or use public transportation. Drinking coffee or taking a cold shower will not make you sober.

Similarly, prescription and nonprescription drugs affect your alertness, perception and reaction time. Consult with your doctor or pharmacist before driving while under the influence of any of these medications.

WARNING

- **NEVER DRINK AND DRIVE.**
Your perceptions are less accurate, your reflexes are slower and your judgment is impaired.

Safe driving techniques

E00600300433

Driving safety and protection against injury cannot be fully ensured. However, we recommend that you pay extra attention to the following:

Seat belts

Before starting the vehicle, make sure that you and your passengers have fastened your seat belts.

While driving

Keep a tight grip on the steering wheel.

Floor mats

WARNING

- Keep floor mats clear of the pedals by correctly laying floor mats that are suitable for the vehicle.

To prevent the floor mats from slipping out of position, securely retain them using the hook etc.

Note that laying a floor mat over a pedal or laying one floor mat on top of another can obstruct pedal operation and lead to a serious accident.

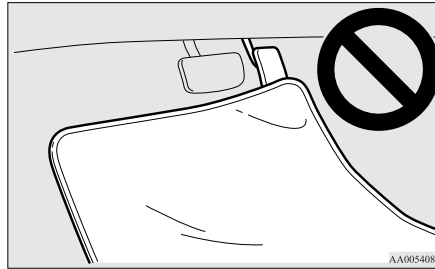

AA0054085

Carrying children in the vehicle

- Never leave your vehicle unattended with the key and children inside the vehicle. Children may play with the driving controls and this could lead to an accident.
- Make sure that infants and small children are properly restrained in accordance with the laws and regulations, and for maximum protection in case of an accident.
- Prevent children from playing in the luggage compartment. It is quite dangerous to allow them to play there while the vehicle is moving.

Loading luggage

When loading luggage, be careful not to load above the height of seats. This is dangerous not only because rearward vision will be obstructed, but also the luggage may be projected into the passenger compartment under hard braking.

Running-in recommendations

E00600401343

For future performance and economy of your vehicle, we recommend that you carry out the following precautions.

- Avoid exceeding the engine revolutions of 5,000 rpm for the first 1,000 km (620 miles).
- Avoid rough driving such as fast starts, prolonged highspeed driving and rough shifting for the first 500 km (310 miles).
- Give your vehicle's high-performance brake pads time to settle into place by avoiding hard braking for the first 500 km (310 miles).

Subjecting the brake pads to hard operation without first giving them time to settle into place could result in abnormal brake noise and vibration.

- Do not overload the vehicle. Observe the seating capacity (See "Cargo loads precautions" on page 4-41).
- Do not use this vehicle for trailer towing.

Starting and driving

Parking brake

E00600501344

To park the vehicle, first bring it to a complete stop, fully apply the parking brake lever sufficiently to hold the vehicle.

To apply the parking brake

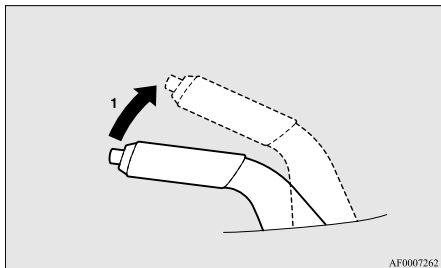

- 1- Firmly depress and hold the brake pedal, then pull the lever up without pushing the button at the end of hand grip.

CAUTION

- When you intend to apply the parking brake, firmly press the brake pedal to bring the vehicle to a complete stop before pulling the parking brake lever. Pulling the parking brake lever with the vehicle moving could make the rear wheels lock up, thereby making the vehicle unstable. It could also make the parking brake malfunction.

NOTE

- Apply sufficient force to the parking brake lever to hold the vehicle stationary after the foot brake is released.
- If the parking brake does not hold the vehicle stationary after the foot brake is released, have your vehicle checked immediately.

To release the parking brake

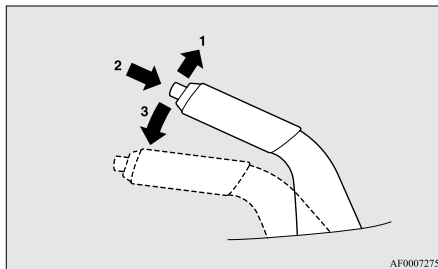

- 1- Firmly depress and hold the brake pedal, then pull the lever up slightly.
- 2- Push the button at the end of hand grip.
- 3- Lower the lever fully.

CAUTION

- Before driving, be sure that the parking brake is fully released and brake warning lamp is off. If you drive without the parking brake fully released, the warning display will appear on the information screen in the multi-information display. If a vehicle is driven without releasing the parking brake, the brake will be overheated, resulting in ineffective braking and possible brake failure.

Warning lamp



Warning display



- If the brake warning lamp does not extinguish when the parking brake is fully released, the brake system may be an abnormal. Have your vehicle checked immediately. For details, refer to “Brake warning lamp” on page 3-33.

Parking

E00600601390

To park the vehicle, fully engage the parking brake, and then move the gearshift lever to 1st or “R” (Reverse) position for vehicles with M/T, or set the gearshift lever to “P” (PARK) position for vehicles with Twin Clutch SST.

Parking on a hill

To prevent the vehicle from rolling, follow these procedures:

Parking on a downhill slope

Turn the front wheels towards the kerb and move the vehicle forward until the kerb side wheel gently touches the kerb.

Apply the parking brake and place the gearshift lever into the “R” (Reverse) position (with M/T) or the gearshift lever into the “P” (PARK) position (with Twin Clutch SST).

If necessary, apply chocks to wheels.

Parking on an uphill slope

Turn the front wheels away from the kerb and move the vehicle back until the kerb side wheel gently touches the kerb.

Apply the parking brake and place the gearshift lever into the 1st position (with M/T) or the gearshift lever into the “P” (PARK) position (with Twin Clutch SST).

If necessary, apply chocks to wheels.

NOTE

- If your vehicle is equipped with Twin Clutch SST, be sure to apply the parking brake before moving the gearshift lever to the “P” (PARK) position. If you move the gearshift lever to the “P” (PARK) position before applying the parking brake, it may be difficult to disengage the gearshift lever from the “P” (PARK) position when next you drive the vehicle, requiring application of a strong force to the gearshift lever to move from the “P” (PARK) position.

Parking with the engine running

Never leave the engine running while you take a short sleep/rest, or you open or close a gate or garage door, etc. Also, never leave the engine running in a closed or poorly ventilated place.

WARNING

- Leaving the engine running risks injury or death from accidentally moving the gearshift lever or the accumulation of toxic exhaust fumes in the passenger compartment.

Where you park

WARNING

- Do not park your vehicle in areas where combustible materials such as dry grass or leaves can come in contact with a hot exhaust, since a fire could occur.

When leaving the vehicle

Always carry the key and lock all doors when leaving the vehicle unattended.

Always try to park your vehicle in a well lit area.

Starting and driving

Steering wheel height adjustment

E00600700378

1. Release the tilt lock lever while holding the steering wheel up.
2. Adjust the steering wheel to the desired height.
3. Securely lock the steering wheel by pulling the tilt lock lever fully upward.

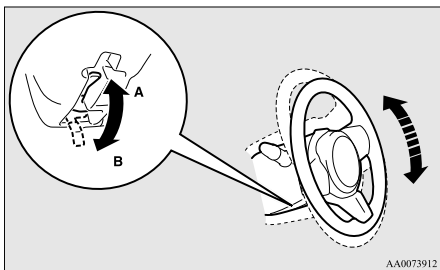

A- Locked
B- Release

⚠ WARNING

- Do not attempt to adjust the steering wheel while you are driving the vehicle.

Inside rear-view mirror

E00600800861

Adjust the rear-view mirror only after making any seat adjustments so you have a clear view to the rear of the vehicle.

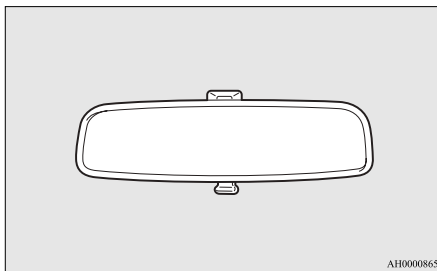

⚠ WARNING

- Do not attempt to adjust the rear-view mirror while driving. This can be dangerous. Always adjust the mirror before driving.

Adjust the rear-view mirror to maximize the view through the rear window.

To adjust the vertical mirror position

It is possible to move the mirror up and down to adjust its position.

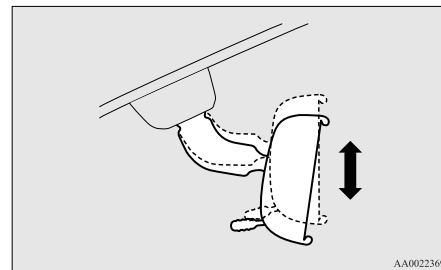

To adjust the mirror position

It is possible to move the mirror up/down and left/right to adjust its position.

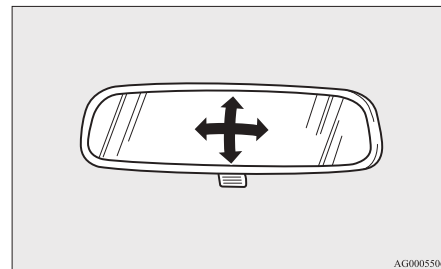

To reduce the glare

The lever (A) at the bottom of the mirror can be used to adjust the mirror to reduce the glare from the headlamps of vehicles behind you during night driving.

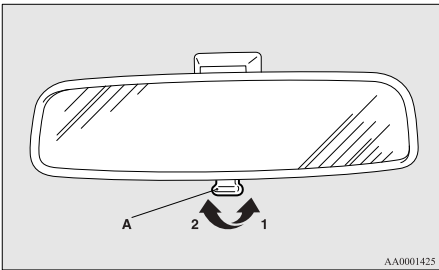

- 1- Normal
- 2- Anti-glare

Outside rear-view mirrors

E00600900501

To adjust the mirror position

The outside rear-view mirrors can be operated when the ignition switch is in the “ON” or “ACC” position.

⚠ WARNING

- Do not attempt to adjust the rear-view mirrors while driving. This can be dangerous. Always adjust the mirrors before driving.
- Your vehicle is equipped with convex type mirrors. Please take into consideration, objects you see in the mirror will look smaller and farther away compared to a normal flat mirror. Do not use this mirror to estimate distance of following vehicles when changing lanes.

1. Place the lever (A) to the same side as the mirror whose adjustment is desired.

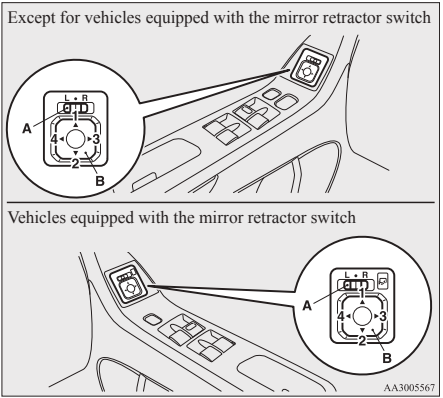

Except for vehicles equipped with the mirror retractor switch

Vehicles equipped with the mirror retractor switch

- L- Left outside mirror adjustment
- R- Right outside mirror adjustment

2. Press the switch (B) to the left, right, up or down to adjust the mirror position.

- 1- Up
- 2- Down
- 3- Right
- 4- Left

3. Return the lever (A) back to the middle position (●).

Retracting and extending the outside mirrors

E00618200415

The outside mirror can be folded in towards the side window to prevent damage when parking in narrow areas.

⚠ CAUTION

- Do not drive the vehicle with the mirror folded in. The lack of rearward visibility normally provided by the mirror could lead to an accident.

[Except for vehicles equipped with the mirror retractor switch]

Push the mirror towards the back of the vehicle with your hand to retract it in. When extending the mirror, pull it out towards the front of the vehicle until it clicks to lock in place.

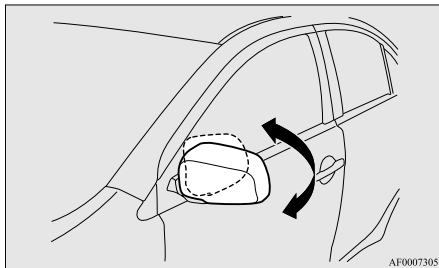

[For vehicles equipped with the mirror retractor switch]

Retracting and extending the mirrors using the mirror retractor switch

With the ignition switch in the “ON” or “ACC” position, push the mirror retractor switch to retract the mirrors. Push it again to extend the mirrors to their original positions.

After placing the ignition switch in the “LOCK” position, it is possible to retract and extend the mirrors using the mirror retractor switch for about 30 seconds.

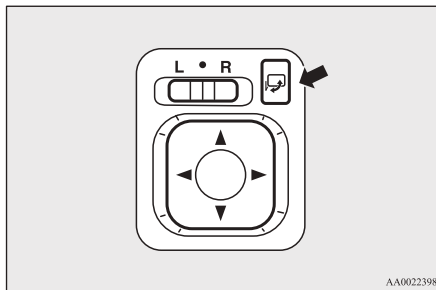

⚠ CAUTION

- It is possible to retract and extend the mirrors by hand. After retracting a mirror using the mirror retractor switch, however, you should extend it by using the switch again, not by hand. If you extended the mirror by hand after retracting it using the switch, it would not properly lock in position. As a result, it could move because of the wind or vibration while you are driving, taking away your rearward visibility.

NOTE

- Be careful not to get your hands trapped while a mirror is moving.

- If you move a mirror by hand or it moves after hitting a person or object, you may not be able to return it to its original position using the mirror retractor switch. If this happens, push the mirror retractor switch to place the mirror in its retracted position and then push the switch again to return the mirror to its original position.
- When freezing has occurred and mirrors fail to operate as intended, please refrain from repeated pushing of the retractor switch as this action can result in burn-out of the mirror motor circuits.

Retracting and extending the mirrors without using the mirror retractor switch

[Vehicles with keyless entry system]

The mirrors automatically retract or extend when the doors are locked or unlocked using the remote control switches of the keyless entry system.

Refer to “Keyless entry system” on page 1-04.

[Vehicles equipped with keyless operation system]

The mirrors automatically retract or extend when the doors are locked or unlocked using the remote control switches or the keyless operation function of the keyless operation system.

Refer to “Keyless operation system: To operate using the keyless operation function, Keyless entry system” on pages 1-09 and 1-04.

NOTE

- Functions can be modified as stated below. Consult a MITSUBISHI MOTORS Authorized Service Point.

- Automatically extend when the ignition switch is turned to the “ON” position, and automatically retract when the driver’s door is opened after the ignition switch is turned to the “OFF” position.
- Automatically extend when the vehicle speed reaches 30 km/h (19 mph).
- Deactivate the automatic extension function.

Heated mirror*

E00601200051

To demist or defrost the outside rear-view mirrors, press the rear window demister switch. The indication lamp (A) will illuminate while the demister is on. The heater will be turned off automatically in about 20 minutes.

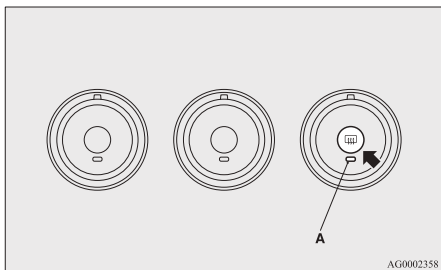

AG0002358

Ignition switch

E00601401946

[For vehicles equipped with the keyless operation system]

For information on operations for vehicles equipped with the keyless operation system, refer to “Keyless operation system: Ignition switch” on pages 1-11, 1-16.

[Except for vehicles equipped with the keyless operation system]

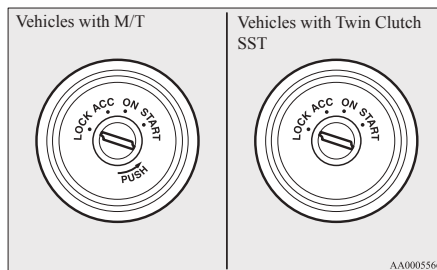

LOCK

The engine is stopped and the steering wheel locked. The key can only be inserted and removed in this position.

ACC

The engine is stopped, but the electric devices such as the radio and cigarette lighter can be operated.

ON

The engine is running, and all the vehicle’s electric devices can be operated.

START

The starter motor operates. After the engine has started, release the key and it will automatically return to the “ON” position.

NOTE

- Your vehicle is equipped with an electronic immobilizer. To start the engine, the ID code which the transponder inside the key sends must match the one registered in the immobilizer computer. Refer to “Electronic immobilizer (Anti-theft starting system)” on page 1-03.)

ACC power auto-cutout function

E00620300208

After about 30 minutes has elapsed with the ignition switch in the “ACC” position, the function automatically cuts out the power for the audio system and other electric devices that can be operated with that position.

When the ignition switch is turned from the “ACC” position, the power is supplied again to those devices.

NOTE

- It is possible to modify functions as follows:
 - The time until the power cuts out can be changed to approximately 60 minutes.
 - The ACC power auto-cutout function can be deactivated.

For details, we recommend you to consult a MITSUBISHI MOTORS Authorized Service Point.

Starting and driving

To remove the key

E0062040094

For vehicles with a M/T, when removing the key, push the key in at the “ACC” position and keep it depressed until it is turned to the “LOCK” position and remove it.

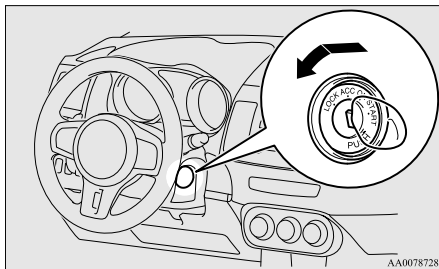

4

For vehicles with a Twin Clutch SST, when removing the key, first set the gearshift lever to the “P” (PARK) position, and then turn the key to the “LOCK” position and remove it.

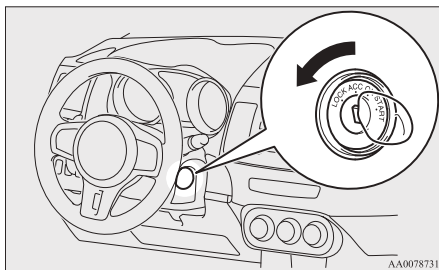

⚠ CAUTION

- Do not remove the ignition key from the ignition switch while driving. The steering wheel will be locked, causing loss of control.
- If the engine is stopped while driving, the brake servomechanism will cease to function and braking efficiency will deteriorate. Also, the power steering system will not function and it will require greater manual effort to operate the steering.
- Do not leave the key in the “ON” position for a long time when the engine is not running, doing so will cause the battery to be discharged.
- Do not turn the key to the “START” position when the engine is running, doing so could damage the starter motor.

Steering wheel lock

E00601500490

[For vehicles equipped with the keyless operation system]

For information on operations for vehicles equipped with the keyless operation system, refer to “Keyless operation system: Steering wheel lock” on pages 1-13, 1-17.

[Except for vehicles equipped with the keyless operation system]

To lock

Remove the key at the “LOCK” position. Turn the steering wheel until it is locked.

To unlock

Turn the key to the “ACC” position while moving the steering wheel slightly right and left.

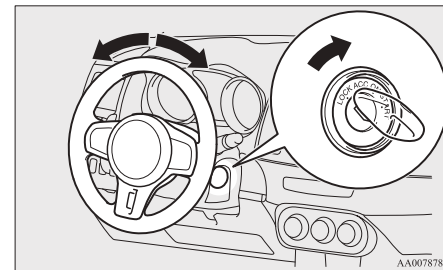

⚠ CAUTION

- Remove the key when leaving the vehicle. In some countries, it is prohibited to leave the key on the vehicle when parked.

Starting and stopping the engine

E00620600155

Tips for starting

- Do not operate the starter motor continuously longer than 10 seconds; doing so could run down the battery. If the engine does not start, turn the ignition switch back to “LOCK”, wait a few seconds, and then try again.
Trying repeatedly with the starter motor still turning will damage the starter mechanism.
- After starting the engine in cold weather, drive in a way that keeps the engine speed low until the bar graph of engine coolant temperature display starts to move (the engine speed decreases). Otherwise, the engine will not rev smoothly and the vehicle will move jerkily.
- On vehicles equipped with the Twin Clutch SST, the following may occur after the engine is started, but they do not indicate an abnormality.
 - You may hear operational sounds of the Twin Clutch SST and you may feel vibration in the vehicle body.
 - If you shift the gearshift lever into the “N” (NEUTRAL) position and depress the accelerator pedal, increases in the engine speed will be limited.

⚠ WARNING

- Never run the engine in a closed or poorly ventilated area any longer than is needed to move your vehicle in or out of the area. Carbon monoxide gases are odourless and can be fatal.

⚠ CAUTION

- Never attempt to start the engine by pushing or pulling the vehicle.
- Do not run the engine at high rpm or drive the vehicle at high speed until the engine has had a chance to warm up.
- Release the ignition key as soon as the engine starts to avoid damaging the starter motor.

Starting the engine

E00620700387

[For vehicles equipped with keyless operation system]

For information on operations for vehicles equipped with the keyless operation system, refer to “Keyless operation system: Starting” on pages 1-14, 1-17.

[Except for vehicles equipped with keyless operation system]

The starting procedure is as follows:

1. Insert the ignition key and fasten the seat belt.
2. Make sure the parking brake is applied.
3. Depress and hold the brake pedal.
4. Fully depress the clutch pedal (M/T).
5. On vehicles with M/T, place the gearshift lever in the “N” (Neutral) position.

Starting and driving

On vehicles with Twin Clutch SST, make sure the gearshift lever is in the “P” (PARK) position.

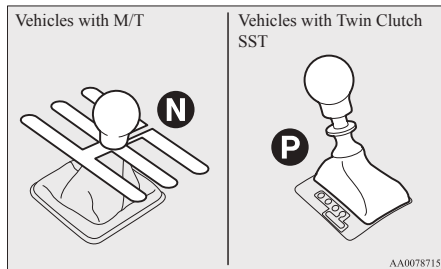

NOTE

- On vehicles with Twin Clutch SST, the starter will not operate unless the gearshift lever is in the “P” (PARK) position or the gearshift lever is in the “N” (NEUTRAL) position with the brake pedal depressed. For safety reasons, start the engine in the “P” (PARK) position so that the wheels are locked.
6. After turning the ignition key to the “ON” position, make certain that all warning lamps are functioning properly before starting the engine.
7. Turn the ignition key to the “START” position without depressing the accelerator pedal, and release it when the engine starts.

When it is difficult to start the engine

After several attempts, you may experience that the engine still does not start.

1. Make sure that all electric devices, such as lamps, air conditioning blower and rear window demister, are turned off.
2. While depressing the brake pedal on vehicles equipped with Twin Clutch SST or the clutch pedal on the vehicles equipped with manual transmission, press the accelerator pedal halfway and hold it there, then crank the engine. Release the accelerator pedal, immediately after the engine starts.
3. If the engine still will not start, the engine could be flooded with too much petrol. While depressing the brake pedal on vehicles equipped with Twin Clutch SST or the clutch pedal on the vehicles equipped with manual transmission, push the accelerator pedal all the way down and hold it there, then crank the engine for 5 to 6 seconds. Return the ignition switch to the “LOCK” position and release the accelerator pedal. Wait a few seconds, and then crank the engine again for 5 to 6 seconds while depressing the brake pedal or the clutch pedal, but do not push the accelerator pedal. Release the ignition key if the engine starts. If the engine fails to start, repeat these procedures. If the engine still will not start, we recommend you to have the vehicle checked.

Idling speed in high altitude area

E00623800015

At high altitude locations, the idling speed may be higher. This is done in order to stabilize the idling speed when the power steering system and other systems operate. It does not indicate a malfunction.

Stopping the engine

E00620800199

1. Bring the vehicle to a complete stop.

2. Fully engage the parking brake while depressing the brake pedal.
3. For vehicles with M/T, turn the ignition switch to the “LOCK” position to stop the engine, and then move the gearshift lever to the 1st (on a uphill) or “R” (Reverse) (on a downhill) position.
For vehicles with Twin Clutch SST, place the gearshift lever in the “P” (PARK) position, and then turn the ignition switch to the “LOCK” position to stop the engine.

NOTE

- For vehicles with Twin Clutch SST, the engine will stop and the vehicle power will turn off approximately 1 second after the ignition switch is turned to the “LOCK” position.

The reason for this is that, in the time from when the ignition switch is turned to the “LOCK” position until the engine stops, the gears inside the Twin Clutch SST disengage so that the engine will start smoothly the next time it is started.

Two clutches installed in the Twin Clutch SST alternately engage and disengage to achieve smooth shifting.

In addition, the gear on the side with the free clutch is engaged, therefore, quick shifting is performed.

If the engine was stopped with the gear engaged like this, it would provide resistance the next time the engine is started. Therefore, the gear disengages in the approximately 1-second period until the engine stops.

- For vehicles with Twin Clutch SST, do not operate the gearshift lever or the accelerator pedal for approximately 1 second until the engine stops.

- If the temperature inside the engine compartment is high, the cooling fans (A) will continue to operate for some time even if the engine is stopped.

Therefore, the operation sound of the cooling fans may be heard even after the engine is stopped. This sound is normal and does not indicate a malfunction.

After operating for a period of time, the cooling fans will stop automatically.

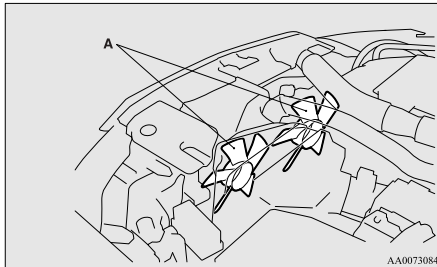

Turbocharger operation

E00611200038

⚠ CAUTION

- **Do not run the engine at high speeds (for example, by revving it or by accelerating rapidly) immediately after starting it.**
- **Do not stop the engine immediately after high-speed or uphill driving. First allow the engine to idle to give the turbocharger a chance to cool down.**

Turbocharger

The turbocharger increases engine power by pushing large amounts of air into the engine's cylinders. The finned parts inside the turbocharger turn at extremely high speeds and are subjected to extremely high temperatures. They are lubricated by engine oil and cooled by engine oil and coolant. If the engine oil is not replaced at the specified intervals, the bearings may seize or emit abnormal noise.

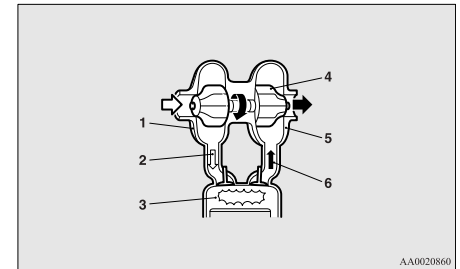

- 1- Air compressor
- 2- Compressed air
- 3- Cylinder
- 4- Turbo fin
- 5- Turbine
- 6- Exhaust gas

Starting and driving

Clutch pedal operation

E0061130039

Observe the following cautions when using the clutch pedal. Not observing them could result in rapid clutch wear or in clutch damage.

- Press the clutch pedal all the way down while shifting gears.
- Press and hold the clutch pedal all the way down before starting the engine.
- Do not rest your foot on the clutch pedal.
- On hills and other gradients, do not hold the vehicle in position by slipping the clutch without using the brakes.
- Make sure the space under the clutch pedal is free of objects that could obstruct the pedal.

⚠ CAUTION

- If the clutch is engaged suddenly while the engine revolution is high, an extremely large load will be applied instantaneously to the power train, possibly leading to the breakage of that component. Please ensure, therefore, that the clutch pedal is always applied in a slow yet firm manner. Your vehicle has a special feature to protect the power train from damage; the engine is controlled in such a way that excessive increase in engine revolution is prevented in situations where the accelerator pedal is depressed while the vehicle is stationary and the clutch pedal has been depressed.

NOTE

- If either of the following occurs, we recommend you to have the clutch inspected.
 - The pedal stroke until clutch disengagement suddenly increases.
 - The engine revs when the clutch is not disengaged.

Manual transmission*

E00602000421

The shift pattern is shown on the gearshift lever knob. Be sure to always fully depress the clutch pedal before attempting to shift the lever.

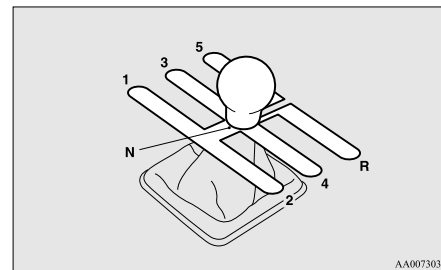

⚠ CAUTION

- Do not move the gearshift lever into reverse while the vehicle is moving forward; doing so will damage the transmission.
- Do not rest your foot on the clutch pedal while driving as this will cause premature clutch wear or damage.

NOTE

- During cold weather, shifting may be difficult until the transmission lubricant has warmed up. This is normal and not harmful to the transmission.

- If it is hard to shift into 1st, depress the clutch pedal again; the shift will then be easier to make.
- To shift into reverse from 5th gear, move the gearshift lever to the “N” (Neutral) position, and then shift it into reverse.
- In hot weather and/or when the vehicle is continuously driven at high speeds for a long time, the vehicle’s maximum speed may automatically be restricted to about 220 km/h (137 mph). The speed restriction is a protective control function that limits temperature increases in the manual transmission oil. It is not abnormal.

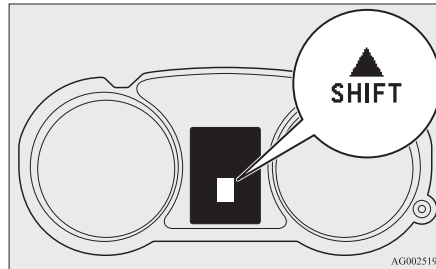

Changing gears while the vehicle is moving

E00610600282

Always take care to change the gear with the vehicle speed matched to the engine speed. Proper shifting will improve fuel economy and prolong engine life.

Avoid shifting down at high speed, as this may cause excessive engine speed (the tachometer needle into the red zone) and damage the engine.

NOTE

- The gearshift indicator shows recommended gearshift points for fuel-efficient driving. It shows a “▲” when an upshift is recommended, and it shows a “▼” when a downshift is recommended.

Starting and driving

Possible driving speed

E00610800763

Avoid shifting down at high speed, as this may cause excessive engine speed (the tachometer needle into the red zone) and damage the engine.

Shift point	Speed limit
1 st gear	60 km/h (37 mph)
2 nd gear	90 km/h (56 mph)
3 rd gear	120 km/h (74 mph)
4 th gear	160 km/h (99 mph)

Use 5th gear whenever vehicle speed allows, for maximum fuel economy.

Twin Clutch SST (Sport Shift Transmission)*

E00620900086

The Twin Clutch SST is a transmission that, through integrated control of the engine and transmission, is able to achieve both the smooth shifting of an automatic transmission and the acceleration and fuel economy close to a manual transmission. In addition, the control mode can be selected from three types to suit the driving conditions. Together with manual shifting, the transmission is capable of responding to a variety of driving circumstances.

Twin Clutch SST control mode → p. 4-19
Manual shift → p. 4-21

Gearshift lever operation



E00621000198

The Twin Clutch SST has 6 forward gears and 1 reverse gear. The individual gears are selected automatically, depending on the position of the gearshift lever, the speed of the vehicle and the position of the accelerator pedal.

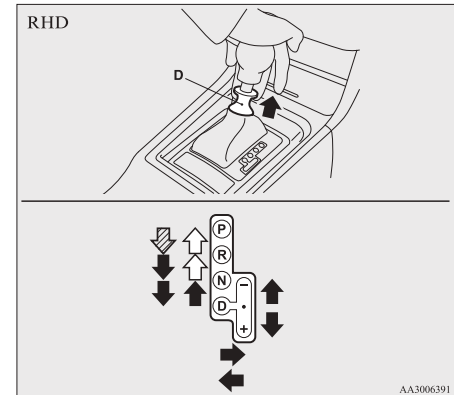
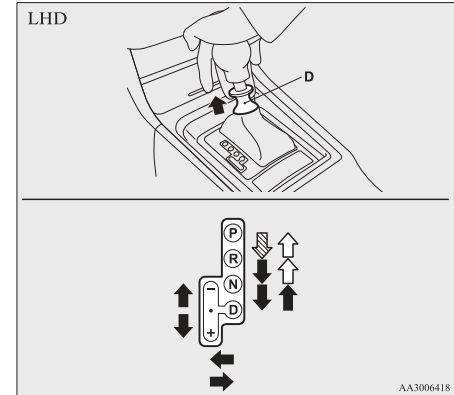
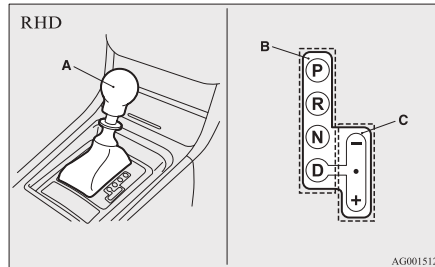
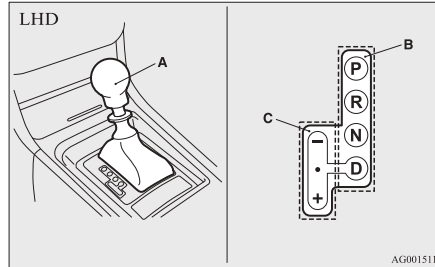
The gearshift lever (A) has 2 gates; the main shift gate (B) and the manual shift gate (C).



Starting and driving

	The pull-ring (D) must be pulled up while the brake pedal is depressed to move the gearshift lever.
	The pull-ring (D) must be pulled up to move the gearshift lever.
	The pull-ring (D) need not be pulled up to move the gearshift lever.

WARNING

- If the pull-ring is always pulled up to operate the gearshift lever, the lever may be accidentally shifted into the “P” (PARK) or “R” (REVERSE) position. Be sure not to pull up the pull-ring when performing the operations indicated by  in the illustration.
- Always depress the brake pedal when shifting the gearshift lever into the other position from the “P” (PARK) or “N” (NEUTRAL) position.
Never put your foot on the accelerator pedal while shifting the gearshift lever from the “P” (PARK) or “N” (NEUTRAL) position.

NOTE

- If the brake pedal is not depressed and held, the shift-lock device activates to prevent the gearshift lever from being moved from the “P” (PARK) position.
- Do not accelerate immediately after moving the gearshift lever. It may take some time for the transmission to shift to the selected gear.

- When the gearshift lever is operated while the Twin Clutch SST fluid temperature is low, the time required to shift to the selected gear may be longer than usual.

Gearshift lever position display

E00621100274

When the ignition switch is turned to the “ON” position, the position of the gearshift lever is indicated in the multi-information display.

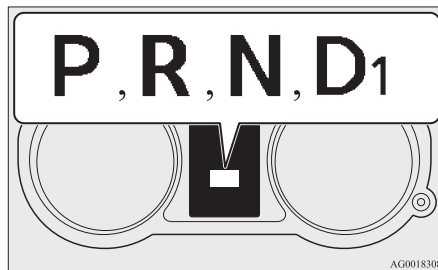

In addition, when the vehicle is driven with the gearshift lever in the “D” (DRIVE) position, the forward gear number is shown.

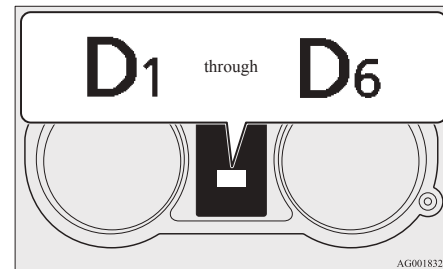

If the gearshift lever position display blinks and the buzzer beeps

E00627100159

With the gearshift lever in the “R” (REVERSE) position, if the gearshift lever position display  blinks and the buzzer beeps, the transmission gears have not properly engaged. To correct this situation, the following procedure must be performed.

1. Depress the brake pedal with your right foot and place the gearshift lever in the “N” (NEUTRAL) position.
2. Again place the gearshift lever in the “R” (REVERSE) position and confirm that the gearshift lever position display has stopped blinking and that the buzzer has stopped beeping.
3. Repeat 1 and 2 above if the gearshift lever position display continues to blink and the buzzer beeps.

WARNING

- To avoid unintended vehicle movement when the gearshift lever position display **R** blinks and the buzzer beeps, keep brake pedal applied with your right foot and do not depress the accelerator pedal.

If the gearshift lever position display is not showing

E00627200017

There may be a problem in the Twin Clutch SST. If this occurs, the safety device operates and prevents the vehicle from moving. Perform the following procedure.

1. Park your vehicle in a safe place and stop the engine.
2. Restart the engine.

If the gearshift lever position display is shown and the vehicle can move after this procedure is performed, there is no malfunction.

If the gearshift lever position display is not shown and the vehicle cannot move, or if this problem occurs repeatedly, have the vehicle checked by a MITSUBISHI MOTORS Authorized Service Point as soon as possible.

Gearshift lever positions (Manual shift gate)

E00621200099

“P” PARK

This position locks the transmission to prevent the vehicle from moving. The engine can be started in this position.

“R” REVERSE

This position is to back up.

CAUTION

- Never shift into the “P” (PARK) or “R” (REVERSE) position while the vehicle is in motion to avoid a transmission damage.

“N” NEUTRAL

At this position the transmission is disengaged. It is the same as the neutral position on a M/T, and should only be used when the vehicle is stationary for an extended length of time during driving, such as in a traffic jam.

WARNING

- Never move the gearshift lever to the “N” (NEUTRAL) position while driving. A serious accident could occur since you could accidentally move the lever into the “P” (PARK) or “R” (REVERSE) position or you will lose engine braking.
- On a gradient the engine should be started in the “P” (PARK) position. Although the engine can be started when the vehicle is in the “N” (NEUTRAL) position if the brake pedal is depressed, for safety reasons, do not start the engine in the “N” (NEUTRAL) position.
- Always keep your right foot on the brake pedal when shifting into or out of “N” (NEUTRAL), to minimise the risk of loss of control.

“D” DRIVE

This position is for normal driving. The transmission automatically selects a suitable gear ratio for your speed and acceleration.

Engine braking is automatically applied when necessary, depending on road conditions.

CAUTION

- Never shift into the “D” (DRIVE) position from the “R” (REVERSE) position while the vehicle is in motion to avoid a transmission damage.

NOTE

- When the engine is cold, upshifts occur at a higher vehicle speed than when the engine is warm.

This control is performed to quickly warm up the engine. It does not indicate a malfunction. After the vehicle has been driven for a while, upshifts will occur at the regular engine speeds.

Twin Clutch SST control mode



E00621300205

Select the control mode from the following three types to suit the driving conditions.

Starting and driving

Twin Clutch SST control mode	Characteristic
NORMAL (Control mode when engine is started)	Control mode for normal driving on local roads, expressways, and the like. Smooth shifting is performed at low engine speeds for economical driving with good ride quality.
SPORT	Control mode for driving on mountain roads, roads with uphill and downhill slopes, and expressways with long downhill slopes where engine braking is necessary. Compared to “Normal” mode, shifting occurs at higher engine speeds and is quicker. In addition, quick downshifting is possible when the accelerator pedal is depressed for quick acceleration or when the brakes are applied.
S-Sport (Super Sport)	In the “S-Sport” mode, shifting occurs at higher engine speeds and is even quicker than in the “Sport” mode. “S-Sport” mode is designed to be used while driving on closed circuit tracks. Do not use this mode on public roads.

NOTE

- Damage to your vehicle caused by racing and/or driving on closed circuit tracks will not be covered under warranty. Please review the “Service booklet: NEW VEHICLE LIMITED WARRANTY”.
- When continuously driving on closed circuit tracks or at other locations where the engine is operated at high speeds and under a heavy load, the Twin Clutch SST fluid temperature will have a tendency to rise. In this case, if the temperature rises too high, both “SLOW DOWN” and the  warning display will appear on the information screen in the multi-information display to alert the driver. If the  warning display appears, be sure to refer to “Warning display” on page 4-23 and follow the appropriate measures.
- The Twin Clutch SST control mode can be selected both when “D” range operation is selected and when manual shifting is selected.
- If you select “Sport” mode or “S-Sport” mode while the engine is cold, the transmission may shift up at different speeds compared to that when the engine is warm. This is simply the operation of the control system to warm the engine quickly. It does not indicate a malfunction.
- For slippery road surfaces, such as roads with accumulated snow, “Normal” mode is recommended for smooth shifting at low engine speeds.

Twin Clutch SST control mode switch

E00621400192

When the ignition switch is set to the “ON” position, operate the Twin Clutch SST control mode switch (A) to change the control mode.

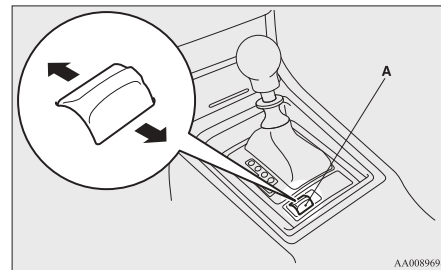

When the engine is started, the control mode is automatically set to the “Normal” mode. Use the following procedures to change the control mode.

To shift from “Normal” mode to “Sport” mode

While the vehicle is stopped or being driven, push the Twin Clutch SST control mode switch forward.

To shift from “Sport” mode to “S-Sport” mode

While the vehicle is stopped, push the Twin Clutch SST control mode switch forward and hold it for 3 seconds or more.



CAUTION

- For safety reasons, shift from the “Sport” mode to the “S-Sport” mode only when the vehicle is stopped.

To shift from “S-Sport” mode to “Sport” mode or

To shift from “Sport” mode to “Normal” mode
While the vehicle is stopped or being driven, push the Twin Clutch SST control mode switch rearward.

NOTE

- If the Twin Clutch SST control mode switch is continuously pushed after a control mode has been selected, an erroneous operation prevention function operates and the control mode is automatically set to the “Normal” mode.

If you would like to select a control mode again, return the ignition switch to the “ACC” or “LOCK” position and restart the engine. Then, push the Twin Clutch SST control mode switch.

Twin Clutch SST control mode display

When the ignition switch is set to the “ON” position, the currently selected control mode is displayed on the multi-information display.

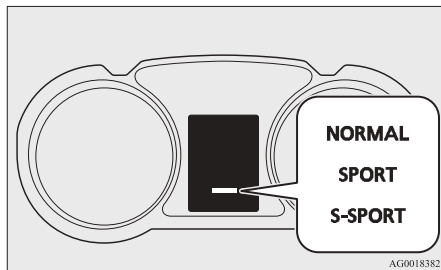

Manual shift

E00621600208

Using the gearshift lever (A) or the shift paddles (B), shifting can be performed manually.

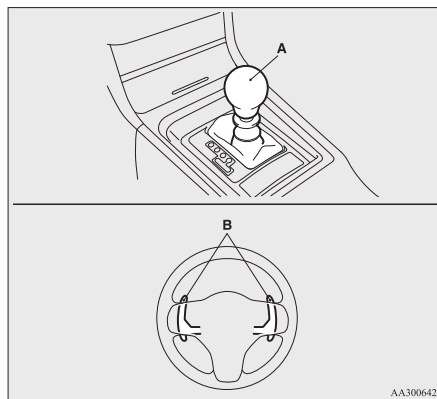

Shifting can be performed even while the accelerator pedal is depressed.

This allows the driver to enjoy sporty driving, such as quick cornering, by nimbly downshifting to reduce vehicle speed just before entering a curve.

CAUTION

- When manually shifting while the vehicle is being driven, select the correct shift position to control the engine speed so that the tachometer indicator does not enter the red zone.

CAUTION

- Sudden engine braking and rapid acceleration can cause the vehicle to skid. Shift down according to road conditions and vehicle speed.
- If both the left and right shift paddles are operated at the same time, the transmission may not change gears.

NOTE

- Only the forward gears 1 to 6 can be selected.
To reverse or park, place the gearshift lever in the “R” (REVERSE) or “P” (PARK) position.
- During manual shifting, downshifting will be performed automatically when the vehicle slows down and the transmission will downshift to 1st gear before the vehicle stops.
- If the gearshift lever or shift paddles are operated repeatedly, the transmission will also shift repeatedly.
- In order to ensure driving performance, upshifting may not occur depending on the vehicle speed even if the gearshift lever or shift paddles are operated. In addition, in order to prevent excessive engine speed, the buzzer sounds and downshifting may not occur depending on the vehicle speed even if the gearshift lever or shift paddles are operated.
- When driving in an aggressive manner involving high engine rpm, sudden acceleration and/or deceleration, the Twin Clutch SST could take longer to shift due to higher fluid temperatures.

Starting and driving

Shifting using the gearshift lever

E00621700023

Selecting manual shifting

While the vehicle is stopped or being driven, move the gearshift lever from the “D” (DRIVE) position in the main shift gate towards the driver’s seat to select manual shifting.

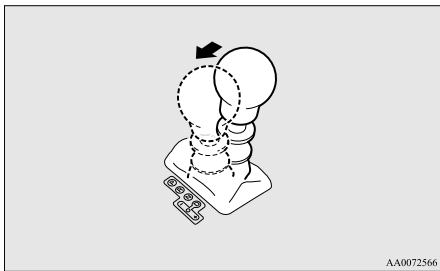

4

Shifting up and shifting down

Each time the gearshift lever is pulled rearward, the transmission shifts up 1 gear. In addition, each time the gearshift lever is pushed forward, the transmission shifts down 1 gear.

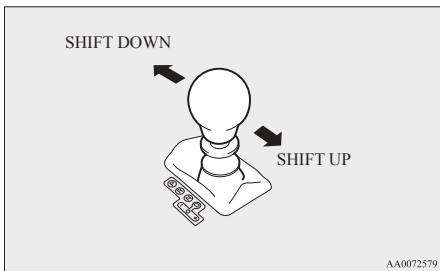

NOTE

- After manual shifting is selected using the gearshift lever, shifting up and down can also be performed using the shift paddles.

Returning to “D” range operation

Move the gearshift lever towards the front passenger’s seat to return to “D” range operation.

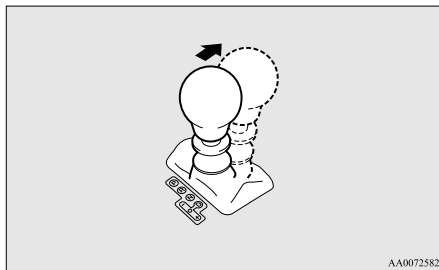

NOTE

- When the gearshift lever is moved to the “D” (DRIVE) position from the manual shift gate, it may automatically select a gear different from the gear selected during manual shifting depending on vehicle speed or driving conditions.

Shifting using the shift paddles

E00621800138

Selecting manual shifting

While the vehicle is stopped or being driven with the gearshift lever in the “D” (DRIVE) position, manual shifting can be selected by pulling one of the shift paddles towards you.

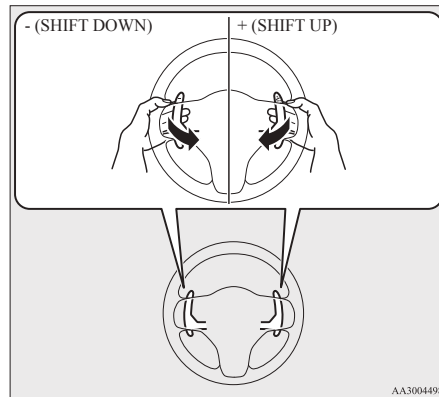

Shifting up

Each time the + (SHIFT UP) shift paddle is pulled, the transmission shifts up 1 gear.

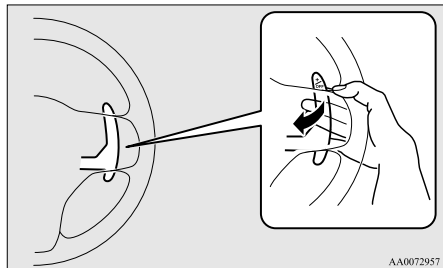

AA0072957

Shifting down

Each time the - (SHIFT DOWN) shift paddle is pulled, the transmission shifts down 1 gear.

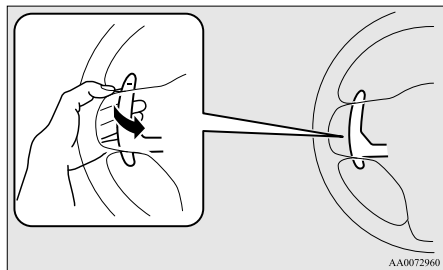

AA0072960

NOTE

- After manual shifting is selected using the shift paddles, shifting up and down can also be performed using the gearshift lever.

Returning to “D” range operation

When the gearshift lever is in the “D” (DRIVE) position, pull the + (SHIFT UP) shift paddle towards you for 2 seconds or more to return to “D” range operation.

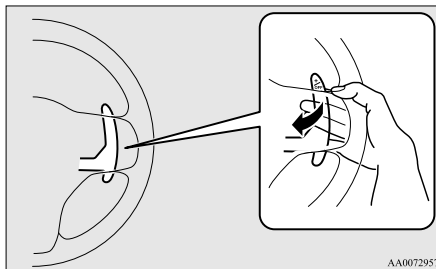

AA0072957

NOTE

- If manual shifting is selected using the shift paddles when the gearshift lever is in the “D” (DRIVE) position, the transmission will automatically return to “D” range operation before the vehicle stops.
- When the transmission returns to “D” range operation from manual shifting, it may automatically shift up or down from the gear selected using manual shifting depending on the vehicle speed or driving conditions.
- If manual shifting is selected using the shift paddles, “D” range operation will again be selected by moving the gearshift lever from the “D” (DRIVE) position towards the driver’s seat, then return it towards the front passenger’s seat.

Manual shift display

E00623500113

In manual shift, the currently selected gear is displayed on the multi-information display.

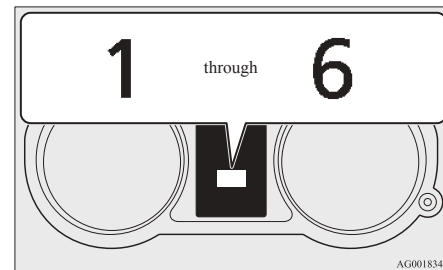



AG0018340

Warning display

E00626700132



When the  warning display or the  warning display appears on the information screen in the multi-information display while you are driving, take the following measures.

When  warning display is showing

E00626800146

The temperature of the Twin Clutch SST fluid is high.

If this occurs, take one of the following measures.

- Reduce the vehicle speed.
- Stop the vehicle in a safe place, place the gearshift lever in the “P” (PARK) position, and then open the bonnet with the engine running to cool the engine.

Starting and driving

After a while, check that the  warning display has gone out. If the display goes out, the vehicle can be driven normally. If the warning display remains on or comes on frequently, have the vehicle checked by a MITSUBISHI MOTORS Authorized Service Point.

CAUTION

- If the  warning display is shown, such as when the vehicle does not accelerate while traveling even if the accelerator pedal is depressed, the vehicle may not be able to be driven normally. For safety, pay attention to your surroundings when driving the vehicle.

4

NOTE



- If the vehicle is continuously driven on hilly roads or in a sporty manner, the vehicle may vibrate. This vibration is to alert the driver that the Twin Clutch SST fluid temperature has risen. It does not indicate a malfunction. If this occurs, perform the same measures for when the  warning appears. If the vibration stops, the vehicle can be driven normally.

If vehicle is driven with warning displayed

If the vehicle continues to be driven after the  warning display and “SLOW DOWN” appear, and the temperature of the Twin Clutch SST fluid continues to rise, the transmission protection control may operate and cause the transmission to function as if the gearshift lever was in the “N” (NEUTRAL) position.

(At this time, the vehicle temporarily cannot be driven.)

If this occurs, take the following measures.

1. Depress the brake pedal and stop the vehicle in a safe place.
2. Place the gearshift lever in the “P” (PARK) position, and then open the bonnet with the engine running to cool the engine.
3. After a while, check that the  warning display has gone out, and then stop the engine if the  warning display has gone out.
4. If the engine can be restarted, the vehicle can be driven normally.

If the warning display remains on or comes on frequently, have the vehicle checked by a MITSUBISHI MOTORS Authorized Service Point.

When warning display is showing

E00626900020

A safety device in the Twin Clutch SST has been activated due to a possible malfunction in the Twin Clutch SST or in the engine electronic control module.

If this occurs, perform the following procedure.

1. Park your vehicle in a safe place and stop the engine.
2. Restart the engine.

If the  warning display goes out, there is no abnormal condition.

If the warning display remains on or comes on frequently, have the vehicle checked by a MITSUBISHI MOTORS Authorized Service Point as soon as possible.

CAUTION

- If the  warning display is shown, such as when the vehicle does not accelerate while traveling even if the accelerator pedal is depressed, the vehicle may not be able to be driven normally. For safety, pay attention to your surroundings when driving the vehicle.

Operation of the Twin Clutch SST

E00622000081

CAUTION

- Before selecting a position with the engine running and the vehicle stationary, fully depress the brake pedal to prevent the vehicle from creeping. The vehicle will begin to move as soon as the Twin Clutch SST is engaged, the brakes should only be released when you are ready to drive away.
- Depress the brake pedal with the right foot at all times. Using the left foot could cause driver movement delay in case of an emergency.
- To prevent sudden acceleration, never race the engine when shifting from the “P” (PARK) or “N” (NEUTRAL) position.
- Operating the accelerator pedal while the other foot is resting on the brake pedal will affect braking efficiency and may cause premature wear of brake pads.

⚠ CAUTION

- Use the gearshift lever in the correct shift position in accordance with driving conditions.
Never coast downhill backward with the gearshift lever in the “D” (DRIVE) or manual shifting position or coast forward with the gearshift lever in the “R” (REVERSE) position.
The engine may stop and the unexpected increase in brake pedal effort and steering wheel weight could lead to an accident.
- Do not race the engine with brake pedal pressed when the vehicle is stationary. This can cause sudden acceleration and damage the Twin Clutch SST.
Also, when you depress the accelerator pedal while holding down the brake pedal with the gearshift lever in the “D” (DRIVE) position, the engine revolutions may not rise as high as when performing the same operation with the gearshift lever in the “N” (NEUTRAL) position.

Passing acceleration

E00622100011

To gain extra acceleration in “D” (DRIVE) position push the accelerator to the floor. The Twin Clutch SST will automatically downshift.

NOTE

- In manual shift, downshifts do not take place when the accelerator is depressed all the way to the floor.

Uphill/downhill driving

E00622200168

DRIVING UPHILL



The Twin Clutch SST may not upshift to a higher shift position if the computer determines the current speed cannot be maintained once a higher shift position is engaged.

For smoother vehicle performance, if you release the throttle while climbing a steep grade, the Twin Clutch SST may not upshift. This is normal, as the computer is temporarily preventing shifting. After reaching the top of the hill, normal shift function will resume.

⚠ CAUTION

- Do not use the tendency of the vehicle to creep forward in order to drive at low speeds up hills.
The transmission may be damaged and an accident may occur due to the following conditions.
 - The Twin Clutch SST fluid temperature will rise and can cause transmission damage.

⚠ CAUTION

- If the vehicle is continuously driven at low speeds using the tendency of the vehicle to creep forward, the vehicle will vibrate or “SLOW DOWN” and the  warning display will appear on the information screen in the multi-information display to alert the driver that the Twin Clutch SST fluid temperature has risen.
After that, if the Twin Clutch SST fluid temperature rises even higher, the transmission protection control will operate.
If this occurs, the vehicle may suddenly reverse as if the gearshift lever was in the “N” (NEUTRAL) position and cause an accident.
If the  warning display appears or the transmission protection control operates, refer to “When  warning display is showing” on page 4-23.

DRIVING DOWNHILL

When travelling down steep grades, the computer may automatically select a lower shift position. This function assists engine braking efforts, reducing the need for using the service brakes.

Waiting

E00622300156

For short waiting periods, such as at traffic signals, the gearshift lever can be left in position and the vehicle held stationary with the service brake.

Starting and driving



For longer waiting periods with the engine running, place the gearshift lever in the “N” (NEUTRAL) position and apply the parking brake, while holding the vehicle stationary with the service brake.

CAUTION

- Do not keep the vehicle in a stopped position on an uphill slope by depressing the accelerator pedal instead of the brake pedal. The transmission may be damaged and an accident may occur due to the following conditions.
 - The Twin Clutch SST fluid temperature will rise and can cause transmission damage.

4

CAUTION

- If the vehicle is kept in a stopped position by depressing the accelerator pedal instead of the brake pedal, the vehicle will vibrate or “SLOW DOWN” and the  warning display will appear on the information screen in the multi-information display to alert the driver that the Twin Clutch SST fluid temperature has risen. After that, if the Twin Clutch SST fluid temperature rises even higher, the transmission protection control will operate. If this occurs, the vehicle may suddenly reverse as if the gearshift lever was in the “N” (NEUTRAL) position and cause an accident. If the  warning display appears or the transmission protection control operates, refer to “When warning display is showing” on page 4-23.

Parking

E00622400014

To park the vehicle, first bring it to a complete stop, fully engage the parking brake, and then move the gearshift lever to the “P” (PARK) position.

If you are going to leave the vehicle unattended, always switch off the engine and carry the key.

NOTE

- On a slope, be sure to apply the parking brake before moving the gearshift lever to the “P” (PARK) position. If you move the gearshift lever to the “P” (PARK) position before applying the parking brake, it may be difficult to disengage the gearshift lever from the “P” (PARK) position when next you drive the vehicle, requiring application of a strong force to the gearshift lever to move from the “P” (PARK) position.

What to do if the following occur with the Twin Clutch SST

E00622500204

If there is a malfunction in the Twin Clutch SST or engine electronic control module, the following may occur.

- Twin Clutch SST does not shift.
- Vehicle cannot move.
- Twin Clutch SST acceleration is slow.
- Vehicle does not creep.
- “Shift shock” is large.
- Shifting occurs at higher engine speed.
- Response is slow.

If any of these occurs, perform the following procedure.

When warning display is showing

The temperature of Twin Clutch SST fluid is high. Refer to “Warning display” on page 4-23 and follow the appropriate measures.

When the check engine warning lamp comes on or blinking

There could be a malfunction in the engine electronic control module.

Full-time 4WD

E00604900192

Full-time 4WD vehicles are propelled by engine power distributed constantly and appropriately to all 4 wheels.

Not only does this ensure better handling on dry, paved roads but also permits better traction when driving on slippery, wet or snow-covered roads and when moving out of mud.

These vehicles, however, are not designed for off-road use, and are unsuitable for driving on bumpy ground that may cause excessive strain. Full-time 4WD vehicles should be driven only under the same conditions as are suitable for ordinary front-wheel drive vehicles.

Refer to “Check engine warning lamp” on page 3-34 and follow the appropriate measures.

When the gearshift lever position display is not showing

A safety device in the Twin Clutch SST has been activated due to a possible malfunction in the Twin Clutch SST.

Refer to “If the gearshift lever position display is not showing” on page 4-19 and follow the appropriate measures.

When  warning display is showing or when no warning is showing in the multi-information display

A safety device in the Twin Clutch SST has been activated due to a possible malfunction in the Twin Clutch SST or in the engine electronic control module.

Perform the following procedure.

1. Park your vehicle in a safe place and stop the engine.
2. Restart the engine.

If the vehicle moves and accelerates normally after this procedure is performed, there is no malfunction.

However, if the vehicle does not move or accelerate normally, or if this problem occurs repeatedly, have the vehicle checked by a MITSUBISHI MOTORS Authorized Service Point as soon as possible.

 CAUTION

- **When the Twin Clutch SST fluid temperature is high, the engine idle speed when the vehicle is stopped may increase or the vehicle will have a weak tendency to creep. After that, if the Twin Clutch SST fluid temperature rises even higher, the  warning display will appear.**

Starting and driving

Cautions on handling of 4-wheel drive vehicles

E00606800687

Tyres and wheels

Since the driving torque can be applied to the 4 wheels, the performance of the vehicle when operating in 4-wheel drive is greatly affected by the condition of the tyres.

Pay close attention to the tyres.

- Install specified tyres on all wheels. Refer to the “Tyres and wheels” on page 9-09.
- Be sure to fit all four tyres and wheels of the same size and type.
When replacement of any of the tyres or wheels is necessary, replace all of them.
- All tyres should be rotated whenever the wear difference between the front and rear tyres is recognizable.

Good vehicle performance cannot be expected if there is a difference in wear between tyres. Refer to the “Tyre rotation” on page 8-11.

- Check the tyre inflation pressure regularly.

⚠ CAUTION

- Always use tyres of the same size, same type, and same brand, and which have no wear differences.
Using the tyres of different size, type, brands or the degree of wear, will increase the differential oil temperature, resulting in possible damage to the driving system. Further, the drive train will be subjected to excessive loading, possibly leading to oil leakage, component seizure, or other serious faults.

Towing

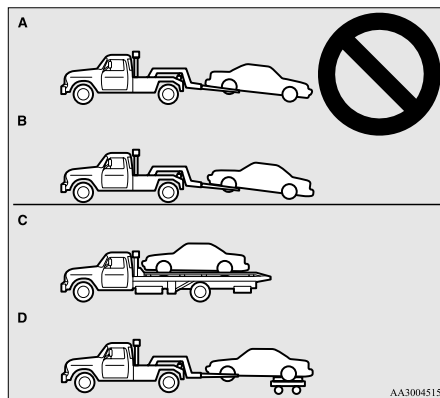

⚠ CAUTION

- Do not tow 4WD vehicles with the front or rear wheels on the ground (Type A or Type B) as illustrated. This could result in damage to the vehicle’s driving system or the vehicle could jump at the carriage. If you tow 4WD vehicles, use Type C or Type D equipment.

Jacking up a 4-wheel drive vehicle

⚠ WARNING

- Do not crank the engine while jacking up the vehicle.
The tyre on the ground may turn and the vehicle may roll off the jack.

S-AWC (Super-All Wheel Control)

E00622600032

S-AWC is an integrated vehicle dynamics control system that helps enhance driving performance, cornering performance, and vehicle stability over a wide range of driving conditions through integrated management of the ACD (Active centre differential system), the AYC (Active yaw control system), the anti-lock brake system (ABS) and the Active Stability Control (ASC).

Please read this section in conjunction with the following sections.

ACD (Active centre differential system) → p. 4-29

AYC (Active yaw control system) → p. 4-29

Anti-lock brake system (ABS) → p. 4-32

Active stability control (ASC) → p. 4-33

CAUTION

- Do not over-rely on the S-AWC. Even the S-AWC cannot prevent the natural laws of physics from acting on the vehicle. This system, like any other system, has limits and cannot help you to maintain traction and control of the vehicle in all circumstances. Reckless driving may lead to accidents. It is the driver's responsibility to drive carefully. This means taking into account the traffic, road and environmental conditions.

CAUTION

- Be sure to use tyres that are the same specified size, type, and brand, and have no difference in the amount of wear for all four wheels. Otherwise, the S-AWC may not work properly.

ACD (Active centre differential system)

E00622700033

The ACD is a system that improves acceleration performance and straight-ahead stability by regulating the differential limiting action and power drive distribution of the centre differential.

NOTE

- If the parking brake lever is pulled up while the vehicle is moving, the centre differential is designed to switch to a free state condition which will allow the rear wheel to lock easier.

AYC (Active yaw control system)

E00622800034

The AYC is a system, with a left-right differential limiting function and yaw control function, that enhances cornering performance and stability during cornering by controlling the left-right drive power difference of the rear wheels, the braking force of all four wheels, and the vehicle yaw moment.

CAUTION

- Control of the braking force does not enhance the stopping performance of the vehicle, therefore, pay careful attention to the safety of your surroundings when driving.

Left-right differential limiting function

The left-right differential limiting function is a function that enhances driving performance and vehicle stability by preventing idle spinning of a wheel when driving on slippery road surfaces or when the road surfaces of the left and right wheels are different.

Yaw control function

The yaw control function is a function that enhances vehicle cornering performance by controlling the drive power difference of the left and right wheels and the braking force when the vehicle does not turn in response to steering input, such as when the steering wheel is turned quickly or when driving on slippery road surfaces.

S-AWC control mode

E00623000121

Select the control mode from the following three types to suit the driving conditions.

S-AWC control mode	Operation
TARMAC	Normally, use this control mode. Use this mode for paved roads.

Starting and driving

S-AWC control mode	Operation
GRAVEL	Use this control mode when driving on somewhat slippery road surfaces, such as wet road surfaces and gravel roads.
SNOW	Use this control mode when driving on slippery road surfaces, such as snow-covered roads.

S-AWC control mode switch

When the ignition switch is set to the “ON” position, operate the AWC switch to change the control mode.

4

Except for vehicles with steering wheel audio remote control switches

Push the switch down to change the control mode in the order “TARMAC” → “GRAVEL” → “SNOW” or push it up to change the control mode in the order “SNOW” → “GRAVEL” → “TARMAC”.

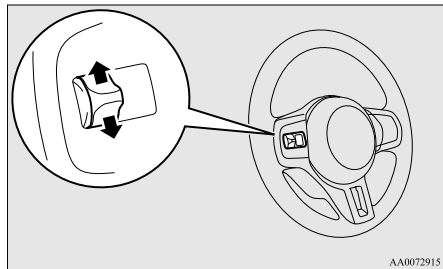

AA0072915

Vehicles with steering wheel audio remote control switches

Each time the switch is pushed, the control mode changes in the order “TARMAC” → “GRAVEL” → “SNOW” → “TARMAC”.

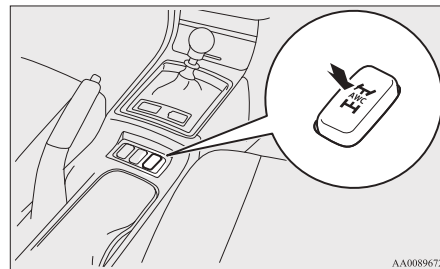

AA0089672

NOTE

- The control mode can be changed while the vehicle is moving.
- The selected control mode is stored in memory even if the engine is stopped. However, if a battery terminal is disconnected, the control mode stored in memory will be erased and the control mode will be set to the “TARMAC” mode.

S-AWC control mode display

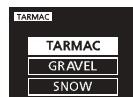

Example: “TARMAC” mode is selected.

The currently selected control mode is displayed on the multi-information display.

In addition, when the control mode is changed, the selected mode appears on the interrupt display screen of the information screen in the multi-information display.

The control mode display will appear on the information screen for a few seconds, and then the original screen will return.

CAUTION

- The S-AWC control mode display may flash under aggressive driving conditions. At this time, S-AWC control is temporarily suspended in order to protect the S-AWC device, but this will not affect normal driving. After the vehicle is driven for a while, if the S-AWC control mode display remains on, the S-AWC control will start operating again.

S-AWC operation display

E00623100122

The S-AWC operation status can be displayed on the information screen in the multi-information display.

To display the status, press the multi-information meter switch to change the information screen.

Refer to “Information screen (when the ignition switch is “ON”)” on page 3-08.

Display example

The S-AWC operation status is displayed.

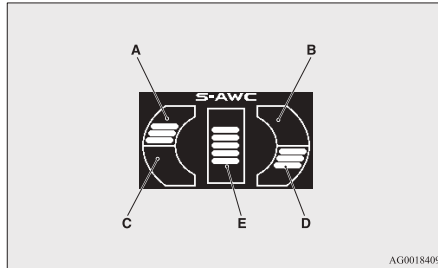
**AYC operation display**

The amount of the yaw moment added by AYC is displayed as a bar graph.

- A, D- Clockwise yaw moment about the vehicle's centre of gravity
- B, C- Anticlockwise yaw moment about the vehicle's centre of gravity

ACD operation display

The strength of the differential limiting action (centre differential) of the ACD is displayed in section (E) of the meter as a bar graph.

⚠ WARNING

- Always concentrate on your driving first. Keep your eyes and mind on the road. Distractions while driving can lead to an accident.



S-AWC warning display

E00623200093

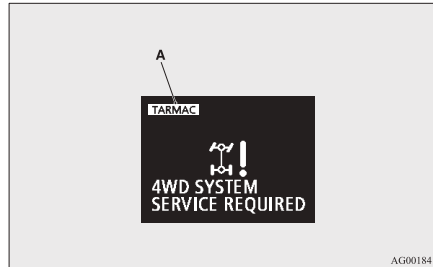
When there is a malfunction in the system, the  warning display will appear on the information screen in the multi-information display. In addition, the S-AWC control mode display in section (A) will go out at the same time.



⚠ CAUTION

- The system may be malfunctioning. Park your vehicle in a safe place and stop the engine. Restart the engine and check whether the  warning display goes out. If the  goes out, there is no abnormal condition. If the  warning display does not go out or appears frequently, it is not necessary to stop the vehicle immediately, but we recommend you to have your vehicle inspected.

NOTE

- If the ambient temperature drops and the viscosity of the AWC control fluid increases, the warning may be displayed. At this time, S-AWC control is temporarily suspended, but this will not affect normal driving. After the vehicle is driven for a while, if the engine is restarted after the AWC control fluid warms up or the ambient temperature increases, the S-AWC control will start operating again if the  warning display goes out.

Starting and driving

Anti-lock brake system (ABS)

E00607101046

The anti-lock brake system (ABS) helps prevent the wheels from locking up when braking. This helps maintain vehicle drivability and steering wheel handling.

Driving hints

- Always keep a safe distance from the vehicle in front of you. Even if your vehicle is equipped with the ABS, leave a greater braking distance when:
 - Driving on gravel or snow-covered roads.
 - Driving with tyre chains installed.
 - Driving on uneven road surfaces.
- Operation of ABS is not restricted to situations where brakes are applied suddenly. This system may also prevent the wheels from locking when you drive over manholes, steel roadwork plates, road markings, or any uneven road surface.
- When the ABS is in use, you may feel the brake pedal pulsation and the vibrations of the vehicle body and steering wheel. It may also feel as if the pedal resists being pressed. **In this situation, simply hold the brake pedal down firmly. Do not pump the brake, which will result in reduced braking performance.**
- An operation noise is emitted from the engine compartment or feel a shock from the brake pedal when start driving immediately after starting the engine. These are normal sound or operation that the ABS makes when performing a self-check. It does not indicate a malfunction.

- The ABS can be used after the vehicle has reached a speed over approximately 10 km/h (6 mph). It stops working when the vehicle slows below approximately 5 km/h (3 mph).

CAUTION

- The ABS cannot prevent accidents. It is your responsibility to take safety precautions and to drive carefully.
- To prevent failure of the ABS, be sure all 4 wheels and tyres are the same size and the same type.
- Do not install any aftermarket limited-slip differential (LSD) on your vehicle. The ABS may stop functioning properly.

ABS warning lamp/display

E00607201047

Warning lamp



Warning display



If there is a malfunction in the system, the ABS warning lamp will come on and the warning display will appear on the information screen in the multi-information display.

Under normal conditions, the ABS warning lamp only comes on when the ignition switch is turned to the “ON” position and goes off a few seconds later.

CAUTION

- Any of the following indicates that the ABS is not functioning and only the standard brake system is working. (The standard brake system is functioning normally.) If this happens, we recommend you to have your vehicle inspected as soon as possible.
 - When the ignition switch is in the “ON” position, the warning lamp does not come on or it remains on and does not go off.
 - The warning lamp comes on while driving.
 - The warning display appears while driving.

If the warning lamp/display illuminate while driving

E00607301208

If only the ABS warning lamp/display illuminate

Avoid hard braking and high-speed driving. Stop the vehicle in a safe place.

Restart the engine and check to see whether the lamp goes out after a few minutes driving; if it then remains off during driving, there is no problem.

However, if the warning lamp/display do not disappear, or if they come on again when the vehicle is driven, we recommend you to have the vehicle checked.

If the ABS warning lamp/display and brake warning lamp/display illuminate at the same time

Warning lamp



Warning display



The ABS and brake force distribution function may not work, so hard braking could make the vehicle unstable.

Avoid hard braking and high-speed driving. Stop the vehicle in a safe place and we recommend you to have the vehicle checked.

NOTE

- The ABS warning lamp and brake warning lamp illuminate at the same time and the warning displays appear alternately on the information screen in the multi-information display.

After driving on icy roads

E0061880091

After driving on snow or icy roads, remove any snow and ice which may have be left around the wheels. On vehicles that have an ABS, be careful not to damage the wheel speed sensors (A) or the cables located at each wheel.

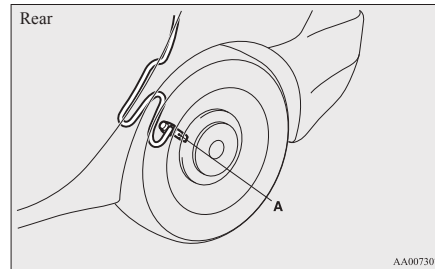
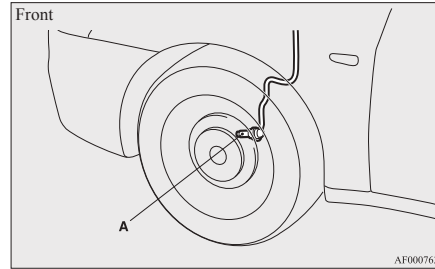

Active stability control (ASC)

E00616700139

The Active Stability Control (ASC) takes overall control of the anti-lock brake system, traction control function and stability control function to help maintain the vehicle's control and traction. Please read this section in conjunction with the pages on the anti-lock brake system, traction control function and stability control function.

Anti-lock brake system (ABS) → p. 4-32

Traction control function → p. 4-34

Stability control function → p. 4-34

CAUTION

- Do not over-rely on the ASC. Even the ASC cannot prevent the natural laws of physics from acting on the vehicle. This system, like any other system, has limits and cannot help you to maintain traction and control of the vehicle in all circumstances. Reckless driving may lead to accidents. It is the driver's responsibility to drive carefully. This means taking into account the traffic, road and environmental conditions.
- Be sure to use the same specified type and size of tyre on all 4 wheels. Otherwise, the ASC may not work properly.
- Do not install any aftermarket limited-slip differential (LSD) on your vehicle. The ASC may stop functioning properly.

Starting and driving

NOTE

- An operation noise may be emitted from the engine compartment in the following situations. The sound is associated with checking the operations of the ASC. At this time, you may feel a shock from the brake pedal if you depress it. These do not indicate a malfunction.
 - When the ignition switch is set to the “ON” position.
 - When the vehicle is driven for a while after the engine is turned on.
- When the ASC is activated, you may feel a vibration in the vehicle body or hear a whining sound from the engine compartment. This indicates that the system is operating normally. It does not indicate a malfunction.
- When the anti-lock brake system warning lamp is illuminated, the ASC is not active.

Traction control function

E0061900074

On slippery surfaces, the traction control function prevents the drive wheels from spinning excessive, thus helping the vehicle to start moving from a stopped condition. It also provides sufficient driving force and steering performance as the vehicle turns while pressing the acceleration pedal.

CAUTION

- When driving a vehicle on a snowy or icy road, be sure to install snow tyres and drive the vehicle at moderate speeds.

Stability control function

E00619100017

The stability control function is designed to help the driver maintain control of the vehicle on slippery roads or during rapid steering manoeuvres. It works by controlling the engine output and the brake on each wheel.

NOTE

- The stability control function operates at speeds of about 15 km/h (9 mph) or higher.

“ASC OFF” switch

E00619200454

When the ignition switch is turned to the “ON” position, the ASC automatically turns ON. If the “ASC OFF” switch is pressed to turn OFF the ASC, the  display in the meter comes on. Press the switch again to turn ON the ASC.

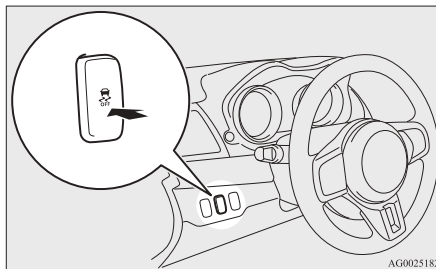

CAUTION

- For safety reasons, press the “ASC OFF” switch when the vehicle is stopped.

CAUTION

- Be sure to turn ON the ASC for normal driving.

NOTE

- When moving out of mud, sand or fresh snow, pressing the accelerator pedal may not allow the engine speed to increase. In such situations, temporarily turning off the ASC with the “ASC OFF” switch will make it easier to move out your vehicle.
- By pressing the “ASC OFF” switch, both the stability control function and the traction control function are turned OFF.
- By pressing down the “ASC OFF” switch for 3 seconds or longer, you can deactivate the ASC and the braking control of the AYC. At this time, the  display will appear for a few seconds.

**AYC BRAKE
OFF**

Then, the previous screen will return and the “!” mark will come on. Press the “ASC OFF” switch again to turn ON the ASC.

- If the “ASC OFF” switch is continuously pressed after the ASC has been turned OFF or the ASC and the braking control of AYC have been turned off, an erroneous operation prevention function operates and the ASC is automatically turned ON.

ASC operation display or ASC OFF display

E00619300628



ASC operation display/ASC indicator
The display/indicator will blink when the ASC is operating.





ASC OFF display
The  display is displayed when the ASC has been deactivated with the “ASC OFF” switch.

CAUTION

- When  display/indicator blinks, ASC is operating, which means that the road is slippery or that your vehicle's wheels are beginning to slip. If this happens, drive slower with less accelerator input.

NOTE

- The  display may come on in the instrument cluster when you start the engine. This means that the battery voltage momentarily dropped when the engine was started. It does not indicate a malfunction, provided that the display goes out immediately.

- When a compact spare tyre has been put on your vehicle, the gripping ability of the tyre will be lower, making it more likely that the  display/indicator will blink.

ASC warning display

E00619400531

If an abnormal condition occurs in the system, the following display/indicator will turn on.



ASC indicator



ASC OFF display

Warning display



CAUTION

- The system may be malfunctioning. Park your vehicle in a safe place and stop the engine. Restart the engine and check whether the display/ indicator goes out. If they go out, there is no abnormal condition. If they do not go out or appear frequently, it is not necessary to stop the vehicle immediately, but we recommend you to have your vehicle inspected.

Braking

E00607001508

All the parts of the brake system are critical to safety. We recommend you to have the vehicle checked at regular intervals according to the service booklet.

CAUTION

- Avoid driving habits that cause heavy braking and never “ride” the brakes by resting your foot on the brake pedal while driving. It causes brake overheating and fade.

Brake system

The service brake is divided into two brake circuits. And your vehicle is equipped with power brakes. If one brake circuit fails, the other is available to stop the vehicle. If your vehicle should lose the power assist for some reason, the brakes will still work. In these situations, even if the brake pedal moves down to the very end of its possible stroke or resists being depressed, keep depressing the brake pedal down harder and further than usual; stop driving as soon as possible and have the brake system repaired.

WARNING

- Do not turn off the engine while your vehicle is in motion. If you turn off the engine while driving, the power assistance for the braking system will stop working and your brakes will not work effectively.

WARNING

- If the power assist is lost or if either brake hydraulic system stops working properly, have your vehicle checked immediately.

Warning display

The brake warning lamp illuminates to indicate a fault in the braking system. A warning is also displayed on the multi-information display. Refer to “Brake warning lamp” on page 3-33 and “Brake warning display” on page 3-35.

When brakes are wet

Check the brake system while driving at a low speed immediately after starting, especially when the brakes are wet, to confirm they work normally. A film of water can be formed on the brake discs and prevent normal braking after driving in heavy rain, through large puddles, or after the vehicle is washed. If this occurs, dry the brakes out by driving slowly while lightly depressing the brake pedal.

When driving downhill

It is important to take advantage of the engine braking by shifting to a lower shift position while driving on steep downhill roads in order to prevent the brakes from overheating.

WARNING

- Do not leave any objects near the brake pedal or let a floor mat slide under it; doing so could prevent the full pedal stroke that would be necessary in an emergency. Make sure that the pedal can be operated freely at all times. Make sure the floor mat is securely held in place.

Brake pads

- New brakes need to be broken-in by moderate use for the first 200 km (124 miles). Avoid hard braking situations.
- The disc brakes are provided with a warning device which continuously emits a shrieking metallic sound while braking if the brake pads have reached their wear limit. If you hear this sound continuously, have the brake pads inspected immediately.

WARNING

- Driving with worn brake pads will make it harder to stop, and can cause an accident.

NOTE

- When the brakes are applied, a faint noise may be heard, but this is a characteristic of high-performance brakes; it does not indicate a problem.

Brake assist system

E00627000480

The brake assist system is a device assisting drivers who cannot depress the brake pedal firmly when it is necessary to do so (such as in emergency stop situations) and provides greater braking force.

If the brake pedal is depressed suddenly, the brakes will be applied with more force than usual.

CAUTION

- The brake assist system is not a device designed to exercise braking force greater than its capacity. Make sure to always keep a sufficient distance between vehicles in front of you without relying too much on the brake assist system.

NOTE

- Once the brake assist system is operational, it maintains great braking force even if the brake pedal is lightly released. To stop its operation, completely remove your foot from the brake pedal.
- The brake assist system may become operational when the brake pedal is fully depressed even if it has not been depressed suddenly.

- When the brake assist system is in use, you may feel as if the depressed brake pedal is soft, the pedal moves in small motions in conjunction with the sound of the ABS operation, or the vehicle body and the steering wheel vibrate. This occurs when the brake assist system is operating normally and does not indicate faulty operation. Continue to firmly depress the brake pedal.
- You may hear an operation noise when the brake pedal is suddenly or fully depressed while stationary. This does not indicate a malfunction and the brake assist system is operating normally.

Power steering system

E00607400417

The power steering system operates while the engine is running. It helps reduce the effort needed to turn the steering wheel.

The power steering system has mechanical steering capability in case the power assist is lost. If the power assist is lost for some reason, you will still be able to steer your vehicle, but you will notice it takes much more effort to steer. If this happens, have your vehicle inspected at a MITSUBISHI MOTORS Authorized Service Point.

WARNING

- Do not stop the engine while the vehicle is moving. Stopping the engine would make the steering wheel extremely hard to turn, possibly resulting in an accident.

CAUTION

- Do not leave the steering wheel turned all the way in one direction. This can cause damage to the power steering system.

Cruise control*

E00609101170

Cruise control is an automatic speed control system that keeps a set speed. It can be activated at speeds from about 40 km/h (25 mph) up to about 200 km/h (124 mph).

CAUTION

- When you do not wish to drive at a set speed, turn off the cruise control for safety.
- Do not use cruise control when driving conditions will not allow you to stay at the same speed, such as in heavy traffic or on roads that are winding, icy, snow-covered, wet, slippery, on a steep downhill slope.
- On vehicles with M/T, do not move the gearshift lever to the “N” (Neutral) position while driving at a set speed without depressing the clutch pedal. The engine will run too fast and might be damaged.

NOTE

- Cruise control may not be able to keep your speed on uphills or downhills.
- Your speed may decrease on a steep uphill. You may use the accelerator pedal if you want to stay at your set speed.
- Your speed may increase to more than the set speed on a steep downhill. You must use the brake to control your speed. As a result, the set speed driving is deactivated.

Starting and driving

Cruise control switches

E00624100044

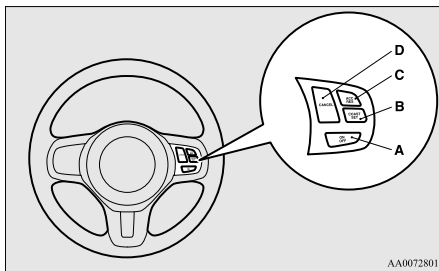

AA0072801

A- "ON OFF" switch

Used to turn on and off the cruise control.

B- "COAST SET" switch

Used to reduce the set speed and to set the desired speed.

C- "ACC RES" switch

Used to increase the set speed and to return to the original set speed.

D- "CANCEL" switch

Used to deactivate the set speed driving.

NOTE

- When operating the cruise control switches, press the cruise control switches correctly. The set speed driving may be deactivated automatically if two or more switches of the cruise control are pressed at the same time.

To activate

E00609301231

1. With the ignition switch in the "ON" position, press the "ON OFF" switch (A) to turn on the cruise control. The "CRUISE" indication lamp in the meter cluster will come on.

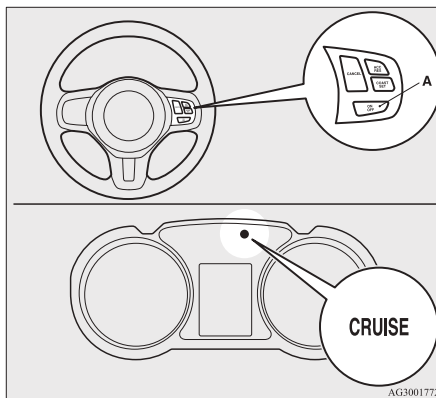

AC32001772

NOTE

- If the cruise control is on when the ignition switch is turned to the "LOCK" or "ACC" position, cruise control will be on automatically the next time you start the engine. The "CRUISE" indication lamp will also be on.
 - If the battery voltage is insufficient, the memory data for the cruise control may be erased.
- As a result, the "CRUISE" indication lamp may not come on when you restart the engine.

If this happens, press the "ON OFF" switch once again to turn on the cruise control.

2. Confirm that the Twin Clutch SST control mode is set to "Normal" (on vehicles with Twin Clutch SST). Refer to "Twin Clutch SST control mode" on page 4-19.

NOTE

- The cruising speed cannot be set when the Twin Clutch SST control mode is set to "Sport" mode or "S-Sport" mode.
3. Accelerate or decelerate to your desired speed, then press and release the "COAST SET" switch (B) when the "CRUISE" indication lamp is illuminated. The vehicle will then maintain the desired speed.

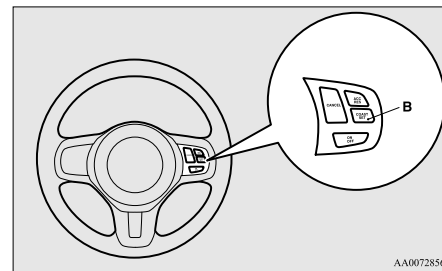

AA0072856

NOTE

- When you release the "COAST SET" switch, the vehicle speed will be set.

To increase the set speed

E00609400509

There are 2 ways to increase the set speed.

“ACC RES” switch

Press and hold the “ACC RES” switch (C) while driving at the set speed, and your speed will then gradually increase.

When you reach your desired speed, release the switch. Your new cruising speed is now set.

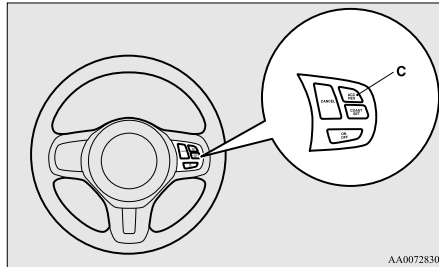

AA0072830

To increase your speed in small amounts, press the “ACC RES” switch for less than about 1 second and release it.

Each time you press the “ACC RES” switch, your vehicle will go about 1.6 km/h (1 mph) faster.

Accelerator pedal

While driving at the set speed, use the accelerator pedal to reach your desired speed and then press the “COAST SET” switch (B) and release the switch momentarily to set a new desired cruising speed.

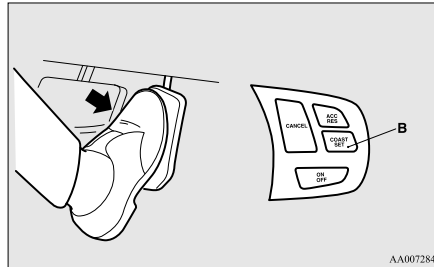

AA0072843

To decrease the set speed

E00609500438

There are 2 ways to decrease the set speed.

“COAST SET” switch

Press and hold the “COAST SET” switch (B) while driving at the set speed, and your speed will slow down gradually.

When you reach your desired speed, release the switch. Your new cruising speed is now set.

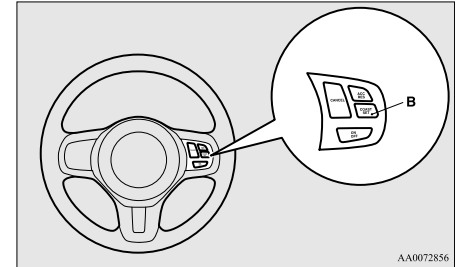

AA0072856

To slow down your speed in small amounts, press the “COAST SET” switch for less than about 1 second and release it.

Each time you press the “COAST SET” switch, your vehicle will slow down by about 1.6 km/h (1 mph).

Starting and driving

Brake pedal

While driving at the set speed, use the brake pedal, which disengages the cruise control, then press the “COAST SET” switch (B) and release the switch momentarily to set a new desired cruising speed.

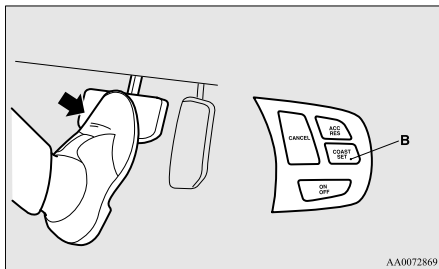

4 To temporarily increase or decrease the speed

E00619500053

To temporarily increase the speed

Depress the accelerator pedal as you would normally. When you release the pedal, you will return to your set speed.

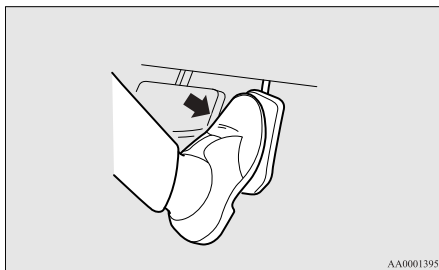

To temporarily decrease the speed

Depress the brake pedal to decrease the speed. To return to the previously set speed, press the “ACC RES” switch (C). Refer to “To resume the set speed” on page 4-41.

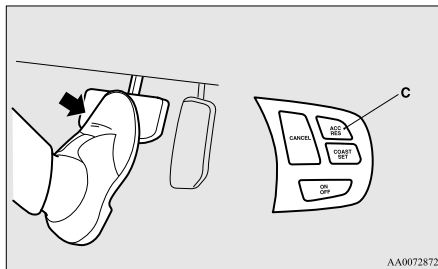

To deactivate

E00609701394

The set speed driving can be deactivated as follows:

- Press the “ON OFF” switch (A) (Cruise control will be turned off)
- Press the “CANCEL” switch (D).

- Depress the brake pedal.

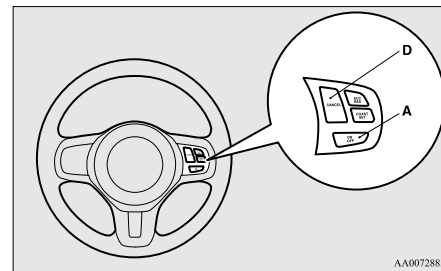

The set speed driving is deactivated automatically in any of the following ways.

- When you depress the clutch pedal (on vehicles with M/T).
- When your speed slows to about 15 km/h (9 mph) or more below the set speed because of a hill, etc.
- When your speed slows to about 40 km/h (25 mph) or less.
- When the Twin Clutch SST control mode is set to “Sport” mode (on vehicles with Twin Clutch SST). Refer to “Twin Clutch SST control mode” on page 4-19.
- When the Active Stability Control (ASC) starts operating. Refer to “Active stability control (ASC)” on page 4-33.

⚠ WARNING

- On vehicles with Twin Clutch SST, although the set speed driving will be deactivated when shifting to the “N” (NEUTRAL) position, never move the gearshift lever to the “N” (NEUTRAL) position while driving. You would have no engine braking and could cause a serious accident.

Also, the set speed driving may be deactivated as follows:

- When the engine speed rises and approaches the tachometer's red zone (the red-coloured part of the tachometer dial).

⚠ CAUTION

- When the set speed driving is deactivated automatically in any situation other than those listed above, there may be a system malfunction. Press the “ON-OFF” switch to turn off the cruise control and have your vehicle inspected by a MITSUBISHI MOTORS Authorized Service Point.

To resume the set speed

E00609800486

If the set speed driving is deactivated by the condition described in “To deactivate” on page 4-40, you can resume the previously set speed by pressing the “ACC RES” switch (C) while driving at a speed of about 40 km/h (25 mph) or higher.

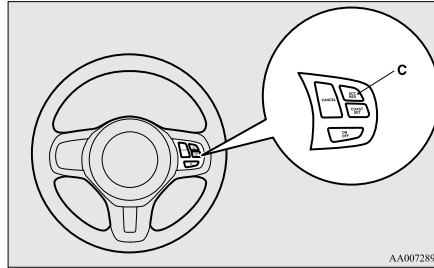

Under either of the following conditions, however, using the switch does not allow you to resume the previously set speed. In these situations, repeat the speed setting procedure:

- The “ON OFF” switch is pressed.
- The ignition switch is turned OFF.
- “CRUISE” indication lamp is turned OFF.

Cargo loads

E00609901543

Cargo loads precautions**⚠ CAUTION**

- Do not load cargo or luggage higher than the top of the seatback. Be sure that your cargo or luggage cannot move once your vehicle is moving. Having the driver's vision blocked, and your cargo being thrown inside the cabin if you suddenly have to brake can cause a serious accident or injury.
- Load heavy cargo or luggage in the front of the vehicle. If the load in the back of the vehicle is too heavy, steering may become unstable.

Loading a roof carrier**⚠ CAUTION**

- Use a roof carrier that properly fits your vehicle. Do not load luggage directly onto the roof. For installation, refer to the instruction manual accompanying the roof carrier.

Starting and driving

NOTE

- We recommend you to use a genuine MITSUBISHI roof carrier, since the brackets to be used have a special shape. For details, we recommend you to consult a MITSUBISHI MOTORS Authorized Service Point.

Roof carrier mounting brackets

When installing the roof carrier, use the brackets (A).

The brackets (A) are located under each cover (B).

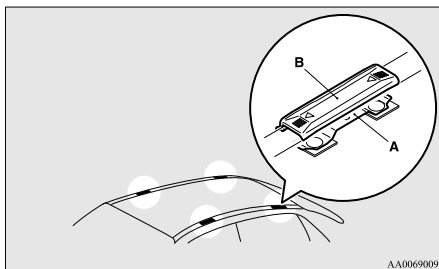

Attaching the roof carrier

Slide each cover (B) towards the front of the vehicle to remove it.

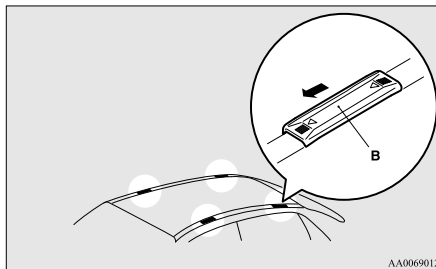

Refitting the covers

1. With each cover, put the tabs (C) on the cover in the holes (D) in the roof.
2. Slide the cover (B) towards the rear of the vehicle to install it.

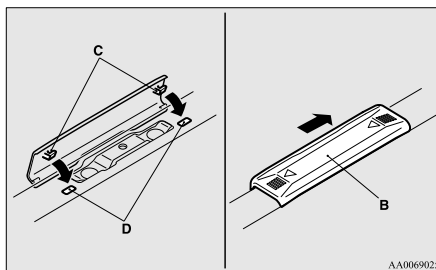

Roof carrier precaution

⚠ CAUTION

- Make sure that the weight of the luggage does not exceed the allowable roof load. If the allowable roof load is exceeded, this may cause damage to the vehicle. The roof load is the total allowable load on the roof (the weight of the roof carrier plus the weight of luggage placed on the roof carrier). For specific figures, please refer to “Maximum roof load” on page 9-06.
- When luggage is loaded onto the vehicle, please make sure to drive slowly and avoid excessive manoeuvres such as sudden braking or quick turning. In addition, place the luggage on the carrier so that its weight is distributed evenly with the heaviest items on the bottom. Do not load items that are wider than the roof carrier. The additional weight on the roof could raise the vehicle’s centre of gravity and affect vehicle handling characteristics. As a result, driving errors or emergency manoeuvres could lead to a loss of control and result in an accident.
- Before driving and after travelling a short distance, always check the load to make sure it is securely fastened to the roof carrier. Check periodically during your travel that the load remains secure.

NOTE

- To prevent wind noise or reduction in fuel economy, remove the roof carrier when not in use.
- Before using an automatic car wash, remove the roof carrier.

Rear-view camera*

E00618400534

The rear-view camera is a system that shows the view behind the vehicle on a screen of the MITSUBISHI Multi Communication System (MMCS) or the DISPLAY AUDIO.

⚠ CAUTION

- The rear-view camera is an assistance system that enables the driver to check for obstacles behind the vehicle. Its range of view is limited, so you should not overly depend on it. Please drive just as carefully as you would if the vehicle did not have the rear-view camera.
- Be sure to visually confirm safety around the vehicle with your own eyes. Do not depend entirely on the rear-view camera.

Range of view of rear-view camera

The range of view of the rear-view camera is limited to the area shown in the illustrations. It cannot show both sides and the lower part of the rear bumper, etc.

When reversing, be sure to visually confirm safety around the vehicle.

Location of rear-view camera

The rear-view camera (A) is built-in to the trunk lid.

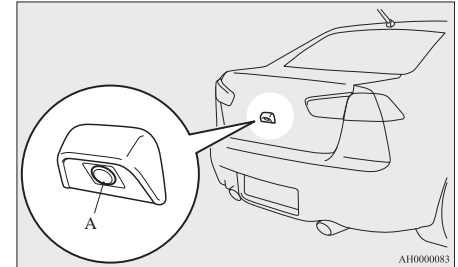

AH0000083

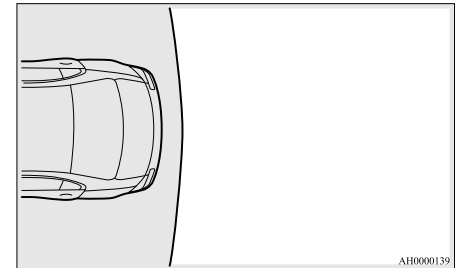
Range of view of rear-view camera

AH0000139

Starting and driving

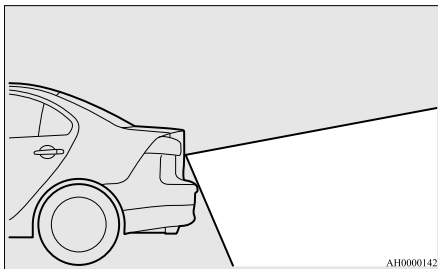

How to use the rear-view camera

When you place the gearshift lever in the “R” position with the ignition switch in the “ON” position, the view behind the vehicle will automatically appear on the screen of the MITSUBISHI Multi Communication System (MMCS) or the DISPLAY AUDIO. When you move the gearshift lever to any other position, the screen will return to its original indication.

4

CAUTION

- The rear-view camera has a special lens that can make objects shown on the screen appear to be closer or further away than they actually are.

NOTE

- Because the rear-view camera has a special lens, the lines on the ground between parking spaces may not look parallel on the screen.
- In the following situations, the screen indication may be difficult to see. There is no abnormality.

- Low light (nighttime)
- When the light of the sun or the light from a vehicle’s headlamps shines directly into the lens
- If the camera is hot and is then cooled by rain or a car wash, the lens can mist up. This phenomenon does not indicate a malfunction.
- It is not possible to fully see obstacles when the lens is dirty. If the lens becomes contaminated by water droplets, snow, mud or oil, wipe off the contamination, taking care not to scratch the lens.
- Please observe the following cautions. Ignoring them could lead to a camera malfunction.
 - Do not subject the camera to physical shock.
 - Do not apply wax to the camera.
 - Do not splash the camera with boiling water.
 - Do not disassemble the camera.

Reference lines on the screen

Reference lines and upper surface of the rear bumper (A) are displayed on the screen.

- Red line (B) indicates approximately 50 cm behind the rear bumper.
- Two Green lines (C) indicate approximately 20 cm outside of the vehicle body.
- Short transverse lines (1 to 3) indicate distance from the rear bumper.

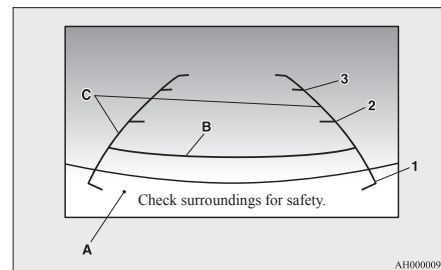

- 1- Approximately at the rear edge of the rear bumper
- 2- Approximately 100 cm
- 3- Approximately 200 cm

NOTE

- When the vehicle is tilting because of the number of people in the vehicle, the weight and positioning of luggage, and/or the condition of the road surface, the lines in the view from the rear-view camera may not be accurately positioned relative to the actual road. The reference lines for distance and vehicle width are based on a level, flat road surface. In the following cases, objects shown on the screen will appear to be farther off than they actually are.

Trailer towing

E00610000244

- When the rear of the vehicle is weighed down with the weight of passengers and luggage in the vehicle.

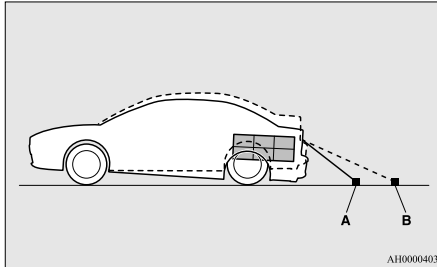

AH0000403

- A- Actual objects
- B- Objects shown on the screen

- When there is an upward slope at the back.

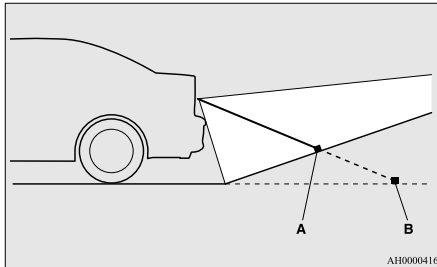

AH0000416

- A- Actual objects
- B- Objects shown on the screen

- The reference lines for distance and vehicle width are intended to indicate the distance to a flat object such as a level, flat road surface. This may make the distance to a projecting object shown on the screen differ from the actual distance to the projecting object. Do not use them as a guide for distances to solid objects.

Example: On the screen the point B appears the nearest, then the point C and A in order of distance. The points A and B actually are the same distances from the vehicle, and the point C is farther off than the points A and B.

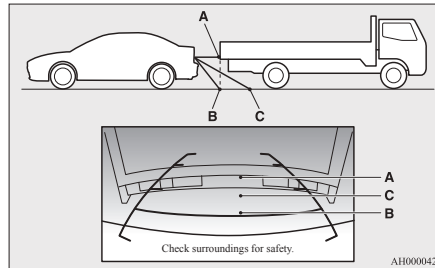

AH0000429

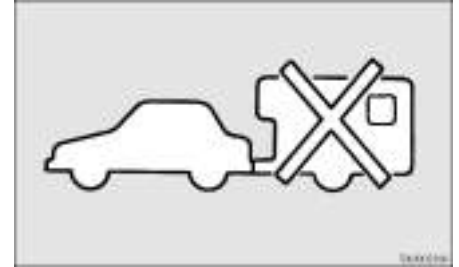

⚠ WARNING

- Do not use this vehicle for trailer towing. It may cause an accident or damage the vehicle.

A series of 15 horizontal dashed lines spanning the width of the page, providing a template for handwriting practice.

For pleasant driving

Ventilators.....	5-02	Storage spaces.....	5-62
Automatic air conditioning.....	5-04	Cup holder.....	5-64
Important operation tips for the air conditioning.....	5-08	Bottle holder.....	5-65
Air purifier.....	5-09	Assist grip.....	5-65
LW/MW/FM radio/CD player*.....	5-09	Coat hook.....	5-66
Handling of Discs.....	5-12		
Audio Files (MP3/WMA/AAC).....	5-13		
Important Points on Safety for the Customer.....	5-17		
Operation Keys.....	5-17		
Listen to Radio.....	5-21		
Listen to DAB*.....	5-22		
Listen to Traffic Messages.....	5-23		
Listen to CDs.....	5-24		
Listen to MP3s.....	5-25		
Listen to an iPod.....	5-26		
Listen to Audio Files on a USB Device.....	5-27		
Listen to Bluetooth Audio*.....	5-29		
Display Indicator.....	5-31		
Audio Quality and Volume Balance Adjustment.....	5-33		
System Settings.....	5-33		
Troubleshooting.....	5-37		
Antenna.....	5-39		
Link System*.....	5-39		
Bluetooth® 2.0 interface*.....	5-40		
USB input terminal*.....	5-56		
Sun visors.....	5-58		
Ashtray*.....	5-59		
Cigarette lighter*.....	5-59		
Accessory socket*.....	5-60		
Interior lamps.....	5-60		

For pleasant driving

Ventilators

E00700100777

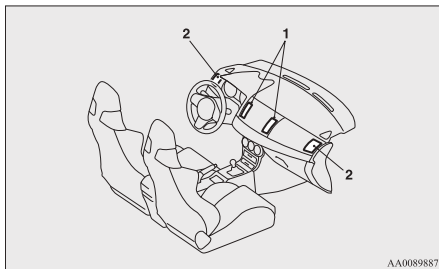

- 1- Centre ventilators
- 2- Side ventilators

NOTE

- Do not place beverages on top of the instrument panel. If they splash into the air conditioning ventilators, they could damage the system.

Air flow and direction adjustments

E00700200781

Centre ventilators

Move the knob (A) to make adjustments.

To close the ventilator, move the knob (A) to the inside as far as possible.

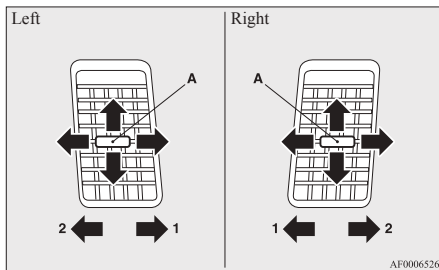

- 1- Close
- 2- Open

Side ventilators

Move the knob (A) to make adjustments.

To close the ventilator, move the knob (A) to the outside as far as possible.

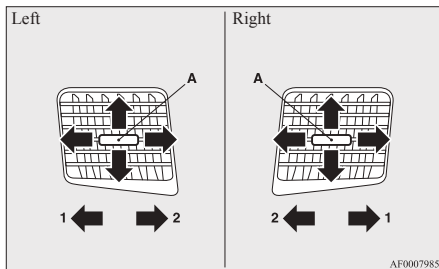

- 1- Close
- 2- Open

NOTE

- The cool air from the ventilators may appear as a mist. This is due to moist air being suddenly cooled by the air conditioning. This will clear after a few moments.

Mode selection dial

E00726500098

To change the position and amount of air flowing from the ventilators, turn the mode selection dial.



AG0002071

CAUTION

- When using the mode selection dial between the “” and “” positions, prevent fogging by pressing the air selection switch to select outside air. (Refer to “Air selection switch” on page 5-05.)

Changing the mode selection

E00700301330

To change the position and amount of air flowing from the ventilators, turn the mode selection dial. (Refer to “Mode selection dial” on page 5-02.) These symbols are used in the next several illustrations to demonstrate the quantity of air coming from the ventilators.

- : Small amount of air from the ventilators
- ➔: Medium amount of air from the ventilators
- ➔➔: Large amount of air from the ventilators

Face position

Air flows only to the upper part of the passenger compartment.

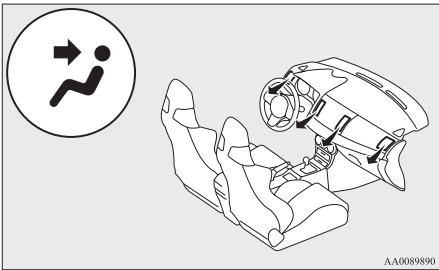

Foot/Face position

Air flows to the upper part of the passenger compartment, and flows to the leg area.

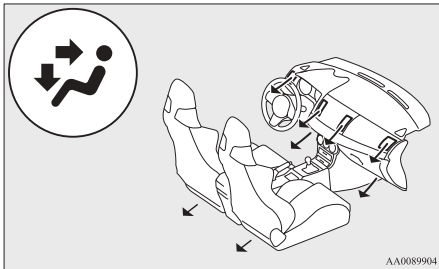

NOTE

- With the mode selection dial between the “↗” and “↗↗” positions, air flows mainly to the upper part of the passenger compartment.
- With the mode selection dial between the “↗↗” and “↗↗↗” positions, air flows mainly to the leg area.

Foot position

Air flows mainly to the leg area.

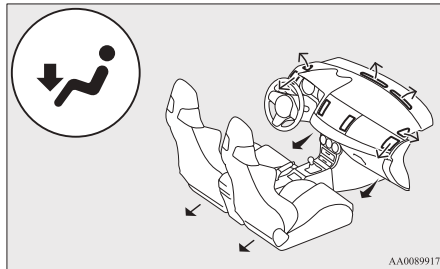



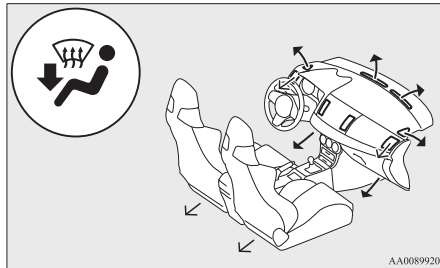

Foot/Demister position

Air flows to the leg area, the windscreen and the door windows.



For pleasant driving

NOTE

- With the mode selection dial between the “” and “” positions, air flows mainly to the leg area. With the mode selection dial between the “” and “” positions, air flows mainly to the windscreen and door windows.

Demister position

Air flows mainly to the windscreen and the door windows.

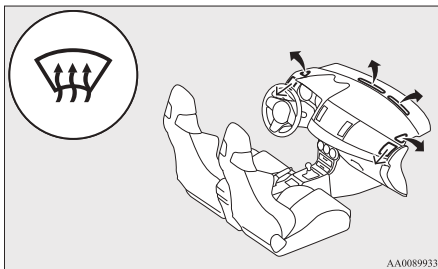

Automatic air conditioning

E00702400367

The air conditioning can only be used while the engine is running.

Control panel

E00702501264

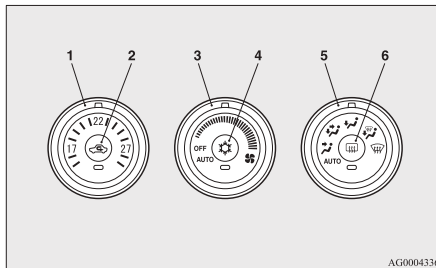

- 1- Temperature control dial
- 2- Air selection switch
- 3- Blower speed selection dial
- 4- Air conditioning switch
- 5- Mode selection dial
- 6- Rear window demister switch → p. 3-47

NOTE

- There is an interior air temperature sensor (A) in the illustrated position. Never place anything on top of the sensor, since doing so will prevent it from functioning properly.

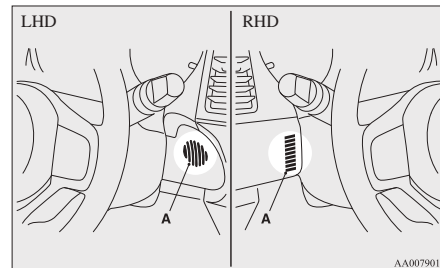

Blower speed selection dial

E00702800215

Select the blower speed by turning the blower speed selection dial clockwise or anticlockwise. The blower speed will gradually increase as the dial is turned to the right.

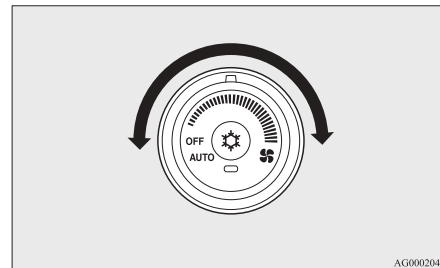

Temperature control dial

E00703000399

Turn the temperature control dial clockwise or anticlockwise.

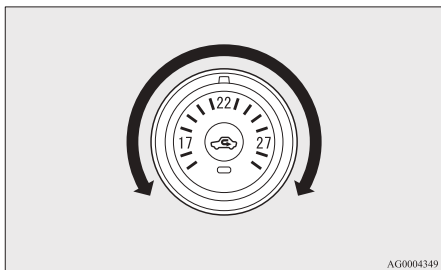

AG0004349

NOTE

- While the engine coolant temperature is low, the temperature of the air from the heater will be cool/cold until the engine warms up, even if you have selected warm air with the dial.
- When the temperature is set to the highest or the lowest, the air selection and the air conditioning will be automatically changed as follows.
 - Quick Heating (When the temperature is set to the highest setting) Outside air will be introduced and the air conditioning will stop.
 - Quick Cooling (When the temperature is set to the lowest setting) Inside air will be recirculated and the air conditioning will operate.

The settings described above are the factory settings. The air selection and air conditioning switches can be customised (function setting changed), and the automatic switching of outside air and the air conditioning according to operating conditions can be changed as desired. For further information, we recommend you to consult a MITSUBISHI MOTORS Authorized Service Point.

Refer to “Customizing the air conditioning switch (Changing function settings)” on page 5-06.

Refer to “Customizing the air selection (Changing function settings)” on page 5-05.

Air selection switch

E00703400508

To change the air selection, simply press the air selection switch.

A sound will be made every time you push the switch.

- Outside air: Indication lamp (A) is OFF
Outside air is introduced into the passenger compartment.
- Recirculated air: Indication lamp (A) is ON
Air is recirculated inside the passenger compartment.

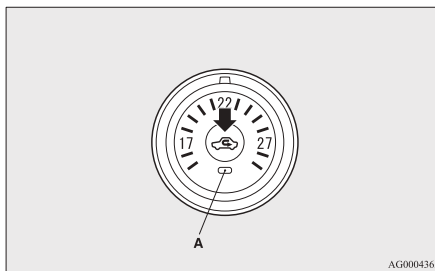

AG0004365

CAUTION

- Normally, use the outside position to keep the windscreen and side windows clear and quickly remove fog or frost from the windscreen.
If high cooling performance is desired, or if the outside air is dusty or otherwise contaminated use the recirculation position. Switch to the outside position periodically to increase ventilation so that the windows do not become fogged up.
- Use of the recirculation position for an extended time may cause the windows to fog up.

NOTE

- When the mode selection dial or the blower speed selection dial is set to the “AUTO” position again after manual operation, the air selection switch will also be automatically controlled.
- When the engine coolant temperature rises to a certain level, the air selection is automatically switched to the recirculation position and the indication lamp (A) comes on. At this time, the system will not switch to the outside position even if the air selection switch is pushed.

Customizing the air selection (Changing function settings)

E00732600023

Functions can be changed as desired, as stated below.

For pleasant driving

- **Enable automatic air control:**
If the mode selection dial or blower speed selection dial is turned to the “AUTO” position, the air selection switch is also controlled automatically.
- **Disable automatic air control:**
Even if the mode selection dial or blower speed selection dial is turned to the “AUTO” position, the air selection switch is not controlled automatically.
- **Setting change method**
Hold down the air selection switch for about 10 seconds or more.
When the setting is changed, a sound is emitted and the indication lamp flashes.
 - When the setting is changed from enable to disable 3 sounds are emitted and the indication lamp flashes 3 times.
 - When the setting is changed from disable to enable 2 sounds are emitted and the indication lamp flashes 3 times.

NOTE

- The factory setting is “Enable automatic air control”.
- When the mode selection dial is turned to “”, in order to prevent misting of the windows the ventilator automatically switches to outside air even if “Disable automatic air control” is set.

Air conditioning switch

E00703500929

Push the switch to turn the air conditioning on, indication lamp (A) will come on.

A sound will be made every time you push the switch.

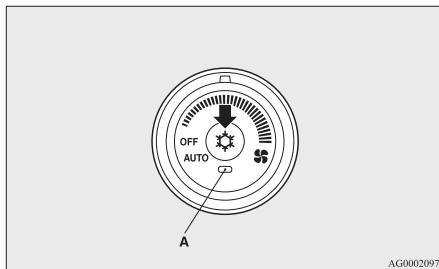

Push the switch again to switch it off.

CAUTION

- **When using the air conditioning, the idling speed may slightly increase as the air conditioning compressor is switched on/off automatically.**
While the vehicle with a Twin Clutch SST is stationary, fully depress the brake pedal to prevent the vehicle from creeping.

NOTE

- If a problem is detected in the air conditioning system, the air conditioning operation indication lamp (A) blinks. Press the air conditioning switch once to turn it off, then once more to turn it back on. If the air conditioning operation indication lamp (A) does not blink for a while, there is nothing wrong. If it starts to blink again, we recommend you to have it checked.
- Sometimes, for example after using a high-pressure car wash, the condenser can get wet, and the operation indication lamp (A) blinks temporarily. In this case there is nothing wrong. Wait for a while, press the air conditioning switch once to turn the system off, then once more to turn it back on. Once the water evaporates, the blinking will stop.

Customizing the air conditioning switch (Changing function settings)

E00732700040

Functions can be changed as desired, as stated below.

- **Enable automatic air conditioning control:**
If the mode selection dial or blower speed selection dial is turned to the “AUTO” position, or the temperature control dial is set to the minimum temperature, the air conditioning switch is controlled automatically.
- **Disable automatic air conditioning control:**
The air conditioning switch is not controlled automatically as long as the air conditioning switch is not operated.
- **Setting change method:**
Hold down the air conditioning switch for about 10 seconds or more.

When the setting is changed, a sound is emitted and the indication lamp flashes.

- When the setting is changed from enable to disable 3 sounds are emitted and the indication lamp flashes 3 times.
- When the setting is changed from disable to enable 2 sounds are emitted and the indication lamp flashes 3 times.

NOTE

- The factory setting is “Enable automatic air conditioning control”.
- When you turn the mode selection dial to “

Operating the system in automatic mode

E00704100658

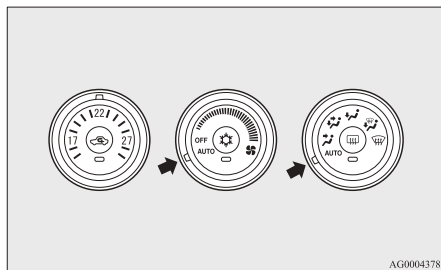

AG0004378

In normal conditions, use the system in the AUTO mode and follow these procedures:

1. Set the blower speed selection dial to the “AUTO” position.
2. Set the temperature control dial to the desired temperature.
3. Set the mode selection dial to the “AUTO” position.

The outlet position (except “

To stop the system, turn the blower speed selection dial to the “OFF” position.

CAUTION

- When using the air conditioning, the idling speed may slightly increase as the air conditioning compressor is switched on/off automatically. While the vehicle with a Twin Clutch SST is stationary, fully depress the brake pedal to prevent the vehicle from creeping.

NOTE

- While the engine coolant temperature is low, the temperature of the air from the heater will be cool/cold until the engine warms up, even if you have selected warm air with the dial. To prevent the windscreen and windows from fogging up, the ventilator mode will be changed to “
 - If the blower speed selection dial, air conditioning switch, mode selection dial, or air selection switch is operated while the system is operating in the AUTO mode, the activated function overrides the corresponding function of automatic control. All other functions remain under automatic control.

Operating the system in manual air mode

E00704200095

Blower speed and ventilator mode may be controlled manually by setting the blower speed selection dial and the mode selection dial to the desired positions. To return to automatic operation, set the dials to the “AUTO” position.

Demisting of the windscreen and door windows

E00704300849

CAUTION

- For safety, make sure you have a clear view through all the windows.

To remove frost or mist from the windscreen and door windows, use the mode selection dial (“

5

For pleasant driving

For ordinary demisting

Use this setting to keep the windscreen and door windows clear of mist, and to keep the leg area heated.

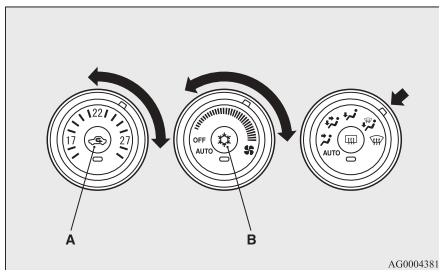

1. Set the air selection switch (A) to the outside position.
2. Set the mode selection dial to the “OFF AUTO” position.
3. Select your desired blower speed by turning the blower speed selection dial.
4. Select your desired temperature by turning the temperature control dial.
5. Push the air conditioning switch (B).

For quick demisting

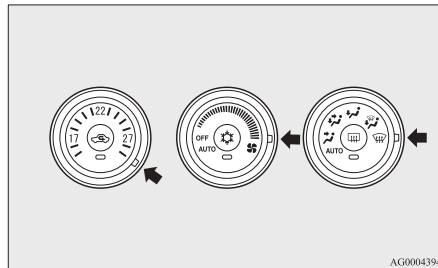

1. Set the mode selection dial to the “OFF AUTO” position.
2. Set your blower to the maximum speed.
3. Set the temperature to the highest position.

NOTE

- While the mode selection dial is set to the “OFF AUTO” position, the air conditioning will operate automatically and the outside air position will also be selected automatically.
- To demist effectively, direct the air flow from the side ventilators towards the door windows.
- Do not set the temperature control dial to the max. cool position. Cool air will blow against the window glasses and prevent demisting.

Important operation tips for the air conditioning

E00708300603

- Park the vehicle in the shade.
Parking in the hot sun will make the vehicle inside extremely hot, and it will require more time to cool the interior.
If it is necessary to park in the sun, open the windows for the first few minutes of air conditioning operation to expel the hot air.
- Close the windows when the air conditioning is in use. The entry of outside air through open windows will reduce the cooling efficiency.
- Too much cooling is not good for the health. The inside air temperature should only be 5 to 6 °C below the outside air temperature.
- When operating the system, make sure the air intake, which is located in front of the windscreen, is free of obstructions such as leaves and snow. Leaves collected in the air-intake plenum may reduce air flow and plug the plenum water drains.

Air conditioning system refrigerant and lubricant recommendations

If the air conditioning seems less effective than usual, the cause might be a refrigerant leak. We recommend you to have the system inspected.

The air conditioning system in your vehicle must be charged with the refrigerant HFC-134a and the lubricant SUN-PAG56.

Use of any other refrigerant or lubricant will cause severe damage which will result in the need to replace your vehicle's entire air conditioning system. The release of refrigerant into the atmosphere should be prevented.

It is recommended that the refrigerant be recovered and recycled for further use.

During a long period of disuse

The air conditioning should be operated for at least five minutes each week, even in cold weather. This is to prevent the compressor from seizing and to maintain the air conditioning in the best operating condition.

Air purifier

E00708400473

An air filter has been incorporated into this air conditioning so that dirt and dust are cleaned from the air.

Replace the air filter periodically as its ability to clean the air will be reduced as it collects pollen and dirt. For the maintenance interval, refer to the “SERVICE BOOKLET”.

NOTE

- Operation in certain conditions such as driving on a dusty road and frequent use of the air conditioning can lead to reduction of service life of the filter. When you feel that the airflow is lower than normal or when the windscreen or windows start to fog up easily, replace the air filter. We recommend you to have it checked.

LW/MW/FM radio/CD player*

E00708502335

The audio system can only be used when the ignition switch or the operation mode is in ON or ACC.

NOTE

- When listening to the audio system while the engine is not running, be sure to turn the ignition switch to the “ACC” position. If the ignition switch is left in the “ACC” position, the accessory power will automatically turn off after a certain period of time and you will no longer be able to use the audio system. The accessory power comes on again if the ignition switch is turned from the “ACC” position. Refer to “ACC power auto-cutout function” on page 4-09.
- If a cellular phone is used inside the vehicle, it may create noise from the audio equipment. This does not mean that anything is wrong with your audio equipment. In such a case, use the cellular phone at a place as far away as possible from the audio equipment.
- If foreign objects or water get into the audio equipment, or if smoke or a strange odour comes from it, immediately turn off the audio system. We recommend you to have it checked. Never try to repair it by yourself. Avoid continuous usage without inspection by a qualified person.

For pleasant driving

Important Points on Usage

E00735500023

*iPod/iPhone Playback Function**

- This product supports audio playback from iPod/iPhone devices, however differing versions mean that playback cannot be guaranteed.
- Please be aware that depending on the iPod/iPhone model or version, operation may differ.

How to Clean

E00735700025

- If the product becomes dirty, wipe with a soft cloth.
- If very dirty, use a soft cloth dipped in neutral detergent diluted in water, and then wrung out. Do not use benzene, thinners, or other chemical wipes. This may harm the surface.

Trademarks

E00735800026

- Product names and other proper names are the trademarks or registered trademarks of their respective owners.
- Furthermore, even if there is no specific denotation of trademarks or registered trademarks, these are to be observed in their entirety.



“Made for iPod,” “Made for iPhone” mean that an electronic accessory has been designed to connect specifically to iPod or iPhone, respectively, and has been certified

by the developer to meet Apple performance standards.

iPhone, iPod, iPod classic, iPod nano, and iPod touch are trademarks of Apple Inc., registered in the U.S. and other countries.

Apple is not responsible for the operation of this device or its compliance with safety and regulatory standards.

NOTE

- iPod and iTunes licensing allows individual users to privately reproduce and play back non-copyrighted material as well as material that may be legally copied and reproduced. Infringement of copyright is prohibited.
- Supported models for equipment by type (vehicles with a Bluetooth® 2.0 interface) will vary. For details, see the Johnson Controls, Inc. website.

iPod



iPod
5th generation
(video)
60GB 80GB



iPod
5th generation
(video)
30GB

iPod classic



iPod classic
160GB (2009)



iPod classic
160GB (2007)



iPod classic
80GB

iPod nano



iPod nano
6th generation
8GB 16GB



iPod nano
5th generation
(video camera)
8GB 16GB



iPod nano
4th generation (video)
8GB 16GB



iPod nano
3rd generation
(video)
4GB 8GB



iPod nano
2nd generation
(aluminium)
2GB 4GB 8GB



iPod nano
1st generation
1GB 2GB 4GB

AA5013326

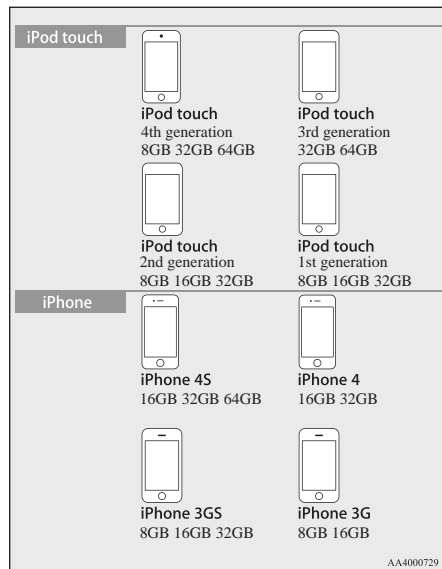

Handling of Discs

E00735900027

This explains care that should be taken in the handling of discs.

Important Points on Handling

- Fingerprints or other marks on the read surface of the disc may result in its content being more difficult to read. When holding the disc, grip both edges, or one edge and the centre hole, in order that the read surface is not touched.
- Do not affix paper or stickers, or otherwise damage the disc.
- Do not forcefully insert a disc if another is already within the device. This can result in damage to discs, or malfunction.

Cleaning

- Periodically clean the read surface of the disc. When cleaning, do not wipe in a circular motion. Instead, wipe gently outwards from the centre of the disc to the outer edge.
- New discs may have burring around the outer edge or in the hole in the centre. Ensure you check for these. If there are burrs, these may lead to faulty operation, therefore ensure these are removed.

Important Points on Storage

- When not using discs, ensure these are kept in cases, and stored out of direct sunlight.
- If discs are not going to be used for a long period of time, remove these from the product.

Disc Playback Environment

In cold environments such as in mid-winter when the interior of the vehicle is cold, turning the heater on and immediately trying to use the product may cause condensation (water droplets) to form on the disc and internal optical components, and this may prevent the product from operating correctly. In these conditions, remove the disc, and wait a short time before use.



Copyright

Actions such as unauthorized reproduction, broadcast, public performance, or rental of discs that comprise other than personal use are prohibited by law.

Types of Disc That Can Be Played Back

E00736000038

The following marks are printed on the disc label, package, or jacket.

Type	Size	Maximum playback time	Comments
CD-DA 	12 cm	74 minutes	—
CD-TEXT 	12 cm	74 minutes	—

Type	Size	Maximum playback time	Comments
CD-R/RW 	12 cm	—	•Disc containing MP3 files

Discs That May Not Be Played Back

- Playback of discs other than those described in “Types of Disc That Can Be Played Back” is not guaranteed.
- 8 cm discs may not be used.
- Do not insert irregularly-shaped discs (for example, heartshaped), as these may result in malfunction. Additionally, discs that have transparent portions may not be played back.
- Discs that have not been finalized cannot be played back.
- Even if recorded using the correct format on a recorder or computer, application software settings and environments; disc peculiarities, damage, or marking; or dirt or condensation on the lens inside the product may render the disc unplayable.
- Depending on the disc, some functions may not be used, or the disc may not play back.
- Do not use discs with cracks or warps.
- If the disc has stickers affixed, remains from removed stickers, or affixed adhesive, then do not use the disc.
- Discs that have decorative labels or stickers may not be used.

Nonstandard CDs

This product will play back audio CDs, however please be aware of the following points regarding CD standards.

- Ensure that you use discs with  on the label surface.

- Playback of other than standard CDs is not guaranteed. Even if the audio can be played back, the audio quality cannot be guaranteed.
- When playing back other than standard CDs, the following may occur.
 - There may be noise during playback.
 - There may be jumping in the audio.
 - The disc may not be recognized.
 - The first track may not be played back.
 - It may take longer than usual until start of playback of tracks.
 - Playback may start from within the track.
 - Some parts may not be played back.
 - Tracks may freeze during playback.
 - Tracks may be displayed erroneously.

Audio Files (MP3/WMA/AAC)

E00736100026

This product can play back MP3/WMA/AAC format audio files recorded on CD-ROM, CD-R/RW, and USB devices.

There are limitations on the files and media that can be used, therefore read the following prior to recording MP3/WMA/AAC format audio files on discs or USB devices. Additionally, ensure you read the user manuals for your CDR/RW drive and the writing software, and ensure these are used correctly.

If the MP3/WMA/AAC format audio files includes title information or other data, then this can be displayed.

CAUTION

- CD-ROM and CD-R/RW media can only play back MP3 format audio files.
- Actions such as copying audio CDs or files and either distributing these to others for free or for charge, or uploading files via the Internet or other means to servers is an infringement of the law.

⚠ CAUTION

- Do not append the file extensions “.mp3”, “.wma”, or “.m4a”, to other than MP3/WMA/AAC format files. Playing back discs with these types of files recorded upon them may cause the files to be incorrectly identified for playback, which may lead to loud noise, resulting in speaker damage or accident.

NOTE

- Depending on the condition of the disc recorder or recording software used, correct playback may not be possible. In these cases, refer to the user manual for your product or software.
- Depending on your computer’s operating system, version, software, or settings, files may not have a file extension appended. In these cases, append the file extensions “.mp3”, “.wma”, or “.m4a” when copying the files.

- Files larger than 2GB in size cannot be played back.

Data Formats That Can Be Played Back

E00736200027

Data formats that can be played on discs (CD-ROM, CDR/RW) and USB devices differ.

Data format	DISC	USB device
MP3	○	○
WMA	X	○
AAC	X	○

Folder Structure

E00736300044

Up to 8 folder levels can be recognized.

You can create a folder structure as in Genre - Artist - Album - Track (MP3/WMA/AAC format audio files) for management of tracks.

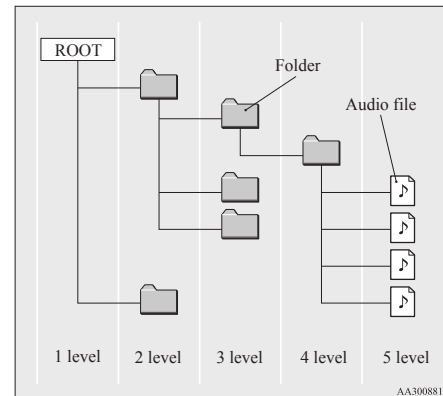

AA3008816

Name	Specification	Explanation	
Format specifications	ISO9660	Level 1	Maximum 8 character file name, and 3 character file extension. (single-byte alphanumeric capital letters, numerals, “_” may be used)
	ISO9660 extension	Joliet	
Multisession	Not supported (only first session supported)		
Maximum number of levels	8 levels (if the root is the 1 st level)		
Maximum folder number	700 folders (including root)		
Maximum file number*1	65535 files (total number on media. Other than MP3, WMA, and AAC files not included)		

Name	Specification	Explanation
File name and folder name restrictions	Maximum 64 bytes (for Unicode, 32 characters), files/folders with file/folder names longer than this will not be displayed or played back.	
USB supported formats	The recommended file system is FAT32. 1 partition only	

*1: Do not include other than MP3/WMA/AAC files. However, if storing many tracks within the same folder, these may not be recognized even if less than the maximum number of tracks. In these cases, divide the tracks up into multiple folders.

NOTE

- The order in which folders and audio files are displayed on this product may be different to how they are displayed on a computer.

What Is MP3?

E00736400029

MP3 is the abbreviation of “MPEG-1 Audio Layer 3”. MPEG is an abbreviation of “Motion Picture Experts Group”, and this is a video compression standard used in video CDs, etc.

MP3 is one of the audio compression methods contained in the MPEG audio standard, and reduces the quality of sounds that are beyond the auditory resolution of the human ear and that are hidden by louder sounds, thus creating high-quality data with a lower data size.

This can compress CD audio to approximately 1/10 its original data size without perceptible loss, approximately 10 CDs can be written to a single CD-R/RW disc.



CAUTION

- **MP3 files different to the standards at right may not play back correctly, or file/folder names may not be displayed correctly.**

Standards for MP3 Files That Can Be Played Back

Specifications for MP3 files that can be played are as shown below.

Item	Details
Specification	MPEG-1 AUDIO LAYER3
	MPEG-2 AUDIO LAYER3
Sampling frequency [kHz]	MPEG-1: 32/44.1/48
	MPEG-2: 16/22.05/24
Bit rate [kbps]	MPEG-1: 32 to 320
	MPEG-2: 8 to 160
VBR (variable bit rate)	Support
Channel mode	Stereo/ Joint stereo/ Dual channel/ Monaural
File extension	mp3

Item	Details
Supported tag information	ID3 tag Ver. 1.0, Ver. 1.1, Ver. 2.2, Ver. 2.3, Ver. 2.4 (ISO-8859-1, UTF-16 (Unicode)), Titles, Artist name, Album name
Maximum number of characters that can be indicated on the display	64 characters

What Is WMA?

E00736600021

WMA is the abbreviation of Windows Media Audio, and this is an audio compression format from Microsoft. This is a compression format that has a higher compression ratio than MP3.

NOTE

- Microsoft, Windows Media, and Windows are registered trademarks of Microsoft Corporation (USA) and in other countries.

CAUTION

- WMA supports digital rights management (DRM). This product cannot play back WMA files protected using this system.
- WMA files different to the standards at right may not play back correctly, or file/folder names may not be displayed correctly.
- “Pro”, “Lossless”, and “Voice” are not supported.

Standards for WMA Files That Can Be Played Back

Specifications for WMA files that can be played are as shown below.

Item	Details
Specification	Windows Media Audio Version7.0/8.0/9.0
Sampling frequency [kHz]	32/44.1/48
Bit rate [kbps]	48 to 320
VBR (variable bit rate)	Support
Channel mode	Stereo/Monaural
File extension	wma
Supported tag information	WMA tags Title name, Artist name, Album name

Item	Details
Maximum number of characters that can be indicated on the display	64 characters

What is AAC?

E0073680023

AAC is the abbreviation of Advanced Audio Coding, and this is an audio compression standard used in “MPEG-2” and “MPEG-4”. This features 1.4x the compression of MP3, with comparable audio quality.

CAUTION

- AAC supports digital rights management (DRM). This product cannot play back AAC files protected using this system.
- AAC files different to the standards at right may not play back correctly, or file/folder names may not be displayed correctly.

Standards for AAC Files That Can Be Played Back

Specifications for AAC files that can be played are as shown below.

Item	Details
Specification	Advanced Audio Coding MPEG4/AAC-LC MPEG2/AAC-LC

Item		Details
Sampling frequency [kHz]	MPEG4	8/11.025/12/16/22.05/24/32/44.1/48
	MPEG2	8/11.025/12/16/22.05/24/32/44.1/48
Bit rate [kbps]	MPEG4	8 to 320
	MPEG2	8 to 320
VBR (variable bit rate)	Support	
Channel mode	Stereo/Monaural	
File extension	m4a	
Supported tag information	AAC tags or ID3 tags Title, Artist name, Album name	
Maximum number of characters that can be indicated on the display	64 characters	

Important Points on Safety for the Customer

E0073700035

This product features a number of pictorial indications as well as points concerning handling so that you can use the product correctly and in a safe manner, as well as prevent injury or damage to yourself, other users, or property.

⚠ WARNING

- The driver should not pay close attention to the display while driving.
This may prevent the driver looking where they are going, and cause an accident.
- The driver should not perform complicated operations while driving.
Performing complicated operations while driving may prevent the driver looking where they are going, and cause an accident.
Therefore stop the vehicle in a safe location before performing such operations.
- Do not use during malfunctions, such as when no sound is audible.
This may lead to accident, fire, or electric shock.
- Ensure water or other foreign objects do not enter the product.
This may lead to smoking, fire, electric shock, or malfunction.
- Do not insert foreign objects into the disc slot.
This may lead to fire, electric shock, or malfunction.

⚠ WARNING

- In the event of abnormalities occurring when foreign objects or water enter the product, resulting in smoke or a strange smell, immediately stop using the product, and consult a MITSUBISHI MOTORS Authorized Service Point.
Continuing to use the product may result in accident, fire, or electric shock.
- Do not disassemble or modify the product.
This may lead to malfunction, fire, or electric shock.
- During thunderstorms, do not touch the antenna or the front panel.
This may lead to electrical shock from lightning.

⚠ CAUTION

- Do not block ventilation holes or heat sinks on the product.
Blocking ventilation holes or heat sinks may prevent heat from escaping from within the product, leading to fire or malfunction.
- Do not turn the volume up to the extent that you cannot hear sounds from outside the vehicle while driving.
Driving without being able to hear sounds from outside the vehicle may result in an accident.
- Do not insert your hand or fingers into the disc slot.
This may result in injury.

Operation Keys

E00737100023

Turn the Power ON/ OFF

E00737200024

1. Press the PWR/VOL key.

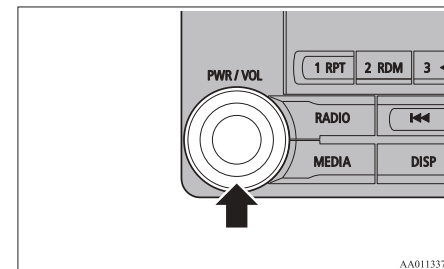

AA0113377

Turn the power on, and resume playback from the previous status.

2. Press the PWR/VOL key.
Turn the power OFF.

NOTE

- Hold down the steering MODE key to also turn the audio function ON/OFF.

Adjust Volume

E00737300025

1. Turn the PWR/VOL key to adjust the volume.

For pleasant driving

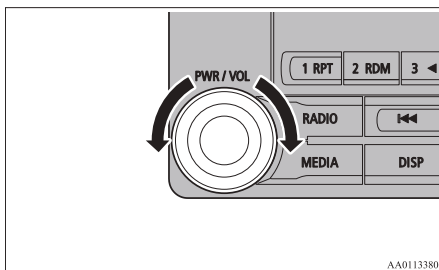

Turn the PWR/VOL key clockwise to increase, and counter-clockwise to decrease the volume.

NOTE

- The maximum value for volume is 45, and the minimum is 0.
- The initial setting for volume is “17”.

Push the disc in a certain amount, and the product will pull the disc in, and playback will start.

2. Press the  key.
This will eject the disc from the product, so remove the disc.

CAUTION

- When replacing discs, first ensure that the vehicle is stopped in an area in which stopping is permitted.
- Do not insert your hand, fingers, or foreign objects into the disc slot. This may lead to injury, smoking, or fire.
- 8 cm CDs are not supported.

5

Insert/Eject Discs

E0073740026

1. Insert the disc into the disc slot with the label surface up.

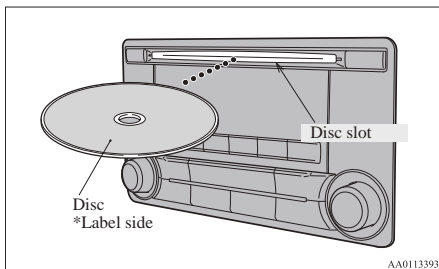

Explanation of Buttons

This explains names and functions of each part.

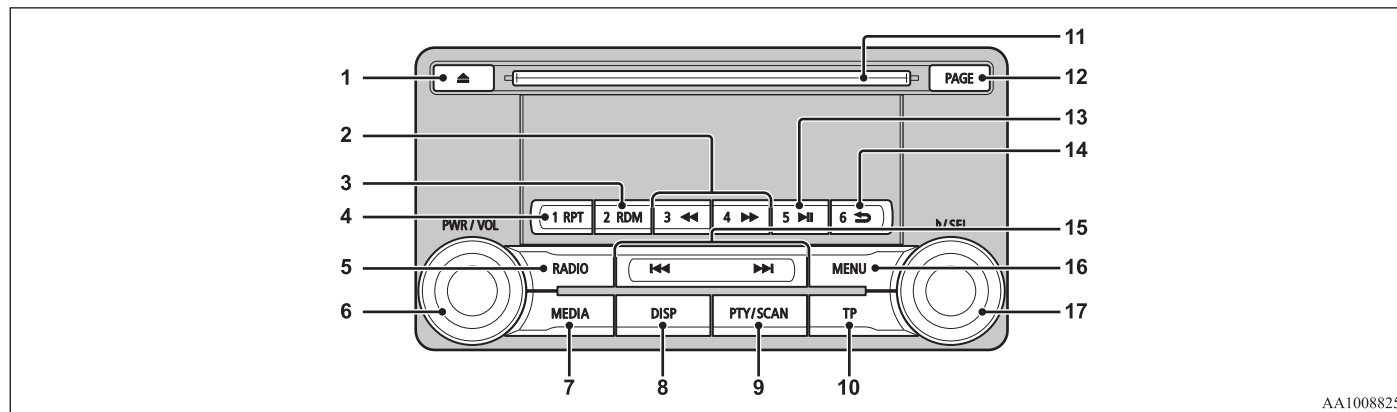

AA1008825

- | | |
|---|---|
| <p>1- ▲ key
Use to eject a disc.</p> <p>2- 3◀◀ key/4▶▶ key
For audio, rewind/fast forward.
For radio, use as preset keys 3 and 4.</p> <p>3- 2RDM key
For audio, play random playback; for radio, use as preset key 2.</p> <p>4- 1RPT key
For audio, play repeat playback; for radio, use as preset key 1.</p> <p>5- RADIO key
Switch the radio and the band.</p> <p>6- PWR/VOL key
Adjust the volume, and turn the power ON/OFF.</p> <p>7- MEDIA key
Switch between CD and other sources.</p> | <p>8- DISP key
Switch the content of the display.</p> <p>9- PTY/SCAN key
For audio, play scan playback; for radio, search PTY.</p> <p>10- TP key
Receive traffic messages.</p> <p>11- Disc slot</p> <p>12- PAGE key
Display indicator page advance.</p> <p>13- 5 ▶▶ key
Play/Pause Bluetooth Audio*, and use as preset key 5 for radio.</p> <p>14- 6 ◀ key
Return during audio track search, and stop Bluetooth Audio*.
For radio, use as preset key 6.</p> |
|---|---|

For pleasant driving

15-  key/ key

For audio, select audio track/file; for radio, perform automatic station selection.

16- MENU key

Switch to Menu mode.

17-  /SEL key

Adjust audio quality and select items.

For radio, manually select stations.

*: Requires a separately-purchased Bluetooth-capable audio device in equipment by type (vehicles with a Bluetooth[®] 2.0 interface).

Steering wheel audio remote control switches*

E0073760099

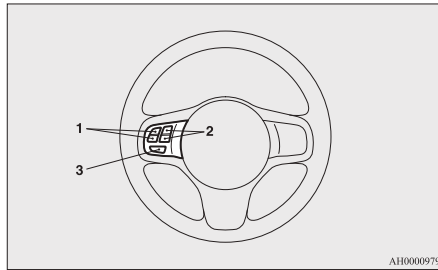

AH0000979

- 1- Vol + key, - key
Adjust audio functions and the mobile phone function volume.
- 2- CH ∇ key, \blacktriangle key
Select CD and other audio source tracks and radio stations. Hold down to skip up and down through tracks.
- 3- MODE Key
Hold down to turn the audio function ON/OFF. Additionally, each time this is pressed, this switches the audio source. The order of switching is as shown below. If devices are not connected, then these are to be skipped, and the next source selected.

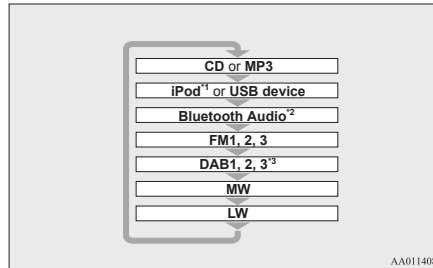

AA0114084

- *1: An iPod cable (available separately) is required.
- *2: Requires a separately-purchased Bluetooth-capable audio device (vehicles with a Bluetooth® 2.0 interface).
- *3: Requires DAB tuner connection.

Listen to Radio

E0073770032

This explains how to listen to FM, MW, and LW radio broadcasts.

To Listen to the Radio

Press the RADIO key to switch the band.

Switch between FM1, FM2, FM3, MW, and LW bands.

The selected band is indicated on the display.

NOTE

- This switches in the order FM1, FM2, FM3, DAB1*, DAB2*, DAB3*, MW, and LW.
*:When a DAB tuner is connected.

Manual/Seek Station Selection

Turn the \blacktriangleright /SEL key to the frequency to listen to.

\blacktriangleright /SEL key (counter-clockwise)	Reduces the frequency being received.
\blacktriangleright /SEL key (clockwise)	Increases the frequency being received.
$\blacktriangleright\blacktriangleright$ key (hold down)	Release the button to start seek station selection, and when a station is received, scanning stops.
$\blacktriangleleft\blacktriangleleft$ key (hold down)	

Preset Memory

Register the broadcast station in advance, and select this at a later time.

1. Tune in to the frequency to register.

For pleasant driving

2. Hold down any of the keys from the 1RPT key to the 6  key.

A “Beep” sounds, and the preset key is registered.

NOTE

- The preset memory can register a maximum of 6 stations for each band (FM1, FM2, FM3).
- If a preset key that already has a station registered is selected, then this is overwritten with the new preset.
- Pressing the preset key will select the previously registered frequency.

Auto Memory (Auto Store)

The top 6 stations with a strong signal can be automatically registered in order with preset keys.

Hold down the RADIO key.

After completion of auto store operations, the product will receive the station registered in the preset key [1].

CAUTION

- Please be aware that the formerly-registered frequency in the memory will be overwritten.

NOTE

- Using auto store for FM1 and FM2 switches to FM3.

PTY Search

Select PTY (program content), and automatically scan for stations.

1. During FM reception, press the PTY/SCAN key.

This switches to the PTY selection mode.

2. Turn the /SEL key to select PTY.

The PTY (program content) indicator will flash, and station selection will automatically start. When a station is received, the station name is displayed.

NOTE

- This receives the station detected first.
- 10 seconds after reception, PTY search mode will be cancelled.

Listen to DAB*

E00739100014

This explains how to listen to DAB.





To listen to DAB





1. Press the RADIO key to switch the band. Switch between DAB1, DAB2, and DAB3 bands. The selected band is indicated on the display.

NOTE

- This switches in the order FM1, FM2, FM3, DAB1, DAB2, DAB3, MW, and LW.

Select a Service

1. Hold down the  key or the  key. Receives the lead services of the ensembles that can be received.
2. Press the  key or the  key to select the service.

 key (hold down)	Automatically receives lower lead services within ensembles that can be received.
 key (hold down)	Automatically receives higher lead services within ensembles that can be received.
 key	Switches to lower services.
 key	Switches to higher services.

NOTE

- Going to the first service or last service within the ensemble switches to the next ensemble.

Register the Service

Register the service in advance, and select this at a later time.

1. Tune in to the service to register.
2. Hold down any of the keys from the 1RPT key to the 6 ➤ key.
A “Beep” sounds, and the preset key is registered.

NOTE

- If a preset key that already has a service registered is selected, then this is overwritten with the new preset.
- Pressing the preset key will select the previously registered service.

Search for a Service

Search for ensembles and services that can be received.

1. Turn the ▶/SEL key to select the ensemble.
2. Press the ▶/SEL key.
The service name within the selected ensemble is displayed.
3. Turn the ▶/SEL key to select the service.
4. Press the ▶/SEL key.
Receive the selected service.

NOTE

- If the text information for the service name cannot be obtained, then nothing is displayed.
- If there is no operation for 10 seconds, then service search mode will be cancelled.

PTY Search

Select PTY (program content), and automatically scan for services.

1. Press the PTY/SCAN key.
This switches to the PTY selection mode.
2. Turn the ▶/SEL key to select PTY.
3. Press the ◀◀ key or ▶▶ key.
This starts PTY search.

◀◀ key	Lower PTY search starts.
▶▶ key	Higher PTY search starts.

NOTE

- When selecting PTY, press any of the keys from the 1RPT key to the 6 ➤ key to switch to the PTY registered as a preset.
- When selecting PTY, select the PTY to register, and hold down any of the keys from the 1RPT key to the 6 ➤ key to register the PTY as a preset.
- While in PTY select status, if there is no operation for 2 seconds, then an upwards search within the selected PTY will start.

Listen to Traffic Messages

E00739200015

This explains how to listen to traffic messages.

To Listen to Traffic Messages

1. When not in MW or LW mode, press the TP key.
If traffic messages are being broadcast, these are received.



CAUTION

- When receiving a MW or LW signal, traffic messages cannot be received.

NOTE

- Receiving traffic messages will indicate “TRAF INF” on the display, and if text information can be received, the station name is displayed.
- If traffic messages are received, then this will switch to the volume of the previously received traffic messages or emergency broadcasts. The volume when receiving traffic messages or emergency broadcasts is that at which subsequent broadcasts will be received.

Traffic Message Standby Mode

When the broadcast of traffic messages starts, this automatically switches to the station that is broadcasting traffic messages.

1. When not in MW or LW mode, press the TP key.
“TP” is indicated on the display, and the product switches to standby mode.
If traffic messages are being broadcast, these are received.

For pleasant driving

- When not in MW or LW mode, press the TP key.
“TP” disappears from the display, and standby mode will be cancelled.

CAUTION

- When receiving a MW or LW signal, traffic message standby mode will be cancelled.

Listen to CDs

E0073780059

This explains how to listen to audio CDs (CD-DA/CD-TEXT).

Play CDs

Insert the disc.

Insert a disc to automatically start playback. → “Insert/Eject Discs” on page 5-18
If a disc is already within the product, press the MEDIA key to switch to CD as the source.

Select the Track

Press the ◀◀ key or ▶▶ key to select the track.

This enables selection of the next or previous track.

Fast Forward or Rewind

Hold down the 3◀◀ key or the 4▶▶ key.

Fast forward/rewind is possible.

Switch Playback Mode

Repeat playback, random playback, and scan playback are possible.

Repeat Playback (RPT)

Press the 1RPT key.

Repeat playback of the track currently being played.

NOTE

- Pressing again will cancel.

- Selecting a track, ejecting, fast forwarding, or rewinding will cancel.

Random Playback (RDM)

Press the 2RDM key.

Play the tracks on the disc in a random order.

NOTE

- Pressing again will cancel.
- Ejecting will cancel this.

Scan Playback (SCAN)

Press the PTY/SCAN key.

Play the first 10 seconds of each of the tracks on the whole disc in order.

NOTE

- Press this button again during playback if you wish to hear that track, and that track will play normally.

Listen to MP3s

E00737900034

This explains how to listen to audio files on a disc.

CAUTION

- CD-ROM and CD-R/RW media can only play back MP3 format audio files.

To Listen to MP3s

Insert the disc.

Insert a disc to automatically start playback. → “Insert/Eject Discs” on page 5-18
If a disc is already within the product, press the MEDIA key to switch to CD as the source.

NOTE

- Depending on the file structure, it may take some time to read the contents of the disc.

Select the Track (File)

Press the ◀◀ key or ▶▶ key to select the track.

This enables selection of the next or previous track.

Fast Forward or Rewind

Hold down the 3◀◀ key or the 4▶▶ key.

Fast forward/rewind is possible.

Switch Playback Mode

Repeat playback, random playback, and scan playback are possible.

Repeat Playback (RPT)

Press the 1RPT key.

Repeat playback of the track currently being played.

NOTE

- Pressing again will cancel.
- Selecting a file, ejecting, fast forwarding, or rewinding will cancel.

Folder Repeat Playback

Hold down the 1RPT key.

Repeat playback of the tracks within the folder currently being played.

NOTE

- Pressing again will cancel.
- Even if the file is selected, folder repeat playback will not be cancelled.

Random Playback (RDM)

Press the 2RDM key.

Play the tracks in the folder in a random order.

NOTE

- Pressing again will cancel.

Folder Random Playback

Hold down the 2RDM key.

Play all tracks in folders on the disc in a random order.

NOTE

- Pressing again will cancel.

Scan Playback (SCAN)

Press the SCAN key.

Play the first 10 seconds of each of the tracks in the folder currently being played in order.

Search Tracks

Search folders and files, and select a track.

1. Turn the ▶/SEL key to select the folder.
2. Press the ▶/SEL key.

Files within the selected folder are displayed.

3. Turn the ▶/SEL key to select the file.
4. Press the ▶/SEL key.

This plays the selected file (track).

NOTE

- While the folder is selected, press the 6 ➡ key to cancel track search mode.
- If there is no operation for 10 seconds after selecting the folder, then track search mode will be cancelled.
- Select the folder, and hold down the ▶/SEL key to start playback from the first track in that folder.
- While the file is selected, press the 6 ➡ key to return to the previous operation.
- While the file is selected, hold down the 6 ➡ key to cancel track search mode.
- If there is no operation for five seconds after selecting the file, that file is played back.
- Disc operations such as selecting a track will cancel track search mode.

Listen to an iPod

E00738000045

By connecting commercially-available iPod/iPhone devices to this product, you can play back tracks on these through the product.

CAUTION

- Do not leave the iPod/iPhone unattended in the vehicle.
- Never hold these devices in your hand to operate while driving, as this is dangerous.
- No indemnification for data loss resulting when the iPod/iPhone is connected to the product will be possible.
- Depending on how the devices are handled, audio files being damaged or lost, therefore it is recommended that data be backed up.

5

NOTE

- Depending on the generation, model, or software version of the iPod/iPhone, playback on this product may not be possible. (→5-10) Additionally, playback as explained in this document may not be possible.
- Regarding details such as types of iPod/iPhone that can be connected to equipment by type (vehicles with a Bluetooth® 2.0 interface), and types of files that can be played back, refer to “Types of connectable devices and supported file specifications” on page 5-57.
- Usage of iPod/iPhone hardware with the latest software version is recommended.

- Regarding how to connect the iPod/iPhone, refer to “How to connect an iPod” on page 5-56.
- When connecting the iPod/iPhone, use a commercially available iPod connection cable.
- Set up the device in order that no unsafe actions, such as plugging in the connection cable are taken while driving.
- When inserting and removing the iPod/iPhone, for safety’s sake first stop the vehicle.
- Depending on the status of the iPod/iPhone, it may take some time until the device is recognized, or playback starts.
- Buttons on the product will not operate while iPod/iPhone is connected.
- iPod/iPhone specifications and settings may mean that connection is not possible, or result in differences in operation or display.
- Depending on audio data in the iPod/iPhone, track information may not be displayed correctly.
- Depending on the status of the vehicle and device, the iPod/iPhone may not play back after starting the engine.
- Data containing copyright information may not play back.
- It is recommended that the iPod/iPhone equaliser settings be set to flat.
- Operate the iPod/iPhone while connected to this product.
- If the iPod/iPhone is connected via Bluetooth as a Bluetooth-capable audio device, then do not connect the iPod/iPhone using an iPod cable. Connection using both methods will result in erroneous operation.

- If an iPod/iPhone does not operate correctly, then remove the iPod/iPhone from the product, reset, then reconnect.

Play iPod

Press the MEDIA key to set the iPod as the source.

The selected source is indicated on the display.

Select the Track (File)

Press the ◀◀ key or ▶▶ key to select the track.

This enables selection of the next or previous track.

Fast Forward or Rewind

Hold down the 3◀◀ key or the 4▶▶ key.

Fast forward/rewind is possible.

Switch Playback Mode

Repeat playback and shuffle playback are possible.

Repeat Playback (RPT)

Press the 1RPT key.

Repeat playback of the track currently being played.

NOTE

- Pressing again will cancel.

Shuffle Playback (RDM)

Press the 2RDM key.

Play tracks in the category currently being played in a random order.

NOTE

- Pressing again will cancel.

Album Shuffle Playback

Hold down the 2RDM key.

Play back the album in a random order (tracks in any order on the album).

NOTE

- Pressing again will cancel.

Search Tracks

Search categories or track names, and select a track.

1. Turn the **▶** /SEL key to select the category.
2. Press the **▶** /SEL key. Categories or tracks within the selected category are displayed.
3. Turn the **▶** /SEL key to select the category or track.
4. Press the **▶** /SEL key.
Repeat steps 1 to 4, and search for tracks.
Select the track, and press the **▶** /SEL key to play.

NOTE

- While the category (1st level) is selected, press the 6 **⇒** key to cancel track search mode.
- If there is no operation for 10 seconds after selecting the category, then track search mode will be cancelled.
- Select the category, and hold down the **▶** /SEL key to start playback from the first track in that category.

- While the track is selected, press the 6 **⇒** key to return to the previous operation.
- While the track is selected, hold down the 6 **⇒** key to cancel track search mode.
- If there is no operation for five seconds after selecting the track, that file is played back.
- iPod operations such as selecting a track will cancel track search mode.

Listen to Audio Files on a USB Device

E00736500062

By connecting commercially-available USB devices such as USB memory to this product, you can play back audio files on these through the product.

⚠ CAUTION

- Do not leave the USB device unattended in the vehicle.
- Never hold these devices in your hand to operate while driving, as this is dangerous.
- Do not use hard discs, card readers, or memory readers, as damage may occur to these or to the data contained therein. If these are erroneously connected, then turn the engine ignition "OFF", then remove.
- Because of the risk of data loss, it is recommended that files be backed up.
- No guarantee is made as regards damage to the USB device, nor regarding loss or damage to data contained therein.
- Depending on how the devices are handled, audio files being damaged or lost, therefore it is recommended that data be backed up.

NOTE

- Regarding details such as types of USB devices that can be connected, and USB input ports, refer to "Device types" on page 5-57.

For pleasant driving

- Regarding details of types of files that can be played back in equipment by type (vehicles with a Bluetooth® 2.0 interface), refer to “File specifications” on page 5-58.
- Regarding how to connect USB devices, refer to “How to connect a USB memory device” on page 5-56.
- When connecting a USB device, use a connection cable. Failure to use a connection cable when connecting may place undue load on, or damage the USB connector.
- Set up the device in order that no unsafe actions, such as plugging in the connection cable are taken while driving.
- When inserting and removing the USB device, for safety’s sake first stop the vehicle.
- Do not insert other than audio devices into the USB port. Damage to the device or equipment may result.
- Depending on the status of the USB device, it may take some time until the device is recognized, or playback starts.
- Buttons on the product will not operate while USB device is connected.
- USB device specifications and settings may mean that connection is not possible, or result in differences in operation or display.
- Depending on audio data in the USB device, track information may not be displayed correctly.
- Depending on the status of the vehicle and device, the iPod/iPhone may not play back after starting the engine.
- Data containing copyright information may not play back.
- This product can play back MP3, WMA, and AAC format audio files.

- Depending on the type of USB device, usage may not be possible, or functions that can be used may be restricted.
- The recommended file system for USB memory is FAT32.
- The maximum supported capacity for USB memory is 32GB.
- Operate the USB device containing recorded audio files while connected to this product.

Play Back of Audio Files on a USB Device

Press the MEDIA key to set

USB as the source. The selected source is indicated on the display.

Select the Track (File)

Press the ◀◀ key or ▶▶ key to select the track.

This enables selection of the next or previous track.

Fast Forward or Rewind

Hold down the 3◀◀ key or the 4▶▶ key.

Fast forward/rewind is possible.

Switch Playback Mode

Repeat playback, random playback, and scan playback are possible.

Repeat Playback (RPT)

Press the 1RPT key.

Repeat playback of the track currently being played.

NOTE

- Pressing again will cancel.
- Selecting a file will cancel this.

Folder Repeat Playback

Hold down the 1RPT key.

Repeat playback of the tracks within the folder currently being played.

NOTE

- Pressing again will cancel.
- Even if the file is selected, folder repeat playback will not be cancelled.

Folder Random Playback (RDM)

Press the 2RDM key.

Play tracks in the folder currently being played in a random order.

NOTE

- Pressing again will cancel.
- Even if the file is selected, folder random playback will not be cancelled.

All Folder Random Playback

Hold down the 2RDM key.

Play the tracks in all folders in a random order.

NOTE

- Pressing again will cancel.
- Even if the file is selected, all folder random playback will not be cancelled.

Scan Playback (SCAN)

Press the PTY/SCAN key.

Play the first 10 seconds of each of the tracks on the whole USB device in order.

NOTE

- Press this button again during playback if you wish to hear that track, and that track will play normally.

Folder Scan Playback

Hold down the PTY/SCAN key.

Play the first 10 seconds of the first track in each folder on the USB device in order.

NOTE

- Press this button again during playback if you wish to hear that track, and that track will play normally.

Search Tracks

Search folders and files, and select a track.

1. Turn the **▶/SEL** key to select the folder.
2. Press the **▶/SEL** key.

Files within the selected folder are displayed.

3. Turn the **▶/SEL** key to select the file.
4. Press the **▶/SEL** key.

This plays the selected file (track).

NOTE

- While the folder is selected, press the **6 ↵** key to cancel track search mode.

- If there is no operation for 10 seconds after selecting the folder, then track search mode will be cancelled.
- Select the folder, and hold down the **▶/SEL** key to start playback from the first track in that folder.
- While the file is selected, press the **6 ↵** key to return to the previous operation.
- While the file is selected, hold down the **6 ↵** key to cancel track search mode.
- If there is no operation for five seconds after selecting the file, that file is played back.
- Operations such as selecting a track will cancel track search mode.

Listen to Bluetooth Audio*

E00736700077

This product can play back tracks on commercially-available Bluetooth-capable audio devices.

⚠ CAUTION

- **Never hold these devices in your hand to operate while driving, as this is dangerous.**
- **Do not leave the Bluetooth audio device unattended in the vehicle.**
- **Depending on how the devices are handled, audio files being damaged or lost, therefore it is recommended that data be backed up.**

NOTE

- Depending on the type of Bluetooth-capable audio devices, usage may not be possible, or functions that can be used may be restricted.
- Confirm together with the user manuals for the commercially- available Bluetooth-capable audio devices.
- Depending on the type of Bluetooth-capable audio devices, volume levels may differ. There is the danger of loud volumes, so prior to use, it is recommended that you turn the volume down.
→ “Adjust Volume” on page 5-17
- Depending on the status of the Bluetooth audio device, it may take some time until the device is recognized, or playback starts.

For pleasant driving

- Bluetooth audio device specifications and settings may mean that connection is not possible, or result in differences in operation or display.
- Depending on audio data in the Bluetooth audio device, track information may not be displayed correctly.
- Depending on the status of the vehicle and device, the iPod/iPhone may not play back after starting the engine.

Connect a Bluetooth-capable Audio Device

Regarding how to connect your Bluetooth device, refer to “Connecting the Bluetooth® 2.0 interface and Bluetooth® device” on page 5-44.

Operation methods below describe situations once connection has been completed.

NOTE

- If the iPod/iPhone is connected via Bluetooth as a Bluetooth-capable audio device, then do not connect the iPod/iPhone using an iPod cable. Connection using both methods will result in erroneous operation.

Play Bluetooth Audio

1. Press the MEDIA key to set Bluetooth Audio as the source.

The selected source is indicated on the display.

2. Press the 5 **▶||** key. Bluetooth Audio playback starts.

NOTE

- Hold down the 5 **▶||** key to pause.
- Press the 6 **➔** key to stop.

Select the Track (File)

Press the **◀◀** key or **▶▶** key to select the track.

This enables selection of the next or previous track.

Fast Forward or Rewind

Hold down the **◀◀** key or the **▶▶** key.

Fast forward/rewind is possible.

Switch Playback Mode

Repeat playback, random playback, and scan playback are possible.

Repeat Playback (RPT)

Press the 1RPT key.

Repeat playback of the track currently being played.

NOTE

- Each time the 1RPT key is pressed, this switches in the order Repeat OFF, 1 track repeat, All track repeat, and Repeat OFF.

Random Playback (RDM)

Press the 2RDM key.

Play the tracks in the Bluetooth Audio device in a random order.

NOTE

- Pressing again will cancel.

Scan Playback (SCAN)

Press the PTY/SCAN key.

Play the first 10 seconds of each of the tracks on the whole Bluetooth Audio device in order.

NOTE

- Press this button again during playback if you wish to hear that track, and that track will play normally.

Display Indicator

E00738100033

This explains content of the display indicator.

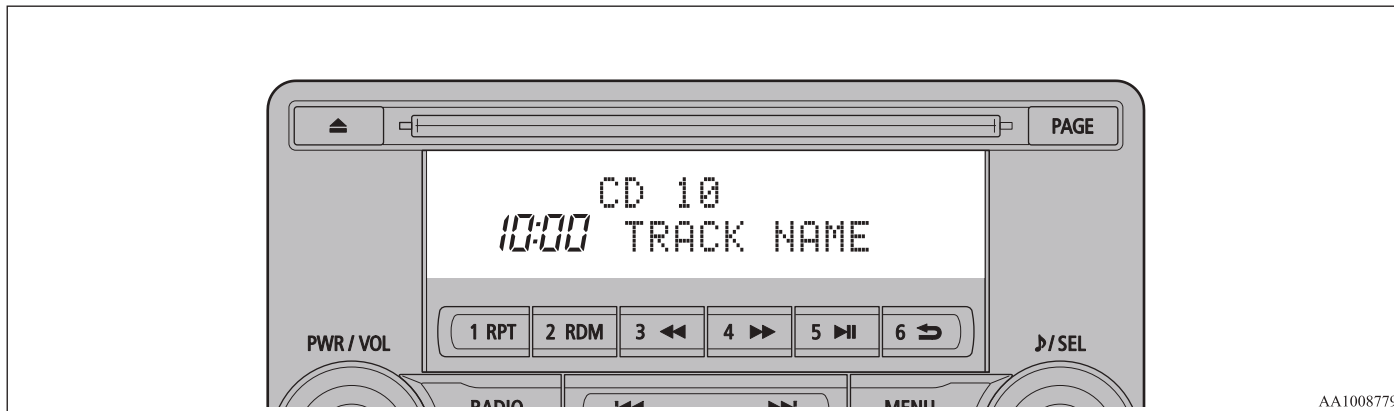

AA1008779

For pleasant driving

Change the Display Mode

E00738500037

You can change the content of the display indicator.

Press the DISP key to switch the display content.

Each time the DISP key is pressed, the display content changes.

CAUTION

- The operation of changing display contents may impede safe driving, therefore check safety before operation.

NOTE

- Up to 11 characters may be displayed at one time. To display 12 or more characters, press the PAGE key, and subsequent characters will be displayed.

5 *During DAB Reception**

This switches in the order “Service name”, “Ensemble name”, and “CH no. (CH ID)”.

NOTE

- If the text information for the service name and ensemble name cannot be obtained, then nothing is displayed.

During CD-DA playback

This switches in the order “Disc title”, “Track title”, and “Operating status”.

NOTE

- If there is no text information to display, then “NO TITLE” is displayed.

During MP3/WMA/AAC Playback

This switches in the order “Folder title”, “File title”, and “Operating status”.

NOTE

- If there is no text information to display, then “NO TITLE” is displayed.

Display the ID3tag

Hold down the DISP key.

This switches the ID3tag display.

[DISP] Each time the key is pressed, this switches in the order “Album name”, “Track name”, “Artist name”, “Genre name”*, and “Operating status”.

- *: Displayed when playing back audio files on a USB device (vehicles with a Bluetooth® 2.0 interface).

NOTE

- During display of the ID3tag, hold down the DISP key to switch to the folder title display.
- The genre name display may not be possible.

During iPod Playback

E00738900028

This switches in the order “Albums”, “Track name”, “Artist name”, “Genre name”*, and “Operating status”.

NOTE

- If there is no text information to display, then “NO TITLE” is displayed.
- Displayed genre name in equipment by type (vehicles with a Bluetooth® 2.0 interface).
- The genre name display may not be possible.

During Bluetooth® 2.0 Audio Playback*

E00739000013

Operating details are the same as in “During iPod Playback” on page 5-32.

Audio Quality and Volume Balance Adjustment

E00738200021

Change audio quality settings.

Adjust Audio Quality and Volume Balance

- Press the **▶** /SEL key to select settings items.
Each time the **▶** /SEL key is pressed, this switches in the order BASS, TREBLE, FADER, BALANCE, SCV, and Cancel.
- Turn the **▶** /SEL key to adjust.

Ad-just-ment items	Turn counter-clock-wise	Turn clockwise
BASS	-6 to 0 (low low-pass volume)	0 to +6 (high low-pass volume)
TREBLE	-6 to 0 (Low high-pass volume)	0 to +6 (High high-pass volume)
FADER	CENTER to REAR 11 (emphasise REAR)	FRONT 11 to CENTER (emphasise FRONT)
BALANCE	LEFT 11 to CENTER (emphasise LEFT)	CENTER to RIGHT 11 (emphasise RIGHT)

Ad-just-ment items	Turn counter-clock-wise	Turn clockwise
SCV	OFF, LOW (Low vehicle compensated volume effect)	MID, HIGH (High vehicle compensated volume effect)

System Settings

E00738300051

Change system settings such as product time.

- Press the MENU key.
- Press the **▶** /SEL key to select settings items.

- Each time the **▶** /SEL key is pressed, this switches in the order Gracenote DB*, PHONE settings, Adjust time, and Cancel.
- Turn the **▶** /SEL key to set.
 - Press the **▶** /SEL key to determine.

This completes settings, and displays the next settings item.

- *: Displayed when playing back audio files (vehicles with a Bluetooth® 2.0 interface).

DAB Setting*

Change DAB settings.
("Set value" bold typeface indicates factory default settings.)

Settings name	Settings value	Settings content
DAB-DAB Link settings	OFF	If low reception sensitivity, switch to another service.
	ON	
DAB Band settings	BAND III	Set used broadcast band to 174 to 239 MHz.

For pleasant driving

Settings name	Settings value	Settings content
	L-BAND	Set used broadcast band to 1452 to 1490 MHz.
	BOTH	Set used broadcast band to Band III and L-Band.

RDS Setting

Change RDS settings.

("Set value" bold typeface indicates factory default settings.)

Settings name	Settings value	Settings content
AF	AF ON	Automatically track the same station as the program being received.
	AF OFF	Do not automatically track the same station as the program being received.
REG	REG ON	Do not automatically track the local station for the program being received.

Settings name	Settings value	Settings content
REG	REG OFF	Automatically track the local station for the program being received.
TP-S	TP-S ON	Automatically search for traffic messages (TP stations).
	TP-S OFF	Do not automatically search for traffic messages (TP stations).
PI-S	PI-S ON	Search for the same station or local station for that registered in the preset channel.
	PI-S OFF	Do not search for the same station or local station for that registered in the preset channel.
PTY	ENGLISH	Set the display language for the program content search (PTY search) to English.

Settings name	Settings value	Settings content
PTY	FRANCAIS	Set the display language for the program content search (PTY search) to French.
	DEUTSCH	Set the display language for the program content search (PTY search) to German.
	SVENSK	Set the display language for the program content search (PTY search) to Swedish.
	ESPANOL	Set the display language for the program content search (PTY search) to Spanish.
	ITALIANO	Set the display language for the program content search (PTY search) to Italian.
CT	CT ON	Update the time if time data is received.

Settings name	Settings value	Settings content
CT	CT OFF	Do not update the time even if time data is received.

*: It is necessary to press the [TP] key and turn traffic message standby mode “ON”.

Time Setting

Turning the RDS setting CT setting “CT OFF” enables manual setting of the time.

1. Select “YES” at the “Adjust time” screen, and press the **▶/SEL** key.

The hour can be adjusted. Press the **▶/SEL** key again to adjust the minutes.

2. Turn the **▶/SEL** key to adjust the volume.
3. Press the **▶/SEL** key.

This completes the adjustment.

NOTE

- In order to finish adjusting the time, hold down the **▶/SEL** key until the seconds are reset to “00”.

PHONE Settings

Change the mobile phone voice cut- in settings and the Bluetooth® 2.0 interface language.

Depending on the vehicle, PHONE settings may not be possible.

NOTE

- Cancel functions such as the mobile phone “dial lock”, and connect while on the stand-by screen.
- While connected, mobile phone (receiving calls, etc.) operations may not function correctly.
- Depending on the distance between the product and the mobile phone, the conditions within the vehicle, and types of screening, connection may not be possible. In these cases, situate the mobile phone as close as possible to the product.
- Even though a Bluetooth-capable mobile phone, characteristics and specifications may mean that correct operation may not be possible.
- For safety’s sake, do not operate the mobile phone while driving. When operating the mobile phone, first stop the vehicle in a safe location.
- Even though a Bluetooth-capable mobile phone, phone specifications and settings may result in differences in display, or prevent correct operation.
- Some models may not be confirmed as connected, or may not connect.

Supported profiles

Hands-free	HFP(v1.5)
Phone book transfer	OPP(v1.1), PBAP(v1.0)

Vehicles without a Bluetooth® 2.0 Interface

A hands-free kit (available separately) is required. (“Set value” bold typeface indicates factory default settings.)

Settings value	Settings content
PHONE OFF	Do not use mobile phone voice cut-in.
PHONE MUTE	During mobile phone voice cut-in, mute the audio.
PHONE ATT	During mobile phone voice cut-in, output audio from all speakers.
PHONE IN-L	During mobile phone voice cut-in, output sound from the left front speaker.
PHONE IN-R	During mobile phone voice cut-in, output sound from the right front speaker.
PHONE IN-LR	During mobile phone voice cut-in, output sound from the left and right front speakers.

Vehicles with a Bluetooth® 2.0 Interface

(“Set value” bold typeface indicates factory default settings.)

Settings name	Settings value	Settings content
PHONE IN settings	PHONE IN-R	During mobile phone voice cut-in, output sound from the right front speaker.

For pleasant driving

Settings name	Settings value	Settings content
PHONE IN settings	PHONE IN-L	During mobile phone voice cut-in, output sound from the left front speaker.
HFM voice language settings	ENGLISH	Change the hands free module voice language.
	FRENCH	
	GERMAN	
	SPANISH	
	ITALIAN	
	DUTCH	
	PORTUGUESE	
	RUSSIAN	

5

NOTE

- Depending on the vehicle model, this may not display.

Gracenote DB (Vehicles with a Bluetooth® 2.0 interface)

The version number can be confirmed.

1. Select “Gracenote DB” and press the **▶/SEL** key.
2. Turn the **▶/SEL** key and select “DB Version”.
3. Press the **▶/SEL** key.
The DB Version is displayed.

Troubleshooting

E00738400052

Please check these items if a message appears on the display, or if you think something is not working properly.

If This Message Appears...

A message is displayed on this product according to the situation.

Mode	Message	Cause	Response
CD	CHECK DISC	The disc is inserted upside down.	Insert with the label side up.
		The disc has condensation on it.	Wait a while before inserting again.
	DISC ERROR	The disc is damaged.	Clean the read surface of the disc.
		The disc is dirty.	
	INTERNAL E	The drive has malfunctioned for some reason.	Check that there is no problem with the disc, and insert the disc again. If the problem persists, consult a MITSUBISHI MOTORS Authorized Service Point.
HEAT ERROR	The temperature inside the product is high.	Remove the disc, and wait for the internal temperature to return to normal.	
Mode	Message	Cause	Response
USB	FILE ERROR	Files that cannot be played are selected.	Select files that can be played. → “Audio Files (MP3/WMA/AAC)” on page 5-13
	USB BUS PWR	There is high or low electrical current or voltage.	Turn the power OFF and wait a short while. If the problem persists, consult a MITSUBISHI MOTORS Authorized Service Point.
	LSI ERROR	There is an internal malfunction for some reason.	
	UNSUPPORTED	Unsupported audio files have been played.	Confirm audio files that can be played. → “Audio Files (MP3/WMA/AAC)” on page 5-13
	FORMAT		
	UNSUPPORTED	An unsupported USB device has been connected.	Please connect a USB memory device.
	DEVICE		
iPod	NO SONG	An iPod/iPhone not containing any tracks has been connected.	Connect an iPod/iPhone containing tracks.
	VER ERROR	This iPod/iPhone software version is not supported.	Please change to a supported software version.

For pleasant driving

Mode	Message	Cause	Response
Other	ERROR DC	An abnormal direct voltage has been sent to the speakers.	Turn the power OFF and wait a short while. If the problem persists, consult a MITSUBISHI MOTORS Authorized Service Point.

If You Think Something Is Not Working Properly...

Here is a list of symptoms, causes and responses if you think something is not working properly.

Symptoms	Cause	Response
There is no sound or quiet sound.	The volume is turned to its minimum.	Adjust the volume. → “Adjust Volume” on page 5-17
	The balance or fader is turned to one side.	Adjust the balance or fader. → “Adjust Audio Quality and Volume Balance” on page 5-33
The disc cannot be inserted.	A disc is already in the product.	Eject the disc. → “Insert/Eject Discs” on page 5-18
	There is no disc in the product, but the product says it is loading.	Press the eject button once. → “Insert/Eject Discs” on page 5-18
The disc cannot be played.	The disc is inserted upside down.	Insert with the label side up.
	The disc has condensation on it.	Wait a while before inserting.
	The disc is dirty.	Clean the read surface of the disc.
The sound skips in the same place.	The disc is damaged or dirty.	Check the disc.
There is no sound, even if the disc is inserted.	Damage to or dirt on the disc means that its data cannot be read.	Check the disc. Additionally, if using CD-R/RW discs, their characteristics may render them unable to be played.

Antenna

E00710500295

Roof antenna

Before listening to the radio, raise the antenna until you feel a click.

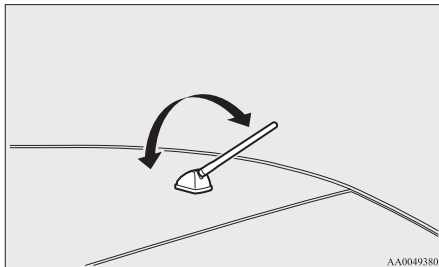

To remove

Turn the pole (A) anticlockwise.

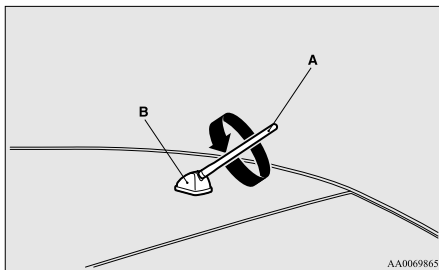

To install

Screw the pole (A) clockwise into the base (B) until it is securely retained.

NOTE

- Be sure to remove the roof antenna in the following cases:
 - When using an automatic car wash.
 - When placing a car cover over the vehicle.
- Before driving into a structure that has a low ceiling, fold down the antenna to prevent it from hitting the ceiling.

Link System*

E00764500256

The Link System takes overall control of the devices connected via the USB input terminal or the Bluetooth® 2.0 interface allowing the connected devices to be operated by using the switches in the vehicle or voice commands.

See the following section for details on how to operate.

Refer to “Bluetooth® 2.0 interface” on page 5-40.

Refer to “USB input terminal” on page 5-56.

Refer to “Listen to Audio Files on a USB Device” on page 5-27.

Refer to “Listen to Bluetooth Audio” on page 5-29.

Bluetooth® is a registered trademark of BLUE-TOOTH SIG, INC.

Link System End User Licence Agreement

E00764600013

You have acquired a device that includes software licensed by MITSUBISHI MOTORS CORPORATION from JOHNSON CONTROLS Inc (the automotive experience business unit), and their subsequent 3rd party suppliers. For a complete list of these 3rd party products and their end user licence agreements, please go to the following website.
<http://www.jciblueconnect.com/faq/fulldisclosure.pdf>

For pleasant driving

Bluetooth® 2.0 interface*

E0072600918

The Bluetooth® 2.0 interface allows for making/receiving hands-free calls in the vehicle using a Bluetooth® compatible cellular phone based on the wireless communication technology commonly known as Bluetooth®. It also allows the user to play music, saved in a Bluetooth® music player, from the vehicle's speakers.

The system is equipped with a voice recognition function, which allows you to make hands-free calls by simple switch operations and voice command operations using a defined voice tree.

The Bluetooth® 2.0 interface can be used when the ignition switch is in the "ON" or "ACC" position.

Before you can use the Bluetooth® 2.0 interface, you must pair the Bluetooth® device and Bluetooth® 2.0 interface. Refer to "Connecting the Bluetooth® 2.0 interface and Bluetooth® device" on page 5-44.

Bluetooth® is a registered trademark of BLUE-TOOTH SIG, INC.

⚠ WARNING

- Although the Bluetooth® 2.0 interface allows you to make hands-free calls, if you choose to use the cellular phone while driving, you must not allow yourself to be distracted from the safe operation of your vehicle. Anything, including cellular phone usage, that distracts you from the safe operation of your vehicle increases your risk of an accident.

⚠ WARNING

- Refer to and comply with all state and local laws in your area regarding cellular phone usage while driving.

NOTE

- If the ignition switch is left in the "ACC" position, the accessory power will automatically turn off after a certain period of time and you will no longer be able to use the Bluetooth® 2.0 interface. The accessory power comes on again if the ignition switch is turned from the "ACC" position. Refer to "ACC power auto-cutout function" on page 4-09.
- The Bluetooth® 2.0 interface cannot be used if the Bluetooth® device has a flat battery or the device power is turned off.
- Hands-free calls will not be possible if your phone does not have service available.
- Some Bluetooth® devices are not compatible with the Bluetooth® 2.0 interface.
- You can confirm the Link System software version by pressing the HANG-UP button 3 times (press and hold 2 times and then press briefly) within 10 seconds.
- For details on the Bluetooth® 2.0 interface, you can see them by accessing the MITSUBISHI MOTORS website. Please read and agree on the "Warning about Links to the Web Sites of Other Companies" because it connects to other than MITSUBISHI MOTORS website. <http://www.mitsubishi-motors.com/en/products/index.html>

- Software updates by cellular phone/digital audio device manufacturers may change/alter device connectivity.

Steering control switch and microphone
→ p. 5-40

Voice recognition function → p. 5-41

Useful voice commands → p. 5-42

Speaker enrollment function → p. 5-43

Connecting the Bluetooth® 2.0 interface and Bluetooth® device → p. 5-44

Operating a music player connected via Bluetooth® → p. 5-47

How to make or receive hands-free calls
→ p. 5-47

Phone book function → p. 5-49

Steering control switch and microphone

E00727200409

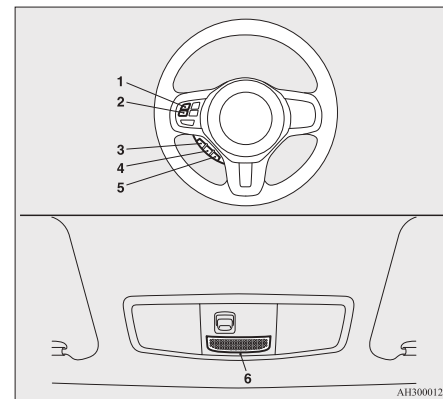

- 1- Volume up button
- 2- Volume down button
- 3- SPEECH button
- 4- PICK-UP button
- 5- HANG-UP button
- 6- Microphone

Volume up button

Press this button to increase the volume.

Volume down button

Press this button to decrease the volume.

SPEECH button

- Press this button to change to voice recognition mode.
While the system is in voice recognition mode, “Listening” will appear on the audio display.
- If you press the button briefly while in voice recognition mode, it will interrupt prompting and allow voice command input.
Pressing the button longer will deactivate the voice recognition mode.
- Pressing this button briefly during a call will enable voice recognition and allow voice command input.

PICK-UP button

- Press this button when an incoming call is received to answer the telephone.
- When another call is received during a call, press this button to put the first caller on hold and talk to the new caller.
 - In such circumstances, you can press the button briefly to switch between callers. You will switch to the first caller and the other caller will be put on hold.

- To establish a three-way call in such situations, press the SPEECH button to enter voice recognition mode and then say “Join calls”.

HANG-UP button

- Press this button when an incoming call is received to refuse the call.
- Press this button during a call to end the current call.
When another call is on hold, you will switch to that call.
- If this button is pressed in the voice recognition mode, the voice recognition mode will be deactivated.

NOTE

- When you press the SPEECH button to enter voice recognition mode with a cellular phone paired to the system, current information on the cellular phone, such as “remaining battery life,” “signal strength” or “roaming,” will be displayed on the audio display.*
*: Some cellular phones will not send this information to the Bluetooth® 2.0 interface.
- Call waiting and three-way calls can be used by the Bluetooth® 2.0 interface, only if it is possible to use those services with your cellular phone.

Microphone

Your voice will be recognized by a microphone in the room lamp (front), allowing you to make hands-free calls with voice commands.

NOTE

- If a cellular phone is brought close to the microphone, it may create noise in the voice on the phone. In such a case, take the cellular phone at a place as far as possible from the microphone.

Voice recognition function

E00727300615

The Bluetooth® 2.0 interface is equipped with a voice recognition function.
Simply say voice commands and you can perform various operations and make or receive hands-free calls.

With the Bluetooth® 2.0 interface, voice recognition is possible for English, French, Spanish, Italian, German, Dutch, Portuguese and Russian. The factory setting is “English” or “Russian.”

NOTE

- If the voice command that you say differs from the predefined command or cannot be recognised due to ambient noise or some other reason, the Bluetooth® 2.0 interface will ask you for the voice command again up to 3 times.
- For best performance and further reduction of ambient noise, close the vehicle windows, lower the blower speed and refrain from conversation with your passengers while engaging the voice recognition function.
- Some voice commands have alternative commands.
- Depending on the selected language, some functions may not be available.

For pleasant driving

Selecting the Language

1. Press the SPEECH button.
2. Say "Setup".
3. Say "Language."
4. The voice guide will say "Select a language: English, French, Spanish, Italian, German, Dutch, Portuguese or Russian" Say the desired language. (Example: Say "English.")
5. The voice guide will say "English (French, Spanish, Italian, German, Dutch, Portuguese or Russian) selected. Is this correct?" Say "Yes."
Answer "No" to return to Step 4.

NOTE

- The voice guide will repeat the same message twice. The first message is in the current language, and the second message is in the selected language.
 - If many entries are registered in the vehicle phone book, changing the language will take longer.
 - Changing the language deletes the mobile phone book imported to the Bluetooth® 2.0 interface. If you wish to use it, you will have to import it again.
6. When the voice guide says "English (French, Spanish, Italian, German, Dutch, Portuguese or Russian) selected," the language change process will be completed and the system will return to the main menu.

Useful voice commands

Help function

E0076000019

E00760100010

The Bluetooth® 2.0 interface is equipped with a help function.

If you say "Help" when the system is waiting for a voice command input, the system will tell you a list of the commands that can be used under the circumstances.

Cancelling

E00760200011

There are 2 cancel functions.

If you are at the main menu, say "Cancel" to exit from the Bluetooth® 2.0 interface.

If you are anywhere else within the system, say "Cancel" to return to the main menu.

Confirmation function setting

E00760400013

The Bluetooth® 2.0 interface is equipped with a confirmation function.

With the confirmation function activated, you are given more opportunities than normal to confirm a command when making various settings to the Bluetooth® 2.0 interface. This allows you to decrease the possibility that a setting is accidentally changed.

The confirmation function can be turned on or off by following the steps below.

1. Press the SPEECH button.
2. Say "Setup."
3. Say "Confirmation prompts."
4. The voice guide will say "Confirmation prompts are <on/off>. Would you like to turn confirmation prompts <off/on>."
Answer "Yes" to change the setting or answer "No" to keep the current setting.
5. The voice guide will say "Confirmation prompts are <off/on>" and then the system will return to the main menu.

Security function

E00760500144

It is possible to use a password as a security function by setting a password of your choice for the Bluetooth® 2.0 interface.

When the security function is turned on, it is necessary to make a voice input of a 4-digit password in order to use all functions of the Bluetooth® 2.0 interface, except for reception.

Setting the password

Use the following procedure to turn on the security function by setting a password.

1. Press the SPEECH button.
2. Say "Setup."
3. Say "Password."
4. The voice guide will say "Password is disabled. Would you like to enable it?" Answer "Yes."
Answer "No" to cancel the setting of the password and return to the main menu.
5. The voice guide will say "Please say a 4-digit password. Remember this password. It will be required to use this system."
Say a 4-digit number which you want to set as a password.
6. For confirmation purposes, the voice guide will say "Password <4-digit password>. Is this correct?" Answer "Yes."
Answer "No" to return to the password input in Step 5.
7. When the registration of the password is completed, the voice guide will say "Password is enabled" and the system will return to the main menu.

NOTE

- Password will be required to access the system after the next ignition cycle.
- It is required for a little time after engine stop that the entered password is actually recorded in the system.

If the ignition switch is made to “ACC” or “ON” or the engine is started immediately after engine stop, there is a case when the entered password is not recorded in the system. At this time, please try to enter the password again.

Entering the password

If a password has been set and the security function is enabled, the voice guide will say “Hands-free system is locked. State the password to continue” when the SPEECH button is pressed to enter voice recognition mode. Say the 4-digit password number to enter the password.

If the entered password is wrong, the voice guide will say “<4- digit password>, Incorrect password. Please try again.” Enter the correct password.

NOTE

- You can reenter the password as many times as you want.
- If you have forgotten your password, say “Cancel” to quit the voice input mode and then check with a MITSUBISHI MOTORS Authorized Service Point.

Disabling the password

Use the following procedure to turn off the security function by disabling the password.

NOTE

- System must be unlocked to disable the password.

1. Press the SPEECH button.
2. Say “Setup.”
3. Say “Password.”
4. The voice guide will say “Password is enabled. Would you like to disable it?” Answer “Yes.”

Answer “No” to cancel the disabling of the password and return to the main menu.

5. When the disabling of the password is completed, the voice guide will say “Password is disabled” and the system will return to the main menu.

Speaker enrollment function

E00727400209

The Bluetooth® 2.0 interface can use the speaker enrollment function to create a voice model for one person per language.

This makes it easier for the Bluetooth® 2.0 interface to recognise voice commands said by you.

You can turn a voice model registered with the speaker enrollment function on and off whenever you want.

Speaker enrollment

E00727500213

It takes about 2 to 3 minutes to complete the speaker enrollment process.

To ensure the best results, run through the process while in the driver’s seat, in an environment that is as quiet as possible (when there is no rain or strong winds and the vehicle windows are closed). Please turn off your phone while in speaker enrollment to prevent interruption of the process.

Use the following procedure for speaker enrollment.

1. Stop your vehicle in a safe area, put the gear-shift lever in the “N” (Neutral) position (M/T), or the gearshift lever in the “P” (PARK) position (Twin Clutch SST), and pull the parking brake lever.

NOTE

- Speaker enrollment is not possible unless the vehicle is parked. Make sure you park the vehicle in a safe area before attempting speaker enrollment.

2. Press the SPEECH button.
3. Say “Voice training”.
4. The voice guide will say “This operation must be performed in a quiet environment while the vehicle is stopped. See the owner’s manual for the list of required training phrases. Press and release the SPEECH button when you are ready to begin. Press the HANG-UP button to cancel at any time.” Press the SPEECH button to start the speaker enrollment process.

NOTE

- If you do not start the speaker enrollment process within 3 minutes after pressing the SPEECH button, the speaker enrollment function will time out. The voice guide will say “Speaker enrollment has timed out.” The system will then beep and the voice recognition mode will be deactivated.

For pleasant driving

5. The voice guide will prompt for phrase 1. Repeat the corresponding phrase listed in table “Enrollment Commands” on page 5-55. The system will register your voice and then move on to the registration of the next command. Continue the process until all phrases have been registered.

NOTE

- To repeat the most recent voice training command, press and release the SPEECH button.
- If you press the HANG-UP button anytime during the process, the system will beep and stop the speaker enrollment process.

6. When all enrollment commands have been read out, the voice guide will say “Speaker enrollment is complete.” The system will then end the speaker enrollment process and return to the main menu.

5

NOTE

- Completing the speaker enrollment process will turn on the voice model automatically.
- The commands “Help” and “Cancel” will not work in this mode.

Enabling and disabling the voice model and re-training

E00727600096

You can turn a voice model registered with the speaker enrollment function on and off whenever you want.

You can also retrain the system.

Use the following procedure to perform these actions.

1. Press the SPEECH button.

2. Say “Voice training”.
3. If you have completed a speaker enrollment process once already, the voice guide will say either “Enrollment is enabled. Would you like to disable or retrain?” or “Enrollment is disabled. Would you like to enable or retrain?”
4. When enrollment is “enabled,” the voice model is on; when enrollment is “disabled,” the voice model is off. Say the command that fits your needs.
Say “Retrain” to start the speaker enrollment process and recreate a new voice model. (Refer to “Speaker enrollment” on page 5-43.)

Connecting the Bluetooth® 2.0 interface and Bluetooth® device

E00760600233

Before you can make or receive hands-free calls or play music using the Bluetooth® 2.0 interface function, you must pair the Bluetooth® device and Bluetooth® 2.0 interface.

NOTE

- Pairing is required only when the device is used for the first time. Once the device has been paired with the Bluetooth® 2.0 interface, you only need to bring the device into the vehicle next time and the device will automatically connect to the Bluetooth® 2.0 interface (if supported by the device). The device must have Bluetooth® turned ON to connect.

Up to 7 Bluetooth® devices can be paired with the Bluetooth® 2.0 interface.

If multiple paired Bluetooth® devices are available in the vehicle, the cellular phone or music player most recently connected is automatically connected to the Bluetooth® 2.0 interface.

You can also change a Bluetooth® device to be connected.

To pair

To pair a Bluetooth® device with the Bluetooth® 2.0 interface, follow the steps below.

1. Stop your vehicle in a safe area, put the gearshift lever in the “N” (Neutral) position (M/T), or the gearshift lever in the “P” (PARK) position (Twin Clutch SST), and pull the parking brake lever.

NOTE

- You cannot pair Bluetooth® devices with the Bluetooth® 2.0 interface unless the vehicle is parked. Before pairing a Bluetooth® device with the Bluetooth® 2.0 interface, confirm that the vehicle is parked in a safe location.

2. Press the SPEECH button.
3. Say “Setup”.
4. Say “Pairing options.”
5. The voice guide will say “Select one of the following: pair, edit, delete, or list.” Say “Pair.”

NOTE

- If 7 devices have already been paired, the voice guide will say “Maximum devices paired” and then the system will end the pairing process. To register a new device, delete one device and then repeat the pairing process.
(Refer to “Selecting a device: Deleting a device” on page 5-45.)
6. The voice guide will say “Please say a 4-digit pairing code.” Say a 4-digit number. When the confirmation function is on, the system will confirm whether the number said is acceptable. Answer “Yes.”
Answer “No” to return to pairing code selection.

NOTE

- Some Bluetooth® devices require a specific pairing code. Please refer to the device manual for pairing code requirements.
 - The pairing code entered here is only used for the Bluetooth® connection certification. It is any 4-digit number the user would like to select.
Remember the pairing code as it needs to be keyed into the Bluetooth® device later in the pairing process.
Depending on the connection settings of the Bluetooth® device, this code may have to be entered each time you connect the Bluetooth® device to the Bluetooth® 2.0 interface. For the default connection settings, refer to the instructions for the device.
7. The voice guide will say “Start pairing procedure on the device. See the device manual

for instructions.” Enter in the Bluetooth® device the 4-digit number you have registered in Step 6.

NOTE

- According to the corresponding device to Bluetooth®, it might take a few minutes to pair the Bluetooth® device with the Bluetooth® 2.0 interface.
 - If the Bluetooth® 2.0 interface cannot recognize the Bluetooth® device, the voice guide will say “Pairing has timed out” and the pairing process will be cancelled.
Confirm that the device you are pairing supports Bluetooth®, and try pairing it again.
 - If you enter the wrong number, the voice guide will say “Pairing failed” and the pairing process will be cancelled.
Confirm the number is right, and try pairing it again.
8. The voice guide will say “Please say the name of the device after the beep.” You can assign a desired name for the Bluetooth® device and register it as a device tag. Say the name you want to register after the beep.

NOTE

- When the confirmation function is on, after repeating the device tag you have said, the voice guide will ask “Is this correct?” Answer “Yes.”
To change the device tag, answer “No” and then say the device tag again.

9. The voice guide will say “Pairing complete,” after which a beep will be played and the pairing process will end.

Selecting a device

E00760700090

If multiple paired Bluetooth® devices are available in the vehicle, the cellular phone or music player most recently connected is automatically connected to the Bluetooth® 2.0 interface.
You can connect to the other paired cellular phone or music player by following setting change procedures.

To select a cellular phone

1. Press the SPEECH button.
2. Say “Setup.”
3. Say “Select phone.”
4. After the voice guide says “Please say,” the numbers of the cellular phones and device tags of corresponding cellular phones will be read out in order, starting with the cellular phone that has been most recently connected. Say the number of the cellular phone that you want to connect to.
When the confirmation function is on, the system will ask you again whether the phone that you want to connect to is correct. Answer “Yes” to continue and connect to the cellular phone.
Answer “No,” and the voice guide will say “Please say.” Say the number of the phone that you want to connect to.

For pleasant driving

NOTE

- You can connect to a phone at any time by pressing the SPEECH button and saying the number, even before all of the paired numbers and device tags of corresponding cellular phones are read out by the system.

5. The selected phone will be connected to the Bluetooth® 2.0 interface. The voice guide will say “<device tag> selected” and then the system will return to the main menu.

To select a music player

1. Press the SPEECH button.
2. Say “Setup.”
3. Say “Select music player.”
4. After the voice guide says “Please say,” the numbers of the music players and device tags of corresponding music players will be read out in order, starting with the music player that has been most recently connected. Say the number of the music player that you want to connect to.

When the confirmation function is on, the system will ask you again whether the music player that you want to connect to is correct. Answer “Yes” to continue and connect to the music player.

Answer “No,” and the voice guide will say “Please say.” Say the number of the music player that you want to connect to.

NOTE

- You can connect to a music player at any time by pressing the SPEECH button and saying the number, even before all of the paired numbers and device tags of corresponding music players are read out by the system.

5. The selected music player will be connected to the Bluetooth® 2.0 interface.

The voice guide will say “<device tag> selected” and then the system will return to the main menu.

Deleting a device

Use the following procedure to delete a paired Bluetooth® device from the Bluetooth® 2.0 interface.

1. Press the SPEECH button.
2. Say “Setup.”
3. Say “Pairing options.”
4. The voice guide will say “Select one of the following: pair, edit, delete, or list.” Say “Delete.”
5. After the voice guide says “Please say,” the numbers of the devices and device tags of corresponding devices will be read out in order, starting with the device that has been most recently connected. After it completes reading all pairs, the voice guide will say “or all.” Say the number of the device that you want to delete from the system. If you want to delete all paired phones from the system, say “All.”
6. For confirmation purposes, the voice guide will say “Deleting <device tag> <number>. Is this correct?” or “Deleting all devices. Is this correct?” Answer “Yes” to delete the phone(s). Answer “No,” the system will return to Step 4.
7. The voice guide will say “Deleted,” and then the system will end the device deletion process.

NOTE

- If the device deletion process fails for some reason, the voice guide will say “Delete failed” and then the system will cancel deleting the device.

To check a paired Bluetooth® device

E00760800017

You can check a paired Bluetooth® device by following the steps below.

1. Press the SPEECH button.
2. Say “Setup.”
3. Say “Pairing options.”
4. The voice guide will say “Select one of the following: pair, edit, delete, or list.” Say “List.”
5. The voice guide will read out device tags of corresponding devices in order, starting with the Bluetooth® device that has been most recently connected.
6. After the device tags of all paired Bluetooth® devices have been read, the system will say “End of list, would you like to start from the beginning?” To hear the list again from the beginning, answer “Yes.” When you are done, answer “No” to return to the main menu.

NOTE

- If you press and release the SPEECH button and say “Continue” or “Previous” while the list is being read, the system will advance or rewind the list. Say “Continue” to proceed to the device with the next highest number or “Previous” to return to the phone with the previous number.

- You can change the device tag by pressing and releasing the SPEECH button and then saying “Edit” while the list is being read.
- You can change the phone to be connected by pressing and releasing the SPEECH button and then saying “Select phone” while the list is being read.
- You can change the music player to be connected by pressing and releasing the SPEECH button and then saying “Select music player” while the list is being read.

Changing a device tag

E00760900018

You can change the device tag of a paired cellular phone or music player.

Follow the steps below to change a device tag.

1. Press the SPEECH button.
2. Say “Setup.”
3. Say “Pairing options.”
4. The voice guide will say “Select one of the following: pair, edit, delete, or list.” Say “Edit.”
5. The voice guide will say “Please say,” and read out the numbers of the Bluetooth® devices and device tags of corresponding devices in order, starting with the Bluetooth® that has been most recently connected.
After all paired device tags have been read, the voice guide will say “Which device, please?” Say the number of the device tag you want to change.

NOTE

- You can press and release the SPEECH button while the list is being read, and immediately say the number of the device tag you want to change.

6. The voice guide will say “New name, please.” Say the name you want to register as a new device tag.
When the confirmation function is on, the voice guide will say “<New device tag>. Is this correct?” Answer “Yes.”
Answer “No,” you can say the new device tag you want to register again.
7. The device tag is changed.
When the change is complete, the voice guide will say “New name saved” and then the system will return to the main menu.

Operating a music player connected via Bluetooth®

E00761000087

For the operation of a music player connected via Bluetooth®, refer to “Listen to Bluetooth Audio” on page 5-29.

How to make or receive hands-free calls

E00761100046

You can make or receive hands-free calls using a Bluetooth® compatible cellular phone connected to the Bluetooth® 2.0 interface.
You can also use the phone books in the Bluetooth® 2.0 interface to make calls without dialling telephone numbers.

To make a call → p. 5-47

Send function → p. 5-48

Receiving calls → p. 5-49

Mute function → p. 5-49

Switching between hands-free mode and private mode → p. 5-49

NOTE

- The hands-free calls might not be operated correctly when it makes calling or receiving by operating the cellular phone directly.

To make a call

E00761200135

You can make a call in the following 3 ways using the Bluetooth® 2.0 interface:

Making a call by saying a telephone number, making a call using the Bluetooth® 2.0 interface’s phone book, and making a call by redialing.

Making a call by using the telephone number

You can make a call by saying the telephone number.

1. Press the SPEECH button.
2. Say “Dial.”
3. After the voice guide says “Number please,” say the telephone number.
4. The voice guide will say “Dialing <number recognised>.” The Bluetooth® 2.0 interface will then make the call.

When the confirmation function is on, the system will confirm the telephone number again. To continue with that number, answer “Yes.”

To change the telephone number, answer “No.” The system will say “Number please” then say the telephone number again.

NOTE

- In the case of English, the system will recognise both “zero” and “oh” (Letter “o”) for the number “0.”
- The Bluetooth® 2.0 interface supports numbers (0 to 9) and characters (+, # and *).

For pleasant driving

- The maximum supported telephone number length is as follows:
 - International telephone number: + and telephone numbers (to 18 digits).
 - Except for international telephone number: telephone numbers (to 19 digits).

Making a call using a phone book

You can make calls using the vehicle phone book or mobile phone book of the Bluetooth® 2.0 interface.

For details on the phone books, refer to “Phone book function” on page 5-49.

1. Press the SPEECH button.
2. Say “Call.”

NOTE

- If you say “Call” when the vehicle phone book and the mobile phone book are empty, the voice guide will say “The vehicle phone book is empty. Would you like to add a new entry now?” Answer “Yes,” and the voice guide will say “Entering the phone book - new entry menu.” You can now create data in the vehicle phone book. Answer “No,” the system will return to the main menu.
3. After the voice guide says “Name please,” say the name you want to call, from those registered in the phone book.
 4. If there is only 1 match, the system will proceed to Step 5. If there are 2 or more matches, the voice guide will say “More than one match was found, would you like to call <returned name>.” If that person is the one you want to call, answer “Yes.”

Answer “No,” the name of the next matching person will be uttered by the voice guide.

NOTE

- If you say “No” to all names read by the system, the voice guide will say “Name not found, returning to main menu” and the system will return to the main menu.

5. If only 1 telephone number is registered under the name you just said, the voice guide will proceed to Step 6.

If 2 or more telephone numbers are registered that match the name you just said, the voice guide will say “Would you like to call <name> at [home], [work], [mobile], or [other]?” Select the location to call.

NOTE

- If the name you selected has matching data in the vehicle phone book but no telephone number is registered under the selected location, the voice guide will say “{home/work/mobile/other} not found for <name>. Would you like to add location or try again?” Say “Try again,” and the system will return to Step 3. Say “Add location” and you can register an additional telephone number under the selected location.

- If the name you selected has matching data in the mobile phone book but no telephone number is registered under the selected location, the voice guide will say “{home/work/mobile/other} not found for <name>. Would you like to try again?” Answer “Yes,” and the system will return to Step 3.

Answer “No,” and the call will be cancelled. Start over again from Step 1.

6. The voice guide will say “Calling <name> <location>” and then the system will dial the telephone number.

NOTE

- When the confirmation function is on, the system will check if the name and location of the receiver are correct. If the name is correct, answer “Yes.” To change the name or location to call, answer “No.” The system will return to Step 3.

Redialing

You can redial the last number called, based on the history of dialed calls in the paired cellular phone.

Use the following procedure to redial.

1. Press the SPEECH button.
2. Say “Redial.”

Send function

E00761300035

During a call, press the SPEECH button to enter voice recognition mode, then say “<numbers> SEND” to generate DTMF tones.

For example, if during a call you need to simulate the pressing of a phone button as a response to an automated system, press the SPEECH button and speak “1 2 3 4 pound send” and the 1234# will be sent via your cellular phone.

Receiving calls

E00761600012

If an incoming phone call is received while the ignition switch is in the “ACC” or “ON” position, the audio system will be automatically turned on and switched to the incoming call, even when the audio system was originally off.

The voice guide announcement for the incoming call will be output from the front passenger’s seat speaker.

If the CD player or radio was playing when the incoming call was received, the audio system will mute the sound from the CD player or radio and output only the incoming call.

To receive the call, press the PICK-UP button on the steering wheel control switch.

When the call is over, the audio system will return to its previous state.

Mute function

E00760300041

At any time during a call, you can mute the vehicle microphone.

Pressing the SPEECH button and then saying “Mute” during a call will turn ON the mute function and mute the microphone.

Saying “Mute off” in the same way will turn off the mute function and cancel the mute on the microphone.

Switching between hands-free mode and private mode

E00761400036

The Bluetooth® 2.0 interface can switch between hands-free mode (hands-free calls) and private mode (calls using cellular phone).

If you press the SPEECH button and say “Transfer call” during a hands-free call, you can stop the hands-free mode and talk in private mode.

To return to hands-free mode, press the SPEECH button again and say “Transfer call.”

Phone book function

E00763700017

The Bluetooth® 2.0 interface has 2 types of unique phone books that are different from the phone book stored in the cellular phone. They are the vehicle phone book and the mobile phone book.

These phone books are used to register telephone numbers and make calls to desired numbers via voice recognition function.

NOTE

- Disconnecting the battery cable will not delete information registered in the phone book.

Vehicle phone book

E00763800210

This phone book is used when making calls with the voice recognition function.

Up to 32 names can be registered in the vehicle phone book per language.

Also, each entry has 4 locations associated with: home, work, mobile and other. You can register one telephone number for each location.

You can register a desired name as a name for any phone book entry registered in the vehicle phone book.

Names and telephone numbers can be changed later on.

The vehicle phone book can be used with all paired cellular phones.

To register a telephone number in the vehicle phone book

You can register a telephone number in the vehicle phone book in the following 2 ways: Reading out a telephone number, and selecting and transferring 1 phone book entry from the phone book of the cellular phone.

To register by reading out a telephone number

1. Press the SPEECH button.
2. Say “Phone book.”
3. The voice guide will say “Select one of the following: new entry, edit number, edit name, list names, delete, erase all, or import contact.” Say “New entry.”
4. The voice guide will say “Name please.” Say your preferred name to register it.

NOTE

- If the maximum number of entries are already registered, the voice guide will say “The phone book is full. Would you like to delete a name?” Say “Yes” if you want to delete a registered name. Say “No,” to return to the main menu.
5. When the name has been registered, the voice guide will say “home, work, mobile, or other?” Say the location for which you want to register a telephone number.

For pleasant driving

NOTE

- When the confirmation function is on, the voice guide will say “<Location>. Is this correct?” Answer “Yes.”
If a telephone number has been registered for the selected location, the voice guide will say “The current number is <telephone number>, number please.”
If you do not want to change the telephone number, say “cancel” or the original number to keep it registered.
6. The voice guide will say “Number please.” Say the telephone number to register it.

NOTE

- In the case of English, the system will recognise both “zero” and “oh” (Letter “o”) for the number “0.”
7. The voice guide will repeat the telephone number you have just read, and then register the number.
When the telephone number has been registered, the voice guide will say “Number saved. Would you like to add another number for this entry?”
To add another telephone number for a new location for the current entry, answer “Yes.” The system will return to location selection in Step 5.
Answer “No” to end the registration process and return to the main menu.

NOTE

- When the confirmation function is on, after repeating the telephone number you have read, the voice guide will ask “Is this correct?” Answer “Yes.”
Answer “No” to return to telephone number registration in step 6.

To select and transfer one phone book entry from the phone book of the cellular phone

You can select 1 phone book entry from the phone book of the cellular phone and register it in the vehicle phone book.

NOTE

- Transfer is not permitted unless the vehicle is parked. Before transferring, make sure that the vehicle is parked in a safe location.
- All or part of data may not be transferred, even when the cellular phone supports Bluetooth®, depending on the compatibility of the device.
- The maximum supported telephone number length is 19 digits. Any telephone number of 20 digits or more will be truncated to the first 19 digits.
- If telephone numbers contain characters other than 0 to 9, *, # or +, these characters are deleted before the transfer.
- For the connection settings on the cellular phone side, refer to the instructions for the cellular phone.

1. Press the SPEECH button.
2. Say “Phone book.”

3. The voice guide will say “Select one of the following: new entry, edit number, edit name, list names, delete, erase all, or import contact.” Say “Import contact.”
4. The voice guide will say “Would you like to import a single entry or all contacts?” Say “Single entry.”
The Bluetooth® 2.0 interface will become ready to receive transferred phone book data.

NOTE

- If the maximum number of entries are already registered, the voice guide will say “The phone book is full. Would you like to delete a name?” Say “Yes” if you want to delete a registered name.
Say “No,” to return to the main menu.
5. After the voice guide says “Ready to receive a contact from the phone. Only a home, a work, and a mobile number can be imported,” the Bluetooth® 2.0 interface will receive the phone book data from the Bluetooth® compatible cellular phone.
 6. Operate the Bluetooth® compatible cellular phone to set it up so that the phone book entry you want to register in the vehicle phone book can be transferred to the Bluetooth® 2.0 interface.

NOTE

- If the Bluetooth® 2.0 interface cannot recognise the Bluetooth® compatible cellular phone or the connection takes too much time, the voice guide will say “Import contact has timed out” and then the system will cancel the registration. In such case, start over again from Step 1.
 - Pressing the HANG-UP button or pressing and holding the SPEECH button will cancel the registration.
7. When the reception is complete, the voice guide will say “<Number of telephone numbers that had been registered in the import source> numbers have been imported. What name would you like to use for these numbers?”
Say the name you want to register for this phone book entry.

NOTE

- If the entered name is already used for other phone book entry or similar to a name used for other phone book entry, that name cannot be registered.
8. The voice guide will say “Adding <name>.”
When the confirmation function is on, the system will ask if the name is correct. Answer “Yes.”
Answer “No,” and the voice guide will say “Name please.” Register a different name.
9. The voice guide will say “Numbers saved.”

10. The voice guide will say “Would you like to import another contact?”
Answer “Yes” if you want to continue with the registration. You can continue to register a new phone book entry from Step 5.
Answer “No,” to return to the main menu.

To change the content registered in the vehicle phone book

You can change or delete a name or telephone number registered in the vehicle phone book. You can also listen to the list of names registered in the vehicle phone book.

NOTE

- The system must have at least one entry.

[Editing a telephone number]

1. Press the SPEECH button.
2. Say “Phone book.”
3. The voice guide will say “Select one of the following: new entry, edit number, edit name, list names, delete, erase all, or import contact.” Say “Edit number.”
4. The voice guide will say “Please say the name of the entry you would like to edit, or say list names.” Say the name of the phone book entry you want to edit.

NOTE

- Say “List names,” and the names registered in the phone book will be read out in order. Refer to “Vehicle phone book: Listening to the list of registered names” on page 5-49.

5. The voice guide will say “Home, work, mobile or other?” Select and say the location where the telephone number you want to change or add is registered.
When the confirmation function is on, the system will check the target name and location again. Answer “Yes” if you want to continue with the editing.
Answer “No” to return to Step 3.
6. The voice guide will say “Number please.” Say the telephone number you want to register.

NOTE

- If the telephone number is already registered in the selected location, the voice guide will say “The current number is <current number>. New number, please.” Say a new telephone number to change the current number.
7. The voice guide will repeat the telephone number.
When the confirmation function is on, the system will ask if the number is correct. Answer “Yes.”
Answer “No” to return to Step 3.
8. Once the telephone number is registered, the voice guide will say “Number saved” and then the system will return to the main menu.

NOTE

- If the location where a telephone number was already registered has been overwritten with a new number, the voice guide will say “Number changed” and then the system will return to the main menu.

[Editing a name]

For pleasant driving

1. Press the SPEECH button.
2. Say “Phone book.”
3. The voice guide will say “Select one of the following: new entry, edit number, edit name, list names, delete, erase all, or import contact.” Say “Edit name.”
4. The voice guide will say “Please say the name of the entry you would like to edit, or say list names.” Say the name you want to edit.

NOTE

- Say “List names,” and the names registered in the phone book will be read out in order. Refer to “Vehicle phone book: Listening to the list of registered names” on page 5-49.
5. The voice guide will say “Changing <name>.”
When the confirmation function is on, the system will ask if the name is correct. Answer “Yes” if you want to continue with the editing based on this information. Answer “No” to return to Step 4.
 6. The voice guide will say “Name please.” Say the new name you want to register.
 7. The registered name will be changed.
When the change is complete, the system will return to the main menu.

[Listening to the list of registered names]

1. Press the SPEECH button.
2. Say “Phone book.”
3. The voice guide will say “Select one of the following: new entry, edit number, edit name, list names, delete, erase all, or import contact.” Say “List names.”

4. Bluetooth® 2.0 interface will read out the entries in the phone book in order.
5. When the voice guide is done reading the list, it will say “End of list, would you like to start from the beginning?” When you want to check the list again from the beginning, answer “Yes.”
When you are done, answer “No” to return to the previous or main menu.

NOTE

- You can call, edit or delete a name that is being read out.
Press the SPEECH button and say “Call” to call the name, “Edit name” to edit it, or “Delete” to delete it.
The system will beep and then execute your command.
- If you press the SPEECH button and say “Continue” or “Previous” while the list is being read, the system will advance or rewind the list. Say “Continue” to proceed to the next entry or “Previous” to return to the previous entry.

[Deleting a telephone number]

1. Press the SPEECH button.
2. Say “Phone book.”
3. The voice guide will say “Select one of the following: new entry, edit number, edit name, list names, delete, erase all, or import contact.” Say “Delete.”
4. The voice guide will say “Please say the name of the entry you would like to delete, or say list names.” Say the name of the phone book entry in which the telephone number you want to delete is registered.

NOTE

- Say “List names,” and the names registered in the phone book will be read out in order. Refer to “Vehicle phone book: Listening to the list of registered names” on page 5-49.
5. If only one telephone number is registered in the selected phone book entry, the voice guide will say “Deleting <name> <location>.”
If multiple telephone numbers are registered in the selected phone book entry, the voice guide will say “Would you like to delete [home], [work], [mobile], [other], or all?” Select the location to delete, and the voice guide will say “Deleting <name> <location>.”

NOTE

- To delete the telephone numbers from all locations, say “All.”
6. The system will ask if you really want to delete the selected telephone number(s) to go ahead with the deletion, answer “Yes.”
Answer “No,” the system will cancel deleting the telephone number(s) and then return to Step 4.
 7. When the deletion of the telephone number is completed, the voice guide will say “<name> <location> deleted” and then the system will return to the main menu.
If all locations are deleted, the system will say “<name> and all locations deleted” and the name will be removed from the phone book. If numbers still remain under the entry, the name will retain the other associated numbers.

Erasing the phone book

You can delete all registered information from the vehicle phone book.

1. Press the SPEECH button.
2. Say “Phone book.”
3. The voice guide will say “Select one of the following: new entry, edit number, edit name, list names, delete, erase all, or import contact.” Say “Erase all.”
4. For confirmation purposes, the voice guide will ask “Are you sure you want to erase everything from your hands-free system phone book?” Answer “Yes.”
Answer “No” to cancel the deletion of all registered information in the phone book and return to the main menu.
5. The voice guide will say “You are about to delete everything from your hands-free system phone book. Do you want to continue?” Answer “Yes” to continue.
Answer “No” to cancel the deletion of all registered information in the phone book and return to the main menu.
6. The voice guide will say “Please wait, erasing the handsfree system phone book” and then the system will delete all data in the phone book.
When the deletion is complete, the voice guide will say “Hands-free system phone book erased” and then the system will return to the main menu.

Mobile phone book

E00763900064

All entries in the phone book stored in the cellular phone can be transferred in a batch and registered in the mobile phone book.

Up to 7 mobile phone books, each containing up to 1,000 names, can be registered.

The Bluetooth® 2.0 interface automatically converts from text to voice the names registered in the transferred phone book entries, and creates names.

NOTE

- Only the mobile phone book transferred from the connected cellular phone can be used with that cellular phone.
- You cannot change the names and telephone numbers in the phone book entries registered in the mobile phone book. You cannot select and delete specific phone book entries, either.
To change or delete any of the above, change the applicable information in the source phone book of the cellular phone and then transfer the phone book again.

To import a devices phone book

Follow the steps below to transfer to the mobile phone book the phone book stored in the cellular phone.

NOTE

- Transfer should be completed while the vehicle is parked. Before transferring, make sure that the vehicle is parked in a safe location.
- The already stored phone book in the mobile phone book is overwritten by the stored phone book in the cellular phone.
- All or part of data may not be transferred, even when the cellular phone supports Bluetooth®, depending on the compatibility of the device.
- Only a home, a work, and a mobile number can be imported.

- The maximum supported telephone number length is 19 digits. Any telephone number of 20 digits or more will be truncated to the first 19 digits.
- If telephone numbers contain characters other than 0 to 9, *, # or +, these characters are deleted before the transfer.
- For the connection settings on the cellular phone side, refer to the instructions for the cellular phone.

1. Press the SPEECH button.
2. Say “Phone book.”
3. The voice guide will say “Select one of the following: new entry, edit number, edit name, list names, delete, erase all, or import contact.” Say “Import contact.”
4. The voice guide will say “Would you like to import a single entry or all contacts?” Say “All contacts.”
5. The voice guide will say “Importing the contact list from the mobile phone book. This may take several minutes to complete. Would you like to continue?” Answer “Yes,” transferring to the mobile phone book the phone book stored in the cellular phone will start.
Answer “No,” to return to the main menu.

NOTE

- The transfer may take some time to complete depending on the number of contacts.
- If the Bluetooth® 2.0 interface could not be connected to the Bluetooth® compatible cellular phone, the voice guide will say “Unable to transfer contact list from phone” and then the system will return to the main menu.

For pleasant driving

- If you press the HANG-UP button or press and hold the SPEECH button during the data transfer, the transfer will be cancelled and the system will return to the main menu.
 - If an error occurs during the data transfer, all transfer will be cancelled and the voice guide will say “Unable to complete the phone book import” and then the system will return to the main menu.
 - If there are no contacts in the phone book, the voice guide will say “There are no contacts on the connected phone.”
6. When the transfer is complete, the voice guide will say “Import complete” and then the system will return to the main menu.

Enrollment commands

E00732400210

Phrase	English	French	Spanish	Italian	German	Dutch	Portuguese	Russian
1	123456789	123456789	123456789	123456789	123456789	123456789	123456789	123456789
2	888 555 1212	888 555 1212	888 555 1212	888 555 1212	888 555 1212	888 555 1212	888 555 1212	888 555 1212
3	Call	Appeler	Llamar	Chiama	Anrufen	Bellen	Ligar	Вызов
4	Dial	Composer	Marcar	Componi	Wählen	Nummer keuze	Marcar	Набор
5	Setup	Configurer	Configuración	Configura	Einrichtung	Setup	Configurar	Настройка
6	Cancel	Annuler	Cancelar	Annulla	Abbrechen	Annuleren	Cancelar	Отмена
7	Continue	Continuer	Continuar	Continua	Weiter	Doorgaan	Continuar	Продолжить
8	Help	Aide	Ayuda	Aiuto	Hilfe	Help	Ajudá	Справка

For pleasant driving

USB input terminal*

E00761900060

You can connect your USB memory device or iPod* to play music files stored in the USB memory device or iPod.

The following explains how to connect and remove a USB memory device or iPod.

Refer to the following sections for details on how to play music files:

Refer to "Listen to Audio Files on a USB Device" on page 5-27.

*: "iPod" is a registered trademark of Apple Inc. in the United States and other countries.

How to connect a USB memory device

E00762000286

1. Park your vehicle in a safe place and turn the ignition switch to the "LOCK" position.
2. Open the USB input terminal cover (A) in the glove box.

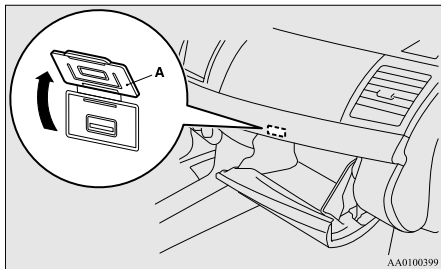

3. Connect a commercially available USB connector cable (C) to the USB memory device (B).

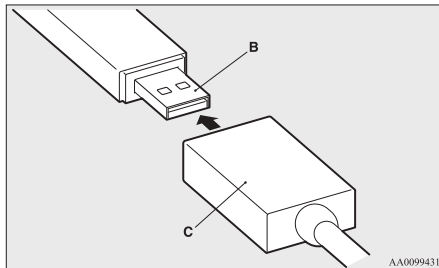

4. Connect the USB connector cable (C) to the USB input terminal (D).

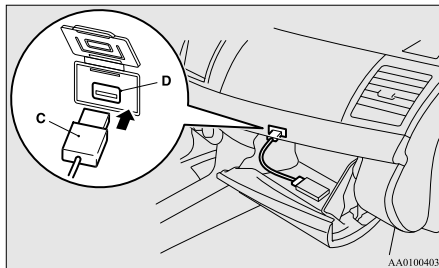

CAUTION

- Keep the lid of the glove box closed while driving the vehicle. A lid or the contents of the glove box could otherwise cause injuries.

NOTE

- Do not connect the USB memory device to the USB input terminal directly. The USB memory device may be damaged.
 - When closing the glove box, be careful not to trap the USB connector cable.
5. To remove the USB connector cable, turn the ignition switch to the "LOCK" position first and perform the installation steps in reverse.

How to connect an iPod

E00762100131

1. Park your vehicle in a safe place and turn the ignition switch to the "LOCK" position.
2. Open the USB input terminal cover (A) in the glove box.

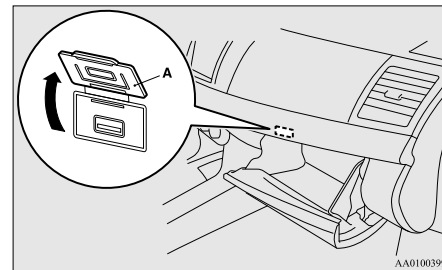

- Connect the Dock connector (C) to the iPod (B).

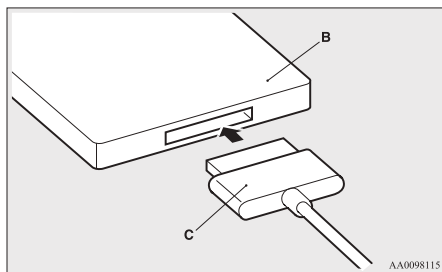

NOTE

- Use a genuine Dock connector from Apple Inc.

- Connect the Dock connector (C) to the USB input terminal (D).

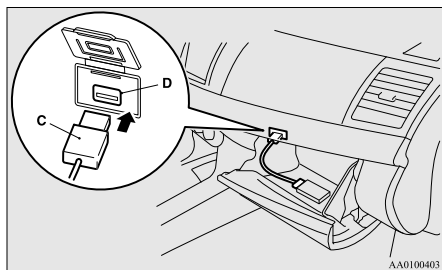

⚠ CAUTION

- Keep the lid of the glove box closed while driving the vehicle. A lid or the contents of the glove box could otherwise cause injuries.

NOTE

- When closing the glove box, be careful not to trap the connector cable.

- To remove the Dock connector, turn the ignition switch to the “LOCK” position first and perform the installation steps in reverse.

Types of connectable devices and supported file specifications

E00762200015

Device types

E00762300289

Devices of the following types can be connected.

Model name	Condition
USB memory device	Storage capacity of 256 Mbytes or more
iPod touch*	F/W Ver.1.1.1 or later
iPod classic*	F/W Ver.1.0 or later
iPod (fifth generation)*	F/W Ver.1.2.2 or later
iPod nano (fifth generation)*	F/W Ver.1.2 or later

*: “iPod touch,” “iPod classic,” “iPod” and “iPod nano” are registered trademarks of Apple Inc. in the United States and other countries.

Model name	Condition
iPod nano (second generation)*	F/W Ver.1.1.2 or later
Models other than USB memory devices and iPods	Digital audio player supporting mass storage class

*: “iPod touch,” “iPod classic,” “iPod” and “iPod nano” are registered trademarks of Apple Inc. in the United States and other countries.

NOTE

- Depending on the type of the USB memory device or other device connected, the connected device may not function properly or the available functions may be limited.
- It is recommended to use an iPod with firmware updated to the latest version.
- You can charge your iPod by connecting it to the USB input terminal when the ignition switch is in the “ACC” or “ON” position.
- Do not keep your USB memory device or iPod in your vehicle.
- It is recommended that you back up files in case of data damage.
- Do not connect to the USB input terminal any device (hard disk, card reader, memory reader, etc.) other than the connectable devices specified in the previous section. The device and/or data may be damaged. If any of these devices was connected by mistake, remove it after turning the ignition switch to the “LOCK” position.

For pleasant driving

File specifications

E00762400017

You can play music files of the following specifications that are saved in a USB memory device or other device supporting mass storage class.

Item	Condition
File format	MP3, WMA, AAC, WAV
Maximum number of levels (including the root)	Level 8
Number of folders	700
Number of files	65,535

Sun visors

E00711200521

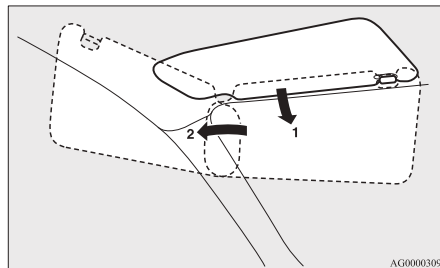

- 1- To eliminate front glare
- 2- To eliminate side glare

AG0000309

Card holder

E00732000098

Cards can be slipped into the holder (A) on the back of the sun visor.

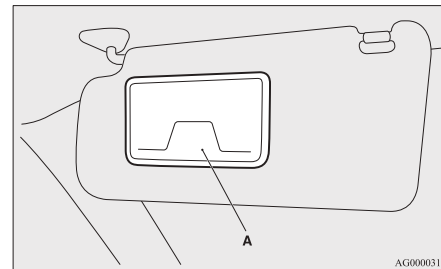

AG0000312

Vanity mirror

E00731900133

A vanity mirror is fitted to the back of sun visor.

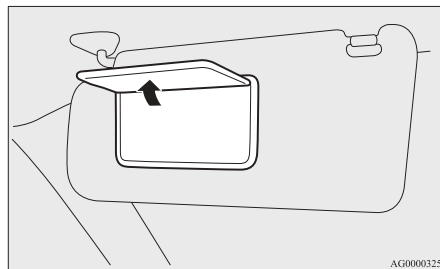

AG0000325

Ashtray*

E00711400855

⚠ CAUTION

- Put out matches and cigarettes before they are placed in the ashtray.
- Don't put papers and other things that burn into your ashtrays. If you do, cigarettes or other smoking materials could set them on fire, causing damage.
- Always close the ashtray. If left open, other cigarette butts in the ashtray may be rekindled.

To use the ashtray, open up the lid.

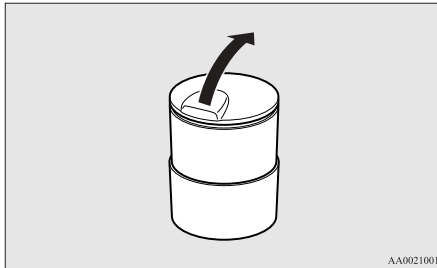

Mounting position for moveable ash-tray

The moveable ashtray can be fitted at the indicated positions. Refer to "Cup holder" on page 5-64

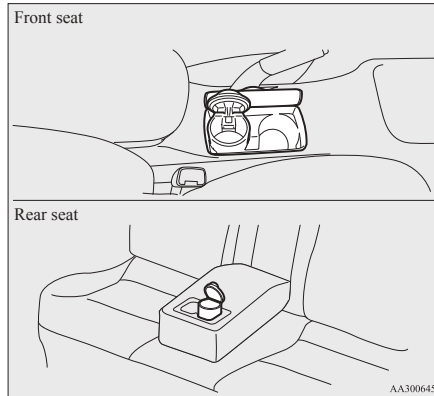

For pleasant driving

Cigarette lighter*

E00711501299

The cigarette lighter can be used while the ignition switch is in the "ON" or "ACC" position.

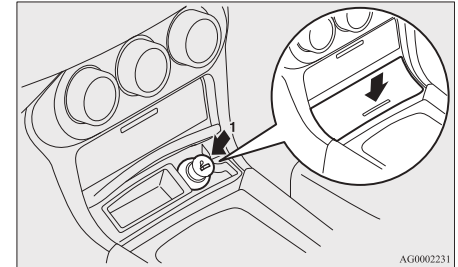

1- Push all the way in.

The cigarette lighter will automatically return to its original position with a "click" when ready. Pull it out for use.

After use, insert the cigarette lighter to its original position in the socket.

NOTE

- Do not leave the cigarette lighter removed from its socket, because the socket might become clogged by foreign material and be short-circuited.

⚠ CAUTION

- Do not touch heating element or cigarette lighter housing, hold the knob only as burns may occur.

⚠ CAUTION

- Do not allow children to operate or play with the cigarette lighter as burns may occur.
- Something is wrong with the cigarette lighter if it does not pop back out within approximately 30 seconds of being pushed in. Pull it out and have the problem corrected at MITSUBISHI MOTORS Authorized Service Point.
- When the cigarette lighter socket is used as a power source for an electric appliance, be sure that the electric appliance operates at 12 V and has an electric capacity of 120 W or less. In addition, long use of the electric appliance without running the engine may run down the battery.

5

*Accessory socket**

E00711601199

The accessory socket can be used while the ignition switch is in the “ON” or “ACC” position. Pull out the plug to uncover the socket. Use it to plug in an electrical device.

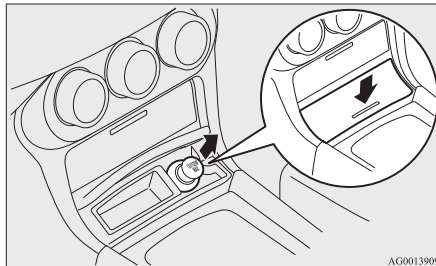

⚠ CAUTION

- Be aware that using electronic equipment with the engine off may run the battery down.
- When you connect an electrical device, make sure it is rated at 12 V and its electrical capacity does not exceed 120 W.
- When the accessory socket is not in use, be sure to close the plug, because the socket might become clogged by foreign material and be short-circuited.

Interior lamps

E00712001334

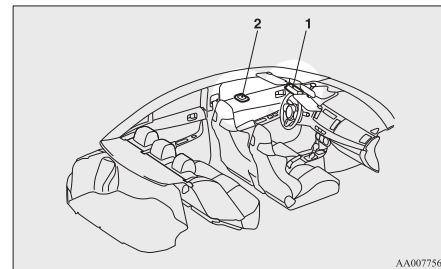

- 1- Front room & map lamp
- 2- Rear room lamp

NOTE

- If you leave the interior lamps on without running the engine, you will run down the battery. Before you leave the vehicle, make sure that all the interior lamps are off.

Front room & map lamps

E00717400440

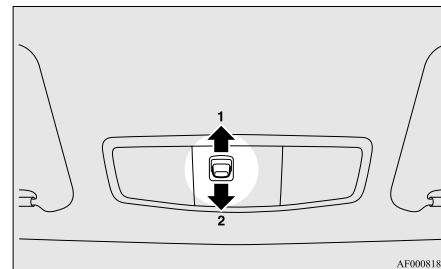

1 (DOOR) - The front room & map lamp goes on when a door is opened. It goes off about 15 seconds after all doors are closed.

However, the lamp goes off immediately in the following cases:

- The ignition switch is turned to the “ON” position.
- All doors are locked using the central door lock function.
- When the remote control switch of the keyless entry system is used to lock the vehicle.
- If the vehicle is equipped with the keyless operation system, when the remote control switch of the keyless operation system or the keyless operation function is used to lock the vehicle.

- The time until the lamp goes off can be adjusted. For details, please consult a MITSUBISHI MOTORS Authorized Service Point.

2 (OFF) - The lamp goes off.

Map lamps

Push the lens (A) to turn on the lamp. Push it again to turn it off.

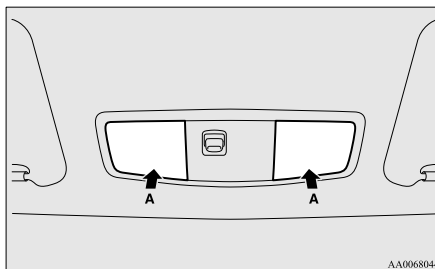

Rear room lamp

E00712300516

The room lamp can be turned on by sliding the room lamp switch.

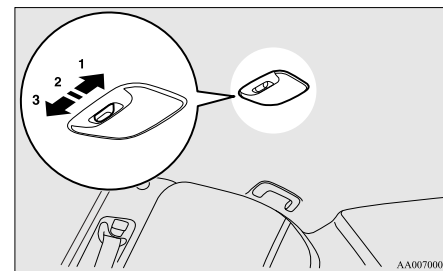

1 (ON) - The room lamp goes on.

NOTE

- When the key was used to start the engine, if the key is removed while the doors are closed, the lamp is illuminated and after about 15 seconds it goes off. For vehicles with Twin Clutch SST, the lamp will not illuminate if the key is removed before the engine stops.
- When the keyless operation function was used to start the engine, if the ignition switch is turned to the “LOCK” position while the doors are closed, the lamp illuminates and after about 15 seconds it goes off.

For pleasant driving

- 2 (●) - The rear room lamp goes on when a door is opened. It goes off about 15 seconds after all doors are closed.

However, the lamp goes off immediately in the following cases:

- The ignition switch is turned to the "ON" position.
- All doors are locked using the central door lock function.
- When the remote control switch of the keyless entry system is used to lock the vehicle.
- If the vehicle is equipped with the keyless operation system, when the remote control switch of the keyless operation system or the keyless operation function is used to lock the vehicle.

NOTE

- When the key was used to start the engine, if the key is removed while the doors are closed, the lamp is illuminated and after about 15 seconds it goes off. For vehicles with Twin Clutch SST, the lamp will not illuminate if the key is removed before the engine stops.
- When the keyless operation function was used to start the engine, if the ignition switch is turned to the "LOCK" position while the doors are closed, the lamp illuminates and after about 15 seconds it goes off.

- The time until the lamp goes off can be adjusted. For details, please consult a MITSUBISHI MOTORS Authorized Service Point.

- 3 (OFF) - The lamp goes off.

Lamps (room lamps, etc.) auto-cutout function

E00712901346

If any of the interior lamps are left switched on with the ignition switch in any position other than "ON" or "ACC", it goes off automatically after approximately 30 minutes.

The lamp goes on again if the ignition switch is turned to the "ON" or "ACC" position, any door or the trunk lid is opened and closed, or the keyless entry remote control or the keyless operation system is operated.

NOTE

- The interior lamps auto-cutout function can be deactivated. The time until the lamps automatically go off can be adjusted. For details, please consult a MITSUBISHI MOTORS Authorized Service Point.

Storage spaces

E00713101462

CAUTION

- Never leave lighters, cans of carbonated drink, and spectacles in the cabin when parking the vehicle in hot sunshine. The cabin will become extremely hot, so lighters and other flammable items may catch fire and unopened drink cans (including beer cans) may rupture. The heat may also deform or crack plastic spectacle lenses and other spectacle parts that are made of plastic.
- Keep the lids of storage spaces closed while driving the vehicle. A lid or the contents of a storage space could otherwise cause injuries.

NOTE

- Do not leave valuables in any storage space when leaving the vehicle.

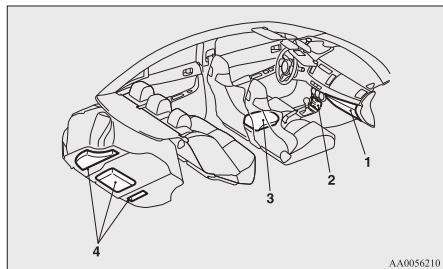

- 1- Glove box
- 2- Front console boxes
- 3- Floor console box
- 4- Luggage floor boxes

AA0056210

Glove box

To open, pull the lever (A).

E00717601524

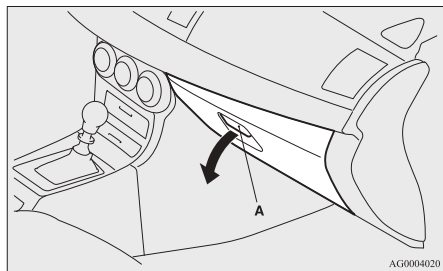

AG0004020

NOTE

- The USB input terminal (if so equipped) is located in the glove box. For details, refer to “USB input terminal” on page 5-56.

Card holder

There is a card holder on the inside of the glove box.

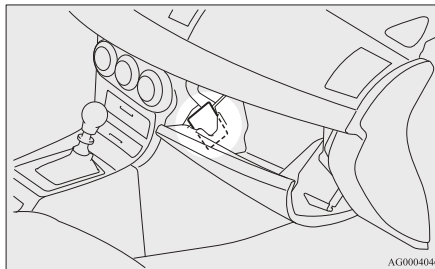

AG0004046

NOTE

- The card holder can hold up to 2 cards.

Front console boxes

To open, push the lid.

E00733400477

Upper box

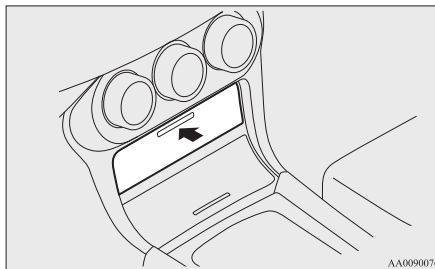

AA0090076

Lower box

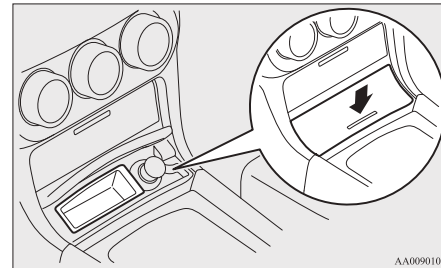

AA0090106

NOTE

- Do not use the front console boxes as an ash-tray. This could cause a fire or the boxes will be damaged.

Floor console box

To open the console box, lift the release lever (A) and raise the lid.

E00723300109

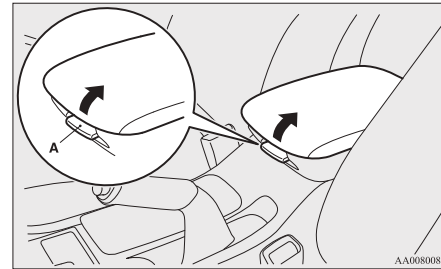

AA0080086

For pleasant driving

Tissue holder

The tissue holder (B) is located on the back of the floor console box lid.

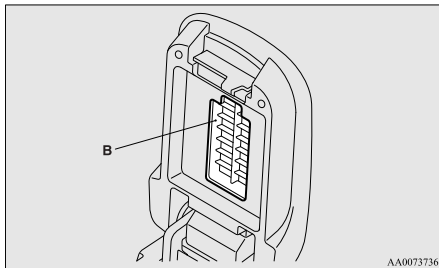

Luggage floor boxes

E00718700772

The boxes for storing articles are located inside the luggage compartment.

To use the boxes, remove the floor mat (A) and raise the lids (B).

Vehicles equipped with spare tyre

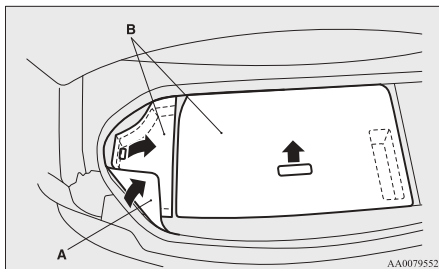

Except for vehicles equipped with spare tyre

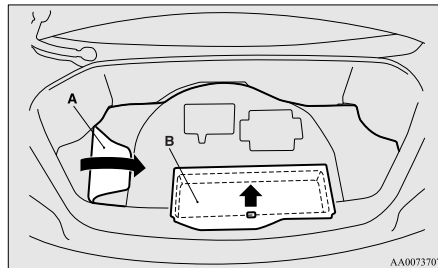

Cup holder

E00714501098

CAUTION

- Do not drink beverages while driving the vehicle; doing so could distract you and result in an accident.
- Beverages can spill due to vibration or other movement during vehicle operation. Be careful not to get scalded by a hot beverage if spilled

For the front seat

The cup holder is located in front of the floor console.

To use the cup holder, open the lid.

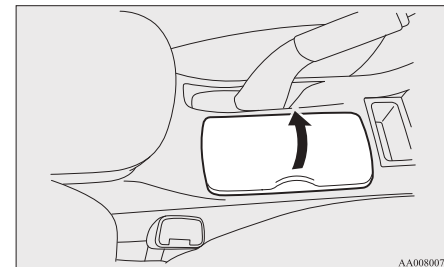

For the rear seat

E00716900376

In order to use the cup holder, allow the armrest (A) to drop down.

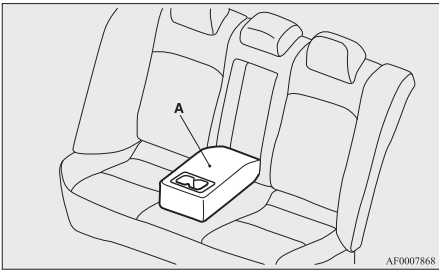

Bottle holder

E00718200142

⚠ CAUTION

- Do not drink beverages while driving the vehicle; doing so could distract you and result in an accident.
- Beverages can spill owing to vibration or other movement during vehicle operation. Be careful not to get scalded by a hot beverage if it spills.

NOTE

- Make sure the cap of any plastic bottle to be placed in a bottle holder is tightly closed.
- The bottle holders may not accommodate bottles of certain shapes and sizes.

For the front seat

The bottle holders are provided at both sides.

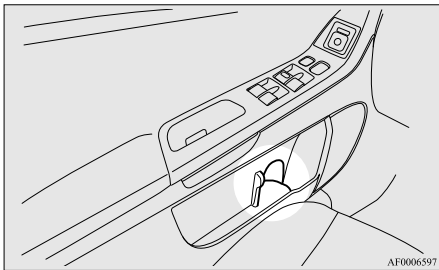

Assist grip

E00732800083

These grips are to support the body by hand while seated in the vehicle.

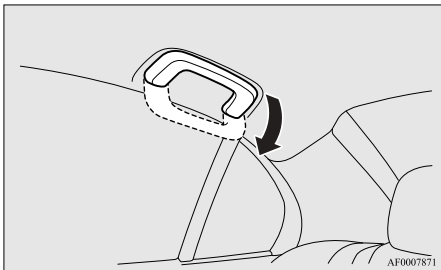

⚠ CAUTION

- Do not use the assist grips when getting into or out of the vehicle. The assist grips could detach and cause an accident.

For pleasant driving

Coat hook

E00725600281

There is a coat hook on the rear seat assist grip of the driver's side.

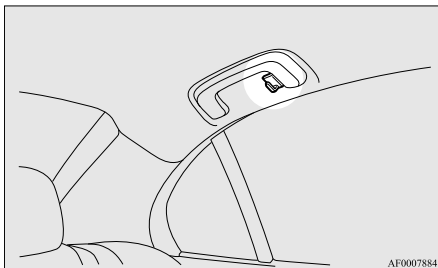

⚠ WARNING

- Do not put a hanger or any heavy or pointed object on the coat hook. If the curtain airbag was activated, any such item could be propelled away with great force and could prevent the curtain airbag from inflating correctly. Hang clothes directly on the coat hook (without using a hanger). Make sure there are no heavy or sharp objects in the pockets of clothes that you hang on the coat hook.

5

For emergencies

If the vehicle breaks down.....	6-02
Emergency starting.....	6-02
Engine overheating.....	6-04
Tools, jack and tyre repair kit.....	6-05
How to change a tyre.....	6-12
Towing.....	6-17
Operation under adverse driving conditions.....	6-19

For emergencies

If the vehicle breaks down

E00800101195

If the vehicle breaks down on the road, move it to the shoulder and use the hazard warning flashers and/or the warning triangle etc.

Refer to “Hazard warning flasher switch” on page 3-43.

If the engine stops/fails

Vehicle operation and control are affected if the engine stops. Before moving the vehicle to a safe area, be aware of the following:

- The brake booster becomes inoperative and the pedal effort will increase. Press down the brake pedal harder than usual.
- Since the power steering system is no longer operative, the steering wheel feels heavy when turning it.

Emergency starting

E00800502196

If the engine cannot be started because the battery is weak or dead, the battery from another vehicle can be used with jumper cables to start the engine.

⚠ WARNING

- To start the engine using jumper cables connected to another vehicle, perform the correct procedures according to the instruction below. Incorrect procedures could result in a fire or explosion or damage to the vehicles.

⚠ CAUTION

- Do not attempt to start the engine by pulling or pushing the vehicle. It could damage your vehicle.
- Always wear protective eye goggles when working near the battery.
- Keep the battery out of the reach of children.

1. Get the vehicles close enough so the jumper cables can reach, but be sure the vehicles aren't touching each other.

⚠ CAUTION

- Check the other vehicle. It must have a 12-volt battery. If the other system isn't 12-volt, shorting can damage both vehicles.

2. Set the parking brake firmly on each vehicle. Put an A/T or Twin Clutch SST in “P” (PARK) or a M/T in “N” (Neutral). Turn off the ignition switch.

⚠ WARNING

- Turn off the ignition on both vehicles beforehand. Make sure that the cables or your clothes cannot be caught by the fan or drive belt. Personal injury could result.

3. Turn off all lamps, heater and other electrical loads.
4. Remove the joint terminal cover (A).

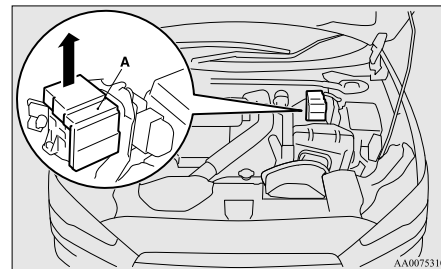

- Connect one end of one jumper cable to the positive (+) terminal of the joint terminal (B), and the other end to the positive (+) terminal of the booster battery (C).

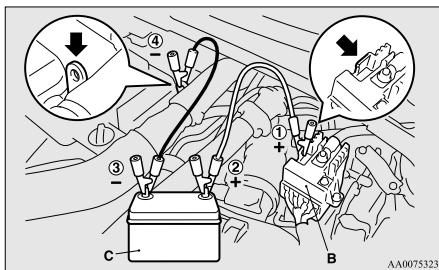

- Connect one end of the other jumper cable to the negative (-) terminal of the booster battery, and the other end to the engine block of the vehicle with the discharged battery.

⚠ WARNING

- Be sure to observe the connecting sequence of ① → ② → ③ → ④.
- Make sure that the connection ④ is made to the appointed position (shown in the illustration). If the connection is made directly to the negative side of the battery, the inflammable gasses generated from the battery might catch fire and explode.

⚠ WARNING

- When connecting the jumper cable, do not connect the positive (+) cable to the negative (-) terminal. Otherwise sparks might cause explosion of the battery.

⚠ CAUTION

- Take care not to get the jumper cable caught in the cooling fan or other rotating part in the engine compartment.
- Use the proper cables suitable for the battery size to prevent overheating of the cables.
- Check the jumper cables for damage and corrosion before use.

- Start the engine in the vehicle which has the booster battery, let the engine idle a few minutes, then start the engine in the vehicle with the discharged battery.

⚠ CAUTION

- Keep the engine of the vehicle giving assistance running.
- After the engine is started, disconnect the cables in the reverse order and keep the engine running for several minutes.

⚠ WARNING

- Be sure to have a MITSUBISHI MOTORS Authorized Service Point charge the battery. Do not charge the battery yourself. Flammable gases may leak from the battery and explode.
- Electrolyte is corrosive diluted sulphuric acid. If electrolyte (battery acid) comes into contact with your hands, eyes, clothes and the painted surface of your vehicle, it should be thoroughly flushed with water. If electrolyte gets in your eyes, flush them with water immediately and thoroughly, and get prompt medical attention.
- Never remove the battery label, upper cover, exhaust tube or pipe. Flammable gases may leak and explode.

⚠ CAUTION

- This vehicle is equipped with a special battery. Therefore, a battery may not be installed properly into the vehicle, even if it is the same type. Be sure to have a MITSUBISHI MOTORS Authorized Service Point replace the battery.
- Do not try to start your vehicle by pushing or towing. Especially for Twin Clutch SST vehicles, since their structure is different from vehicles with a manual transmission, the engine will not start using this method.

For emergencies

NOTE

- If the vehicle is put in motion without fully charging the battery, it might cause the loss of smooth engine operation and the anti-lock brake warning lamp to illuminate. Refer to “Anti-lock brake system (ABS)” on page 4-32.

Engine overheating

E00800602748

When the engine is overheating, the information screen in the multi-information display will be interrupted and the engine coolant temperature warning display will appear. Also “” will blink. If this occurs, take the following corrective measures:

1. Stop the vehicle in a safe place.
2. Check whether steam is coming from the engine compartment.

[If steam does not come from the engine compartment]

With the engine still running, raise the bonnet to ventilate the engine compartment.

[If steam is coming from the engine compartment]

Stop the engine, and when the steam stops, raise the bonnet to ventilate the engine compartment. Restart the engine.

WARNING

- Do not open the bonnet while steam is coming from the engine compartment. It could cause steam or hot water to spurt out, causing burns. Hot water could spurt out even when there is no steam coming out, and some parts will be very hot. Be very careful when opening the bonnet.
- Be careful of hot steam, which could be blowing off the reserve tank cap.
- Do not attempt to remove the radiator cap while the engine is hot.

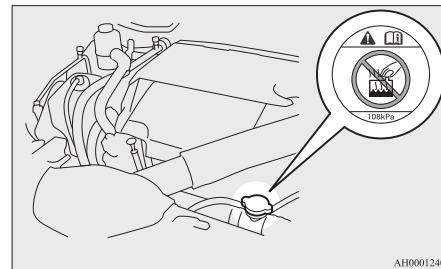

AH0001240

3. Confirm that the cooling fans are turning. If the fans (A) are not turning, stop the engine immediately and have it checked.

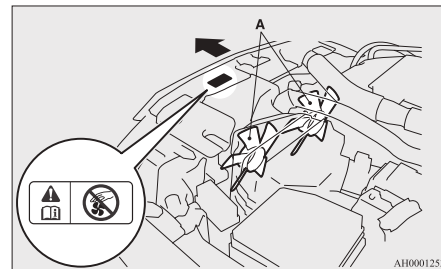

AH0001253

WARNING

- Be careful not to get your hands or clothes caught in the cooling fan.

- When the bar graph in the engine coolant temperature warning display in the multi-information display drops, stop the engine.

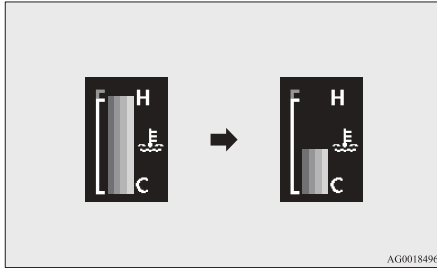

- Check the coolant level in the reserve tank (B).

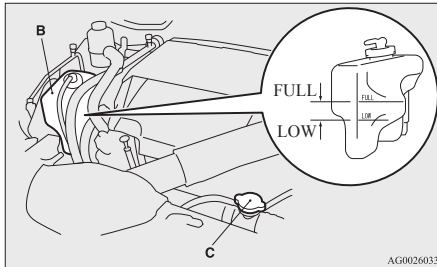

⚠ WARNING

- If there is none, make sure that the engine has cooled down before removing the radiator cap (C), because hot steam or boiling water otherwise will gush from the filler port and may scald you.

- Add coolant to the radiator and/or reserve tank if necessary. (Refer to the “Maintenance” section.)

⚠ CAUTION

- Do not add coolant while the engine is hot. Suddenly adding cold coolant could damage the engine. Wait for the engine to cool down, then add coolant a little at a time.

- Examine the radiator hoses for coolant leakage and the drive belt for looseness or damage. If there is anything wrong with the cooling system or drive belt, we recommend you to have it checked and repaired.

For emergencies

Tools, jack and tyre repair kit

E00800901223

Storage

The tools, jack and tyre repair kit are stowed in the trunk room.

The storage location of the tools, jack and tyre repair kit should be remembered in case of an emergency.

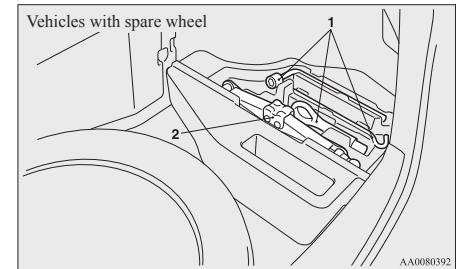

- Tools
- Jack

For emergencies

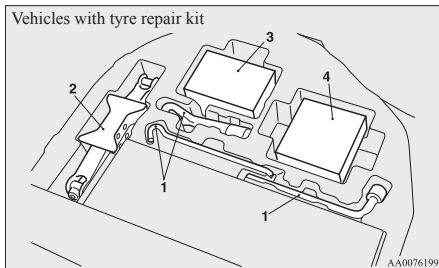

- 1- Tools
- 2- Jack
- 3- Tyre repair set
- 4- Tyre compressor

Tools

E00801900627

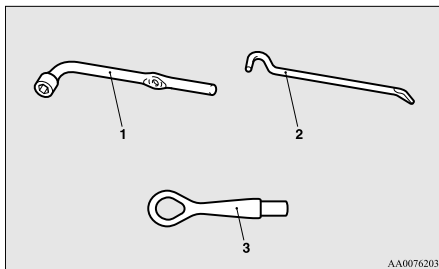

- 1- Wheel nut wrench
- 2- Jack bar
- 3- Towing hook

Jack

E00802000306

Before removing the jack, lift up the luggage floor board.

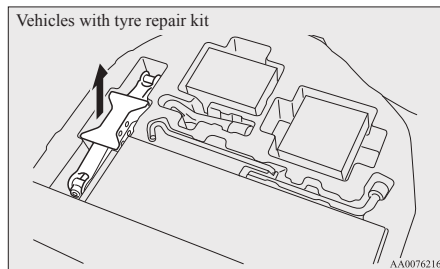
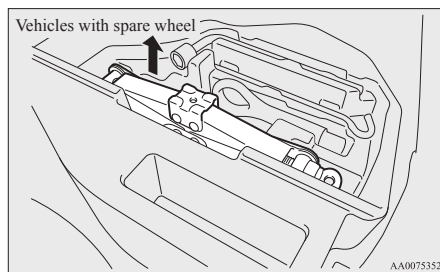

Tyre repair kit*

E00802200425

This kit enables emergency repair of a small puncture in the tread area of a tyre that has run over a nail, screw, or similar object.

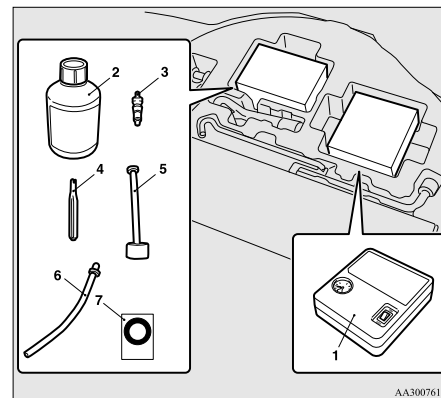

- 1- Tyre compressor
- 2- Tyre sealant bottle
- 3- Valve insert (spare)
- 4- Valve remover
- 5- Filler hose
- 6- Extension hose
(This hose is used for removal of sealant. It is not used in emergency puncture repair.)
- 7- Speed restriction sticker

⚠ CAUTION

- The tyre sealant can cause health damage if swallowed. If you accidentally swallow it, drink as much water as possible and immediately consult a doctor.
- If the tyre sealant gets in your eyes or on your skin, rinse with lots of water. If you still sense an abnormality, consult a doctor.
- Consult a doctor immediately if any allergic reactions occur.
- Do not allow children to touch the tyre sealant.
- Do not breathe in the vapours of tyre sealant.

NOTE

- The tyre sealant cannot be used in any of the situations listed below. If any of these situations occurs, please contact a MITSUBISHI MOTORS Authorized Service Point or another specialist.
 - The tyre sealant's expiry date has passed. (The expiry date is shown on the bottle label.)

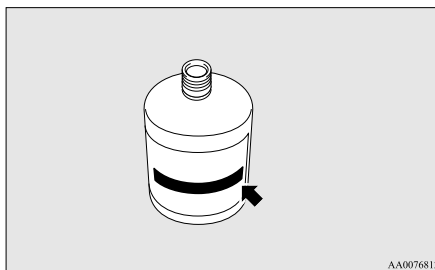

- More than one tyre is punctured.
- The puncture hole has a length or width of 4 mm or more.
- The tyre is punctured in the side wall (A), not in the tread (B).

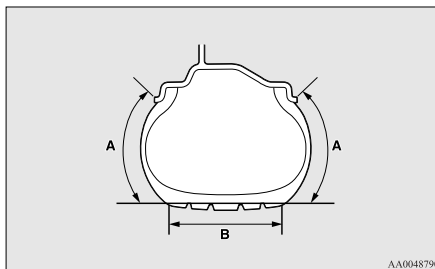

- The vehicle has been driven with the tyre almost completely flat.
- The tyre has completely slipped over the wheel rim and has come off the wheel.
- The wheel is damaged.

- Use the tyre sealant only at ambient temperatures of -30 °C to + 60 °C.
- Effect an emergency repair without pulling out the object (nail, screw, etc.) that is stuck in the tyre.
- Do not use the tyre sealant if the tyre has been damaged by being driven when insufficiently inflated (e.g. bumps, cuts, cracks etc. on the tyre).
- Wipe tyre sealant off the paintwork immediately with a damp cloth.
- Immediately wash clothes contaminated with tyre sealant.

Before repairing a tyre, first stop your vehicle in a safe, flat location.

1. Park the vehicle on level and stable ground.
2. Set the parking brake firmly.
3. On vehicles with M/T, turn the ignition switch to the "LOCK" position, move the gearshift lever to the "R" (Reverse) position. On vehicles with Twin Clutch SST, move the gearshift lever to the "P" (PARK) position, turn the ignition switch to the "LOCK" position.
4. Turn on the hazard warning flashers and set up a warning triangle, flashing signal lamp, etc., at an adequate distance from the vehicle, and have all your passengers leave the vehicle.
5. Take out the tyre sealant bottle and the compressor.
6. Shake the tyre sealant bottle well.

For emergencies

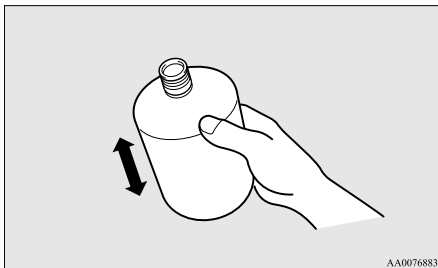

NOTE

- In cold conditions (when the ambient temperature is 0 °C or lower), thickening of the tyre sealant can make the tyre sealant hard to squeeze out of the bottle. Warm the bottle inside the vehicle.

7. Do not remove the seal (C). Screw the filler hose (D) onto the bottle (E). As you screw the filler hose onto the bottle, the seal will break, allowing the sealant to be used.

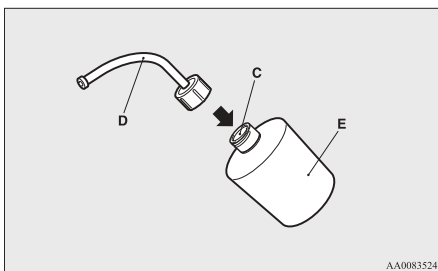

⚠ CAUTION

- If you shake the bottle after screwing on the hose, sealant may spray out of the hose.

8. Take the valve cap (F) off the tyre valve (G), then press the valve remover (H) onto the valve as illustrated. Allow all of the air in the tyre to escape.

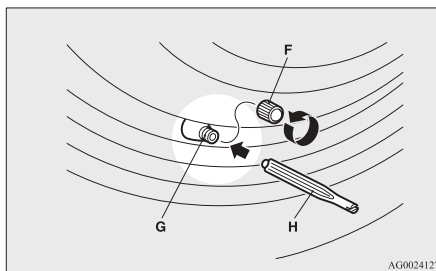

9. Remove the valve insert (I) by turning it anticlockwise using the valve remover (H). Put the removed valve insert in a clean place so it does not get dirty.

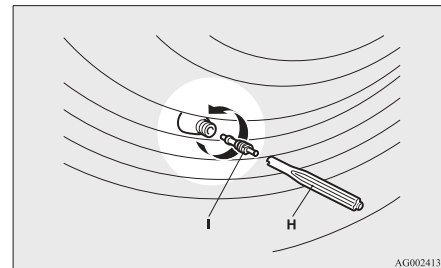

⚠ CAUTION

- If there is any air left in the tyre when you remove the valve insert, the valve insert may fly out and injure you. Make sure the tyre contains no air before removing the valve insert.

10. Remove the plug (J) from the free end of the hose (K). Press the hose onto the valve (G).

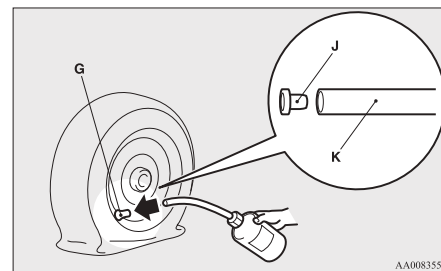

11. Holding the sealant bottle upside-down, squeeze it again and again to inject all of the sealant into the tyre.

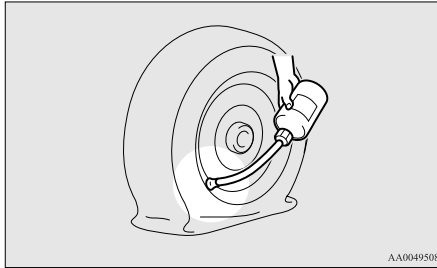

NOTE

- When injecting the sealant, position the valve away from the bottom, i.e., away from the point where the tyre touches the ground. If the valve is near the point where the tyre touches the ground, the sealant may not go into the tyre easily.
12. After injecting the sealant, pull the hose off the valve, remove any residual sealant from the valve, rim and/or tyre.

13. Fit the valve insert (I) into the valve (G), and screw the valve insert securely into place using the valve remover (H).

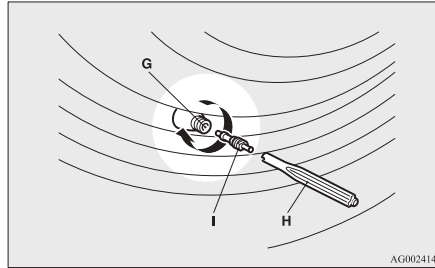

NOTE

- When removing and screwing in the valve insert using the valve remover, turn the valve remover by hand. Using a tool to turn the valve remover could damage it.

14. Pull out the compressor hose (L) from the side of the tyre compressor, and then securely attach the hose to the tyre valve (G).

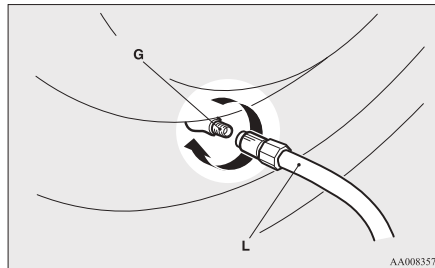

For emergencies

14. Place the compressor (M) with its air pressure gauge (N) on top. Pull out the compressor's power cord (O), insert the plug on the cord into the accessory socket or cigarette lighter socket (P), and then turn the ignition switch to the "ACC" position. Turn ON the compressor switch (Q) and inflate the tyre to the specified pressure.

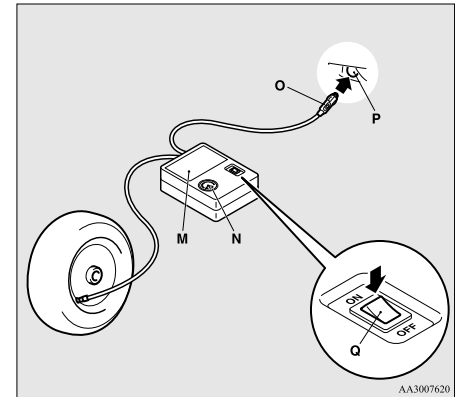

⚠ CAUTION

- The supplied compressor is designed only for inflation of passenger vehicle tyres.
- The compressor is designed to run on a vehicle's 12 V power supply. Do not connect it to any other power source.

For emergencies

⚠ CAUTION

- The compressor is not waterproof. If you use it in rain, make sure water does not get on it.
- Any sand or dust sucked into the compressor could make the compressor break down. Do not place the compressor directly on any sandy or dusty surface when using it.
- Do not disassemble or modify the compressor. Also, do not subject the air pressure gauge to shock. It could malfunction.

15. Check and adjust the tyre pressure with reference to the air pressure gauge on the compressor. If you overinflate the tyre, release air by loosening the hose's end fitting. (Refer to "Tyre inflation pressures" on page 8-10.) If there is a gap between the tyre and wheel because the tyre has moved inward from the wheel rim, press the periphery of the tyre towards the wheel to close the gap before running the compressor. (With no gaps, the tyre pressure will rise.)

⚠ CAUTION

- Be careful not to get your fingers trapped between the tyre and wheel as the tyre inflates.
- The surface of the compressor will get hot while the compressor is running. Do not keep the compressor running continuously for more than 10 minutes. After using the compressor, wait for the compressor to cool before using it again.

⚠ CAUTION

- If the compressor becomes sluggish or hot while operating, it is overheating. Immediately place the switch in the OFF position and let the compressor cool down for at least 30 minutes.

NOTE

- If the tyre pressure does not rise to the specified level within 10 minutes, the tyre may be so severely damaged that the tyre sealant cannot be used to effect an emergency repair. Please contact a MITSUBISHI MOTORS Authorized Service Point or another specialist in this event.

16. Turn OFF the compressor switch, then pull the power cord plug out of the socket.

NOTE

- Simply putting sealant and air into the tyre using the tyre repair kit does not seal the puncture hole. Air will leak through the puncture hole until the emergency repair procedure is completed (through step 20 of these instructions).

17. Affix the speed restriction sticker (R) to the steering wheel at the position shown in the illustration. Then immediately drive with great care to a MITSUBISHI MOTORS Au-

thorized Service Point or another specialist and have tyre repair/replacement performed.

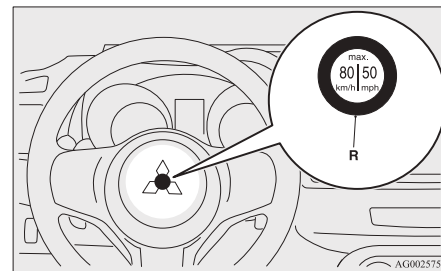

⚠ CAUTION

- Do not affix the sticker anywhere except the specified position on the pad of the steering wheel. Affixing the sticker in an incorrect position could prevent the SRS airbag from working normally.
- Be sure to check the tyre pressure for confirmation that the emergency repair procedure is complete.

18. When you have inflated the tyre to the specified pressure, stow the compressor, bottle, and other items in the vehicle and promptly start driving the vehicle so that the tyre sealant can spread evenly in the tyre. Drive with great care. Do not exceed a speed of 80 km/h (50 mph). Observe local speed limits.

CAUTION

- If you sense any abnormality while driving, stop the vehicle and contact a MITSUBISHI MOTORS Authorized Service Point or another specialist. Otherwise the tyre pressure may drop before the emergency repair procedure is completed, rendering the vehicle unsafe.

NOTE

- Driving faster than 80 km/h (50 mph) can make the vehicle vibrate.
19. After driving for 10 minutes or 5 km (3 miles), check the tyre pressure using the air pressure gauge on the compressor. (Refer to “Tyre inflation pressures” on page 8-10.)
- If the tyre pressure is not sufficient, inflate the tyre to the specified pressure again and drive the vehicle carefully without exceeding a speed of 80 km/h (50 mph).

CAUTION

- If the tyre pressure is lower than the minimum permitted pressure (1.3 bar {130 kPa}), the tyre cannot successfully be repaired with the tyre sealant. Do not drive the vehicle any further. Contact a MITSUBISHI MOTORS Authorized Service Point or another specialist.

20. After driving for 10 minutes or 5 km (3 miles), check the tyre pressure using the air pressure gauge on the compressor. (Refer

to “Tyre inflation pressures” on page 8-10.) If the tyre pressure has apparently not dropped, the emergency repair procedure is complete. You must still not exceed a speed of 80 km/h (50 mph). Observe local speed limits.

NOTE

- If the tyre pressure has dropped below the specified level when you check it at the end of the repair procedure, do not drive the vehicle any further. Contact a MITSUBISHI MOTORS Authorized Service Point or another specialist.
 - In cold conditions (when the ambient temperature is 0 °C or lower), the time and driving distance necessary until completion of the repair can be longer than in warmer conditions, meaning that the tyre pressure can drop below the specified level even when you have inflated the tyre a second time and subsequently driven the vehicle. If this happens, inflate the tyre to the specified pressure once more, drive for about 10 minutes or 5 km (3 miles), then check the tyre pressure again. If the tyre pressure has again dropped below the specified level, stop driving the vehicle and contact a MITSUBISHI MOTORS Authorized Service Point or another specialist.
 - Please give the empty sealant bottle to your MITSUBISHI MOTORS Authorized Service Point when you purchase new sealant or dispose of the sealant bottle according to national regulations for the disposal of chemical waste.
- A tyre in which puncture sealant has been used should ideally be replaced with a new one. If you wish to have such a tyre properly repaired for reuse, please contact a MITSUBISHI MOTORS Authorized Service Point or another specialist. Note that a proper repair is impossible following an emergency repair if the puncture hole cannot be located.
 - Wipe away any sealant that gets on the wheel. Provided the valve is replaced with a new one, the wheel can be reused.
 - The manufacturer is unable to guarantee that all tyre punctures can be repaired with the tyre repair kit, in particular cuts or perforations with a diameter of more than 4 mm or away from the tyre’s tread. The manufacturer is not liable for damage sustained through improper use of the tyre repair kit.
 - The manufacturer is not liable for damage sustained through re-use of any tyre in which tyre sealant has been used.

For emergencies

How to change a tyre

E00801202464

Before changing a tyre, first stop your vehicle in a safe, flat location.

1. Park the vehicle on level and stable ground, free of loose pebbles, etc.
2. Set the parking brake firmly.
3. On vehicles with M/T, turn the ignition switch to the “LOCK” position, and move the gearshift lever to the “R” (Reverse) position.

On vehicles with Twin Clutch SST, move the gearshift lever to the “P” (PARK) position, and turn the ignition switch to the “LOCK” position.

4. Turn on the hazard warning flashers and set up a warning triangle, flashing signal lamp, etc., at an adequate distance from the vehicle, and have all your passengers leave the vehicle.
5. To prevent the vehicle from rolling when it is raised on the jack, place chocks or blocks (A) at the tyre that is diagonally opposite from the tyre (B) you are changing.

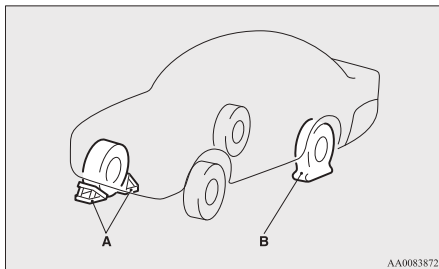

⚠ WARNING

- Be sure to apply chocks or blocks to the correct tyre when jacking up the vehicle. If the vehicle moves while jacked up, the jack could slip out of position, leading to an accident.

NOTE

- The chocks shown in the illustration do not come with your vehicle. It is recommended that you keep some in the vehicle for use if needed.
 - If chocks or blocks are not available, use stones or any other objects that are large enough to hold the wheel in position.
6. Get the jack, bar and wheel nut wrench ready. Refer to “Tools, jack and tyre repair kit” on page 6-05.

Spare wheel information*

E00803600673

Check the air pressure of the spare tyre frequently and make sure it is ready for emergency use at any time.

Maintaining the spare wheel at the highest specified air pressure will ensure that it can always be used under any conditions (city/high-speed driving, varying load weight, etc.).

The spare wheel is stored beneath the luggage floor board of the luggage compartment.

⚠ CAUTION

- The pressure should be periodically checked and maintained at the specified pressure while the tyre is stowed. Driving with an insufficient tyre pressure can lead to an accident. If you have no choice but to drive with an insufficient tyre pressure, keep your speed down and inflate the tyre to the correct pressure as soon as possible. (Refer to “Tyre inflation pressures” on page 8-10.)

Compact spare wheel*

The compact spare tyre is designed to save space in the luggage compartment and its lighter weight makes it easier to use if a flat tyre occurs.

⚠ CAUTION

- The compact spare wheel is for temporary use only and should be removed as soon as the original wheel can be repaired or replaced.
- The vehicle must not be driven at speeds in excess of 80 km/h (50 mph) while using the compact spare wheel.
- The compact spare tyre is not as good as a standard tyre in controllability and stability. When the compact spare tyre is used, avoid quick starts, sudden braking and sharp steering.
- The compact spare wheel is specifically designed for your vehicle and it should not be used on any other vehicle.

⚠ CAUTION

- Do not use tyre chains with your compact spare wheel. Because the diameter is different from that of a standard type, the tyre chain will not fit properly. This could cause damage to the wheel and result in loss of the chain.

If a rear tyre becomes flat when using tyre chains, first replace a front wheel with the compact spare wheel and then use the removed front wheel to replace the flat rear wheel so that you can continue to use the chains.

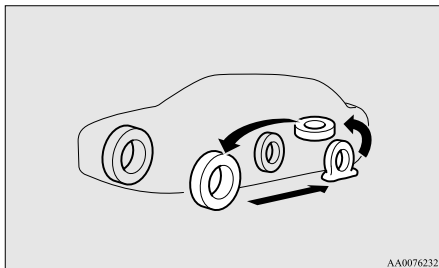

⚠ CAUTION

- Since the diameter of the compact spare tyre is different from that of a standard tyre, when passing over the projections on the road, take care not to drive the vehicle with the same feeling as used in driving with the standard tyre on.

⚠ CAUTION

- Do not install more than one compact spare wheel at the same time.

To remove the spare tyre

E00803500308

1. Lift up the luggage floor board.
2. To remove the spare tyre, remove the installation clamp (A) by turning it anticlockwise.

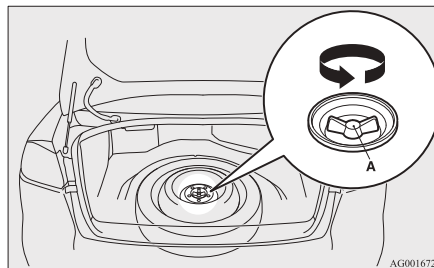

NOTE

- Put the spare wheel under the vehicle body near the jack. This makes it safer if the jack slips out of position.

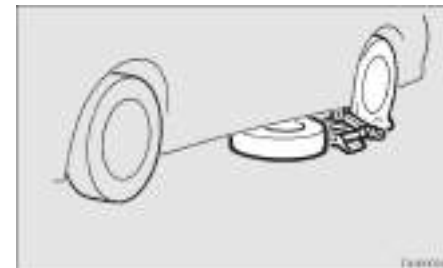

To change a tyre

E00803200901

1. Loosen the wheel nuts a quarter turn with the wheel nut wrench. Do not remove the wheel nuts yet.

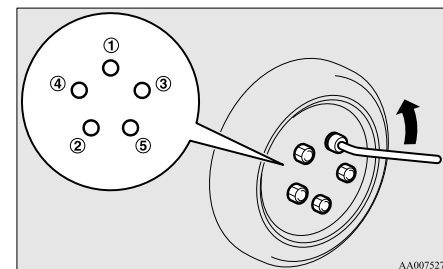

2. Place the jack under one of the jacking points (A) shown in the illustration. Use the jacking point closest to the tyre you wish to change.

For emergencies

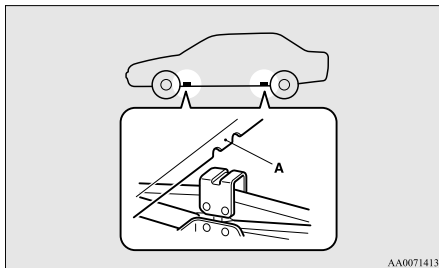

⚠ WARNING

- Set the jack only at the positions shown here. If the jack is set at a wrong position, it could dent your vehicle or the jack might fall over and cause personal injury.
- Do not use the jack on a tilted or soft surface. Otherwise, the jack might slip and cause personal injury. Always use the jack on a flat, hard surface. Before setting the jack, make sure there are no sand or pebbles under the jack base.

3. Rotate the jack by hand until the flange portion (B) fits in the groove (C) at the top of the jack.

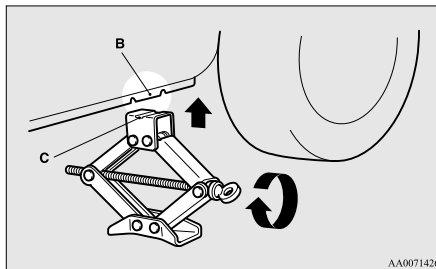

4. Insert the jack bar (D) into the wheel nut with the wheel nut wrench (E). Then put the end of the jack bar into the shaft's jack end, as shown in the illustration. Slowly rotate the wheel nut wrench until the tyre is raised slightly off the ground surface.

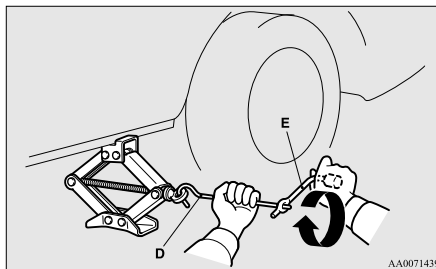

⚠ WARNING

- Stop jacking up the vehicle as soon as the tyre is raised off the ground. It is dangerous to raise the vehicle any higher.
- Do not get under your vehicle while using the jack.
- Do not bump the raised vehicle or leave it sitting on the jack for a long time. Both are very dangerous.
- Do not use a jack except the one that came with your vehicle.
- The jack should not be used for any purpose other than to change a tyre.
- No one should be in your vehicle when using the jack.
- Do not start or run the engine while your vehicle is on the jack.
- Do not turn the raised wheel. The tyres still on the ground could turn and make your vehicle fall off the jack.

5. Remove the wheel nuts with the wheel nut wrench, then take the wheel off.

⚠ CAUTION

- Handle the wheel carefully when changing the tyre, to avoid scratching the wheel surface.
6. Clean out any mud, etc. on the hub surface (F), hub bolts (G) or in the installation holes (H) in the wheel, and then mount the spare tyre.

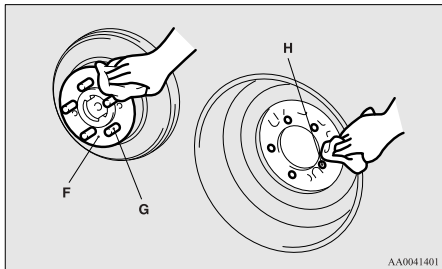

⚠ WARNING

- Mount the spare wheel with the valve stem (I) facing outboard. If you cannot see the valve stem (I), you have installed the wheel backwards. Operating the vehicle with the spare wheel installed backwards can cause vehicle damage and result in an accident.

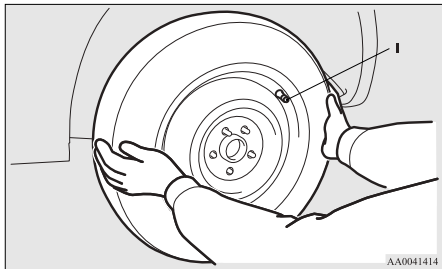

7. Finger-tighten the wheel nuts.
- Normal wheels and aluminium spare wheel

Tighten the wheel nuts until the flanges of the wheel nuts touch the wheel and the wheel is not loose.

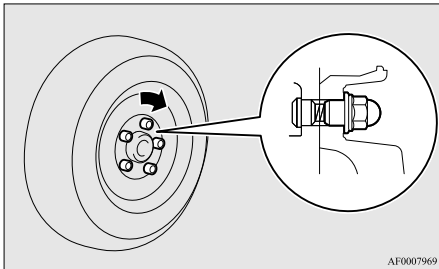

- Steel spare wheel
Tighten the wheel nuts until the tapered parts of the wheel nuts make light contact with the seats of the wheel holes and the wheel is not loose.

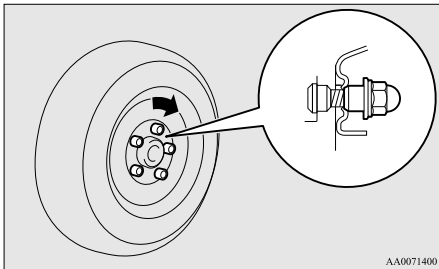

⚠ CAUTION

- Never apply oil to either the wheel bolts or the nuts, or they will tighten too much.

NOTE

- Flange nuts can be temporarily used on the steel spare wheel, but return to the original wheel and tyre as soon as possible.
- If all 4 aluminium wheels are changed to steel wheels, e.g. when fitting winter tyres, use tapered nuts.

8. Lower the vehicle slowly by rotating the wheel nut wrench anticlockwise until the tyre touches the ground.

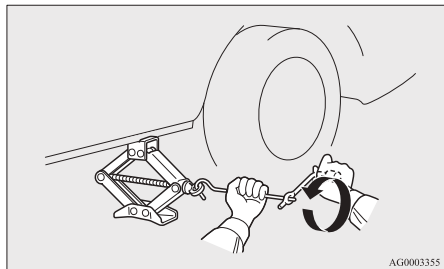

9. Tighten the nuts in the order shown in the illustration until each nut has been tightened to the torque listed here.

Tightening torque
88 to 108 Nm

For emergencies

(Achieved by applying a force of 350 to 420 N at the end of the wheel nut wrench supplied with the vehicle.)

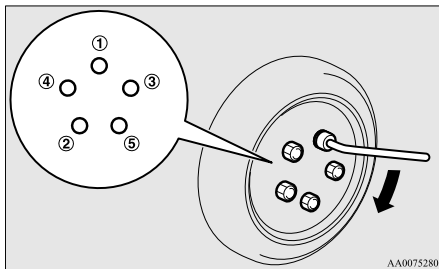

⚠ CAUTION

- Never use your foot or a pipe extension for extra force in the wheel nut wrench. If you do so, you will tighten the nut too much.

- 6
10. Lower the jack all the way and remove it.
 11. Check your tyre inflation pressure at the next gasstation. The correct pressures are shown on the driver's door label. See the illustration.

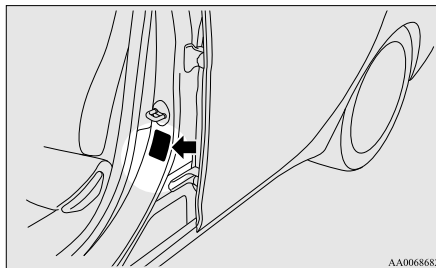

⚠ CAUTION

- The tyre pressure should be periodically checked and maintained at the specified pressure while the tyre is stowed.
- The compact spare tyre is to be used only temporarily when the standard tyre is damaged. Repair the damaged tyre as soon as possible and use it to replace the compact spare tyre.
- After changing the tyre and driving the vehicle about 1000 km (620 miles), re-tighten the wheel nuts to make sure that they have not come loose.
- If the steering wheel vibrates when driving after changing the tyre, we recommend you to have the tyres checked for balance.
- Do not mix one type of tyre with another or use a different size from the one listed. This would cause early wear and poor handling.

To store the flat tyre or spare wheel

E00803700469

1. Lift up the luggage floor board.

2. To store the flat tyre or spare wheel, fit the installation clamp (A) by turning it clockwise.

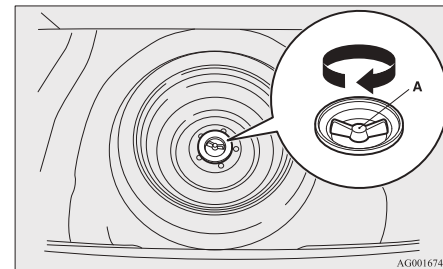

NOTE

- On vehicles with a compact spare wheel, the clamp cannot be used for a normal size tyre.
3. Have your damaged tyre repaired as soon as possible.

To store the tools and jack

E00803800138

Reverse the removing procedure when storing the jack, jack bar and wheel nut wrench. Refer to "Tools, jack and tyre repair kit" on page 6-05.

Towing

E00801503305

If your vehicle needs to be towed

If towing is necessary, we recommend you to have it done by your MITSUBISHI MOTORS Authorized Service Point or a commercial tow truck service.

In the following cases, transport the vehicle using a tow truck.

- The engine runs but the vehicle does not move or abnormal noise is produced.
- Inspection of the vehicle's underside reveals that oil or some other fluid is leaking.

If a wheel gets stuck in a ditch, do not try to tow the vehicle. Please contact your MITSUBISHI MOTORS Authorized Service Point or a commercial tow truck service for assistance.

Only when you cannot receive a towing service from a MITSUBISHI MOTORS Authorized Service Point or commercial tow truck service, tow your vehicle carefully in accordance with the instructions given in "Emergency towing" in this part.

The regulations concerning towing may differ from country to country. It is recommended that you obey the regulations of the area where you are driving your vehicle.

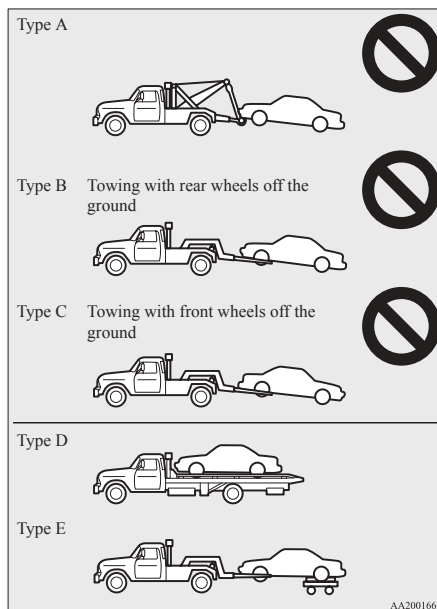

Towing the vehicle by a tow truck

⚠ CAUTION

- This vehicle must not be towed by a tow truck using sling lift type equipment (Type A) as illustrated. Using a sling lift will damage the bumper and front end.
- Do not tow 4WD vehicles with the front or rear wheels on the ground (Type B or Type C) as illustrated. This could result in driving system damage or the vehicle may jump at the carriage. If you tow 4WD vehicles, use Type D or Type E equipment.

Emergency towing

If towing service is not available in an emergency, your vehicle may be temporarily towed by a rope secured to the towing hook.

If your vehicle is to be towed by another vehicle, pay careful attention to the following points.

If your vehicle is to be towed by another vehicle

1. Take out the towing hook, wheel nut wrench and jack bar.
(Refer to "Tools, jack and tyre repair kit" on page 6-05.)

For emergencies

2. Cover the tip of the jack bar with a cloth, then use it to remove the cover (A) that is located on the front bumper.

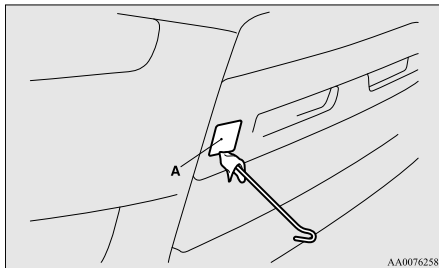

3. Use the wheel nut wrench (B) to securely mount the towing hook (C).

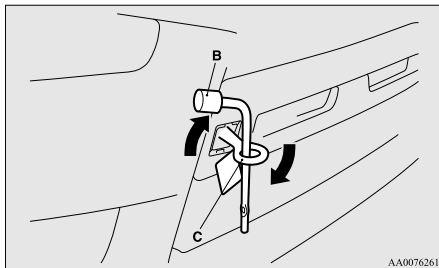

4. Secure the tow rope to the front towing hook.

⚠ CAUTION

- Do not tow the vehicle with the rope at an excessive diagonal angle.

NOTE

- To avoid deforming or otherwise damaging the vehicle body when hooking the rope onto the towing hook, observe the following instructions:
 - Mount the towing hook securely.
 - Do not attach the rope to any part of the vehicle other than the towing hook.
 - Ensure that the tow rope is taut when the towing vehicle moves away.

5. Keep the engine running.
If the engine is not running, turn the ignition switch to the “ACC” or “ON” position (M/T) to unlock the steering wheel.

⚠ CAUTION

- On vehicles with Twin Clutch SST, have the vehicle transported by a tow truck with all wheels raised off the ground if the engine does not start.
If the vehicle is towed without starting the engine, the Twin Clutch SST may be damaged because the fluid will not reach all parts of the transmission. Refer to “If your vehicle needs to be towed” on page 6-17.

⚠ CAUTION

- When the engine is not running, the brake booster and power steering system do not operate. This means higher brake depression force and higher steering effort are required. Therefore, vehicle operation is more difficult than usual.
- Do not turn the ignition switch to “LOCK” position. The steering wheel will be locked, causing loss of control.

6. Place the gearshift lever in the “N” (Neutral) position (M/T) or the “N” (NEUTRAL) position (Twin Clutch SST).
7. Turn on the hazard warning lamps if required by law. (Follow the local driving laws and regulations.)
8. During towing make sure that close contact is maintained between the drivers of both vehicles, and that the vehicles travel at low speed.

⚠ CAUTION

- The person in the vehicle being towed must pay attention to the brake lamps of the towing vehicle and make sure the rope never becomes slack.
- Avoid sudden braking, sudden acceleration and sharp turning; such operation could cause damage to the towing hooks or the tow rope.
People in the vicinity could be injured as a result.

⚠ CAUTION

- When towing or being towed down a long slope, the brakes may overheat reducing the effectiveness. In this situation, have your vehicle transported by a tow truck.
- When the vehicle with Twin Clutch SST is to be towed by another vehicle with the all wheels on the ground, make sure that the towing speed and distance given below are never exceeded, causing damage to the transmission.

Towing speed: 40 km/h (25 mph)
Towing distance: 40 km (25 miles)

For the towing speed and the towing distance, follow the local driving laws and regulations.

9. When finished towing, remove the towing hook, and stow it in the specified location. Refer to “Tools, jack and tyre repair kit” on page 6-05.
When installing the cover, align the hook with the cut out area on the vehicle, and firmly insert.

If your vehicle tows another vehicle

NOTE

- Your vehicle cannot tow any other vehicle.

Operation under adverse driving conditions

E00801702573

On a flooded road

- Avoid flooded roads. Water could enter the brake discs, resulting in temporarily ineffective brakes. In such cases, lightly depress the brake pedal to see if the brakes operate properly. If they do not, lightly depress the pedal several times while driving in order to dry the brake pads.
- When driving in rain or on a road with many puddles a layer of water may form between the tyres and the road surface. This reduces a tyre’s frictional resistance on the road, resulting in loss of steering stability and braking capability.

To cope with this, observe the following items:

- Drive your vehicle at a slow speed.
- Do not drive on worn tyres.
- Always maintain the specified tyre inflation pressures.

On a snow-covered or frozen road

- When driving on a snow-covered or frozen road, it is recommended that you use snow tyres or tyre chains. Refer to the “Snow tyres” and “Tyre chains” sections.
- Avoid high-speed operation, sudden acceleration, abrupt brake application and sharp cornering.

- Depressing the brake pedal during travel on snowy or icy roads may cause tyre slippage and skidding. When traction between the tyres and the road is reduced the wheels may skid and the vehicle cannot readily be brought to a stop by conventional braking techniques. Braking will differ, depending upon whether you have anti-lock brake system (ABS). As your vehicle is equipped with ABS, brake by pressing the brake pedal hard, and keeping it pressed.
- Allow extra distance between your vehicle and the vehicle in front of you, and avoid sudden braking.
- Accumulation of ice on the braking system can cause the wheels to lock. Pull away from a standstill slowly after confirming safety around the vehicle.

⚠ CAUTION

- Do not press the accelerator pedal rapidly. If the wheels break free of the ice, the vehicle could suddenly start moving and possibly cause an accident.

On a bumpy or rutted road

Drive as slow as possible when driving on bumpy or rutted roads.

⚠ CAUTION

- The impact on tyres and/or wheels when driving on a bumpy or rutted road can damage the tyre and/or wheel.

For emergencies

⚠ CAUTION

- The vehicle's body, bumper, muffler and other parts may be damaged if the vehicle is:
 - driven over a step (for example, at the entrance or exit of a parking lot);
 - parked too closely against a kerb or parking block, or by the side of a road with kerbstones;
 - driven on a steep slope;

Vehicle care

Vehicle care precautions..... 7-02
Cleaning the interior of your vehicle..... 7-02
Cleaning the exterior of your vehicle..... 7-03

Vehicle care precautions

E00900100900

In order to maintain the value of your vehicle, it is necessary to perform regular maintenance using the proper procedures.

Always maintain your vehicle in compliance with any environmental pollution control regulations. Carefully select the materials used for washing, etc., to be sure that they do not contain corrosives; if in doubt, we recommend you to consult a specialist for the selection of these materials.

CAUTION

- **Cleaning products can be dangerous. Always follow the instructions of the cleaning product supplier.**
- **To avoid damage, never use the following to clean your vehicle:**
 - Petrol
 - Paint Thinner
 - Benzine
 - Kerosene
 - Turpentine
 - Naphtha
 - Lacquer Thinner
 - Carbon Tetrachloride
 - Nail Polish Remover
 - Acetone

Cleaning the interior of your vehicle

E00900200552

After cleaning the interior of your vehicle with water, cleaner or similar, wipe and dry in a shady, well-ventilated area.

CAUTION

- **Do not use organic substances (solvents, benzine, kerosene, alcohol, petrol, etc.) or alkaline or acidic solutions. These chemicals can cause discolouring, staining or cracking of the surface. If you use cleaners or polishing agents, make sure their ingredients do not include the substances mentioned above.**

Plastic, vinyl leather, fabric and flocked parts

E00900300335

1. Gently wipe off with gauze or other soft cloth soaked with a 3 % aqueous solution of neutral detergent.
2. Dip cloth in fresh water and wring out well. Using this cloth, wipe off the detergent thoroughly.

NOTE

- Do not use cleaners, conditioners, and protectants containing silicones or wax. Such products, when applied to the instrument panels or other parts, may cause reflections on the windscreen and obscure vision. Also, if such products get on the switches of the electrical accessories, it may lead to failure of these accessories.

Upholstery

E00900500177

1. To maintain the value of your new vehicle, handle the upholstery carefully and keep the interior clean.
Use a vacuum cleaner and brush to clean the seats. If stained, vinyl and synthetic leather should be cleaned with an appropriate cleaner, and cloth fabrics can be cleaned with either upholstery cleaner or a 3 % solution of neutral detergent in lukewarm water.
2. Clean the carpeting with a vacuum cleaner and remove any stains with carpet cleaner. Oil and grease can be removed by lightly dabbing with a clean colourfast cloth and stain remover.

Genuine leather*

E00900600846

1. Lightly wipe off with gauze or other soft cloth soaked with a 5 % aqueous solution of neutral detergent.
2. Dip cloth in fresh water and wring it out well. Using this cloth, wipe off the detergent thoroughly.
3. Apply leather protecting agent to the genuine leather surface.

NOTE

- If genuine leather is wet with water or is washed in water, wipe off water as quickly as possible with a dry, soft cloth. If left damp, mildew may grow.
- The genuine leather surface may be damaged if a nylon brush or synthetic fibre is rubbed hard against it.
- Organic solvents such as benzine, kerosene, alcohol and petrol, acid or alkaline solvents may discolour the genuine leather surface. Be sure to use neutral detergents.
- Remove dirty patches or oil substances quickly as they can stain genuine leather.
- The genuine leather surface may harden and shrink if it is exposed to direct sun for long hours. When your vehicle is parked, place it in the shade as much as possible.
- When the temperature of the vehicle interior rises in summer, vinyl products left on the genuine leather seat may deteriorate and stick to the seat.

Cleaning the exterior of your vehicle

E00900700111

If the following is left on your vehicle, it may cause corrosion, discolouration and stains, wash the vehicle as soon as possible.

- Seawater, road deicing products.
- Soot and dust, iron powder from factories, chemical substance (acids, alkalis, coal-tar, etc.).
- Droppings from birds, carcasses of insects, tree sap, etc.

Washing

E00900902090

Chemicals contained in the dirt and dust picked up from the road surface can damage the paint coat and body of your vehicle if left in prolonged contact.

Frequent washing and waxing is the best way to protect your vehicle from this damage. This will also be effective in protecting it from environmental elements such as rain, snow, salt air, etc. Do not wash the vehicle in direct sunlight. Park the vehicle in the shade and spray it with water to remove dust. Next, using an ample amount of clean water and a car washing brush or sponge, wash the vehicle from top to bottom.

Use a mild car washing soap if necessary. Rinse thoroughly and wipe dry with a soft cloth. After washing the vehicle, carefully clean the joints and flanges of the doors, bonnet, etc., where dirt is likely to remain.

CAUTION

- When washing the under side of your vehicle or wheel, be careful not to injure your hands.
- This vehicle is equipped with a high performance brake. Because the wheels become contaminated by its brake dusts easily, wash the dusts off frequently. It is difficult to remove the dusts after a long time.
- As your vehicle has rain sensor wipers, place the wiper switch lever in the “OFF” position to deactivate the rain sensor before washing the vehicle. Otherwise, the wipers will operate in the presence of water spray on the windscreen and may get damaged as a result.
- Refrain from excessively using a car wash as its brushes may scratch the paint surface, causing it to lose its gloss. Scratches will be especially visible on darker coloured vehicles.
- Never spray or splash water on the electrical components in the engine compartment, as this may adversely affect engine starting. Exercise caution also when washing the underbody; be careful not to spray water into the engine compartment.
- Some types of hot water washing equipment apply high pressure and heat to the vehicle. They may cause heat distortion and damage to the vehicle resin parts and may result in flooding of the vehicle interior. Therefore;

CAUTION

- Maintain a distance of approx. 50 cm or more between the vehicle body and the washing nozzle.
- When washing around the door glass, hold the nozzle at a distance of more than 50 cm and at right angles to the glass surface.
- After washing the vehicle, drive the vehicle slowly while lightly depressing the brake pedal several times in order to dry out the brakes.
Leaving the brakes wet could result in reduced braking performance. Also, there is a possibility that they could freeze up or become inoperative due to rust, rendering the vehicle unable to move.
- When using high-pressure water to wash a vehicle equipped with the keyless operation system, keep the water from spraying on the open button on the trunk. This could cause the trunk to open and flood the inside of the trunk.
- Using an automatic car wash, pay attention to the following items, referring to the operation manual or consulting a car wash operator. If the following procedure is not followed, it could result in damage to your vehicle.
 - The outside rear-view mirrors are retracted.
 - The roof antenna is removed.
 - If your vehicle is equipped with a rear spoiler, consult a car wash operator before using the car wash.

CAUTION

- As your vehicle has rain sensor wipers, place the wiper switch lever in the “OFF” position to deactivate the rain sensor.

During cold weather

The salt and other chemicals spread on the roads in some areas in winter can have a harmful effect on the vehicle body. You should therefore wash the vehicle as often as possible in accordance with our care-instructions. It is recommended to have a preservative applied and the underfloor protection checked before and after the cold weather season. After washing your vehicle, wipe off all water-drops from the rubber parts around the doors to prevent the doors from freezing.

NOTE

- To prevent freezing of the weatherstripping on the doors, bonnet, etc., they should be treated with silicone spray.

Waxing

E00901000935

Waxing the vehicle will help prevent the adherence of dust and road chemicals to the paintwork. Apply a wax solution after washing the vehicle, or at least once every three months to assist displacing of water.

Do not wax your vehicle in direct sunlight. You should wax after the surfaces have cooled.

CAUTION

- Waxes containing high abrasive compounds should not be used. Such waxes remove rust and stain effectively from the paintwork but they are harmful to the lustre of the painted surface.
Further, they are harmful to glossy surfaces such as grille, garnish, mouldings, etc.
- Do not use petrol or paint thinners to remove road tar or other contamination to the vehicle surface.
- Do not apply wax on the areas having black mat coating as it can cause uneven discolouration, patches, blurs, etc. If stained with wax, immediately wipe off with a piece of soft cloth and warm water.

Polishing

E00901100112

The vehicle should only be polished if the paintwork has become stained or lost its lustre. Matt-finish parts and plastic bumpers must not be polished, polishing these parts will stain them or damage their finish.

Damaged paint

E00901200012

Small cracks and scratches in the paint coat should be touched up as soon as possible with MITSUBISHI touch-up paint to prevent corrosion. Check body areas facing the road or the tyres carefully for damage to the paint coat caused by flying stones, etc. The paint code number for your vehicle can be found on the vehicle information code plate in the engine compartment.

Cleaning plastic parts

E00901300752

Use a sponge or chamois leather.

If a car wax adheres on a grey or black rough surface of the bumper, moulding or lamps, the surface becomes white. In such a case, wipe it off using lukewarm water and soft cloth or chamois leather.

CAUTION

- Do not use a scrubbing brush or other hard tools as they may damage the plastic part surface.
- Do not use wax containing compound (polishing powder) which may damage the plastic part surface.
- Do not bring the plastic parts into contact with petrol, light oil, brake fluids, engine oils, greases, paint thinners, and sulphuric acid (battery electrolyte) which may crack, stain or discolour the plastic parts. If they touch the plastic parts, wipe them off with soft cloth, chamois or the like and an aqueous solution of neutral detergent then immediately rinse the affected parts with water.

Chrome parts

E00901400157

In order to prevent spots and corrosion of chrome parts, wash with water, dry thoroughly, and apply a special protective coating. This should be done more frequently in winter.

Aluminium wheels

E00901500132

1. Remove dirt using a sponge while sprinkling water on the wheel.

2. Use neutral detergent on any dirt that cannot be removed easily with water.
Rinse off the neutral detergent after washing the wheel.
3. Dry the wheel thoroughly using a chamois leather or a soft cloth.

CAUTION

- Do not use a brush or other hard implement on the wheels.
Doing so could scratch the wheels.
- Do not use any cleaner that contains an abrasive substance or is acidic or alkaline. Doing so could cause the coating on the wheels to peel or become discoloured or stained.
- Do not directly apply hot water using a steam cleaner or by any other means.
- Contact with seawater and road deicer can cause corrosion. Rinse off such substances as soon as possible.

Window glass

E00901600029

The window glass can normally be cleaned using only a sponge and water.

Glass cleaner can be used to remove oil, grease, dead insects, etc. After washing the glass, wipe dry with a clean, dry, soft cloth. Never use the same cloth to wipe the window glass as would be used to wipe the paintwork; wax from the painted surfaces could adhere to the glass and reduce its transparency and visibility.

NOTE

- To clean the inside of the rear window, always use a soft cloth and wipe the window glass along the demister heater element so as not to cause damage.

Wiper blades

E00901700059

Use a soft cloth and glass cleaner to remove grease, dead insects, etc., from the wiper blades. Replace the wiper blades when they no longer wipe properly. (Refer to page 8-14.)

Engine compartment

E00902100311

Clean the engine compartment at the beginning and end of winter. Pay particular attention to flanges, crevices and peripheral parts where dust containing road chemicals and other corrosive materials might collect.

If salt and other chemicals are used on the roads in your area, clean the engine compartment at least every three months.

Never spray or splash water on the electrical components in the engine compartment, as this may cause damage.

Do not bring the nearby parts, the plastic parts and so on into contact with sulphuric acid (battery electrolyte) which may crack, stain or discolour them.

If they are in contact, wipe off with soft cloth, chamois or the like and an aqueous solution of neutral detergent then immediately rinse the affected parts with plenty of water.

A series of 15 horizontal dashed lines spanning the width of the page, providing a template for handwriting practice.

Maintenance

Service precautions.....	8-02
Catalytic converter.....	8-02
Bonnet.....	8-03
Engine oil.....	8-04
Engine coolant.....	8-05
AWC control fluid.....	8-06
Washer fluid.....	8-07
Brake fluid/Clutch fluid*.....	8-07
Power steering fluid.....	8-08
Battery.....	8-08
Tyres.....	8-09
Parking brake break-in.....	8-13
Wiper blade rubber replacement.....	8-14
General maintenance.....	8-14
For cold and snowy weather.....	8-15
Fusible links.....	8-15
Fuses.....	8-16
Replacement of lamp bulbs.....	8-22

Service precautions

E01000101051

Adequate care of your vehicle at regular intervals serves to preserve the value and appearance as long as possible.

Maintenance items as described in this owner's manual can be performed by the owner.

We recommend you to have the periodic inspection and maintenance performed by a MITSUBISHI MOTORS Authorized Service Point or another specialist.

In the event a malfunction or other problem is discovered, we recommend you to have it checked and repaired. This section contains information on inspection maintenance procedures that you can do yourself. Follow the instructions and cautions for each of the various procedures.

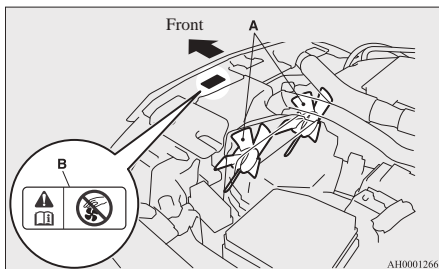

A- Cooling fans
B- Caution label

⚠ WARNING

- When checking or servicing the inside of the engine compartment, make sure the engine is switched off and has had a chance to cool down.
- If it is necessary to do work in the engine compartment with the engine running, be especially careful that your clothing, hair, etc., does not become caught by the fans, drive belts, or other moving parts.
- The fans may turn on automatically even if the engine is not running; turn the ignition switch to “LOCK” position and remove the key to ensure safety while you work in the engine compartment.
- Do not smoke, cause sparks or allow open flames around fuel or battery. The fumes are flammable.
- Be extremely cautious when working around the battery. It contains poisonous and corrosive sulphuric acid.
- Do not get under your vehicle with just the body jack supporting it. Always use automotive jack stands.
- Improper handling of components and materials used in the vehicle can endanger your personal safety. We recommend you to consult a specialist for necessary information.

Catalytic converter

E01000201137

For ordinary use, there are no particular precautions except that unleaded petrol should be used.

The exhaust gas scavenging devices used with the catalytic converter are extremely efficient for the reduction of noxious gases. The catalytic converter is installed in the exhaust system.

It is important to keep the engine properly tuned to ensure proper catalyst operation and prevent possible catalyst damage.

⚠ WARNING

- As with any vehicle, do not park or operate this vehicle in areas where combustible materials such as dry grass or leaves can come in contact with a hot exhaust since a fire could occur.
- Paint should not be applied to the catalytic converter.

NOTE

- Use UNLEADED PETROL ONLY of the type recommended in “Fuel selection” on page 02.

Bonnet

E01000302441

CAUTION

- To avoid the risk of being burned, do not touch the air outlets (A) and air scoop (B) on the bonnet when the engine compartment is hot (when the engine is running or immediately after the vehicle has been driven).

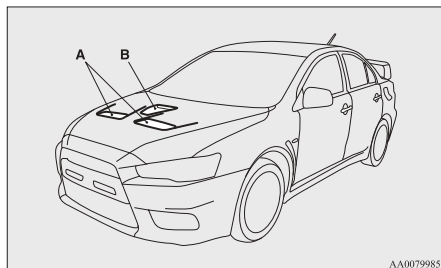

To open

1. Pull the release lever towards you to unlock the bonnet.

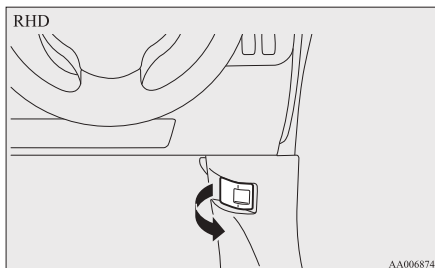
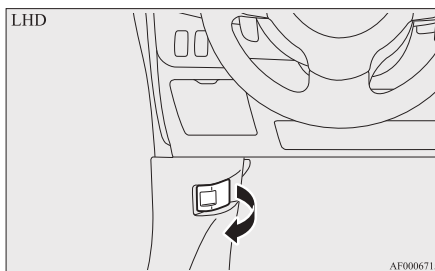

2. Raise the bonnet while pressing the safety lock.

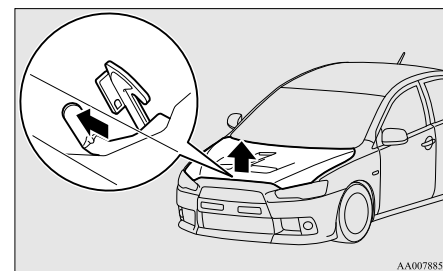

NOTE

- Only open the bonnet when the wipers are in the parked position. In any other position, the wipers could damage the paint or bonnet.

3. Support the bonnet by inserting the support bar in its slot.

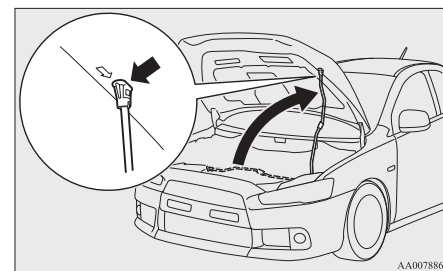

CAUTION

- Note that the support bar may disengage the bonnet if the open bonnet is lifted by a strong wind.

⚠ CAUTION

- After inserting the support bar into the slot, make sure the bar supports the bonnet securely from falling down on to your head or body.

To close

1. Unlatch the support bar and clip it in its holder.

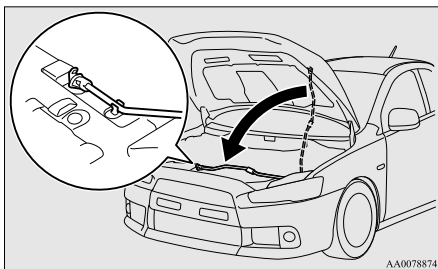

2. Slowly lower the bonnet to a position about 20 cm above the closed position, then let it drop.
3. Make sure the bonnet is securely locked by softly lifting the centre of the bonnet.

⚠ CAUTION

- Be careful that hands or fingers are not trapped when closing the bonnet.

⚠ CAUTION

- Before driving, make sure that the bonnet is securely locked. An incompletely locked bonnet can suddenly open while driving. This can be extremely dangerous.

NOTE

- If this does not close the bonnet, release it from a slightly higher position.
- Do not press down the bonnet hard with a hand as it may damage the bonnet.
- If you drive with the bonnet left open, warning display is displayed on the information screen in the multi-information display.



Engine oil

E01000402859

To check and refill engine oil

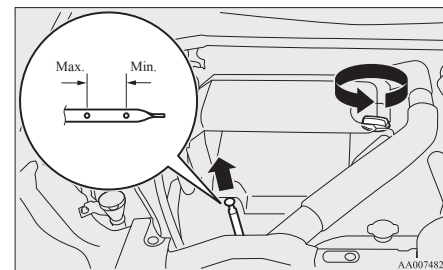

The engine oil used has a significant effect on the engine's performance, service life and startability. Be sure to use oil of the recommended quality and appropriate viscosity.

All engines consume a certain amount of oil during normal operation. Therefore, it is important to check the oil level at regular intervals or before starting a long trip.

1. Park the car on a horizontal surface.
2. Switch off the engine.
3. Wait a few minutes.
4. Remove the dipstick and wipe it with a clean cloth.
5. Reinsert the dipstick as far as it goes.
6. Remove the dipstick and read the oil level, which should always be within the range indicated.

7. If the oil level is below the specified limit, remove the cap located on the cylinder head cover and add enough oil to raise the level to within the specified range. Do not overfill to avoid engine damage. Be sure to use the specified engine oil and do not mix various types of oil.
8. After adding oil, close the cap securely.
9. Confirm the oil level by repeating step 4 to 6.

Use only the recommended oils with an ACEA or API classification as specified in this manual.

NOTE

- The engine oil will deteriorate rapidly if the vehicle is subjected to severe conditions, requiring earlier oil replacement. Please refer to the maintenance schedule.
- For information on how to dispose of used engine oil, refer to page 05.

Selection of engine oil

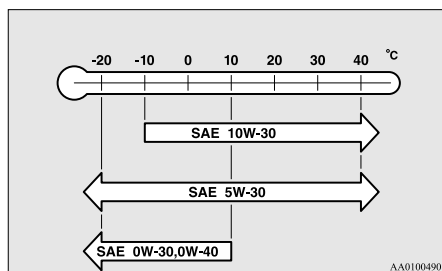

- Select engine oil of the proper SAE viscosity number according to the atmospheric temperature.
SAE 5W-30, 0W-30 and 0W-40 engine oil can only be used if it meets ACEA A3/B3, A3/B4 or A5/B5 and API SM or higher specifications.
- SAE 0W-30 and 0W-40 engine oil are recommended to use to improve engine startability on a very cold weather condition. When the ambient temperature is $-25\text{ }^{\circ}\text{C}$ or lower, use of synthetic oil is recommended to ensure startability.
- Use engine oil conforming to the following classification:
 - API classification: “For service SM” or higher
 - ILSAC certified oil
 - ACEA classification: “For service A1/B1, A3/B3, A3/B4 or A5/B5”

NOTE

- Use of additives is not recommended since they may reduce the effectiveness of additives already included in the engine oil. It may result in failure of the mechanical assembly.

Engine coolant

E01000502124

To check the coolant level

A transparent coolant reserve tank (A) is located in the engine compartment.

The coolant level in this tank should be kept between the “LOW” and “FULL” marks when measured while the engine is cold.

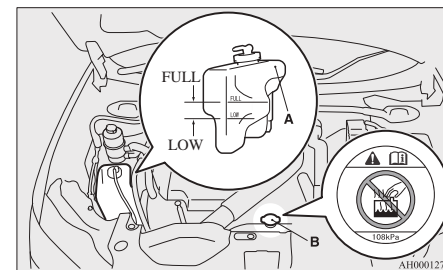

To add coolant

The cooling system is a closed system and normally the loss of coolant should be very slight. A noticeable drop in the coolant level could indicate leakage. If this occurs, we recommend you to have the it checked as soon as possible.

If the level should drop below the “LOW” level on the reserve tank, open the lid and add coolant.

Also, if the reserve tank is completely empty, remove the radiator cap (B) and add coolant until the level reaches the filler neck.

Maintenance

⚠ WARNING

- Do not open the radiator cap while the engine is hot. The coolant system is under pressure and any hot coolant escaping could cause severe burns.

Anti-freeze

The engine coolant contains an ethylene glycol anti-corrosion agent. Some parts of the engine are cast aluminium alloy, and periodic changing of the engine coolant is necessary to prevent corrosion of these parts.

Use “MITSUBISHI MOTORS GENUINE SUPER LONG LIFE COOLANT PREMIUM” or equivalent*.

- *: similar high quality ethylene glycol based non-silicate, non-amine, non-nitrate and non-borate coolant with long life hybrid organic acid technology

MITSUBISHI MOTORS GENUINE Coolant has excellent protection against corrosion and rust formation of all metals including aluminium and can avoid blockages in the radiator, heater, cylinder head, engine block, etc.

Because of the necessity of this anti-corrosion agent, the coolant must not be replaced with plain water even in summer. The required concentration of anti-freeze differs depending on the expected ambient temperature.

Above -35 °C: 50 % concentration of anti-freeze
Below -35 °C: 60 % concentration of anti-freeze

⚠ CAUTION

- Do not use alcohol or methanol anti-freeze or any engine coolants mixed with alcohol or methanol anti-freeze. The use of an improper anti-freeze can cause corrosion of the aluminium components.
- Do not use water to adjust the concentration of coolant.
- Concentrations exceeding 60 % will result in a reduction of both the anti-freeze and cooling performance thus adversely affecting the engine.
- Do not top up with water only.

During cold weather

The engine coolant mixture used at the factory provides protection against freezing for temperatures as low as approximately -35 °C. The concentration should be checked before the start of cold weather and anti-freeze added to the system if necessary to prevent damage to engine and radiator due to freezing.

AWC control fluid

E01009700011

To check the fluid level

Remove the lid on the trunk room right side trim. Check the fluid level in the reservoir 90 minutes or more after turning the ignition switch to the “LOCK” position.

Check to make certain that the AWC control fluid level is always between the “MAX” and “MIN” level markings on the fluid reservoir and refill the fluid, if necessary.

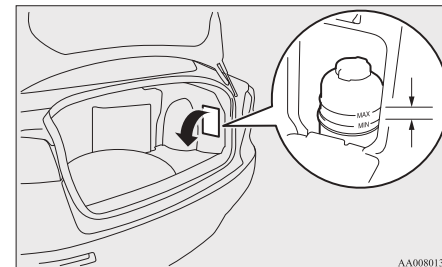

Fluid type

Lubricant	MITSUBISHI MOTORS Genuine ATF SP III
-----------	--------------------------------------

Washer fluid

E01000700773

Windscreen washer

The windscreen washer fluid reservoir is in the trunk.

Check the washer fluid level at regular intervals and add washer fluid to reservoir if necessary.

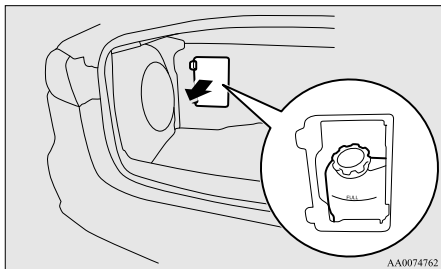

If the level is low, replenish the container with washer fluid.

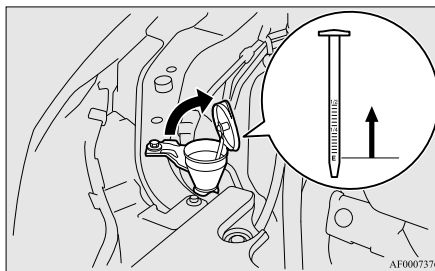

During cold weather

To ensure proper operation of the washers at low temperatures, use a fluid containing an anti-freezing agent.

NOTE

- Do not spill the fluid onto the trunk. If the fluid spilled, wipe it up immediately.

Headlamps washer fluid

Open the headlamps washer fluid reservoir cap and check the level of washer fluid with the dipstick.

Brake fluid/Clutch fluid*

E01000800556

The brake fluid and the clutch fluid share the reservoir tank.

To check the fluid level

The fluid level must be between the “MAX” and “MIN” marks on the reservoir.

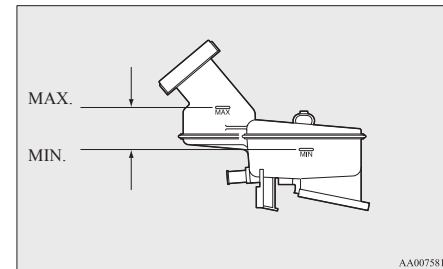

The fluid level is monitored by a float. When the brake fluid level falls below the “MIN” mark, the brake fluid warning lamp lights up.

The fluid level falls slightly with wear of the brake pads, but this does not indicate any abnormality.

If the fluid level falls markedly in a short length of time, it indicates leaks from the brake system.

If this occurs, we recommend you to have the vehicle checked.

Fluid type

Use brake fluid conforming to DOT3 or DOT4 from a sealed container. The brake fluid is hygroscopic. Too much moisture in the brake fluid will adversely affect the brake system and clutch system, reducing the performance.

A CAUTION

- Take care in handling brake fluid as it is harmful to the eyes, may irritate your skin and also damage to painted surfaces.
- Use only the specified brake fluid. Do not mix or add different brand of brake fluid to prevent chemical reaction. Do not let any petroleum-based fluid touch, mix with, or get into the brake fluid. This will damage the seals.
- Keep the reservoir tank cap closed to prevent the brake fluid from deteriorating except maintenance.
- Clean the filler cap before removing and close the cap securely after maintenance.

Power steering fluid

E01001101351

To check the fluid level

Check the fluid level in the reservoir while the engine is idling. Check to make certain that the power steering fluid level is always between the “MAX” and “MIN” level markings on the fluid reservoir and top up the fluid, if necessary.

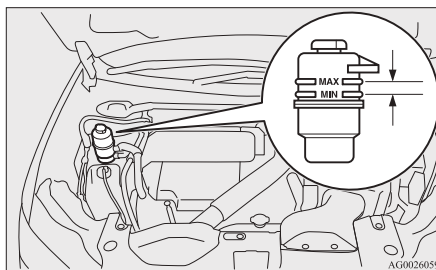

Fluid type

Use “MITSUBISHI MOTORS GENUINE PSF (Power Steering Fluid)”.

Battery

E01001201974

The condition of the battery is very important for quick starting of the engine and proper functioning of the vehicle’s electrical system. Regular inspection and care are especially important in cold weather.

Be sure to have a MITSUBISHI MOTORS Authorized Service Point check the battery.

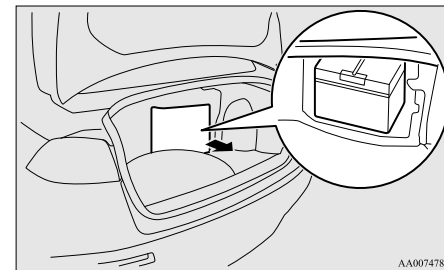

A WARNING

- Be sure to have a MITSUBISHI MOTORS Authorized Service Point charge the battery. Do not charge the battery yourself. In addition, never remove the battery label, upper cover, exhaust tube, or pipe. Flammable gases may leak and explode.

Tyres

E01001300242

During cold weather

The capacity of the battery is reduced at low temperatures. This is an inevitable result of its chemical and physical properties. This is why a very cold battery, particularly one that is not fully charged will only deliver a fraction of the starter current which is normally available.

We recommended you have the battery and charging system checked by a MITSUBISHI MOTORS Authorized Service Point before the start of cold weather. If necessary, have it replaced.

Disconnection and connection

To disconnect the battery cable, stop the engine, first disconnect the negative (-) terminal and then the positive (+) terminal. When connecting the battery, first connect the positive (+) terminal and then the negative (-) terminal.

⚠ WARNING

- Keep sparks, cigarettes, and flames away from the battery because the battery could explode.
- The battery electrolyte is extremely caustic. Do not allow it to come in contact with your eyes, skin, clothing, or the painted surfaces of the vehicle. Spilt electrolyte should be flushed immediately with ample amounts of water. Irritation to eyes or skin from contact with electrolyte requires immediate medical attention.

⚠ CAUTION

- Keep it out of reach of children.
- Never disconnect the battery when the ignition switch is in the "ON" position. Doing so could damage electric components.
- Never short-circuit the battery. This could cause it to overheat and be damaged.
- In order to prevent a short circuit, be sure to disconnect the negative (-) terminal first.
- Always wear protective eye goggles when working near the battery.
- Do not bring the nearby parts, the plastic parts and so on into contact with sulphuric acid (battery electrolyte) which may crack, stain or discolour them. If they are in contact, wipe off with soft cloth, chamois or the like and an aqueous solution of neutral detergent then immediately rinse the affected parts with plenty of water.

NOTE

- Check to see if the battery is securely installed and cannot be moved during travel.
- This vehicle is equipped with a special battery. Therefore, a battery may not be installed properly into the vehicle, even if it is the same type. Be sure to have a MITSUBISHI MOTORS Authorized Service Point replace the battery.

⚠ WARNING

- Driving with tyres that are worn, damaged or improperly inflated can lead to a loss of control or blow out of the tyres which can result in a collision with serious or fatal injury.

Tyre inflation pressures

E01001402869

Item	Tyre size	Normal loading		Above 160 km/h (99 mph)	
		Front	Rear	Front	Rear
Normal tyre	245/40R18 93Y	2.2 bar (32 psi) {220 kPa}	2.0 bar (29 psi) {200 kPa}	2.5 bar (36 psi) {250 kPa}	2.3 bar (33 psi) {230 kPa}
Compact spare tyre	T145/70R18 107M	4.2 bar (60 psi) {420 kPa}		—	

Check the tyre inflation pressure of all the tyres while they are cold; if insufficient or excessive, adjust to the specified value. After the tyre inflation pressure has been adjusted, check the tyres for damage and air leaks. Be sure to put caps on the valves.

Wheel condition

E01001800579

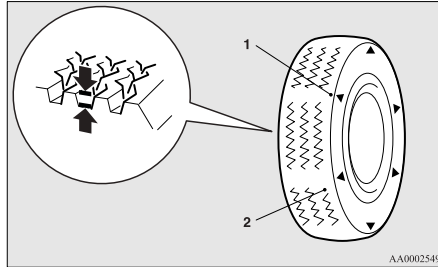

AA0002549

- 1- Location of the tread wear indicator
- 2- Tread wear indicator

Check the tyres for cuts, cracks and other damage. Replace the tyres if there are deep cuts or cracks. Also check each tyre for pieces of metal or pebbles.

The use of worn tyres can be very dangerous because of the greater chance of skidding or hydroplaning. The tread depth of the tyres must exceed 1.6 mm in order for the tyres to meet the minimum requirement for use.

Tread wear indicators will appear on the surface of the tyre as the tyre wears, thereby indicating that the tyre no longer meets the minimum requirement for use. When these wear indicators appear, the tyres must be replaced with new ones.

When replacement of any of the tyres is necessary, replace all of them.

⚠ CAUTION

- Always use tyres of the same size, same type, and same brand, and which have no wear differences. Using tyres of different size, type, brands or degree of wear, will increase the differential oil temperature, resulting in possible damage to the driving system. Further, the drive train will be subjected to excessive loading, possibly leading to oil leakage, component seizure, or other serious faults.

Replacing tyres and wheels

E01007200054

⚠ CAUTION

- Avoid using different size tyres from the one listed and the combined use of different types of tyres, as this can affect driving safety. Refer to “Tyres and wheels” on page 9-09.
- Even if a wheel has the same rim size and offset as the specified type of wheel, its shape may prevent it from being fitted correctly. We recommend you to consult a specialist before using wheels that you have.

Tyre rotation

E01001901492

Tyre wear varies with vehicle conditions, road surface conditions and individual driver's driving habits. To equalize the wear and help extend tyre life, it is recommended to rotate the tyres immediately after discovery of abnormal wear, or whenever the wear difference between the front and rear tyres is recognizable.

Maintenance

When rotating tyres, check for uneven wear and damage. Abnormal wear is usually caused by incorrect tyre pressure, improper wheel alignment, out of balance wheel, or severe braking. We recommend you to have it checked to determine the cause of irregular tread wear.

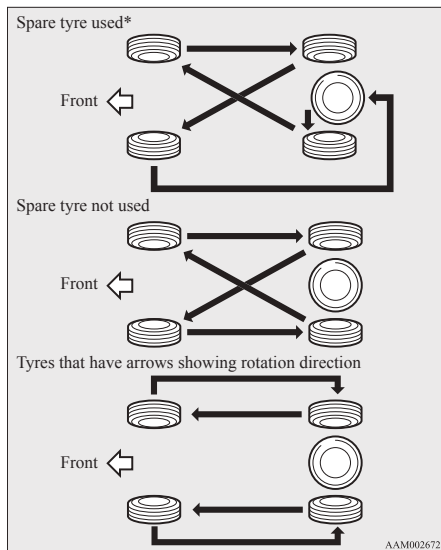

*: Vehicle with 245/40R18 93Y size spare tyre only.

⚠ CAUTION

- A compact spare tyre can be fitted temporarily in place of a tyre that has been removed during the tyre rotation. However, it must not be included in the regular tyre rotation sequence.
- If the tyres have arrows (A) indicating the correct direction of rotation, swap the front and rear wheels on the left hand side of the vehicle and the front and rear wheels on the right hand side of the vehicle separately. Keep each tyre on its original side of the vehicle. When fitting the tyres, make sure the arrows point in the direction in which the wheels will turn when the vehicle moves forward. Any tyre whose arrow points in the wrong direction will not perform to its full potential.

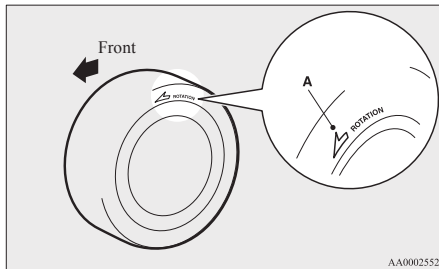

⚠ CAUTION

- Avoid the combined use of different types of tyres. Using different types of tyres can affect vehicle performance and safety.

Snow tyres

E01002000666

The use of snow tyres is recommended for driving on snow and ice. To preserve driving stability, mount snow tyres of the same size and tread pattern on all four wheels.

Snow tyres worn more than 50 % are no longer suitable for use as snow tyres.

Snow tyres which do not meet specifications must not be used.

⚠ CAUTION

- Observe permissible maximum speed for your snow tyres and the legal speed limit.

NOTE

- The laws and regulations concerning snow tyres (driving speed, required use, type, etc.) vary. Find out and follow the laws and regulations in the area you intend to drive.
- If flange nuts are used on your vehicle, change to tapered nuts when steel wheels are used.

Tyre chains

E01002101954

If tyre chains have to be used, ensure that they are fitted only on the rear wheels.

Use only tyre chains which are designed for use with the tyres mounted on the vehicle: use of the incorrect size or type of chain could result in damage to the vehicle body.

Before fitting tyre chains, we recommend you to consult a MITSUBISHI MOTORS Authorized Service Point. The max. chain height is as follows.

Tyre size	Wheel size	Max. chain height [mm]
245/40R18 93Y	18x8 1/2JJ	9

When driving with tyre chains on the tyres, do not drive faster than 50 km/h (30 mph). When you reach roads that are not covered in snow, immediately remove the tyre chains.

CAUTION

- Practice fitting the chains before you need them. Don't expect help from other people in the cold.
- Choose a clear straight stretch of road where you can pull over and still be seen while you are fitting the chains.
- Do not fit chains before you need them. This will wear out your tyres and the road surface.
- After driving around 100-300 metres, stop and retighten the chains.
- Drive carefully and do not exceed 50 km/h (30 mph). Remember that preventing accidents is not the purpose of tyre chains.
- When tyre chains are installed, take care that they do not damage the disc wheel or body.

CAUTION

- Do not install a tyre chain on an emergency wheel which is compact in size. If one of the rear wheels has punctured, replace it with one of the front wheels and install the compact spare wheel in that place before fitting a tyre chain.
- An aluminium wheel can be damaged by a tyre chain while driving. When fitting a tyre chain on an aluminium wheel, take care that any part of the chain and fitting cannot be brought into contact with the wheel.
- When installing or removing the tyre chains, take care that hands and other parts of your body are not injured by the sharp edges of the vehicle body.

NOTE

- The laws and regulations concerning the use of tyre chains vary. Always follow local laws and regulations.
In most countries, it is prohibited by law to use tyre chains on roads without snow.

Parking brake break-in

E01008300137

Break-in the parking brake linings whenever the brake performance of the parking brake is insufficient or whenever the parking brake linings and/or discs are replaced, in order to assure the best brake performance.

This procedure is described in the vehicle service manual and can be carried out by an authorized MITSUBISHI MOTORS dealer.

Maintenance

Wiper blade rubber replacement

E01008200093

1. Lift the wiper arm off the windscreen.
2. Pull the wiper blade until its stopper (A) disengages from the hook (B). Then, pull the wiper blade further to remove it.

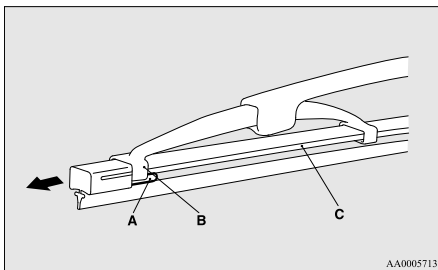

NOTE

- Do not allow the wiper arm to fall onto the windscreen; it could damage the glass.

3. Attach retainers (C) to a new wiper blade.

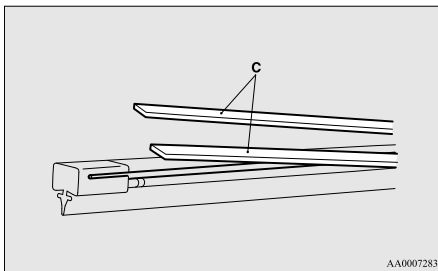

4. Insert the wiper blade into the arm, starting with the opposite end of the blade from the stopper. Make sure the hook (B) is fitted correctly in the grooves in the blade.

NOTE

- If retainers are not supplied with the new wiper blade, use the retainers from the old blade.

5. Push the wiper blade until the hook (B) engages securely with the stopper (A).

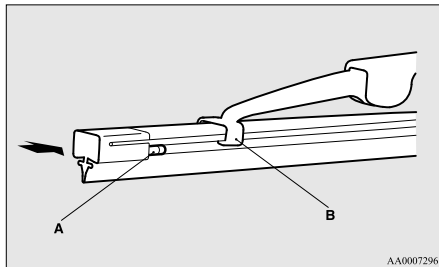

General maintenance

E01002700504

Fuel, engine coolant, oil and exhaust gas leakage

Look under the body of your vehicle to check for fuel, engine coolant, oil and exhaust gas leaks.

⚠ WARNING

- If you see a suspicious fuel leak or if you smell fuel, do not operate the vehicle; we recommend you to call for assistance.

Exterior and interior lamp operation

Operate the combination lamp switch to check that all lamps are functioning properly.

If the lamps do not illuminate, the probable cause is a blown fuse or defective lamp bulb. Check the fuses first. If there is no blown fuses, check the lamp bulbs.

For information regarding the inspection and replacement of the fuses and the lamp bulbs, refer to "Fuses" on page 8-16 and "Replacement of lamp bulbs" on page 8-22.

If the fuses and bulbs are all OK, we recommend you to have your vehicle checked and repair.

Meter, gauge and indicator/warning lamps operation

Run the engine to check the operation of all meters, gauges, and indicator/warning lamps.

If there is anything wrong, we recommend you to have your vehicle inspection.

Hinges and latches lubrication

Check all latches and hinges, and, if necessary, have them lubricated.

For cold and snowy weather

E01002800257

Ventilation slots

The ventilation slots in front of the windscreen should be kept clear of leaves or brushed clear after heavy snowfall, so that the operation of the heating and ventilation systems will not be impaired.

Weatherstripping

To prevent freezing of the weatherstripping on the doors, bonnet, etc., they should be treated with silicone grease or spray.

Additional equipment

It is a good idea to carry a shovel or a short-handled spade in the vehicle during the winter so that you can clear away snow if you get stranded. A small hand-brush for sweeping snow off the vehicle and a plastic scraper for the windscreen and rear window are also useful.

Fusible links

E01002900580

The fusible links will melt to prevent a fire if a large current attempts to flow through certain electrical systems.

In case of a melted fusible link, we recommend you to have your vehicle inspected.

For the fusible links, please refer to “Fuse load capacity” on page 8-18.

WARNING

- **Fusible links must not be replaced by any other device. Failing to fit the correct fusible link may result in fire in the vehicle, property destruction and serious or fatal injuries at any time.**

Fuses

E01003002117

Fuse block location

To prevent damage to the electrical system due to shortcircuiting or overloading, each individual circuit is provided with a fuse.

There are fuse blocks in the passenger compartment and in the engine compartment.

Passenger compartment (LHD vehicles)

The fuse blocks in the passenger compartment are located behind the fuse lid in front of the driver's seat at the position shown in the illustration.

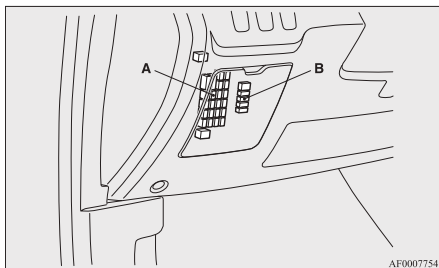

A- Main fuse block
B- Sub fuse block

1. Open the fuse lid and pull to remove it.

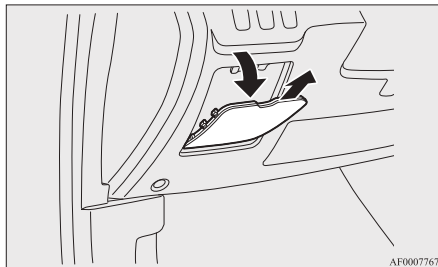

2. On vehicles with the bottom cover, use the puller to loosen the 2 clips (A) and push down the bottom cover. The puller is in the fuse block in the engine compartment. Refer to "Fuse replacement" on page 8-21.

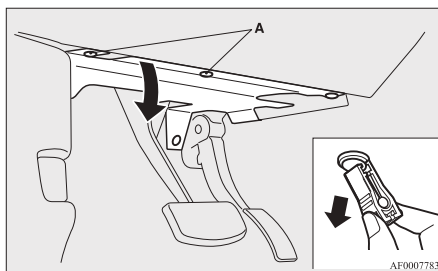

WARNING

- When changing fuses, do not damage the driver's knee airbag harness or accidentally strike the airbag area with hard objects. Improper work methods could result in an accidental driver's knee airbag deployment or could make the driver's knee airbag inoperable. Either of these situations could result in serious injury or death.

3. To put back the fuse lid, line up the fuse lid hook (B) with the clamp (C) on the instrument panel and push the lid back in.

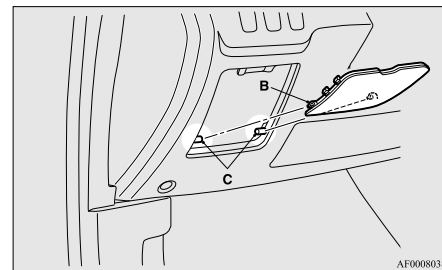

Passenger compartment (RHD vehicles)

The fuse blocks in the passenger compartment are located behind the glove box at the position shown in the illustration.

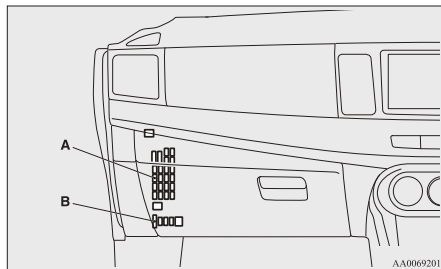

A- Main fuse block
B- Sub fuse block

1. Open the glove box.

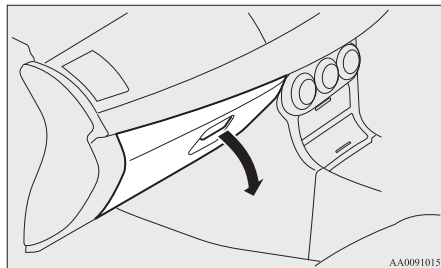

2. Move the rod (A) on the left side of the glove box to the left side of the box.

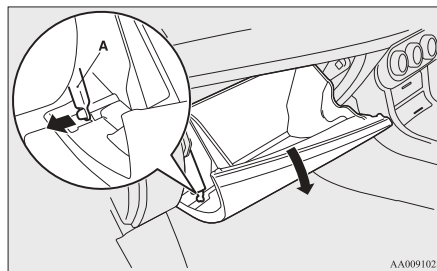

3. While pressing the side of the glove box, unhook the left and right hooks (B) and lower the glove box.

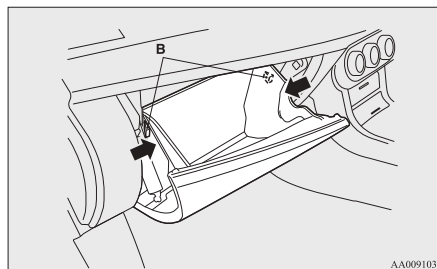

4. Remove the glove box fastener, and then remove the glove box.

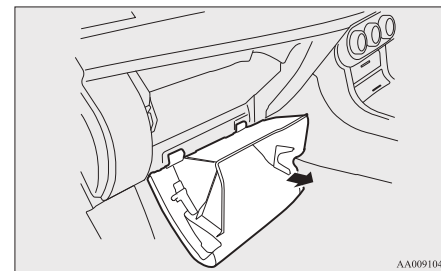

Engine compartment

In the engine compartment, the fuse block is located as shown in the illustration.

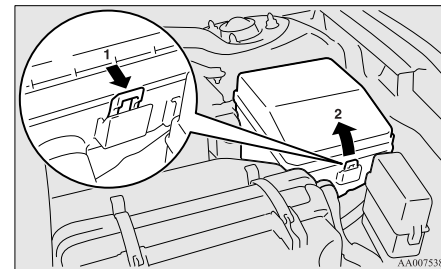

1- Push the knob.
2- Remove the cover.

Maintenance

Fuse load capacity

E01007700567

The fuse capacity and the names of electrical systems protected by the fuses are indicated on the inside of the fuse lid (LHD vehicles), the inside of the glove box (RHD vehicles) and inside of the fuse block cover (inside of the engine compartment).

Passenger compartment fuse location table

NOTE

- Spare fuses are provided on the lid of fuse block in the engine compartment. Always use a fuse of the same capacity for replacement.

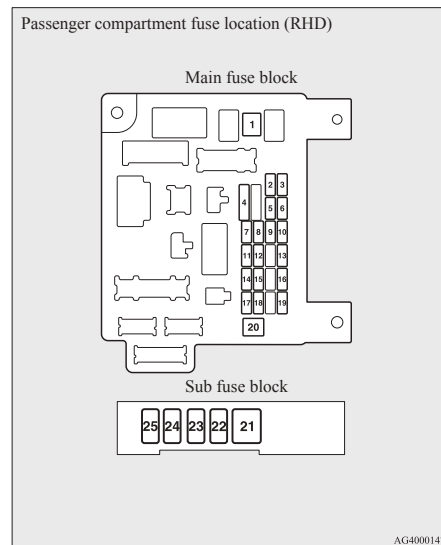
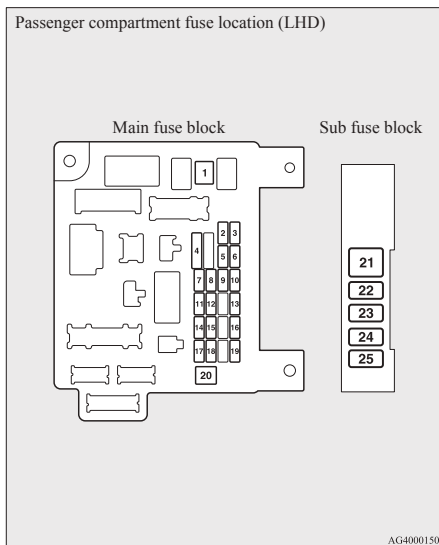

No.	Symbol	Electrical system	Capacities
1	⏏	Heater	30 A*
2	STOP	Stop lamps (Brake lamps)	15 A
3	⦶	Rear fog lamp	10 A
4	⦶	Windscreen wipers	30 A
5	⦶	Option	10 A

*: Fusible link

No.	Symbol	Electrical system	Capacities
6		Door locks	20 A
7		Radio	15 A
8		Control unit relay	7.5 A
9		Interior lamps (Room lamps)	15 A
10		Hazard warning flasher	15 A
11		Rear window wiper	15 A
12		Instruments	7.5 A
13		Cigarette lighter/Accessory socket	15 A
14		Ignition switch	10 A
15		Sunroof	20 A
16		Outside rear-view mirrors	10 A
17		4-wheel drive system	10 A
18		Reversing lamps (Backup lamps)	7.5 A
19		Accessory socket	15 A
20		Electric window control	30 A*

*: Fusible link

No.	Symbol	Electrical system	Capacities
21		Rear window demister	30 A*
22		Heated door mirror	7.5 A
23		AC power supply	15 A
24		Power seats	25 (20) A
25		Heated seat	30 A

*: Fusible link

- Some fuses may not be installed on your vehicle, depending on the vehicle model or specifications.
- The table above shows the main equipment corresponding to each fuse.



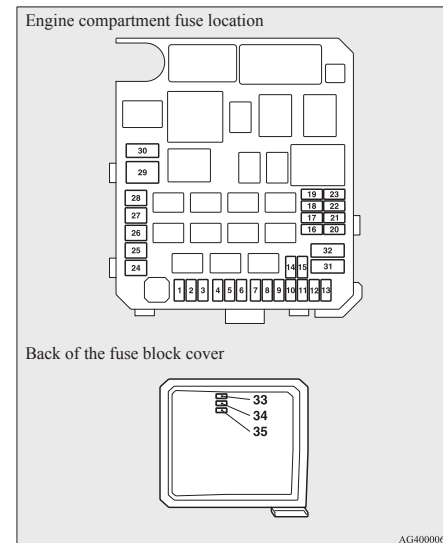











Engine compartment fuse location table











No.	Symbol	Electrical system	Capacities
1		Front fog lamps	15 A
2		Engine	7.5 A
3		Automatic transmission	20 A

*: Fusible link



Maintenance

No.	Sym- bol	Electrical system	Ca- pac- ities
4		Horn	10 A
5		Alternator	7.5 A
6		Headlamp washer	20 A
7		Air conditioning	10 A
8		ETV	15 A
9		Security horn	20 A
10		Wiper de-icer	15 A
11	—	—	—
12		Electric tailgate	30 A
13		Daytime running lamps	10 A
14		Headlamp high-beam (left)	10 A
15		Headlamp high-beam (right)	10 A
16		Headlamp high/low beam (left)	Discharge 20 A
17		Headlamp high/low beam (right)	Discharge 20 A
18		Headlamp low beam (left)	Halogen 10 A

*: Fusible link

No.	Sym- bol	Electrical system	Ca- pac- ities
		Bending lamps (Adaptive Front lighting System (AFS)) (left)	Discharge
		Headlamp low beam (right)	Halogen
19		Bending lamps (Adaptive Front lighting System (AFS)) (right)	Discharge 10 A
20		Inter cooler water spray	10 A
21		Ignition coil	10 A
22		ENG/POWER	20 A
23		Fuel pump	20 A
24		Starter	30 A*
25	—	—	—
26		Anti-lock brake system	40 A*
27		Anti-lock brake system	30 A*
28		Air conditioning condenser fan motor	30 A*

*: Fusible link

No.	Sym- bol	Electrical system	Ca- pac- ities
29		Radiator fan motor	40 A*
30	IOD	IOD	30 A
31		Audio system amp	30 A
32		Diesel	30 A
33	—	Spare fuse	10 A
34	—	Spare fuse	15 A
35	—	Spare fuse	20 A

*: Fusible link

- Some fuses may not be installed on your vehicle, depending on the vehicle model or specifications.
- The table above shows the main equipment corresponding to each fuse.

The fuse block does not contain spare 7.5 A, 25 A or 30 A fuses. If one of these fuses burns out, substitute with the following fuse.

7.5 A: 10 A spare fuse

25 A: 20 A spare fuse

30 A: 30 A audio system amp fuse

When using a substitute fuse, replace with a fuse of the correct capacity as soon as possible.

Identification of fuse

E01008100337

Capacity	Colour
7.5 A	Brown
10 A	Red

Capacity	Colour
15 A	Blue
20 A	Yellow
25 A	Natural (White)
30 A	Green (fuse type)/ Pink (fusible link type)
40 A	Green

Fuse replacement

E01007800731

1. Before replacing a fuse, always turn off the electrical circuit concerned and place the ignition switch in the "LOCK" position.
2. Remove the fuse puller (A) from the inside of the fuse block in the engine compartment.

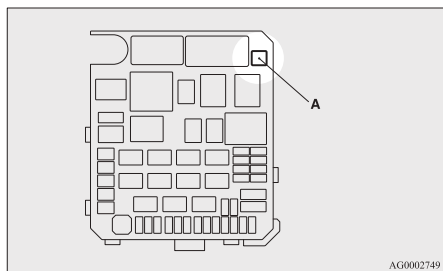

3. Referring to the fuse load capacity table, check the fuse pertaining to the problem.

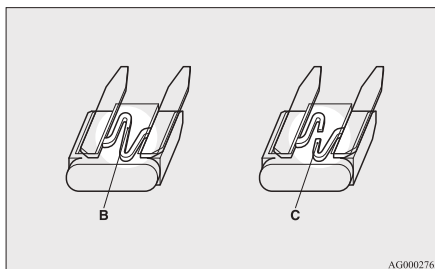

B- Fuse is OK

C- Blown fuse

NOTE

- If any system does not function but the fuse corresponding to that system is normal, there may be a fault in the system elsewhere. We recommend you to have your vehicle checked.

4. Insert a new fuse of the same capacity by using the fuse puller into the same place at the fuse block.

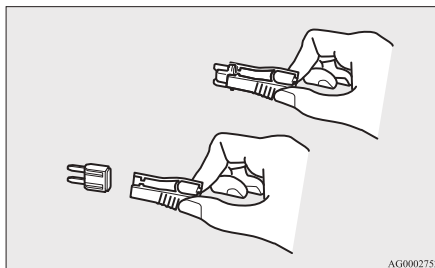

⚠ CAUTION

- If the newly inserted fuse blows again after a short time, we recommend you to have the electrical system checked to find the cause and rectify it.
- Never use a fuse with a capacity larger than that specified or any substitute, such as wire, foil, etc.; doing so will cause the circuit wiring to heat up and could cause a fire.

Maintenance

Replacement of lamp bulbs

E01003100215

Before replacing a bulb, ensure the lamp is off. Do not touch the glass part of the new bulb with your bare fingers; the skin oil left on the glass will evaporate when the bulb gets hot and the vapour will condense on the reflector and dim the surface.

CAUTION

- **Bulbs are extremely hot immediately after being turned off. When replacing a bulb, wait for it to cool sufficiently before touching it. You could otherwise be burnt.**

NOTE

- If you are unsure of how to carry out the work as required, we recommend you to consult a specialist.
- Be careful not to scratch the vehicle body when removing a lamp or lens.
- When it rains, or when the vehicle has been washed, the inside of the lens sometimes becomes foggy. This is the same phenomenon as when window glass mists up on a humid day, and does not indicate a functional problem. When the lamp is switched on, the heat will remove the fog. However, if water gathers inside the lamp, we recommend you to have the lamp checked.

8

Bulb capacity

E01003200085

When replacing a bulb, use a new bulb with the same wattage and colour.

Outside

E01003301650

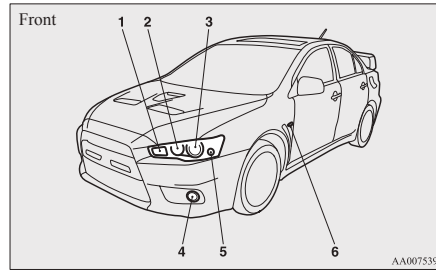

- 1- Front turn-signal lamps: 21 W (WY21W)
- 2- Bending lamps (Adaptive Front lighting System (AFS)): 55 W (H11)
- 3- Headlamps, high/low beam (Discharge bulb)*1: 35 W
- 4- Front fog lamps: 55 W (H11)
- 5- Position lamps: 5 W (W5W)
- 6- Side turn-signal lamps*1: 5 W

*1: Have the lamps bulbs replaced at a MITSUBISHI MOTORS Authorized Service Point.

Codes in parentheses indicate bulb types.

WARNING

- **Check with a MITSUBISHI MOTORS Authorized Service Point when it is necessary to repair a high intensity discharge headlamp or to replace the bulb. The power circuit, bulb and electrodes generate high voltages that may cause a severe shock.**

NOTE

- It is not possible to repair or replace only the bulb for the side turn-signal lamp. Check with a MITSUBISHI MOTORS Authorized Service Point when the lamp needs to be repaired or replaced.

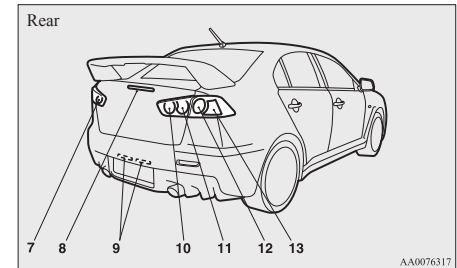

- 7- Rear fog lamp (LHD vehicles): 21 W (W21W)
- 8- Reversing lamp (RHD vehicles): 21 W (W21W)
- 9- High-mounted stop lamp
- 10- Licence plate lamps: 5 W (W5W)
- 11- Rear fog lamp (RHD vehicles): 21 W (W21W)
- 12- Reversing lamp (LHD vehicles): 21 W (W21W)
- 13- High-mounted stop lamp

- 10- Reversing lamp (LHD vehicles): 21 W (W21W)
- Rear fog lamp (RHD vehicles): 21 W (W21W)
- 11- Tail lamps: 5 W (W5W)
- 12- Stop and tail lamps: 21/5 W (W21/5W)
- 13- Rear turn-signal lamps: 21 W (W21W)

Codes in parentheses indicate bulb types.

NOTE

- The high-mounted stop lamp uses LEDs rather than bulbs. For repair and replacement, we recommend you to consult a specialist.

Inside

E01003402052

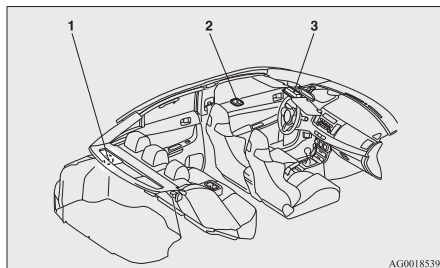

- 1- Trunk room lamp: 5 W
- 2- Rear room lamp: 8 W
- 3- Front room & map lamp: 8 W

Headlamps (high/low beam)

E01003501001

Do not attempt to disassemble or repair headlamps, and do not attempt to replace their bulbs.

⚠ WARNING

- A high voltage is present in the power circuit and in the bulbs and bulb terminals. To avoid the risk of an electric shock, contact a MITSUBISHI MOTORS Authorized Service Point whenever repair or replacement is necessary.

Bending lamps (Adaptive Front lighting System (AFS))

E01008800262

1. When replacing the bulb on the right side of the vehicle, remove the bolt (A) holding down the headlamps washer tank spout and move the spout towards the rear of the vehicle.

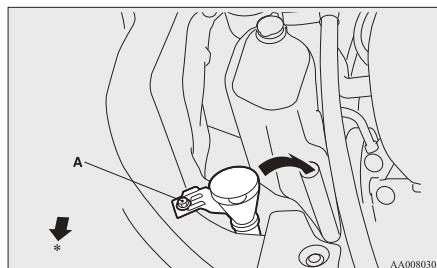

*: Front of the vehicle

2. Turn the cap (B) anticlockwise to remove it.

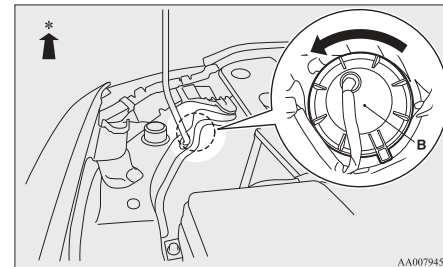

*: Front of the vehicle

3. Turn the bulb (C) anticlockwise to remove it.

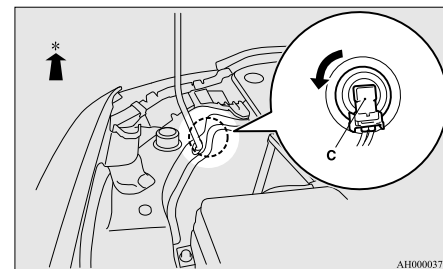

*: Front of the vehicle

Maintenance

4. While pressing the tab (D), remove the bulb (E).

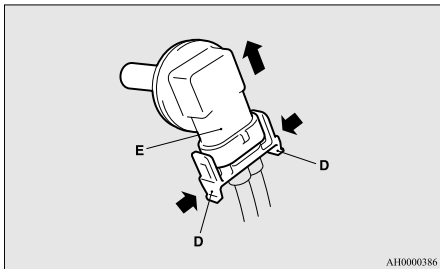

5. To install the bulb, perform the removal steps in reverse.

⚠ CAUTION

- Handle halogen lamp bulbs with care. The gas inside halogen lamp bulbs is highly pressurized, so dropping, knocking, or scratching a halogen lamp bulb can cause it to shatter.
- Never hold the halogen lamp bulb with a bare hand, dirty glove, etc. The oil from your hand could cause the bulb to break the next time the bending lamps (Adaptive Front lighting System (AFS)) are operated. If the glass surface is dirty, it must be cleaned with alcohol, paint thinner, etc., and refit it after drying it thoroughly.

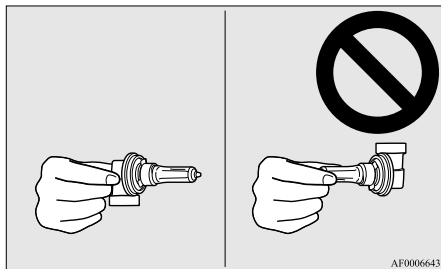

Position lamps

E01003700501

1. To create enough work space, turn the steering wheel all the way in the direction opposite to the side you wish to replace.
2. Remove the clips (A), clip (B) and screw (C) to turn up the cover (D).

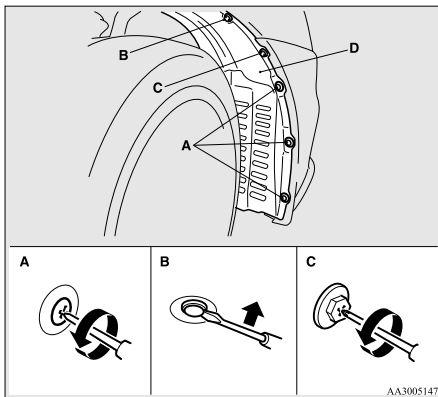

3. Turn the socket (E) anticlockwise to remove it.

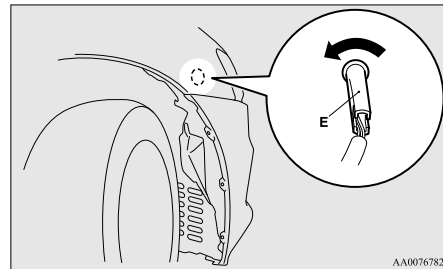

4. Pull the bulb out of the socket.

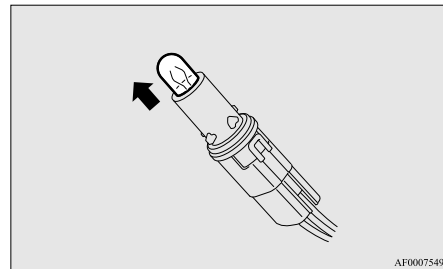

5. To install the bulb, perform the removal steps in reverse.

Front turn-signal lamps

E01003801017

1. Remove the clips (A) and clips (B), then remove the duct (C) and the upper cover (D).

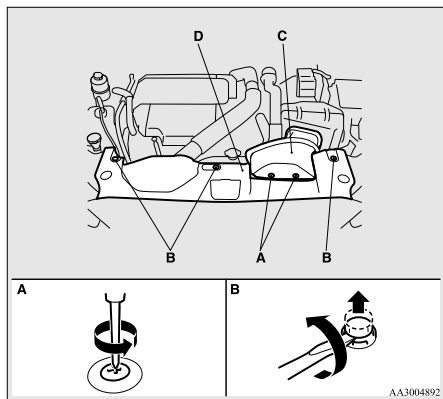

2. Remove the entire socket and bulb assembly (E) by turning it anticlockwise.

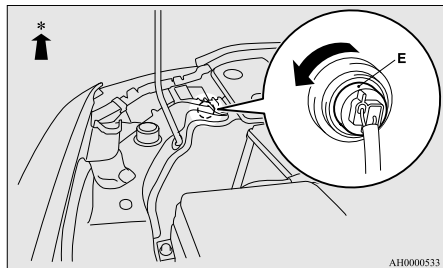

*: Front of the vehicle

3. Remove the bulb by pulling it out.

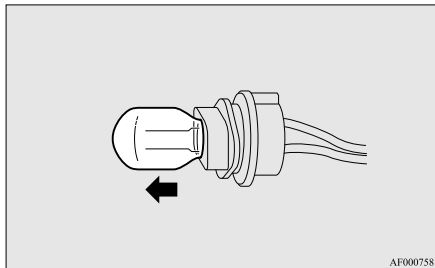

4. To install the bulb, perform the removal steps in reverse.

Front fog lamps

E01004000859

1. Remove the clips (A) and clips (B), then turn up the cover (C).

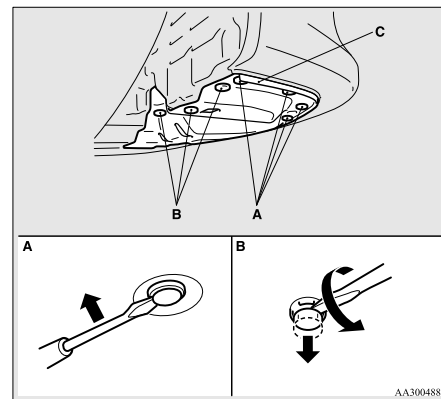

2. While holding down the tab (D), pull out the socket (E).

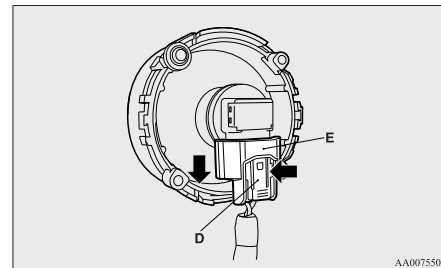

Maintenance

3. Turn the bulb (F) anticlockwise to remove it.

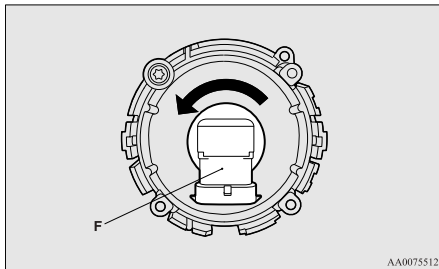

4. To install the bulb, perform the removal steps in reverse.

⚠ CAUTION

- Handle halogen lamp bulbs with care. The gas inside halogen lamp bulbs is highly pressurized, so dropping, knocking, or scratching a halogen lamp bulb can cause it to shatter.
- Never hold the halogen lamp bulb with a bare hand, dirty glove, etc. The oil from your hand could cause the bulb to break the next time the fog lamps are used. If the glass surface is dirty, it must be cleaned with alcohol, paint thinner, etc., and refit it after drying thoroughly.

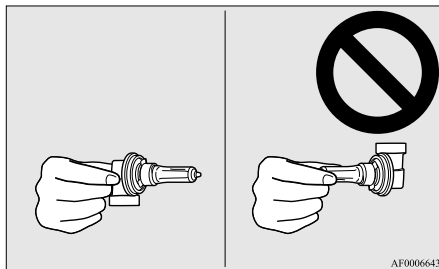

Rear combination lamps

E01004201177

Stop and tail lamps and rear turn-signal lamps

1. Remove the screws (A) from the lamp unit.

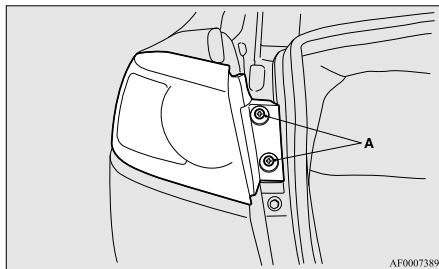

2. Remove the lamp unit in the rear direction.

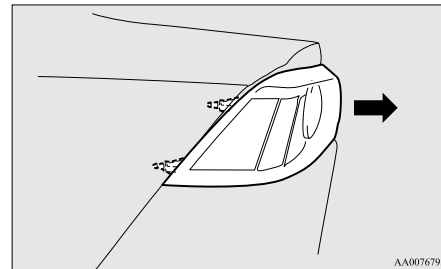

3. Remove the socket and bulb assemblies by turning them anticlockwise.

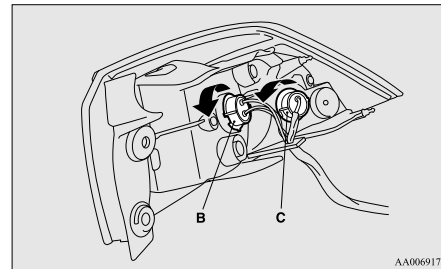

- B- Stop and tail lamp
C- Rear turn-signal lamp

4. Remove the bulb by pulling it out.

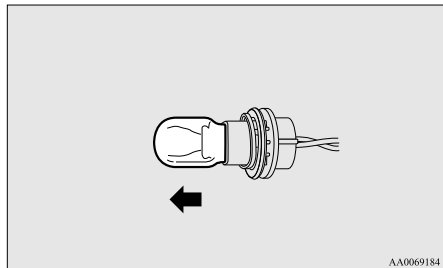

5. To install the bulb, perform the removal steps in reverse.

NOTE

- When mounting the lamp unit, align the pins (D) on the lamp unit with the holes in the body.

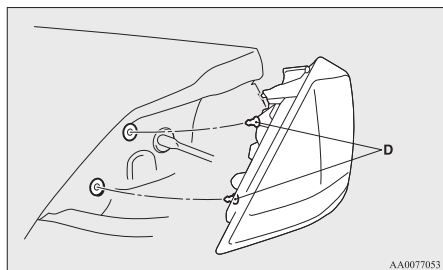

Tail lamps, reversing lamp and rear fog lamp

1. Open the trunk lid.

Remove the clips (A) by prying with a straight blade (or minus) screwdriver, and remove the cover (B).

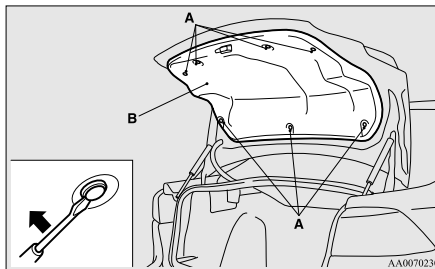

2. Remove the socket and bulb assemblies by turning them anticlockwise.

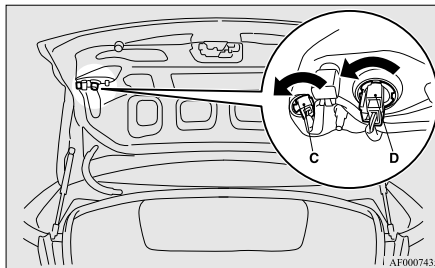

C- Tail lamp

D- Rear fog lamp (driver's side)

Reversing lamp (passenger's side)

3. Remove the bulb by pulling it out.

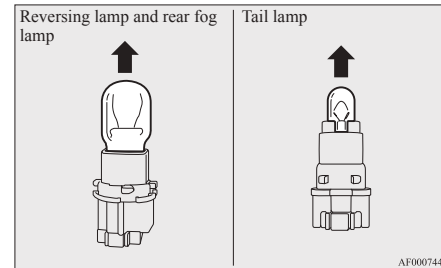

4. To install the bulb, perform the removal steps in reverse.

Licence plate lamps

E01004600897

1. Remove the screws (A) from the licence plate lamp lens (B). Then, remove the lens and gasket (C), and withdraw the bulb.

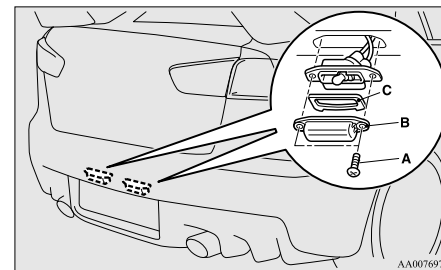

Maintenance

2. Remove the socket and bulb assembly together by turning it anticlockwise.

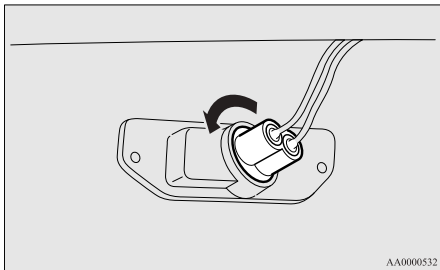

3. Remove the bulb by pulling it out.

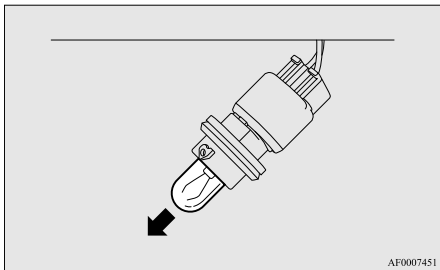

4. To install the bulb, perform the removal steps in reverse.

Front room & map lamps

E01004800091

When replacing the bulb, put the front room & map lamps switch into the "OFF" position.

1. Insert a straight blade (or minus) screwdriver with a cloth over its tip into the notch of the lamp assembly. Gently pry to remove the lens.

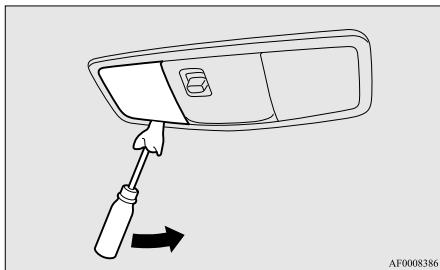

2. While holding down the tab (A), pull out the bulb.

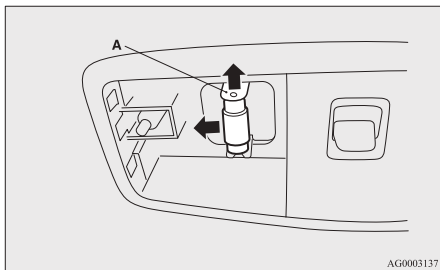

3. To install the bulb, perform the removal steps in reverse.

NOTE

- When mounting the lens, align the tab (B) to the hole on the vehicle body.

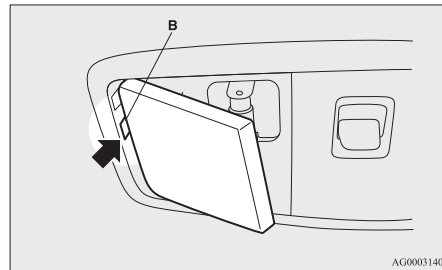

Rear room lamp

E01004700582

When replacing the bulb, put the rear room lamp switch into the "OFF" position.

1. Insert a straight blade (or minus) screwdriver with a cloth over its tip into the notch of the lamp assembly and pry gently to remove the lens.

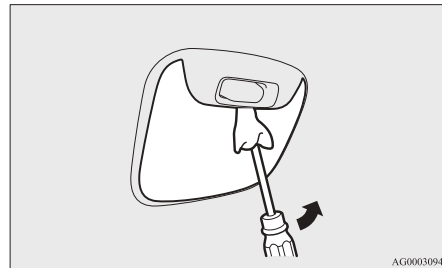

2. While holding down the tab (A), pull out the bulb.

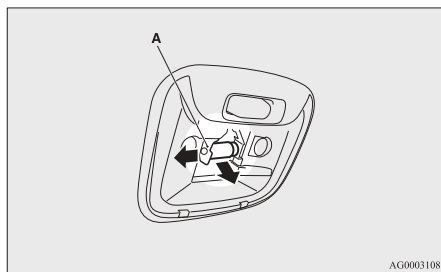

3. To install the bulb, perform the removal steps in reverse.

NOTE

- When mounting the lens, align the tabs (B) with the holes on the vehicle body.

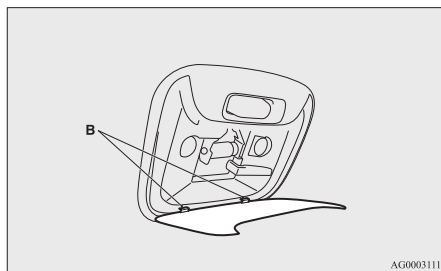

Trunk room lamp

E01005300237

1. Pull both clips (A) away from the centre as shown and remove the lamp unit. Then remove the bulb by pulling out.

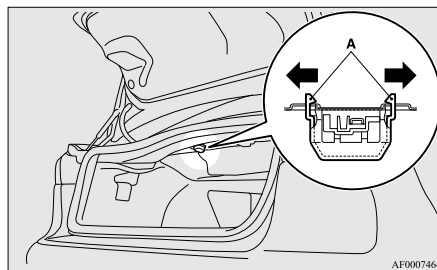

2. To install the bulb, perform the removal steps in reverse.

A series of 15 horizontal dashed lines spanning the width of the page, providing a template for handwriting practice.

Specifications

Vehicle labeling.....	9-02
Vehicle dimensions.....	9-04
Vehicle performance.....	9-05
Vehicle weight.....	9-06
Engine specifications.....	9-07
Electrical system.....	9-08
Tyres and wheels.....	9-09
Fuel consumption.....	9-10
Refill capacities.....	9-11

Specifications

Vehicle labeling

E01100101863

Vehicle identification number

The vehicle identification number is stamped as shown in the illustration.

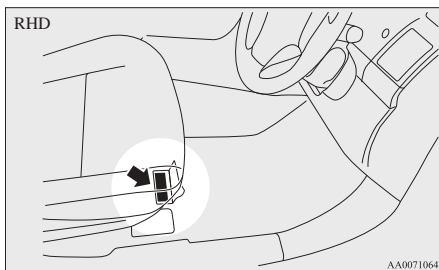
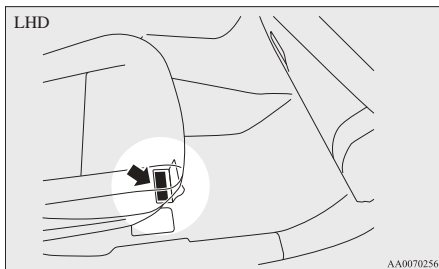

Vehicle information code plate

The vehicle information code plate is riveted as shown in the illustration.

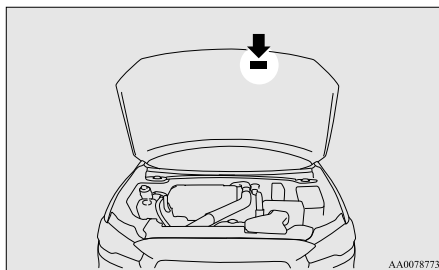

The plate shows model code, engine model, transmission model and body colour code, etc.

Please use this number when ordering replacement parts.

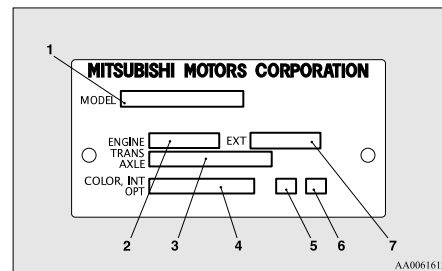

- 1- Model code
- 2- Engine model code
- 3- Transmission model code
- 4- Body colour code
- 5- Interior code
- 6- Option code
- 7- Exterior code

Vehicle identification number plate (RHD vehicles only)

The vehicle identification number is stamped on the plate riveted to the left front corner of the vehicle body. It is visible from outside of the vehicle through the windscreen.

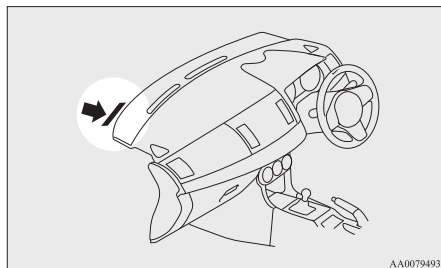

Engine number

The engine number is stamped on the engine cylinder block as shown in the illustration.

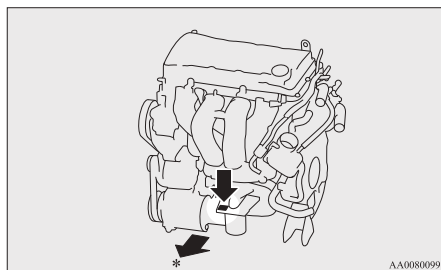

*: Front of the vehicle

Vehicle dimensions

E01100201460

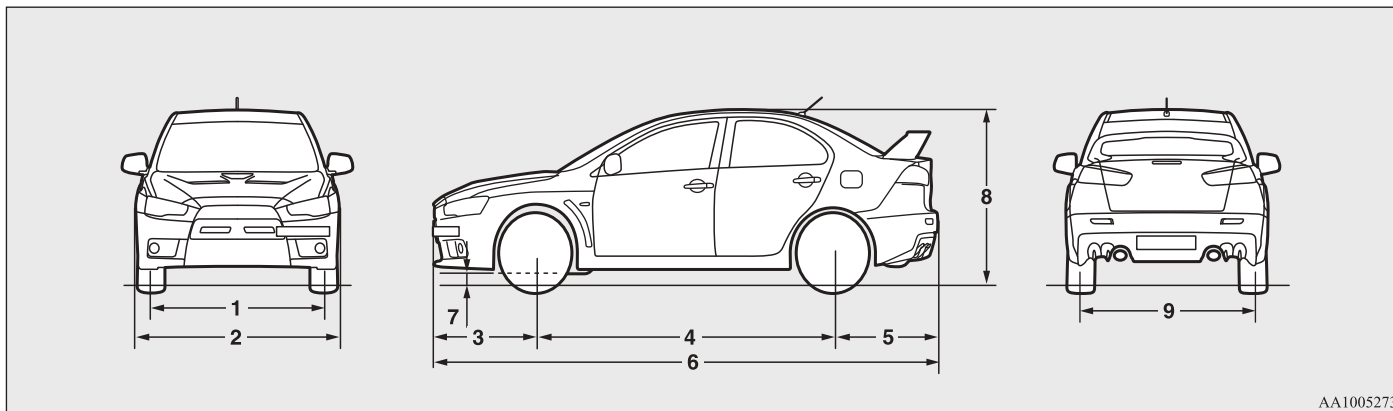

AA1005273

1	Front track	1,545 mm
2	Overall width	1,810 mm
3	Front overhang	920 mm
4	Wheel base	2,650 mm
5	Rear overhang	935 mm
6	Overall length	4,505 mm
7	Ground clearance (unladen)	140 mm
8	Overall height (unladen)	1,480 mm
9	Rear track	1,545 mm
9	Minimum turning radius	Body 6.2 m
		Wheel 5.9 m

Vehicle performance

E01100300813

Item	M/T	Twin Clutch SST
Maximum speed	240 km/h (149 mph)	242 km/h (150 mph)

Vehicle weight

E01100405747

Item		GSR		MR
		M/T	Twin Clutch SST	
Kerb weight	Without optional parts	1,560 kg	1,615 kg	1,600 kg (LHD) 1,605 kg (RHD)
	With full optional parts	1,592 kg	1,625 kg	1,635 kg (LHD) 1,640 kg (RHD)
Maximum gross vehicle weight		2,040 kg		
Maximum axle weight	Front	1,080 kg		
	Rear	1,030 kg		
Maximum roof load		40 kg		
Seating capacity		5 persons		

Engine specifications

E01100601552

Engine model	4B11
No. of cylinders	4 in line
Total displacement	1,998 cc
Bore	86.0 mm
Stroke	86.0 mm
Camshaft	Double overhead
Mixture preparation	Electronic injection
Maximum output (EEC net)	217 kW/6,500 r/min
Maximum torque (EEC net)	366 Nm/3,500 r/min

Electrical system

E01100802160

Voltage		12 V
Battery	Type (JIS)	S65D26L
	Capacity (5HR)	44 Ah
Alternator capacity		130 A
Spark plug type	NGK	DILKR8B6

Tyres and wheels

E01100902376

Tyre		245/40R18 93Y
Wheel	Size	18x8 1/2 JJ
	Offset	38 mm

Fuel consumption

E01101100805

Model	Item	Combined		Urban conditions		Extra-urban conditions	
		CO ₂ (g/km)	Fuel consumption (L/100 km)	CO ₂ (g/km)	Fuel consumption (L/100 km)	CO ₂ (g/km)	Fuel consumption (L/100 km)
GSR	M/T	243	10.5	336	14.6	189	8.1
	Twin Clutch SST	240	10.1	329	13.9	189	7.9
MR	Twin Clutch SST	240	10.4	329	14.4	189	8.1

NOTE

- The values shown above apply to a vehicle on which optional equipment has not been fitted.
- The results given do not express or imply any guarantee of the fuel consumption of the particular vehicle. The vehicle itself has not been tested and there are inevitably differences between individual vehicles of the same model. In addition, this vehicle may incorporate particular modifications. Furthermore, the driver's style and road and traffic conditions, as well as the extent to which the vehicle has been driven and the standard of maintenance, will all affect its fuel consumption.

Refill capacities

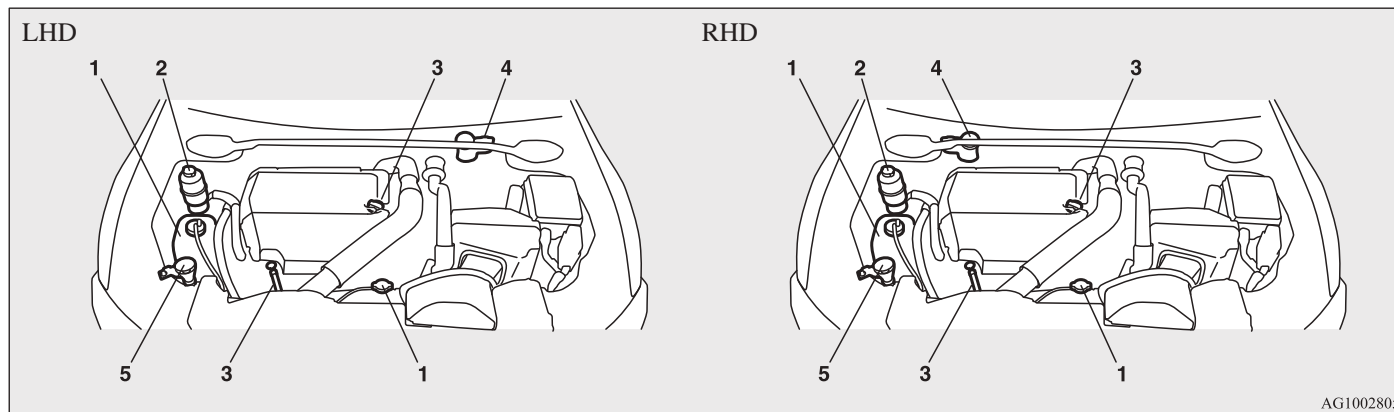

AG1002805

No.	Item	Quantity	Lubricants
1	Engine coolant	7.5 litres {includes 0.65 litre in the reserve tank}	MITSUBISHI MOTORS GENUINE SUPER LONG LIFE COOLANT PREMIUM or equivalent*
2	Power steering fluid	As required	MITSUBISHI MOTORS GENUINE PSF (Power Steering Fluid)
3	Engine oil		Refer to page 8-04.
	Oil pan	4.8 litres	
	Oil filter	0.3 litre	
	Oil cooler	0.5 litre	
4	Brake fluid	As required	Brake fluid DOT 3 or DOT 4
	Clutch fluid	As required	

*: similar high quality ethylene glycol based non-silicate, non-amine, non-nitrate and non-borate coolant with long life hybrid organic acid technology

Specifications

No.	Item		Quantity	Lubricants
5	Washer fluid for headlamp washer		1.9 litres	—
6	Washer fluid for windscreen		4.0 litres	—
7	Twin Clutch SST fluid		7.6 litres {includes 0.5 litres in the oil cooler}	MITSUBISHI MOTORS GENUINE SSTF-I
8	Manual transmission oil		2.5 litres	MITSUBISHI MOTORS GENUINE NEW MULTI GEAR OIL API classification GL-3, SAE 75W-80
9	Transfer oil		0.8 litre	MITSUBISHI MOTORS GENUINE LSD gear oil
10	AWC control fluid		1.0 litre {includes hydraulic piping}	MITSUBISHI MOTORS GENUINE ATF SP III
11	AYC fluid	For differential mechanism	0.55 litre	MITSUBISHI MOTORS GENUINE LSD gear oil
		For torque transfer mechanism	0.6 litre	MITSUBISHI MOTORS GENUINE ATF SP III
12	Refrigerant (air conditioning)		480 - 520 g	HFC-134a

*: similar high quality ethylene glycol based non-silicate, non-amine, non-nitrate and non-borate coolant with long life hybrid organic acid technology

AYC: Active yaw control system

LSD: Limited-slip differential

NOTE

- No.6 (Washer fluid for windscreen) is located in the luggage compartment. Refer to “Washer fluid” on page 8-07.

A

Accessory (Installation) 04
 Accessory socket 5-60
 ACD (Active centre differential system) 4-29
 Active stability control (ASC) 4-33
 Adaptive Front lighting System (AFS) 3-41
 Adaptive Front lighting System (AFS) indications 3-42
 Additional equipment 8-15
 AFS 3-41
 Air conditioning
 Automatic air conditioning 5-04
 Important operation tips for the air conditioning 5-08
 Refrigerant 9-11
 Air purifier 5-09
 Airbag 2-18
 Curtain airbag system 2-26
 Driver's and front passenger's airbag system 2-22
 Driver's knee airbag system 2-23
 Front passenger's airbag ON-OFF switch 2-21
 Side airbag system 2-25
 Antenna
 Roof antenna 5-39
 Anti-lock brake system (ABS) 4-32
 Display 4-32
 Warning lamp 4-32
 Armrest 2-05
 ASC 4-33
 Ashtray 5-59
 Assist grip 5-65
 Audio
 Steering wheel audio remote control switches 5-21
 Troubleshooting 5-37
 Automatic headlamp levelling 3-40

AWC control fluid 8-06,9-11
 AYC (Active yaw control system) 4-29
 AYC
 Fluid 9-11

B

Battery 8-08
 Charge warning display 3-36
 Charge warning lamp 3-34
 Discharged battery (Emergency starting) 6-02
 Specification 9-08
 Bending lamps
 Bulb capacity 8-22
 Replacement 8-23
 Bluetooth® 2.0 interface 5-40
 Bonnet 8-03
 Bottle holder 5-65
 Brake
 Anti-lock brake 4-32
 Brake warning lamp 3-33
 Braking 4-35
 Fluid 8-07,9-11
 Parking brake 4-04
 Warning display 3-35

C

Card holder 5-58,5-63
 Cargo loads 4-41
 Catalytic converter 8-02
 Cautions on handling of 4-wheel drive vehicles 4-28
 Central door locks 1-23
 Charge warning display 3-36
 Charge warning lamp 3-34
 Check engine warning lamp 3-34
 Child restraint 2-09
 Child-protection rear doors 1-26

Cigarette lighter 5-59
 Cleaning
 Exterior of your vehicle 7-03
 Interior of your vehicle 7-02
 Clutch
 Clutch pedal operation 4-14
 Fluid 8-07,9-11
 Coat hook 5-66
 Combination headlamps and dipper switch 3-37
 Auto-cutout function 3-38
 Compact spare wheel 6-12
 Coolant (engine) 8-05,9-11
 Cruise control 4-37
 Switches 4-38
 Cup holder 5-64
 Curtain airbag system 2-26

D

Daytime dipper button 3-02
 Daytime running lamp 3-37
 Dead Lock System 1-24
 Demister (rear window) 3-47
 Digital clock
 Time Setting 5-35
 Dimensions 9-04
 Dipper (High/Low beam change) 3-39
 Doors
 Central door locks 1-23
 Child-protection 1-26
 Lock and unlock 1-22
 Driver's and front passenger's airbag system 2-22
 Driver's knee airbag system 2-23
 Driving, alcohol and drugs 4-02

E

ECO mode indicator 3-12
 Economical driving 4-02

Alphabetical index

Electric window control 1-34
 Lock switch 1-35
 Timer function 1-35
Electrical system 9-08
Electronic immobilizer (Anti-theft starting system) 1-03
Emergency starting 6-02
Engine oil level warning display 3-36
Engine specifications 9-07
Engine
 Coolant 8-05,9-11
 Number 9-03
 Oil 8-04
 Oil and filter 9-11
 Overheating 6-04
 Specifications 9-07
 Used engine oils safety instructions and disposal information 05
Exterior and interior lamp operation 8-14

F

Floor console box 5-63
 Tissue holder 5-64
Fluid capacities and lubricants 9-11
Fluid
 AWC control 9-11
 AWC control fluid 8-06
 AYC 9-11
 Brake fluid 8-07,9-11
 Clutch fluid 8-07,9-11
 Engine coolant 8-05,9-11
 Headlamps washer 9-11
 Power steering fluid 8-08,9-11
 Twin Clutch SST 9-11
 Washer fluid 8-07,9-11
 Windscreen washer 9-11
For cold and snowy weather 8-15
Front console boxes 5-63

Front fog lamps
 Bulb capacity 8-22
 Indication lamp 3-33
 Replacement 8-25
Front fog lamp
 Switch 3-43
Front passenger's airbag ON-OFF switch 2-21
Front room & map lamp
 Bulb capacity 8-23
Front room & map lamps
 Replacement 8-28
Front seat 2-03
Front turn-signal lamps
 Bulb capacity 8-22
 Replacement 8-25
Fuel consumption 9-10
Fuel
 Filling the fuel tank 03
 Fuel selection 02
 Modification/alterations to the electrical or fuel systems 05
 Tank capacity 03
Full-time 4WD 4-27
Fuses 8-16
Fusible links 8-15

G

Gauges 3-02
General maintenance 8-14
General vehicle data 9-04
Genuine parts 05
Glove box 5-63
 Card holder 5-63

H

Hazard warning flasher switch 3-43
Hazard warning indication lamps 3-33

Head restraints 2-05
Headlamp levelling
 Automatic headlamp levelling 3-40
Headlamp washer switch 3-47
Headlamps
 Bulb capacity 8-22
 Headlamp flasher 3-39
 Replacement 8-23
 Switch 3-37
Heated mirror 4-09
Heated seats 2-04
High-beam indication lamp 3-33
High-mounted stop lamp 8-22
Hinges and latches lubrication 8-15
Horn switch 3-48

I

If the vehicle breaks down 6-02
Ignition switch 1-11,1-16,4-09
Indication and warning lamps 3-21
Indication lamps 3-33
Information screen display 3-35
 Brake warning display 3-35
 Charge warning display 3-36
 Engine oil level warning display 3-36
 Oil pressure warning display 3-36
Inside rear-view mirror 4-06
Installation of accessories 04
Instruments 3-02
Interior lamps 5-60
 Auto-cutout function 5-62
 Front room & map lamps 5-61
 Rear room lamp 5-61

J

Jack 6-06
 Storage 6-05

Jump starting (Emergency starting) 6-02

K

Keyless entry system 1-04,1-19
 Keyless operation system 1-07
 Keys 1-02

L

Labeling 9-02
 Lamp monitor buzzer 3-38
 Leakage (Fuel, engine coolant, oil and exhaust gas) 8-14
 Licence plate lamps
 Bulb capacity 8-22
 Replacement 8-27
 Link System 5-39
 Lubricants 9-11
 Luggage floor boxes 5-64

M

Manual transmission 4-14
 Oil 9-11
 Map lamps 5-61
 Mirror
 Inside rear-view mirror 4-06
 Outside rear-view mirrors 4-07
 Vanity mirror 5-58
 Modification/alterations to the electrical or fuel systems 05
 Multi-information display 3-03

O

Oil pressure warning display 3-36
 Oil
 Engine oil 8-04

Manual transmission oil 9-11
 Transfer oil 9-11
 Operation under adverse driving conditions 6-19
 Outside rear-view mirrors 4-07
 Overheating 6-04

P

Parking 4-05
 Parking brake 4-04
 Parking brake break-in 8-13
 Position lamps
 Bulb capacity 8-22
 Indication lamp 3-33
 Replacement 8-24
 Power steering
 Fluid 8-08,9-11
 System 4-37
 Precautions to observe when using wipers and washers 3-47
 Pregnant women restraint 2-08
 Puncture (Tyre changing) 6-12
 Puncture
 Tyre repair kit 6-06

R

Rain sensor 3-44
 Rear fog lamp
 Bulb capacity 8-22
 Indication lamp 3-33
 Switch 3-43
 Rear room lamp 5-61
 Bulb capacity 8-23
 Replacement 8-28
 Rear seat 2-05
 Rear turn-signal lamps
 Bulb capacity 8-23
 Replacement 8-25,8-26

Rear window demister switch 3-47
 Rear-view camera 4-43
 Rear-view mirror
 Inside rear-view mirror 4-06
 Outside 4-07
 Refill capacities 9-11
 Replacement of lamp bulbs 8-22
 Reversing lamps
 Bulb capacity 8-22
 Replacement 8-26
 Roof carrier precaution 4-42
 Running-in recommendations 4-03

S

S-AWC (Super-All Wheel Control) 4-29
 ACD (Active centre differential system) 4-29
 AYC (Active yaw control system) 4-29
 Safe driving techniques 4-03
 Seat 2-02
 Adjustment 2-03
 Armrest 2-05
 Front seat 2-03
 Head restraints 2-05
 Heated seat 2-04
 Rear seat 2-05
 Seat belt 2-06
 Adjustable seat belt anchor 2-08
 Child restraint 2-09
 Force limiter system 2-09
 Front passenger seat belt warning lamp 2-08
 Inspection 2-18
 Pregnant women restraint 2-08
 Pretensioner system 2-09
 Warning display 2-07
 Warning lamp 2-07
 Security alarm system 1-28
 Service precaution 8-02
 Side airbag system 2-25

Alphabetical index

Side turn-signal lamp
 Bulb capacity 8-22
Snow tyres 8-12
Spark plug 9-08
Specifications 9-02
Speedometer 3-02
Sport Shift Transmission (SST)
 Selector lever position display 4-19
Starting 1-14,1-17,4-11
Steering
 Power steering fluid 8-08,9-11
 Power steering system 4-37
 Steering wheel height adjustment 4-06
 Steering wheel lock 1-13,1-17,4-10
Stop and tail lamps
 Bulb capacity 8-23
 Replacement 8-26
Storage spaces 5-62
 Floor console box 5-63
 Glove box 5-63
 Luggage floor boxes 5-64
Sun visors 5-58
 Card holder 5-58
 Vanity mirror 5-58
Supplemental restraint system 2-18
 How the Supplemental Restraint System works 2-19
 Servicing 2-29
 Warning display 2-28
 Warning lamp 2-28

T

Tachometer 3-02
Tail lamps
 Bulb capacity 8-23
 Replacement 8-26
Tank capacity 03
Tissue holder 5-64

Tools 6-06
 Storage 6-05
Towing 6-17
Transfer oil 9-11
Transmission
 Manual transmission 4-14
 Twin Clutch SST (Sport Shift Transmission) 4-17
Trunk lid 1-26
Trunk room lamp
 Replacement 8-29
Turbocharger operation 4-13
Turn-signal indication lamps 3-33
Turn-signal lamps
 Replacement 8-26
Turn/Lane-change signals 3-41
Twin Clutch SST (Sport Shift Transmission) 4-17
 Fluid 9-11
 Gearshift lever 4-17
 Gearshift lever position display 4-18
 Gearshift lever positions 4-19
 Manual shift 4-21
Tyres 8-09
 How to change a tyre 6-12
 Inflation pressures 8-10
 Rotation 8-11
 Size (tyre and wheel) 9-09
 Snow tyres 8-12
 Tyre chains 8-12
 Tyre repair kit 6-06
 Wheel condition 8-11

U

USB input terminal 5-56
 How to connect an iPod 5-56
USB input terminal device
 How to connect a USB memory device 5-56

Used engine oils safety instructions and disposal information 05

V

Vanity mirror 5-58
Vehicle care precautions 7-02
Vehicle dimensions 9-04
Vehicle identification number 9-02
Vehicle identification number plate 9-03
Vehicle information code plate 9-02
Vehicle labeling 9-02
Vehicle performance 9-05
Vehicle weight 9-06
Ventilators 5-02

W

Warning lamps 3-33
Washer
 Fluid 8-07,9-11
 Switch 3-44
Washing 7-03
Waxing 7-04
Weatherstripping 8-15
Weight 9-06
Wheel condition 8-11
Wheel
 Specification 9-09
Windscreen washer 8-07
Wiper
 Rain sensor 3-44
 Switch 3-44
 Windscreen 3-44
 Wiper blades 8-14

OMRON

OMRON Corporation
6368 NENJO-ZAKA OKUSA
KOMAKI-CITY
AICHI
485-0802 JAPAN
PHONE: +81-568-78-6392
FAX: +81-568-78-6179

DECLARATION of CONFORMITY

We, **OMRON Corporation, ELECTRONICS COMPONENTS COMPANY** hereby declare, at our sole responsibility, that the following product conforms to the Essential Requirements of the Radio and Telecommunications Terminal Equipment Directive 1999/5/EC in accordance with the tests conducted to the appropriate requirements of the relevant standards, as listed herewith.

Product : ECU / FOB / RAM / WCM / Transmitter
Model/ Type Number : ECU : G8D-640M-ECU
: FOB : G8D-640M-KEY-E
: RAM : G8D-640M-RAM-E
Transmitter : G8D-576M-A
WCM : G8D-649M
Directive and Standards used as appropriate: **Radio** : EN 300 220-1 V2.1.1 * EN 300 220-3 V2.1.1 ...*
: EN 300 330-1 V1.3.1 EN 300 330-2 V1.3.1
EMC : EN 301 489-1 V1.6.1 EN 301 489-3 V1.4.1
Safety : EN 60065:2002 + Amd.1

* except for G8D-640M-ECU

Year of affixing CE marking : 2007

Model/ Type Number : **FOB** : G8D-644M-KEY-E
Transmitter : G8D-635M-A
WCM : G8D-646M
Directive and Standards used as appropriate: **Radio** : EN 300 220-1 V2. 1. 1 EN 300 220-2 V2. 1. 1
: EN 300 330-1 V1. 5. 1 EN 300 330-2 V1. 3. 1
EMC : EN 301 489-3 V1. 4. 1 EN 301 489-1 V1. 6. 1
Safety : EN 60065:2002

Year of affixing CE marking : 2006

●**CAUTION**

Danger of explosion if battery is incorrectly replaced.
Replace only with the same or equivalent type.
Battery shall not be exposed to excessive heat such as sunshine, fire or the like.

Signature : *S. Yamashita*

Name : Shuji Yamashita

Title and position : Manager
RFC Business Promotion Department (RF & Wireless)
DEVELOPMENT DIV.

Date : December 28, 2007

 1731

[Czech]	OMRON Corporation tímto prohlašuje, že tento [G8D-640M-ECU* G8D-640M-KEY-E* G8D-576M-A* G8D-640M-RAM-E* G8D-649M* G8D-644M-KEY-E* G8D-646M* G8D-635M-A* G8D-841M-ECU-E* G8D-841M-WCM-E*] je ve shodě se základními požadavky a dalšími příslušnými ustanoveními směrnice 1999/5/EC.
[Danish]	Undertegnede OMRON Corporation erklærer herved, at følgende udstyr [G8D-640M-ECU* G8D-640M-KEY-E* G8D-576M-A* G8D-640M-RAM-E* G8D-649M* G8D-644M-KEY-E* G8D-646M* G8D-646M* G8D-635M-A* G8D-841M-ECU-E* G8D-841M-WCM-E*] overholder de væsentlige krav og øvrige relevante krav i direktiv 1999/5/EC.
[German]	Hiermit erkläre OMRON Corporation, dass sich das Gerät [G8D-640M-ECU* G8D-640M-KEY-E* G8D-576M-A* G8D-640M-RAM-E* G8D-649M* G8D-644M-KEY-E* G8D-646M* G8D-635M-A* G8D-841M-ECU-E* G8D-841M-WCM-E*] in Übereinstimmung mit den grundlegenden Anforderungen und den übrigen einschlägigen Bestimmungen der Richtlinie 1999/5/EG befindet.
[Estonian]	Kaasolevaga kinnitab OMRON Corporation seadme [G8D-640M-ECU* G8D-640M-KEY-E* G8D-576M-A* G8D-640M-RAM-E* G8D-649M* G8D-644M-KEY-E* G8D-646M* G8D-635M-A* G8D-841M-ECU-E* G8D-841M-WCM-E*] vastavalt direktiivi 1999/5/EÜ nõuetele ja nimetatud direktiivist tulenevatele teistele asjakohaste sätetele.
[English]	Hereby, OMRON Corporation, declares that this [G8D-640M-ECU* G8D-640M-KEY-E* G8D-576M-A* G8D-640M-RAM-E* G8D-649M* G8D-644M-KEY-E* G8D-646M* G8D-635M-A* G8D-841M-ECU-E* G8D-841M-WCM-E*] is in compliance with the essential requirements and other relevant provisions of Directive 1999/5/EC.
[Spanish]	Por medio de la presente OMRON Corporation declara que el [G8D-640M-ECU* G8D-640M-KEY-E* G8D-576M-A* G8D-640M-RAM-E* G8D-649M* G8D-644M-KEY-E* G8D-646M* G8D-635M-A* G8D-841M-ECU-E* G8D-841M-WCM-E*] cumple con los requisitos esenciales y cualesquiera otras disposiciones aplicables o exigibles de la Directiva 1999/5/CE.
[Greek]	ΜΕ ΤΗΝ ΠΑΡΟΥΣΑ ΟΜΡΟΝ Corporation ΔΗΛΩΝΕΙ ΟΤΙ [G8D-640M-ECU* G8D-640M-KEY-E* G8D-576M-A* G8D-640M-RAM-E* G8D-649M* G8D-644M-KEY-E* G8D-646M* G8D-635M-A* G8D-841M-ECU-E* G8D-841M-WCM-E*] ΣΥΜΠΟΥΝΕΙΤΑΙ ΠΙΘΕΣ ΤΙΣ ΟΥΣΙΩΔΕΙΣ ΑΠΑΙΤΗΣΕΙΣ ΚΑΙ ΤΙΣ ΑΟΙΠΗΣ ΣΥΜΠΛΗΡΩΜΑΤΙΚΕΣ ΑΠΑΙΤΗΣΕΙΣ ΤΗΣ ΟΜΗΤΙΑΣ 1999/5/ΕΚ.
[French]	Par la présente OMRON Corporation déclare que l'appareil [G8D-640M-ECU* G8D-640M-KEY-E* G8D-576M-A* G8D-640M-RAM-E* G8D-649M* G8D-644M-KEY-E* G8D-646M* G8D-635M-A* G8D-841M-ECU-E* G8D-841M-WCM-E*] est conforme aux exigences essentielles et aux autres dispositions pertinentes de la directive 1999/5/CE.
[Italian]	Con la presente OMRON Corporation dichiara che questo [G8D-640M-ECU* G8D-640M-KEY-E* G8D-576M-A* G8D-640M-RAM-E* G8D-649M* G8D-644M-KEY-E* G8D-646M* G8D-635M-A* G8D-841M-ECU-E* G8D-841M-WCM-E*] è conforme ai requisiti essenziali ed alle altre disposizioni pertinenti stabilite dalla direttiva 1999/5/CE.
[Latvian]	Ar šo OMRON Corporation deklarē, ka [G8D-640M-ECU* G8D-640M-KEY-E* G8D-576M-A* G8D-640M-RAM-E* G8D-649M* G8D-644M-KEY-E* G8D-646M* G8D-635M-A* G8D-841M-ECU-E* G8D-841M-WCM-E*] atbilst Direktīvas 1999/5/EK būtiskajām prasībām un citiem ar to saistītiem noteikumiem.
[Lithuanian]	Šiuo OMRON Corporation deklaruojau, kad šis [G8D-640M-ECU* G8D-640M-KEY-E* G8D-576M-A* G8D-640M-RAM-E* G8D-649M* G8D-644M-KEY-E* G8D-646M* G8D-635M-A* G8D-841M-ECU-E* G8D-841M-WCM-E*] atitinka esminius reikalavimus ir kitus 1999/5/EB Direktyvos nuostatus.
[Dutch]	Hierbij verklaart OMRON Corporation dat het toestel [G8D-640M-ECU* G8D-640M-KEY-E* G8D-576M-A* G8D-640M-RAM-E* G8D-649M* G8D-644M-KEY-E* G8D-646M* G8D-635M-A* G8D-841M-ECU-E* G8D-841M-WCM-E*] in overeenstemming is met de essentiële eisen en de andere relevante bepalingen van richtlijn 1999/5/EG.
[Maltese]	Hawnhekk, OMRON Corporation, jidkljara li dan [G8D-640M-ECU* G8D-640M-KEY-E* G8D-576M-A* G8D-640M-RAM-E* G8D-649M* G8D-644M-KEY-E* G8D-646M* G8D-635M-A* G8D-841M-ECU-E* G8D-841M-WCM-E*] jikkonforma mal-ligjiet essenzjali u ma provvedimenti oħrajn rilevanti li hemm fid-Direttiva 1999/5/EC.
[Hungarian]	Alulírott, OMRON Corporation nyilatkozom, hogy a [G8D-640M-ECU* G8D-640M-KEY-E* G8D-576M-A* G8D-640M-RAM-E* G8D-649M* G8D-644M-KEY-E* G8D-646M* G8D-635M-A* G8D-841M-ECU-E* G8D-841M-WCM-E*] megfelel a vonatkozó alapvető követelményeknek és az 1999/5/EC irányelv egyéb előírásainak.

[Polish]	[OMRON Corporation] niniejszym oświadczają, że [G8D-640M-ECU]*, [G8D-640M-KEY-E]*, [G8D-576M-A]*, [G8D-640M-RAM-E]*, [G8D-649M]*, [G8D-649M]*, [G8D-644M-KEY-E]*, [G8D-646M]*, [G8D-646M]*, [G8D-646M]*, [G8D-841M-ECU-E]*, [G8D-841M-WCM-E]*] spełnia zasadnicze wymogi oraz inne istotne postanowienia dyrektywy 1999/5/EC.
[Portuguese]	OMRON Corporation declara que este [G8D-640M-ECU]*, [G8D-640M-KEY-E]*, [G8D-576M-A]*, [G8D-640M-RAM-E]*, [G8D-649M]*, [G8D-649M]*, [G8D-644M-KEY-E]*, [G8D-646M]*, [G8D-646M]*, [G8D-841M-ECU-E]*, [G8D-841M-WCM-E]*] está conforme com os requisitos essenciais e outras disposições da Directiva 1999/5/CE.
[Slovenian]	OMRON Corporation izjavlja, da je ta [G8D-640M-ECU]*, [G8D-640M-KEY-E]*, [G8D-576M-A]*, [G8D-640M-RAM-E]*, [G8D-649M]*, [G8D-649M]*, [G8D-644M-KEY-E]*, [G8D-646M]*, [G8D-646M]*, [G8D-841M-ECU-E]*, [G8D-841M-WCM-E]*] v skladu z bistvenimi zahtevami in ostalimi relevantnimi določili direktive 1999/5/ES.
[Slovak]	OMRON Corporation týmto vyhlasuje, že [G8D-640M-ECU]*, [G8D-640M-KEY-E]*, [G8D-576M-A]*, [G8D-640M-RAM-E]*, [G8D-649M]*, [G8D-649M]*, [G8D-644M-KEY-E]*, [G8D-646M]*, [G8D-646M]*, [G8D-841M-ECU-E]*, [G8D-841M-WCM-E]*] spĺňa základné požiadavky a všetky príslušné ustanovenia Smernice 1999/5/ES.
[Finnish]	OMRON Corporation vakuuttaa täten että [G8D-640M-ECU]*, [G8D-640M-KEY-E]*, [G8D-576M-A]*, [G8D-640M-RAM-E]*, [G8D-649M]*, [G8D-649M]*, [G8D-644M-KEY-E]*, [G8D-646M]*, [G8D-646M]*, [G8D-841M-ECU-E]*, [G8D-841M-WCM-E]*] täyttävät kaikki direktiivin 1999/5/EY osittain koskevien direktiivin muiden ehtojen mukaiset vaatimukset ja sitä koskevien direktiivin muiden ehtojen mukainen.
[Swedish]	Härmed intygar OMRON Corporation att denna [G8D-640M-ECU]*, [G8D-640M-KEY-E]*, [G8D-576M-A]*, [G8D-640M-RAM-E]*, [G8D-649M]*, [G8D-649M]*, [G8D-644M-KEY-E]*, [G8D-646M]*, [G8D-646M]*, [G8D-841M-ECU-E]*, [G8D-841M-WCM-E]*] står i överensstämmelse med de väsentliga egenskapskrav och övriga relevanta bestämmelser som framgår av direktiv 1999/5/EG.
[Icelandic]	Hér með lýsir OMRON Corporation yfir því að [G8D-640M-ECU]*, [G8D-640M-KEY-E]*, [G8D-576M-A]*, [G8D-640M-RAM-E]*, [G8D-649M]*, [G8D-649M]*, [G8D-644M-KEY-E]*, [G8D-646M]*, [G8D-646M]*, [G8D-841M-ECU-E]*, [G8D-841M-WCM-E]*] er í samræmi við grunnkröfur og aðrar kröfur, sem gerðar eru í tilskipun 1999/5/EC.
[Norwegian]	OMRON Corporation erklærer herved at utstyret [G8D-640M-ECU]*, [G8D-640M-KEY-E]*, [G8D-576M-A]*, [G8D-640M-RAM-E]*, [G8D-649M]*, [G8D-649M]*, [G8D-644M-KEY-E]*, [G8D-646M]*, [G8D-646M]*, [G8D-841M-ECU-E]*, [G8D-841M-WCM-E]*] er i samsvar med de grunnleggende krav og øvrige relevante krav i direktiv 1999/5/EF.
[Turkish]	İşbu belge ile OMRON Corporation, bu [G8D-640M-ECU]*, [G8D-640M-KEY-E]*, [G8D-576M-A]*, [G8D-640M-RAM-E]*, [G8D-649M]*, [G8D-649M]*, [G8D-644M-KEY-E]*, [G8D-646M]*, [G8D-646M]*, [G8D-841M-ECU-E]*, [G8D-841M-WCM-E]*] in 1995/5/EC Yönetmeliği esas gerekşinimlerine ve diğler şartlarına uyğun olduğunu beyan eder.
[Romanian]	„Noi OMRON Corporation declaram că aparatul [G8D-640M-ECU]*, [G8D-640M-KEY-E]*, [G8D-576M-A]*, [G8D-640M-RAM-E]*, [G8D-649M]*, [G8D-649M]*, [G8D-644M-KEY-E]*, [G8D-646M]*, [G8D-646M]*, [G8D-841M-ECU-E]*, [G8D-841M-WCM-E]*] este în conformitate cu cerințele esențiale și cu alte prevederi relevante ale Hotărârii Guvernului nr.88/2003 și Directivei 1999/5/EC.
[Bulgarian]	С настоящия документ OMRON Corporation декларира, че [G8D-640M-ECU]*, [G8D-640M-KEY-E]*, [G8D-576M-A]*, [G8D-640M-RAM-E]*, [G8D-649M]*, [G8D-649M]*, [G8D-644M-KEY-E]*, [G8D-646M]*, [G8D-646M]*, [G8D-841M-ECU-E]*, [G8D-841M-WCM-E]*] е в съответствие с основните изисквания и съответните постановления на Директива 1999/5/EC.

EC-Declaration of Conformity

Manufacturer / responsible person Johnson Controls Interior Experience
 Address: 915 E. 32nd Street
Holland Michigan USA 49423

Declares that the product:
 type: BlueTooth Hands Free for Automotive
 model: 187Z669, 187Z721
 Intended use/: Hands Free cellphone interface to vehicle audio system

complies with the essential requirements of Article 3 of the R&TTE 1999/5/EC Directive, if used as intended and that the following standards has been applied:

- 1 Safety (Article 3.1.a of the R&TTE Directive)
 applied standard(s) EN 60 950-1 issue 2001
+ A 11 issue 2004
EN 50371 issue 2008
- 2 Electromagnetic compatibility (Article 3.1.b of the R&TTE Directive)
 applied standard(s) ETSI EN 301 489-1 V1.6.1 issue 2005-09
ETSI EN 301 489-17 V1.2.1 issue 2002-08
- 3 Efficient use of the radio frequency spectrum (Article 3.2 of the R&TTE Directive)
 applied standard(s) ETSI EN 300 328 V1.7.1 issue 2006-10

Holland, MI USA 8/30/2009
 (Place and date of the declaration of conformity)

John D. Spencer
 (Name and signature)

Česky [Czech]:	Toto zařízení je v souladu se základními požadavky a ostatními odpovídajícími ustanoveními Směrnice 1999/5/EC.
Dansk [Danish]:	Denne udstyr er i overensstemmelse med de væsentlige krav og andre relevante bestemmelser i Direktiv 1999/5/EF.
Deutsch [German]:	Dieses Gerät entspricht den grundlegenden Anforderungen und den weiteren entsprechenden Vorgaben der Richtlinie 1999/5/EG.
Eesti [Estonian]:	See seade vastab direktiivi 1999/5/EÜ olulistele nõuetele ja teiste asjakohastele sätetele.
English:	This equipment is in compliance with the essential requirements and other relevant provisions of Directive 1999/5/EC.
Español [Spanish]:	Este equipo cumple con los requisitos esenciales así como con otras disposiciones de la Directiva 1999/5/CE.
Ελληνική [Greek]:	Αυτό το εξοπλιστικό είναι σε συμμόρφωση με τις ουσιαστικές απαιτήσεις και άλλες σχετικές διατάξεις της Οδηγίας 1999/5/ΕΚ.
Français [French]:	Cet appareil est conforme aux exigences essentielles et aux autres dispositions pertinentes de la Directive 1999/5/CE.
Íslenska [Icelandic]:	Þetta tæki er samkvæmt grunnkröfum og öðrum viðeigandi ákvæðum Tilskipunar 1999/5/EC.
Italiano [Italian]:	Questo apparato è conforme ai requisiti essenziali ed agli altri principi sanciti dalla Direttiva 1999/5/CE.
Latviski [Latvian]:	Šī iekārta atbilst Direktīvas 1999/5/EK būtiskajām prasībām un citiem ar to sastipņajiem noteikumiem.
Lietuvių [Lithuanian]:	Šis įrenginys tenkina 1999/5/EB Direktivos esminius reikalavimus ir kitas šios direktyvos nuostatas.
Nederlands [Dutch]:	Dit apparaat voldoet aan de essentiële eisen en andere van toepassing zijnde bepalingen van de Richtlijn 1999/5/EG.
Maltili [Maltese]:	Dan l-apparat huwa konformi mal-hiġġiet essenzjali u l-provvedimenti l-oħra rilevanti tad-Direttiva 1999/5/EC.
Magyar [Hungarian]:	Ez a készülék teljesíti az alapvető követelményeket és más 1999/5/EK irányelvben meghatározott vonatkozó rendelkezéseket.
Norsk [Norwegian]:	Denne utstyret er i samsvar med de grunnleggende krav og andre relevante bestemmelser i EU-direktiv 1999/5/EF.
Polski [Polish]:	Urządzenie jest zgodne z ogólnymi wymaganiami oraz szczegółowymi warunkami określonymi Dyrektywą UE: 1999/5/EC.
Português [Portuguese]:	Este equipamento está em conformidade com os requisitos essenciais e outras provisões relevantes da Diretiva 1999/5/EC.
Slovensko [Slovenian]:	Ta naprava je skladna z bistvenimi zahtevami in ostalimi relevantnimi pogoji Direktive 1999/5/EC.
Slovensky [Slovak]:	Toto zariadenie je v zhode so základnými požiadavkami a inými prísľusnými nariadeniami direktívy 1999/5/EC.
Suomi [Finnish]:	Tämä laite täyttää direktiivin 1999/5/EY olennaiset vaatimukset ja on siinä asetettujen muiden laitteita koskevien määräysten mukainen.
Svenska [Swedish]:	Denna utrustning är i överensstämmelse med de väsentliga kraven och andra relevanta bestämmelser i Direktiv 1999/5/EC.

A series of 15 horizontal dashed lines spanning the width of the page, providing a template for handwriting practice.

A series of 12 horizontal dashed lines spanning the width of the page, intended for writing or drawing.

A series of 15 horizontal dashed lines spanning the width of the page, providing a template for handwriting practice.