



i-MiEV - ENGLISH - OHAE12E5

i-MiEV - ENGLISH - OHAE12E5



OWNER'S MANUAL



i-MiEV

Foreword

E09200103705

Thank you for selecting a i-MiEV as your new vehicle. This owner's manual will add to your understanding and full enjoyment of the many fine features of this vehicle. It contains information prepared to acquaint you with the proper way to operate and maintain your vehicle for the utmost in driving pleasure.

MITSUBISHI MOTORS Europe B.V. reserves the right to make changes in design and specifications and/or to make additions to or improvements in this product without obligation to install them on products previously manufactured.

It is an absolute requirement for the driver to strictly observe all laws and regulations concerning vehicles.

This owner's manual has been written in compliance with such laws and regulations, but some of the contents may become contradictory with later amendment of the laws and regulations.

Please leave this owner's manual in this vehicle at time of resale. The next owner will appreciate having access to the information contained in this owner's manual.

Repairs to your vehicle:

Vehicles in the warranty period:

All warranty repairs must be carried out by a MITSUBISHI MOTORS Authorized Service Point.

Vehicles outside the warranty period:

Where the vehicle is repaired is at the discretion of the owner.

Throughout this owner's manual the words **WARNING** and **CAUTION** appear.

These serve as reminders to be especially careful. Failure to follow instructions could result in personal injury or damage to your vehicle.

WARNING

indicates a strong possibility of severe personal injury or death if instructions are not followed.

CAUTION

means hazards or unsafe practices that could cause minor personal injury or damage to your vehicle.

You will see another important symbol:

NOTE: gives helpful information.

***: indicates optional equipment.**

It may differ according to the sales classification; refer to the sales catalogue.

Abbreviations used in this owner's manual:

LHD: Left-Hand Drive

RHD: Right-Hand Drive

Information for station service

E09300102480

Tyre inflation pressure

Refer to the "Vehicle care and Maintenance" section for the tyre inflation pressure.

Mitsubishi Motors Europe B.V.

© 2011 Mitsubishi Motors Corporation

OHAE12E5
BLC11.000897

12

Table of contents

<i>Overview</i>	
<i>General information</i>	
<i>Charging</i>	1
<i>Locking and unlocking</i>	2
<i>Seat and seat belts</i>	3
<i>Instruments and controls</i>	4
<i>Starting and driving</i>	5
<i>For pleasant driving</i>	6
<i>For emergencies</i>	7
<i>Vehicle care and Maintenance</i>	8
<i>Specifications</i>	9

Instruments and Controls (Driver's area)

E00100106409

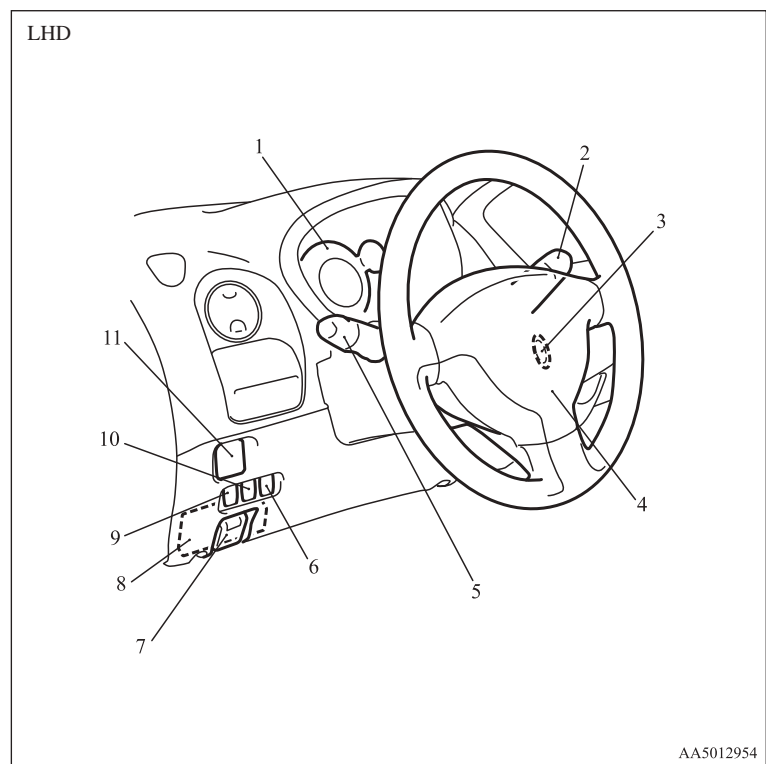

1. Instruments p. 4-02
2. Windscreen wiper and washer switch p. 4-16
Rear window wiper and washer switch p. 4-17
3. Electric motor switch p. 5-07
Horn switch p. 4-19
4. Supplemental restraint system - airbag (for driver's seat) p. 3-20
Turn-signal lever p. 4-14
Front fog lamp switch* p. 4-15
Rear fog lamp switch p. 4-16
5. Combination headlamps and dipper switch p. 4-11
Turn-signal lever p. 4-14
Front fog lamp switch* p. 4-15
Rear fog lamp switch p. 4-16
6. Acoustic Vehicle Alerting System (AVAS) OFF switch p. 5-13
7. Regular charging lid opener p. 1-07
8. Fuses p. 8-20
9. Headlamp levelling switch p. 4-13
10. Active Stability Control (ASC) OFF switch p. 5-17
11. Electric remote-controlled outside rear-view mirrors switch p. 5-05

RHD

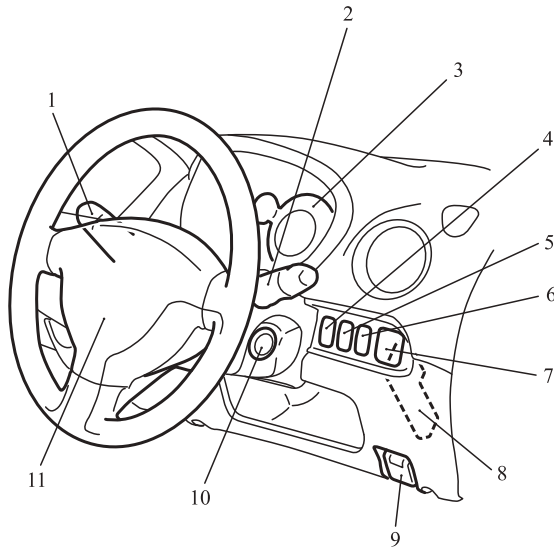

AA5012185

1. Combination headlamps and dipper switch p. 4-11
Turn-signal lever p. 4-14
Front fog lamp switch* p. 4-15
Rear fog lamp switch p. 4-16
2. Windscreen wiper and washer switch p. 4-16
Rear window wiper and washer switch p. 4-17
3. Instruments p. 4-02
4. Headlamp levelling switch p. 4-13
5. Active Stability Control (ASC) OFF switch p. 5-19
6. Rear window demister switch p. 4-18
7. Electric remote-controlled outside rear-view mirrors switch p. 5-05
8. Fuses p. 8-20
9. Regular charging lid opener p. 1-07
10. Electric motor switch p. 5-07
11. Supplemental restraint system - airbag (for driver's seat) p. 3-20
Horn switch p. 4-19

Instruments and Controls (Instrument panel)

E00100106412

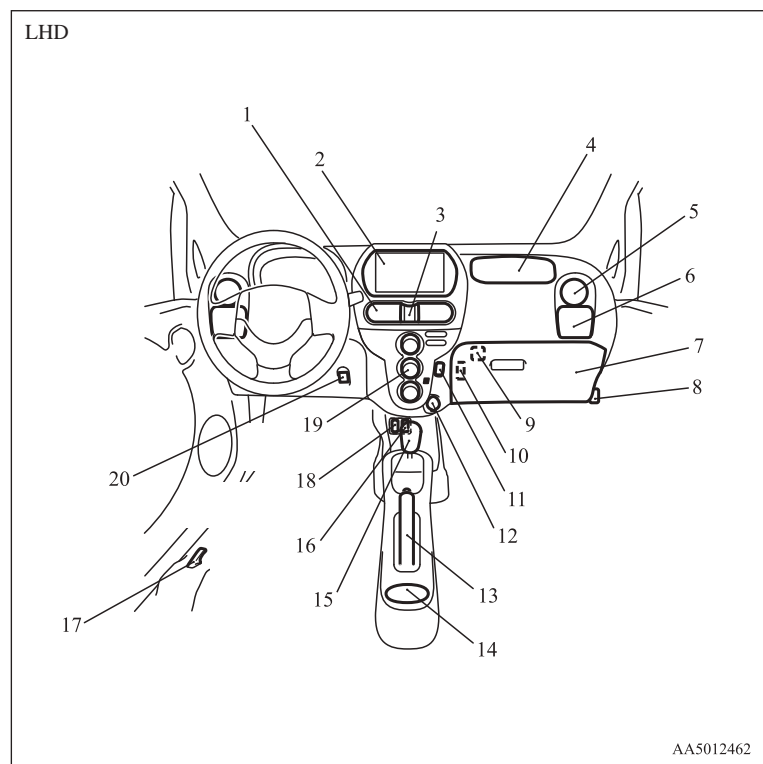

1. Centre ventilators p. 6-02
2. Digital clock* p. 6-31
Audio* p. 6-10
3. Hazard warning flasher switch p. 4-15
4. Supplemental restraint system - airbag (for front passenger) p. 3-20
5. Side ventilators p. 6-02
6. Cup holder p. 6-40
7. Glove box p. 6-39
8. Bonnet release lever p. 8-07
9. Front passenger's airbag ON-OFF switch p. 3-23
10. Card holder p. 6-39
11. Rear window demister switch p. 4-18
12. Accessory socket p. 6-36
13. Parking brake lever p. 5-03
14. Cup holder p. 6-40
15. Selector lever p. 5-09
16. Heated seat switch p. 3-04
17. Quick charging lid opener p. 1-11
18. USB input terminal* p. 6-33
19. Air conditioning p. 6-04
20. Heated seat switch p. 3-04

RHD

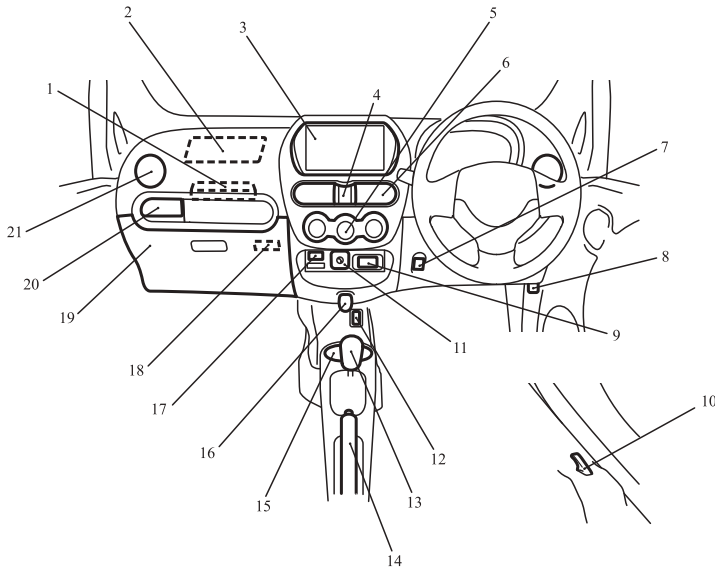

AA5012967

1. Secret box p. 6-39
2. Supplemental restraint system - airbag (for front passenger) p. 3-20
3. Digital clock* p. 6-31
Audio* p. 6-10
4. Hazard warning flasher switch p. 4-15
5. Air conditioning p. 6-04
6. Centre ventilators p. 6-02
7. Heated seat switch p. 3-04
8. Bonnet release lever p. 8-07
9. Acoustic Vehicle Alerting System (AVAS) OFF switch p. 5-13
10. Quick charging lid opener p. 1-11
11. Front passenger's airbag ON-OFF switch p. 3-23
12. Heated seat switch p. 3-04
13. Selector lever p. 5-09
14. Parking brake lever p. 5-03
15. Cup holder p. 6-40
16. Accessory socket p. 6-36
17. USB input terminal* p. 6-33
18. Card holder p. 6-39
19. Glove box p. 6-39
20. Cup holder p. 6-40
21. Side ventilators p. 6-02

Interior

E00100204536

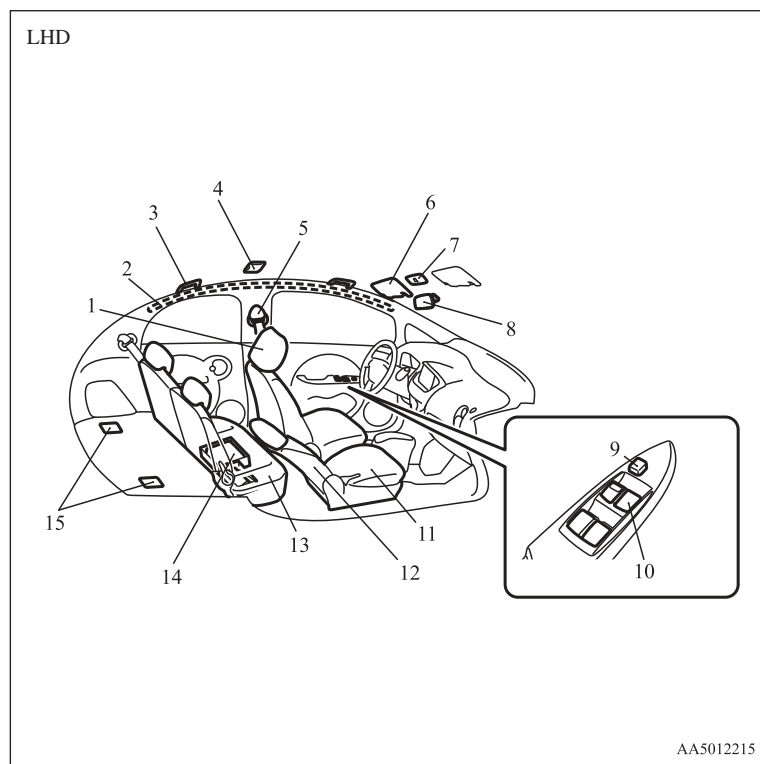

1. Head restraints p. 3-07
2. Supplemental restraint system - curtain airbag p. 3-27
3. Assist grip p. 6-41
4. Room lamp (rear) p. 6-38, 8-24
5. Seat belts p. 3-08
6. Sun visor p. 6-35
Vanity mirror p. 6-35
Card holder p. 6-36
7. Map & room lamps (front) p. 6-37, 8-24
8. Inside rear-view mirror p. 5-05
9. Electric window lock switch p. 2-10
10. Electric window control switch p. 2-09
11. Front seat p. 3-03
12. Supplemental restraint system - side airbag (for front seats) p. 3-27
13. Rear seat* p. 3-05
14. Tyre repair kit p. 7-04
15. Tether anchorages for child restraint system p. 3-18

RHD

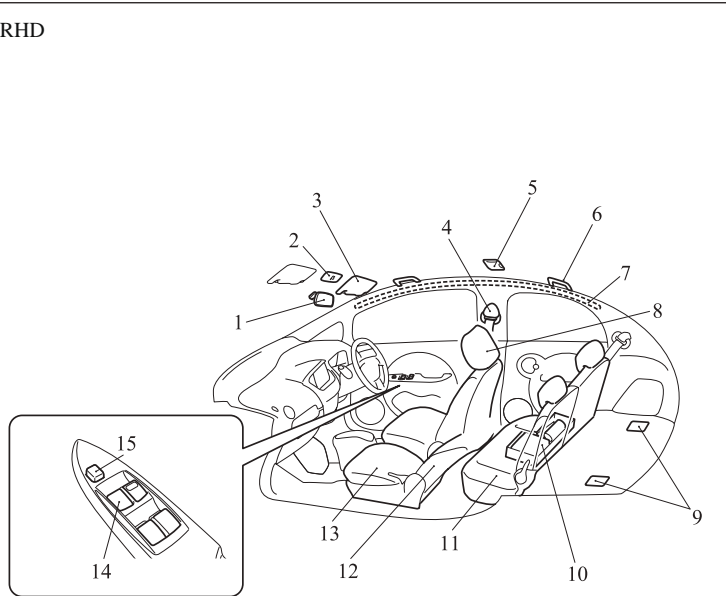

AA5012228

1. Inside rear-view mirror p. 5-05
2. Map & room lamps (front) p. 6-37, 8-24
3. Sun visor p. 6-35
Vanity mirror p. 6-35
Card holder p. 6-36
4. Seat belts p. 3-08
5. Room lamp (rear) p. 6-38, 8-24
6. Assist grip p. 6-41
7. Supplemental restraint system - curtain airbag p. 3-27
8. Head restraints p. 3-07
9. Tether anchorages for child restraint system p. 3-18
10. Tyre repair kit p. 7-04
11. Rear seat* p. 3-05
12. Supplemental restraint system - side airbag (for front seats) p. 3-27
13. Front seat p. 3-03
14. Electric window control switch p. 2-09
15. Electric window lock switch p. 2-10

Electric motor unit room

E00100800013

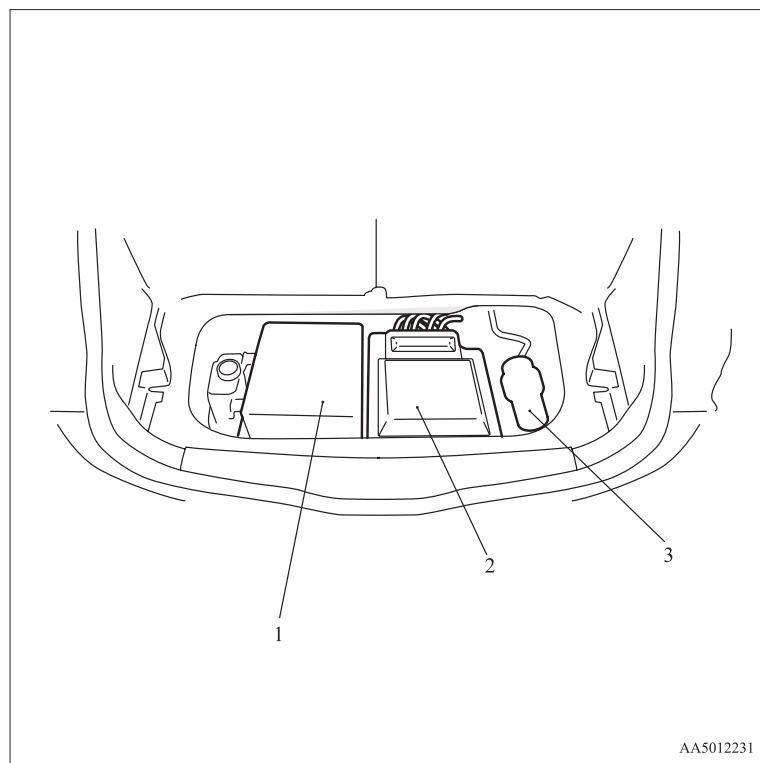

1. On board charger/DC-DC converter p. 8-06
2. Inverter p. 8-06
3. Brake electric vacuum pump

AA5012231

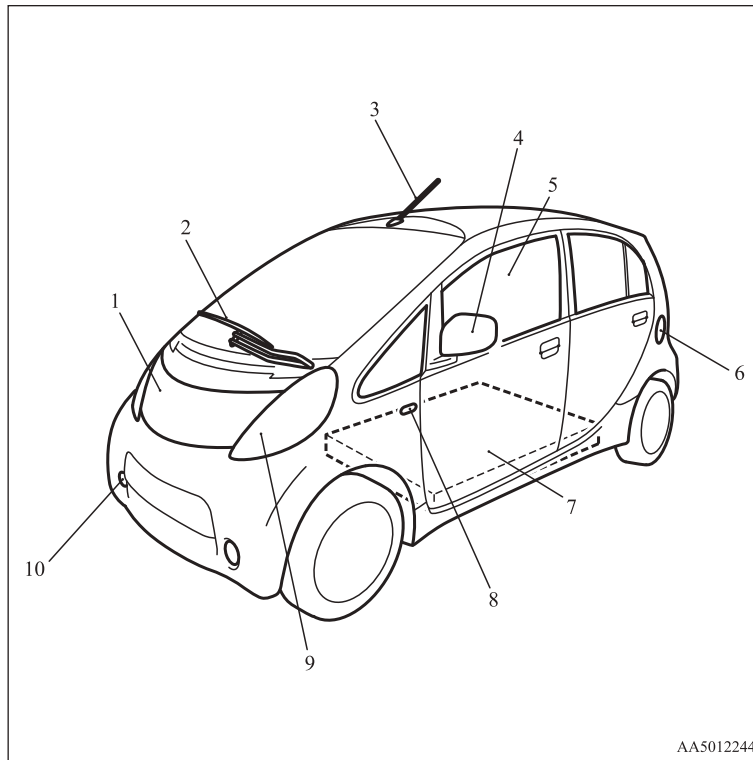
Outside (Front)

AA5012244

1. Bonnet p. 8-07
2. Windscreen wipers p. 4-16
3. Antenna p. 6-30
4. Outside rear-view mirror p. 5-05
5. Electric window control p. 2-09
6. Quick charging lid p. 1-11
7. Traction battery p. 8-06
8. Side turn-signal lamps/Hazard warning lamps p. 4-09, 8-24, 8-30
9. Headlamps p. 4-11, 8-24, 8-24, 8-28, 8-29
Position lamps p. 4-11, 8-24, 8-24, 8-30
Front turn-signal lamps/Hazard warning lamps p. 4-09, 8-24, 8-24, 8-30
10. Front fog lamps* p. 4-15, 8-24, 8-31
Daytime running lamps* p. 4-13, 8-24, 8-31

Outside (Rear)

E00100504702

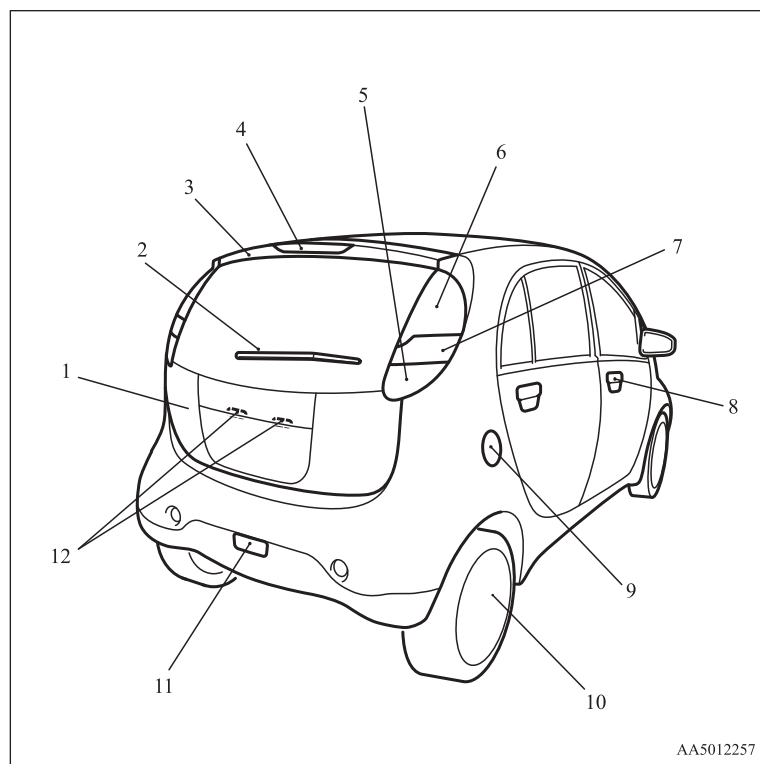

1. Tailgate p. 2-08
2. Rear window wiper p. 4-17
3. Rear spoiler
4. High-mounted stop lamp p. 8-24, 8-34
5. Reversing lamps p. 8-24, 8-33
6. Stop lamps/Tail lamps p. 4-14, 8-24, 8-33
7. Turn-signal lamps/Hazard warning lamps p. 4-14, 4-15, 8-24, 8-33
8. Keyless entry system p. 2-03
Locking and unlocking the doors p. 2-05
9. Regular charging lid p. 1-07
10. Tyre inflation pressures p. 8-15
Tyre rotation p. 8-16
Tyre chains p. 8-17
Size of tyres and wheels p. 9-05
11. Rear fog lamp p. 4-16, 8-24, 8-32
12. Licence plate lamps p. 4-11, 8-24, 8-34

AA5012257

General information

Familiarizing yourself with i-MiEV.....	02
Installation of accessories.....	03
Modification/alterations to the electrical systems.....	04
Genuine parts.....	04
Disposal information for used batteries.....	05
Cautions and actions to deal with intense heat.....	06
Cautions and actions to deal with intense cold.....	08

General information

Familiarizing yourself with i-MiEV

E00202600016

This section describes features that the i-MiEV has as an electric vehicle and gives precautions that you should observe. It is important. Please read it carefully.

Main features

E00202700033

- Energy required for driving is only electricity and fuel supply is not required.
- The traction battery and electric motor unit are mounted outside the passenger compartment. In this way, passenger space is obtained for riding of four adults.
- With the high performance motor, noise and vibration during driving are greatly limited and powerful acceleration can also be obtained.
- With regenerative braking, the traction battery is automatically charged when the accelerator is released.
- The vehicle can be charged from general power outlets (rated AC 220-240 V).
- Charge with the quick charger for i-MiEV is also available.
- The creeping behaviour occurs in i-MiEV like a vehicle with automatic transmission.

WARNING

- Always pay special attention to pedestrians.
Even if the Acoustic Vehicle Alerting System (AVAS) sounds, pedestrians may not notice your vehicle. Refer to “Acoustic Vehicle Alerting System (AVAS)” on page 5-12.

Regenerative braking

It is equivalent to engine braking of an engine vehicle. If you step off the accelerator pedal during driving, motion energy is converted into electric energy using the motor as a power generator.

In this conversion, braking force is generated and converted electric energy is charged in the traction battery.

Regenerative braking is stronger in the order of the selector lever position of “C” (COMFORT), “D” (DRIVE), “B” (BRAKE).

Put the selector lever to the “B” (BRAKE) or “C” (COMFORT) position according to the driving condition.

“B”: Strong regenerative braking (For downhill)

“C”: Weak regenerative braking (For long cruising)

Traction battery

E00202800034

WARNING

- A sealed lithium ion high voltage battery is adopted for i-MiEV. If the lithium ion battery is improperly disposed of, there is a risk of severe burns and electrical shock that may result in serious injury or death and there is also a risk of environmental damage.

- It is the battery to operate the motor (electric motor unit) and the air conditioning. In addition to the traction battery, i-MiEV has the auxiliary battery to operate lamps, wipers, etc.
- Compact, light-weight lithium ion battery with high energy density is used for the traction battery.
- The lithium ion battery has the following characteristics. Please read this carefully and treat the battery paying attention to the following:

Characteristics

- It is not necessary to consume the battery completely before charging.
- The capacity is gradually degraded depending on time used and operating conditions. This will result in a decrease from the vehicle’s initial cruising range.
- The performance may be changed due to the outside temperature. At low temperature, in particular, the cruising range is short and the charging time is long, compared to operation at normal temperature.

- If you store your vehicle at an extremely high or low temperature, the battery capacity may be lowered.
- The battery is gradually discharged without use and the battery charge is lowered.

Precautions for operation

- Do not store your vehicle with the energy level gauge showing 0 bars.
Doing so could damage the traction battery. The battery may have to be replaced depending on the low capacity.
- If you do not use your vehicle for a long time, please charge the traction battery to the full every 3 months so that the energy level gauge may not be 0 bars.
- MITSUBISHI MOTORS collects traction batteries. If you scrap your vehicle, please consult a MITSUBISHI MOTORS Authorized Service Point.

NOTE

- The progress of the battery capacity loss depends on the vehicle usage and the environment.
We recommend to do regular charging from 2 bars or less to charge completely at least once in 3 months.
The procedure lets the battery remaining indicator adjusted automatically.

Cruising range

E00202900019

- Even if the charge level is the same, the cruising range may vary depending on the driving conditions. Since driving at high speed or climbing on a hill requires higher consumption of the traction battery than usual, the cruising range is shortened.

- Since the air conditioning (cooling or heating) consumes power of the traction battery, its operation results in a shorter cruising range. Maintain an appropriate temperature.
- Put the selector lever to the “B” (BRAKE) or “C” (COMFORT) position according to the road condition. To charge the traction battery with appropriate use of regenerative braking can increase the cruising range.

Installation of accessories

E00200301003

We recommend you to consult a MITSUBISHI MOTORS Authorized Service Point.

- The installation of accessories, optional parts, etc., should only be carried out within the limits prescribed by law in your country, and in accordance with the guidelines and warnings contained within the documents accompanying this vehicle.
- Installing electric components incorrectly could lead to a fire. See the “Modification/alterations to the electrical systems” section within this owner’s manual.
- Using a cellular phone or radio set inside the vehicle without an external antenna may cause electrical system interference, which could lead to unsafe vehicle operation.
- Tyres and wheels which do not meet specifications must not be used.
Refer to the “Specifications” section for information regarding wheel and tyre sizes.

Important points!

Due to large number of accessory and replacement parts of different manufactures available in the market, it is not possible, not only for MITSUBISHI MOTORS, but also for a MITSUBISHI MOTORS Authorized Service Point, to check whether the attachment or installation of such parts affects the overall safety of your MITSUBISHI-vehicle.

General information

Even when such parts are officially authorized, for example by a “general operators permit” (an appraisal for the part) or through the execution of the part in an officially approved manner of construction, or when a single operation permit following the attachment or installation of such parts, it cannot be deduced from that alone, that the driving safety of your vehicle has not been affected.

Consider also that there basically exists no liability on the part of the appraiser or the official. Maximum safety can only be ensured with parts recommended, sold and fitted or installed by a MITSUBISHI MOTORS authorized Service Point (MITSUBISHI MOTORS genuine replacement parts and MITSUBISHI MOTORS accessories). The same also pertains to modifications of MITSUBISHI vehicles with respect to the production specifications. For safety reasons, do not attempt any modifications other than those that follow the recommendations of a MITSUBISHI MOTORS authorized Service Point.

Modification/alterations to the electrical systems

E00200400414

MITSUBISHI MOTORS CORPORATION has always manufactured safe, high quality vehicles. In order to maintain this safety and quality, it is important that any accessory that is to be fitted, or any modifications carried out which involve the electrical systems, should be carried out in accordance with MITSUBISHI guidelines.

CAUTION

- If the wires interfere with the vehicle body or improper installation methods are used (protective fuses not included, etc.), electronic devices may be adversely affected, resulting in a fire or other accident.

Genuine parts

E00200500499

MITSUBISHI MOTORS has gone to great lengths to bring you a superbly crafted automobile offering the highest quality and dependability.

Use MITSUBISHI MOTORS Genuine Parts, designed and manufactured to maintain your MITSUBISHI MOTORS automobile at top performance. MITSUBISHI MOTORS Genuine Parts are identified by this mark and are available at all MITSUBISHI MOTORS Authorized Service Points.

**MITSUBISHI MOTORS
GENUINE PARTS**

Disposal information for used batteries

E00201300045



Your vehicle contains batteries and/or accumulators.

Do not mix with general household waste.

For proper treatment, recovery and recycling of used batteries, please take them to applicable collection points, in accordance with your national legislation and the Directives 2006/66/EC. MITSUBISHI MOTORS collects traction batteries. If you scrap your vehicle, please consult a MITSUBISHI MOTORS Authorized Service Point.

By disposing of these batteries correctly, you will help to save valuable resources and prevent any potential negative effects on human health and the environment which could otherwise arise from inappropriate waste handling.

Cautions and actions to deal with intense heat

E00203000033

- When the vehicle is driven in a high ambient temperature, its air-conditioner performance can be insufficient. Also, using the air conditioner can reduce the vehicle's cruising range.
- When the ambient temperature is approximately 40 °C or higher, the phenomena described below may occur. Please take the described corrective action.

Approx. ambient temperature	Phenomena		Corrective action
Approx. 40 °C or higher	Startup and driving	<ul style="list-style-type: none"> ● During quick charging, repeated high-speed driving, or repeated uphill driving, the power down warning lamp* comes on and the motor output is restricted to protect the traction battery or motor (electric motor unit). ● Regenerative braking performance may decrease. 	<ul style="list-style-type: none"> ● Stop the vehicle for a while, avoid quick charging, and wait for the power down warning lamp* to go off.
	Charging and battery	<ul style="list-style-type: none"> ● During quick charging, charging times get longer. 	
Approx. 45 °C or higher	Startup and driving	<ul style="list-style-type: none"> ● During quick charging, repeated high-speed driving, or repeated uphill driving, the power down warning lamp* comes on and the motor output is restricted to protect the traction battery or motor (electric motor unit). ● If you continue driving after the power down warning lamp* has come on, the vehicle may stop when you have driven a few kilometres. 	
		Charging and battery	
Approx. 60 °C or higher	Startup and driving	<ul style="list-style-type: none"> ● The power down warning lamp* comes on, and the vehicle may stop. 	<ul style="list-style-type: none"> ● Park in a well-ventilated, shady place, avoid quick charging, and wait for the power down warning lamp* to go off.
	Charging and battery	<ul style="list-style-type: none"> ● Regular charging or quick charging may become impossible. 	<ul style="list-style-type: none"> ● Park in a well-ventilated, shady place.

NOTE

- *: Refer to “Power down warning lamp” on page 4-11. Illumination of the power down warning lamp does not indicate a malfunction.

Cautions and actions to deal with intense cold

E00203100047

- When the vehicle is driven in a low ambient temperature, its heater performance can be insufficient. Also, using the heater can reduce the vehicle's cruising range.
- When the ambient temperature is approximately -15 °C or lower, the phenomena described below may occur. Please take the described corrective action.

Approx. ambient temperature	Phenomena		Corrective action
Approx. -15 °C or lower	Startup and driving	<ul style="list-style-type: none"> ● Motor output is restricted, and the power down warning lamp*1 may come on. <Reference: When the traction battery temperature is -15 °C or lower and the traction battery's remaining power is 50 %, the driving performance may decrease by approximately 30 %> 	<ul style="list-style-type: none"> ● Keep driving if you can drive the same speed as surrounding vehicles. If you cannot drive the same speed as surrounding vehicles, stop the vehicle in a safe place and charge the traction battery or drive carefully safely surrounding vehicles.
		<ul style="list-style-type: none"> ● Regenerative braking performance may decrease. 	<ul style="list-style-type: none"> ● When braking, depress the brake pedal more strongly
	Charging and battery	<ul style="list-style-type: none"> ● Charging times get longer. ● Charging may not be completed. 	<ul style="list-style-type: none"> ● When you have finished driving, charge the traction battery before its temperature falls.

Approx. ambient temperature	Phenomena		Corrective action
Approx. -25 °C or lower	Startup and driving	<ul style="list-style-type: none"> ● Motor output is restricted, and the power down warning lamp*1 may come on. <Reference: When the traction battery temperature is -25 °C or lower and the traction battery's remaining power is 50 %, the driving performance may decrease by approximately 50 %> 	<ul style="list-style-type: none"> ● Keep driving if you can drive the same speed as surrounding vehicles. If you cannot drive the same speed as surrounding vehicles, stop the vehicle in a safe place and charge the traction battery or drive carefully safely surrounding vehicles.
		<ul style="list-style-type: none"> ● Regenerative braking performance may decrease. 	<ul style="list-style-type: none"> ● When braking, depress the brake pedal more strongly.
	Charging and battery	<ul style="list-style-type: none"> ● Charging may become impossible. 	<ul style="list-style-type: none"> ● When you have finished driving, charge the traction battery before its temperature falls.
Approx. -30 °C or lower	Startup and driving	<ul style="list-style-type: none"> ● The ready indicator*2 does not come on, and startup may not be possible. ● In the worst-case scenario, the vehicle may become undrivable (with the energy level gauge and cruising range indications still shown). 	<ul style="list-style-type: none"> ● In the daytime, wait for the temperature to rise. When the temperature in the vicinity of the traction battery has risen, start up.
		<ul style="list-style-type: none"> ● Regenerative braking performance may decrease. 	<ul style="list-style-type: none"> ● When braking, depress the brake pedal more strongly
	Charging and battery	<ul style="list-style-type: none"> ● Charging may become impossible. 	<ul style="list-style-type: none"> ● In the daytime, wait for the temperature to rise. When the temperature in the vicinity of the traction battery has risen, start up.

⚠ CAUTION

- If the outside temperature is -25 °C or less, the lithium ion battery may freeze and it cannot be charged or provide power to drive the vehicle. Move the vehicle to a warm location.

General information

NOTE

- *1: Refer to “Power down warning lamp” on page 4-11. Illumination of the power down warning lamp does not indicate a malfunction.
- *2: Refer to “Ready indicator” on page 4-09.

Charging

Battery.....	1-02
Basic knowledge for charging.....	1-02
EV charging cable.....	1-04
Regular charging (charging method with rated AC 220-240 V outlet).....	1-06
Quick charging (charging method with quick charger).....	1-11
MiEV Remote System*.....	1-13

Charging

Battery

E08300100027

There are two types of batteries installed in your vehicle: a traction battery for operating the motor (electric motor unit) and air conditioning as well as an auxiliary battery for starting the electric motor unit and operating the lamps, wipers, etc. This chapter explains charging of the traction battery.

NOTE

- The auxiliary battery is automatically charged while the ready indicator is illuminated or during charge for the traction battery. Refer to “Ready indicator” on page 4-09.
- If the auxiliary battery is flat, the electric motor unit cannot be started. Also, the charging cannot be started. Refer to “Emergency starting” on page 7-02.

Basic knowledge for charging

E08300200031

There are two types of charging: regular charging and quick charging.

Regular charging is performed through the on-board charger using rated AC 220-240 V outlet as the power source.

The rated AC voltage may differ from country to country.

Quick charging is performed with the quick charger compatible with i-MiEV.

WARNING

- To reduce the risk of electric shock or fire due to electric leak, always use an outlet protected by a residual current detector, rated for amperage equal to or greater than the value specified by MITSUBISHI MOTORS, and that is connected to a dedicated branch circuit. If the circuit is shared, and another electrical device is being used at the same time the vehicle is charging, the breaker may trip and the circuit may cause adverse interference on MCB (Moulded Circuit Board) and household electrical appliances such as TVs and audio systems.
- It is possible to charge even in rain or snow. However, be sure to pay attention to the following:
 - Never connect or disconnect the charge connector with a wet hand to prevent an electric shock.
 - Never make the connection wet when charging.

Never charge in bad weather such as heavy rain, strong wind and with the risk

WARNING

of lightning. Also, do not keep opening the inner lid and the charging lid or do not leave the EV charging cable in outdoor areas. Doing so could lead to water entering the charge connector or the charge port, resulting in fire or an electric shock.

- If the connected part of the charging plug has been buried in snow while charging, turn off the hand switch or the breaker connected with the outlet first, then remove the snow and disconnect the charging plug. If your vehicle body has been buried in snow while charging, remove the snow and then disconnect the charge connector.

CAUTION

- Do not attempt to perform a jump start on the auxiliary battery at the same time that the traction battery is being charged. Doing so may damage the vehicle or charging cable and could cause injury. Refer to “Emergency starting” on page 7-02.

NOTE

- Repeatedly performing only quick charging may reduce the battery capacity. In usual charge, regular charging is recommended.
- To maintain the capacity of the traction battery, the following is recommended:
 - Fully charge the vehicle in regular charging every two weeks.

- Do not repeat charging near the full charge level.
- The quick charging gives priority when the regular charging and the quick charging are performed at the same time.
At this time, the regular charging will be stopped.
- The progress of the battery capacity loss depends on the vehicle usage and the environment.
We recommend to do regular charging from 2 segments or less to charge completely at least once in 3 months.
The procedure lets the battery remaining indicator adjusted automatically.
- In the event of an electrical power outage while charging, charging restarts automatically with the restoration of electricity.

Guideline for charging time

E08300700036

The regular charging time (from 1 bar of energy level gauge to full charge) is different according to the current value.

- 230 V/10 A → about 8 hours
- 230 V/8 A → about 10 hours

About 30 minutes with quick charger (About 80 % of full charge)

NOTE

- The charging time may vary depending on the battery condition, operation environment of the vehicle and specification of the quick charger.

Charging

EV charging cable

E08301100040

Your vehicle is equipped with the EV charging cable (A) with control box (B).

The indicator illuminates/blinks in the following conditions.

○: Illuminates ◎: Blinking ●: Not illuminates

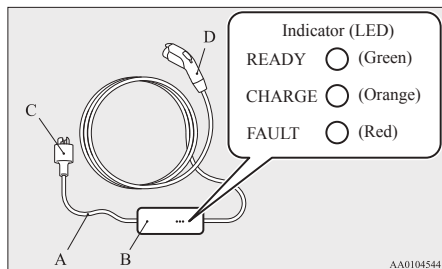

READY (Green)	CHARGE (Orange)	FAULT (Red)	Status and action to be taken
○	○	○	Every time the charging cable plug (C) is connected to an outlet, all indicator lights illuminate for 0.5 seconds.
○	●	●	After initial processing is completed, when the regular charge connector is not connected to the vehicle, or the regular charge connector is connected to the vehicle but charging is not being performed.
○	○	●	While the traction battery is being charged
○	●	◎	When an electric leakage occurs or the EV charging cable malfunctions Stop use immediately and contact a MITSUBISHI MOTORS Authorized Service Point.
○	●	○	When the EV charging cable malfunctions Stop use immediately and contact a MITSUBISHI MOTORS Authorized Service Point.
●	●	●	If the control box indicator light does not illuminate after connecting the charging cable plug to the outlet, check the circuit breaker for the outlet. If the breaker has tripped, the circuit may not be suitable for use with EV charging cable. You should have a licensed electrician inspect and repair the electrical circuit. If the breaker is not tripped, stop using the EV charging cable and contact a MITSUBISHI MOTORS Authorized Service Point.

⚠ WARNING

- If the green or orange indicator does not illuminate or the red indicator blinks or illuminates during regular charging, please contact a MITSUBISHI MOTORS Authorized Service Point.
- Do not charge with the EV charging cable banded or rolled.
The cable may be heated and resulting in fire.
- Do not alter or disassemble the EV charging cable.
Doing so could cause fire, an electric shock or injury.
- Be sure to install the cap to the regular charge connector and store the EV charging cable at a place where the cable is not exposed to water or dust. Entry of foreign matter such as water or dust at the metal terminal of the regular charge connector or charging cable plug may cause a fire or malfunction. Contact with metal such as wire or tool may cause fire, an electric shock or malfunction.
- Never force the connection if the EV charging cable or connector shows damage or is not easily connected due to foreign material entering the connector or the outlet. And never use an outlet that is worn, damaged, or will not hold the plug firmly. Doing so could cause fire, an electric shock, or short circuit.
- Pay attention to the following for handling the EV charging cable.
Damage to the cable could cause fire, an electric shock, or short circuit.
 - Do not pull with undue force.
 - Do not twist.

⚠ WARNING

- Do not drag.
- Do not put an object on top.
- Do not put the cable close to a heating unit including heater.
- Do not drop the regular charge connector or do not give strong impact to it.

⚠ CAUTION

- Do not charge with the outlet that is smaller than the current value described on the control box.

NOTE

- All indicators are illuminated momentarily for confirming operation when the charging cable plug is inserted into an outlet. After that the green indicator is continuously illuminated.
- The orange indicator will go off when the charging is completed. The green indicator is continuously illuminated while the charging plug is inserted into an outlet.

Handling and storing the control box

E08301200025

⚠ CAUTION

- While charging, it must be prevented being damaged to the control box by the attached rope as shown in the following illustration.

NOTE

- Use the hook with load capacity over 4 kg, that weight is the EV charging cable.
- Check the rope has no damage or no loose before use.

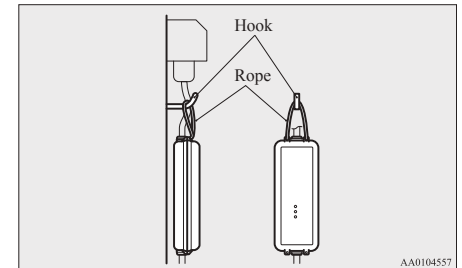
**Cleaning the EV charging cable**

E08301300042

1. Gently wipe off with gauze or other soft cloth soaked with a 3 % aqueous solution of neutral detergent.
2. Wipe off all the detergent with a soft cloth dipped in fresh water and thoroughly wrung out.

Charging

3. Wipe all moisture off and dry in a shaded, well-ventilated area.

WARNING

- In cleaning, be sure to remove the charging cable plug and the regular charge connector from the outlet. Do not connect or disconnect the plug and the connector with wet hands. Doing so could cause an electric shock.
- Do not have the metal terminal of the regular charge connector and the charging cable plug be exposed to water or neutral detergent. Operation with water could cause fire or an electric shock.

CAUTION

- Never use benzene, petrol, or other organic solvents, or acid or alkaline solvents. Doing so could cause deformation, discolor, or malfunction. Also, these substances may be present in various cleaners, so check carefully before use.

Regular charging (charging method with rated AC 220-240 V outlet)

E08300900038

WARNING

- For safety, do not allow children or people who are not familiar with charging to charge for themselves. Also, do not use the charge connector within reach of children.
- Persons who use electro-medical apparatus such as implantable cardiac pacemaker or implantable cardioverter defibrillator must check effect from charging with the manufacturer of electro-medical apparatus.
- If you use any medical electric devices, take into account the following precautions.
 - Do not stay inside the vehicle.
 - Do not go inside the vehicle, for example to remove or place an item in the passenger compartment.
 - Do not open the rear hatch, for example to remove or place an item in the cargo area.Charging may affect the operation of electric medical devices and result in serious personal injury or death.
- Do not charge with the EV charging cable banded or rolled. Doing so the cable may be heated and this might result in fire.

WARNING

- Before charging, make sure that there is no foreign matter such as dust at the regular charge port and the regular charge connector. At this time, do not touch the regular charge port.
- When the regular charge connector is connected to the charge port, prevent foreign matter such as water or dust from entering in the port. Connection with foreign matter such as water or dust may cause fire or an electric shock. Do not perform charging if there might be strong exposure to water at the connection.
- Never pull the cable to remove the plug. And never submerge the EV charging connector, control box or plug in water.
- Please observe the following in order to prevent accidents during charging such as electrocution.
 - Make sure to use the EV charging cable that comes with the vehicle.
 - Do not charge another vehicle using the attached EV charging cable. Doing so the cable may be heated and this might result in fire.
 - Make sure to use an outlet that is protected from water entering.
 - Do not perform charging with the body cover.
 - Do not remove and insert plugs with wet hands.
 - Do not charge the battery if there is a risk of lightning.

⚠ WARNING

- While it is normal for the connector and charging cable to become warm during charging, discontinue use immediately if the connector or charging cable becomes hot to the touch.
- While it is normal for the control box to become warm during charging, discontinue use immediately if the control box becomes hot to the touch.
- If abnormal smells are detected or the vehicle produces smoke, quickly stop charging.
- Do not perform charging at a poorly ventilated place with surroundings covered. Keep sparks, cigarettes, and flames away from the auxiliary battery. Flammable gas generated from the auxiliary battery in charging may be filled in a building, resulting in explosion. If charging is inevitably required, ventilate the area well.
- Grasp the regular charging plug when connecting or disconnecting the EV charging cable. Grasping the cable could cause an electric shock, short circuit, and/or fire.
- During charging, the cooling fans inside the bonnet room may automatically be operated even if the electric motor switch is in the “LOCK” position. Keep your hands away from the cooling fan during charging.

⚠ CAUTION

- Do not perform charging from other power source like a generator. Doing so could cause a malfunction.

NOTE

- If the charge connector is not easily connected to the charge port due to foreign material entering, never force the connection. Doing so could damage the charging equipment or the vehicle. Contact a MITSUBISHI MOTORS Authorized Service Point.
- The on board charger is only for rated AC 220-240 V outlets.
- When connecting or disconnecting the regular charging plug, insert/pull out the plug straight. Also, do not incline or twist the plug. Doing so could cause a bad connection or malfunction.
- Make sure to lock the doors to prevent theft, etc. during charging.

Charging from rated AC 220-240 V outlet

E08301000049

1. Fully apply the parking brake and place the selector lever to the “P” (PARK) position.
2. Stop the electric devices such as lamps and turn the electric motor switch to the “LOCK” position.

3. Pull the regular charging opener (A) at the bottom left/right of the instrument panel to open the regular charging lid (B) at the right rear side of the vehicle.

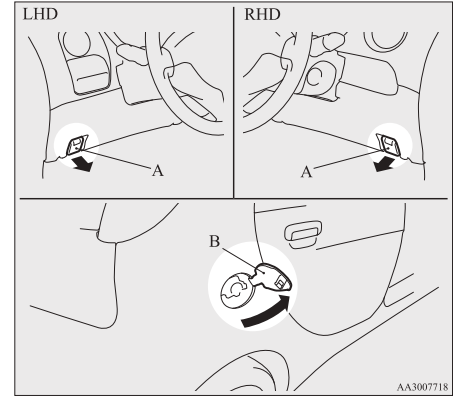

4. Press the tab (C) to open the inner lid (E).

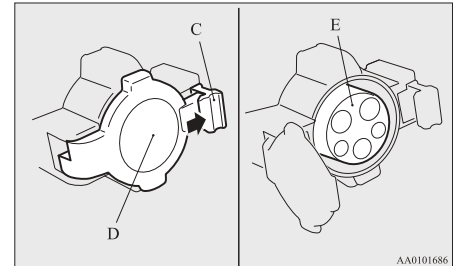

Charging

⚠ WARNING

- Do not touch the metal terminal of the regular charge port (E) and the regular charge connector. Doing so could cause an electric shock and/or malfunction.

⚠ CAUTION

- Do not leave for a long time with the inner lid opened. It becomes impossible to charge if foreign material enters the regular charge port.

NOTE

- There is a hole on the charge port for water drainage. If this hole is blocked and water gets trapped in the charge port, do not charge. Contact a MITSUBISHI MOTORS Authorized Service Point.
- If the charge port is frozen, melt the ice using a hair drier. Forcing the charge connector to connect while frozen could result in malfunction.

5. Insert the charging cable plug into an outlet.

NOTE

- The shape of the charging cable plug and outlet may differ from country to country as shown in the illustration.
- Use the following outlets.

⚠ WARNING

- Make sure that the plug is inserted all the way into the outlet before use.
- To reduce the risk of electric shock or fire due to electric leak, always use an outlet protected by a residual current detector, rated for amperage equal to or greater than the value specified by MITSUBISHI MOTORS, and that is connected to a dedicated branch circuit. If the circuit is shared, and another electrical device is being used at the same time the vehicle is charging, the breaker may trip and the circuit may cause adverse interference on MCB (Moulded Circuit Board) and household electrical appliances such as TVs and audio systems.
- To reduce the risk of electric shock, connect only to a properly earthed and water-proofed outlet.

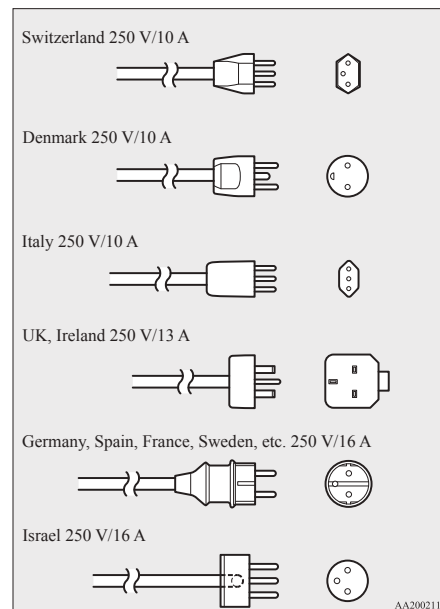

- Remove the cap (F) on the regular charge connector (G) and make sure that there is no foreign matter such as dust at the end of the regular charge connector and the regular charge port.

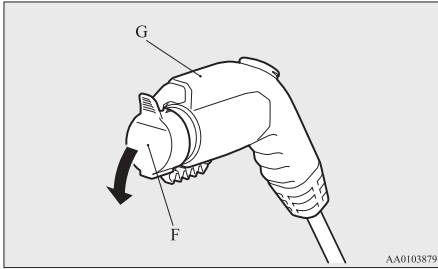

- Connect the regular charge connector until a click sound is heard without pressing the button (H).

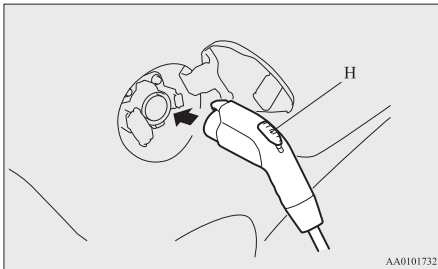

CAUTION

- Do not clasp the top of regular charge connector. It could cause injury to touch the protrusion on the lid.

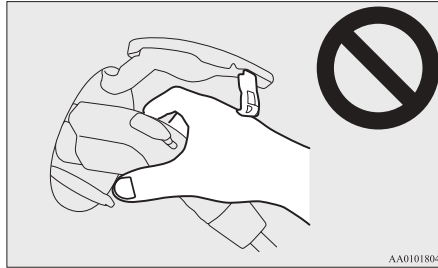

NOTE

- If the electric motor switch is turned to the "START" position with the regular charge connector connected to the regular charge port, the electric motor unit cannot be started.
- Make sure that the charging indicator on the instrument cluster is illuminated.

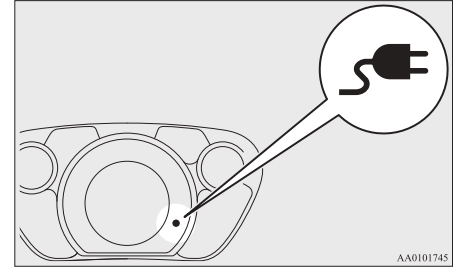

If the charging indicator is not illuminated, charging is not started. Make sure that the regular charge port, the plug and the connector are appropriately connected, and perform charging from Step 5 again.

NOTE

- When the regular charge connector is connected to the charge port, the charging indicator is blinking. When charging is started, the charging indicator is illuminated.
- The charge level for traction battery can be checked with the energy level gauge (I) on the instrument cluster. Refer to "Energy level gauge" on page 4-06.

Charging

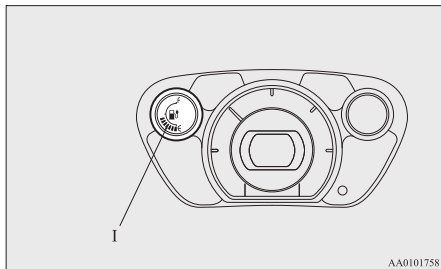

- 1
9. Charging is complete when the charging indicator turns off. Pull out the regular charging plug while pressing the button (J).

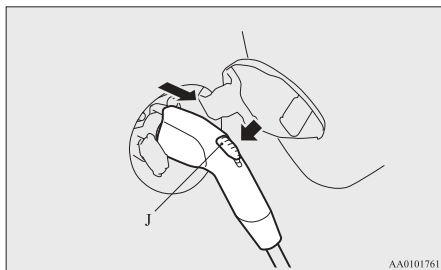

NOTE

- Charging can be stopped half way. In this case, also, pull out the regular charge connector while pressing the button.

10. Close the inner lid and close the regular charging lid.

NOTE

- Make sure that the inner lid is completely closed.
If the regular charging lid is forcibly closed without completely closing the inner lid, the hinge on the inner lid may be broken.

11. Remove the charging cable plug from the outlet.
12. Install the cap on the regular charge connector.

⚠ WARNING

- After charging, be sure to close the inner lid and the regular charging lid completely.
Be careful that water or dust does not enter in the regular charge port, inner lid and regular charge connector.
Entry of water or dust could cause electric leakage, resulting in fire or electric shock.
- After charging, be sure to disconnect the charge connector from the charge port.
If the charge connector is only partially engaged and the connector latch is unlocked, you could turn the electric motor switch to the “START” position and the vehicle could start moving. It could lead to an unexpected accident.

⚠ CAUTION

- After charging, be sure to disconnect the plug from the outlet.
If the plug is left connected to the outlet, immersion in water or tampering may cause leakage or an electric shock.

Quick charging (charging method with quick charger)

E08301400043

⚠ WARNING

- Be sure to use the quick charger compatible with i-MiEV.
Use of a non-compatible quick charger may cause fire or malfunction.
For the quick charger compatible with i-MiEV, consult a MITSUBISHI MOTORS Authorized Service Point.
- For operation of quick chargers, follow the manual of each quick charger.
- Persons who use electro-medical apparatus such as implantable cardiac pacemaker or implantable cardioverter defibrillator must check effect from charging with the manufacturer of electro-medical apparatus. Electro-medical apparatus operations could be affected by charging.
- Before charging, make sure that there is no foreign matter such as dust at the quick charge port and the quick charge connector.
At this time, do not touch the quick charge port.
- When the quick charge connector is connected to the quick charge port, prevent foreign matter such as water or dust from entering in the port.
Connection with foreign matter such as water or dust may cause fire or an electric shock. Do not perform charging if there might be strong exposure to water at the connection.

⚠ WARNING

- During charging, the cooling fans inside the bonnet room may automatically be operated even if the electric motor switch is in the “LOCK” position.
Keep your hands away from the cooling fan during charging.

NOTE

- If the charge connector is not easily connected to the charge port due to foreign material entering, never force the connection. Doing so could damage the charging equipment or the vehicle. Contact a MITSUBISHI MOTORS Authorized Service Point.
- The quick charger might be installed in the public parking space, some chargers are not suitable for this vehicle. Check the manual of each quick charger when charging.
- The charge connector and the EV charging cable stick out of the vehicle body while charging, so be careful that your body does not get stuck with them or they do not touch the next vehicle.
- The vehicle equipped with a quick charge port is compatible with most CHAdeMO (Japanese industry standard) connectors on charging stations.
- Make sure to lock the doors to prevent theft, etc. during charging.

1. Fully apply the parking brake and move the selector lever to the “P” (PARK) position.
2. Stop the electric devices such as lamps, air conditioning, etc. and turn the electric motor switch to the “LOCK” position.

Charging

3. Pull the quick charging lid opener (A) at the bottom left/right of the driver’s seat to open the quick charging lid (B) at the left rear side of the vehicle.

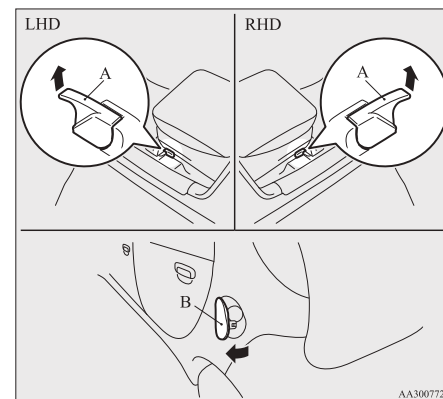

4. Press the tab (C) to open the inner lid (D).

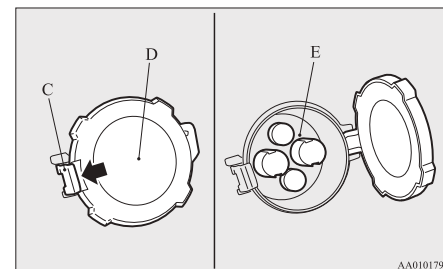

Charging

⚠ WARNING

- Do not touch the metal terminal of the quick charge port (E) and the quick charge connector. Doing so could cause an electric shock and/or malfunction.

⚠ CAUTION

- Be sure to insert the quick charge connector straight into the quick charge port right up to the base. Failure to do so may result in the traction battery not charging or could cause damage to the charging equipment.
- Do not leave for a long time with the inner lid opened. It becomes impossible to charge if a foreign material is entered to the quick charge port.

NOTE

- There is a hole on the charge port for water drainage. If this hole is blocked and water gets trapped in the charge port, do not charge. Contact a MITSUBISHI MOTORS Authorized Service Point.
 - If the charge port is frozen, melt the ice using a hair drier. Forcing the charge connector to connect while frozen could result in malfunction.
5. Connect the quick charge connector in the quick charge port to begin charging. For connecting and disconnecting, follow the instruction manual for each quick charger.

6. Make sure that the charging indicator on the instrument cluster is illuminated.

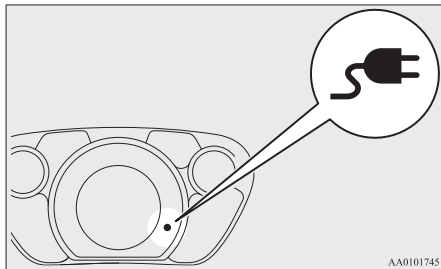

If the charging indicator is not illuminated, charging is not started. Follow the manual of each quick charger.

NOTE

- When the regular charge connector is connected to the charge port, the charging indicator is blinking. When charging is started, the charging indicator is illuminated.
- The charge level for traction battery can be checked with the energy level gauge (F) on the instrument cluster.

Refer to “Energy level gauge” on page 4-06.

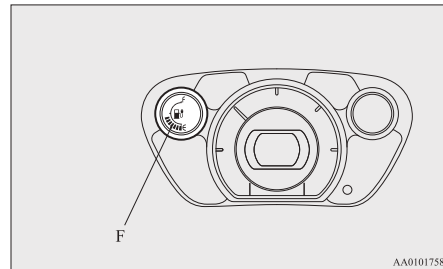

- Operation noise may be heard from the vehicle body during quick charging. This noise comes from operation of the traction battery cooling system, and it is not a malfunction.
 - Since the traction battery cooling system uses cool air of the air conditioning, the air conditioning is automatically operated. After quick charging, if the area under the vehicle is wet, transparent and loose, it is dehumidified water from the air conditioning and not a malfunction.
7. Charging is complete when the charging indicator turns off. Disconnect the quick charge connector according to the manual of the quick charger.

⚠ CAUTION

- As the quick charge connector is heavier in comparison to the regular charge connector, allowing it to drop could cause damage to the vehicle or charge connector or personal injury. When removing the connector, be sure to pull it out straight and as carefully as possible.
- Do not leave the quick charge connector connected to the quick charge port after charging. Doing so, someone might stumble and it could cause an injury or the quick charge port might be damaged by playing it.

8. Close the inner lid and close the quick charging lid.

⚠ WARNING

- After charging, be sure to close the inner lid and the quick charging lid completely. Be careful that water or dust does not enter in the quick charge port, inner lid and quick charge connector. Entry of water or dust could cause fire, electric shock or short circuit.
- After charging, be sure to disconnect the charge connector from the charge port. If the charge connector is only partially engaged and the connector latch is unlocked, you could turn the electric motor switch to the “START” position and the vehicle could start moving. It could lead to an unexpected accident.

NOTE

- If the electric motor switch is turned to the “START” position with the quick charge connector connected to the quick charge port, the electric motor unit cannot be started. Be sure to disconnect the quick charge connector before start.
- Charging may be completed before full charge. This is a control for efficient charge and not a malfunction. To achieve full charge, repeat charging from Step 5 again.
- Make sure that the inner lid is completely closed. If the quick charging lid is forcibly closed without completely closing the inner lid, the hinge on the inner lid may be broken.

MiEV Remote System*

E08301800018

The MiEV Remote System has the following three functions.

- **Timer Charging**
When the EV charging cable (regular charger) is connected, the batteries will only charge during the pre-set time period selected using the MiEV Remote.
- **Remote Climate Control**
When the EV charging cable (regular charger) is connected, the air-conditioner can be activated for up to 30 minutes prior to using the vehicle. This feature can be used to cool or heat the car and to activate the front and rear window defroster.
- **Traction Battery Level Indicator**
The charge remaining in the traction battery can be confirmed through the MiEV Remote.

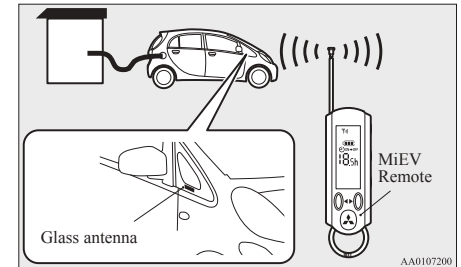

⚠ WARNING

- 1**
- Individuals who use implantable pacemakers or implantable cardiovascular-defibrillators should keep away from the external and internal transmitters. The electromagnetic waves used in the MiEV Remote System may affect the operation of implantable pacemakers and implantable cardiovascular defibrillators.
 - Individuals using other electro-medical apparatus besides implantable pacemakers and implantable cardiovascular defibrillators should check with the manufacturer of the apparatus to confirm the effect of the electromagnetic waves used by the MiEV Remote System. The electromagnetic waves may affect the operations of the electro-medical apparatus.
 - Never use the MiEV Remote near medical equipment. Electromagnetic waves could adversely affect the medical equipment.
 - Keep the MiEV Remote in the place where children will not touch or play with the remote.
 - When bringing the MiEV Remote on flights, do not press any switches on the MiEV Remote while on the plane. If a switch is pressed on the plane, the MiEV Remote emits electromagnetic waves which like cell phones and other wireless devices, could interfere with systems on the airplane.
When carrying the MiEV Remote in a bag, be careful that no switches on the MiEV Remote can be pressed by mistake.

⚠ CAUTION

- Never disassemble or modify the MiEV Remote. No user serviceable parts are inside except batteries.
- Disassembling or modifying the MiEV Remote or removing a label from the MiEV Remote may violate regulations.

NOTE

- The MiEV Remote system uses radio waves. The MiEV Remote can operate within approximately 100 m from the vehicle. In the following environments or situations, the MiEV Remote may not transmit and receive radio waves correctly. As a result, the remote may not operate properly.
 - When the vehicle and the MiEV Remote are separated by a concrete wall.
 - When there is a metal wall between the vehicle and the MiEV Remote.
 - When the vehicle is surrounded by other tall vehicles.
 - When the vehicle and/or the MiEV Remote is near a facility emitting strong radio waves, such as a television tower, a transformer substation, a broadcasting station or an airport.
 - When other electrical equipment such as computers or cell-phones are placed near the MiEV Remote.
 - When the MiEV Remote touches something metallic, or is covered by a metal object.
 - When batteries for the MiEV Remote are weak.

- Melody and buzzer from the MiEV Remote can be turned on or off. Refer to “To turn on/off melody and buzzer” on page 1-24.
- The transmitter signal will reach further when the antenna of the MiEV Remote is fully extended and held upright.
- The onboard antenna is printed on the right side delta glass of the vehicle.
- When the MiEV Remote is not used for more than 30 seconds, the MiEV Remote will automatically turn off.
- Some charge facilities have a timer function which turns the power supply on and off automatically. When using a charge facility with this timer function, please adjust the charging time set by the MiEV Remote to be consistent with the timer used by of the charging facility.

MiEV Remote

E08301900019

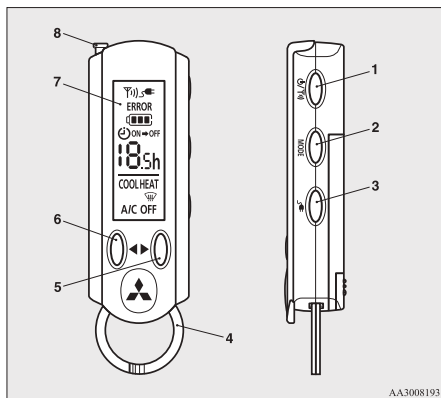

AA3008193

1. Power/communication switch

- When the MiEV Remote is off, the MiEV Remote can be activated by pressing the switch for 1 second or more.
- When the MiEV Remote is on, the MiEV Remote will communicate with the vehicle by pressing the switch for less than 1 second.
- When the MiEV Remote is on, the MiEV Remote can be turned off by pressing the switch for 3 seconds or more.

2. MODE switch

The display of the MiEV Remote is changed in the order of “ON timer”, “OFF timer” and “Remote Climate Control” by pressing this switch.

3. The manual charge switch ON timer, OFF timer and Remote Climate Control are canceled by pressing this switch.
4. Ring
5. UP switch
Preset time is increased by pressing this switch.
6. DOWN switch
Preset time is decreased by pressing this switch.
7. Display
8. Antenna

NOTE

- When you need additional MiEV Remotes, please contact your MITSUBISHI MOTORS Authorized Service Point. Up to four MiEV Remotes can be used per vehicle.

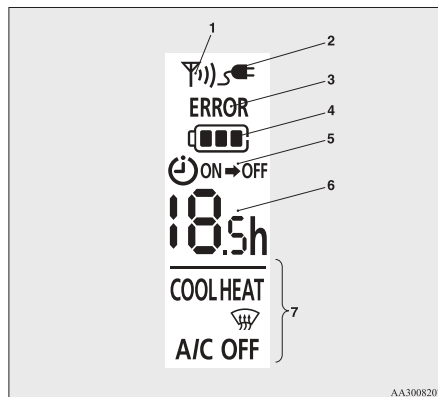

AA3008207



Display

- 1- The indicator blinks during communication with the vehicle.
If a communication error occurs, the indicator blinks rapidly.
- 2- The indicator lights up during charging. The indicator blinks when the manual charging button is pressed. The indicator will rapidly blink, if EV charging cable (regular charger) is not connected when the timer charging or Remote Climate Control is set.
- 3- When communicating with the vehicle, the MiEV Remote display blinks if a communication error occurs or the MiEV Remote is not functioning properly. If the buzzer sounds while this indicator blinks, a problem has been detected. Refer to “Actions to be taken when the system does not operate correctly” on page 1-26.

NOTE

- The buzzer can be turned off. Refer to “To turn on/off melody and buzzer” on page 1-24.
- 4- The indicator shows the charge status of the traction battery using dots. When the Remote Climate Control is set, the indicator  will blink if the traction battery is empty on charge.

NOTE

- The condition of the MiEV Remote’s battery is not displayed.
- 5-  ON: When this is shown, time set by ON timer is shown on 6.
 -  ON/OFF: When this is shown, time set by OFF timer is shown on 6.

Charging

- 6- Time set by ON timer or OFF timer is shown.
- 7- When the Remote Climate Control is set, the display lights up.
COOL: Pre-Cooling Mode
HEAT: Pre-Heating Mode
: Pre-Defroster Mode
A/C OFF: Remote Climate Control OFF

CAUTION

- Never leave the MiEV Remote in a place where it will be subject to high temperatures, such as in direct sunlight, or subject to extreme low temperatures. The MiEV Remote can be damaged and may not properly operate.
- Never drop or hit the MiEV Remote. Do not apply force to bend the antenna. These can cause damage to or failure of the remote.
- If the MiEV Remote gets wet, please wipe water off immediately. Water entering the MiEV Remote can cause a failure.

Timer Charging

E08302000017

The Timer Charging can be set as follows.

- ON timer: Time from the present to when charging will begin.
- OFF timer: Time from the start of charging to the end of charging

To set the timer, the following conditions must be met.

- Selector lever: "P" (PARK) position
- Electric motor switch: "LOCK" position

- EV charging cable (regular charger): Connected

WARNING

- Improper charging can result in fire, property damage, and serious injury or death. Before timer charging, carefully read and follow the instructions in "Basic knowledge for charging" on page 1-02 and "Regular charging (charging method with rated AC 220-240 V outlet)" on page 1-06.

NOTE

- Timer charging cannot be used with a quick charging system.

Example of Timer Charging

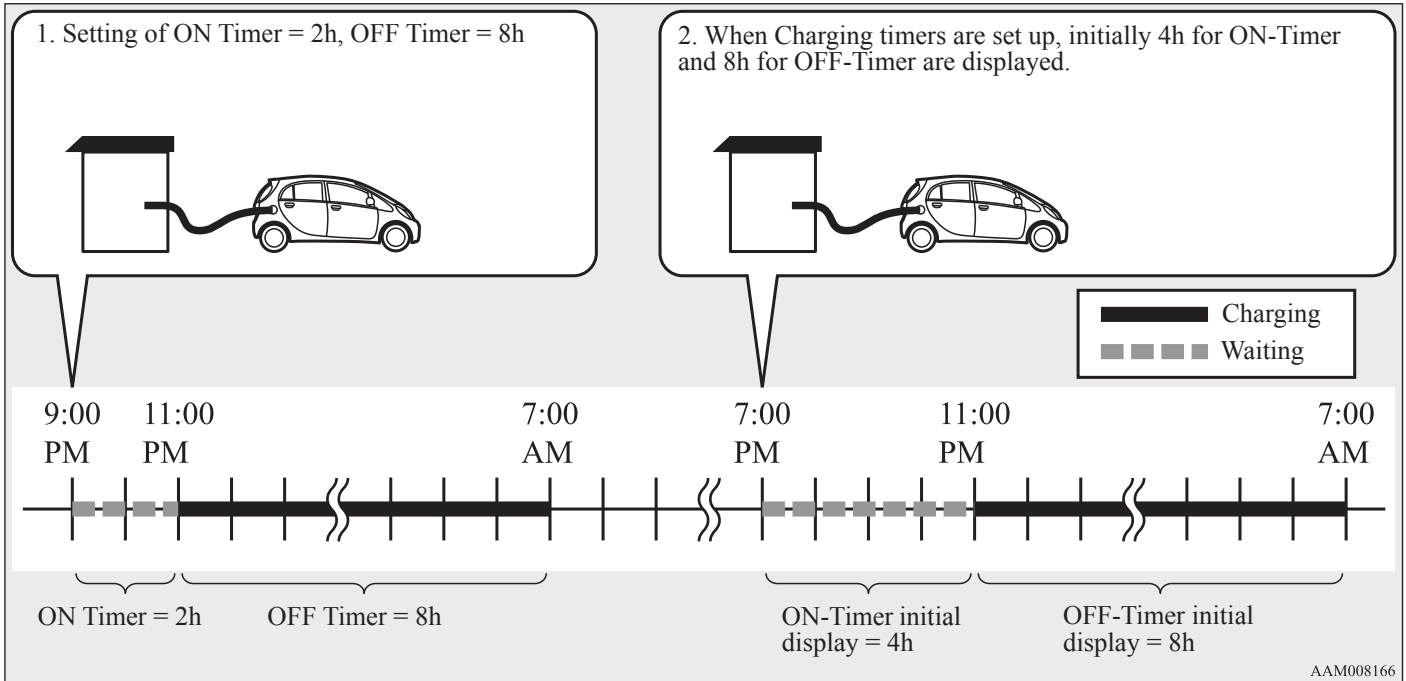

Charging

To turn the MiEV Remote ON/OFF

E08302200019

1. Extend the antenna (A) and press the power/communication switch (B) for 1 second or more to turn the MiEV Remote on. When it properly communicates with the vehicle, the vehicle information will be displayed on the screen.

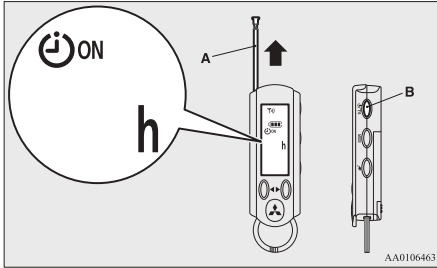

2. To turn the MiEV Remote off, press the power/communication switch (B) for 3 seconds or more and store the antenna (A).

To set the ON timer

E08302300010

1. Start the regular charging. Refer to “Regular charging (charging method with rated AC 220-240 V outlet)” on page 1-06.
2. Turn on the MiEV Remote. Refer to “To turn the MiEV Remote ON/OFF” on page 1-18.
3. Press the UP switch (C) or the DOWN switch (D) once. The time remaining from the present to the time that was previously set for the ON timer will be displayed and blink.

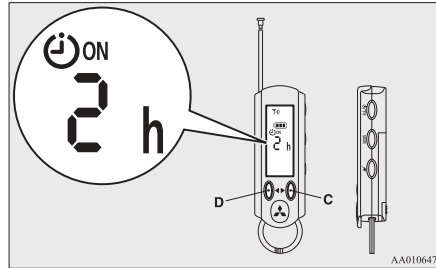

NOTE

- The remaining time for the last charging is displayed with blinking as follows.
Example: If you set the charging starting time to 11:00 PM of the day before:

Present time	Remaining time	Display
9:00 PM	2:00	2h
9:10 PM	1:50	2h
9:40 PM	1:20	1.5h

- If the MiEV Remote cannot communicate with the vehicle, the remaining time will not be displayed.
4. If you need to change the remaining time for the ON timer, press the UP switch (C) or the DOWN switch (D) to change the remaining time.

The remaining time can be changed within the range from 0 to 19.5 hours in half hour increments.

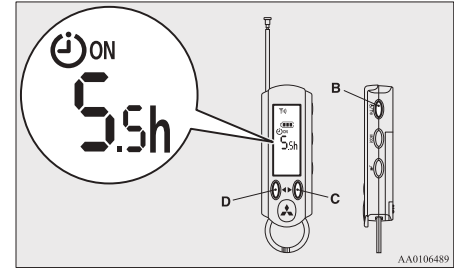

NOTE

- When you want to start the charging at the same time as last time, changing the remaining time is unnecessary.
- When the remaining time is set to 0h, the charging starts immediately after step 5.

5. Press the power/communication switch (B) for less than 1 second to send the setting data to the vehicle.

The MiEV Remote will sound melodies on transmission and reception.

NOTE

- The melodies can be turned off. Refer to “To turn on/off melody and buzzer” on page 1-24.

- If a communication error occurs or the MiEV Remote System is not functioning properly, the buzzer will sound. Refer to “Display of MiEV Remote during communicating with vehicle” on page 1-21.
 - If the OFF Timer is unset when setting the ON timer, the OFF timer will be automatically set with “fully charged”.
 - To set OFF Timer, refer to “To set OFF Timer” on page 1-20.
6. To turn off the MiEV Remote, refer to “To turn the MiEV Remote ON/OFF” on page 1-18.

NOTE

- The energy level gauge in the instrument panel on the vehicle will illuminate and the charging indicator will blink approximately 30 seconds after the vehicle has received the setting for the ON timer. After approximately 30 seconds, the energy level gauge and the charging indicator will

go off, and the vehicle will be prepared for the timer charging.

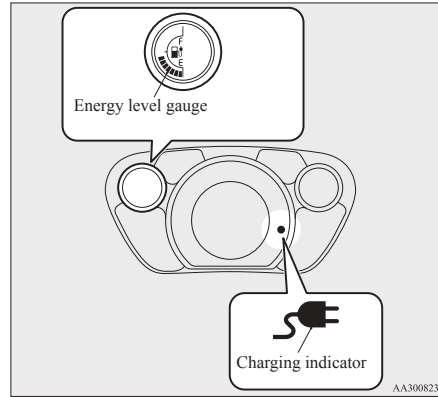

- Turning the electric motor switch to the “ON” position or the “ACC” position will cancel the timer charging.
- If the MODE switch is pressed while changing the ON timer setting, the change will be cancelled.
- The ⚡ symbol on the MiEV Remote will be illuminated while the vehicle is charging.
- If the charge connector is disconnected before the time set by the ON timer, the timer charging is not cancelled. If the charge connector is re-connected again before starting the charge or setting the charge timers, the timer charging will resume.

To start the charging immediately after the ON timer has been set

E08302400011

1. Turn on the MiEV Remote. Refer to “To turn the MiEV Remote ON/OFF” on page 1-18.
2. Press the UP switch (C) or the DOWN switch (D) once, and the remaining time from the present to the time set for the ON timer will be displayed and blink.

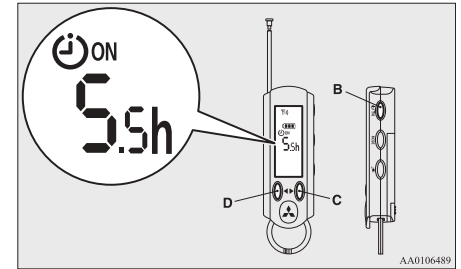

3. Change the remaining time to 0h by pressing the UP switch (C) or the DOWN switch (D).
4. Press the power/communication switch (B) for less than 1 second to send the setting data to the vehicle. The MiEV Remote will sound melodies on transmission and reception. The charging will start. Refer to “Regular charging (charging method with rated AC 220-240 V outlet)” on page 1-06.
5. Turn off the MiEV Remote. Refer to “To turn the MiEV Remote ON/OFF” on page 1-18.

Charging

To set OFF Timer

E08302500012

The OFF timer can be set during the regular charging or after setting the ON timer.

1. When the power of MiEV Remote is off, turn the power on. Refer to “To turn the MiEV Remote ON/OFF” on page 1-18.
2. Press the MODE switch (E) to change the display to the OFF timer (2).

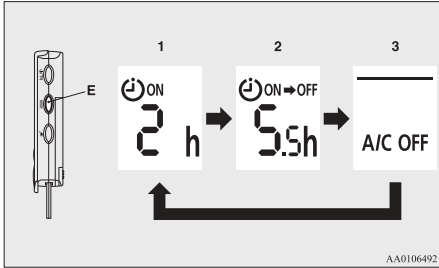

- 1- Shown the ON timer
- 2- Shown the OFF timer
- 3- Shown the Remote Climate Control

3. Press the UP switch (C) or the DOWN switch (D) once.

The time set last time for the OFF timer will be displayed and blink.

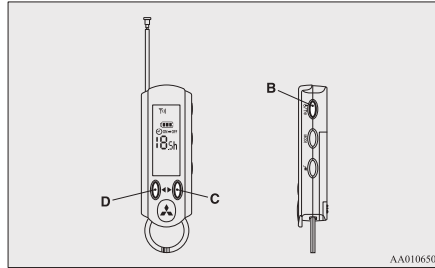

4. If you need to change the time for the OFF timer, press the UP switch (C) or the DOWN switch (D) to change the time.
 - The time can be changed within the range from 0.5h to 19.5h by half hour and can be changed to “-h”.
 - When “-h” is displayed, the charging will end when the traction battery is fully charged.

NOTE

- To display “-h”, press the UP switch (C) when 19.5h is displayed or press the DOWN switch (D) when 0.5h is displayed.

5. Press the power/communication switch (B) for less than 1 second to send the setting data to the vehicle.
The MiEV Remote will sound melodies on transmission and reception.

NOTE

- The melodies can be turned off. Refer to “To turn on/off melody and buzzer” on page 1-24.
 - If a communication error occurs or the MiEV Remote System is not functioning properly, the buzzer will sound. Refer to “Display of MiEV Remote during communicating with vehicle” on page 1-21.
 - If the ON timer is unset when setting the OFF timer, the ON timer will be automatically set with “0h”.
6. Turn off the MiEV Remote. Refer to “To turn the MiEV Remote ON/OFF” on page 1-18.

NOTE

- The energy level gauge in the instrument panel will illuminate and the charging indicator will blink approximately 30 seconds after the vehicle has received the setting for the OFF timer.
After approximately 30 seconds, the energy level gauge and the charging indicator will then go off, and the vehicle will be prepared

for timer charging in accordance with the ON/OFF setting.

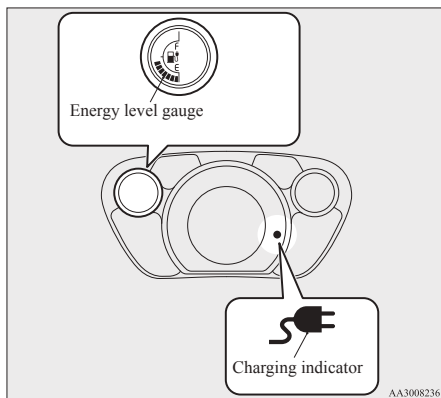

- The  symbol on the MiEV Remote illuminates while the traction battery is charging.
- The timer charging will be cancelled if the electric motor switch is turned to the “ON” or “ACC” position.
- Once the traction battery is fully charged, the charging will end even if this is before the time set by the OFF timer.
- If the charge connector is disconnected during charging, the OFF charging timer will be cancelled.

Display of MiEV Remote during communicating with vehicle

E08302600013

It communicates with the vehicle when the power of the MiEV Remote is turned on with pressing the power supply/communication switch (B) for 1 second or more and if the power supply/communication switch (B) is pressed for less than 1 second while the power of the MiEV Remote is on.

If the normal reception melody sounds after the transmitting melody, it is set completion.

Communication symbol (F) blinks while communicating with the vehicle.

If the buzzer sounds and the ERROR symbol (G) blinks, a problem is detected. Refer to “Actions to be taken when the system does not operate correctly” on page 1-26.

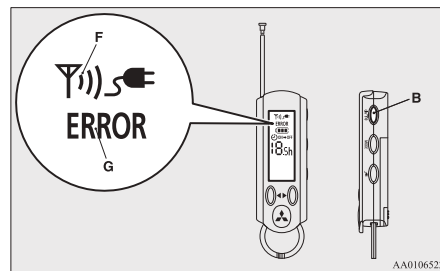

To cancel Timer Charging

E08302700014

There are two methods to cancel Timer Charging.

- By using the MiEV Remote
- By operating the electric motor switch on the vehicle

NOTE

- If the timer charging is cancelled during charging, the charging will continue until the traction battery is fully charged.
- If the timer charging is cancelled before charging starts, charging will start immediately and continue until the traction battery is fully charged.
- Timer charging cannot be cancelled by disconnecting the charge connector before the time set by the ON timer. The timer charging will resume when the charging connector is again connected to the vehicle.

A- By using the MiEV Remote

1. When the power of MiEV Remote is off, turn the power ON. Refer to “To turn the MiEV Remote ON/OFF” on page 1-18.
2. Press the manual charging switch (H), then press the power/communication switch (B) for less than 1 second.

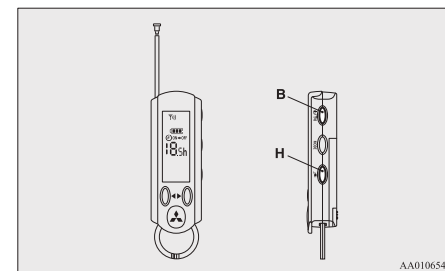

Charging

NOTE

- If the manual charging switch (H) is pressed, the  symbol of MiEV Remote will blink. The Remote Climate Control is also stopped.
 - 3. Cancelling timer charging is complete, and the MiEV Remote will sound two different melodies.
 - 4. Turn off the MiEV Remote. Refer to “To turn the MiEV Remote ON/OFF” on page 1-18.
- B- By operating the electric motor switch on the vehicle
Turn the electric motor switch to the “ACC” or “ON” position, then turn back to the “LOCK” position.
Cancelling the timer charging is now complete.

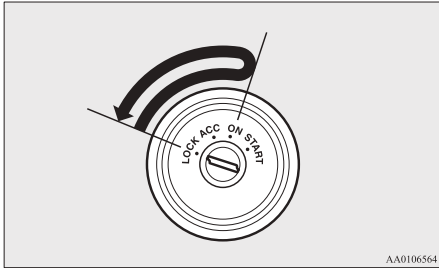

Remote Climate Control

E08302800015

WARNING

- **The Remote Climate Control, even when set, cannot be relied upon to maintain safe vehicle cabin temperatures while the vehicle is stopped or parked. Never leave children or persons requiring supervision/nursing unattended inside the vehicle. The temperature inside the vehicle could become extremely high or low resulting in a risk of heat stroke or hyperthermia that could result in death. In addition, children can activate switches and controls, resulting in injury or a fatal accident.**
- **While the Remote Climate Control is activated, keep away from the cooling fan under the bonnet, since the cooling fan may automatically operate even if the electric motor switch is in the “LOCK” position.**

NOTE

- The Remote Climate Control works regardless of the position of the air conditioning switch or dial on the vehicle. While the Remote Climate Control is activated, the air conditioning switch or dial on the vehicle will not affect operation of the cooler, heater or defroster.
- The Remote Climate Control will automatically stop 30 minutes after the Remote Climate Control has been set.

- The Remote Climate Control is operated by electric power supplied through the EV charging cable (regular charger).
- Under the following conditions, the effect of the Remote Climate Control can be decreased.
 - When the outside temperature is very high.
 - When the sunlight is strong.
 - When the outside temperature is very low.
- When the Remote Climate Control is activated while charging the traction battery, the time required to fully charge the traction battery will become longer or the amount of charge may decrease if the OFF timer has been set.
- While the Remote Climate Control is activated, if a heated seat switch is ON, the heated seat will operate.

To operate the Remote Climate Control

E08302900016

The following conditions must be met to operate the Remote Climate Control.

- Selector lever: P (PARK) position.
- Electric motor switch: LOCK position.
- EV charging cable (regular charger): Connected.
- Quick charging: Not used.
- Traction Battery Level Indicator: Shows one bar or more.
Refer to “Traction Battery Level Indicator” on page 1-24.
- All doors and the liftgate: Closed.

⚠ WARNING

- Improper charging can result in fire, property damage, and serious injury or death. Carefully read and follow instructions in “Basic knowledge for charging” on page 1-02 and “Charging method with rated AC 220-240 V outlet” on page 1-07.

1. Start charging. Refer to “Charging method with rated AC 220-240 V outlet” on page 1-07.
2. Turn on the MiEV Remote. Refer to “To turn the MiEV Remote ON/OFF” on page 1-18.
3. Press the MODE switch (E) to change the mode to Remote Climate Control (3).

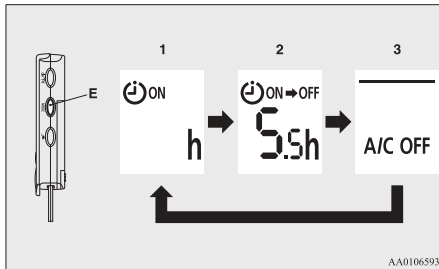

- 1- Shown the ON timer
 - 2- Shown the OFF timer
 - 3- Shown the Remote Climate Control
4. Select a desired mode by pressing UP switch (C) or DOWN switch (D).

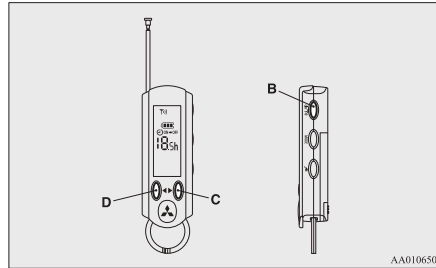

The modes will be changed in the order from 1 to 4 by pushing the UP switch.

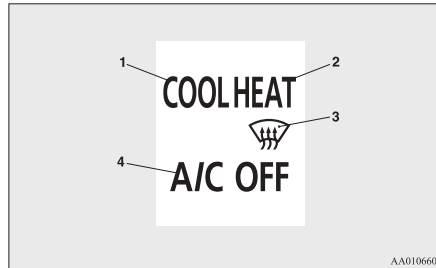

- 1- COOL: Pre-Cooling Mode
- 2- HEAT: Pre-Heating Mode
- 3- ❄️: Pre-Defroster Mode
- 4- A/C OFF: Remote Climate Control OFF

5. Press the power/communication switch (B) for less than 1 second to send the setting to the vehicle. The MiEV Remote will sound melodies on transmission and reception.

NOTE

- The melodies can be turned off. Refer to “To turn on/off melody and buzzer” on page 1-24.
 - If a communication error occurs or the MiEV Remote System is not functioning properly, the buzzer will sound. Refer to “Display of MiEV Remote during communicating with vehicle” on page 1-21.
6. Turn off the MiEV Remote. Refer to “To turn the MiEV Remote ON/OFF” on page 1-18.

To stop the Remote Climate Control

E0830300014

The Remote Climate Control can be stopped by either of the following methods.

- A- Send by MiEV Remote after pressing the manual charging switch.
- B- By using the MiEV Remote, select the A/C OFF mode and send the setting. Refer to “To operate the Remote Climate Control” on page 1-22.
- C- Turn the electric motor switch to the “ACC” or the “ON” position.
- D- Disconnect the regular charge connector from the vehicle.

NOTE

- The Remote Climate Control will not stop if the doors or liftgate are opened after the Remote Climate Control has started.

Charging

To turn on/off melody and buzzer

E08303100015

1. Turn on the MiEV Remote. Refer to “To turn the MiEV Remote ON/OFF” on page 1-18.
 - To turn off the sounds, press the UP switch (C) while pressing MODE switch (E).
 - To turn on the sounds, press the DOWN switch (D) while pressing MODE switch (E).

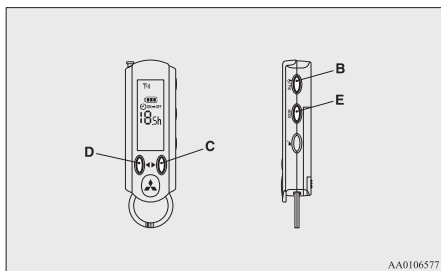

AA0106577

2. Turn off the MiEV Remote. Refer to “To turn the MiEV Remote ON/OFF” on page 1-18.

Traction Battery Level Indicator

E08303200016

The remaining energy in the traction battery can be checked using the MiEV Remote.

1. If the MiEV Remote has been turned off, turn on the MiEV Remote. Refer to “To turn the MiEV Remote ON/OFF” on page 1-18.
2. Current remaining energy in the traction battery is shown on the display while the MiEV Remote is ON.

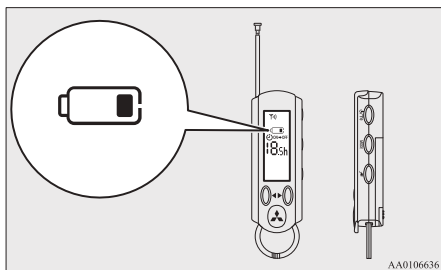

AA0106636

The remaining energy is shown by the number of segments displayed.

- 3 segments: Full or nearly full
- 2 segments: Moderate
- 1 segment: Low
- 0 segments: Empty or nearly empty

NOTE

- More than remaining quantity in the traction battery is necessary to operate the Remote Climate Control.

3. Turn off the MiEV Remote. Refer to “To turn the MiEV Remote ON/OFF” on page 1-18.

Replacement of batteries for the MiEV Remote

E08303300017

CAUTION

- MiEV Remote is a precision electronic device with a built-in signal transmitter. Do not disassemble or touch internal parts. Keep away from water or dust.
- Be careful not to break the tab on the battery cover when removing or installing the battery cover.

About the battery

E08303400018

Two coin type batteries are used. Replace if necessary to assure proper operation.

NOTE

- Standard battery life on the MiEV Remote is about 1 year. Battery life can vary depending on environmental and usage conditions.

To replace the batteries

E08303500019

1. Before replacing the batteries, remove static electricity from your body by touching a metal grounded object.

2. The battery cover (B) lifts when the slide portion (A) is moved to the direction indicated by the arrow.

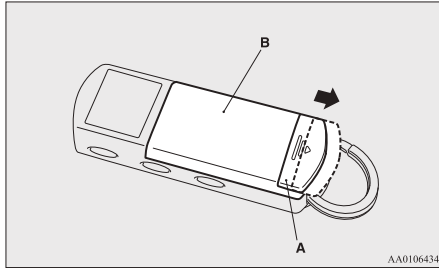

3. By moving the battery cover (B) in the direction indicated by the arrow, the tabs (C) on the battery cover will come out and the battery cover can be removed.

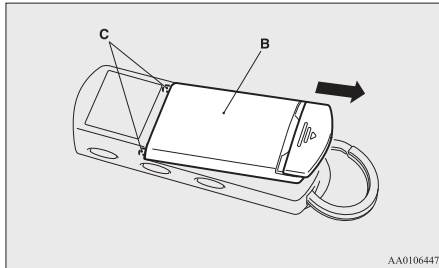

4. Remove the old batteries.

5. Install two new batteries (D) with the “+” side up.

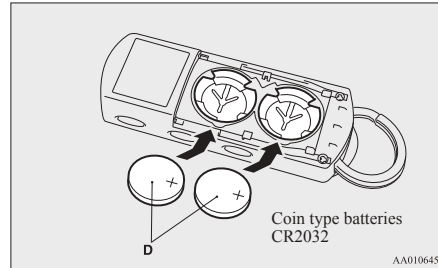

6. Attach the battery cover (A) in the reverse order from the way you have detached it.
7. Confirm the MiEV Remote can be turned ON. Refer to “To turn the MiEV Remote ON/OFF” on page 1-18.

NOTE

- Replace both batteries with new ones at the same time.
- If you prefer, you can have the batteries replaced by a MITSUBISHI MOTORS Authorized Service Point.

Charging

Actions to be taken when the system does not operate correctly



E08303600010

Take the following actions when the system does not operate correctly. If the system still does not operate correctly after the action(s) have been taken, a system component may not be working properly. Please consult a MITSUBISHI MOTORS Authorized Service Point to check it.

Phenomena		Cause	Remedy
1	Charging does not start when the regular charge connector is inserted.	“ON” timer has been set.	Cancel the “ON” timer.
		The regular charge connector is not locked completely.	Lock the regular charge connector securely.
		A household electrical outlet, which the EV charging cable is connected to, is shut down.(e.g. disconnected plug)	Turn on the household electrical outlet which the EV charging cable is connected to.
MiEV Remote does not operate normally.	MiEV Remote is not powered on.	Batteries in the MiEV Remote are defective.	Replace the batteries in the MiEV Remote. Refer to “Replacement of batteries for the MiEV Remote” on page 1-24.
	All indicators are off when the power supply/communication switch is pressed to make the system communicate.		
	Melody or buzzer does not sound.	Melody or buzzer has been disabled.	Enable the melody or buzzer. Refer to “To turn on/off melody and buzzer” on page 1-24.
The following symbol blinks when the power supply/communication switch on the MiEV Remote is pressed. ● ERROR symbol ●  symbol	Blinks after about 1 second.	<ul style="list-style-type: none"> ● Noise source is present in the vicinity of the MiEV Remote.(e.g. personal computer) ● Noise source is present between the vehicle and the MiEV Remote. 	Go away from the noise source.



Phenomena		Cause	Remedy
	Blinks after about 10 seconds.	Out of effective communication range around the vehicle.(e.g. too far away from the vehicle, or radio signal is interfered)	Move to the location where the system reaches the effective communication range.
		The electric motor switch is at the position other than "LOCK" position.	Turn the electric motor switch to the "LOCK" position.
		<ul style="list-style-type: none"> ● Noise source is present in the vicinity of the vehicle. ● Noise source is present between the vehicle and the MiEV Remote. 	Go away from the noise source.
		Auxiliary battery is discharged.	Charge or replace the auxiliary battery. Refer to "Emergency starting" on page 7-02, "Low voltage electrical system" on page 9-04.
		The MiEV Remote antenna is not extended.	Extend the MiEV Remote antenna to communicate.
The symbol below blinks when the power/communication switch on the MiEV Remote is pressed. ● ERROR symbol		The system is in processing.	Press the power/communication switch again.

Charging

Phenomena		Cause	Remedy
1 Timer charging is not possible.	After the power/communication switch is pressed, the following symbol blinks for several seconds. <ul style="list-style-type: none"> ● ERROR symbol ●  symbol 	Regular charge connector is not inserted or not locked completely.	Lock the regular charge connector securely.
		A household electrical outlet, to which the EV charging cable (regular charger) is connected, is shut down.(e.g. disconnected plug)	Turn on the household electrical outlet to which the EV charging cable (regular charger) is connected.
		An earth leakage circuit breaker at the household electrical outlet is working. Otherwise, the power supply at the household electrical outlet is cut off.	Check the earth leakage circuit breaker and the power supply cut.
		If the charging unit is equipped with the timer function, the power supply to the unit has been cut off.	Preset the timer charging while the charging unit with timer function is powered on.
	After the power/communication switch is pressed, the following symbol blinks for several seconds. <ul style="list-style-type: none"> ● ERROR symbol 	The selector lever is at the position other than P (PARK).	Set the selector lever to the “P” (PARK) position.
		Quick charging is in progress. (The  symbol illuminates.)	Terminate the quick charging, or wait until the quick charging completes.
		The temperature of the traction battery has exceeded about 60 °C.	Allow the temperature of the traction battery to reach normal operating temperature. Refer to “Cautions and actions to deal with intense heat” on page 06.
		The temperature of the traction battery has been under about -25 °C.	Allow the temperature of the traction battery to reach normal operating temperature. Refer to “Cautions and actions to deal with intense cold” on page 08.

Phenomena	Cause	Remedy
Timed charging is impossible.	Charging is preset, but the specified charging level is not satisfied. ● The charging level is not expected amount.	The timer is cancelled or the preset time is changed by using another MiEV Remote.
	● Is not charged.	The electric motor switch has been operated before the system is charged.
	● Is not charged at the preset time.	The temperature of the traction battery has exceeded about 60 °C.
		The temperature of the traction battery has been under about -25 °C.
		Timer charging is not preset correctly.
	Although the charging is preset, too much time is needed to charge the system fully.	The Remote Climate Control has been activated.
		Temperature of the traction battery is low.
	It is not fully charged.	If the charging unit is equipped with the timer function, the power supply to the unit has been cut off.
		Check whether another person has operated his or her MiEV Remote.
		Check whether the electric motor switch has been operated before the system is charged.
		Allow the temperature of the traction battery to reach normal operating temperature. Refer to “Cautions and actions to deal with intense heat” on page 06.
		Allow the temperature of the traction battery to reach normal operating temperature. Refer to “Cautions and actions to deal with intense cold” on page 08.
		Preset the timed charging again.
		Check whether the Remote Climate Control has been activated.
		Refer to “Cautions and actions to deal with intense cold” on page 08.
		Preset the timer charging while the charging unit with timer function is powered on.

Charging

Phenomena	Cause	Remedy
<p>The Remote Climate Control cannot be activated.</p>	<p>After the power/communication switch is pressed, the following symbol blinks for several seconds.</p> <ul style="list-style-type: none"> ● ERROR symbol ●  symbol 	<p>The regular charge connector is not inserted or it is not locked completely.</p>
	<p>A household electrical outlet, to which the EV charging cable (regular charge) is connected, is shut down.(e.g. disconnected plug)</p>	<p>Turn on the household electrical outlet to which the EV charging cable (regular charger) is connected.</p>
	<p>An earth leakage circuit breaker at the household electrical outlet is working. Otherwise, the power supply at the household electrical outlet is cut off.</p>	<p>Check the earth leakage circuit breaker and the power supply cut.</p>
	<p>If the charging unit is equipped with the timer function, the power supply to the unit has been cut off.</p>	<p>Preset the timer charging while the charging unit with timer function is powered on.</p>
	<p>After the power/communication switch is pressed, the following symbol blinks for several seconds.</p> <ul style="list-style-type: none"> ● ERROR symbol ●  symbol 	<p>The traction battery charging level is low.</p>

Phenomena		Cause	Remedy
The Remote Climate Control cannot be activated.	After the power/communication switch is pressed, the following symbol blinks for several seconds. ● ERROR symbol	Any of the doors or liftgate is open.	Close all the doors and liftgate.
		The selector lever is at the position other than P (PARK).	Set the selector lever to the “P” (PARK) position.
		Quick charging is in progress. (The  symbol will illuminate.)	Terminate the quick charging, or wait until the quick charging completes.
		The temperature of the traction battery has exceeded about 60 °C.	Allow the temperature of the traction battery to reach normal operating temperature. Refer to “Cautions and actions to deal with intense heat” on page 06.
		The temperature of the traction battery has been under about -25 °C.	Allow the temperature of the traction battery to reach normal operating temperature. Refer to “Cautions and actions to deal with intense cold” on page 08.
	The Remote Climate Control is not activated.	The electric motor switch has been operated before the system is charged.	Check whether the electric motor switch has been operated before the system is charged.
		The temperature of the traction battery has exceeded about 60 °C.	Allow the temperature of the traction battery to reach normal operating temperature. Refer to “Cautions and actions to deal with intense heat” on page 06.
The temperature of the traction battery has been under about -25 °C.		Allow the temperature of the traction battery to reach normal operating temperature. Refer to “Cautions and actions to deal with intense cold” on page 08.	
The Remote Climate Control cannot be activated.	The heated seat is not powered on.	The heated seat switch is turned off.	Turn on the heated seat switch.
	The heated seat becomes hot while the air conditioning (cooling) is activated.	The heated seat switch is turned on.	Turn off the heated seat switch.

Charging

Cleaning the MiEV Remote

E08303700011

1. Gently wipe with gauze or another soft cloth soaked with a 3 % aqueous solution of neutral detergent.
2. Wipe off all the detergent with a soft cloth dipped in fresh water and thoroughly wrung out.
3. Wipe all moisture off and dry in a shaded, well-ventilated area.

CAUTION

- **Never use benzine, petrol, or other organic solvents, or acid or alkaline solvents. Doing so could cause deformation, discolor, or malfunction. Also, these substances may be present in various cleaners, so check carefully before use.**

Locking and unlocking

Keys.....	2-02
Electronic immobilizer (Anti-theft starting system).....	2-02
Keyless entry system.....	2-03
Doors.....	2-05
Central door locks.....	2-06
“Child-protection” rear doors.....	2-07
Tailgate.....	2-08
Electric window control.....	2-09

Locking and unlocking

Keys

E00300102399

Two keys are provided. The key fits all locks. Keep one in a safe place as a spare key.

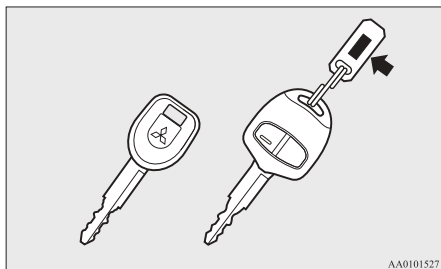

⚠ WARNING

- When taking a key on flights, do not press any switches on the key while on the plane. If a switch is pressed on the plane, the key emits electromagnetic waves, which could adversely affect the plane's flight operation. When carrying a key in a bag, be careful that no switches on the key can be easily pressed by mistake.

NOTE

- The key number is stamped on the tag as indicated in the illustration. Make a record of the key number and store the key and key number tag in separate places, so that you can order a key in the event the original keys are lost.

- The key is a precision electronic device with a built-in signal transmitter. Please observe the following in order to prevent malfunctioning.

- Do not leave the key anywhere where exposed to direct sunlight, for example on the dashboard.
 - Do not disassemble or modify.
 - Do not excessively bend the key or subject it to strong impacts.
 - Do not expose to water.
 - Keep away from magnetic key rings.
 - Keep away from audio systems, personal computers, TVs, and other equipment that generates a magnetic field.
 - Keep away from devices that emit strong electromagnetic waves, such as cellular phones, wireless devices and high frequency equipment (including medical devices).
 - Do not clean with ultrasonic cleaners or similar equipment.
 - Do not leave the key where it may be exposed to high temperature or high humidity.
- The electric motor unit is designed so that it will not start if the ID code registered in the immobilizer computer and the key's ID code do not match. Refer to the "Electronic immobilizer" section for details and key usage.

Electronic immobilizer (Anti-theft starting system)

E00300201928

The electronic immobilizer is designed to significantly reduce the possibility of vehicle theft. The purpose of the system is to immobilize the vehicle if an invalid start is attempted. A valid start attempt can only be achieved by using a key "registered" to the immobilizer system.

NOTE

- In the following cases, the vehicle may not be able to receive the registered ID code from the registered key and the electric motor unit may not start.
 - When the key contacts a key ring or other metallic or magnetic object (Type A)
 - When the key grip contacts metal of another key (Type B)

- When the key contacts or is close to other immobilizing keys (including keys of other vehicles) (Type C)

In cases like these, remove the object or additional key from the vehicle key and turn the key back to the “ACC” or “LOCK” position. Then try again to start the electric motor unit. If the electric motor unit does not start, we recommend you to contact your MITSUBISHI MOTORS Authorized Service Point.

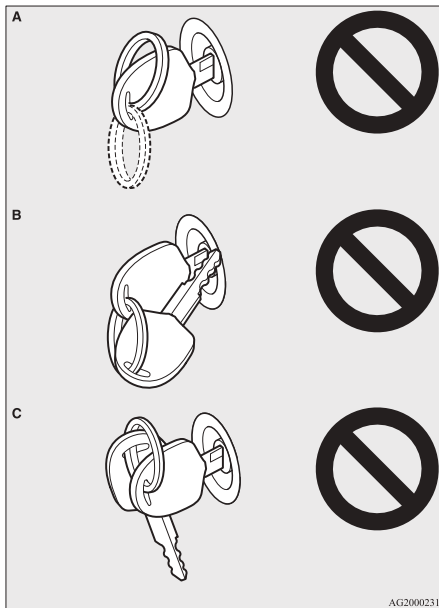

- Two keys are provided. If you lose one of them, order a key from your MITSUBISHI MOTORS Authorized Service Point as soon as possible. To obtain a replacement or extra spare key, take your vehicle and any remaining key to your MITSUBISHI MOTORS Authorized Service Point. All the keys have to be registered in the immobilizer computer unit. The immobilizer can register up to 8 different keys.

CAUTION

- Don't make any alterations or additions to the immobilizer system; alterations or additions could cause failure of the immobilizer.

Locking and unlocking

Keyless entry system

E00300302434

Press the remote control switch, and all doors and the tailgate will be locked or unlocked as desired.

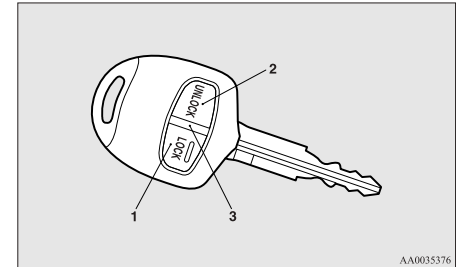

- 1- LOCK switch
- 2- UNLOCK switch
- 3- Indication lamp

To lock

Press the LOCK switch (1), and all doors and the tailgate will be locked. When they are locked with the room lamp at the middle (•) position or at the “DOOR” position, the room lamp and the turn-signal lamps blink once.

To unlock

Press the UNLOCK switch (2), and all doors and the tailgate will be unlocked. When unlocked with the room lamp at the (•) position or at the “DOOR” position, the room lamp will be turned on for approximately 15 seconds and the turn-signal lamps will blink twice.

Locking and unlocking

NOTE

- The indication lamp (3) comes on each time a switch is pressed.
- If the UNLOCK switch (2) is pressed and any of the doors or the tailgate is not opened within approximately 30 seconds, relocking will automatically occur.
- It is possible to modify functions as follows: For further information, please contact your MITSUBISHI MOTORS Authorized Service Point.
 - The time for automatic relocking can be changed.
 - The confirmation function (flashing of the turn-signal lamps) can be set to operate only when the doors and the tailgate are locked or only when the doors and the tailgate are unlocked.
 - The confirmation function (this indicates locking or unlocking of the doors and the tailgate with the flash of the turn-signal lamps) can be deactivated.
 - The number of times the turn-signal lamps are flashed by the confirmation function can be changed.
- The keyless entry system does not operate in the following conditions:
 - The key is left in the key cylinder.
 - The door or the tailgate is open.
- The remote control switch will operate within approximately 4 m from the vehicle. However, the operating range of the remote control switch may change if the vehicle is located near a power station, or radio/TV broadcasting station.
- If either of the following problems occurs, the battery may be exhausted.

- The remote control switch is operated at the correct distance from the vehicle, but the doors and the tailgate are not locked/unlocked in response.
- The indication lamp (3) is dim or does not come on.

For further information, please contact your MITSUBISHI MOTORS Authorized Service Point.

If you replace the battery yourself, refer to “Procedure for replacing the remote control switch battery” on page 2-04.

- If your remote control switch is lost or damaged, please contact your MITSUBISHI MOTORS Authorized Service Point for a replacement remote control switch.
- If you wish to add a remote control switch, we recommend you to contact a MITSUBISHI MOTORS Authorized Service Point.
A maximum of 4 remote control switches are available for your vehicle.

Operation of the outside rear-view mirrors

E00310800119

To fold

Within 30 seconds of locking the doors and the tailgate using the LOCK switch (1), press the LOCK switch twice rapidly to fold the outside rear-view mirrors.

To extend

Within 30 seconds of unlocking the doors and the tailgate using the UNLOCK switch (2), press the UNLOCK switch twice rapidly to return the outside rear-view mirrors to their extended positions.

Procedure for replacing the remote control switch battery

E00309500204

1. Before replacing the battery, remove static electricity from your body by touching a metal part such as doorknob of the room.
2. Remove the screw (A) from the remote control switch.

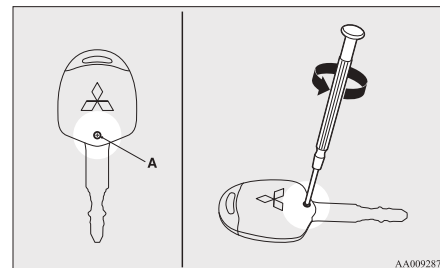

3. With the MITSUBISHI mark facing you, insert the clothcovered tip of a straight blade (or minus) screwdriver into the notch in the remote control switch case and use it to open the case.

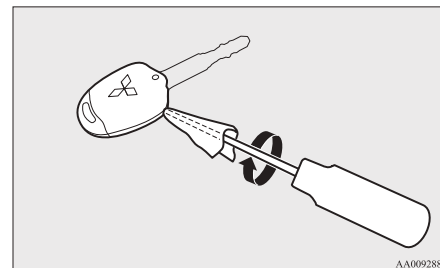

Doors

E00300402187

NOTE

- Be sure to perform the procedure with the MITSUBISHI mark facing you. If the MITSUBISHI mark is not facing you when you open the remote control switch case, the switches may come out.
4. Remove the remote control transmitter from the remote control switch case. Then, open the remote control transmitter using the method described in step 3.

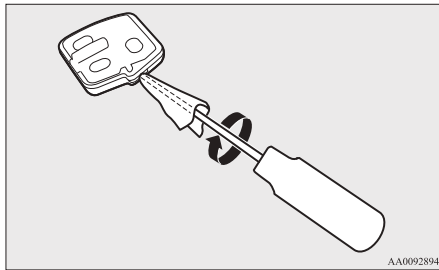

5. Remove the old battery.

6. Install a new battery with the + side (B) down.

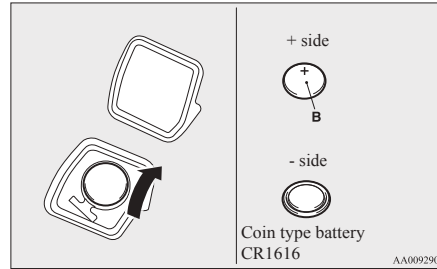

7. Close the remote control transmitter firmly.
8. Place the remote control transmitter in the remote control switch case, then securely close the remote control switch case.
9. Attach the screw (A) removed in step 2.
10. Check the keyless entry system to see that it works.

NOTE

- You may purchase a replacement battery at an electric appliance store.
- A MITSUBISHI MOTORS Authorized Service Point can replace the battery for you if you prefer.

CAUTION

- When the remote control switch case is opened, be careful to keep water, dust, etc. out. Also, do not touch the internal components.

CAUTION

- Make sure the doors are closed: driving with doors not completely closed is dangerous.
- Never leave children in the vehicle unattended.
- Be careful not to lock the doors while the key is inside the vehicle.

NOTE

- To prevent the key from being locked inside the vehicle, neither the lock knob on the driver's door nor the key can be used to lock the driver's door when it is open.

To lock or unlock with the key

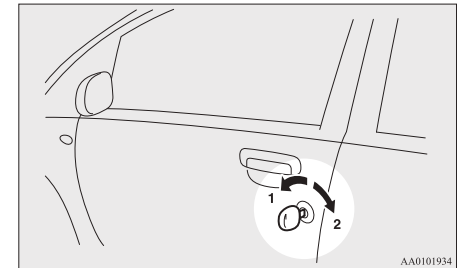

- 1- Lock
2- Unlock

Locking and unlocking

To lock or unlock from inside the vehicle

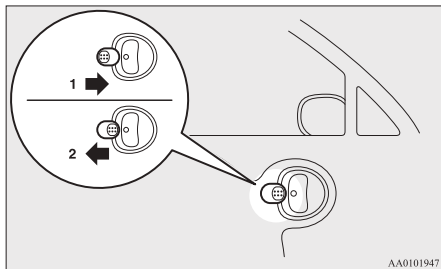

- 1- Lock
- 2- Unlock

Pull the inside door handle towards you to open the door.

NOTE

- The driver's door can be opened without using the lock knob by pulling on the inside door handle. Also, all other doors and the tailgate are unlocked at the same time.

To lock without using the key

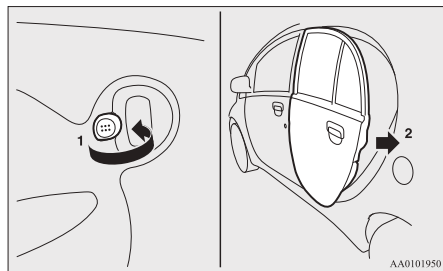

Set the inside lock knob (1) to the locked position, and close the door (2).

NOTE

- The driver's door cannot be locked using the inside lock knob while the driver's door is opened.

Central door locks

E00300801852

NOTE

- Each of the doors can be locked or unlocked independently by using the inside lock knob.
- Repeated continuous operation between lock and unlock could activate the central door locking systems built-in protection circuit and prevent the system from operating. If this occurs, wait about 1 minute before operating the inside lock knob or the key.

Driver's door with key

Using the key on the driver's door locks or unlocks all doors and the tailgate.

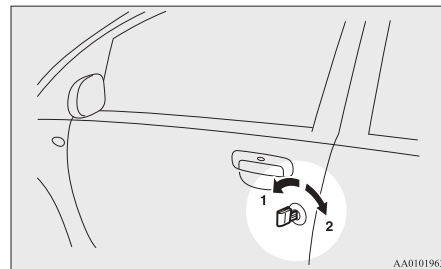

- 1- Lock
- 2- Unlock

Driver's door with inside lock knob

Using the inside lock knob on the driver's door locks or unlocks all doors and the tailgate.

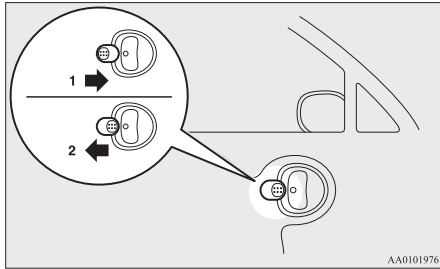

- 1- Lock
- 2- Unlock

Unlocking doors using selector lever

It is possible to unlock all doors and the tailgate using the selector lever by placing it in the "P" position while the electric motor switch is in the "ON" position.

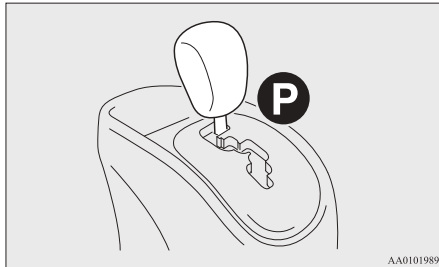

NOTE

- The vehicle is shipped from the factory with a setting established such that the doors and the tailgate are not unlocked when the selector lever is placed in the "P" position with the electric motor switch in the "ON" position. If you wish to change the setting such that the doors and the tailgate are unlocked, contact your MITSUBISHI MOTORS Authorized Service Point.

"Child-protection" rear doors

E0030091026

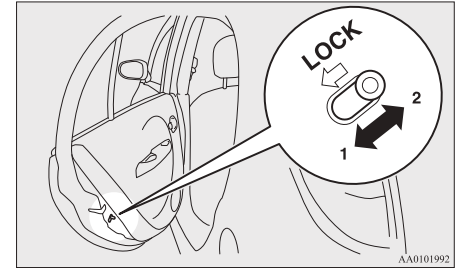

- 1- Lock
- 2- Unlock

Child protection helps prevent the rear doors from being opened accidentally from the inside.

If the lever is set to the locked position, the rear door cannot be opened using the inside handle, but only with the outside handle.

If the lever is set to the "Unlock" position, the child protection mechanism does not function.

CAUTION

- When driving with a child in the rear seat, please use the child protection to prevent accidental door opening which may cause an accident.

Locking and unlocking

Tailgate

E00301401161

WARNING

- When opening and closing the tailgate, make sure that there are no people nearby and be careful not to hit your head or pinch your hands, neck, etc.

To open

After unlocking the tailgate, push the switch (A) and pull up the tailgate.

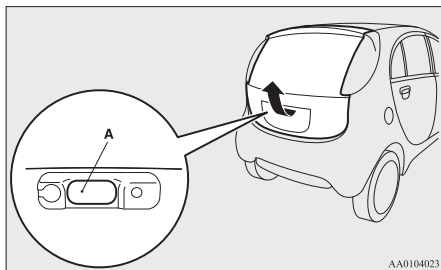

AA0104023

NOTE

- If you do not open the tailgate immediately after pulling the handle, the tailgate cannot be lifted. If this happens, pull the handle again and lift the tailgate.
- The tailgate cannot be opened when the battery is flat or disconnected.

To close

Pull the tailgate grip (A) downward as illustrated. Gently push the upper gate from the outside with enough force so that it is completely closed. Always ensure the tailgate is securely closed.

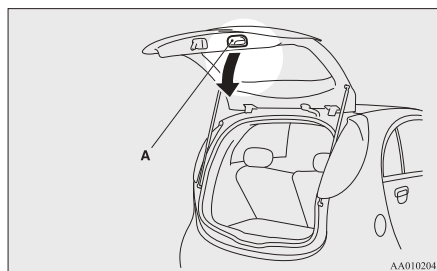

AA0102045

CAUTION

- When closing the tailgate, always ensure your or other person's fingers cannot be caught by the tailgate.

NOTE

- Gas struts (B) are installed to support the tailgate.
To prevent damage or faulty operation.
 - Do not hold the gas struts when closing the tailgate.
 - Also, do not push or pull the gas struts.
 - Do not attach any plastic material, tape, etc., to the gas struts.
 - Do not tie string, etc., around the gas struts.
 - Do not hang any object on the gas struts.

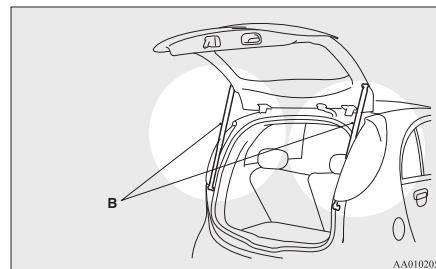

AA0102058

Electric window control

E00302200550

The electric windows can only be operated with the electric motor switch in the “ON” position.

⚠ WARNING

- Before operating the electric window control, make sure that nothing can get trapped (head, hand, finger, etc.).
- Never leave the vehicle without removing the key.
- Never leave a child (or other person who might not be capable of safe operation of the electric window control) in the vehicle alone.
- The child may tamper with the switch at the risk of its hands or head being trapped in the window.

Electric window control switch

E00302301705

Each window opens or closes while the corresponding switch is operated.

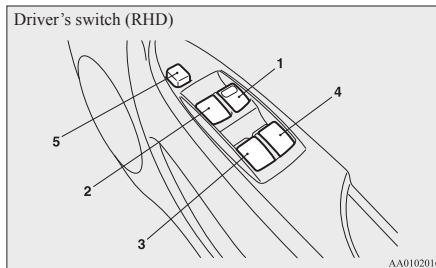
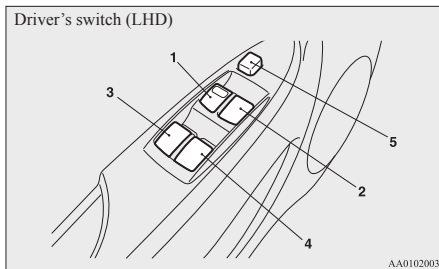

- 1- Driver's door window
- 2- Front passenger's door window
- 3- Rear left door window
- 4- Rear right door window
- 5- Lock switch

Driver's switches

The driver's switches can be used to operate all door windows.

A window can be opened or closed by operating the corresponding switch.

Press the switch down to open the window, and pull up the switch to close it.

If the switch for the driver's door window is fully pressed down, the door window automatically opens completely.

If you want to stop the door window movement, pull up the switch.

Passenger's switches

The passenger's switches can be used to operate the corresponding passenger's door windows.

Locking and unlocking

Press the switch down for opening the door window, and pull up the switch for closing.

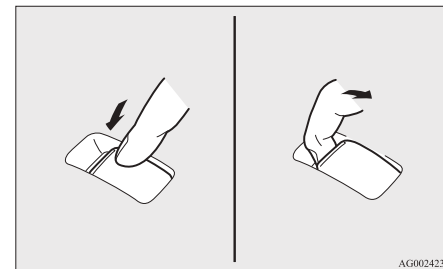

NOTE

- Repeated operation with the electric motor unit stopped will run down the battery. Operate the window switches only while the electric motor unit is running.

Lock switch

E00303101188

When this switch is operated, the passenger's switches cannot be used to open or close the windows and the driver's switch cannot open or close any windows other than the driver's window.

Locking and unlocking

To unlock, press it once again.

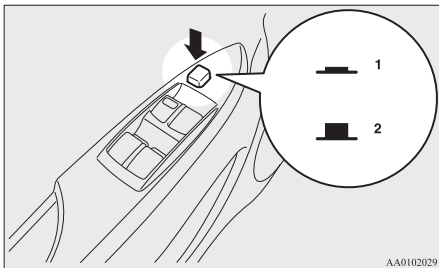

- 1- Lock
- 2- Unlock

⚠ *WARNING*

- A child may tamper with the switch at the risk of its hands or head being trapped in the window. When driving with a child in the vehicle, please press the window lock switch to disable the passenger's switches.

Timer function

E00302400927

The door windows can be opened or closed for 30 seconds after the electric motor switch is turned from the "ON" position to the "ACC" or "LOCK" position.

However, once the driver's door or the front passenger's door is opened, the windows cannot be operated.

Seat and seat belts

Seat.....	3-02
Seat adjustment.....	3-03
Front seat.....	3-03
Rear seat*.....	3-05
Head restraints.....	3-07
Seat belts.....	3-08
Pregnant women restraint.....	3-10
Seat belt pretensioner system and force limiter system.....	3-11
Child restraint.....	3-11
Seat belt inspection.....	3-20
Supplemental restraint system (SRS) - airbag.....	3-20

Seat

E00400101960

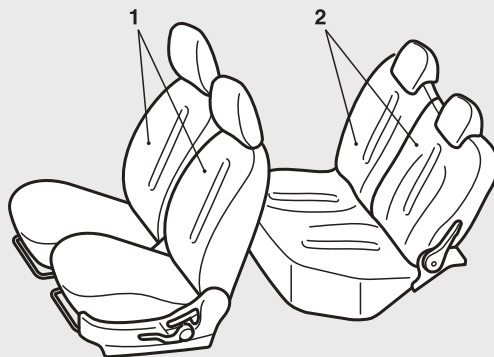

AA1008030

1-Front seat

- To adjust forward or backward → p. 3-03
- To recline the seatback → p. 3-04
- To adjust seat height (driver's seat only) → p. 3-04
- Heated seat → p. 3-04

2-Rear seat*

- To recline the seatback → p. 3-05
- Folding the seatbacks forward → p. 3-06

Seat adjustment

E00400300633

Adjust the driver's seat so that you are comfortable and that you can reach the pedals, steering wheel, switches etc. while retaining a clear field of vision.

⚠ WARNING

- Do not attempt to adjust the seat while driving. This can cause loss of vehicle control and result in an accident. After adjustments are made, ensure the seating is locked in position by attempting to move the seat forward and rearward without using the adjusting mechanism.
- Do not allow people or children to ride in any area of your vehicle that is not equipped with seats and seat belts, and make sure that everyone travelling in your vehicle is in a seat and wearing a seat belt, or in the case of a child is strapped in a child restraint.
- To minimize the risk of personal injury in the event of a collision or sudden braking, the seatbacks should always be in the almost upright position while the vehicle is in motion. The protection provided by the seat belts may be reduced significantly when the seatback is reclined. There is greater risk that the passenger will slide under the seat belt, resulting in serious injury, when the seatback is reclined.

⚠ CAUTION

- Make sure the seat is adjusted by an adult or with adult supervision for correct and safe operation.
- Do not place a cushion or the like between your back and the seatback while driving. The effectiveness of the head restraints will be reduced in the event of an accident.
- When sliding the seats, be careful not to catch your hand or foot.

Front seat

E00400400197

To adjust forward or backward

E00400500794

Pull the seat adjusting lever and adjust the seat forward or backward to the desired position, and release the adjusting lever.

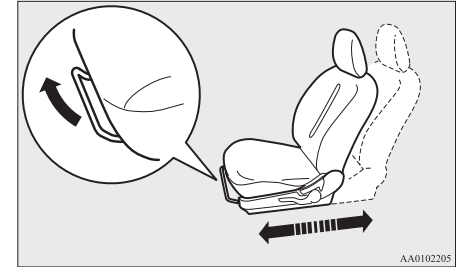

AA0102205

⚠ WARNING

- To ensure the seat is locked securely, try to move the seat forward or backward without using the adjusting lever.

Seat and seat belts

To recline the seatback

E00400601008

In order to recline the seatback, lean forward slightly, pull the seatback lock lever up, and then lean backward to the desired position and release the lever. The seatback will lock in that position.

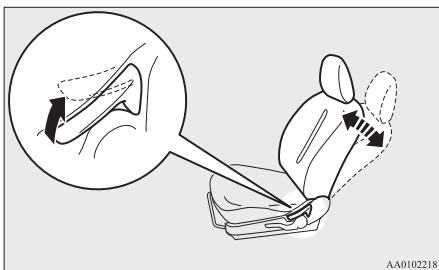

⚠ CAUTION

- The reclining mechanism of the seatback is spring loaded, causing it to return to the vertical position when the lock lever is operated. When using the lever, sit close to the seatback or hold it with your hand to control its return motion.

To adjust seat height (driver's seat only)

E00400701054

To adjust the seat height, operate the lever repeatedly.

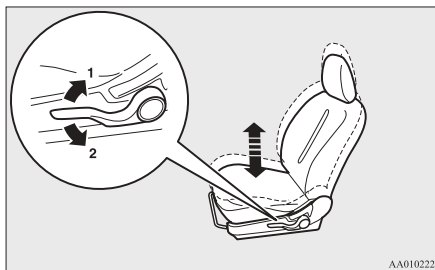

- 1- Raise
- 2- Lower

Heated seat

E00401101071

The heated seat can be operated with the electric motor switch in the "ON" position. Operate the switch as indicated by arrows. The heated seat switch (A) is for the driver's seat and the switch (B) is for the passenger's seat. The indication lamp (C) will illuminate while the heater is on.

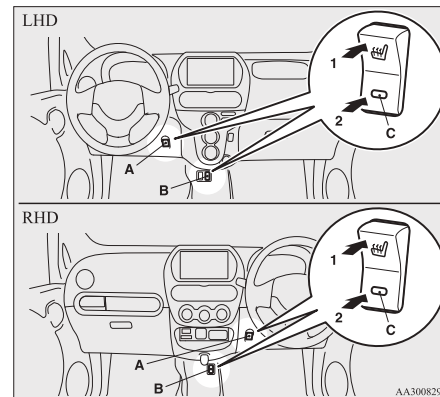

- 1- Heater on.
- 2- Heater off.

⚠ CAUTION

- Switch off the seat heater when not in use.
- Continuous use while the ready indicator is not illuminated can cause the auxiliary battery to run down.
- If the following types of persons use the heated seat, they might become too hot or

CAUTION

receive minor burns (red skin, heat blisters, etc.):

- Elderly or ill people
- People with sensitive skin
- Excessively tired people
- People under the influence of sleep inducing medication, etc.
- Do not place heavy objects on the seat or stick pins, needles, or other pointed objects into it.
- Do not use a blanket, cushion, or other material with high heat insulation properties on the seat while using the heater; this might cause the heater element to overheat
- Do not use benzine, kerosene, petrol, alcohol or other organic solvents when cleaning the seat. Doing so could damage not only the seat cover, but also the heater element.
- If water or any other liquid is spilled on the seat, allow it to dry thoroughly before attempting to use the heater.
- Turn the heater off immediately if it appears to be malfunctioning during use.

*Rear seat**

E00401300425

WARNING

- When a person sits in the rear seat, pull up the head restraint to a height at which it locks in position. Be sure to make this adjustment before starting to drive. Serious injuries could otherwise be suffered as the result of an impact. Refer to “Head restraints” on page 3-07.

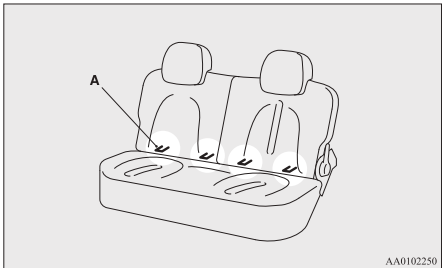
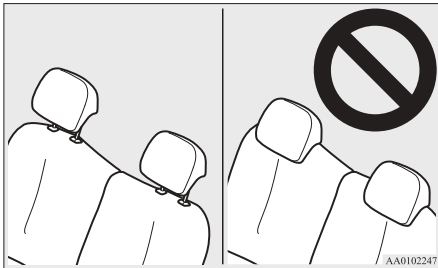

AA0102250

To recline the seatback

E00401500254

In order to recline the seatback, lean forward slightly, pull the lever, and then lean backward to the desired position and release the lever. The seatback will lock in that position.

3

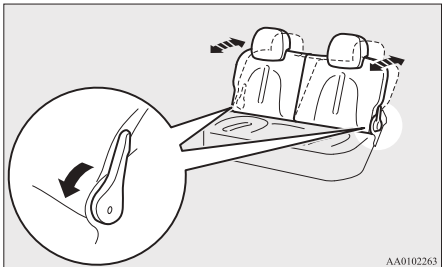

AA0102263

CAUTION

- Child restraint lower anchorages (A) are provided between the seat cushion and the seatback. Be careful that the lower anchorages may be hot due to heat of the electric motor unit room.

NOTE

- It is possible to adjust the seatback angle independently on each side.

Seat and seat belts

Folding the seatbacks forward

E00401600330

Larger objects can be loaded into the vehicle if a seatback is folded forward.

⚠ CAUTION

- Do not stack luggage in the vehicle higher than the seatback height. Also, firmly secure the luggage. Serious accidents could result due to unrestrained objects entering the passenger compartment during sudden braking.

3

To fold

Pull the lever, and fold the rear seatbacks forward.

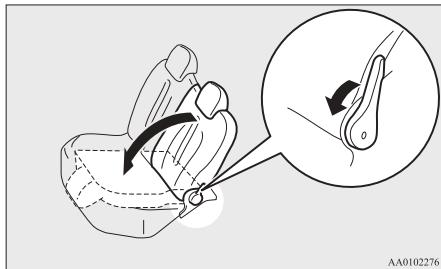

NOTE

- Do not operate the lever in the wrong direction. Doing so could damage the lever and make it impossible to operate the seatback.

To replace

1. Raise the seatback until it locks securely into place.
2. Push lightly on the seatback to confirm that it has actually been secured.

Rear seat cushion

E00401900173

The rear seat cushion can be removed. It is removed when the tyre repair kit stored under the seat cushion is taken out. Use this function when putting the seat covers on, etc.

To remove

1. Pull the seat stoppers (A) to unlock the seat cushion (B).
2. Lift up the seat cushion and pull it towards you to remove it.

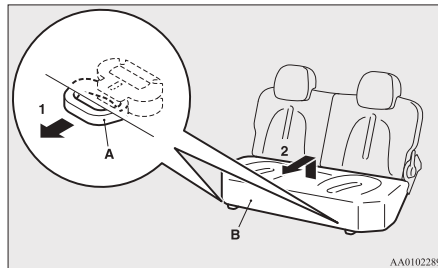

To install

1. Place the seat belt's buckles on top of the seat cushion.

2. Pushing the seat cushion as far back as possible, press the hooks (A) on the underside of the seat cushion into the right and left stopper installation holes (B) until a click is heard.

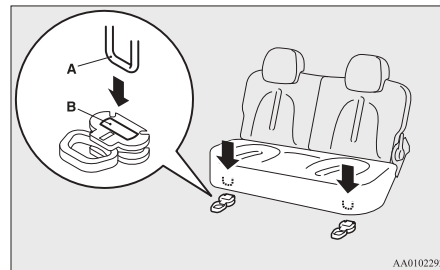

3. After installing the seat cushion, shake it lightly to check that it is properly fixed in position.

Head restraints

E00403301497

⚠ WARNING

- Driving without the head restraints in place can cause you and your passengers serious injury or death in an accident. To reduce the risk of injury in an accident, always make sure the head restraints are installed and properly positioned when the seat is occupied.
- Never place a cushion or similar device on the seatback. This can adversely affect head restraint performance by increasing the distance between your head and the restraint.

To adjust height

Adjust the head restraint height so that the centre of the head restraint is as close as possible to eye level to reduce the chances of injury in the event of collision. Any person too tall for the head restraint to reach their seated eye level, should adjust the restraint as high as possible.

To raise the head restraint, move it upward. To lower the restraint, move it downward while pushing the height adjusting knob (A) in the direction of the arrow. After adjustment, push the head restraint downward and make sure that it is locked.

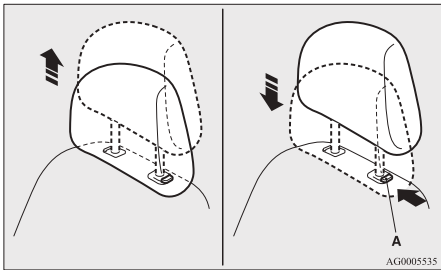

To remove

Lift the head restraint with the height adjusting knob (A) pushed in.

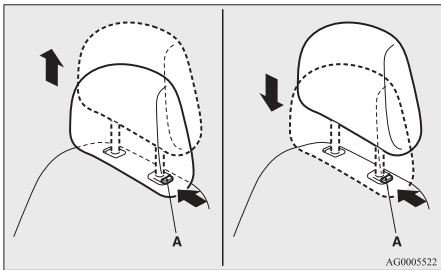

Installation

Confirm that they are facing the correct direction, and then insert them into the seatback while pressing the height adjusting knob (A) in the direction indicated by the arrow.

⚠ CAUTION

- Confirm that the height adjusting knob (A) is correctly adjusted as shown in the illustration, and also lift the head restraints to ensure that they do not come out of the seatback.

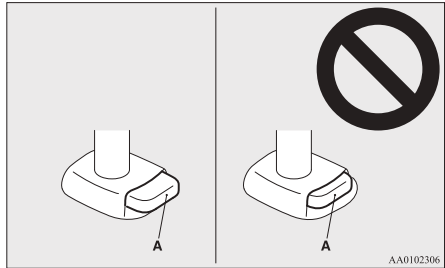

⚠ CAUTION

- The head restraints for the seats differ in shape and size. When installing head restraints, make sure the head restraints are fitted in their respective seats and do not install the head restraints in the wrong direction.

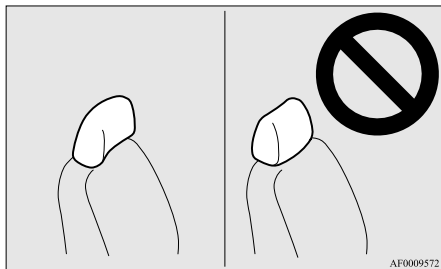

Seat belts

E00404800636

To protect you and your passengers in the event of an accident, it is most important that the seat belts be worn correctly while driving.

The front seat belts have a pretensioner system. These belts are used the same way as a conventional seat belt.

Refer to “Seat belt pretensioner system and force limiter system” on page 3-11

⚠ WARNING

- Always place the shoulder belt over your shoulder and across your chest. Never put it behind you or under your arm.
- One seat belt should be used by only one person. Doing otherwise can be dangerous.
- The seat belt will provide its wearer with maximum protection if the recliner seatback is placed in fully upright position. When the seatback is reclined, there is greater risk that the passenger will slide under the belt, especially in a forward impact accident, and may be injured by the belt or by striking the instrument panel or seatbacks.
- Seat belts should always be worn by every adult who drives or rides in this vehicle, and by all children who are tall enough to wear seat belts properly. Other children should always use proper child restraint systems.
- Remove any twists when using the belt.

⚠ WARNING

- No modifications or additions should be made by the user which will either prevent the seat belt adjusting devices from operating to remove slack, or prevent the seat belt assembly from being adjusted to remove slack.
- Never hold a child in your arms or on your lap when riding in this vehicle, even if you are wearing your seat belt. To do so risks severe or fatal injury to the child in a collision or sudden stop.
- Always adjust the belt to a snug fit.
- Always wear the lap portion of the belt over your hips.



3-point type seat belt (with emergency locking mechanism)*

E00404901504

This type of belt requires no length adjustment. Once worn, the belt adjusts itself to the movement of the wearer, but in the event of a sudden or strong shock, the belt automatically locks to hold the wearer's body.

NOTE

- You can check if the belt locks by pulling it forward quickly.

To fasten

1. Pull the seat belt out slowly while holding the latch plate.

NOTE

- When the seat belts cannot be pulled out in a locked condition, pull the belts once forcefully and then return them. After that, pull the belts out slowly once again.

2. Insert the latch plate into the buckle until a “click” is heard.

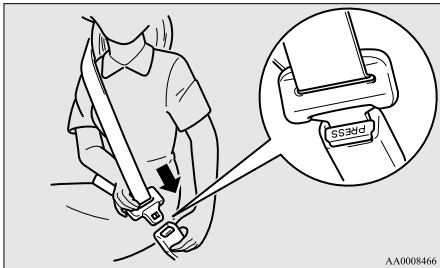

⚠ WARNING

- Never wear the lap portion of the belt across your abdomen. During accidents it can press sharply against the abdomen and increase the risk of injury.

⚠ WARNING

- The seat belts must not be twisted when worn.

3. Pull the belt slightly to adjust slackness as desired.

To unfasten

Hold the latch plate and push the button on the buckle.

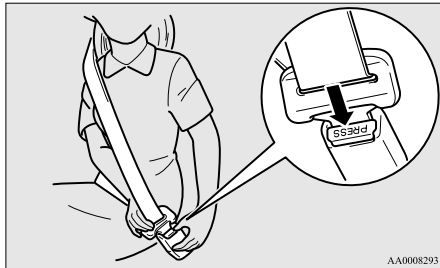

NOTE

- As the belt retracts automatically, keep holding the latch plate while retracting so that the belt stows slowly. Failure to do this could damage the vehicle.

Seat belt warning

Driver's and front passenger's seat belt reminder/warning lamp

The driver's and front passenger's seat belt warning lamp is located on the instrument panel.

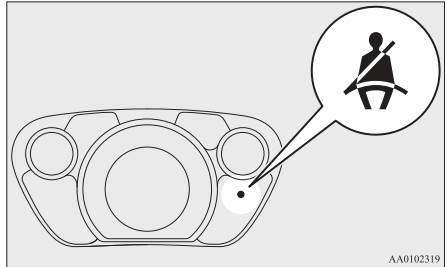

When the electric motor switch is turned to the “ON” position, if a driver or a front passenger has not fastened the seat belt, the warning lamp will illuminate.

Having passed approximately 1 minute since the electric motor switch is turned to the “ON” position, if the seat belt remains unfastened when the vehicle is driven, the warning lamp will flash and the tone will sound intermittently for approximately 90 seconds.

If the seat belt subsequently remains unfastened, the warning lamp and tone will issue further warnings each time the vehicle starts moving from a stop. And if the passenger unfastens the seat belt while driving, the warning will operate in the same way.

When the seat belt is fastened, the warnings will stop.

Seat and seat belts

NOTE

- For the front passenger seat, the warning function works only while a person is sitting on the seat.
- When luggage is placed on the front passenger seat, a sensor in the seat cushion may, depending on the weight and position of the luggage, cause the warning tone to sound and the warning lamp to come on.

*Rear passenger's seat belt warning lamps**

E00414900021

The rear passenger's seat belt warning lamps are located on the instrument panel.

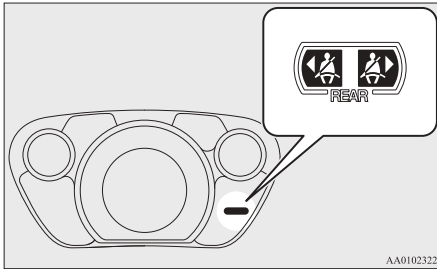

If the electric motor switch is turned to the “ON” position while a seat belt is not fastened, the warning lamp comes on for approximately 30 seconds to remind the rear passenger to fasten the seat belt. If the vehicle is driven with the seat belt still unfastened, the warning lamp comes on for approximately another 30 seconds. (This illumination happens only the first time the vehicle starts moving with the seat belt still unfastened.)

The warning lamp goes off when the seat belt is fastened.

NOTE

- The warning lamps come on even if no one is sitting on the rear seat.
- If a seat belt is unfastened while the vehicle is being driven, the tone sounds for approximately 1 second and the warning lamp comes on for approximately 30 seconds.
- If the seat belts are initially fastened but a seat belt is unfastened while the vehicle is stationary and the vehicle is then driven with the seat belt still unfastened, the warning lamp comes on again for approximately 30 seconds.

Pregnant women restraint

E00405600077

⚠ WARNING

- **Seat belts work for everyone, including pregnant women. Pregnant women should use the available seat belts. This will reduce the likelihood of injury to both the woman and the unborn child. The lap belt should be worn across the thighs and as snug against the hips as possible, but not across the waist. Consult your doctor if you have any additional questions or concerns.**

Seat belt pretensioner system and force limiter system

E00405700166

The driver's seat and front passenger's seat each have a seat belt equipped with a pretensioner system.

Pretensioner system

E00405801164

The pretensioner system will retract its respective seat belts instantaneously, thus maximizing the seat belt's effectiveness, if there is a frontal impact severe enough to injure the driver and/or front passenger and the electric motor switch is in the "ON" or "START" position.

WARNING

- To obtain the best results from your pretensioner seat belt, make sure you have adjusted your seat correctly and wear your seat belt properly.

CAUTION

- Installation of audio equipment or repairs in the vicinity of the pretensioner seat belts or floor console must be performed in line with MITSUBISHI MOTORS guidelines. It is important to do so because the work could affect the pretensioner systems.

CAUTION

- If you need to scrap the vehicle, please consult a MITSUBISHI MOTORS Authorized Service Point. It is important to do so because unexpected activation of the pretensioner seat belts could cause injuries.

NOTE

- The pretensioner seat belts will be activated if the vehicle suffers a severe frontal impact, even if the seat belts are not worn.
- The pretensioner seat belts are designed to work only once. After the pretensioner seat belts have been activated, we recommend you have them replaced by a MITSUBISHI MOTORS Authorized Service Point.

SRS warning lamp

E00405900315

This warning lamp is shared by the SRS airbags and the pretensioner seat belts. Refer to "SRS warning lamp" on page 3-29.

Force limiter system

E00406000209

In the event of a collision, each force limiter system will effectively absorb the load applied to the seat belt to minimize the impact to the passenger.

Child restraint

E00406401747

When transporting children in your vehicle, some type of child restraint system should always be used according to the size of the child. This is required by law in most countries.

The regulations concerning driving with children in the front seat may differ from country to country. You are advised to comply with the relevant regulations.

WARNING

- When possible, put children in the rear seat. Accident statistics indicate that children of all sizes and ages are safer when properly restrained in the rear seat rather than in the front seat.
- Holding a child in your arms is no substitute for a restraint system. Failure to use a proper restraint system can result in severe or fatal injury to the child.
- Each child restraint device or fixing is to be used only by one child.

Seat and seat belts

Caution for installing the child restraint on vehicles with a front passenger airbag

E00406500318

The label shown here is attached on vehicles with a front passenger airbag.



⚠ WARNING

- **Extreme Hazard!**
Do not use a rearward facing child restraint on a seat protected by an airbag in front of it!

Use rearward facing child restraints in the rear seat or turn off the front passenger's airbag ON-OFF switch. (Refer to "To turn an airbag off" on page 3-23)



⚠ WARNING

- A REARWARD FACING CHILD RESTRAINT must NOT be used in the front passenger seat if the front passenger's airbag has not been deactivated. The force of an inflating airbag could kill or cause serious injuries to the child. A rearward facing child restraint must only be used in the rear seat.
- A FORWARD FACING CHILD RESTRAINT should be used in the rear seat whenever possible; if used in the front seat, turn off the front passenger's airbag ON-OFF switch.

Infants and small children

E00406600999

When transporting infants and small children in your vehicle, follow the instruction given below.

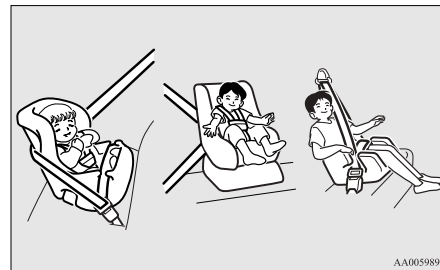

Instruction:

- For small infants, an infant carrier should be used. For small children whose height when seated allows the shoulder belt to lie in contact with the face or the throat, a child seat should be used.
- The child restraint system should be appropriate for the child's weight and height and properly fit in the vehicle. For a higher degree of safety: THE CHILD RESTRAINT SYSTEM SHOULD BE INSTALLED IN THE REAR SEAT.

NOTE

- Before purchasing a child restraint system, try installing it in the rear seat to make sure there is a good fit. Because of the location of the seat belt buckles and the shape of the seat cushion, it may be difficult to securely install some manufacturer's child restraint systems. If the child restraint system can be pulled forward or to either side easily on the seat cushion after the seat belt has been tightened, choose another manufacturer's child restraint system.

WARNING

- **When installing a child restraint system, refer to the instructions provided by the manufacturer of the restraint system. Failure to do so can result in severe or fatal injury to the child.**
- **After installation, push and pull the child restraint system back and forth, and side to side, to see that it is properly secured. If the child restraint system is not installed securely, it may cause injury to the child or other occupants in case of an accident or sudden stops.**
- **When the child restraint system is not in use, keep your child restraint system secured with the seat belt or remove it from the vehicle in order to prevent it from being thrown around inside the vehicle during an accident.**

Depending on the seating position in the vehicle and the child restraint system that you have, the child restraint can be attached using one of the following two locations:

- To the lower anchorage in the rear seat **ONLY** if the child restraint has ISOFIX mountings (See page 3-18).
- To the seat belt (See page 3-19).

Older children

E00406700277

Children who have outgrown the child restraint system should be seated in the rear seat and wear combination lap shoulder belt.

The lap portion of the belt should be snug and positioned low on the abdomen so that it is below the top of the hip-bone. Otherwise, the belt could intrude into the child's abdomen during an accident and cause injury.

Suitability for various ISOFIX positions

E00411400373

Mass group	Size class	Fixture	Vehicle ISOFIX positions
			Rear (Left side/Right side)
Carycot	F	ISO/L1	X
	G	ISO/L2	X
0 - Up to 10 kg (0-9 months)	E	ISO/R1	X
0+ - Up to 13 kg (0-2 years)	E	ISO/R1	IL* ¹ , IL* ² , # ₁
	D	ISO/R2	X
	C	ISO/R3	X
I - 9 to 18 kg (9 months-4 years)	D	ISO/R2	X
	C	ISO/R3	X
	B	ISO/F2	IUF
	B1	ISO/F2X	IUF, IL* ³
	A	ISO/F3	IUF
II & III - 15 to 36 kg (4-12 years)			X

#1: When installing a child restraint system, adjust the front seat in position more than 2 notches forward from the centre of its fore-aft adjustment range.

CAUTION

- When installing a child restraint system, prevent the head restraint from touching the child restraint system by removing it or adjusting its height.
- When installing a child restraint system, prevent the front seats from touching the child restraint system.
If the driver's seat touches the child restraint system, install the child restraint system in the rear seat of the passenger's side.

Definition of characters to be inserted in the table above:

- IUF- Suitable for ISOFIX forward child restraints systems of universal category approved for use in the mass group.
- IL- Suitable for particular ISOFIX child restraint systems given in the following list (MITSUBISHI MOTORS genuine parts).
- X- ISOFIX position not suitable for ISOFIX child restraint systems in this mass group.

IL (Genuine part information)

	Genuine part No.	ECE No.
*1	MZ314393 (Child restraint system), MZ314394 (ISOFIX base)	E1-04301146
*2	MZ314509 (Child restraint system) ^{#2} , MZ314394 (ISOFIX base)	E1-04301146
*3	MZ313045	E1-04301133

#2: To be available in 2012

NOTE

- MITSUBISHI MOTORS Europe B.V. reserves the right to changes without any prior announcement.
For further information, please contact a MITSUBISHI MOTORS Authorized Service Point.

Suitability for various seating positions

Mass group		Seating position		
		Front passenger		Rear (Left side/Right side)
		Activated airbag	Deactivated air-bag ^{#3}	
0	- Up to 10 kg (0-9 months)	X	X	X
0+	- Up to 13 kg (0-2 years)	X	L*1, L*2	U, L*1, L*2
I	-9 to 18 kg (9 months-4 years)	X	L*3, L*4	U, L*3, L*4
II & III	-15 to 36 kg (4-12 years)	X	L*5	U, L*5

^{#3}: With front passenger's airbag deactivated by means of front passenger's airbag ON-OFF switch

⚠ CAUTION

- When installing a child restraint system, prevent the head restraint from touching the child restraint system by removing it or adjusting its height.
- When installing a child restraint system, prevent the front seats from touching the child restraint system.
If the driver's seat touches the child restraint system, install the child restraint system in the rear seat of the passenger's side.

Definition of characters to be inserted in the table above:

- U- Suitable for "universal" category restraints approved for use in this mass group.
- L- Suitable for particular child restraints in the following list (MITSUBISHI MOTORS genuine parts).
- X- Seat position not suitable for children in this mass group.

L (Genuine part information)

	Genuine part No.	ECE No.
*1	MZ314393	E1-04301146
*2	MZ314509 ^{#4}	E1-04301146
*3	MZ313045	E1-04301133
*4	MZ314451	E1-04301203
*5	MZ314250	E1-04301169

#4: To be available in 2012

NOTE

- There is no applicable MITSUBISHI MOTORS Genuine Parts to the Mass Group “0-Up to 10 kg”.
- MITSUBISHI MOTORS Europe B.V. reserves the right to changes without any prior announcement.
For further information, please contact a MITSUBISHI MOTORS Authorized Service Point.

Seat and seat belts

Installing a child restraint system to the lower anchorage (ISOFIX child restraint mountings) and tether anchorage*

E00406900817

Lower anchorage location

Your vehicle's rear seat is fitted with lower anchorages for attaching a child restraint system with ISOFIX mountings.

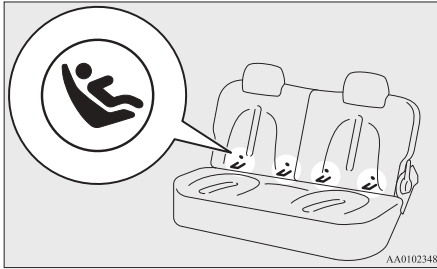

Tether anchorage locations

There are 2 child restraint anchorage points located on the luggage compartment floor. These are for securing a child restraint system tether strap to each of the 2 rear seating positions in your vehicle.

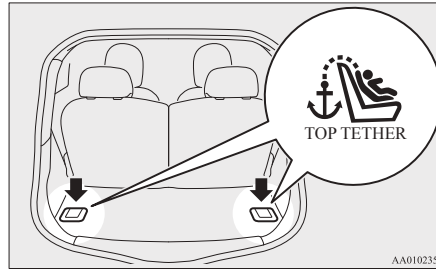

⚠ WARNING

- Child restraint anchorages are designed to withstand only those loads imposed by correctly fitted child restraints. Under no circumstances are they to be used for adult seat belts, harnesses, or for attaching other items or equipment to the vehicle.

Child restraint system with ISOFIX mountings

The child restraint system is designed only for seats that incorporate lower anchorages. Retain the child restraint system using the lower anchorages.

It is not necessary to retain the child restraint system using the vehicle's seat belts.

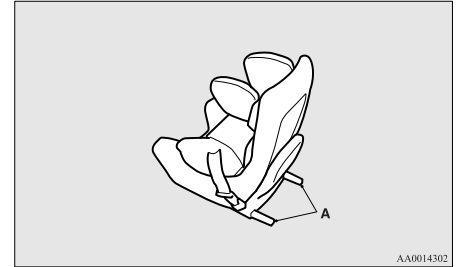

A- Child restraint system connectors

To install

1. Remove any foreign material in or around the connectors and ensure the vehicle seat belt is in its normal storage position.
2. Open the gap a little between the seat cushion (A) and the seatback (B) with your hand to locate the lower anchorages (C).
3. Push the child restraint system's connectors (D) into the lower anchorages (C) in accordance with the instructions provided by the child restraint system's manufacturer.

Installing a child restraint system to a 3-point type seat belt (with emergency locking mechanism)*

E00408700675

3-point type seat belt location

The child restraint system can be fitted by using the 3-point type seat belt at the seating position illustrated below.

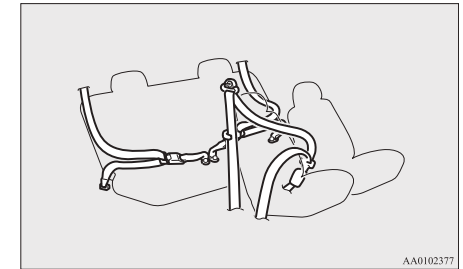

Installation:

1. Fasten the seat belt to secure the child restraint system. Make sure you hear a “click” when you insert the latch plate in the buckle.
2. Use the locking clip to completely eliminate any slackness.
3. Push and pull the child restraint in all directions to be sure it is secure.

5. Open the tether anchorage cover (E), and then latch the tether strap hook (F) of the child restraint system to the tether anchorage bracket (G) and tighten the top tether strap hook so it is securely fastened.

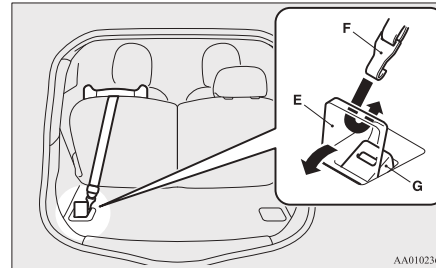

6. Push and pull the child restraint system in all directions to be sure it is firmly secured.

To remove

Remove the child restraint system in accordance with the instructions provided by the child restraint system’s manufacturer.

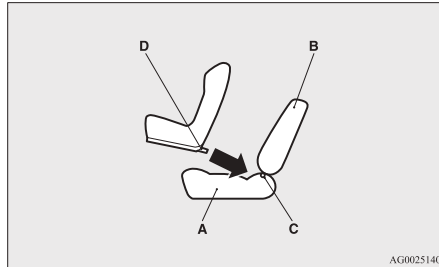

- A- Vehicle seat cushion
- B- Vehicle seatback
- C- Lower anchorage
- D- Connector

If your child restraint system requires the use of a tether strap, fasten the tether strap in accordance with steps 3 through 4.

4. Remove the head restraint from the location in which you wish to install a child restraint.

⚠ WARNING

- For some types of child restraint, the locking clip (A) should be used to help avoid personal injury during a collision or sudden manoeuvre.

It must be fitted and used in accordance with the child restraint manufacturer's instructions.

The locking clip must be removed when the child restraint is removed.

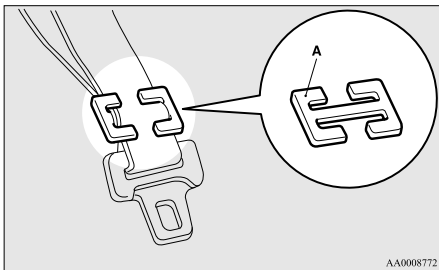

Seat belt inspection

E00406300576

- Check the belts for cuts, worn or frayed webbing and for cracked or deformed metallic parts. Replace the belt assembly if it is defective.
- A dirty belt should be cleaned with neutral detergent in warm water. After rinsing in water, let it dry in the shade. Do not attempt to bleach or re-dye the belts because this will affect their characteristics.

⚠ WARNING

- We recommend you to have all seat belt assemblies including retractors and attaching hardware inspected after any collision. We recommend that seat belt assemblies in use during a collision be replaced unless the collision was minor and the belts show no damage and continue to operate properly.
- Do not attempt to repair or replace any part of the seat belt assemblies; we recommend you to have this work done by a MITSUBISHI MOTORS Authorized Service Point. Incorrect repair or replacement could reduce the effectiveness of the belts and could result in serious injury in the event of a collision.
- Once the pretensioner has been activated, it cannot be re-used. It must be replaced together with the retractor.

Supplemental restraint system (SRS) - airbag

E00407202026

The information for SRS airbags includes important information concerning the driver's and front passenger's airbags, the side airbags and the curtain airbags.

The SRS driver and front passenger airbags are designed to supplement the primary protection of the driver and front passenger side seat belt systems by providing those occupants with protection against head and chest injuries in certain moderate-to-severe frontal collisions.

The SRS side airbags are designed to supplement properly worn seat belts and provide the driver and front passenger with protection against chest, abdomen and hip injuries in certain moderate-to-severe side impact collisions.

The SRS curtain airbags are designed to supplement properly worn seat belts and provide the driver and passenger with protection against head injuries in certain moderate-to-severe side impact collisions.

The SRS is NOT a substitute for the seat belts. To ensure the maximum protection during all types of collisions and accidents, all occupants, including the passengers as well as the driver, must wear their seat belts.

How the Supplemental Restraint System works

E00407301600

The SRS includes the following components:

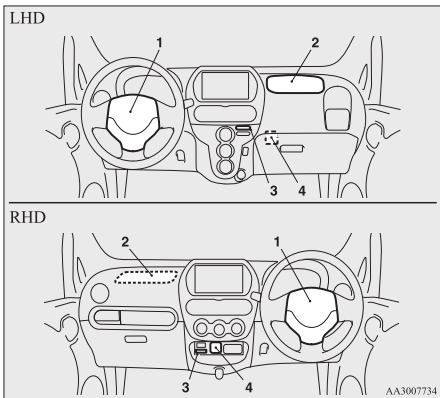

- 1- Airbag module (Driver)
- 2- Airbag module (Passenger)
- 3- Front passenger's airbag OFF indication lamp

4- Front passenger's airbag ON-OFF switch

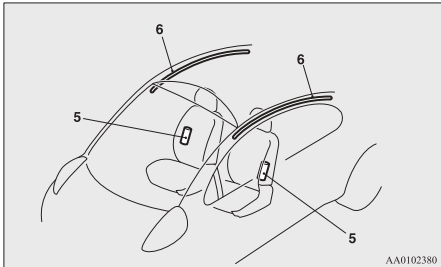

- 5- Side airbag modules
- 6- Curtain airbag modules

The airbags will operate only when the electric motor switch is in the "ON" or "START" position. The airbags deployment produces a sudden, loud noise, and releases some smoke and powder, but these conditions are not injurious, and do not indicate a fire in the vehicle. People with respiratory problems may feel some temporary irritation from chemicals used to produce the deployment; open the windows after airbag deployment, if safe to do so.

The airbags deflate very rapidly after deployment, so there is little danger of obscured vision.

CAUTION

- Airbags inflate at an extremely rapid speed. In certain situations, contact with inflating airbags can result in abrasions, light cuts, bruises, and the like.

WARNING

- IT IS VERY IMPORTANT TO BE PROPERLY SEATED.

A driver or front passenger too close to the steering wheel or instrument panel during airbag deployment can be killed or seriously injured.

Airbags inflate very fast, and with great force.

If the driver and front passenger are not properly seated and restrained, the airbags may not protect you properly, and could cause serious or fatal injuries when it inflates.

- Do not sit on the edge of the seat, or lean head or chest close to the steering wheel or instrument panel. Do not put feet or legs on or against the instrument panel.
- Place all infants and small children in the rear seat and properly restrained using an appropriate child restraint system. The rear seat is the safest place for infants and children.



Seat and seat belts

⚠ WARNING

- Infants and small children should never be unrestrained, stand up against the instrument panel or be held in your arms or on your lap. They could be seriously injured or killed in a collision, including when the airbag inflates. They should be properly seated in the rear seat in an appropriate child restraint system. See the "Child restraint" section of this owner's manual.



Use rearward facing child restraints in the rear seat or turn off the front passenger's airbag ON-OFF switch. (Refer to "To turn an airbag off" on page 3-23)

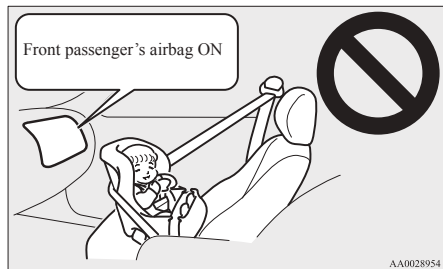

⚠ WARNING

- A REARWARD FACING CHILD RESTRAINT must NOT be used in the front passenger seat if the front passenger's airbag has not been deactivated. The force of an inflating airbag could kill or cause serious injuries to the child.
A rearward facing child restraint must only be used in the rear seat.
- A FORWARD FACING CHILD RESTRAINT should be used in the rear seat whenever possible; if they must be used in the front passenger seat, turn off the front passenger's airbag ON-OFF switch. Failure to do so could kill or cause serious injuries to the child.

⚠ WARNING

- Older children should be seated in the rear seat, properly wearing the seat belt, with an appropriate booster seat if needed.

Caution for installing the child restraint on vehicles with a front passenger airbag

E00408800474

The label shown here is attached on vehicles with a front passenger airbag.

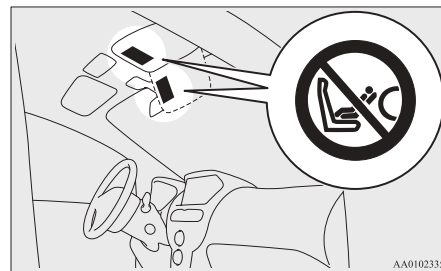

⚠ WARNING

- Extreme Hazard!
Do not use a rearward facing child restraint on a seat protected by an airbag in front of it!

Front passenger's airbag ON-OFF switch

E00410100272

The front passenger's airbag ON-OFF switch can be used to disable the front passenger's airbag. If you have a child restraint system that cannot be fitted to any seat other than the front passenger seat, be sure to turn OFF the front passenger's airbag ON-OFF switch before using it. (Refer to "To turn an airbag off" on page 3-23)

The front passenger's airbag ON-OFF switch is located as shown in the illustration.

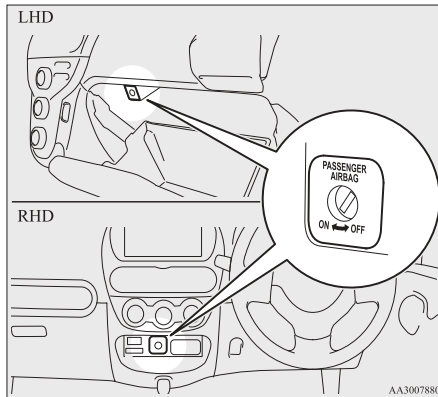

Front passenger's airbag OFF indication lamp

E00410200316

The front passenger's airbag OFF indication lamp is located as shown in the illustration.

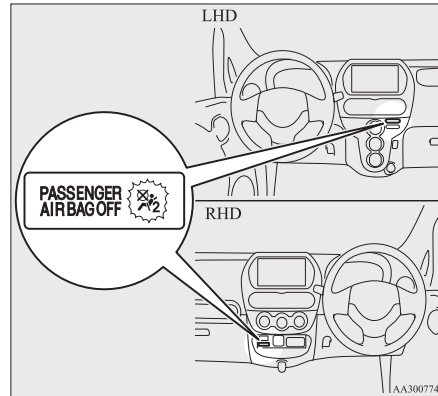

The indication lamp normally comes on when the electric motor switch is turned to the "ON" position, and goes off a few seconds later.

When the front passenger's airbag ON-OFF switch is turned OFF, the indication lamp will stay on to show that the front passenger's airbag is not operational. When the front passenger's airbag ON-OFF switch is turned ON, the indication lamp goes off to show that the front passenger's airbag is operational.

WARNING

- Do not fit any accessory that makes the indication lamp impossible to see, and do not cover the indication lamp with a sticker. You would not be able to verify the status of the passenger airbag system.

To turn an airbag off

E00412300076

WARNING

- To reduce risk of serious or fatal injury:
 - Always remove the key from the electric motor switch before operating the front passenger's airbag ON-OFF switch. Failure to do so could adversely affect the airbag performance.
 - Wait at least 60 seconds to operate the front passenger's airbag ON-OFF switch after turning the electric motor switch to the "LOCK" position. The SRS airbag system is designed to retain enough voltage to deploy the airbag.
 - Always remove the key from the front passenger's airbag ON-OFF switch after operating that switch. Failure to do so could lead to improper position of the front passenger's airbag ON-OFF switch.
 - Do not turn OFF the front passenger's airbag ON-OFF switch except when a child restraint system is fitted to the front passenger seat.

3

⚠ WARNING

- Turn ON the front passenger's airbag ON-OFF switch immediately after removing a child restraint system from the front passenger seat.
- If the indication lamp does not come on when the front passenger's airbag ON-OFF switch is turned OFF, do not fit a child restraint system to the front passenger seat. We recommend you to have the system inspected by a MITSUBISHI MOTORS Authorized Service Point.
- If the indication lamp remains on when the front passenger's airbag ON-OFF switch is turned ON, do not allow anyone to sit on the front passenger seat. We recommend you to have the system inspected by a MITSUBISHI MOTORS Authorized Service Point.

To turn an airbag off, follow these steps:

1. Insert the key into the front passenger's airbag ON-OFF switch, and turn it to the "OFF" position.
2. Remove the key from the key opening of the front passenger's airbag ON-OFF switch.

3. Insert the key into the electric motor switch, and turn the electric motor switch to the "ON" position. The front passenger's airbag OFF indication lamp will stay on.

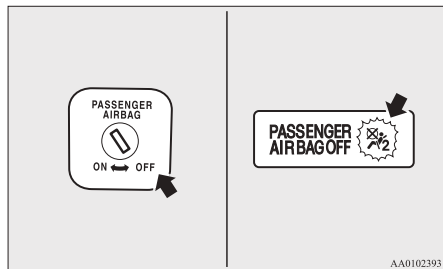

The front passenger's airbag is now deactivated and will not deploy until switched on again.

Driver's and front passenger's airbag system

E00407400792

The driver's airbag is located under the padded cover in the middle of the steering wheel. The front passenger's airbag is contained in the instrument panel above the glove box.

The driver's airbag and the front passenger's airbag are designed to inflate at the same time even if the passenger seat is not occupied.

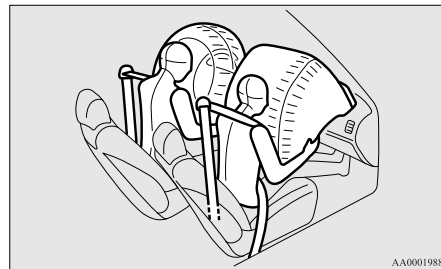

Deployment of front airbags

E00407501660

The front airbags ARE DESIGNED TO DEPLOY when...

The front airbags are designed to deploy when the vehicle suffers a moderate to severe frontal impact. A typical condition is shown in the illustration.

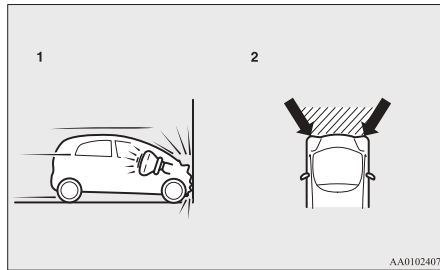

- 1- Head-on collision with a solid wall at a speed of approximately 25 km/h (16 mph) or higher
- 2- Moderate-to-severe frontal impact within the shaded area between the arrows

The front airbags will deploy if the severity of the impact is above the designed threshold level, comparable to an approximately 25 km/h (16 mph) collision when impacting straight into a solid wall that does not move or deform. If the severity of the impact is below the above threshold level, the front airbags may not deploy. However, this threshold speed will be considerably higher if the vehicle strikes an object that absorbs the impact by either deforming or moving (for example, another stationary vehicle, pole or a guard rail).

Because frontal collisions can easily move you out of position, it is important to always properly wear your seat belts. Your seat belts will help keep you a safe distance from the steering wheel and instrument panel during the initial stages of airbag deployment. The initial stage of airbag inflation is the most forceful one, and can possibly cause serious or fatal injuries. Moreover, the seat belts in your vehicle are your primary means of protection in a collision. The airbags are designed to provide additional protection. Therefore, for your safety and the safety of all occupants, be sure to always properly wear your seat belts.

The front airbags MAY NOT DEPLOY when...

With certain types of frontal collisions, the vehicle's body structure is designed to absorb the shock to help protect the occupants from harm. (The vehicle body's front area may deform significantly as it absorbs the impact.) Under such circumstances, the front airbags may not deploy irrespective of the deformation and damage to the vehicle body.

Examples of some typical conditions are shown in the illustration.

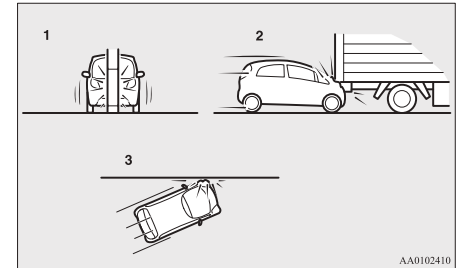

- 1- Collision with a utility pole, tree or other narrow objects.
- 2- Vehicle slides under the rear body of a truck
- 3- Oblique frontal impacts

Because the front airbags do not protect the occupant in all types of frontal collisions, be sure to always properly wear your seat belts.

Seat and seat belts

The front airbags ARE NOT DESIGNED TO DEPLOY when...

The front airbags are not designed to deploy in conditions where they cannot typically provide protection to the occupant. Such conditions are shown in the illustration.

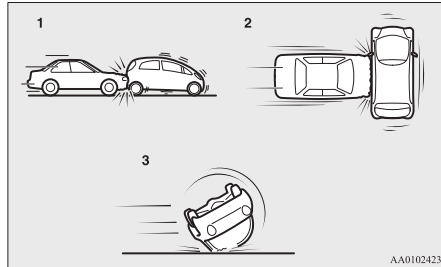

- 1- Rear end collisions
- 2- Side collisions
- 3- Vehicle rolls onto its side or roof

Because the front airbags do not protect the occupant in all types of collisions, be sure to always properly wear your seat belts.

The front airbags MAY DEPLOY when...

The front airbags may deploy if the bottom of the vehicle suffers a moderate-to-severe impact (under-carriage damage).

Examples of some typical conditions are shown in the illustration.

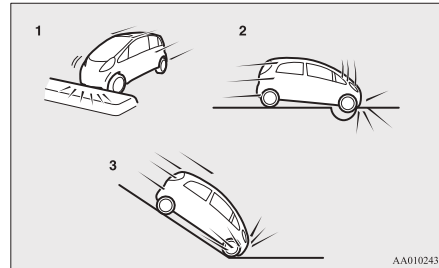

- 1- Collision with an elevated median/island or kerb
- 2- Vehicle travels over a deep hole/pothole
- 3- Vehicle drives down a steep slope and hits the ground

Because the front airbags may deploy in certain types of unexpected impacts as shown in the illustration that can easily move you out of position, it is important to always properly wear your seat belts. Your seat belts will help keep you a safe distance from the steering wheel and instrument panel during the initial stages of airbag deployment. The initial stage of airbag inflation is the most forceful one and can possibly cause serious or fatal injuries if you contact it at this stage.

WARNING

- Do not attach anything to the steering wheel's padded cover, such as badges or accessories. It might strike and injure an occupant if the airbag inflates.
- Do not set anything on, or attach anything to, the instrument panel above the glove box. It might strike and injure an occupant if the airbag inflates.

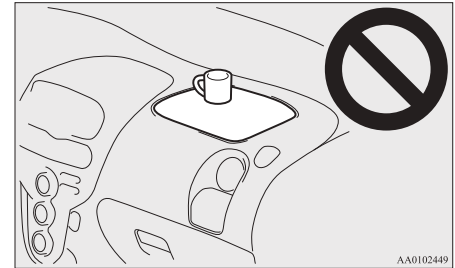

WARNING

- Do not attach accessories to, or put them in front of, the windshield. These objects could restrict the airbag inflation, or strike and injure an occupant if the airbags inflate.
- Do not put packages, pets or other objects between the airbags and the driver or front passenger. It could affect airbag performance, or could cause injury when the airbag inflates.

⚠ WARNING

- Right after the airbag inflation, several airbag system components will be hot. Do not touch these components. There is a danger of being burnt.
- The airbag system is designed to work only once. Once the airbags have deployed, they will not work again. They must promptly be replaced, and we recommend you to have the entire airbag system inspected by a MITSUBISHI MOTORS Authorized Service Point.

Side airbag system

E00407600518

The side airbags (A) are contained in the driver and front passenger seatbacks. The side airbag is designed to inflate only on the side of the vehicle that is impacted, even with no passenger in the front seat.

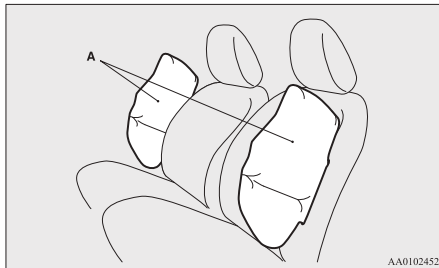

The label shown here is attached to the seatbacks with a side airbag.

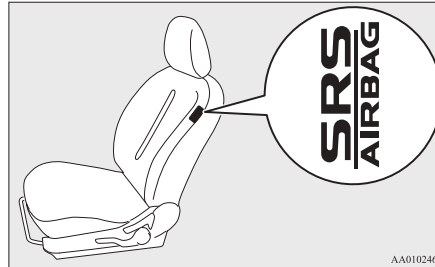

Curtain airbag system

E00409100562

The curtain airbags are contained in the front pillars and roof side rail. The curtain airbag is designed to inflate only on the side of the vehicle that is impacted, even with no passenger in the front seat or rear seat.

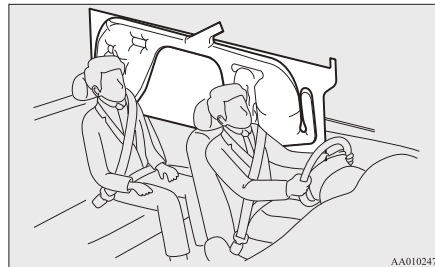

Deployment of side airbags and curtain airbags

E00407701457

The side airbags and curtain airbags ARE DESIGNED TO DEPLOY when...

The side airbags and curtain airbags are designed to deploy when the vehicle suffers a moderate-to-severe side impact to the middle of the passenger compartment.

The typical condition is shown in the illustration.

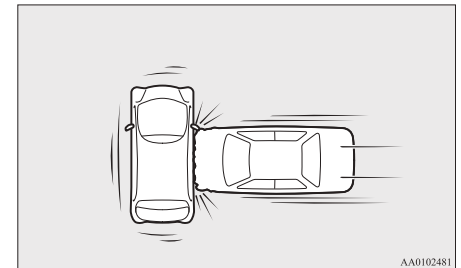

The seat belts in your vehicle are your primary means of protection in a collision. The side airbags and curtain airbags are designed to provide additional protection. Therefore, for your safety and the safety of all occupants, be sure to always properly wear your seat belts.

Seat and seat belts

The side airbags and curtain airbags MAY NOT DEPLOY when...

With certain types of side collisions, the vehicle's body structure is designed to absorb the shock to help protect the occupants from harm. (The vehicle body's side area may deform significantly as it absorbs the impact.) Under such circumstances, the side airbags and curtain airbags may not deploy irrespective of the deformation and damage to the vehicle body. Examples of some typical conditions are shown in the illustration.

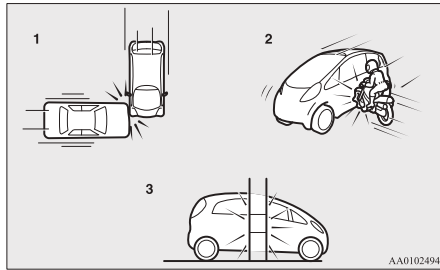

- 1- Side impacts in an area away from the passenger compartment
- 2- Motorcycle or other similar small vehicle collides with the side of vehicle

- 3- Collision with a utility pole, tree or other narrow object

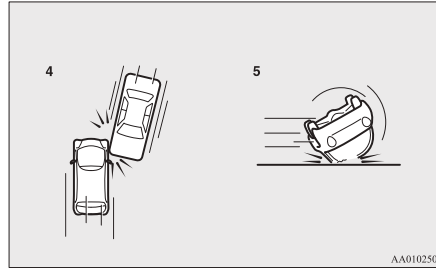

- 4- Oblique side impacts
- 5- Vehicle rolls onto its side or roof

Because the side airbags and curtain airbags do not protect the occupant in all types of side collisions, be sure to always properly wear your seat belts.

The side airbags and curtain airbags ARE NOT DESIGNED TO DEPLOY when...

The side airbags and curtain airbags are not designed to deploy in conditions where they cannot usually provide protection to the occupant. Typical conditions are shown in the illustration.

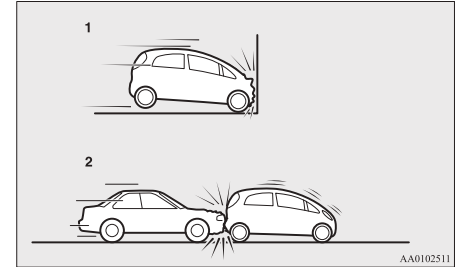

- 1- Head-on collisions
- 2- Rear end collisions

Because the side airbags and curtain airbags do not protect the occupant in all types of collisions, be sure to always properly wear your seat belts.

⚠ WARNING

- The side airbags and curtain airbags are designed to supplement the driver and passenger seat belts in certain side impacts. Seat belts should always be worn properly, and the driver and passenger should sit well back and upright without leaning against the window or door.

⚠ WARNING

- The side airbags and curtain airbags inflate with great force. The driver and passenger should not put their arms out the window, and should not lean against the door, in order to reduce risk of serious or possible fatal injury from the deploying side airbags and curtain airbags.

**⚠ WARNING**

- Do not allow any rear seat occupant to hold onto the seatback of either front seat, in order to reduce risk of injury from the deploying side airbags. Special care should be taken with children.
- Do not place any objects near or in front of the seatback of either front seat. They could interfere with proper side airbag inflation, and also could cause injury if thrown free by side airbag deployment.

⚠ WARNING

- Do not place stickers, labels or additional trim on the seatback of either front seat. They could interfere with proper side airbag inflation.
- Do not install seat covers on seats with side airbags. Do not re-cover seats that have side airbags. This could interfere with proper side airbag inflation.
- Do not attach a microphone (A) or any other device or object around the part where the curtain airbags (B) activate such as on the windscreen, side door glass, front and rear pillars and roof side or assist grips. When the curtain airbags inflate, the microphone or other device or object will be hurled with great force or the curtain airbags may not activate correctly, resulting in death or serious injury.

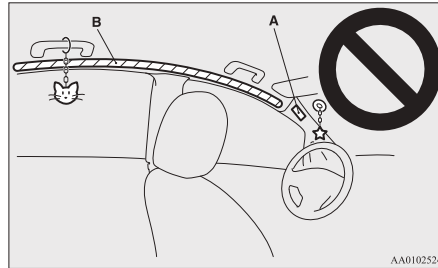
**⚠ WARNING**

- Never install a rearward facing child restraint in the front passenger seat. A forward facing child restraint should be used in the rear seat whenever possible. If a forward facing child restraint must be used in the front passenger seat, adjust the seat to the most rearward position, and ensure that the child stays in the child restraint and away from the door.
- Do not allow the child to lean against or close to the door even if the child is seated in a child restraint system. The child's head should also not be leaned against or be close to the area where the side airbags and curtain airbags are located. It is dangerous if the side airbags and curtain airbags inflate. Failure to follow all of these instructions could lead to serious or fatal injury to the child.
- We recommend work around and on the side airbags and curtain airbags system to be done by a MITSUBISHI MOTORS Authorized Service Point.

SRS warning lamp

E00407801591

There is a Supplemental Restraint System ("SRS") warning lamp on the instrument panel. The system checks itself and the lamp tells you if there is a problem. When the electric motor switch is turned to the "ON" or "START" position, the warning lamp should illuminate for several seconds and then should go out. This means the system is ready.

Seat and seat belts

If an SRS airbag or pretensioner seat belt is not operating properly, the warning lamp comes on and stays on.

The SRS warning lamp is shared by the SRS airbag and the seat belt pretensioner system.

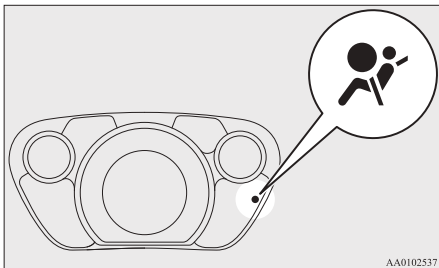

⚠ WARNING

- If any of the following conditions occur, the SRS and/or seat belt pretensioners are not working properly, and we recommend you to have it inspected by a MITSUBISHI MOTORS Authorized Service Point immediately.
 - The SRS warning lamp does not illuminate when the electric motor switch is turned “ON”.
 - The SRS warning lamp does not go out after several seconds.
 - The SRS warning lamp illuminates while driving.

SRS servicing

E00407901550

⚠ WARNING

- We recommend any maintenance performed on or near the components of the SRS to be performed by a MITSUBISHI MOTORS Authorized Service Point. Improper work on the SRS components or wiring could result in inadvertent deployment of the airbags, or could render the SRS inoperative; either situation could result in serious injury.
- Do not modify your steering wheel, seat belt retractor or any other SRS components. For example, replacement of the steering wheel, or modifications to the front bumper or body structure can adversely affect SRS performance and lead to possible injury.
- If your vehicle has sustained any damage, we recommend you to have the SRS inspected to ensure it is in proper working order.
- Do not modify your front seats, centre pillar and centre console. It can adversely affect SRS performance and lead to possible injury. If you found any tear, scratch, crack or damage to the seat fabric near the side airbag, the portion of the front and rear pillars and roof side rail, you should have the SRS inspected by a MITSUBISHI MOTORS Authorized Service Point.

NOTE

- When you transfer ownership of the vehicle to some other person, we urge you to alert the new owner that it is equipped with the SRS and refer the new owner to the applicable section in this owner’s manual.
- If your vehicle has to be scrapped, do this in line with local legislation and contact a MITSUBISHI MOTORS Authorized Service Point to safely dismantle the airbag system.

Instruments and controls

Instruments.....	4-02
Indication and warning lamps.....	4-08
Indication lamps.....	4-09
Warning lamps.....	4-09
Combination headlamps and dipper switch.....	4-11
Headlamp levelling switch.....	4-13
Turn-signal lever.....	4-14
Hazard warning flasher switch.....	4-15
Fog lamp switch.....	4-15
Wiper and washer switch.....	4-16
Rear window demister switch.....	4-18
Horn switch.....	4-19

Instruments

E00500101251

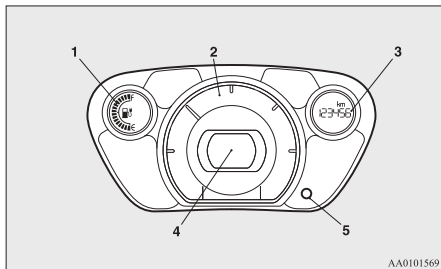

AA0101569

- 1- Energy level gauge
- 2- Energy usage indicator
- 3- Odometer/Tripmeter/Meter illumination control/Service reminder/Cruising range indicator
- 4- Speedometer (km/h or MPH)
- 5- Reset button/Daytime dipper button/Selector button

Speedometer

E00500201050

When the electric motor switch is in the “ON” position, the speedometer indicates the vehicle speed in kilometers per hour (km/h) (Type 1) or miles per hour (MPH) (Type 2).

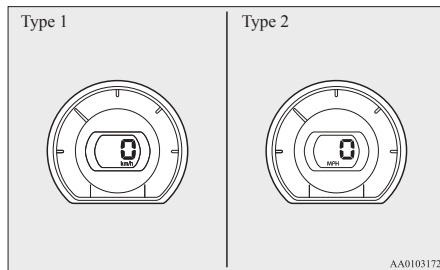

AA0103172

NOTE

- The display setting can be changed to the preferred units (km or miles) (Type 2). Refer to “Changing the display unit*” on page 4-02.

Changing the display unit*

E00529500026

It is possible to select the speedometer’s display unit.

1. Press the reset button (A) to display the odometer (B).
(Refer to “To change the display” on page 4-03.)

2. Keep the reset button pressed for two seconds or longer to change the display unit from MPH to km/h or from km/h to MPH.

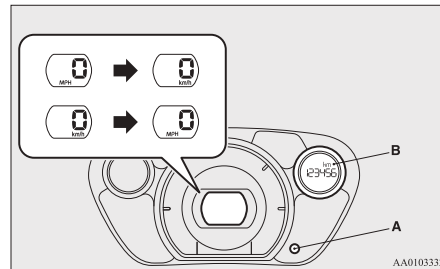

AA0103332

NOTE

- Once the display unit has changed, keeping the reset button pressed will not cause the display unit to change again.

The display unit for the cruising range will change to match the selected speedometer display unit.

Speedometer	Cruising range
MPH	Miles
km/h	km

NOTE

- Even if speedometer display unit is changed, the display units for the odometer, tripmeter, and service reminder do not change.

Energy usage indicator

E00529600014

The consumption power of the electric motor unit and the air conditioning, and charged power of electric energy generated from the regenerative brake are indicated.

When the ready indicator illuminates, the indicating needle moves to the standard position (A) and moves to the left or right according to the use conditions of the vehicle.

[When the indicating needle moves to the right of the standard position]

Indicates consumption power of the electric motor unit and the air conditioning.

The more the needle moves to the right, the more electrical power is being consumed.

[When the indicating needle moves to the left of the standard position]

Indicates charged power of electric energy generated from regenerative braking.

The more the needle moves to the left, the more electric energy is charged.

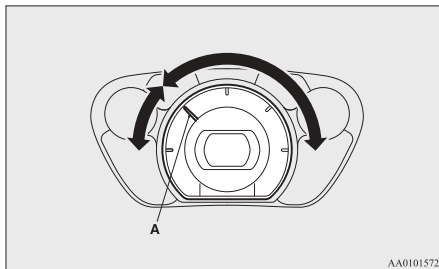

Odometer/Tripmeter/Meter illumination control/Service reminder/Cruising range indicator

E00500601214

With the electric motor switch in the “ON” position, the odometer, tripmeter, meter illumination control, service reminder and cruising range indicator are displayed.

To change the display

E00530700015

The display is changed every time the reset button (A) is pressed lightly (less than 1 second).

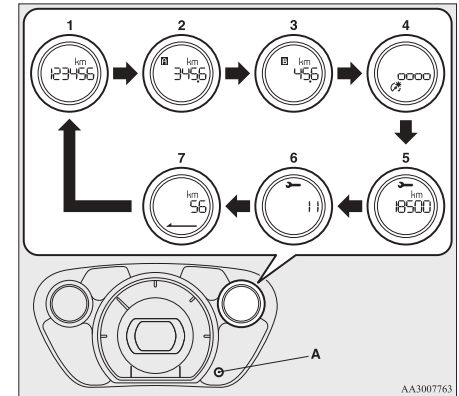

- 1- Odometer
- 2- Tripmeter **A**
- 3- Tripmeter **B**
- 4- Meter illumination control
- 5- Service reminder (Drive distance remaining until next inspection)
- 6- Service reminder (Number of months remaining until next inspection)
- 7- Cruising range indicator

NOTE

- The cruising range indicator is indicated when the electric motor switch is in the “ON” position.

Instruments and controls

- If there is no operation for about 10 seconds when the meter illumination control or service reminder is shown, the display returns to the odometer.

Odometer

E0053080016

The odometer indicates the total distance the vehicle has travelled.

NOTE

- Even if the electric motor switch is turned to “ACC” or “LOCK”, the odometer will be displayed for about 30 seconds after the reset button is pressed.

Tripmeter

E00530900017

The tripmeter indicates the distance travelled during a particular trip or period.

There are two tripmeter displays: Tripmeter **A** and **B**.

Tripmeter **A** can be used to measure the distance travelled since the current trip began. At the same time, Tripmeter **B** can be used to measure the distance from an intermediate location.

NOTE

- Even if the electric motor switch is turned to the “ACC” or “LOCK” position, the tripmeter will be displayed for about 30 seconds after the reset button is pressed.

To reset the tripmeter

To return the display to “0”, press the reset button (A) for more than 2 seconds. Only the currently displayed value will be reset.

NOTE

- If the auxiliary battery terminal is removed, the memories for the tripmeter **A** and **B** displays are erased and the displays return to 0.

Service reminder

E00517700164

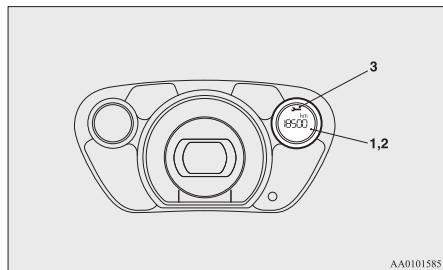

The service reminder shows the driving distance (1) or number of months (2) remaining until the next 12-monthly (20,000 km / 12,500 miles) inspection.

When the next inspection is nearly due, the display shows “-----”.

At this time, a spanner mark (3) is shown for a few seconds whenever the electric motor switch is turned from the “LOCK” position or the “ACC” position to the “ON” position.

NOTE

- Even if the electric motor switch is turned to the “ACC” or “LOCK” position, the service reminder will be displayed for about 30 seconds after the reset button is pressed.

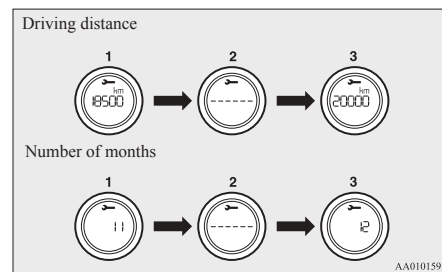

1. The display shows the driving distance or number of months remaining until the next inspection.
2. When the next inspection is nearly due, the display shows “-----”.

For further information, we recommend you to consult a MITSUBISHI MOTORS Authorized Service Point.

At this time, a spanner mark is shown for a few seconds whenever the electric motor

switch is turned from the “LOCK” position or the “ACC” position to the “ON” position.

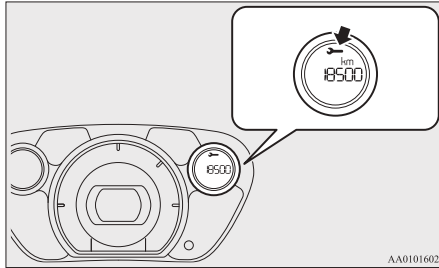

3. When the vehicle is inspected at a MITSUBISHI MOTORS Authorized Service Point, the driving distance or number of months remaining until the next inspection will be shown.

NOTE

- The indicated distance decreases in steps of 100 km (62 miles). The indicated number of months decreases in steps of one month.
- It is possible to change the settings for the service reminder.
For further information, we recommend you to consult a MITSUBISHI MOTORS Authorized Service Point.

Resetting the service reminder

With the electric motor switch in the “LOCK” position or the “ACC” position, it is possible to reset the spanner mark (A) and “-----” indication (B).

When they have been reset, the driving distance or number of months remaining until the next inspection are shown and the spanner mark (A) is no longer shown every time the electric motor switch is turned from the “LOCK” position or the “ACC” position to the “ON” position.

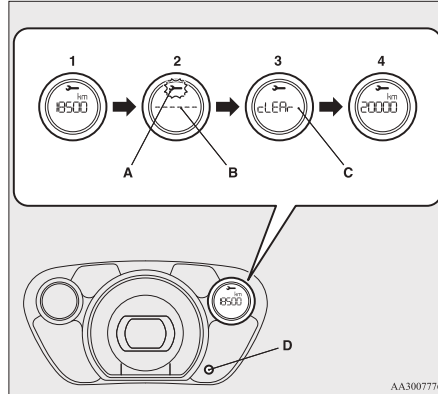

1. Push the reset button (D) to view the driving distance or number of months remaining until the next inspection.
2. Give the reset button (D) a long push (at least two seconds) to make the spanner mark (A) start flashing. (If you do not touch the reset button for 10 seconds while the spanner mark is flashing, the display will revert to its original indication.)
3. Give the reset button (D) a gentle push while the spanner mark is flashing. The “-----” indication (B) will change to “cLEAR” (C).

4. The driving distance or number of months remaining until the next inspection will be shown.

CAUTION

● **Daily and periodic inspections and maintenance are your responsibility. Be sure to perform them to help prevent accidents and breakdowns.**

NOTE

- It is not possible to reset the “-----” indication (B) with the electric motor switch in the “ON” position.
- When a certain distance has been driven and a certain period has elapsed after appearance of the “-----” indication (B), the indication is automatically reset and the number of months until the next periodic inspection is shown.
- If you accidentally reset the display, consult a MITSUBISHI MOTORS Authorized Service Point.

Instruments and controls

Daytime dipper button (meter illumination control)

E00529700028

Each time you press the daytime dipper button (2), the brightness of the instruments changes.

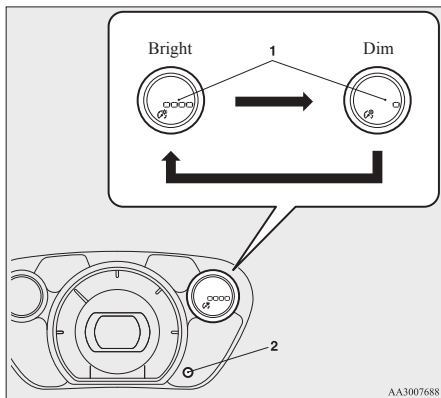

- 1- Brightness display
2- Daytime dipper button

NOTE

- You can adjust to 4 different levels for when the tail lamps are illuminated and 4 for when they are not.
- When the lamp switch is in the “AUTO” position, the meter illumination switches automatically to the adjusted brightness, depending on the brightness outside the vehicle.
- The brightness level of the instruments is stored when the electric motor switch is turned off.

- If you press and hold the button for longer than about 1 second, the brightness automatically scrolls through its different levels, and stops scrolling when you release the button. Select your desired level of brightness.

Cruising range indicator

E00529900020

This displays the approximate cruising range (how many more kilometres or miles you can drive). When the cruising range becomes short, the indication changes to “---”.

NOTE

- The cruising range is displayed based on the past drive data. It may vary depending on the driving condition (road condition, driving situation, etc.) and air conditioning operation status.
For example, the cruising range can be shortened by driving on congested roads, by driving uphill, by repeated hard acceleration, and by use of the air conditioner and heater.
When the auxiliary battery terminal is disconnected, the power consumption data of the traction battery in the past is deleted. A different value from before may be displayed. Be sure to use the display only for reference.
- When the traction battery is charged, the cruising range is updated. If the charge level is low, the correct value is not displayed.
- On vehicles with speedometer of Type 2, the display setting can be changed to the preferred units (km or miles). Refer to “Changing the display unit*” on page 4-02.

Energy level gauge

E00530000018

The energy level gauge indicates the remaining power in the traction battery during charging or when the electric motor switch is in the “ON” position.

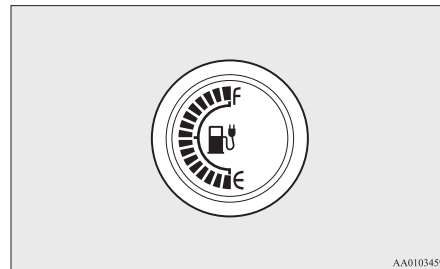

- F- Battery is fully powered.
E- Charge the battery.

NOTE

- The charging indicator is also illuminated during charging. Refer to “Charging indicator” on page 4-09.

Low energy warning indicator

E00530300011

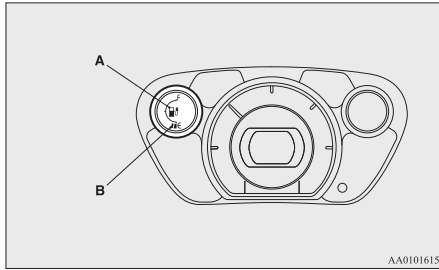

When the electric motor switch is in the “ON” position and the remaining bar of the energy level gauge shows 2 bars or less, the warning indicator (A) and the graduation (B) flash as follows:

When the energy level gauge shows 2 bars: The warning indicator flashes.

When the energy level gauge shows 1 bar: The warning indicator and the graduation flash alternately.

Recharge the traction battery as soon as possible.

NOTE

- If the energy level gauge shows 0 bars during use of the air conditioning (cooling or heating), the air conditioning stops operation and the mode is changed to fan only.
- If the energy level gauge shows 0 bars, the power down warning lamp is illuminated to control the output.

- If the energy level gauge shows 2 bars while the traction battery is being charged, the warning indicator flashes. If the energy level gauge shows 1 bar while the traction battery is being charged, the warning indicator and the graduation flash alternately.

Indication and warning lamps

E00501502220

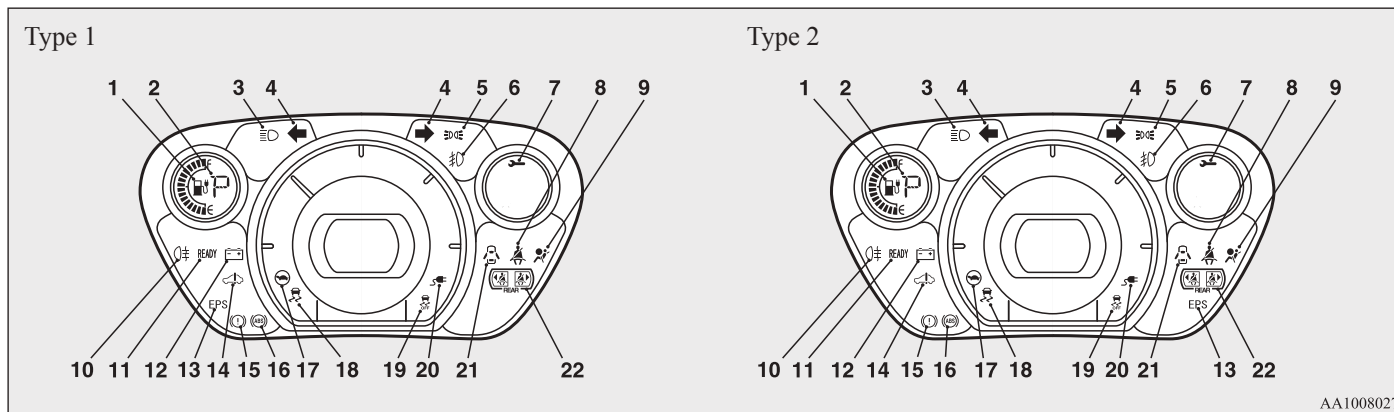

- 1- Low energy warning indicator → p. 4-07
2. Selector lever position indicator → p. 5-10
- 3- High-beam indication lamp → p. 4-09
- 4- Turn-signal indication lamps/Hazard warning indication lamps → p. 4-09
- 5- Position lamp indication lamp → p. 4-09
- 6- Front fog lamp indication lamp* → p. 4-09
- 7- Service reminder → p. 4-04
- 8- Driver's and front passenger's seat belt warning lamp → p. 3-09
- 9- Supplement Restraint System (SRS) warning lamp → p. 3-29
- 10- Rear fog lamp indication lamp → p. 4-09
- 11- Ready indicator → p. 4-09

- 12- Auxiliary battery charge warning lamp → p. 4-10
- 13- Electric power steering system (EPS) warning lamp → p. 5-17
- 14- Electric motor unit warning lamp → p. 4-11
- 15- Brake warning lamp → p. 4-09
- 16- Anti-lock brake system (ABS) warning lamp → p. 5-16
- 17- Power down warning lamp → p. 4-11
- 18- Active stability control (ASC) indication lamp → p. 5-19
- 19- Active stability control (ASC) OFF indication lamp → p. 5-19
- 20- Charging indicator → p. 4-09
- 21- Door ajar warning lamp → p. 4-10
- 22- Rear passenger's seat belt warning lamps* → p. 3-10

Indication lamps

E00501600012



Turn-signal indication lamps/ Hazard warning indication lamps

E00501700374

These indication lamps blink on and off when a turn-signal lamp is operating.

NOTE

- If the blinking is too fast, the cause may be a blown lamp bulb or a faulty turn-signal connection.

When the hazard warning lamp switch is pressed, all turn-signal lamps will flash on and off continuously.



High-beam indication lamp

E00501800072

This indication lamp illuminates when the high-beam is used.



Front fog lamp indication lamp*

E00501900132

This indication lamp illuminates while the front fog lamps are on.



Rear fog lamp indication lamp

E00502000084

This indication lamp illuminates while the rear fog lamp is on.



Position lamp indication lamp

E00508900102

This lamp illuminates with the lamp switch at “ D ” or “ D ” position



Ready indicator

E00530100019

This indicator illuminates when the electric motor switch is turned to “START” and driving becomes possible.



Charging indicator

E00530200010

This indicator flashes when the regular charging cable or quick charging cable is connected.

After that, the lamp switches to being illuminated when charging starts and goes out when charging is completed.

Warning lamps

E00502400017



Brake warning lamp (brake warning buzzer)

E00502502490

This lamp illuminates when the electric motor switch is turned to the “ON” position, and goes off after a few seconds. Always make sure that the lamp goes off before driving.

With the electric motor switch in the “ON” position, the brake warning lamp illuminates under the following conditions:

- When the parking brake lever has been engaged.
- When the brake fluid level in the reservoir falls to a low level.
- When there is a fault in the brake vacuum pressure system.
- When the brake force distribution function is not operating correctly.

Brake warning buzzer

When the brake vacuum pressure is insufficient, a buzzer will sound to alert the driver that braking performance may decrease. If this buzzer should continue to sound, park your vehicle in a safe place and we recommend you to have it checked.

NOTE

- Depressing the brake pedal repeatedly may turn on the brake warning lamp and brake warning buzzer. It is normal if the lamp goes out and the buzzer stops sounding after a few seconds.

⚠ CAUTION

- In the situations listed below, brake performance may be compromised or the vehicle may become unstable if brakes are applied suddenly; consequently, avoid driving at high speeds or applying the brakes suddenly. Furthermore, the vehicle should be brought to a stop in a safe location and to have it checked.
 - The brake warning lamp does not illuminate when the parking brake is applied or does not turn off when the parking brake is released.
 - The brake warning lamp remains illuminated during driving.
 - The brake warning lamp and ABS warning lamp are both illuminated at the same time. Refer to “ABS warning lamp” on page 5-16.
 - The brake warning buzzer will not stop sounding.

⚠ CAUTION

- The vehicle should be brought to a halt in the following manner when brake performance has deteriorated.
 - Depress the brake pedal harder than usual. Even if the brake pedal moves down to the very end of its possible stroke, keep it pressed down hard.
 - Should the brakes fail, use regenerative braking to reduce your speed and carefully pull the parking brake lever. Depress the brake pedal to operate the stop lamp to alert the vehicles behind you.

NOTE

- Operation sounds of the brake electric vacuum pump may be heard from the electric motor unit room just after the electric motor switch has been turned “ON” or when the brake pedal is depressed. This occurs when the brake electric vacuum pump is operating normally and does not indicate faulty operation.



Auxiliary battery charge warning lamp

E00502701219

This warning lamp will illuminate when there is a fault with the charging system of the auxiliary battery.

Normally, when the electric motor switch is turned to the “ON” position, this warning lamp will illuminate. When the electric motor unit is started, the lamp goes out.

⚠ CAUTION

- If it illuminates while the ready indicator is illuminated, there is a problem in the charging system. In this case, immediately park your vehicle in a safe place and we recommend you to have it checked.



Door ajar warning lamp

E00503300840

This lamp illuminates when either of the doors (also, the tailgate) is not completely closed.

If the vehicle speed exceeds about 8 km/h (5 mph) with a door ajar, the warning lamp will flash 16 times and, at the same time, the buzzer will sound 16 times to notify the driver that a door is ajar.

⚠ CAUTION

- Before moving your vehicle, check that the warning lamp is OFF.

NOTE

- The flashing of the warning lamp and the buzzer can be disabled. For further information, we recommend you to consult a MITSUBISHI MOTORS Authorized Service Point.
- When the driver's door is open, the door ajar warning buzzer does not sound because the electric motor reminder or selector lever reminder sounds.

**Electric motor unit warning lamp**

E00530400012

This warning lamp will illuminate when there is a fault at the high voltage area. Refer to “Service precautions” on page 8-06.

⚠ CAUTION

- If the lamp illuminates while driving, immediately park your vehicle in a safe place and we recommend you to have it checked.

**Power down warning lamp**

E00530500026

This warning lamp illuminates at the following cases, and activation of the safety mechanism will limit output.

- When the energy level gauge shows 0 bars
- When the traction battery capacity is not sufficient, the voltage is low or the temperature of the motor (electric motor unit) or traction battery is high or low

NOTE

- When the power down warning lamp illuminates, avoid sudden acceleration and sudden starting. When the remaining power in the traction battery is low, recharge the traction battery as soon as possible.
- Illumination of the power down warning lamp does not indicate a malfunction.
- If the power down warning light illuminates during use of the air conditioning (cooling or heating), the air conditioning may stop operation and the mode is changed to fan only.

Combination headlamps and dipper switch

E00506002099

Headlamps**NOTE**

- Do not leave the lamps on for a long time while the ready indicator is not illuminated. A run-down auxiliary battery could result.
- When it rains, or when the vehicle has been washed, the inside of the lens sometimes becomes foggy, but this does not indicate a functional problem. When the lamp is switched on, the heat will remove the fog. However, if water gathers inside the lamp, we recommend you to have it checked.

Rotate the switch to turn on the lamps.

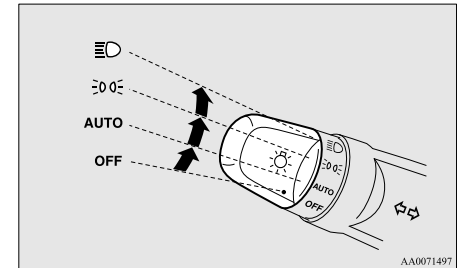

Instruments and controls

OFF	All lamps off
AUTO	With the electric motor switch in the “ON” position, headlamps, position, tail, licence plate, and instrument panel lamps turn on and off automatically in accordance with outside light level. All lamps turn off automatically when the electric motor switch is turned to the “OFF” position.
	Position, tail, licence plate and instrument panel lamps on
	Headlamps and other lamps go on

NOTE

- The sensitivity of the automatic on/off control can be adjusted. For further information, please contact your MITSUBISHI MOTORS Authorized Service Point.
- When the headlamps are turned off by the automatic on/off control with the electric motor switch in the “ON” position, the front fog lamps (if so equipped) and rear fog lamps also go off. When the headlamps are subsequently turned back on by the automatic on/off control, the front fog lamps also come on but the rear fog lamp stays off. If you wish to turn the rear fog lamp back on, operate the switch again.
- Do not place anything on the automatic light sensor (A), and do not clean with a glass cleaner.

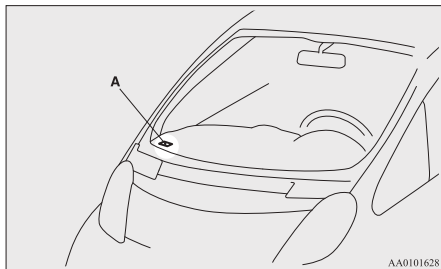

- If the lamps do not turn on or off with the switch in the “AUTO” position, manually operate the switch and we recommend you to have your vehicle checked.

Lamps (headlamps, fog lamp, etc.) auto-cutout function

E00532700396

- If the key is turned to the “LOCK” or “ACC” position or removed from the electric motor switch, and without opening the driver’s door for 3 minutes while the lamp switch in the “ ” position, the lamps will turn off automatically.
- If the key is turned to the “LOCK” or “ACC” position or removed from the electric motor switch and the driver’s door is opened within 3 minutes while the lamp switch is in the “ ” position, a buzzer will sound to warn the driver that the lamps have not been turned off, and these lamps will automatically turn off.

NOTE

- The lamp auto-cutout will not function when the lamp switch is in the “ ” position.
- When the key has been turned to either the “LOCK” or “ACC” position or removed from the electric motor switch with the lamp switch in the “ ” position, and the lamp switch is returned to the “OFF” position within approximately 3 minutes, the auto-cutout function will not be activated.

When you want to keep the lamps on

1. Turn the lamp switch in the “OFF” position while the key is in the “LOCK” position.
2. Turn on the lamps with the switch in the “ ” or “ ” position again, then the lamps will remain on.

NOTE

- It is possible to disable the lamp auto-cutout function. For further information, we recommend you to consult MITSUBISHI MOTORS Authorized Service Point.

Lamp monitor buzzer

E00506100605

If the driver’s door is opened when the key is in the “LOCK” or “ACC” position or removed from the electric motor switch while the lamps are on, a buzzer will sound to remind the driver to turn off the lamps.

When the lamp auto-cutout function acts, the buzzer will stop automatically.

Daytime running lamp*

E00530600014

The daytime running lamps come on when the ready indicator illuminates and the lamp switch is in the “OFF” or “AUTO” position and the tail lamps are off.

Dipper (High/Low beam change)

E00506200329

When the lamp switch is in the “” position, the beam changes from high to low (or low to high) each time the lever is pulled fully (1). While the high-beam is on, the high-beam indication lamp in the instrument cluster will also illuminate.

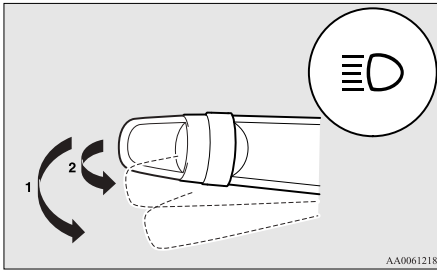

AA0061218

Headlamp flasher

E00506300199

The high-beams flash when the lever is pulled slightly (2), and will go off when it is released. When the high-beam is on, the high-beam indication lamp in the instrument cluster will illuminate.

NOTE

- The high-beams can also flash when the lamp switch is OFF.

- If you turn the lamps off with the headlamps set to high-beam, the headlamps are automatically returned to their low-beam setting when the lamp switch is next turned to the “” position.

Headlamp levelling switch

E00506400839

The angle of the headlamp beam varies depending on the load carried by the vehicle. The headlamp levelling switch can be used to adjust the headlamp illumination distance (when the lower beam is illuminated) so that the headlamps' glare does not distract other drivers. Set the switch according to the following table.

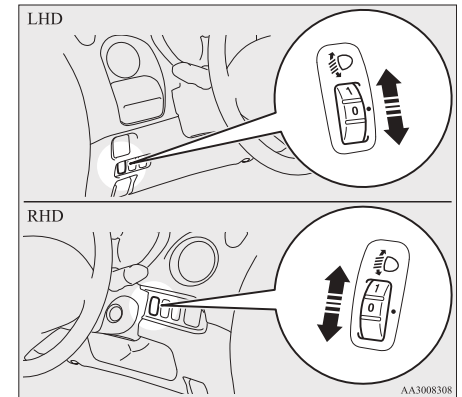

AA3008308

CAUTION

- Always perform adjustments before driving.
Do not attempt to adjust while driving, as it could cause an accident.

Instruments and controls

NOTE

- When adjusting the beam position, first put the dial in the “0” position (the highest beam position).

Except for vehicles with only the front seats

Vehicle condition					
Switch position	“0”	“0”	“1”	“1”	“2”

•: 1 person

: Full luggage loading

Switch position 0- Driver only/Driver + 1 front passenger

Switch position 1- 4 passengers (including driver)/
4 passengers (including driver) + Full luggage loading

Switch position 2- Driver + Full luggage loading

Vehicles with only the front seats

Vehicle condition		
Switch position	“0”	“1”

•: 1 person

: Full luggage loading

Switch position 0- Driver only

Switch position 1- Driver + Full luggage loading

Turn-signal lever

E00506501459

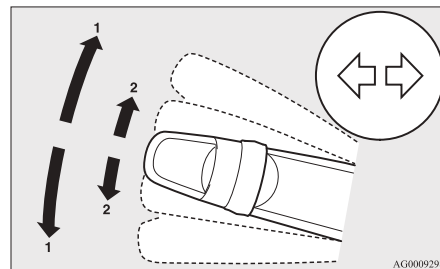

1- Turn-signals

When making a normal turn, use position (1). The lever will return automatically when cornering is completed.

2- Lane-change signals

When moving the lever to (2) slightly to change a lane, the turn-signal lamps and indication lamp in the instrument cluster will only flash while the lever is operated.

Also, when you move the lever to (2) slightly then release it, the turn-signal lamps and indication lamp in the instrument cluster will flash 3 times.

NOTE

- If the lamp flashes unusually quickly, the bulb in a turn-signal lamp may have burned out. We recommend you to have the vehicle inspected.
- It is possible to activate the following functions. For further information, we recommend you to consult a MITSUBISHI MOTORS Authorized Service Point.

- Flashing of the turn-signal lamps when the lever is operated with the electric motor switch in the “ACC” position
- The turn-signal lamps 3-flash function for lane changes can be deactivated.
- The time required to operate the lever for the 3-flash function can be adjusted.

Hazard warning flasher switch

E00506600958

Use the hazard warning flasher switch when the vehicle has to be parked on the road for any emergency. The hazard warning flashers can always be operated, regardless of the position of the electric motor switch.

Push the switch to turn on the hazard warning flashers, all turn-signal lamps flash continuously. To turn them off, push the switch again.

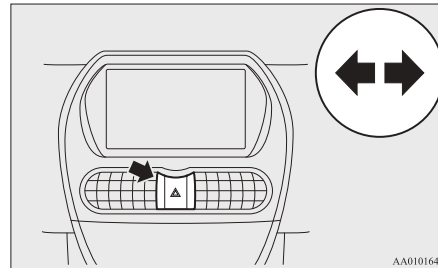

AA0101644

NOTE

- If the switch is used for a long period while the ready indicator is not illuminated, the auxiliary battery could go flat and it could be impossible to start the electric motor unit.

Fog lamp switch

E00506700034

Front fog lamp switch*

E00508300685

The front fog lamps can be operated while the headlamps or tail lamps are on. Turn the knob in the “ON” direction to turn on the front fog lamps. An indication lamp in the instrument cluster will also come on. Turn the knob in the “OFF” direction to turn off the front fog lamps. The knob will automatically return to its original position when you release it.

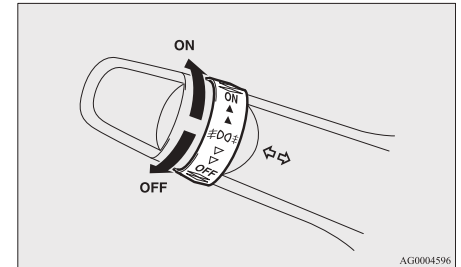

AG0004596

NOTE

- The front fog lamps are automatically turned off when the headlamps or tail lamps are turned off. To turn the front fog lamps on again, turn the knob in the “ON” direction after turning on the headlamps or tail lamps.
- Do not use fog lamps except in conditions of fog, otherwise excessive lamp glare may temporarily blind oncoming vehicle drivers.

Instruments and controls

Rear fog lamp switch

E00508400569

The rear fog lamp can be operated when the headlamps or front fog lamps (if so equipped) turn on. An indication lamp in the instrument cluster comes on when the rear fog lamp is turned on.

[Vehicle without front fog lamps]

Turn the knob once in the “ON” direction to turn on the rear fog lamp. To turn the rear fog lamp off, turn the knob once in the “OFF” direction. The knob will automatically return to its original position when you release it.

[Vehicle with front fog lamps]

Turn the knob once in the “ON” direction to turn on the front fog lamps. Turn the knob once more in the “ON” direction to turn on the rear fog lamp. To turn the rear fog lamp off, turn the knob once in the “OFF” direction. Turn the knob once more in the “OFF” direction to turn off the front fog lamps. The knob will automatically return to its original position when you release it.

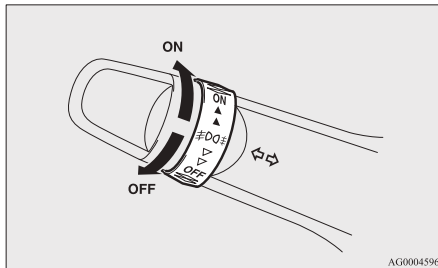

NOTE

- The rear fog lamp is automatically turned off when the headlamps or front fog lamps (if so equipped) are turned off.
- To turn the rear fog lamp on again, turn the knob once in the “ON” direction after turning on the headlamps. (Vehicle without front fog lamps)
- To turn the rear fog lamp on again, turn the knob twice in the “ON” direction after turning on the headlamps. (Vehicle with front fog lamps)

Wiper and washer switch

E00507101667

CAUTION

- If the washer is used in cold weather, the washer fluid sprayed against the glass may freeze, which may hinder visibility. Warm the glass with the defroster or rear window demister before using the washer.

Windscreen wipers

E00516900534

The windscreen wipers can be operated with the electric motor switch in the “ON” or “ACC” position.

If the blades are frozen to the windscreen or rear window, do not operate the wipers until the ice has melted and the blades are freed, otherwise the wiper motor may be damaged.

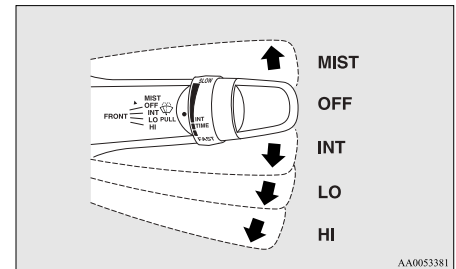

- MIST- Misting function
The wipers will operate once.
- OFF- Off
- INT- Intermittent (Speed sensitive)
- LO- Slow
- HI- Fast

To adjust intermittent intervals

With the lever in the “INT” (speed-sensitive) position, the intermittent intervals can be adjusted by turning the knob (A).

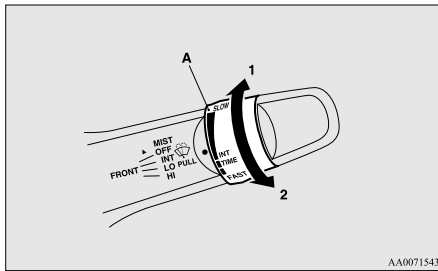

- 1- Fast
- 2- Slow

NOTE

- The speed-sensitive-operation function of the windscreen wipers can be deactivated. For further information, we recommend you to consult a MITSUBISHI MOTORS Authorized Service Point.

Misting function

The wipers will operate once if the wiper lever is raised to the “MIST” position and released. This operation is useful when it is drizzling, etc. The wipers will continue to operate while the lever is held in the “MIST” position.

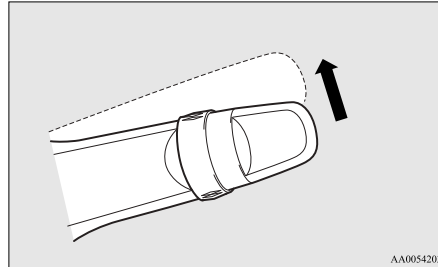

Windscreen washer

The washer fluid will be sprayed onto the windscreen by pulling the lever towards you. The wipers operate automatically several times while the washer fluid is being sprayed.

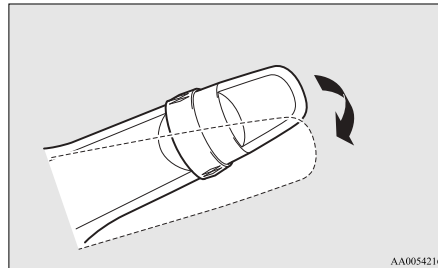

CAUTION

- If the washer is used in cold weather, the washer fluid sprayed against the glass may freeze resulting in poor visibility. Heat the glass with the defroster or demister before using the washer.

Rear window wiper and washer

The rear window wiper and washer switch can be operated with the electric motor switch in the “ON” or “ACC” position.

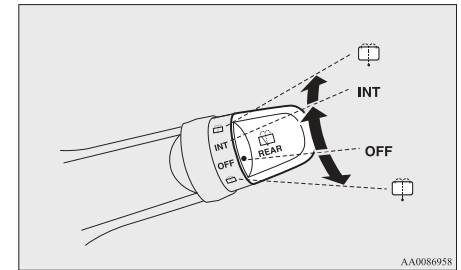

Instruments and controls

INT - The wiper operates continuously for several seconds then operates intermittently at intervals of about every 8 seconds.

OFF - Off



- The washer fluid will be sprayed onto the rear window when the knob is turned fully in either direction.

The wipers operate automatically several times while the washer fluid is being sprayed.

NOTE

- To ensure a clear rearward view, the wiper performs several continuous operations when the reverse gear is engaged while the switch is in the “INT” position.
Following this continuous operation, the wiper will automatically switch to intermittent operation.
- It is possible to activate the following functions. For further information, we recommend you to consult a MITSUBISHI MOTORS Authorized Service Point.
 - Adjustment of the interval for intermittent operation
 - Changing intermittent wiper operation to continuous wiper operation

Precautions to observe when using wipers and washers

E00507600131

- If the moving wipers become blocked by ice or other deposits on the glass, the motor may burn out even if the wiper switch is turned to OFF. If obstruction occurs, park your vehicle in a safe place, turn off the electric motor switch, and clean the deposits from the glass so that the wipers operate smoothly.
- Do not use the wipers when the glass is dry. They may scratch the glass surface and the blades wear out prematurely.
- Before using the wipers in cold weather, check that the wiper blades are not frozen onto the glass. The motor may burn out if the wipers are used with the blades frozen onto the glass.
- Avoid using the washer continuously for more than 20 seconds. Do not operate the washer when the fluid reservoir is empty. Otherwise, the motor may burn out.
- Periodically check the level of washer fluid in the reservoir and refill if required. During cold weather, add a recommended washer solution that will not freeze in the washer reservoir. Failure to do so could result in loss of washer function and frost damage to the system components.

Rear window demister switch

E00507901216

The rear window demister switch can be operated when the ready indicator illuminates.

Push the switch to turn on the rear window demister. It will be turned off automatically in about 20 minutes. To turn off the demister within about 20 minutes, push the switch again.

The indication lamp (A) will illuminate while the demister is on.

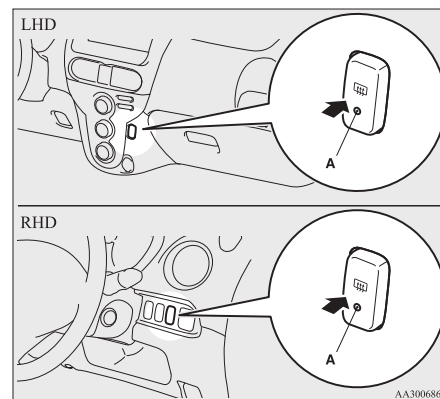

NOTE

- Since the demister requires a significant amount of power, stop the demister as soon as the window is demisted.

- If your vehicle is equipped with heated mirrors, when the rear window demister switch is pressed, the outside rear-view mirrors are defogged or defrosted. Refer to “Heated mirror” on page 5-07.
- The demister switch is not to melt snow but to clear mist. Remove snow before use of the demister switch.
- When cleaning the inside of the rear window, use a soft cloth and wipe gently along the heater wires, being careful not to damage the wires.
- Do not allow objects to touch the inside of the rear window glass, damaged or broken wires may result.

Horn switch

E00508000318

Press the steering wheel on or around the “” mark.

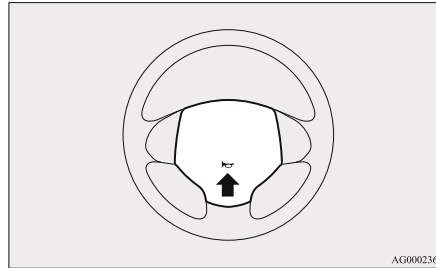

A series of 15 horizontal dashed lines spanning the width of the page, providing a template for handwriting practice.

Starting and driving

Economical driving.....	5-02
Driving, alcohol and drugs.....	5-02
Safe driving techniques.....	5-03
Parking brake.....	5-03
Parking.....	5-04
Inside rear-view mirror.....	5-05
Outside rear-view mirrors.....	5-05
Electric motor switch.....	5-07
Steering wheel lock.....	5-08
Starting the electric motor unit.....	5-08
Transmission.....	5-09
Driving the vehicle.....	5-11
Inspection and maintenance following rough road operation.....	5-12
Acoustic Vehicle Alerting System (AVAS).....	5-12
Braking.....	5-14
Brake assist system.....	5-15
Anti-lock brake system (ABS).....	5-15
Electric power steering system (EPS).....	5-17
Active stability control (ASC).....	5-18
Cargo loads.....	5-20
Trailer towing.....	5-21

Starting and driving

Economical driving

E00600101092

For economical driving, there are some technical requirements that have to be met. In order to achieve longer life of the vehicle and the most economical operation, we recommend you to have the vehicle checked at regular intervals in accordance with the service standards.

Starting and acceleration

Avoid driving with the accelerator pedal is pushed way down, such as for unnecessarily sudden starts, acceleration and deceleration. Smoothly depress the accelerator pedal.

Observe the speed limit and keep the speed as constant as possible while driving.

Idling

Parking for a long period with the ready indicator illuminated will shorten the cruising range.

Speed

At higher vehicle speed, more traction battery is consumed. Avoid driving at full speed. Even a slight release of the accelerator pedal will save a significant amount of traction battery.

Tyre inflation pressure

Check the tyre inflation pressures at regular intervals. Low tyre inflation pressure increases road resistance. In addition, low tyre pressures adversely affect tyre wear and driving stability.

Cargo loads

Do not drive with unnecessary articles in the luggage compartment.

Air conditioning

Too much cooling/heating can affect the cruising range, so maintain an appropriate temperature to extend the cruising range.

Driving, alcohol and drugs

E00600200070

Driving after drinking alcohol is one of the most frequent causes of accidents.

Your driving ability can be seriously impaired even with blood alcohol levels far below the legal minimum. If you have been drinking, don't drive. Ride with a designated non-drinking driver, call a cab or a friend, or use public transportation. Drinking coffee or taking a cold shower will not make you sober. Similarly, prescription and nonprescription drugs affect your alertness, perception and reaction time. Consult with your doctor or pharmacist before driving while under the influence of any of these medications.

WARNING

- **NEVER DRINK AND DRIVE.**
Your perceptions are less accurate, your reflexes are slower and your judgment is impaired.

Safe driving techniques

E00600300635

Driving safety and protection against injury cannot be fully ensured. However, we recommend that you pay extra attention to the following:

Seat belts

Before starting the vehicle, make sure that you and your passengers have fastened your seat belts.

Floor mats

⚠ WARNING

- Keep floor mats clear of the pedals by correctly laying floor mats that are suitable for the vehicle.

To prevent the floor mats from slipping out of position, securely retain them using the hook etc.

Note that laying a floor mat over a pedal or laying one floor mat on top of another can obstruct pedal operation and lead to a serious accident.

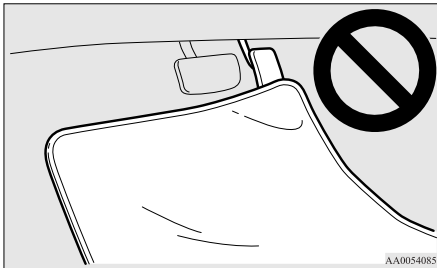

AA0054085

Carrying children in the vehicle

- Never leave your vehicle unattended with the key and children inside the vehicle. Children may play with the driving controls and this could lead to an accident.
- Make sure that infants and small children are properly restrained in accordance with the laws and regulations, and for maximum protection in case of an accident.
- Prevent children from playing in the luggage compartment. It is quite dangerous to allow them to play there while the vehicle is moving.

Loading luggage

When loading luggage, be careful not to load above the height of seats. This is dangerous not only because rearward vision will be obstructed, but also the luggage may be projected into the passenger compartment under hard braking.

Parking brake

E00600501647

To park the vehicle, first bring it to a complete stop, fully apply the parking lever sufficiently to hold the vehicle.

To apply the parking brake

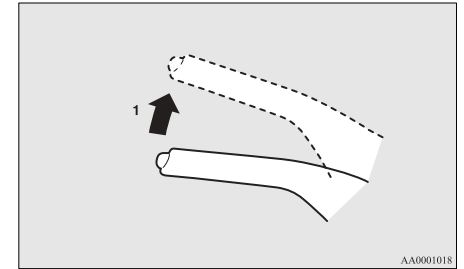

AA0001018

- 1- Firmly depress and hold the brake pedal, then pull the lever up without pushing the button at the end of hand grip.

⚠ CAUTION

- When you intend to apply the parking brake, firmly press the brake pedal to bring the vehicle to a complete stop before pulling the parking brake lever. Pulling the parking brake lever with the vehicle moving could make the rear wheels lock up, thereby making the vehicle unstable. It could also make the parking brake malfunction.

Starting and driving

NOTE

- Apply sufficient force to the parking brake lever to hold the vehicle stationary after the foot brake is released.
- If the parking brake does not hold the vehicle stationary after the foot brake is released, have your vehicle checked immediately.

To release the parking brake

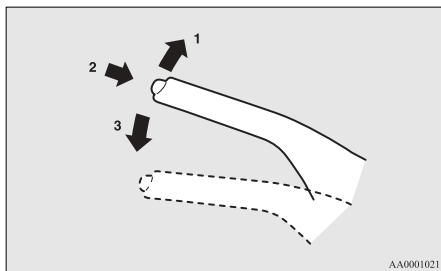

- 1- Firmly depress and hold the brake pedal, then pull the lever up slightly.
- 2- Push the button at the end of hand grip.
- 3- Lower the lever fully.

⚠ CAUTION

- Before driving, be sure that the parking brake is fully released and the brake warning lamp is off. If a vehicle is driven without releasing the parking brake, the brake will be overheated, resulting in ineffective braking and possible brake failure.

⚠ CAUTION

- If the brake warning lamp does not extinguish when the parking brake is fully released, the brake system may be malfunctioning. Have your vehicle checked immediately. For details, refer to “Brake warning lamp” on page 4-09.

Parking

E00600601534

To park the vehicle, fully engage the parking brake, and then move the selector lever to the “P” (PARK) position.

Parking on a hill

To prevent the vehicle from rolling, follow these procedures:

Parking on a downhill slope

Turn the front wheels towards the kerb and move the vehicle forward until the kerb side wheel gently touches the kerb.

Apply the parking brake and place the selector lever into the “P” (PARK) position.

If necessary, apply chocks to the wheels.

Parking on an uphill slope

Turn the front wheels away from the kerb and move the vehicle back until the kerb side wheel gently touches the kerb.

Apply the parking brake and place the selector lever into the “P” (PARK) position.

If necessary, apply chocks to the wheels.

NOTE

- Be sure to apply the parking brake before moving the selector lever to the “P” (PARK) position. If you move the selector lever to the “P” (PARK) position before applying the parking brake, it may be difficult to disengage the selector lever from the “P” (PARK) position when you next drive the vehicle, requiring application of a strong force to the selector lever to move it from the “P” (PARK) position.

Parking with the electric motor unit running

Never leave the electric motor unit running while you take a short sleep/rest.

⚠ WARNING

- Leaving the electric motor unit running risks injury or death from accidentally moving the selector lever.

Do not keep the steering wheel fully turned for a long time

More effort could be required to turn the steering wheel. Refer to “Electric power steering system (EPS)” on page 5-17.

When leaving the vehicle

Always carry the key and lock all doors and the tailgate when leaving the vehicle unattended.
Always try to park your vehicle in a well lit area.

Inside rear-view mirror

E00600800672

Adjust the rear-view mirror only after making any seat adjustments so you have a clear view to the rear of the vehicle.

⚠ WARNING

- Do not attempt to adjust the rear-view mirror while driving. This can be dangerous. Always adjust the mirror before driving.

Adjust the rear-view mirror to maximize the view through the rear window.

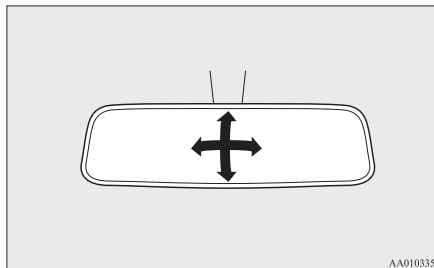

AA0103358

Outside rear-view mirrors

E00600900628

To adjust the mirror position

E00601000655

The outside rear-view mirrors can be operated when the electric motor switch is in the “ON” or “ACC” position.

⚠ WARNING

- Do not attempt to adjust the rear-view mirrors while driving. This can be dangerous. Always adjust the mirrors before driving.
- Your vehicle is equipped with convex type mirrors. Please take into consideration, that objects you see in the mirror will look smaller and farther away compared to a normal flat mirror. Do not use this mirror to estimate distance of following vehicles when changing lanes.

Starting and driving

1. Place the lever (A) to the same side as the mirror you wish to adjust.

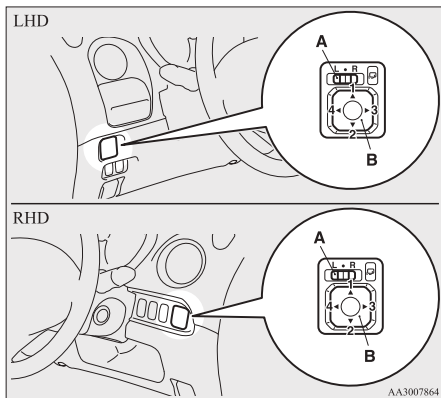

L- Left outside mirror adjustment
R- Right outside mirror adjustment

2. Press the switch (B) to the left, right, up or down to adjust the mirror position.
 - 1- Up
 - 2- Down
 - 3- Right
 - 4- Left
3. Return the lever (A) back to the middle position (•).

Retracting and extending the outside mirrors

E00601100669

The outside mirror can be folded in towards the side window to prevent damage when parking in narrow areas.

CAUTION

- Do not drive the vehicle with the mirror folded in. The lack of rearward visibility normally provided by the mirror could lead to an accident.

With the electric motor switch in the “ON” or “ACC” position, push the mirror retractor switch to retract the mirrors.

Push it again to extend the mirrors to their original positions.

After turning the electric motor switch to the “LOCK” position, it is possible to retract and extend the mirrors using the mirror retractor switch for about 30 seconds.

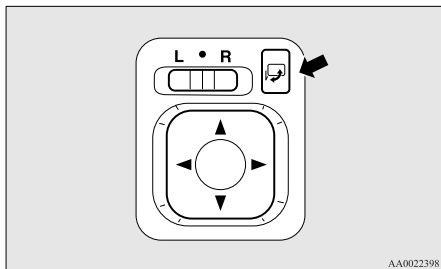

CAUTION

- It is possible to retract and extend the mirrors by hand. After retracting a mirror using the mirror retractor switch, however, you should extend it by using the switch again, not by hand. If you extended the mirror by hand after retracting it using the switch, it would not properly lock in position. As a result, it could move because of the wind or vibration while you are driving, taking away your rearward visibility.

NOTE

- Be careful not to get your hands trapped while a mirror is moving.
- The mirrors can be retracted or extended with the keyless entry system remote control switch. Refer to “Keyless entry system” on page 2-03.
- If you move a mirror by hand or it moves after hitting a person or object, you may not be able to return it to its original position using the mirror retractor switch. If this happens, push the mirror retractor switch to place the mirror in its retracted position and then push the switch again to return the mirror to its original position.
- When freezing has occurred and mirrors fail to operate as intended, please refrain from repeated pushing of the retractor switch as this action can result in burn-out of the mirror motor circuits.

Heated mirror*

E00601200514

To demist or defrost the outside rear-view mirrors, press the rear window demister switch.

The indication lamp (A) will illuminate while the demister is on.

The heater will be turned off automatically in about 20 minutes.

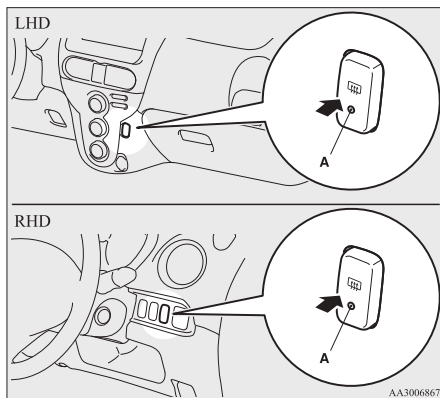
**NOTE**

- Since the demister requires a significant amount of power, stop the demister as soon as the window is demisted.

Electric motor switch

E00629400013

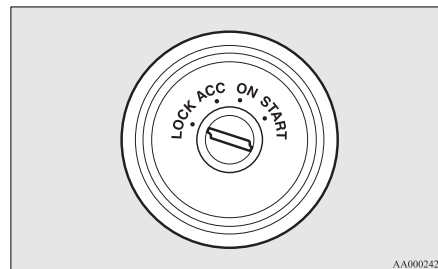
**LOCK**

The steering wheel is locked. The key can only be inserted and removed in this position.

ACC

The ready indicator is not illuminated, but the audio system and other electric devices can be operated.

ON

The electric motor unit is running, and all the vehicle's electrical devices can be operated.

START

The electric motor unit operates. After the electric motor unit has started, release the key and it will automatically return to the "ON" position.

NOTE

- Your vehicle is equipped with an electronic immobilizer.

To start the electric motor unit, the ID code which the transponder inside the key sends must match the one registered in the immobilizer computer. Refer to "Electronic immobilizer (Anti-theft starting system)" on page 2-02.

To remove the key

E00629500014

1. Set the selector lever to the "P" (PARK) position.
2. Turn the key to the "LOCK" position and remove it.

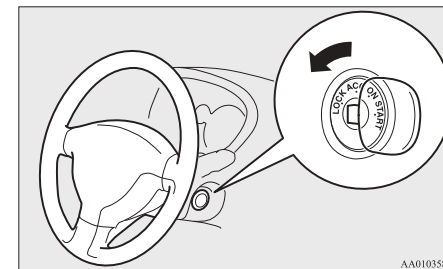

⚠ CAUTION

- If the ready indicator goes out while driving, the brake servomechanism will cease to function and braking efficiency will deteriorate. Also, the power steering system may not operate, the steering wheel feels heavy when turning it.
- When the ready indicator has turned off, turn the electric motor switch to the “LOCK” position.

Leaving the electric motor switch in the “ON” or “ACC” position and using electrical devices such as the audio system for a long time could cause the auxiliary battery to go flat and prevent the electric motor unit from being started.

Steering wheel lock

E00601500692

To lock

Remove the key at the “LOCK” position. Turn the steering wheel until it is locked.

To unlock

Turn the key to the “ACC” position while moving the steering wheel slightly right and left.

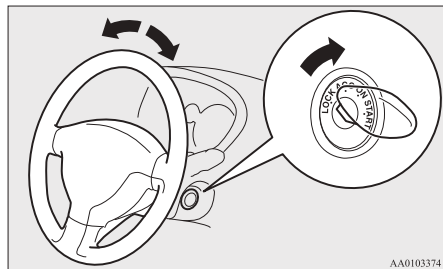

AA0103374

⚠ CAUTION

- Remove the key when leaving the vehicle. In some countries, it is prohibited to leave the key in the vehicle when parked.

Starting the electric motor unit

E00629300012

⚠ CAUTION

- Never attempt to start the electric motor unit by pushing or pulling the vehicle.

The starting procedure is as follows:

1. Insert the key in the electric motor switch and fasten the seat belt.
2. Make sure the parking brake is applied.
3. Depress and hold the brake pedal.
4. Make sure the selector lever is in the “P” (PARK) position.



AA0101989

NOTE

- The electric motor unit will not start unless the selector lever is in the “P” (PARK) position.

- Press the brake pedal with your right foot. Turn the electric motor switch fully, keep it in the “START” position for one to two seconds, and slowly return it to its original position. When you hear the startup sound and the ready indicator comes on, startup of the electric motor unit is complete.

NOTE

- If the ready indicator does not illuminate, return the electric motor switch to the “LOCK” position once. After a while, turn it to the “START” position to start the electric motor unit.
- To prevent a careless start, your vehicle is equipped with electric motor reminder. Refer to “Electric motor reminder” on page 5-09.

Electric motor reminder

E0063070029

If the driver’s door is opened while the key is in the “ON” position, the electric motor reminder buzzer sounds intermittently to remind the key is in the electric motor switch.

Selector lever reminder

E0063080017

If the driver’s door is opened while the selector lever is placed into the other positions from the “P” (PARK) position while the electric motor switch is on, the selector lever reminder buzzer sounds in the interval shorter than electric motor reminder buzzer.

Transmission

E00603200677

Selector lever operation

E00603301037

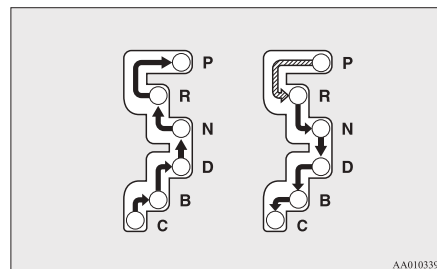
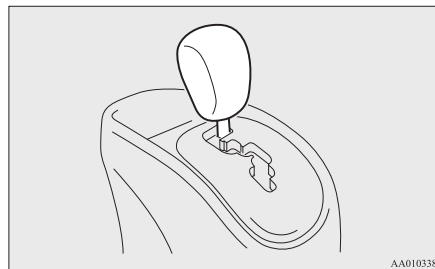

	While depressing the brake pedal, move the selector lever through the gate.
	Move the selector lever through the gate.

WARNING

- Always depress the brake pedal when shifting the selector lever into the other position from the “P” (PARK) or “N” (NEUTRAL) position. Never put your foot on the accelerator pedal while shifting the selector lever from the “P” (PARK) or “N” (NEUTRAL) position.

NOTE

- To avoid erroneous operation, move the selector lever firmly into each position and briefly hold it there. Always check the position shown by the selector lever position display after moving the selector lever.
- If the brake pedal is not depressed and held, the shift-lock device activates to prevent the selector lever from being moved from the “P” (PARK) position.

Starting and driving

Selector lever position indicator

E00603400028

When the electric motor switch is turned to the “ON” position, the position of the selector lever is indicated on the instrument cluster.

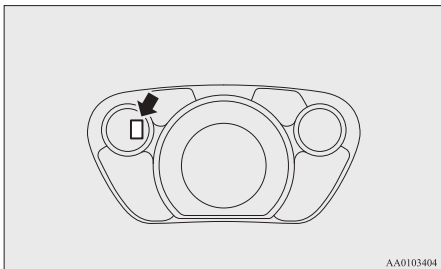

When the selector lever position indicator blinks

E00629600031

When the selector lever position indicator blinks while you are driving, there could be a malfunction in the transmission system.

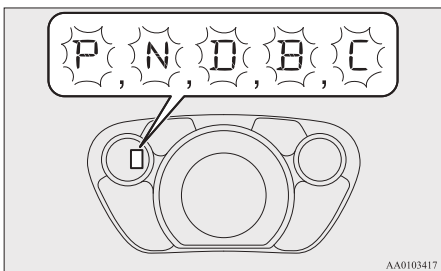

CAUTION

- If the selector lever position indicator blinks while you are driving, it is likely that a safety device is operating because of a malfunction in the transmission system. We recommend you to have your vehicle inspected as soon as possible.
- The selector lever position indicator warning function does not operate with the selector lever in the “R” (REVERSE) position.

Selector lever positions

E00603800644

“P” PARK

This position locks the transmission to prevent the vehicle from moving. The electric motor unit can be started in this position.

“R” REVERSE

This position is to back up.

CAUTION

- Never shift into the “P” (PARK) or “R” (REVERSE) position while the vehicle is in motion to avoid transmission damage.

“N” NEUTRAL

It should only be used when the vehicle is stationary for an extended length of time during driving, such as in a traffic jam.

WARNING

- Never move the selector lever to the “N” (NEUTRAL) position while driving. A serious accident could occur since you could accidentally move the lever into the “P” (PARK) or “R” (REVERSE) position or you will lose regenerative braking.
- On a gradient, the electric motor unit should be started in the “P” (PARK) position, not in the “N” (NEUTRAL) position.
- Always keep your right foot on the brake pedal when shifting into or out of “N” (NEUTRAL), to minimize the risk of loss of control.

“D” DRIVE

This position is for normal driving. Regenerative braking is automatically applied when necessary, depending on road conditions.

CAUTION

- Never shift into the “D” (DRIVE) position from the “R” (REVERSE) position while the vehicle is in motion to avoid transmission damage.

“B” BRAKE

This position gives stronger regenerative braking than the “D” (DRIVE) position. It increases the vehicle’s usability on hills and enables more energy-efficient driving. It is intended for downhill driving.

⚠ WARNING

- Avoid sudden regenerative braking when driving on wet or icy roads. Using sudden regenerative braking under these conditions could cause the vehicle to skid, resulting in a serious accident.

NOTE

- When the traction battery level is nearly full or the traction battery temperature is low, the regenerative braking performance may be weakened. In this case, drive the vehicle at a low speed.

“C” COMFORT

This position gives weaker regenerative braking than the “D” (DRIVE) position. It enables relaxed driving in circumstances in which you do not accelerate or decelerate much (for example, suburban driving). It is intended for long cruising.

Driving the vehicle

E00629700016

Operation of the transmission

E00629800020

⚠ CAUTION

- Before selecting a position with the electric motor unit running and the vehicle stationary, fully depress the brake pedal to prevent the vehicle from creeping. The vehicle will begin to move as soon as the transmission is engaged, the brakes should only be released when you are ready to drive away.
- Depress the brake pedal with the right foot at all times. Using the left foot could cause driver movement delay in case of an emergency.
- Operating the accelerator pedal while the other foot is resting on the brake pedal will affect braking efficiency and may cause premature wear of brake pads.

Waiting

E00630900018

For short waiting periods, such as at traffic signals the vehicle can be left in selector lever position and held stationary with the service brake.

For longer waiting periods with the electric motor unit running, place the selector lever in the “N” (NEUTRAL) position and apply the parking brake, while holding the vehicle stationary with the service brake.

⚠ CAUTION

- Never hold the vehicle stationary while in transmission on a hill with the accelerator, always apply the parking brake and/or service brake.

Parking

E00631000016

To park the vehicle, first bring it to a complete stop, fully engage the parking brake, and then move the selector lever to the “P” (PARK) position. If you are going to leave the vehicle unattended, always switch off the electric motor unit and carry the key.

NOTE

- On a slope, be sure to apply the parking brake before moving the selector lever to the “P” (PARK) position. If you move the selector lever to the “P” (PARK) position before applying the parking brake, it may be difficult to disengage the selector lever from the “P” (PARK) position when you next drive the vehicle, requiring application of a strong force to the selector lever to move it from the “P” (PARK) position.

Inspection and maintenance following rough road operation

E00606700383

After operating the vehicle in rough road conditions, be sure to perform the following inspection and maintenance procedures:

- Check that the vehicle has not been damaged by rocks, gravel, etc.
- Carefully wash the vehicle with water. Drive the vehicle slowly while lightly depressing the brake pedal in order to dry out the brakes. If the brakes still do not function properly, we recommend you to have the brakes checked as soon as possible.
- Remove the insects, dried grass, etc. clogging the radiator core.
- Check the inside of the vehicle. If water entry is found, dry the carpet etc.
- Inspect the headlamps. If the headlamp bulb is flooded with water, we recommend you to have it drained.

Acoustic Vehicle Alerting System (AVAS)

E00631600012

The Acoustic Vehicle Alerting System (AVAS) is a device that uses sound to alert pedestrians of the presence of the vehicle. The system operates when the vehicle speed is about 35 km/h (22 mph) or less. The sound starts when the AVAS is operated in the following conditions.

- When the vehicle speed is about 3 km/h (2 mph) or less and the brake pedal is not depressed.
- When the vehicle speed is about 3 km/h (2 mph) to 35 km/h (22 mph).

The sound does not start in the following cases.

- When the vehicle speed is about 3 km/h (2 mph) or less and the brake pedal is depressed.
- When the vehicle speed is about 35 km/h (22 mph) or more.
- When the selector lever is in the “P” (PARK) position.
- When the indication lamp (A) in the AVAS OFF switch illuminates.

Under normal conditions, the indication lamp (A) illuminates when the electric motor switch is turned to the “ON” position and goes off a few seconds later.

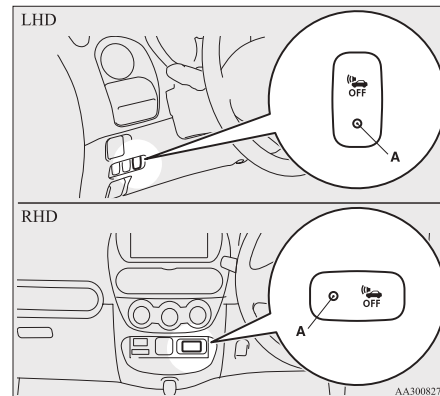

⚠ WARNING

- Even if the Acoustic Vehicle Alerting System (AVAS) sounds, pay special attention to pedestrians. Pedestrians may not notice the oncoming vehicle, which may cause an accident resulting in serious personal injury or death.

CAUTION

- Always confirm the indication lamp (A) goes off before driving. If the indication lamp (A) blinks, the electric motor switch is turned to the “LOCK” position and the electric motor switch is turned to the “ON” position again. It is not abnormal if the indication lamp (A) goes off. If the indication lamp (A) blinks again, have the vehicle inspected by a MITSUBISHI MOTORS Authorized Service Point as soon as possible.

AVAS OFF switch

E00631700013

If the electric motor switch is turned on, the AVAS is automatically turned on.

The AVAS should be turned on while normal driving.

When driving on the freeway etc., it is possible to turn off the AVAS by pressing the AVAS OFF switch.

If pressing the AVAS OFF switch, the audible alarm does not sound and indication lamp (A) illuminates.

If pressing the AVAS OFF switch once again, the AVAS is activated.

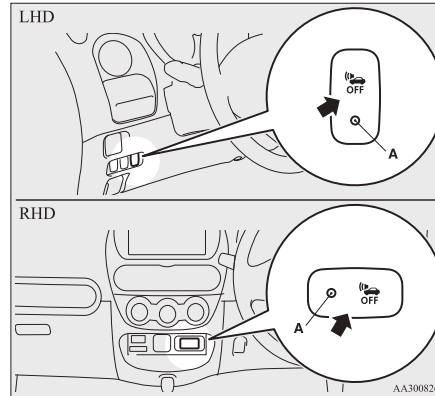

WARNING

- Never turn the Acoustic Vehicle Alerting System (AVAS) off if you are in a place where pedestrians might be present.

NOTE

- If the electric motor switch is turned to the “ACC” or “LOCK” position while the AVAS has been turned off, and the electric motor switch is turned to the “ON” position again, the AVAS is activated.

- If the AVAS OFF switch is continuously pressed after the AVAS is turned off, the incorrect operation prevention function works and the system turns on again.

Starting and driving

Braking

E00607001830

All the parts of the brake system are critical to safety. We recommend you to have the vehicle checked at regular intervals according to the service booklet.

CAUTION

- **Avoid driving habits that cause heavy braking and never “ride” the brakes by resting your foot on the brake pedal while driving. It causes brake overheating and fading.**

Brake system

The service brake is divided into two brake circuits. And your vehicle is equipped with power brakes. If one brake circuit fails, the other is available to stop the vehicle. If you should lose the power assist for some reason, the brakes will still work. In these situations, even if the brake pedal moves down to the very end of its possible stroke or resists being depressed, keep depressing the brake pedal down harder and further than usual; stop driving as soon as possible and have the brake system repaired.

WARNING

- **Do not turn off the electric motor unit while your vehicle is in motion. If you turn off the electric motor unit while driving, the power assistance for the braking system will stop working and your brakes will not work effectively.**

WARNING

- **If the power assist is lost or if either brake hydraulic system stops working properly, have your vehicle checked immediately.**

Warning lamp

The brake warning lamp illuminates to indicate a fault in the braking system. Refer to “Brake warning lamp” on page 4-09.

When brakes are wet

Check the brake system while driving at a low speed immediately after starting, especially when the brakes are wet, to confirm they work normally. A film of water can be formed on the brake discs or brake drums and prevent normal braking after driving in heavy rain or through large puddles, or after the vehicle is washed. If this occurs, dry the brakes out by driving slowly while lightly depressing the brake pedal.

When driving downhill

It is important to take advantage of regenerative braking by shifting to the “B” (BRAKE) position while driving on steep downhill roads in order to prevent the brakes from overheating.

WARNING

- **Do not leave any objects near the brake pedal or let a floor mat slide under it; doing so could prevent the full pedal stroke that would be necessary in an emergency. Make sure that the pedal can be operated freely at all times. Make sure the floor mat is securely held in place.**

Brake pad and linings

- **Avoid hard braking situations.**
New brakes need to be broken-in by moderate use for the first 200 km (125 miles).
- **The disc brakes are provided with a warning device which emits a shrieking metallic sound while braking if the brake pads have reached their wear limit. If you hear this sound, have the brake pads replaced immediately.**

WARNING

- **Driving with worn brake pads will make it harder to stop, and can cause an accident.**

Brake assist system

E00627000174

The brake assist system is a device assisting drivers who cannot depress the brake pedal firmly when it is necessary to do so (such as in emergency stop situations) and provides greater braking force.

If the brake pedal is depressed suddenly, the brakes will be applied with more force than usual.

CAUTION

- **The brake assist system is not a device designed to exercise braking force greater than its capacity. Make sure to always keep a sufficient distance between vehicles in front of you without relying too much on the brake assist system.**

NOTE

- Once the brake assist system is operational, it maintains great braking force even if the brake pedal is lightly released. To stop its operation, completely remove your foot from the brake pedal.
- The brake assist system may become operational when the brake pedal is fully depressed even if it has not been depressed suddenly.

- When the brake assist system is in use, you may feel as if the depressed brake pedal is soft, the pedal moves in small motions in conjunction with the sound of the ABS operation, or the vehicle body and the steering wheel vibrate. This occurs when the brake assist system is operating normally and does not indicate faulty operation. Continue to firmly depress the brake pedal.
- You may hear an operation noise when the brake pedal is depressed suddenly while stationary. This does not indicate a malfunction and the brake assist system is operating normally.

Anti-lock brake system (ABS)

E00607101394

The anti-lock brake system (ABS) helps prevent the wheels from locking during braking. This helps maintain vehicle drivability and steering wheel handling.

Driving hints

- Always keep a safe distance from the vehicle in front of you. Even if your vehicle is equipped with ABS, leave a greater braking distance when:
 - Driving on gravel or snow-covered roads.
 - Driving with tyre chains installed.
 - Driving on uneven road surfaces.
- Operation of ABS is not restricted to situations where brakes are applied suddenly. This system may also prevent the wheels from locking when you drive over manholes, steel roadwork plates, road markings, or any uneven road surface.
- When the ABS is activated, you may feel the brake pedal pulsation and the vibrations of the vehicle body and steering wheel. It may also feel as if the pedal resists being pressed. **In this situation, simply hold the brake pedal down firmly. Do not pump the brake, which will result in reduced braking performance.**
- An operation noise may be emitted from the bonnet room in the following situations. The sound is associated with checking the operations of the anti-lock brake system. At this time, you may feel a shock from the brake pedal if you depress it. These do not indicate a malfunction.
 - When the electric motor switch is turned to the “ON” position.

Starting and driving

- When the vehicle is driven for a while after the electric motor is turned on.
- The ABS can be used after the vehicle has reached a speed over approximately 10 km/h (6 mph). It stops working when the vehicle slows below approximately 5 km/h (3 mph).

A CAUTION

- The ABS cannot prevent accidents. It is your responsibility to take safety precautions and to drive carefully.
- To prevent failure of the ABS, be sure wheels and tyres are of the specified size and the same type.
- Do not install any aftermarket limited-slip differential (LSD) on your vehicle. The ABS may stop functioning properly.

ABS warning lamp

E00607201207

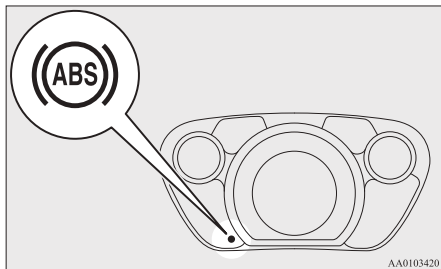

If there is a malfunction in the system, the ABS warning lamp will come on.

Under normal conditions, the ABS warning lamp only comes on when the electric motor switch is turned to the “ON” position and goes off a few seconds later.

A CAUTION

- Any of the following indicates that the ABS is not functioning and only the standard brake system is working. (The standard brake system is functioning normally.) If this happens, we recommend you to have your vehicle inspected as soon as possible.
 - When the electric motor switch is turned to the “ON” position, the warning lamp does not come on or it remains on and does not go off.
 - The warning lamp comes on while driving

If the warning lamp illuminates while driving

E00607301338

If only the ABS warning lamp illuminates

Avoid hard braking and high-speed driving. Stop the vehicle in a safe place, put the selector lever to the “P” (PARK) position and turn off the electric motor unit.

Restart the electric motor unit and check to see whether the lamp goes out after a few minutes driving; if it then remains off during driving, there is no problem.

However, if the warning lamp does not disappear, or if it comes on again when the vehicle is driven, we recommend you to have the vehicle checked.

If the ABS warning lamp and brake warning lamp illuminate at the same time

The ABS and brake force distribution function may not work, so hard braking could make the vehicle unstable.

Avoid hard braking and high-speed driving. Stop the vehicle in a safe place and we recommend you to have it checked.

NOTE

- The warning lamp may be illuminated when the electric motor unit is started while the auxiliary battery voltage is low, but this is not an ABS malfunction. When the traction battery is charged, the auxiliary battery is charged at the same time, and the warning lamp will go out. If the warning lamp does not go out or illuminates from time to time even after the battery is charged, have the vehicle inspected at a MITSUBISHI MOTORS Authorized Service Point.

After driving on icy roads

E00618800176

After driving on snowy or icy roads, remove any snow and ice which may have been left around the wheels. Be careful not to damage the wheel speed sensors (A) or the cables located at each wheel.

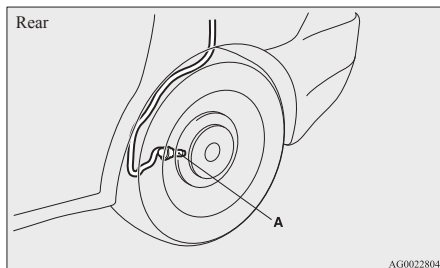
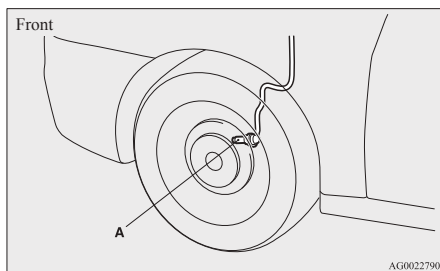

Electric power steering system (EPS)

E00629200138

The electric power steering system (EPS) uses an electric motor to assist the turning of the steering wheel.

The power steering system operates while the electric motor unit is running. It helps reduce the effort needed to turn the steering wheel.

The power steering system has mechanical steering capability in case the power assist is lost. If the power assist is lost for some reason, you will still be able to steer your vehicle. If the power assist is lost, you will notice it takes much more effort to steer and that there is much more “free play” in the steering wheel. If this happens, we recommend you to have your vehicle inspected.

WARNING

- Do not stop the electric motor unit while the vehicle is moving. Stopping the electric motor unit would make the steering wheel extremely hard to turn, possibly resulting in an accident.

NOTE

- During repeated full-lock turning of the steering wheel (for example, while you are manoeuvring the vehicle into a parking space), a protection function may be activated to prevent overheating of the power steering system. This function will make the steering wheel gradually harder to turn. In this event, limit your turning of the steering wheel for a while. When the system has cooled down, the steering action will return to normal.
- If you turn the steering wheel while the vehicle is stationary with the headlamps on, the headlamps may become dim. This behaviour is not abnormal. The headlamps will return to their original brightness after a short while.

Electric power steering system warning lamp

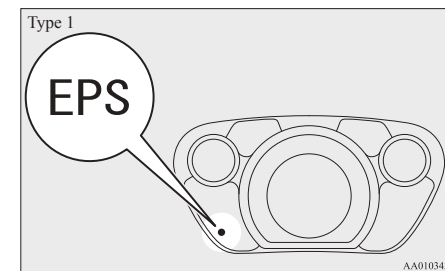

Starting and driving

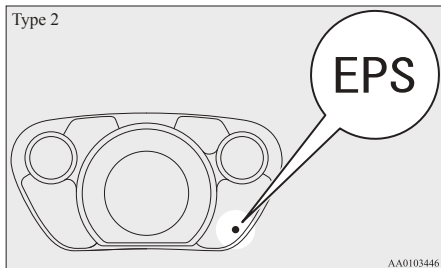

If there is a malfunction in the system, the warning lamp will come on.

Under normal conditions, the warning lamp comes on when the electric motor switch is turned to the “ON” position and goes off a few seconds later.

⚠ CAUTION

- If the warning lamp appears during driving, it may become harder to turn the steering wheel.

If the warning lamp appears while driving

1. Stop the vehicle in a safe place, put the selector lever to the “P” (PARK) position and turn off the electric motor unit.
2. Restart the electric motor unit to check whether the warning lamp goes out; if it then remains off, there is no problem.
If the warning lamp does not go out, or it appears again while driving, we recommend you to have your vehicle inspected.

Active stability control (ASC)

E00616700429

The Active Stability Control (ASC) takes overall control of the anti-lock brake system, traction control function and stability control function to help maintain the vehicle’s control. Please read this section in conjunction with the page on the anti-lock brake system, traction control function and stability control function.

Anti-lock brake system (ABS) → p. 5-15

Traction control function → p. 5-18

Stability control function → p. 5-19

⚠ CAUTION

- Do not over-rely on the ASC. Even the ASC cannot prevent the natural laws of physics from acting on the vehicle. This system, like any other system, has limits and cannot help you to maintain traction and control of the vehicle in all circumstances. Reckless driving may lead to accidents. It is the driver’s responsibility to drive carefully. This means taking into account the traffic, road and environmental conditions.
- Be sure to use the specified type and size of tyre on all 4 wheels. Otherwise, the ASC may not work properly.
- Do not install any aftermarket limited-slip differential (LSD) on your vehicle. The ASC may stop functioning properly.

NOTE

- An operation noise may be emitted from the bonnet room in the following situations. The sound is associated with checking the operations of the ASC. At this time, you may feel a shock from the brake pedal if you depress it. These do not indicate a malfunction.
 - When the electric motor switch is turned to the “ON” position.
 - When the vehicle is driven for a while after the electric motor is turned on.
- When the ASC is activated, you may feel a vibration in the vehicle body or hear a whining sound from the bonnet room. This indicates that the system is operating normally. It does not indicate a malfunction.
- When the anti-lock brake system warning lamp is illuminated, the ASC is not active.

Traction control function

E00619000087

On slippery surfaces, the traction control function prevents the drive wheels from spinning excessively, thus helping the vehicle to start moving from a stopped condition. It also provides sufficient driving force and steering performance as the vehicle turns while pressing the acceleration pedal.

⚠ CAUTION

- When driving a vehicle on a snowy or icy road, be sure to install snow tyres and drive the vehicle at moderate speeds.

Stability control function

E00619100088

The stability control function is designed to help the driver maintain control of the vehicle on slippery roads or during rapid steering manoeuvres. It works by controlling the electric motor unit output and the brake on each wheel.



NOTE

- The stability control function operates at speeds of about 15 km/h (9 mph) or higher.

“ASC OFF” switch

E00619200496

The ASC is automatically activated when the electric motor switch is turned to the “ON” position. You can deactivate the system by pressing down the “ASC OFF” switch for 3 seconds or longer.

When the ASC is deactivated, the  indication lamp will turn on. To reactivate the ASC, momentarily press the “ASC OFF” switch; the  indication lamp is turned off.

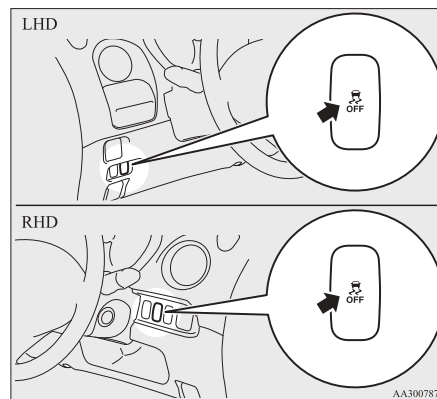

CAUTION

- For safety reasons, the “ASC OFF” switch should be operated when your vehicle is stopped.
- Be sure to keep the ASC on while driving in normal circumstances.

NOTE

- When moving out of mud, sand or fresh snow, pressing the accelerator pedal may not allow the electric motor speed to increase. In such situations, temporarily turning off the ASC with the “ASC OFF” switch will make it easier to move out your vehicle.
- Using the “ASC OFF” switch turns off both the stability control function and the traction control function.
- If you continue to press the “ASC OFF” switch after the ASC is turned off, the “mistaken operation protection function” will activate and the ASC will turn back on.

ASC indication lamp or ASC OFF indication lamp

E00619300556



ASC indication lamp

The indication lamp will blink when the ASC is operating.



ASC OFF indication lamp

This indication lamp will turn on when the ASC is turned off with the “ASC OFF” switch.



CAUTION

- When the  indication lamp blinks, ASC is operating, which means that the road is slippery or that your vehicle’s wheels are beginning to slip. If this happens, drive slower with less accelerator input.

Starting and driving

If the indication lamp illuminates while driving

E00631100017

If an abnormal condition occurs in the system, the  indication lamp and  indication lamp will turn on.

CAUTION

- The system may be malfunctioning. Stop the vehicle in a safe place, put the selector lever to the “P” (PARK) position and turn off the electric motor unit. Restart the electric motor unit and check whether the indication lamp goes out. If they go out, there is no abnormal condition. If they do not go out or appear frequently, it is not necessary to stop the vehicle immediately, but we recommend you to have your vehicle inspected.

Towing

E00624400089

CAUTION

- When towing the vehicle with only the front wheels raised off the ground, do not place the electric motor switch in the “ON” position. Placing the electric motor switch in the “ON” position could cause the ASC to operate, resulting in an accident.
Note that the correct towing method depends on the vehicle’s drive configuration. For details, refer to “Towing” on page 7-10.

Cargo loads

E00609901413

Cargo load precautions

CAUTION

- Do not load cargo or luggage higher than the top of the seatback. Be sure that your cargo or luggage cannot move once your vehicle is moving. Having the driver’s vision blocked, and your cargo being thrown inside the cabin if you suddenly have to brake can cause a serious accident or injury.
- Load heavy cargo or luggage in the front of the vehicle. If the load in the back of the vehicle is too heavy, steering may become unstable.

Loading a roof carrier

CAUTION

- Use a roof carrier that properly fits your vehicle. Do not load luggage directly onto the roof.
For installation, refer to the instruction manual accompanying the roof carrier.
- When attaching/removing the roof carrier and loading/removing luggage, do not apply excessive pressure on a single point. Depending on how and where the force is applied, this may cause dents on the vehicle roof.

NOTE

- We recommend you to use a genuine MITSUBISHI roof carrier.

Roof carrier precautions

⚠ CAUTION

- Make sure that the weight of the luggage does not exceed the allowable roof load (43 kg).
If the allowable roof load is exceeded, this may cause damage to the vehicle.
The roof load is the total allowable load on the roof (the weight of the roof carrier plus the weight of luggage placed on the roof carrier).
- When luggage is loaded onto the vehicle, please make sure to drive slowly and avoid excessive manoeuvres such as sudden braking or quick turning.
In addition, place the luggage on the carrier so that its weight is distributed evenly with the heaviest items on the bottom. Do not load items that are wider than the roof carrier.
The additional weight on the roof could raise the vehicle's centre of gravity and affect vehicle handling characteristics.
As a result, driving errors or emergency manoeuvres could lead to a loss of control and result in an accident.

⚠ CAUTION

- Before driving and after travelling a short distance, always check the load to make sure it is securely fastened to the roof carrier.
Check periodically during your travel that the load remains secure.

NOTE

- To prevent wind noise, remove the roof carrier when not in use.
- Remove the roof carrier before using an automatic car wash.
- Be sure that adequate clearance is maintained for raising the tailgate when installing a roof carrier.

Trailer towing

E00610000244

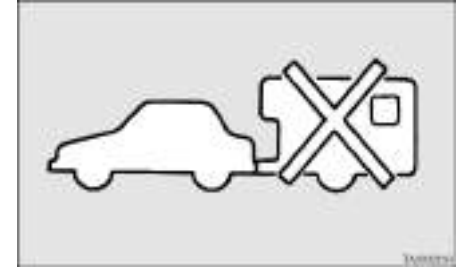

⚠ WARNING

- Do not use this vehicle for trailer towing. It may cause an accident or damage the vehicle.

A series of 15 horizontal dashed lines spanning the width of the page, providing a template for handwriting practice.

For pleasant driving

Remote Climate Control.....	6-02
Ventilators.....	6-02
Air conditioning.....	6-04
Important operation tips for the air conditioning.....	6-09
Air purifier.....	6-10
LW/MW/FM electronic tuning radio with CD player*.....	6-10
To play tracks from USB device*.....	6-20
Error codes.....	6-26
Error codes (iPod).....	6-27
Error codes (USB memory device).....	6-28
Handling of compact discs.....	6-29
Antenna.....	6-30
Digital clock*.....	6-31
Link System*.....	6-33
USB input terminal*.....	6-33
Sun visors.....	6-35
Accessory socket.....	6-36
Interior lamps.....	6-37
Storage spaces.....	6-39
Cup holder.....	6-40
Assist grips.....	6-41

For pleasant driving

Remote Climate Control

E00735400022

You can run the air conditioning in advance of using the vehicle.

For details, refer to “Remote Climate Control” on page 1-22.

Ventilators

E00700100911

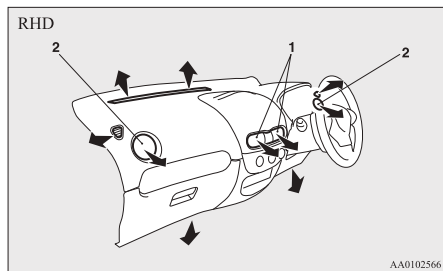
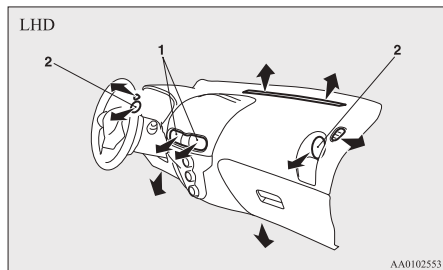

- 1- Centre ventilators
- 2- Side ventilators

NOTE

- Do not place beverages on top of the instrument panel. If they splash into the air conditioning ventilators, they could damage the system.

Air flow and direction adjustments

E00700200879

Centre ventilators

Move the knob (A) and ventilator to adjust.

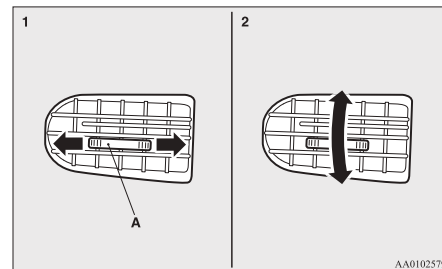

- 1- Left-right adjustment
- 2- Up-down adjustment

Side ventilators

When the dimple (A) is pressed, the ventilators open. To close the ventilators, press the dimple (B) on the opposite side.

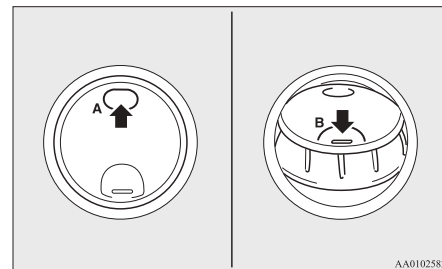

NOTE

- The cool air from the ventilators may appear as a mist. This is due to moist air being suddenly cooled by the air conditioning. This will clear after a few moments.
- Be careful not to spill drinks, etc., into the ventilators.
Doing so might cause the air conditioning not to function normally.

Mode selection dial

E00726500362

To change the amount of air flowing from the ventilators, turn the mode selection dial.

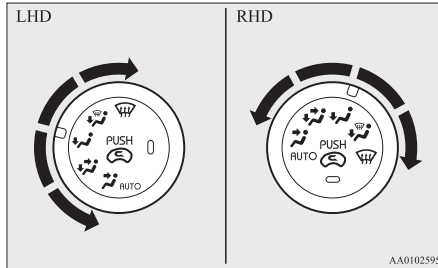

Face position

Air flows only to the upper part of the passenger compartment.

Foot/face position

Air flows to the upper part of the passenger compartment, and flows to the leg area.

Foot position

Air flows mainly to the leg area.

Foot/demister position

Air flows to the leg area, the windscreen and the door windows.

Demister position

Air flows mainly to the windscreen and the door windows.

“AUTO” position

The ventilators change to the following positions according to the position of the temperature control dial.
Refer to “Temperature control dial” on page 6-05.

Temperature control dial position	Ventilator
Between “C” and middle (•)	Upper part of the passenger compartment
Middle (•)	Set the dial to middle (•) from the “C” side Upper part of the passenger compartment
	Set the dial to middle (•) from the “H” side Leg area
Between middle (•) and “H”	Near middle (•) Leg area
	Near “H” Leg area, windscreen and door windows

CAUTION

- When using the mode selection dial between the “” and “” positions, prevent fogging by pressing the air selection switch to select outside air. (Refer to “Air selection switch” on page 6-05.)

NOTE

- With the mode selection dial between the “” and “” positions, the air flows mainly to the upper part of the passenger compartment. With the mode selection dial between the “” and “” positions, the air flows mainly to the leg area.
- With the mode selection dial between the “” and “” positions, the air flows mainly to the leg area. With the mode selection dial between the “” and “” positions, the air flows mainly to the windscreen and door windows.

For pleasant driving

Air conditioning

E00700500478

The air conditioning can only be used when the ready indicator is illuminated.

NOTE

- If the energy level gauge is at 0 bars or the power down warning lamp illuminates, the vehicle interior may not be cooled/heated even though the dial or switch is operated. Furthermore, the demist performance may also be reduced. Refer to “Energy level gauge” on page 4-06. Refer to “Power down warning lamp” on page 4-11.

Control panel

E00700600567

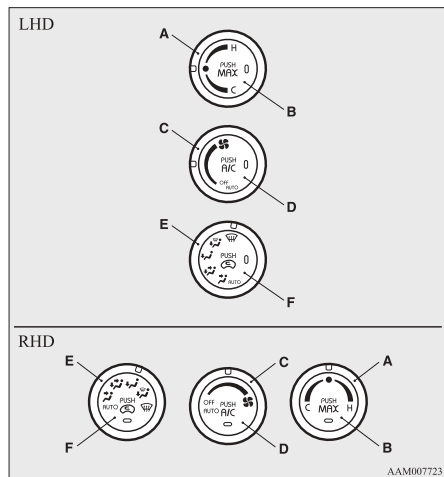

- A- Temperature control dial
- B- MAX switch
- C- Blower speed selection dial
- D- Air conditioning switch
- E- Mode selection dial
- F- Air selection dial

NOTE

- There is an interior air temperature sensor (G) in the illustrated position. Never place anything over the sensor, since doing so will prevent it from functioning properly.

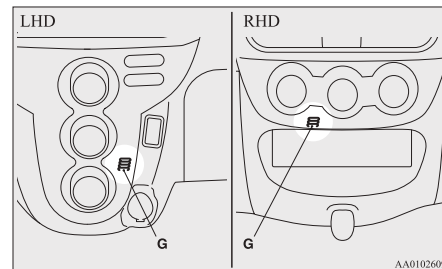

Blower speed selection dial

E00700700281

Select the blower speed by turning the blower speed selection dial clockwise or anticlockwise.

Turn the dial clockwise to increase the air flow and anticlockwise to decrease the air flow.

When the dial is set to the “AUTO” position, the air flow is adjusted automatically according to the temperature of the interior and the position of the temperature control dial.

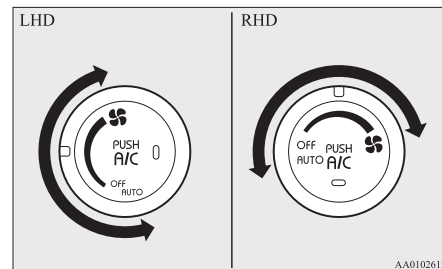

Temperature control dial

E00700900401

Turn the temperature control dial clockwise or anti-clockwise.

When the dial is set to the middle (•) position, only uncooled and unheated air will flow.

When the dial is moved to the middle (•) position when using cooling or heating, the cooling or heating stops.

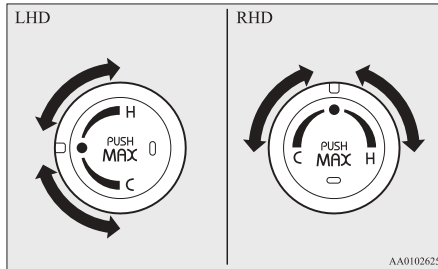

NOTE

- When the dial is moved from the middle (•) position to the left while the air conditioning is not operating, the air temperature will not change.
- When the dial is moved to the middle (•) position and then to the left while the air conditioning is operating, the air conditioning is operated again.

- When the temperature control dial is set to the “C” position, the air selection dial changes automatically to the recirculation position and the air conditioning operates.

When the dial is moved thereafter, the air conditioning continues to operate and the air selection setting returns to the setting before the dial was set to the “C” position.

Air selection switch

E00701300747

To change the air selection, simply press the air selection switch.

- Outside air: Indication lamp (A) is OFF
Outside air is introduced into the passenger compartment.
- Recirculated air: Indication lamp (A) is ON
Air is recirculated inside the passenger compartment.

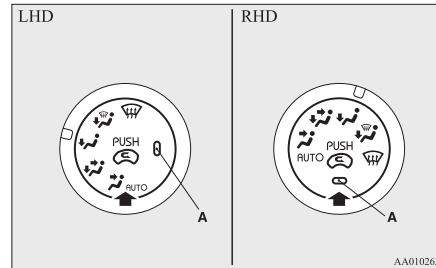

CAUTION

- Normally, use the outside position to keep the windscreen and side windows clear and quickly remove fog or frost from the windscreen.
If high cooling performance is desired, or if the outside air is dusty or otherwise contaminated use the recirculation position. Switch to the outside position periodically to increase ventilation so that the windows do not become fogged up.
- Use of the recirculation position for extended time may cause the windows to fog up.

Air conditioning switch (Air conditioning)

E00701500954

Push the switch to turn the air conditioning on, the indication lamp (A) will come on.

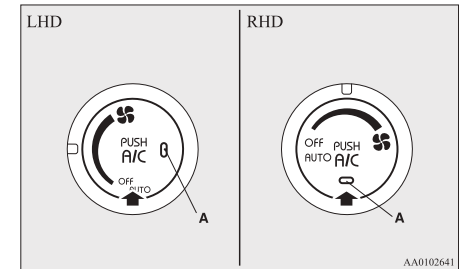

Push the switch again to switch it off.

For pleasant driving

MAX switch

E00765300017

When the blower speed selection dial is not OFF and the MAX switch is pressed, the indication lamp (A) illuminates and cooling/heating performance and the air conditioning setting is changed according to the temperature control dial position. When the switch is pressed again, the operation returns to the mode before pressing the switch.

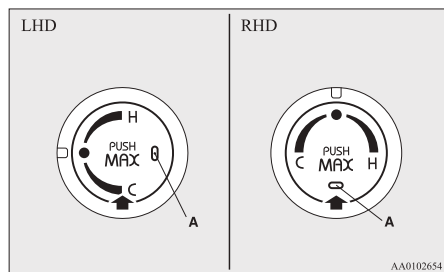

When the temperature control dial is set between the middle (•) and the “H” position
The heating capability is the maximum.

When the temperature control dial is in the middle (•) position
The air flow is the maximum.

When the temperature control dial is set between the “C” and the middle (•) position
The air conditioning automatically operates and the cooling capability is the maximum.

NOTE

- When the blower speed selection dial or temperature control dial is operated with the indication lamp illuminated, the indication lamp goes out and the selected function overrides others. Other functions return to the mode before pressing the MAX switch.
- When the air conditioning is operated with the MAX switch, the air conditioning does not stop if the function is cancelled.
- Do not use the cooling/heating function with the MAX switch for a long time. Since the power consumption is larger than cooling/heating not using the MAX switch, the cruising range is shortened.

Operating the air conditioning system

E00701800465

Heating

1. Set the mode selection dial to the “” position
2. Set the selection switch (A) to the outside position.
3. Turn the temperature control dial clockwise or anticlockwise to the desired temperature between the middle (•) and “H” position.

4. Select the desired blower speed.

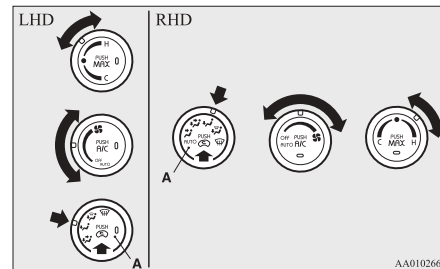

NOTE

- When the blower speed selection dial is set to the “AUTO” position, the air flow is adjusted automatically according to the temperature of the interior and the position of the temperature control dial.

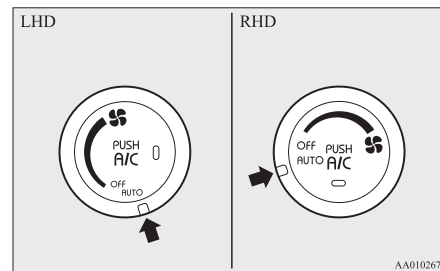

Quick heating

1. Set the mode selection dial to the “” position.

- Set the air selection switch (A) to the outside position.
- Turn the temperature control dial clockwise or anticlockwise between the middle (•) position and “H” position.
- Turn the blower speed selection dial to any position other than “OFF” position.
- Press the MAX switch (B).

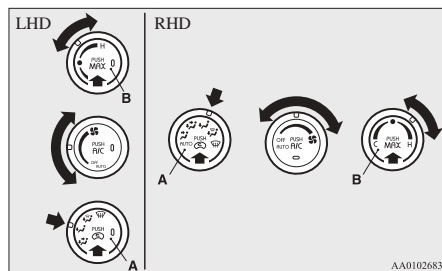

NOTE

- Do not use the heating function with the MAX switch for a long time. Since the power consumption is larger than heating not using the MAX switch, the cruising range is shortened.

Cooling

E00701900714

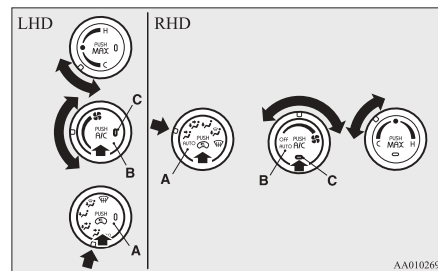

- Set the mode selection dial to the “A/C” position.
- Set the air selection switch (A) to the outside position.
- Turn the temperature control dial clockwise or anticlockwise to the desired temperature between the middle (•) and “C” position.
- Select the desired blower speed.
- Push the air conditioning switch (B).
- When the air conditioning is operating, the switch indication lamp (C) illuminates.

 **CAUTION**

- If the outside air is dusty or otherwise contaminated, or if high-cooling performance is desired, set the air selection switch to the recirculation position and the temperature control dial all the way to the left. Switch to the outside position periodically to increase ventilation so that the windows do not become fogged up.

NOTE

- When the blower speed selection dial is set to the “AUTO” position, the air flow is adjusted automatically according to the temperature of the interior and the position of the temperature control dial.

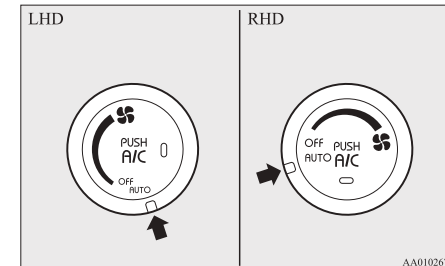

For pleasant driving

Quick cooling

E00765400018

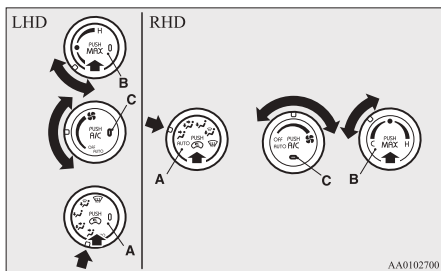

1. Set the mode selection dial to the “” position.
2. Set the air selection switch (A) to the recirculation position.
3. Turn the temperature control clockwise or anticlockwise between the middle (•) and “C” position.
4. Turn the blower speed selection dial to any position other than “OFF” position.
5. Press the MAX switch (B).

The air conditioning automatically operates and the indication lamp (C) illuminates.

NOTE

- Do not use the cooling function with the MAX switch for a long time. Since the power consumption is larger than cooling not using the MAX switch, the cruising range is shortened.

Demisting of the windscreen and door windows

E00702100830

CAUTION

- For safety, make sure you have a clear view through all the windows.

Use the mode selection dial (“” or “”) to remove frost or mist from the windscreen or door windows, and to heat the leg area.

For ordinary demisting

Perform the following settings to prevent misting of the windscreen and door windows, and to heat the leg area.

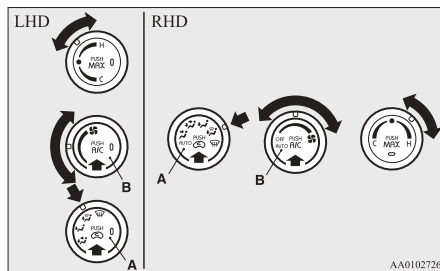

1. Set the air selection switch (A) to the outside position.
2. Set the mode selection dial to the “” position.
3. Turn the temperature control dial clockwise or anticlockwise to the desired temperature between the middle (•) and “H” position.
4. Select the desired blower speed.
5. Push the air conditioning switch (B).

For quick demisting

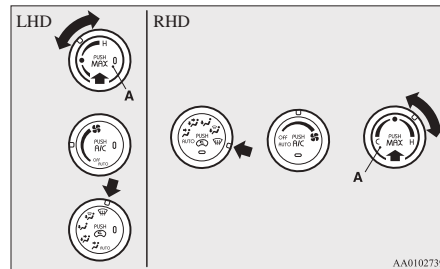

1. Set the mode selection dial to the “” position.
2. Turn the temperature control dial clockwise or anticlockwise to the desired temperature between the middle (•) and “H” position.
3. Press the MAX switch (A).

NOTE

- When the mode selection dial is in the “” position, the system operates automatically and outside air is set automatically.
- To demist effectively, direct the air flow from the side ventilators towards the door windows.
- Do not set the temperature control dial to the max. cool position. Cool air will blow against the window glasses and prevent demisting.
- Since demisting or defrosting with the MAX switch consumes the power greatly, stop the switch after demisting or defrosting. Use for a long time may shorten the cruising range.

Introduction of outside air

E00702200424

To introduce air into the vehicle during hot weather, follow these procedures:

1. Set the mode selection dial to any position other than “WH” position.
2. Turn the temperature control dial to the middle (•) position.
3. Set the air selection switch (A) to the outside position.
4. Select the desired blower speed.

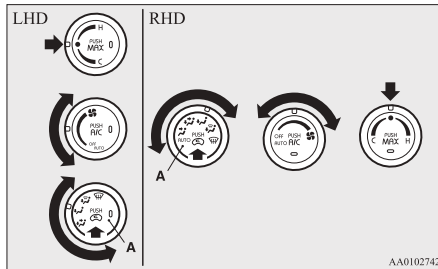
**NOTE**

- When the temperature control dial is turned to the middle (•) position while the air conditioning is operating, the air conditioning turns off.

Important operation tips for the air conditioning

E00708301020

- Park the vehicle in the shade.
Parking in the hot sun will make the vehicle inside extremely hot, and it will require more time to cool the interior.
If it is necessary to park in the sun, open the windows for the first few minutes of air conditioning operation to expel the hot air.
- Close the windows when the air conditioning is in use.
The entry of outside air through open windows will reduce the cooling efficiency.
- Too much cooling is not good for the health.
Keep the difference between the vehicle interior temperature and outside temperature to 5 to 6 °C.
- When operating the system, make sure the air intake, which is located in front of the windscreen, is free of obstructions such as leaves and snow. Leaves collected in the air-intake plenum may reduce air flow and plug the plenum water drains.
- Too much cooling/heating can affect the cruising range, so maintain an appropriate temperature to extend the cruising range.

Air conditioning system refrigerant and lubricant recommendations

If the air conditioning seems less effective than usual, the cause might be a refrigerant leak. We recommend you to have the system inspected.

The air conditioning system in your vehicle must be charged with the refrigerant HFC-134a and the lubricant POE MA68EV.

Use of any other refrigerant or lubricant will cause severe damage which will result in the need to replace your vehicle's entire air conditioning system. The release of refrigerant into the atmosphere is not recommended.

The new refrigerant HFC-134a in your vehicle will not harm the ozone layer.

We recommend you to recover and recycle the refrigerant for reuse.

During a long period of disuse

The air conditioning should be operated for at least five minutes each week, even in cold weather. This is to prevent the compressor from seizing and to maintain the air conditioning in the best operating condition.

For pleasant driving

Air purifier

E00708400561

An air filter has been incorporated into the air conditioning so that pollen and dust are cleaned from the air.

Replace the air filter periodically as its ability to clean the air will be reduced as it collects pollen and dirt. For the maintenance interval, refer to the "SERVICE BOOKLET".

NOTE

- Operation in certain conditions such as driving on a dusty road and frequent use of the air conditioning can lead to reduction of service life of the filter. When you feel that the air flow is lower than normal or when the air flow is lower than normal or when the windscreen or windows start to fog up easily, replace the air filter.
We recommend you to have it checked.

LW/MW/FM electronic tuning radio with CD player*

E00708502250

The audio system can be used when the electric motor switch is in the "ON" or "ACC" position.

NOTE

- To listen to the audio system while the electric motor unit is stopped, turn the electric motor switch to the "ACC" position.
- If a cellular phone is used inside the vehicle, it may create noise from the audio equipment. This does not mean that anything is wrong with your audio equipment. In such a case, use the cellular phone at a place as far away as possible from the audio equipment.
- If foreign objects or water get into the audio equipment, or if smoke or a strange odour comes from it, immediately turn off the audio system. We recommend you to have it checked. Never try to repair it by yourself. Avoid continuous usage without inspection by a qualified person.

Volume and tone control panel

E00708601153

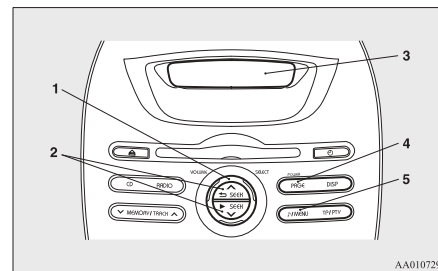

AA0107297

- 1- VOLUME (Volume control) knob
- 2- SEEK (Audio adjust) button
- 3- Display
- 4- POWER (On-Off) button
- 5-  (Mode change) button

To adjust the volume

E00708700678

Turn the VOLUME knob clockwise to increase the volume; anticlockwise to decrease the volume. The status will be displayed in the display.

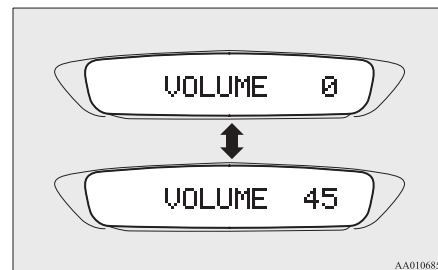

AA0106854

NOTE

- The volume control mode will shut off automatically if another mode is selected, or if no adjustment is made within about 2 seconds.

To adjust the tone

E00708801285

1. Press the **▶** button repeatedly to select the tone, balance and SCV (Speed Compensated Volume) function control to change. The order is: BASS → TREBLE → FADER → BALANCE → SCV → Audio adjust mode OFF
2. Press the SEEK button to change the tone, balance and SCV function setting. The status will be displayed in the display.

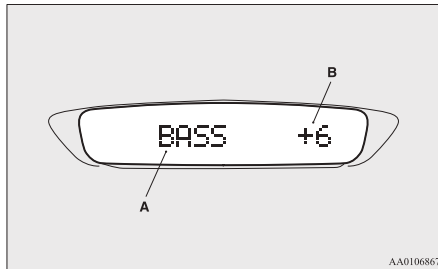

- A- Adjust mode
B- Adjust level

Adjust mode	Adjust level	Adjusting operation	
		Λ	V
BASS	-6 to 6	Stronger	Weaker
TREBLE		Stronger	Weaker
FADER	F11 to R11	F (Front) increases	R (Rear) increases
BALANCE	L11 to R11	R (Right) increases	L (Left) increases
SCV	HIGH, MID, LOW, OFF	HIGH ↑ MID ↑ LOW ↑ OFF	HIGH ↓ MID ↓ LOW ↓ OFF

BASS (Bass tone control)

To select the desired bass level.

TREBLE (Treble tone control)

To select the desired treble level.

FADER (Front/Rear balance control)

To balance the volume from the F (front) and the R (rear) speakers.

BALANCE (Left/Right balance control)

To balance the volume from the L (left) and the R (right) speakers.

NOTE

- Keep the FADER setting in the middle position. Since no rear speakers are connected, adjusting the FADER setting towards the “R” side will result in loss of sound output.

SCV (Speed Compensated Volume) function

The Speed Compensated Volume function is a feature that automatically adjusts the VOLUME, BASS and TREBLE settings in accordance with the vehicle speed.

The effects of the SCV function can be selected either of three levels (LOW, MID and HIGH). Select the degree of your choice by pressing the SEEK button.

If you want to stop the SCV function, select the OFF.

NOTE

- The audio adjust mode will automatically shut off when another mode is selected, or if no adjustment is made within about 10 seconds.

For pleasant driving

Radio control panel and display

E00708901231

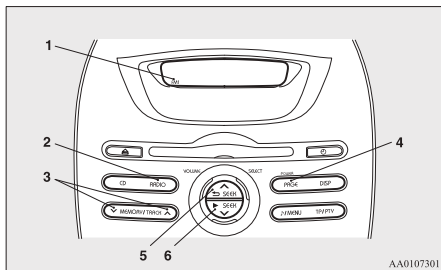

- 1- FM (FM1/FM2/FM3) indicator
- 2- RADIO (FM/MW/LW selection) button
- 3- MEMORY (Memory selection) button
- 4- POWER (On-Off) button
- 5- SEEK \blacktriangle (Up-seek) button
- 6- SEEK \blacktriangledown (Down-seek) button

To listen to the radio

E00709000900

1. Press the POWER button until it beeps to turn the audio system on and off. The system turns on in the last mode used.
2. Press the RADIO button to select the desired band.
3. Press the SEEK button to tune to a station, or press the MEMORY button either \blacktriangle or \blacktriangledown to recall a station memorised.

To tune the radio

E00709100640

Automatic tuning

After pressing the SEEK button, a receivable station will be automatically selected and reception of the station will begin.

Manual tuning

The frequency changes every time the SEEK button is pressed. Press the button to select the desired station.

To enter frequencies into the memory

E00716101186

Manual setting

You can assign a maximum of 18 stations in the FM band (6 FM1, 6 FM2 and 6 FM3 stations) and 6 stations each in the MW and LW band to the MEMORY button. (Stations already assigned to the MEMORY button are replaced by any newly assigned stations.)

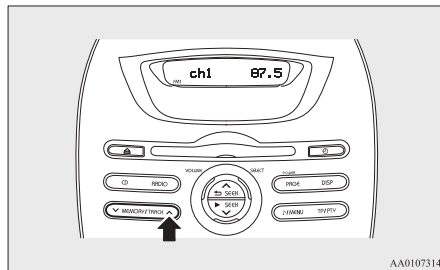

Follow the steps described below.

1. Press the SEEK button to tune to the frequency you wish to keep in the memory.

2. Press the MEMORY button either \blacktriangle or \blacktriangledown until it beeps. The sound will be momentarily interrupted while the frequency is being entered into the memory.
3. The preset memory setting is retrieved by pressing the button and then releasing it within 2 seconds.

NOTE

- Disconnecting the auxiliary battery terminal erases all the radio frequencies stored in the memory.

Automatic setting

With the method, all manually set stations in the band currently selected for reception are replaced with stations in the same band that are automatically selected in order of signal strength. The radio automatically selects 6 stations in the FM band (FM3 station only) and 6 stations each in the MW and LW band.

Follow the steps described below.

1. With the radio mode selected, hold down the RADIO button for 2 seconds or longer. The 6 stations with the best signal strength will automatically be assigned to the MEMORY button, with the lowest-frequency station being assigned to the lowest-number.
2. When you subsequently press a MEMORY button to select a channel number, the radio will begin receiving the station assigned to that number.

NOTE

- If you press the RADIO button for 2 seconds or longer while tuning in the FM1 or FM2 band, the radio will automatically switch to the FM3 band, where the automatic seeking/ tuning will be activated.

Radio data system (RDS)

E00709200478

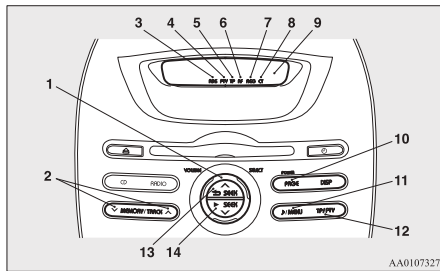

AA0107327

- 1- SELECT knob
- 2- MEMORY button
- 3- RDS (Radio data system) indicator
- 4- PTY (Program type) indicator
- 5- TP (Traffic program identification) indicator
- 6- AF (Alternative Frequencies) indicator
- 7- REG (Regional program) indicator
- 8- CT (Clock time) indicator
- 9- Display
- 10- POWER (On-Off) switch
- 11- MENU button
- 12- TP (Traffic program)/PTY (Program type) button
- 13- SEEK ▲ (Up-step/Up-seek) button
- 14- SEEK ▼ (Down-step/Down-seek) button

RDS uses PI (program identification) signal and AF (alternative frequency) list transmitted in addition to the normal FM broadcasting programs, and picks up the FM stations that are transmitting the same program from the AF list and automatically tunes to the station with the strongest signal intensity.

Therefore, you can continue listening to one program in, for example, a long distance driving without retuning to the other station transmitting the same program when you are leaving the service area of the currently receiving station.

The RDS radio also features the limited reception of the program types, the break-in reception of the traffic announcement to the EON (enhanced other network) and emergency broadcast, and the limited/unlimited reception of the regional programs.

AF (Alternative Frequencies) function

E00720900175

The AF function finds a station broadcasting the same program and selects the station with the strongest signal of AF lists.

The AF function is turned on (with the AF indicator shown on the display) at all times unless you manually switch it off.

The AF function can be turned ON and OFF.

Refer to “Function setup mode” on page 6-15.

CT (Clock Time) function

E00721000160

The clock can be set automatically by using the signal from the local RDS stations. Refer to “Digital clock” on page 6-31.

REG (Regional) function

E00721100057

REG function limits to receive the stations broadcasting regional programs.

Regional programming and regional networks are organized differently depending on the country or area (they may be changed according to the hour, state, or broadcast area), so if you don’t want to receive the regional programs automatically, you can set up REG ON not to receive regional programs.

The REG function can be turned ON and OFF.

Refer to “Function setup mode” on page 6-15.

PI (Program Identification) search function

E00721200289

When travelling long distance and the recalled preset station is weak, the radio searches another frequency broadcasting the same programming with the same PI code in AF list.

If there are no frequencies broadcasting the same programming, the radio searches a frequency broadcasting the regional programming. The radio succeeds in searching the regional programming, then the display shows the REG indicator.

If the radio does not succeed in searching the regional programming, the radio returns to the recalled preset station.

The PI function can be turned ON and OFF.

Refer to “Function setup mode” on page 6-15.

NOTE

- While searching, the audio system is muted. The display shows “WAIT” or “SEARCH”.

PTY (Program type)

E00721300352

RDS broadcasts are classified according to program type (PTY) as follows. Use the SELECT knob to select your desired PTY.

1. NEWS
2. AFFAIRS (Current affairs)

For pleasant driving

3. INFO (Information)
4. SPORT
5. EDUCATE (Education)
6. DRAMA
7. CULTURE
8. SCIENCE
9. VARIED
10. POP M (Pop music)
11. ROCK M (Rock music)
12. EASY M (Easy music)
13. LIGHT M (Light classics)
14. CLASSICS
15. OTHER M (Other music)
16. WEATHER (Weather information)
17. FINANCE
18. CHILDREN
19. SOCIAL
20. RELIGION
21. PHONE IN
22. TRAVEL
23. LEISURE
24. JAZZ
25. COUNTRY
26. NATION M (National music)
27. OLDIES
28. FOLK M (Folk music)
29. DOCUMENT

To search for a broadcast of desired program type:

1. Press the TP/PTY button.
2. Turn the SELECT knob to select your desired PTY.
3. Two seconds after a desired PTY has been selected, the radio will begin to search for a broadcast of your selected PTY. During search, the selected PTY on the display blinks.
4. When the radio picks up a station with your desired PTY, the display will show the name of the station.

NOTE

- If the SEEK button is pressed for more than 1 second, the radio will try to find out another broadcast of the same program type as currently selected.
- If no station is found with your desired PTY, the display will show “EMPTY” for about 5 seconds and the radio will return to the previous station.

How to enter PTYs in the memory

E00721400164

As many as 6 PTYs can be entered in the memory. Follow the steps described below.

1. Turn the SELECT knob to tune the PTY to be entered in the memory.
2. Press the MEMORY button for 2 seconds or longer. The channel number to the entry into the memory and the PTY are displayed.
3. The preset memory setting is retrieved by pressing the MEMORY button and then releasing it within about 2 seconds.

To change the language of PTY display

E00721500240

You can select your favourite language among English, French, German, Swedish, Spanish and Italian.

1. Press the MENU button for 2 seconds or longer to select the language of PTY display mode.
Refer to “Function setup mode” on page 6-15.

2. Press the SEEK button to select a language.

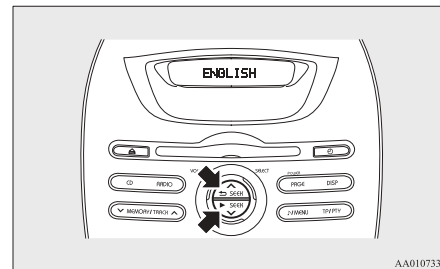

NOTE

- After selecting a mode, you can leave the function setup mode by taking either of the following steps:
 - Press the MENU button for at least 2 seconds.
 - Make no entry for 10 seconds.

Traffic information

E00721600267

The radio will automatically tune in to traffic information broadcasts while receiving FM broadcasts or playing compact discs etc.

To select this function, follow the instructions below.

1. Press the TP/PTY button. The display will show TP indicator. If the RDS data can be read, the display will show RDS indicator. If not, the display will show “NO RDS” for about 5 seconds.

- If the radio detects traffic information on either the station currently selected or another station, the display will show “TRAF INF” for 5 seconds followed by a 2-second indication of the frequency. Then, it will show the name of the station broadcasting the traffic information to which you will listen. The volume level is set separately for listening to normal audio programs and for listening to traffic information. The volume level will therefore change automatically to that set when traffic information was last received. When the traffic information broadcast is over, the radio will return to the previously received program and to the corresponding volume level.
- Press the TP/PTY button to return to the previous condition.

NOTE

- While “TP” is illuminated, the radio stops only at TP stations even if the SELECT knob is turned.

TP (Traffic information Program) search function

E00721800201

The traffic information program standby function is turned on (with the TP indicator shown on the display) and after about 45 seconds since the RDS indicator turns off due to weak signal or the tuning station is changed over from a TP station to a station which does not broadcast traffic information, and seeks out a TP station in all frequencies automatically.

The TP search function can be turned ON and OFF. Refer to “Function setup mode” on page 6-15.

Emergency broadcasts

E00721700255

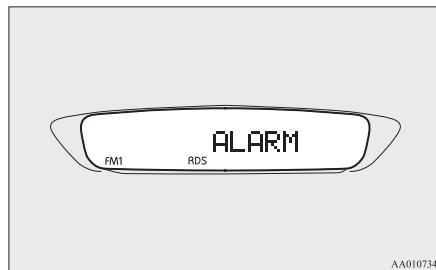

If an emergency broadcast is caught while receiving a FM broadcast or playing back a compact disc with the electric motor switch in the “ACC” or “ON” position, the display will show “ALARM” and the emergency broadcast will interrupt the current program. The volume level is set separately for listening to normal audio programs and for listening to emergency broadcasts. The volume level will therefore change automatically to that set when an emergency broadcast or traffic information broadcast was last received. When the emergency broadcast is over, the radio will return to the previously received program and to the corresponding volume level.

Function setup mode

E00722500452

It is possible to change the following functions:

- AF
- REG*
- TP-S
- PI-S*
- Language of PTY display

- Press the MENU button for 2 seconds or longer to select the function setup mode.

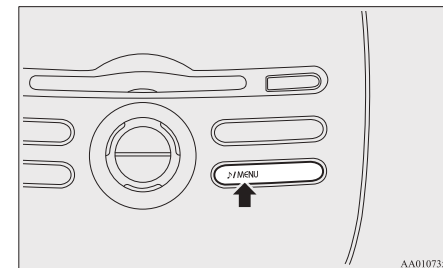

- Press the MENU button repeatedly to select the mode you wish to change.
The order is: AF → REG* → TP-S → PI-S* → Language of PTY display → Function setup mode OFF.
- Select the desired setting for each mode to be turned ON and OFF as shown below.

For pleasant driving

The setting will be shown on the display.

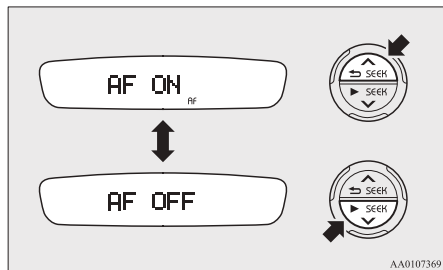

NOTE

- After selecting a mode, you can leave the function setup mode by taking either of the following steps:
 - Press the MENU button for at least 2 seconds.
 - Make no entry for 10 seconds.

CD control panel and display

E00709501218

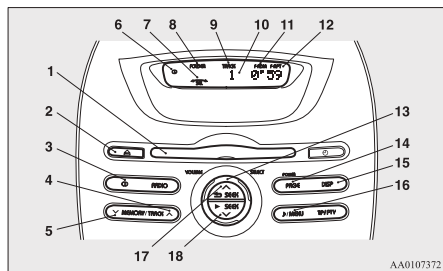

- 1- Disc-loading slot
- 2- Eject button
- 3- CD (CD mode changeover) button
- 4- TRACK ▲ (Fast-forward/Track up) button
- 5- TRACK ▼ (Fast-reverse/Track down) button
- 6- CD indicator
- 7- SEL (Select mode) indicator
- 8- FOLDER indicator
- 9- TRACK indicator
- 10- Display
- 11- RDM/F-RDM indicator
- 12- RPT/F-RPT indicator
- 13- SELECT knob
- 14- POWER (On-Off) button/PAGE (Title scroll) button
- 15- DISP (Title display) button
- 16- MENU button
- 17- SEEK ▲ (Up-seek) button/↵ (Return) button
- 18- SEEK ▼ (Down-seek) button/▶ (Select) button

To listen to a CD

E00709602304

To set a disc

1. Press the POWER button until it beeps to turn the audio system ON and OFF. The system turns on in the last mode used.
2. Insert disc with label facing up. When a disc is inserted, the CD indicator will come on and the CD player will begin playing even if the radio is being used. The CD player will also begin playing when the CD button is pressed with a disc set in the CD player or in the disc loading slot, even if the radio is being used.

NOTE

- For information concerning the adjustment of volume and tone, refer to "To adjust the volume" on page 6-10 and "To adjust the tone" on page 6-11.
- An 8 cm compact disc cannot be played on this CD player.
- For information concerning the handling of the compact discs, refer to "Handling of compact discs" on page 6-29.

To eject a disc

When the eject button is pressed, the disc automatically stops and is ejected. The system automatically switches to radio mode.

NOTE

- If you do not remove an ejected disc before 15 seconds have elapsed, the disc will be re-loaded.

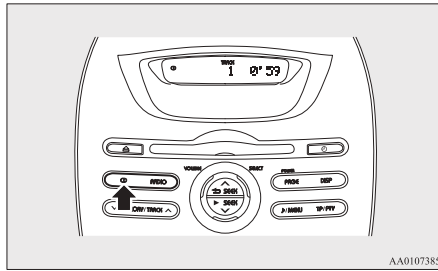
To listen to a music CD

Push the CD button if a disc is already in the CD player. The audio system will enter CD mode and start playback. The track number and the playing time will appear on the display. The tracks in the disc will be played consecutively and continuously.

To listen to an MP3 CD

This CD player allows you to play MP3 (MPEG Audio Layer-3) files recorded on CD-ROMs, CD-Rs (recordable CDs), and CD-RWs (rewritable CDs) in ISO9660 Level 1/Level 2, Joliet, and Romeo formats. Each disc may have a maximum of 16 trees, 100 folders and 255 files. During MP3 playback, the unit can display ID3 tag information. For information concerning ID3 tag, refer to “CD text and MP3 title display” on page 6-19.

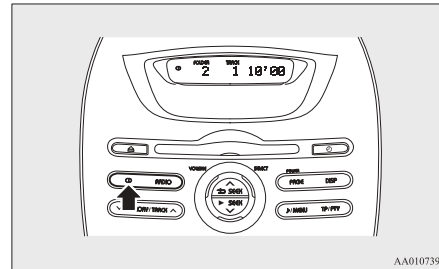

Push the CD button if a disc is already in the CD player. The display shows “READING”, then playback begins. The folder number, the track number and the playing time will appear on the display.

NOTE

- While listening to a disc on which CD-DA (CD-Digital Audio) and MP3 files have both been recorded, you can switch between reading of the CD-DA, reading of the MP3 files, and the external audio input mode by pressing the CD button for 2 seconds or longer (until you hear a beep).
- With a disc that contains both CD-DA and MP3 files, the CD-DA files are automatically played first.
- The playback sound quality differs depending on the encoding software and the bit rate. For details, refer to the user manual of your encoding software.
- Depending on file/folder configurations on a disc, it may take some time before playback starts.
- MP3 encoding software and writing software are not supplied with this unit.
- You may encounter trouble in playing an MP3 or displaying the information of MP3 files recorded with certain writing software or CD recorders (CD-R/RW drivers).
- If you record too many folders or files other than MP3 onto a disc, it may take some time before playback starts.
- This unit does not record MP3 files.
- For information on CD-Rs/RWs, refer to “Notes on CD-Rs/RWs” on page 6-29.

⚠ CAUTION

- Attempting to play a file not in the MP3 format which has a “.mp3” file name may produce noise from the speakers and speaker damage, and can damage your hearing.

Folder selection order/MP3 file playback order (Example)

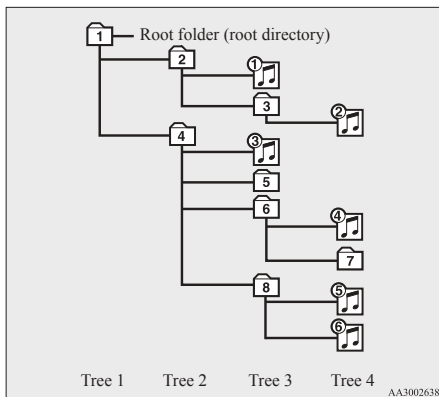

Folder selection

In the order

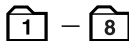

File selection

In the order



To fast-forward/fast-reverse the disc

To fast forward or fast reverse the disc, press the TRACK **▲** button or the TRACK **▼** button.

Fast-forward

You can fast-forward the disc by pressing the TRACK **▲** button. While the button is kept pressed, the disc will be fast-forwarded.

Fast-reverse

You can fast reverse the disc by pressing the TRACK **▼** button. While the button is kept pressed, the disc will be fastreversed.

To select a desired track

You can select your desired track by using the TRACK button.

Track up

Press the TRACK **▲** button repeatedly until the desired track number appears on the display. When listening to an MP3 CD, keep pressing the button to continue to move up tracks.

Track down

Press the TRACK **▼** button repeatedly until the desired track number appears on the display. When listening to an MP3 CD, keep pressing the button to continue to move down tracks.

NOTE

- Pressing the TRACK **▼** button once during the song will cause the CD player to restart playback from the beginning of the song.

To find a file (MP3 CDs only)

Operate the following buttons or the SELECT knob to select the desired file.

When this mode is activated by pressing the **↔** button, the SEL indicator will be displayed in the display.

- ↔** button : Press the button to start this mode or cancel the selection.
- SELECT knob : Turn the knob to show the folder or file.
- ▶** button : Press the button to select the folder or file.

NOTE

- If no operation is performed for 10 seconds or more or another button is operated after the SELECT knob has been turned, searching of the desired file is cancelled.
- If no operation is performed for 5 seconds or more after the file is displayed, playback starts.
- When the SEL indicator is not shown on the display and the SELECT knob is operated, the volume adjustment is effective.

To select the playing mode

1. Press the MENU button until you hear a beep.

E00765900013

2. Press the SEEK Δ/V button repeatedly to select the mode.

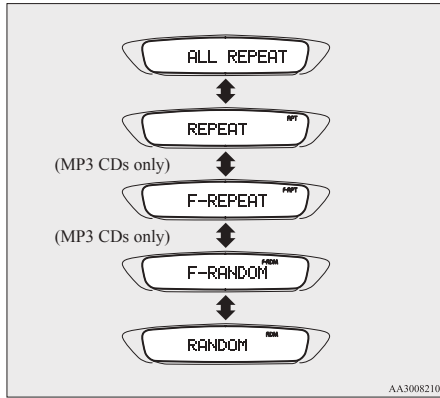

3. Press the MENU button until you hear a beep. The selected mode will operate.

To play tracks in repeat

E00766000011

Repeat all tracks (normal playback)

Select the ALL REPEAT mode. Refer to “To select the playing mode” on page 6-18. All tracks on the disc will be played repeatedly.

Repeat a track

Select the REPEAT mode. Refer to “To select the playing mode” on page 6-18. The RPT indicator will come on and repeat the same track.

Repeat tracks in the same folder (MP3 CDs only)

Select the F-REPEAT mode. Refer to “To select the playing mode” on page 6-18. The F-RPT indicator will come on and all tracks in the currently selected folder will be played repeatedly.

NOTE

- With a disc that contains both CD-DA and MP3 files, the repeat mode causes only files of the same format (CD-DA only or MP3 files only) to be repeated.

To play tracks in random order

E00766100012

Random playback for a disc (music CDs only)

Select the RANDOM mode. Refer to “To select the playing mode” on page 6-18. The RDM indicator will come on and the tracks on the disc will be played in a random sequence.

Random playback for a folder (MP3 CDs only)

Select the F-RANDOM mode. Refer to “To select the playing mode” on page 6-18. The F-RDM indicator will come on and the tracks on the currently selected folder will be played in a random sequence.

Random playback for all folders on a disc (MP3 CDs only)

Select the RANDOM mode. Refer to “To select the playing mode” on page 6-18. The RDM indicator will come on and the files from all the folders on the disc will be played in random sequence.

NOTE

- With a disc that contains both CD-DA and MP3 files, the repeat mode causes only files of the same format (CD-DA only or MP3 files only) to be repeated.

CD text and MP3 title display

E00725000689

This audio system can display CD text and MP3 titles, including ID3 tag information.

CD text

The audio system can display disc and track titles for discs with converted disc and track title information. Press the DISP button repeatedly to make selections in the following sequence: disc name → track name → normal display mode.

NOTE

- The display can show up to 11 characters. If a disc name or track name has more than 11 characters, press the PAGE button to view the next 11 characters.
- When there is no title information to be displayed, the display shows “NO TITLE”.
- Characters that the audio system cannot display are shown as “ ”.

MP3 title

The audio system can display folder and track titles for discs with converted folder and track information. Press the DISP button repeatedly to make selections in the following sequence: folder name → track name → normal display mode.

ID3 tag information

The audio system can display ID3 tag information for files that have been recorded with ID3 tag information.

For pleasant driving

1. Press the DISP button for 2 seconds or longer to switch to the ID3 tag information. “TAG” will appear on the display.
2. Press the DISP button repeatedly to make selections in the following sequence: album name → track name → artist name → normal display mode.

NOTE

- To return from ID3 tag information to the folder name, press the DISP button again for 2 seconds or longer.
- When there is no title information to be displayed, the display shows “NO TITLE”.
- The display can show up to 11 characters. If a folder name, track name, or item of ID3 tag information has more than 11 characters, press the PAGE button to view the next 11 characters.
- Folder names, track names and ID3 tag information can each be displayed up to a length of 32 characters.
- Characters that the audio system cannot display are shown as “ ”.

To play tracks from USB device*

E00756100211

You can connect your iPod or USB memory device to the USB input terminal and play music files stored in the iPod or USB memory device.

See the following section for the types of connectable devices and supported files.

Refer to “Types of connectable devices and supported file specifications” on page 6-34.

See the following sections for the connecting methods, “How to connect an iPod” on page 6-34 and “How to connect a USB memory device” on page 6-33.

NOTE

- A file protected by copyright may not be able to playback.
- It is recommended to adjust the equalizer of the connected device to 0 db or neutral.

iPod control panel and display

E00756200244

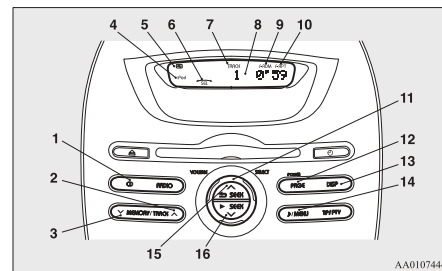

- 1- CD (CD mode changeover) button
- 2- TRACK ▲ (Fast-forward/Track up) button
- 3- TRACK ▼ (Fast-reverse/Track down) button
- 4- iPod indicator
- 5- (USB device active) indicator
- 6- SEL (Select mode) indicator
- 7- TRACK indicator
- 8- Display
- 9- RDM/F-RDM indicator
- 10- RPT/F-RPT indicator
- 11- SELECT knob
- 12- POWER (On-Off) button/PAGE (Title scroll) button
- 13- DISP (Title display) button
- 14- MENU button
- 15- SEEK ▲ (Up-seek) button/↵ (Return) button
- 16- SEEK ▼ (Down-seek) button/▶ (Select) button

To play from an iPod

E00756300385

1. Press the POWER button to turn on the audio system. The system turns on in the last mode used.
2. Connect your iPod to the USB input terminal. Refer to “How to connect an iPod” on page 6-34.
3. Press the CD button to switch to the iPod mode. The mode changes every time the CD button is pressed.
CD mode → iPod mode → CD mode
The iPod indicator is illuminated and then the iPod mode will be activated.
4. Once the device is selected, playback starts and  indicator appears on the display.

NOTE

- Depending on the condition of your iPod, it may take a longer time before the playback starts.
5. To stop the playback, change over to a different mode.

NOTE

- Buttons on the iPod are disabled while the iPod is connected to the audio system.
- To adjust the volume and tone, refer to “To adjust the volume” and “To adjust the tone”.

To fast-forward/reverse the track

E00756400126

Fast-forward

To fast-forward the current track, press the TRACK  button. While the button is pressed, the track will be fast-forwarded.

Fast-reverse

To fast-reverse the current track, press the TRACK  button. While the button is pressed, the track will be fast-reversed.

To select a desired track

E00756500101

Track up

Press the TRACK  button repeatedly until the desired track number appears on the display.

Track down

Press the TRACK  button repeatedly until the desired track number appears on the display.

NOTE

- Pressing the TRACK  button once during the song will cause the audio system to restart playback from the beginning of the song.



To find a track from the iPod menu

E00756600199

You can select desired tracks from the “Playlists”, “Artists”, “Albums” or “Songs” menus on your iPod.

Operate the following buttons or knob to select desired tracks.

When this mode is activated by pressing the  button, the SEL indicator will be displayed in the display.



-  button : Press the button to start this mode or cancel the selection.
- SELECT knob : Turn the knob to show the menu or category or track.
-  button : Press the button to select the menu or category or track.

NOTE

- If no operation is performed for 10 seconds or more or other button is operated after the SELECT knob has been pressed, searching of the desired tracks is cancelled.
- If no operation is performed for 5 seconds or more after the track is displayed, playback starts.
- If the  button is pressed when the category is deleted, playback of the first tracks in the selected category starts.
- When the SEL indicator is not shown on the display and the SELECT knob is operated, the volume adjustment is effective.

To select the playing mode

E00769200014

1. Press and hold the MENU button until you hear a beep.
2. Press the MENU button repeatedly to select the playing mode you wish to change to. The order is: REPEAT mode → SHUFFLE mode → mode off.
3. Press the SEEK  /  button repeatedly to select the mode.

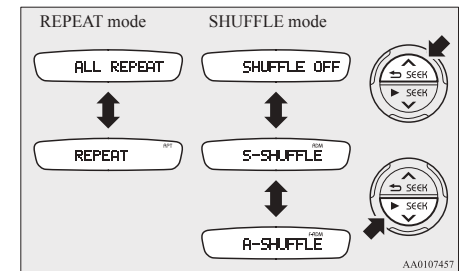

For pleasant driving

4. Press the MENU button until you hear a beep. The selected mode will operate.

NOTE

- When the SHUFFLE OFF mode is selected in the SHUFFLE mode, the random playback is cancelled.

To play tracks in repeat

E00769300015

Repeat all tracks (normal playback)

Select the ALL REPEAT mode. Refer to “To select the playing mode” on page 6-21. All tracks will be played repeatedly.

Repeat a track

Select the REPEAT mode. Refer to “To select the playing mode” on page 6-21. The RPT indicator will come on and repeat the same track.

To play tracks in random order

E00756900105

Random playback

Select the S-SHUFFLE mode, and the RDM indicator will come on. Refer to “To select the playing mode” on page 6-21.

The iPod randomly selects tracks from the current category and plays the selected tracks.

Random playback for each album

Select the A-SHUFFLE mode, and the F-RDM indicator will come on. Refer to “To select the playing mode” on page 6-21.

The iPod randomly selects tracks in the album from the current category and play the selected tracks.

To switch the display

E00757100117

The display changes as follows every time the DISP button is pressed during playback.

Album title → Track name → Artist name → Normal display

NOTE

- Up to 11 characters are shown in the display at once. If the title is cut off in the middle, press the PAGE button (5). The next characters are displayed every time this button is pressed.
- If no title is stored, “NO TITLE” is shown in the display.
- Characters that cannot be displayed are substituted by “ ”.

USB control panel and display

E00758100244

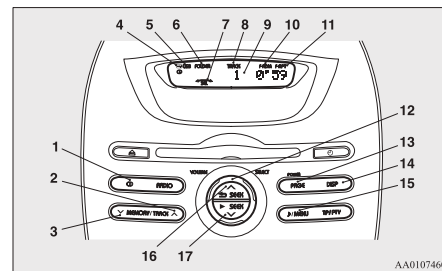

- 1- CD (CD mode changeover) button
- 2- TRACK ▲ (Fast-forward/Track up) button
- 3- TRACK ▼ (Fast-reverse/Track down) button
- 4- USB device active indicator
- 5- USB indicator
- 6- FOLDER indicator
- 7- SEL (Select mode) indicator
- 8- TRACK indicator
- 9- Display
- 10- RDM/F-RDM indicator
- 11- RPT/F-RPT indicator
- 12- SELECT knob
- 13- POWER (On-Off) button/PAGE (Title scroll) button
- 14- DISP (Title display) button
- 15- MENU button
- 16- SEEK ▲ (Up-seek) button/↩ (Return) button
- 17- SEEK ▼ (Down-seek) button/▶ (Select) button

To play from a USB memory device

E00762500379

1. Press the POWER button to turn on the audio system. The system turns on in the last mode used.
2. Connect your USB memory device to the USB input terminal.
Refer to “How to connect a USB memory device” on page 6-33.
3. Press the CD button to switch to the USB mode. The mode changes as follows every time the CD button is pressed.
CD mode → USB mode → CD mode
The USB indicator is illuminated and then the USB mode will be activated.
4. Once the device is selected, playback starts and the indicator appears on the display.

NOTE

- Depending on the condition of your USB device, it may take a longer time before the playback starts.
5. To stop the playback, change over to a different mode.

NOTE

- To adjust the volume and tone, refer to “To adjust the volume” and “To adjust the tone”.

Supported compressed music files

E00758300376

This audio can play MP3, WMA, AAC and WAV files recorded in a USB memory device. This audio supports up to 65,535 files in 700 folders on 8 levels.

Folder selection order/file playback order (example)

The folder and file hierarchy in the USB memory device is shown below.

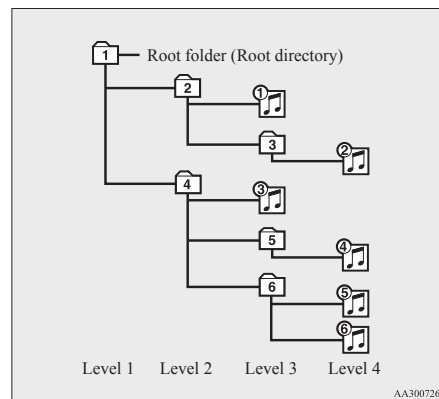

Folder selection

In the order

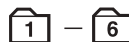

File selection

In the order



NOTE

- If a file protected by copyrights is played, the file will be skipped.

To fast-forward/reverse the file

E00758400104

Fast-forward

To fast-forward the current file, press the TRACK **Λ** button. While the button is pressed, the file will be fast-forwarded.

Fast-reverse

To fast-reverse the current file, press the TRACK **∇** button. While the button is pressed, the file will be fast-reversed.

To select a file

E00758500105

File up

Press the TRACK **Λ** button repeatedly until the desired file number appears on the display.

File down

Press the TRACK **∇** button repeatedly until the desired file number appears on the display.

NOTE

- Pressing the TRACK **∇** button once during the song will cause the audio system to restart playback from the beginning of the song.

To find a file

E00758600324

Operate the following buttons or the SELECT knob to select the desired file.

When this mode is activated by pressing the **➡** button, the SEL indicator will be displayed in the display.

For pleasant driving

- ↵ button : Press the button to start this mode or cancel the selection.
- SELECT knob : Turn the knob to show the folder or file.
- ▶ button : Press the button to select the folder or file.

NOTE

- If no operation is performed for 10 seconds or more or another button is operated after the SELECT knob has been turned, searching of the desired file is cancelled.
- If no operation is performed for 5 seconds or more after the file is displayed, playback starts.
- When the SEL indicator is not shown on the display and the SELECT knob is operated, the volume adjustment is effective.

To select the playing mode

E00769400016

1. Press the MENU button until you hear a beep.

2. Press the SEEK Δ /V button repeatedly to select the mode.

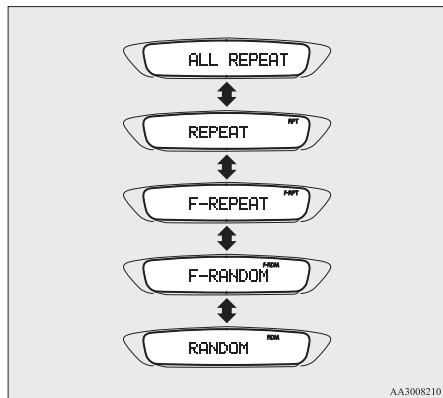

3. Press the MENU button until you hear a beep. The selected mode will operate.

To play tracks in repeat

E00769500017

Repeat all tracks (normal playback)

Select the ALL REPEAT mode. Refer to “To select the playing mode” on page 6-24. All tracks will be played repeatedly.

Repeat a track

Select the REPEAT mode. Refer to “To select the playing mode” on page 6-24. The RPT indicator will come on and repeat the same track.

Repeat tracks in the same folder

Select the F-REPEAT mode. Refer to “To select the playing mode” on page 6-24. The F-RPT indicator will come on and all tracks in the currently selected folder will be played repeatedly.

To play tracks in random order

E00769600018

Random playback for a folder

Select the F-RANDOM mode. Refer to “To select the playing mode” on page 6-24. The F-RDM indicator will come on and the tracks on the currently selected folder will be played in a random sequence.

Random playback for all folders

Select the RANDOM mode. Refer to “To select the playing mode” on page 6-24. The RDM indicator will come on and the files from all the folders will be played in random sequence.

To switch the display

E00759300201

The display changes as follows every time the DISP button is pressed during playback. Folder title → File title → Normal display

ID3 tag information

1. Press and hold the DISP button until you hear a beep to show “TAG” in the display.
2. The display changes as follows every time the DISP button is pressed briefly: Album title → Track title → Artist name → Normal display

NOTE

- Press and hold the DISP button again until you hear a beep, and the tag information display returns to the folder title display.
- Up to 11 characters are shown in the display at once. If the title is cut off in the middle, press the PAGE button. The next characters are displayed every time this button is pressed.
- If no title is stored, “NO TITLE” is shown in the display.
- Characters that cannot be displayed are substituted by “ ”.

Error codes

E00710101328

If an error code appears in the display, take action in accordance with the table below.

Error display	Problem	Item	Repair
NO DISC	No disc inserted	Disc is not in CD player.	Insert disc.
CHECK DISC	Focus error	Disc is not loaded correctly, or condensation on disc.	Insert disc with label facing up. Remove moisture from disc.
DISC ERROR	Disc error	Disc is dirty, scratched, or deformed; or excessive vehicle vibration.	Clean or replace disc. Retry when vibrations stop.
INTERNAL E	Mechanism error	Loading or eject error. Pick-up is out of position.	Eject disc and reload. If disc will not eject, have the equipment inspected.
HEAT ERROR	Inside of audio system is hot.	Internal protection against high temperatures.	Allow radio to cool by waiting about 30 minutes.
ERROR DC	DC offset output voltage	Foreign material is inside the radio or amplifier.	Consult a MITSUBISHI MOTORS Authorized Service Point.
ERROR	Communication or power supply error	Communication error between external device and audio equipment. Power supply error of external device.	Consult a MITSUBISHI MOTORS Authorized Service Point.

Error codes (iPod)

E00763500060

If an error code appears in the display, take action in accordance with the table below.

Error display	Item	Repair
NO SONG	There are no playable music files.	Record music files in the iPod.
VER ERROR (Blink)	The iPod or its software cannot be recognized.	Connect a supported iPod.
USB BUS PWR (Blink)	An overcurrent or other power-supply error has occurred.	Remove the iPod. Have the vehicle inspected at a MITSUBISHI MOTORS Authorized Service Point.
CONNECT RETRY (Blink)	If the iPod indicator illuminates, the iPod cannot be authenticated.	Reconnect the iPod.
	If the iPod indicator goes out, it shows the USB communication error.	Reconnect the iPod correctly. If this error is displayed again, have the vehicle inspected at a MITSUBISHI MOTORS Authorized Service Point.

Error codes (USB memory device)

E00763600061

If an error code appears in the display, take action in accordance with the table below.

Error display	Item	Repair
U NO SONG	There are no playable music files.	Record music files in the format supported by the USB memory device.
U FILE ERROR (Blink)	The file cannot be played.	The file is protected by copyrights, etc. An error is displayed for several seconds, and then the next playable file is played automatically.
UNSUPPORTED DEVICE (Blink)	The USB memory device cannot be recognized.	Remove the USB memory device.
UNSUPPORTED FORMAT (Blink)	The USB memory device format cannot be recognized.	Remove the USB memory device.
USB BUS PWR (Blink)	An overcurrent or other power-supply error has occurred.	Remove the USB memory device. Have the vehicle inspected at a MITSUBISHI MOTORS Authorized Service Point.
U LSI ERROR (Blink)	Internal device errors	Have the vehicle inspected at a MITSUBISHI MOTORS Authorized Service Point.
U CONNECT RETRY (Blink)	USB communication error	Reconnect the USB memory device correctly. If this error is displayed again, have the vehicle inspected at a MITSUBISHI MOTORS Authorized Service Point.

Handling of compact discs

E00723000441

- Use only the type of compact discs that have the mark shown in the illustration below. (Playback of CD-R or CD-RW discs may cause problems.)



- The use of special shaped, damaged compact discs (like cracked discs) or low-quality compact discs (like warped discs or burrs on the discs) such as those shown will damage the CD player.

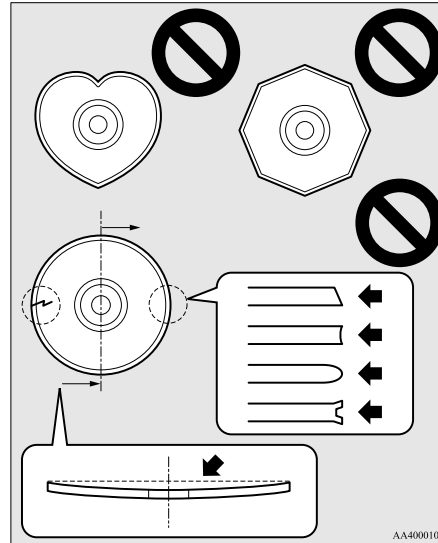

- In the following circumstances, moisture can form on discs and inside the audio system, preventing normal operation.
 - When there is high humidity (for example, when it is raining).
 - When the temperature suddenly rises, such as right after the heater is turned on in cold weather.

In this case, wait until the moisture has had time to dry out.

- When the CD player is subjected to violent vibrations, such as during off-road driving, the tracking may not work.

- When storing compact discs, always store them in their separate cases. Never place compact discs in direct sunlight, or in any place where the temperature or humidity is high.
- Never touch the flat surface of the disc without a label. This will damage the disc surface and could affect the sound quality. When handling a compact disc, always hold it by the outer edge and the centre hole.
- To clean a disc, use a soft, clean, dry cloth. Wipe directly from the centre hole towards the outer edge. Do not wipe in a circle. Never use any chemicals such as benzene, paint thinner, a disc spray cleaner, or an anti-static agent on the disc.
- Do not use a ball point pen, felt pen, pencil, etc. to write on the label surface of the disc.
- Do not put additional labels (A) or stickers (B) on compact discs. Also, do not use any compact disc on which a label or sticker has started to peel off or any compact disc that has stickiness or other contamination left by a peeled-off label or sticker. If you use such a compact disc, the CD player may stop working properly and you may not be able to eject the compact disc.

Notes on CD-Rs/RWs

E00725100039

- You may have trouble playing back some CD-R/RW discs recorded on CD recorders (CD-R/RW drives), either due to their recording characteristics or dirt, fingerprints, scratches, etc. on the disc surface.
- CD-R/RW discs are less resistant to high temperatures and high humidity than ordinary music CDs. Leaving them inside a vehicle for extended periods may damage them and make playback impossible.

For pleasant driving

- The unit may not successfully play back a CD-R/RW that was made by the combination of writing software, a CD recorder (CD-R/RW drive) and a disc if they are incompatible with one another.
- This player cannot play the CD-R/RW discs if the session is not closed.
- This player cannot play CD-R/RW discs which contain other than CD-DA or MP3 data (Video CD, etc.).
- Be sure to observe the handling instructions for the CD-R/RW disc.

⚠ WARNING

- Operating the CD player in a manner other than specifically instructed herein may result in hazardous radiation exposure. Do not remove the cover and attempt to repair the CD player by yourself. There are no user serviceable parts inside. In case of malfunction, we recommend you to have it checked.

Antenna

E00710500673

When listening to the radio, fully raise the antenna up.

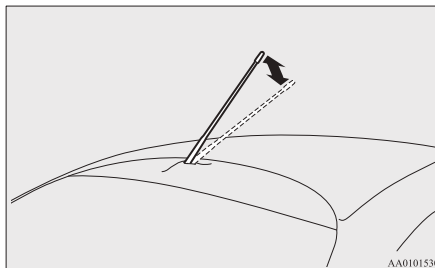

To remove

Turn the pole (A) anticlockwise.

To install

Screw the pole (A) clockwise into the base (B) until it is securely retained.

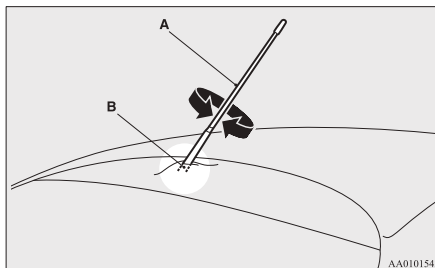

NOTE

- Be sure to remove the roof antenna in the following cases:
 - When entering a place with low clearance.
 - When using an automatic car wash.
 - When placing a car cover over the vehicle.

Digital clock*

E00711800527

To display the clock

Press the **⏻** button to switch the clock mode. To exit the clock mode, press the **⏻** button.

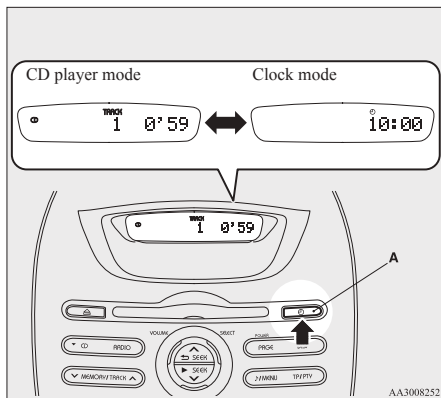

A- **⏻** (Clock) button

NOTE

- While the clock mode is selected, the display will switch to the applicable operation display whenever the CD player or radio is operated. Then, if no entries are made for 7 seconds, the display will automatically return to the clock mode.
- While the clock mode is selected, the display will not switch to the applicable operation display when the CD is fast-forwarded or fast-reversed.

- During automatic tuning in the radio mode, the automatic tuning will stop and the clock mode will be displayed when the **⏻** button is pressed. In addition, the radio will return to the previous station before automatic tuning began.

To adjust the clock

Automatic mode and manual mode is available for digital clock adjustment. Select the automatic mode or the manual mode by performing the following operations:

1. Press the POWER button (A) to turn ON the audio system.
2. Enter the function setup mode by pressing the **⏻** button for 2 seconds or longer.

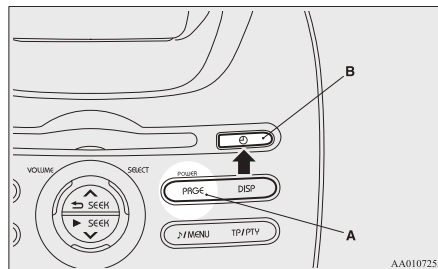

A- POWER (On-Off) button

B- **⏻** (Clock) button

3. Select the desired setting for each mode to be turned ON and OFF.

For pleasant driving

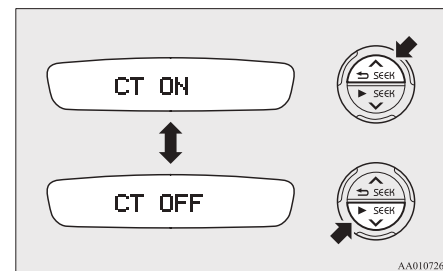

CT ON-

Automatic mode

CT OFF-

Manual mode

NOTE

- After selecting a mode, you can leave the function setup mode by taking either of the following steps:
 - Press the **⏻** button for at least 2 seconds.
 - Make no entry for 7 seconds.

For pleasant driving

Automatic mode

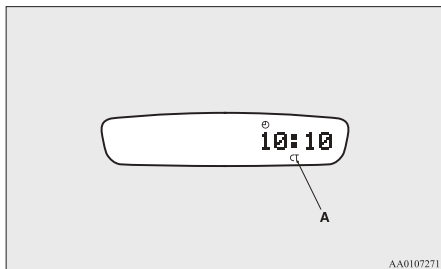

The automatic adjustment mode can set the local time automatically by using the signal from local RDS stations. In this mode, the CT indicator (A) is shown in the display. Refer to “Radio data system (RDS)” on page 6-13.



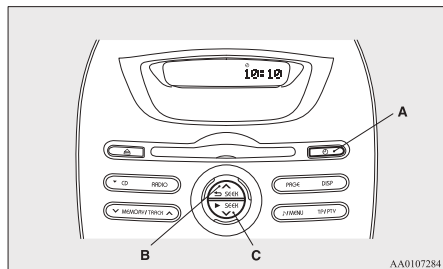

Manual mode

The manual mode is also available in case the automatic mode shows the incorrect time when the adjacent local RDS stations are located in a different time zone. Refer to “Radio data system (RDS)” on page 6-13.



- A-  (Clock) button
B- SEEK  (clock adjustment up) button
C- SEEK  (clock adjustment down) button

1. Press and hold the  button and the clock display flashes.
2. Press the SEEK  button to adjust the “hours” digit.
If you keep pressing the button, fast-forward begins.
3. When the “hours” digit is adjusted, press the clock button to flash the “minutes” digit.
Press the SEEK  button to adjust the “minutes” digit.
If you keep pressing the button, fast-forward begins.
4. When the time is set, press the clock button to stop the clock display from flashing.

NOTE

- Reset the time after the auxiliary battery terminals are disconnected and reconnected.
- Seconds do not appear in the clock display, but after adjusting the “minutes” setting, the clock begins to operate from 0 seconds.

Link System*

E00764500139

The Link System takes overall control of the devices connected via the USB input terminal allowing the connected devices to be operated by using the switches in the vehicle.

See the following section for details on how to operate.

Refer to “USB input terminal” on page 6-33.

Refer to “To play tracks from USB device” on page 6-20.

USB input terminal*

E00761900015

You can connect your USB memory device or iPod* to play music files stored in the USB memory device or iPod.

The following explains how to connect and remove a USB memory device or iPod.

Refer to the following sections for details on how to play music files:

Refer to “To play tracks from USB device” on page 6-20.

*: “iPod” is a registered trademark of Apple Inc. in the United States and other countries.

How to connect a USB memory device

E00762000316

1. Park your vehicle in a safe place and turn the electric motor switch to the “LOCK” position.
2. Open the USB input terminal cover (A).

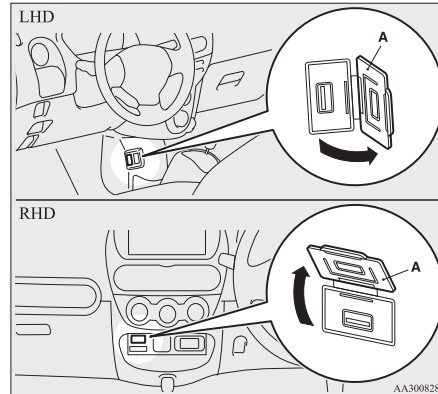

For pleasant driving

3. Connect a commercially available USB connector cable (C) to the USB memory device (B).

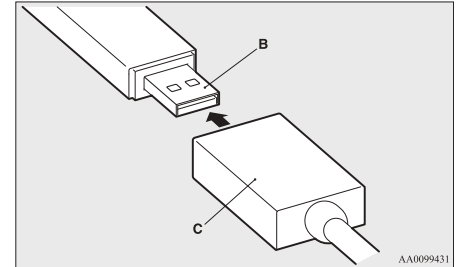

4. Connect the USB connector cable (C) to the USB input terminal (D).

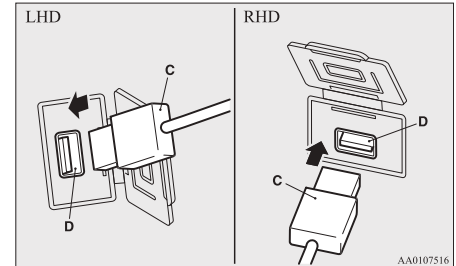

For pleasant driving

⚠ WARNING

- Place the USB memory device and the USB connector cable so as not to interfere with driving.

NOTE

- Do not connect the USB memory device to the USB input terminal directly. The USB memory device may be damaged.
5. To remove the USB connector cable, turn the electric motor switch to the “LOCK” position first and perform the installation steps in reverse.

How to connect an iPod

E00762100258

1. Park your vehicle in a safe place and turn the electric motor switch to the “LOCK” position.

2. Open the USB input terminal cover (A).

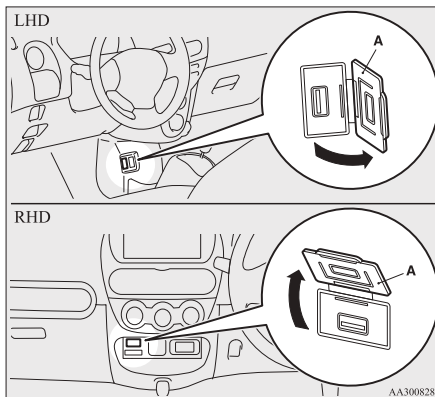

3. Connect the Dock connector (C) to the iPod (B).

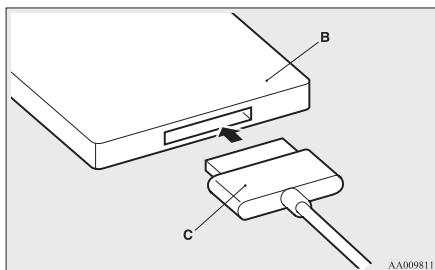

NOTE

- Use a genuine Dock connector from Apple Inc.

4. Connect the Dock connector (C) to the USB input terminal (D).

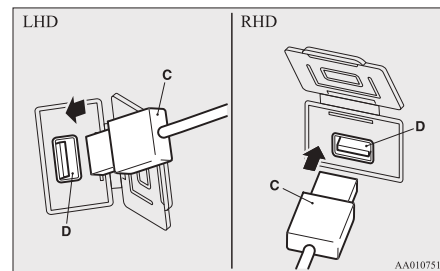

⚠ WARNING

- Place the iPod and the USB connector cable so as not to interfere with driving.

5. To remove the Dock connector, turn the electric motor switch to the “LOCK” position first and perform the installation steps in reverse.

Types of connectable devices and supported file specifications

E00762200015

Device types

E00762300250

Devices of the following types can be connected.

Model name	Condition
USB memory device	Storage capacity of 256 Mbytes or more
iPod touch*	F/W Ver.1.1.1 or later
iPod classic*	F/W Ver.1.0 or later
iPod (fifth generation)*	F/W Ver.1.2.2 or later
iPod nano (fifth generation)*	F/W Ver.1.2 or later
iPod nano (second generation)*	F/W Ver.1.1.2 or later
Models other than USB memory devices and iPods	Digital audio player supporting mass storage class

*: “iPod touch,” “iPod classic,” “iPod” and “iPod nano” are registered trademarks of Apple Inc. in the United States and other countries.

NOTE

- Depending on the type of the USB memory device or other device connected, the connected device may not function properly or the available functions may be limited.
- Use the iPod whose firmware has been updated to the latest version.
- You can charge your iPod by connecting it to the USB input terminal when the electric motor switch is in the “ACC” or “ON” position.
- Do not keep your USB memory device or iPod in your vehicle.
- It is recommended that you back up files in case of data damage.

- Do not connect to the USB input terminal any device (hard disk, card reader, memory reader, etc.) other than the connectable devices specified in the previous section. The device and/or data may be damaged. If any of these devices was connected by mistake, remove it after turning the electric motor switch to the “LOCK” position.

File specifications

E00762400017

You can play music files of the following specifications that are saved in a USB memory device or other device supporting mass storage class.

Item	Condition
File format	MP3, WMA, AAC, WAV
Maximum number of levels (including the root)	Level 8
Number of folders	700
Number of files	65,535

Sun visors

E00711201209

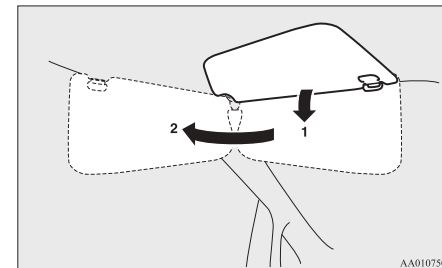

- 1- To eliminate front glare
- 2- To eliminate side glare

Vanity mirror

E00731900247

A vanity mirror is fitted to the back of the sun visor.

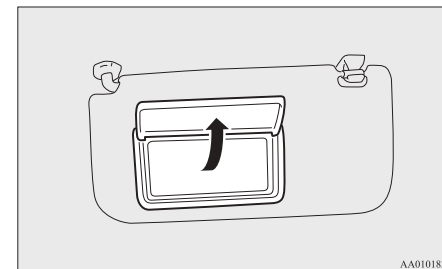

For pleasant driving

Card holder

E00732000232

Cards can be slipped into the holder (A) on the back of the sun visor.

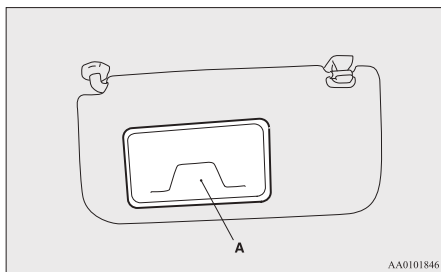

Accessory socket

E00711601388

To use a plug-in type accessory, open the lid, and insert the plug in the accessory socket.

The accessory socket can be used while the electric motor switch is in the “ON” or “ACC” position.

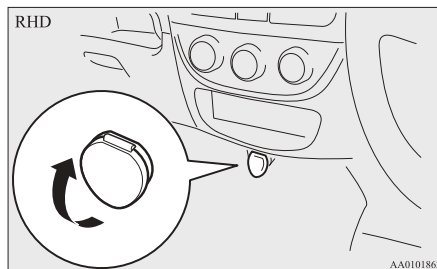
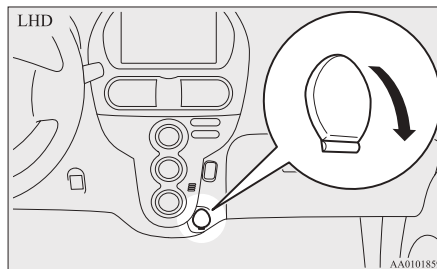

⚠ CAUTION

- Long use of the electric appliance when the ready indicator is not illuminated may run down the auxiliary battery.
- When the accessory socket is not in use, be sure to close the lid, because the socket might become clogged by foreign material and be short-circuited.

⚠ CAUTION

- Be sure to use a “plug-in” type accessory operating at 12 V and at 120 W or less.

Interior lamps

E00712001220

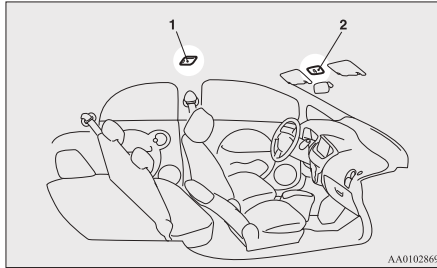

- 1- Room lamp (rear)
- 2- Map & room lamps (front)

NOTE

- If you leave the lamps on when the ready indicator is not illuminated, you will run down the auxiliary battery. Before you leave the vehicle, make sure that the lamps are turned off.

Map & room lamps (front)

E00717300609

Room lamp

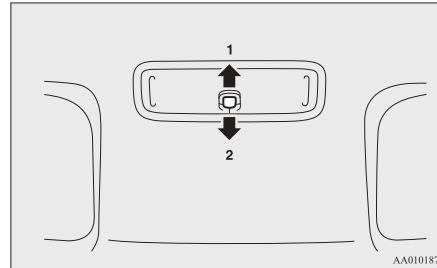

1- (DOOR)

- The lamp illuminates when a door or the tailgate is opened. It goes off about 15 seconds after the door or tailgate is closed (delayed off function). However, the lamp goes off immediately in the following cases:
 - When the electric motor switch is turned to the “ON” position.
 - When the central door lock function is used to lock the vehicle.
 - When the remote control switch of the keyless entry system is used to lock the vehicle.
- If the lamp is left switched on with the electric motor switch in the “LOCK” or “ACC” position and a door or the tailgate is opened, it goes off automatically after approximately 30 minutes. The lamp will illuminate again after it automatically goes off in the following cases:

- When the electric motor switch is turned to the “ON” position.
- When the remote control switch of the keyless entry system is operated.
- When any of the doors or the tailgate is opened after all doors and the tailgate are closed.

NOTE

- When the key is removed while the doors and tailgate are closed, the lamp is illuminated and after about 15 seconds it goes off.
 - The time until the lamp goes off (delayed off) can be adjusted. For details, please consult a MITSUBISHI MOTORS Authorized Service Point.
 - The auto cut-out function can be deactivated. For details, please consult a MITSUBISHI MOTORS Authorized Service Point.
- 2-
- The lamp stays off regardless of whether the doors and tailgate are open or closed.

For pleasant driving

Map lamps

E00765200058

Regardless of the position of the room lamp switch, when the lens is pressed, the lamp on the side that was pressed will illuminate. Press the lens again to turn off the lamp.

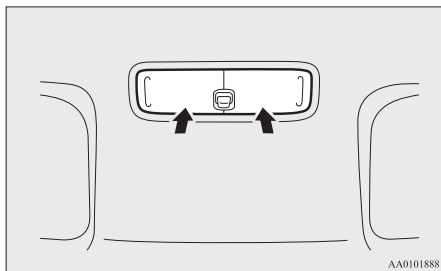

Room lamp (rear)

E00712300385

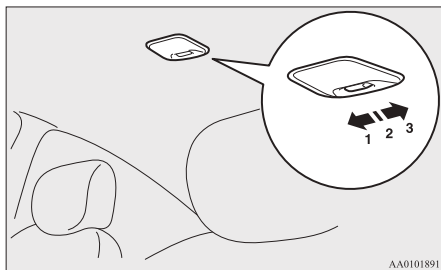

1- (ON)

The lamp illuminates regardless of whether the doors and tailgate are open or closed.

2- (●)

- The lamp illuminates when a door or the tailgate is opened. It goes off about 15 seconds after the door or tailgate is closed (delayed off function).

However, the lamp goes off immediately in the following cases:

- When the electric motor switch is turned to the “ON” position.
- When the central door lock function is used to lock the vehicle.
- When the remote control switch of the keyless entry system is used to lock the vehicle.

- If the lamp is left switched on with the electric motor switch in the “LOCK” or “ACC” position and a door or the tailgate is opened, it goes off automatically after approximately 30 minutes.

The lamp will illuminate again after it automatically goes off in the following cases:

- When the electric motor switch is turned to the “ON” position.
- When the remote control switch of the keyless entry system is operated.
- When any of the doors or the tailgate is opened after all doors and the tailgate are closed.

NOTE

- When the key is removed while the doors and tailgate are closed, the lamp is illuminated and after about 15 seconds it goes off.
- The time until the lamp goes off (delayed off) can be adjusted. For details, please consult a MITSUBISHI MOTORS Authorized Service Point.

- The auto cut-out function cannot be operated when the room lamp switch is in the “ON” position.

Also, this function can be deactivated. For details, please consult a MITSUBISHI MOTORS Authorized Service Point.

3- (OFF)

The lamp goes off regardless of whether the doors and tailgate are open or closed.

Storage spaces

E00713101752

CAUTION

- Never leave lighters, cans of carbonated drink, and spectacles in the cabin when parking the vehicle in hot sunshine. The cabin will become extremely hot, so lighters and other flammable items may catch fire and unopened drink cans (including soft drink or beer cans) may rupture. Also, spectacles with plastic lenses or materials could deform or crack.
- Keep the lids of storage spaces closed while driving the vehicle. A lid or the contents of a storage space could otherwise cause injuries.

NOTE

- When leaving your vehicle, do not leave valuables in the storage spaces.

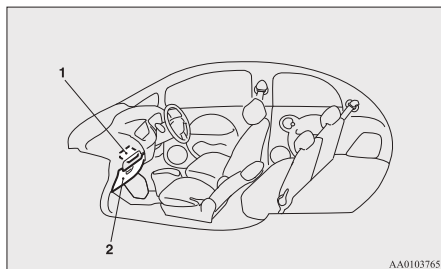

- 1- Secret box (RHD vehicles only)
- 2- Glove box

Glove box

E00726200242

To open, pull the lever (A).

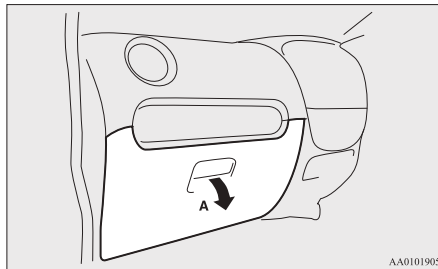

Card holder

E00765500019

There is a card holder inside the glove box.

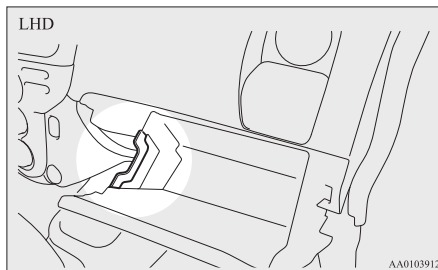

For pleasant driving

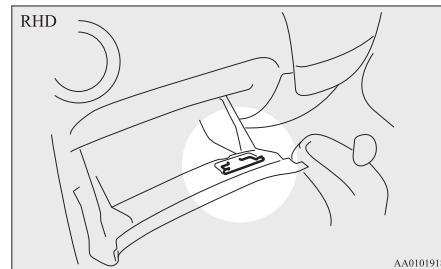

Secret box (RHD vehicles only)

E00724900056

The secret box is located on the upper part of the glove box.

To use the box, open the lid.

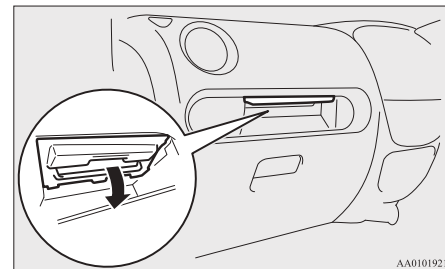

For pleasant driving

Cup holder

E00714500974

CAUTION

- Do not drink beverages while driving. This is distracting and could cause an accident.
- Beverages can be spilled owing to vibration or other movement during vehicle operation. Be careful not to get scalded by a hot beverage if it is spilled.

LHD vehicles

Type 1

The cup holder is located behind the parking brake lever.

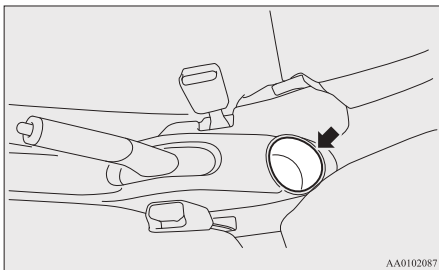

Type 2

Tip the cup holder towards you to use it.

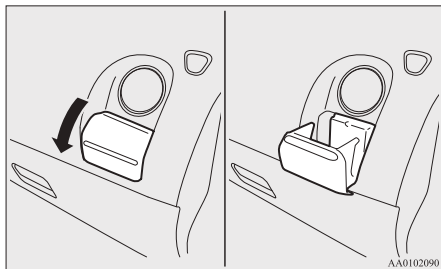

NOTE

- When not using the holder, push the holder to stow it away.
- Do not put your hand on the cup holder while getting in or out of the vehicle. The cup holder could break.
- Never place anything other than a cup or drink can in the cup holder.

RHD vehicles

Type 1

The cup holder is located in front of the floor console.

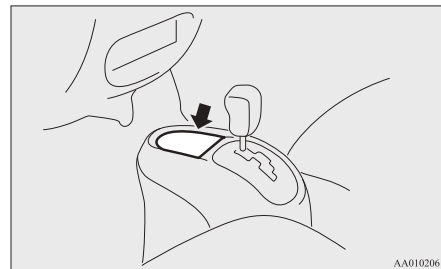

Type 2 (Passenger's side only)

To use the cup holder, pull it out.

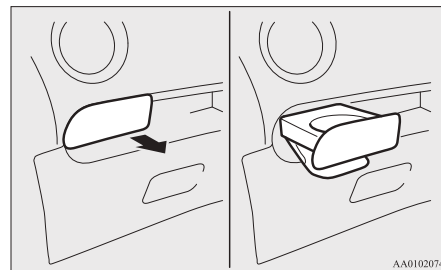

NOTE

- When not using the holder, push the holder to stow it away.

Assist grips

E00732800272

The assist grips (located above the doors on the headliner) are not designed to support body weight. They are intended for use only while seated in the vehicle.

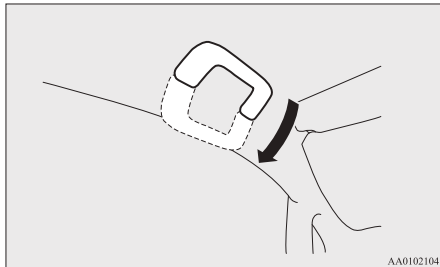

⚠ CAUTION

- Do not use the assist grips when getting in to or out of the vehicle. The assist grips could detach causing you to fall.

A series of 15 horizontal dashed lines spanning the width of the page, providing a template for handwriting practice.

For emergencies

If the vehicle breaks down.....	7-02
Emergency starting.....	7-02
Tyre repair kit.....	7-04
Towing.....	7-10
Operation under adverse driving conditions.....	7-12

For emergencies

If the vehicle breaks down

E00800101355

If the vehicle breaks down on the road, move it to the shoulder and use the hazard warning flashers and/or the warning triangle etc.

Refer to “Hazard warning flasher switch” on page 4-15.

⚠ WARNING

- If you are not able to safely assess the vehicle due to vehicle damage, do not touch the vehicle. Leave the vehicle and contact a MITSUBISHI MOTORS Authorized Service Point or another specialist and convey that this is an electric vehicle first.

If the ready indicator goes out while driving

Vehicle operation and control are affected if the ready indicator goes out while driving. Before moving the vehicle to a safe area, be aware of the following:

- The brake booster may become inoperative and the pedal effort will increase. Press down the brake pedal harder than usual.
- The power steering system may not operate, the steering wheel feels heavy when turning it.

Emergency starting

E00800502750

If the electric motor unit cannot be started because the auxiliary battery is weak or dead, the battery from another vehicle can be used with jumper cables to start the electric motor unit.

⚠ WARNING

- To start the electric motor unit by using jumper cables from another vehicle, perform the correct procedures according to the instruction below. Incorrect procedures could result in a fire or explosion or damage to the vehicles.

⚠ CAUTION

- The electric motor unit cannot be started by pulling or pushing the vehicle.
- Always wear protective eye goggles when working near the battery.
- Keep the battery out of the reach of children.

1. Get the vehicles close enough so the jumper cables can reach, but be sure the vehicles aren't touching each other.

⚠ CAUTION

- Check the other vehicle. It must have a 12-volt battery. If the other system isn't 12-volt, shorting can damage both vehicles.

2. Turn off all lamps, heater and other electrical loads.
3. Set the parking brake firmly on your vehicle and move the selector lever into the “P” position.
4. Set the parking brake firmly on another vehicle. Put an A/T in “P” (PARK) or a M/T in “N” (Neutral).
5. Turn the ignition switch or the electric motor switch to the “LOCK” position.

⚠ WARNING

- Perform step 5 on both vehicles beforehand. Make sure that the cables or your clothes cannot be caught by the fan or drive belt. Personal injury could result.

6. Remove the battery cover, and then make sure auxiliary battery electrolyte is at the proper level. Refer to “Auxiliary battery” on page 8-12.

⚠ WARNING

- If electrolyte fluid is not visible, or appears to be frozen, Do Not Attempt Jump Starting! A battery might rupture or explode if the temperature is below the freezing point or if it is not filled to the proper level.

7. Connect one end of one jumper cable to the positive (+) terminal of the discharged battery (A), and the other end to the positive (+) terminal of the booster battery (B).

Connect one end of the other jumper cable to the negative (-) terminal of the booster battery, and the other end to the designated location of the vehicle with the discharged battery at the point farthest from the battery.

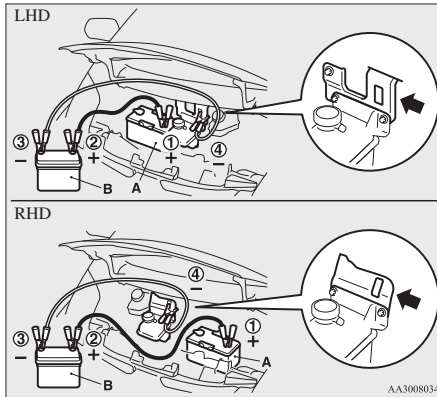

⚠ WARNING

- Make sure you observe the following order when connecting the cables: ①→②→③→④
- Make sure you make connection ④ to the correct designated location (as shown in the illustration). If the connection is made directly to the negative (-) side of the discharged battery, flammable gases generated from the battery might catch fire and explode.

⚠ WARNING

- When connecting the jumper cables, do not connect the positive (+) cable to the negative (-) terminal. Otherwise sparks might cause explosion of the battery.

⚠ CAUTION

- Take care not to get the jumper cable caught in the cooling fan or other rotating part in the bonnet room or engine compartment.
- Use the proper cables suitable for the battery size to prevent overheating of the cables.
- Check the jumper cables for damage and corrosion before use.

8. Start the engine in the vehicle which has the booster battery, let the engine idle a few minutes, then start the electric motor unit in the vehicle with the discharged battery.

9. Check that the ready indicator illuminates.

[When the ready indicator illuminates]
Stop the engine of another vehicle, disconnect the cables in the reverse order and charge the auxiliary battery for more than 30 minutes.

After the auxiliary battery is charged, continue the process from step 16.

[When the ready indicator does not illuminate]
Both the auxiliary battery and the traction battery have gone flat at the same time. Charge the auxiliary battery and the traction battery by the following procedures (from steps 10 to 14).

10. Keep connecting the jumper cable to each vehicle, turn the electric motor switch of your vehicle to the “LOCK” position.

NOTE

- The jumper cable needs to be connected to the auxiliary battery when you start charging the traction battery because the on board charger etc. operate with a power source of auxiliary battery.
11. Charge the traction battery by regular charging. (Refer to “Regular charging” on page 1-06.)
 12. When the charging indicator on the instrument cluster is illuminated, stop the engine of another vehicle, disconnect the cables in the reverse order.

For emergencies

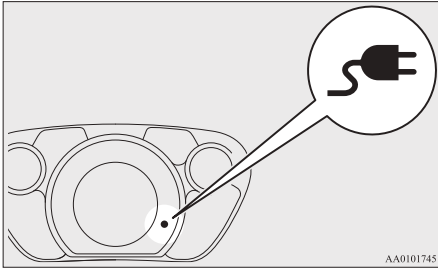

NOTE

- When the regular charge connector is connected to the charge port, the charging indicator is blinking. When charging is started, the charging indicator is illuminated.
- The auxiliary battery is automatically charged while charging the traction battery.

13. Charge the traction battery for more than 1 hour.
14. Disconnect the charging cable.
(Refer to “Regular charging” on page 1-06.)
15. Turn the electric motor switch to the “START” position, make sure that the ready indicator on the instrument cluster is illuminated.
If the ready indicator does not illuminate, perform the procedure again from step 7.
If charging cannot be performed, consult a MITSUBISHI MOTORS Authorized Service Point.
16. Refit the battery cover. (Refer to “Auxiliary battery” on page 8-12.)

⚠ WARNING

- Do not charge the auxiliary battery using an external battery charger while the auxiliary battery is mounted in the vehicle. Doing so could cause the auxiliary battery to catch fire and explode and could result in damage to the vehicle.
- Keep sparks, cigarettes, and flames away from the auxiliary battery because the battery may produce an explosion.
- Use adequate ventilation when charging or using the auxiliary battery in an enclosed space.
- Remove all the caps before charging the auxiliary battery.
- Electrolyte is corrosive diluted sulphuric acid.

If electrolyte (battery acid) comes into contact with your hands, eyes, clothes and the painted surface of your vehicle, it should be thoroughly flushed with water. If electrolyte gets in your eyes, flush them with water immediately and thoroughly, and get prompt medical attention.

NOTE

- If the electric motor unit is started without fully charging the auxiliary battery, it might cause the anti-lock brake warning lamp to illuminate. Refer to “Anti-lock brake system (ABS)” on page 5-15.

Tyre repair kit

E00800901311

This kit enables emergency repair of a small puncture in the tread area of a tyre that has run over a nail, screw, or similar object.

Storage

The tyre repair kit is stowed under the rear seat cushion. The storage location of the tyre repair kit should be remembered in case of an emergency.

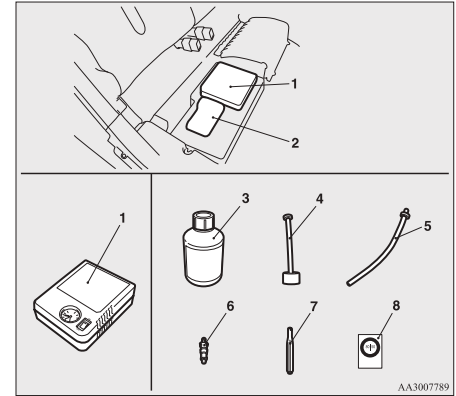

- 1- Tyre compressor
- 2- Tyre repair set
- 3- Tyre sealant bottle
- 4- Filler hose
- 5- Extension hose
(This hose is used for removal of sealant. It is not used in emergency puncture repair.)
- 6- Valve insert (spare)
- 7- Valve remover
- 8- Speed restriction sticker

To remove

1. Remove the rear seat cushion. Refer to “Rear seat cushion” on page 3-06.
2. Remove the screws (A), and remove the cover (B).

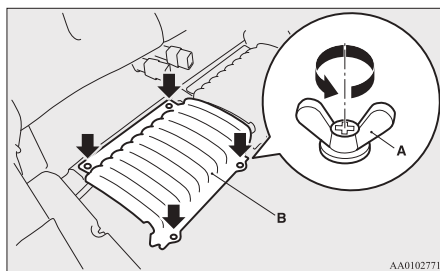

AA0102771

3. Take out the tyre repair kit.

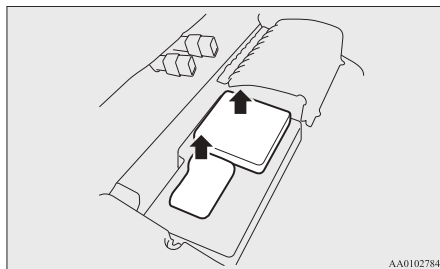

AA0102784

To install

Perform the removal steps in reverse.

How to use the tyre repair kit

E00802200379

CAUTION

- The tyre sealant can cause health damage if swallowed. If you accidentally swallow it, drink as much water as possible and immediately consult a doctor.
- If the tyre sealant gets in your eyes or on your skin, rinse with lots of water. If you still sense an abnormality, consult a doctor.
- Consult a doctor immediately if any allergic reactions occur.
- Do not allow children to touch the tyre sealant.
- Do not breathe in the vapours of tyre sealant.
- Be sure to use a genuine MITSUBISHI tyre sealant.

NOTE

- The tyre sealant cannot be used in any of the situations listed below. If any of these situations occurs, please contact a MITSUBISHI MOTORS Authorized Service Point or another specialist.
 - The tyre sealant's expiry date has passed. (The expiry date is shown on the bottle label.)



AA0064525

- More than one tyre is punctured.
- The puncture hole has a length or width of 4 mm or more.
- The tyre is punctured in the side wall (A), not in the tread (B).

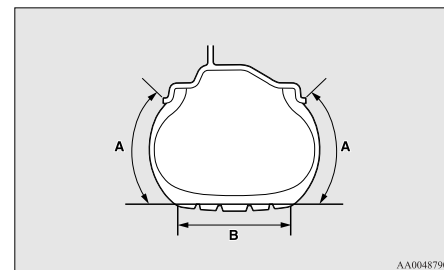

AA0048790

- The vehicle has been driven with the tyre almost completely flat.
- The tyre has completely slipped over the wheel rim and has come off the wheel.
- The wheel is damaged.

For emergencies

- Use the tyre sealant only at ambient temperatures of -30 °C to +60 °C.
- Effect an emergency repair without pulling out the object (nail, screw, etc.) that is stuck in the tyre.
- Do not use the tyre sealant if the tyre has been damaged by being driven when insufficiently inflated (e.g. bumps, cuts, cracks etc. on the tyre).
- Wipe tyre sealant off the paintwork immediately with a damp cloth.
- Immediately wash clothes contaminated with tyre sealant.

Before repairing a tyre, first stop your vehicle in a safe, flat location.

1. Park the vehicle on level and stable ground.
2. Set the parking brake firmly.
3. Move the selector lever to the “P” (PARK) position and turn the electric motor switch to the “LOCK” position.
4. Turn on the hazard warning flashers and set up a warning triangle, flashing signal lamp, etc., at an adequate distance from the vehicle, and have all your passengers leave the vehicle.
5. Take out the tyre sealant bottle and the compressor.
6. Shake the tyre sealant bottle well.

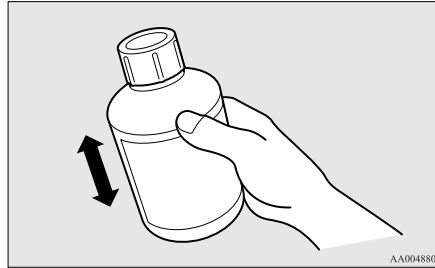

NOTE

- In cold conditions (when the ambient temperature is 0 °C or lower), thickening of the tyre sealant can make the tyre sealant hard to squeeze out of the bottle. Warm the bottle inside the vehicle.

7. Take the cap (C) off the tyre sealant bottle (D). Do not remove the seal (E). Screw the filler hose (F) onto the bottle (D). As you screw the filler hose onto the bottle, the seal will break, allowing the sealant to be used.

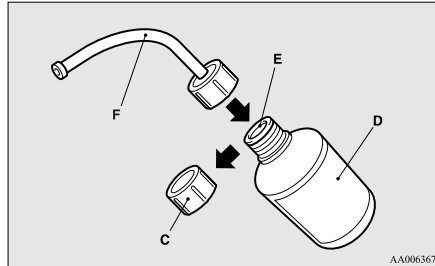

⚠ CAUTION

- If you shake the bottle after screwing on the hose, sealant may spray out of the hose.

8. Take the valve cap (G) off the tyre valve (H), then press the valve remover (I) onto the valve as illustrated. Allow all of the air in the tyre to escape.

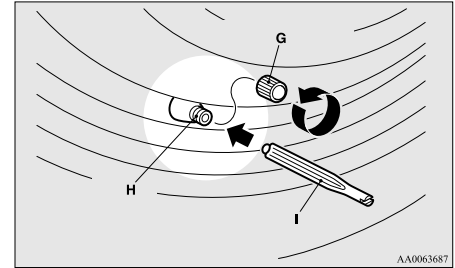

9. Remove the valve insert (J) by turning it anti-clockwise using the valve remover (I). Put the removed valve insert in a clean place so it does not get dirty.

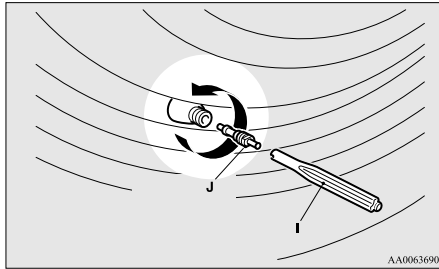

⚠ CAUTION

- If there is any air left in the tyre when you remove the valve insert, the valve insert may fly out and injure you. Make sure the tyre contains no air before removing the valve insert.

10. Remove the plug (K) from the free end of the hose (L). Press the hose onto the valve (H).

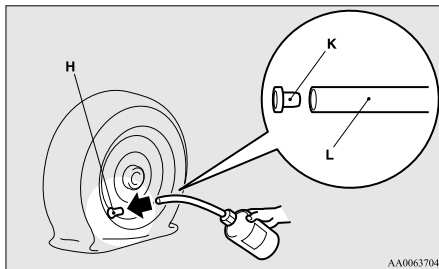

11. Holding the sealant bottle upside-down, squeeze it again and again to inject all of the sealant into the tyre.

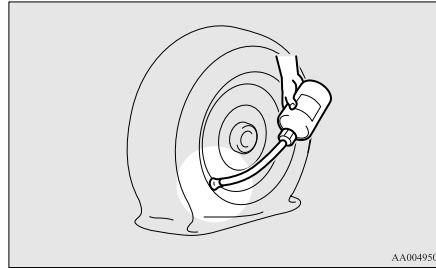

NOTE

- When injecting the sealant, position the valve away from the bottom, i.e., away from the point where the tyre touches the ground. If the valve is near the point where the tyre touches the ground, the sealant may not go into the tyre easily.

12. After injecting the sealant, pull the hose off the valve, remove any residual sealant from the valve, rim and/or tyre.

For emergencies

Fit the valve insert (J) into the valve (H), and screw the valve insert securely into place using the valve remover (I).

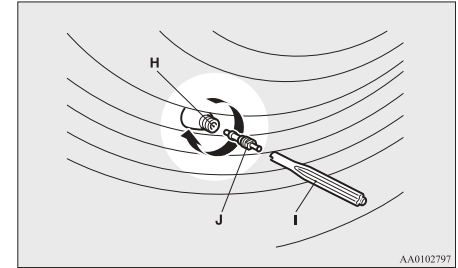

NOTE

- When removing and screwing in the valve insert using the valve remover, turn the valve remover by hand. Using a tool to turn the valve remover could damage it.

13. Pull out the compressor hose (M) from the side of the tyre compressor, and then securely attach the hose to the tyre valve (H).

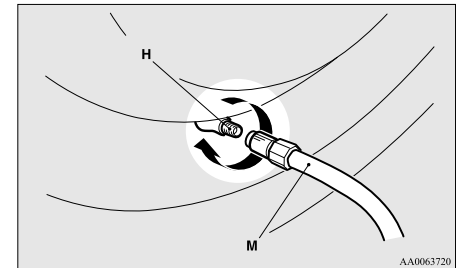

For emergencies

14. Place the compressor (N) with its air pressure gauge (O) on top.

Pull out the compressor's power cord (P), insert the plug on the cord into the accessory socket (Q), and then turn the electric motor switch to the "ACC" position.

Turn ON the compressor switch (R) and inflate the tyre to the specified pressure.

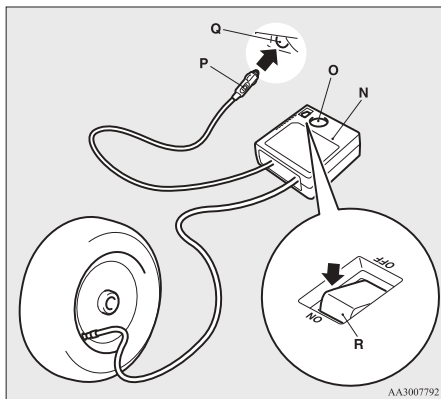

⚠ CAUTION

- The supplied compressor is designed only for inflation of your vehicle tyres.
- The compressor is designed to run on a vehicle's 12 V power supply. Do not connect it to any other power source.
- The compressor is not waterproof. If you use it in rain, make sure water does not get on it.

⚠ CAUTION

- Any sand or dust sucked into the compressor could make the compressor break down. Do not place the compressor directly on any sandy or dusty surface when using it.
- Do not disassemble or modify the compressor. Also, do not subject the air pressure gauge to shock. It could malfunction.

15. Check and adjust the tyre pressure with reference to the air pressure gauge on the compressor. If you overinflate the tyre, release air by loosening the hose's end fitting. (Refer to "Tyre inflation pressures" on page 8-15.)

If there is a gap between the tyre and wheel because the tyre has moved inward from the wheel rim, press the periphery of the tyre towards the wheel to close the gap before running the compressor. (With no gaps, the tyre pressure will rise.)

⚠ CAUTION

- Be careful not to get your fingers trapped between the tyre and wheel as the tyre inflates.
- The surface of the compressor will get hot while the compressor is running. Do not keep the compressor running continuously for more than 10 minutes. After using the compressor, wait for the compressor to cool before using it again.

⚠ CAUTION

- If the compressor becomes sluggish or hot while operating, it is overheating. Immediately place the switch in the OFF position and let the compressor cool down for at least 30 minutes.

NOTE

- If the tyre pressure does not rise to the specified level within 10 minutes, the tyre may be so severely damaged that the tyre sealant cannot be used to effect an emergency repair. Please contact a MITSUBISHI MOTORS Authorized Service Point or another specialist in this event.

16. Turn OFF the compressor switch, then pull the power cord plug out of the socket.

NOTE

- Simply putting sealant and air into the tyre using the tyre repair kit does not seal the puncture hole. Air will leak through the puncture hole until the emergency repair procedure is completed (through step 19 of these instructions).

17. When you have inflated the tyre to the specified pressure, stow the compressor, bottle, and other items in the vehicle and promptly start driving the vehicle so that the tyre sealant can spread evenly in the tyre. Drive with great care. Do not exceed a speed of 80 km/h (50 mph). Observe local speed limits.

⚠ CAUTION

- If you sense any abnormality while driving, stop the vehicle and contact a MITSUBISHI MOTORS Authorized Service Point or another specialist. Otherwise the tyre pressure may drop before the emergency repair procedure is completed, rendering the vehicle unsafe.

NOTE

- Driving faster than 80 km/h (50 mph) can make the vehicle vibrate.
18. After driving for 10 minutes or 5 km (3 miles), check the tyre pressure using the air pressure gauge on the compressor. (Refer to “Tyre inflation pressures” on page 8-15.)
If the tyre pressure is not sufficient, inflate the tyre to the specified pressure again and drive the vehicle carefully without exceeding a speed of 80 km/h (50 mph).

⚠ CAUTION

- If the tyre pressure is lower than the minimum permitted pressure (1.3 bar {130 kPa}), the tyre cannot successfully be repaired with the tyre sealant. Do not drive the vehicle any further. Contact a MITSUBISHI MOTORS Authorized Service Point or another specialist.

19. After driving for 10 minutes or 5 km (3 miles), check the tyre pressure using the air pressure gauge on the compressor. (Refer to “Tyre inflation pressures” on page 8-15.)

If the tyre pressure has apparently not dropped, the emergency repair procedure is complete. You must still not exceed a speed of 80 km/h (50 mph). Observe local speed limits.

⚠ CAUTION

- Be sure to check the tyre pressure for confirmation that the emergency repair procedure is complete.

NOTE

- If the tyre pressure has dropped below the specified level when you check it at the end of the repair procedure, do not drive the vehicle any further. Contact a MITSUBISHI MOTORS Authorized Service Point or another specialist.
- In cold conditions (when the ambient temperature is 0 °C or lower), the time and driving distance necessary until completion of the repair can be longer than in warmer conditions, meaning that the tyre pressure can drop below the specified level even when you have inflated the tyre a second time and subsequently driven the vehicle. If this happens, inflate the tyre to the specified pressure once more, drive for about 10 minutes or 5 km (3 miles), then check the tyre pressure again. If the tyre pressure has again dropped below the specified level, stop driving the vehicle and contact a MITSUBISHI MOTORS Authorized Service Point or another specialist.

20. Affix the speed restriction sticker (R) to the three-diamond mark on the steering wheel. Then immediately drive with great care to a MITSUBISHI MOTORS Authorized Service

Point or another specialist and have tyre repair/replacement performed.

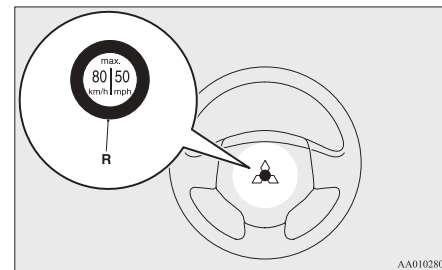
**⚠ CAUTION**

- Do not affix the sticker anywhere except the specified position on the pad of the steering wheel. Affixing the sticker in an incorrect position could prevent the SRS airbag from working normally.

NOTE

- Please give the empty sealant bottle to your MITSUBISHI MOTORS Authorized Service Point when you purchase new sealant or dispose of the sealant bottle according to national regulations for the disposal of chemical waste.

For emergencies

- A tyre in which puncture sealant has been used should ideally be replaced with a new one. If you wish to have such a tyre properly repaired for reuse, please contact a MITSUBISHI MOTORS Authorized Service Point or another specialist. Note that a proper repair is impossible following an emergency repair if the puncture hole cannot be located.
- Wipe away any sealant that gets on the wheel. Provided the valve is replaced with a new one, the wheel can be reused.
- The manufacturer is unable to guarantee that all tyre punctures can be repaired with the tyre repair kit, in particular cuts or perforations with a diameter of more than 4 mm or away from the tyre's tread. The manufacturer is not liable for damage sustained through improper use of the tyre repair kit.
- The manufacturer is not liable for damage sustained through re-use of any tyre in which tyre sealant has been used.

Towing

E00801503549

If your vehicle needs to be towed

If you need to tow your vehicle, we recommend that you contact a MITSUBISHI MOTORS Authorized Service Point or a commercial tow truck service.

In the following cases, transport the vehicle using a tow truck.

- The ready indicator illuminates but the vehicle does not move, or an abnormal noise is produced.
- Inspection of the vehicle's underside reveals that oil or some other fluid is leaking.

If a wheel gets stuck in a ditch, do not try to tow the vehicle. Please contact your MITSUBISHI MOTORS Authorized Service Point or a commercial tow truck service for assistance.

Only when you cannot receive a towing service from a MITSUBISHI MOTORS Authorized Service Point or commercial tow truck service, tow your vehicle carefully in accordance with the instructions given in "Emergency towing" in this part.

The regulations concerning towing may differ from country to country. It is recommended that you obey the regulations of the area where you are driving your vehicle.

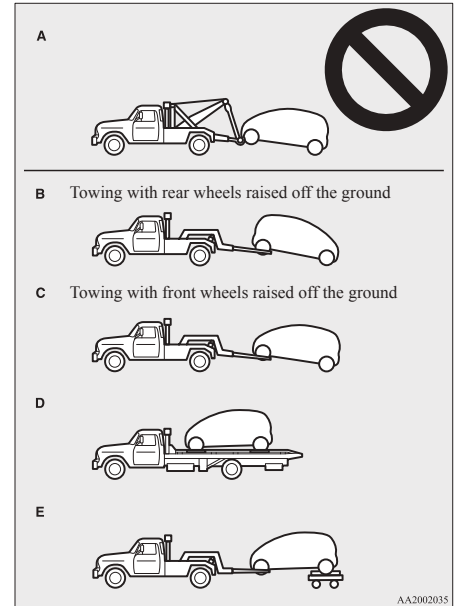

Towing the vehicle by a tow truck

⚠ CAUTION

- This vehicle must not be towed by a tow truck using sling lift type equipment (Type A) as illustrated. Using a sling lift will damage the bumper and front end.
- If the transmission is malfunctioning or damaged, transport the vehicle with the driving wheels on a carriage (Type B, D or E) as illustrated.
- If you tow the vehicle with only the front wheels or only the rear wheels raised off the ground (Type B or C) after starting the electric motor unit, the Active Stability Control (ASC) system may operate, resulting in an accident.
- If you tow the vehicle with the driving wheels on the ground (Type C) as illustrated, make sure that the towing speed and distance given below are never exceeded, causing damage to the transmission.

Towing speed: 30 km/h (19 mph)
Towing distance: 30 km (19 miles)

For the towing speed and the towing distance, follow the local driving laws and regulations.

Towing with rear wheels raised off the ground (Type B)

Place the selector lever in the “N” (NEUTRAL) position.

Turn the electric motor switch to the “ACC” position and secure the steering wheel in a straight-ahead position with a rope or tie-down strap.

Towing with front wheels raised off the ground (Type C)

Release the parking brake.

Place the selector lever in the “N” (NEUTRAL) position.

Turn the electric motor switch to the “ACC” position.

Emergency towing

If towing service is not available in an emergency, your vehicle may be temporarily towed by a rope secured to the towing hook.

In case of your vehicle is to be towed by another vehicle, pay careful attention to the following points.

If your vehicle is to be towed by another vehicle

1. The front towing hook (A) is located as shown in the illustration. Secure the tow rope to the front towing hook.

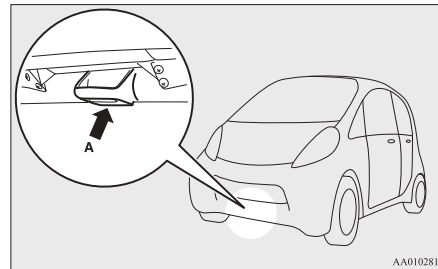

NOTE

- Using any part other than the designated towing hook (A) could result in damage to the vehicle body.

- Using a wire rope or metal chain can result in damage to the vehicle body. It is best to use a non-metallic rope. If you use a wire rope or metal chain, wrap it with cloth at any point where it touches the vehicle body.
- Take care that the tow rope is kept as horizontal as possible. An angled tow rope can damage the vehicle body.

2. Start the electric motor unit.

If the electric motor unit does not start, turn the electric motor switch to the “ACC” position.

⚠ CAUTION

- If the vehicle is towed with the electric motor switch in the “ON” position without starting the electric motor unit, the auxiliary battery may be flat during towing. In this case, the brake performance may be very poor. Steering is also very heavy. Therefore, start the electric motor unit as much as possible for towing.
- Do not leave the electric motor switch in the “LOCK” position. The steering wheel will lock, causing loss of control.

3. Place the selector lever in the “N” (NEUTRAL) position.
4. Turn on the hazard warning lamps if required by law. (Follow the local driving laws and regulations.)
5. During towing make sure that close contact is maintained between the drivers of both vehicles, and that the vehicles travel at low speed.

CAUTION

- The person in the vehicle being towed must pay attention to the brake lamps of the towing vehicle and make sure the rope never becomes slack.
- Avoid sudden braking, sudden acceleration and sharp turning; such operation could cause damage to the towing hooks or the tow rope.
People in the vicinity could be injured as a result.
- When towing or being towed down a long slope, the brakes may overheat reducing the effectiveness. In this situation, have your vehicle transported by a tow truck.
- When the vehicle is to be towed by another vehicle with all wheels on the ground, make sure that the towing speed and distance given below are never exceeded, causing damage to the transmission.

Towing speed: 30 km/h (19 mph)
Towing distance: 30 km (19 miles)

For the towing speed and the towing distance, follow the local driving laws and regulations.

7 Towing another vehicle

Your vehicle cannot be used to tow another vehicle.

Operation under adverse driving conditions

E00801702717

On a flooded road

- Do not drive on a flooded road. If you drive on a flooded road, not only the electric motor unit stops but also a failure like electric leakage or short circuit may occur.
If you inevitably had to run on a flooded road and the vehicle was exposed to water, be sure to have your vehicle inspected by a MITSUBISHI MOTORS Authorized Service Point.
- If there is water on the brakes after driving through puddles or washing the vehicle, resulting in temporarily ineffective brakes. In such cases, lightly depress the brake pedal to see if the brakes operate properly. If they do not, lightly depress the pedal several times while driving in order to dry the brake pads.
- When driving in rain or on a road with many puddles a layer of water may form between the tyres and the road surface.
This reduces a tyre's frictional resistance on the road, resulting in loss of steering stability and braking capability.

To cope with this, observe the following items:

- (a) Drive your vehicle at slow speed.
- (b) Do not drive on worn tyres.
- (c) Always maintain the specified tyre inflation pressures.

On a snow-covered or frozen road

- When driving on a snow-covered or frozen road, it is recommended that you use snow tyres or tyre chains.
Refer to the “Snow tyres” and “Tyre chains” sections.
- Avoid high-speed driving, sudden acceleration, sudden braking, and sharp turns.
- Depressing the brake pedal during travel on snowy or icy roads may cause tyre slippage and skidding. Tyres may slip if the ability of the tyres to grip the road surface lessens. This may make it more difficult to stop the vehicle with normal braking operations. For vehicles with an anti-lock brake system (ABS), firmly depress and hold down the brake pedal.
- Allow extra distance between your vehicle and the vehicle in front of you, and avoid sudden braking.
- Accumulation of ice on the braking system can cause the wheels to lock. Pull away from a standstill slowly after confirming safety around the vehicle.

CAUTION

- Do not press the accelerator pedal rapidly. If the wheels break free of the ice, the vehicle could suddenly start moving and possibly cause an accident.

On a bumpy or rutted road

Drive as slow as possible when driving on bumpy or rutted roads.

⚠ CAUTION

- The impact on tyres and/or wheels when driving on a bumpy or rutted road can damage the tyre and/or wheel.
- The vehicle's body, bumper, muffler and other parts may be damaged if the vehicle is:
 - driven over a step (for example, at the entrance or exit of a parking lot);
 - parked too closely against a kerb or parking block, or by the side of a road with kerbstones;
 - driven on a steep slope;

A series of 15 horizontal dashed lines spanning the width of the page, providing a template for handwriting practice.

Vehicle care and Maintenance

Vehicle care precautions.....	8-02
Cleaning the interior of your vehicle.....	8-02
Cleaning the exterior of your vehicle.....	8-03
Service precautions.....	8-06
Bonnet.....	8-07
Coolant/Hot water heater fluid.....	8-09
Washer fluid.....	8-11
Brake fluid.....	8-11
Auxiliary battery.....	8-12
Tyres.....	8-14
Wiper blades.....	8-17
General maintenance.....	8-19
For cold and snowy weather.....	8-20
Fusible links.....	8-20
Fuses.....	8-20
Replacement of lamp bulbs.....	8-23

Vehicle care precautions

E08400100015

In order to maintain the value of your vehicle, it is necessary to perform regular maintenance using the proper procedures.

Always maintain your vehicle in compliance with environmental pollution control regulations.

Carefully select the materials used for washing, etc., to be sure that they do not contain corrosives.

If in doubt, we recommend you to consult a specialist for selection of these materials.

CAUTION

- Cleaning products can be dangerous. Always follow the instructions of the cleaning product supplier.
- To avoid damage, never use the following to clean your vehicle:
 - Petrol
 - Paint Thinner
 - Benzine
 - Kerosene
 - Turpentine
 - Naphtha
 - Lacquer Thinner
 - Carbon Tetrachloride
 - Nail Polish Remover
 - Acetone

Cleaning the interior of your vehicle

E08400200016

After cleaning the interior of your vehicle with water, cleaner or similar, wipe and dry in a shady, well-ventilated area.

CAUTION

- Do not use organic substances (solvents, benzine, kerosene, alcohol, petrol, etc.) or alkaline or acidic solutions. These chemicals can cause discolouring, staining or cracking of the surface. If you use cleaners or polishing agents, make sure their ingredients do not include the substances mentioned above.

Plastic, vinyl leather, fabric and flocked parts

E08400300017

1. Gently wipe off with a sponge, gauze or other soft cloth soaked with a 3% aqueous solution of neutral detergent.
2. Dip cloth in fresh water and wring it out well. Using this cloth, wipe off the detergent thoroughly.

NOTE

- Do not use cleaners, conditioners, and protectants containing silicones or wax. Such products, when applied to the instrument panels or other parts, may cause reflections on the windscreen and obscure vision. Also, if such products get on the switches of the electrical accessories, it may lead to failure of these accessories.

Upholstery

E08400400018

1. To maintain the value of your new vehicle, handle the upholstery carefully and keep the interior clean. Use a vacuum cleaner and brush to clean the seats. If stained, vinyl and synthetic leather should be cleaned with an appropriate cleaner. Cloth fabrics can be cleaned with either upholstery cleaner or a 3% aqueous solution of neutral detergent in lukewarm water.
2. Clean the carpeting with a vacuum cleaner and remove any stains with carpet cleaner. Oil and grease can be removed by lightly dabbing with a clean colourfast cloth and stain remover.

Genuine leather

E08400500019

1. Gently wipe off with gauze or other soft cloth soaked with a 5 % aqueous solution of neutral detergent.
2. Dip cloth in fresh water and wring it out well. Using this cloth, wipe off the detergent thoroughly.
3. Apply leather protecting agent to the genuine leather surface.

NOTE

- If genuine leather is wet with water or is washed in water, wipe off water as quickly as possible with a dry, soft cloth. If left damp, mildew may grow.
- The genuine leather surface may be damaged if a nylon brush or synthetic fibre is rubbed hard against it.
- Organic solvents such as benzene, kerosene, alcohol and petrol, acid or alkaline solvents may discolour the genuine leather surface. Be sure to use neutral detergents.
- Remove dirty patches or oil substances quickly as they can stain genuine leather.
- The genuine leather surface may harden and shrink if it is exposed to direct sun for long hours. When your vehicle is parked, place it in the shade as much as possible.

Cleaning the exterior of your vehicle

E08400600010

If the following is left on your vehicle, it may cause corrosion, discolouration and stains, wash the vehicle as soon as possible.

- Seawater, road deicing products.
- Soot and dust, iron powder from factories, chemical substance (acids, alkalis, coal-tar, etc.).
- Droppings from birds, carcasses of insects, tree sap, etc.

Washing

E08400700011

Chemicals contained in the dirt and dust picked up from the road surface can damage the paint coat and body of your vehicle if left in prolonged contact. Frequent washing and waxing is the best way to protect your vehicle from this damage. This will also be effective in protecting it from environmental elements such as rain, snow, salt air, etc.

Do not wash the vehicle in direct sunlight. Park the vehicle in the shade and spray it with water to remove dust. Next, using an ample amount of clean water and a car washing brush or sponge, wash the vehicle from top to bottom.

Use a mild car washing soap if necessary. Rinse thoroughly and wipe dry with a soft cloth. After washing the vehicle, carefully clean the joints and flanges of the doors, bonnet and other sections where dirt is likely to remain.

WARNING

- Do not wash the vehicle while charging the traction battery. Doing so could cause fire or an electric shock.
- Before washing the vehicle, make sure that the charging lid and the inner lid are completely closed. If the lid is open, the charging unit is exposed to water, resulting in fire or an electric shock.
- Do not pour water inside the electric motor unit room. Doing so could cause fire or an electric shock.
- When washing the vehicle, turn the electric motor switch to the “LOCK” position.
- Do not use a high pressure washing machine to clean the underneath of the vehicle. Doing so might cause the electric motor unit problem or malfunction.
- When washing the underside of your vehicle or wheel, be careful not to injure your hands.
- Refrain from excessively using a car wash as its brushes may scratch the paint surface, causing it to lose its gloss. Scratches will be especially visible on darker coloured vehicles.
- Never spray or splash water on the electrical components in the bonnet room. Exercise caution also when washing the underbody; be careful not to spray water into the bonnet room.
- Some types of hot water washing equipment apply high pressure and heat to the

WARNING

vehicle. They may cause heat distortion and damage to the vehicle resin parts and may result in flooding of the vehicle interior.

Therefore;

- Maintain a distance of approx. 70 cm or more between the vehicle body and the washing nozzle.
- When washing around the door glass, hold the nozzle at a distance of more than 70 cm and at right angles to the glass surface.
- After washing the vehicle, drive the vehicle slowly while lightly depressing the brake pedal several times in order to dry out the brakes.

Leaving the brakes wet could result in reduced braking performance. Also, there is a possibility that they could freeze up or become inoperative due to rust, rendering the vehicle unable to move.

- When using an automatic car wash, pay attention to the following items, referring to the operation manual or consulting a car wash operator. If the following procedure is not followed, it could result in damage to your vehicle.
 - The outside mirrors are retracted.
 - The antenna is removed.
 - The wiper arms are secured in place with tape.
 - If your vehicle is equipped with a rear spoiler, consult a car wash operator before using the car wash.

During cold weather

Salt and other chemicals spread on the roads in some areas in winter can have a harmful effect on the vehicle body. You should therefore wash the vehicle as often as possible in accordance with our care-instructions. It is recommended to have a preservative applied and the underfloor protection checked before and after the cold weather season.

After washing your vehicle, wipe off all water-drops from the rubber parts around the doors to prevent the doors from freezing.

NOTE

- To prevent freezing of the weatherstripping on the doors, bonnet, etc., they should be treated with silicone spray.

Waxing

E08400800012

Waxing the vehicle will help prevent the adherence of dust and road chemicals to the paintwork. Apply a wax solution after washing the vehicle, or at least once every three months to assist displacing of water. Do not wax your vehicle in direct sunlight. You should wax after the surfaces have cooled.

CAUTION

- Waxes containing high abrasive compounds should not be used. Such waxes remove rust and stains effectively from the paintwork but they are harmful to the lustre on the painted surface and the plated surface. Further, they are harmful to glossy surfaces such as grille, garnish, mouldings, etc.

CAUTION

- Do not use petrol or paint thinners to remove road tar or other contamination to the painted surface.
- Do not apply wax to sections that have a black mat paint coating, as doing so could cause uneven discolouration, spots or stains. If wax gets on such areas, wipe it off using lukewarm water and a soft cloth.

Polishing

E08400900013

The vehicle should only be polished if the paintwork has become stained or lost its lustre. Do not polish parts with a mat coating and the plastic bumpers. Doing so could cause stains or damage the finish.

Damaged paint

E08401000011

Small cracks and scratches in the paint coat should be touched up as soon as possible with MITSUBISHI touch-up paint to prevent corrosion. Check body areas facing the road or the tyres carefully for damage to the paint caused by gravels, etc. The paint code number for your vehicle can be found on the vehicle information code plate. (Refer to "Vehicle information code plate" on page 9-02.)

Cleaning plastic parts

E08401100012

Use a sponge or chamois leather. If a car wax adheres on a grey or black rough surface of the bumper, moulding or lamps, the surface becomes white. In such a case, wipe it off using lukewarm water and soft cloth or chamois leather.

CAUTION

- Do not use a scrubbing brush or other hard tools as they may damage the plastic part surface.
- Do not use wax containing compound (polishing powder) which may damage the plastic part surface.
- Do not bring the plastic parts into contact with petrol, light oil, brake fluids, greases, paint thinners, and sulphuric acid (battery electrolyte) which may crack, stain or discolour the plastic parts. If they touch the plastic parts, wipe them off with soft cloth, chamois or the like and an aqueous solution of neutral detergent then immediately rinse the affected parts with water.

Chrome parts

E08401200013

In order to prevent spots and corrosion of chrome parts, wash with water, dry thoroughly, and apply a special protective coating. This should be done more frequently in winter.

Aluminium wheels

E08401300014

1. Remove dirt using a sponge while sprinkling water on the vehicle.
2. Use neutral detergent on any dirt that cannot be removed easily with water. Rinse off the neutral detergent after washing the vehicle.
3. Dry the vehicle thoroughly using a chamois leather or a soft cloth.

CAUTION

- Do not use a brush or other hard implement on the wheels. Doing so could scratch the wheels.
- Do not use any cleaner that contains an abrasive substance or is acidic or alkaline. Doing so could cause the coating on the wheels to peel or become discoloured or stained.
- Do not directly apply hot water using a steam cleaner or by any other means.
- Contact with seawater and road deicer can cause corrosion. Rinse off such substances as soon as possible.

Window glass

E08401400015

The window glass can normally be cleaned using only a sponge and water. Glass cleaner can be used to remove oil, grease, insect carcasses, etc. After washing the glass, wipe it dry with a clean, dry, soft cloth. Never use a cloth that is used for cleaning a painted surface to clean a window. Wax from the painted surface could get on the glass and lower glass transparency and visibility.

NOTE

- To clean the inside of the rear window, always use a soft cloth and wipe the window glass along the demister heater element so as not to cause damage.

Wiper blades

E08401500016

Use a soft cloth and glass cleaner to remove grease, dead insects, etc., from the wiper blades. Replace the wiper blades when they no longer wipe properly. (Refer to page 8-17.)

Bonnet room

E08401600017

Clean the bonnet room at the beginning and end of winter. Pay particular attention to flanges, crevices and peripheral parts where dust containing road chemicals and other corrosive materials might collect.

If salt and other chemicals are used on the roads in your area, clean the engine compartment at least every three months.

Never spray or splash water on the electrical components in the bonnet room, as this may cause damage.

Do not bring the nearby parts, the plastic parts and so on into contact with sulphuric acid (battery electrolyte) which may crack, stain or discolour them.

If they are in contact, wipe off with soft cloth, chamois or the like and an aqueous solution of neutral detergent then immediately rinse the affected parts with plenty of water.

Service precautions

E08401700034

Adequate care of your vehicle at regular intervals serves to preserve the value and appearance as long as possible.

Maintenance items as described in this owner's manual can be performed by the owner.

We recommend you to have the periodic inspection and maintenance performed by a MITSUBISHI MOTORS Authorized Service Point or another specialist.

In the event a malfunction or a problem is discovered, we recommend you to have it checked and repaired. Follow the instructions and cautions for each of the various procedures.

⚠ WARNING

- Do not touch any components in the electric motor unit room other than the reserve tank. There are no components requiring inspection other than the reserve tank. Never remove or disassemble the component which generates high voltage, high voltage wire (orange), its connector, EV charging cable, charge connector, plug and an outlet. Doing so could result in a serious injury that may risk your life. These components are affixed with the label indicating precautions for handling. Follow the instructions on the label. Take your vehicle to a MITSUBISHI MOTORS Authorized Service Point for any necessary maintenance.

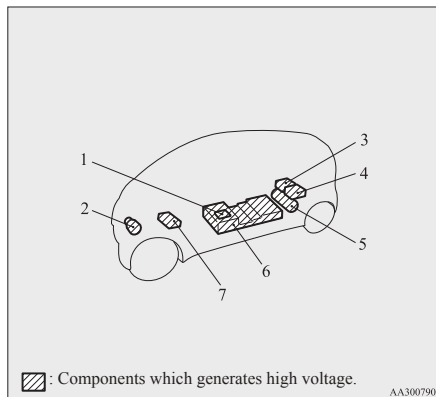

- 1- Service plug
- 2- Air conditioner compressor
- 3- Inverter
- 4- On board charger/DC-DC converter
- 5- Electric motor (Electric motor unit)
- 6- Traction battery
- 7- Heater

⚠ WARNING

- Never touch the service plug (A) under the front seat. Doing so could result in serious injury that may risk your life, including an electric shock. The service plug (A) is used to shut off high voltage from the traction battery for repair of the vehicle at a MITSUBISHI MOTORS Authorized Service Point or another specialist.

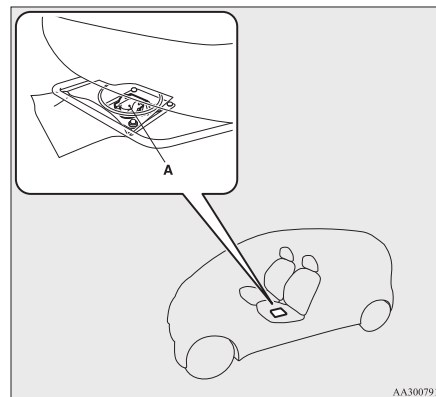

⚠ WARNING

- When checking or servicing the inside of the bonnet room and coolant reserve tank, make sure the electric motor unit is switched off and has had a chance to cool down.
- If it is necessary to do work in the bonnet room with the electric motor running, be especially careful that your clothing, hair, etc., does not become caught by the fan, or other moving parts.
- The fan can turn on automatically even if the electric motor is not running. Turn the electric motor switch to the "LOCK" position to be safe while you work in the bonnet room.
- Do not smoke, cause sparks or allow open flames around the auxiliary battery.

⚠ WARNING

- Be extremely cautious when working around the auxiliary battery. It contains poisonous and corrosive sulphuric acid.
- Improper handling of components and materials used in the vehicle can endanger your personal safety. We recommend you to consult a specialist for necessary information.

⚠ CAUTION

- The components inside the electric motor unit room might be very hot to touch. To avoid being burnt, make sure all components have sufficiently cooled before beginning an inspection. These components are affixed with the label indicating precautions for handling. Follow the instructions on the label.
- When replacing the auxiliary battery, remove the connected positive (+) and negative (-) terminals after turning the electric motor switch to the "LOCK" position and waiting at least 1 minute. If the auxiliary battery terminal is removed just after the electric motor switch is turned to the "LOCK" position, this may cause damage to components of the electric motor unit.

Bonnet

E08402000018

To open

1. Pull the release lever towards you to unlock the bonnet.

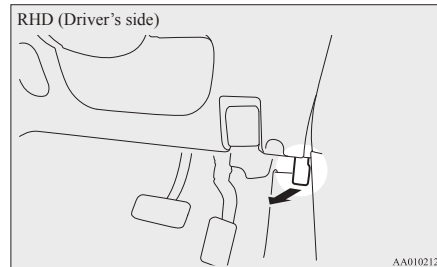
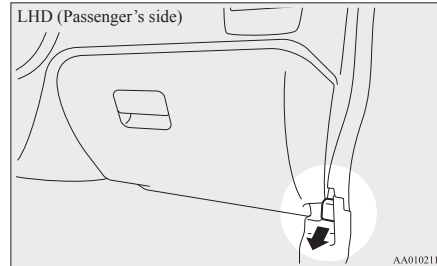

2. Raise the bonnet while pressing the safety lock (A).

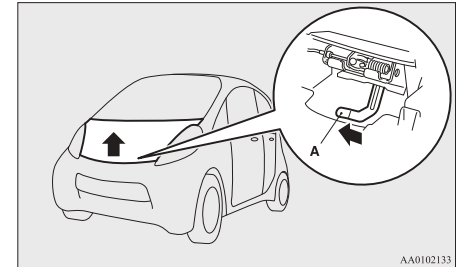

NOTE

- Only open the bonnet when the wipers are in the parked position. In any other position, the wipers could damage the paint or bonnet.
3. Support the bonnet by inserting the support bar (B) into its slot on the underside of the bonnet arm (C).

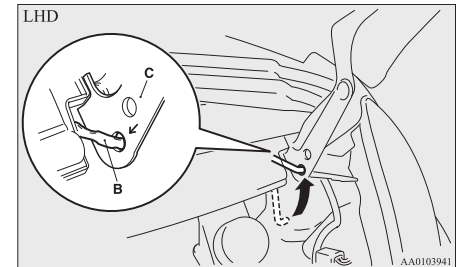

Vehicle care and Maintenance

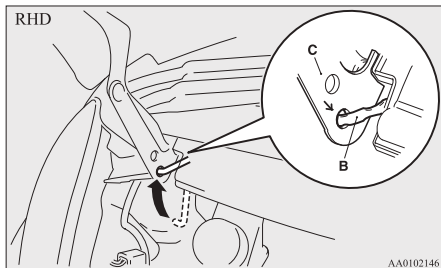

⚠ CAUTION

- Note that the support bar may disengage the bonnet if the open bonnet is lifted by a strong wind.
- After inserting the support bar into the slot, make sure the bar supports the bonnet securely from falling down on to your head or body.

To close

1. While supporting the bonnet, remove the support bar from the bonnet arm hole and secure it to the clip.
2. Slowly lower the bonnet to a position about 30 cm above the closed position, then let it drop.

3. Make sure the bonnet is securely locked by softly lifting the centre of the bonnet.

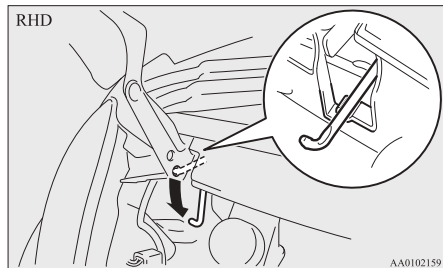
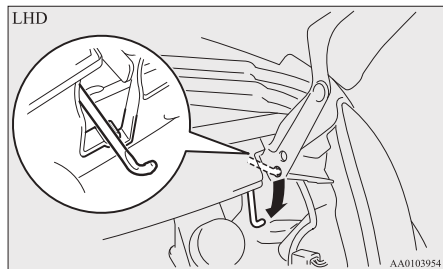

NOTE

- If this does not close the bonnet, release it from a slightly higher position.
- Do not press down the bonnet hard with a hand as it may damage the bonnet.

⚠ CAUTION

- Be careful that hands or fingers are not trapped when closing the bonnet.
- Before driving, make sure that the bonnet is securely locked. An incompletely locked bonnet can suddenly open while driving. This can be extremely dangerous.

Coolant/Hot water heater fluid

E08402100019

To check the coolant level

Coolant

1. Open the tailgate.

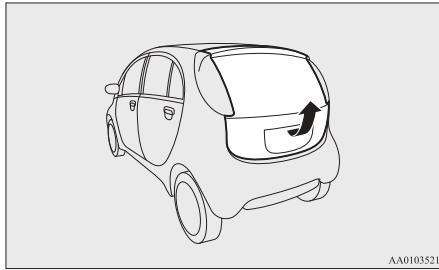

2. Peel off the Velcro fastener (A) to remove the luggage floor carpet (B).

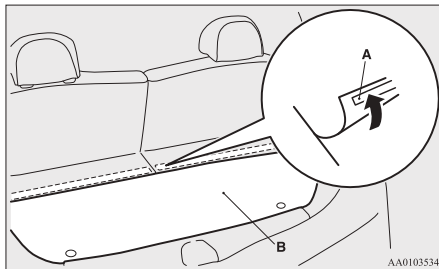

NOTE

- A heat insulating material is attached to the luggage floor carpet. To remove the luggage floor carpet, grab and lift up both the carpet fabric and the heat insulating material.
3. Turn the 4 screws on the front and rear of the electric motor unit room lid (C) anticlockwise to loosen and remove them, and then remove the electric motor unit room lid (C).

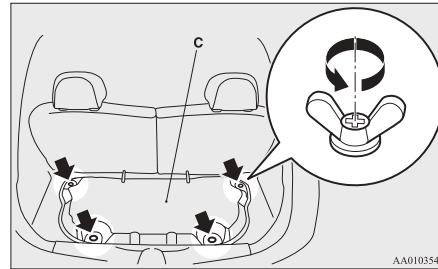

NOTE

- When laying the electric motor unit room lid on the ground, leave the underside of the lid with the rubber surface facing up. If the underside is facing downward rubbish and other foreign material could get on the rubber surface and prevent proper reinstallation of the electric motor unit room lid.
4. Check the coolant level in the reservoir tank (D).

While the motor is cold, the coolant level must always be between the “FULL” and “LOW” marks.

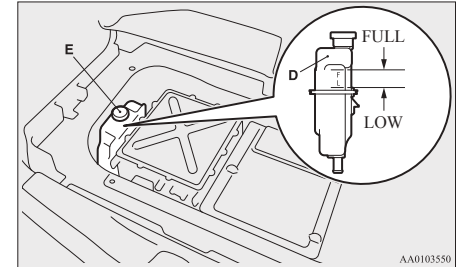

5. Refit the electric motor unit room lid and the luggage floor carpet by following the removal procedures in reverse.

Hot water heater fluid

A transparent reserve tank (A) is located in the bonnet room.

The coolant level in this tank should be kept between the “FULL” and “LOW” marks when measured while the electric motor is cold.

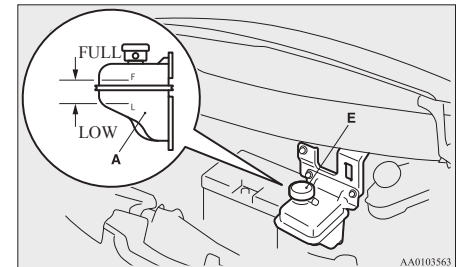

Vehicle care and Maintenance

To add coolant

The cooling system is a closed system and normally the loss of coolant should be very slight. A noticeable drop in the coolant level could indicate leakage. If this occurs, we recommend you to have the system checked as soon as possible.

If the level should drop below the “LOW” level on the reserve tank, open the reserve tank cap (E) and add coolant.

WARNING

- Do not open the reserve tank cap (E) while it is hot. The coolant system is under pressure and any hot coolant escaping could cause severe burns.

Anti-freeze

The coolant contains an ethylene glycol anti-corrosion agent. Some parts of the electric motor are cast aluminium alloy, and periodic changing of the electric motor coolant is necessary to prevent corrosion of these parts.

Use “DIA QUEEN SUPER LONG LIFE COOLANT PREMIUM” or equivalent*.

*: similar high quality ethylene glycol based non-silicate, non-amine, non-nitrate and non-borate coolant with long life hybrid organic acid technology

MITSUBISHI Genuine Coolant has excellent protection against corrosion and rust formation of all metals including aluminium and can avoid blockages in the radiator, heater, etc.

Because of the necessity of this anti-corrosion agent, the coolant must not be replaced with plain water even in summer. The required concentration of anti-freeze differs depending on the expected ambient temperature.

Above -35 °C: 50 % concentration of anti-freeze

Below -35 °C: 60 % concentration of anti-freeze

CAUTION

- Do not use alcohol or methanol anti-freeze or any engine coolants mixed with alcohol or methanol anti-freeze. The use of an improper anti-freeze can cause corrosion of the aluminium components.
- Do not use water to adjust the concentration of coolant.
- Concentrations exceeding 60 % will result in a reduction of both the anti-freeze and cooling performance.
- Do not top up with water only. Water by itself reduces the rust-protective and anti-freeze qualities of the coolant and has a lower boiling point. It can also cause damage to the cooling system if it should freeze. Do not use tapwater, as it can cause corrosion and rust formation.

During cold weather

If the temperatures in your area drop below freezing, there is the danger that the coolant in the electric motor, on board charger/DC-DC converter or radiator could freeze and cause severe damage to the electric motor, on board charger/DC-DC converter and/or radiator. Add a sufficient amount of anti-freeze to the coolant to prevent it from freezing.

The concentration should be checked before the start of cold weather and anti-freeze added to the system if necessary.

Washer fluid

E08402200010

Check if the fluid level is between the “FULL” and “1/2” on the washer fluid reservoir.

If the level is low, replenish the container with washer fluid.

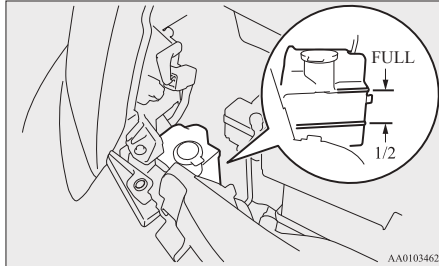

NOTE

- The washer fluid container serves the windscreen, rear window.

During cold weather

To ensure proper operation of the washers at low temperatures, use a fluid containing an anti-freezing agent.

Brake fluid

E08406100017

To check the fluid level

The brake fluid level must be between the “MAX” and “MIN” marks on the reservoir.

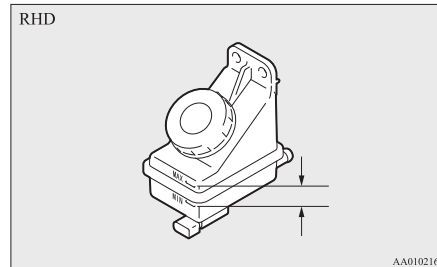
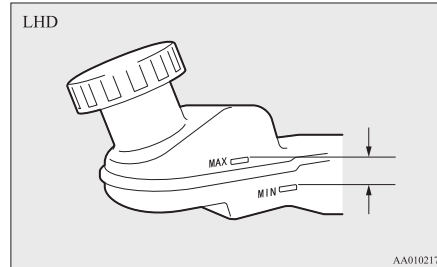

The brake fluid level is monitored by a float. When the brake fluid level falls below the “MIN” mark, the brake fluid warning lamp lights up. The fluid level falls slightly with wear of the brake pads, but this does not indicate any abnormality.

The brake fluid in the master cylinder should be checked when doing other work under the bonnet. The brake system should also be checked for leakage at the same time.

If the brake fluid level falls markedly in a short length of time, it indicates leaks from the brake system.

If this occurs, we recommend you to have the vehicle checked.

Fluid type

Use brake fluid conforming to DOT3 or DOT4 from a sealed container. The brake fluid is hygroscopic. Too much moisture in the brake fluid will adversely affect the brake system, reducing the performance.

CAUTION

- Take care in handling brake fluid as it is harmful to the eyes, may irritate your skin and also damage painted surfaces.
- Use only the specified brake fluid. Do not mix or add different brands of brake fluid to prevent chemical reactions. Do not let any petroleum-based fluid touch, mix with, or get into the brake fluid. This will damage the seals.
- Keep the reservoir tank cap closed to prevent the brake fluid from deteriorating except maintenance.
- Clean the filler cap before removing and close the cap securely after maintenance.

Auxiliary battery

E08402300011

The condition of the auxiliary battery is very important to keep the vehicle's electrical system working properly. Regular inspection and care are especially important in cold weather.

Removing and installing the auxiliary battery upper cover

E08402400012

To remove

1. Turn the plastic nut (A) anticlockwise, and then remove the auxiliary battery upper cover (B).

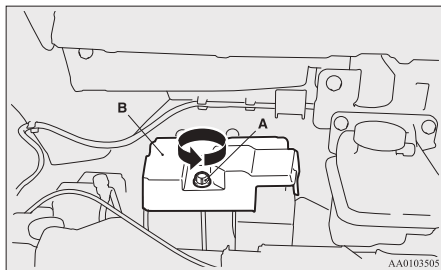

NOTE

- Be careful not to lose the removed plastic nut.

To install

1. Install the auxiliary battery upper cover (B) onto the auxiliary battery, and then push the plastic nut (A) in the direction shown by the arrows to secure the cover.

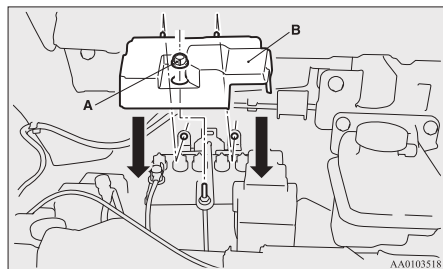

CAUTION

- Be sure to install the auxiliary battery upper cover. Otherwise, the battery electrolyte may spill and cause a malfunction.
- When installing the auxiliary battery upper cover and plastic nut do not touch the cooling fan or other moving parts in the bonnet room.
Be especially careful that the cables, your clothing or hair, etc., do not get caught in the cooling fan or other moving parts.

NOTE

- Be sure to install the plastic nut in the correct direction.

Checking auxiliary battery electrolyte level

E08402500013

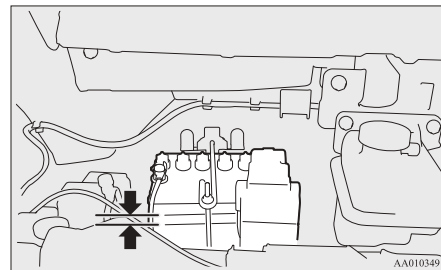

Before checking the auxiliary battery electrolyte level, remove the auxiliary battery's upper cover.

The electrolyte level must be between the specified limit on the outside of the auxiliary battery. Replenish with distilled water as necessary.

The inside of the auxiliary battery is divided into several compartments; remove the cap from each compartment and fill to the upper mark. Do not top up beyond the upper mark because spillage during driving could cause damage.

Check the electrolyte level at least once every 4 weeks, depending on the operating conditions.

If the auxiliary battery is not used, it will discharge by itself with time.

Check it once every four weeks and charge with low current if necessary.

During cold weather

E08402600014

The capacity of the auxiliary battery is reduced at low temperatures. This is an inevitable result of its chemical and physical properties. This is why a very cold auxiliary battery, particularly one that is not fully charged will only deliver a fraction of the starting current which is normally available.

We recommend you to have the auxiliary battery checked before the start of cold weather and, if necessary, have it charged or replaced.

This does not only ensure reliable starting, but an auxiliary battery which is kept fully charged also has a longer life.

Disconnection and connection

E08402700015

To disconnect the auxiliary battery cable, stop the electric motor unit, first disconnect the negative (-) terminal and then the positive (+) terminal. When connecting the auxiliary battery, first connect the positive (+) terminal and then the negative (-) terminal.

NOTE

- Open the terminal cover (A) before disconnecting or connecting the positive (+) terminal of the auxiliary battery.
- Loosen the nut (B), and then disconnect the auxiliary battery cable from the positive (+) terminal.

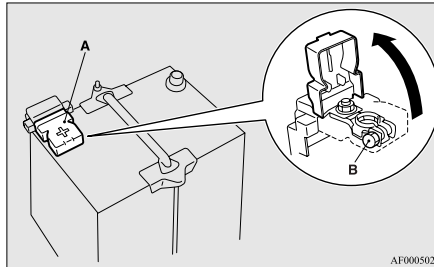

⚠ WARNING

- Keep sparks, cigarettes, and flames away from the auxiliary battery because the auxiliary battery could explode.
- When installing the auxiliary battery, start connection with the positive (+) terminal. If connection is started from the negative (-) terminal, sparks will occur if the positive (+) terminal touches any other parts, and this may cause the auxiliary battery to explode.
- The auxiliary battery electrolyte is extremely caustic. Do not allow it to come in contact with your eyes, skin, clothing, or the painted surfaces of the vehicle. Spilt electrolyte should be flushed immediately with ample amounts of water. Irritation to eyes or skin from contact with electrolyte requires immediate medical attention.
- Ventilate when charging or using the auxiliary battery in an enclosed space.

⚠ CAUTION

- Keep it out of reach of children.
- When replacing the auxiliary battery, remove the connected positive (+) and negative (-) terminals after turning the electric motor switch to the "LOCK" position and waiting at least 1 minute. If the auxiliary battery terminal is removed just after the electric motor switch is turned to the "LOCK" position, this may cause damage to components of the electric motor unit.
- Never short-circuit the auxiliary battery. This could cause it to overheat and be damaged.
- If the auxiliary battery is to be quick-charged, first disconnect the battery cables.
- In order to prevent a short circuit, be sure to disconnect the negative (-) terminal first.
- Always wear protective eye goggles when working near the auxiliary battery.
- Do not bring the nearby parts, the plastic parts and so on into contact with sulphuric acid (battery electrolyte) which may crack, stain or discolour them. If they are in contact, wipe off with soft cloth, chamois or the like and an aqueous solution of neutral detergent then immediately rinse the affected parts with plenty of water.

Vehicle care and Maintenance

NOTE

- Keep the terminals clean. After the auxiliary battery is connected, apply terminal protection grease. To clean the terminals, use lukewarm water.
- Check to see if the auxiliary battery is securely installed and cannot be moved during travel. Also check each terminal for tightness.
- When the vehicle is to be left unused for a long period of time, remove the auxiliary battery and store it in a place where the battery fluid will not freeze. The auxiliary battery should be stored only in a fully charged condition.
- It is necessary to adjust the electronic controlled unit when the auxiliary battery is removed for a long period of time. Consult a MITSUBISHI MOTORS Authorized Service Point.

Tyres

E08402800016



WARNING

- **Driving with tyres that are worn, damaged or improperly inflated can lead to loss of control or blowout of the tyres which can result in a collision with serious or fatal injury.**

Tyre inflation pressures

E08402900033

Tyre size	Front	Rear
145/65R15	2.5 bar (36 psi) [250 kPa]	—
175/55R15	—	2.5 bar (36 psi) [250 kPa]

Check the tyre inflation pressure of all the tyres while they are cold; if insufficient or excessive, adjust to the specified value. After the tyre inflation pressure has been adjusted, check the tyres for damage and air leaks. Be sure to put caps on the valves.

Wheel condition

E0840300015

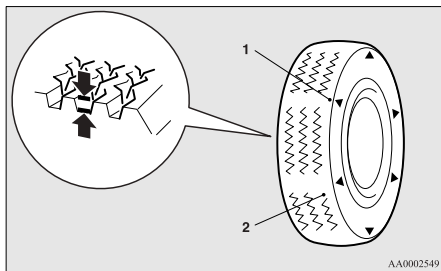

- 1- Location of the tread wear indicator
2- Tread wear indicator

Check the tyres for cuts, cracks and other damage. Replace the tyres if there are deep cuts or cracks. Also check each tyre for pieces of metal or pebbles. The use of worn tyres can be very dangerous because of the greater chance of skidding or hydroplaning. The tread depth of the tyres must exceed 1.6 mm in order for the tyres to meet the minimum requirement for use.

Tread wear indicators will appear on the surface of the tyre as the tyre wears, thereby indicating that the tyre no longer meets the minimum requirement for use. When these wear indicators appear, the tyres must be replaced with new ones.

⚠ CAUTION

- Always use tyres of the same size, same type, and same brand, and which have no wear differences. Using tyres of different size, type, brands or degree of wear, will increase the differential oil temperature, resulting in possible damage to the driving system. Further, the drive train will be subjected to excessive loading, possibly leading to oil leakage, component seizure, or other serious faults.

Replacing tyres and wheels

E08403100016

⚠ CAUTION

- Avoid using different size tyres from the one listed and the combined use of different types of tyres, as this can affect driving safety. Refer to “Tyres and wheels” on page 9-05.
- Even if a wheel has the same rim size and offset as the specified type of wheel, its shape may prevent it from being fitted correctly. We recommend you to consult a specialist before using wheels that you have.

Tyre rotation

E08403200017

Because the front and rear tyres and wheels are not the same size, front and rear tyre rotation is not possible.

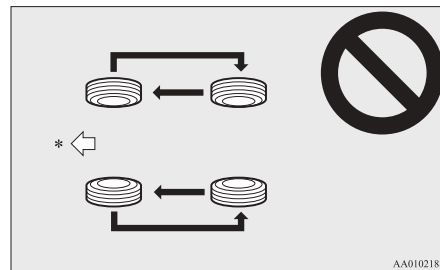

*: Front

⚠ WARNING

- Rotating tyres would compromise the stability and drivability of the vehicle and could lead to a serious accident.

Snow tyres

E08403300018

The use of snow tyres is recommended for driving on snow and ice. To preserve driving stability, mount snow tyres of the same size and tread pattern on wheels.

A snow tyre that is worn down more than 50% is no longer appropriate to use.

Snow tyres which do not meet specifications must not be used.

Wiper blades

E08403500010

If the blades are frozen to the windscreen or rear window, do not operate the wipers until the ice has melted and the blades are freed, otherwise the wiper motor may be damaged.

NOTE

- When replacing the front wiper with a wiper for use in cold regions, it is necessary to adjust the washer nozzle spray positions. Always contact your MITSUBISHI MOTORS Authorized Service Point when replacing the front wiper with a wiper for use in cold regions.
- When removing snow and frost, be careful not to damage the washer nozzles (A) attached to the wiper arm.

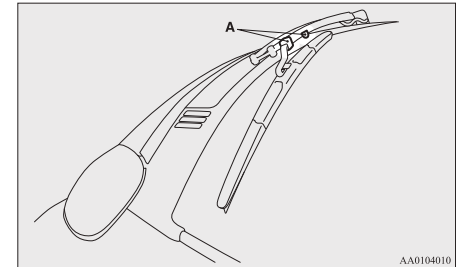

AA0104010

Wiper blade rubber replacement

Windscreen wiper blades

1. Lift the wiper arm off the windscreen.
2. Pull the wiper blade until its stopper (A) disengages from the hook (B) as indicated direc-

CAUTION

- Observe permissible maximum speed for your snow tyres and the legal speed limit.

NOTE

- The laws and regulations concerning snow tyres (driving speed, required use, type, etc.) vary. Find out and follow the laws and regulations in the area you intend to drive.
- If flange nuts are used on your vehicle, change to tapered nuts when steel wheels are used.

Tyre chains

E08403400035

If tyre chains have to be used, ensure that they are fitted only on the drive wheels (rear) in accordance with the manufacturer's instructions.

Use only tyre chains which are designed for use with the tyres mounted on the vehicle: use of the incorrect size or type of chain could result in damage to the vehicle body.

Contact a MITSUBISHI MOTORS Authorized Service Point before putting on tyre chains. The max. chain height is as follows.

Tyre size	Wheel size	Max chain height [mm]
175/55R15	15 x 5 J	14 mm

When driving with tyre chains on the tyres, do not drive faster than 50 km/h (30 mph). When you reach roads that are not covered in snow, immediately remove the tyre chains.

CAUTION

- Practice fitting the chains before you need them. Don't expect help from other people in the cold.
- Choose a clear straight stretch of road where you can pull over and still be seen while you are fitting the chains.
- Do not fit chains before you need them. This will wear out your tyres and the road surface.
- After driving around 100-300 metres, stop and retighten the chains.
- Drive carefully and do not exceed 50 km/h (30 mph). Remember that preventing accidents is not the purpose of tyre chains.
- An aluminium wheel can be damaged by a tyre chain while driving. When fitting a tyre chain on an aluminium wheel, take care that no part of the chain and fitting can be brought into contact with the wheel.
- When installing or removing the tyre chains, take care that hands and other parts of your body are not injured by the sharp edges of the vehicle body.

NOTE

- The laws and regulations concerning the use of tyre chains vary. Always follow local laws and regulations.
- In most countries, it is prohibited by law to use tyre chains on roads without snow.

Vehicle care and Maintenance

tion by the arrow (C) on the hook. Pull the wiper blade to remove it.

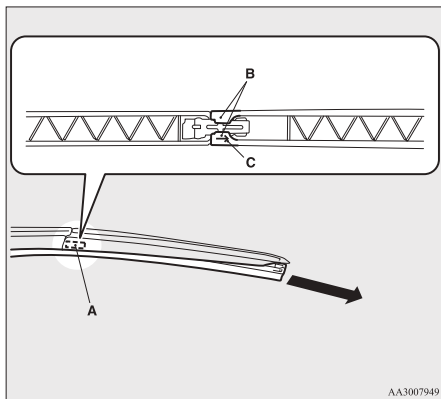

NOTE

- Do not let the wiper arm drop onto the wind-screen. This could damage the glass.

3. Attach the retainers (D) to a new wiper blade. Refer to the illustration to ensure that the retainers are correctly aligned as you attach them.

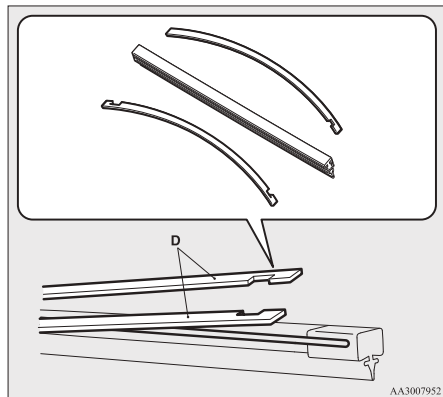

4. Insert the wiper blade into the arm, starting with the opposite end of the blade from the stopper. Make sure the hook (B) is fitted correctly in the grooves in the blade.

NOTE

- If a retainer is not supplied with the new wiper blade, use the retainer from the old blade.

5. Push the wiper blade until the hook (B) engages securely with the stopper (A).

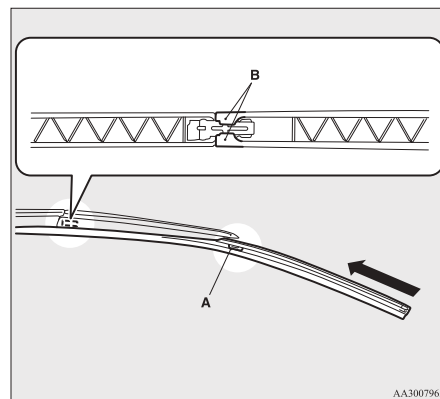

Rear window wiper blades

1. Lift the wiper arm off the window glass.
2. Pull the wiper blade downward to disengage it from the stopper (A) at the end of the wiper arm. Pull the wiper blade further to remove it.
3. Slide a new wiper blade through the hook (B) on the wiper arm.

General maintenance

E08403600011

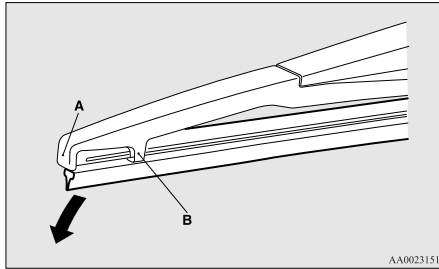

NOTE

- Do not allow the wiper arm to fall onto the window glass; it could damage the glass.

4. Firmly insert the retainer (C) into the groove (D) in the wiper blade. Refer to the illustration to ensure that the retainers are correctly aligned as you insert them into the groove.

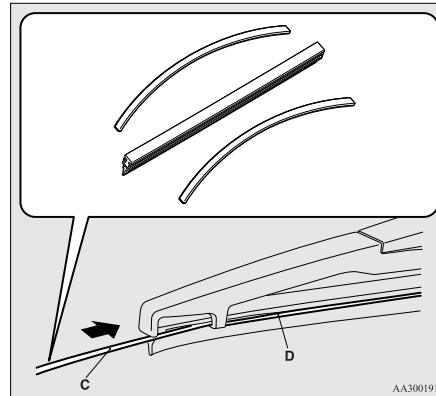

NOTE

- If a retainer is not supplied with the new wiper blade, use the retainer from the old blade.

Coolant and oil leakage

Look under the body of your vehicle to check for coolant and oil leakage.

Exterior and interior lamp operation

Operate the combination lamp switch to check that all lamps are functioning properly.

If the lamps do not illuminate, the probable cause is a blown fuse or defective lamp bulb. Check the fuses first. If there is no blown fuse, check the lamp bulbs.

For information regarding the inspection and replacement of the fuses and the bulbs, refer to "Fuses" on page 8-20 and "Replacement of lamp bulbs" on page 8-23.

If the fuses and bulbs are all OK, we recommend you to have your vehicle checked and repaired.

Meter, gauge and indicator/warning lamps operation

Start the electric motor unit and check the operation of all instruments, gauges and indication and warning lamps.

If there is anything wrong, we recommend you to have your vehicle inspected.

Hinges and latches lubrication

Check all latches and hinges, and, if necessary, have them lubricated.

For cold and snowy weather

E08403700012

Ventilation slots

The ventilation slots in front of the windscreen should be kept clear of leaves or brushed clear after heavy snowfall, so that the operation of the heating and ventilation systems will not be impaired.

Weatherstripping

To prevent freezing of the weatherstripping on the doors, bonnet, etc., they should be treated with silicone grease.

Additional equipment

It is a good idea to carry a shovel or a short-handled spade in the vehicle during the winter so that you can clear away snow if you get stranded. A small hand-brush for sweeping snow off the vehicle and a plastic scraper for the windscreen and rear window are also useful.

Fusible links

E08403800013

The fusible links will melt to prevent a fire if a large current attempts to flow through certain electrical systems.

In case of a melted fusible link, we recommend you to have your vehicle inspected.

For the fusible links, please refer to "Passenger compartment fuse location table" on page 8-21 and "Bonnet room fuse location table" on page 8-22.

⚠ WARNING

- **Fusible links must not be replaced by any other device. Failing to fit the correct fusible link may result in fire in the vehicle, property destruction and serious or fatal injuries at any time.**

Fuses

E08403900014

Fuse block location

E08404000012

To prevent damage to the electrical system due to shortcircuiting or overloading, each individual circuit is provided with a fuse.

There are fuse blocks in the passenger compartment and in the bonnet room.

NOTE

- Spare fuses are not provided. Please purchase it from a MITSUBISHI MOTORS Authorized Service Point or other locations.

Passenger compartment

The fuse block in the passenger compartment is located in front of the driver's seat at the position shown in the illustration.

Press the tab (A) and remove the fuse cover (B).

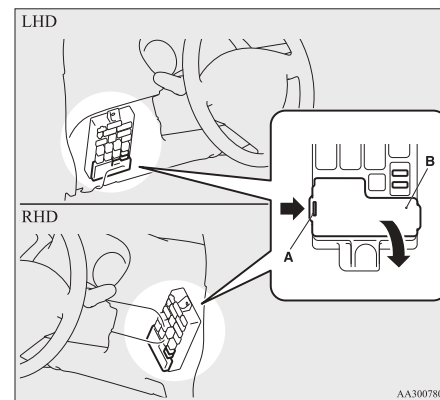

AA3007806

Bonnet room

In the bonnet room, the fuse block is located as shown in the illustration. Press the tab (A) and remove the cover.

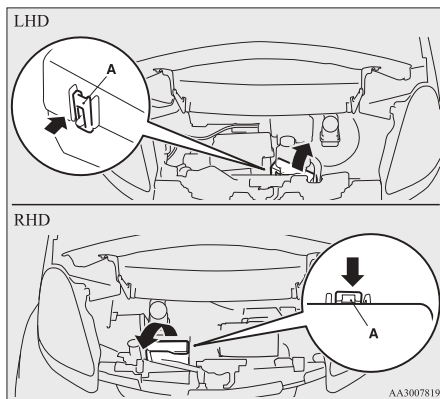

Fuse load capacity

The fuse capacity and the names of electrical systems protected by the fuses are indicated on the fuse block cover.

Passenger compartment fuse location table

E08404200014

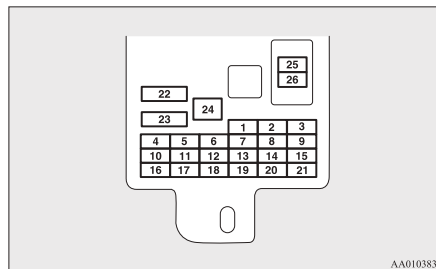

No.	Symbol	Electrical system	Capacities
1		Tail lamp (left)	7.5 A
2		Cigarette lighter/Accessory socket	15 A
3	—	—	—
4		Starter	7.5 A
5		Audio system amp	20 A
6	—	—	—
7		Tail lamp (right)	7.5 A
8		Outside rear-view mirrors	7.5 A
9		Control unit (Electric motor unit)	7.5 A

*: Fusible link

No.	Symbol	Electrical system	Capacities
10		Control unit	7.5 A
11		Rear fog lamp	10 A
12		Central door lock	15 A
13		Room lamp	10 A
14		Rear window wiper	15 A
15		Gauge	7.5 A
16		Relay	7.5 A
17		Heated seat	20 A
18	OPTION	Option	10 A
19		Heated door mirror	7.5 A
20		Windscreen wiper	20 A
21		Reversing lamps	7.5 A
22		Demister	30 A
23		Heater	30 A
24		Auxiliary battery	30 A*
25		Radio	10 A
26		Electronic controlled unit	15 A

*: Fusible link

- Some fuses may not be installed on your vehicle, depending on the vehicle model or specifications.

Vehicle care and Maintenance

- The table above shows the main equipment corresponding to each fuse.

Bonnet room fuse location table

E08404300015

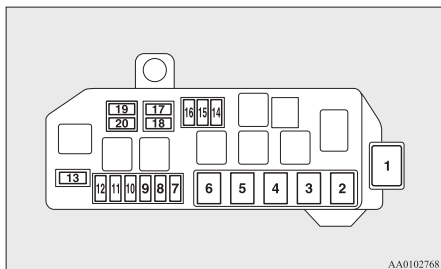

AA0102768

No.	Symbol	Electrical system	Capacity
1	—	—	—
2		Auxiliary battery	30 A*
3		Electric motor switch	40 A*
4		Radiator fan motor	40 A*
5		Electric window control	40 A*
6		Brake electric vacuum pump	30 A*
7		Electric motor unit control	15 A
8	STOP	Stop lamps	15 A

*: Fusible link

No.	Symbol	Electrical system	Capacity
9		Front fog lamps	15 A
10		Water pump (Electric motor unit)	15 A
11		Charge	10 A
12		Hazard warning flasher	10 A
13		Horn	10 A
14		Daytime running lamps	10 A
15		Traction battery cooling fan motor	15 A
16		Water pump (Air conditioning)	10 A
17		Headlamp low beam (right)	20 A
18		Headlamp low beam (left)	20 A
19		Headlamp high-beam (right)	10 A
20		Headlamp high-beam (left)	10 A

*: Fusible link

- Some fuses may not be installed on your vehicle, depending on the vehicle model or specifications.
- The table above shows the main equipment corresponding to each fuse.

Identification of fuse

E08404400016

Capacity	Colour
7.5 A	Brown
10 A	Red
15 A	Blue
20 A	Yellow
30 A	Green (fuse type) / Pink (fusible link type)
40 A	Green (fusible link type)

Fuse replacement

E08404500017

1. Before replacing a fuse, always turn off the electrical circuit concerned and turn the electric motor switch to the “LOCK” position.
2. Remove the fuse puller (A) from the inside of the fuse cover in the passenger compartment.

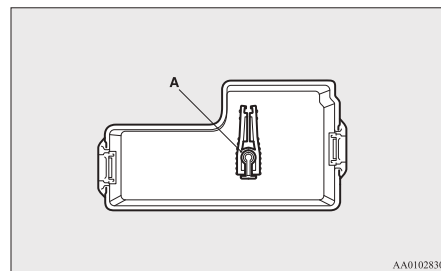

AA0102830

3. Referring to the fuse load capacity table, check the fuse pertaining to the problem.

Replacement of lamp bulbs

E0840460018

Before replacing a bulb, ensure the lamp is off. Do not touch the glass part of the new bulb with your bare fingers; the skin oil left on the glass will evaporate when the bulb gets hot and the vapour will condense on the reflector and dim the surface.

CAUTION

- **Bulbs are extremely hot immediately after being turned off. When replacing a bulb, wait for it to cool sufficiently before touching it. You could otherwise be burnt.**

NOTE

- If you are unsure of how to carry out the work as required, we recommend you to consult a specialist.
- Be careful not to scratch the vehicle body when removing a lamp or lens.
- When it rains or when the vehicle has been washed, the inside of the lens sometimes becomes foggy. This is the same phenomenon as when window glass mists up on a humid day, and does not indicate a functional problem.
When the lamp is switched on, the heat will remove the fog. However, if water gathers inside the lamp, we recommend you to have the lamp checked.

Bulb capacity

E08404700019

When replacing a bulb, use a new bulb with the same wattage and colour.

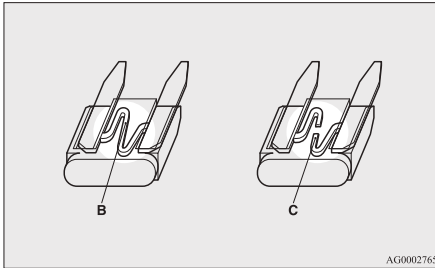

AG0002765

B- Fuse is OK
C- Blown fuse

NOTE

- If any system does not function but the fuse corresponding to that system is normal, there may be a fault in the system elsewhere. We recommend you to have your vehicle checked.
4. Insert a new fuse of the same capacity by using the fuse puller into the same place at the fuse block.

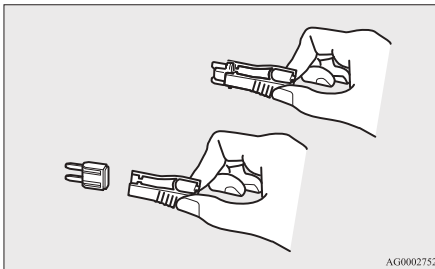

AG0002752

CAUTION

- **If the newly inserted fuse blows again after a short time, we recommend you to have the electrical system checked to find the cause and rectify it.**
- **Never use a fuse with a capacity larger than that specified or any substitute, such as wire, foil, etc.; doing so will cause the circuit wiring to heat up and this could cause fire.**

Vehicle care and Maintenance

Outside

E08404800010

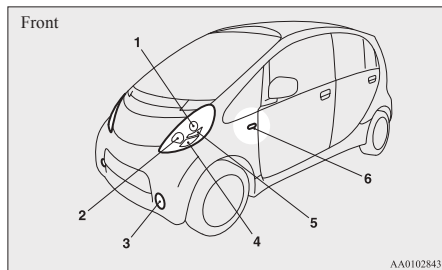

- 1- Headlamps, low beam: 55 W (H11)
- 2- Headlamps, high-beam: 60 W (HB3)
- 3- Front fog lamps*: 35 W (H8)
Daytime running lamps*: 13 W (P13W)
- 4- Front turn-signal lamps: 21 W (W21W)
- 5- Position lamps: 5 W (W5W)
- 6- Side turn-signal lamps: 5 W (WY5W)
*: if so equipped
Codes in parentheses indicate bulb types.

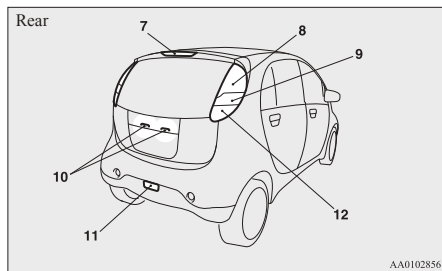

- 7- High-mounted stop lamp: 5 W (W5W)
- 8- Stop and tail lamps
- 9- Rear turn-signal lamps: 21 W (WY21W)
- 10- Licence plate lamps: 5 W (W5W)
- 11- Rear fog lamp: 21 W (W21W)
- 12- Reversing lamps: 21 W (W21W)
Codes in parentheses indicate bulb types.

NOTE

- The stop and tail lamps use LEDs rather than bulbs.
For repair and replacement, we recommend you to contact a MITSUBISHI MOTORS Authorized Service Point.

Inside

E08404900011

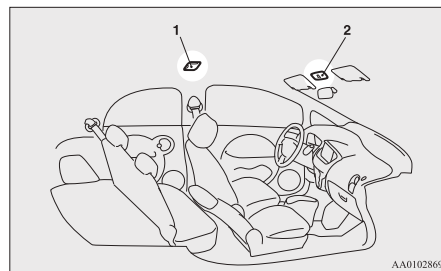

- 1- Room lamp (rear): 8 W
- 2- Room lamp (front) & map lamps: 8 W

Removing and installing the headlamp unit

E08405000022

Bulbs for headlamps, position lamps or front turn-signal lamps are replaced by removing the entire headlamp unit from the vehicle.

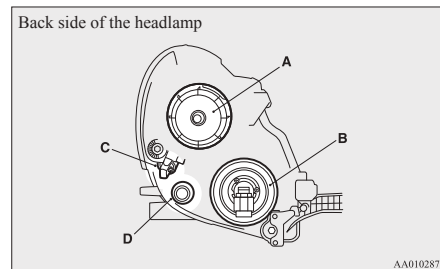

- A- Headlamp (low beam)
- B- Headlamp (high-beam)
- C- Position lamp
- D- Front turn-signal lamp

Refer to the following section for replacement.
Headlamps (low beam) → p. 8-28
Headlamps (high-beam) → p. 8-29
Position lamps → p. 8-30
Front turn-signal lamps → p. 8-30

Use the following steps to remove the headlamp unit.

To remove

1. Open the bonnet. Refer to “Bonnet” on page 8-07.
2. Press the tab (A) to remove the connector (B).

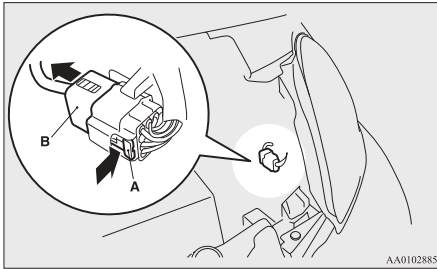

AA0102885

NOTE

- When removing the connector for the left headlamp, do not forget to unhook the headlamp wiring from the wiring bracket (C).

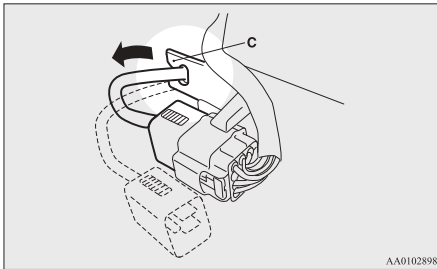

AA0102898

3. Insert a straight blade (or minus) screwdriver with a cloth over its tip at the edge of the work hole cover (D) on the deck garnish (E) and pry gently to remove the cover.

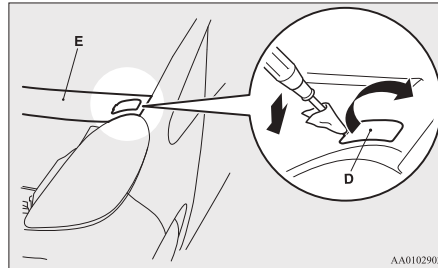

AA0102902

4. Loosen the fixing bolt (F) until the head of the bolt touches the deck garnish (E).

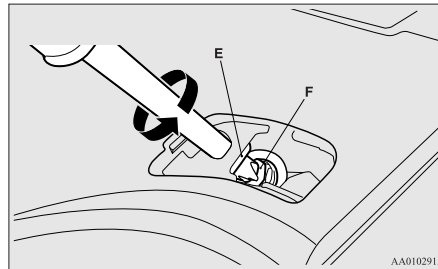

AA0102915

NOTE

- Do not loosen the bolt more than necessary. Doing so could cause the bolt to fall off.

5. Insert a straight blade (or minus) screwdriver to remove the 2 clips holding down the bumper.

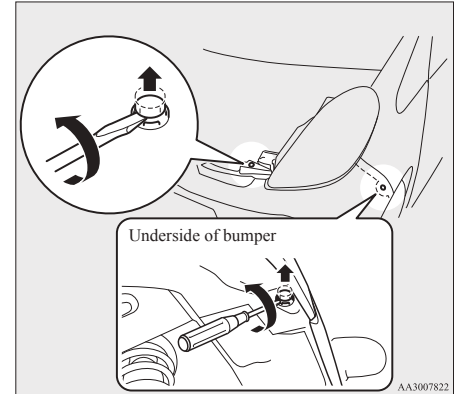

AA3007822

6. Slowly lift up the bumper and disconnect the joint between the bumper and fender.

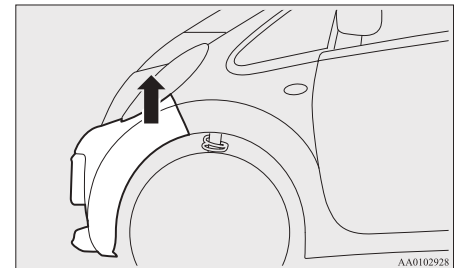

AA0102928

Vehicle care and Maintenance

NOTE

- When disconnecting the joint, be careful not to damage surrounding parts.

7. While keeping the bumper flipped up, remove the side fixing bolt (G).

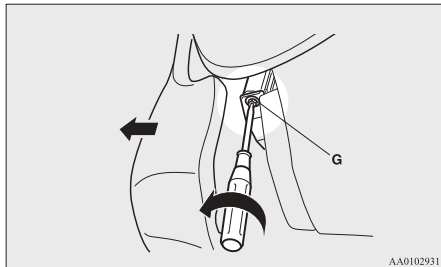

8. Remove the front fixing bolt (H).

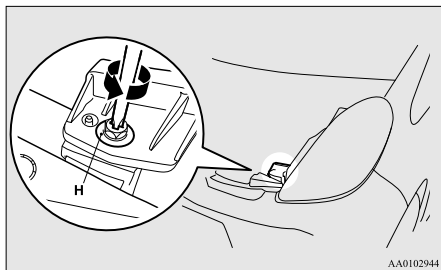

9. As shown in the illustration, shift the entire headlamp unit upward and then unlatch the tab (I) on the upper part of the headlamp to remove it from the vehicle.

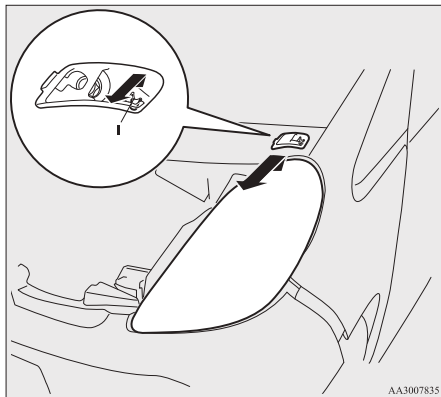

NOTE

- Do not force the headlamp off the vehicle as doing so could damage the tab.

To install

The mounting brackets on the headlamps are engraved with the numbers ① to ③. Install each branch in the order of the assigned numbers.

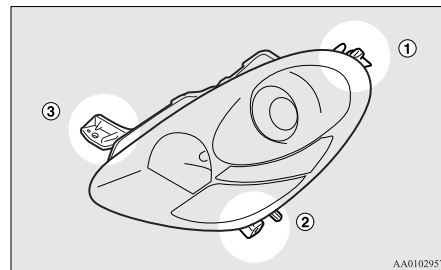

1. As shown in the illustration, insert the cut out area (A) on mounting bracket ① on to the bolt (B) remaining on the vehicle body, and latch the tab (C) on the fixture hole (D) to install the entire headlamp unit to the vehicle body.

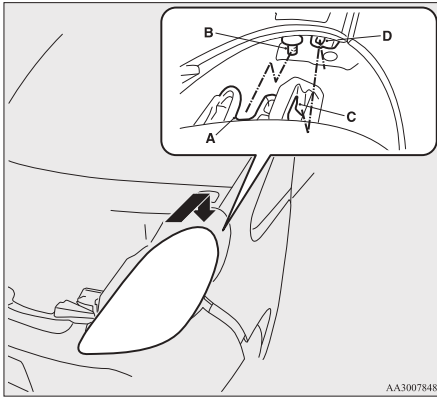

NOTE

- Use the work hole (E) on the deck garnish to confirm that the tab (C) on the upper part of the headlamp is firmly fixed in place.

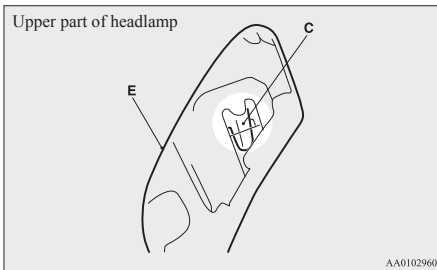

2. Make sure that the tip (F) of the mounting bracket ② is hooked on the body edge (G).

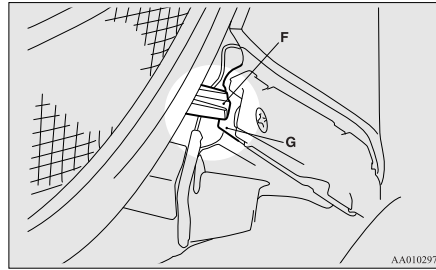

3. Make sure that the pin (H) is inside the hole on the mounting bracket ③.

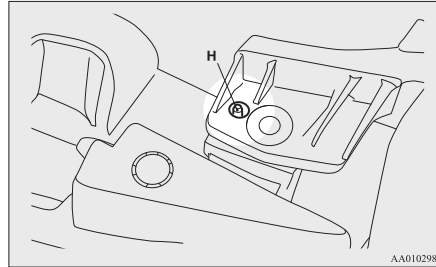

4. Firmly tighten the headlamp mounting bolts in the following order: ① to ③.

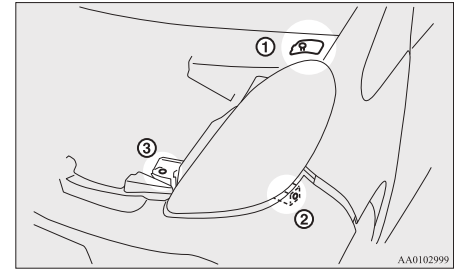

5. After pressing down on the bumper and fender joint from above to fit it in, fix it in place with the clip.

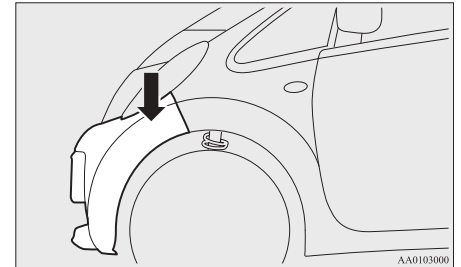

NOTE

- Secure the bumper clip by first inserting it into the mounting hole and then pressing the centre (I) of the clip in.

Vehicle care and Maintenance

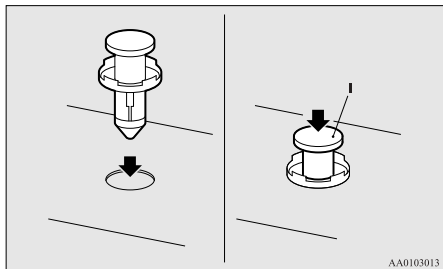

6. Firmly insert the connector (J).

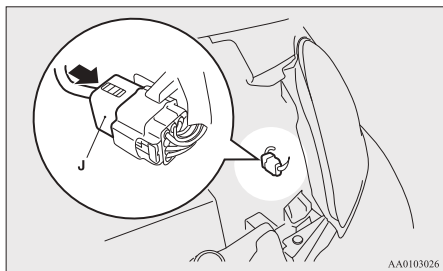

NOTE

- When inserting the connector for the left headlamp, do not forget to hook the headlamp wiring in the wiring bracket (K).

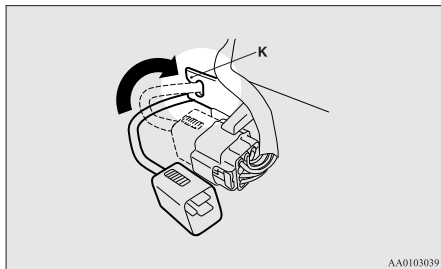

7. Firmly install the cover (L) on the deck garnish.

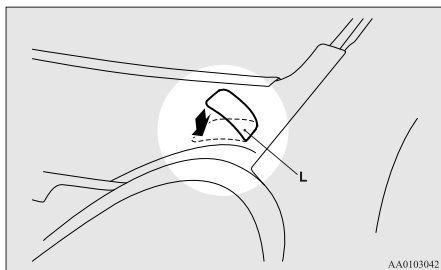

Headlamps (low beam)

E08405100010

1. Turn the cap (A) anticlockwise to remove it.

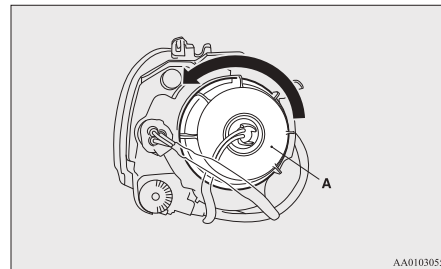

2. Turn the socket (B) anticlockwise to remove it.

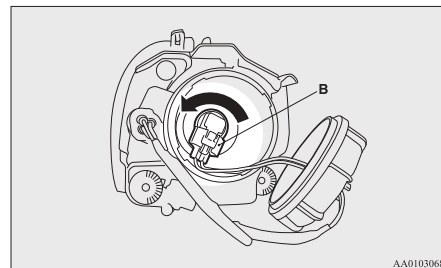

3. While pulling up the tab (C), pull out the bulb (D).

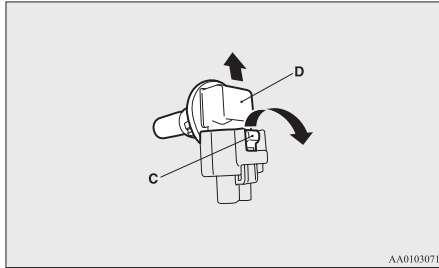

4. To install the bulb, perform the removal steps in reverse.

⚠ CAUTION

- Handle the halogen lamp bulb with care. The gas inside the halogen lamp bulb is highly pressurized, so dropping, knocking, or scratching a halogen lamp bulb can cause it to shatter.
- Never hold the halogen lamp bulb with a bare hand, dirty glove, etc. The oil from your hand could cause the bulb to break the next time the headlamps are operated. If the glass surface is dirty, it must be cleaned with alcohol, paint thinner, etc., and refit it after drying it thoroughly.

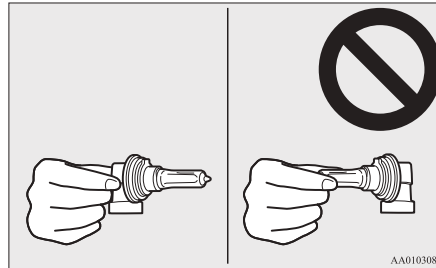

Headlamps (high-beam)

E08405200011

1. Turn the socket (A) anticlockwise to remove it.

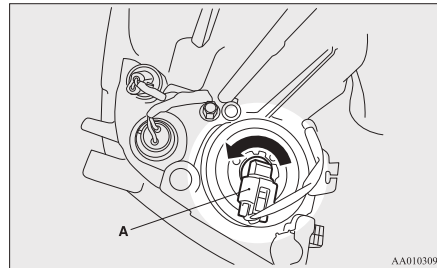

2. While holding down the tab (B), pull out the bulb (C).

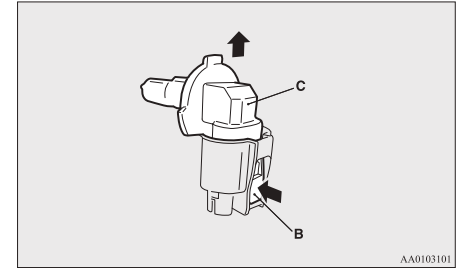

3. To install the bulb, perform the removal steps in reverse.

⚠ CAUTION

- Handle halogen lamp bulbs with care. The gas inside halogen lamp bulbs is highly pressurized, so dropping, knocking, or scratching a halogen lamp bulb can cause it to shatter.
- Never hold the halogen lamp bulb with a bare hand, dirty glove, etc. The oil from your hand could cause the bulb to break the next time the headlamps are operated. If the glass surface is dirty, it must be cleaned with alcohol, paint thinner, etc., and refit it after drying it thoroughly.

Vehicle care and Maintenance

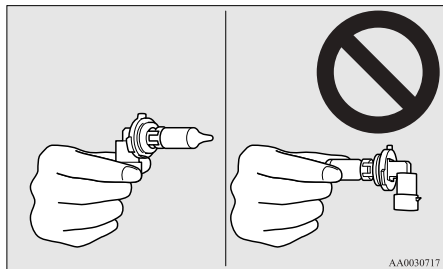

Position lamps

E08405300012

1. Turn the socket (A) anticlockwise to remove it.

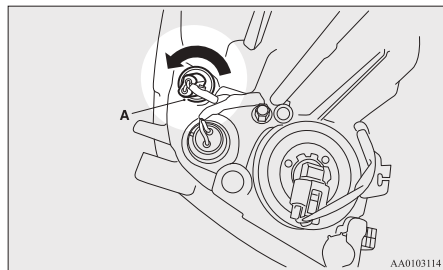

2. Pull the bulb out of the socket.

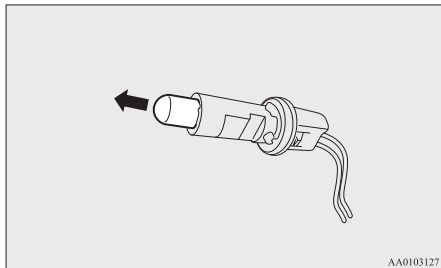

3. To install the bulb, perform the removal steps in reverse.

Front turn-signal lamps

E08405400013

1. Turn the socket (A) anticlockwise to remove it.

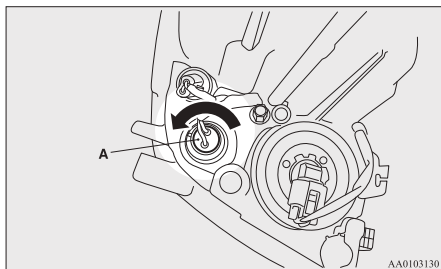

2. Pull the bulb out of the socket.

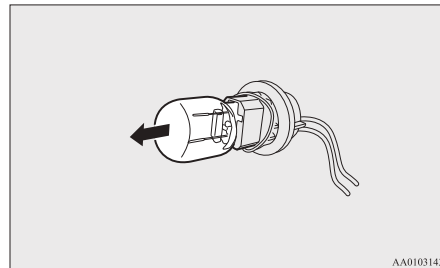

3. To install the bulb, perform the removal steps in reverse.

Side turn-signal lamps

E08405500014

1. To remove a side turn-signal lamp, insert a straight blade (or minus) screwdriver with a cloth over its tip at the end of the lamp near the rear of the body and use it to gently lever the lamp out of the body.

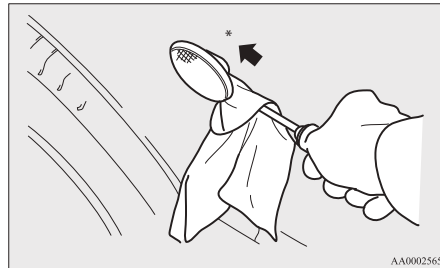

*: Front of the vehicle

2. Remove the socket and bulb assemblies by turning it anticlockwise.

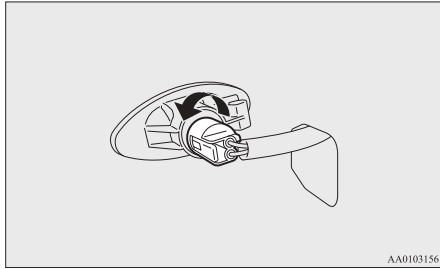

3. Pull the bulb out of the socket.

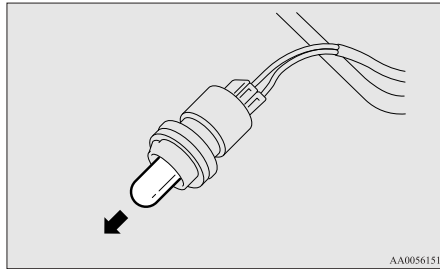

4. To install the bulb, perform the removal steps in reverse.

NOTE

- When installing the lamp assembly, push in the end facing the front of the vehicle first.

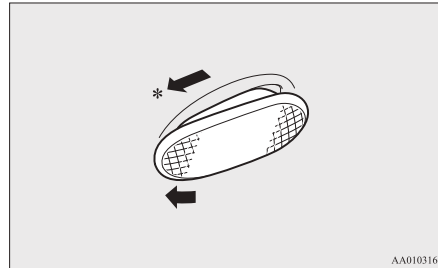

*: Front of the vehicle

Front fog lamps* / Daytime running lamps*

E08405600015

1. To create enough work space, turn the steering wheel all the way in the same direction to the side you wish to replace.
2. Remove the clips (A) by a screwdriver, then lift the cover (B).

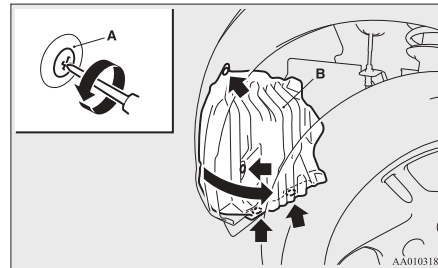

3. Turn the socket (C or D) anticlockwise to remove it.

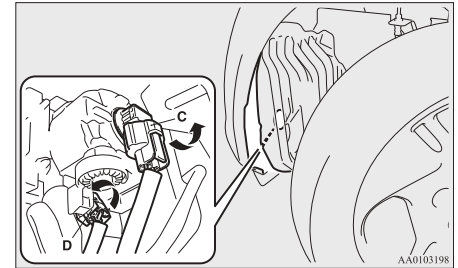

C- Front fog lamp
D- Daytime running lamp

4. While holding down the tab (E), pull out the bulb (F).

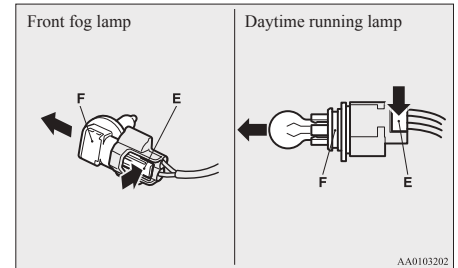

5. To install the bulb, perform the removal steps in reverse.

⚠ CAUTION

- Handle the halogen lamp bulb with care. The gas inside a halogen lamp bulb is highly pressurized, so dropping, knocking, or scratching a halogen lamp bulb can cause it to shatter.
- Never hold the halogen lamp bulb with a bare hand, dirty glove, etc. The oil from your hand could cause the bulb to break the next time the fog lamps are operated. If the glass surface is dirty, it must be cleaned with alcohol, paint thinner, etc., and refit it after drying it thoroughly.

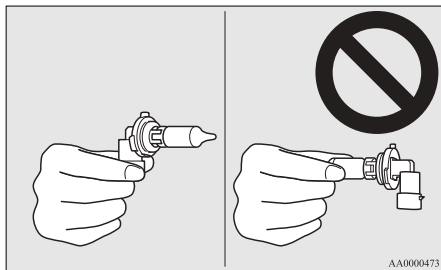

Rear fog lamp

E08405700016

1. When removing the lamp unit (A), push it towards the left side of the vehicle body.

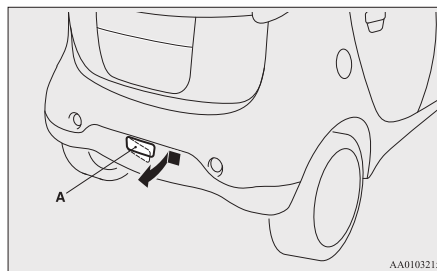

2. Remove the socket (B) and bulb assembly by turning it anticlockwise.

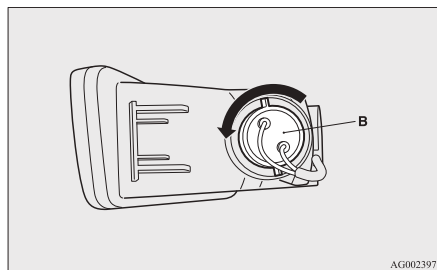

3. Pull the bulb out of the socket.

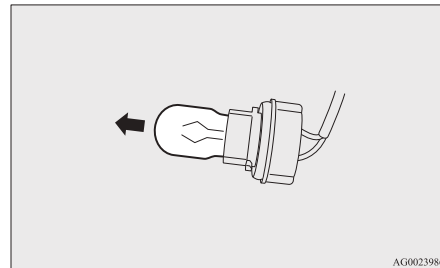

4. To install the bulb, perform the removal steps in reverse.

NOTE

- If the wiring harness is pulled off the harness guides (C) on the lamp unit while replacing the bulb, make sure to secure the wiring harness to the harness guides.

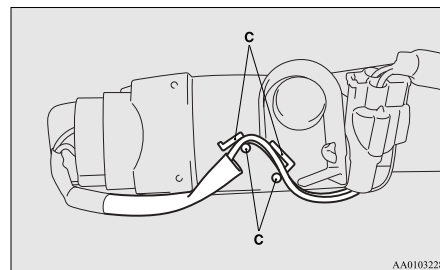

- When installing the lamp unit, first insert the tab (D) into the groove (E) on the body, and then push on the lamp unit to fit it into place.

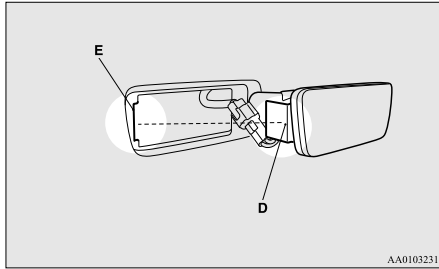

3. Move the lamp unit towards the rear of the vehicle and remove the pins (B) of the lamp unit from the vehicle.

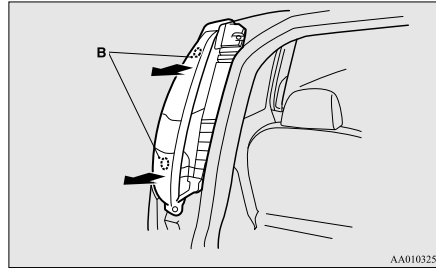

4. Turn the socket anticlockwise to remove it.

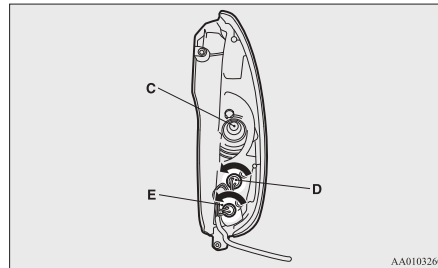

- C- Stop and tail lamp (LED) - cannot be replaced
- D- Rear turn-signal lamp
- E- Reversing lamp

NOTE

- The stop and tail lamps use LEDs rather than bulbs. For repair and replacement, we recommend you to contact a MITSUBISHI MOTORS Authorized Service Point.

5. Pull the bulb out of the socket.

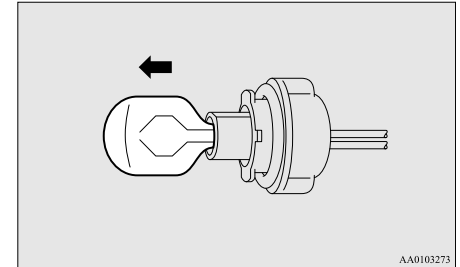

6. To install the bulb, perform the removal steps in reverse.

Rear combination lamps

E08405800017

1. Open the tailgate. (Refer to “Tailgate” on page 2-08.)
2. Remove the screws (A) that hold the lamp unit and remove the lamp unit.

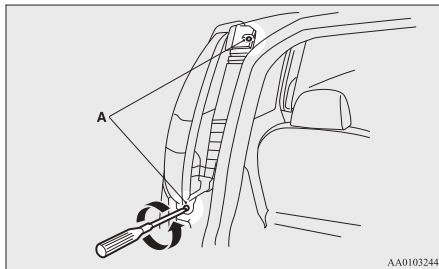

High-mounted stop lamp

E0840600016

1. Remove the mounting screws (A) and remove the lamp unit.

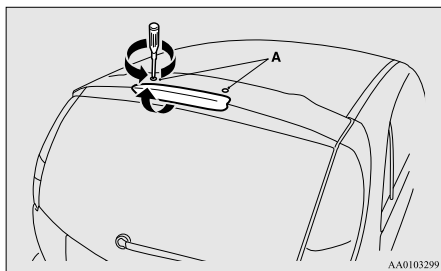

2. Turn the socket anticlockwise to remove it.

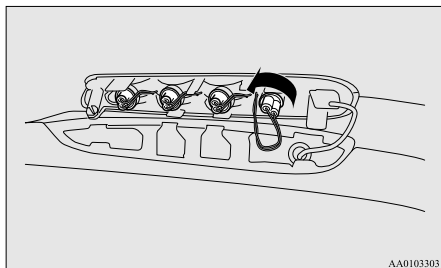

3. Pull the bulb out of the socket.

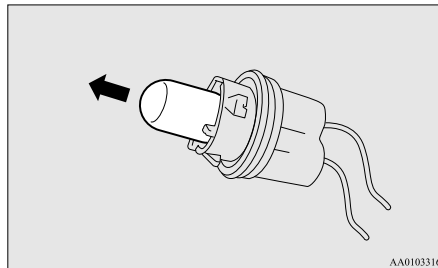

4. To install the bulb, perform the removal steps in reverse.

NOTE

- When installing the lamp unit, make sure not to bend the washer fluid hose (B).

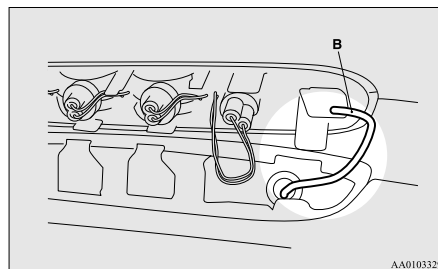

Licence plate lamps

E08405900018

1. When removing the lamp unit (A), push it towards the left side of the vehicle body.

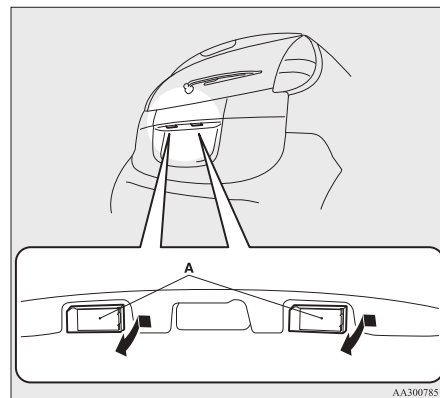

2. Use a straight blade (or minus) screwdriver with a cloth over its tip to gently pry up the tab (B) and remove the lens.

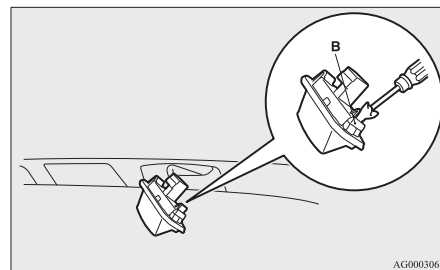

3. Pull the bulb out of the socket.

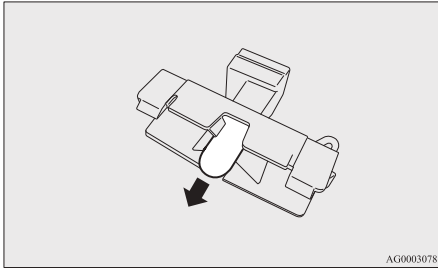

4. To install the bulb, perform the removal steps in reverse.

NOTE

- When installing the lamp, insert tab (C) first then align and insert tab (D).

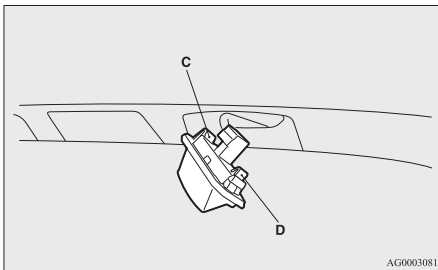

A series of 15 horizontal dashed lines spanning the width of the page, providing a template for handwriting practice.

Specifications

Vehicle labeling.....	9-02
Vehicle dimensions.....	9-03
Electric motor specifications.....	9-04
Low voltage electrical system.....	9-04
Tyres and wheels.....	9-05
Electric energy consumption.....	9-06
Refill capacities.....	9-07

Specifications

Vehicle labeling

E01100102899

Vehicle identification number

The vehicle identification number is stamped in the location shown in the illustration.

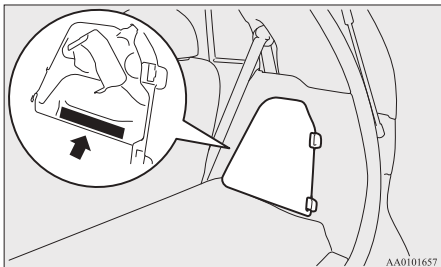

Vehicle information code plate

The vehicle information code plate is riveted as shown in the illustration.

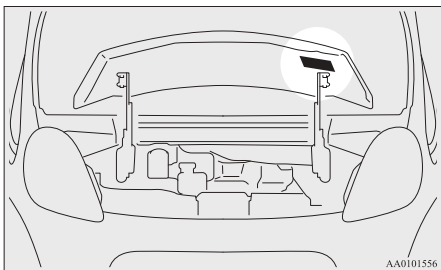

The plate shows model code, engine model, transmission model and body colour code, etc. Please use this number when ordering replacement parts.

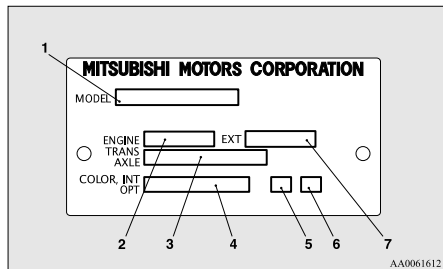

- 1- Model code
- 2- Engine model code
- 3- Transmission model code
- 4- Body colour code
- 5- Interior code
- 6- Option code
- 7- Exterior code

Electric motor number

The electric motor number is stamped on the flange of the electric motor frame as shown in the illustrations.

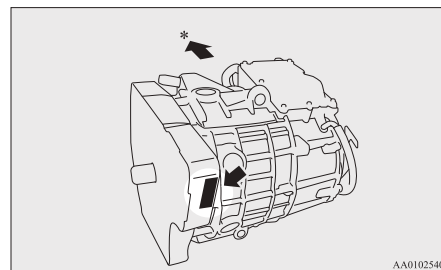

*: Front of the vehicle

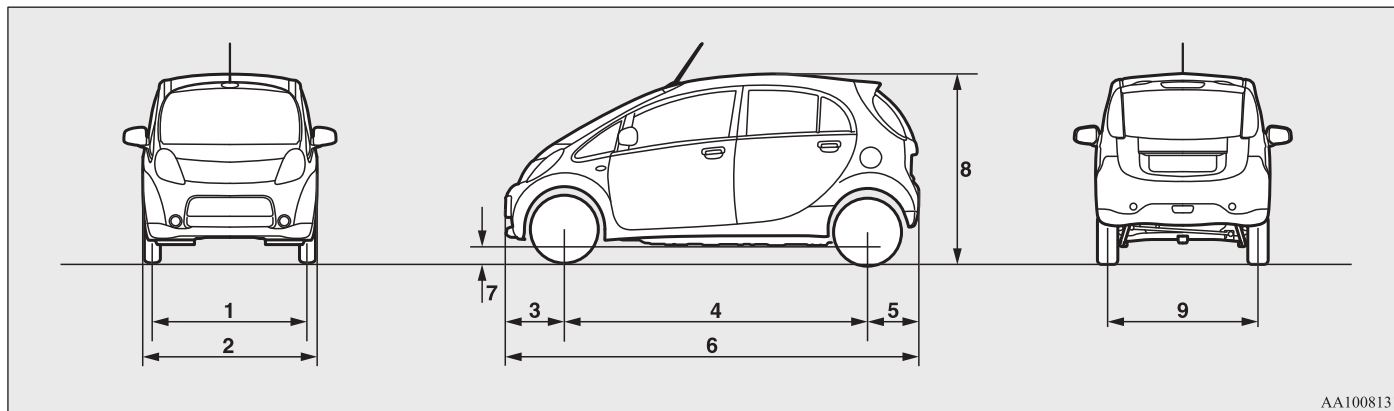
Vehicle dimensions

1	Front track		1,310 mm
2	Overall width		1,475 mm
3	Front overhang		500 mm
4	Wheel base		2,550 mm
5	Rear overhang		425 mm
6	Overall length		3,475 mm
7	Ground clearance (unladen)		150 mm
8	Overall height (unladen)		1,610 mm
9	Rear track		1,270 mm
Minimum turning radius		Body	4.75 m
		Wheel	4.5 m

Specifications

Electric motor specifications

E01100602458

Electric motor model	Y4F1
Maximum output (ECE net)	49 kW/2,500 to 8,000 r/min
Maximum torque	180 Nm/0 to 2,000 r/min
Maximum 30 minutes power (ECE net)	35 kW

Low voltage electrical system

E01100802232

Voltage		12 V
Auxiliary bat- tery	Type (JIS)	34B19L (S)
	Capacity (5HR)	27Ah

Tyres and wheels

E01100902884

Item		Front	Rear
Tyre		145/65R15 72S	175/55R15 77S
Wheel	Size	15x4J	15x5J
	Offset	35 mm	

NOTE

- Contact your MITSUBISHI MOTORS Authorized Service Point for details on the combination used on your vehicle.

Electric energy consumption

E01101800017

Item	Combined
Electric energy consumption [NEDC]*	135 Wh/km
Electric range (Cruising range) [NEDC]*	150 km (93 miles)

*: NEDC stands for New European Driving Cycle. The values of electric energy consumption and electric range are based on ECE R101. These values vary depending on driving style, road and traffic conditions, ambient temperature, use of air conditioners and so forth.

NOTE

- The results given do not express or imply any guarantee of the electric energy consumption of the particular vehicle. The vehicle itself has not been tested and there are inevitably differences between individual vehicles of the same model. In addition, this vehicle may incorporate particular modifications. Furthermore, the driver's style and road and traffic conditions, as well as the extent to which the vehicle has been driven and the standard of maintenance, will all affect its electric energy consumption.
- All mentioned values are referring to a new, driven in vehicle.
- The consumption, but mainly the driving distance depends on the condition of the traction battery.
- Parameters on traction battery are depending on temperature, climate, charging and charging history and age of the traction battery etc.
- A bigger influence as known by combustion engine are the energy consumptive consumers of the vehicle like heating, air conditioning, etc.

Refill capacities

Bonnet room

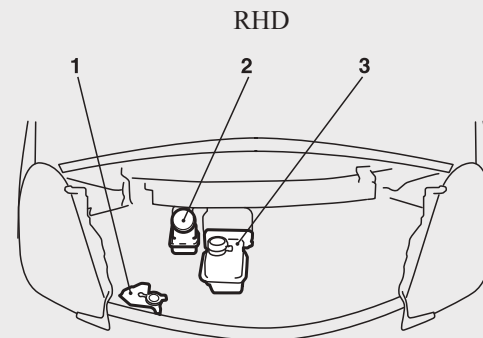
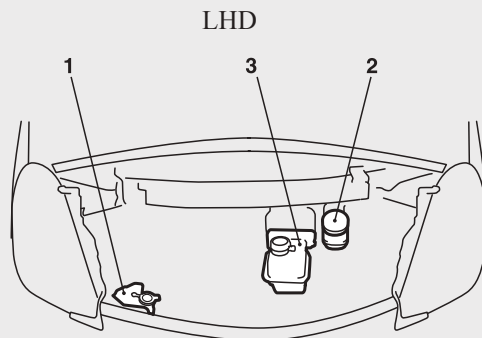

Electric motor unit room (under the floor of the luggage area)

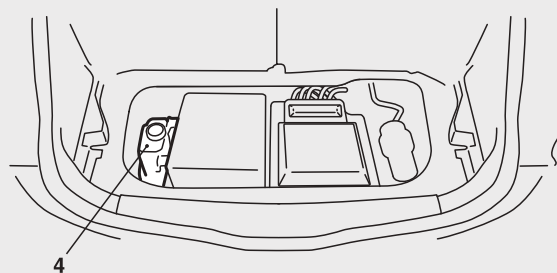

Specifications

No.	Item		Quantity	Lubricants
1	Washer fluid		1.9 litres	—
2	Brake fluid		As required	Brake fluid DOT 3 or DOT 4
3	Hot water heater fluid	LHD	1.9 litres [includes 0.4 litre in the reserve tank]	DIA QUEEN SUPER LONG LIFE COOLANT PREMIUM or equivalent*
		RHD	1.7 litres [includes 0.4 litre in the reserve tank]	
4	Coolant		5.1 litres [includes 1.1 litres in the reserve tank]	
5	Transmission oil		0.75 litre	DIA QUEEN ATF SP III
6	Refrigerant (air conditioning)		305 - 345 g	HFC-134a

*: similar high quality ethylene glycol based non-silicate, non-amine, non-nitrate and non-borate coolant with long life hybrid organic acid technology

A

Accessory (Installation) 03
 Accessory socket 6-36
 Active stability control (ASC) 5-18
 Additional equipment 8-20
 Air conditioning
 Important operation tips for the air condition-
 ing 6-09
 Air purifier 6-10
 Airbag 3-20
 Antenna 6-30
 Anti-lock brake system (ABS) 5-15
 Warning lamp 5-16
 Assist grips 6-41
 Audio
 Error codes 6-26
 Handling of compact discs 6-29
 LW/MW/FM electronic tuning radio with CD
 player 6-10
 Auxiliary battery 8-12
 Specification 9-04
 Auxiliary battery charge warning lamp 4-10

B

Basic knowledge for charging 1-02
 Battery
 Auxiliary battery 8-12
 Auxiliary battery charge warning lamp 4-10
 Discharged battery (Emergency starting) 7-02
 Disposal information for used batteries 05
 Traction battery 02
 Bonnet 8-07
 Brake assist system 5-15
 Brake
 Anti-lock brake 5-15
 Braking 5-14

Fluid 8-11,9-07
 Parking brake 5-03
 Warning lamp 4-09
 Bulb capacity 8-23

C

Capacities 9-07
 Card holder 6-36,6-39
 Cargo loads 5-20
 Central door locks 2-06
 Charging indicator 4-09
 Charging
 Guideline for charging time 1-03
 Quick charging 1-11
 Regular charging 1-06
 Child restraint 3-11
 Child-protection rear doors 2-07
 Cleaning
 Exterior of your vehicle 8-03
 Interior of your vehicle 8-02
 Plastic, vinyl leather, etc. 8-02
 Clock 6-31
 Cold
 Cautions and actions to deal with intense
 cold 08
 Combination headlamps and dipper switch 4-11
 Coolant 8-09,9-07
 Cruising range 03,9-06
 Cruising range indicator 4-03,4-06
 Cup holder 6-40

D

Daytime running lamps 4-13
 Bulb capacity 8-24
 Replacement 8-31
 Demister (rear window) 4-18
 Digital clock 6-31

Dimensions 9-03
 Dipper (High/Low beam change) 4-13
 Door ajar warning lamp 4-10
 Doors
 Central door locks 2-06
 Child-protection 2-07
 Lock and unlock 2-05
 Driving the vehicle 5-11
 Driving, alcohol and drugs 5-02

E

Economical driving 5-02
 Electric motor switch 5-07
 Electric motor unit
 Warning lamp 4-11
 Electric motor
 Number 9-02
 Specifications 9-04
 Electric power steering system (EPS) 5-17
 Electric window control 2-09
 Driver's switches 2-09
 Lock switch 2-09
 Passenger's switches 2-09
 Timer function 2-10
 Electronic immobilizer (Anti-theft starting sys-
 tem) 2-02
 Emergency starting 7-02
 Energy level gauge 4-06
 Energy usage indicator 4-03
 Error codes 6-26
 EV charging cable 1-04
 Exterior and interior lamp operation 8-19

F

Fluid capacities and lubricants 9-07
 Fluid
 Brake fluid 8-11,9-07

Alphabetical index

Coolant 8-09
Hot water heater fluid 8-09,9-07
Washer fluid 8-11,9-07
For cold and snowy weather 8-20
Front fog lamps
 Bulb capacity 8-24
 Indication lamp 4-09
 Replacement 8-31
 Switch 4-15
Front room lamp
 Bulb capacity 8-24
Front seat 3-03
Front turn-signal lamps
 Bulb capacity 8-24
 Replacement 8-30
Fuel
 Modification/alterations to the electrical systems 04
Fuses 8-20
Fusible links 8-20

G

Gauges 4-02,4-08
General maintenance 8-19
General vehicle data 9-03
Genuine parts 04
Glove box 6-39

H

Handling of compact discs 6-29
Hazard warning flasher switch 4-15
Hazard warning indication lamps 4-09
Head restraints 3-07
Headlamp levelling switch 4-13
Headlamps
 Bulb capacity 8-24
 Headlamp flasher 4-13

Replacement 8-24,8-28,8-29
Switch 4-11
Heat
 Cautions and actions to deal with intense heat 06
Heated mirror 5-07
Heated seat 3-04
High-beam indication lamp 4-09
High-mounted stop lamp
 Bulb capacity 8-24
 Replacement 8-34
Hinges and latches lubrication 8-19
Horn switch 4-19
Hot water heater fluid 8-09,9-07

I

i-MiEV 02
 Cruising range 03
 Main features 02
 Traction battery 02
If the vehicle breaks down 7-02
Indication and warning lamps 4-08
Indication lamps 4-09
Inside rear-view mirror 5-05
Inspection and maintenance following rough road operation 5-12
Instruments 4-02
Intense cold
 Cautions and actions 08
Intense heat
 Cautions and actions 06
Interior lamps 6-37

J

Jump starting (Emergency starting) 7-02

K

Keyless entry system 2-03
Keys 2-02

L

Labeling 9-02
Lamp monitor buzzer 4-12
Lamps (headlamps, fog lamp, etc.) auto-cutout function 4-12
Licence plate lamps
 Bulb capacity 8-24
 Replacement 8-34
Link System 6-33
Low voltage electrical system 9-04
Lubricants 9-07
LW/MW/FM electronic tuning radio with CD player 6-10

M

Map lamps 6-37,6-38
 Bulb capacity 8-24
Meter illumination control 4-03,4-06
Mirror
 Inside rear-view mirror 5-05
 Outside rear-view mirrors 5-05
Modification/alterations to the electrical systems 04

O

Odometer 4-03,4-04
Oil
 Transmission oil 9-07
Operation under adverse driving conditions 7-12
Outside rear-view mirrors 5-05

P

- Parking 5-04
 - Parking brake 5-03
- Position lamps
 - Bulb capacity 8-24
 - Indication lamp 4-09
 - Replacement 8-30
- Power down warning lamp 4-11
- Precautions to observe when using wipers and washers 4-18
- Pregnant women restraint 3-10
- Puncture
 - Tyre repair kit 7-04

Q

- Quick charging 1-11

R

- Radio
 - LW/MW/FM electronic tuning radio with CD player 6-10
- Ready indicator 4-09
- Rear combination lamps
 - Bulb capacity 8-24
 - Replacement 8-33
- Rear fog lamp
 - Bulb capacity 8-24
 - Indication lamp 4-09
 - Replacement 8-32
 - Switch 4-16
- Rear room lamp
 - Bulb capacity 8-24
- Rear seat 3-05
- Rear turn-signal lamps
 - Bulb capacity 8-24

- Replacement 8-30,8-33
- Rear window demister switch 4-18
- Rear-view mirror
 - Inside 5-05
 - Outside 5-05
- Refill capacities 9-07
- Regenerative braking 02
- Regular charging 1-06
- Replacement of lamp bulbs 8-23
- Reversing lamps
 - Bulb capacity 8-24
 - Replacement 8-33
- Roof carrier precaution 5-21
- Room lamp (front) 6-37
- Room lamp (rear) 6-38

S

- Safe driving techniques 5-03
- Seat belt 3-08
 - Child restraint 3-11
 - Force limiter 3-11
 - Inspection 3-20
 - Pregnant women restraint 3-10
 - Pretensioner 3-11
 - Seat belt reminder/warning lamp (for driver and front passenger) 3-09
 - Warning lamp (for rear passenger) 3-10
- Seats
 - Adjustment 3-03
 - Front seat 3-03
 - Head restraints 3-07
 - Heated seat 3-04
 - Rear seat 3-05
- Secret box 6-39
- Selector lever 5-09
- Service precaution 8-06
- Service reminder 4-03,4-04
- Side turn-signal lamps

- Bulb capacity 8-24
 - Replacement 8-30,8-33
- Snow tyres 8-16
- Specifications 9-02
- Speedometer 4-02
- Starting the electric motor unit 5-08
- Steering wheel lock 5-08
- Stop lamps
 - Bulb capacity 8-24
 - Replacement 8-33
- Storage spaces 6-39
 - Glove box 6-39
 - Secret box 6-39
- Sun visors 6-35
- Supplemental restraint system 3-20
 - Servicing 3-30
 - Warning lamp 3-29

T

- Tail lamps
 - Bulb capacity 8-24
 - Replacement 8-33
- Tailgate 2-08
- Towing 7-10
- Traction battery 02
- Transmission 5-09
 - Driving the vehicle 5-11
 - Selector lever 5-09
 - Selector lever position indicator 5-10
- Tripmeter 4-03,4-04
- Turn-signal indication lamps 4-09
- Turn-signal lever 4-14
- Tyre repair kit 7-04
- Tyres 8-14
 - Inflation pressures 8-15
 - Size (tyre and wheel) 9-05
 - Snow tyres 8-16
 - Tread wear indicators 8-16

Alphabetical index

Tyre chains 8-17
Tyre repair kit 7-04
Tyre rotation 8-16

U

USB input terminal 6-33
 How to connect an iPod 6-34
USB input terminal device
 How to connect a USB memory device 6-33

V

Vanity mirror 6-35
Vehicle care precautions 8-02
Vehicle dimensions 9-03
Vehicle identification number 9-02
Vehicle information code plate 9-02
Vehicle labeling 9-02
Ventilators 6-02

W

Warning lamps 4-09
Washer
 Fluid 8-11,9-07
 Switch 4-16,4-17
Washing 8-03
Waxing 8-04
Weatherstripping 8-20
Wheel
 Specification 9-05
Wiper
 Rear window 4-17
 Windscreen 4-16
 Wiper blades 8-17

OMRON

OMRON Corporation

5-3-18 HONDA-ZAKA, OKAZAKI-KU, OKAZAKI-CITY,

AICHI 465-0862 JAPAN

PHONE: +81-564-561119

FAX: +81-564-5613074

DECLARATION OF CONFORMITY

We, **OMRON Corporation, AUTOMOTIVE ELECTRONIC COMPONENTS COMPANY** hereby declare, at our sole responsibility, that the following product conforms to the Essential Requirements of the Radio and Telecommunications Terminal Equipment Directive 1999/5/EC in accordance with the tests conducted to the appropriate requirements of the relevant standards, as listed herewith.

Product : Keyless Entry System for vehicle

Model/ Type Number : G8C-930M, G8C-931M, G8C-932M for receiver and immobilizer
: G8D-571M-A for transmitter

Directive and Standards used as appropriate : Radio : EN 300 220-1 V2.1.1

EN 300 220-2 V2.1.2

EN 300 330-1 V1.3.2 ^{*)}EN 300 330-2 V1.3.1 ^{*)}EMC : EN 501 489-1 V1.8.1 ^{*)}EN 301 489-1 V1.6.1 ^{*)}

EN 301 489-3 V1.4.1

Safety : EN 60065:2002+Amd.1:2006+Amd.11:2008 ^{*)}EN 60065:2002+Amd.1:2006 ^{*)}

^{*)}1 except G8C-931M ^{*)}2 except G8D-571M-A ^{*)}3 only G8D-571M-A

Year of affixing CE marking : 2010

Signature : *Fumio Hayashi*

Name : Fumio Hayashi

Title and position : Manager
DEVELOPMENT STRATEGY DEPT.
DEVELOPMENT & DESIGN DIV.

Date : March 24, 2010

CE 1731

[Cestini]	<p>Ovime GABILON kompozicija, injicirane da je ovaj [GID-4075A-A*, GID-4105A-B*, GID-520A-A*, GIC-500A-P, GID-581M-B*, GID-571M-A*, GID-518M-A*, GIC-507M*, GIC-522M-A-C, GIC-541M*, GID-621M-A*, GIC-519M*, GIC-518M*, GIC-527M*, GIC-546M*, GIC-593M*, GIC-591M*, GIC-592M-P] je sklopa s osnovnim zahtevima i drugom referentnom okruženjem Direktive 1999/5/EZ.</p>
[Makalderman]	<p>Crovia, GABILON kompozicija, injicirane da je ovaj [GID-4075A-A*, GID-4105A-B*, GID-520A-A*, GIC-500A-P, GID-581M-B*, GID-571M-A*, GID-518M-A*, GIC-507M*, GIC-522M-A-C, GIC-541M*, GID-621M-A*, GIC-519M*, GIC-518M*, GIC-527M*, GIC-546M*, GIC-593M*, GIC-591M*, GIC-592M-P] je ne kompozicije sa stvarnom izjavom u zvezi s osnovnim zahtevima i drugom referentnom okruženjem Direktive 1999/5/EZ.</p>
[Mikromagnet]	<p>Dvomi, GABILON kompozicija, injicirane da je ovaj [GID-4075A-A*, GID-4105A-B*, GID-520A-A*, GIC-500A-P, GID-581M-B*, GID-571M-A*, GID-518M-A*, GIC-507M*, GIC-522M-A-C, GIC-541M*, GID-621M-A*, GIC-519M*, GIC-518M*, GIC-527M*, GIC-546M*, GIC-593M*, GIC-591M*, GIC-592M-P] je s sklopa s osnovnim zahtevima i drugom referentnom okruženjem Direktive 1999/5/EZ.</p>

OMRON

OMRON Automotive Electronics Co. Ltd.
5-68 SENDO-ZAKA, OKUSA, BOMAG-CITY,
AICHI 465-0802 JAPAN
PHONE: +81-564-79-6000
FAX: +81-564-79-6179

DECLARATION OF CONFORMITY

We, **OMRON Automotive Electronics Co. Ltd.**, hereby declare, at our sole responsibility, that the following product conforms to the Essential Requirements of the Radio and Telecommunications Terminal Equipment Directive 1999/5/EC in accordance with the tests conducted to the appropriate requirements of the relevant standards, as listed herewith.

Product : MIEV Remote System
Model/Type Number : GHW-M603 for MIEV Remote
: CGF-M003 for Antenna Module

Directive and Standards used as appropriate : EN 60950-1:2006+A11:2009
EN 300 228-2 V2.3.1 (Receiver Category 2)
EN 301 489-3 V1.4.1
EN 62311:2008

Year of affixing CE marking : 2011

Signature : 
Name : Shuji Yamashita

Title and position : Manager
SECURITY ENTRY DEVELOPMENT DEPARTMENT

Date : March 17, 2011

CE 0984

[Romania]	<p>Act OMARON Automotive Electronics Co.Ltd. - declaratiu cu privire la societati [OHV-M003* CSE]-M003*) este in conformitate cu cerintele enuntate. In ca sita prezentei referinta este listata in Gasornia Nr.88/2003 si Directiva 1999/5/CE.</p>
[Bulgaria]	<p>Съобщение относно OMARON Automotive Electronics Co.Ltd., посочено в [OHV-M003* CSE-M003*] е в съответствие с изискванията и техническите характеристики посочени в Директива 1999/5/CE.</p>
[Croatia]	<p>Opisno, OMARON Automotive Electronics Co.Ltd. izjavuje da je ovaj [OHV-M003* CSE-M003*] u skladu s bitnim zahtjevima, navedenim u odjeljku Direktive 1999/5/CE.</p>
[Macedonian]	<p>Соопш. OMARON Automotive Electronics Co.Ltd. објавува дека овој [OHV-M003* CSE-M003*] е во согласност со сите технички услови и други параметри наведени во Директивата 1999/5/CE.</p>
[Montenegro]	<p>Opisno, OMARON Auto Elektronika Do.o. izjavuje da je ovaj [OHV-M003* CSE-M003*] u skladu sa navedenim zahtjevima i drugim bitnim odobrenim Direktivo 1999/5/CE.</p>

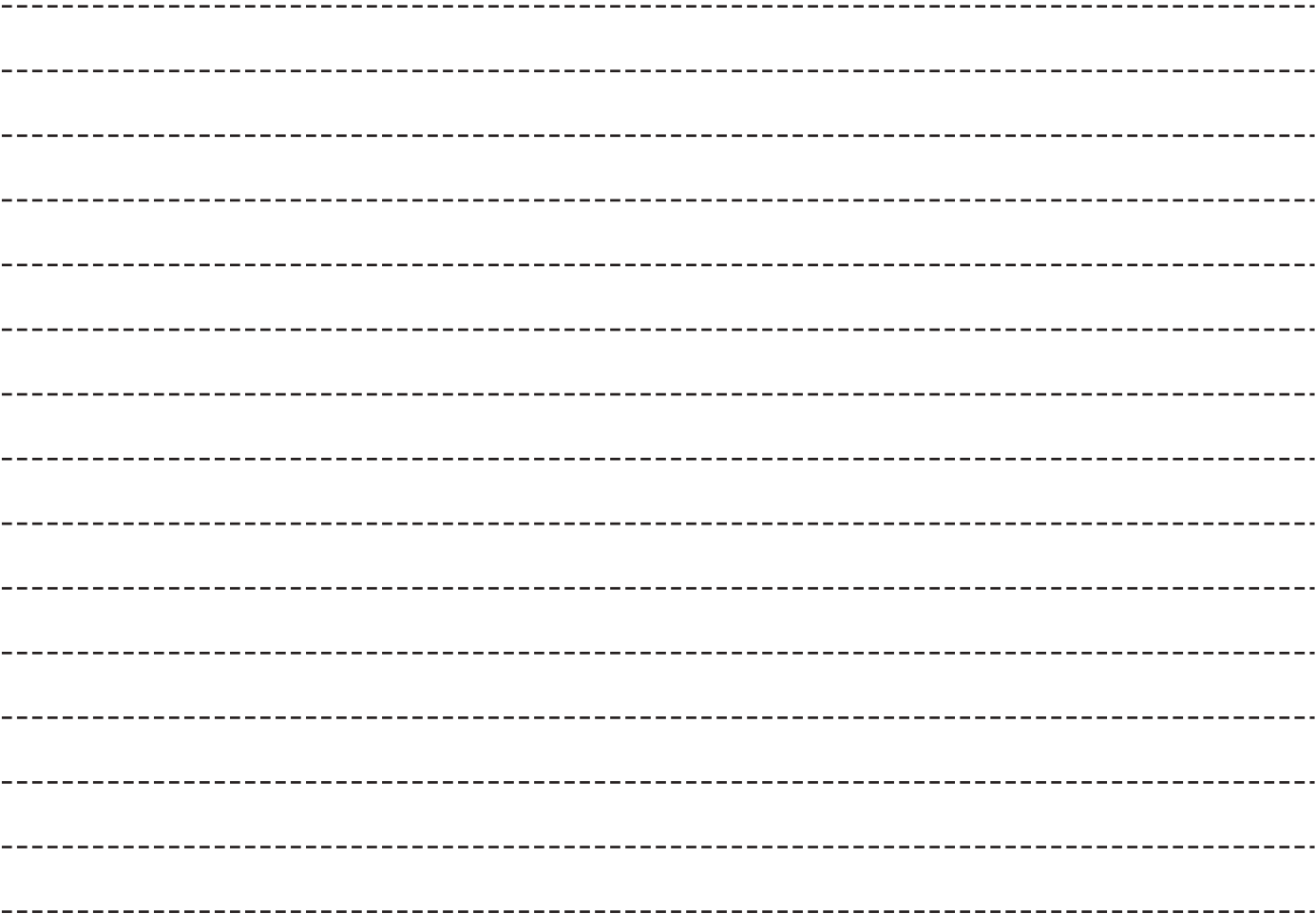

A series of 15 horizontal dashed lines spanning the width of the page, providing a template for handwriting practice.

A series of 15 horizontal dashed lines spanning the width of the page, intended for handwriting practice.