



COLT - ENGLISH - OZME11E1

COLT - ENGLISH - OZME11E1

OWNER'S MANUAL



COLT

Foreword

E09200103460

Thank you for selecting a COLT as your new vehicle.

This owner's manual will add to your understanding and full enjoyment of the many fine features of this vehicle.

It contains information prepared to acquaint you with the proper way to operate and maintain your vehicle for the utmost in driving pleasure.

MITSUBISHI MOTORS Europe B.V. reserves the right to make changes in design and specifications and/or to make additions to or improvements in this product without obligation to install them on products previously manufactured.

It is an absolute requirement for the driver to strictly observe all laws and regulations concerning vehicles.

This owner's manual has been written in compliance with such laws and regulations, but some of the contents may become contradictory with later amendment of the laws and regulations.

Please leave this owner's manual in this vehicle at time of resale. The next owner will appreciate having access to the information contained in this owner's manual.

Repairs to your vehicle:

Vehicles in the warranty period:

All warranty repairs must be carried out by a MITSUBISHI MOTORS Authorized Service Point.

Vehicles outside the warranty period:

Where the vehicle is repaired is at the discretion of the owner.

Throughout this owner's manual the words **WARNING** and **CAUTION** appear.

These serve as reminders to be especially careful. Failure to follow instructions could result in personal injury or damage to your vehicle.

WARNING

indicates a strong possibility of severe personal injury or death if instructions are not followed.

CAUTION

means hazards or unsafe practices that could cause minor personal injury or damage to your vehicle.

You will see another important symbol:

NOTE: gives helpful information.

***:** indicates optional equipment.

It may differ according to the sales classification; refer to the sales catalogue.

Abbreviations used in this owner's manual:

LHD: Left-Hand Drive

RHD: Right-Hand Drive

Information for station service

E09300102435

Fuel	Fuel tank capacity	47 litres
	Fuel requirements	Unleaded petrol octane number (EN228) 95 RON or higher Refer to the "General information" section for the fuel selection.
Engine oil		Refer to the "Maintenance" section for the selection of engine oil.
Tyre inflation pressure		Refer to the "Maintenance" section for the tyre inflation pressure.

Mitsubishi Motors Europe B.V.

© 2010 Mitsubishi Motors Corporation

OZME11E1
BLC10.002826

11

Table of contents

<i>Overview</i>	
<i>General information</i>	
<i>Locking and unlocking</i>	1
<i>Seat and seat belts</i>	2
<i>Instruments and controls</i>	3
<i>Starting and driving</i>	4
<i>For pleasant driving</i>	5
<i>For emergencies</i>	6
<i>Vehicle care</i>	7
<i>Maintenance</i>	8
<i>Specifications</i>	9

Instruments and controls

E00100104085

Except for Clear Tec (LHD)

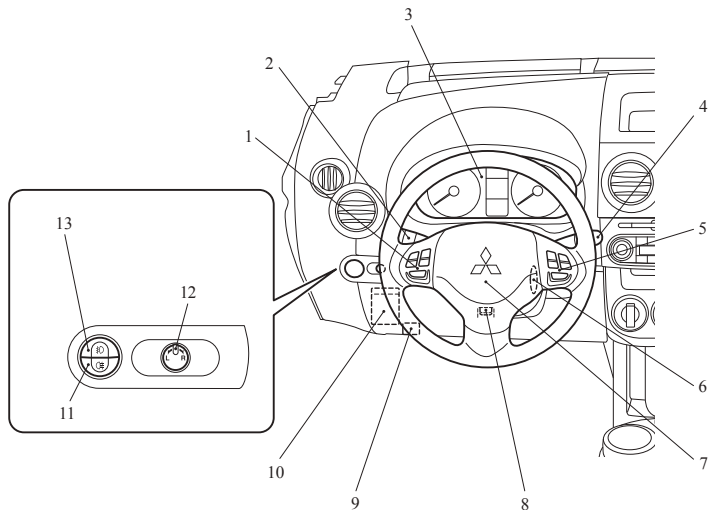

AF5000965

1. Steering wheel audio remote control switch* p. 5-28
2. Combination headlamps and dipper switch p. 3-20
Turn-signal lever p. 3-23
Headlamp levelling switch p. 3-22
3. Instruments p. 3-02
4. Windscreen wiper and washer switch p. 3-25
Rear window wiper and washer switch p. 3-29
5. Cruise control switch* p. 4-32
6. Ignition switch p. 4-10
7. Supplemental restraint system (SRS) - airbag (for driver's seat) p. 2-22
Horn switch p. 3-30
8. Steering wheel height adjustment p. 4-07
9. Bonnet release lever p. 8-03
10. Fuses p. 8-19
11. Rear fog lamp switch p. 3-24
12. Electric remote-controlled outside rear-view mirrors switch* p. 4-09
13. Front fog lamp switch* p. 3-24

Clear Tec (LHD)

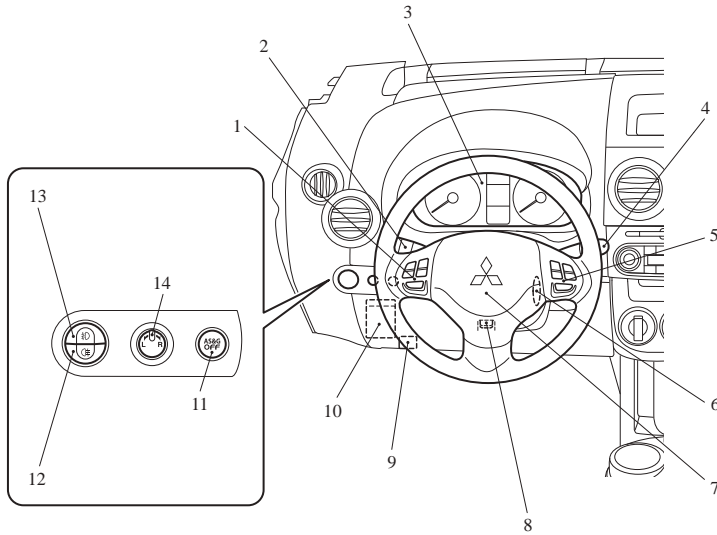

AF5001119

1. Steering wheel audio remote control switch* p. 5-28
2. Combination headlamps and dipper switch p. 3-20
Turn-signal lever p. 3-23
Headlamp levelling switch p. 3-22
3. Instruments p. 3-02
4. Windscreen wiper and washer switch p. 3-25
Rear window wiper and washer switch p. 3-29
5. Cruise control switch* p. 4-32
6. Ignition switch p. 4-10
7. Supplemental restraint system (SRS) - airbag (for driver's seat) p. 2-22
Horn switch p. 3-30
8. Steering wheel height adjustment p. 4-07
9. Bonnet release lever p. 8-03
10. Fuses p. 8-19
11. Auto Stop & Go (AS&G) OFF switch* p. 4-15
12. Rear fog lamp switch p. 3-24
13. Front fog lamp switch* p. 3-24
14. Electric remote-controlled outside rear-view mirrors switch* p. 4-09

Overview

Except for Clear Tec (RHD)

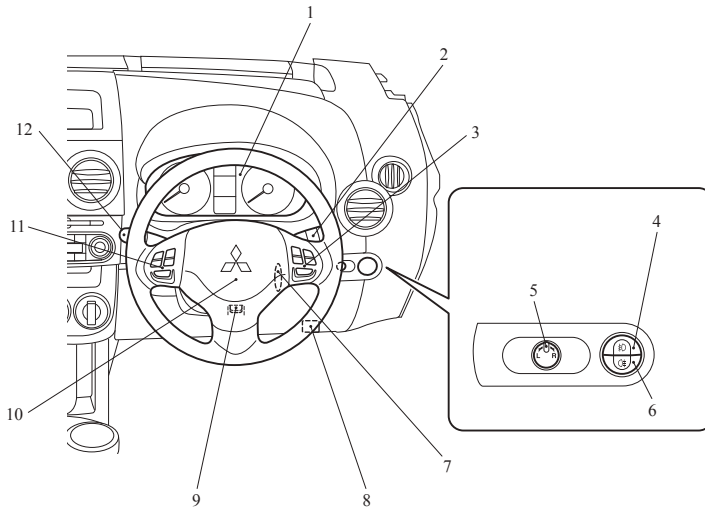

AF5000978

1. Instruments p. 3-02
2. Windscreen wiper and washer switch p. 3-25
Rear window wiper and washer switch p. 3-29
3. Cruise control switch* p. 4-32
4. Front fog lamp switch* p. 3-24
5. Electric remote-controlled outside rear-view mirrors switch* p. 4-09
6. Rear fog lamp switch p. 3-24
7. Ignition switch p. 4-10
8. Bonnet release lever p. 8-03
9. Steering wheel height adjustment p. 4-07
10. Supplemental restraint system (SRS) - airbag (for driver's seat) p. 2-22
Horn switch p. 3-30
11. Steering wheel audio remote control switch* p. 5-28
12. Combination headlamps and dipper switch p. 3-20
Turn-signal lever p. 3-23
Headlamp levelling switch p. 3-22

Clear Tec (RHD)

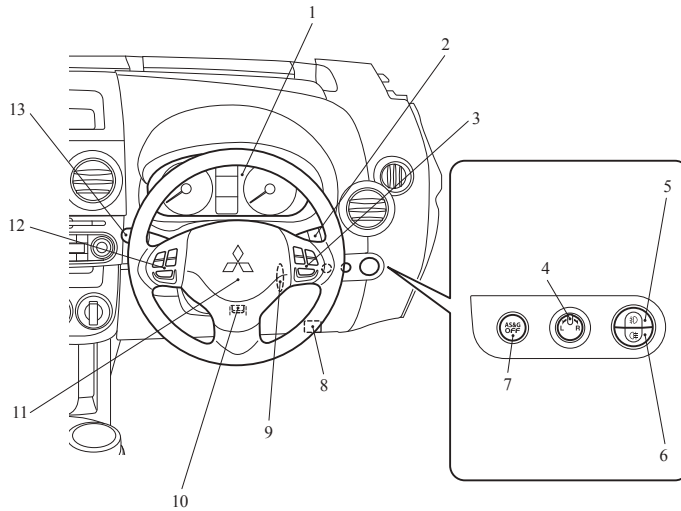

AF5001122

1. Instruments p. 3-02
2. Windscreen wiper and washer switch p. 3-25
Rear window wiper and washer switch p. 3-29
3. Cruise control switch* p. 4-32
4. Electric remote-controlled outside rear-view mirrors switch* p. 4-09
5. Front fog lamp switch* p. 3-24
6. Rear fog lamp switch p. 3-24
7. Auto Stop & Go (AS&G) OFF switch* p. 4-15
8. Bonnet release lever p. 8-03
9. Ignition switch p. 4-10
10. Steering wheel height adjustment p. 4-07
11. Supplemental restraint system (SRS) - airbag (for driver's seat) p. 2-22
Horn switch p. 3-30
12. Steering wheel audio remote control switch* p. 5-28
13. Combination headlamps and dipper switch p. 3-20
Turn-signal lever p. 3-23
Headlamp levelling switch p. 3-22

Overview

LHD

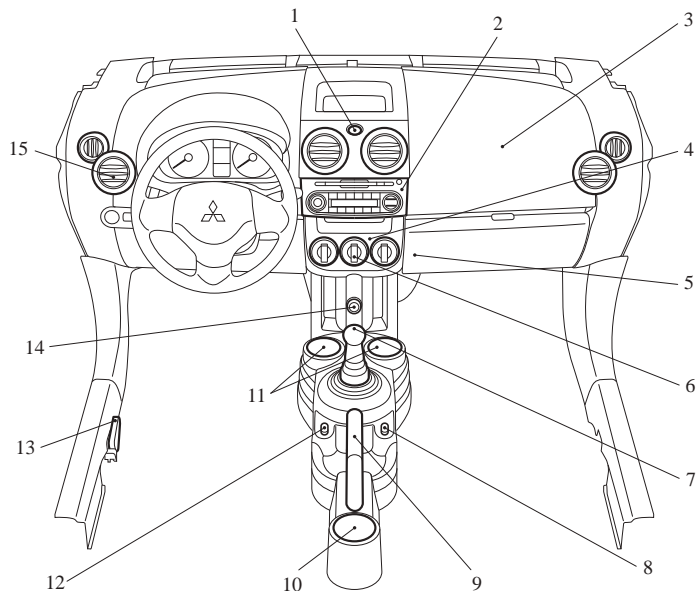

1. Hazard warning flasher switch p. 3-23
2. Audio* p. 5-12
3. Supplemental restraint system (SRS) - airbag (for front passenger's seat) p. 2-22
4. Heater* p. 5-04
Automatic air conditioning* p. 5-07
5. Front passenger's airbag ON-OFF switch p. 2-25
6. Rear window demister switch p. 3-29
7. Gearshift lever* p. 4-16
Allshift lever* p. 4-19
8. Heated seats switch* p. 2-06
9. Parking brake lever p. 4-06
10. Cup holder (for rear seats) p. 5-42
11. Cup holder (for front seats) p. 5-42
12. Heated seats switch* p. 2-06
13. Fuel tank filler door release lever p. 02
14. Accessory socket p. 5-37
15. Ventilators p. 5-02

RHD

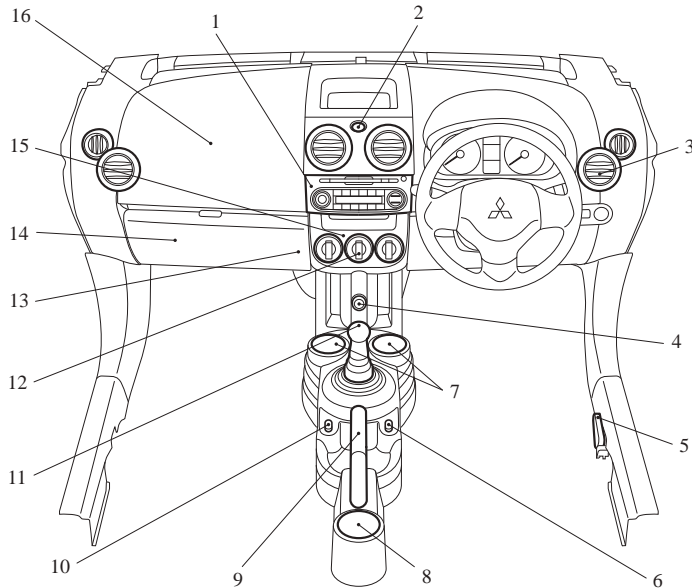

AF5000994

1. Audio* p. 5-12
2. Hazard warning flasher switch p. 3-23
3. Ventilators p. 5-02
4. Accessory socket p. 5-37
5. Fuel tank filler door release lever p. 02
6. Heated seats switch* p. 2-06
7. Cup holder (for front seats) p. 5-42
8. Cup holder (for rear seats) p. 5-42
9. Parking brake lever p. 4-06
10. Heated seats switch* p. 2-06
11. Gearshift lever* p. 4-16
Allshift lever* p. 4-19
12. Rear window demister switch p. 3-29
13. Front passenger's airbag ON-OFF switch p. 2-25
14. Fuses p. 8-19
15. Heater* p. 5-04
Automatic air conditioning* p. 5-07
16. Supplemental restraint system (SRS) - airbag (for front passenger's seat) p. 2-22

Interior

LHD (3-door models)

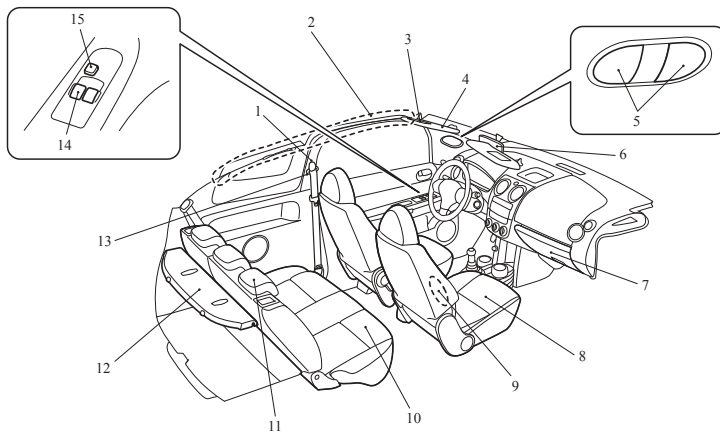

1. Seat belts p. 2-10
2. Supplemental restraint system (SRS) - Curtain airbag* p. 2-30
3. Vanity mirror p. 5-37
4. Sun visors p. 5-36
5. Room lamp/Map lamps p. 5-38
6. Inside rear-view mirror p. 4-08
7. Glove box p. 5-39
8. Front seat p. 2-04
9. Supplemental restraint system (SRS) - Side airbag (for front seats)* p. 2-30
10. Rear seat p. 2-08
11. Head restraints p. 2-06
12. Rear shelf panel* p. 5-42
13. Adjustable seat belt anchor (for front seats) p. 2-11
14. Electric window control switch p. 1-11
15. Lock switch p. 1-12

RHD (3-door models)

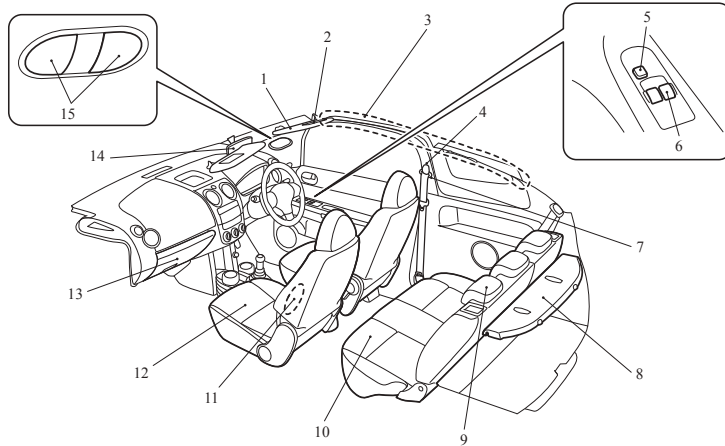

1. Sun visors p. 5-36
2. Vanity mirror p. 5-37
3. Supplemental restraint system (SRS) - Curtain airbag* p. 2-30
4. Seat belts p. 2-10
5. Lock switch p. 1-12
6. Electric window control switch p. 1-11
7. Adjustable seat belt anchor (for front seats) p. 2-11
8. Rear shelf panel* p. 5-42
9. Head restraints p. 2-06
10. Rear seat p. 2-08
11. Supplemental restraint system (SRS) - Side airbag (for front seats)* p. 2-30
12. Front seat p. 2-04
13. Glove box p. 5-39
14. Inside rear-view mirror p. 4-08
15. Room lamp/Map lamps p. 5-38

Overview

LHD (5-door models)

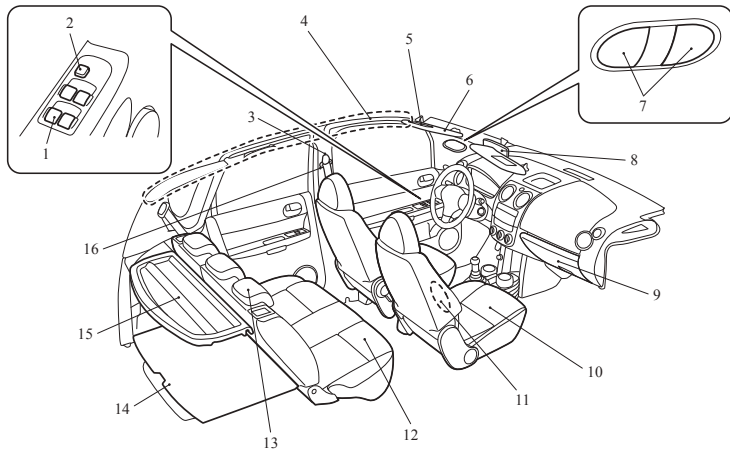

AF500151

1. Electric window control switch p. 1-11
2. Lock switch p. 1-12
3. Seat belts p. 2-10
4. Supplemental restraint system (SRS) - Curtain airbag* p. 2-30
5. Vanity mirror p. 5-37
6. Sun visors p. 5-36
7. Room lamp/Map lamps p. 5-38
8. Inside rear-view mirror p. 4-08
9. Glove box p. 5-39
10. Front seat p. 2-04
11. Supplemental restraint system (SRS) - Side airbag (for front seats)* p. 2-30
12. Rear seat p. 2-08
13. Head restraints p. 2-06
14. Luggage floor lid* p. 5-40
15. Rear shelf panel* p. 5-42
16. Adjustable seat belt anchor (for front seats) p. 2-11

RHD (5-door models)

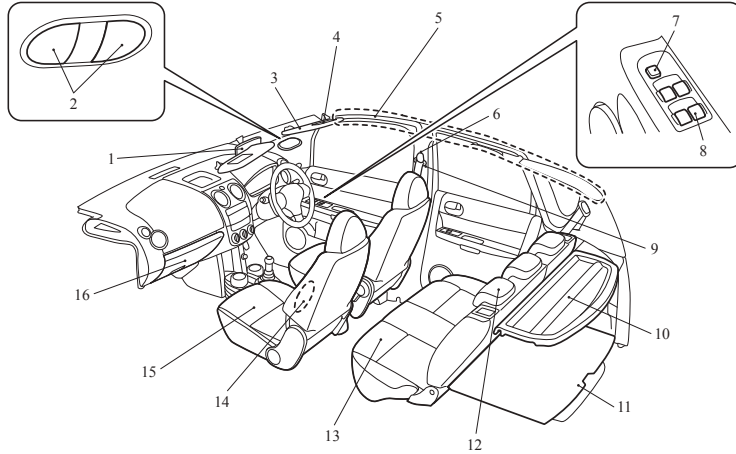

AF5001164

1. Inside rear-view mirror p. 4-08
2. Room lamp/Map lamps p. 5-38
3. Sun visors p. 5-36
4. Vanity mirror p. 5-37
5. Supplemental restraint system (SRS) - Curtain airbag* p. 2-30
6. Seat belts p. 2-10
7. Lock switch p. 1-12
8. Electric window control switch p. 1-11
9. Adjustable seat belt anchor (for front seats) p. 2-11
10. Rear shelf panel* p. 5-42
11. Luggage floor lid* p. 5-40
12. Head restraints p. 2-06
13. Rear seat p. 2-08
14. Supplemental restraint system (SRS) - Side airbag (for front seats)* p. 2-30
15. Front seat p. 2-04
16. Glove box p. 5-39

Luggage area (Except for vehicle with compact spare wheel)

E00100401263

3-door models

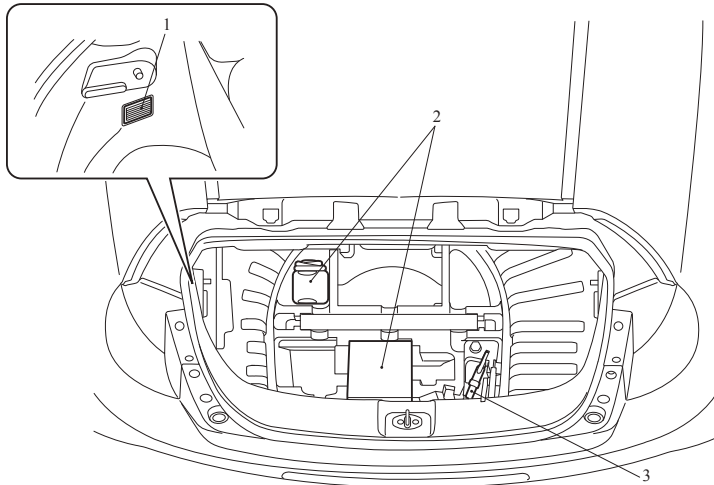

1. Luggage compartment lamp p. 5-38
2. Tyre repair kit p. 6-07
3. Towing hook p. 6-06

AF5001148

5-door models

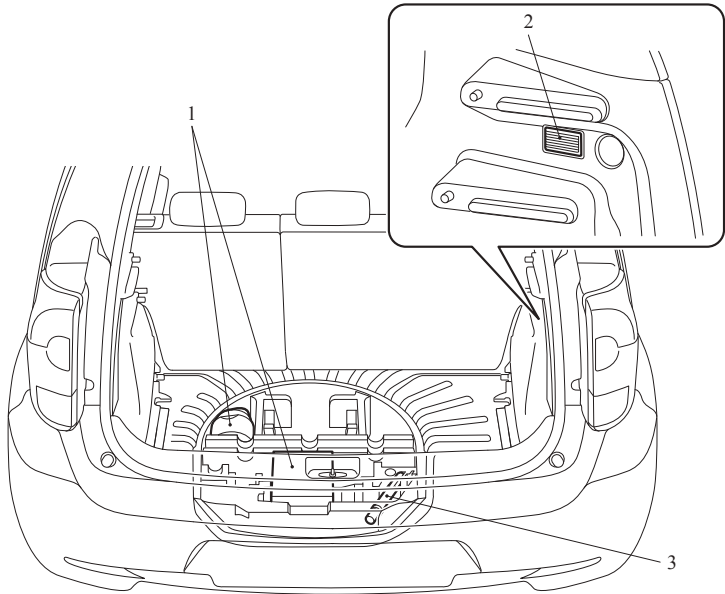

- 1. Tyre repair kit p. 6-07
- 2. Luggage compartment lamp p. 5-38
- 3. Towing hook p. 6-06

Luggage area (Vehicle with compact spare wheel)

E00100401276

3-door models

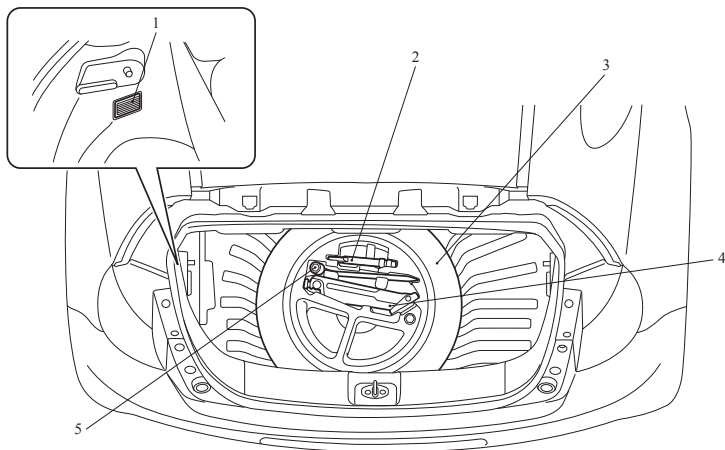

1. Luggage compartment lamp p. 5-38
2. Towing hook p. 6-06
3. Spare wheel p. 6-13
4. Jack p. 6-11
5. Wheel nut wrench p. 6-06

AFS001135

5-door models

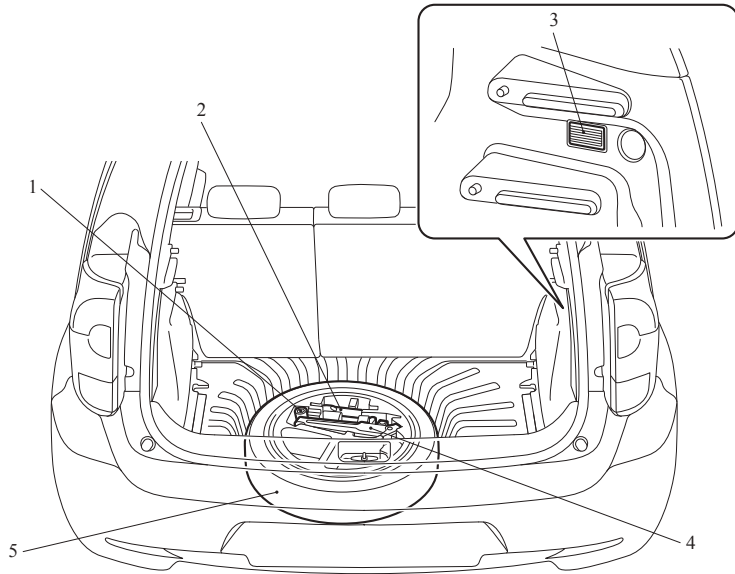

AF5001180

1. Wheel nut wrench p. 6-06
2. Towing hook p. 6-06
3. Luggage compartment lamp p. 5-38
4. Jack p. 6-11
5. Spare wheel p. 6-13

Exterior

E00100503633

3-door models

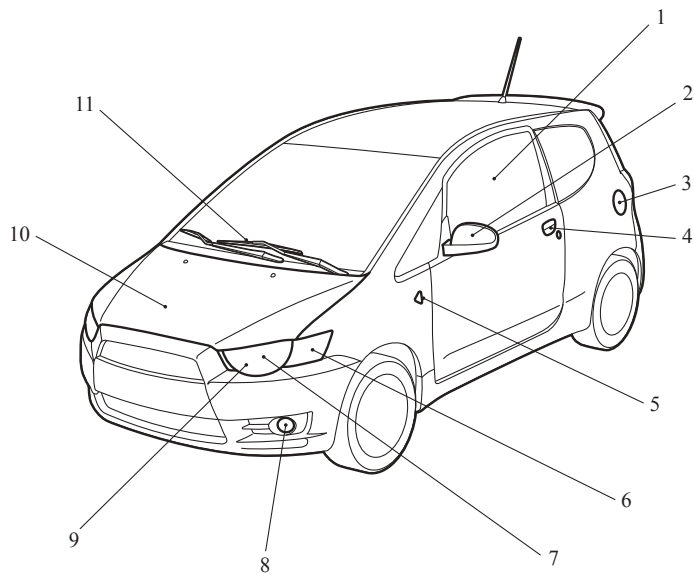

AF5001076

1. Electric window control p. 1-11
2. Outside rear-view mirrors p. 4-08
3. Fuel tank filler p. 02
4. Locking and unlocking p. 1-05
Keyless entry system p. 1-03
5. Side turn-signal lamps p. 3-23, 8-24, 8-26
6. Front turn-signal lamps p. 3-23, 8-24, 8-26
7. Headlamps, low/high-beam p. 3-20, 3-21, 8-23, 8-25
8. Front fog lamps* p. 3-24, 8-23, 8-26
9. Position lamps p. 3-20, 8-23, 8-25
10. Bonnet p. 8-03
11. Windscreen wipers p. 3-25

3-door models

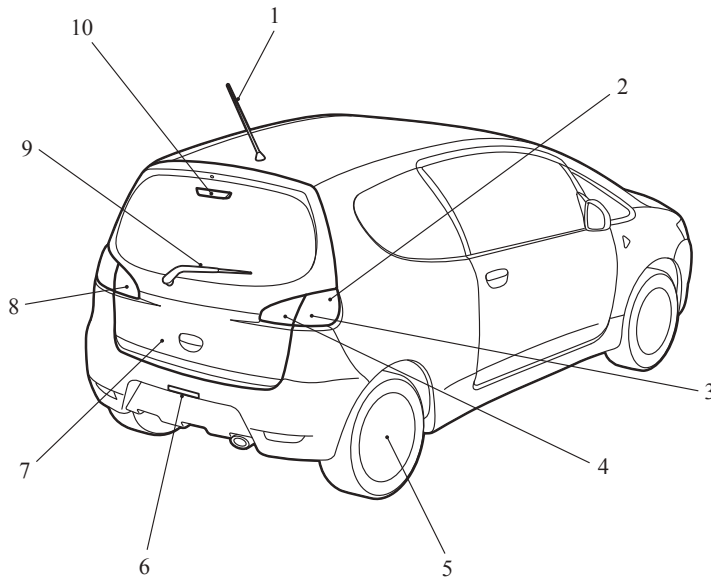

AF5001193

1. Antenna p. 5-33
2. Stop and tail lamps p. 8-24, 8-27
3. Rear turn-signal lamps p. 3-23, 8-24, 8-27
4. Reversing lamp (LHD vehicles) p. 8-24, 8-29
Rear fog lamp (RHD vehicles) p. 3-24, 8-24, 8-29
5. Tyre inflation pressures p. 8-12
Changing tyres p. 6-15
Tyre rotation p. 8-13
Tyre chains p. 8-14
Wheel covers* p. 6-17
6. Licence plate lamps p. 8-24, 8-31
7. Tailgate p. 1-09
8. Rear fog lamp (LHD vehicles) p. 3-24, 8-24, 8-29
Reversing lamp (RHD vehicles) p. 8-24, 8-29
9. Rear window wiper and washer p. 3-29
10. High-mounted stop lamps p. 8-24, 8-30

Overview

5-door models

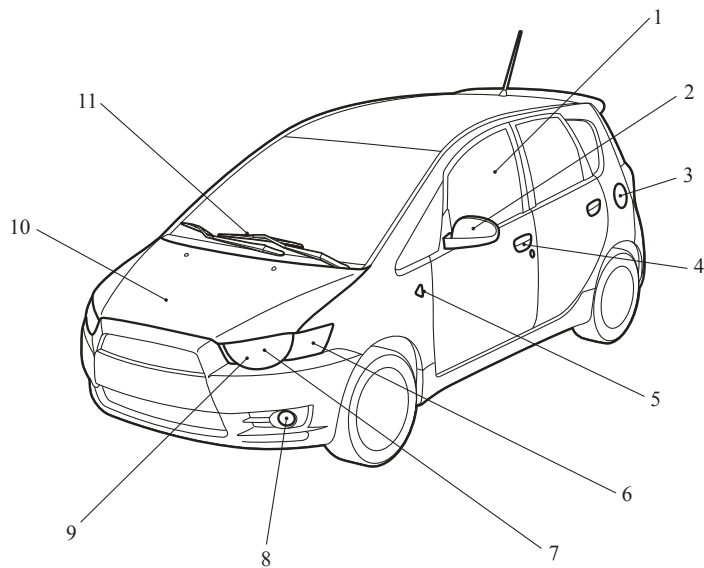

AF5001092

1. Electric window control p. 1-11
2. Outside rear-view mirrors p. 4-08
3. Fuel tank filler p. 02
4. Locking and unlocking p. 1-05
Keyless entry system p. 1-03
5. Side turn-signal lamps p. 3-23, 8-24, 8-26
6. Front turn-signal lamps p. 3-23, 8-24, 8-26
7. Headlamps, low/high-beam p. 3-20, 3-21, 8-23, 8-25
8. Front fog lamps* p. 3-24, 8-23, 8-26
9. Position lamps p. 3-20, 8-23, 8-25
10. Bonnet p. 8-03
11. Windscreen wipers p. 3-25

5-door models

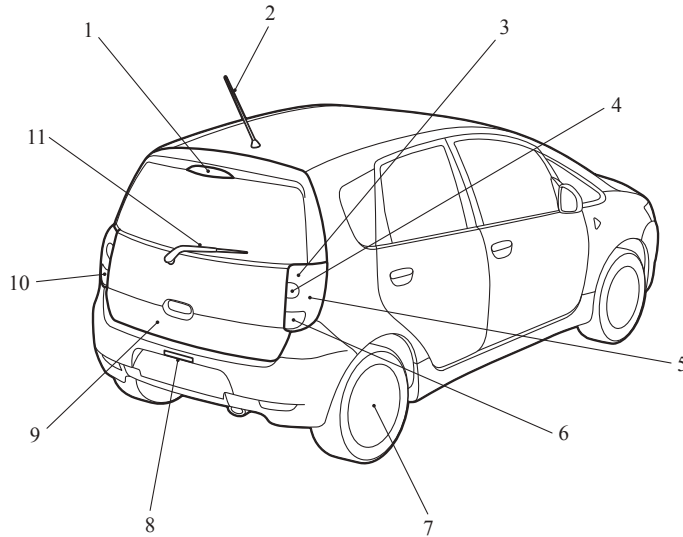

AF5001106

1. High-mounted stop lamps p. 8-24, 8-30
2. Antenna p. 5-33
3. Stop lamps p. 8-24, 8-27
4. Rear turn-signal lamps p. 3-23, 8-24, 8-27
5. Tail lamps p. 8-27
6. Reversing lamp (LHD vehicles) p. 8-24, 8-27
Rear fog lamp (RHD vehicles) p. 3-24, 8-24, 8-27
7. Tyre inflation pressures p. 8-12
Changing tyres p. 6-15
Tyre rotation p. 8-13
Tyre chains p. 8-14
Wheel covers* p. 6-17
8. Licence plate lamps p. 8-24, 8-31
9. Tailgate p. 1-09
10. Rear fog lamp (LHD vehicles) p. 3-24, 8-24, 8-27
Reversing lamp (RHD vehicles) p. 8-24, 8-27
11. Rear window wiper and washer p. 3-29

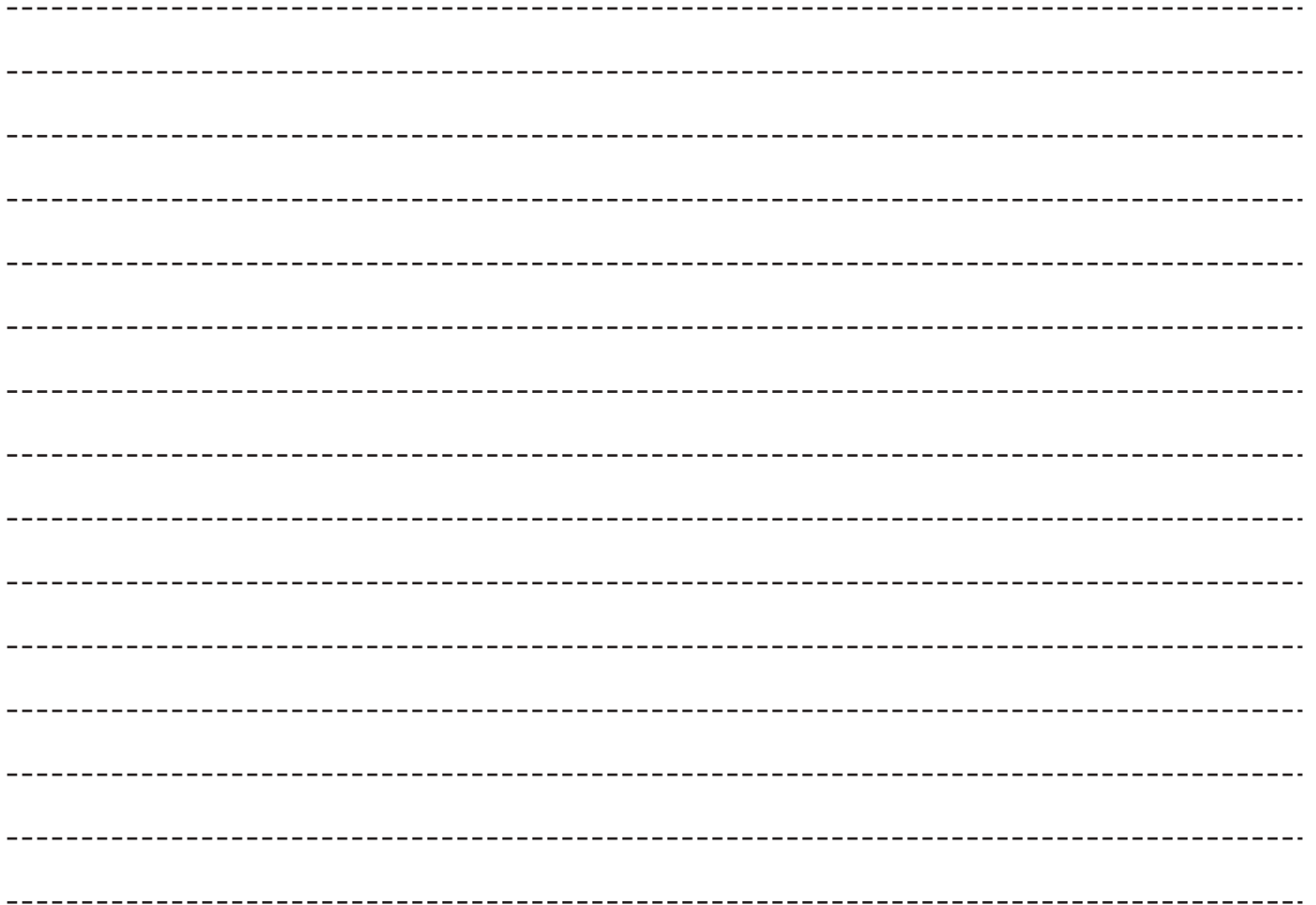

General information

Fuel selection.....	02
Filling the fuel tank.....	02
Installation of accessories.....	04
Modification/alterations to the electrical or fuel systems.....	05
Genuine parts.....	05
Used engine oils safety instructions and disposal information.....	05
Disposal information for used batteries.....	06

General information

Fuel selection

E00200102590

Recommended fuel	Unleaded petrol octane number (EN228) 95 RON or higher
------------------	---

CAUTION

- The use of leaded fuel can result in serious damage to the engine and catalytic converter. Do not use leaded fuel.

NOTE

- Your vehicle has the knock control system so that you can use unleaded petrol 90 RON as an emergent measure in case unleaded petrol 95 RON or higher is not available on journey, etc. In such a case, you don't need to adjust the engine specially.
In case of using unleaded petrol 90 RON, the engine performance level is reduced.
- Repeatedly driving short distances at low speeds can cause deposits to form in the fuel system and engine, resulting in poor starting and poor acceleration. If these problems occur, you are advised to add a detergent additive to the gasoline when you refuel the vehicle. The additive will remove the deposits, thereby returning the engine to a normal condition. Be sure to use a genuine MITSUBISHI FUEL SYSTEM CLEANER. Using an unsuitable additive could make the engine malfunction. For details, please contact a MITSUBISHI MOTORS Authorized Service Point.

- Poor quality petrol can cause problems such as difficult starting, stalling, engine noise and hesitation. If you experience these problems, try another brand and/or grade of petrol. If the check engine warning lamp flashes, have the system checked as soon as possible at a MITSUBISHI MOTORS Authorized Service Point.

Filling the fuel tank

E00200202331

WARNING

- Gasoline is highly flammable and explosive. You could be burned or seriously injured when handling it. When refueling your vehicle, always turn the engine off and keep away from flames, sparks, and smoking materials. Always handle fuel in well-ventilated outdoor areas.
- Before removing the fuel cap, be sure to get rid of your body's static electricity by touching a metal part of the car or the fuel pump. Any static electricity on your body could create a spark that ignites fuel vapour.
- Perform the whole refueling process (opening the fuel tank filler door, removing the fuel cap, etc.) by yourself. Do not let any other person come near the fuel tank filler. If you allowed a person to help you and that person was carrying static electricity, fuel vapour could be ignited.
- Do not move away from the fuel tank filler until refueling is finished. If you moved away and did something else (for example, cleaning your windscreen) part-way through the refueling process, you could pick up a fresh charge of static electricity.
- Be careful not to inhale fuel vapour. Fuel contains toxic substances.

⚠ WARNING

- Keep the doors and windows closed while refueling the vehicle. If they were open, fuel vapour could get into the cabin.

Fuel tank capacity

47 litres

Refueling

1. Before filling with fuel, stop the engine.
2. The fuel tank filler is located on the rear left side of your vehicle.
The fuel tank filler door can be opened from inside the vehicle with the fuel tank filler door release lever located the side of the driver's seat.

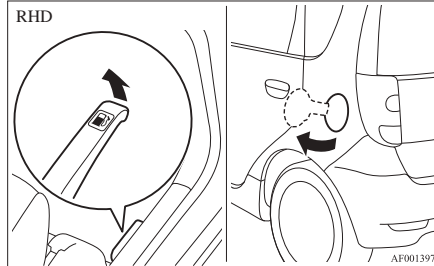
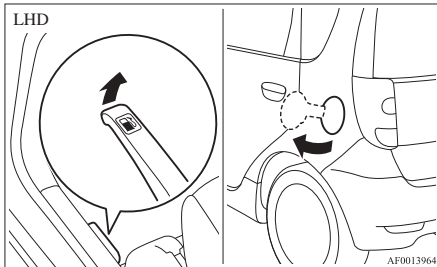

3. Open the fuel tank filler tube by slowly turning the cap anticlockwise.



⚠ CAUTION

- Since the fuel system may be under pressure, remove the fuel tank filler tube cap slowly. This relieves any pressure or vacuum that might have built up in the fuel tank. If the cap is venting vapour or if you hear a hissing sound, wait until it stops before removing the cap. Otherwise, fuel may spray out, injuring you or others.

4. To fill with fuel correctly depends mainly on correct handling of the fuel filler gun. Do not tilt the gun. Insert the gun in the tank port as far as it goes.

⚠ CAUTION

- A label which reads “UNLEADED FUEL ONLY” is attached to the fuel tank filler lid of vehicles which can only operate using unleaded petrol. Serious engine and catalytic converter damage will result if leaded petrol is filled into these vehicles, and consequently, this must never be attempted.

5. When the gun stops automatically, do not fill with fuel any more.

⚠ CAUTION

- To avoid fuel spillage and overfilling, do not “top-off” the fuel tank.

General information

- To close, turn the fuel tank filler tube cap slowly clockwise until you hear clicking sounds, then gently push the fuel tank filler door closed.

CAUTION

- If you need to replace the fuel tank filler tube cap, use only the cap specified for your model vehicle.

Installation of accessories

E00200300413

We recommend you to consult your MITSUBISHI MOTORS Authorized Service Point.

- The installation of accessories, optional parts, should only be carried out within the limits prescribed by law in your country, and in accordance with the guidelines fitting instructions and warnings contained within the documents accompanying the parts or accessories.
- Improper installation of electrical components may cause an electrical fire if incorrectly fitted. Please refer to the Modification/alteration to the electrical or fuel systems section within this owner's manual.
- Using a cellular phone or radio set inside the vehicle without an external antenna may cause electrical system interference, which could lead to unsafe vehicle operation.
- Tyres and wheels which do not meet specifications must not be used.

Refer to the "Specifications" section for information regarding wheel and tyre sizes.

Important points!

Due to large number of accessory and replacement parts of different manufactures available in the market, it is not possible, not only for MITSUBISHI MOTORS, but also for a MITSUBISHI MOTORS Authorized Service Point, to check whether the attachment or installation of such parts affects the overall safety of your MITSUBISHI-vehicle.

Even when such parts are officially authorized, for example by a "general operators permit" (an appraisal for the part) or through the execution of the part in an officially approved manner of construction, or when a single operation permit following the attachment or installation of such parts, it cannot be deduced from that alone, that the driving safety of your vehicle has not been affected.

Consider also that there basically exists no liability on the part of the appraiser or the official. Only in the case of parts (MITSUBISHI MOTORS original replacement or exchange parts as well as MITSUBISHI MOTORS genuine accessories) that are recommended and released by a MITSUBISHI MOTORS Authorized Service Point and that are attached or installed by a MITSUBISHI MOTORS Authorized Service Point can you assume, that optimal safety has been provided. The same also pertains to modifications of MITSUBISHI vehicle with respect to the production specifications. For your own safety, in such cases, you should only undertake modifications according to the recommendations of a MITSUBISHI MOTORS Authorized Service Point.

Modification/alterations to the electrical or fuel systems

E00200400267

MITSUBISHI MOTORS has always manufactured safe, high quality vehicles. In order to maintain this safety and quality, it is important that any accessory that is to be fitted, or any modifications carried out which involve the electrical or fuel systems, should be carried out in accordance with MITSUBISHI MOTORS guidelines.

CAUTION

- If the wiring interferes with any part of the vehicle bodywork or improper installation methods are used, i.e. protective fuses not installed, etc.), electronic devices may be adversely affected, possibly resulting in an electrical fire or other failures that may cause an accident.

Genuine parts

E00200500574

MITSUBISHI MOTORS has gone to great lengths to bring you a superbly crafted automobile offering the highest quality and dependability.

Use MITSUBISHI MOTORS Genuine Parts, designed and manufactured to maintain your MITSUBISHI MOTORS automobile at top performance. MITSUBISHI MOTORS Genuine Parts are identified by this mark and are available at all MITSUBISHI MOTORS Authorized Service Points.

**MITSUBISHI MOTORS
GENUINE PARTS**

Used engine oils safety instructions and disposal information

E00200600025

WARNING

- Prolonged and repeated contact may cause serious skin disorders, including dermatitis and cancer.
- Avoid contact with the skin as far as possible and wash thoroughly after any contact.
- Keep used engine oils out of reach of children.

Protect the environment

It is illegal to pollute drains, water courses and soil. Use authorized waste collection facilities, including civic amenity sites and garages providing facilities for disposal of used oil and used oil filters. If in doubt, contact your local authority for advice on disposal.

Disposal information for used batteries

E00201300016



Your vehicle contains batteries and/or accumulators.

Do not mix with general household waste.

For proper treatment, recovery and recycling of used batteries, please take them to applicable collection points, in accordance with your national legislation and the Directives 2006/66/EC.

By disposing of these batteries correctly, you will help to save valuable resources and prevent any potential negative effects on human health and the environment which could otherwise arise from inappropriate waste handling.

Locking and unlocking

Keys.....	1-02
Electronic immobilizer (Anti-theft starting system).....	1-02
Keyless entry system.....	1-03
Doors.....	1-05
Central door locks.....	1-07
Dead Lock System*.....	1-07
“Child-protection” rear doors (5-door models).....	1-09
Tailgate.....	1-09
Manual window control (5-door models, rear door win- dow only)*.....	1-11
Electric window control.....	1-11

Locking and unlocking

Keys

E00300101653

The key fits all locks.

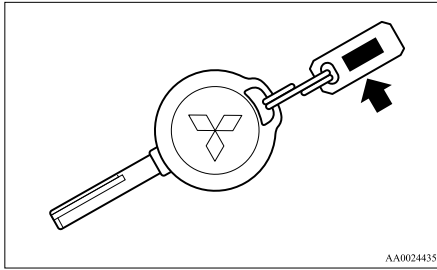

1

⚠ WARNING

- When bringing a key on flights, do not press any switches on the key while on the plane. If a switch is pressed on the plane, the key emits electromagnetic waves, which could adversely affect the plane's flight operation. When carrying a key in a bag, be careful that no switches on the key can be easily pressed by mistake.

NOTE

- The key number is stamped on the tag as indicated in the illustration. Make a record of the key number and store the key and key number tag in separate places, so that you can order a key in the event the original keys are lost.

- The key is a precision electronic device with a built-in signal transmitter. Please observe the following in order to prevent a malfunction.

- Do not leave anywhere that is exposed to direct sunlight, for example on the dashboard.
 - Do not disassemble or modify.
 - Do not excessively bend the key or subject it to a strong impact.
 - Do not expose to water.
 - Keep away from magnetic key holders.
 - Keep away from audio systems, personal computers, TVs, and any other equipment that generates a magnetic field.
 - Do not wash with ultrasonic cleaners or similar equipment.
 - Do not leave the key where it may be exposed to high temperature or high humidity.
- The engine is designed so that it will not start if the ID code registered in the immobilizer computer and the key's ID code do not match. Refer to the section entitled "Electronic immobilizer" for details and key usage.

Electronic immobilizer (Anti-theft starting system)

E00300201872

The electronic immobilizer is designed to significantly reduce the possibility of vehicle theft. The purpose of the system is to immobilize the vehicle if an invalid start is attempted. A valid start attempt can only be achieved (subject to certain conditions) using a keyless operation system "registered" to the immobilizer system.

All of the keys provided with your new vehicle have been programmed into the vehicle's electronics.

The immobilizer indication lamp comes on in the event of a malfunction in the system electronics.

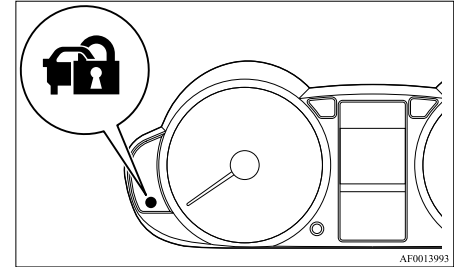

NOTE

- In the following cases, the vehicle may not be able to receive the registered ID code from the key. This means the engine will not start even when the registered key is turned to the "START" position.
 - When the key contacts a key ring or other metallic or magnetic object (Type A)

- When the key grip contacts metal of another key (Type B)
- When the key contacts or is close to other immobilizing keys (including keys of other vehicles) (Type C)

In cases like these, remove the object or additional key from the vehicle key. Then try again to start the engine. If the engine does not start, we recommend you to contact your MITSUBISHI MOTORS Authorized Service Point.

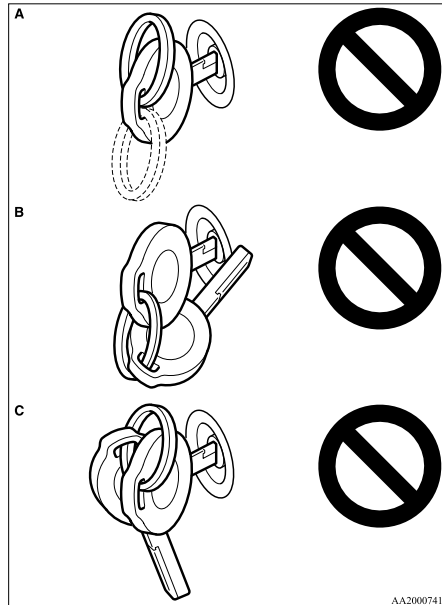

NOTE

- If you lose your key, order a key from your MITSUBISHI MOTORS Authorized Service Point as soon as possible. To obtain a replacement or extra spare key, take your vehicle and all remaining keys to your MITSUBISHI MOTORS Authorized Service Point. All the keys have to be re-registered in the immobilizer computer unit. The immobilizer can register up to 8 different keys for use.

⚠ CAUTION

- Do not modify or add parts to the immobilizer system. Doing so could cause the immobilizer to malfunction.

Keyless entry system

E00300301831

Press the remote control switch, and all doors and the tailgate will be locked or unlocked as desired.



1- LOCK switch
2- UNLOCK switch

To lock

Press the LOCK switch (1). All doors and the tailgate will be locked. When they are locked with the turn-signal lamps blink once.

NOTE

- With a vehicle that has a Dead Lock System, pressing the LOCK switch (1) two times in succession causes the Dead Lock System to be set. (Refer to “Setting the system” on page 1-07.)

To unlock

Press the UNLOCK switch (2). All doors and the tailgate will be unlocked. If they are unlocked while the room lamp is not illuminated, the room lamp will be turned on for approximately 15 seconds and the turn-signal lamps will blink twice.

Locking and unlocking

NOTE

- If the UNLOCK switch (2) is pressed and any of the doors or tailgate is not opened within approximately 30 seconds: relocking will automatically occur.
- It is possible to modify functions as follows: For further information, contact your MITSUBISHI MOTORS Authorized Service Point.
 - The time from pressing the UNLOCK switch (2) to the moment of automatic locking can be changed.
 - The confirmation function (flashing of the turn-signal lamps) can be set to operate only when the doors and tailgate are locked or only when the doors and tailgate are unlocked.
 - The confirmation function (this indicates locking or unlocking of the doors and tailgate with the flash of the turn-signal lamps) can be deactivated.
 - The number of times the turn-signal lamps are flashed by the confirmation function can be changed.

Operation of the Dead Lock System

With a vehicle that has a Dead Lock System, it is possible to set the Dead Lock System using the remote controller.

(Refer to “Dead Lock System” on page 1-07.)

NOTE

- With a vehicle that has a Dead Lock System, the keyless entry system does not work while the key is in the ignition switch.

- Pressing the LOCK switch (1) has no effect (no locking takes place) while a door or the tailgate is open.
- The remote control switch will operate within about 4 m from the vehicle. However, the operating range of the remote control switch may change if the vehicle is located near a TV transmitting tower, power station, or radio broadcasting station.
- If the turn-signal lamps flash nine times when you press the remote control switch, the battery may have run down. For further information, please consult your MITSUBISHI MOTORS Authorized Service Point.
- If you replace the battery yourself, refer to “Procedure for replacing the remote control switch battery” on page 1-04.
- If your remote control switch is lost or damaged, please contact your MITSUBISHI MOTORS Authorized Service Point for a replacement remote control switch.
- If you wish to add a remote control switch, we recommend you to contact your MITSUBISHI MOTORS Authorized Service Point.

A maximum of 8 remote control switches are available for your vehicle.

Procedure for replacing the remote control battery

E00309500031

1. With the MITSUBISHI mark facing you, insert a coin, etc., into the notch in the remote control switch case and use it to open the case.

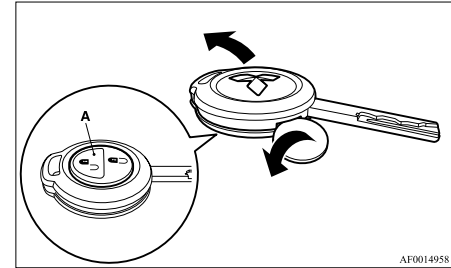

NOTE

- Be sure to perform the procedure with the MITSUBISHI mark facing you. If the MITSUBISHI mark is not facing you when you open the remote control switch case, the buttons may come out.
- When opening the remote control switch case, do not push forcefully on the keyless button area (A). Otherwise, the keyless circuit board may fall out and be damaged.

Doors

E00300401890

2. Insert a straight blade (or minus) screwdriver into the notch in the remote control switch case (B) and remove the old battery.

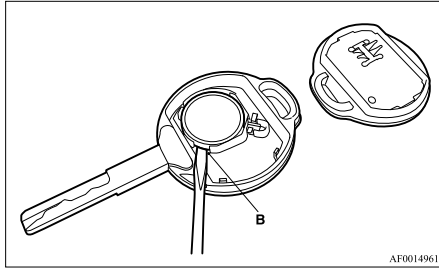

3. Install a new battery with the + side (C) down, and then close the remote control switch case firmly.

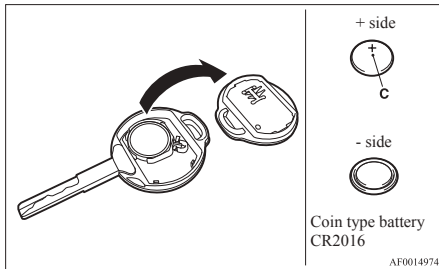

NOTE

- Make sure you hear a “click” when you install the battery and close the case.

4. Check the keyless entry system to see that it works.

NOTE

- You may purchase a replacement battery at an electric appliance store.
- A MITSUBISHI MOTORS Authorized Service Point can replace the battery for you if you prefer.

CAUTION

- When the remote control switch case is opened, be careful to keep water, dust, etc. out. Also, do not touch the internal components.

CAUTION

- Make sure the doors are closed: driving with doors incompletely closed is dangerous.
- Never leave children in the vehicle unattended.
- Be careful not to lock the doors while the key is inside the vehicle.

To lock or unlock with the key

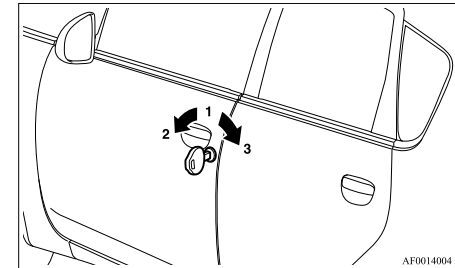

- 1- Insert or remove the key
- 2- Lock
- 3- Unlock

Locking and unlocking

To lock or unlock from inside the vehicle

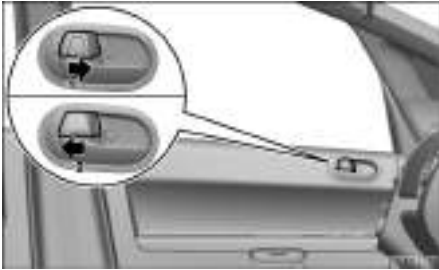

- 1- Lock
- 2- Unlock

Pull the inside door handle towards you to open the door.

NOTE

- The driver's door can be opened without using the lock knob by pulling on the inside door handle.
All other doors and the tailgate are unlocked at the same time.
- In a vehicle that has a Dead Lock System, it is not possible to unlock the door by pushing the lock knob to the unlock side while the Dead Lock System is set.
(Refer to "Dead Lock System" on page 1-07.)

To lock without using the key

Front passenger's door

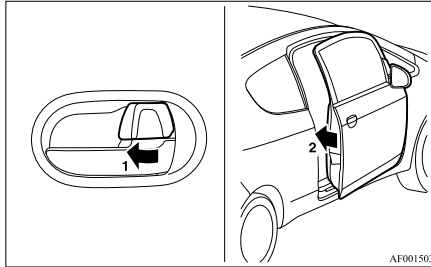

Rear door (5-door models)

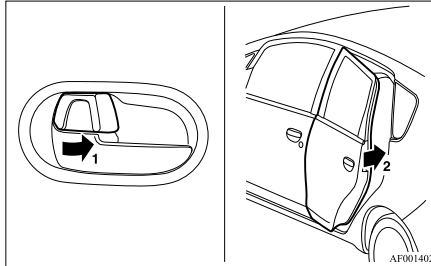

Set the inside lock knob (1) to the locked position, and close the door (2).

NOTE

- The driver's door cannot be locked using the inside lock knob while the driver's door is opened.

Central door locks

E00300801445

NOTE

- Each of the doors can be locked or unlocked independently by using the inside lock knob.
- Repeated continuous operation between lock and unlock could activate the central door locking systems built-in protection circuit and prevent the system from operating. If this occurs, wait about 1 minute before operating the inside lock knob or the key.

All of the doors and the tailgate can be locked and unlocked as described hereafter.

Front doors with key (LHD vehicles only)

Turn the key in the driver's door towards the front of the vehicle to lock the doors and the tailgate and towards the rear of the vehicle to unlock the doors and the tailgate.

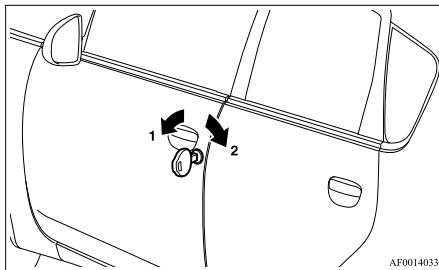

- 1- Lock
2- Unlock

NOTE

- For RHD vehicles, turning the key in the front door will not operate the central door locking system. Therefore, use the keyless entry system instead. If the keyless entry system does not operate, such as when the remote control switch battery is discharged, use the key to unlock the front door.

Driver's door with inside lock knob

Set the inside lock knob on the driver's door towards the front of the vehicle to lock the doors and the tailgate. Set it towards the rear of the vehicle to unlock the doors and the tailgate.

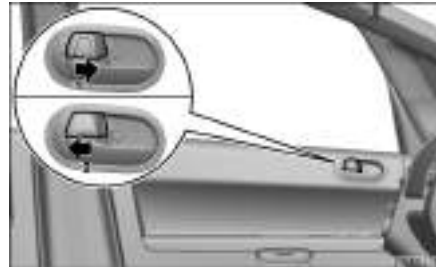

- 1- Lock
2- Unlock

Dead Lock System*

E00305100013

The Dead Lock System helps to prevent theft. When the keyless entry system has been used to lock all of the doors and the tailgate, the Dead Lock System makes it impossible to unlock the doors using the inside lock knobs.

⚠ CAUTION

- Do not set the Dead Lock System when someone is inside the vehicle. With the Dead Lock System set, it is not possible to unlock the doors using the inside lock knobs. If you erroneously set the Dead Lock System, unlock the doors using the UNLOCK switch of the keyless entry system.

Setting the system

E00305200115

1. Remove the key from the ignition switch.
2. Get out of the vehicle. Close all of the doors and the tailgate.
3. Press the LOCK switch (A) of the keyless entry system to lock all of the doors and the tailgate. The turn-signal lamps will blink once.
4. Press the LOCK switch (A) again within 2 seconds. The turn-signal lamps will blink three times to show that the Dead Lock System has been set.

Locking and unlocking



1

NOTE

- Pressing the LOCK switch (A) once while the Dead Lock System is set causes the turn-signal lamps to flash three times, so it is possible to confirm that the Dead Lock System is set.
- It is possible to alter the system's functionality as follows:
 - It is possible to disable the operation confirmation function (flashing of the turn-signal lamps).
 - It is possible to change the number of times the operation confirmation function causes the turn-signal lamps to flash for confirmation of system operation.

For details, please contact a MITSUBISHI MOTORS Authorized Service Point.

Cancelling the system

E00305300031

When the UNLOCK switch (B) of the keyless entry system is pressed to unlock the doors and tailgate, the Dead Lock System is simultaneously cancelled.



NOTE

- If neither a door nor the tailgate is opened within 30 seconds of unlocking, the doors and tailgate are automatically relocked and the Dead Lock System is simultaneously set again.
- Even when it is not possible to use the keyless entry system to unlock the doors, it is possible to use the key to unlock a door. When the key is used to unlock a door, the Dead Lock System is cancelled for only that door. If you wish to subsequently unlock all of the doors, turn the ignition switch to the "ON" or "ACC" position.

- It is possible to adjust the duration after which automatic relocking takes place when the UNLOCK switch (B) has been pressed. For details, please contact a MITSUBISHI MOTORS Authorized Service Point.

Testing the system

E00305400029

Open all of the door windows, then set the Dead Lock System. (Refer to "Setting the system" on page 1-07.)

After setting the Dead Lock System, reach into the vehicle through the windows and confirm that you cannot unlock the doors using the lock knobs.

NOTE

- If you need advice on how to set the Dead Lock System or if it should be difficult to understand, please contact a MITSUBISHI MOTORS Authorized Service Point.

“Child-protection” rear doors (5-door models)

E00300900638

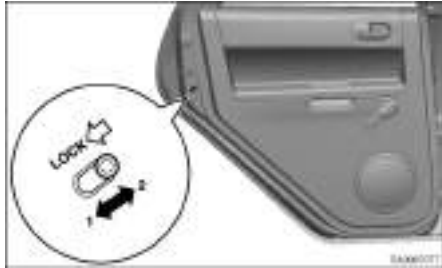

- 1- Lock
- 2- Free

Child protection helps prevent doors from being opened accidentally, especially when small children are in the rear seat.

A lever is provided on each rear door.

If the lever is set to the locked position, the rear door cannot be opened using the inside handle.

To open the rear door while the child protection is in use, pull the outside door handle.

If the lever is set to the “Free” position, the child protection mechanism does not function.

CAUTION

- When driving with a child in the rear seat, please use the child protection to prevent accidental door opening which may cause an accident.

Tailgate

E00301400890

WARNING

- It is dangerous to drive with the tailgate open, since carbon monoxide (CO) gas can enter the cabin. You cannot see or smell CO. It can cause unconsciousness and even death.
- When opening and closing the tailgate, make sure that there are no people nearby and be careful not to hit your head or pinch your hands, neck, etc.

CAUTION

- Do not stand behind the exhaust pipe when loading and unloading luggage. Heat from the exhaust could lead to burns.

NOTE

- Locking/unlocking of the driver’s door by using the key (LHD vehicles only), inside lock knob (driver side) or keyless entry system also locks/unlocks the tailgate.

To lock or unlock from inside the vehicle

The tailgate can be locked or unlocked by using the inside lock knob (driver side), regardless of the position of the ignition key.

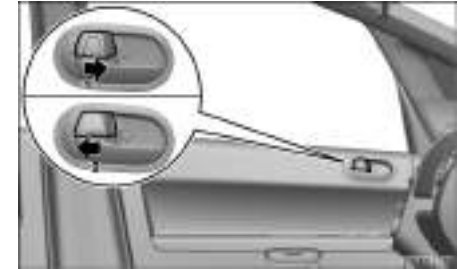

- 1- Lock
- 2- Unlock

If the tailgate is locked or unlocked by using the inside lock knob (driver side), it can still be locked or unlocked with the key.

NOTE

- Repeated continuous operating between lock and unlock could cause the central door locks’ built-in protection circuit to prevent the system from operating. If this occurs, wait about 1 minute before operating the knob.

Locking and unlocking

To open

Pull the tailgate lever upward to open the tailgate.

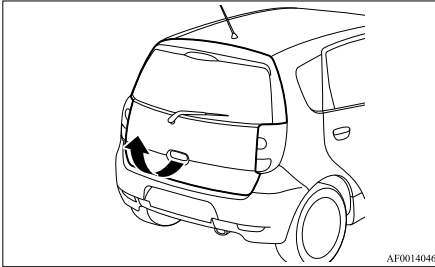

CAUTION

- Make sure there is no one standing nearby when opening the tailgate.

To close

Pull the tailgate grip (A) downward as illustrated and release it before the tailgate closes completely. Gently slam the tailgate from the outside so that it is completely closed.

3-door models

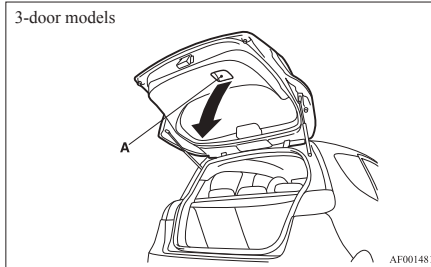

5-door models

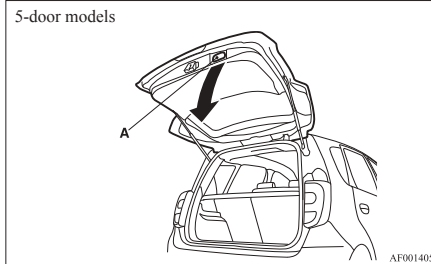

CAUTION

- To avoid injuring your hand or arm, do not attempt to close the tailgate without letting go off the tailgate grip.

CAUTION

- Before driving, make sure that the tailgate is securely closed. If the tailgate opens while driving the vehicle, objects stored in the luggage area could fall out onto the road.

NOTE

- Gas struts (B) are installed in the locations illustrated to support the tailgate. Please observe the following in order to prevent damage or faulty operation.
 - Do not hold the gas struts when closing the tailgate. Also, do not push or pull the gas struts.
 - Do not attach any plastic material, tape, etc., to the gas struts.
 - Do not tie string, etc., around the gas struts.
 - Do not hang any object on the gas struts.

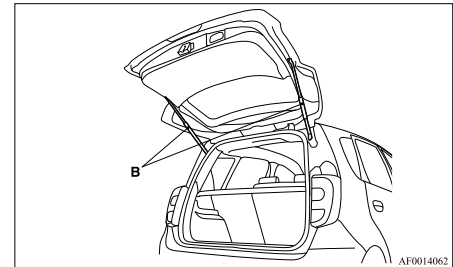

Manual window control (5-door models, rear door window only)*

E00302100083



- 1- To open
- 2- To close

Electric window control

E00302200042

The electric windows can only be operated with the ignition switch in the “ON” position.

Electric window control switch

E00302301330

Each door window opens or closes while the corresponding switch is operated.



- 1- Driver's door window
- 2- Front passenger's door window
- 3- Rear left door window (5-door models)*
- 4- Rear right door window (5-door models)*
- 5- Lock switch

⚠ WARNING

- Before operating the electric window control, make sure that nothing is capable of being trapped (head, hand, finger, etc.).
- Never leave the vehicle without removing the key.
- Never leave a child (or other person who might not be capable of safe operation of the electric window control) in the vehicle alone.
- The child may tamper with the switch at the risk of its hands or head being trapped in the window.

NOTE

- Repeated operation with the engine stopped will run down the battery. Operate the window switches only while the engine is running.

Driver's switches

The driver's switches can be used to operate all door windows. A window can be opened or closed by operating the corresponding switch.

Press the switch down to open the window, and pull up the switch to close it.

If the switch for the driver's window is fully pressed down, the door window automatically opens completely.

If you want to stop the window movement, pull up the switch.

Passenger's switches

The passenger's switches can be used to operate the corresponding passenger's door windows.

Locking and unlocking

Press the switch down for opening the window, and pull up the switch for closing.

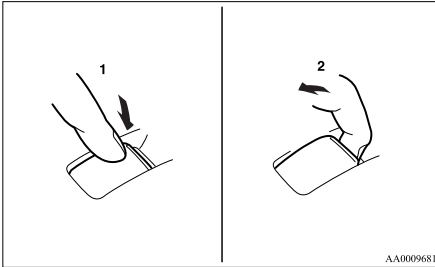

- 1- Open (down)
- 2- Close (up)

NOTE

- The rear door windows (5-door models) only open halfway.

Lock switch

E00303100413

When this switch is operated, the passenger's switches cannot be used to open or close the door windows and the driver's switch cannot open or close any door windows other than the driver's door windows.

To unlock, press it once again.



- 1- Lock
- 2- Unlock

WARNING

- A child may tamper with the switch at the risk of its hands or head being trapped in the window. When driving with a child in the vehicle, please press the window lock switch to disable the passenger's switches.

Seat and seat belts

Seat.....	2-02
Seat arrangement.....	2-03
Seat adjustment.....	2-04
Front seat.....	2-04
Head restraints.....	2-06
Making a luggage area.....	2-08
Seat belts.....	2-10
Pregnant women restraint.....	2-12
Seat belt pretensioner system and force limiter system.....	2-13
Child restraint.....	2-13
Seat belt inspection.....	2-22
Supplemental restraint system (SRS) - airbag.....	2-22

Seat

E00400101380

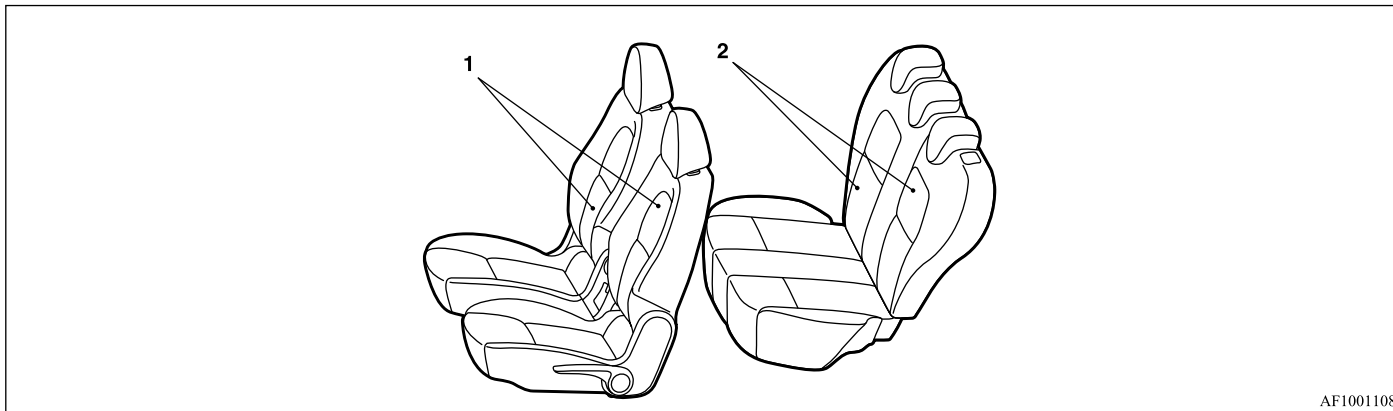

AF1001108

1-Front seat

- To adjust forward or backward → p. 2-04
- To recline the seatback → p. 2-05
- To adjust seat height* → p. 2-05
- To get in and out of the rear seat (3-door models) → p. 2-05
- Heated seats* → p. 2-06

2-Rear seat

- Folding the rear seat → p. 2-08

Seat arrangement

E00400200603

By operating the seats select the desired seats arrangement.

Normal usage	 <p>AFM001191</p>
How to stow large articles (Folding the rear seat)	 <p>AFM001218</p>

Seat adjustment

E00400300486

Adjust the driver's seat so that you are comfortable and that you can reach the pedals, steering wheel, switches etc. while retaining a clear field of vision.

⚠ WARNING

- Do not attempt to adjust the seat while driving. This can cause loss of vehicle control and result in an accident. After adjustments are made, ensure the seating is locked in position by attempting to move the seat forward and rearward without using the adjusting mechanism.
- It is extremely dangerous to ride in the luggage area of a vehicle. Also, the luggage area and rear seats should never be used as a play area by children. In a collision, people or children riding unrestrained in these areas are more likely to be seriously injured or killed.
Do not allow people or children to ride in any area of your vehicle that is not equipped with seats and seat belts, and make sure that everyone travelling in your vehicle is in a seat and wearing a seat belt, or in the case of a child is strapped in a child restraint.

⚠ WARNING

- To minimize the risk of personal injury in the event of a collision or sudden braking, the seatbacks should always be in the almost upright position while the vehicle is in motion. The protection provided by the seat belts may be reduced significantly when the seatback is reclined. There is greater risk that the passenger will slide under the seat belt, resulting in serious injury, when the seatback is reclined.

⚠ CAUTION

- Make sure the seat is adjusted by an adult or with adult supervision for correct and safe operation.
- Do not place a cushion or the like between your back and the seatback while driving. The effectiveness of the head restraints will be reduced in the event of an accident.
- When sliding the seats, be careful not to catch your hand or foot.
- When sliding or reclining the seat rearward, pay careful attention to the rear seat passengers.

Front seat

E00400400012

To adjust forward or backward

E00400500505

Pull the seat adjusting lever and adjust the seat forward or backward to the desired position. After adjustment, release the adjusting lever to lock the seat in position.



⚠ WARNING

- To ensure the seat is locked securely, try to move the seat forward or backward without using the adjusting lever.

To recline the seatback

E00400600623

In order to recline the seatback, lean forward slightly, pull the seatback lock lever up, and then lean backward to the desired position and release the lever. The seatback will lock in that position.



⚠ CAUTION

- The reclining mechanism of the seatback is spring loaded, causing it to return to the vertical position when the lock lever is operated. When operating the lever, sit close to the seatback or hold it with your hand to control its return motion.

To adjust seat height*

E00400700578

Adjust the seat height by repeatedly operating the lever.

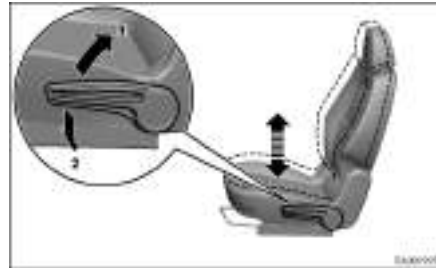

- 1- Raise
- 2- Lower

To get in and out of the rear seat (3-door models)

E00401000060

The lever (A) can be used to make getting in and out easier.

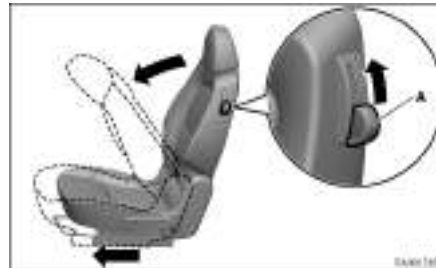

Fold the seatback forward, then slide the entire seat forward.

To return the seat, slide the entire seat rearward and then raise the seatback rearward to lock the seat in position.

⚠ WARNING

- Do not drive the vehicle with the seatback folded forward. The seat is not retained with the seatback in this position, so serious injuries could be suffered in the event of hard braking or a collision.

⚠ CAUTION

- The reclining mechanism of the seatback is spring loaded, causing it to return to the vertical position when the lock lever is operated. When operating the lever, sit close to the seatback or hold it with your hand to control its return motion.

Seat and seat belts

Heated seats*

E00401100625

The heated seats can be operated with the ignition switch in the “ON” position.

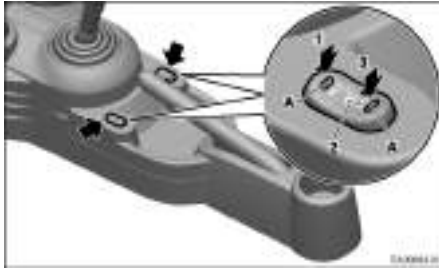

- 1- Heater high (for quick heating).
- 2- Heater off.
- 3- Heater low (to keep the seat warm).

The indication lamp (A) will illuminate while the heater is on.

⚠ CAUTION

- Operate in the high position for quick heating. Once the seat is warm, set the heater to low to keep it warm. Slight variations in seat temperature may be felt while using the heated seats. This is caused by the operation of the heater’s internal thermostat and does not indicate a malfunction.
- If the following types of persons use the heated seats, they might become too hot or receive minor burns (red skin, heat blisters, etc.):

⚠ CAUTION

- Children, elderly or ill people
 - People with sensitive skin
 - Excessively tired people
 - People under the influence of alcohol or sleep inducing medication (cold medicine, etc.)
- Do not use a blanket, cushion, or other material with high heat insulation properties on the seat while using the heater; this might cause the heater element to overheat.
 - Turn the heater off immediately if it appears to be malfunctioning during use.

NOTE

- Do not place heavy objects on the seat or stick pins, needles, or other pointed objects into it.
- When cleaning the seat, do not use benzene, kerosene, petrol, alcohol, or other organic solvents; these might damage the surface of the seat and also the heater element.
- If water or any other liquid is spilled on the seat, allow it to dry thoroughly before attempting to use the heater.

Head restraints

E00403301181

⚠ WARNING

- Driving without the head restraints in place can cause you and your passengers serious injury or death in an accident. To reduce the risk of injury in an accident, always make sure the head restraints are installed and properly positioned when the seat is occupied.
- Never place a cushion or similar device on the seatback. This can adversely affect head restraint performance by increasing the distance between your head and the restraint.
- When a person sits in the seating position of the rear seats, pull up the head restraint to a height at which it locks in position. Be sure to make this adjustment before starting to drive. Serious injuries could otherwise be suffered in the result of an impact.

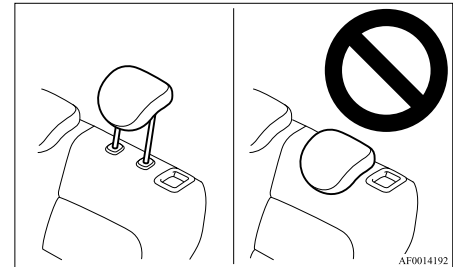

To adjust height

Adjust the head restraint height so that the centre of the restraint is as close as possible to eye level to reduce the chances of injury in the event of collision. Any person too tall for the restraint to reach their seated eye level, should adjust the restraint as high as possible.

To raise the head restraint, move it upward. To lower the restraint, move it downward while pushing the height adjusting knob (A) in the direction of the arrow. After adjustment, push the head restraint downward and make sure that it is locked.

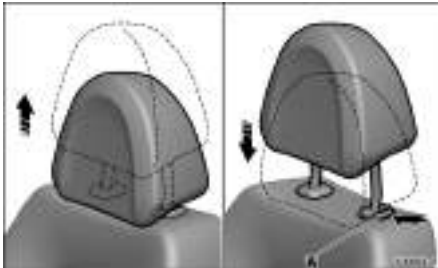

To remove

Lift the head restraint with the height adjusting knob (A) pushed in.

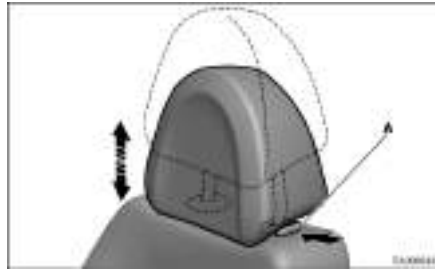

To install

Confirm that the head restraint is facing the correct direction, and then insert it into the seatback while pressing the height adjusting knob (A) in the direction indicated by the arrow.

⚠ CAUTION

- Confirm that the height adjusting knob (A) is correctly adjusted as shown in the illustration, and also lift the head restraints to ensure that they do not come out of the seatback.

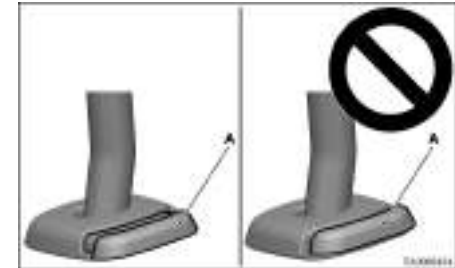

⚠ CAUTION

- The head restraints for the front and rear seats differ in size. When installing head restraints, make sure the front and rear head restraints are fitted in their respective seats. Failure to do so could cause serious injury if involved in an accident.

Making a luggage area

E00403400244

⚠ WARNING

- If required, always operate the seating before the vehicle is in motion.
- After seat operations are made, ensure the seating is locked in position by attempting to move the seat and seatback forward and rearward without using the adjusting mechanism.
- The luggage area in the rear of the vehicle should never be used as a play area by children. Children should be seated with seat belts fastened when the vehicle is in motion. Be sure that the rear seatbacks are returned to their fully upright position and locked in place.

⚠ CAUTION

- Do not stack luggage above the seatback height. Secure the luggage firmly. Otherwise, serious accidents could result due to restricted rear vision or unrestrained objects entering the passenger compartment during sudden braking.
- Make sure that the seat is operated by an adult. If it is operated by a child, an unexpected accident might occur.
- When folding the seat be sure not to catch your hand or leg.

Folding the seatback forward (5-door models except for vehicles with turbo-charger)

E00414500014

Front seat

To fold

Pull the seatback lock lever and fold the seatback forward until it is held securely.

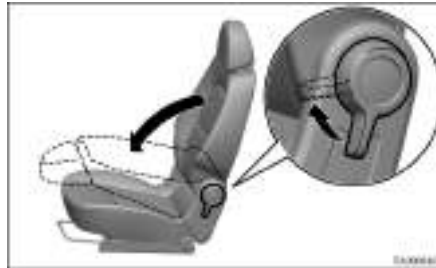

⚠ WARNING

- With the seatback folded forward, do not allow anyone to sit on that seat and do not allow a child to play on it. Otherwise, any sudden braking could result in serious injuries.

To replace

1. Pull the seatback lock lever and raise the seatback until it locks securely into place.
2. Push lightly on the seatback to confirm that it has actually been secured.

Folding the rear seat

E00403700335

To create luggage space, you can fold the rear seat.

NOTE

- Each side of the rear seat can be folded independently of the other.

To fold

1. Move the front seat to a position forward of the middle of its fore-aft adjustment range. (Refer to “To adjust forward or backward” on page 2-04.)
2. Place each rear seat head restraint in its lowest position. (Refer to “Head restraints” on page 2-06.)
3. Pull the strap (A) on the rear of the cushion to flip the cushion forward. Ensure the cushion is in the front most position until it touches the floor.

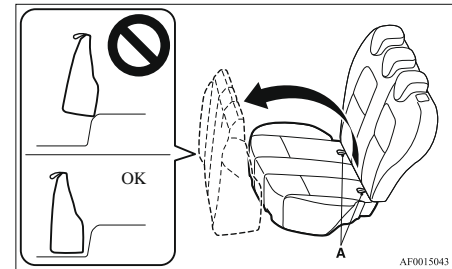

4. Pull the seatback lock lever (B) and fold the seatback forward.

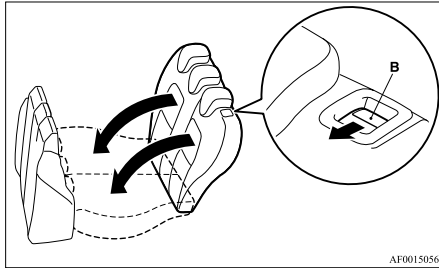

AF0015056

CAUTION

- Do not allow any person to sit on the folded seat, and do not place luggage on the seat cushion. The seat's mounting fittings could bend under the weight, making it impossible for the seat to be retained on the vehicle.
- Do not put rubbish or other foreign matter on the floor. Doing so could make it impossible for the seat to be retained on the floor.
- When allowing anyone to sit on the rear seat with the other part of the seatback folded forward, always turn the seat cushion up as well.
Not doing so may cause a risk of injury while driving or in case of an accident.



AF0015434

To return

1. Raise the seatback until it locks. Next, push lightly on the seat to confirm that it has been securely retained.

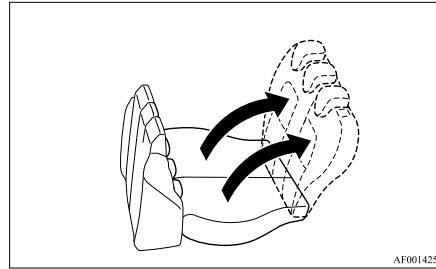

AF0014251

WARNING

- When raising the seatback to its original position, do not pinch the seat belt between the seatback and the latch. Damage to the seat belt could reduce the effectiveness of the belt and could result in serious injury in the event of a collision.

2. Lift up the center buckle and pull it through the seat cushion while pushing the rear of the seat cushion under the seatback.
3. Push down on the front of the seat cushion until it locks securely in place. Next, push and pull lightly on the seat to confirm that it has been securely retained.

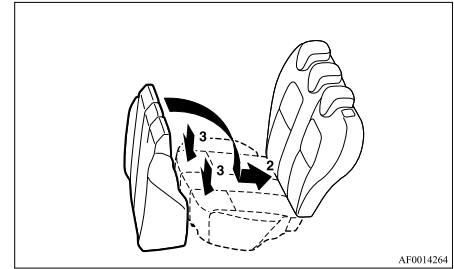

AF0014264

Seat belts

E00404800607

To protect you and your passengers in the event of an accident, it is the most important that the seat belts be worn correctly when you drive.

The front seat belts have a pretensioner system. These belts are used the same way as a conventional seat belt.

Refer to “Seat belt pretensioner system and force limiter system” on page 2-13.

2

⚠ WARNING

- Always place the shoulder belt over your shoulder and across your chest. Never put it behind you or under your arm.
- One seat belt should be used by only one person. Doing otherwise can be dangerous.
- The seat belt will provide its wearer with maximum protection if the recliner seatback is placed in fully upright position. When the seatback is reclined, there is greater risk that the passenger will slide under the belt, especially in a forward impact accident, and may be injured by the belt or by striking the instrument panel or seatbacks.
- Seat belts should always be worn by every adult who drives or rides in this vehicle, and by all children who are tall enough to wear seat belts properly.
- Remove any twists when using the belt.
- No modifications or additions should be made by the user which will either prevent the seat belt adjusting devices from operating to remove slack, or prevent the seat belt assembly from being adjusted to remove slack.

⚠ WARNING

- To reduce risk of serious or fatal injury in an accident, including the deploying driver airbag, the driver should adjust the driver’s seat to the rear most position that still allows good visibility and good control of the steering wheel, the brake and accelerator, and vehicle controls.
- Never hold a child in your arms or on your lap when riding in this vehicle, even if you are wearing your seat belt. To do so risks severe or fatal injury to your child in a collision or sudden stop.
- Always adjust the belt to a snug fit.



3-point type seat belt (with emergency locking mechanism)

E00404901302

This type of belt requires no length adjustment. Once worn, the belt adjusts itself to the movement of the wearer, but in the event of a sudden or strong shock, the belt automatically locks to hold the wearer’s body.

NOTE

- You can check if the belt locks by pulling it forward quickly.

To fasten

1. Pull the seat belt out slowly while holding the latch plate.

NOTE

- When the seat belts cannot be pulled out in a locked condition, pull the belts once forcefully and then return them. After that, pull the belts out slowly once again.
2. Insert the latch plate into the buckle until a “click” is heard.

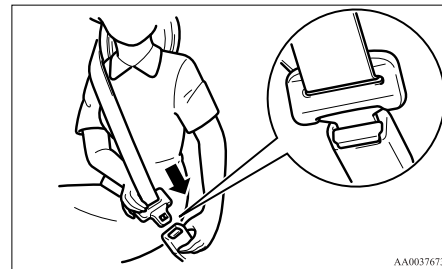

⚠ CAUTION

- Never wear the lap portion of the belt across your abdomen. During accidents it can press sharply against the abdomen and increase the risk of injury.

CAUTION

- The seat belts must not be twisted when worn.

3. Pull the belt slightly to adjust slackness as desired.

To unfasten

Hold the latch plate and push the button on the buckle.

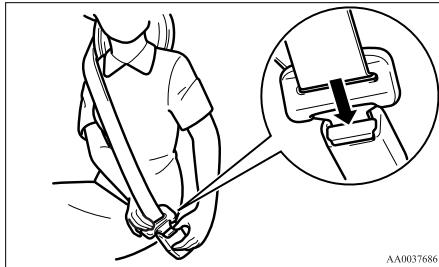
**NOTE**

- As the belt retracts automatically, keep holding the latch plate while retracting so that the belt stows slowly. Failure to do this could damage the vehicle.

Seat belt reminder/warning lamp

E00409800497

A tone and warning lamp are used to remind the driver and front passenger to fasten the seat belt.

NOTE

- For the front passenger seat, the warning function works only while a person is sitting on the seat.

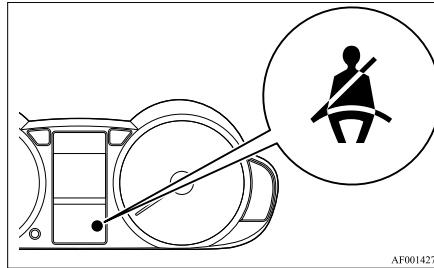

When the ignition key is turned to the “ON” position, the warning lamp will come on and a tone will sound for about 6 seconds. If the front seat belt remains unfastened approximately 1 minute later, the warning lamp will flash and the tone sound intermittently (each 12 times) when the vehicle is driven. If the passenger subsequently unfastens the seat belt while driving, the warning lamp and tone will issue further warnings. And if the seat belt remains unfastened, the warning lamp and tone will issue further warnings each time the vehicle starts moving from a stop. When the seat belt is fastened, the warnings will stop.

WARNING

- In order to reduce the risk of serious or fatal injury in an accident, always wear your own seat belt. Do not allow anyone to ride in your vehicle unless he or she is also seated and wearing a seat belt. Children should additionally be restrained in a secure child restraint system.

NOTE

- When luggage is placed on the front passenger seat, a sensor in the seat cushion may, depending on the weight and position of the luggage, cause the warning tone to sound and the warning lamp to come on.

Adjustable seat belt anchor (front seats)

E00405000055

The seat belt anchor height can be adjusted. Move the seat belt anchor down with the lock knob (A) depressed. To move the anchor up, slide it without depressing the lock knob (A).

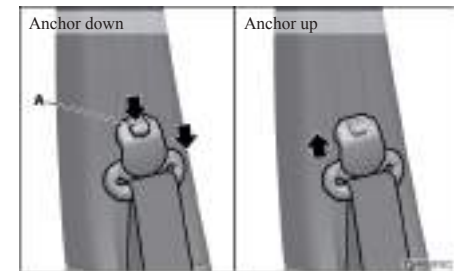

Seat and seat belts

⚠ CAUTION

- When adjusting the seat belt anchor, set it at a position that is sufficiently high so that the belt will make full contact with your shoulder but will not touch your neck.

Rear seat belt storage

E00405300380

When seat belt is not use, fold down or raise the rear seatback, storage the rear seat belt to the holder.

Seat belt plate storage

After passing the belt through the rear notch (A), insert the plate into the front notch (B).

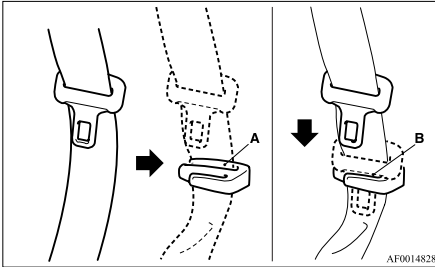

⚠ WARNING

- Secure the seat belt using the seat belt holder. If the seat belt is not secured, it could be pinched between the seatback and the latch when the seatback is raised to its original position. Damage to the seat belt could reduce the effectiveness of the belt and could result in serious injury in the event of a collision.

Pregnant women restraint

E00405600136

⚠ WARNING

- Seat belts work for everyone, including pregnant women. Pregnant women should use the available seat belts. This will reduce the likelihood of injury to both the woman and the unborn child. The lap belt should be worn across the thighs and as snug against the hips as possible, but not across the waist. Consult your doctor if you have any additional questions or concerns.

Seat belt pretensioner system and force limiter system

E0040570010

The driver's seat and front passenger's seat each have a seat belt equipped with a pretensioner system.

Pretensioner system

E00405801151

The pretensioner system will retract their respective seat belts instantaneously, thus maximizing the seat belt's effectiveness, if there is a frontal impact severe enough to injure the driver and/or front passenger and the ignition switch is in the "ON" or "START" position.

WARNING

- To obtain the best results from your pretensioner seat belt, make sure you do the following:
 - Adjust the seat to the proper position. Refer to "Front seat" on page 2-04.
 - Fasten your seat belt properly. Refer to "Seat belts" on page 2-10.

CAUTION

- Installation of audio equipment or repairs in the vicinity of the pretensioner seat belts or floor console must be performed in line with MITSUBISHI MOTORS guidelines. It is important to do so because the work could affect the pretensioner systems.

CAUTION

- If you need to scrap the vehicle, please consult a MITSUBISHI MOTORS Authorized Service Point. It is important to do so because unexpected activation of the pretensioner seat belts could cause injuries.

NOTE

- The pretensioner seat belts will be activated if the vehicle suffers a severe frontal impact, even if the seat belts are not worn.
- The pretensioner seat belts are designed to work only once. After the pretensioner seat belts have been activated, we recommend you have them replaced by a MITSUBISHI MOTORS Authorized Service Point.

SRS warning lamp

E00405900038

This warning lamp is shared by the SRS airbags and the pretensioner seat belts. Refer to "SRS warning lamp" on page 2-33.

Force limiter system

E00406000049

In the event of a collision, each force limiter system will effectively absorb the load applied to the seat belt so as to minimize the impact to the passenger.

Child restraint

E00406401473

When transporting children in your vehicle, some type of child restraint system should always be used according to the size of the child. This is required by law in most countries.

The regulations concerning driving with children in the front seat may differ from country to country. You are advised to comply with the relevant regulations.

WARNING

- When possible, put children in the rear seat. Accident statistics indicate that children of all sizes and ages are safer when properly restrained in the rear seat rather than in the front seat.
- Holding a child in your arms is no substitute for a restraint system. Failure to use a proper restraint system can result in severe or fatal injury to your child.
- Each child restraint device or fixing is to be used only by one child.
- When attaching a child restraint to the rear seat, place the front seatbacks in the upright position. Otherwise, the child could be seriously injured in the event of hard braking or a collision.

Seat and seat belts

Caution for installing the child restraint on vehicle with front passenger airbag

The label shown here is attached on vehicles with front passenger airbag.

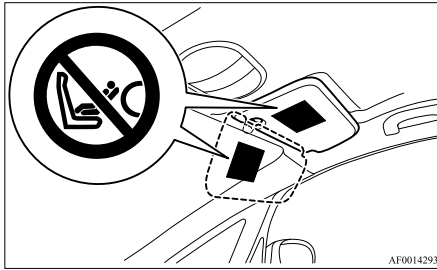

⚠ WARNING

- **Extreme Hazard!**
Do not use a rearward facing child restraint on a seat protected by an airbag in front of it!
- A REARWARD FACING CHILD RESTRAINT must NOT be used in the front passenger seat if the front passenger's airbag has not been deactivated. The force of an inflating airbag could kill or cause serious injuries to the child. A rearward facing child restraint should be used in the rear seat.

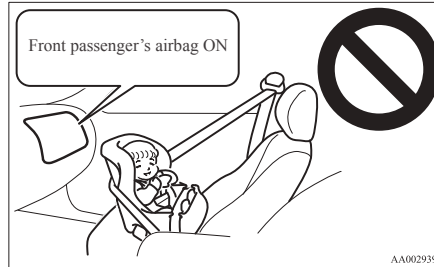

NOTE

- If you have a rearward facing child restraint system that cannot be fitted to any seat other than the front passenger seat, be sure to turn OFF the front passenger's airbag ON-OFF switch before using it. (Refer to "To turn an airbag off" on page 2-26.)



⚠ WARNING

- A FORWARD FACING CHILD RESTRAINT should be used in the rear seat whenever possible; if used in the front seat, adjust the seat to the most rearward position and turn off the front passenger's airbag ON-OFF switch.



Infants and small children

E00406600814

When transporting infants and small children in your vehicle, follow the instruction given below.

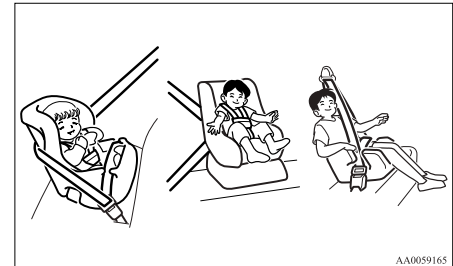

Instruction:

- For small infants, an infant carrier should be used. For small children whose height when seated allows the shoulder belt to lie in contact with the face or the throat, a child seat should be used.
- The child restraint system should be appropriate for the child's weight and height and properly fit in the vehicle. For a higher degree of safety: THE CHILD RESTRAINT SYSTEM SHOULD BE INSTALLED IN THE REAR SEAT.
- Before purchasing a child restraint system, try installing it in the rear seat to make sure there is a good fit. Because of the location of the seat belt buckles and the shape of the seat cushion, it may be difficult to securely install some manufacturer's child restraint systems. If the child restraint system can be pulled forward or to either side easily on the seat cushion after the seat belt has been tightened, choose another manufacturer's child restraint system.

⚠ WARNING

- When installing a child restraint system, refer to the instructions provided by the manufacturer of the restraint system. Failure to do so can result in severe or fatal injury to your child.
- After installation, push and pull the child restraint system back and forth, and side to side, to see that it is positively secured. If the child restraint system is not installed securely, it may cause injury to the child or other occupants in the case of accident or sudden stops.

⚠ WARNING

- When the child restraint system is not in use, keep your child or infant seat secured with the seat belt or remove it from the vehicle in order to prevent injury to your child.

NOTE

- Depending on the seating position in the vehicle and the child restraint system that you have, the child restraint can be attached using one of the following two locations:
 - To the lower anchorage in the rear seat ONLY if the child restraint has ISOFIX mountings (See page 2-20).
 - To the seat belt (See page 2-21).

Older children

E00406700248

Children who have outgrown the child restraint system should be seated in the rear seat and wear combination lap shoulder belt.

The lap portion of the belt should be snug and positioned low on the abdomen so that it is below the top of the hip-bone. Otherwise, the belt could intrude into the child's abdomen during an accident and cause injury.

⚠ CAUTION

- Children who are not buckled up can be thrown out of the vehicle in an accident.
- Children who are not buckled up can strike other people in the vehicle in an accident.

⚠ CAUTION

- A child should never be left unattended in your vehicle. When you leave the vehicle, take the child with you.

Suitability for various ISOFIX positions

E00411400331

Mass group	Size class	Fixture	Vehicle ISOFIX positions
			Second outboard
Carycot	F	ISO/L1	X
	G	ISO/L2	X
			X
0 - Up to 10 kg	E	ISO/R1	X
			X
0+ - Up to 13 kg	E	ISO/R1	X
	D	ISO/R2	X
	C	ISO/R3	X
			X
I - 9 to 18 kg	D	ISO/R2	X
	C	ISO/R3	X
	B	ISO/F2	IUF
	B1	ISO/F2X	IUF, IL* ¹
	A	ISO/F3	IUF
			X
II - 15 to 25 kg			X
III - 22 to 36 kg			X

Key of letters to be inserted in the table above:

- IUF- Suitable for ISOFIX forward child restraints systems of universal category approved for use in the mass group.
- IL- Suitable for particular ISOFIX child restraint systems given in the following list (MITSUBISHI MOTORS genuine parts).
- X- ISOFIX position not suitable for ISOFIX child restraint systems in this mass group and/or this size class.

IL (Genuine part information)

	Genuine part No.	ECE No.
*1	MZ313200	E1-04301133

NOTE

- MITSUBISHI MOTORS Europe B.V. reserves the right to changes without any prior announcement.
For further information, please contact a MITSUBISHI MOTORS Authorized Service Point.

Suitability for various seating positions

Mass group	Seating position				
	Front passenger		Rear outboard		Rear centre
	Activated airbag	Deactivated airbag*1	3-door models	5-door models	
0 - Up to 10 kg (0-9 months)	X	U	U	U	X
0+ - Up to 13 kg (0-2 years)	X	U, L*2, L*3	U, L*2, L*3	U, L*2, L*3	X
I - 9 to 18 kg (9 months-4 years)	X	U, L*4, L*5, L*6	U, L*4, L*5, L*6	U, L*4, L*5, L*6	X
II & III - 15 to 36 kg (4-12 years)	X	U, L*7	U	U, L*7	X

*1: With front passenger's airbag deactivated by means of front passenger's airbag ON-OFF switch.

Key of letters to be inserted in the table above:

- U- Suitable for "universal" category restraints approved for use in this mass group.
- L- Suitable for particular child restraints in the following list (MITSUBISHI MOTORS genuine parts).
- X- Seat position not suitable for children in this mass group.

L (Genuine part information)

	Genuine parts No.	ECE No.
*2	MZ312807	E1-04301146
*3	MZ314393	
*4	MZ313045	E1-04301133
*5	MZ313200	
*6	MZ314451	E1-04301203
*7	MZ314250	E1-04301169

NOTE

- The suitability table above applies to retention of child restraints using seat belts.
- When MITSUBISHI MOTORS genuine part No. MZ313200 is used on the rear seat, it can also be retained by means of ISOFIX child restraint mountings.
- There is no applicable MITSUBISHI MOTORS Genuine Parts to the Mass Group “0-Up to 10 kg (0-9 months)”.

MITSUBISHI MOTORS Europe B.V. reserves the right to changes without any prior announcement.
For further information, please contact a MITSUBISHI MOTORS Authorized Service Point.

Seat and seat belts

Installing a child restraint system to the lower anchorage (ISOFIX child restraint mountings) and tether anchorage

E00408900462

Lower anchorage location

Your vehicle's rear seat is fitted with lower anchorages for attaching a child restraint system with ISOFIX mountings.

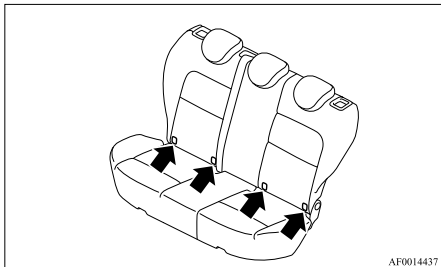

Tether anchorage locations

There are 2 child restraint anchorage points located on the back of the rear seatbacks. These are for fastening the child restraint tether straps to the 2 rear seat seating positions.

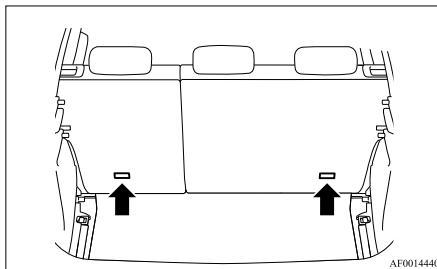

⚠ WARNING

- Child restraint anchorages are designed to withstand only those loads imposed by correctly fitted child restraints. Under no circumstances are they to be used for adult seat belts, or harnesses, or for attaching other items or equipment to the vehicle.

Child restraint system with ISOFIX mountings

E00409000529

The child restraint system is designed only for seats that incorporate lower anchorages. Retain the child restraint system using the lower anchorages.

It is not necessary to retain the child restraint system using the vehicle's seat belts. Only a MITSUBISHI MOTORS genuine child restraint system can be used.

Genuine parts No.:MZ313200
ECE No.:E1-04301133

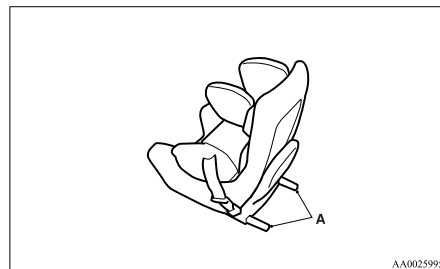

A- Child restraint system connectors

⚠ WARNING

- If a child restraint system other than a MITSUBISHI MOTORS genuine one is used, it may not be properly retained and the child could be seriously injured as a result. Use only a MITSUBISHI MOTORS genuine child restraint system.

To install

1. Insert the child restraint system's connectors (A) into the slit (B) in accordance with the instructions provided by the child restraint system's manufacturer.

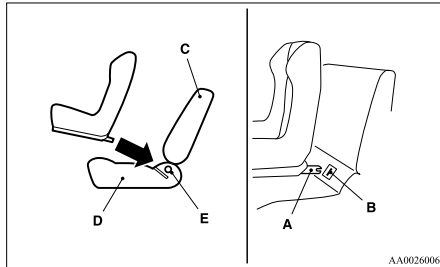

- A- Connector
- B- Slit
- C- Vehicle seatback
- D- Vehicle seat cushion
- E- Lower anchorage

2. Remove the head restraint from the location in which you wish to install a child restraint.

3. Latch the tether strap hook (F) of the child seat to the tether anchorage bar (G) and tighten the top tether strap hook so it is securely fastened.

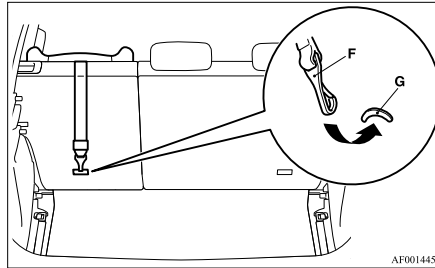

4. Push and pull the child restraint system in all directions to be sure it is firmly secured.

WARNING

- If there is any foreign material in or around the connectors, remove it before installing the child restraint system. Also, make sure the seat belt is away from, not looped through or otherwise interfering with, the child restraint system. If foreign matter is not removed and/or the seat belt interferes with the child restraint system, the child restraint system will not be secured properly and could move forward in the event of sudden braking or a collision, seriously injuring the child and possibly other vehicle occupants.

WARNING

- When the vehicle is moving do not adjust the seat where the child restraint system is installed.

To remove

Remove the child restraint in accordance with the instructions provided by the child restraint system's manufacturer.

Installing a child restraint system to a 3-point type seat belt (with emergency locking mechanism)

E00408700529

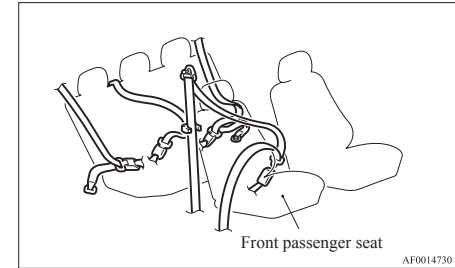

Installation:

1. Fasten the seat belt to secure the child restraint system.
Make sure you hear a "click" when you insert the latch plate into the buckle.
2. Remove all slack by using the locking clip.
3. Push and pull the child restraint in all directions to be sure it is secure.

⚠ CAUTION

- For some types of child restraint, the locking clip (A) should be used to help avoid personal injury during a collision or sudden manoeuvre.

It must be fitted and used in accordance with the child restraint manufacturer's instructions.

The locking clip must be removed when the child restraint is removed.

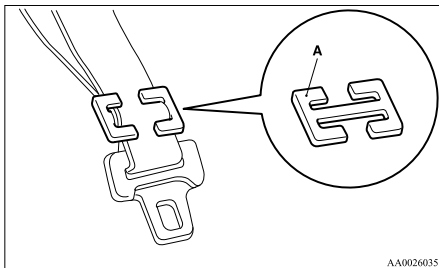

AA0026035

Seat belt inspection

E00406300563

- Check the belts for cuts, worn or frayed webbing and for cracked or deformed metallic parts. Replace the belt assembly if defective.
- A dirty belt should be cleaned with neutral detergent in warm water. After rinsing in water, let it dry in the shade. Do not attempt to bleach or re-dye the belts because this affects their characteristics.

⚠ WARNING

- We recommend you have all seat belt assemblies including retractors and attaching hardware inspected after any collision. We recommend that seat belt assemblies in use during a collision be replaced unless the collision was minor and the belts show no damage and continue to operate properly.
- Do not attempt to repair or replace any part of the seat belt assemblies; we recommend you to have this work done by a MITSUBISHI MOTORS Authorized Service Point. Incorrect repair or replacement could reduce the effectiveness of the belts and could result in serious injury in the event of a collision.
- Once the pretensioner has activated, it cannot be re-used. It must be replaced together with the retractor.

Supplemental restraint system (SRS) - airbag

E00407201670

The information written in this Supplemental Restraint System (SRS) section contains important points concerning the driver, front passenger, side and curtain airbags.

The SRS driver and front passenger airbags are designed to supplement the primary protection of the driver and front passenger side seat belt systems by providing those occupants with protection against head and chest injuries in certain moderate-to-severe frontal collisions.

The SRS side airbags (if so equipped) are designed to supplement the seat belts and provide the driver and front passenger with protection against chest and abdomen injuries in certain moderate-to-severe side impact collisions.

The SRS curtain airbags (if so equipped) are designed to supplement the seat belts and provide the driver and passenger with protection against head injuries in certain moderate-to-severe side impact collisions.

The SRS is NOT a substitute for the seat belts; for maximum protection in all types of crashes and accidents, seat belts should ALWAYS be worn by everyone who drives or rides in this vehicle. (With infants and small children in child restraints and older children buckled in the rear seat.)

⚠ WARNING

- **IT IS VERY IMPORTANT TO ALWAYS PROPERLY WEAR YOUR SEAT BELT, EVEN WITH AN AIRBAG:**
 - Seat belts help keep the driver and passenger properly positioned, which reduces injury risk in all collisions, and reduces the risk of serious or fatal injuries when the airbags inflate. During sudden braking just before a collision, an unrestrained or improperly restrained driver or passenger can move forward into direct contact with or within close proximity to the airbag which may then deploy during the collision. The initial stage of airbag inflation is the most forceful which could cause serious or fatal injuries if the occupant contacts it at this stage.
 - Seat belts reduce the risk of injury in roll-overs, rear impact collisions, and in lower-speed frontal collisions, because driver's and passenger's airbags are not designed to inflate in those situations.
 - Seat belts reduce the risk of being thrown from your vehicle in a collision or roll-over.
- **IT IS VERY IMPORTANT TO BE PROPERLY SEATED.** A driver or front passenger too close to the steering wheel or instrument panel during airbag deployment can be killed or seriously injured. Airbags inflate very fast, and with great force.

⚠ WARNING

If the driver and front passenger are not properly seated and restrained, the airbags may not protect you properly, and could cause serious or fatal injuries when it inflates.

- Before driving, adjust the driver's seat as far back as possible while still maintaining complete control of the vehicle.
- Before driving, adjust the front passenger seat as far back as possible.
- Make sure all vehicle occupants are always properly restrained using the available seat belts.
- With seat belts properly fastened, the driver and passenger should sit well back and upright without leaning against the window or door.
- Do not sit on the edge of the seat, or lean head or chest close to the steering wheel or instrument panel. Do not put feet or legs on or against the instrument panel.
- Place all infants and small children in the rear seat and properly restrained using an appropriate child restraint system. The rear seat is the safest for infants and children.

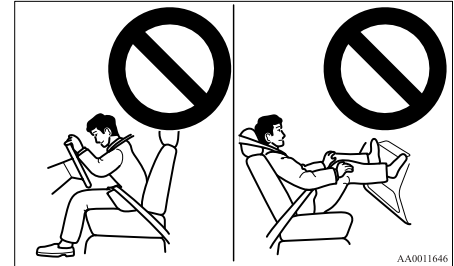

⚠ WARNING

- Infants and small children should never be unrestrained, stand up against the instrument panel or held in your arms or on your lap. They could be seriously injured or killed in a collision, including when the airbag inflates. They should be properly seated in the rear seat in an appropriate child restraint system. See the "Child restraint" section in this owner's manual.

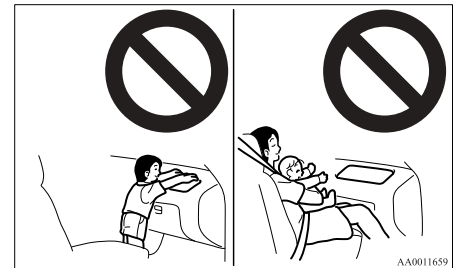

Seat and seat belts

⚠ WARNING

- A **REARWARD FACING CHILD RESTRAINT** must **NOT** be used in the front passenger seat if the front passenger's airbag has not been deactivated. The force of an inflating airbag could kill or cause serious injuries to the child. A rearward facing child restraint should be used in the rear seat.



NOTE

- If you have a rearward facing child restraint system that cannot be fitted to any seat other than the front passenger seat, be sure to turn **OFF** the front passenger's airbag ON-OFF switch before using it. (Refer to "To turn an airbag off" on page 2-26.)

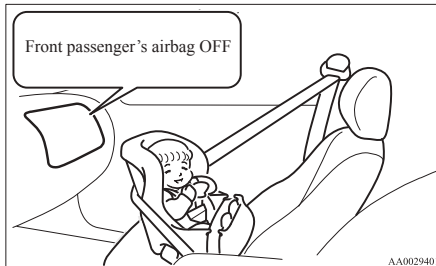

⚠ WARNING

- A **FORWARD FACING CHILD RESTRAINT** should be used in the rear seat whenever possible; if it must be used in the front passenger seat, adjust the seat to the most rearward position and turn off the front passenger's airbag ON-OFF switch. Failure to do so could kill or cause serious injuries to the child.



⚠ WARNING

- Older children should be seated in the rear seat, properly wearing the seat belt, with an appropriate booster seat if needed.

Caution for installing the child restraint on vehicle with front passenger airbag

The label shown here is attached on vehicles with front passenger airbag.

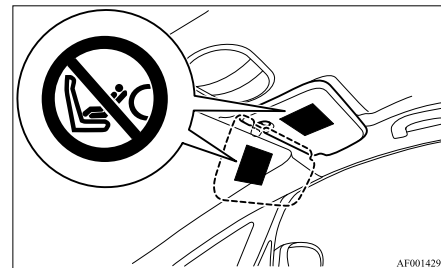

⚠ WARNING

- **Extreme Hazard!**
Do not use a rearward facing child restraint on a seat protected by an airbag in front of it!

How the Supplemental Restraint System works

E00407301583

The SRS includes the following components:

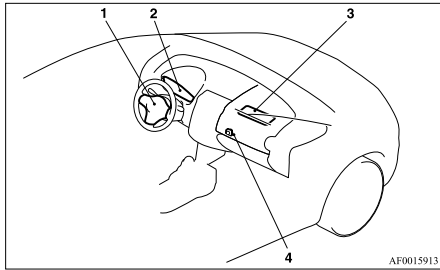

- 1- Airbag module (Driver)
- 2- Front passenger's airbag OFF indication lamp
- 3- Airbag module (Passenger)
- 4- Front passenger's airbag ON-OFF switch

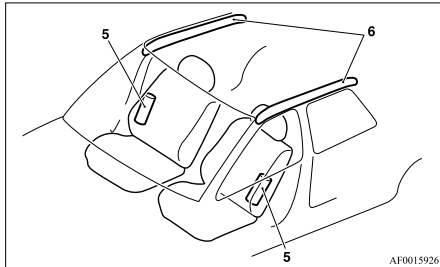

- 5- Side airbag modules*
- 6- Curtain airbag modules*

The airbags will operate only when the ignition switch is in the "ON" or "START" position.

The airbags deployment produces a sudden, loud noise, and releases some smoke and powder, but these conditions are not injurious, and do not indicate a fire in the vehicle. People with respiratory problems may feel some temporary irritation from chemicals used to produce the deployment; open the windows after airbag deployment, if safe to do so.

The airbags deflate very rapidly after deployment, so there is little danger of obscured vision.

CAUTION

- Airbags inflate at an extremely rapid speed. In certain situations, contact with inflating airbags can result in abrasions, light cuts, bruises, and the like.

Front passenger's airbag ON-OFF switch

E00410100197

The front passenger's airbag ON-OFF switch can be used to disable the front passenger's airbag. If you have a child restraint system that cannot be fitted to any seat other than the front passenger seat, be sure to turn OFF the front passenger's airbag ON-OFF switch before using it. (Refer to "To turn an airbag off" on page 2-26.)

The front passenger's airbag ON-OFF switch is located in the glove box.

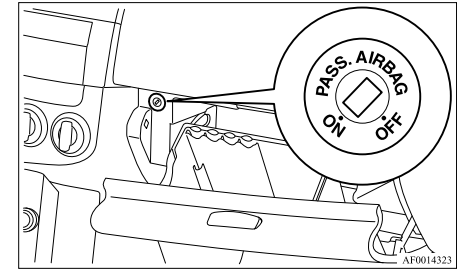

Front passenger's airbag OFF indication lamp

E00411500101

The front passenger's airbag OFF indication lamp is located in the meter.

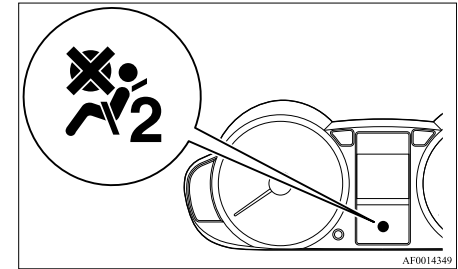

The indication lamp normally comes on when the ignition switch is turned to the "ON" position, and goes off a few seconds later.

Seat and seat belts

When the front passenger's airbag ON-OFF switch is turned OFF, the indication lamp will stay on to show that the passenger front airbag is not operational.

When the front passenger's airbag ON-OFF switch is turned ON, the indication lamp goes off to show that the front passenger's airbag is operational.

To turn an airbag off

E00410600235

A WARNING

- To reduce risk of serious or fatal injury:
 - Always remove the key from the ignition switch before operating a front passenger's airbag ON-OFF switch. Failure to do so could adversely affect the airbag performance.
 - Wait at least 60 seconds to operate the front passenger's airbag ON-OFF switch after turning the ignition switch from "ON" position to "LOCK" position.
- The SRS airbag system is designed to retain enough voltage to deploy the airbag.
- Always remove the key from a front passenger's airbag ON-OFF switch after operating that switch. Failure to do so could lead to improper position of the front passenger's airbag ON-OFF switch.
 - Do not turn OFF the front passenger's airbag ON-OFF switch except when a child restraint system is fitted to the front passenger seat.

A WARNING

- Turn ON the front passenger's airbag ON-OFF switch immediately after removing a child restraint system from the passenger seat.
- If the indication lamp does not come on when the front passenger's airbag ON-OFF switch is turned OFF, do not fit a child restraint system to the front passenger seat. We recommend you to have the system inspected by a MITSUBISHI MOTORS Authorized Service Point.
- If the indication lamp remains on when the front passenger's airbag ON-OFF switch is turned ON, do not allow anyone to sit on the front passenger seat. We recommend you to have the system inspected by a MITSUBISHI MOTORS Authorized Service Point.

To turn an airbag off, follow these steps:

1. Insert the key into the key opening of the front passenger's airbag ON-OFF switch, push the key inwards until stopped by a touch and then turn the key from "ON" to "OFF" position (anticlockwise).
2. Remove the key from the key opening of that the front passenger's airbag ON-OFF switch.

3. Insert the key into the ignition switch, and turn the ignition to "ON" position. The front passenger's airbag OFF indication lamp will stay on.

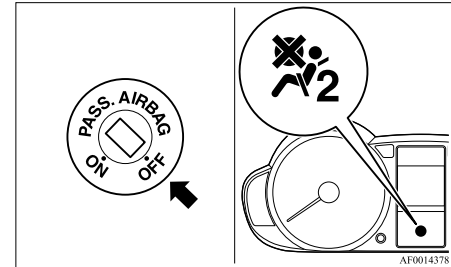

The front passenger's airbag is now deactivated and will not deploy until switched on again.

Driver's and passenger's front airbag system

E00407400213

The driver's airbag is located under the padded cover in the middle of the steering wheel. The front passenger's airbag is contained in the instrument panel above the glove box.

The driver's airbag and the front passenger's airbag are designed to inflate at the same time even if the passenger seat is not occupied.

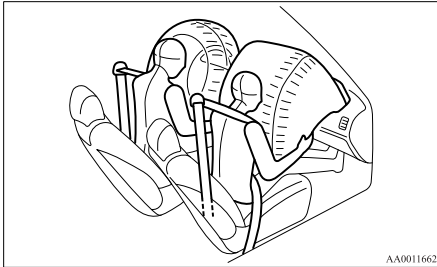

AA0011662

Deployment of front airbags

The front airbags ARE DESIGNED TO DEPLOY when...

E00407501367

Head-on collision with a solid wall at speed of approximately 25 km/h (16 mph) or higher

Moderate to severe frontal impact within the shaded area between the arrows

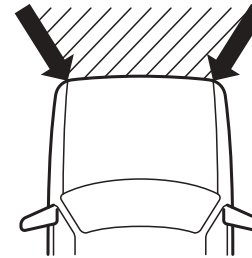
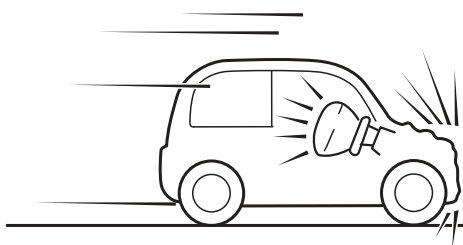

AA1001637

Seat and seat belts

The front airbags are designed to deploy when the vehicle suffers a moderate to severe frontal impact. A typical condition is shown in the illustration.

The front airbags will deploy if the severity of impact is above the designed threshold level, comparable to an approximately 25 km/h (16 mph) collision when impacting straight into a solid wall that does not move or deform. If the severity of the impact is below the above threshold level, the front airbags may not deploy. However, this threshold speed will be considerably higher if the vehicle strikes an object that absorbs the impact by either deforming or moving (for example, another stationary vehicle, pole or a guard rail).

Because frontal collisions can easily move you out of position, it is important to always properly wear your seat belts. Your seat belts will help keep you in a safe distance from the steering wheel and instrument panel during the initial stages of airbag deployment. The initial stage of airbag inflation is the most forceful, and can possibly cause serious or fatal injuries. Moreover, the seat belts in your vehicle are your primary means of protection in a collision. The SRS airbags are designed to provide additional protection. Therefore, for your safety and the safety of all occupants, be sure to always properly wear your seat belts.

The front airbags MAY NOT DEPLOY when...

With certain types of frontal collisions, the vehicle's body structure is designed to absorb the shock to help protect the occupants from harm. (The vehicle body's front area may deform significantly as it absorbs the impact.) Under such circumstances, the front airbags may not deploy irrespective of the deformation and damage to the vehicle body.

Examples of some typical conditions are shown in the illustration.

Because the front airbags do not protect the occupant in all types of frontal collisions, be sure to always properly wear your seat belts.

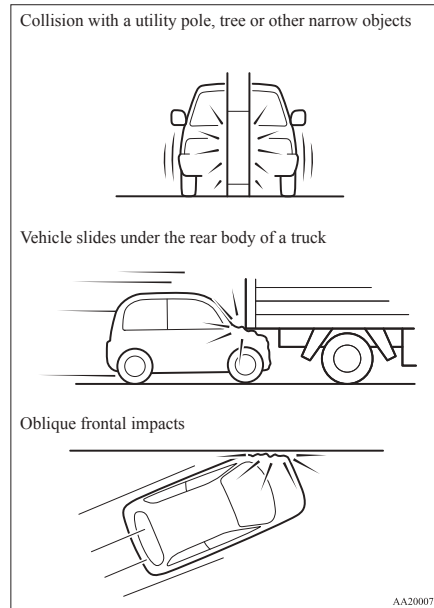

The front airbags ARE NOT DESIGNED TO DEPLOY when...

The front airbags are not designed to deploy in conditions where they cannot typically provide protection to the occupant. Such conditions are shown in the illustration.

Because the front airbags do not protect the occupant in all types of collisions, be sure to always properly wear your seat belts.

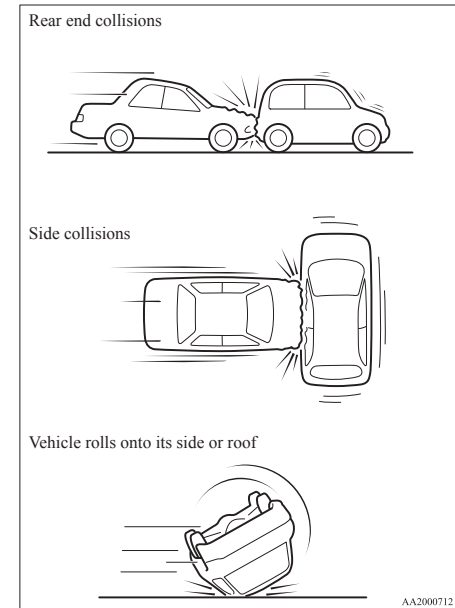

The front airbags MAY DEPLOY when...

The front airbags may deploy if the bottom of the vehicle suffers a moderate-to-severe impact (undercarriage damage).

Examples of some typical conditions are shown in the illustration.

Because the front airbags may deploy in certain types of unexpected impacts as shown in the illustration that can easily move you out of position, it is important to always properly wear your seat belts. Your seat belts will help keep you a safe distance from the steering wheel and instrument panel during the initial stages of airbag deployment. The initial stage of airbag inflation is the most forceful and can possibly cause serious or fatal injuries if you contact it at this stage.

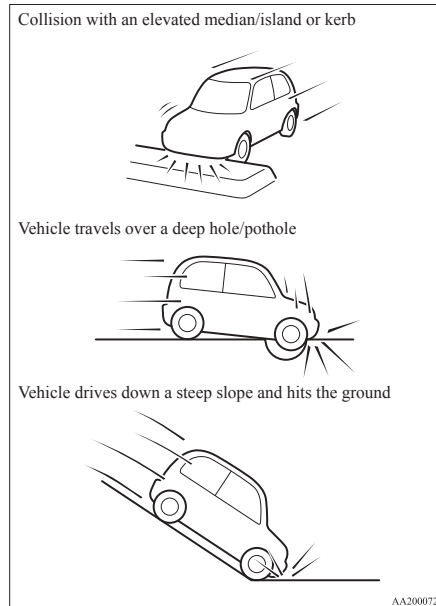

⚠ WARNING

- Do not attach anything to the steering wheel padded cover, such as trim material, badges, etc. It might strike and injure an occupant if the airbag inflates.
- Do not set anything on, or attach anything to, the instrument panel above the glove box. It might strike and injure an occupant if the airbag inflates.

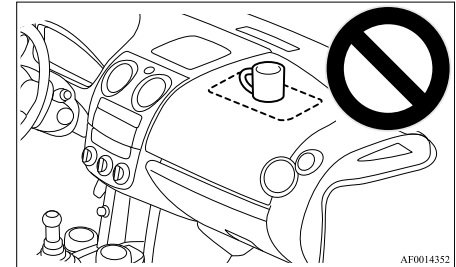

⚠ WARNING

- Do not attach accessories to, or put them in front of, the windscreen. These objects could restrict the airbag inflation, or strike and injure an occupant if the airbags inflate.
- Do not put packages, pets or other objects between the airbags and the driver or front passenger. It could affect airbag performance, or could cause injury when the airbag inflates.

Seat and seat belts

⚠ WARNING

- Right after the airbag inflation, several airbag system components will be hot. Do not touch them; you could be burned.
- The airbag system is designed to work only once. Once the airbags have deployed, they will not work again. They must promptly be replaced, and we recommend you to have the entire airbag system inspected by a MITSUBISHI MOTORS Authorized Service Point.

Side airbag system*

E00407600084

The side airbags (A) are contained in the driver and front passenger seatbacks.

The side airbag is designed to inflate only on the side of the vehicle that is impacted, even with no passenger in the front seat.

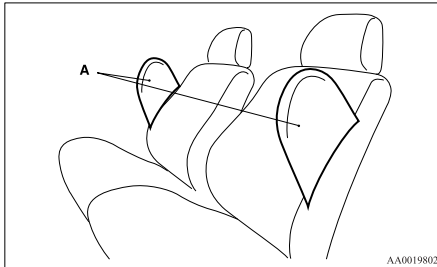

The label shown here is attached to the seatbacks with a side airbag.



Curtain airbag system*

E00409100067

The curtain airbags are contained in the front and rear pillars and roof side rail. The curtain airbag is designed to inflate only on the side of the vehicle that is impacted, even with no passenger in the front seat or rear seat.

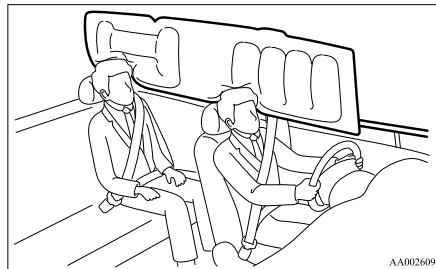

Deployment of side airbags and curtain airbags

E00407701024

The side airbags and curtain airbags ARE DESIGNED TO DEPLOY when...

The side airbags and curtain airbags are designed to deploy when the vehicle suffers a moderate-to-severe side impact to the middle of the passenger compartment.

The typical condition is shown in the illustration.

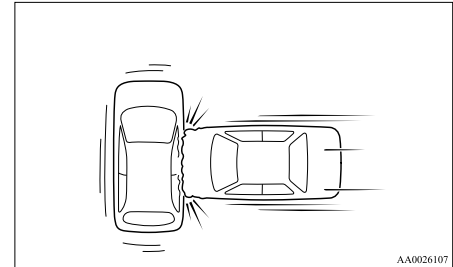

The seat belts in your vehicle are your primary means of protection in a collision. The SRS side airbags and curtain airbags are designed to provide additional protection. Therefore, for your safety and the safety of all occupants, be sure to always properly wear your seat belts.

The side airbags and curtain airbags *MAY NOT* DEPLOY when...

With certain types of side collisions, the vehicle's body structure is designed to absorb the shock to help protect the occupants from harm. (The vehicle body's side area may deform significantly as it absorbs the impact.) Under such circumstances, the side airbags and curtain airbags may not deploy irrespective of the deformation and damage to the vehicle body.

Examples of some typical conditions are shown in the illustration.

Because the side airbags and curtain airbags do not protect the occupant in all types of collisions, be sure to always properly wear your seat belts.

Side impacts in an area away from the passenger compartment

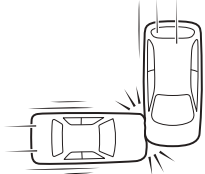

Motorcycle or other similar small vehicle collides with the side of vehicle



Collision with a utility pole, tree or other narrow object



AA2000738

Oblique side impacts



Vehicle rolls onto its side or roof



AA3001152

Seat and seat belts

The side airbags and curtain airbags ARE NOT DESIGNED TO DEPLOY when...

The side airbags and curtain airbags are not designed to deploy in conditions where they cannot usually provide protection to the occupant. Typical conditions are shown in the illustration.

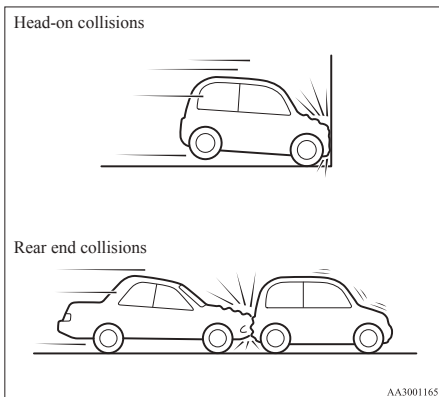

Because the side airbags and curtain airbags do not protect the occupant in all types of collisions, be sure to always properly wear your seat belts.

⚠ WARNING

- The side airbags and curtain airbags are designed to supplement the driver and passenger seat belts in certain side impacts. Seat belts should always be worn properly, and the driver and passenger should sit well back and upright without leaning against the window or door.

⚠ WARNING

- The side airbags and curtain airbags inflate with great force. The driver and passenger should not put their arms out the window, and should not lean against the door, in order to reduce risk of serious or possible fatal injury from the deploying side airbags and curtain airbags.



⚠ WARNING

- Do not allow a child to kneel on the passenger seat facing the passenger's side door, since the side airbags and curtain airbags inflate with great force. Otherwise, the child may be killed or seriously injured.



⚠ WARNING

- Do not allow any rear seat occupant to hold onto the seatback of either front seat, in order to reduce risk of injury from the deploying side airbags. Special care should be taken with children.
- Do not place any objects near or in front of the seatback of either front seat. They could interfere with proper side airbag inflation, and also could cause injury if thrown free by side airbag deployment.
- Do not place stickers, labels or additional trim on the seatback of either front seat. They could interfere with proper side airbag inflation.
- Do not install seat covers on seats with side airbags. Do not re-cover seats that have side airbags. They could interfere with proper side airbag inflation.

⚠ WARNING

- Do not attach a microphone (A) or any other device or object around the part where the curtain airbags activate such as on the windscreen, side door glass, front and rear pillars and roof side or assist grips. When the curtain airbags inflate, the microphone or other device or object will be hurled with great force or the curtain airbags may not activate correctly, resulting in death or serious injury.

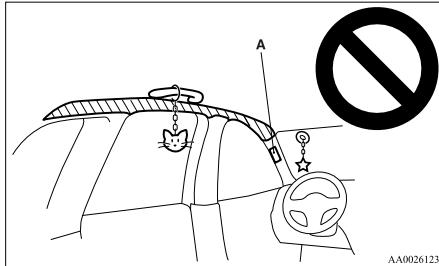

AA0026123

⚠ WARNING

- Do not put a hanger or any heavy or pointed object on the coat hook. If the curtain airbag was activated, any such item could be propelled away with great force and could prevent the curtain airbag from inflating correctly. Hang clothes directly on the coat hook (without using a hanger). Make sure there are no heavy or sharp objects in the pockets of clothes that you hang on the coat hook.
- Do not allow the child to lean against or close to the front door even if the child is seated in a child restraint system. The child's head should also not be leaned against or be close to the area where the side airbags and curtain airbags are located. It is dangerous if the side airbags and curtain airbags inflate. Failure to follow all of these instructions could lead to serious or fatal injury to the child.
- We recommend work around and on the side airbags and curtain airbags system to be done by a MITSUBISHI MOTORS Authorized Service Point. Improper work could result in inadvertent deployment of a side airbags and curtain airbags, or could render a side airbags and curtain airbags inoperative; either situation could result in serious injury.

SRS warning lamp

E00407801214

There is a Supplemental Restraint System ("SRS") warning lamp on the instrument panel. The system checks itself and the lamp tells you if there is a problem. When the ignition key is turned to the "ON" or "START" position, the warning lamp should illuminate for several seconds and then should go out. This means the system is ready. If an SRS airbags or pretensioner seat belt is not operating properly, the warning lamp comes on and stays on and a buzzer sounds.

The SRS warning lamp is shared by the following:

- Driver's airbag
- Front passenger's airbag
- Side airbags*
- Curtain airbags*
- Seat belt pretensioners
- Front passenger's airbag ON-OFF switch

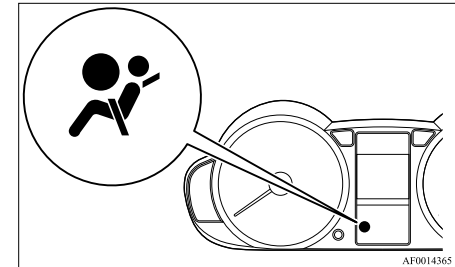

AF0014365

⚠ WARNING

- If any of the following conditions occurs, the SRS and/or seat belt pretensioners are not working properly, and we recommend you to have it inspected by a MITSUBISHI MOTORS Authorized Service Point immediately.
 - The SRS warning lamp does not illuminate when you start the vehicle.
 - The SRS warning lamp does not go out after several seconds.
 - The SRS warning lamp illuminates while driving.

SRS servicing

E00407900784

⚠ WARNING

- We recommend any maintenance performed on or near the components of the SRS to be performed by a MITSUBISHI MOTORS Authorized Service Point. Improper work on the SRS components or wiring could result in inadvertent deployment of the airbags, or could render the SRS inoperative; either situation could result in serious injury.
- Do not modify your steering wheel, seat belt retractor or any other SRS components. For example, replacement of the steering wheel, or modifications to the front bumper or body structure can adversely affect SRS performance and lead to possible injury.

⚠ WARNING

- If your vehicle has received any damage, we recommend you to have the SRS inspected to ensure it is in proper working order.
- On vehicles with the side airbags, do not modify your front seats, centre pillar and centre console. It can adversely affect SRS performance and lead to possible injury. Also, if you have found any tear or open seam in the seat fabric at the portion near the side airbag, we recommend you to have the seat inspected.
- On vehicles with the curtain airbags, if you have found any scratch, crack or damage to the portion of the front and rear pillars and roof side rail, we recommend you to have the SRS inspected by a MITSUBISHI MOTORS Authorized Service Point.

NOTE

- When you transfer ownership of the vehicle to some other person, we urge you to alert the new owner that it is equipped with the SRS and refer that owner to the applicable section in this owner's manual.
- If you junk or scrap the vehicle, we urge you to first take the vehicle to a MITSUBISHI MOTORS Authorized Service Point so that the SRS can be rendered safe.

Instruments and controls

Instruments.....	3-02
Multi-information display.....	3-04
Indication and warning lamps.....	3-16
Indication lamps.....	3-17
Warning lamps.....	3-17
Combination headlamps and dipper switch.....	3-20
Headlamp levelling switch.....	3-22
Turn-signal lever.....	3-23
Hazard warning flasher switch.....	3-23
Front fog lamp switch*.....	3-24
Rear fog lamp switch.....	3-24
Wiper and washer switch.....	3-25
Rear window demister switch.....	3-29
Horn switch.....	3-30

Instruments

E00500100762

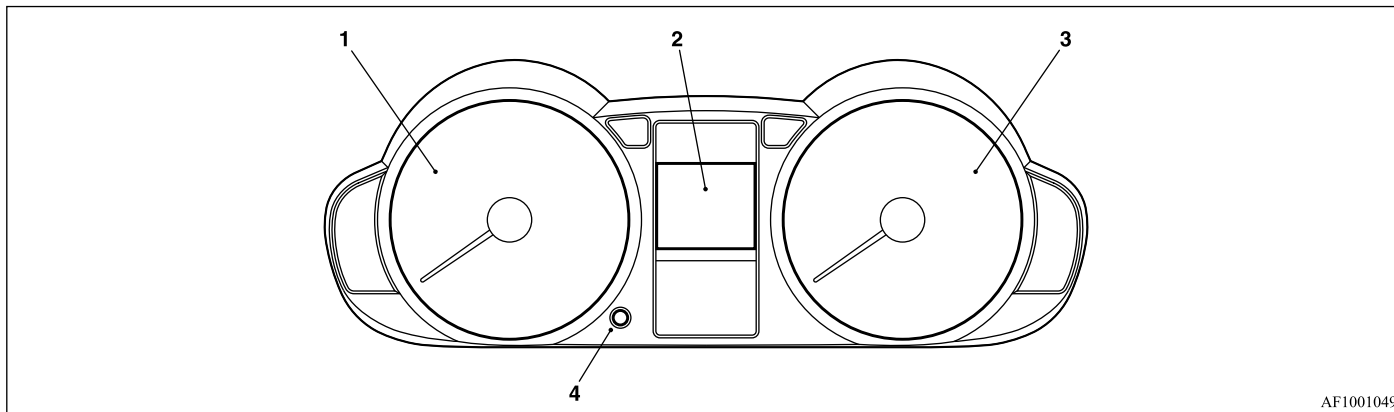

AF1001049

3

- 1- Tachometer
- 2- Multi-information display

- 3- Speedometer
- 4- Multi-information meter switch

Speedometer

E00500200819

Indication for km/h

The speedometer indicates the vehicle's speed in kilometers per hour (km/h).

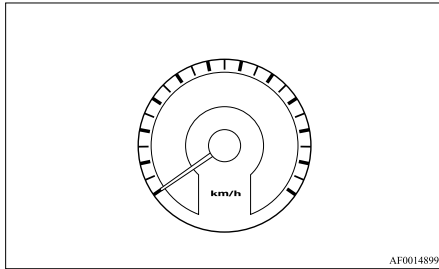

AF0014899

Indication for km/h and mph

The speedometer indicates the vehicle's speed in miles per hour (mph) and kilometers per hour (km/h).

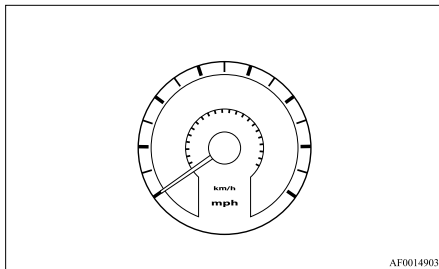

AF0014903

Tachometer

E00500300735

The tachometer indicates the engine speed (r/min). The tachometer can help you obtain more economical driving and also warns you of excessive engine speeds.

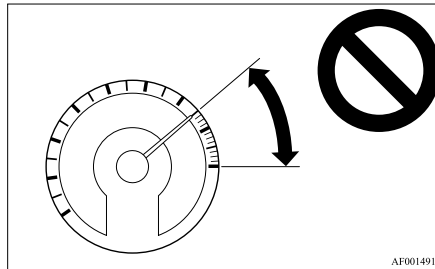

AF0014916

CAUTION

- When during, watch the tachometer to make sure that the engine speed indication does not rise into the red zone (excessive engine rpm).

Multi-information display

E00519900362

Always stop the vehicle in a safe place before operating. The following information is included on the multi-information display: odometer, tripmeter, service reminder, fuel remaining, outside temperature, allshift lever position driving range, momentary and average fuel consumption and average speed. It is also possible to change elements such as the units used on the multi-information display.

When the ignition switch is “OFF”

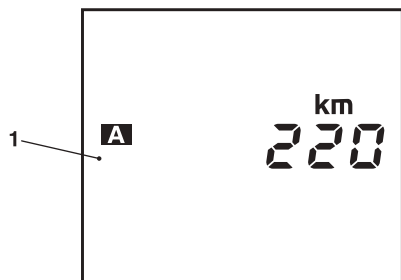

When the ignition switch is “ON”

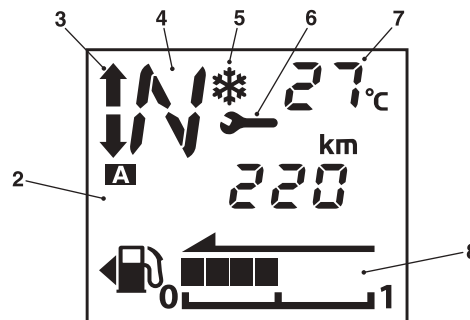

AF1001052

- 1- Information display (when the ignition switch is “OFF”) → p. 3-05
- 2- Information display (when the ignition switch is “ON”) → p. 3-06
- 3- Gearshift indicator* → p. 4-16, 4-20
- 4- Allshift lever position display* → p. 3-09

- 5- Frozen road warning → p. 3-10
- 6- Service reminder → p. 3-11
- 7- Outside temperature display → p. 3-10
- 8- Information display (when the ignition switch is “OFF”) → p. 3-10

NOTE

- The display is different depending on whether the ignition switch is “OFF” or “ON”.
Refer to “Information display (when the ignition switch is “OFF”)” on page 3-05.
Refer to “Information display (when the ignition switch is “ON”)” on page 3-06.

Information display (when the ignition switch is “OFF”)

E00528200026

Each time you lightly press the multi-information meter switch, the display switches in the following order.

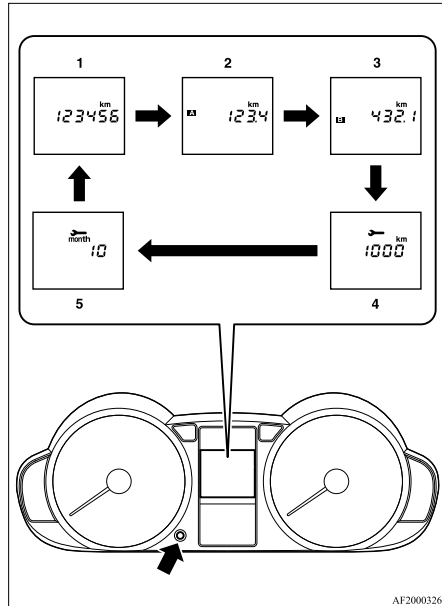

- 1- Odometer
- 2- Tripmeter **A**
- 3- Tripmeter **B**
- 4- Service reminder (distance)
- 5- Service reminder (month)

AF2000326

Odometer

E00527800012

The odometer indicates the distance travelled.

Tripmeter

E00527900013

The tripmeter indicates the distance travelled between two points.

Example usage of tripmeter **A** and tripmeter **B**

It is possible to measure two currently travelled distances, from home using tripmeter **A** and from a particular point on the way using tripmeter **B**.

To reset the tripmeter

To return the display to 0, hold down the multi-information meter switch for about 2 seconds or more. Only the currently displayed value will be reset.

Example

If tripmeter **A** is displayed, only tripmeter **A** will be reset.

NOTE

- Both tripmeters **A** and **B** can count up to 9999.9 km (9999.9 miles). When a tripmeter goes past 9999.9 km (9999.9 miles), it returns to 0.0 km (0.0 miles).
- When disconnecting the battery terminal, the memories of tripmeter display **A** and display **B** are erased, and their displays return to 0.0 km (0.0 miles).



Service reminder

E00521300536

This displays the distance and number of months until the next periodic inspection. Refer to “Service reminder” on page 3-11.

Information display (when the ignition switch is “ON”)

E00528300027

Each time you lightly press the multi-information meter switch in the meter or MODE/SET switch in the audio (if so equipped), the display switches in the following order.

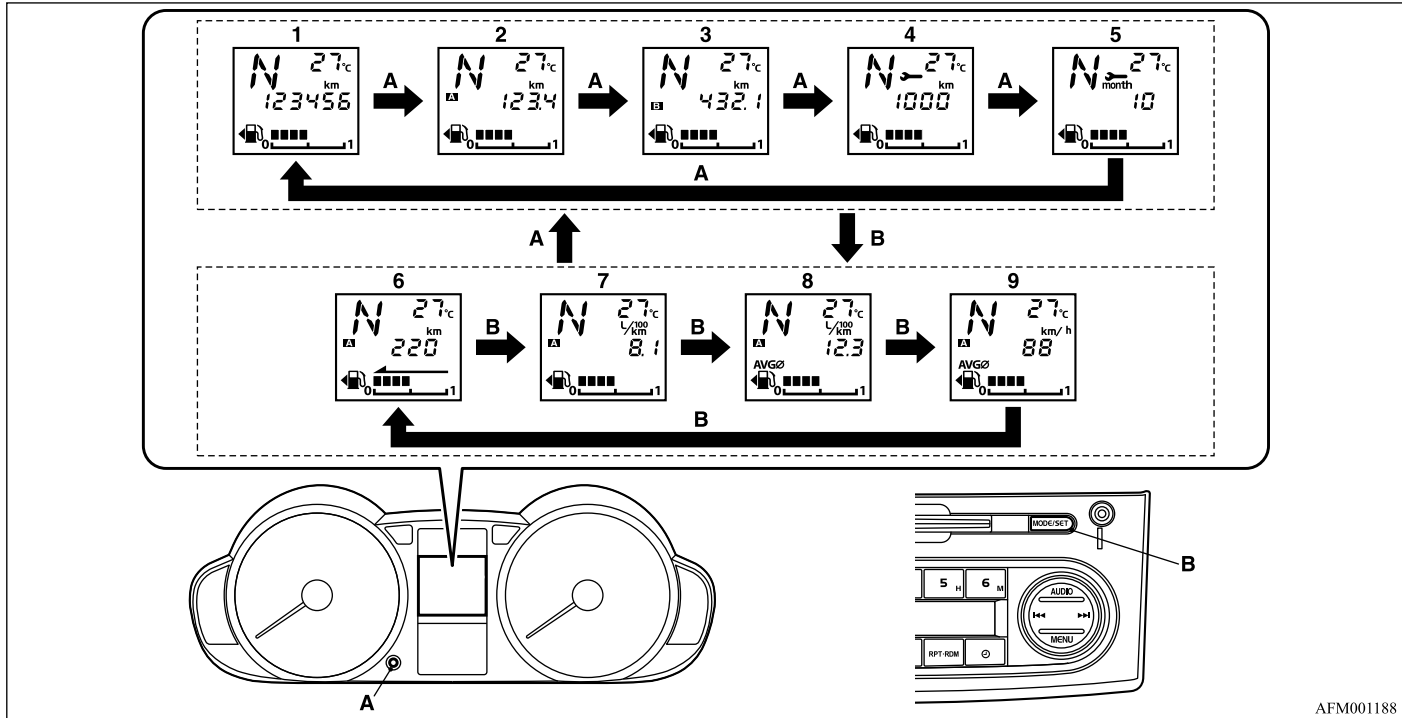

AFM001188

A- Lightly press the multi-information meter switch

B- Lightly press the MODE/SET switch

- 1- Odometer
- 2- Tripmeter **A**
- 3- Tripmeter **B**
- 4- Service reminder (distance)
- 5- Service reminder (month)

- 6- Driving range display*
- 7- Momentary fuel consumption display*
- 8- Average fuel consumption display*
- 9- Average speed display*

NOTE

- Always stop the vehicle in a safe place before operating.
Refer to “Changing the function settings (when the ignition switch is “ON”)” on page 3-12.
- For vehicles that are not equipped with an audio system, the driving range display, momentary fuel consumption display, average fuel consumption display, and average speed display cannot be displayed.



Odometer

E00527700011

The operation method is the same as when the ignition switch is “OFF”. Refer to “Odometer” on page 3-05.



Tripmeter

E00528000011

The operation method is the same as when the ignition switch is “OFF”. Refer to “Tripmeter” on page 3-05.



Service reminder

E00521300552

This displays the distance and number of months until the next periodic inspection. Refer to “Service reminder” on page 3-11.



Driving range display*

E00521500219

This displays the approximate driving range (how many more kilometres or miles you can drive). When the driving range falls below approximately 50 km (30 miles), “---” is displayed. Refuel as soon as possible.



Momentary fuel consumption display*

E00521800544

While driving, this displays the momentary fuel consumption (in L/100 km, km/L or mpg). Calculation and indication of the value begin when the vehicle speed rises above 6 km/h (4 mph).

NOTE

- The remaining distance is based on the previous fuel consumption data. The actual distance will depend on the driving conditions (road conditions, how you drive, etc.). When the battery terminal is disconnected, the previous fuel consumption data is erased. A value different from before may be displayed. Treat the distance displayed as just a rough guideline.
- When you refuel, the driving range display is updated. However, if you only add a small amount of fuel, the correct value will not be displayed. Fill with a full tank whenever possible.
- On rare occasions, the value displayed for the driving range may change if you are parked on an extremely steep incline. This is due to the movement of fuel in the tank and does not indicate any malfunction.

NOTE

- “---” is displayed when the momentary fuel consumption cannot be measured.
- The display setting can be changed to the preferred units (L/100 km, km/L). Refer to “Changing the function settings (when the ignition switch is “ON”)” on page 3-12.
- For vehicles equipped with multi-information displays that show figures in miles, the fuel consumption can only be displayed in miles per gallon (“mpg”).



Average fuel consumption display*

E00521700729

This displays the average fuel consumption (in L/100 km, km/L, or mpg) from the last reset to the present time. There are the following 2 mode settings. For information on how to change the average fuel consumption display setting, refer to “Changing the function settings (when the ignition switch is “ON”)” on page 3-12.

Manual reset mode

- When the average fuel consumption is being displayed, if you hold down the MODE/SET switch, the average fuel consumption and average speed displayed at that time are reset.

- When the ignition switch is switched from “ACC” or “LOCK” to “ON”, the mode setting is automatically switched from manual to auto. Switching to auto occurs automatically. If switching to manual mode is done, however, the data from the last reset is displayed.

Auto reset mode

- When the average fuel consumption is being displayed, if you hold down the MODE/SET switch, the average fuel consumption and average speed displayed at that time are reset.
- If the ignition switch is at “ACC” or “LOCK” for about 4 hours or longer, the average fuel consumption display is automatically reset.

NOTE

- “---” is displayed when the average fuel consumption cannot be measured.
- The initial (default) setting is “Auto reset mode”.
- The average fuel consumption depends on the driving condition (road condition, driving behavior, etc.). The displayed fuel consumption may vary from the actual fuel consumption. Treat the fuel consumption displayed as just a rough guideline.

- The memory of the auto reset mode or manual reset mode for the average fuel consumption display is erased if the battery is disconnected.
- The display setting can be changed to the preferred units (L/100 km, km/L). Refer to “Changing the function settings (when the ignition switch is “ON”)” on page 3-12.
- For vehicles equipped with multi-information displays that show figures in miles, the fuel consumption can only be displayed in miles per gallon (“mpg”).



Average speed display*

E00521600744

This displays the average speed (km/h or mph) from the last reset to the present time.

There are the following 2 mode settings. For the method for changing the average speed display setting, refer to “Changing the function settings (when the ignition switch is “ON”)” on page 3-12.

Manual reset mode

- When the average speed is being displayed, if you hold down the MODE/SET switch, the average speed and average fuel consumption displayed at that time are reset.

- When the ignition switch is switched from “ACC” or “LOCK” to “ON”, the mode setting is automatically switched from manual to auto. Switching to auto occurs automatically. If switching to manual mode is done, however, the data from the last reset is displayed.

Auto reset mode

- When the average speed is being displayed, if you hold down the MODE/SET switch, the average speed and average fuel consumption displayed at that time are reset.
- If the ignition switch is at “ACC” or “LOCK” for about 4 hours or longer, the average speed display is automatically reset.

NOTE

- “---” is displayed when the average speed cannot be measured.
- The initial (default) setting is “Auto reset mode”.
- The memory of the auto reset mode or manual reset mode for the average speed display is erased if the battery is disconnected.



Allshift lever position display*

E00528100012

Shows the position of the allshift lever. Refer to “Allshift lever position and multi-information display” on page 4-20.

Instruments and controls



Outside temperature display

E00528400015

This displays the temperature outside the vehicle.

NOTE

- The display setting can be changed to the preferred units (°C or °F). Refer to “Changing the function settings (when the ignition switch is “ON”)” on page 3-12.
- The outside temperature can be displayed in a range of -40°C to 50°C (-40°F to 122°F).
- Depending on factors such as the driving conditions, the displayed temperature may vary from the actual outside temperature.



Frozen road warning

E00528500016

If the outside air temperature drops below approx. 3°C, the alarm sounds and the outside air temperature warning symbol flashes for about 10 seconds.

CAUTION

- There is a danger the road might be icy, even when this symbol is not flashing, so please take care when driving.



Gearshift indicator*

E00528600020

The gearshift indicator (if so equipped) shows recommended gearshift points for fuel-efficient driving. Refer to “Changing gears” on page 4-17.

Refer to “Driving” on page 4-23.

Fuel remaining display

E00522200444

This displays the amount of fuel remaining.

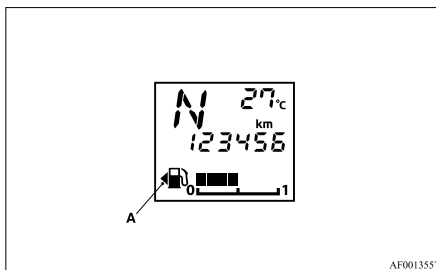

CAUTION

- Do not run out of fuel, or the catalytic converter may be adversely affected. If the warning display appears, refuel as soon as possible.

NOTE

- It may take several seconds to stabilise the display after refilling the tank.

- If fuel is added with the ignition switch in the “ON” position, the fuel gauge may incorrectly indicate the fuel level.

Fuel lid mark

E00522300038

The arrow (A) indicates that the fuel tank filler is located on the left side of the body.

Fuel remaining warning display

E00522400215

If the remaining fuel level is approximately 7 liters or less (one segment displayed) when the ignition switch is turned to the “ON” position, the last segment of the fuel gauge flashes. If the remaining fuel level is approximately 4 liters or less (no segments displayed), “” and the bar graph flash.

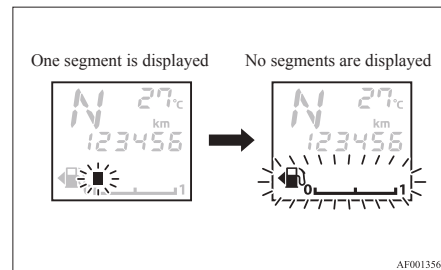

NOTE

- On inclines or curves, the display may be incorrect due to the movement of fuel in the tank.

Service reminder

E00522500388

Displays the approximate time until the next periodic inspection that MITSUBISHI MOTORS recommends. “---” is displayed when the inspection time has arrived.

NOTE

- Depending on the vehicle specifications, the displayed time until the next periodic inspection may differ from that of MITSUBISHI MOTORS recommends. In addition, the display settings for the next periodic inspection time can be modified. To modify the display settings, have it adjusted at a MITSUBISHI MOTORS Authorized Service Point. For more details, consult a MITSUBISHI MOTORS Authorized Service Point.

1. Displays the time until the next periodic inspection.

NOTE

- The distance is shown in units of 100 km (100 miles). The time is shown in units of months.
2. Alerts the driver when the inspection time has arrived. We recommend you to consult a MITSUBISHI MOTORS Authorized Service Point.

At that time, when the ignition switch is switched from “OFF” to “ON”, “” is displayed for 30 seconds on the information display.

To reset

The “---” display can be reset while the ignition switch is “OFF”. When the display is reset, the time until the next periodic inspection is displayed and “” is no longer displayed when the ignition switch is switched from “OFF” to “ON”.

1. When you lightly press the multi-information meter switch a few times, the information display switches to the service reminder display.

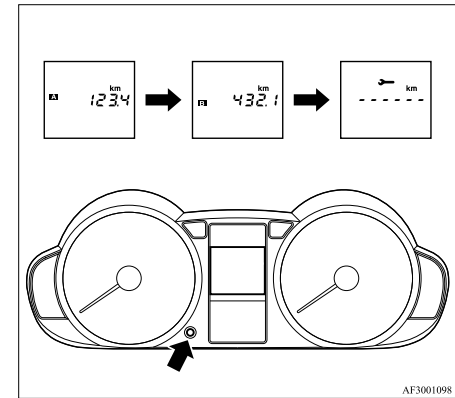
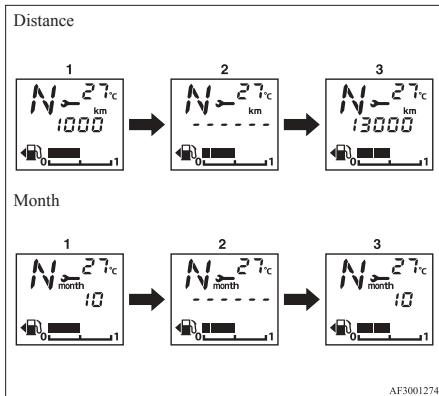

3. After your vehicle is inspected at a MITSUBISHI MOTORS Authorized Service Point, it displays the time until the next periodic inspection.

2. Press and hold the multi-information meter switch for about 2 seconds or more to display “” and make it flash. (If there is no operation for about 10 seconds with flashing, the display returns to the previous display.)

Instruments and controls

3. Lightly press the multi-information meter switch while the icon is flashing to change the display from “---” to “cLEAR”. After this, the time until the next periodic inspection will be displayed.

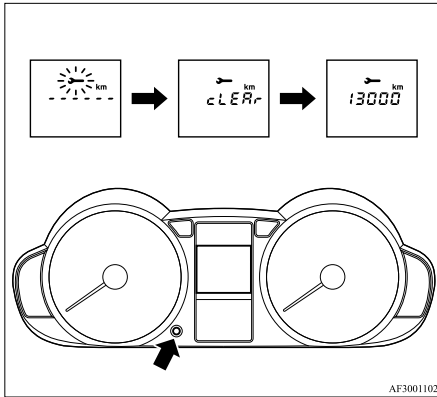

AF3001102

CAUTION

- The customer is responsible for making sure that periodic inspection and maintenance are performed. Inspections and maintenance must be performed to prevent accidents and malfunctions.

NOTE

- “---”display cannot be reset when the ignition switch is “ON”.

- When “---” is displayed, after a certain distance and a certain period of time, the display is reset and the time until the next periodic inspection is displayed.
- If you accidentally reset the display, we recommend you to consult a MITSUBISHI MOTORS Authorized Service Point.

Changing the function settings (when the ignition switch is “ON”)*

E00522700146

The multi-information display fuel consumption unit, average fuel consumption reset mode and speed reset mode and temperature unit, can be modified as desired.

CAUTION

- The driver should not operate the display while the vehicle is in motion.
- When operating the system, stop the vehicle in a safe area.

NOTE

- For vehicles equipped with multi-information displays that show figures in miles, the fuel consumption can only be displayed in miles per gallon (“mpg”).

Changing the reset mode for average fuel consumption and average speed

E00522900281

The mode conditions for the average fuel consumption and average speed display can be switched between “Auto reset” and “Manual reset”.

1. When you lightly press the MODE/SET switch a few times, the information display switches to the driving range display.

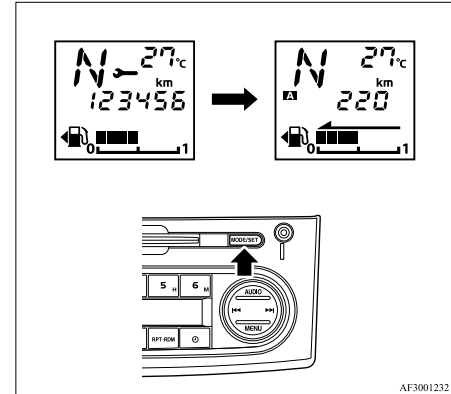

AF3001232

2. Press and hold the MODE/SET switch for about 2 seconds or more to display “A” and make it flash.

(If there is no operation for about 10 seconds with flashing, the display returns to the previous display.)

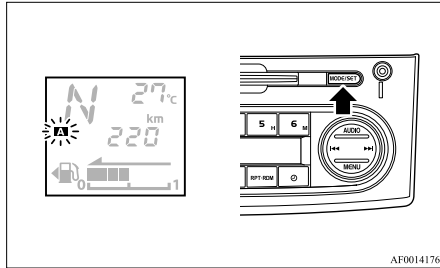

3. Lightly press the MODE/SET switch while the icon is flashing to change the display from “A” to “B”.

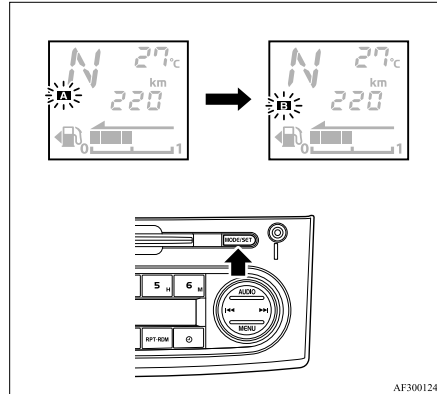

- A- Auto reset mode
- B- Manual reset mode

4. The reset mode can be changed from “B” to “A” using the same procedure.

Manual reset mode

- When the average fuel consumption or average speed is being displayed, if you hold down the MODE/SET switch, the average fuel consumption and average speed displayed at that time are reset.

Auto reset mode

- When the ignition switch is switched from “ACC” or “LOCK” to “ON”, the mode setting is automatically switched from manual to auto.
- Switching to auto occurs automatically. If switching to manual mode is done, however, the data from the last reset is displayed.
- When the average fuel consumption or average speed is being displayed, if you hold down the MODE/SET switch, the average fuel consumption and average speed displayed at that time are reset.
- If the ignition switch is at “ACC” or “LOCK” for about 4 hours or longer, the average fuel consumption display and average speed display are automatically reset.

NOTE

- The memory of the manual reset mode or auto reset mode for the average fuel consumption display and average speed display is erased if the battery is disconnected.
- The initial (default) setting is “Auto reset mode”.

Changing the fuel consumption display unit

E00523000306

The display unit for fuel consumption can be switched. The distance, speed, and amount units are also switched to match the selected fuel consumption unit.

Instruments and controls

1. When you lightly press the MODE/SET switch a few times, the information display switches to the momentary fuel consumption display.

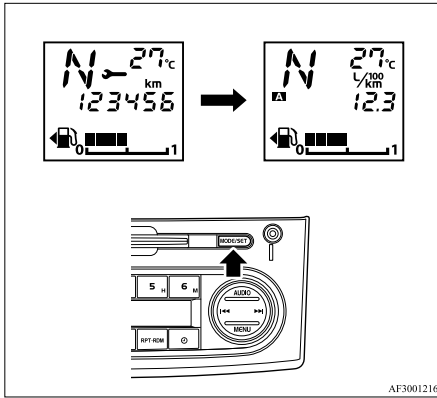

2. Press and hold the MODE/SET switch for about 2 seconds or more to display "L/100 km" and make it flash.

(If there is no operation for about 10 seconds with flashing, the display returns to the previous display.)

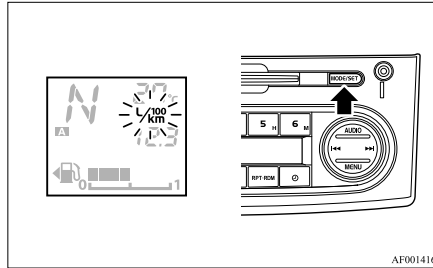

3. Lightly press the MODE/SET switch while the icon is flashing to change the display from "L/100 km" to "km/L".

The icon will stop flashing if there is no operation for about 10 seconds or if the MODE/SET switch is pressed and held.

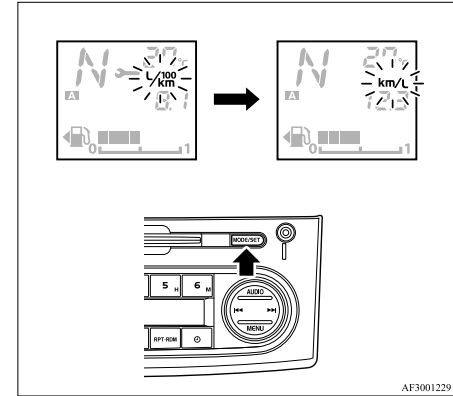

4. The display unit can be changed from "km/L" to "L/100 km" using the same procedure.

NOTE

- The display units for the momentary fuel consumption, the average fuel consumption are switched, but the units for the indicating needle (speedometer), the odometer, the tripmeter, the driving range and the average speed will remain unchanged.
- The memory of the unit setting is erased if the battery is disconnected, and it returns automatically to L/100 km.

Changing the temperature unit

E00523100206

The display unit for temperature can be switched.

1. When you lightly press the multi-information meter switch a few times, the information meter switch a few times, the information display switches to the odometer display.

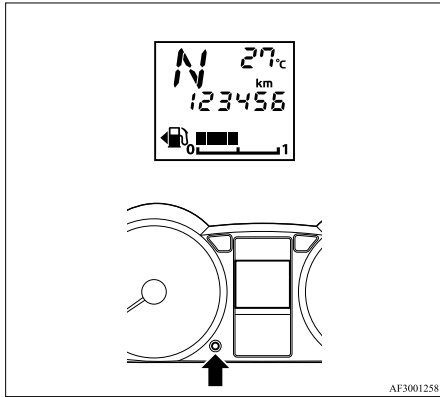

2. Press and hold the multi-information meter switch for about 2 seconds or more to display “°C” and make it flash. (If there is no operation for about 10 seconds with flashing, the display returns to the previous display.)

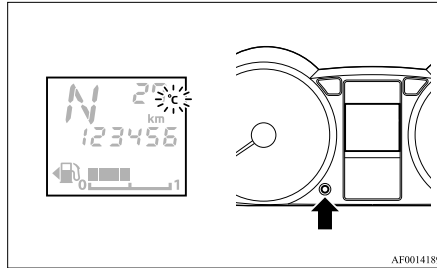

3. Lightly press the multi-information meter switch while the icon is flashing to change the display from “°C” to “°F”.

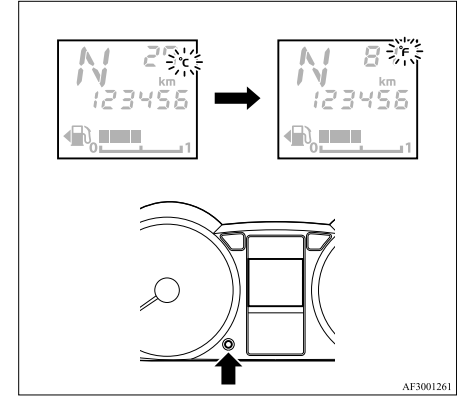

4. The temperature unit can be changed from “°F” to “°C” using the same procedure.

NOTE

- If the battery is disconnected, the unit setting is erased from memory and is automatically set to °C.

Indication and warning lamps

E00501501731

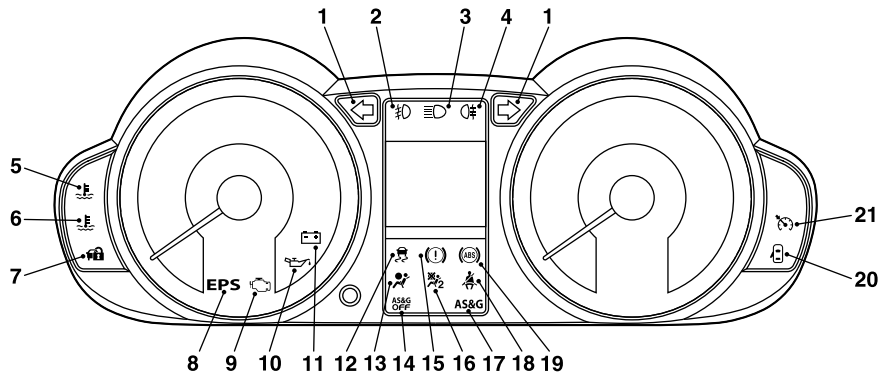

AF1001195

- | | |
|--|--|
| <ul style="list-style-type: none"> 1- Turn-signal indication lamps/Hazard warning indication lamps → p. 3-17 2- Front fog lamp indication lamp* → p. 3-17 3- High-beam indication lamp → p. 3-17 4- Rear fog lamp indication lamp → p. 3-17 5- High coolant temperature warning lamp → p. 3-19 6- Low coolant temperature indication lamp → p. 3-17 7- Immobilizer indication lamp → p. 1-02 8- Electric power steering warning lamp → p. 4-29 9- Check engine warning lamp → p. 3-18 10- Oil pressure warning lamp → p. 3-19 11- Charge warning lamp → p. 3-19 | <ul style="list-style-type: none"> 12- Traction control system (TCL)/Active stability control system (ASC) indication lamp* → p. 4-31 13- SRS warning lamp → p. 2-33 14- Auto Stop & Go (AS&G) OFF indication lamp → p. 4-16 15- Brake warning lamp → p. 3-17 16- Front passenger's airbag OFF indication lamp → p. 2-25 17- Auto Stop & Go (AS&G) indication lamp* → p. 4-13 18- Seat belt warning lamp → p. 2-11 19- Anti-lock brake (ABS) warning lamp → p. 4-28 20- Door ajar warning lamp → p. 3-19 21- Cruise control indication lamp* → p. 4-32 |
|--|--|

Indication lamps

E00501600012



Turn-signal indication lamps/ Hazard warning indication lamps

E00501700286

These indication lamps blink in the following situations.

- When the turn-signal lever is moved to activate a turn-signal lamp.

Refer to “Turn-signal lever” on page 3-23.

- When the hazard warning flasher switch is pressed to activate the hazard warning lamps.

Refer to “Hazard warning flasher switch” on page 3-23.

- When the hazard warning lamps automatically activate due to sudden braking while driving.

Refer to “Emergency stop signal system” on page 4-26.

NOTE

- If these indication lamps blink too fast due to any operation other than sudden braking, the cause may be a blown lamp bulb or a faulty turn-signal connection.



High-beam indication lamp

E00501800072

This indication lamp illuminates when the high-beam is used.



Front fog lamp indication lamp*

E00501900158

This indication lamp illuminates while the front fog lamps are on.



Rear fog lamp indication lamp

E00502000084

This indication lamp illuminates while the rear fog lamp is on.



Low coolant temperature indi- cation lamp

E00502200028

When the engine coolant temperature is low, this indication lamp illuminates and then goes out when the temperature rises to roughly 40 °C or more.

NOTE

- When the indication lamp goes out, this should be used as a rough indication of when the heating starts working.
- If the indication lamp stays illuminated, there may be a fault in the temperature sensor or other component. We recommend you to have your vehicle inspected.

Warning lamps

E00502400017



Brake warning lamp

E00502502445

This lamp illuminates when the ignition switch is turned to the “ON” position, and goes off after a few seconds.

Always make sure that the lamp goes off before driving.

With the ignition switch in the “ON” position, the brake warning lamp illuminates under the following conditions:

- When the parking brake lever has been engaged.

With the ignition switch in the “ON” position, the brake warning lamp illuminates and a buzzer sounds under the following conditions:

- When the brake fluid level in the reservoir falls to a low level.
- The vehicle speed exceeds 8 km/h (5 mph) with the parking brake applied.
- When the brake force distribution function is not operating correctly.



CAUTION

- In the situations listed below, brake performance may be compromised or the vehicle may become unstable if brakes are applied suddenly; consequently, avoid driving at high speeds or applying the brakes suddenly.

CAUTION

Furthermore, the vehicle should be brought immediately to a stop in a safe location and we recommend you to have it checked.

- The brake warning lamp does not illuminate when the parking brake is applied or does not turn off when the parking brake is released.
- The ABS warning lamp and brake warning lamp illuminate at the same time. For details, refer to “ABS warning lamp” on page 4-28.
- The brake warning lamp remains illuminated during driving.
- The vehicle should be brought to a halt in the following manner when brake performance has deteriorated.
 - Depress the brake pedal harder than usual. Even if the brake pedal moves down to the very end of its possible stroke, keep it pressed down hard.

CAUTION

- Should the brakes fail, use engine braking to reduce your speed and pull the parking brake lever. Depress the brake pedal to operate the stop lamp to alert the vehicles behind you.



Check engine warning lamp

E00502601683

This lamp is a part of an onboard diagnostic system which monitors the emissions, engine or automated manual transmission control system/AS&G control system.

If a problem is detected in one of these systems, this lamp illuminates and a buzzer sounds.

Although your vehicle will usually be drivable and not need towing, we recommend you to have the system checked as soon as possible.

This lamp will also illuminate for a few seconds when the ignition switch is turned to the “ON” position. If it does not go off after a few seconds, we recommend you to have the vehicle checked.

CAUTION

- Prolonged driving with this lamp on may cause further damage to the emission control system. It could also affect fuel economy and drivability.
- If the lamp does not illuminate when the ignition switch is turned to the “ON” position, we recommend you to have the system checked.
- If the lamp illuminates while the engine is running, avoid driving at high speeds and we recommend you to have the system checked. During vehicle operation with the lamp illuminated, the vehicle may not accelerate when you depress the accelerator pedal.

NOTE

- The engine electronic control module accommodating the onboard diagnostic system has various fault data (especially about the exhaust emission) stored. This data will be erased if a battery cable is disconnected which will make a rapid diagnosis difficult. Do not disconnect a battery cable when the check engine warning lamp is ON.



Charge warning lamp

E00502700036

This lamp illuminates when the ignition switch is turned to the “ON” position, and the lamp goes off after the engine has started.

In the event of a fault in the charging system, the warning lamp comes on and a buzzer sounds.

CAUTION

- If the warning lamp illuminates and a buzzer sounds while the engine is running, there is a problem in the charging system. In this case, immediately park your vehicle in a safe place and we recommend you to have it checked.



Oil pressure warning lamp

E00502800053

This lamp illuminates when the ignition switch is turned to the “ON” position, and the lamp goes off after the engine has started. If it illuminates and a buzzer sounds while the engine is running, the oil pressure is too low.

If the warning lamp illuminates while the engine is running, turn the engine off and have it inspected.



High coolant temperature warning lamp

E00503000023

This lamp illuminates and a buzzer sounds if the coolant temperature becomes excessively high.

CAUTION

- If this lamp illuminates when the engine oil level is not low, have it inspected.
- This warning lamp does not indicate the amount of oil in the crankcase. This must be determined by checking the oil level on the dipstick, while the engine is switched off.
- If you continue driving with low engine oil level or with this warning lamp illuminated, engine seizure may occur.

NOTE

- The oil pressure warning lamp should not be treated as an indication of the engine’s oil level. The oil level must be checked using the dipstick.

CAUTION

- If the lamp illuminates during vehicle operation, it indicates that the engine is possibly overheating. Continued driving could make the engine fail. Immediately stop the vehicle in a safe place and take appropriate action. (Refer to “Engine overheating” on page 6-04.)

NOTE

- The high coolant temperature warning lamp may illuminate when the vehicle has been driven at high speeds or on hilly roads. This flashing does not necessarily indicate a problem. It should stop if you keep the engine running for a while or continue driving the vehicle.



Door ajar warning lamp

E00503300723

This lamp illuminates when a door or the tailgate is either open or incompletely closed.

A buzzer sounds if the vehicle speed exceeds 5 km/h (3 mph) with a door or the tailgate ajar.

CAUTION

- Before moving your vehicle, check that the warning lamp is OFF.

Combination headlamps and dipper switch

E00506000923

Headlamps

NOTE

- Do not leave the headlamps and other lamps on for a long time while the engine is stationary (not running). A rundown battery could result.
- When it rains, or when the vehicle has been washed, the inside of the lens sometimes becomes foggy. This is the same phenomenon as when window glass mists up on a humid day, and does not indicate a functional problem. When the lamp is switched on, the heat will remove the fog. However, if water gathers inside the lamp, we recommend you to have it checked.

Type 1

Rotate the switch to turn on the lamps.

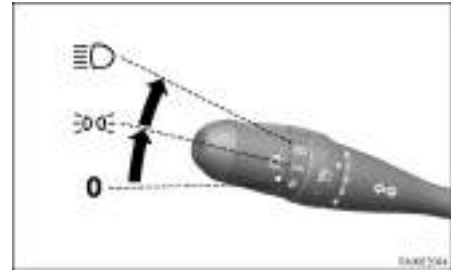

0	All lamps off
⏏	Position, tail, licence plate and instrument panel lamps on
⏏	Headlamps and other lamps go on

Type 2

Rotate the switch to turn on the lamps.

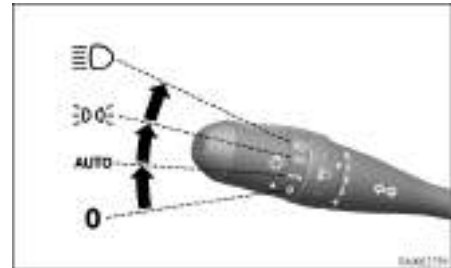

0	All lamps off
AUTO	With the ignition switch in the “ON” position, headlamps, position, tail, licence plate, and instrument panel lamps turn on and off automatically in accordance with outside light level. All lamps turn off automatically when the ignition switch is turned to “OFF” position.
	Position, tail, licence plate and instrument panel lamps on
	Headlamps and other lamps go on

NOTE

- If the front fog lamps (if so equipped) turn on when they are supposed to with the switch in the “AUTO” position, the lamps turn off automatically with the engine switch off.
- Do not cover the sensor (A) for the automatic on/off control by affixing a sticker or label to the windscreen. Also, do not put any water-repellent coating on the windscreen.

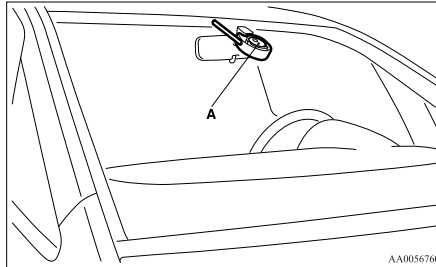

- If the lamps do not turn on or off with the switch in the “AUTO” position, manually operate the switch and we recommend you to have your vehicle checked.

[Vehicles with Daytime Running Lamp]

When the ignition switch is in the “ON” position and the lamp switch is set to the “0” (OFF) position, the low beam of the headlamps, tail lamps, etc., will illuminate.

Lamp monitor buzzer

E00506100067

If the driver’s door is opened when the ignition key is in the “LOCK” or “ACC” position or removed from the ignition switch while the lamps are on, a buzzer will sound to remind the driver to turn off the lamps. Turn off the lamp switch to stop the buzzer.

Dipper (High/Low beam change)

E00506200505

When the lamp switch is in the “

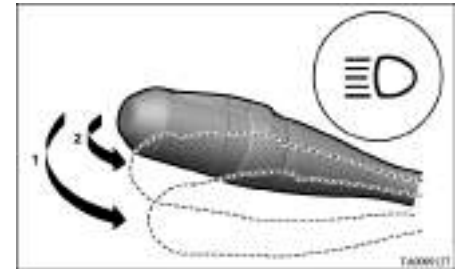

Headlamp flasher

E00506300043

The high-beams flash when the lever is pulled slightly to (2), and will go off when it is released. When the high-beam is on, the high-beam indication lamp in the instrument cluster will also illuminate.

NOTE

- The high-beams can also flash when the lamp switch is OFF.
- If you turn the lamps off with the headlamps set to highbeam illumination, the headlamps are automatically returned to their low-beam setting when the lamp switch is next turned to the “

Instruments and controls

Coming home light

E00529000366

This function turns on the headlamps in the low-beam setting for about 30 seconds after the ignition switch is turned to the "OFF" position.

1. Turn the combination headlamps and dipper switch to the "0" (OFF) or "AUTO" position (for vehicles equipped with the automatic lamp control).
2. Turn the ignition switch to the "OFF" position and remove the ignition key.
3. Within 60 seconds of turning the ignition switch to the "OFF" position, pull the turn-signal lever towards you.

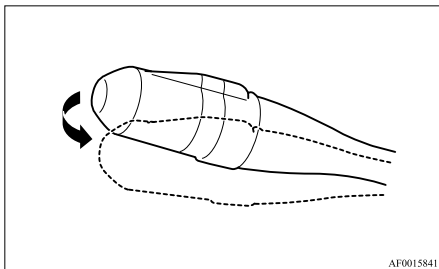

AF0015841

4. The headlamps will come on in the low beam setting for about 30 seconds.

NOTE

- While the coming home light function is operating, perform one of the following operations to cancel the function.
 - Pull the turn-signal lever towards you.
 - Turn the combination headlamps and dipper switch to the "0" or "AUTO" position.

- Turn the ignition switch to the "ON" or "ACC" position.
- If the coming home light function is cancelled, the ignition switch must be turned to the "ON" or "ACC" position before the function can be operated again.
- It is possible to modify functions as follows: For details, we recommend you to consult a MITSUBISHI MOTORS Authorized Service Point.
 - The time that the headlamps remain on can be changed.
 - The coming home light function can be deactivated.

Headlamp levelling switch

E00506400695

The angle of the headlamp beam varies depending upon the load carried by the vehicle.

The headlamp levelling switch (A) can be used to adjust the headlamp illumination distance (when the lower beam is illuminated) so that the headlamps' glare does not distract the drivers of approaching vehicles.

Set the switch (referring to the following table) to the appropriate position according to the number of people and the load in the vehicle.



Except for vehicles with turbocharger

Vehicle condition				
Switch position	"0"	"2"	"3"	"3"

●: 1 person

▨: Full luggage loading

Switch position 0- Driver only/Driver + 1 front passenger

Switch position 2- 5 passengers (including driver)

Switch position 3- 5 passengers (including driver) + Full luggage loading

Switch position 3- Driver + Full luggage loading

Vehicles with turbocharger

Vehicle condition				
Switch position	"0"	"1"	"2"	"2"

●: 1 person

▨: Full luggage loading

Switch position 0- Driver only/Driver + 1 front passenger

Switch position 1- 5 passengers (including driver)

Switch position 2- 5 passengers (including driver) + Full luggage loading

Switch position 2- Driver + Full luggage loading

Turn-signal lever

E00506501000

The turn-signal lamps flash when the lever is operated (with the ignition switch in the "ON" position). At the same time, the turn signal indication lamp flashes.

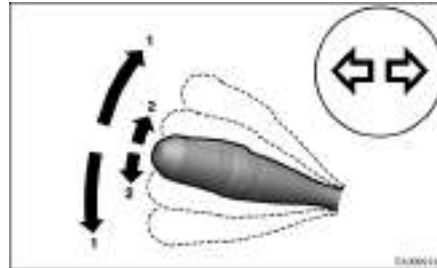

1- Turn-signals

When making a normal turn, use position (1). The lever will return automatically when cornering is completed.

There are times when the lever will not return after cornering. This occurs when the steering wheel is turned only slightly.

In such cases, return the lever by hand.

2- Lane-change signals

When changing lane, gently move the lever once to position (2). The turn-signal lamps and the indication lamp in the meter will flash three times.

NOTE

- If the lamp flashes unusually quickly, the bulb in a turn-signal lamp may have burned out. We recommend you to have the vehicle inspected.

Hazard warning flasher switch

E00506600727

Use the hazard warning flasher switch when the vehicle has to be parked on the road for any emergency. The hazard warning flashers can always be operated, regardless of the position of the ignition key.

Push the switch to turn on the hazard warning flashers; push the switch again to turn them off.

When this switch is operated, all turn-signal lamps flash continuously, as do the turn-signal indication lamps in the instrument cluster.

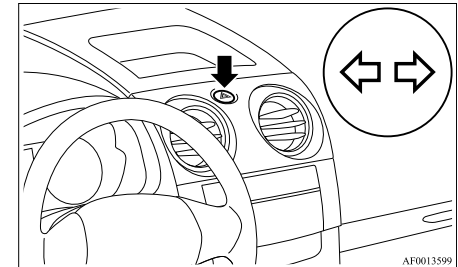

CAUTION

- If the lamps are kept flashing for a long time, the battery will be discharged, resulting in hard engine starting or no start condition.

NOTE

- While the hazard warning lamps are blinking due to having manually pushed the switch, the Emergency stop signal does not operate. Refer to “Emergency stop signal system” on page 4-26.

Front fog lamp switch*

E00506800820

The front fog lamps illuminate only when the headlamps or tail lamps turn on. Push the switch to turn on the front fog lamps, and push the switch again to turn them off.

The indication lamp in the instrument cluster will illuminate while the front fog lamps are on.

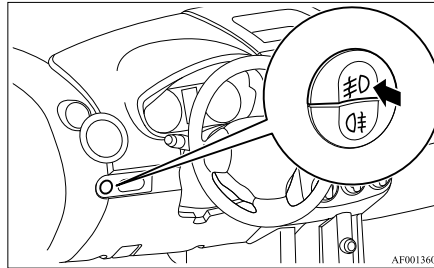

Rear fog lamp switch

E00506900296

The rear fog lamps illuminate only when the headlamps or front fog lamps (if so equipped) turn on. Push the switch to turn on the rear fog lamp, and push the switch again to turn it off.

The indication lamp in the instrument cluster will illuminate while the rear fog lamp is on.

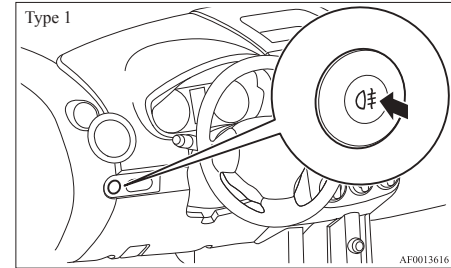

NOTE

- The front fog lamps are automatically turned off when the headlamps and tail lamps turn off. To turn on the front fog lamps again, push the switch again when the headlamps or tail lamps turn on.
- In case of vehicles with Daytime Running Lamp, the front fog lamp can be operated even if the lamp switch is set to the “0” (OFF) position, because the low beam of the headlamps, tail lamps, etc. illuminate when the ignition key is at the “ON” position.

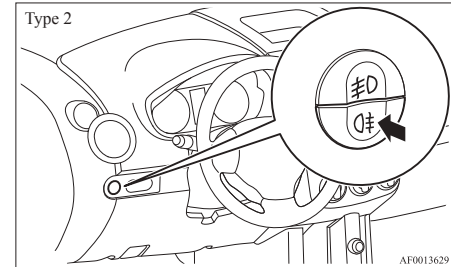

NOTE

- The rear fog lamp is automatically turned off when the headlamps and front fog lamps (if so equipped) turned off. To turn on the rear fog lamp again, push the switch again when the headlamps or front fog lamps (if so equipped) turn on.
- In case of vehicles with Daytime Running Lamp, the rear fog lamp can be operated even if the lamp switch is set to the “0” (OFF) position, because the low beam of the headlamps, tail lamps, etc. illuminate when the ignition key is at the “ON” position.

Wiper and washer switch

E00507101191

CAUTION

- **If the washer is used in cold weather, the washer fluid sprayed against the glass may freeze, which may hinder visibility. Warm the glass with the defroster or rear window demister switch before using the washer.**

Windscreen wipers

E00516900127

Except for vehicle with rain sensor

E00527000072

The windscreen wiper and washer can be operated with the ignition switch in the “ON” or “ACC” position.

If the blades are frozen to the windscreen, do not operate the wipers until the ice has melted and the blades are freed, otherwise the wiper motor may be damaged.

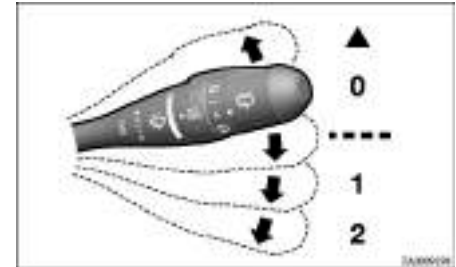

- ▲ Misting function
The wipers will operate once.
- 0 Off
- Intermittent (Speed sensitive)
 - 1- Slow
 - 2- Fast

Instruments and controls

To adjust intermittent intervals

With the lever in the “---” (speed sensitive intermittent operation) position, the intermittent intervals can be adjusted by turning the knob (A).

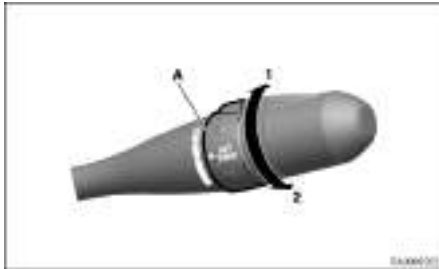

- 1- Fast
- 2- Slow

NOTE

- The speed-sensitive-operation function of the windscreen wipers can be deactivated. For further information, please contact your authorized MITSUBISHI MOTORS dealer.

Misting function

The misting function can be used when the ignition switch is in the “ON” or “ACC” position.

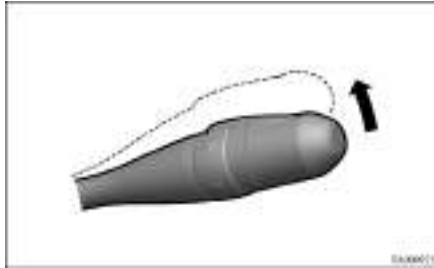

The wipers will operate once if the wiper lever is raised to the “MIST” position and released. This operation is useful when it is drizzling, etc. The wipers will continue to operate while the lever is held in the “▲” position.

Vehicle with rain sensor

E00526400138

The windscreen wipers can be operated with the ignition switch in the “ON” or “ACC” position.

If the blades are frozen to the windscreen, do not operate the wipers until the ice has melted and the blades are freed, otherwise the wiper motor may be damaged.

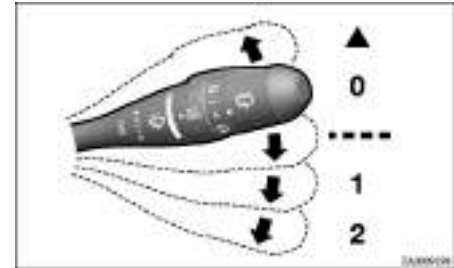

- ▲ Misting function
The wipers will operate once.
- 0 Off
- Auto-wiper control
Rain sensor
The wipers will automatically operate depending on the degree of wetness on the windscreen.
 - 1- Slow
 - 2- Fast

Rain sensor*

Can only be used when the ignition switch is “ON” position.

If the lever is put in the “---” position, the rain sensor (A) will detect the extent of rain (or snow, other moisture, dust, etc.) and the wipers will operate automatically.

Keep the lever in the “0” (OFF) position if the windscreen is dirty and the weather is dry. Wiper operation under these conditions can scratch the windscreen and damage the wipers.

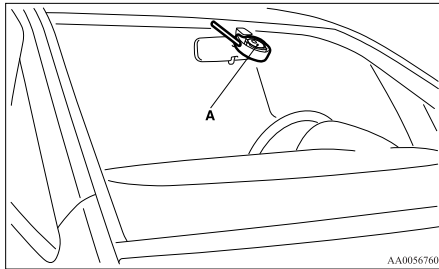

⚠ CAUTION

- **With the ignition switch in the “ON” position and the lever in the “---” position, the wipers may automatically operate in the situations described below. If your hands get trapped, you could suffer injuries or the wipers could malfunction. Be sure to turn the ignition switch to the “OFF” position or move the lever to the “0” (OFF) position to deactivate the rain sensor.**
 - **When cleaning the outside surface of the windscreen, if you touch the rain sensor.**
 - **When cleaning the outside surface of the windscreen, if you wipe with a cloth the rain sensor.**
 - **When using an automatic car wash.**
 - **A physical shock is applied to the windscreen.**
 - **A physical shock is applied the rain sensor.**

NOTE

- To protect the rubber parts of the wipers, this operation of the wipers does not take place when the vehicle is stationary and the ambient temperature is about 5 °C or lower.
- Do not cover the sensor by affixing a sticker or label to the windscreen. Also, do not put any water-repellent coating on the windscreen. The rain sensor would not be able to detect the extent of rain, and the wipers might stop working normally.
- In the following cases, the rain sensor may be malfunctioning. For further information,

please contact your authorized MITSUBISHI MOTORS dealer.

- When the wipers operate at a constant interval despite changes in the extent of rain.
- When the wipers do not operate even though it is raining.
- The wipers may automatically operate when things such as rain, dust, mud, insects, tree sap, oil or salt are affixed to the windscreen on top of the rain sensor or when the windscreen is frozen. (Wrong operation may also occur due to strong electromagnetic waves, etc.) Objects affixed to the windscreen will stop the wipers when the wipers cannot remove them. To make the wipers operate again, place the lever in the “1” or “2” position.
- Contact an authorized MITSUBISHI MOTORS dealer when replacing the windscreen or reinforcing the glass around the sensor.

Instruments and controls

To adjust the sensitivity of the rain sensor

With the lever in the “---” (rain sensor) position, it is possible to adjust the sensitivity of the rain sensor by turning the knob (B).

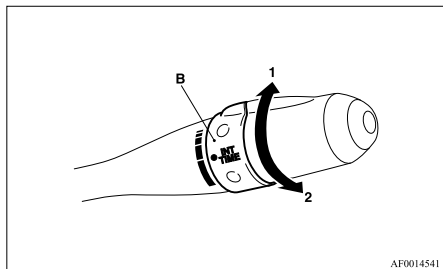

- 1- Higher sensitivity to rain
- 2- Lower sensitivity to rain

NOTE

- It is possible to activate the following functions. For further information, please contact your authorized MITSUBISHI MOTORS dealer.
 - Automatic operation (rain droplet sensitive) can be changed to intermittent operation (vehicle-speed sensitive).
 - Automatic operation (rain droplet sensitive) can be changed to intermittent operation (except vehicle-speed sensitive).

Misting function

Move the lever in the direction of the arrow and release, to operate the wipers once.

Use this function when you are driving in mist or drizzle.

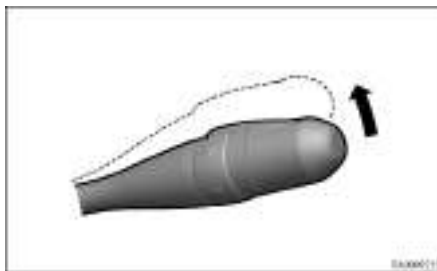

The wipers will operate once if the lever is raised to the “▲” position and released when the ignition switch is in the “ON” or “ACC” position. The wipers will continue to operate while the lever is held in the “▲” position.

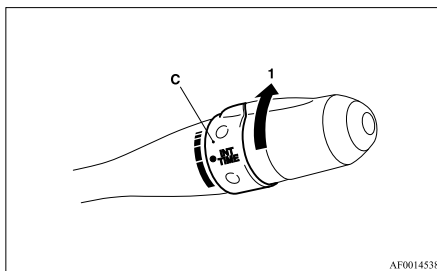

The wipers will operate once if the lever is moved to the “---” position and the knob (C) is turned in the “1” direction when the ignition switch is “ON” position.

Windscreen washer

E00507200342

The windscreen washer can be operated with the ignition switch in the “ON” or “ACC” position. The washer fluid will be sprayed onto the windscreen by pulling the lever towards you. The wipers operate automatically several times while the washer fluid is being sprayed.



⚠ CAUTION

- If the washer is used in cold weather, the washer fluid sprayed against the glass may freeze resulting in poor visibility. Heat the glass with the defroster or demister before using the washer.

NOTE

- It is possible to disable the function that causes the wipers to operate when washer fluid is sprayed. For details, we recommend you to consult a MITSUBISHI MOTORS Authorized Service Point.

Rear window wiper and washer

E00507300532

The rear window wiper and washer switch can be operated with the ignition switch in the “ON” or “ACC” position.
Turn the knob, and the rear window wiper and washer will operate.

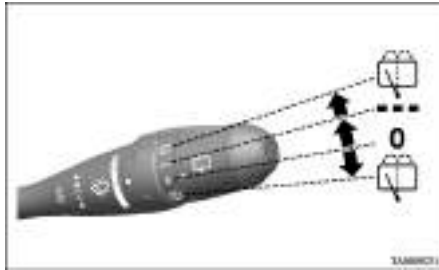

--- The wiper operates continuously for several seconds then operates intermittently at intervals of about every 8 seconds.

0 Off

 The washer fluid will be sprayed onto the rear window when the knob is turned fully in either direction.
The wipers operate automatically several times while the washer fluid is being sprayed.

NOTE

- It is possible to change the behaviour of functions as detailed below. For details, we rec-

ommend you to consult a MITSUBISHI MOTORS Authorized Service Point.

- It is possible to disable the function that causes the wipers to operate every time washer fluid is sprayed.
- It is possible to change the operating interval for intermittent operation of the rear wiper.

Precautions to observe when using wipers and washers

E00507600014

- If the moving wipers become blocked by ice or other deposits on the glass, the motor may burn out even if the wiper switch is turned to OFF. If obstruction occurs, park your vehicle in a safe place, turn off the ignition, and clean the deposits from the glass so that the wipers operate smoothly.
- Do not use the wipers when the glass is dry. They may scratch the glass surface or the blades may prematurely wear out.
- Before using the wipers in cold weather, check that the wiper blades are not frozen onto the glass. The motor may burn out if the wipers are used with the blades frozen onto the glass.
- Avoid using the washer continuously for more than 20 seconds. Do not operate the washer when the fluid reservoir is empty. Otherwise, the motor may burn out.
- Periodically check the level of washer fluid in the reservoir and refill if required. During cold weather, add a recommended washer solution that will not freeze in the washer reservoir. Failure to do so could result in loss of washer function and frost damage to the system components.

Rear window demister switch

E00507900990

The rear window demister switch can be operated with the ignition switch in the “ON” position. Push the switch to turn on the rear window demister. It will be turned off automatically in about 20 minutes. To turn off the demister within about 20 minutes, push the switch again. The indication lamp (A) will illuminate while the demister is on.

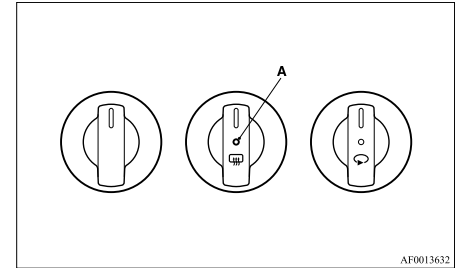

AF0013632

NOTE

- If your vehicle is equipped with heated mirrors, these operate in conjunction with the demister. Refer to “Heated mirror” on page 4-09.

CAUTION

- The demister switch is not to melt snow but to clear mist. Remove snow before use of the demister switch.

⚠ CAUTION

- To avoid unnecessary discharge of the battery, do not use the rear window demister during starting of the engine or when the engine is not running. Turn the demister off immediately after the window is clear.
- When cleaning the inside of the rear window, use a soft cloth and wipe gently along the heater wires, being careful not to damage the wires.
- Do not allow objects to touch the inside of the rear window glass, damaged or broken wires may result.

Horn switch

E00508000581

Pressing the “” mark on the steering wheel, causes the horn to sound.

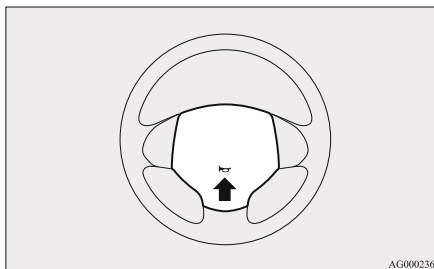

Starting and driving

Economical driving.....	4-02
Driving, alcohol and drugs.....	4-02
Safe driving techniques.....	4-03
Running-in recommendations.....	4-04
Parking brake.....	4-06
Parking.....	4-07
Steering wheel height adjustment.....	4-07
Inside rear-view mirror.....	4-08
Outside rear-view mirrors.....	4-08
Ignition switch.....	4-10
Steering wheel lock.....	4-11
Starting.....	4-11
Auto Stop & Go (AS&G) system*.....	4-13
Manual transmission.....	4-16
Automated manual transmission.....	4-19
How to drive a vehicle with an automated manual trans- mission.....	4-22
Braking.....	4-25
Emergency stop signal system.....	4-26
Brake assist system.....	4-27
Anti-lock brake system (ABS).....	4-27
Electric power steering system.....	4-29
Traction control system (TCL)/Active stability control system (ASC)*.....	4-30
Cruise control*.....	4-32
Cargo loads.....	4-36
Trailer towing.....	4-36

Starting and driving

Economical driving

E00600100763

For economical driving, there are some technical requirements that have to be met. The prerequisite for low fuel consumption is a properly adjusted engine. In order to achieve longer life of the vehicle and the most economical operation, we recommend you to have the vehicle checked at regular intervals in accordance with the service standards.

Fuel economy and generation of exhaust gas and noise are highly influenced by personal driving habits as well as the particular operating conditions. The following points should be observed in order to minimize wear of brakes, tyres and engine as well as to reduce environmental pollution.

Starting

Avoid rapid acceleration and sudden starts; such operation will result in higher fuel consumption.

Shifting

Shift only at an appropriate speed and engine speed. Always use the highest gear possible.

City traffic

Frequent starting and stopping increases the average fuel consumption. Use roads with smooth traffic flow whenever possible. When driving on congested roads, avoid use of a low gear at high engine speeds.

Idling

The vehicle consumes fuel even during idling. Avoid extended idling whenever possible.

Speed

The higher the vehicle speed, the more fuel consumed. Avoid driving at full speed. Even a slight release of the accelerator pedal will save a significant amount of fuel.

Tyre inflation pressure

Check the tyre inflation pressures at regular intervals. Low tyre inflation pressure increases road resistance and fuel consumption. In addition, low tyre pressures adversely affect tyre wear and driving stability.

Load

Do not drive with unnecessary articles in the luggage compartment. Especially during city driving where frequent starting and stopping is necessary, the increased weight of the vehicle will greatly affect fuel consumption. Also avoid driving with unnecessary luggage, etc., on the roof; the increased air resistance will increase fuel consumption.

Cold engine starting

Starting of a cold engine consumes more fuel. Unnecessary fuel consumption is also caused by keeping a hot engine running. After the engine is started, commence driving as soon as possible.

Air conditioning*

The use of the air conditioning will increase the fuel consumption.

Driving, alcohol and drugs

E00600200012

Driving after drinking alcohol is one of the most frequent causes of accidents.

Your driving ability can be seriously impaired even with blood alcohol levels far below the legal minimum. If you have been drinking, don't drive. Ride with a designated non-drinking driver, call a cab or a friend, or use public transportation.

Drinking coffee or taking a cold shower will not make you sober.

Similarly, prescription and nonprescription drugs affect your alertness, perception and reaction time. Consult with your doctor or pharmacist before driving while under the influence of any of these medications.



WARNING

● **NEVER DRINK AND DRIVE.**

Your perceptions are less accurate, your reflexes are slower and your judgment is impaired.

Safe driving techniques

E00600300390

Driving safety and protection against injury cannot be fully ensured. However, we recommend that you pay extra attention to the following:

Seat belts

Before starting the vehicle, make sure that you and your passengers have fastened your seat belts.

Floor mats

⚠ WARNING

- **Keep floor mats clear of the pedals by correctly laying floor mats that are suitable for the vehicle.**

To prevent the floor mats from slipping out position, securely retain them using the hook etc.

Note that laying a floor mat over a pedal or laying one floor mat on top of another can obstruct pedal operation and lead to a serious accident.

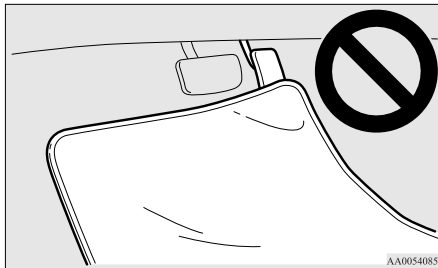

AA0054085

Carrying children in the vehicle

- Never leave your vehicle unattended with the key and children inside the vehicle. Children may play with the driving controls and this could lead to an accident.
- Make sure that infants and small children are properly restrained in accordance with the laws and regulations, and for maximum protection in case of an accident.
- Prevent children from playing in the luggage compartment. It is quite dangerous to allow them to play there while the vehicle is moving.

Loading luggage

When loading luggage, be careful not to load above the height of seats. This is dangerous not only because rearward vision will be obstructed, but also the luggage may be projected into the passenger compartment under hard braking.

Running-in recommendations

E00600402177

During the running-in period for the first 1,000 km (620 miles), it is advisable to drive your new vehicle using the following precautions as a guideline to aid long life as well as future economy and performance.

- Do not race the engine at high speeds.
- Avoid rapid starting, accelerating, braking and prolonged high-speed running.
- Keep to the running-in speed limit shown below.
Please note that the legal speed limits displayed must be adhered to.
- Do not exceed loading limits.
- Refrain from towing a trailer.

Vehicles with manual transmission

Shift point	Speed limit			
	1100 models		1300 models	
	Engine model 134910	Engine model 3A91	Engine model 135930	Engine model 4A90
1 st gear	30 km/h (19 mph)	30 km/h (19 mph)	30 km/h (19 mph)	35 km/h (22 mph)
2 nd gear	50 km/h (30 mph)	55 km/h (34 mph)	55 km/h (34 mph)	60 km/h (37 mph)
3 rd gear	80 km/h (50 mph)	85 km/h (53 mph)	85 km/h (53 mph)	90 km/h (56 mph)
4 th gear	110 km/h (68 mph)	115 km/h (71 mph)	115 km/h (71 mph)	125 km/h (78 mph)
5 th gear	135 km/h (84 mph)	140 km/h (87 mph)	140 km/h (87 mph)	155 km/h (96 mph)

Shift point	Speed limit	
	1500 models	
1 st gear	35 km/h (22 mph)	
2 nd gear	65 km/h (40 mph)	
3 rd gear	90 km/h (56 mph)	
4 th gear	120 km/h (74 mph)	
5 th gear	150 km/h (93 mph)	

NOTE

- The engine model is indicated on the vehicle information code plate.
Refer to “Vehicle information code plate” on page 9-02.

Vehicles with automated manual transmission

Shift point	Speed limit
1 st gear	30 km/h (19 mph)
2 nd gear	50 km/h (30 mph)
3 rd gear	80 km/h (50 mph)
4 th gear	105 km/h (65 mph)
5 th gear	130 km/h (81 mph)
6 th gear	155 km/h (96 mph)

Starting and driving

Parking brake

E00600501588

To park the vehicle, first bring it to a complete stop, fully apply the parking brake lever sufficiently to hold the vehicle.

To apply the parking brake

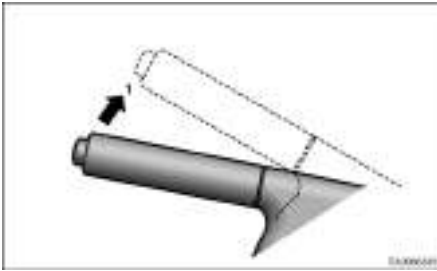

- 1- Firmly depress and hold the brake pedal, then pull the lever up without pushing the button at the end of hand grip.

⚠ CAUTION

- When you intend to apply the parking brake, firmly press the brake pedal to bring the vehicle to a complete stop before pulling the parking brake lever. Pulling the parking brake lever with the vehicle moving could make the rear wheels lock up, thereby making the vehicle unstable. It could also make the parking brake malfunction.

NOTE

- Apply sufficient force to the parking brake lever to hold the vehicle stationary after the foot brake is released.
- If the parking brake does not hold the vehicle stationary after the foot brake is released, have your vehicle checked immediately.

To release the parking brake

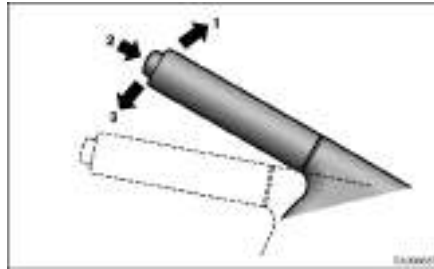

- 1- Firmly depress and hold the brake pedal, then pull the lever up slightly.
- 2- Push the button at the end of hand grip.
- 3- Lower the lever fully.

⚠ CAUTION

- Before driving, be sure that the parking brake is fully released and brake warning lamp is off. If a vehicle is driven without releasing the parking brake, the brake will be overheated, resulting in ineffective braking and possible brake failure.

⚠ CAUTION

- If the brake warning lamp does not extinguish when the parking brake is fully released, the brake system may be abnormal. Have your vehicle checked immediately. For details, refer to “Brake warning lamp” on page 3-17.

Parking

E00600601521

Parking on a hill

To prevent the vehicle from rolling, follow these procedures:

Parking on a downhill slope

Turn the front wheels towards the kerb and move the vehicle forward until the kerb side wheel gently touches the kerb.

Apply the parking brake and place the gearshift lever into the “R” (Reverse) position (with manual transmission) or the allshift lever into the “R” (Reverse) position (with automated manual transmission).

If necessary, apply chocks to wheels.

Parking on an uphill slope

Turn the front wheels away from the kerb and move the vehicle back until the kerb side wheel gently touches the kerb.

Apply the parking brake and place the gearshift lever into the 1st position (with manual transmission) or the allshift lever into the “S” (Stand by) position (with automated manual transmission).

If necessary, apply chocks to wheels.

NOTE

- If your vehicle has an automated manual transmission, place the allshift lever in the “S” (Stand by) position or “R” (Reverse) position before stopping the engine.
If you move the allshift lever after stopping the engine, a gearshift will not take place.

Parking with the engine running

Never leave the engine running while you take a short sleep/rest. Also, never leave the engine running in a closed or poorly ventilated place.

⚠ WARNING

- Leaving the engine running risks injury or death from accidentally moving the gearshift lever (manual transmission) or the allshift lever (automated manual transmission) or the accumulation of toxic exhaust fumes on the passenger compartment.

Where you park

Your front bumper can be damaged if you scrape it over kerbs or parking stop blocks. Be careful when travelling up or down steep slopes where your bumper can scrape the road.

⚠ WARNING

- Do not park your vehicle in areas where combustible materials such as dry grass or leaves can come in contact with a hot exhaust, since a fire could occur.

When leaving the vehicle

Always remove the key from the ignition switch and lock all doors and the tailgate when leaving the vehicle unattended.

Always try to park your vehicle in a well lit area.

Steering wheel height adjustment

E00600700466

To adjust the steering wheel height, release the tilt lock lever while holding the steering wheel by hand, and raise or lower the steering wheel to the desired height.

After adjustment, securely lock the lever by pulling it upward.

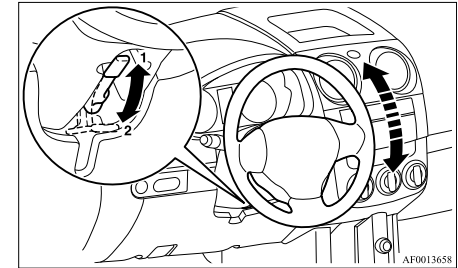

- 1- Locked
- 2- Release

⚠ WARNING

- After adjusting to the desired height, check to be sure that the lever is locked.
- Do not attempt to adjust the steering wheel while you are driving the vehicle.
- When releasing the tilt lock lever, move it to the release position (2) and hold the steering wheel by hand to prevent it falling to the lowest position.

Starting and driving

Inside rear-view mirror

E00600800047

The lever (A) at the bottom of the mirror can be used to adjust the mirror to reduce the glare from the headlamps of vehicles behind you during night driving.

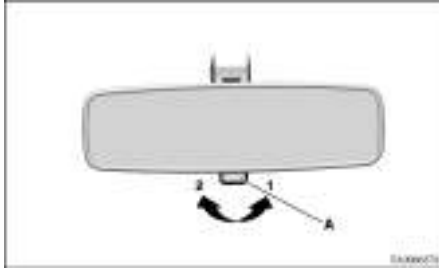

- 1- Normal
- 2- Anti-glare

⚠ WARNING

- Do not attempt to adjust the rear-view mirrors while driving. This can be dangerous. Always adjust the mirrors before driving.

Outside rear-view mirrors

E00600900042

Compound curved-surface mirror (LHD vehicles only)

On the driver's seat side, a compound curved-surface mirror is used, while on the front passenger's seat side, a single curved-surface mirror is used.

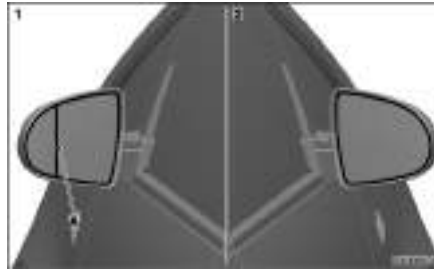

- 1- Compound curved-surface mirror
- 2- Single curved-surface mirror

While the single curved-surface mirror has a fixed curvature, the compound curved-surface mirror has different curvatures between the inner and outer sides of the boundary line (A).

The inner side of the boundary line provides the same vision as that available from an ordinary door mirror.

However, the outer side of the boundary line provides a wider vision than an ordinary door mirror.

⚠ WARNING

- The sense of distance that you get from an object you see on the inner side of the mirror boundary line differs from the sense of distance that you get from an object you see on the outer side. An object you see on the outer side of the boundary line of the mirror will look farther away than actually is (farther away than if you see in a normal flat mirror) as compared with an object you see on the inner side.

To adjust the mirror position

E00601000570

⚠ WARNING

- Do not attempt to adjust the rear-view mirrors while driving. This can be dangerous. Always adjust the mirrors before driving.
- Your vehicle is equipped with convex type mirrors. Please take into consideration. Objects you see in the mirror will look smaller and farther away compared to a normal flat mirror. Do not use this mirror to estimate distance of following vehicles when changing lanes.

Manual remote-controlled outside rear-view mirrors*

Adjust the mirror position by operating the lever as indicated by the arrows.

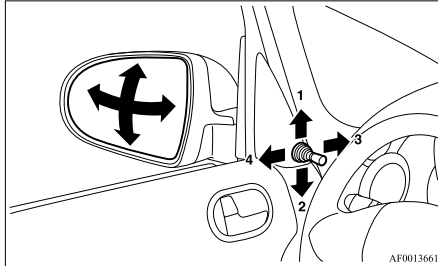

- 1- Up
- 2- Down
- 3- Right
- 4- Left

Electric remote-controlled outside rear-view mirrors*

E0061090054

The electric remote-controlled outside rear-view mirrors can be operated when the ignition switch is in the "ON" or "ACC" position.

1. Turn the switch to the same side as the mirror whose adjustment is desired.

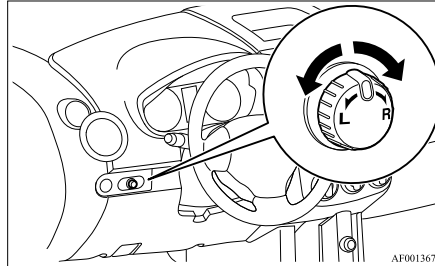

- L- Left outside mirror adjustment
- R- Right outside mirror adjustment

NOTE

- After adjustment, return the switch to centre position.

2. Adjust the mirror by moving the switch left, right, up or down.

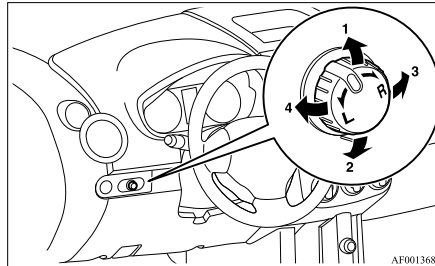

- 1- Up
- 2- Down
- 3- Right
- 4- Left

To fold the mirror

E00601100454

The outside mirror can be folded in towards the side window to prevent damage when parking in narrow areas.

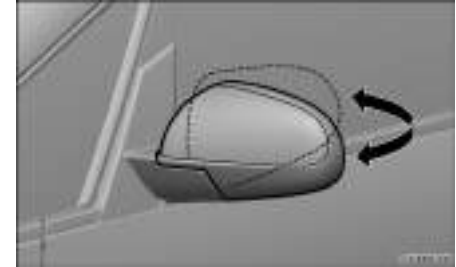
**Heated mirror***

E00601200413

When the rear window demister switch is pressed, the outside rear-view mirrors are demisted or defrosted. Current will flow through the heater element inside the mirrors, thus clearing away frost or condensation.

Starting and driving

The indication lamp (A) will illuminate while the demister is on. The heater will be turned off automatically in about 20 minutes.

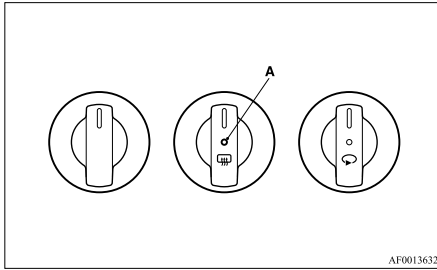

Ignition switch

E00601401500

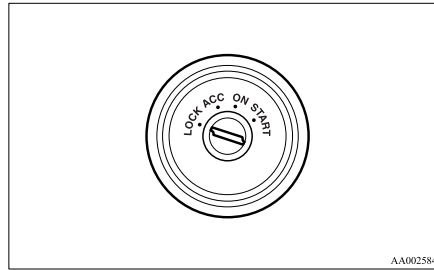

LOCK

The engine is stopped and the steering wheel locked. The key can only be inserted and removed only when the switch is in this position

ACC

The engine is stopped, but the radio, accessory socket and other electric devices can be operated.

ON

The engine is running, and all the vehicle's electrical devices can be operated.

START

The starter motor operates. After the engine has started, release the key and it will automatically return to the "ON" position.

NOTE

- For vehicles equipped with the Daytime Running Lamp, when the ignition switch is in the "ON", the headlamp low beams etc. are turned on. Refer to "Headlamps" on page 8-25.
- Your vehicle is equipped with an electronic immobilizer, to start the engine, the ID code which the transponder inside the key sends must match the one registered to the immobilizer computer. Refer to page 1-02.

To remove the key

When removing the key, turn the key to "LOCK" position and remove it.

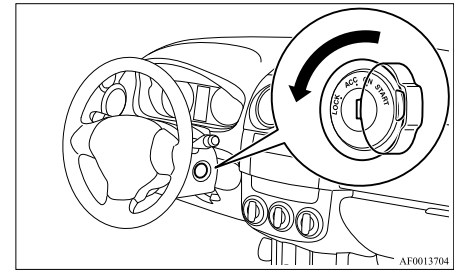

CAUTION

- Do not remove the ignition key from the ignition switch while driving. The steering wheel will locked, causing loss of control.

⚠ CAUTION

- If the engine is stopped while driving, the brake servomechanism will cease to function and braking efficiency will deteriorate. Also, the power steering system will not function and it will require greater manual effort to operate the steering.
- Do not leave the key in the “ON” position for a long time when the engine is not running, doing so will cause the battery to be discharged.
- Do not turn the key to the “START” position when the engine is running, doing so could damage the starter motor.

Steering wheel lock

E00601500605

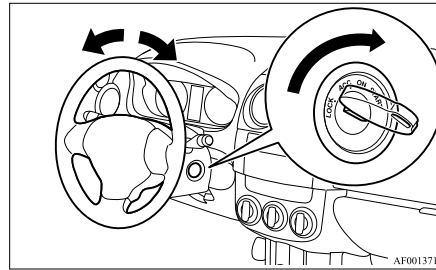

To lock

Remove the key at the “LOCK” position. Turn the steering wheel until it is locked.

To unlock

Turn the key to the “ACC” position while moving the steering wheel slightly.

⚠ CAUTION

- Remove the key when leaving the vehicle.

NOTE

- If the front wheels are turned, the anti-theft lock may sometimes make it difficult to turn the key from “LOCK” to “ACC”. Firmly turn the steering wheel to the left or to the right as you turn the key.

Starting

E00601601007

Tips for starting

- Do not operate the starter motor continuously longer than 10 seconds; doing so could run down the battery. If the engine does not start, turn the ignition switch back to “LOCK”, wait a few seconds, and then try again. Trying repeatedly with the starter motor still turning will damage the starter mechanism.
- If the engine cannot be started because the battery is weak or dead, refer to the “Emergency starting” section for instructions on starting the engine.
- The engine is well warmed up with the engine speed decreases. Extended warming-up operation will result in excessive fuel consumption.

⚠ WARNING

- Never run the engine in a closed or poorly ventilated area any longer than is needed to move your vehicle in or out of the area. Carbon monoxide gases are odourless and can be fatal.

⚠ CAUTION

- Never attempt to start the engine by pushing or pulling the vehicle. This can be very dangerous.

Starting and driving

⚠ CAUTION

- Do not run the engine at high rpm or drive the vehicle at high speed until the engine has had a chance to warm up.
- Release the ignition key as soon as the engine starts to avoid damaging the starter motor.
- If your vehicle is equipped with a turbocharger, do not stop the engine immediately after high-speed or uphill driving. First allow the engine to idle to give the turbocharger a chance to cool down.

Starting the engine

E00601702005

This vehicle is equipped with an electronically controlled fuel injection system which is automatically controlled. When starting the engine, do not depress the accelerator pedal.

The starting procedure is as follows:

Vehicles with manual transmission

1. Insert the ignition key and fasten the seat belt.
2. Make sure the parking brake is applied.
3. Depress and hold the brake pedal.
4. Fully depress the clutch pedal.

5. Place the gearshift lever in the “N” (Neutral) position.



6. Turn the ignition key to the “ON” position and make certain that all warning lamps are functioning properly before starting the engine.
7. Turn the ignition key to the “START” position without depressing the accelerator pedal, and release it when the engine starts.

NOTE

- A ticking noise may be heard after starting the engine. This is not an abnormal condition. The noise will disappear after a short time of engine running. If the ticking noise continues after the engine is warmed up, we recommend you to have your vehicle checked.

Vehicles with automated manual transmission

1. Insert the ignition key and fasten the seat belt.
2. Make sure the parking brake is applied.
3. Depress and hold the brake pedal.

4. Turn the ignition key to the “ON” position and make certain that all warning lamps are functioning properly.
5. Place the allshift lever in the “N” (Neutral) position and confirm that “N” is shown by the multi-information display. Refer to “Moving the allshift lever” on page 4-21.

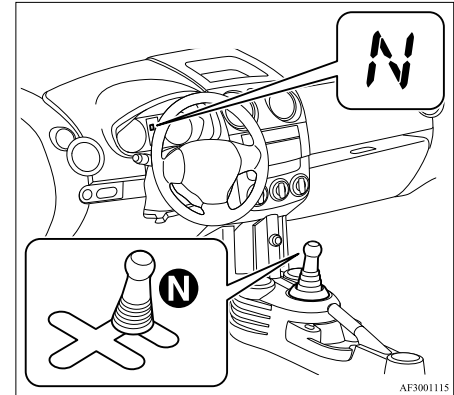

6. Turn the ignition key to the “START” position without depressing the accelerator pedal, and release it when the engine starts.

NOTE

- For safety, the vehicle is designed so that the engine will not start unless the allshift lever is in the “N” (Neutral) position. Place the allshift lever in the “N” (Neutral) position before starting the engine.

- If you turn the ignition key to the “START” position when the gearshift is not in the “N” (Neutral) position, the multi-information display will behave as follows to indicate that the engine will not start.
 - Gearshift in “S” (Stand by) position: An “A” or “1” will be shown. Or “0” will flash.
 - Gearshift in “R” (Reverse) position: An “R” will be shown. Or “0” will flash.

Confirm that “N” is shown by the multi-information display.

Auto Stop & Go (AS&G) system*

E00627400022

The Auto Stop & Go (AS&G) system automatically stops and restarts the engine without operating the ignition switch when the vehicle is stopped, such as at a traffic light or in a traffic jam, to reduce exhaust gases, increase fuel efficiency.

CAUTION

- If the vehicle will be stopped for a long time or if you will leave the vehicle unattended, turn the ignition switch to the “LOCK” position to stop the engine.

Automatically stopping the engine

E00627500010

The Auto Stop & Go (AS&G) system is automatically activated when the ignition switch is turned to the “ON” position.

You can deactivate the system by pressing the “Auto Stop & Go (AS&G) OFF” switch.

Refer to “To deactivate” on page 4-16.

1. Stop the vehicle.

Starting and driving

While depressing the brake pedal, fully depress the clutch pedal and place the gearshift lever in the “N” (Neutral) position.

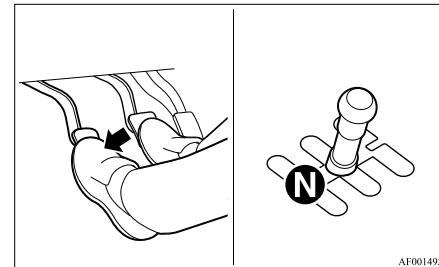

2. Release the clutch pedal. The “AS&G” indication lamp in the meter will illuminate and the engine will stop automatically.

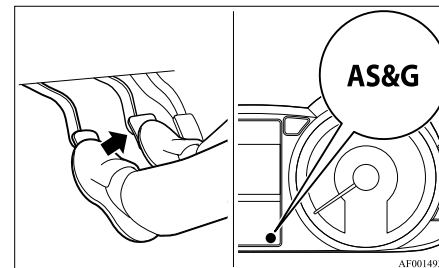

Starting and driving

NOTE

- Under normal conditions, the “AS&G” indication lamp will also illuminate for a few seconds when the ignition switch is turned to the “ON” position.
- The brake booster becomes inoperative and the pedal effort will increase when the engine is stopped automatically. If the vehicle is moving, press down the brake pedal harder than usual.

CAUTION

- Observe the following precautions when the engine is stopped automatically. Otherwise, an unexpected accident might occur when the engine restarts automatically.
 - Do not depress the accelerator pedal to race the engine while the vehicle is stopped (regardless of whether the engine is running or stopped). Otherwise, an unexpected accident might occur when the engine restarts automatically.

CAUTION

- Do not leave the driver’s seat or open the bonnet.
If the driver’s seat belt is unfastened or if the bonnet is opened, the “AS&G” indication lamp will blink to inform the driver. If this occurs, the engine will not restart automatically even if the clutch pedal is depressed, the seat belt is refastened, and the bonnet is closed. While depressing the brake pedal, fully depress the clutch pedal and turn the ignition switch to the “START” position to start the engine. For details, refer to “Starting the engine” on page 4-12.
- Do not move the gearshift lever to a position other than the “N” (Neutral) position.
If the gearshift lever is moved to a position other than the “N” (Neutral) position, the “AS&G” indication lamp blinks and the buzzer sounds.
If the gearshift lever is returned to the “N” (Neutral) position, the lamp stops blinking and the buzzer stops sounding. The engine will not restart if the gearshift lever is in a position other than the “N” (Neutral) position.

NOTE

- In the following cases, the Auto Stop & Go (AS&G) system will not operate and the engine will not stop automatically even if the vehicle is stopped.
 - Driver’s seat belt is not fastened

- Bonnet is open
- After the engine restarts automatically, the vehicle speed has not exceeded approximately 5 km/h (3 mph)
- Brake booster vacuum pressure is low because the brake pedal is depressed repeatedly or depressed harder than usual
- After the ignition switch is turned from the “LOCK” position to the “START” position, approximately 3 minutes or more have not elapsed
- After the ignition switch is turned from the “ON” position to the “START” position, approximately 30 seconds or more have not elapsed.
- After the engine restarts automatically, the vehicle stops again within 10 seconds
- Engine coolant temperature is low
- Ambient temperature is lower than approximately 3°C
- Air conditioner is operating and passenger compartment has not sufficiently cooled (for vehicles with automatic air conditioning)
- Mode selection dial is set to the demister position (for vehicles with automatic air conditioning)
Refer to “For quick demisting” on page 5-10.
- Electric power consumption is high, such as when the rear window demister or other electrical components are operating or the blower speed is set to a high setting
- Battery voltage or battery performance is low
- Check engine warning lamp is illuminated or the “AS&G” indication lamp is blinking

[For vehicles with automatic air conditioning]

- If the Auto Stop & Go (AS&G) system operates while the air conditioner is operating, both the engine and the air conditioning compressor will stop. Therefore, only the blower will operate.
- If air is flowing from the demister and the engine is stopped automatically, it is recommended to set the mode selection dial to the Demister/Face or Foot/Demister position. Refer to “Changing the mode selection” on pages 5-02, 5-02.
- If the air conditioner is operating, set the temperature control dial to 22°C or higher to lengthen the time that the engine is stopped automatically.
- If the air conditioner is operating when the ambient temperature is high, such as during the summer, change the air selection from outside air to recirculated air to lengthen the time that the engine is stopped automatically.

Automatically restarting the engine

E00627600066

Depress the clutch pedal while the gearshift lever is in the “N” (Neutral) position. The “AS&G” indication lamp in the meter turns off and the engine restarts automatically.

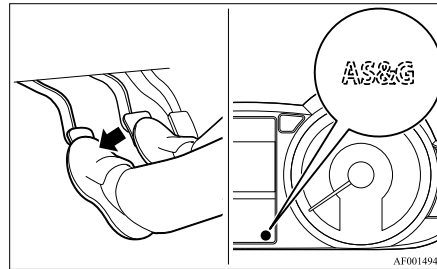

NOTE

- If the engine does not restart automatically or if the engine stalls, the oil pressure warning lamp, charge warning lamp, and check engine warning lamp will illuminate. If this occurs, the engine will not restart even if the clutch pedal is depressed again. While depressing the brake pedal, fully depress the clutch pedal and turn the ignition switch to the “START” position to start the engine. For details, refer to “Starting the engine” on page 4-12.

CAUTION

- In the following cases, the engine will restart automatically even if the engine was stopped by the Auto Stop & Go (AS&G)

CAUTION

system. Pay attention, otherwise an unexpected accident might occur when the engine restarts.

- Vehicle speed is 3 km/h (2 mph) or higher when coasting down a slope
- Brake booster vacuum pressure is low because the brake pedal is depressed repeatedly or depressed harder than usual
- Steering wheel is turned
- Engine coolant temperature is low
- When the air conditioner is ON, the passenger compartment temperature rises and the air conditioning compressor operates to lower the temperature (for vehicles with automatic air conditioning)
- Mode selection dial is set to the demister position (for vehicles with automatic air conditioning)
Refer to “For quick demisting” on page 5-10.
- Electric power consumption is high, such as when the rear window demister or other electrical components are operating or the blower speed is set to a high setting.

NOTE

- If the “Auto Stop & Go (AS&G) OFF” switch is pressed to deactivate the Auto Stop & Go (AS&G) system while the engine is stopped automatically, the engine will not restart automatically even if the clutch pedal is depressed.

Starting and driving

To deactivate

E00627700012

The Auto Stop & Go (AS&G) system is automatically activated when the ignition switch is turned to the "ON" position. You can deactivate the system by pressing the "Auto Stop & Go (AS&G) OFF" switch.

When the Auto Stop & Go (AS&G) system is deactivated, the "AS&G OFF" indication lamp will be illuminated in the meter.

To reactivate the Auto Stop & Go (AS&G) system, press the "Auto Stop & Go (AS&G) OFF" switch; the indication lamp will turn off.

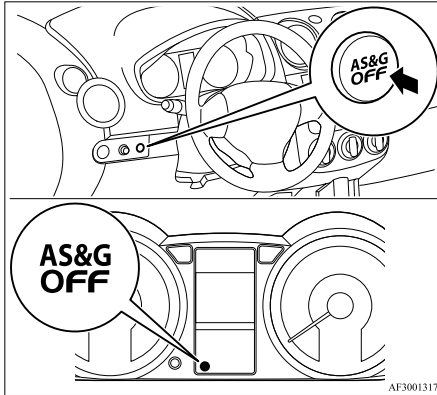

NOTE

- This lamp will also illuminate for a few seconds when the ignition switch is turned to the "ON" position.

If the ^{AS&G}OFF indication lamp blinks while driving

E00627800026

If the "^{AS&G}OFF" indication lamp blinks, the Auto Stop & Go (AS&G) system is malfunctioning and will not operate.

We recommend you to consult a MITSUBISHI MOTORS Authorized Service Point.

Manual transmission

E00602000232

The shift pattern is shown on the gearshift lever knob. Be sure to always fully depress the clutch pedal before attempting to shift the lever.

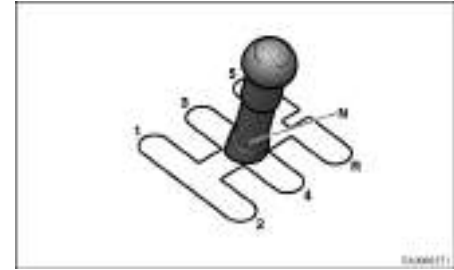

⚠ CAUTION

- Do not move the gearshift lever into reverse while the vehicle is moving forward; doing so will damage the transmission.
- Do not rest your foot on the clutch pedal while driving as this will cause premature clutch wear or damage.

NOTE

- If it is hard to shift into 1st, depress the clutch pedal again; the shift will then be easier to make.
- To shift into reverse from 5th gear, move the gearshift lever to the "N" (Neutral) position, and then shift it into reverse.

- To avoid grinding noises when shifting into reverse, wait approximately 3 seconds with the clutch depressed when the vehicle is stationary.

Changing gears

E00610600240

Always take care to change the gear with the vehicle speed matched to the engine speed. Proper shifting will improve fuel economy and prolong engine life.

Avoid shifting down at high speed, as this may cause excessive engine speed (the tachometer needle into the red zone) and damage the engine.

NOTE

- The gearshift indicator (if so equipped) shows recommended gearshift points for fuel-efficient driving. It shows a “↑” when an upshift is recommended, and it shows a “↓” when a downshift is recommended.

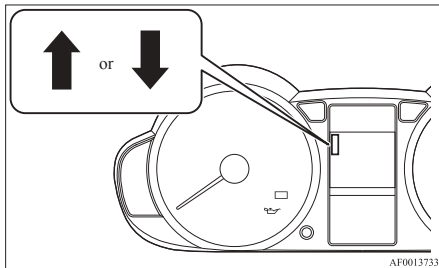

Possible driving speed

E00610801311

Shift point	Speed limit			
	1100 models		1300 models	
	Engine model 134910	Engine model 3A91	Engine model 135930	Engine model 4A90
1 st gear	45 km/h (28 mph)	45 km/h (28 mph)	45 km/h (28 mph)	50 km/h (30 mph)
2 nd gear	80 km/h (50 mph)	85 km/h (53 mph)	85 km/h (53 mph)	90 km/h (56 mph)
3 rd gear	120 km/h (74 mph)	130 km/h (81 mph)	130 km/h (81 mph)	140 km/h (87 mph)
4 th gear	165 km/h (102 mph)	170 km/h (106 mph)	170 km/h (106 mph)	185 km/h (115 mph)

Shift point	Speed limit	
	1500 models	
1 st gear	50 km/h (30 mph)	
2 nd gear	95 km/h (59 mph)	
3 rd gear	135 km/h (84 mph)	
4 th gear	180 km/h (112 mph)	

5th gear is an overdrive ratio and its use reduces engine speed below that of the 4th gear. Use 5th gear whenever vehicle speed allows, for maximum fuel economy.

NOTE

- The engine model is indicated on the vehicle information code plate. Refer to “Vehicle information code plate” on page 9-02.

Automated manual transmission

E00612500038

An automated manual transmission is a transmission in which operation of the clutch and shifting of gears are performed automatically under electronic control. The transmission has 6 forward gears and 1 reverse gear.

It is possible to choose between an automatic mode and a manual mode by using the allshift lever (A).

- Manual mode: The driver effects gearshifts using the allshift lever, and the clutch is controlled automatically.
- Automatic mode: Gearshifts take place automatically in accordance with the vehicle speed, and the clutch is controlled automatically.



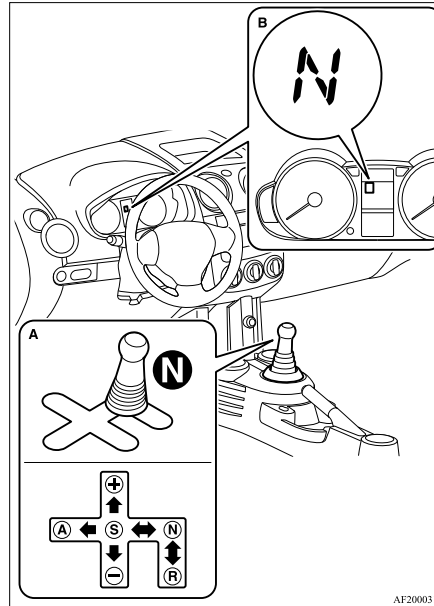



The currently selected shift position, manual mode or automatic mode is indicated on the multi-information display (B).



AF2000313

Allshift lever position and multi-information display

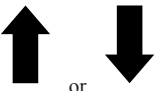
E0061260055

Multi-information display	Allshift lever position		Description		
	N (Neutral)		Power is not transmitted. This is the only position where the engine can be started.		
	R (Reverse)		This position is used for reversing.		
	S (Stand by)	automatic mode*	Gearshifts are performed automatically at all vehicle speeds (from a standing start right up to highway speeds).		
		manual mode*	+ (UP SHIFT)	Shift up	Gearshifts can be performed from 1 st gear to 6 th gear using the allshift lever.
		- (DOWN SHIFT)	Shift down		
	S (Stand by)		The indicator shows the recommended gearshift points for fuel-efficient driving.		
	N (Neutral) or R (Reverse) or S (Stand by)		If you do not depress the brake pedal when moving the selector lever from the “N” (Neutral) position to the “S” (Stand by) position (or vice versa) or from the “N” (Neutral) position to the “R” (Reverse) position (or vice versa), the indicator will show that a gearshift has not taken place.		

*: When the allshift lever is moved from the “S” (Stand by) position to the “A” (Auto) position, the transmission switches to the automatic mode or to the manual mode.

Moving the allshift lever

E00612700014

The allshift lever is operated as follows;

Moving the allshift lever between “N” (Neutral) position ↔ “S” (Stand by) position, “N” (Neutral) position ↔ “R” (Reverse) position

E00613700053

1. Bring the vehicle to a complete stop.
2. While depressing the brake pedal, place the allshift lever in the “S” (Stand by) position, “R” (Reverse) position or “N” (Neutral) position.

The multi-information display will be shown as follows;

- “S” (Stand by) position: “A” (automatic mode) or “1” (manual mode)
- “R” (Reverse) position: “R”
- “N” (Neutral) position: “N”

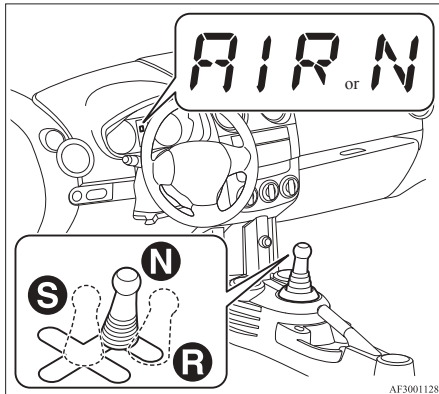

NOTE

- You must have the brake pedal firmly depressed when moving the allshift lever. If you only move the allshift lever (without depressing the brake pedal), a gearshift will not take place. At this time, a “0” will appear on the multi-information display to show that a gearshift has not taken place. Depress the brake pedal to cause the gearshift to take place. The multi-information display will show the selected gearshift position.

Choosing between automatic mode and manual mode

E00612800057

Whether the vehicle is stationary or in motion, choosing between automatic mode and manual mode is allowed.

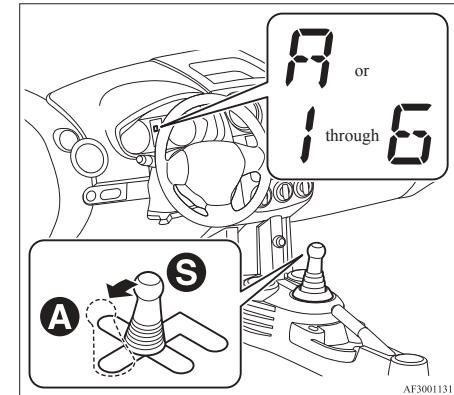

NOTE

- When you turn the ignition switch to the “ACC” or “LOCK” position, the mode selection used until that moment will be erased. When you subsequently turn the ignition switch to the “ON” position, a mode will automatically be selected as a manual mode.

Starting and driving

Performing gearshifts (manual mode)

E00612900061

1. Choose the manual mode using the allshift lever. Refer to “Choosing between automatic mode and manual mode” on page 4-21.
2. While holding the accelerator pedal steady, move the allshift lever in the + (UP SHIFT) or - (DOWN SHIFT) direction. The currently selected gear is indicated on the multi-information display.

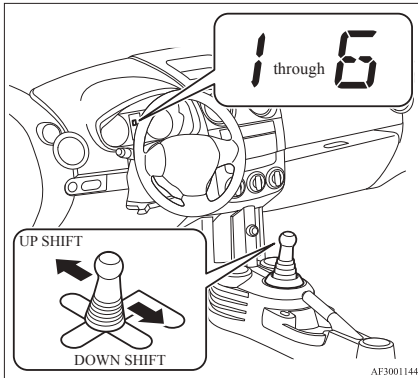

+ (UP SHIFT)

Push the allshift lever forward once to shift up one gear.

- (DOWN SHIFT)

Push the allshift lever backward once to shift down one gear.

⚠ CAUTION

- To maintain good running performance, the transmission may refuse to perform an upshift when the allshift lever is moved to the “+ (SHIFT UP)” position at certain vehicle speeds. Also, to prevent overrevving of the engine, the lever is moved to the “- (SHIFT DOWN)” position at certain vehicle speeds.
- Hard engine braking and sharp acceleration can cause the tyres to slip on the road surface. Perform downshifts in a manner appropriate for the current road conditions and vehicle speed.

NOTE

- During vehicle operation, the transmission automatically shifts down when the vehicle speed decreases. It selects 1st gear just before the vehicle reaches a standstill.

How to drive a vehicle with an automated manual transmission

E00613000014

Starting from a standstill

E00613100060

1. Depress the brake pedal with your right foot.
2. Place the allshift lever in the “S” (Stand by) position if you wish to drive forward and in the “R” (Reverse) position if you wish to reverse. Confirm that either an “A”, a “1” or an “R” is shown by the multi-information display.

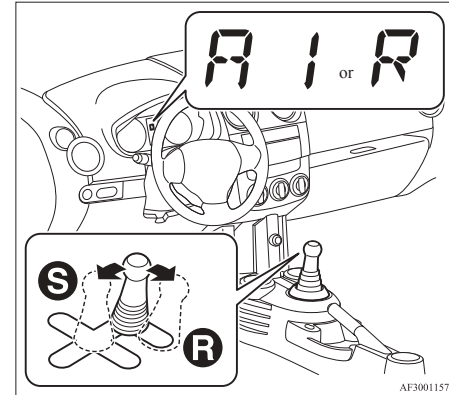

NOTE

- If the brake pedal is not depressed when the allshift lever is moved, a gearshift will not take place. At this time, the driver is notified by a “0” on the multi-information display. Depress the brake pedal to cause the gearshift to take place. The multi-information display will show the selected gearshift position.
3. Choose between the automatic mode and manual mode with the allshift lever. Refer to “Choosing between automatic mode and manual mode” on page 4-21.
 4. Confirm safety around the vehicle, then release the parking brake.
 5. Start moving by gradually easing off the brake pedal while gently applying pressure to the accelerator pedal.

NOTE

- When driving away on a slippery road, push the allshift lever forward into the “+ (UP SHIFT)” position from the “S” (Stand by) position. This causes the transmission to shift into the 2nd gear which is better for smooth driving away on a slippery road. At this time, the multi-information display shows “2”. Push the allshift lever to the “- (DOWN SHIFT)” side to shift back to the 1st gear.

Starting from a standstill on an uphill slope

1. To prevent unwanted movement of the vehicle, release the brake pedal while leaving the parking brake applied.
2. Gently apply pressure to the accelerator pedal. As you feel the vehicle starts to move, release the parking brake and pull away.

CAUTION

- **When pulling away from a standstill on an uphill slope, be sure to start with the parking brake applied. If you released the brake pedal without the parking brake applied, therefore, the vehicle would roll backward, possibly causing an accident.**

Driving

E00613200058

WARNING

- **Never move the allshift lever to the “N” (NEUTRAL) position while driving. A serious accident could occur since you will lose engine braking.**

Automatic mode

Drive with the allshift lever in the “S” (Stand by) position. Gearshifts will take place automatically in accordance with the vehicle speed.

Manual mode

Select appropriate gears using the allshift lever. Always select the gear that suits the speed at which you wish to drive.

NOTE

- When “↑” and the allshift lever position display are flashing alternately, an upshift is recommended. When “↓” and the allshift lever position display are flashing alternately, a downshift is recommended.

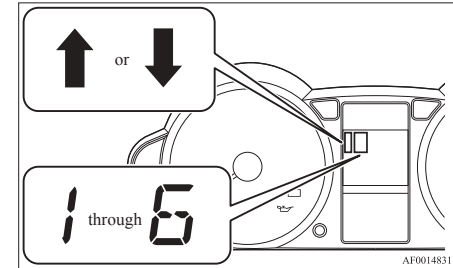
**Passing acceleration**

- Automatic mode: Depress the accelerator pedal to the floor.
- Manual mode: Use the allshift lever to shift to an appropriate gear before depressing the accelerator pedal to accelerate.

Driving downhill

When driving downhill, shift down to an appropriate gear in order to use engine braking. On long downward slopes, repeated use of the brake pedal can cause the brake system to overheat, resulting in reduced braking performance. Be sure to use engine braking as well as the brake system.

Starting and driving

⚠ WARNING

- **Hard engine braking can cause the tyres to slip on the road surface, possibly leading to a serious accident.**

Waiting

E00613300059

1. With the allshift lever in the “S” (Stand by) position, firmly depress the brake pedal.
2. If necessary, apply the parking brake.

⚠ CAUTION

- **On an uphill slope, the transmission’s creep effect may not stop the vehicle from rolling backward if the brakes are not applied. There is no creep effect while 2nd gear is selected. When stopping, be sure to depress the brake pedal and securely apply the parking brake.**
- **Do not attempt to hold the vehicle in place on an uphill road in 1st gear by depressing on the accelerator pedal. The transmission could malfunction if you do.**

3. When you are stationary for a long period (for example, when stuck in a traffic jam), place the allshift lever in the “N” (Neutral) position.

⚠ CAUTION

- **Continue to pay attention to the vehicle while stationary. If you allow your attention to wander and the allshift lever is in any position other than “N” (Neutral), the vehicle could move suddenly and unexpectedly.**

4. When you are ready to start moving again, first confirm that the allshift lever is in the “S” (Stand by) position or “R” (Reverse) position and that an “A”, “1”, or “R” is shown on the multi-information display.

NOTE

- During vehicle operation, the transmission automatically shifts down when the vehicle speed decreases. It selects 1st gear just before the vehicle reaches a standstill.

⚠ CAUTION

- **The actions described below cause rapid clutch wear and can cause clutch damage. Do not perform them.**
 - **Depressing the brake and accelerator pedals at the same time.**
 - **Holding the vehicle in place on an uphill road by depressing the accelerator pedal (and not depressing the brake pedal) with 1st gear selected.**

Parking

E00613400034

1. Bring the vehicle to a complete stop.

2. While depressing the brake pedal, securely apply the parking brake.
3. Move the allshift lever into the “S” (Stand by) position when parking on an uphill grade, into the “R” (Reverse) position when parking on a downhill grade. And confirm that there is an “A”, “1” or “R” in the multi-information display.

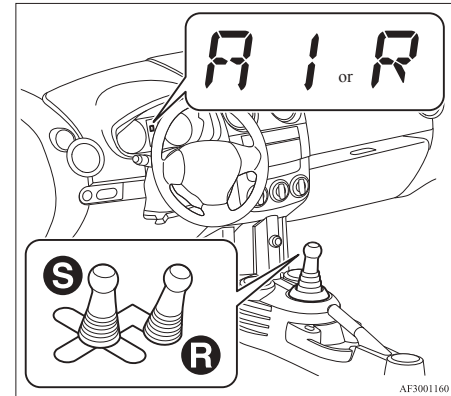

4. Stop the engine.

CAUTION

- When leaving the vehicle, be sure to stop the engine and remove the key from the ignition switch. If you were to leave the engine running with the allshift lever in the “S” (Stand by) or “R” position, the transmission’s creep effect could cause the vehicle to move by itself. Also, the vehicle could suddenly move if you accidentally pressed the accelerator pedal when getting back in the vehicle.

NOTE

- Sit in the correct position for driving even if you plan to move just a short distance. Make sure you are able to depress the brake pedal and accelerator pedal properly.
- Reversing involves twisting to look rearward in a position that makes operation of the pedals more difficult. Make sure you are able to depress the brake pedal.

Braking

E00607001801

All the parts of the brake system are critical to safety. We recommend you to have the vehicle checked at regular intervals according to the service booklet.

CAUTION

- Avoid driving habits that cause heavy braking and never “ride” the brakes by resting your foot on the brake pedal while driving. It causes brake overheating and fade.

Brake system

The service brake is divided into two brake circuits. And your vehicle is equipped with power brakes. If one brake circuit fails, the other is available to stop the vehicle. If you should lose the power assist for some reason, the brakes will still work. In these situations, even if the brake pedal moves down to the very end of its possible stroke or resists being depressed, keep depressing the brake pedal down harder and further than usual; stop driving as soon as possible and have the brake system repaired.

WARNING

- Do not turn off the engine while your vehicle is in motion. If you turn off the engine while driving, the power assistance for the braking system will stop working and your brakes will not work effectively.

WARNING

- If the power assist is lost or if either brake hydraulic system stops working properly, have your vehicle checked immediately.

Warning lamp

The brake warning lamp illuminates to indicate a fault in the braking system. Read “Brake warning lamp” on page 3-17.

When brakes are wet

Check the brake system while driving at a low speed immediately after starting, especially when the brakes are wet, to confirm they work normally. A film of water can be formed on the brake discs or brake drums and prevent normal braking after driving in heavy rain or through large puddles, or after the vehicle is washed. If this occurs, dry the brakes out by driving slowly while lightly depressing the brake pedal.

When driving downhill

It is important to take advantage of the engine braking by shifting to a lower shift position while driving on steep downhill roads in order to prevent the brakes from overheating.

WARNING

- **Do not leave any objects near the brake pedal or let a floor mat slide under it; doing so could prevent the full pedal stroke that would be necessary in an emergency. Make sure that the pedal can be operated freely at all times. Make sure the floor mat is securely held in place.**

Brake pads and linings

- With new brake pads or linings, avoid where possible sudden full application of the brakes for the first 200 km (124 miles) of driving.
- The disc brakes are provided with a warning device which emits a shrieking metallic sound while braking if the brake pads have reached their wear limit.
If you hear this sound, have the brake pads replaced immediately.

WARNING

- **Driving with worn brake pads will make it harder to stop, and can cause an accident.**

Emergency stop signal system

E0062600021

This is a device that reduces the possibility of rear end collisions by the rapid and automatic blinking of the hazard warning lamps to alert vehicles approaching from behind during sudden braking. When the emergency stop signal system operates, the hazard warning indication lamp in the instrument cluster blinks rapidly at the same time.

CAUTION

- **If the ABS warning lamp or TCL/ASC indication lamp is illuminated, the emergency stop signal system may not operate. Refer to “ABS warning lamp” on page 4-28. Refer to “Traction control system (TCL)/Active stability control system (ASC) indication lamp” on page 4-31.**

NOTE

- [Activating condition for the emergency stop signal system]
It activates when all of the following conditions are met.
 - The vehicle speed is approximately 55 km/h (34 mph) or higher.
 - The brake pedal has been depressed, and the system judges that it was sudden braking from the vehicle deceleration and the operating condition of the anti-lock brake system (ABS).[Deactivating condition for the emergency stop signal system]

It deactivates when one of the following conditions is met.

- The brake pedal is released.
- The hazard warning flasher switch is pressed.
- The system judges that it was not sudden braking from the vehicle deceleration and the operating condition of the anti-lock brake system (ABS).

Brake assist system

E00627000262

The brake assist system is a device assisting drivers who cannot depress the brake pedal firmly when it is necessary to do so (such as in emergency stop situations) and provides greater braking force.

If the brake pedal is depressed suddenly, the brakes will be applied with more force than usual.

CAUTION

- **The brake assist system is not a device designed to exercise braking force greater than its capacity. Make sure to always keep a sufficient distance between vehicles in front of you without relying too much on the brake assist system.**

NOTE

- Once the brake assist system is operational, it maintains great braking force even if the brake pedal is lightly released.
To stop its operation, completely remove your foot from the brake pedal.
- The brake assist system may become operational when the brake pedal is fully depressed even if it has not been depressed suddenly.

- When the brake assist system is in use, you may feel as if the depressed brake pedal is soft, the pedal moves in small motions in conjunction with the sound of the ABS operation, or the vehicle body and the steering wheel vibrate. This occurs when the brake assist system is operating normally and does not indicate faulty operation. Continue to firmly depress the brake pedal.
- You may hear an operation noise when the brake pedal is depressed suddenly while stationary. This does not indicate a malfunction and the brake assist system is operating normally.

Anti-lock brake system (ABS)

E00607100791

Environmental conditions can have an effect on braking. During sudden braking when there is snow, ice, oil, water etc. on the road surface, a skid may occur. In this situation, steering control and braking effectiveness is reduced and the stopping distance is increased. The vehicle may also go into an uncontrolled spin.

The ABS helps prevent the wheels from locking during braking, thus maintaining directional stability, ensuring controllability and providing optimum braking force.

Driving hints

- When using the anti-lock brake system (sudden braking), steering is slightly different from normal driving conditions. Use the steering wheel carefully.
- Always maintain the same distance from the vehicle in front of you as you would for a vehicle not equipped with ABS.
Compared with vehicles not fitted with ABS, your vehicle may require a longer stopping distance in the following cases:
 - Driving on gravel or snow-covered roads.
 - Driving with tyre chains installed.
 - Driving on roads where the road surface is pitted or has other differences in surface height.
 - Driving on bumpy roads or other poor driving surfaces.

Starting and driving

- Operation of ABS is not restricted to situations where brakes are applied suddenly. This system may also operate to prevent wheel lock when you are driving over manholes, steel road-work plates, or the vehicle is driven over steps or level differences in the road, road markings, or other surfaces which are difficult for the wheels to grip.
- When the ABS is activated, you may feel the brake pedal pulsating and hear a characteristic noise. Also at this time, it may feel as if the pedal attempts to resist being depressed. **In this situation, to let the ABS work for you, just hold the brake pedal down more firmly. Do not pump the brake. This will result in reduced braking performance.**

A CAUTION

- Even the ABS cannot prevent the natural laws of physics from acting on the vehicle. It cannot for instance avoid accidents that may result from excessive speed on bends or following another vehicle too closely or aquaplaning. It should remain the driver's task to observe safety precautions to judge speeds and brake applications correctly in such conditions.
- Be sure to use tyres of the same type and size on 4 wheels.
If tyre types or sizes are mixed, ABS may not function properly.

A CAUTION

- Never install a limited-slip differential, which is not MITSUBISHI MOTORS genuine parts, as the ABS may not function properly. We recommend to consult a MITSUBISHI MOTORS Authorized Service Point.

ABS warning lamp

E00607200835

The ABS warning lamp comes on and a buzzer sounds in the event of a malfunction in the anti-lock brake system. It will also come on as a self-check for a few seconds when the ignition switch is turned to the "ON" position, and the lamp goes off after a few seconds. Always make sure that the lamp goes out before beginning to drive.

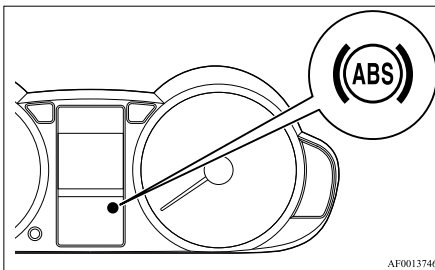

A CAUTION

- If the warning lamp stays on or does not illuminate when you start the vehicle, it indicates that the ABS is not functioning and that only the standard brake system is in operation. (In this condition the standard hydraulic brake system will still function.) We recommend you to consult a MITSUBISHI MOTORS Authorized Service Point.

If the warning lamp illuminates while driving

E00607301035

If only the ABS warning lamp illuminates

- Avoid hard braking and high-speed driving. Stop the vehicle in a safe place. Restart the engine and check to see whether the lamp goes out after a few minutes driving; if it then remains off during driving, there is no problem. However, if the lamp does not go out, or if it lights up again when the vehicle is driven, we recommend you to consult a MITSUBISHI MOTORS Authorized Service Point.

- The ABS warning lamp can illuminate if the battery voltage is insufficient when the engine is started. In this case, it does not indicate an ABS fault.

Charge the battery by allowing the engine to idle for a while.

If the battery has been charged but the ABS warning lamp continues to illuminate or illuminates intermittently, we recommend you to consult a MITSUBISHI MOTORS Authorized Service Point.

If the ABS warning lamp and brake warning lamp illuminate at the same time

- The brake force distribution function may not work, so hard braking could make the vehicle unstable.

Avoid hard braking and high-speed driving. Stop the vehicle in a safe place and we recommend you to consult a MITSUBISHI MOTORS Authorized Service Point.

NOTE

- Immediately after the vehicle starts moving after engine start up, a whining sound of a motor will be heard from the engine compartment. If the brake pedal is depressed at that moment, a brake pedal pulsating is felt. This whining sound and pulsation are due to the self-diagnosis operation of the ABS and does not indicate a malfunction.
- After driving on snowy roads, remove any snow and ice which may have become adhered to the wheel areas. When doing this, be careful not to damage the wheel speed sensors (A) and cables loca-

ted at each wheel on vehicles equipped with an ABS.

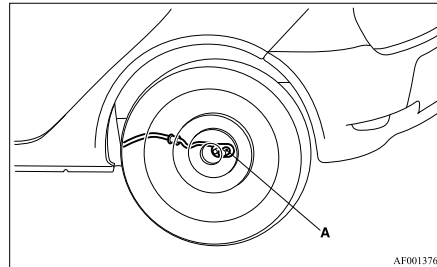
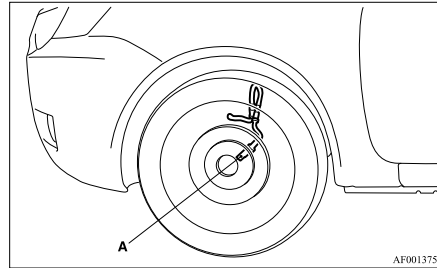

- The ABS becomes operative after the vehicle has accelerated to a speed in excess of approximately 10 km/h (6 mph). It stops operating when the vehicle decelerates to a speed below approximately 10 km/h (6 mph).

Electric power steering system

E00607400026

The electric power steering system reduces the effort required to turn the steering wheel. It operates while the engine is running.

⚠ CAUTION

- **Do not stop the engine while driving. With the engine stopped, the steering action would become extremely heavy and an unexpected accident might occur.**

NOTE

- If you repeatedly turn the steering wheel fully to either side (while parking, for example), a protective function that prevents the system from overheating will be activated, making the steering action gradually heavier. In this event, turn the steering wheel as little as possible for a while. When the system's temperature decreases, the steering action will return to normal.
- If you turn the steering wheel while the vehicle is stationary with its headlamps on, the headlamps may grow dim. This phenomenon does not indicate a fault. The headlamps will return to their original brightness after a short while.

Electric power steering warning lamp

E00612400024

The electric power steering warning lamp comes on and a buzzer sounds in the event of a control abnormality in the electric power steering system.

Starting and driving

When the system is normal, the electric power steering warning lamp comes on when the ignition switch is turned to the “ON” position and goes off after a few seconds.

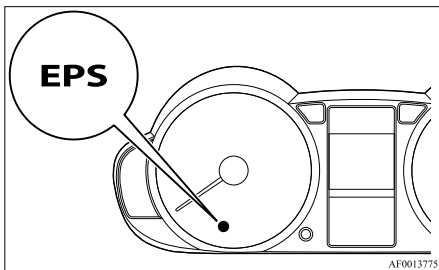

4

⚠ CAUTION

- If the electric power steering warning lamp comes on while the vehicle is moving, the steering action may become heavy.

If the warning lamp illuminates while driving

E00613600049

1. Park your vehicle in a safe place and stop the engine.
2. Turn the ignition switch to the “ON” position. If the electric power steering warning lamp comes on then goes off after a few seconds, there is no abnormality. However, if the lamp does not go off, or if it comes on again when the vehicle is driven, we recommend you to have the power steering inspected by a MITSUBISHI MOTORS Authorized Service Point.

Traction control system (TCL)/ Active stability control system (ASC)*

E00611700176

The Traction control system (TCL)/Active stability control system (ASC) takes overall control of the anti-lock brake system, Traction Control System and Active Stability Control system to help maintain the vehicle’s control and traction. Please read this section in conjunction with the page on the anti-lock brake system, Traction Control System and Active Stability Control system.

Anti-lock brake system (ABS) → p. 4-27

Traction control system (TCL) → p. 4-30

Active stability control system (ASC) → p. 4-31

⚠ CAUTION

- Do not over-rely on the Traction Control System (TCL)/Active Stability Control system (ASC). Even when the Traction Control System (TCL)/Active Stability Control system (ASC) is operating, there are limits to the system and its ability to maintain control and traction. Reckless driving may lead to accidents. Always drive carefully, taking account of the road conditions.
- Be sure to use the same specified type and size of tyre on all 4 wheels. Otherwise, there is a possibility that the Traction Control System (TCL)/Active Stability Control system (ASC) will not work properly.

NOTE

- Immediately after the vehicle starts moving after engine start up, a whining sound of a motor will be heard from the engine compartment. If the brake pedal is depressed at that moment, you can feel the brake pedal pulsating.

This whining sound and pulsation are due to the self-diagnosis operation of the Traction Control System (TCL)/ Active Stability Control system (ASC) and do not indicate a malfunction.

- Some vibration will be felt in the vehicle body and a whining sound of a motor will be heard from the engine compartment when the Traction Control System (TCL)/ Active Stability Control system (ASC) functions. This is a normal result of the Traction Control System (TCL)/Active Stability Control system (ASC) operation, and does not indicate a malfunction.
- The Traction Control System (TCL)/Active Stability Control system (ASC) does not operate while the ABS warning lamp is illuminated.

Traction control system (TCL)

E00611800089

On slippery surfaces, Traction Control System (TCL) prevents the drive wheels from excessive spinning, thus helping the vehicle to start moving from a stop. It also provides sufficient driving force and steering performance as the vehicle turns at accelerated speeds.

CAUTION

- When driving a vehicle on a snowy or icy road, be sure to install snow tyres and drive the vehicle at moderate speeds.

NOTE

- When moving out of mud or fresh snow, pressing the accelerator pedal may not allow the engine speed to increase.

Active stability control system (ASC)

E0061200091

The Active Stability Control system (ASC) is designed to help maintain the vehicle's control in slippery conditions, or during rapid steering manoeuvres. It works by controlling the engine output and brake on each wheel.

NOTE

- The Active Stability Control system (ASC) functions at speeds of approximately 10 km/h (6 mph) or higher.

Traction control system (TCL)/Active stability control system (ASC) indication lamp

E00612100119

The Traction Control System (TCL) and Active Stability Control system (ASC) share the same indication lamp.

The indication lamp should illuminate when the ignition switch is turned to the "ON" position, and should go off after a few seconds. Always make sure that the lamp goes off before beginning to drive.

If the indication lamp stays on or does not illuminate when the ignition switch is turned to the "ON" position, we recommend you to consult a MITSUBISHI MOTORS Authorized Service Point. The indication lamp blinks when the Traction Control System (TCL) or Active Stability Control system (ASC) is operating.

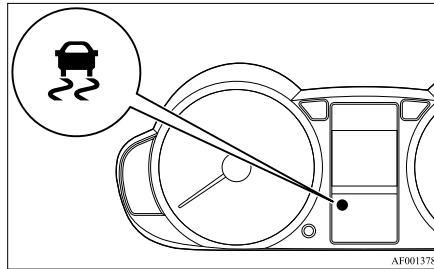

AF0013788

CAUTION

- When the indication lamp blinks, the Traction Control System (TCL) or Active Stability Control system (ASC) is operating, which means that the road is slippery or that your vehicle's wheels are slipping excessively. If this happens, drive slower with less accelerator input.

CAUTION

- If a malfunction occurs in the device, the indication lamp will continuously illuminate. Park your vehicle in a safe place and stop the engine. Then, start the engine again and check whether the indication lamp goes out.

If the indication lamp remains on even after your vehicle is driven a short distance after starting the engine, we recommend you to consult a MITSUBISHI MOTORS Authorized Service Point.

- If the vehicle is towed with the ignition switch in the "ON" position and only the front wheels or only the rear wheels raised off the ground, the Traction Control System (TCL) may operate, resulting in an accident. When towing the vehicle with the front wheels raised, keep the ignition switch in the "LOCK" or "ACC" position. When towing the vehicle with the rear wheels raised, keep the ignition switch in the "ACC" position. Refer to "Towing" on page 6-18.

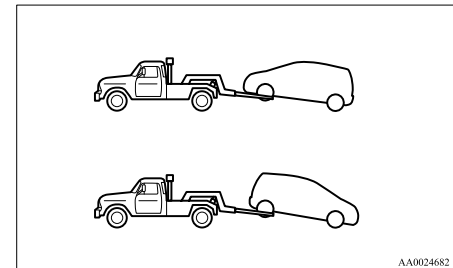

AA0024682

Starting and driving

Cruise control*

E00609100623

Cruise control is an automatic speed control system that keeps a set speed. It can be activated at about 40 km/h (25 mph) or more.

⚠ CAUTION

- When you do not wish to drive at a set speed, turn off the cruise control for safety.
- Do not use cruise control when driving conditions will not allow you to stay at the same speed, such as in heavy traffic or on roads that are winding, icy, snow-covered, wet, slippery, on a steep downhill slope.
- On vehicles with M/T, do not move the gearshift lever to the “N” (Neutral) position while driving at a set speed without depressing the clutch pedal. The engine will run too fast and might be damaged.

NOTE

- Cruise control may not be able to keep your speed on uphill or downhill.
- Your speed may decrease on a steep uphill. You may use the accelerator pedal if you want to stay at your set speed.
- Your speed may increase to more than the set speed on a steep downhill. You have to use the brake to control your speed. As a result, the set speed driving is deactivated.

Cruise control switches

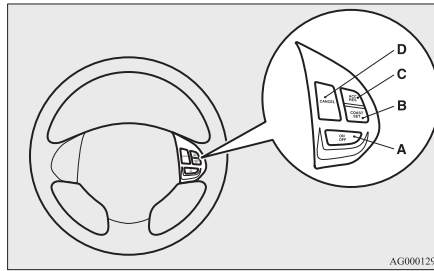

A- “ON OFF” switch

Used to turn on and off the cruise control.

B- “COAST SET” switch

Used to reduce the set speed and to set the desired speed.

C- “ACC RES” switch

Used to increase the set speed and to return to the original set speed.

D- “CANCEL” switch

Used to deactivate the set speed driving.

NOTE

- When operating the cruise control switches, press the cruise control switches correctly. The set speed driving may be deactivated automatically if two or more switches of the cruise control are pressed at the same time.

To activate

E00609300700

1. With the ignition switch in the “ON” position, press the “ON OFF” switch (A) to turn

on the cruise control. The “CRUISE” indication lamp in the meter cluster will come on.

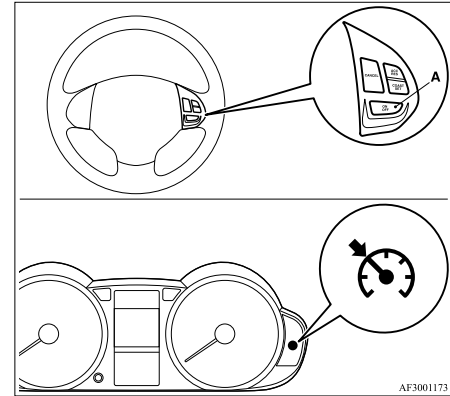

NOTE

- If the cruise control is on when the ignition switch is turned to the “LOCK” or “ACC” position, cruise control will be on automatically the next time you start the engine. The “CRUISE” indication lamp will also be on.
- If the battery voltage is insufficient, the memory data for the cruise control may be erased. As a result, the “CRUISE” indication lamp may not come on when you restart the engine. If this happens, press the “ON OFF” switch once again to turn on the cruise control.

- Accelerate or decelerate to your desired speed, then press and release the “COAST SET” switch (B) when the “CRUISE” indication lamp is illuminated. The vehicle will then maintain the desired speed.

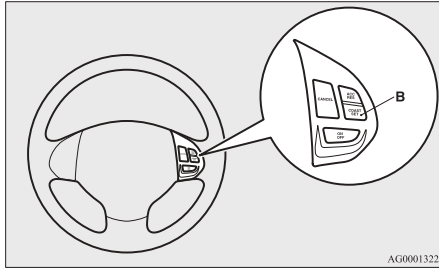

NOTE

- When you release the “COAST SET” switch, the vehicle speed will be set.

To increase the set speed

E00609400479

There are 2 ways to increase the set speed.

“ACC RES” switch

Press and hold the “ACC RES” switch (C) while driving at the set speed, and your speed will then gradually increase.

When you reach your desired speed, release the switch. Your new cruising speed is now set.

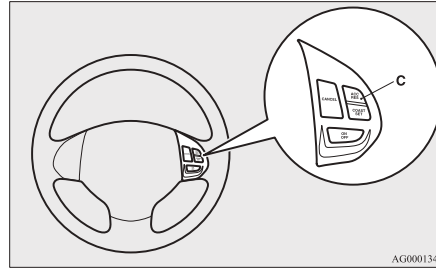

To increase your speed in small amounts, press the “ACC RES” switch for less than about 1 second and release it.

Each time you press the “ACC RES” switch, your vehicle will go about 1.6 km/h (1 mph) faster.

Accelerator pedal

While driving at the set speed, use the accelerator pedal to reach your desired speed and then press the “COAST SET” switch (B) and release the switch momentarily to set a new desired cruising speed.

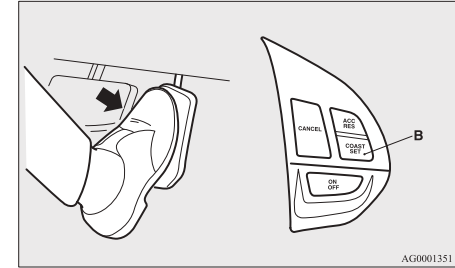

To decrease the set speed

E00609500409

There are 2 ways to decrease the set speed.

“COAST SET” switch

Press and hold the “COAST SET” switch (B) while driving at the set speed, and your speed will slow down gradually.

Starting and driving

When you reach your desired speed, release the switch. Your new cruising speed is now set.

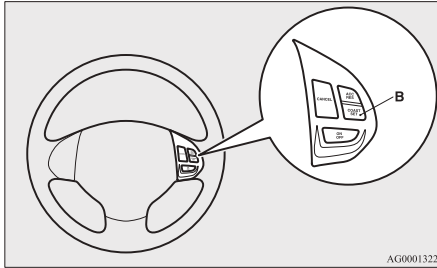

AG0001322

To slow down your speed in small amounts, press the “COAST SET” switch for less than about 1 second and release it.

Each time you press the “COAST SET” switch, your vehicle will slow down by about 1.6 km/h (1 mph).

Brake pedal

While driving at the set speed, use the brake pedal, which disengages the cruise control, then press the “COAST SET” switch (B) and release the switch momentarily to set a new desired cruising speed.

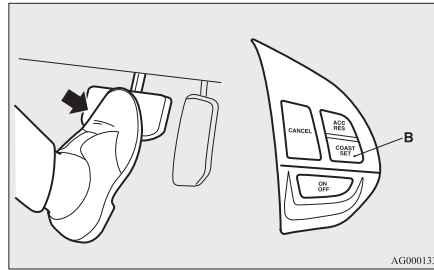

AG0001335

To temporarily increase or decrease the speed

E00609600149

To temporarily increase the speed

Depress the accelerator pedal as you would normally. When you release the pedal, you will return to your set speed.

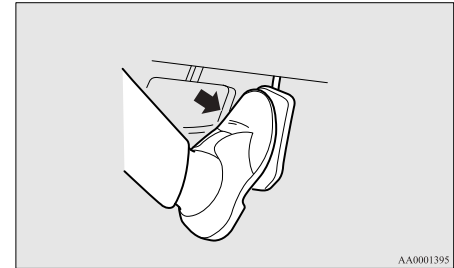

AA0001395

NOTE

- In some driving conditions, the set speed driving may be deactivated. If this happens, refer to “To activate” on page 4-32 and repeat the speed setting procedure.

To temporarily decrease the speed

Depress the brake pedal to decrease the speed. To return to the previously set speed, press the “ACC RES” switch (C).

Refer to “To resume the set speed” on page 4-35.

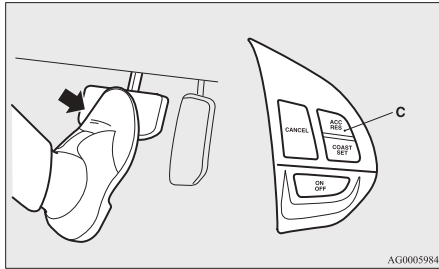

To deactivate

E00609700889

The set speed driving can be deactivated as follows:

- Press the “ON OFF” switch (A) (Cruise control will be turned off.)
- Press the “CANCEL” switch (D).
- Depress the brake pedal.

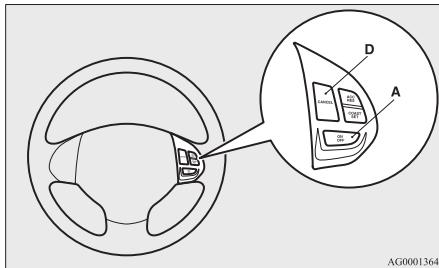

The set speed driving is deactivated automatically in any of the following ways.

- When you depress the clutch pedal (on vehicles with manual transmission).
- When your speed slows to about 15 km/h (9 mph) or more below the set speed because of a hill, etc. (on vehicles with manual transmission).
- When your speed slows to about 40 km/h (25 mph) or less.
- When the Active Stability Control system (ASC) starts operating. (if so equipped)
Refer to “Traction control system (TCL)/Active stability control system (ASC)” on page 4-30.

WARNING

- **On vehicles with AMT, although the set speed driving will be deactivated when shifting to the “N” (NEUTRAL) position, never move the allshift lever to the “N” (NEUTRAL) position while driving. You would have no engine braking and could cause a serious accident.**

Also, the set speed driving may be deactivated as follows:

- When the engine speed rises and approaches the tachometer’s red zone (the red-coloured part of the tachometer dial).

CAUTION

- **When the set speed driving is deactivated automatically in any situation other than those listed above, there may be a system malfunction. Press the “ON OFF” switch to turn off the cruise control and have your vehicle inspected by a MITSUBISHI MOTORS Authorized Service Point.**

To resume the set speed

E00609800457

If the set speed driving is deactivated by the condition described in “To deactivate” on page 4-35, you can resume the previously set speed by pressing the “ACC RES” switch (C) while driving at a speed of about 40 km/h (25 mph) or higher.

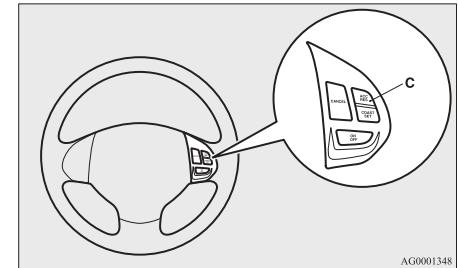

Under either of the following conditions, however, using the switch does not allow you to resume the previously set speed. In these situations, repeat the speed setting procedure:

- The “ON OFF” switch is pressed.
- The ignition switch is turned OFF.

Starting and driving

- “CRUISE” indication lamp is turned OFF.

Cargo loads

E00609901240

Cargo loads precautions

CAUTION

- When loading luggage, be careful to the following.
 - Stow cargo and luggage in the luggage compartment whenever possible.
 - Distribute cargo or luggage evenly not to be unbalanced in weight of a load.
 - Do not place cargo or luggage on the instrument panel.

Also, do not stack up cargo or luggage on the front passenger's seat or the rear seats.

Having the driver's vision blocked, and your cargo being thrown inside the cabin if you suddenly have to brake can cause a serious accident or injury.

Trailer towing

E00610000488

In order to tow a trailer with your vehicle, have a trailer towing device that meets all relevant regulations in your area, mounted consult a MITSUBISHI MOTORS Authorized Service Point. The regulations concerning the towing of a trailer may differ from country to country. You are advised to obey the regulations in each area.

CAUTION

- **Danger of Accident!**
A towing bar should be fitted according to MITSUBISHI MOTORS guidelines.

NOTE

- If you are going to tow a trailer, pay careful attention to the following points.

Maximum towable weight with brake and maximum trailer-nose weight

Never exceed the maximum towable weight with brake and the maximum trailer-nose weight as listed in the specifications.

(Refer to page 9-07.)

If you tow a trailer at an altitude of more than 1,000 m above sea-level, reduce your weight by 10 % of the gross combination weight for every increase of 1,000 m above sea-level, as the engine output is lowered owing to decrease in atmospheric pressure.

Towing bar mounting specifications

See the following table for fixing points (A) for the towing bar.

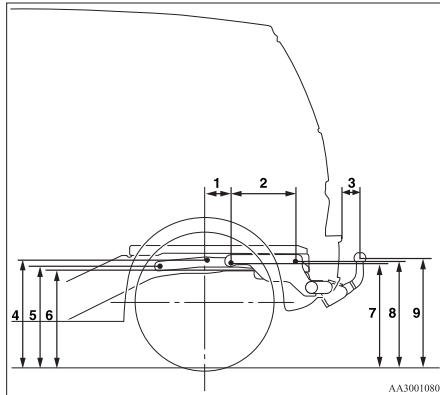

3-door models

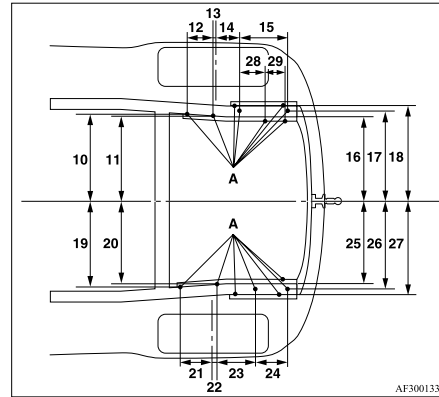

1	111 mm	15	214 mm
2	195 mm	16	435 mm
3	80 mm	17	470 mm
4	452 mm	18	506 mm
5	425 mm	19	458 mm
6	410 mm	20	442 mm
7	443 mm	21	193 mm
8	450 mm	22	10 mm
9*1	457 mm (unladen) 370 mm (laden)	23	222 mm

*1: Except for vehicles with turbocharger

*2: Vehicles with turbocharger

9*2	464 mm (unladen) 389 mm (laden)	24	111 mm
10	456 mm	25	435 mm
11	445 mm	26	470 mm
12	150 mm	27	504 mm
13	13 mm	28	118 mm
14	137 mm	29	82 mm

*1: Except for vehicles with turbocharger

*2: Vehicles with turbocharger

Item 4, 5, 6, 7 or 8: at kerb weight

NOTE

- The value of item 4, 5, 6, 7 or 8 is applicable to unladen vehicles. This value can also be varied depending on the tyre size, optional equipment and suspension conditions.
- The value of item 9 can also be varied depending on the tyre size, optional equipment and suspension conditions.

Starting and driving

5-door models

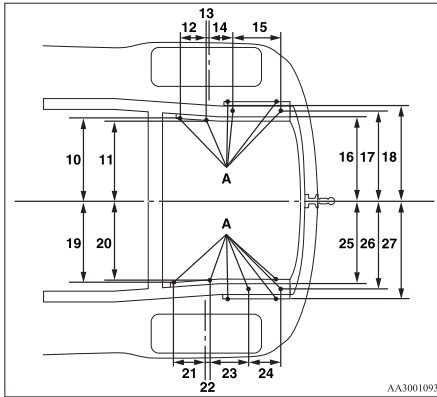

1	111 mm	14	137 mm
2	275 mm	15	278 mm
3	70 mm	16	436 mm
4	452 mm	17	470 mm
5	425 mm	18	504 mm
6	410 mm	19	458 mm
7	443 mm	20	442 mm
8	450 mm	21	193 mm
9*1	466 mm (unladen) 378 mm (laden)	22	9.5 mm

*1: Except for vehicles with turbocharger

*2: Vehicles with turbocharger

9*2	473 mm (unladen) 395 mm (laden)	23	222.5 mm
10	456 mm	24	183 mm
11	445 mm	25	436 mm
12	150 mm	26	470 mm
13	13 mm	27	504 mm

*1: Except for vehicles with turbocharger

*2: Vehicles with turbocharger

Item 4, 5, 6, 7 or 8: at kerb weight

NOTE

- The value of item 4, 5, 6, 7 or 8 is applicable to unladen vehicles. This value can also be varied depending on the tyre size, optional equipment and suspension conditions.
- The value of item 9 can also be varied depending on the tyre size, optional equipment and suspension conditions.

Operating hints

- Do not let the clutch slip and do not increase the engine speed more than necessary when starting.
- Be sure that the driving speed does not exceed 100 km/h (62 mph) for trailer operation. It is also recommended that you obey the local regulations in case driving speed with a trailer is limited to less than 100 km/h (62 mph).
- To prevent shocks from the overrun brake, depress the brake pedal lightly at first and then more strongly.
- To make full use of engine braking, change to a lower gear before descending a slope.

- The body, brakes, clutch, and chassis will be under additional strain when towing a trailer.
- The heavier weight and higher rolling and air resistance will increase fuel consumption.

For pleasant driving

Ventilators.....	5-02
Heater*.....	5-04
Automatic air conditioning*.....	5-07
Important operation tips for the air conditioning.....	5-11
Air purifier.....	5-12
LW/MW/FM electronic tuning radio with CD player*.....	5-12
To use the external audio input function.....	5-27
Steering wheel audio remote control switches*.....	5-28
Error codes.....	5-30
Handling of compact discs.....	5-32
Antenna.....	5-33
Digital clock*.....	5-34
Sun visors.....	5-36
Vanity mirror.....	5-37
Accessory socket.....	5-37
Interior lamps.....	5-38
Storage spaces.....	5-39
Cup holder.....	5-42
Rear shelf panel*.....	5-42
Coat hooks*.....	5-43

For pleasant driving

Ventilators

E00700100647

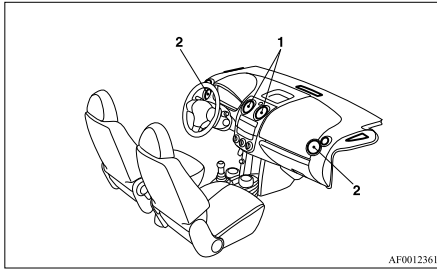

- 1- Centre ventilators
- 2- Side ventilators

NOTE

- Do not place beverages on top of the instrument panel. If they splash into the air conditioning ventilators, they could damage the system.

5

Air flow and direction adjustments

E00700200635

Push the section of the ventilator (A) to open it up.

Close the ventilators by pushing the section of the (B).

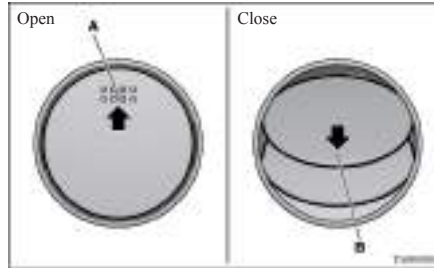

Change the direction of the airflow by turning the ventilator itself.



NOTE

- On air conditioned vehicles, the cool air from the ventilators may appear as a mist. This is due to moist air being suddenly cooled by the air conditioning. This will clear after a few moments.

Changing the mode selection

E00700301398

To change the position and amount of air flowing from the ventilators, turn the mode selection dial. (Refer to "Mode selection dial" on pages 5-05, 5-08.

These symbols are used in the next several illustrations to demonstrate the quantity of air coming from the ventilators.

- : Small amount of air from the ventilators
- ➔: Medium amount of air from the ventilators
- : Large amount of air from the ventilators

Face position

Air flows only to the upper part of the passenger compartment.

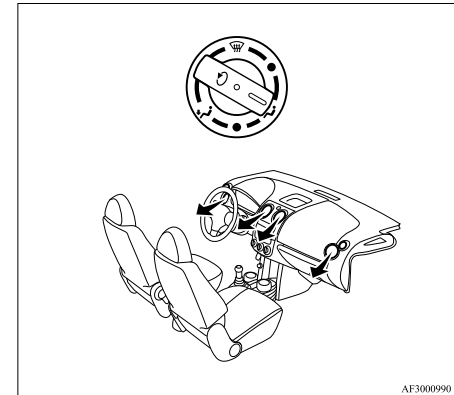

Foot/Face position

Air flows to the upper part of the passenger compartment, and flows to the leg area.

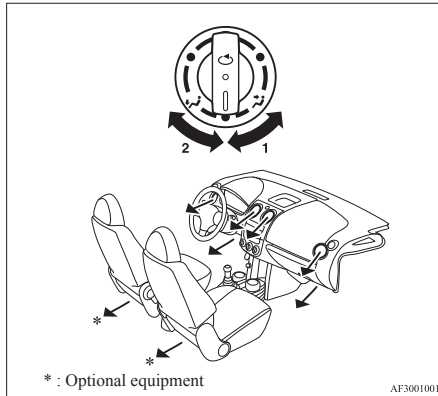

NOTE

- When the dial is set to position (1), air flows mostly to the upper part of the passenger compartment. In position (2), air flows mostly to the leg area.

Foot position

Air flows mainly to the leg area.

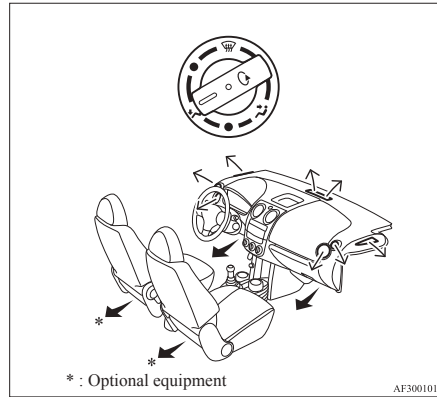

Foot/Demister position

Air flows to the leg area, the windscreen and the door windows.

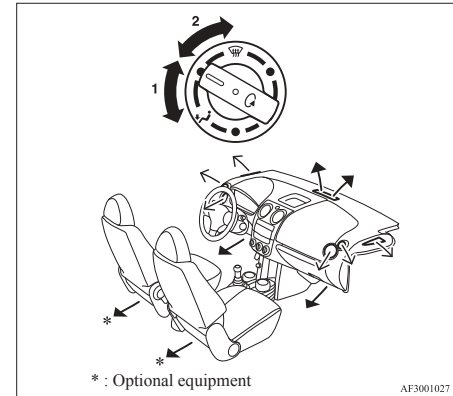

NOTE

- With the dial set to position (1), air flows mostly to the leg area. In position (2), air flows mostly to the windscreen.

For pleasant driving

Demister position

Air flows mainly to the windscreen and the door windows.

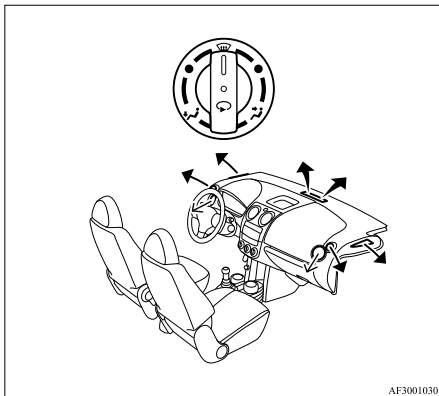

Demister/Face position

Air flows to the windscreen, the door windows and the upper part of the passenger compartment.

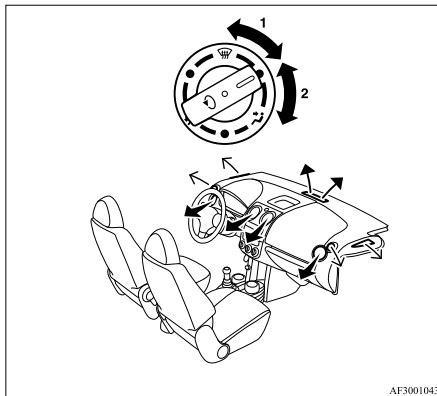

NOTE

- With the dial set to position (1), air flows mostly to the windscreen. In position (2), air flows mostly to the upper part of the passenger compartment.

*Heater**

E00700500090

The heater can only be used while the engine is running.

Control panel

E00700600495

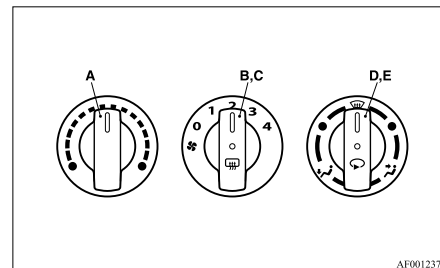

- A- Temperature control dial
- B- Blower speed selection dial
- C- Rear window demister switch → p. 3-29
- D- Mode selection dial
- E- Air selection switch

Blower speed selection dial

E00700700210

Select the blower speed by turning the blower speed selection dial clockwise or anticlockwise. The blower speed will gradually increase as the dial is turned to the right.

When the blower speed selection dial is set to the “0” position, all fan-driven airflow will stop.

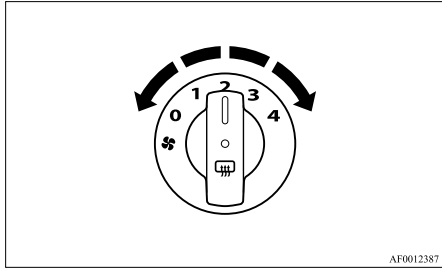

AF0012387

Temperature control dial

E00700900300

The temperature control dial is used to adjust the air temperature. Turn it clockwise to increase the temperature and anticlockwise to reduce the temperature.

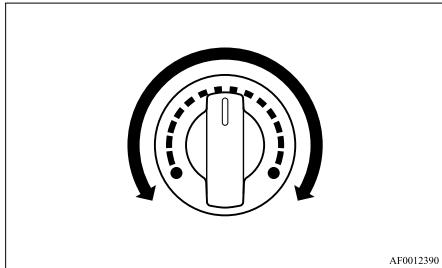

AF0012390

NOTE

- While the engine coolant temperature is low, the temperature of the air from the heater will be cool/cold until the engine warms up, even if you have selected warm air with the dial.

Mode selection dial

E00701100325

To change the amount of air flowing from the ventilators, turn the mode selection dial. (Refer to “Changing the mode selection” on page 5-02.)

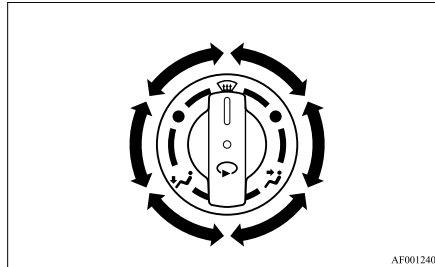

AF0012404

Air selection switch

E00701300662

To change the air selection, simply press the air selection switch.

- Outside air {Indication lamp (A) is OFF}
Outside air is introduced into the passenger compartment.

For pleasant driving

- Recirculated air {Indication lamp (A) is ON}
Air is recirculated inside the passenger compartment.

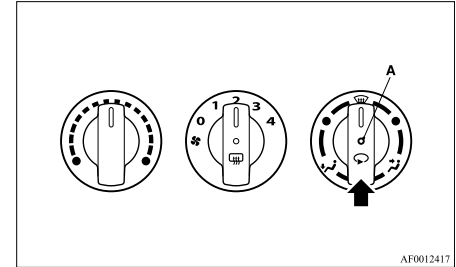

AF0012417

⚠ CAUTION

- Normally, use the outside position to keep the windscreen and side windows clear and quickly remove fog or frost from the windscreen. If the outside air is dusty or otherwise contaminated use the recirculation position. Switch to the outside position periodically to increase ventilation so that the windows do not become fogged up.
- Use of the recirculation position for extended time may cause the windows to fog up.

NOTE

- Even if the recirculation position is being used before the engine is stopped, outside air will automatically be selected following the next engine startup.

For pleasant driving

Operating the heater system

E00701800393

Heating

Set the mode selection dial to the “” position and set the air selection switch (A) to the outside position.

Turn the temperature control dial clockwise or anti-clockwise to the desired temperature. Select the desired blower speed.

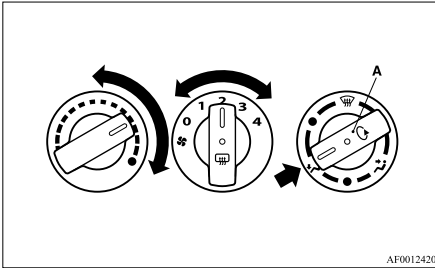

The air flow will be directed to the leg area and the upper part of the passenger compartment. Select desired blower speed.

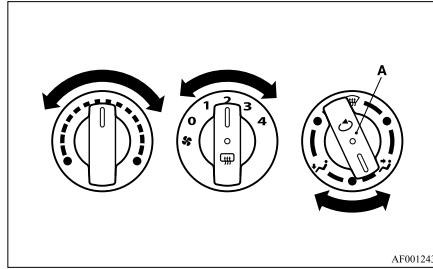

Warm air flows to the leg area and unheated or slightly warm air (depending upon temperature setting) flows to the upper part of the passenger compartment.

Demisting of the windscreen and door windows

E00702100683

CAUTION

- For safety, make sure you have a clear view through all windows.

To remove frost or mist from the windscreen and door windows, use the mode selection dial. (Foot/Demister position or Demister position)

For ordinary demisting

Use this setting to keep the windscreen and door windows clear of mist, and to keep the leg area heating (when driving in rain or snow).

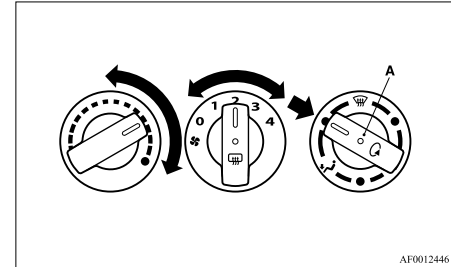

1. Set the air selection switch (A) to the outside position.
2. Set the mode selection dial to the position shown in the illustration.
3. Select your desired blower speed by turning the blower speed selection dial.
4. Select your desired temperature by turning the temperature control dial.

NOTE

- For maximum heat, set the blower speed at the 3rd position.

Combination of unheated air and heated air

E00702000389

Select the mode selection dial to the position shown in the illustration and set the air selection switch (A) to the outside position.

For quick demisting

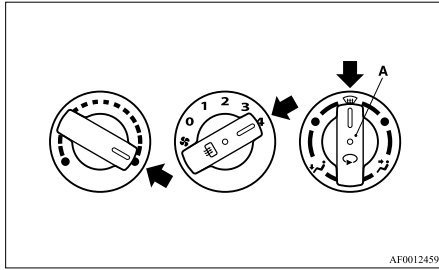

AF0012459

1. Set the air selection switch (A) to the outside position.
2. Set the mode selection dial to the “WH” position.
3. Set the blower speed to the maximum blower speed position.
4. Set the temperature to the maximum temperature position.

NOTE

- To demist effectively, direct the air flow from the side ventilators towards the door windows.

Introduction of outside air

E00702200352

To introduce air into the vehicle during hot weather, set the air selection switch (A) to the outside position and set the temperature control dial to the positions shown in the illustration. Be sure to set the temperature control dial all the way to the left. Select the desired blower speed.

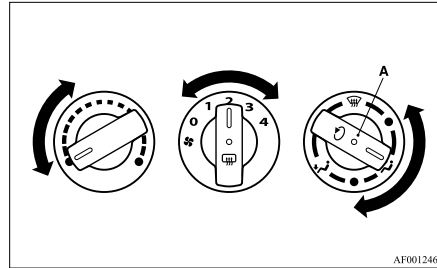

AF0012462

NOTE

- Turn the mode selection dial clockwise or anticlockwise and air will flow to the leg area and the windscreen.

Automatic air conditioning*

E00702400022

The air conditioning can only be used while the engine is running.

Control panel

E00702501004

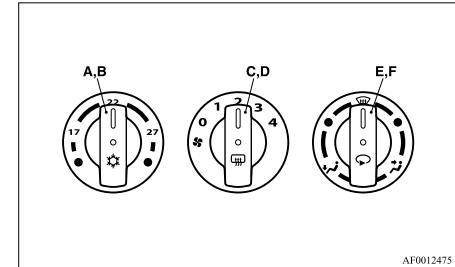

AF0012475

- A- Temperature control dial
- B- Air conditioning switch
- C- Blower speed selection dial
- D- Rear window demister switch → p. 3-29
- E- Mode selection dial
- F- Air selection switch

NOTE

- There is an interior air temperature sensor (A) inside the vehicle.

For pleasant driving

Never place anything on top of the sensor, since doing so will prevent it from functioning properly.

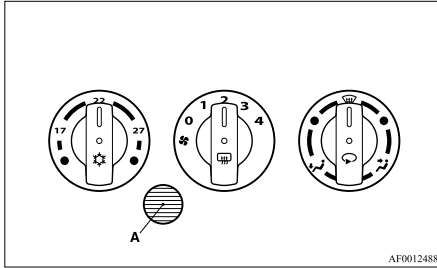

AF0012488

Blower speed selection dial

E00702800329

Select the blower speed by turning the blower speed selection dial clockwise or anticlockwise.

The blower speed will gradually increase as the dial is turned to the right.

When the blower speed selection dial is set to the “0” position, all fan-driven airflow will stop.

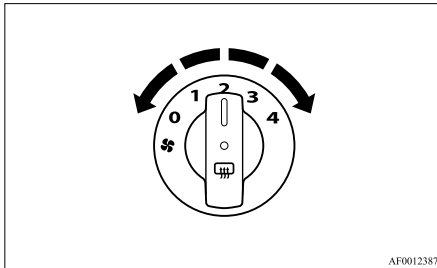

AF0012387

Temperature control dial

E00703000490

The temperature control dial is used to adjust the cabin temperature. Turn it clockwise to increase the temperature and anticlockwise to reduce the temperature.

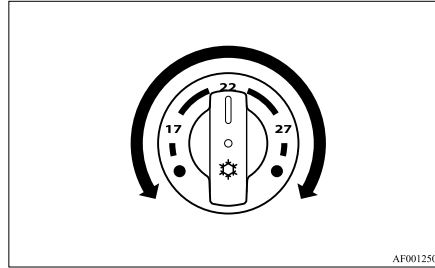

AF0012505

NOTE

- While the engine coolant temperature is low, the temperature of the air from the heater will be cool/cold until the engine warms up, even if you have selected warm air with the dial.

Mode selection dial

E00703200447

To change the amount of air flowing from the ventilators, turn the mode selection dial. (Refer to “Changing the mode selection” on page 5-02.)

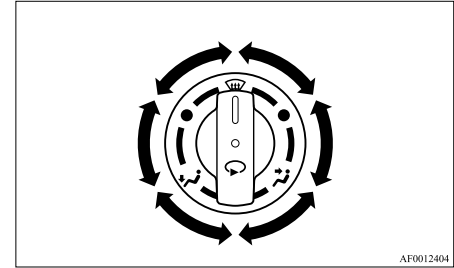

AF0012404

Air selection switch

E00703400641

To change the air selection, simply press the air selection switch.

- Outside air {Indication lamp (A) is OFF}
Outside air is introduced into the passenger compartment.

- Recirculated air {Indication lamp (A) is ON}
Air is recirculated inside the passenger compartment.

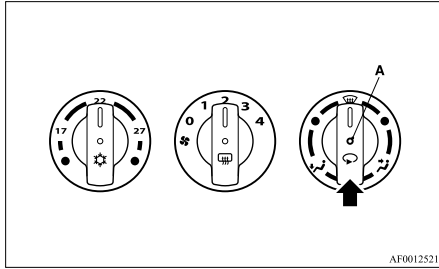

AF0012521

NOTE

- For vehicles with automatic air conditioning, an automatic fresh/recirculation control function is included to improve the efficiency of the air conditioning. If the outside air temperature rises, the air conditioning automatically switches to the recirculation mode. To deactivate the automatic fresh/recirculation control, press the air selection switch while the ignition switch is “ON”. However, once the automatic fresh/recirculation control is deactivated, it can only be reactivated by ignition switch is “OFF”.
- When the recirculation mode is selected by the automatic fresh/recirculation control, the air conditioning will switch to the outside air mode for about 30 seconds at intervals of approximately 20 minutes in order to ventilate the passenger compartment.

CAUTION

- Normally, use the outside position to keep the windscreen and side windows clear and quickly remove fog or frost from the windscreen. If high cooling performance is desired, or if the outside air is dusty or otherwise contaminated use the recirculation position. Switch to the outside position periodically to increase ventilation so that the windows do not become fogged up.
- Use of the recirculation position for extended time may cause the windows to fog up.

Air conditioning switch

E00703501131

Push the switch, and the air conditioning compressor will turn on. The air conditioning indication lamp (A) will come on.

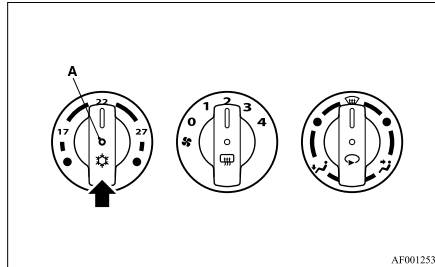

AF0012534

Push the switch again and the air conditioning compressor will stop working and the indication lamp goes off.

CAUTION

- When using the air conditioning, the idling speed may slightly increase as the air conditioning compressor is switched on/off automatically. While the vehicle with an automated manual transmission is stationary, fully depress the brake pedal to prevent the vehicle from creeping.

NOTE

- If the air conditioning indication lamp is flashing, the air conditioning system may be malfunctioning. Press the air conditioning switch to turn off the air conditioning, and then press the switch again to turn on the air conditioning. If the air conditioning indication lamp flashes again after a while, consult a MITSUBISHI MOTORS Authorized Service Point. If the air conditioning indication lamp no longer flashes, there is no problem.

Operating the air conditioning system

E00704100834

Heating

Set the mode selection dial to the “” position and set the air selection switch (A) to the outside position.

For pleasant driving

Turn the temperature control dial clockwise or anticlockwise to the desired temperature. Select the desired blower speed.

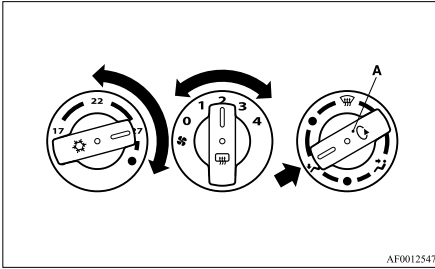



NOTE

- For maximum heat, set the blower speed at the 3rd position.

Cooling

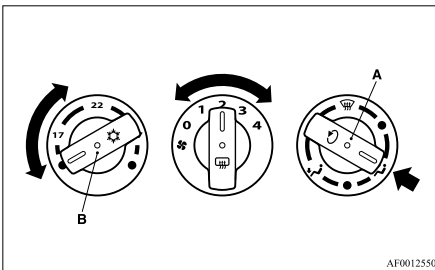
E0072200024



1. Set the mode selection dial to the “” position.

2. Set the air selection switch (A) to the outside position.
3. Push the air conditioning switch (B).
4. Change your desired temperature by turning the control dial clockwise or anticlockwise.
5. Select the desired blower speed.

NOTE

- If the outside air is dusty or otherwise contaminated, or if high cooling performance is desired, set air selection switch to the recirculation position and the temperature control dial all the way to the left. Switch to the outside position periodically to increase ventilation so that the windows do not become fogged up.

Combination of unheated air and heated air

E00722100025

Select the mode selection dial to the position shown in the illustration and set the air selection switch (A) to the outside position. The air flow will be directed to the leg area and the upper part of the passenger compartment. Select desired blower speed.

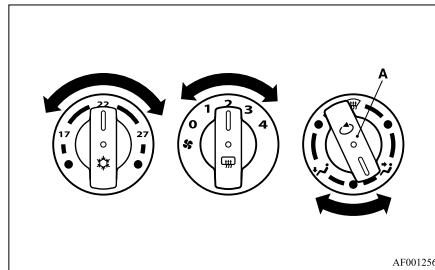

Warm air flows to the leg area and unheated or slightly warm air (depending upon temperature setting) flows to the upper part of the passenger compartment.

Demisting of the windscreen and door windows

E00722200055

CAUTION

- For safety, make sure you have a clear view through all windows.

To remove frost or mist from the windscreen and door windows, use the mode selection dial. (Foot/Demister position or Demister position)

For ordinary demisting

Use this setting to keep the windscreen and door windows clear of mist, and to keep leg area heating (when driving in rain or snow).

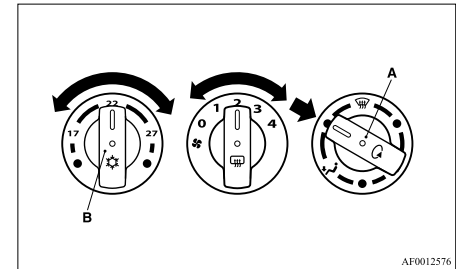

1. Set the air selection switch (A) to the outside position.
2. Set the mode selection dial to the position shown in the illustration.

3. Select your desired blower speed by turning the blower speed selection dial.
4. Select your desired temperature by turning the temperature control dial.
5. Push the air conditioning switch (B).

For quick demisting

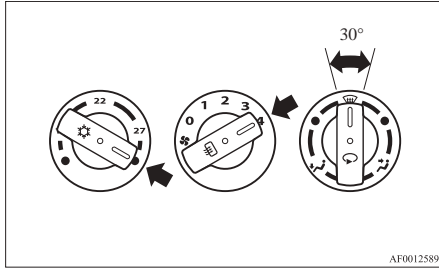

1. Set the mode selection dial to the position shown in the illustration.
2. Set your blower to the maximum speed.
3. Set the temperature to the highest position.

NOTE

- While the mode selection dial is set to the position shown in the illustration, the air conditioning will operate automatically and the outside air position will also be selected automatically. (In this case, the air conditioning indicator will not change)
- To demist effectively, direct the air flow from the side ventilators towards the door windows.

- Do not set the temperature control dial to the max. cool position. Cool air will blow against the window glasses and form mist on them.
- For Clear Tec models, if the mode selection dial is set to the demister position shown in the illustration (within $\pm 15^\circ$ of the center), the Auto Stop & Go (AS&G) system will not operate and the engine will not stop automatically even if the vehicle is stopped. This is to ensure that good visibility is maintained.

Important operation tips for the air conditioning

E00708300948

- Park the vehicle in the shade.
Parking in the hot sun will make the vehicle inside extremely hot, and it will require more to cool the interior.
If it is necessary to park in the sun, open the windows for the first few minutes of air conditioning operation to expel the hot air.
- Close the windows when the air conditioning is in use.
The entry of outside air through open windows will reduce the cooling efficiency.
- Too much cooling is not good for the health.
The inside air temperature should only be 5 to 6 °C below the outside air temperature.
- When operating the system, make sure the air intake, which is located in front of the windscreen, is free of obstructions such as leaves and snow. Leaves collected in the air-intake plenum may reduce air flow and plug the plenum water drains.

Air conditioning system refrigerant and lubricant recommendations

If the air conditioning seems less effective than usual, the cause might be a refrigerant leak. We recommend you to have the system inspected.

The air conditioning system in your vehicle must be charged with the refrigerant HFC-134a and the lubricant SUN-PAG56.

Use of any other refrigerant or lubricant will cause severe damage which will result in the need to replace your vehicle's entire air conditioning system. The release of refrigerant into the atmosphere should be prevented.

For pleasant driving

It is recommended that the refrigerant be recovered and recycled for further use.

During a long period of disuse

The air conditioning should be operated for at least five minutes each week, even in cold weather. This is to prevent poor lubrication of the compressor internal parts and to maintain the air conditioning in the best operating condition.

Air purifier

E00708400024

An air filter has been incorporated into this air conditioning so that dirt and dust are cleaned from the air.

Replace the air filter periodically as its ability to clean the air will be reduced as it collects pollen and dirt. For the maintenance interval, refer to the "SERVICE BOOKLET".

NOTE

- Operation in certain conditions such as driving on a dusty road and frequent use of the air conditioning can lead to reduction of service life of the filter. When the air flow rate suddenly drops or when the windscreen or windows start to fog up easily, the air filter requires replacement.

We recommend you to have it checked.

LW/MW/FM electronic tuning radio with CD player*

E00708502175

The audio system can be used when the ignition switch is in the "ON" or "ACC" position.

NOTE

- To listen to the audio system while the engine is stopped, turn the ignition key to the "ACC" position.
For Clear Tec models, the audio system will continue to operate if the ignition switch is in the "ON" position when the engine stops automatically. However, in some cases, the audio system may stop producing sound or turn off.
- If a cellular phone is used inside the vehicle, it may create noise from the audio equipment. This does not mean that anything is wrong with your audio equipment. In such a case, use the cellular phone at a place as far away as possible from the audio equipment.
- If foreign objects or water get into the audio equipment, or if smoke or a strange odour comes from it, immediately turn off the audio system. We recommend you to have it checked. Never try to repair it by yourself. Avoid continuous usage without inspection by a qualified person.

Volume and tone control panel

E00708600882

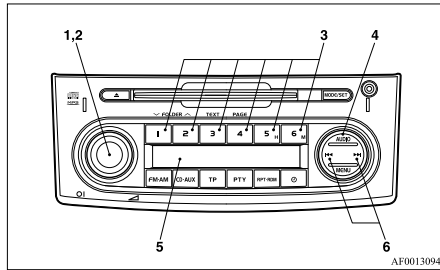

- 1- PWR (On-Off) switch
- 2- VOL (Volume control) knob
- 3- Memory select buttons
- 4- AUDIO button
- 5- Display
- 6- Audio adjust button

To adjust the volume

E00708700649

VOL (Volume control)

Turn the VOL knob (2) clockwise to increase the volume; anticlockwise to decrease the volume. The status will be displayed in the display (5).

To adjust the tone

E00708800914

Press the AUDIO button (4) to select SCV → BASS → TRE → FADE → BAL → Audio adjust mode off. The status will be displayed in the display (5).

SCV (Speed Compensated Volume)

SCV function is a feature that automatically adjusts the VOLUME, BASS, and TREBLE settings in accordance with the vehicle speed. Press the audio adjust button (6) either ◀◀ or ▶▶ to select OFF or the desired settings 1-6.

BASS (Bass tone control)

Press the audio adjust button (6) either ◀◀ or ▶▶ to select the desired bass tone quality.

TRE (Treble tone control)

Press the audio adjust button (6) either ◀◀ or ▶▶ to select the desired treble tone quality.

FADE (Front/Rear balance control)

Press the audio adjust button (6) either ◀◀ or ▶▶ to balance the volume of sound from the front and the rear speakers.

BAL (Left/Right balance control)

Press the audio adjust button (6) either ◀◀ or ▶▶ to balance the volume of sound from the left and the right speakers.

NOTE

- Audio adjust mode will be cancelled when radio or CD operation is performed or no adjustment is performed for more than 7 seconds or press the AUDIO button (4) for 2 seconds or longer.

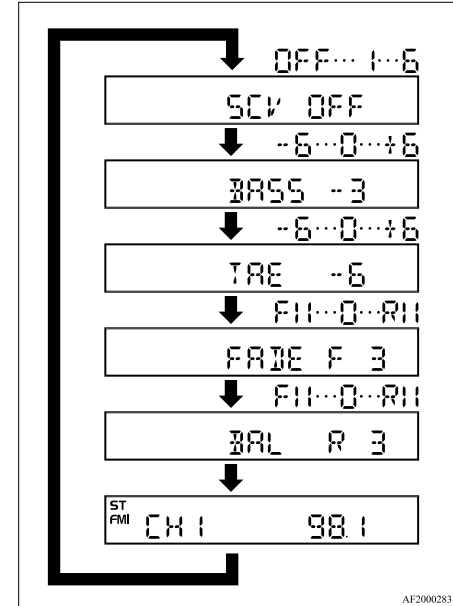

AF2000283

To enter audio tone settings into the memory

It is possible to enter the audio adjustment condition (SCV, BASS, TRE, FADE, BAL) into the memory.

1. Make the desired adjustments in the audio adjust mode.
Refer to “To adjust the tone” on page 5-13.
2. In the audio adjust mode, press and hold one of the memory select buttons (3) [1-6]. When you hear a bleep, the memorization is complete. The display will show the button number [SOUND1-SOUND6] for which the settings were memorised.

For pleasant driving

3. In future, when you gently press the memory select button in the audio adjust mode, the audio adjustment condition memorised for that button will take effect.

Radio control panel and display

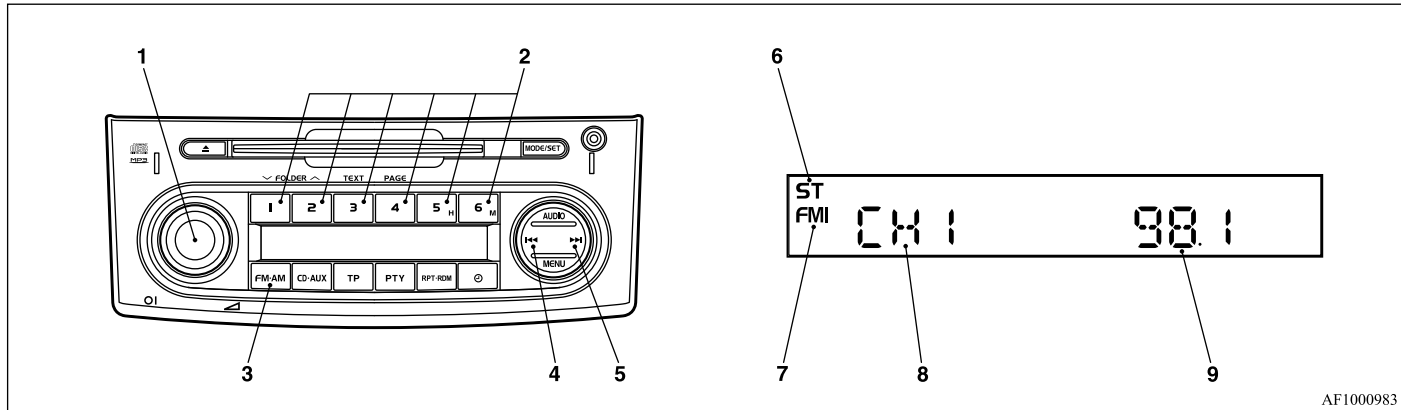

AF1000983

- 1- PWR (On-Off) switch
- 2- Memory select buttons
- 3- FM/AM (FM/MW/LW selection) button
- 4- TUNE/SEEK (Down-step/Down-seek) button
- 5- TUNE/SEEK (Up-step/Up-seek) button

- 6- ST (Stereo) indicator
- 7- FM (FM1/FM2/FM3) indicators
- 8- Preset memory number display
- 9- Frequency display window

For pleasant driving

To listen to the radio

E00709000711

1. Press the PWR switch (1) to turn the audio system on and off.
Press the FM/AM button (3) to turn on the radio if a CD is being played.
2. Press the FM/AM button (3) to select the desired band.
3. Press the TUNE/SEEK button (4 or 5) to tune to a station, or press one of the memory select button (2) to recall a station memorised for that button.

To tune the radio

E00709100073

Automatic tuning

After keeping the TUNE/SEEK button (4 or 5) depressed until it beeps, release the button, and the selected station reception will start.

Manual tuning

The frequency changes every time the TUNE/SEEK button (4 or 5) is pressed. Press the button to select the desired station.

To enter frequencies into the memory

E00716100974

Manual setting

You can assign to the memory select buttons (2) a maximum of 18 stations in the FM band (6 FM1, 6 FM2 and 6 FM3 stations) and 6 stations each in the MW and LW band. (Stations already assigned to the memory select buttons are replaced by any newly assigned stations.)

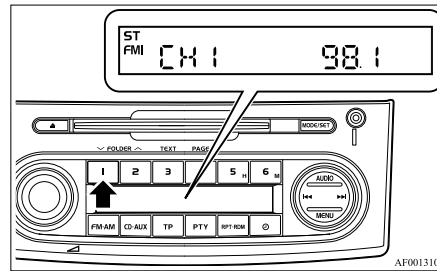

Follow the steps described below.

1. Press either the TUNE/SEEK button (4 or 5) to tune the frequency to be entered in the memory.
2. Press one of the memory select buttons (2) for 2 seconds or longer. The sound will be momentarily interrupted while the frequency is being entered into the memory.
The number of the button corresponding to the entry in the memory and the frequency are displayed.
3. The preset memory setting is retrieved by pressing the button and then releasing it within 2 seconds.

NOTE

- Disconnecting the battery terminal erases all the radio frequencies stored in the memory.

Automatic setting

With the method, all manually set stations in the band currently selected for reception are replaced with stations in the same band that are automatically selected in order of signal strength. The radio automatically selects 6 stations in the FM band (FM3 station only) and 6 stations each in the MW and LW band.

Follow the steps described below.

1. With the radio mode selected, hold down the AM/FM button (3) for 2 seconds or longer. The 6 stations with the best signal strength will automatically be assigned to the memory select buttons (2), with the lowest-frequency station being assigned to the lowest-number button.
2. When you subsequently press a memory select button to select a channel number, the radio will begin receiving the station assigned to that number.

NOTE

- If you press the AM/FM button (3) for 2 seconds or longer while tuning in the FM1 or FM2 band, the radio will automatically switch to the FM3 band, where the automatic seeking/storing will be activated.

Radio data system (RDS)

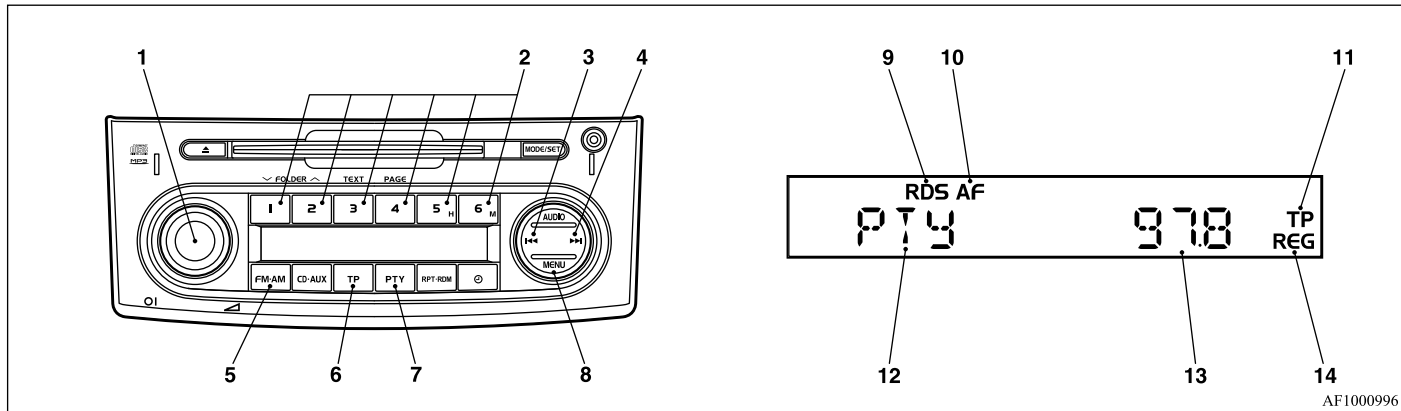

- 1- PWR (On-Off) switch
- 2- Memory select buttons
- 3- TUNE/SEEK (Down-step/Down-seek) button
- 4- TUNE/SEEK (Up-step/Up-seek) button
- 5- FM/AM (FM/MW/LW selection) button
- 6- TP (Traffic program) button
- 7- PTY (Program type) button

- 8- Menu button
- 9- RDS (Radio data system) indicator
- 10- AF (Alternative frequencies) indicator
- 11- TP (Traffic program identification) indicator
- 12- PTY (Program type)/CT (Clock time) indicator
- 13- Frequency display window
- 14- REG (Regional program) indicator

RDS uses PI (program identification) signal and AF (alternative frequency) list transmitted in addition to the normal FM broadcasting programs, and picks up the FM stations that are transmitting the same program from the AF list and automatically tunes to the station with the strongest signal intensity.

Therefore, you can continue listening to one program in, for example, a long distance driving without retuning to the other station transmitting the same program when you are leaving the service area of the currently receiving station.

The RDS radio also features the limited reception of the program types, the break-in reception of the traffic announcement to the EON (enhanced other network) and emergency broadcast, and the limited/unlimited reception of the regional programs.

For pleasant driving

AF (Alternative Frequencies) function

E00720900146

The AF function finds a station broadcasting the same program and selects the station with the strongest signal of AF lists.

The AF function is turned on (with the AF indicator (10) shown on the display) at all times unless you manually switch it off.

The AF function can be turned ON and OFF. Refer to “Function setup mode” on page 5-20.

CT (Clock Time) function

E00721000128

The clock can be set automatically by using the signal from the local RDS stations. Refer to “Digital clock” on page 5-34.

REG (Regional) function

E00721100015

REG function limits to receive the stations broadcasting regional programs. Regional programming and regional networks are organized differently depending on the country or area (they may be changed according to the hour, state, or broadcast area), so if you don't want to receive the regional programs automatically, you can set up REG ON not to receive regional programs.

The REG function can be turned ON and OFF. Refer to “Function setup mode” on page 5-20.

PI (Program Identification) search function

E00721200175

When travelling long distance and the recalled preset station is weak, the radio searches another frequency broadcasting the same programming with the same PI code in AF list.

If there are no frequencies broadcasting the same programming, the radio searches a frequency broadcasting the regional programming. The radio succeeds in searching the regional programming, then the display shows the REG indicator (14).

If the radio does not succeed in searching the regional programming, the radio returns to the recalled preset station.

The PI function can be turned ON and OFF on some vehicles.

Refer to “Function setup mode” on page 5-20.

NOTE

- While searching, the audio system is muted. The display shows “WAIT” or “SEARCH”.

PTY (Program Type)

E00721300264

RDS broadcasts are classified according to program type (PTY) as follows. Use the TUNE/SEEK button (3 or 4) to select your desired PTY.

1. NEWS
2. AFFAIRS (Current affairs)
3. INFO (Information)
4. SPORT
5. EDUCATE (Education)
6. DRAMA
7. CULTURE
8. SCIENCE
9. VARIED
10. POP M (Pop music)
11. ROCK M (Rock music)
12. EASY M (Easy music)
13. LIGHT M (Light classics)
14. CLASSICS
15. OTHER M (Other music)
16. WEATHER (Weather information)
17. FINANCE

18. CHILDREN
19. SOCIAL
20. RELIGION
21. PHONE IN
22. TRAVEL
23. LEISURE
24. JAZZ
25. COUNTRY
26. NATION M (National music)
27. OLDIES
28. FOLK M (Folk music)
29. DOCUMENT
30. TEST
31. ALARM

To search for a broadcast of desired program type:

1. Press the PTY button (7).
2. Press the TUNE/SEEK button (3 or 4) for less than 1 second at a time to select your desired PTY.
3. Two seconds after a desired PTY has been selected, the radio will begin to search for a broadcast of your selected PTY. During search, the selected PTY on the display blinks and the radio will begin to search for a broadcast of your selected PTY.

- When the radio picks up a station with your desired PTY, the display will show the name of the station.

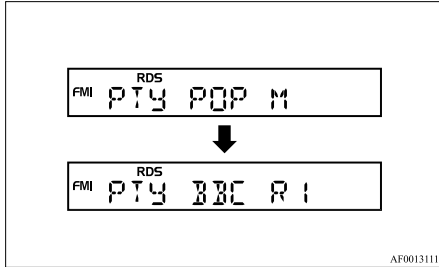

NOTE

- If the TUNE/SEEK button (3 or 4) is pressed for more than 1 second, the radio will try to find out another broadcast of the same program type as currently selected.
- If no station is found with your desired PTY, the display will show “EMPTY” for about 5 seconds and the radio will return to the previous station.

How to enter PTYs in the memory

E00721400034

As many as 6 PTYs can be entered in the memory. Follow the steps described below.

- Press either the TUNE/SEEK button (3 or 4) to tune the PTY to be entered in the memory.
- Press one of the memory select buttons (2) for 2 seconds or longer. The sound will be momentarily interrupted while the PTY is being entered into the memory. The number of the button corresponding to the entry into the memory and the PTY are displayed.

- The preset memory setting is retrieved by pressing the button and then releasing it within about 2 seconds.

To change the language of PTY display

E00721500194

You can select your favourite language among English, French, German, Swedish, Spanish and Italian.

- Press the MENU button (8) to select the language of PTY display mode. Refer to “Function setup mode” on page 5-20.
- Press the TUNE/SEEK button (3 or 4) to select a language.

NOTE

- After selecting a mode, you can leave the function setup mode by taking either of the following steps:
 - Press the MENU button (8) for at least 2 seconds.
 - Make no entry for 7 seconds.

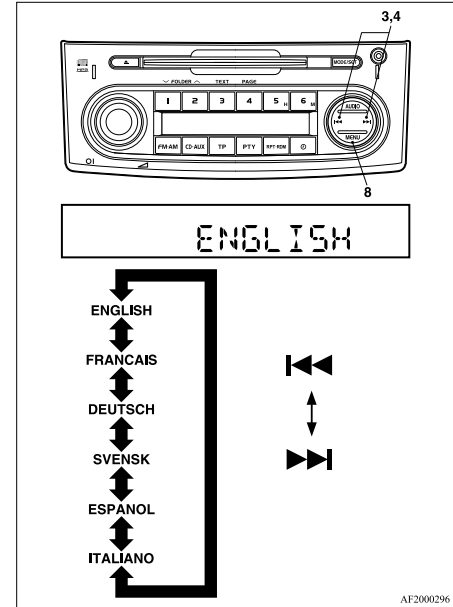

Traffic information

E00721600225

The radio will automatically tune in to traffic information broadcasts while receiving FM broadcasts or playing compact discs.

To select this function, follow the instructions below.

- Press the TP button (6). The display will show “TP” (11). If the RDS data can be read, the display will show “RDS” (9). If not, the display will show “NO RDS” for about 5 seconds.

For pleasant driving

- If the radio detects traffic information on either the station currently selected or another station, the display will show "TRAF INF" for 5 seconds followed by a 2-second indication of the frequency. Then, it will show the name of the station broadcasting the traffic information to which you will listen. The volume level is set separately for listening to normal audio programs and for listening to traffic information. The volume level will therefore change automatically to that set when an emergency broadcast or traffic information was last received. When the traffic information broadcast is over, the radio will return to the previously received program and to the corresponding volume level.
- Press the TP button (6) to return to the previous condition.

NOTE

- While "TP" is illuminated, the radio stops only at TP stations even if the TUNE/SEEK button (3 or 4) is pressed.

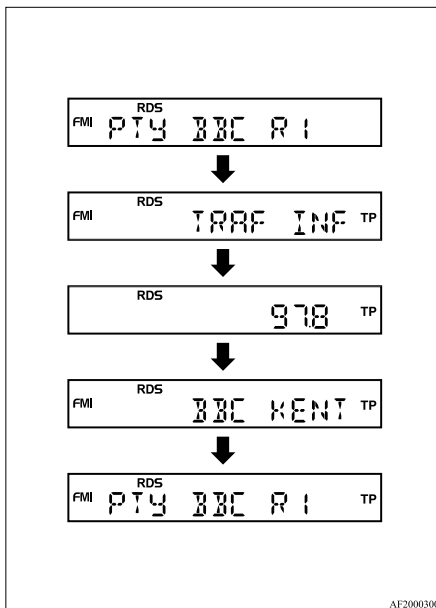

TP (Traffic information Program) search function

E00721800155

The traffic information program standby function is turned on (with the TP indicator (11) shown on the display) and after about 45 seconds since the RDS indicator (9) turns off due to weak signal or the tuning station is changed over from a TP station to a station which does not broadcast traffic information, the sound will beep 5 times and seeks out a TP station in all frequencies automatically.

The TP search function can be turned ON and OFF. Refer to "Function setup mode" on page 5-20.

Emergency broadcasts

E00721700183

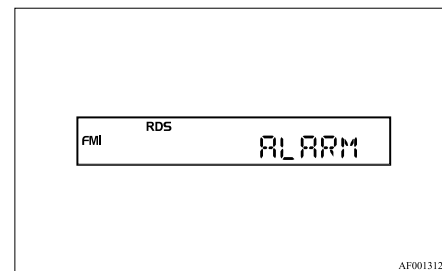

Except during MW tuning, if an emergency broadcast is caught when the ignition switch is in the "ACC" or "ON" position, the display will show "ALARM" and the emergency broadcast will interrupt the current program. The volume level is set separately for listening to normal audio programs and for listening to emergency broadcasts. The volume level will therefore change automatically to that set when an emergency broadcast or traffic information broadcast was last received. When the emergency broadcast is over, the radio will return to the previously received program and to the corresponding volume level.

Function setup mode

E00722500348

It is possible to change the following functions:

- AF
- CT
- REG
- TP-S
- PI-S
- PHONE IN

- MUTE
- Language of PTY display

1. Press the “MENU” button to select the function setup mode.

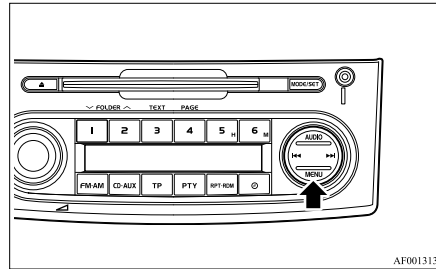

AF0013137

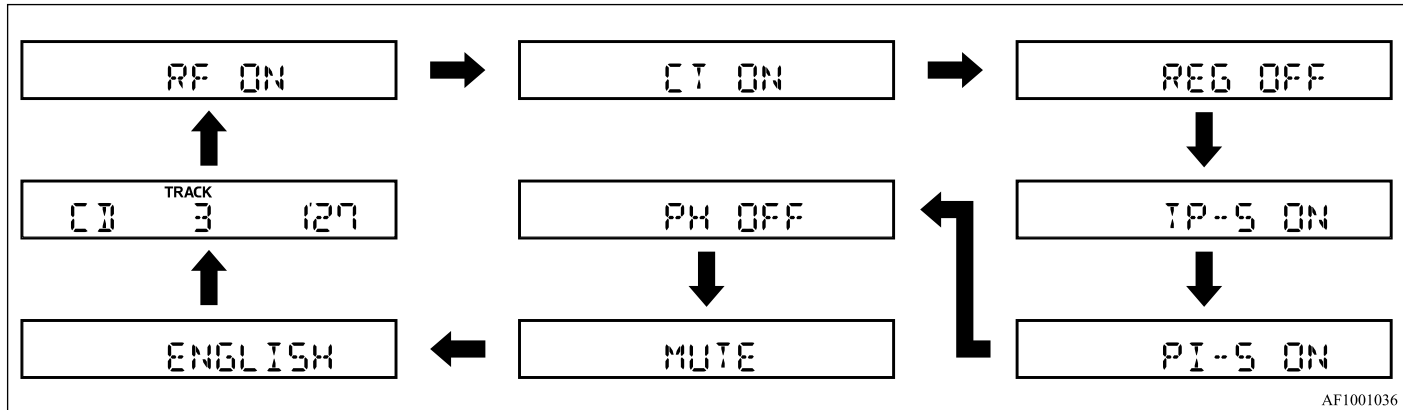

AF1001036

2. Press the “MENU” button repeatedly to select the mode you wish to change. The order is: AF → CT → REG → TP-S → PI-S → PHONE IN (PH) → MUTE → Language of PTY display → Function setup mode OFF.

NOTE

- Although “PHONE IN (PH)” and “MUTE” appear on the display, the PHONE IN and MUTE functions are inoperative.
- “MUTE” will appear only if the PHONE IN function is set to “PH ON”.

3. Select the desired setting for each mode to be turned ON and OFF as shown below.

For pleasant driving

The setting will be shown on the display.

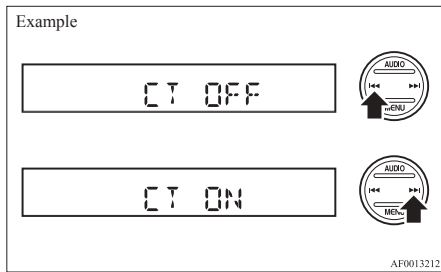

NOTE

- After selecting a mode, you can leave the function setup mode by taking either of the following steps:
 - Press the “MENU” button for at least 2 seconds.
 - Make no entry for 7 seconds.
- For instructions on setting the language of PTY display, refer to “To change the language of PTY display” on page 5-19.

CD control panel and display (MP3 compatible type)

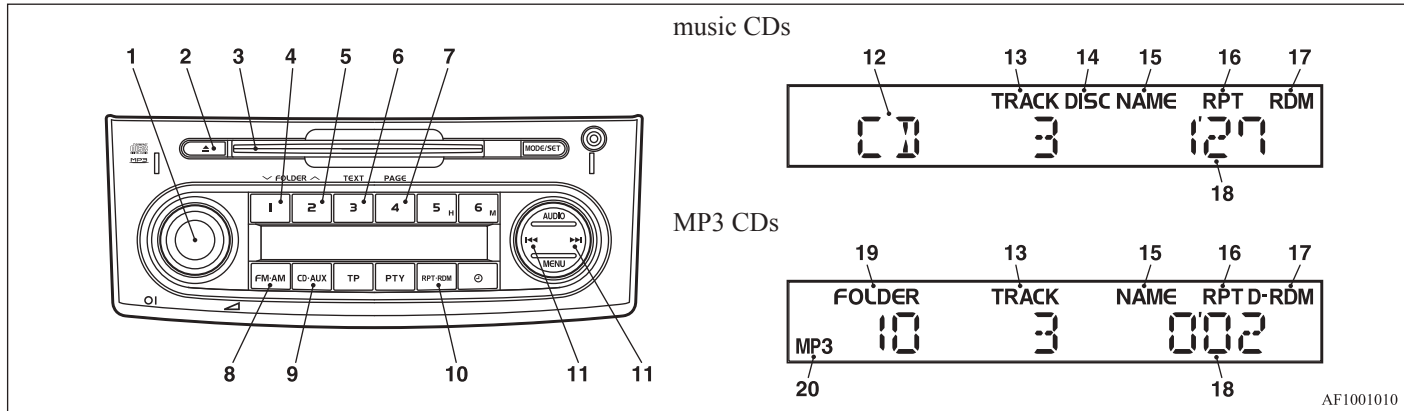

- 1- PWR (On-Off) switch
- 2- CD eject button
- 3- Disc-loading slot
- 4- FOLDER (Folder down) button
- 5- FOLDER (Folder up) button
- 6- TEXT (Title display) button
- 7- PAGE (Title scroll) button
- 8- FM/AM (FM/MW/LW selection) button
- 9- CD button
- 10- RPT/RDM (Repeat/Random) button

- 11- TRACK (Track down/up) button
- 12- CD indicator
- 13- TRACK indicator
- 14- DISC TEXT indicator
- 15- NAME indicator
- 16- RPT (Repeat-mode) indicator
- 17- RDM/D-RDM (Random-mode) indicator
- 18- Track play time display
- 19- FOLDER indicator
- 20- MP3 indicator

For pleasant driving

To listen to a CD

E00709601554

1. Insert disc with label facing up.
When a disc is inserted, the CD player will begin playing even if the radio is being used. The CD player will also start playback when the CD button (9) is pressed with a disc in the player even if the radio is being used.
2. To stop the CD, turn off the power by pressing the PWR switch (1), or change over to the radio mode by pressing the FM/AM button (8), or change over to the external audio input mode by pressing the CD button (9), or eject the disc by pressing the eject button (2).

NOTE

- To adjust the volume and tone, refer to “To adjust the volume” on page 5-13 and “To adjust the tone” on page 5-13.
- When an 8 cm compact disc is used, the adapter is not used for playback. Insert the disc in the centre of the disc-loading slot.
- For information concerning the handling of compact discs, refer to “Handling of compact discs” on page 5-32.

To fast-forward/reverse the disc

To fast-forward or reverse the disc, use the TRACK buttons (11).

Fast-forward

You can fast-forward by holding down the ►► side of the TRACK button (11) for more than about 1 second.

Fast-reverse

You can fast-reverse by holding down the ◀◀ side of the TRACK button (11) for more than about 1 second.

NOTE

- When you have fast-forwarded/fast-reversed the disc, the playing-time may be shown with deviation.

To listen to an MP3 CD

This CD player allows you to play MP3 (MPEG Audio Layer-3) files recorded on CD-ROMs, CD-Rs (recordable CDs), and CD-RWs (rewritable CDs) in ISO9660 Level 1/Level 2, Joliet, and Romeo formats. Each disc may have a maximum of 100 trees, 100 folders, and 255 files per disc. During MP3 playback, the unit can display ID3 tag information. For information concerning ID3 tag, refer to “CD text and MP3 title display” on page 5-26.

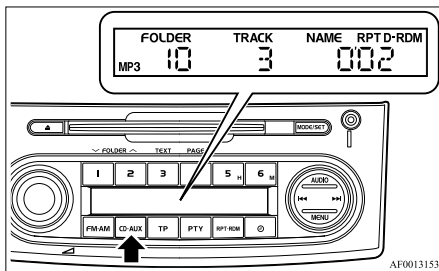

1. Insert a disc containing MP3 files into the slot.
When a disc is inserted, the CD player will begin playing even if the radio is being used. The CD player will also start playback when the CD button (9) is pressed with a disc in the player even if the radio is being used.

2. Press the CD button (9) for 2 seconds or longer to switch to MP3 CD mode from normal music CD mode. The display shows “READING”, then playback will begin. The folder number and the track number will appear on the display.

NOTE

- While listening to a disc on which CD-DA (CD-Digital Audio) and MP3 files have both been recorded, you can switch between reading of the CD-DA, and reading of the MP3 files by pressing the CD button (9) for 2 seconds or longer (until you hear a beep).
- Lightly press the CD button (9) to switch the external audio input mode.
- With a disc that contains both CD-DA and MP3 files, the CD-DA files are automatically played first.
- The playback sound quality differs depending on the encoding software and the bit rate. For details, refer to the user manual of your encoding software.
- Depending on file/folder configurations on a disc, it may take some time before playback starts.
- MP3 encoding software and writing software are not supplied with this unit.
- You may encounter trouble in playing an MP3 or displaying the information of MP3 files recorded with certain writing software or CD recorders (CD-R/RW drivers).
- If you record too many folders or files other than MP3 onto a disc, it may take some time before playback starts.
- This unit does not record MP3 files.

- For information on CD-Rs/RWs, refer to “Notes on CD-Rs/RWs” on page 5-33.

CAUTION

- Attempting to play a file not in the MP3 format which has a “.mp3” file name may produce noise from the speakers and speaker damage, and can damage your hearing.

Folder selection order/MP3 file playback order (Example)

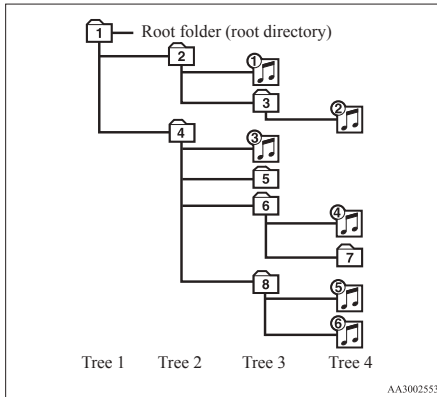

Folder selection

In the order

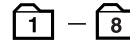

File selection

In the order

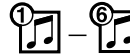

To select a desired folder (MP3 CDs only)

You can select your desired folder by pressing the FOLDER buttons (4 or 5).

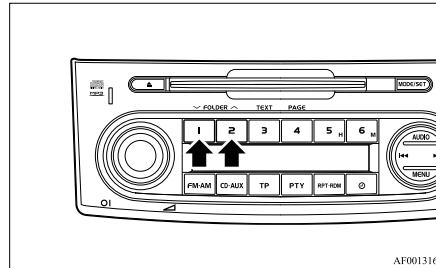

Folder up

Press the FOLDER button (5) until the desired folder number appears on the display.

Folder down

Press the FOLDER button (4) until the desired folder number appears on the display.

To select a desired track

You can select your desired track by using the TRACK button (11).

Track up

Press the  side of the TRACK button (11) repeatedly until the desired track number appears on the display.

Track down

Press the  side of the TRACK button (11) repeatedly until the desired track number appears on the display.

NOTE

- Pressing the  side of the TRACK button (11) once during the song will cause the CD player to restart playback from the beginning of the song.

To repeat a track

Press the RPT/RDM button (10) while the track is playing.

“RPT” will appear on the display. To exit the repeat mode, repeatedly press the RPT/RDM button until the “RPT” display disappears.

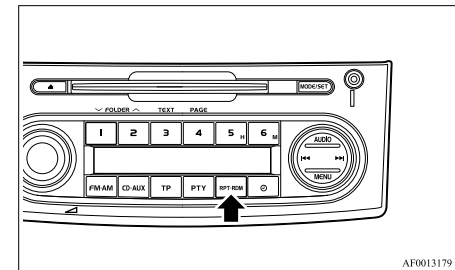

For pleasant driving

NOTE

- The repeat mode will be cancelled by pressing the track button (11) or eject button (2).
- With a disc that contains both CD-DA and MP3 files, the repeat mode causes only files of the same format (CD-DA only or MP3 files only) to be repeated.

To change the order of tracks for playback

Random playback for a disc (music CDs only)

Press the RPT/RDM button (10) two times. “RDM” will appear on the display. Tracks on the currently selected disc will be played in a random sequence.

To exit the random mode, repeatedly press the RPT/RDM button until the “RDM” display disappears.

Random playback for a folder (MP3 CDs only)

Press the RPT/RDM button (10) two times. “RDM” will appear on the display. Tracks in the currently selected folder will be played in a random sequence. To exit the random mode, repeatedly press the RPT/RDM button until the “RDM” display disappears.

Random playback for all folders on a disc (MP3 CDs only)

Press the RPT/RDM button (10) three times. “D-RDM” will appear on the display. Tracks from all the folders on the currently selected disc will be played in a random sequence. To exit the random mode, repeatedly press the RPT/RDM button until the “D-RDM” display disappears.

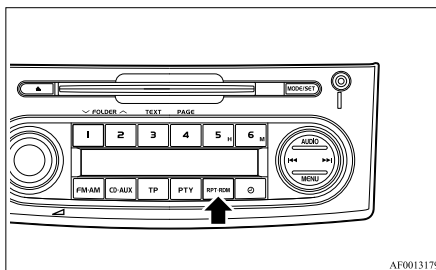

NOTE

- With a disc that contains both CD-DA and MP3 files, the random mode causes only files of the same format (CD-DA only or MP3 files only) to be played in a random sequence.

To eject a disc

When the CD eject button (2) is pressed, the disc automatically stops and is ejected. The system automatically switches to radio mode.

CD text and MP3 title display

This CD player can display CD text and MP3 titles including ID3 tag information.

CD text

The CD player can display disc and track titles for discs encoded with disc and track title information. Press the TEXT button (6) repeatedly to make selections in the following sequence: disc name → track name → normal display mode.

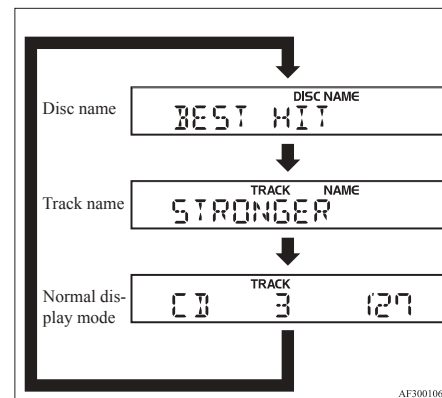

NOTE

- The display can show up to 11 characters. If a disc name or track name has more than 11 characters, press the PAGE button (7) to view the next 11 characters.
- When there is no title information to be displayed, the display shows “NO TITLE”.
- Characters that the CD player cannot display are shown as an asterisk.

MP3 title

The CD player can display folder and track titles for discs encoded with folder and track information. Press the TEXT button (6) for less than 1 second repeatedly to make selections in the following sequence: folder name → track name → normal display mode.

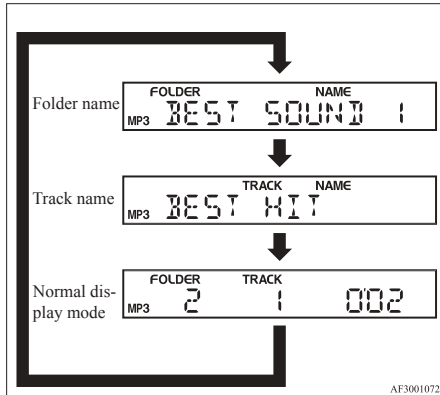

ID3 tag information

The CD player can display ID3 tag information for files that have been recorded with ID3 tag information.

1. Press the TEXT button (6) for 2 seconds or longer to switch to the ID3 tag information. "TAG" will appear on the display for 2 seconds, and then the ID3 tag information will appear.
2. Then press the TEXT button (6) for less than 1 second repeatedly to make selections in the following sequence: album name → track name → artist name → normal display mode.

NOTE

- To return from ID3 tag information to the folder name, press the TEXT button (6) again for 2 seconds or longer.
- When there is no title information to be displayed, the display shows "NO TITLE".
- The display can show up to 11 characters. If a folder name, track name, or item of ID3 tag information has more than 11 characters, press the PAGE button (7) to view the next 11 characters.
- Folder names, track names and items of ID3 tag information can each be displayed up to a length of 32 characters.
- Characters that the CD player cannot display are shown as an asterisk.

To use the external audio input function

E00732200771

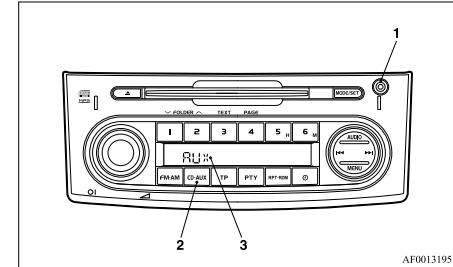

- 1- Auxiliary Audio connector (mini-jack)
- 2- AUX button
- 3- AUX display

You can listen to commercially available audio equipment, such as a portable audio system, from your vehicle's speakers, by connecting the audio equipment to the auxiliary audio connector (1).

NOTE

- Use a stereo mini-jack connector to connect the audio equipment to the auxiliary audio connector.

To activate the external audio input mode

1. Connect the headphone port of the portable audio system to the auxiliary audio connector (1) using a commercially available connection cord.

For pleasant driving

2. Press the AUX button (2).
The display (3) will show “AUX” and then the external audio input mode will be activated.
3. To deactivate the external audio input mode, press the AUX button (2). To switch to another mode.

⚠ CAUTION

- **Do not operate the connected audio equipment while driving. This could distract you and an accident might occur.**

NOTE

- The connected audio equipment cannot be operated with the vehicle’s audio system.
- Depending on the connected audio equipment, it may produce noise from the speakers.
- Use the connected audio equipment’s own power source, such as its battery.
Noise may be produced from the speakers if the connected audio equipment is used while charging it using the accessory socket of the vehicle.
- Do not activate the external audio input mode when no audio equipment is connected. Otherwise, noise may be produced from the speakers.
- Connect audio equipment when the external audio input mode is deactivated or lower the vehicle’s speaker volume before connecting it. Noise may be produced from the speakers if audio equipment is connected after the external audio input mode is activated.

- Compared to the CD player mode and radio mode, the vehicle’s speaker volume will be lower in the external audio input mode. Therefore, be careful when switching from the external audio input mode to the CD player mode or radio mode since the speaker volume will be higher.
- Do not use excessive force on the connection cord. Otherwise, the cord and connectors may be damaged.
- If the connection cord alone is left connected to the auxiliary audio connector, noise may be produced from the speakers.
- For information on how to connect and operate the commercially available audio equipment, refer to the owner’s manual for the commercially available audio equipment.

Steering wheel audio remote control switches*

E00710000447

The remote control switch is located on the left side of the steering wheel.
It can be used when the ignition switch is in the “ON” or “ACC” positions.

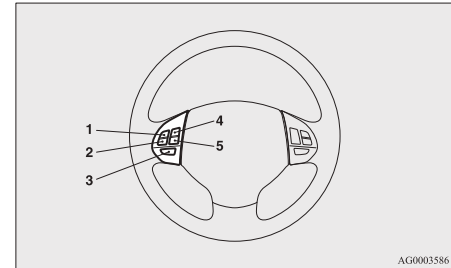

- 1- Volume up button
- 2- Volume down button
- 3- Power switch/mode selector button
- 4- Seek up/track up/fast-forward button
- 5- Seek down/track down/ fast-reverse button

NOTE

- When operating the steering wheel audio remote control switches, do not operate more than one at the same time.

Turning on the power

Press the power switch (3) to turn on the power. When you turn the power on, the mode that was selected when the power was last turned off appears. To turn off the power, press and hold down the power switch (3) for about 2 seconds until you hear a beep.

Volume adjustment

Volume up button - 1

While the button is pressed, the volume continues to increase.

Volume down button - 2

While the button is pressed, the volume continues to decrease.

Mode selection

Press the mode selector button (3) to select the desired mode.

The mode changes in the following order.

FM1 → FM2 → FM3 → MW → LW → CD → AUX → FM1

To listen to the radio

Press the mode selector button (3) to select the desired band (LW/MW/FM).

Automatic tuning

Seek up button - 4/ Seek down button - 5

After pressing these buttons, reception of the selected station will begin.

To listen to a CD

Press the mode selector button (3) and select CD mode.

To fast-forward/reverse the disc

To fast-forward/reverse the disc, press the fast-forward button (4) or the fast-reverse button (5).

Fast-forward

You can fast-forward the disc by holding down the fast-forward button (4). While the button is kept pressed, the disc will be fast-forwarded.

Fast-reverse

You can fast-reverse the disc by holding down the fast-reverse button (5). While the button is kept pressed, the disc will be fast-reversed.

NOTE

- In the case of an MP3 CD, you can fast-forward and fast-reverse tracks in the same folder.

To select a desired track

You can select your desired track by using the track up button (4) or the track down button (5).

NOTE

- Pressing the track down button (5) once during the song will cause the system to restart playing from the beginning of the song.

Error codes

E00710100972

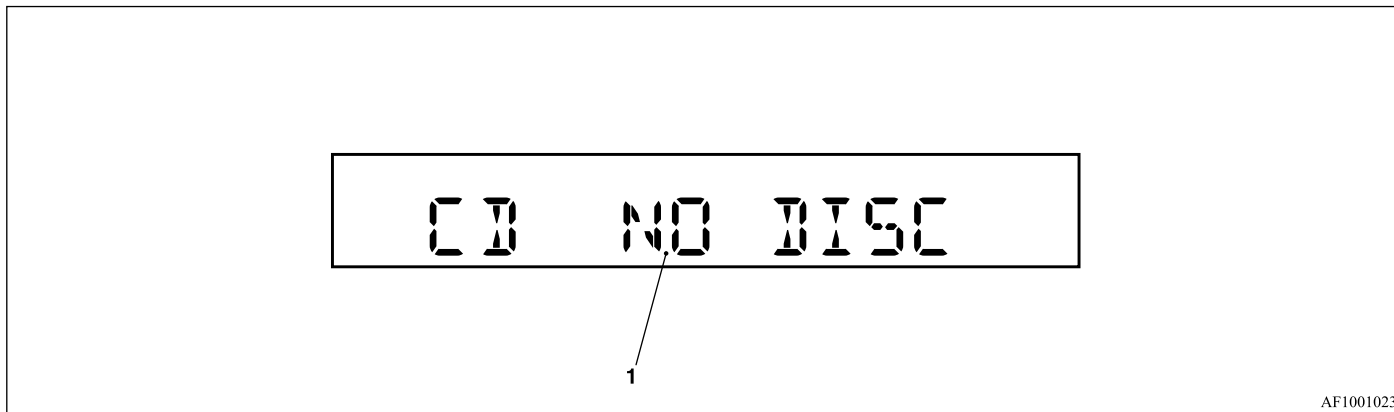

AF1001023

5

If an error code (1) appears in the display, take action in accordance with the table below.

Error display	Problem	Item	Repair
NO DISC	No disc inserted	Disc is not in CD player.	Insert disc.
E 01	Focus error	Disc is not loaded correctly, or condensation on disc.	Insert disc with label facing up. Remove moisture from disc.
E 02	Disc error	Disc is dirty, scratched, or deformed; or excessive vehicle vibration.	Clean or replace disc. Retry when vibrations stop.
E 03	Mechanism error	Loading or eject error. Pick-up is out of position.	Eject disc and reload. If disc will not eject, have the equipment inspected.
E HOT	Inside of audio system is hot.	Internal protection against high temperatures.	Allow radio to cool by waiting about 30 minutes.
E	Communication or power supply error	Communication error between external device and audio equipment. Power supply error of external device.	Consult a MITSUBISHI MOTORS Authorized Service Point.
NO MP3	NO MP3 file in the inserted disc	MP3 CD mode was selected even though inserted disc does not contain MP3 file.	Switch to CD mode or insert CD that contains MP3 file.

For pleasant driving

Handling of compact discs

E00723000207

- Use only the type of compact discs that have the mark shown in the illustration below. (Playback of CD-R or CD-RW discs may cause problems.)

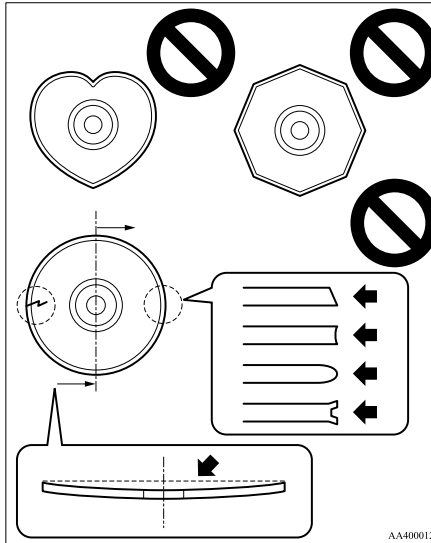

- The use of special shaped, damaged compact discs (like cracked discs) or low-quality compact discs (like warped discs or burrs on the discs) such as those shown will damage the CD player.

- In the following circumstances, moisture can form on discs and inside the audio system, preventing normal operation.
 - When there is high humidity (for example, when it is raining).

- When the temperature suddenly rises, such as right after the heater is turned on in cold weather.

In this case, wait until the moisture has had time to dry out.

- When the CD player is subjected to violent vibrations, such as during off-road driving, the tracking may not work.
- When storing compact discs, always store them in their separate cases. Never place compact discs in direct sunlight, or in any place where the temperature or humidity is high.
- Never touch the flat surface of the disc where there isn't a label. This will damage the disc surface and could affect the sound quality. When handling a compact disc, always hold it by the outer edge and the centre hole.
- To clean a disc, use a soft, clean, dry cloth. Wipe directly from the centre hole towards the outer edge. Do not wipe in a circle. Never use any chemicals such as benzine, paint thinner, a disc spray cleaner, or an anti-static agent on the disc.

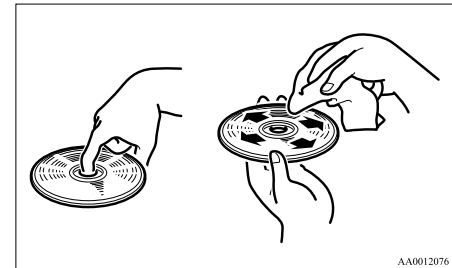

- Do not use a ball point pen, felt pen, pencil, etc. to write on the label surface of the disc.
- Do not put additional labels (A) or stickers (B) on compact discs. Also, do not use any compact disc on which a label or sticker has started to peel off or any compact disc that has stickiness or other contamination left by a peeled-off label or sticker. If you use such a compact disc, the CD player may stop working properly and you may not be able to eject the compact disc.

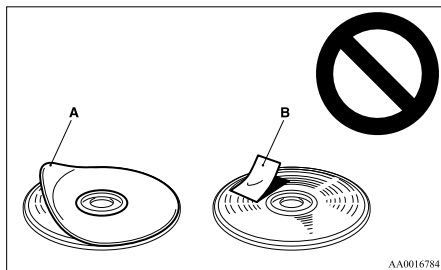

Notes on CD-Rs/RWs

E00725100026

- You may have trouble playing back some CD-R/RW discs recorded on CD recorders (CD-R/RW drives), either due to their recording characteristics or dirt, fingerprints, scratches, etc. on the disc surface.
- CD-R/RW discs are less resistant to high temperatures and high humidity than ordinary music CDs. Leaving them inside a vehicle for extended periods may damage them and make playback impossible.

- The unit may not successfully play back a CD-R/RW that was made by the combination of writing software, a CD recorder (CD-R/RW drive) and a disc if they are incompatible with one another.
- This player cannot play the CD-R/RW discs if the session is not closed.
- This player cannot play CD-R/RW discs which contain other than CD-DA or MP3 data (Video CD, etc.).
- Be sure to observe the handling instructions for the CD-R/RW disc.

WARNING

- Operating the CD player in a manner other than specifically instructed herein may result in hazardous radiation exposure. Do not remove the cover and attempt to repair the CD player by yourself. There are no user serviceable parts inside. In case of malfunction, we recommend you to have it checked.

For pleasant driving

Antenna

E00710500396

Roof antenna

To remove the roof antenna, unscrew it by turning it anticlockwise.

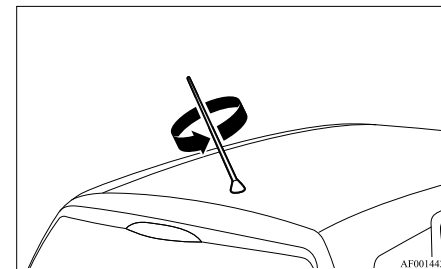



NOTE

- Be sure to remove the roof antenna in the following cases:
 - When entering a place with low clearance.
 - When going into an automatic car wash.
 - When placing a car cover over the vehicle.

For pleasant driving

Digital clock*

E00711800338

Press the  (CLOCK) button to switch the clock mode. To exit the clock mode, press the  (CLOCK) button.

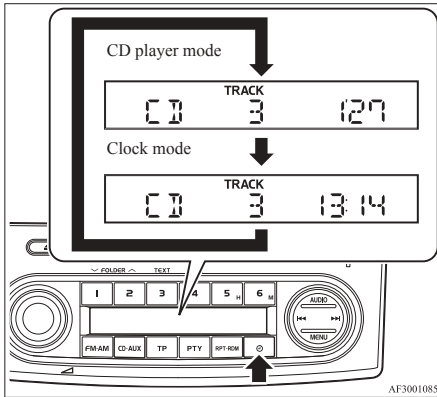

NOTE

- While the clock mode is selected, the display will switch to the applicable operation display whenever the CD player, external audio input mode or radio is operated. Then, if no entries are made for 7 seconds, the display will automatically return to the clock mode.
- While the clock mode is selected, the display will not switch to the applicable operation display when the CD is fast-forwarded or fast-reversed.
- During automatic tuning in the radio mode, the automatic tuning will stop and the clock mode will be displayed when the  (CLOCK) button is pressed. In addition, the radio will return to the previous station before automatic tuning began.

To adjust the clock

Automatic mode and manual mode is available for digital clock adjustment:

Select the automatic mode or the manual mode by performing the following operations:

1. Press the PWR switch (A) to turn ON the audio system.
2. Enter the function setup mode by pressing the Menu button (B).

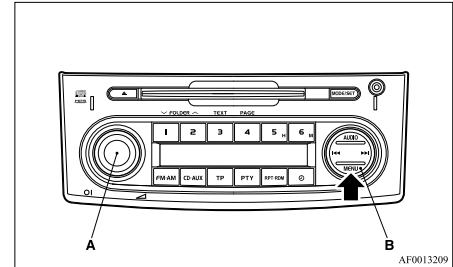

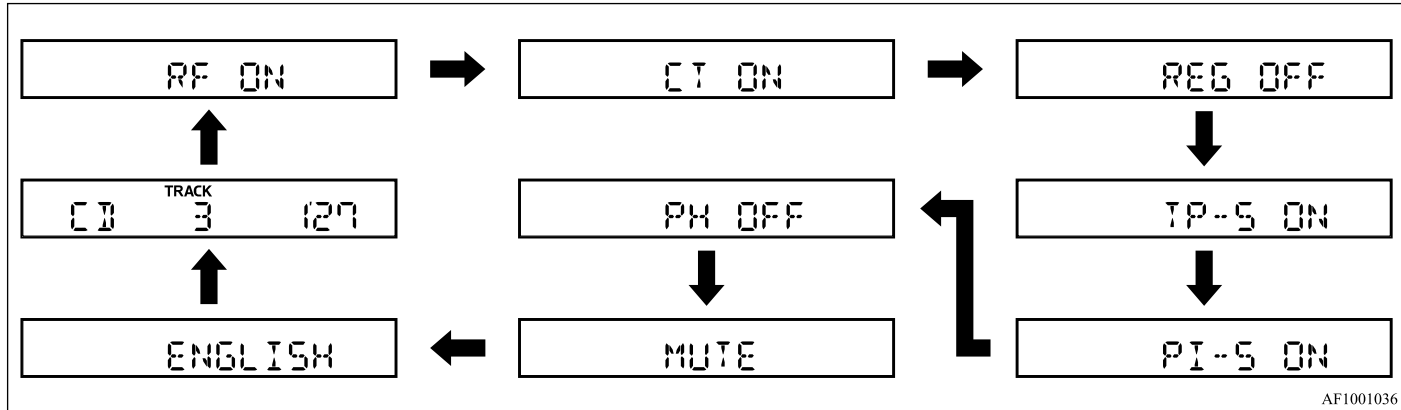

AF1001036

3. Press the Menu button (B) repeatedly to select the CT (Clock Time) mode.
 The order is: AF → CT → REG → TP-S → PI-S → PHONE IN (PH) → MUTE → Language of PTY display Function setup mode OFF
 (Refer to “Function setup mode” on page 5-20.)

4. Select the desired setting for each mode to be turned ON and OFF.

NOTE

- After selecting a mode, you can leave the function setup mode by taking either of the following steps:
 - Press the Menu button (B) for at least 2 seconds.
 - Make no entry for 7 seconds.

NOTE

- Although “PHONE IN (PH)” and “MUTE” appear on the display, the PHONE IN and MUTE function is inoperative.
- “MUTE” will appear only if the PHONE IN function is set to “PH ON”.

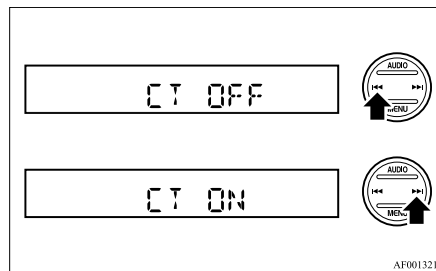

AF0013212

CT ON- Automatic mode
 CT OFF- Manual mode

For pleasant driving

Automatic mode

The automatic mode can set the local time automatically by using the signal from the local RDS stations. Refer to “Radio data system (RDS)” on page 5-17.

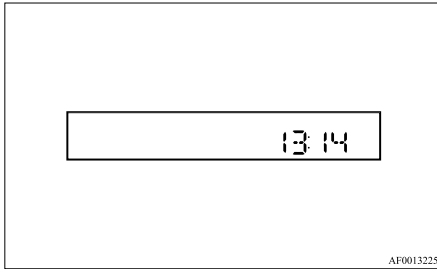

Manual mode

The manual mode is also available in case the “Automatic mode” shows the incorrect time when the adjacent local RDS stations are located in a different time zone. Refer to “Radio data system (RDS)” on page 5-17.

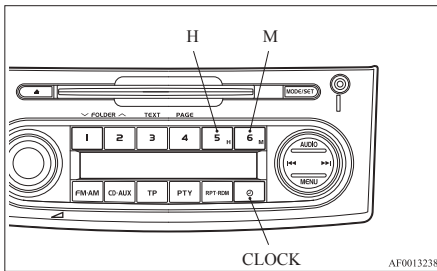

Set the time by pressing the various buttons as described below.

1. Keep the  (CLOCK) button pressed until the time display flashes.
2. Press the appropriate buttons to adjust the time.

“H” button - To adjust the hour

“M” button - To adjust the minutes

3. To exit the adjust mode, press the  (CLOCK) button.

NOTE

- When using the manual mode to adjust the clock, set the “CT” function to “OFF”. If the “CT” function is set to “ON”, the time will automatically be corrected using the signals from the local RDS stations even if it was set manually.
- If the battery cables are disconnected during repairs or for any other reason, reset the clock to the correct time after they are reconnected.
- The digital clock does not have a second display. When the “minute” display is adjusted and reset to zero, the clock begins at zero seconds for the selected minute.

Sun visors

E00711201010



- 1- To eliminate front glare
- 2- To eliminate side glare

Vanity mirror

E00711300708

A vanity mirror is fitted to the back of the sun visor.

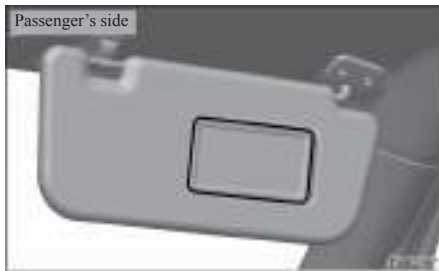
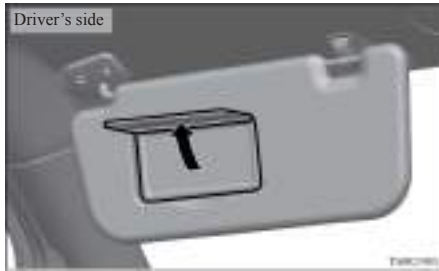

Accessory socket

E00711601085

The accessory socket can be used while the ignition switch is in either the "ON" or "ACC" position. Open the cap to uncover the socket. Use it to plug in an electrical device.

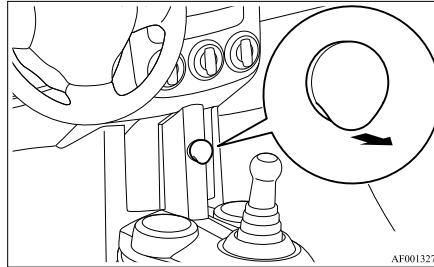

NOTE

- Long use of the electric appliance without running the engine may run down the battery.

⚠ CAUTION

- Be sure to use a "plug-in" type accessory operating at 12 V and at 120 W or less. When using the socket, make sure the total power consumption of the electrical accessories does not exceed 120 W at 12 V. Also be aware that using electronic equipment with the engine off may run the battery down.
- When the accessory socket is not in use, be sure to close the cap, because the socket might become clogged by foreign material and be short-circuited.

For pleasant driving

Interior lamps

E00712000799

The interior lamps go on when a door or tailgate is opened.

When all doors and tailgate are closed, the interior lamps are illuminated and dimmed gradually for 15 seconds then go out.

However, the interior lamps go out immediately without being dimmed in the following cases:

- The ignition switch is turned "ON".
- All doors and tailgate are locked using the key mechanism of the driver's door, the lock knob of the driver's door, or the remote control switch of the keyless entry system.

NOTE

- The dimming period is adjustable. For further information, we recommend you to consult a MITSUBISHI MOTORS Authorized Service Point.
- If you leave the lamps on without running the engine, you will run down the battery. Before you leave the vehicle, make sure that all the lamps are off.

Room lamp with map lamps

E00724300018

Room lamp

Opening a door or the tailgate makes the room lamp come on.

Closing it makes the room lamp go off.



Map lamps

Push the map lamp cover to turn on the lamp. Push it again to turn it off.



Opening a door or the tailgate makes the luggage compartment lamp come on. Closing it makes the luggage compartment lamp go off.



Luggage compartment lamp

E00712700480

The luggage compartment lamp (A) is located on left-hand side (3-door models) or the right-hand side (5-door models) of the luggage compartment.

Storage spaces

E00713101244

CAUTION

- Never leave lighters, cans of carbonated drink, and spectacles in the cabin when parking the vehicle in hot sunshine. The cabin will become extremely hot, so lighters and other flammable items may catch fire and unopened drink cans (including beer cans) may rupture. The heat may also deform or crack plastic spectacle lenses and other spectacle parts that are made of plastic.
- Keep the lids of storage spaces closed while driving the vehicle. A lid or the contents of a storage space could otherwise cause injuries.

NOTE

- Do not leave valuables in any storage space when leaving the vehicle.

3-door models

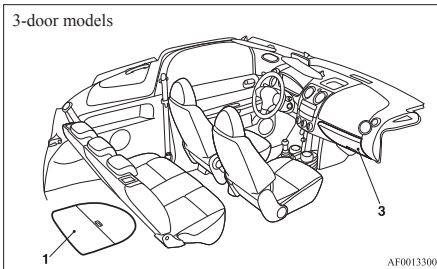

5-door models

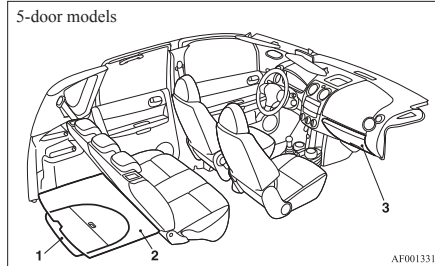

- 1- Luggage floor boxes
- 2- Luggage floor lid*
- 3- Glove box, Cool box*

Glove box

E00717600963

To open the glove box, pull the lid towards you while pressing the lever (A).

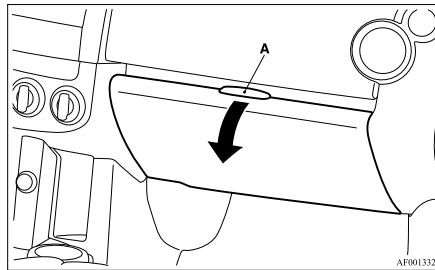

Pen holder, coin holder and card holder

The glove box contains a pen holder (B), a coin holder (C) and card holder (D).

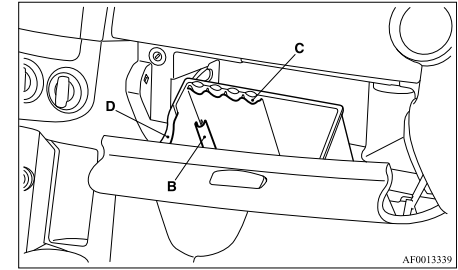

Cool box*

E00721900084

The cool box (A) is located inside the glove box. You can put plastic and other bottles in the box. The cool box can be operated when the air conditioning is operating. Refer to the “Automatic air conditioning” on page 5-07.

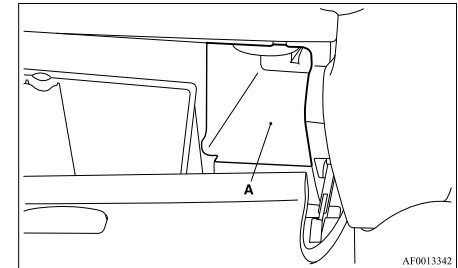

For pleasant driving

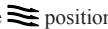
1. Set the cool box dial (B) inside the glove box to the  position.

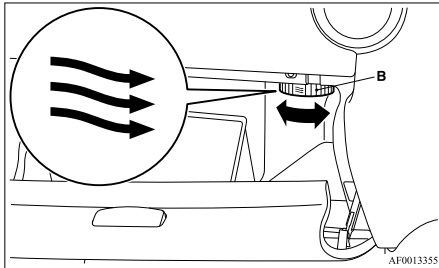

NOTE

- When the cool box is not being used, set the cool box dial to the  position.
2. Select the desired blower speed by turning the dial (C).
 3. Select the desired temperature by turning the temperature control dial (D).
 4. Set the mode selection dial (F) within the face position range as shown in the illustration.

5. Push the air conditioning switch (E).

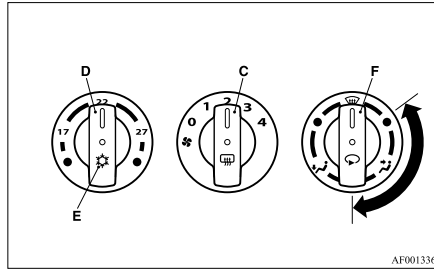

NOTE

- Do not put things that decay easily in the cool box.

Luggage floor lid (5-door models)*

E0073440025

Raise the luggage floor lid to store articles in the luggage compartment.

CAUTION

- Do not pile up the luggage beyond the seat-back height. Otherwise, serious accidents could result due to hindered rearward view or flying objects during sudden braking.

To use

Raise the luggage floor lid (A).

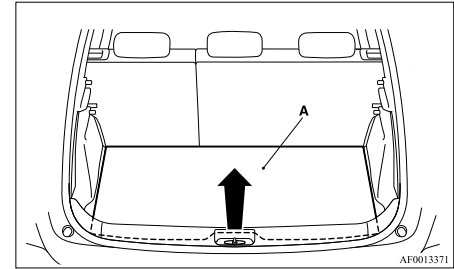

NOTE

- Raise the luggage floor lid (A) and insert it between the rear seat and the support (B) to hold it in place.

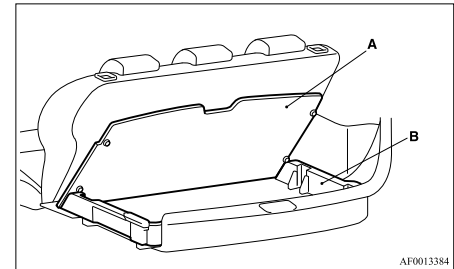

To refit

To return the luggage floor lid to its original position, perform the using steps in the reverse.

NOTE

- Fit the stoppers (C) on the bottom of the luggage floor lid into the groove (D) in the support.

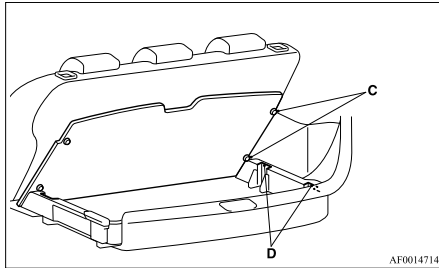

Luggage floor boxes

E00718700554

The box for storing articles is located inside the luggage compartment.

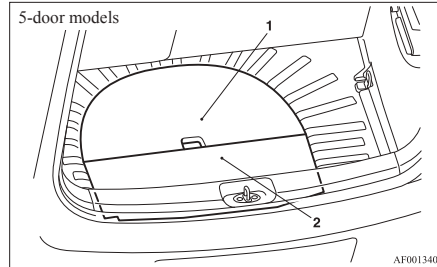
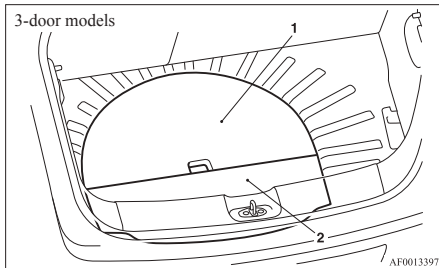

- 1- Luggage floor box (Front)
- 2- Luggage floor box (Rear)

NOTE

- For vehicles with the luggage floor lid (5-door models), securely retain the lid before raising the luggage floor boards. Refer to “Luggage floor lid (5-door models)” on page 5-40.

To use

Raise the luggage floor board.

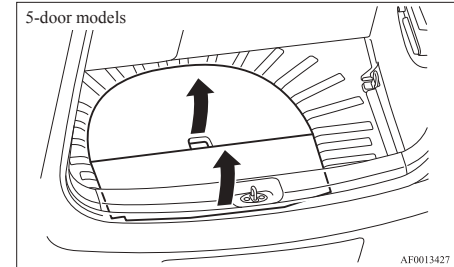
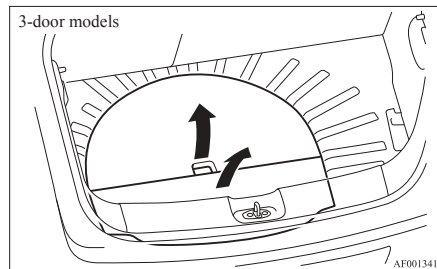

For pleasant driving

Cup holder

E00714500671

⚠ CAUTION

- Do not drink beverages while driving the vehicle; doing so could distract you and result in an accident.
- Beverages can spill owing to vibration or other movement during vehicle operation or owing to opening and closing of the rear doors. Be careful not to get scalded by a hot beverage if it spills.

For the front seat

The cup holders are located in front of the gearshift or allshift lever.

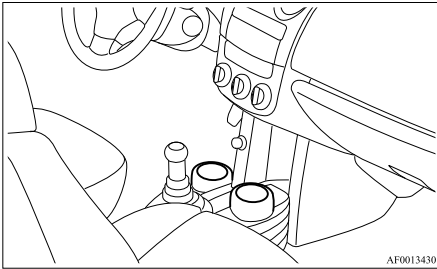

For the rear seat

E00716900099

The cup holder is located in front of the rear-center seat.



Rear shelf panel*

E00715400071

3-door models

The rear shelf panel is provided in the luggage area.

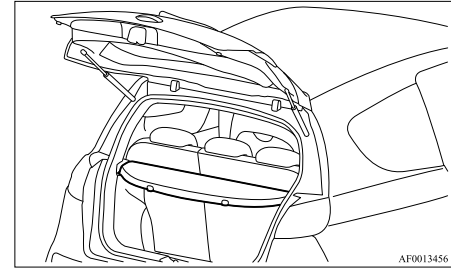

To remove

Unsnap by lifting the shelf panel pivoting points.

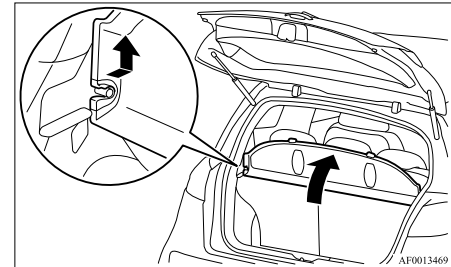

To stow

Stow the removed rear shelf panel in the luggage compartment.

Coat hooks*

E00725600382

There are 2 hooks on the rear pillar for use in hanging clothes.

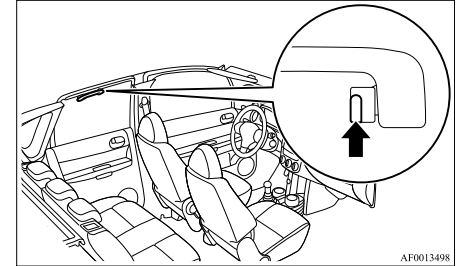

AF0013498

⚠ WARNING

- Do not put a hanger or any heavy or pointed object on the coat hook. If the curtain airbag was activated, any such item could be propelled away with great force and could prevent the curtain airbag from inflating correctly. Hang clothes directly on the coat hook (without using a hanger). Make sure there are no heavy or sharp objects in the pockets of clothes that you hang on the coat hook.

5

NOTE

- Do not place heavy luggage (more than about 1 kg) on the rear shelf panel.

5-door models

The rear shelf panel is provided in the luggage area. The rear shelf panel can be locked in the upright position.

To lock

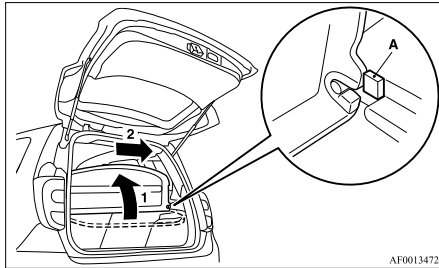

AF0013472

1. Lift the rear shelf panel.
2. Slide the rear shelf panel to the right until it contacts the stopper (A) to lock it.
3. To lower the rear shelf panel, perform the locking steps in the reverse.

⚠ CAUTION

- Do not operate the vehicle with the rear shelf panel in the upright position. Otherwise, serious accidents could result due to restricted rear vision.

To remove

1. Unsnap by lifting the rear shelf panel pivoting points.

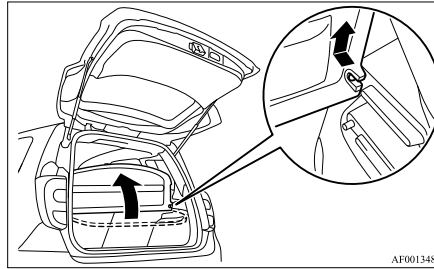

AF0013485

To stow

Stow the removed rear shelf panel in the luggage compartment.

NOTE

- Do not place heavy luggage (more than about 1 kg) on the rear shelf panel.

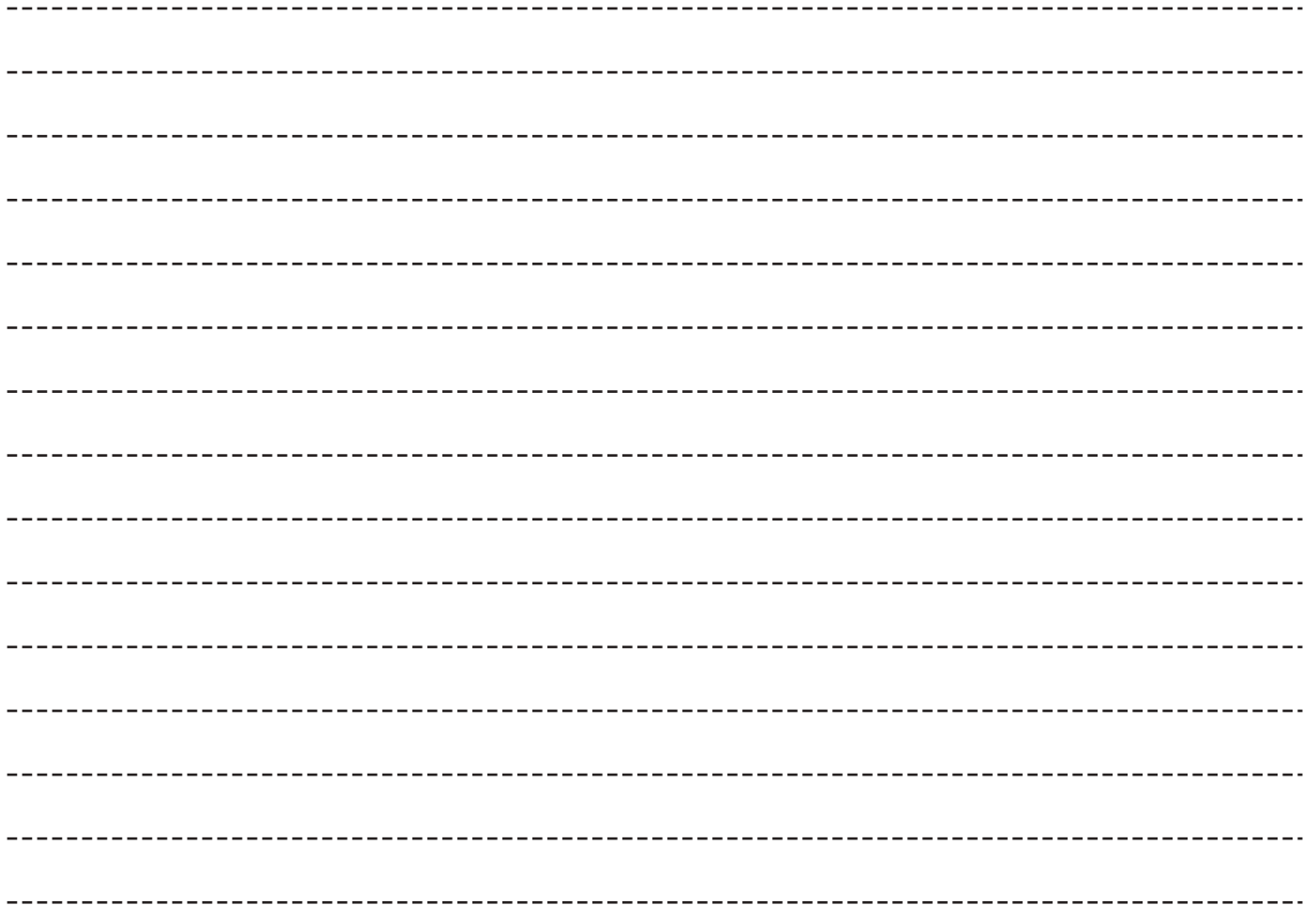

For emergencies

If the vehicle breaks down.....	6-02
Emergency starting.....	6-02
Engine overheating.....	6-04
Tools, jack and tyre repair kit*.....	6-06
Jacking up the vehicle.....	6-12
Spare wheel*.....	6-13
How to change a tyre.....	6-15
Towing.....	6-18
Operation under adverse driving conditions.....	6-22

For emergencies

If the vehicle breaks down

E00800101254

If the vehicle breaks down on the road, move it to the shoulder and use the hazard warning flashers and/or the warning triangle etc.

Refer to “Hazard warning flasher switch” on page 3-23.

If the engine stops/fails

Vehicle operation and control are affected if the engine stops.

Before moving the vehicle to a safe area, be aware of the following:

- The brake booster becomes inoperative and the pedal effort will increase. Press down the brake pedal harder than usual.
- Since the power steering system is no longer operative, the steering wheel feels heavy when turning it.

Emergency starting

E00800501900

If the engine cannot be started because the battery is weak or dead, the battery from another vehicle can be used with jumper cables to start the engine.

⚠ WARNING

- **To start the engine using jumper cables connected to another vehicle, perform the correct procedures according to the instruction below. Incorrect procedures could result in a fire or explosion or damage to the vehicles.**

1. Get the vehicles close enough so the jumper cables can reach, but be sure the vehicles aren't touching each other.
If they are, it could cause a ground connection you don't want. The vehicle will not start, and the bad grounding could damage the electrical systems.

⚠ CAUTION

- **Check the other vehicle. It must have a 12-volt battery.
If the other system isn't 12-volt, shorting can damage both vehicles.**

2. You could be injured if the vehicles move. Set the parking brake firmly on each vehicle. Put an automatic transmission in “P” (PARK) or a manual transmission and an automated manual transmission in “N” (Neutral). With an automated manual transmission vehicle, confirm that “N” is shown by the allshift indicator display. Turn off the ignition switch.

⚠ WARNING

- **Turn off the ignition on both vehicles beforehand. Make sure that the cables or your clothes cannot be caught by the fan or drive belt. Personal injury could result.**

NOTE

- Turn off all lamps, heater and other electrical loads. This will avoid sparks and help save both batteries.
3. Make sure battery electrolyte is at the proper level. Refer to “Battery” on page 8-10.

⚠ WARNING

- **If electrolyte fluid is not visible, or appears to be frozen, Do Not Attempt Jump Starting!
A battery might rupture or explode if the temperature is below the freezing point or if it is not filled to the proper level.**

- Connect one end of one jumper cable to the positive (+) terminal of the discharged battery (A), and the other end to the positive (+) terminal of the booster battery (B).

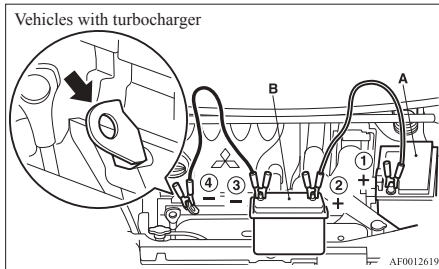
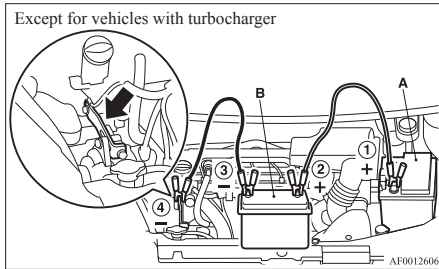

- Connect one end of the other jumper cable to the negative (-) terminal of the booster battery (B), and the other end to the engine block of the vehicle with the discharged battery at the point farthest from the battery.

NOTE

- Open the cover before connecting the jumper cable to the positive (+) terminal of the battery. Refer to “Battery” on page 8-10.

⚠ WARNING

- Be sure to observe the connecting sequence of ① → ② → ③ → ④.
- Make sure that the connection ④ is made to the appointed position (shown in the illustration). If the connection is made directly to the negative side of the battery, the inflammable gasses generated from the battery might catch fire and explode.
- When connecting the jumper cables, do not connect the positive (+) cable to the negative (-) terminal. Otherwise sparks might cause explosion of the battery.

⚠ CAUTION

- Take care not to get the jumper cable caught in the cooling fan or other rotating part in the engine compartment.
- Use the proper cables suitable for the battery size to prevent overheating of the cables.
- Check the jumper cables for damage and corrosion before use.

- Start the engine in the vehicle which has the booster battery, let the engine idle a few minutes, then start the engine in the vehicle with the discharged battery.

⚠ CAUTION

- Keep the engine of the vehicle giving assistance running.

- After the engine is started, disconnect the cables in the reverse order.

⚠ WARNING

- Charging the battery while it is installed in the vehicle might cause the battery to catch fire and explode. Or damage to the vehicle could result. If it has to be charged in that condition for unavoidable reasons, disconnect the vehicle side negative (-) terminal connected to the battery.
- Keep sparks, cigarettes and flames away from the battery because the battery may produce an explosion.
- Use adequate ventilation when charging or using the battery in an enclosed space.
- Remove all the caps before charging the battery.
- Electrolyte is corrosive diluted sulphuric acid. If electrolyte (battery acid) comes into contact with your hands, eyes, clothes and the painted surface of your vehicle, it should be thoroughly flushed with water. If electrolyte gets in your eyes, flush them with water immediately and thoroughly, and get prompt medical attention.

For emergencies

⚠ CAUTION

- Do not attempt to start the engine by pulling or pushing the vehicle. It could damage your vehicle.
- Always wear protective eye goggles when working near the battery.
- Keep the battery out of the reach of children.

NOTE

- If the vehicle is put in motion without fully charging the battery, it might cause the loss of smooth engine operation and the anti-lock brake warning lamp to illuminate. Refer to “Anti-lock brake system (ABS)” on page 4-27.
- For Clear Tec models, press the “Auto Stop & Go (AS&G) OFF” switch to deactivate the Auto Stop & Go (AS&G) system and prevent the engine from automatically stopping before the battery is sufficiently charged. Refer to “To deactivate” on page 4-16.

Engine overheating

E00800601839

If the high coolant temperature warning lamp flashes during the engine is running, the engine may be overheating. If this occurs, take the following corrective measures:

1. Stop the vehicle in a safe place.
2. Check whether steam is coming from the engine compartment.

[If steam does not come from the engine compartment]

With the engine still running, raise the bonnet to ventilate the engine compartment.

NOTE

- For Clear Tec models, press the “Auto Stop & Go (AS&G) OFF” switch to deactivate the Auto Stop & Go (AS&G) system before stopping the vehicle. Refer to “To deactivate” on page 4-16.

[If steam is coming from the engine compartment]

Stop the engine, and when the steam stops, raise the bonnet to ventilate the engine compartment. Restart the engine.

⚠ WARNING

- Do not open the bonnet while steam is coming from the engine compartment. It could cause steam or hot water to spurt out, causing burns. Hot water could spurt out even when there is no steam coming out, and some parts will be very hot. Be very careful when opening the bonnet.

⚠ WARNING

- Be careful of hot steam, which could blow off the reserve tank cap.
 - Do not attempt to remove the radiator cap while the engine is hot.
3. Confirm that the cooling fan is turning. If the fan is not turning, stop the engine immediately and have it checked.

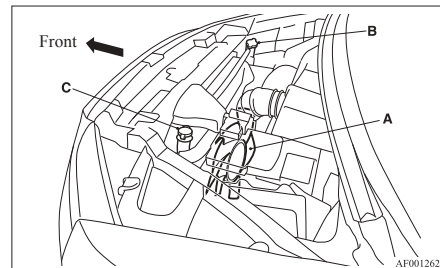

- A- Cooling fan
- B- Radiator cap
- C- Reserve tank

⚠ WARNING

- Be careful not to get your hands or clothes caught in the cooling fans.

- After the engine coolant temperature has dropped to the normal temperature, stop the engine.

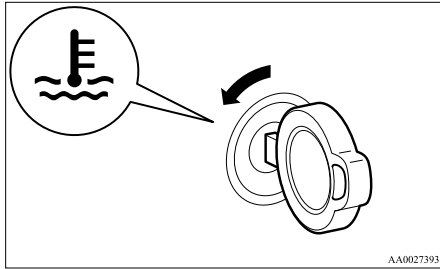

- Check the coolant level in the reserve tank.
Except for vehicles with turbocharger
 The coolant level in this tank should be kept between the “LOW” and “FULL” marks.

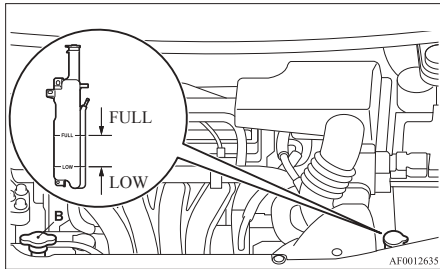

Vehicles with turbocharger

The reserve tank lid is equipped with a dipstick.

Remove the dipstick and wipe it with a clean cloth. Reinsert the dipstick as far as it goes. Remove the dipstick and read the coolant level, which should always be within the range “F” (FULL) or “L” (LOW).

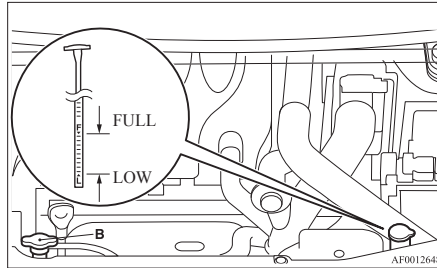

WARNING

- If there is none, make sure that the engine has cooled down before removing the radiator cap (B), because hot steam or boiling water otherwise will gush from the filler port and may scald you.

- Add coolant to the radiator and/or reserve tank if necessary (refer to the “Maintenance” section).

CAUTION

- Do not add coolant while the engine is hot. Suddenly adding cold coolant could damage the engine. Wait for the engine to cool down, then add coolant a little at a time.

- Examine the radiator hoses for coolant leakage and the drive belt for looseness or damage. If there is anything wrong with the cooling system or drive belt, we recommend you to have it checked and repaired.

For emergencies

Tools, jack and tyre repair kit*

E00800901089

Storage

The storage location of the tools, jack and tyre repair kit should be remembered in case of an emergency.

Vehicles with compact spare wheel

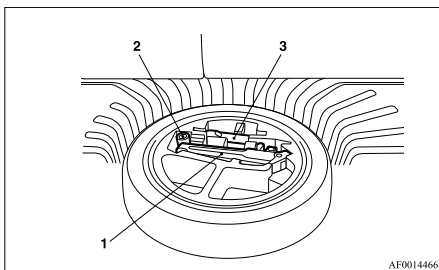

- 1- Jack
- 2- Wheel nut wrench
- 3- Towing hook

Except for vehicles with compact spare wheel

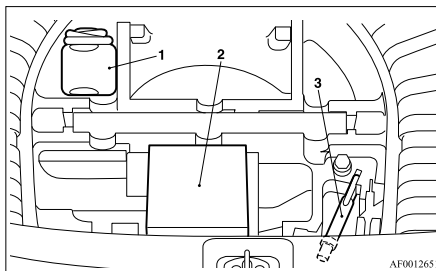

- 1- Tyre repair kit
- 2- Tyre compressor
- 3- Towing hook

NOTE

- The tools, jack and tyre repair kit are stored beneath the luggage floor board of the luggage compartment.

Tools

E00801900799

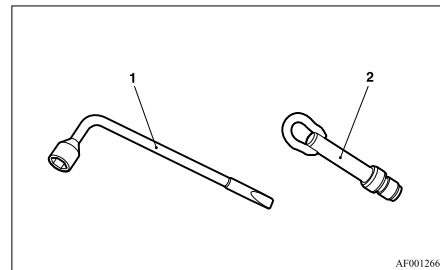

- 1- Wheel nut wrench*
- 2- Towing hook

Tyre repair kit*

E00802200294

This kit enables emergency repair of a small puncture in the tread area of a tyre that has run over a nail, screw, or similar object.

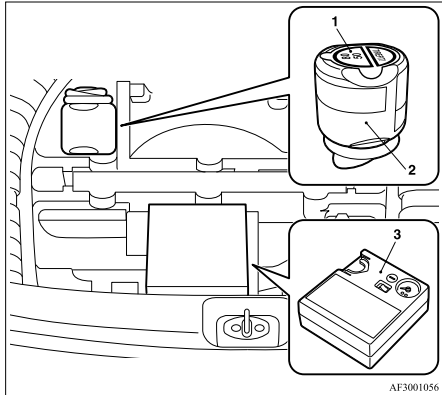

- 1- 80 km/h and 50 mph labels
- 2- Tyre sealant bottle
- 3- Tyre compressor

⚠ CAUTION

- The tyre sealant can cause health damage if swallowed. If you accidentally swallow it, drink as much water as possible and immediately consult a doctor.
- If the tyre sealant gets in your eyes or on your skin, rinse with lots of water. If you still sense an abnormality, consult a doctor.

⚠ CAUTION

- Consult a doctor immediately if any allergic reactions occur.
- Do not allow children to touch the tyre sealant.
- Do not breathe in the vapours of tyre sealant.

NOTE

- The tyre sealant cannot be used in any of the situations listed below. If any of these situations occurs, please contact a MITSUBISHI MOTORS Authorized Service Point or another specialist.
 - The tyre sealant's expiry date has passed. (The expiry date is shown on the bottle label.)

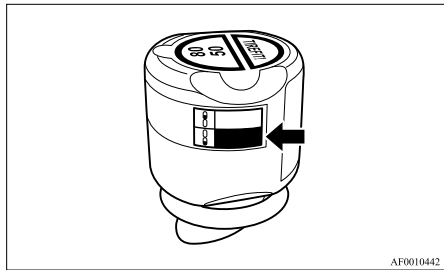

- More than one tyre is punctured.
- The puncture hole has a length or width of 4 mm or more.

- The tyre is punctured in the side wall (A), not in the tread (B).

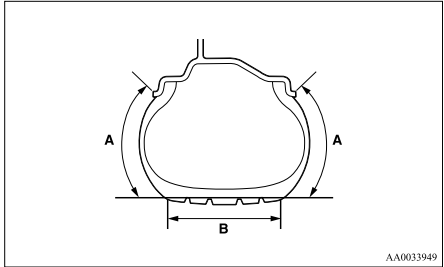

- The vehicle has been driven with the tyre almost completely flat.
- The tyre has completely slipped over the wheel rim and has come off the wheel.
- The wheel is damaged.
- Use the tyre sealant only at ambient temperatures of -20 °C to + 60 °C.
- Effect an emergency repair without pulling out the object (nail, screw, etc.) that is stuck in the tyre.
- Do not use the tyre sealant if the tyre has been damaged by being driven when insufficiently inflated (e.g. bumps, cuts, cracks etc. on the tyre).
- Wipe tyre sealant off the paintwork immediately with a damp cloth.
- Immediately wash out any clothes contaminated with the tyre sealant.

Before repairing a tyre, first stop your vehicle in a safe, flat location.

1. Park the vehicle on level and stable ground.
2. Set the parking brake firmly.

For emergencies

3. On vehicles with manual transmission, turn the ignition key to the "LOCK" position, move the gearshift lever to the "R" (Reverse) position.

On vehicles with automated manual transmission, move the allshift lever to the "R" (Reverse) position, turn the ignition key to the "LOCK" position.

With an automated manual transmission vehicle, confirm that that "R" is shown by the allshift indicator display.

4. Turn on the hazard warning flashers and set up a warning triangle, flashing signal lamp, etc., at an adequate distance from the vehicle, and have all your passengers leave the vehicle.
5. Take out the tyre sealant bottle and the compressor.

NOTE

- In cold conditions (when the ambient temperature is 0 °C or lower). Warm the bottle inside the vehicle.

6. Shake the tyre sealant bottle (C) well.

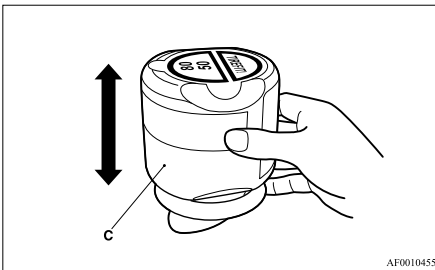

7. Take the valve cap (D) off the tyre valve (E).

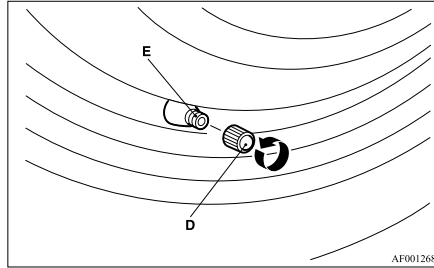

8. Unwind the bottle hose (F) from around the bottle (G).

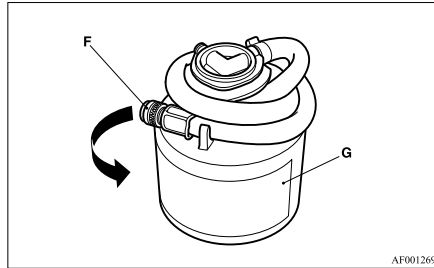

9. Pull out the compressor's hose (H) from the bottom of the compressor and securely attach it to the valve (I) of the bottle.

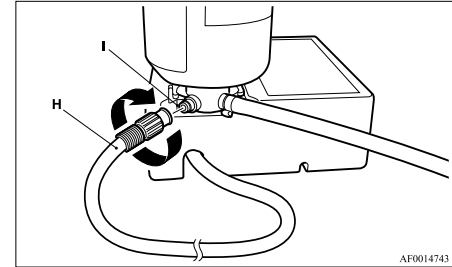

10. Install the bottle (J) onto the compressor (K).

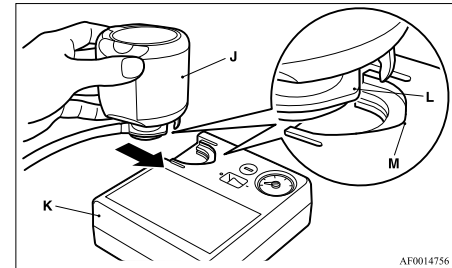

NOTE

- When installing the bottle, align the projection (L) on the bottle with the indentation (M) in the compressor.

11. Securely attach the bottle hose (F) to the tyre valve (N).

Remove the “max. 80 km/h” or “max. 50 mph” label from the bottle, that must be displayed on the instrument panel within the driver’s field of view.

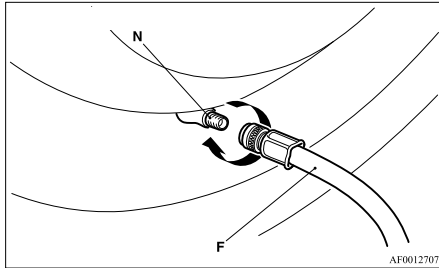

12. Insert the plug on the compressor’s power cord (O) into the accessory socket (P), then turn the ignition switch to the “ACC” or “ON” position.

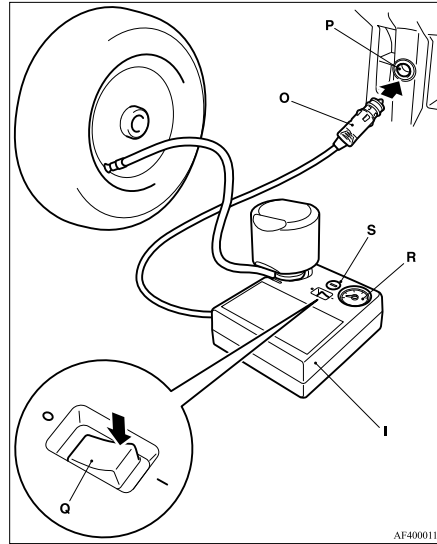

13. Turn ON the compressor switch (Q) and inflate the tyre to the specified pressure. Check and adjust the tyre pressure with reference to the air pressure gauge (R) on the compressor (I). If you overinflate the tyre, release air by pressing the pressure release switch (S) on the compressor or by loosening the hose’s end fitting. (Refer to “Tyre inflation pressures” on page 8-12.)

⚠ CAUTION

- Do not keep the compressor running continuously for more than 6 minutes. Doing so could result in a malfunction.

If the tyre pressure does not rise adequately, remove the compressor from the tyre and carefully drive the vehicle 10 metres forwards or backwards to distribute the tyre sealant amount in the tyre’s interior, then try inflating the tyre again.

If there is a gap between the tyre and wheel because the tyre has moved inward from the wheel rim, press the periphery of the tyre towards the wheel to close the gap before running the compressor. (With no gaps, the tyre pressure will rise.)

⚠ CAUTION

- Be careful not to get your fingers trapped between the tyre and wheel as the tyre inflates.

14. Turn OFF the compressor switch, then pull the power cord plug out of the accessory socket.

NOTE

- The supplied compressor is designed only for inflation of passenger vehicle tyres.
- The compressor is designed to run on a vehicle’s 12 V power supply. Do not connect it to any other power source.

For emergencies

- The surface of the compressor will get hot while the compressor is running. Do not keep the compressor running continuously for more than 6 minutes. After using the compressor, wait for the compressor to cool before using it again.
- If the tyre pressure does not rise to the necessary of at least 1.8 bar level within 5 minutes, the tyre may be so severely damaged that the tyre sealant cannot be used to effect an emergency repair. Please contact a MITSUBISHI MOTORS Authorized Service Point or another specialist in this event.
- Simply putting sealant and air into the tyre using the tyre repair kit does not seal the puncture hole. Air will leak through the puncture hole until the emergency repair procedure is completed (through step 17 of these instructions).

15. When you have inflated the tyre to the specified pressure, stow the compressor and bottle in the vehicle and promptly start driving the vehicle so that the tire sealant can spread evenly in the tyre. Drive with great care. Do not exceed a speed of 80 km/h (50 mph). Observe local speed limits. Remove the “max. 80 km/h” or “max. 50 mph” label from the bottle, that must be displayed on the instrument panel within the driver’s field of view.



CAUTION

- **If you sense any abnormality while driving, stop the vehicle and contact a MITSUBISHI MOTORS Authorized Service Point or another specialist. Otherwise the tyre pressure may drop before the emergency repair procedure is completed, rendering the vehicle unsafe.**

NOTE

- Driving faster than 80 km/h (50 mph) can make the vehicle vibrate.

16. After driving for 10 minutes, check the tyre pressure using the air pressure gauge on the compressor. If the tyre pressure is not sufficient, inflate the tyre to the specified pressure again and drive the vehicle carefully without exceeding a speed of 80 km/h (50 mph).



CAUTION

- **If the tyre pressure is lower than the minimum permitted pressure (1.3 bar {130 kPa}), the tyre cannot successfully be repaired with the tyre sealant. Do not drive the vehicle any further. Contact a MITSUBISHI MOTORS Authorized Service Point or another specialist.**

17. After driving for 10 minutes, check the tyre pressure using the air pressure gauge on the compressor. (Refer to “Tyre inflation pressures” on page 8-12.) If the tyre pressure has apparently not dropped, the emergency re-

pair procedure is complete. You must still not exceed a speed of 80 km/h (50 mph). Observe local speed limits.

NOTE

- If the tyre pressure has dropped below the specified level when you check it at the end of the repair procedure, do not drive the vehicle any further. Contact a MITSUBISHI MOTORS Authorized Service Point or another specialist.
 - In cold conditions (when the ambient temperature is 0 °C or lower), the time and driving distance necessary until completion of the repair can be longer than in warmer conditions, meaning that the tyre pressure can drop below the specified level even when you have inflated the tyre a second time and subsequently driven the vehicle. If this happens, inflate the tyre to the specified pressure once more, drive for about 10 minutes or 5 km (3 miles), then check the tyre pressure again. If the tyre pressure has again dropped below the specified level, stop driving the vehicle and contact a MITSUBISHI MOTORS Authorized Service Point or another specialist.
18. Then immediately drive with great care to a MITSUBISHI MOTORS Authorized Service Point or another specialist and have tyre repair/replacement performed.

CAUTION

- Be sure to check the tyre pressure for confirmation that the emergency repair procedure is complete.

NOTE

- Please give the empty sealant bottle to your MITSUBISHI MOTORS Authorized Service Point when you purchase new sealant or dispose of the sealant bottle according to national regulations for the disposal of chemical waste.
- A tyre in which puncture sealant has been used should ideally be replaced with a new one. If you wish to have such a tyre properly repaired for reuse, please contact a MITSUBISHI MOTORS Authorized Service Point or another specialist. Note that a proper repair is impossible following an emergency repair if the puncture hole cannot be located.
- Wipe away any sealant that gets on the wheel. Provided the valve is replaced with a new one, the wheel can be reused.
- The manufacturer is unable to guarantee that all tyre punctures can be repaired with the tyre repair kit, in particular cuts or perforations with a diameter of more than 4 mm or away from the tyre's tread. The manufacturer is not liable for damage sustained through improper use of the tyre repair kit.
- The manufacturer is not liable for damage sustained through re-use of any tyre in which tyre sealant has been used.

Jack*

E00802000423

To remove

1. For vehicles with luggage floor lid, open the luggage floor lid.
Refer to "Luggage floor lid" on page 5-40.
2. Lift the carpet, then remove the luggage floor boards (A).

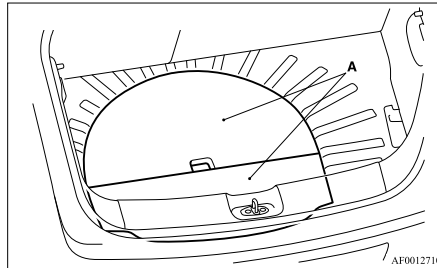

3. Take out the jack from its designated position.

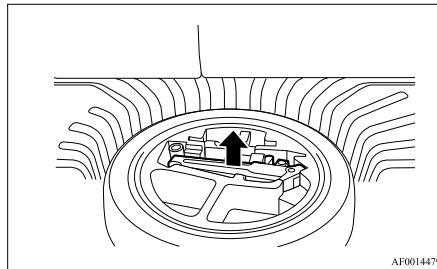

To store

1. Retract the jack, then return it to its original position.

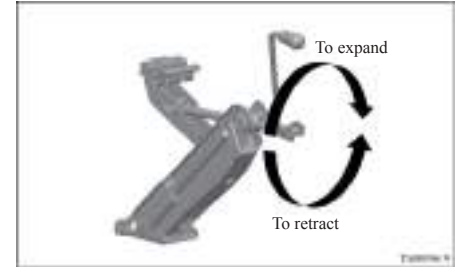

2. Return the luggage floor board to its original position.

For emergencies

Jacking up the vehicle

E00801001218

1. Park the vehicle on level and stable ground.
2. Set the parking brake firmly.
3. On vehicles with manual transmission, turn the ignition key to the "LOCK" position, move the gearshift lever to the "R" (Reverse) position.

On vehicles with automated manual transmission, move the allshift lever to the "R" (Reverse) position, turn the ignition key to the "LOCK" position.

With an automated manual transmission vehicle, confirm that there is a "A" or "1" in the allshift indicator display.

4. Turn on the hazard warning flashers and set up a warning triangle, flashing signal lamp, etc., at an adequate distance from the vehicle, and have all your passengers leave the vehicle.
5. To prevent the vehicle from rolling when it is raised on the jack, place chocks or blocks (A) at the tyre that is diagonally opposite from the tyre (B) you are changing.

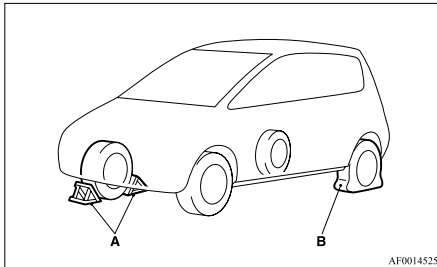

⚠ WARNING

- Be sure to apply chocks or blocks to the correct tyre when jacking up the vehicle. If the vehicle moves while jacked up, the jack could slip out of position, leading to an accident.

NOTE

- The chocks shown in the illustration do not come with your vehicle. It is recommended that you keep one in the vehicle for use if needed.
 - If chocks are not available, use stones or any other objects that are large enough to hold the wheel in position.
6. Place the jack under one of the jacking points (C) shown in the illustration. Use the jacking point closest to the tyre you wish to change.

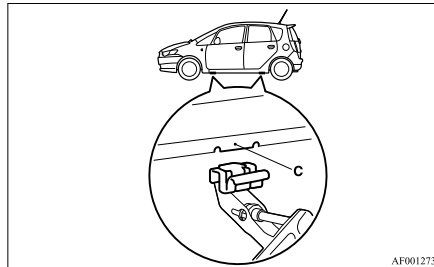

⚠ WARNING

- Set the jack only at the positions shown here. If the jack is set at a wrong position, it could dent your vehicle or the jack might fall over and cause personal injury.
- Do not use the jack on a tilted or soft surface. Otherwise, the jack might slip and cause personal injury. Always use the jack on a flat, hard surface. Before setting the jack, make sure there are no sand or pebbles under the jack base.

7. Holding the jack in position by hand, turn the handle until the flange portion (D) fits in the groove (E) at the top of the jack.



8. Slowly turn the jack handle until the tyre is raised slightly off the ground surface.

WARNING

- Stop jacking up the vehicle as soon as the tyre is raised off the ground. It is dangerous to raise the vehicle any higher.
- Do not get under your vehicle while using the jack.
- Do not bump the raised vehicle or leave it sitting on the jack for a long time. Both are very dangerous.
- Do not use a jack except the one that came with your vehicle.
- The jack should not be used for any purpose other than to change a tyre.
- No one should be in your vehicle when using the jack.
- Do not start or run the engine while your vehicle is on the jack.
- Do not turn the raised wheel. The tyres still on the ground could turn and make your vehicle fall off the jack.

*Spare wheel**

E00801101394

Check the air pressure of the spare tyre frequently and make sure it is ready for emergency use at any time.

Maintaining the spare wheel at the highest specified air pressure will ensure that it can always be used under any conditions (city/high-speed driving, varying load weight, etc.).

The spare wheel is stored beneath the luggage floor board of the luggage compartment.

Compact spare wheel

The compact spare tyre is designed to save space in the luggage compartment and its lighter weight makes it easier to use if a flat tyre occurs.

CAUTION

- The pressure should be periodically checked and maintained at the specified pressure while the tyre is stowed. Driving with an insufficient tyre pressure can lead to an accident. If you have no choice but to drive with an insufficient tyre pressure, keep your speed down and inflate the tyre to the correct pressure as soon as possible. (Refer to “Tyre inflation pressures” on page 8-12.)
- The compact spare wheel is for temporary use only and should be removed as soon as the original wheel can be repaired or replaced.
- The vehicle must not be driven at speeds in excess of 80 km/h (50 mph) while using the compact spare wheel.

CAUTION

- The compact spare tyre is not as good as a standard tyre in controllability and stability. When the compact spare tyre is used, avoid quick starts, sudden braking and sharp steering.
- Avoid driving through automatic vehicle washers and over obstacles that could possibly damage the vehicle’s undercarriage. Because the compact spare wheel is smaller than the original wheel, the ground clearance is slightly reduced.
- The compact spare wheel is specifically designed for your vehicle and it should not be used on any other vehicle.
- Do not use tyre chains with your compact spare wheel. Because of the smaller tyre size, a tyre chain will not fit properly. This could cause damage to the wheel and result in loss of the chain. If a front tyre becomes flat when using tyre chains, first replace a rear wheel with the compact spare wheel and then use the removed rear wheel to replace the flat front wheel so that you can continue to use the chains.

For emergencies

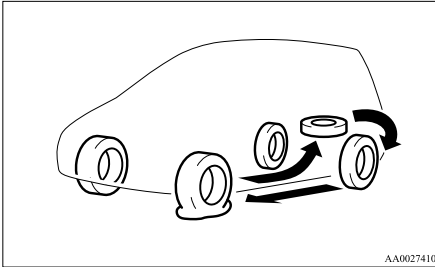

⚠ CAUTION

- The compact spare tyre should not be used on any other wheels, nor should standard tyres, snow tyres, wheel covers or trim rings be used with the compact spare wheel. If such use is attempted, damage to these items or other vehicle components may occur.
- Upon installation of the compact spare tyre, the overall vehicle height is lowered slightly as the tyre is smaller in diameter than the standard tyre. When passing over the projections on the road, take care not to drive the vehicle with the same feeling as used in driving with the standard tyre on.
- Do not install more than one compact spare wheel at the same time.
- When the tread wear indicators appear, the tyre must be replaced. Refer to “Wheel condition” on page 8-13.

To remove

1. For vehicles with luggage floor lid, open the luggage floor cargo lid. Refer to “Luggage floor lid” on page 5-40.
2. Lift the carpet, then remove the luggage floor boards (A).

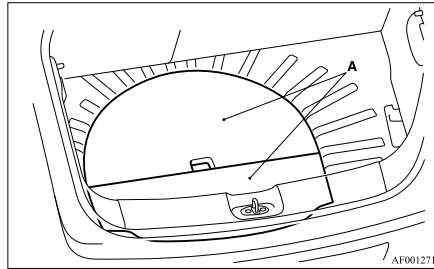

3. Remove the clamp (B) which secures the spare wheel by turning it anticlockwise. Take out the spare wheel.

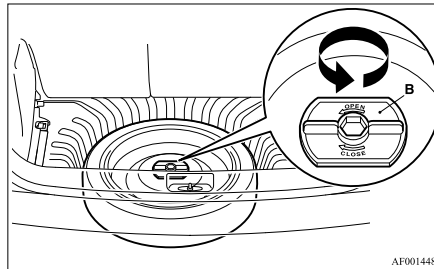

To install

To install the spare wheel, tighten the clamp by turning it clockwise until the spare wheel cannot move.

How to change a tyre

E00801202086

Before changing a tyre, first stop your vehicle in a safe, flat location.

1. Park the vehicle on level and stable ground.
2. Set the parking brake firmly.
3. On vehicles with manual transmission, turn the ignition key to the “LOCK” position, move the gearshift lever to the “R” (Reverse) position.

On vehicles with automated manual transmission, move the allshift lever to the “R” (Reverse) position, turn the ignition key to the “LOCK” position.

With an automated manual transmission vehicle, confirm that that “R” is shown by the allshift indicator display.

4. Turn on the hazard warning flashers and set up a warning triangle, flashing signal lamp, etc., at an adequate distance from the vehicle, and have all your passengers leave the vehicle.
5. To prevent the vehicle from rolling when it is raised on the jack, place chocks or blocks (A) at the tyre that is diagonally opposite from the tyre (B) you are changing.

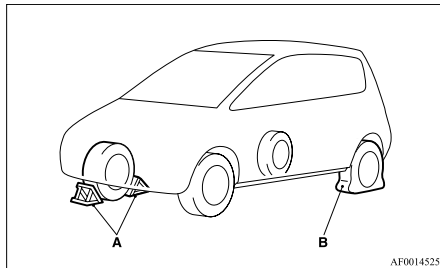

WARNING

- Be sure to apply chocks or blocks to the correct tyre when jacking up the vehicle. If the vehicle moves while jacked up, the jack could slip out of position, leading to an accident.

NOTE

- The chocks shown in the illustration do not come with your vehicle. It is recommended that you keep one in the vehicle for use if needed.
- If chocks are not available, use stones or any other objects that are large enough to hold the wheel in position.

6. Get the spare wheel, jack, jack handle and wheel nut wrench ready.

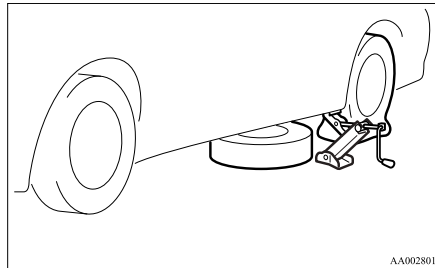

NOTE

- Put the spare wheel under the vehicle body near the jack. This makes it safer if the jack slips out of position.

For emergencies

7. On vehicles with wheel covers, first remove the covers (refer to “Wheel covers” on page 6-17). Then loosen the wheel nuts with the wheel nut wrench. Do not remove the wheel nuts yet.

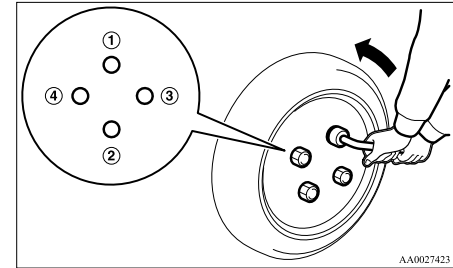

8. Find the closest jacking point to the flat tyre (refer to “Jacking up the vehicle” on page 6-12). Then position the jack and raise the vehicle until the tyre is slightly off the ground.
9. Remove the wheel nuts with the wheel nut wrench, then take the wheel off.

CAUTION

- Handle the wheel carefully when changing the tyre, to avoid scratching the wheel surface.

10. Clean out any mud, etc. on the hub surface (C), hub bolts (D) or in the installation holes (E) in the wheel, and then mount the spare wheel.

For emergencies

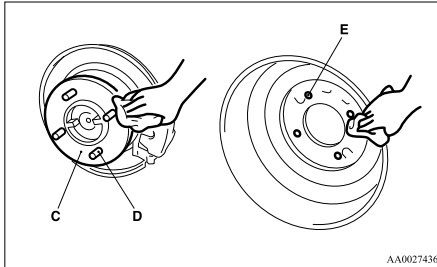

⚠ WARNING

- Mount the spare wheel with the valve stem (F) facing outboard. If you cannot see the valve stem (F), you have installed the wheel backwards. Operating the vehicle with the spare wheel installed backwards can cause vehicle damage and result in an accident.

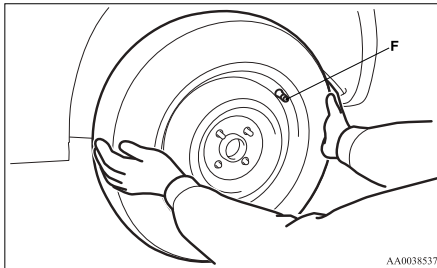

11. Finger-tighten the wheel nuts. (Turn them clockwise.)

Tighten the wheel nuts until the tapered parts of the wheel nuts make light contact with the seats of the wheel holes and the wheel is not loose.

Tighten the wheel nuts in the same way with a compact spare wheel.

Vehicle with steel wheels

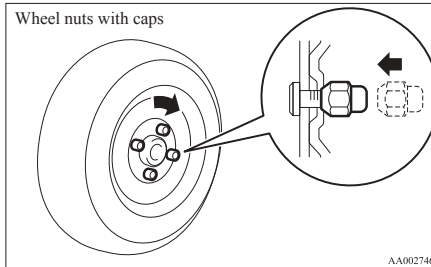
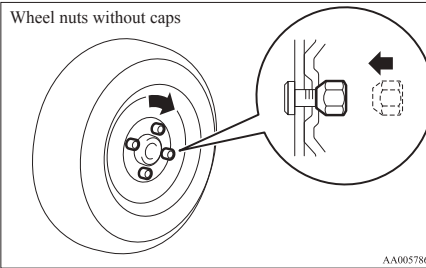

Vehicles with aluminium wheels

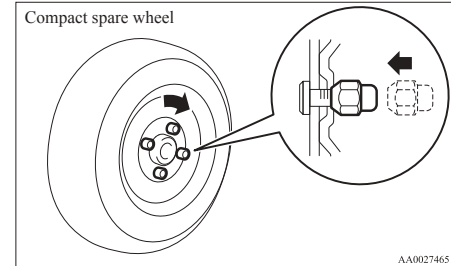
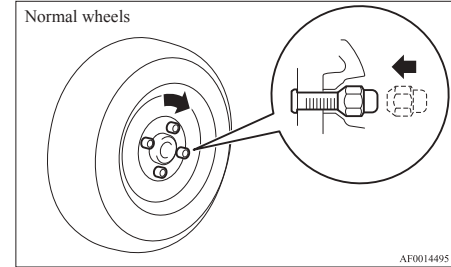

⚠ CAUTION

- Never apply oil to either the wheel bolts or the nuts, or they will tighten too much.

12. Lower the vehicle slowly and then tighten the nuts in the order shown in the illustration until each nut has been tightened to the torque listed here.

Tightening torque

98 to 118 Nm
(Achieved by applying a force of 440 to 520 N at the end of the wheel nut wrench supplied with the vehicle.)

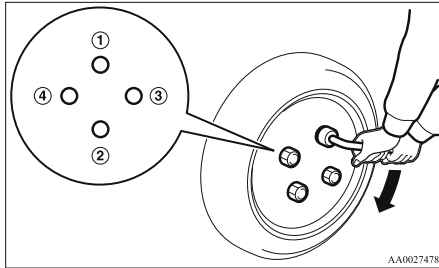

AA0027478

CAUTION

- Never use your foot or a pipe extension for extra force in the wheel nut wrench. If you do so, you will tighten the nut too much.

- Lower and remove the jack, then store the jack, flat tyre, and chock. Have your damaged tyre repaired as soon as possible.
- Check your tyre inflation pressure. The correct pressures are shown on the door label. See the illustration.

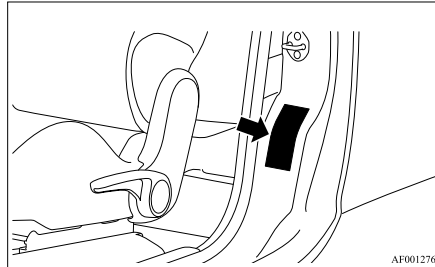

AF0012765

CAUTION

- The tyre pressure should be periodically checked and maintained at the specified pressure while the tyre is stowed.
- The compact spare tyre is to be used only temporarily when the standard tyre is damaged. Repair the damaged tyre as soon as possible and use it to replace the compact spare tyre.
- After changing the tyre and driving the vehicle about 1,000 km (620 miles), retighten the wheel nuts to make sure that they have not come loose.
- If the steering wheel vibrates when driving after changing the tyre, we recommend you to have the tyres checked for balance.
- Do not mix one type of tyre with another or use a different size from the one listed. This would cause early wear and poor handling.

For emergencies

Wheel covers*

E00801300298

To remove

- Wrap the tip of the wheel nut wrench (if so equipped) or straight blade (or minus) screwdriver with a cloth, insert it deeply behind a spoke of the wheel cover, and use it to lever up the cover a little.

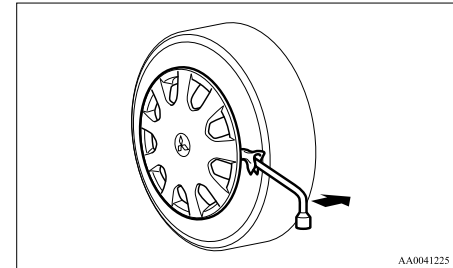

AA0041225

- With the cover raised a little, pry it off completely using the wheel nut wrench. Insert the wheel nut wrench under the cover, and move it around the circumference, prying the cover away from the wheel little by little as you move the wheel nut wrench around.

NOTE

- The wheel cover is made of plastic; take care when prying it off.

For emergencies

CAUTION

- Use the wheel nut wrench until the wheel cover comes completely off. If you try to use your hands, they may be hurt by the edge of the wheel cover.

To install

1. Align the air valve (A) of the tyre with the notch (B) in the wheel cover.

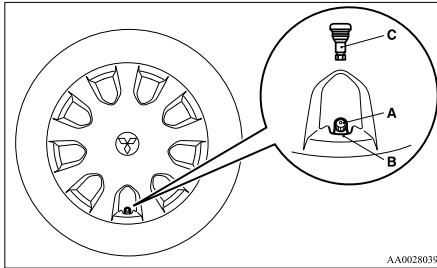

NOTE

- Full wheel covers have a symbol mark (C) provided on the reverse side to show the air valve location. Before installing the wheel cover to the wheel, make sure that the opening with the symbol mark is correctly aligned with the air valve.
2. Press the bottom part (D) of the wheel cover onto the wheel.
3. Gently push both sides (E) of the wheel cover and hold them in place with both knees.

4. Gently tap around the circumference of the wheel cover at the top (F), then push the wheel cover into place.

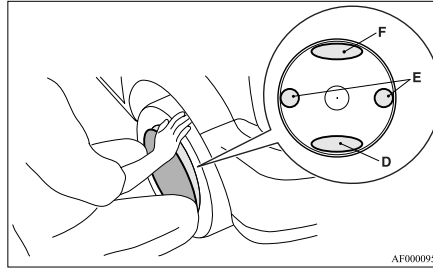

NOTE

- Before installing the wheel cover, make sure the tabs on the back are correctly fitted on the rings. If the tabs are not correctly fitted on the rings, the wheel cover may come off. If the tabs are broken, do not install the wheel cover.

Towing

E00801503291

If your vehicle needs to be towed

If towing is necessary, we recommend you to have it done by your MITSUBISHI MOTORS Authorized Service Point or a commercial tow truck service.

In the following cases, transport the vehicle using a tow truck.

- The engine runs but the vehicle does not move or abnormal noise is produced.
- Inspection of the vehicle's underside reveals that oil or some other fluid is leaking.

If a wheel gets stuck in a ditch, do not try to tow the vehicle. Please contact your MITSUBISHI MOTORS Authorized Service Point or a commercial tow truck service for assistance.

Only when you cannot receive a towing service from a MITSUBISHI MOTORS Authorized Service Point or commercial tow truck service, tow your vehicle carefully in accordance with the instructions given in "Emergency towing" in this part.

The regulations concerning towing may differ from country to country. It is recommended that you obey the regulations of the area where you are driving your vehicle.

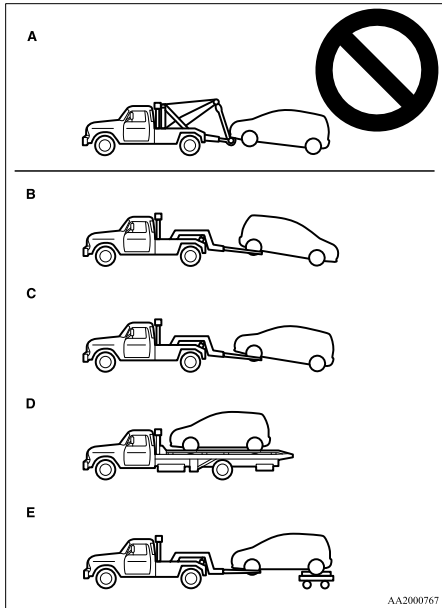

Towing the vehicle by a tow truck

⚠ CAUTION

- This vehicle must not be towed by a tow truck using sling lift type equipment (Type A) as illustrated. Using a sling lift will damage the bumper and front end.
- If the transmission is malfunctioning or damaged, transport the vehicle with the driving wheels on a carriage (Type C, D or E) as illustrated.
- If your vehicle has an automated manual transmission, place the allshift lever in the “N” (Neutral) position before stopping the engine.
- [For vehicles with the Traction Control System (TCL)/Active Stability Control system (ASC)]
If the vehicle is towed with the ignition switch in the “ON” position and only the front wheels or only the rear wheels raised off the ground, the Traction Control System (TCL) may operate, resulting in an accident.

Towing with rear wheels off the ground (Type B)
Place the gearshift lever (manual transmission) or the allshift lever (automated manual transmission) in the “N” (Neutral) position. With a vehicle that has an automated manual transmission, confirm that the transmission is in the “N” (Neutral) position by checking that “N” is shown by the allshift indicator display and by pushing the vehicle. Turn the ignition key to the “ACC” position and secure the steering wheel in a straight-ahead position with a rope or tiedown strap. Never place the ignition key in the “LOCK” position when towing.

If, with a vehicle that has an automated manual transmission, the engine will not start and the transmission is not in the “N” (Neutral) position, press the brake pedal, turn the ignition switch to the “ON” position, and move the allshift lever to the “N” (Neutral) position.

Towing with front wheels off the ground (Type C)
Release the parking brake.

Place the gearshift lever (manual transmission) or the allshift lever (automated manual transmission) in the “N” (Neutral) position. With a vehicle that has an automated manual transmission, confirm that the transmission is in the “N” (Neutral) position by checking that “N” is shown by the allshift indicator display and by pushing the vehicle.

If, with a vehicle that has an automated manual transmission, the engine will not start and the transmission is not in the “N” (Neutral) position, press the brake pedal, turn the ignition switch to the “ON” position, and move the allshift lever to the “N” (Neutral) position.

Emergency towing

If towing service is not available in an emergency, your vehicle may be temporarily towed by a rope secured to the towing hook.

If your vehicle is to be towed by another vehicle or if your vehicle tows another vehicle, pay careful attention to the following points:

For emergencies

⚠ CAUTION

- If your vehicle has an automated manual transmission, place the allshift lever in the “N” (Neutral) position before stopping the engine.

If your vehicle is to be towed by another vehicle

1. Take out the towing hook and wheel nut wrench (if so equipped). (Refer to “Tools jack and tyre repair kit” on page 6-06.)
2. Press by hand the side of the cover (A) that has a “◁” mark, then remove the cover.

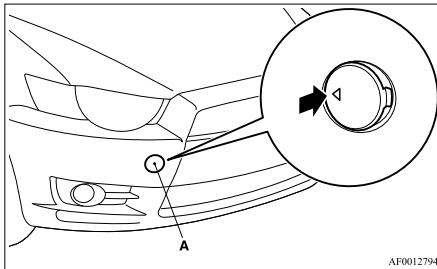

3. Use the wheel nut wrench (B) to securely mount the towing hook (C).

If your vehicle does not have a wheel nut wrench, securely tighten the towing hook (C) by hand.

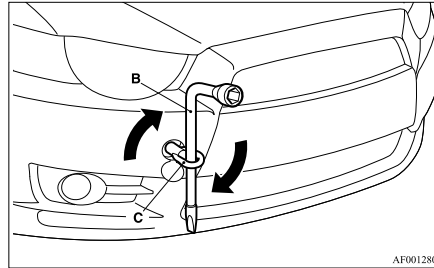

4. Secure the tow rope to the front towing hook.

⚠ CAUTION

- Do not tow the vehicle with the rope at an excessive diagonal angle.

NOTE

- To avoid deforming or otherwise damaging the vehicle body when hooking the rope onto the towing hook, observe the following instructions:
 - Mount the towing hook securely.
 - Do not attach the rope to any part of the vehicle other than the towing hook.
 - Do not drive in a way that subjects the towing hook to significant physical shock.

5. Keep the engine running.

If the engine is not running, turn the ignition key to the “ACC” or “ON” position to unlock the steering wheel.

⚠ CAUTION

- When the engine is not running, the brake booster and power steering do not operate. This means higher brake depression force and higher steering effort are required. Therefore, vehicle operation is more difficult than usual.
- Do not leave the key in the “LOCK” position. The steering wheel will lock, causing loss of control.

6. Place the gearshift lever (manual transmission) or the allshift lever (automated manual transmission) in the “N” (Neutral) position. With a vehicle that has an automated manual transmission, confirm that the transmission is in the “N” (Neutral) position by checking that “N” is shown by the allshift indicator display and by pushing the vehicle. If, with a vehicle that has an automated manual transmission, the engine will not start and the transmission is not in the “N” (Neutral) position, press the brake pedal, turn the ignition switch to the “ON” position, and move the allshift lever to the “N” (Neutral) position.
7. Turn on the hazard warning lamps if required by law. (Follow the local driving laws and regulations.)
8. During towing make sure that close contact is maintained between the drivers of both vehicles, and that the vehicles travel at low speed.

⚠ WARNING

- To prevent entry of exhaust gas from the towing vehicle, set your air selection switch to the recirculation position.

⚠ CAUTION

- The person in the vehicle being towed must pay attention to the brake lamps of the towing vehicle and make sure the rope never becomes slack.
- Avoid sudden braking, sudden acceleration and sharp turning; such operation could cause damage to the towing hooks or the tow rope.
- People in the vicinity could be injured as a result.
- When towing or being towed down a long slope, the brakes may overheat reducing the effectiveness. In this situation, have your vehicle transported by a tow truck.

9. When finished towing, remove the towing hook, and stow it in the specified location. (Refer to “Tools jack and tyre repair kit” on page 6-06.)

When installing the cover on the bumper, align the tab (D) with the hole in the vehicle body and press the cover securely into place.

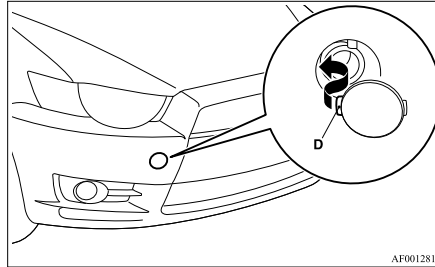

AF0012811

If your vehicle tows another vehicle

The rear towing hook (A) is located as shown in the illustration. Secure the tow rope to the rear towing hook.

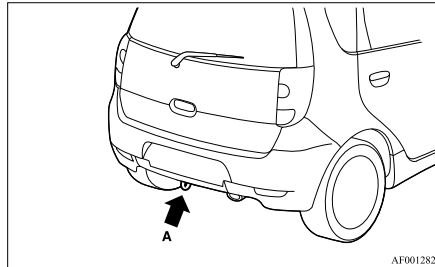

AF0012824

NOTE

- Using any part other than the designated towing hook (A) could result in damage to the vehicle body.

NOTE

- Your vehicle should only be used to tow another vehicle if the weight of the other vehicle is less than the weight of your vehicle.

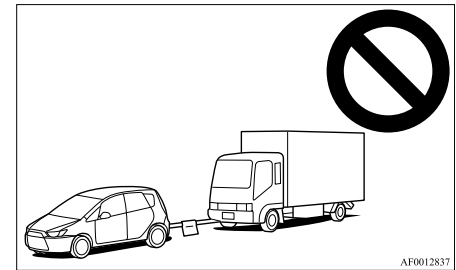

AF0012837

⚠ WARNING

- Do not use the rear towing hook as a jacking point.

Operation under adverse driving conditions

E00801701840

If your vehicle becomes stuck in sand, mud or snow

If the vehicle becomes stuck in snow, sand, or mud, it can often be moved by a rocking motion. For vehicle with manual transmission, move the gearshift lever alternately between 1st and Reverse, while applying slight pressure to the accelerator pedal.

With an automated manual transmission vehicle, place the allshift lever in the “A” (automatic mode) position to select automatic mode or select 1st or 2nd gear in the manual mode or place the allshift lever in the “R” (Reverse) position for reverse. Confirm that there is an “A”, “1”, “2” or “R” in the allshift indicator display, then gently press the accelerator pedal. Do not press the accelerator pedal while moving the allshift lever.

Avoid racing the engine or spinning the wheels. Prolonged efforts to free a stuck vehicle may result in overheating and transmission failure. Allow the engine to idle for a few minutes to let the transmission cool between rocking attempts.

If the vehicle remains stuck after several rocking attempts, seek other assistance.

WARNING

- When attempting to rock your vehicle out of a stuck position, be sure that the area around the vehicle is clear of people and physical objects. The rocking motion may cause the vehicle to suddenly launch forward or backward, causing injury or damage to nearby people or objects.

On a flooded road

- Avoid flooded roads. Water could enter the brake discs, resulting in temporarily ineffective brakes. In such cases, lightly depress the brake pedal to see if the brakes operate properly. If they do not, lightly depress the pedal several times while driving in order to dry the brake pads.
- When driving in rain or on a road with many puddles a layer of water may form between the tyres and the road surface. This reduces a tyre’s frictional resistance on the road, resulting in loss of steering stability and braking capability.

To cope with this, observe the following items:

- (a) Drive your vehicle at slow speed.
- (b) Do not drive on worn tyres. Always maintain the specified tyre inflation pressures.

On a snow-covered or frozen road

- When driving on a snow-covered or frozen road, it is recommended that you use snow tyres or tyre chains. Refer to the “Snow tyres” and “Tyre chains” sections.

- Avoid high-speed operation, sudden acceleration, abrupt brake application and sharp cornering.
- Depressing the brake pedal during travel on snowy or icy roads may cause tyre slippage and skidding. When traction between the tyres and the road is reduced the wheels may skid and the vehicle cannot readily be brought to a stop by conventional braking techniques. Braking will differ, depending upon whether you have anti-lock brake system (ABS). As your vehicle is equipped with anti-lock brake system (ABS), brake by pressing the brake pedal hard, and keeping it pressed.
- Allow extra distance between your vehicle and the vehicle in front of you, and avoid sudden braking.

On a bumpy or rutted road

- Drive as slow as possible when driving on bumpy or rutted roads.

CAUTION

- The impact on tyres and/or wheels when driving on a bumpy or rutted road can damage the tyre and/or wheel.

Vehicle care

Vehicle care precautions.....	7-02
Cleaning the interior of your vehicle.....	7-02
Cleaning the exterior of your vehicle.....	7-03

Vehicle care precautions

E00900100665

In order to maintain the value of your vehicle, it is necessary to perform regular maintenance using the proper procedures. Always maintain your vehicle in compliance with environmental pollution control regulations. Carefully select the materials used for washing, etc., to be sure that they do not contain corrosives. If in doubt, we recommend you to consult a specialist for selection of these materials.

CAUTION

- **Cleaning products can be dangerous. Some are poisonous. Others can burst into flame if you strike a match or drop them on a hot part of the vehicle. Some are dangerous if you breathe their fumes in a closed space. When you use anything in a container to clean your vehicle, always follow the instructions and always open your vehicle doors or windows when you're cleaning the inside. Never use the following to clean your vehicle:**
 - Petrol
 - Paint Thinner
 - Benzine
 - Kerosene
 - Turpentine
 - Naphtha
 - Lacquer Thinner
 - Carbon Tetrachloride
 - Nail Polish Remover
 - Acetone
- **These are all dangerous, and can damage your vehicle.**

Cleaning the interior of your vehicle

E00900200347

After cleaning the interior of your vehicle with water, cleaner or similar, wipe and dry in a shady, well-ventilated area.

CAUTION

- **Do not use organic substances (solvents, benzine, kerosene, alcohol, petrol, etc.) or alkaline or acidic solutions. These chemicals can cause discolouring, staining or cracking of the surface. If you use cleaners or polishing agents, make sure their ingredients do not include the substances mentioned above.**

NOTE

- Always read the instructions on the cleaner label.

Plastic, vinyl leather, fabric and flocked parts

E00900300045

1. Gently wipe off with gauze or other soft cloth soaked with a 3 % aqueous solution of neutral detergent.
2. Dip cloth in fresh water and wring out well. Using this cloth, wipe off the detergent thoroughly.

NOTE

- Do not use cleaners, conditioners, and protectants containing silicons or wax. Such products may cause annoying reflections and obscure vision.

Upholstery

E00900500135

1. To maintain the value of your new vehicle, handle the upholstery carefully and keep the interior clean. Use a vacuum cleaner and brush to clean the seats. If stained, vinyl and synthetic leather should be cleaned with an appropriate cleaner, and cloth fabrics can be cleaned with either upholstery cleaner or a 3 % solution of neutral detergent in lukewarm water.
2. Clean the carpeting with a vacuum cleaner and remove any stains with carpet cleaner. Oil and grease can be removed by lightly dabbing with a clean colourfast cloth and stain remover.

Genuine leather*

E00900600569

1. Lightly wipe off with gauze or other soft cloth soaked with a 5 % aqueous solution of neutral detergent.
2. Dip cloth in fresh water and wring it out well. Using this cloth, wipe off the detergent thoroughly.
3. Apply leather protecting agent to the genuine leather surface.

NOTE

- If genuine leather is wet with water or is washed in water, wipe off water as quickly as possible with a dry, soft cloth. If left damp, mildew may grow.
- The genuine leather surface may be damaged if a nylon brush or synthetic fibre is rubbed hard against it.
- Organic solvents such as benzine, kerosene, alcohol and petrol, acid or alkaline solvents may discolour the genuine leather surface. Be sure to use neutral detergents.
- Remove dirty patches or oil substances quickly as they can stain genuine leather.
- The genuine leather surface may harden and shrink if it is exposed to direct sun for long hours. When your vehicle is parked, place it in the shade as much as possible.
- When the temperature of the vehicle interior rises in summer, vinyl products left on the genuine leather seat may deteriorate and stick to the seat.

Cleaning the exterior of your vehicle

E00900700010

If the following is left on your vehicle, it may cause corrosion, discolouration and stains, wash the vehicle as soon as possible.

- Seawater, anti-freeze for road use.
- Soot and dust, iron powder from factories, chemical substance (acids, alkalis, coal-tar, etc.).
- Droppings from birds, carcasses of insects, tree sap, etc.

Washing

E00900902351

Chemicals contained in the dirt and dust picked up from the road surface can damage the paint coat and body of your vehicle if left in prolonged contact. Frequent washing and waxing is the best way to protect your vehicle from this damage. This will also be effective in protecting it from environmental elements such as rain, snow, salt air, etc.

Do not wash the vehicle in direct sunlight. Park the vehicle in the shade and spray it with water to remove dust. Next, using an ample amount of clean water and a car washing brush or sponge, wash the vehicle from top to bottom.

Use a mild car washing soap if necessary. Rinse thoroughly and wipe dry with a soft cloth. After washing the vehicle, carefully clean the joints and flanges of the doors, bonnet, etc., where dirt is likely to remain.

CAUTION

- When washing the under side of your vehicle or wheel, be careful not to injure your hands.
- If your vehicle has rain sensor wipers, place the wiper switch lever in the “0” (OFF) position to deactivate the rain sensor before washing the vehicle. Otherwise, the wipers will operate in the presence of water spray on the windscreen and may get damaged as a result.
- Refrain from using a car wash as its brushes may scratch the paint surface, causing it to lose its gloss. Scratches will be especially visible on darker coloured vehicles.
- Never spray or splash water on the electrical components in the engine compartment, as this may adversely affect engine starting. Exercise caution also when washing the underbody; be careful not to spray water into the engine compartment.
- Some types of hot water washing equipment apply high pressure and heat to the vehicle. They may cause heat distortion and damage to the vehicle resin parts and may result in flooding of the vehicle interior. Therefore; observe the following.
 - Maintain a distance of approx. 50 cm or more between the vehicle body and the washing nozzle.
 - When washing around the door glass, hold the nozzle at a distance of more than 50 cm and at right angles to the glass surface.

CAUTION

- After washing the vehicle, drive the vehicle slowly while lightly depressing the brake pedal several times in order to dry out the brakes. Leaving the brakes wet could result in reduced braking performance. Also, there is a possibility that they could freeze up or become inoperative due to rust, rendering the vehicle unable to move.
- When using an automatic car wash, pay attention to the following items, referring to the operation manual or consulting a car wash operator. If the following procedure is not followed, it could result in damage to your vehicle.
 - The outside mirrors are retracted.
 - The antenna is removed.
 - The rear wiper arm assembly is taped or removed.
 - If your vehicle is equipped with a rear spoiler, consult a car wash operator before using the car wash.
 - If your vehicle has rain sensor wipers, place the wiper switch lever in the “0” (OFF) position to deactivate the rain sensor.

7

During cold weather

Salt and other chemicals spread on the roads in some areas in winter can have a harmful effect on the vehicle body. You should therefore wash the vehicle as often as possible in accordance with our care-instructions. It is recommended to have a preservative applied and the underfloor protection checked before and after the cold weather season.

After washing your vehicle, wipe off all water-drops from the rubber parts around the doors to prevent the doors from freezing.

NOTE

- To prevent freezing of the weatherstripping on the doors, bonnet, etc., they should be treated with silicone spray.

Waxing

E00901000717

Waxing the vehicle will help prevent the adherence of dust and road chemicals to the paintwork. Apply a wax solution after washing the vehicle, or at least once every three months to assist displacing of water. Do not wax your vehicle in direct sunlight. You should wax after the surfaces have cooled.

CAUTION

- Waxes containing high abrasive compounds should not be used. Such waxes remove rust and stains effectively from the paintwork but they are harmful to the lustre on the painted surface and the plated surface. Further, they are harmful to glossy surfaces such as grille, garnish, mouldings, etc.
- Do not use petrol or paint thinners to remove road tar or other contamination to the vehicle surface.
- Do not apply wax on the areas having black mat coating as it can cause uneven discolouration, patches, blurs, etc. If stained with wax, immediately wipe off with a piece of soft cloth and warm water.

Polishing

E00901100011

The vehicle should only be polished if the paintwork has become stained or lost its lustre. Matt-finish parts and plastic bumpers must not be polished, polishing these parts will stain them or damage their finish.

Damaged paint

E00901200168

Small cracks and scratches in the paint coat should be touched up as soon as possible with MITSUBISHI touch-up paint to prevent corrosion. Check body areas facing the road or the tyres carefully for damage to the paint coat caused by flying stones, etc. The paint code number for your vehicle can be found on the vehicle information code plate on the door sill.

Cleaning plastic parts

E00901300550

Use a sponge or chamois leather. If a car wax adheres on a grey or black rough surface of the bumper, moulding or lamps, the surface becomes white. In such a case, wipe it off using lukewarm water and soft cloth or chamois leather.

CAUTION

- Do not use a scrubbing brush or other hard tools as they may damage the plastic part surface.
- Do not use wax containing compound (polishing powder) which may damage the plastic part surface.

CAUTION

- Do not bring the plastic parts into contact with petrol, light oil, brake fluids, engine oils, greases, paint thinners, and sulphuric acid (battery electrolyte) which may crack, stain or discolour the plastic parts. If they touch the plastic parts, wipe them off with soft cloth, chamois or the like and an aqueous solution of neutral detergent then immediately rinse the affected parts with water.

Chrome parts

E00901400014

In order to prevent spots and corrosion of chrome parts, wash with water, dry thoroughly, and apply a special protective coating. This should be done more frequently in winter.

Aluminium wheels*

E00901500086

1. Remove dirt using a sponge while sprinkling water on the wheel.
2. Use neutral detergent on any dirt that cannot be removed easily with water. Rinse off the neutral detergent after washing the wheel.
3. Dry the wheel thoroughly using a chamois leather or a soft cloth.

CAUTION

- Do not use a brush or other hard implement on the wheels. Doing so could scratch the wheels.

CAUTION

- Do not use any cleaner that contains an abrasive substance or is acidic or alkaline. Doing so could cause the coating on the wheels to peel or become discoloured or stained.
- Do not directly apply hot water using a steam cleaner or by any other means.
- Contact with seawater and road deicer can cause corrosion. Rinse off such substances as soon as possible.

Window glass

E00901600104

The window glass can normally be cleaned using only a sponge and water.

Glass cleaner can be used to remove oil, grease, dead insects, etc. After washing the glass, wipe dry with a clean, dry, soft cloth. Never use the same cloth to wipe the window glass as would be used to wipe the paintwork; wax from the painted surfaces could adhere to the glass and reduce its transparency and visibility.

CAUTION

- If your vehicle has rain sensor wipers, place the wiper switch lever in the “0” (OFF) position to deactivate the rain sensor before washing the windscreen. Otherwise, the wipers will operate in the presence of water spray on the windscreen and may get damaged as a result.

NOTE

- To clean the inside of the tailgate window, always use a soft cloth and wipe the window glass along the demister heater element so as not to cause damage.

Wiper blades

E00901700017

Use a soft cloth and glass cleaner to remove grease, dead insects, etc., from the wiper blades. Replace the wiper blades when they no longer wipe properly. (Refer to page 8-16.)

Engine compartment

E00902100265

Clean the engine compartment at the beginning and end of winter. Pay particular attention to flanges, crevices and peripheral parts where dust containing road chemicals and other corrosive materials might collect.

If salt and other chemicals are used on the roads in your area, clean the engine compartment at least every three months.

Never spray or splash water on the electrical components in the engine compartment, as this may cause damage.

Do not bring the nearby parts, the plastic parts and so on into contact with sulphuric acid (battery electrolyte) which may crack, stain or discolour them. If they are in contact, wipe off with soft cloth, chamois or the like and an aqueous solution of neutral detergent then immediately rinse the affected parts with plenty of water.

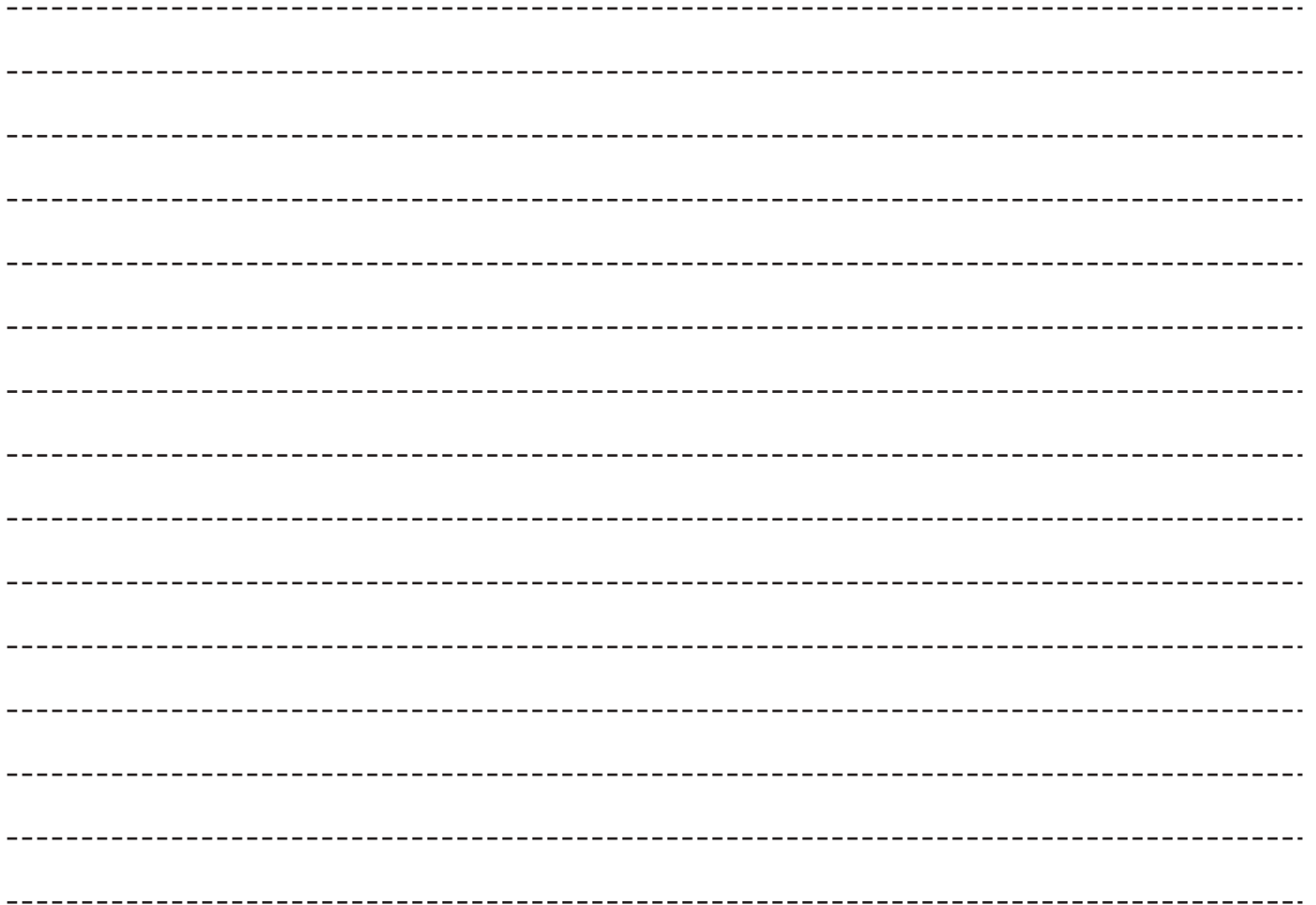

Maintenance

Service precautions.....	8-02
Catalytic converter.....	8-02
Bonnet.....	8-03
Engine oil.....	8-05
Engine coolant.....	8-07
Washer fluid.....	8-09
Brake fluid/Clutch fluid*.....	8-09
Battery.....	8-10
Tyres.....	8-11
Clutch pedal free play*.....	8-15
Brake pedal free play.....	8-16
Parking brake lever stroke.....	8-16
Wiper blades.....	8-16
General maintenance.....	8-18
For cold and snowy weather.....	8-18
Fusible links.....	8-19
Fuses.....	8-19
Replacement of lamp bulbs.....	8-23

Service precautions

E01000100458

Adequate care of your vehicle at regular intervals serves to preserve the value and appearance as long as possible.

Maintenance items as described in this owner's manual can be performed by the owner.

We recommend you to have the periodic inspection and maintenance performed by a MITSUBISHI MOTORS Authorized Service Point or another specialist. In the event a malfunction or other problem is discovered, we recommend you to have it checked and repaired. This section contains information on inspection maintenance procedures that you can do yourself. Follow the instructions and cautions for each of the various procedures.

WARNING

- When checking or servicing the inside of the engine compartment, make sure the engine is switched off and has had a chance to cool down.
- If it is necessary to do work in the engine compartment with the engine running, be especially careful that your clothing, hair, etc., does not become caught by the fans, drive belts, or other moving parts.
- The fan may turn on automatically even if the engine is not running; turn the ignition key to "LOCK" position and remove the key to ensure safety while you work in the engine compartment.
- Do not smoke, cause sparks or allow open flames around fuel or battery. The fumes are flammable.

WARNING

- Be extremely cautious when working around the battery. It contains poisonous and corrosive sulphuric acid.
- Do not get under your vehicle with just the body jack supporting it. Always use automotive jack stands.
- Improper handling of components and materials used in the vehicle can endanger your personal safety. We recommend you to consult a specialist for necessary information.

Catalytic converter

E01000201140

For ordinary use, there are no particular precautions except that of using unleaded petrol.

The exhaust gas scavenging devices used with the catalytic converter are extremely efficient for the reduction of noxious gases. The catalytic converter is installed in the exhaust system.

It is important to keep the engine properly tuned to ensure proper catalyst operation and prevent possible catalyst damage.

CAUTION

- Damage to the catalytic converter can result if your vehicle is not kept in proper operating condition. In the event of an engine malfunction particularly involving engine misfire or other apparent loss of performance, have your vehicle serviced promptly. Continued operation of your vehicle with a severe overheated condition may result in possible damage to the converter and vehicle.

WARNING

- As with any vehicle, do not park or operate this vehicle in areas where combustible materials such as dry grass or leaves can come in contact with a hot exhaust since a fire could occur.
- Paint should not be applied to the catalytic converter.

Bonnet

E01000302470

The catalytic converter itself gets hot quickly, and may be damaged if overheated. The following points should be noted in order to prevent the ignition of unburnt petrol within the catalytic converter.

- Use UNLEADED PETROL ONLY of the type recommended in “Fuel selection” on page 02.
- Do not drive with an extremely low fuel level; running out of fuel could cause damage to the catalytic converter.
- Do not attempt to start the engine by pushing the vehicle. If the battery is weak or discharged, use another battery to start the engine.
- Do not idle the engine with any spark plug wires disconnected or removed such as performing diagnostic tests.
- Do not idle the engine for prolonged periods during very rough idle or malfunctioning operating conditions.
- Do not race the engine when turning off the ignition switch. This will cause the catalytic converter to be damaged due to contact with unburnt fuel.
- Stop driving the vehicle if you think the performance is noticeably low, or if the engine has a malfunction such as with the ignition, etc.

If it is impractical to stop driving immediately, reduce the speed and drive for only a short time. We recommend you to have your vehicle inspected as soon as possible.

- In unusual situations involving grossly malfunctioning engine operation, a burnt smell may indicate severe and abnormal catalyst overheating.

If this occurs, the vehicle should be stopped in a safe place, the engine switched off and the vehicle allowed to cool. Once the engine is cool, a service, including a tune-up to manufacturer’s specifications, should be obtained immediately.

To open

Pull the release lever towards you to unlock the bonnet.

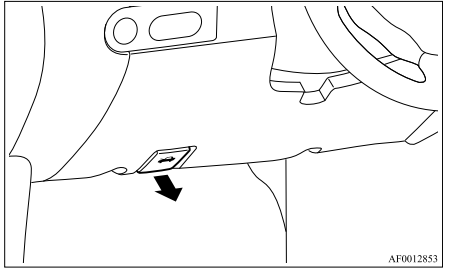

Raise the bonnet while pressing the safety lock.

NOTE

- Only open the bonnet when the wipers are in the parked position. Failure to do so may cause paint/body damage.

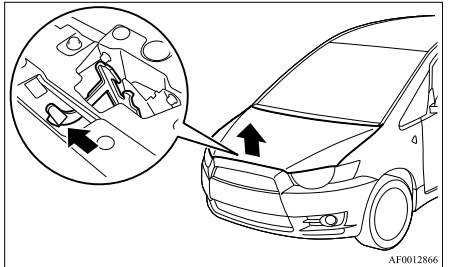

Maintenance

Support the bonnet by inserting the support bar in its slot.

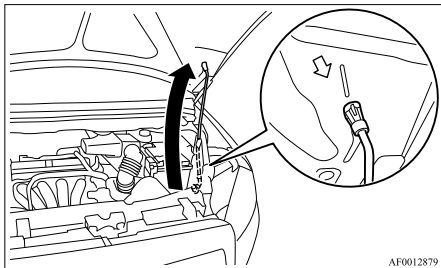

Slowly lower the bonnet to a position about 20 cm above the closed position, then let it drop.

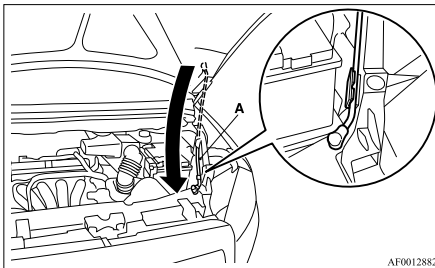

⚠ CAUTION

- Be careful that hands or fingers are not trapped when closing the bonnet.
- Before driving, make sure that the bonnet is securely locked. An incompletely locked bonnet can suddenly open while driving. This can be extremely dangerous.

⚠ CAUTION

- Note that the support bar may disengage the bonnet if the open bonnet is lifted by a strong wind.
- Always insert the support bar into the hole provided specifically for this purpose. Supporting the bonnet at any other location could result in the support bar slipping out and lead to an accident.

To close

Unlatch the support bar (A) and clip it in its holder.

NOTE

- If this does not close the bonnet, release it from a slightly higher position.
- Do not press down the bonnet hard with a hand as it may damage the bonnet.
- Push the support bar (A) down completely into its holder.

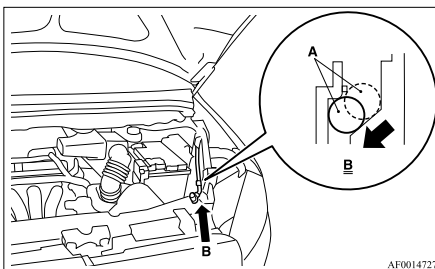

Engine oil

E01000402530

To check and refill engine oil

The engine oil used has a significant effect on the engine's performance, service life and startability. Be sure to use oil of the recommended quality and appropriate viscosity.

All engines consume a certain amount of oil during normal operation, and engine oil consumption is greatly influenced by payload, engine speed, etc. Therefore, it is important to check the oil level at regular intervals or before starting a long trip.

This check must be made with the engine warm but not running. Park the vehicle on a level surface, stop the engine, and then wait a few moments to allow the engine oil in circulation to return to the oil pan to ensure accurate measurement.

Remove the dipstick and wipe it with a clean cloth. Reinsert the dipstick as far as it goes. Remove the dipstick and read the oil level, which should always be within the range indicated.

If the oil level is below the specified limit, remove the cap located on the cylinder head cover and add enough oil to raise the level to within the specified range.

Be sure to use the specified engine oil and do not mix various types of oil. Also, avoid mixing different makes of oil together if possible.

After adding oil, close the cap securely.

Use only the recommended oils with an MB classification as specified in this manual.

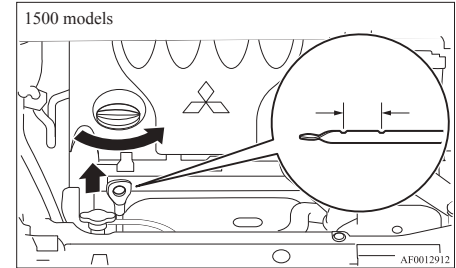
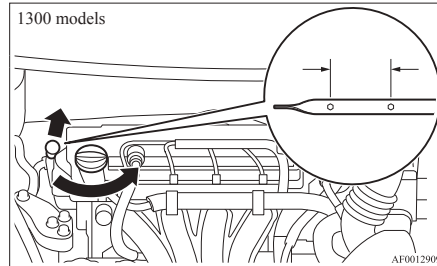
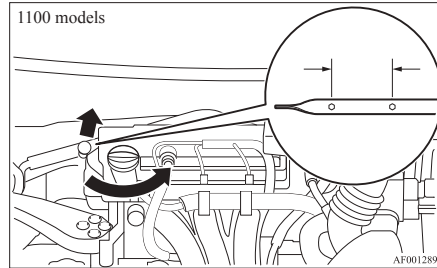

NOTE

- The engine oil will deteriorate rapidly if the vehicle is subjected to severe conditions (for example, repeated operation on rough roads, in mountainous regions, on roads with many uphill and downhill gradients, or over short distances). Consequently, the oil will require earlier replacement.
- For handling of used engine oils, refer to page 05.

Selection of engine oil

Maintenance

Except for vehicles with turbocharger (Engine models 134910 and 135930)

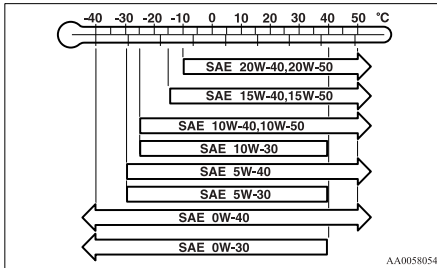

- Select engine oil of the proper SAE viscosity number according to the atmospheric temperature.
- Use engine oil conforming to the following classification:
 - “MB 229.1” or higher

Except for vehicles with turbocharger (Engine models 3A91 and 4A90)

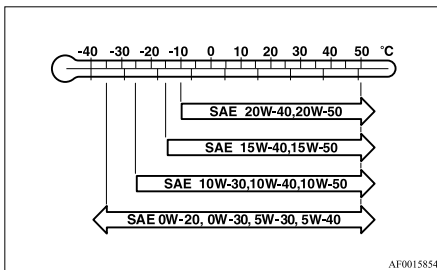

- Select engine oil of the proper SAE viscosity number according to the atmospheric temperature.
- SAE 0W-20, 0W-30, 5W-30, and 5W-40 engine oils can only be used if they meet ACEA A3/B3, A3/B4 or A5/B5 and API SM specifications.
- Use engine oil conforming to the following classification:
 - API classification: “For service SM”
 - ILSAC certified oil
 - ACEA classification:
 - “For service A1/B1, A3/B3, A3/B4 or A5/B5”

NOTE

- Use of additives is not recommended since they may reduce the effectiveness of additives already included in the engine oil. It may result in failure of the mechanical assembly.
- The engine model is indicated on the vehicle information code plate. Refer to “Vehicle information code plate” on page 9-02.

Vehicles with turbocharger

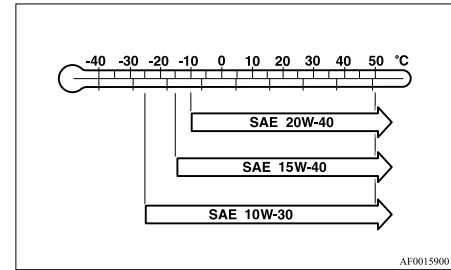

- Select engine oil of the proper SAE viscosity number according to the atmospheric temperature.
- Use engine oil conforming to the following classification:
 - API classification: “For service SG” or higher
 - ILSAC certified oil
 - ACEA classification:
 - “For service A1/B1, A3/B3, A3/B4 or A5/B5”

NOTE

- Use of additives is not recommended since they may reduce the effectiveness of additives already included in the engine oil. It may result in failure of the mechanical assembly.
- SAE 5W-30 engine oil can be used to improve engine startability in very cold weather areas where the lowest atmospheric tempera-

ture is below the range shown in the illustration.

In this case, use engine oil conforming to the following classification:

- ACEA classification:
“For service A3/ B3, A3/B4 or A5/B5”
- API classification:
“For service SG” or higher

Engine coolant

E01000501390

To check the coolant level

A translucent coolant reserve tank is located in the engine compartment.

Except for vehicles with turbocharger

The coolant level in this tank should be kept between the “LOW” and “FULL” marks when measured while the engine is cold.

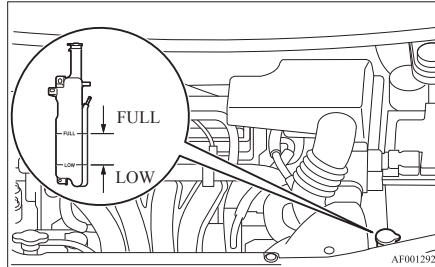

Vehicles with turbocharger

Check the coolant level in the reserve tank. The reserve tank lid is equipped with a dipstick.

Remove the dipstick and wipe it with a clean cloth. Reinsert the dipstick as far as it goes. Remove the dipstick and read the coolant level, which should always be within the range “F” (FULL) or “L” (LOW) while the engine is cold.

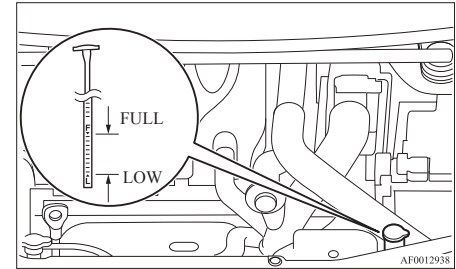

To add coolant

The cooling system is a closed system and normally the loss of coolant should be very slight. A noticeable drop in the coolant level could indicate leakage. If this occurs, we recommend you to have the system checked as soon as possible.

Except for vehicles with turbocharger

If the level should drop below the “LOW” level on the reserve tank, open the lid and add coolant to “FULL” level.

Also, if the reserve tank is completely empty, remove the radiator cap (A) and add coolant until the level reaches the filler neck.

Maintenance

WARNING

- **Do not open the radiator cap while the engine is hot.**
The coolant system is under pressure and any hot coolant escaping could cause severe burns.

Vehicles with turbocharger

If the level should drop below the “L” (LOW) level on the dipstick, add coolant to the reserve tank. Also, if the reserve tank is completely empty, remove the radiator cap (A) and add coolant until the level reaches the filler neck.

WARNING

- **Do not open the radiator cap while the engine is hot.**
The coolant system is under pressure and any hot coolant escaping could cause severe burns.

Anti-freeze

The engine coolant contains an ethylene glycol anti-corrosion agent. The cylinder head and water pump housing are cast aluminium alloy, and periodic changing of the engine coolant is necessary to prevent corrosion of these parts.

Use High-quality ethylene glycol based coolant. It has excellent protection against corrosion and rust formation of all metals including aluminium and can avoid blockages in the radiator, heater, cylinder head, engine block, etc.

Because of the necessity of this anti-corrosion agent, the coolant must not be replaced with plain water even in summer. The required concentration of anti-freeze differs depending on the expected ambient temperature.

Ambient temperature (minimum) °C	-30	-35	-50
Anti-freeze concentration %	45	50	60

CAUTION

- **Do not use alcohol or methanol anti-freeze or any engine coolants mixed with alcohol or methanol anti-freeze.** The use of an improper anti-freeze can cause corrosion of the aluminium components.
- **For effective anti-corrosion and anti-freeze performance, keep the anti-freeze concentration within the range of 45 to 60 %.**
Concentrations exceeding 60 % will result in a reduction of both the anti-freeze and cooling performance thus adversely affecting the engine.
- **Do not top up with water only.**
Water by itself reduces the rust-protective and anti-freeze qualities of the coolant and has a lower boiling point. It can also cause damage to the cooling system if it should freeze. Do not use tapwater, as it can cause corrosion and rust formation.

During cold weather

If the temperatures in your area drop below freezing, there is the danger that the coolant in the engine or radiator could freeze and cause severe damage to the engine and/or radiator.

Add a sufficient amount of anti-freeze to the coolant to prevent it from freezing.

The concentration should be checked before the start of cold weather and anti-freeze added to the system if necessary.

Washer fluid

E01000700702

Check the washer fluid level in the container.
If the level is low, replenish the container with washer fluid.

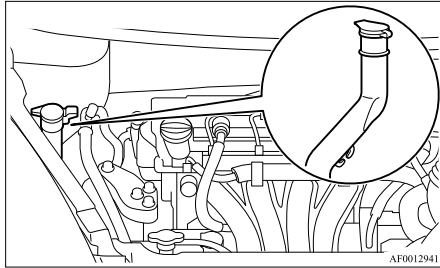

NOTE

- The washer fluid container serves the windscreen and the rear window.

During cold weather

To ensure proper operation of the washers at low temperatures, use a fluid containing an anti-freezing agent.

Brake fluid/Clutch fluid*

E01000800035

The brake fluid (A) and the clutch fluid (B) share reservoir tank.

To check the fluid level



- A- Brake fluid
- B- Clutch fluid
- C- Partition

The fluid level must be between the “MAX” and “MIN” marks on the reservoir.

The brake fluid level is monitored by a float. When the fluid level falls below the “MIN” mark, the brake fluid warning lamp lights up.

The brake fluid level falls slightly with wear of the brake pads, but this does not indicate any abnormality.

The fluid in the master cylinder should be checked when doing other work under the bonnet. The brake system should also be checked for leaks at the same time.

If the fluid level falls markedly in a short length of time, it indicates leaks from the each system.

If this occurs, we recommend you to have the vehicle checked.

Fluid type

Use brake fluid conforming to DOT4+ from a sealed container.

The brake fluid is hygroscopic. Too much moisture in the brake fluid will adversely affect the brake system and clutch system, reducing the performance.

⚠ CAUTION

- Take care in handling brake fluid as it is harmful to the eyes, may irritate your skin and also damage painted surfaces.
- Use only the specified brake fluid.
Do not mix or add different brands of brake fluid to prevent chemical reactions.
Do not let any petroleum-based fluid touch, mix with, or get into the brake fluid. This will damage the seals.
- Keep the reservoir tank cap closed to prevent the brake fluid from deteriorating except maintenance.
- Clean the filler cap before removing and close the cap securely after maintenance.

Battery

E01001202160

The condition of the battery is very important for quick starting of the engine and proper functioning of the vehicle's electrical system. Regular inspection and care are especially important in cold weather.

Checking battery electrolyte level

The inside of the battery is divided into several compartments.

Checking the electrolyte level in each cell after removing the cap.

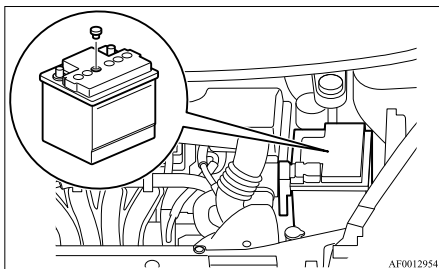

If the part marked (A) inside each cell is below the surface of the electrolyte (B), the electrolyte level is normal. Top up the electrolyte with distilled water if necessary. Do not overfill the cell; spillage during driving could cause damage.

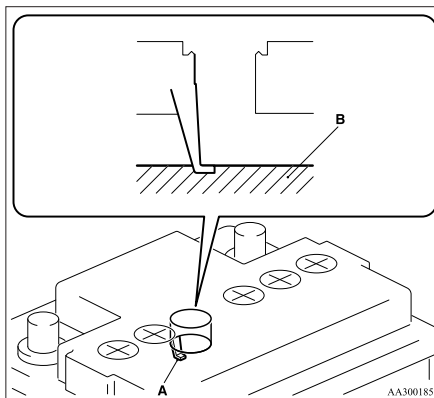

Check the electrolyte level at least once every 4 weeks, depending on the operating conditions.

If the battery is not used, it will discharge by itself with time.

Check it once every 4 weeks and charge with low current as necessary.

During cold weather

The capacity of the battery is reduced at low temperatures. This is an inevitable result of its chemical and physical properties. This is why a very cold battery, particularly one that is not fully charged, will only deliver a fraction of the starter current which is normally available.

We recommend you to have the battery checked before the start of cold weather and, if necessary, have it charged or replaced.

This does not only ensure reliable starting, but a battery which is kept fully charged also has a longer life.

Disconnection and connection

⚠ CAUTION

- Do not disconnect the battery terminals for at least one minute after the ignition switch is turned "OFF". If the battery terminals are disconnected immediately after the ignition switch is turned "OFF", the automated manual transmission may be damaged.

To disconnect the battery cable, stop the engine, first disconnect the negative (-) terminal and then the positive (+) terminal.

When connecting the battery, first connect the positive (+) terminal and then the negative (-) terminal.

NOTE

- Open the terminal cover (A) before disconnecting or connecting the positive (+) terminal of the battery.
- Loosen the nut (B), and then disconnect the battery cable from the positive (+) terminal.

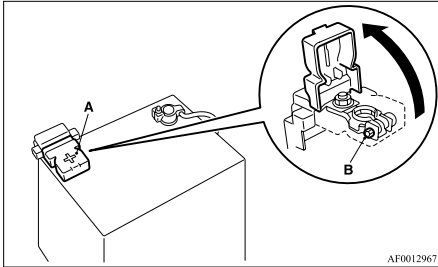

AF0012967

⚠ WARNING

- Keep sparks, cigarettes, and flames away from the battery because the battery could explode.
- The battery electrolyte is extremely caustic. Do not allow it to come in contact with your eyes, skin, clothing, or the painted surfaces of the vehicle. Spilt electrolyte should be flushed immediately with ample amounts of water. Irritation to eyes or skin from contact with electrolyte requires immediate medical attention.
- Ventilate when charging or using the battery in an enclosed space.

⚠ CAUTION

- Never disconnect the battery with the ignition switch in the “ON” position; doing so could damage the vehicle’s electrical components.
- Never short-circuit the battery; doing so could cause it to overheat and be damaged.

⚠ CAUTION

- Always wear protective eye goggles when working near the battery.
- If the battery is to be quick-charged, first disconnect the battery cables.
- In order to prevent a short circuit, be sure to disconnect the negative (-) terminal first.
- Keep it out of reach of children.
- Do not bring the nearby part, the plastic parts and so on into contact with sulphuric acid (battery electrolyte) which may crack, stain or discolour them. If they are in contact, wipe off with soft cloth, chamois or the like and an aqueous solution of neutral detergent then immediately rinse the affected parts with plenty of water.

NOTE

- Keep the terminals clean. After the battery is connected, apply terminal protection grease. To clean the terminals, use lukewarm water.
- Check to see if the battery is securely installed and cannot be moved during travel. Also check each terminal for tightness.
- When the vehicle is to be left unused for a long period of time, remove the battery and store it in a place where the battery fluid will not freeze. The battery should be stored only in a fully charged condition.

Tyres

E01001300226

⚠ WARNING

- Driving with tyres that are worn, damaged or improperly inflated can lead to a loss of control or blow out of the tyres which can result in a collision with serious or fatal injury.

Tyre inflation pressures

E01001402494

Item	Tyre size	Normal		At trailer towing	
		Front	Rear	Front	Rear
Normal tyre	175/65R14 82T 195/50R15 82H 205/45R16 83H	2.2 bar (220 kPa), 2.5 bar (250 kPa) *	2.2 bar (220 kPa), 2.5 bar (250 kPa) *	2.2 bar (220 kPa)	2.5 bar (250 kPa)
	205/45R16 83V	2.4 bar (240 kPa), 2.5 bar (250 kPa) *	2.4 bar (240 kPa), 2.5 bar (250 kPa) *	2.4 bar (240 kPa)	2.5 bar (250 kPa)
Special low rolling resistance tyre	175/65R14 82T 185/55R15 82H	2.4 bar (240 kPa), 2.5 bar (250 kPa) *	2.4 bar (240 kPa), 2.5 bar (250 kPa) *	2.4 bar (240 kPa)	2.5 bar (250 kPa)
Compact spare tyre	T115/70D15 T115/70R15	4.2 bar (420 kPa)		—	

*: Above 160 km/h (99 mph)

Check the tyre inflation pressure of all the tyres while they are cold; if insufficient or excessive, adjust to the specified value. After the tyre inflation pressure has been adjusted, check the tyres for damage and air leaks. Be sure to put caps on the valves.

Wheel condition

E01001800407

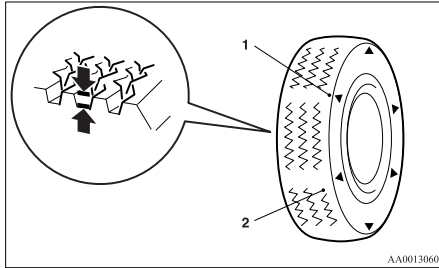

AA0013060

- 1- Location of the tread wear indicator
- 2- Tread wear indicator

Check the tyres for cuts, cracks and other damage. Replace the tyres if there are deep cuts or cracks. Also check each tyre for pieces of metal or pebbles. The use of worn tyres can be very dangerous because of the greater chance of skidding or hydroplaning. The tread depth of the tyres must exceed 1.6 mm in order for the tyres to meet the minimum requirement for use.

If there are tread wear indicators on the tyres, they will appear in six places on the surface of the tyre as the tyre wears, thereby indicating that the tyre no longer meets the minimum requirement for use. When these wear indicators appear, the tyres must be replaced with new ones.

Check that the wheel nuts are tightened correctly. Refer to the section entitled “For emergencies” for information concerning replacement of the tyres.

NOTE

- The mark and the location of the tyre tread wear indicators are different depending on the tyre manufacturer.

Replacing tyres and wheels

E01007200038

⚠ CAUTION

- **Avoid using different size tyres from the one listed and the combined use of different types of tyres, as this can affect driving safety. Refer to “Tyres and wheels” on page 9-12.**
- **Even if a wheel has the same rim size and offset as the specified type of wheel, its shape may prevent it from being fitted correctly. We recommend you to consult a specialist before using wheels that you have.**

Tyre rotation

E01001900121

Tyre wear varies with vehicle conditions, road surface conditions and individual driver’s driving habits. To equalize the wear and help extend tyre life, it is recommended to rotate the tyres immediately after discovery of abnormal wear, or whenever the wear difference between the front and rear tyres is recognizable.

When rotating tyres, check for uneven wear and damage. Abnormal wear is usually caused by incorrect tyre pressure, improper wheel alignment, out of balance wheel, or severe braking. We recommend you to have it checked to determine the cause of irregular tread wear.

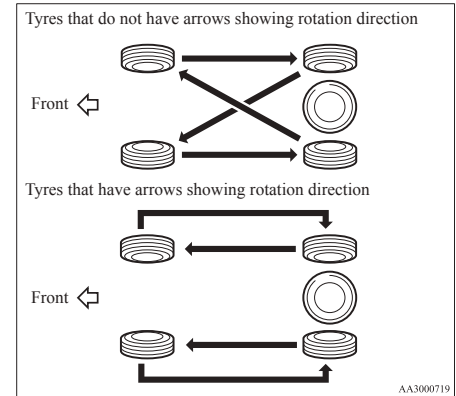

AA3000719

⚠ CAUTION

- **A compact spare tyre can be fitted temporarily in place of a tyre that has been removed during the tyre rotation. However, it must not be included in the regular tyre rotation sequence.**

⚠ CAUTION

- If the tyres have arrows (A) indicating the correct direction of rotation, swap the front and rear wheels on the left hand side of the vehicle and the front and rear wheels on the right hand side of the vehicle separately. Keep each tyre on its original side of the vehicle. When fitting the tyres, make sure the arrows point in the direction in which the wheels will turn when the vehicle moves forward. Any tyre whose arrow points in the wrong direction will not perform to its full potential.

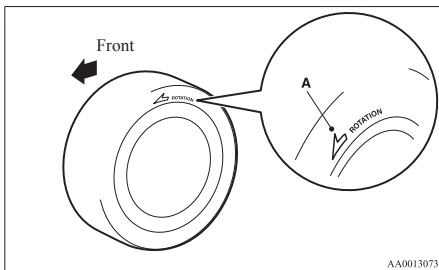

⚠ CAUTION

- Avoid the combined use of different types of tyres. This can affect vehicle performance and safety.

Snow tyres

E01002000549

The use of snow tyres is recommended for driving on snow and ice. To preserve driving stability, mount snow tyres of the same size and tread pattern on all 4 wheels.

Snow tyres worn more than 50% are no longer suitable for use as snow tyres.

Snow tyres which do not meet specifications must not be used.

⚠ CAUTION

- Observe permissible maximum speed for your snow tyres and the legal speed limit.

NOTE

- The laws and regulations concerning snow tyres (driving speed, required use, type, etc.) vary. Find out and follow the laws and regulations in the area you intend to drive.
- If flange nuts are used on your vehicle, change to tapered nuts when steel wheels are used.

Tyre chains

E01002101491

If tyre chains have to be used, ensure that they are fitted only on the drive wheels (front).

Use only tyre chains which are designed for use with the tyres mounted on the vehicle: use of the incorrect size or type of chain could result in damage to the vehicle body.

Before fitting tyre chains, we recommend you to consult a MITSUBISHI MOTORS Authorized Service Point. The max. chain height is as follows.

Item	Tyre size	Wheel size	Max. chain height [mm]
Except for Clear Tec	175/65R14 *1 *2	14x5.5 J	12
	185/55R15 *3	15x6.0 J	
Clear Tec	175/65R14	14x5.5 J	
	185/55R15	15x6.0 J	

*1: Vehicles with turbocharger have 15-inch brakes, so 14-inch tyres and wheels cannot be used on them.

*2: Use only 175/65R14 snow tyres (M + S) with the 1500 models of the vehicles without turbocharger.

*3: Snow tyres (M + S) only

⚠ CAUTION

- For vehicle with 195/50R15 or 205/45R16 tyres, chains should not be used. The clearance between the chains and the body is small, and the body might be damaged. However, if chains must be used on vehicles with 195/50R15 or 205/45R16 tyres, because of the adverse road conditions such as snow or ice, proceed as follows: Change all the original tyres (including wheels) to 175/65R14 tyres (14x5.5 J wheels) or 185/55R15 M + S tyres (15x6.0 J wheels) and then use the chains on front wheels.

The speed limit for tyre chain is 50 km/h (30 mph) and remove the tyre chains as soon as possible on snow free roads.

⚠ WARNING

- **DO NOT** use a jack when fitting the chains, as in these conditions, the tyres may slip on the icy road causing the vehicle to slip off the jack.

⚠ CAUTION

- Practice fitting the chains before you need them.
Don't expect help from other people in the cold.
- Choose a clear straight stretch of road where you can pull over and still be seen while you are fitting the chains.
- Do not fit chains before you need them. This will wear out your tyres and the road surface.
- After driving around 100-300 metres, stop and retighten the chains.
- Care should be taken with extremes of steering lock to prevent possible contact between the chains and the vehicle body.
- Drive carefully and do not exceed 50 km/h (30 mph). Remember, fitting chains is not going to stop accidents from happening.
- When tyre chains are installed, take care that they do not damage the disc wheel or body.

⚠ CAUTION

- Do not install a tyre chain on an emergency wheel which is compact in size. If one of the front wheels has punctured, replace it with one of the rear wheels and install the compact spare wheel in that place before fitting a tyre chain.
- An aluminium wheel can be damaged by a tyre chain while driving. When fitting a tyre chain on an aluminium wheel, take care that any part of the chain and fitting cannot be brought into contact with the wheel.
- Remove the wheel covers before installing a tyre chain, otherwise they may be damaged by the tyre chain. (Refer to "Wheel covers" on page 6-17.)
- When installing or removing the tyre chains, take care that hands and other parts of your body are not injured by the sharp edges of the vehicle body.
- Install the chains only on the rear tyres and tighten them as tightly as possible with the ends securely fastened.

NOTE

- The laws and regulations concerning the use of tyre chains vary. Find out and follow the laws and regulations of the area you're driving in.
In most countries, it is prohibited by law to use tyre chains on roads without snow.

Clutch pedal free play*

E01002200222

Press down the clutch pedal with your fingers until initial resistance is felt.

This distance should be within the specified range.

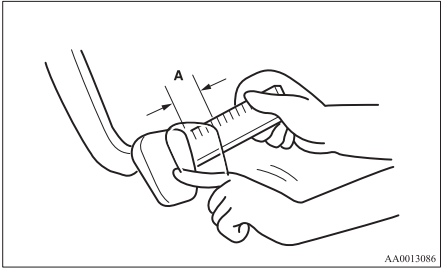

AA0013086

A- Free play: 4 to 13 mm

If the clutch pedal free play is not within the standard range, we recommend you to have it checked.

Maintenance

Brake pedal free play

E01002300281

Stop the engine, depress the brake pedal several times, and press down the pedal with your fingers until initial resistance is felt. This distance should be within the specified range.

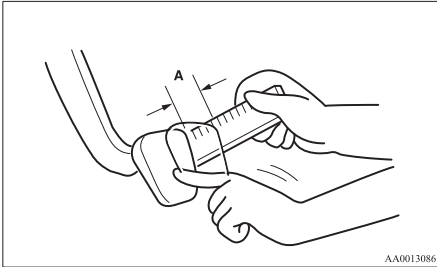

A- Free play: 3 to 8 mm

If the brake pedal free play is not within the standard range, we recommend you to have it checked.

Parking brake lever stroke

E01005800388

Pull the parking brake lever up to check the number of “clicks” that the ratchet makes. One click represents a lever movement of one notch. The lever should move the specified number of notches for normal brake application.

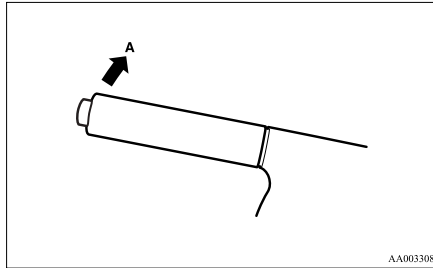

A- Parking brake lever stroke: 5 to 7 notches
(Parking brake adjustment when pulled with a force of 200 N)

If the parking brake lever stroke is out of the standard range, we recommend you to have it checked.

⚠ WARNING

- Continued operation of the vehicle with the parking brake lever out of adjustment may result in the vehicle moving when unattended.

Wiper blades

E01002600473

If the blades are frozen to the windscreen or rear window, do not operate the wipers until the ice has melted and the blades are freed, otherwise the wiper motor may be damaged.

NOTE

- Under icy conditions, do not cause high impact on the wiper blade by slamming it on the glass. In extremely low temperatures, the plastic wiper blade is vulnerable to such shock and may be damaged because of its less plasticity.

Wiper blade rubber replacement

Windscreen wiper blade (driver's side)

1. Lift the wiper arm off the windscreen.
2. Pull the wiper blade until its stopper (A) disengages from the hook (B). Then, pull the wiper blade further to remove it.

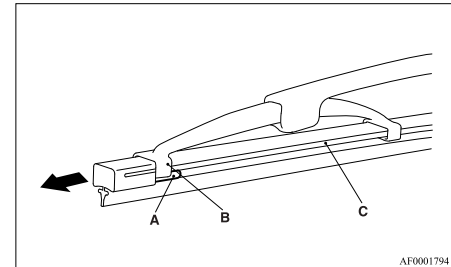

AF0001794

NOTE

- Do not allow the wiper arm to fall onto the windshield; it could damage the glass.

3. Attach the retainers (C) to a new wiper blade.

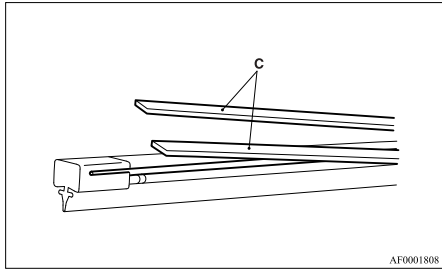

4. Insert the wiper blade into the arm, starting with the opposite end of the blade from the stopper. Make sure the hook (B) is fitted correctly in the grooves in the blade.

NOTE

- If retainers are not supplied with the new wiper blade, use the retainers from the old blade.

5. Push the wiper blade until the hook (B) engages securely with the stopper (A).

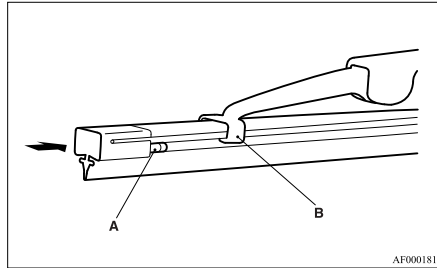

Windscreen wiper blade (passenger's side)

1. Lift the wiper arm off the windshield.
2. Pull the wiper blade until its stopper (A) disengages from the hook (B). Then, pull the wiper blade further to remove it.
3. Slide a new wiper blade through the hook (B) on the wiper arm.

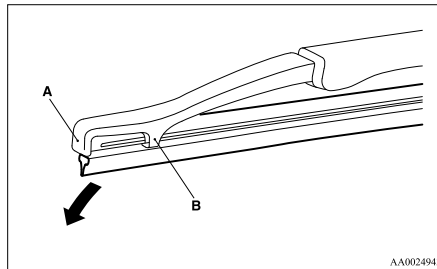

NOTE

- Do not allow the wiper arm to fall onto the windshield; it could damage the glass.

4. Firmly insert the retainer (C) into the groove (D) in the wiper blade. Refer to the illustration to ensure that the retainers are correctly aligned as you insert them into the groove.

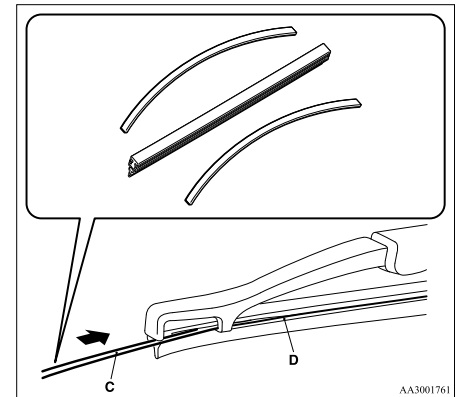

NOTE

- If retainers are not supplied with the new wiper blade, use the retainers from the old blade.

Rear window wiper blade

The rear window wiper uses a wiper arm and wiper blade designed specially for that wiper. If replacement becomes necessary, please consult a MITSUBISHI MOTORS Authorized Service Point or another specialist.

General maintenance

E01002700113

Fuel, engine coolant, oil and exhaust gas leakage

Look under the body of your vehicle to check for fuel, engine coolant, oil and exhaust gas leaks.

WARNING

- If you see a suspicious fuel leak or if you smell fuel, do not operate the vehicle; we recommend you to call for assistance.

Exterior and interior lamp operation

Operate the combination lamp switch to check that all lamps are functioning properly.

If the lamps do not illuminate, the probable cause is a blown fuse or defective lamp bulb. Check the fuses first. If there is no blown fuses, check the lamp bulbs.

For information regarding the inspection and replacement of the fuses and the lamp bulbs, refer to “Fuses” on page 8-19 and “Replacement of lamp bulbs” on page 8-23.

If the fuses and bulbs are all OK, we recommend you to have your vehicle checked and repaired.

Meter, gauge and indicator/warning lamps operation

Run the engine to check the operation of all meters, gauges, and indicator/warning lamps.

If there is anything wrong, we recommend you to have your vehicle inspected.

Hinges and latches lubrication

Check all latches and hinges, and lubricate if necessary by first cleaning and then applying multipurpose grease.

For cold and snowy weather

E01002800172

Ventilation slots

The ventilation slots in front of the windscreen should be brushed clear after a heavy snowfall so that the operation of the heating and ventilation systems will not be impaired.

Weatherstripping

To prevent freezing of the weatherstripping on the doors, bonnet, etc., they should be treated with silicone grease or spray.

Additional equipment

It is a good idea to carry a shovel or a short-handled spade in the vehicle during the winter so that you can clear away snow if you get stranded. A small hand-brush for sweeping snow off the vehicle and a plastic scraper for the windscreen and rear window are also useful.

Fusible links

E01002900030

The fusible links will melt to prevent a fire if a large current attempts to flow through certain electrical systems.

In case of a melted fusible link, we recommend you to have your vehicle inspected.

Fuses

E01003001963

Fuse block location

To prevent damage to the electrical system due to shortcircuiting or overloading, each individual circuit is provided with a fuse.

There is a fuse block in the passenger compartment.

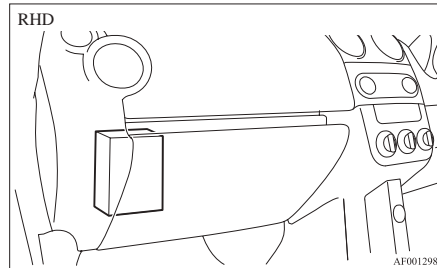
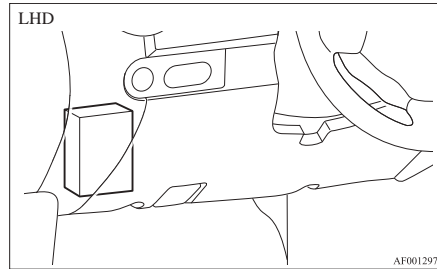

The location of the fuse block in the passenger compartment depends whether the vehicle is LHD or RHD. In a LHD vehicle, it is located behind the cover in front of the driver's seat. In a RHD vehicle, it is located at the back of the glove box (as shown in the illustration).

Fuse load capacity

The fuse capacities and the names of the electrical systems protected by the fuses are shown on the back of the cover in a LHD vehicle and behind the cover at the back of the glove box in a RHD vehicle.

NOTE

- The vehicle is not equipped with spare fuses. Please purchase replacement fuses as necessary.

Passenger compartment fuse location table

NOTE

- When replacing a fuse, be sure to use a fuse of the same capacity.

Maintenance

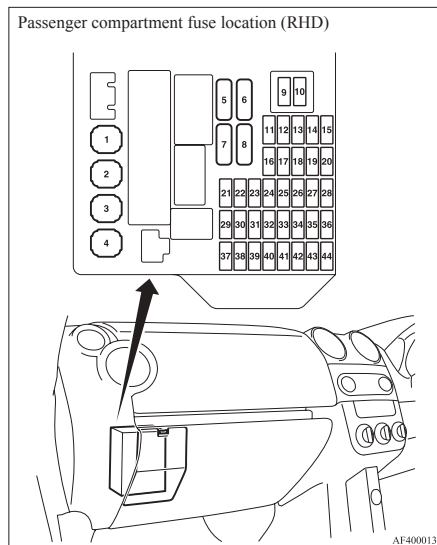
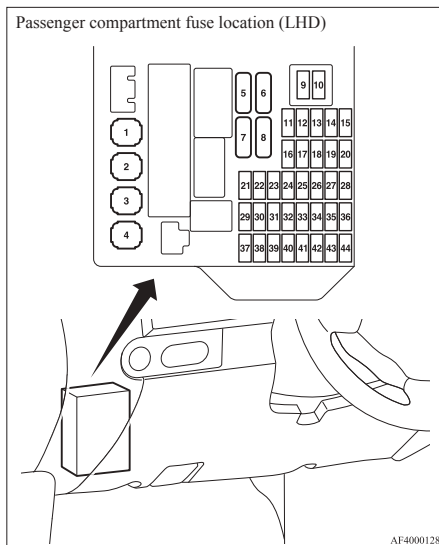

No.	Symbol	Electrical system	Capacity
1		Ignition switch	40 A
2		Electric window system	40 A
3		Radiator fan	40 A
4	A/T	Automated manual transmission	40 A
5		Demister	30 A
6		Heated seat	30 A

No.	Symbol	Electrical system	Capacity
7	—	—	—
8		Heater	40 A
9		Radio	10 A
10		Room lamp	10 A
11		Heated door mirror	7.5 A
12		Electronic control module	7.5 A
13		Windscreen wiper	20 A
14		Tail lamp (right)	7.5 A
15		Tail lamp (left)	7.5 A
16		Engine	20 A
17		Fuel pump	15 A
18		Horn	10 A
19		Headlamp high-beam (left)	10 A
20		Headlamp high-beam (right)	10 A
21	—	—	—
22	—	—	—
23		Outside rear-view mirrors	7.5 A
24		Rear fog lamp	7.5 A
25		Accessory socket	15 A

No.	Symbol	Electrical system	Capacity
26		Rear window wiper	15 A
27	—	—	—
28	—	—	—
29	—	—	—
30	—	—	—
31		Hazard warning flasher	10 A
32	—	—	—
33		Door locks	15 A
34		Front fog lamps	15 A
35		Headlamp low beam (left)	10 A
36		Headlamp low beam (right)	10 A
37		Reversing lamp	7.5 A
38		Engine control	7.5 A
39		Ignition coil	10 A
40		Gauge	7.5 A
41		Relay	7.5 A
42	STOP	Stop lamps	15 A
43		Air conditioning	7.5 A
44	—	—	—

● Some fuses may not be installed on your vehicle, depending on the vehicle model or specifications.

● The table above shows the main equipment corresponding to each fuse.

Identification of fuse

Capacity	Colour
7.5 A	Brown
10 A	Red
15 A	Blue
20 A	Yellow
30 A	Green
40 A	Orange (fuse type)/Green (fusible link type)

Fuse replacement

1. Before replacing a fuse, always turn off the electrical circuit concerned and place the ignition switch in the “LOCK” position.

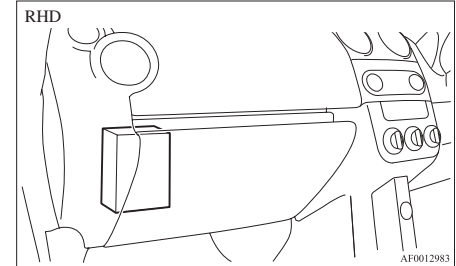
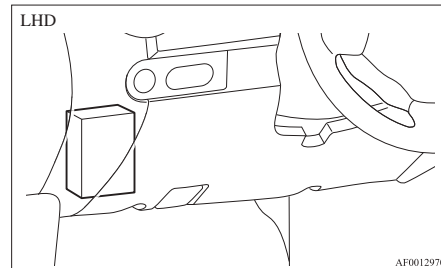

2. Remove the fuse puller from the cover. (Refer to “To remove the cover” on pages 8-22, 8-22.)
3. Referring to the fuse load capacity table, check the fuse pertaining to the problem.

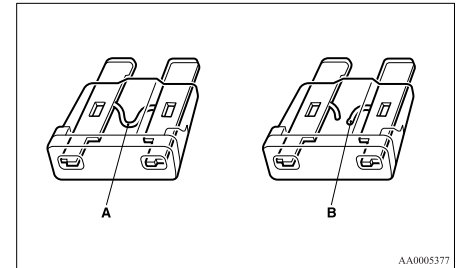

A- Fuse is OK
B- Blown fuse

NOTE

● If any system does not function but the fuse corresponding to that system is normal, there may be a fault in the system elsewhere. We recommend you to have your vehicle checked.

Maintenance

4. Insert a new fuse of the same capacity by using the fuse puller and insert the fuse at the same place in the fuse block.

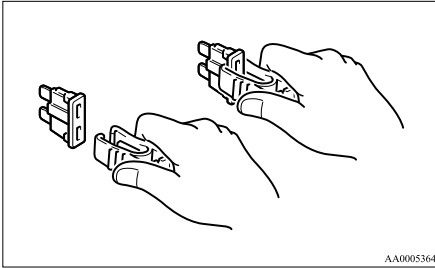

⚠ CAUTION

- If the newly inserted fuse blows again after a short time, we recommend you to have the electrical system checked to find the cause and rectify it.
- Never use a fuse with a capacity larger than that specified or any substitute, such as wire, foil, etc.; doing so will cause the circuit wiring to heat up and could cause a fire.

To remove the cover (LHD vehicles)

E01006800066

1. Turn the clips (A) anticlockwise, then remove the cover (B).

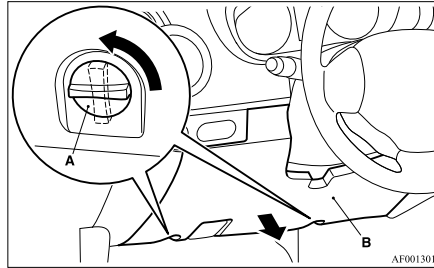

2. Remove the fuse puller (C) from the cover (B).

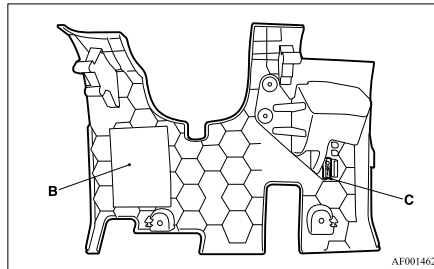

2. Press the tab (A) and remove the cover (B).

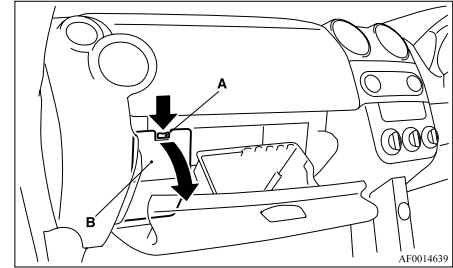

3. Remove the fuse puller (C) from the cover (B).

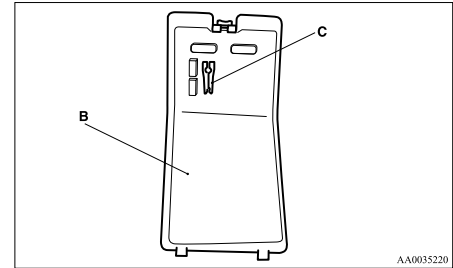

To remove the cover (RHD vehicles)

E01006800079

1. Open the glove box.

To replace the cover (LHD vehicles)

E01006900096

1. Align the cover hooks (A) with the holes in the vehicle panel, then press the cover into place.

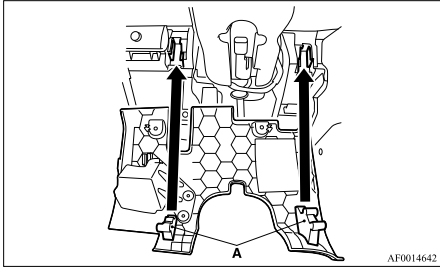

AF0014642

2. Turn the clips (B) clockwise to retain the cover.

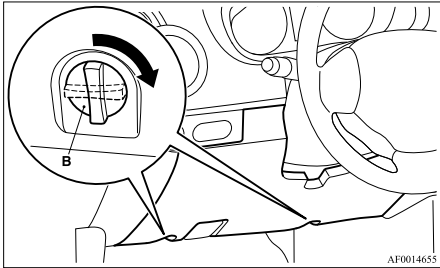

AF0014655

To replace the cover (RHD vehicles)

E01006900100

Align the tabs (A) on the cover with the holes, then press the cover into place.

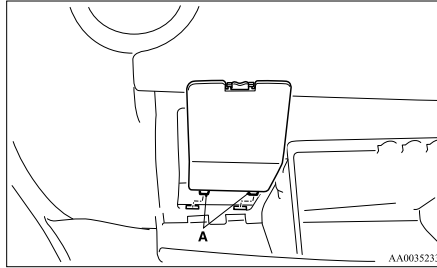

AA0035233

Replacement of lamp bulbs

E01003100433

Before replacing a bulb, ensure the lamp is off. Do not touch the glass part of the new bulb with your bare fingers; the skin oil left on the glass will evaporate when the bulb gets hot and the vapour will condense on the reflector and dim the surface.

CAUTION

- Bulbs are extremely hot immediately after being turned off. When replacing a bulb, wait for it to cool sufficiently before touching it. You could otherwise be burnt.

NOTE

- If you are unsure of how to carry out the work as required, we recommend you to consult a specialist.
- Be careful not to scratch the vehicle body when removing a lamp or lens.
- When it rains or when the vehicle has been washed, the inside of the lens sometimes becomes foggy. This is the same phenomenon as when window glass mists up on a humid day, and does not indicate a functional problem. When the lamp is switched on, the heat will remove the fog. However, if water gathers inside the lamp, we recommend you to have the lamp checked.

Bulb capacity

E01003200043

When replacing a bulb, use a new bulb with the same wattage and colour.

Maintenance

Outside

E01003302048

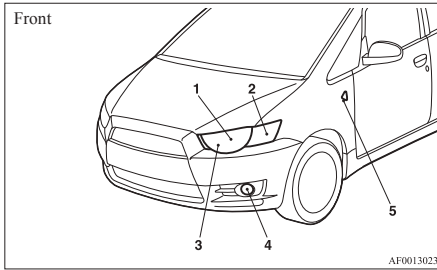

- 1- Headlamps, high/lowbeam: 60/55 W (H4)
 - 2- Front turn-signal lamps: 21 W (P21W)
 - 3- Position lamps: 5 W (W5W)
 - 4- Front fog lamps*: 55W (H11)
 - 5- Side turn-signal lamps: 5 W (WY5W)
- Codes in parentheses indicate bulb types.

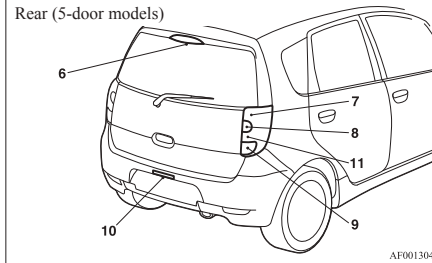
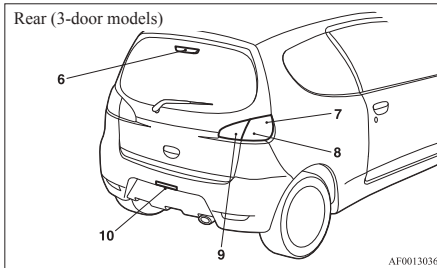

- 6- High-mounted stop lamp: 5 W (W5W)
- 7- Stop and tail lamps (3-door models): 21/5 W (P21/5W)
- 8- Rear turn-signal lamps (3-door models): 21 W (P21W)
- 9- Rear fog lamp (3-door models, driver's side): 21 W (P21W)
- Reversing lamp (3-door models, passenger's side): 21 W (P21W)
- Rear fog lamp (5-door models, driver's side): 21 W (P21W)
- Reversing lamp (5-door models, passenger's side): 21 W (P21W)
- 10- Licence plate lamps: 5 W (W5W)
- 11- Tail lamps (5-door models): 5 W (R5W)

Codes in parentheses indicate bulb types.

Inside

E01003401332

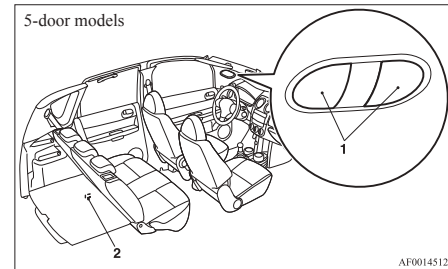
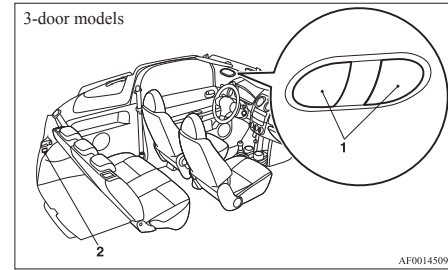

- 1- Room lamps & map lamps: 5 W
- 2- Luggage compartment lamp: 10 W

Headlamps

E01003501261

1. Turn the cover (A) anticlockwise to remove it.

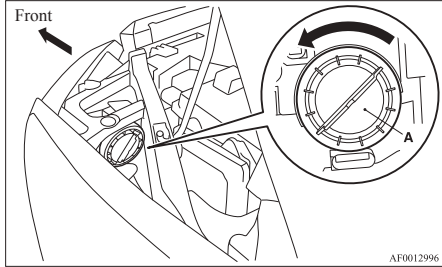

AF0012996

2. Disconnect the connector (B).

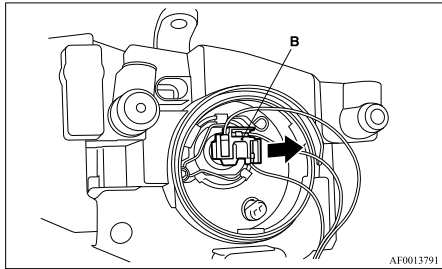

AF0013791

3. Unhook the spring (C) which secures the bulb, and then remove the headlamp bulb.

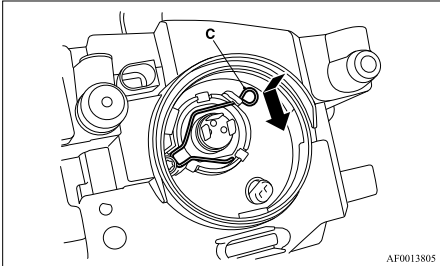

AF0013805

CAUTION

- Handle halogen lamp bulb with care. The gas inside halogen lamp bulb is highly pressurized, so dropping, knocking, or scratching a halogen lamp bulb can cause it to shatter.
- Never hold the halogen lamp bulb with a bare hand, dirty glove, etc. The oil from your hand could cause the bulb to break the next time the headlamps are operated. If the glass surface is dirty, it must be cleaned with alcohol, paint thinner, etc., and refit it after drying it thoroughly.

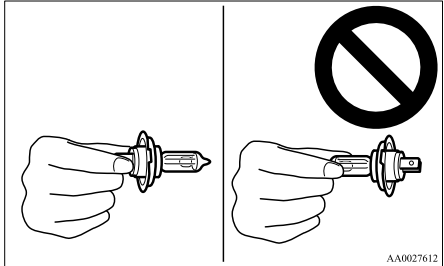

AA0027612

4. To install the bulb, perform the removal steps in reverse.

NOTE

- When installing the bulb, align the upper part as illustrated then press the bulb into place.

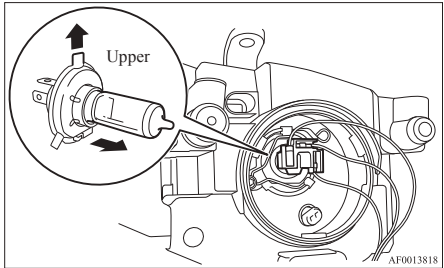

AF0013818

Position lamps

E01003700732

1. Disconnect the headlamp connector. (Refer to "Headlamps" on page 8-25.)

Maintenance

2. Remove the socket and bulb assembly (A) together by pulling out, and then remove the bulb by pulling out.

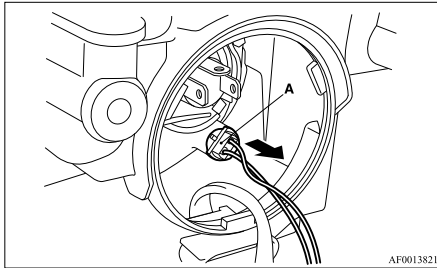

3. To install the bulb, perform the removal steps in reverse.

Front turn-signal lamps

E01003800687

1. Turn the bulb socket anticlockwise to remove it. And remove the bulb from the socket by turning it anticlockwise while pressing in.

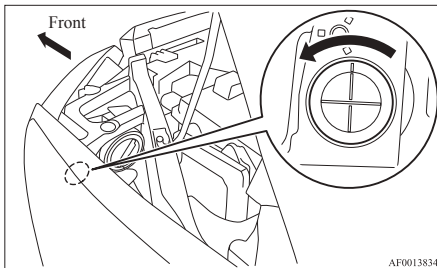

2. To install the bulb, perform the removal steps in reverse.

Side turn-signal lamps

E01003900369

1. Remove the lamp housing by levering it towards the front of the vehicle.

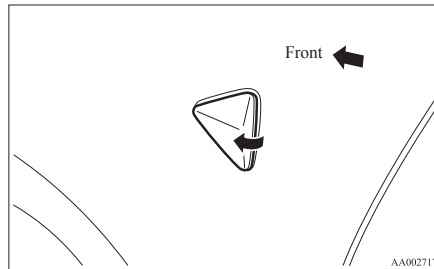

2. Remove the socket and bulb assembly together by turning it anticlockwise, and then remove the bulb by pulling out.

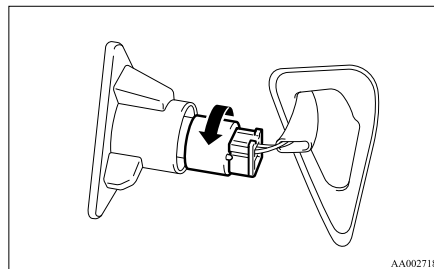

3. To install the bulb, perform the removal steps in reverse.

Front fog lamps*

E01004001276

1. Remove the bezel (A).

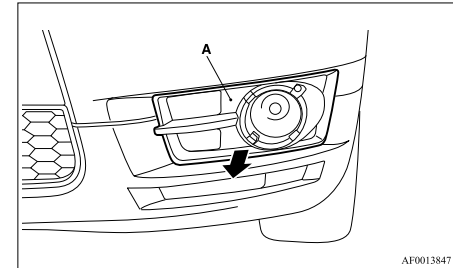

2. Remove the lamp mounting screws (B) and pull the entire lamp bracket out.

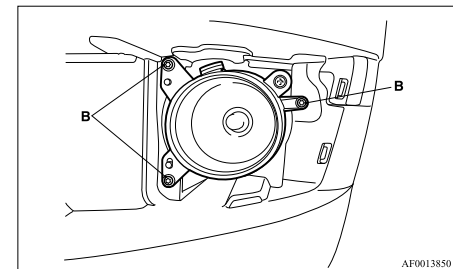

- Push the connector (C) to disconnect and remove the fog lamp.

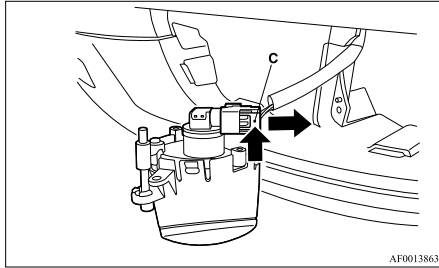

- Remove the entire socket and bulb assembly (D) by turning it anticlockwise.

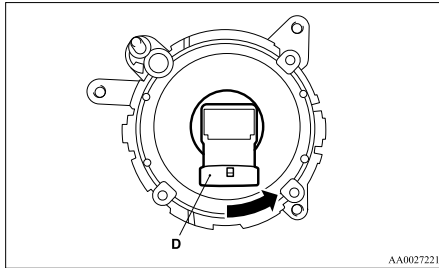

- To install the bulb, perform the removal steps in reverse.

NOTE

- When mounting the lamp unit, align the holes in the lamp unit with the pins (E) on the vehicle body.

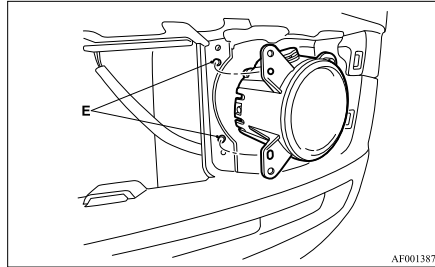

⚠ CAUTION

- Handle halogen lamp bulbs with care. The gas inside halogen lamp bulbs is highly pressurized, so dropping, knocking, or scratching a halogen lamp bulb can cause it to shatter.
- Never hold the halogen lamp bulb with a bare hand, dirty glove, etc. The oil from your hand could cause the bulb to break the next time the fog lamps are operated. If the glass surface is dirty, it must be cleaned with alcohol, paint thinner, etc., and refit it after drying thoroughly.

Maintenance

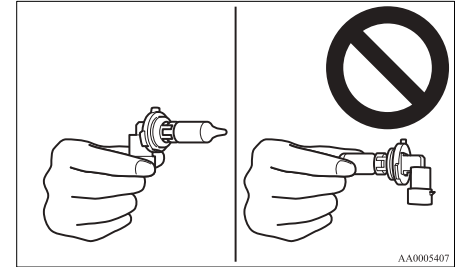

Rear combination lamps

E01004201382

3-door models

- Remove the screws (A) (2 locations), and then remove the lamp unit.

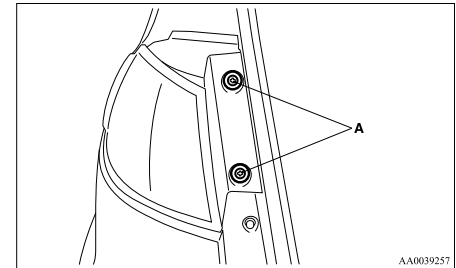

Maintenance

2. Pull out the connector (B) while pressing the tab (C).

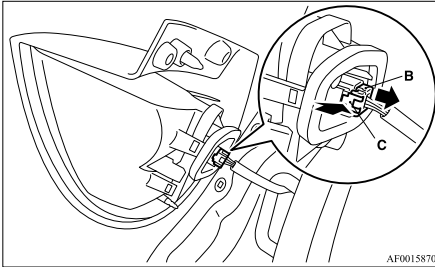

3. Undo the clips (D) (4 locations) one by one (pull each clip in the direction of the arrow), and then remove the bulb holder.

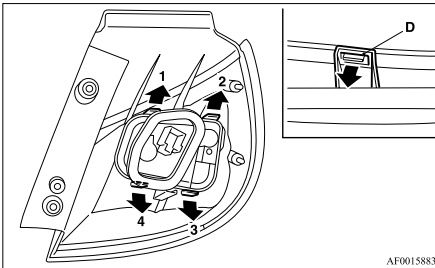

4. Remove the bulb by turning it anticlockwise while pressing in.

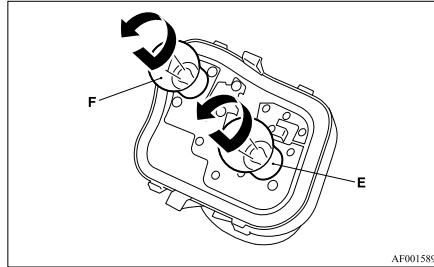

E- Rear turn-signal lamp
F- Stop lamp

5. To install the bulb, perform the removal steps in reverse.

NOTE

- When mounting the lamp unit, align the pins (G) on the lamp unit with the holes in the body.

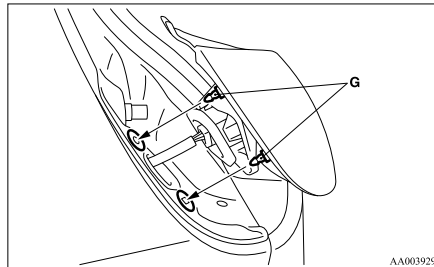

5-door models

1. Remove the screws (A) (2 locations), and then remove the lamp unit.

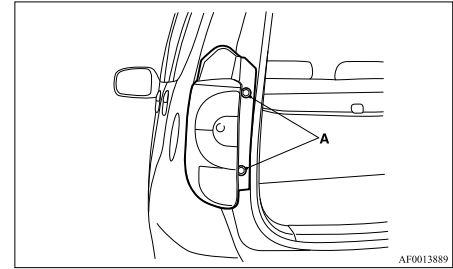

2. Push the tab (B) inward with a straight blade (or minus) screwdriver, and undo the lock in the direction of the arrow (C), thereby freeing the rear combination lamp unit from the connector.

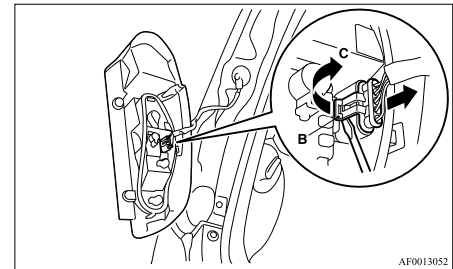

3. Undo the clips (D) (6 locations) one by one, starting at the top and finishing at the bottom. (Pull each clip in the direction of the arrow to undo it.) Then, remove the bulb holder.

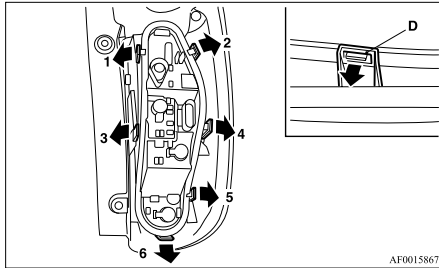

AF0015867

4. Remove the bulb by turning it anticlockwise while pressing in (except for stop lamp) or by pulling out (stop lamp).

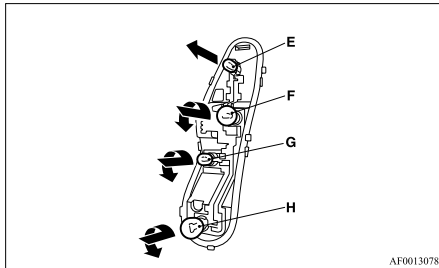

AF0013078

- E- Stop lamp
- F- Rear turn-signal lamp
- G- Tail lamp
- H- Rear fog lamp (driver's side)
Reversing lamp (passenger's side)

5. To install the bulb, perform the removal steps in reverse.

NOTE

- When mounting the lamp unit, align the pins (I) on the lamp unit with the hole and the clip in the body.

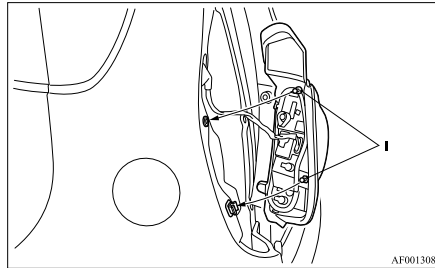

AF0013081

**Reversing lamp (passenger's side)/
Rear fog lamp (driver's side)**

E01004400228

3-door models

1. Press the tab (A) and remove the cover (B).

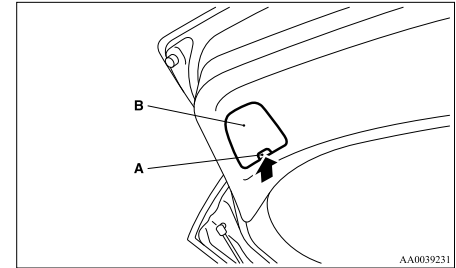

AA0039251

2. Remove the socket and bulb assembly (C) together by turning it anticlockwise, and then remove the bulb by turning it anticlockwise while pressing in.

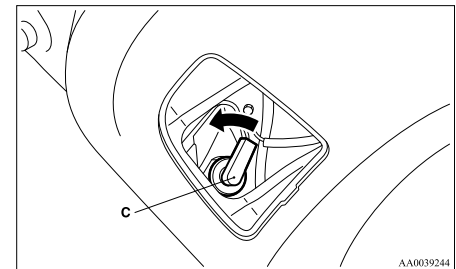

AA0039244

Maintenance

3. To install the bulb, perform the removal steps in reverse.

High-mounted stop lamps

EE01004500519

3-door models

1. Open the tailgate and remove the clips (A) (2 locations).
To remove each clip, press part (B) of the clip then pry around the clip to get the clip out.

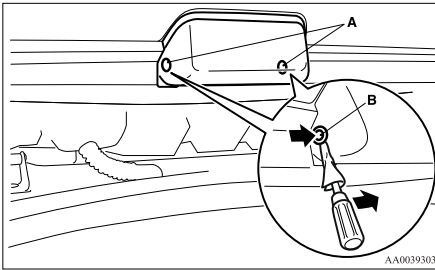

2. Remove the screws (C) (2 locations) and remove the bulb holder, then pull out the bulb.

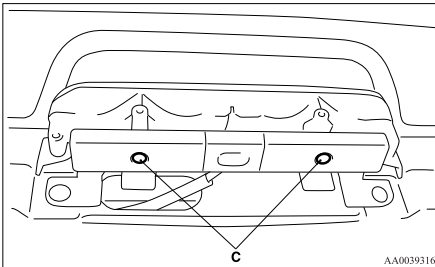

To reinstall

Reverse the above removal procedure. When refitting each of the clips of the lid, push the clip into the lid with the pin pressed inward (as illustrated). Then, push in the pin to lock the clip in place.

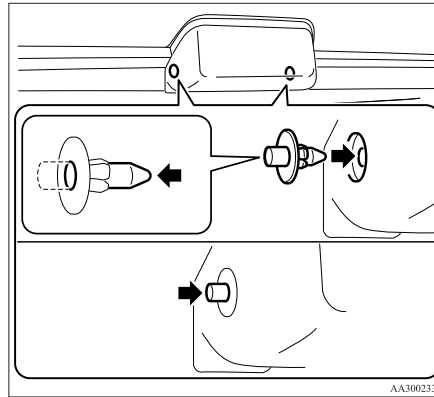

5-door models

1. Open the tailgate and remove the covers (A) (2 locations).

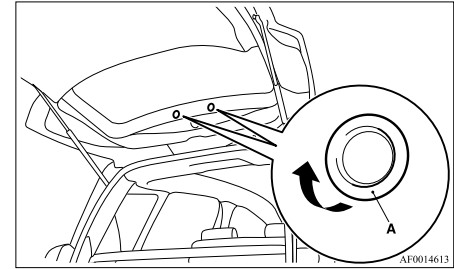

2. Push the hooks (B) (2 locations) into the holes and remove the high-mounted stop lamp. (Close the tailgate to cause the lamp assembly to come out.)

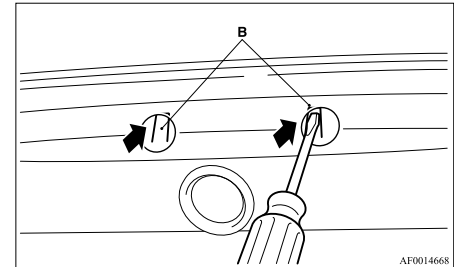

3. Gently close the tailgate, remove the lamp assembly, and remove the connector (C), then remove the lamp body.

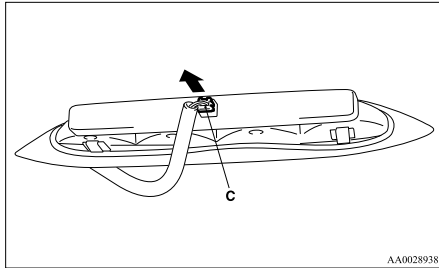

4. Undo the clips (D) and remove the bulb holder, then pull out the bulb.

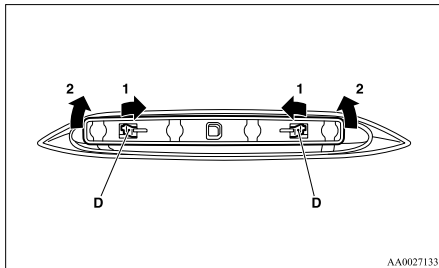

5. To install the bulb, perform the removal steps in reverse.

Licence plate lamps

E01004600800

1. Remove the lamp assembly by levering it out with a straight blade (or minus) screwdriver.

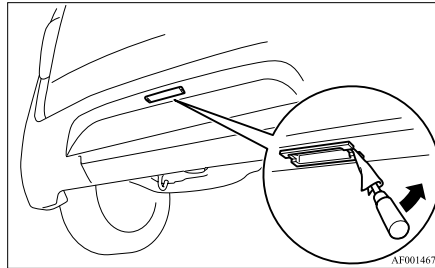

2. Remove the socket and bulb assembly together by turning it anticlockwise, and then remove the bulb by pulling out.

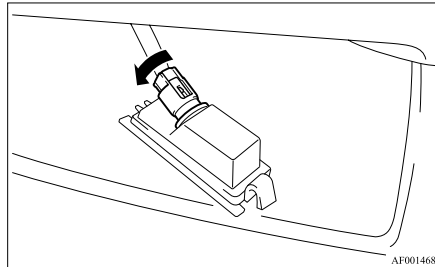

3. To install the bulb, perform the removal steps in reverse.

NOTE

- When installing the lamp, insert tab (A) first, then align and insert tab (B).

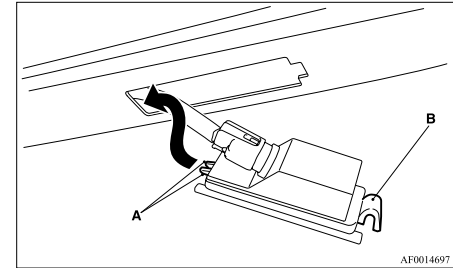

Room lamps & map lamps

E01004700478

1. Insert a straight blade (or minus) screwdriver into the notch of the lens and pry gently to remove the lens.
2. Turn the lamp bulb anticlockwise to remove it from the lamp bulb holder.

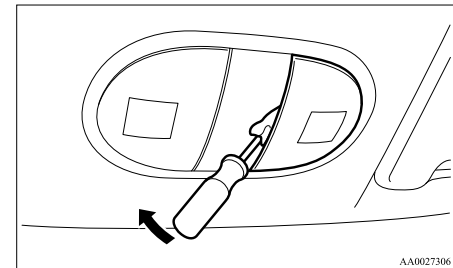

Maintenance

NOTE

- Wrap a piece of cloth around the tip of the screwdriver in order to avoid scratching the lens.

3. To install the bulb, perform the removal steps in reverse.

Luggage compartment lamp

E01005300370

1. Insert a straight blade (or minus) screwdriver with a cloth over its tip into the notch of the lens and pry gently to remove the lens.
2. Remove the bulb from the lamp holder.

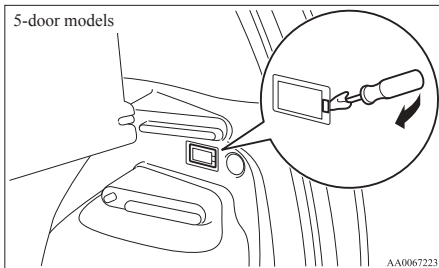
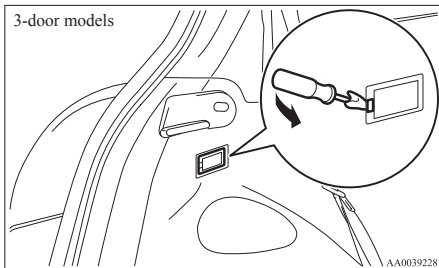

NOTE

- Wrap a piece of cloth around the tip of the screwdriver in order to avoid scratching the lens.

3. To install the bulb, perform the removal steps in reverse.

Specifications

Vehicle labeling.....	9-02
Vehicle dimensions.....	9-04
Vehicle performance.....	9-06
Vehicle weight.....	9-07
Engine specifications.....	9-09
Transmission specifications.....	9-10
Electrical system.....	9-11
Tyres and wheels.....	9-12
Other specifications.....	9-13
Fuel consumption.....	9-14
Refill capacities.....	9-16

Specifications

Vehicle labeling

E01100102831

Vehicle identification number: (VIN)

The vehicle identification number (VIN) is stamped as shown in the illustration.

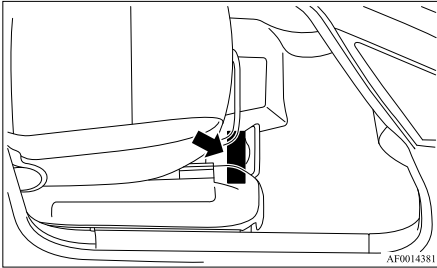

Vehicle information code plate

The vehicle information code plate is riveted as shown in the illustration.

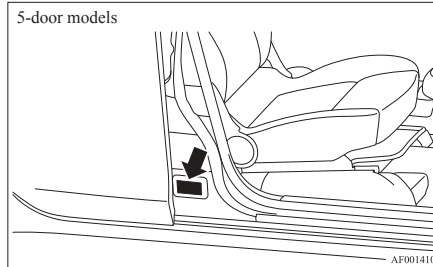
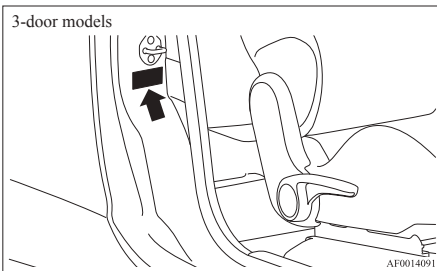

The plate shows model code, engine model, transmission model and body colour code, etc.

Please use this number when ordering replacement parts.

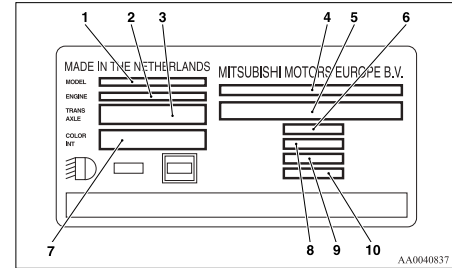

- 1- Model code
- 2- Engine model code,
Exterior code
- 3- Transmission model code
- 4- Approval number
- 5- Chassis number
- 6- Maximum gross vehicle weight
- 7- Body colour code,
Interior code,
Option code
- 8- Gross combination weight
- 9- Maximum axle weight (Front)
- 10- Maximum axle weight (Rear)

Vehicle identification number plate (RHD vehicles only)

The vehicle identification number is stamped on the plate riveted to the left front corner of the instrument panel pad. It is visible from outside of the vehicle through the windscreen.

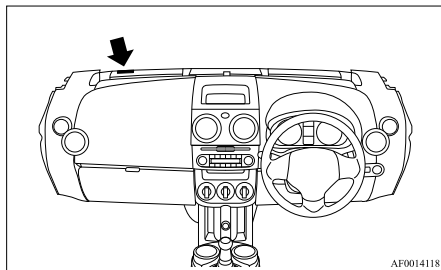

Engine number

The engine number is stamped on the engine cylinder block as shown in the illustration.

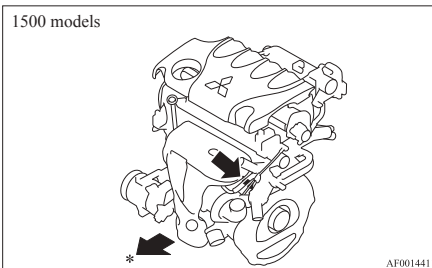
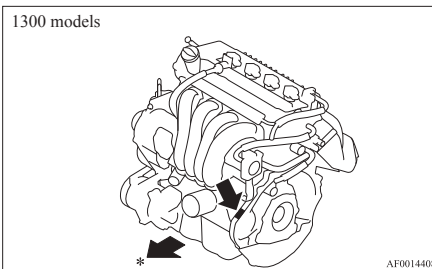
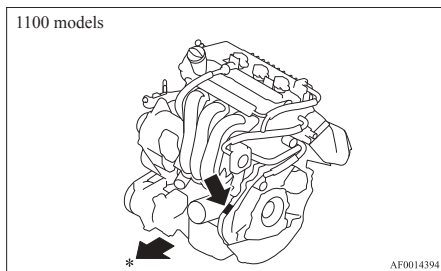

*: Front of the vehicle

Vehicle dimensions

E01100201734

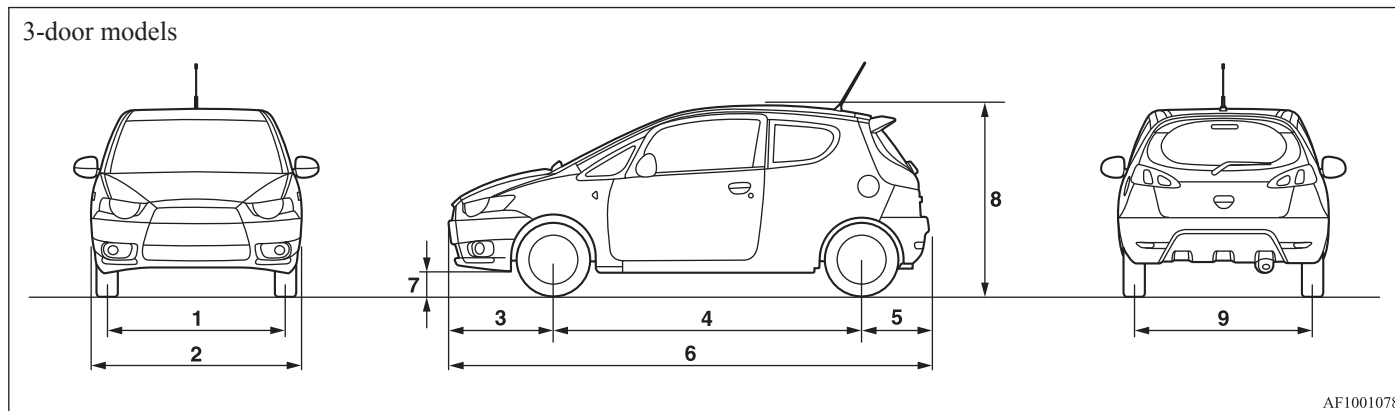

1	Front track	1,460 mm
2	Overall width	1,695 mm
3	Front overhang	845 mm
4	Wheel base	2,500 mm
5	Rear overhang	535 mm
6	Overall length	3,880 mm
7	Ground clearance (unladen)	154 mm
8	Overall height (unladen)	1,520 mm
9	Rear track	1,445 mm

5-door models

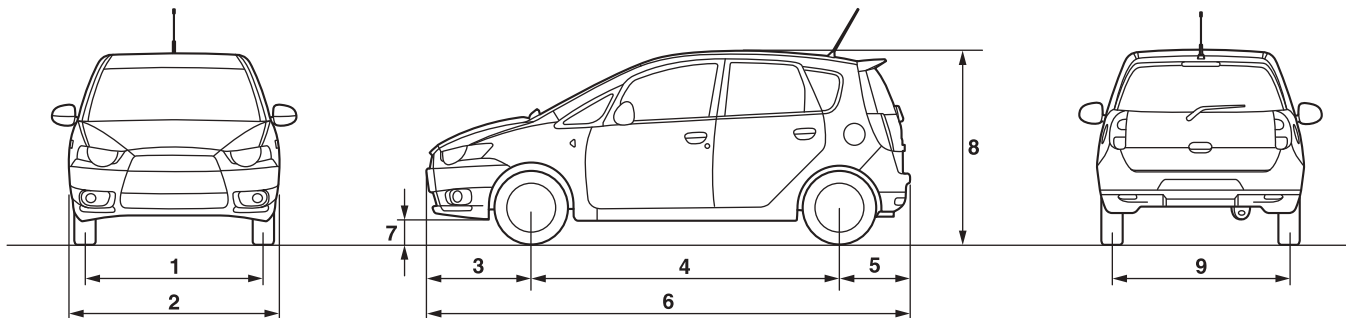

AF1001081

1	Front track	1,460 mm
2	Overall width	1,695 mm
3	Front overhang	845 mm
4	Wheel base	2,500 mm
5	Rear overhang	595 mm
6	Overall length	3,940 mm
7	Ground clearance (unladen)	154 mm
8	Overall height (unladen)	1,550 mm
9	Rear track	1,445 mm

Vehicle performance

E01100302022

Item		1100 models	1300 models	1500 models
Maximum speed		165 km/h (102 mph)	180 km/h (112 mph)	210 km/h (130 mph)
Minimum turning radius	Body	5.4 m		
	Wheel	5.1 m		

Vehicle weight

3-door models

Item		1100 models		1300 models			1500 models
				Manual transmission		Automated manual transmission	
		Except for Clear Tec	Clear Tec	Except for Clear Tec	Clear Tec		
Kerb weight	Without optional parts	925 kg	930 kg	930 kg	935 kg	935 kg	1,050 kg
	With full optional parts	990 kg	993 kg	995 kg	998 kg	1,000 kg	1,076 kg
Maximum gross vehicle weight		1,420 kg, 1,480 kg*	1,425 kg, 1,485 kg*	1,430 kg, 1,490 kg*	1,435 kg, 1,495 kg*	1,435 kg, 1,495 kg*	1,520 kg, 1,580 kg*
Maximum axle weight	Front	735 kg	740 kg	745 kg	750 kg	745 kg	820 kg
	Rear	720 kg, 785 kg*					
Maximum towable weight	With brake	750 kg					
	Without brake	500 kg					
Maximum trailer-nose weight		50 kg					
Maximum roof load		50 kg					
Seating capacity		5 persons					

*: In case of trailer towing

NOTE

- Trailer specifications indicate the manufacturer's recommendation.

Specifications

5-door models

Item		1100 models		1300 models			1500 models
				Manual transmission		Automated manual transmission	
		Except for Clear Tec	Clear Tec	Except for Clear Tec	Clear Tec		
Kerb weight	Without optional parts	965 kg	970 kg	970 kg	975 kg	975 kg	1,090 kg
	With full optional parts	1,033 kg	1,036 kg	1,038 kg	1,041 kg	1,043 kg	1,119 kg
Maximum gross vehicle weight		1,450 kg, 1,510 kg*	1,455 kg, 1,515 kg*	1,460 kg, 1,520 kg*	1,465 kg, 1,525 kg*	1,465 kg, 1,525 kg*	1,550 kg, 1,610 kg*
Maximum axle weight	Front	735 kg	740 kg	745 kg	750 kg	745 kg	830 kg
	Rear	745 kg, 810 kg*					
Maximum towable weight	With brake	750 kg		1,000 kg			
	Without brake	500 kg					
Maximum trailer-nose weight		50 kg					
Maximum roof load		50 kg					
Seating capacity		5 persons					

*: In case of trailer towing

NOTE

- Trailer specifications indicate the manufacturer's recommendation.

Engine specifications

E01100602386

Item		1100 models		1300 models		1500 models
Engine type		Three-cylinder, in line, water cooled four-cycle, double overhead camshaft		Four-cylinder, in line, water cooled four-cycle, double overhead camshaft		Four-cylinder, in line, water cooled four-cycle, double overhead camshaft with intercooler and turbocharger
Engine model		134910	3A91	135930	4A90	4G15
Total displacement		1,124 cc		1,332 cc		1,468 cc
Bore		75.0 mm		75.0 mm		75.5 mm
Stroke		84.8 mm		75.4 mm		82.0 mm
Compression ratio		10.5	11.0	10.5	11.0	9.0
Valve clearance	Intake	0.18 - 0.26 mm (cold)				Automatically
	Exhaust	0.26 - 0.34 mm (cold)				Automatically
Firing order		1-3-2		1-3-4-2		
Maximum output (EEC net)		55 kW/6.000 r/min		70 kW/6.000 r/min		110 kW/6.000 r/min
Maximum torque (EEC net)		100 Nm/4,000 r/min		125 Nm/4,000 r/min		210 Nm/3,500 r/min

Transmission specifications

E01100701478

Item	1100 models		1300 models			1500 models
			Manual transmission		Automated manual transmission	
	Engine model 134910	Engine model 3A91	Engine model 135930	Engine model 4A90		
1 st gear ratio	3.308	3.308	3.308	3.308	3.071	3.538
2 nd gear ratio	1.913	1.913	1.913	1.913	1.913	1.913
3 rd gear ratio	1.258	1.258	1.258	1.258	1.258	1.344
4 th gear ratio	0.943	0.943	0.943	0.943	0.943	1.027
5 th gear ratio	0.763	0.763	0.763	0.763	0.763	0.833
6 th gear ratio	—	—	—	—	0.643	—
Reverse gear ratio	3.231	3.231	3.231	3.231	3.231	3.357
Final gear ratio	4.353	4.158	4.158	3.842	4.529	3.737

NOTE

- The engine model is indicated on the vehicle information code plate. Refer to “Vehicle information code plate” on page 9-02.

Electrical system

E01100802157

Item	1100 models			1300 models			1500 models
	Except for Clear Tec		Clear Tec	Except for Clear Tec		Clear Tec	
	Engine model 134910	Engine model 3A91		Engine model 135930	Engine model 4A90		
Voltage	12 V						
Battery capacity (DIN type)	42 Ah (542), 61 Ah (561)*		61 Ah (561)	42 Ah (542), 61 Ah (561)*		61 Ah (561)	42 Ah (542), 61 Ah (561)*
Alternator capacity	85 A		95 A	85 A		95 A	80 A
Spark plug type	BOSCH	FR7SE, FR7NPP33	—	FR7SE, FR7NPP33	—		
	NGK	—	LZFR5BI-11	—	LZFR6BI- 11	ILZFR6C-K	

*: Optional equipment

NOTE

- For Clear Tec models, contact an authorized MITSUBISHI MOTORS dealer when replacing the battery.
- The engine model is indicated on the vehicle information code plate.
Refer to “Vehicle information code plate” on page 9-02.

Specifications

Tyres and wheels

E01100902682

Tyre		175/65R14 82T	185/55R15 82H 195/50R15 82H	205/45R16 83H 205/45R16 83V
Wheel	Size	14x5 1/2 J	15x6 J	16x6 1/2 J
	Offset	46 mm		

NOTE

- Contact your MITSUBISHI MOTORS Authorized Service Point for details on the combination used on your vehicle.

Other specifications

E01101000950

Item		1100 models, 1300 models	1500 models
Fuel system	Fuel control	Electric controlled injection	
	Fuel pump	Electric motor type	
Clutch		Dry single disc clutch, hydraulic action	
Steering system		Rack and pinion type, electric power assisted	
Suspension	Front	Independent type, MacPherson strut, coil spring	
	Rear	Torsion beam rigid type	
Service brakes	Type	Hydraulic, dual diagonal circuit with power assistance and anti-lock brake system with electronic brake force distribution function	
	Front	Ventilated disc brakes	
	Rear	Drum brakes, Disc brakes*	Disc brakes
Parking brakes		Parking brake acts mechanically on rear wheels	

*: Optional equipment

Fuel consumption

E01101100599

Item			Combined		Urban conditions		Extra-urban conditions		
			CO ₂ (g/km)	Fuel consumption (L/100 km)	CO ₂ (g/km)	Fuel consumption (L/100 km)	CO ₂ (g/km)	Fuel consumption (L/100 km)	
1100 models	Except for Clear Tec	With 175/65R14 tyres	125	5.4	156	6.8	107	4.6	
		With 195/50R15 or 205/45R16 tyres	125	5.4	156	6.8	107	4.6	
	Clear Tec	With 175/65R14 or 185/55R15 tyres	115	4.9	140	6.0	100	4.3	
1300 models	Except for Clear Tec	Manual transmission	With 175/65R14 tyres	130	5.6	167	7.2	109	4.7
			With 195/50R15 or 205/45R16 tyres	130	5.6	167	7.2	109	4.7
		Automated manual transmission	With 175/65R14 tyres	125	5.4	158	6.8	106	4.5
			With 195/50R15 or 205/45R16 tyres	127	5.5	161	7.0	107	4.6
	Clear Tec	With 175/65R14 or 185/55R15 tyres	119	5.1	148	6.4	102	4.4	
1500 models			153	6.6	196	8.5	128	5.5	

NOTE

- The values shown above apply to a vehicle on which optional equipment has not been fitted.
- The results given do not express or imply any guarantee of the fuel consumption of the particular vehicle. The vehicle itself has not been tested and there are inevitably differences between individual vehicles of the same model. In addition, this vehicle may incorporate particular modifications. Furthermore, the driver's style and road and traffic conditions, as well as the extent to which the vehicle has been driven and the standard of maintenance, will all affect its fuel consumption.

Refill capacities

E01101303475

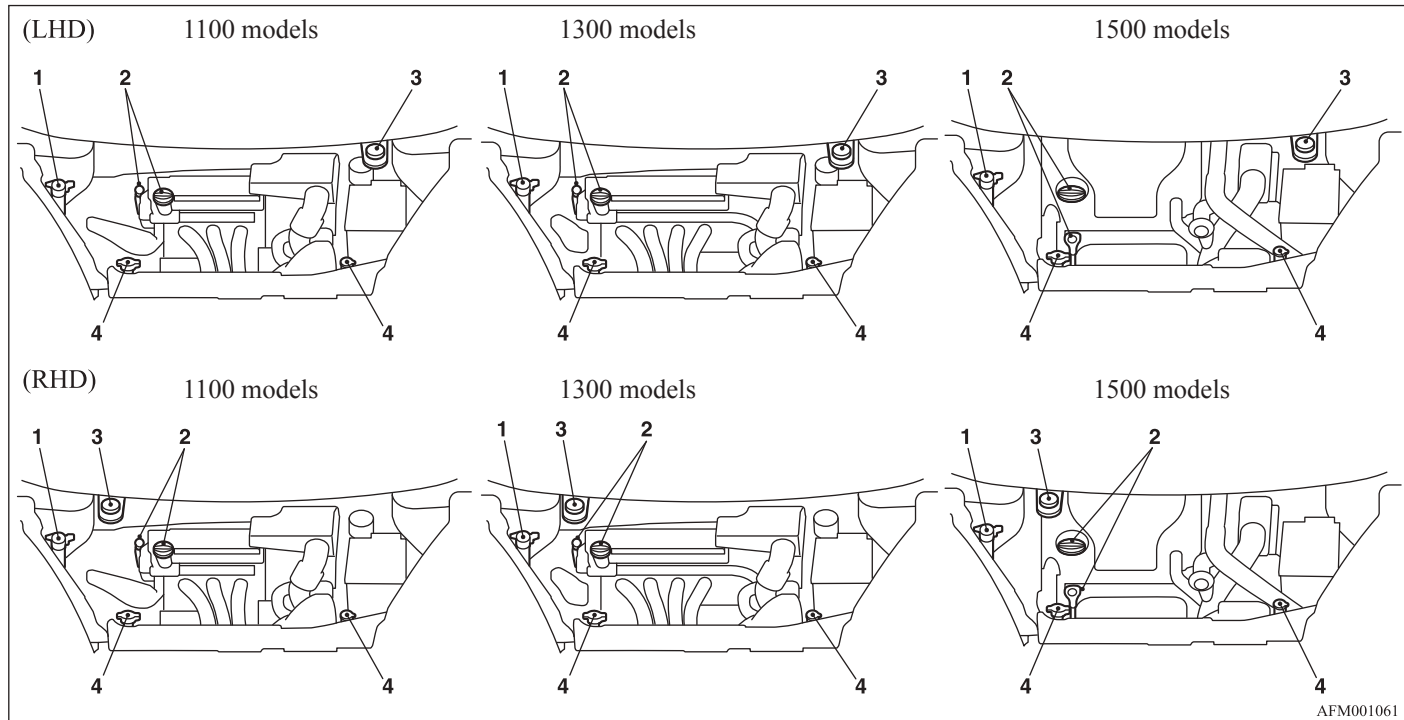

AFM001061

No.	Item		Quantity	Lubricants	
1	Washer fluid		5.16 litres	—	
2	Engine oil	1100 models	Oil pan	3.0 litres	Refer to page 8-05.
			Oil filter	0.2 litre	
		1300 models	Oil pan	4.0 litres	
			Oil filter	0.2 litre	
		1500 models	Oil pan	3.3 litres	
			Oil filter	0.3 litre	
		Oil cooler	0.1 litre		
3	Brake fluid		As required	Brake fluid DOT 4 +	
	Clutch fluid				
4	Engine coolant [includes 0.6 litre in the reserve tank]	1100 models	4.2 litres	High-quality ethylene glycol based coolant	
		1300 models	4.6 litres		
		1500 models	6.0 litres		
5	Manual transmission oil	Except for vehicles with turbocharger	1.75 litres	DiaQueen WIDE GEAR OIL G-1 or Castrol/ Burmah gear oil BOT328 (or exact equivalents)	
		Vehicles with turbocharger	1.75 litres	DiaQueen WIDE GEAR OIL G-1 or Castrol/ Burmah gear oil BOT328 (or exact equivalents)	
	Automated manual transmission oil		1.75 litres	DiaQueen WIDE GEAR OIL G-1 or Castrol/ Burmah gear oil BOT328 (or exact equivalents)	
6	Refrigerant (air conditioning)		410 - 450 g	HFC-134a	

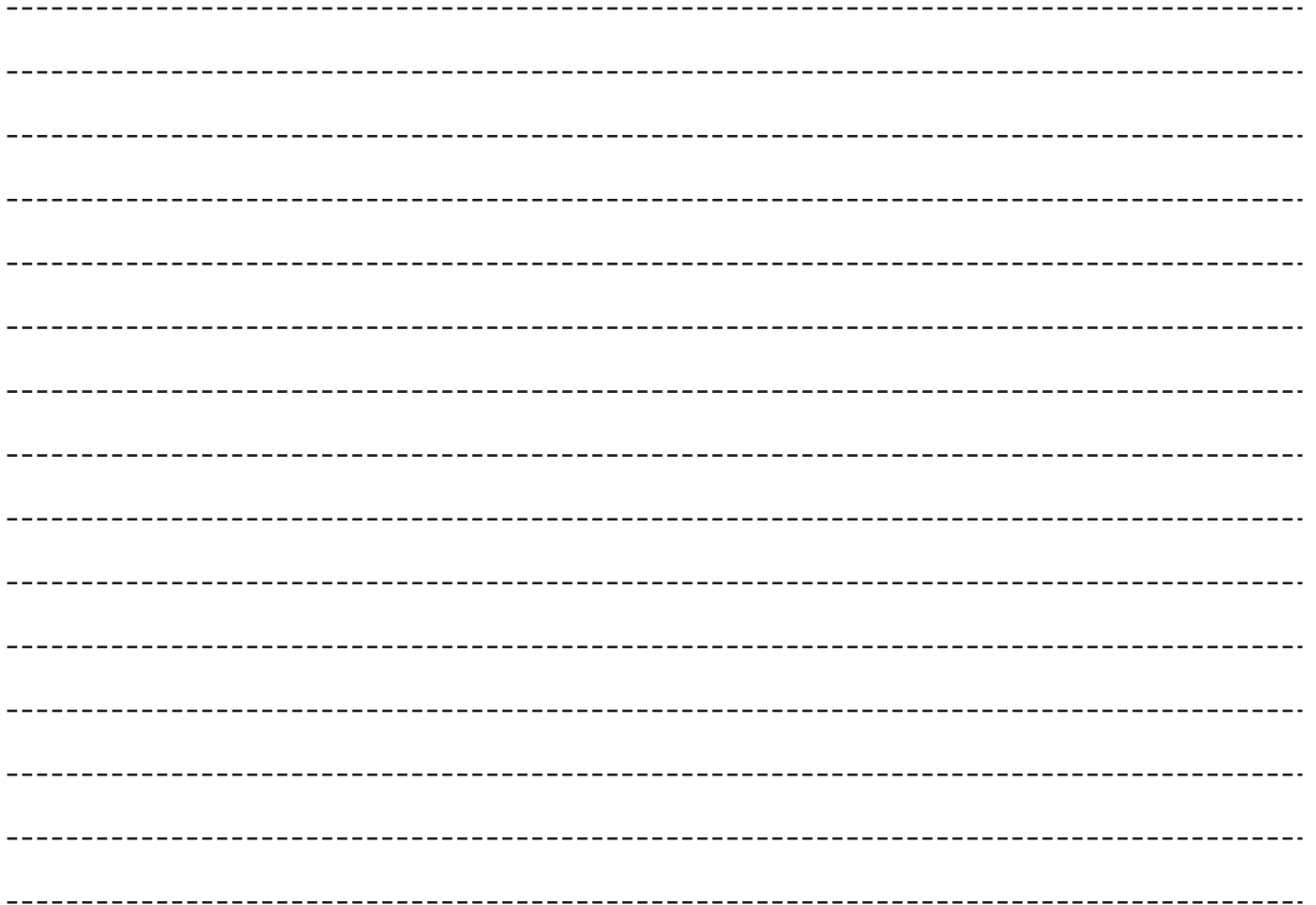

A

- Accessory (Installation) 04
- Accessory socket 5-37
- Active stability control system (ASC) 4-30
 - Indication lamp 4-31
- Additional equipment 8-18
- Air conditioning
 - Automatic air conditioning 5-07
 - Important operation tips for the air conditioning 5-11
- Air purifier 5-12
- Airbag 2-22
 - Front passenger's airbag OFF indication lamp 2-25
 - Front passenger's airbag ON-OFF switch 2-25
- Antenna 5-33
- Anti-lock brake system (ABS) 4-27
 - Warning lamp 4-28
- Audio
 - Error codes 5-30
 - Handling of compact discs 5-32
 - LW/MW/FM electronic tuning radio with CD player 5-12
- Auto Stop & Go (AS&G) system 4-13
- Automated manual transmission 4-19
 - Oil 9-16
- Automatic air conditioning 5-07

B

- Battery 8-10
 - Charge warning lamp 3-19
 - Discharged battery (Emergency starting) 6-02
 - Specification 9-11
- Bonnet 8-03
- Brake
 - Anti-lock brake 4-27

- Brake assist system 4-27
- Braking 4-25
- Fluid 8-09,9-16
- Parking brake 4-06
- Parking brake lever stroke 8-16
- Pedal free play 8-16
- Warning lamp 3-17
- Bulb capacity 8-23

C

- Capacities 9-16
- Cargo loads 4-36
- Catalytic converter 8-02
- Central door locks 1-07
- Changing a fuse 8-21
- Charge warning lamp 3-19
- Chassis number 9-02
- Check engine warning lamp 3-18
- Child restraint 2-13
- Child-protection rear doors 1-09
- Cleaning
 - Exterior of your vehicle 7-03
 - Genuine leather 7-02
 - Interior of your vehicle 7-02
 - Plastic, vinyl leather, etc 7-02
- Clock 5-34
- Clutch
 - Fluid 8-09
 - Pedal free play 8-15
- Coat hooks 5-43
- Combination headlamps and dipper switch 3-20
- Coming home light 3-22
- Compact spare wheel 6-13
- Cool box 5-39
- Coolant (engine) 8-07,9-16
- Cruise control 4-32
- Cup holder 5-42

D

- Dead Lock System 1-07
- Demister (rear window) 3-29
- Digital clock 5-34
- Dipper (High/Low beam change) 3-21
- Door ajar warning lamp 3-19
- Doors
 - Central door locks 1-07
 - Child-protection 1-09
 - Dead Lock System 1-07
 - Lock and unlock 1-05
- Driving, alcohol and drugs 4-02

E

- Economical driving 4-02
- Electric power steering system 4-29
- Electric remote-controlled outside rear-view mirrors 4-09
- Electric window control 1-11
- Electrical system 9-11
- Electronic immobilizer (Anti-theft starting system) 1-02
- Emergency starting 6-02
- Emergency stop signal system 4-26
- Engine
 - Coolant 8-07,9-16
 - High coolant temperature warning lamp 3-19
 - Number 9-03
 - Oil 8-05
 - Oil and filter 9-16
 - Overheating 6-04
 - Specifications 9-09
 - Used engine oils safety instructions and disposal information 05
- Error codes 5-30
- Exterior and interior lamp operation 8-18

Alphabetical index

F

Fluid capacities and lubricants 9-16

Fluid

Brake fluid 8-09,9-16

Clutch fluid 8-09,9-16

Engine coolant 8-07,9-16

Washer fluid 8-09,9-16

For cold and snowy weather 8-18

Front fog lamps

Bulb capacity 8-24

Indication lamp 3-17

Replacement 8-26

Switch 3-24

Front passenger's airbag ON-OFF switch 2-25

Front seat 2-04

Front turn-signal lamps

Bulb capacity 8-24

Replacement 8-26

Frozen road warning 3-10

Fuel consumption 9-14

Fuel

Filling the fuel tank 02

Fuel selection 02

Fuel tank filler door release lever 03

Modification/alterations to the electrical or fuel systems 05

Tank capacity 03

Fuse load capacity 8-19

Fuse replacement 8-21

Fuses 8-19

Fusible links 8-19

G

Gauges 3-02,3-16

General maintenance 8-18

Genuine parts 05

Glove box 5-39

H

Handling of compact discs 5-32

Hazard warning flasher switch 3-23

Hazard warning indication lamps 3-17

Head restraints 2-06

Headlamp levelling switch 3-22

Headlamps

Bulb capacity 8-23

Headlamp flasher 3-21

Replacement 8-25

Switch 3-20

Heated mirror 4-09

Heated seats 2-06

Heater 5-04

High coolant temperature warning lamp 3-19

High-beam indication lamp 3-17

High-mounted stop lamp

Bulb capacity 8-24

High-mounted stop lamps

Replacement 8-30

Hinges and latches lubrication 8-18

Horn switch 3-30

How to drive a vehicle with an automated manual transmission 4-22

I

If the vehicle breaks down 6-02

Ignition switch 4-10

Indication and warning lamps 3-16

Indication lamps 3-17

Inside rear-view mirror 4-08

Installation of accessories 04

Instruments 3-02

Interior lamps 5-38

J

Jacking up the vehicle 6-12

Jack 6-11

Storage 6-06

Jump starting (Emergency starting) 6-02

K

Keyless entry system 1-03

Keys 1-02

L

Labeling 9-02

Lamp monitor buzzer 3-21

Leakage (Fuel, engine coolant, oil and exhaust gas) 8-18

Licence plate lamps

Bulb capacity 8-24

Replacement 8-31

Lubricants 9-16

Luggage compartment lamp 5-38

Bulb capacity 8-24

Replacement 8-32

Luggage floor boxes 5-41

Luggage floor cargo 5-40

LW/MW/FM electronic tuning radio with CD player 5-12

M

Manual transmission 4-16

Oil 9-16

Map lamps 5-38

Mirror

Inside rear-view mirror 4-08

Outside rear-view mirrors 4-08

Modification/alterations to the electrical or fuel systems 05
 Multi-information display 3-04

O

Oil pressure warning lamp 3-19
 Oil
 Automated manual transmission oil 9-16
 Engine oil 8-05
 Manual transmission oil 9-16
 Operation under adverse driving conditions 6-22
 Other specifications 9-13
 Outside rear-view mirrors 4-08
 Electric remote-controlled outside rear-view mirrors 4-09
 Manual remote-controlled outside rear-view mirrors 4-09
 Overheating 6-04

P

Parking 4-07
 Parking brake 4-06
 Parking brake lever stroke 8-16
 Position lamps
 Bulb capacity 8-24
 Replacement 8-25
 Power steering
 System 4-29
 Precautions to observe when using wipers and washers 3-29
 Pregnant women restraint 2-12
 Puncture (Tyre changing) 6-15

R

Radio

LW/MW/FM electronic tuning radio with CD player 5-12
 Rain sensor 3-26
 Rear combination lamps
 Bulb capacity 8-24
 Replacement 8-27
 Rear fog lamp
 Bulb capacity 8-24
 Indication lamp 3-17
 Replacement 8-27,8-29
 Switch 3-24
 Rear shelf panel 5-42
 Rear turn-signal lamps
 Bulb capacity 8-24
 Replacement 8-27
 Rear window demister switch 3-29
 Rear-view mirror
 Inside 4-08
 Outside 4-08
 Replacement of lamp bulbs 8-23
 Reversing lamps
 Bulb capacity 8-24
 Replacement 8-27,8-29
 Room lamp 5-38
 Room lamps & map lamps
 Bulb capacity 8-24
 Replacement 8-31
 Running-in recommendations 4-04

S

Safe driving techniques 4-03
 Seat belt 2-10
 Adjustable seat belt anchor 2-11
 Child restraint 2-13
 Inspection 2-22
 Pregnant women restraint 2-12
 Pretensioner 2-13
 Seat belt reminder/warning lamp 2-11

Seat
 Adjustment 2-04
 Arrangement 2-03
 Front seat 2-04
 Head restraints 2-06
 Heated seats 2-06
 Service precaution 8-02
 Side turn-signal lamps
 Bulb capacity 8-24
 Replacement 8-26
 Snow tyres 8-14
 Spare wheel 6-13
 Spark plug 9-11
 Specifications 9-02
 Speedometer 3-03
 Starting 4-11
 Steering
 Power steering system 4-29
 Steering wheel height adjustment 4-07
 Steering wheel lock 4-11
 Stop lamps
 Bulb capacity 8-23
 Replacement 8-27
 Storage spaces 5-39
 Sun visors 5-36
 Supplemental restraint system 2-22
 Curtain airbag system 2-30
 How the Supplemental Restraint System works 2-25
 Servicing 2-34
 Side airbag system 2-30
 Warning lamp 2-33

T

Tachometer 3-03
 Tail lamp
 Bulb capacity 8-24
 Replacement 8-27

Alphabetical index

Tailgate 1-09
Tank capacity 03
Tools 6-06
 Storage 6-06
Towing 6-18
Traction control system (TCL) 4-30
 Indication lamp 4-31
Trailer towing 4-36
Transmission
 Automated manual transmission 4-19
 Manual transmission 4-16
 Specifications 9-10
Turn-signal indication lamps 3-17
Turn-signal lever 3-23
Tyre repair kit 6-07
Tyres 8-11
 How to change a tyre 6-15
 Inflation pressures 8-12
 Rotation 8-13
 Size (tyre and wheel) 9-12
 Snow tyres 8-14
 Tyre chains 8-14
 Wheel condition 8-13

U

Used engine oils safety instructions and disposal information 05

V

Vanity mirror 5-37
Vehicle care precautions 7-02
Vehicle information code plate 9-02
Vehicle labeling 9-02
Vehicle performance 9-06
Vehicle weight 9-07
Ventilators 5-02

W

Warning lamps 3-17
Washer
 Fluid 8-09,9-16
 Switch 3-25,3-28,3-29
Washing 7-03
Waxing 7-04
Weatherstripping 8-18
Weight 9-07
Wheel
 Covers 6-17
 Specification 9-12
Wiper
 Rain sensor 3-26
 Rear window 3-29
 Switch 3-25
 Wiper blades 8-16

Name: Rajeev Gajwani
Department: SV C BC P2 RF T0
Tel: +49 (0)91 1700-1004
Fax: +49 (0)91 1700-10054
E-Mail: Rajeev.Gajwani@siemens-vdo.com
Internet: www.siemens-vdo.de
Car Ref.: D4C_5W645107_004
Date: 08/18/2003

Declaration of Conformity in accordance with Directive 1999/5/EC (R&TTE Directive)

Manufacturer: Siemens VDO Automotive AG
Body & Chassis Electronics

Address: Dep. SV C BC P2 RF T0
Siemensstrasse 12
D-93055 Regensburg
Germany

Product type designation: BWN4 5107
Intended use: Vehicle immobilization system

The product mentioned above complies with the essential requirements and other relevant provisions of Directive 1999/5/EC, when used for its intended purpose.

Health and safety pursuant to §3.1 of Applied standard(s): EN 60950: 2000

Electromagnetic compatibility pursuant to §3.1.1: Applicable standard(s): EN 301 488-1 & 3, V1.4.1 (2002-08)

Efficient use of spectrum pursuant to §3.2: Applicable standard(s): EN 300 330 -1; V1.3.2 (2002-12)

The following marking applies to the above mentioned product:



SiemensVDO Automotive AG
Regensburg, 2003-10-08

Helmut Malsch
Executive Vice President and CEO
Body and Chassis Electronics

Wolfgang Wimmer
Director
Access & Immobilization Systems

SiemensVDO Automotive AG Body & Chassis Electronics

Internal Model:
D4C_5W645107

Postal Address: (Also address:
SiemensVDO Automotive AG
D-93055 Regensburg
Tel: +49 (0)91 1700-1000

P.O. Box 91 0143
D-93055 Regensburg

Name: Rüdiger Changier
Department: SV C, BG P2, RF TO
Tel: +49 0204 1790-3394
Fax: +49 0204 1790-133 954
E-Mail: Ruediger.Changier@siemens.com
Internet: www.siemensvdo.de
Our Ref: Doc. 8W645 108 888
Date: 19/04/2003

Declaration of Conformity in accordance with Directive 1999/5/EC (R&TTE Directive)

Manufacturer: Siemens VDO Automotive AG
Body & Chassis Electronics

Address: Dep. SV C, BG P2, RF TO
Steinbühlstraße 12
D-93060 Regensburg
Germany

Product type designation: 8W64 5106
Intended use: Radio frequency transmitter used in vehicle immobilization systems

The product mentioned above complies with the essential requirements and other relevant provisions of Directive 1999/5/EC, when used for its intended purpose.

Health and safety pursuant to §3.1.4.

Applied standard(s):
EN 60951: 2000

Electromagnetic compatibility pursuant to § 3.1.3: Applied standard(s):
EN 301 480 -1&3; V.1.4.1 (09-2002)

Efficient use of spectrum pursuant to § 3.2: Applied standard(s):
EN 300 220 -1; V.1.3.3 (12-2002)

The following marking applies to the above mentioned product:



SiemensVDO Automotive AG
Regensburg, 2003-04-19.

Helmut Majisch
Executive Vice President and CEO
Body & Chassis Electronics

Norbert Müller
Director
Access & Immobilisation Systems

SiemensVDO Automotive AG Body & Chassis Electronics

Head of Mobile
Phone 8888

Postal Address:
SiemensVDO Automotive AG

P.O. Box 10 04 0

D-93060 Regensburg

Office Address:
Steinbühlstraße 12

D-93060 Regensburg

Tel. +49 0204 1790 40

[Czech]	Siemens ICD Automotive AG I lids profiškovej, za tento Immobilex systém (SIWV45107), RF transformátor (SIWV45109) je v súlade so základným požiadavky a ďalším príslušenstvom ustanovenými smernicou 1999/5/EC.
[Danish]	Underskrevet Siemens ICD Automotive AG erklærer hermed, at følgende mobilex immobiliser system (SIWV45107), RF transformator (SIWV45109) overholder de væsentlige krav og andre relevante krav i direktiv 1999/5/EF.
[German]	Hiermit erklärt Siemens ICD Automotive AG, dass sich das Gerät Immobilex system (SIWV45107), RF transformator (SIWV45109) in Übereinstimmung mit den grundlegenden Anforderungen und den sonstigen einschlägigen Bestimmungen der Richtlinie 1999/5/EG befindet.
[Estonian]	Käesolevaga kinnitab Siemens ICD Automotive AG seadme Immobilex system (SIWV45107), RF transformator (SIWV45109) vastavalt direktiivi 1999/5/EEU põhinõuetele ja nimetatud direktiiviga sätestatud teatavate ajastatavate standarditega.
[English]	I hereby, Siemens ICD Automotive AG, declare that this Immobilex system (SIWV45107), RF transformator (SIWV45109) is in compliance with the essential requirements and other relevant provisions of Directive 1999/5/EC.
[Spanish]	Por medio de lo presente, Siemens ICD Automotive AG declara que el inmóvilizer system (SIWV45107), RF transformator (SIWV45109) cumple con los requisitos esenciales y cualesquiera otros disposiciones aplicables o exigidas de la Directiva 1999/5/CE.
[Greek]	ΜΕ ΤΗΝ ΠΑΡΟΥΣΙΑ, Siemens ICD Automotive AG ΠΡΟΚΗΡΥΣΣΕΤΙ Immobilex system (SIWV45107), RF transformator (SIWV45109) ΕΥΜΟΡΦΟΒΗΜΕΤΑΙ ΠΡΟΣ ΤΙΣ ΟΥΣΙΩΜΕΝΕΣ ΑΠΑΙΤΗΣΕΙΣ ΚΑΙ ΤΕ ΑΝΤΙΣΤΟΙΧΑ ΔΕΔΙΚΜΕΝΑ ΔΕΔΙΚΤΑ ΤΗΣ ΔΙΕΥΘΥΝΣΗΣ 1999/5/ΕΚ.
[French]	Par la présente, Siemens ICD Automotive AG déclare que l'appareil Immobilex system (SIWV45107), RF transformator (SIWV45109) est conforme aux exigences essentielles et aux autres dispositions pertinentes de la directive 1999/5/CE.
[Roman]	Con lo presente, Siemens ICD Automotive AG declara, che questo Immobilex system (SIWV45107), RF transformator (SIWV45109) e conforme ai requisiti essenziali ed alle altre disposizioni pertinenti stabilite dalla direttiva 1999/5/CE.
[Lithuanian]	Aš šiuo Siemens ICD Automotive AG deklaruju, kad šis Immobilex system (SIWV45107), RF transformator (SIWV45109) atitinka esminius reikalavimus ir kitus 1999/5/EB Direktyvos nuostatas susijusius su pagrindiniais reikalavimais ir kitais šios direktyvos nuostatais.
[Dutch]	Hierbij verklaart Siemens ICD Automotive AG dat het beslot Immobilex system (SIWV45107), RF transformator (SIWV45109) in overeenstemming is met de essentiële eisen en de andere relevante bepalingen van richtlijn 1999/5/EG.
[Maltese]	Hiermeelek, Siemens ICD Automotive AG, jiddeklara li dan Immobilex system (SIWV45107), RF transformator (SIWV45109) jikkonforma mal-Nigjet essenzjali u ma provjondamenti oħrajn rilevanti li hemm fuq-Direttiva 1999/5/EC.

[Hungarian]	Aldott, SiemensIDO Automotive AG nyilatkozom, hogy a Innovatívok systere (SWK45107), RF paraméter (SWK45109) megfelel a vonatkozó alapvető követelményeknek és az 1995/EC irányelv 601b cikkének.
[Portuguese]	SiemensIDO Automotive AG declara que este Inovativo do sistema (SWK45107), RF parâmetro (SWK45109) está conforme com os requisitos essenciais e outras disposições do Directiva 1995/CE.
[Slovenian]	SiemensIDO Automotive AG izjavlja, da je ta Inovativni sistem (SWK45107), RF parametar (SWK45109) v skladu z bistvenimi zahtevami in ostalimi relevantnimi delodeli direktive 1995/EU.
[Slovak]	SiemensIDO Automotive AG týmto vyhlasuje, ze Inovativny system (SWK45107), RF parametar (SWK45109) spĺna základné požiadavky a vsetky prídružné ustanovenia Smernice 1995/ES.
[Finnish]	SiemensIDO Automotive AG vakuuttaa täten että Inovatiivisen systeemin (SWK45107), RF-parametrit (SWK45109) täyttävät lähteen on direktiivin 1995/EY'ä koskevat vaatimukset ja että laikaan edellyttämien muuten ehtojen mukainen.
[Swedish]	Härmed intygar SiemensIDO Automotive Akt att denna Innovativa system (SWK45107), RF-parameter (SWK45109) står i överensstämmelse med de väsentliga grundläggande och övriga relevanta bestämmelser som framgår av direktiv 1995/EC.
[Dutch]	Ik verklaar dat SiemensIDO Automotive AG-er bij de Innovatieve system (SWK45107), RF-parameter (SWK45109) er i overeenstemming met de essentiële eisen van Richtlijn 1995/EC.
[Norwegian]	SiemensIDO Automotive AG erklærer hermed at utvalgte Innovativt system (SWK45107), RF-parametere (SWK45109) er i samsvar med de grunnleggende krav og øvrige relevante krav i direktiv 1995/EF.

