



Mercedes-Benz



M-class Operator's Manual

ML 320
ML 430
ML 55 AMG

Our company and staff congratulate you on the purchase of your new Mercedes-Benz.

Your selection of our product is a demonstration of your trust in our company name. Further, it exemplifies your desire to own an automobile that will be as easy as possible to operate and provide years of service.

Your Mercedes-Benz represents the efforts of many skilled engineers and craftsmen. To ensure your pleasure of ownership, and for your safety and that of your passengers, we ask you to make a small investment of your time:

- Please read this manual carefully before putting it aside. Then return it to your vehicle where it will be handy for your reference.
- Please abide by the recommendations contained in this manual. They are designed to acquaint you with the operation of your Mercedes-Benz.
- Please abide by the warnings and cautions contained in this manual. They are designed to help improve the safety of the vehicle operator and occupants.

We extend our best wishes for many miles of safe, pleasurable driving.

DaimlerChrysler AG

Introduction

| | |
|--------------------------------|----|
| Product information | 7 |
| Roadside assistance | 10 |
| Where to find it | 14 |
| Reporting Safety Defects | 16 |

Instruments and controls

| | |
|--------------------------------|----|
| Instruments and controls | 18 |
| Center console | 20 |
| Overhead control panel | 21 |

Operation

| | |
|--|----|
| Vehicle keys | 24 |
| Start lock-out | 25 |
| General notes on the central locking system | 26 |
| Central locking system | 26 |
| Radio frequency remote control | 26 |
| Unlocking the liftgate | 28 |
| Panic button | 28 |
| Mechanical keys | 29 |

| | |
|---|----|
| Doors | 30 |
| Central locking switch | 32 |
| Automatic central locking | 32 |
| Emergency unlocking in case of accident | 33 |
| Liftgate | 34 |
| Antitheft alarm system | 35 |
| Tow-away alarm and glass breakage sensor | 36 |
| Seats, front | 37 |
| Manual seats | 39 |
| Power seats | 40 |
| Head restraint | 41 |
| Heated seats | 44 |
| Seat belts and integrated restraint system | 46 |
| Seat belts | 46 |
| Seat belt nonusage warning system | 47 |
| BabySmart™ airbag deactivation system | 53 |
| Self-test BabySmart™ without special child seat installed | 53 |

| | |
|---|----|
| Supplemental restraint system (SRS) | 54 |
| Emergency tensioning retractor (ETR) | 55 |
| Airbags | 56 |
| Safety guidelines for the seat belt, emergency tensioning retractor and airbag | 63 |
| Infant and child restraint systems | 65 |
| Adjustable steering wheel | 70 |
| Inside rear view mirror | 71 |
| Antiglare night position | 71 |
| Exterior rear view mirrors | 73 |
| Exterior rear view mirror, electrically folding | 75 |
| Instrument cluster | 76 |
| Indicator lamps in the instrument cluster | 78 |
| Trip computer | 83 |
| Flexible service system (FSS) | 87 |
| Engine oil level indicator | 89 |
| Exterior lamp switch | 90 |

Fog lamp switch
(except Canada) 92

Fog lamp switch
(Canada only) 93

Hazard warning flasher
switch 94

Headlamp cleaning system 94

Windshield wiper/washer
switch 95

Rear window wiper/washer 96

Climate control 98

 Basic setting – Heater 100

 Basic setting –
 Air conditioner 100

 Special setting 101

 Dust filter 102

 Air recirculation 102

 Rear window defroster 103

Power windows 104

Rear quarter windows 106

Sliding/pop-up roof 107

Skyview Top 109

Interior lighting 110

Sun visors 113

Illuminated vanity mirrors 113

Interior 114

Storage compartments,
 armrest and cup holder 114

 Glove box 115

Armrest in rear bench seat 117

Ashtrays 118

Lighter 119

Split rear seat bench 120

 Easy entry/exit feature 123

 Rear seat head restraints 124

Third row seats 126

Removable cargo floor plates 129

Enlarged cargo area 131

Cargo tie-down rings 132

Hooks 133

Partition net 133

Loading instructions 136

Cargo area cover blind 137

Telephone, general 139

Cellular telephone 139

Garage door opener 140

Driving

Control and operation of
 radio transmitters 146

The first 1 000 miles
 (1 500 km) 147

Maintenance 147

Tele Aid 148

Catalytic converter 160

Emission control 161

Steering lock 162

Starting and turning off
 the engine 164

Automatic transmission 165

Parking brake 173

Driving instructions 174

 Drive sensibly – save fuel 174

 Drinking and driving 174

 Pedals 174

 Power assistance 175

 Brakes 175

 Driving off 176

 Parking 176

 Tires 177

| | |
|---|-----|
| Snow chains | 179 |
| Winter driving instructions | 180 |
| Deep water | 181 |
| Passenger compartment | 182 |
| Traveling abroad | 182 |
| Off-Road driving | 183 |
| Trailer towing | 190 |
| Cruise control | 196 |
| Brake assist system (BAS) | 199 |
| Antilock brake system (ABS) | 201 |
| Four-wheel electronic traction system (4-ETS+) | 203 |
| Electronic brake proportioning (EBP) | 204 |
| Electronic stability program (ESP) | 205 |
| Transmission control – LOW RANGE mode | 209 |
| What you should know at the gas station | 212 |
| Check regularly and before a long trip | 215 |

Instrument cluster display

| | |
|---|-----|
| Malfunction and indicator lamps in the instrument cluster | 218 |
| On-board diagnostic system – Check engine malfunction indicator lamp | 218 |
| Brake warning lamp | 219 |
| Supplemental restraint system (SRS) indicator lamp | 219 |
| Fuel reserve warning | 220 |
| Electronic stability program (ESP) / Electronic traction system (ETS) – warning lamp | 221 |
| BAS/ESP malfunction indicator lamp | 221 |
| 4-ETS malfunction indicator lamp | 221 |
| LOW RANGE indicator lamp | 221 |
| ABS malfunction indicator lamp | 222 |

| | |
|---|-----|
| Adjustable steering wheel – indicator lamp | 222 |
| AIRBAG OFF indicator lamp | 222 |
| Seat belt warning lamp | 223 |
| Charge indicator lamp | 223 |
| Low engine oil level warning lamp | 224 |
| Low engine coolant level warning | 224 |
| Brake pad wear indicator lamp | 225 |
| FSS indicator | 225 |

Practical hints

| | | | | | |
|---|-----|--|-----|---|-----|
| First aid kit | 228 | Vehicle jack, wheel bolt wrench and screwdriver | 237 | Exterior lamps | 260 |
| Fuses | 228 | Air pump | 239 | Headlamp assembly | 261 |
| Electrical outlet | 230 | Wheels | 240 | Taillamp assemblies | 265 |
| Stowing things in the vehicle | 230 | Tire replacement | 240 | Adjusting headlamp aim | 268 |
| Hood | 231 | Rotating wheels | 241 | Remote control battery replacement | 270 |
| Checking engine oil level | 233 | Spare wheel | 242 | Synchronizing remote control | 271 |
| Automatic transmission fluid level | 234 | Changing wheels | 245 | Emergency operation of sliding/pop-up roof | 272 |
| Engine oil consumption | 234 | Tire inflation pressure | 250 | Emergency operation of Skyview Top | 273 |
| Coolant level | 234 | Battery | 251 | Manual release for fuel filler flap | 274 |
| Adding coolant | 235 | Jump starting | 253 | Replacing wiper blades | 275 |
| Windshield washer/headlamp cleaning system | 236 | Towing the vehicle | 255 | Roof rack | 276 |
| Windshield and headlamp washer fluid mixing ratio | 237 | Transmission selector lever, manually unlocking | 259 | | |
| | | Stranded vehicle | 259 | | |

Vehicle care

| | |
|--|-----|
| Cleaning and care of the vehicle | 278 |
| Power washer | 279 |
| Tar stains | 279 |
| Paintwork, painted body components | 279 |
| Engine cleaning | 280 |
| Vehicle washing | 280 |
| Ornamental moldings | 280 |
| Headlamps, taillamps, turn signal lenses | 280 |
| Window cleaning | 281 |
| Wiper blades | 281 |
| Light alloy wheels | 281 |
| Instrument cluster | 281 |
| Steering wheel and gear selector lever | 281 |

| | |
|--------------------------------|-----|
| Cup holder | 282 |
| Seat belts | 282 |
| Headliner | 282 |
| Upholstery | 282 |
| Hard plastic trim items | 282 |
| Plastic and rubber parts | 282 |

Technical data

| | |
|---|-----|
| Spare parts service | 284 |
| Warranty coverage | 284 |
| Identification labels | 285 |
| Layout of poly-V-belt drive | 286 |
| Technical data | 287 |
| Fuels, coolants, lubricants etc. – capacities | 292 |
| Engine oils | 294 |
| Engine oil additives | 294 |
| Air conditioner refrigerant | 294 |

| | |
|---------------------------------|-----|
| Brake fluid | 294 |
| Premium unleaded gasoline | 295 |
| Fuel requirements | 295 |
| Gasoline additives | 296 |
| Coolants | 296 |
| Consumer information | 298 |

Index

| | |
|-------------|-----|
| Index | 300 |
|-------------|-----|

Product information

Kindly observe the following in your own best interest:

We recommend using Mercedes-Benz original parts as well as conversion parts and accessories explicitly approved by us for your vehicle model.

We have tested these parts to determine their reliability, safety and their special suitability for Mercedes-Benz vehicles.

We are unable to make an assessment for other products and therefore cannot be held responsible for them, even if in individual cases an official approval or authorization by governmental or other agencies should exist. Use of such parts and accessories could adversely affect the safety, performance or reliability of your vehicle. Please do not use them.

Mercedes-Benz original parts as well as conversion parts and accessories approved by us are available at your authorized Mercedes-Benz Light Truck Center where you will receive comprehensive information, also on permissible technical modifications, and where proper installation will be performed.

Operator's manual

This Operator's Manual contains a great deal of useful information. We urge you to read it carefully and familiarize yourself with the vehicle before driving.

For your own safety and longer service life of the vehicle, we urge you to follow the instructions and warnings contained in this manual. Ignoring them could result in damage to the vehicle or personal injury to you or others. Vehicle damage caused by failure to follow instructions is not covered by the Mercedes-Benz Limited Warranty.

Your vehicle may have some or all of the equipment described in this manual. Therefore, you may find explanations for optional equipment not installed in your vehicle. If you have any questions about the operation of any equipment, your authorized Mercedes-Benz Light Truck Center will be glad to demonstrate the proper procedures.

Service and warranty information

The Service and Warranty Information Booklet contains detailed information about the warranties covering your Mercedes-Benz, including:

- New Light Truck Limited Warranty,
- Emission System Warranty,
- Emission Performance Warranty,
- California, Maine, Massachusetts, and Vermont Emission Control System Warranty (California, Maine, Massachusetts, and Vermont only),
- State Warranty Enforcement Laws (Lemon Laws).

Important notice for California retail buyers of Mercedes-Benz automobiles

Under California law you may be entitled to a replacement of your vehicle or a refund of the purchase price, if Mercedes-Benz USA, LLC or its authorized Mercedes-Benz Center fails to conform the vehicle to its express warranties after a reasonable number of repair attempts during the period of one year or 12 000 miles from original delivery of the vehicle. A reasonable number of repair attempts is presumed for a retail buyer (1) if the vehicle is out of service by reason of repair of substantial nonconformities for a cumulative total of more than 30 calendar days or (2) the same substantial non-conformity has been subject to repair four or more times **and you have at least once directly notified us in writing of the need to repair the non-conformity and have given us an opportunity to perform the repair ourselves. Notifications should be sent to the nearest Mercedes-Benz Regional Office listed in the Service and Warranty Information Booklet.**

Maintenance

The Service Booklet describes all the necessary maintenance work which should be performed at regular intervals.

Always have the Service Booklet with you when you take the vehicle to your authorized Mercedes-Benz Light Truck Center for service. The service advisor will record each service in the booklet for you.

Roadside assistance

The Mercedes-Benz Roadside Assistance Program provides factory trained technical help in the event of a breakdown. Calls to the toll-free Roadside Assistance number:

1-800-FOR-MERCEdes (in the USA)

1-800-387-0100 (in Canada)

will be answered by Mercedes-Benz Client Assistance Representatives 24 hours a day, 365 days a year.

Roadside assistance will be provided in accordance with standard program guidelines which include providing service to the vehicle up to a reasonable distance from a paved roadway. We will make every effort to assist in a breakdown situation, however, the accessibility of your vehicle will be determined by our authorized Mercedes-Benz Light Truck Center technician or the tow service provider on a case by case basis and may be a factor in our ability to respond.

Additional charges may be applicable for a breakdown location determined not to be a reasonably accessible roadside location as determined by our authorized technician and tow service provider.

For additional information refer to the Mercedes-Benz Roadside Assistance Program brochure in your glove box.

Change of address or ownership

If you change your address, be sure to send in the “Change of Address Notice” found in the Service and Warranty Information Booklet, or simply call the Mercedes-Benz Client Assistance Center (in the USA) at 1-800-FOR-MERCEdes, or Customer Service (in Canada) at 1-800-387-0100. It is in your own interest that we can contact you should the need arise.

If you sell your Mercedes, please leave all literature with the vehicle to make it available to the next operator.

If you bought this vehicle used, be sure to send in the “Notice of Purchase of Used Car” found in the Service and Warranty Information Booklet, or call the Mercedes-Benz Client Assistance Center (in the USA) at 1-800-FOR-MERCEdes, or Customer Service (in Canada) at 1-800-387-0100.

Operating your vehicle outside the USA or Canada

If you plan to operate your vehicle in foreign countries, please be aware that:

- Service facilities or replacement parts may not be readily available,
- unleaded gasoline for vehicles with catalytic converters may not be available; the use of leaded fuels will damage the catalysts,
- gasoline may have a considerably lower octane rating, and improper fuel can cause engine damage.

We continuously strive to improve our product, and ask for your understanding that we reserve the right to make changes in design and equipment. Therefore, information, illustrations and descriptions in this Operator's Manual might differ from your vehicle.

Optional equipment is also described in this manual, including operating instructions wherever necessary. Since they are special-order items, the descriptions and illustrations herein may vary slightly from the actual equipment of your vehicle.

If there are any equipment details that are not shown or described in this Operator's Manual, your authorized Mercedes-Benz Light Truck Center will be glad to inform you of correct care and operating procedures.

The Operator's Manual and Service Booklet are important documents and should be kept with the vehicle.

Warning!

This Sport Utility Vehicle is designed for both on-road and off-road use. It can go places and perform tasks for which conventional 2-wheel drive passenger cars were not intended. This vehicle will handle and maneuver differently from conventional passenger cars in driving conditions which may occur on streets, highways and off-road use.

This vehicle has a higher ground clearance and a higher center of gravity than many passenger cars. As with other vehicles of this type, if you make sharp turns at excessive speeds or abrupt maneuvers, the vehicle may roll over or may go out of control and crash. Utility vehicles have a significantly higher rollover rate than other types of vehicles. Failure to operate this vehicle safely may result in an accident, rollover of the vehicle, and severe or fatal injury.

Before you start to drive this vehicle, read the Operator's Manual. Take time to become familiar with the driving characteristics of this vehicle. Be sure you are familiar with all vehicle controls. Learn how your vehicle handles on different road surfaces. Do not attempt sharp turns at excessive speeds or abrupt maneuvers or other unsafe driving actions that can cause loss of vehicle control. When driving off-road or working the vehicle, do not overload it. And, always wear your seat belts at all times. In a rollover crash, an unbelted person is significantly more likely to die than a person wearing a seat belt.

Where to find it

The Operator's Manual is divided into eight sections:

- **Instruments and controls:** An overview of all the controls that can be operated from the driver's seat.
- **Operation:** Information on the vehicle's equipment and its operation.
- **Driving:** Important information on driving.
- **Instrument cluster display:** Indicator lamps on the instrument cluster with brief instructions.
- **Practical hints:** Assistance and instructions in the event of an emergency.
- **Car care:** Instructions on caring for your vehicle.
- **Technical data:** All the important technical data for your vehicle as well as consumer information such as fuels, coolants, lubricants etc. is contained here.
- **Index:** Key terms to help you find a topic quickly.

Other documents may also be supplied, depending on your vehicle's equipment.

Explanation of color used:

Warning notices for the protection of yourself and others appear on red background.

Problems with your vehicle

If you should experience a problem with your vehicle, particularly one that you believe may affect its safe operation, we urge you to immediately contact your authorized Mercedes-Benz Light Truck Center to have the problem diagnosed and corrected if required. If the matter is not handled to your satisfaction, please discuss the problem with the Mercedes-Benz Light Truck Center management, or if necessary contact us at the following addresses:

In the USA: Client Assistance Center
Mercedes-Benz USA, LLC
One Mercedes Drive
Montvale, NJ 07645-0350

In Canada: Customer Relations Department
Mercedes-Benz Canada, Inc.
849 Eglinton Avenue East
Toronto, Ontario, M4G 2L5

For the USA only:

The following text is published as required of manufacturers under Title 49, Code of U.S. Federal Regulations, Part 575 pursuant to the “National Traffic and Motor Vehicle Safety Act of 1966”.

Reporting Safety Defects

If you believe that your vehicle has a defect which could cause a crash or could cause injury or death, you should immediately inform the National Highway Traffic Safety Administration (NHTSA) in addition to notifying Mercedes-Benz USA, LLC.

If NHTSA receives similar complaints, it may open an investigation, and if it finds that a safety defect exists in a group of vehicles, it may order a recall and remedy campaign. However, NHTSA cannot become involved in individual problems between you, your retailer, or Mercedes-Benz USA, LLC.

To contact NHTSA, you may either call the Auto Safety Hotline toll-free at 1-800-424-9393 (or 366-0123 in Washington, D.C. area) or write to: NHTSA, U.S. Department of Transportation, Washington, D.C. 20590. You can also obtain other information about motor vehicle safety from the Hotline.

Instruments and controls

| | |
|--------------------------------|----|
| Instruments and controls | 18 |
| Center console | 20 |
| Overhead control panel | 21 |

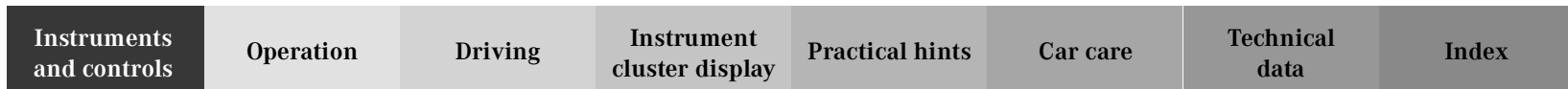

Instruments and controls

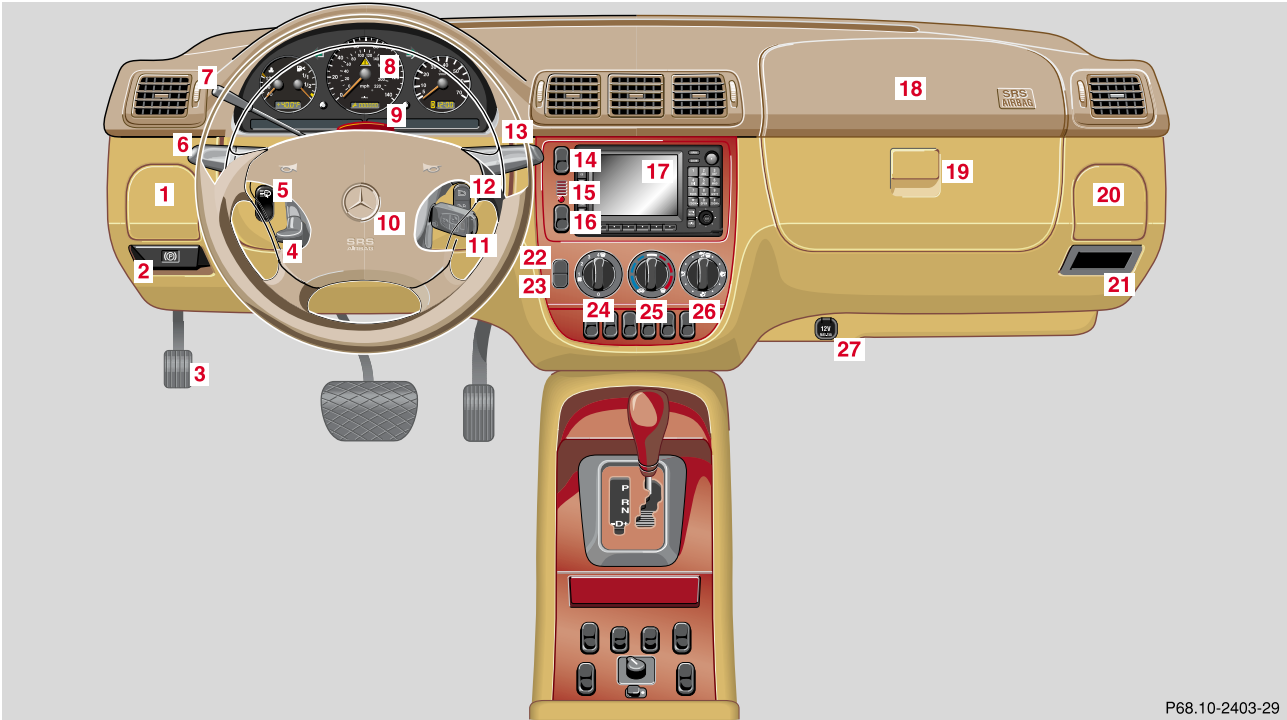

For more detailed descriptions see index on page 300.

For adjustment of air outlets, refer to climate control, see page 98.

- 1 Cup holder, see page 114
- 2 Parking brake release, see page 173
- 3 Parking brake pedal, see page 173
- 4 Steering wheel adjustment lever, see page 70
- 5 Headlamp washer switch, see page 94
- 6 Exterior lamp switch, see page 90
- 7 Cruise control switch, see page 196
- 8 Instrument cluster, see page 76
- 9 Hazard warning flasher switch, see page 94
- 10 Horn (with key in steering lock position 1 or 2), Driver airbag, see page 56
- 11 Steering lock with ignition/starter switch, see page 162
- 12 Switch for exterior rear view mirrors, electrically folding, see page 75
- 13 Windshield wiper/washer switch, see page 95

- 14 Transmission control – LOW RANGE mode, see page 209
- 15 Indicator lamp for antitheft alarm system
- 16 Auxiliary front fog lamp/rear fog lamp switch, see page 92
- 17 MCS (Optional Modular Control System), see separate operator's manual
- 18 Front passenger airbag, see page 56
- 19 Glove box (illuminated with key in steering lock position 1 or 2)
- 20 Cup holder, see page 114
- 21 Storage compartment
- 22 Air recirculation switch, see page 98
- 23 Air conditioner on/off switch, see page 98
- 24 Air volume control switch
- 25 Temperature selector switch
- 26 Air distribution switch
- 27 Electrical outlet, see page 230

| | | | | | | | |
|---------------------------------|------------------|----------------|-----------------------------------|------------------------|-----------------|-----------------------|--------------|
| Instruments and controls | Operation | Driving | Instrument cluster display | Practical hints | Car care | Technical data | Index |
|---------------------------------|------------------|----------------|-----------------------------------|------------------------|-----------------|-----------------------|--------------|

Instruments and controls

20

Center console



- 1 Left front seat heater switch, see page 44
- 2 Switch for rear quarter window, left, see page 106
- 3 Switch for rear window washer/wiper, see page 96
- 4 ESP control switch, see page 207
- 5 Switch for rear quarter window, right, see page 106
- 6 Right front seat heater switch, see page 44
- 7 Storage compartment
- 8 Selector lever, see page 165
- 9 Ashtray with lighter, see page 118
- 10 Power window switch, left front door, see page 104
- 11 Central locking switch, see page 32
- 12 Rear window defroster switch, see page 103
- 13 Power window switch, right front door, see page 104
- 14 Power window switch, left rear door, see page 104
- 15 Mirror adjustment switch, see page 73
- 16 Power window safety switch, rear doors, see page 104
- 17 Power window switch, right rear door, see page 104

Overhead control panel

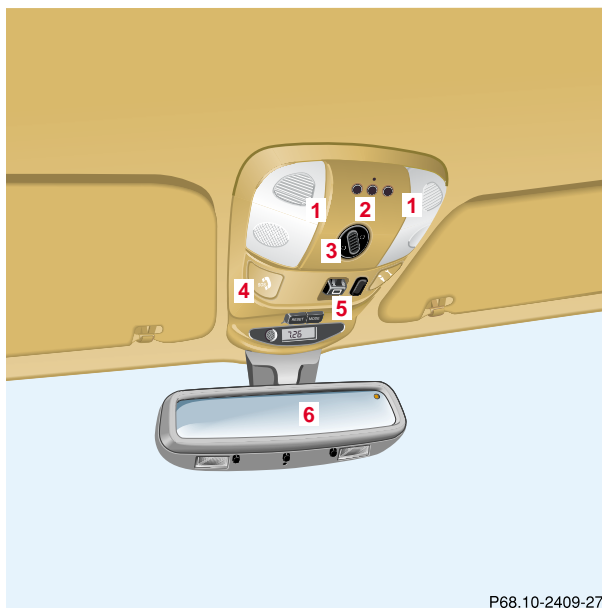

- 1 Interior lighting, see page 110
- 2 Garage door opener, see page 140
- 3 Hands-free microphone for Tele Aid, telephone and voice recognition system
- 4 Tele Aid (emergency call system), see page 148
- 5 Sliding/pop-up roof, see page 107
Skyview Top, see page 109
- 6 Rear view mirror, see page 71
Reading lamps inside rear view mirror, see page 110

| | | | | | | | |
|---------------------------------|------------------|----------------|-----------------------------------|------------------------|-----------------|-----------------------|--------------|
| Instruments and controls | Operation | Driving | Instrument cluster display | Practical hints | Car care | Technical data | Index |
|---------------------------------|------------------|----------------|-----------------------------------|------------------------|-----------------|-----------------------|--------------|

Contents - Operation

Operation

| | | | | | |
|--|----|---|----|--|-----|
| Vehicle keys | 24 | Head restraint | 41 | Antiglare night position | 71 |
| Start lock-out | 25 | Heated seats | 44 | Exterior rear view mirrors | 73 |
| General notes on the central locking system | 26 | Seat belts and integrated restraint system | 46 | Exterior rear view mirror, electrically folding | 75 |
| Central locking system | 26 | Seat belts | 46 | Instrument cluster | 76 |
| Radio frequency remote control | 26 | Seat belt nonusage warning system | 47 | Indicator lamps in the instrument cluster | 78 |
| Unlocking the liftgate | 28 | BabySmart™ airbag deactivation system | 53 | Trip computer | 83 |
| Panic button | 28 | Self-test BabySmart™ without special child seat installed | 53 | Flexible service system (FSS) | 87 |
| Mechanical keys | 29 | Supplemental restraint system (SRS) | 54 | Engine oil level indicator | 89 |
| Doors | 30 | Emergency tensioning retractor (ETR) | 55 | Exterior lamp switch | 90 |
| Central locking switch | 32 | Airbags | 56 | Fog lamp switch (except Canada) | 92 |
| Automatic central locking | 32 | Safety guidelines for the seat belt, emergency tensioning retractor and airbag | 63 | Fog lamp switch (Canada only) | 93 |
| Emergency unlocking in case of accident | 33 | Infant and child restraint systems | 65 | Hazard warning flasher switch | 94 |
| Liftgate | 34 | Adjustable steering wheel | 70 | Headlamp cleaning system | 94 |
| Antitheft alarm system | 35 | Inside rear view mirror | 71 | Windshield wiper/washer switch | 95 |
| Tow-away alarm and glass breakage sensor | 36 | | | Rear window wiper/washer | 96 |
| Seats, front | 37 | | | Climate control | 98 |
| Manual seats | 39 | | | Basic setting – Heater | 100 |
| Power seats | 40 | | | | |

| | | | | | |
|-----------------------------|-----|----------------------------------|-----|------------------------------------|-----|
| Basic setting - | | Illuminated vanity mirrors | 113 | Removable cargo floor plates | 129 |
| Air conditioner | 100 | Interior | 114 | Enlarged cargo area | 131 |
| Special setting | 101 | Storage compartments, | | Cargo tie-down rings | 132 |
| Dust filter | 102 | armrest and cup holder | 114 | Hooks | 133 |
| Air recirculation | 102 | Glove box | 115 | Partition net | 133 |
| Rear window defroster | 103 | Armrest in rear bench seat | 117 | Loading instructions | 136 |
| Power windows | 104 | Ashtrays | 118 | Cargo area cover blind | 137 |
| Rear quarter windows | 106 | Lighter | 119 | Telephone, general | 139 |
| Sliding/pop-up roof | 107 | Split rear seat bench | 120 | Cellular telephone | 139 |
| Skyview Top | 109 | Easy entry/exit feature | 123 | Garage door opener | 140 |
| Interior lighting | 110 | Rear seat head restraints | 124 | | |
| Sun visors | 113 | Third row seats | 126 | | |

Central locking system

24

Vehicle keys

Included with your vehicle are:

- 2 remote controls with folding master keys,
- 1 reserve key,

Warning!

When leaving the vehicle always remove the key from the steering lock, and lock your vehicle. Do not leave children unattended in the vehicle, or with access to an unlocked vehicle. Unsupervised use of vehicle equipment may cause serious personal injury.

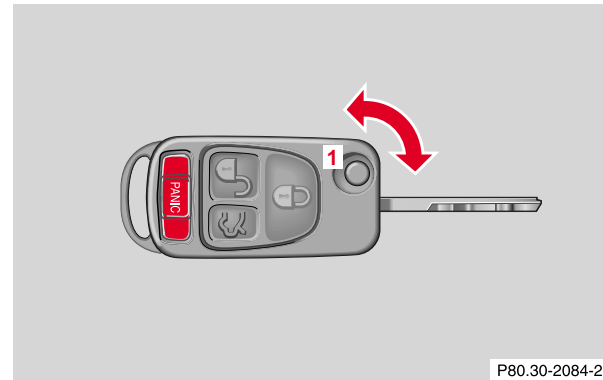
Remote control with folding master key

The remote control operates all locks on the vehicle.

To release the key, press button (1). The key unfolds from the holder by itself.

The transmitter for the remote control is located in the key holder.

Reserve key



The reserve key fits all locks on the vehicle.

For notes on the mechanical keys refer to page 29.

Note:

We recommend that you carry the reserve key with you and keep it in a safe place (e.g. your wallet) so that it is always handy. Never leave the reserve key in the vehicle.

Obtaining replacement keys

Your vehicle is equipped with a theft deterrent locking system requiring a special key manufacturing process. For security reasons, replacement keys can only be obtained from your authorized Mercedes-Benz Light Truck Center.

Start lock-out

Important!

Removing the key from the steering lock activates the start lock-out. The engine cannot be started.

Turning the key in the steering lock to position 2 deactivates the start lock-out.

Note:

In case the engine cannot be started and the messages **Start** and **Error** are shown in the odometer display field, the system is not operational. Contact an authorized Mercedes-Benz Light Truck Center or call 1-800-FOR-MERCEdes (in the USA), or 1-800-387-0100 (in Canada).

Central locking system

26

General notes on the central locking system

If the key in the steering lock is in position 1 or 2, the vehicle cannot be locked or unlocked with the remote control.

If the vehicle cannot be locked or unlocked:

- Check the batteries of the remote control, see page 270.
- Synchronize the remote control, see page 271.

Central locking system**(Radio frequency remote control)**

The master key has an integrated radio frequency remote control.

Due to the extended operational range of the remote control, it could be possible to unintentionally lock or unlock the vehicle by pressing the transmit button.

The vehicle doors, liftgate and fuel filler flap can be centrally locked and unlocked via remote control.

With vehicle centrally locked, the liftgate can also be unlocked by using the remote control.

If the key in the steering lock is in position 1 or 2, the vehicle cannot be locked or unlocked with the remote control.

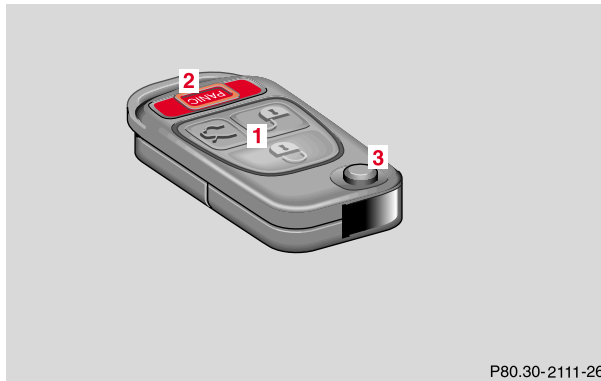

- 1 Transmit button
 -  Locking
 -  Unlocking
 -  Unlocking liftgate
- 2 PANIC button
- 3 Release button for master key

Locking and unlocking with remote control

Unlocking:

Press transmit button  once. All turn signal lamps blink once to indicate that the driver's door and fuel filler flap are unlocked.

The antitheft alarm system is also deactivated.

Press transmit button  a second time to unlock remaining doors and liftgate.

Notes:

If the fuel filler flap cannot be opened, see page 274.

If within 40 seconds of unlocking with the remote control, neither door nor liftgate is opened or the key is not inserted in the steering lock, the vehicle will automatically lock and reactivate the antitheft alarm system.

Central locking system

28

Locking:

Press transmit button  once. All turn signal lamps blink three times to indicate that the vehicle is locked and the antitheft alarm is activated.

Notes:

If the turn signal lamps do not blink three times when locking the vehicle, a door, the liftgate, or the hood is not properly closed. Close the respective element and lock the vehicle again with the remote control.

If the vehicle cannot be locked or unlocked by pressing the transmit button, then it may be necessary to change the batteries in the remote control or to synchronize the remote control, see page 270 and page 271.

Unlocking the liftgate



Press transmit button  to unlock the liftgate. This also deactivates the antitheft alarm.

Important!

A minimum height clearance of 7 ft. (2.15 m) is required to open the liftgate.

Panic button

To activate press and hold button (1) for at least one second. An audible alarm and blinking turn signal lamps will operate for approximately 3 minutes. Additionally the interior lights switch on automatically for approximately 3 minutes.

To deactivate press button (1) again, or press transmit button ,  or  on the remote control, or turn key in steering lock to position 1.

Note:

For operation in the USA only: This device complies with Part 15, Subpart C, Section 209 of the FCC Rules. Operation is subject to the following two conditions:

- (1) This device may not cause harmful interference, and
- (2) this device must accept any interference received, including interference that may cause undesired operation.

WARNING: Changes or modification not expressly approved by party responsible for compliance could void the users's authority to operate the equipment.

Mechanical keys

The mechanical keys fit all locks on the vehicle.

Notes:

Use of the key does not operate the central locking system or arm or disarm the antitheft alarm system.

The alarm sounds when unlocking the door. Cancel alarm by turning key in steering lock to position 1, or with the remote control by pressing button .

Central locking system

30

Doors

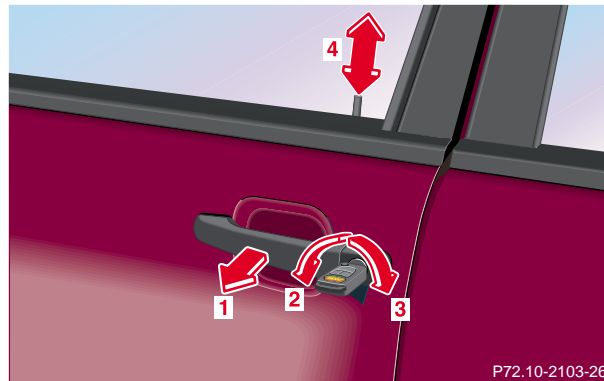

- 1 Opening – pull handle
- 2 Unlocking driver's door lock
- 3 Locking driver's door lock
- 4 Individual door from inside:
Push lock button down to lock.
Pull lock button up to unlock.

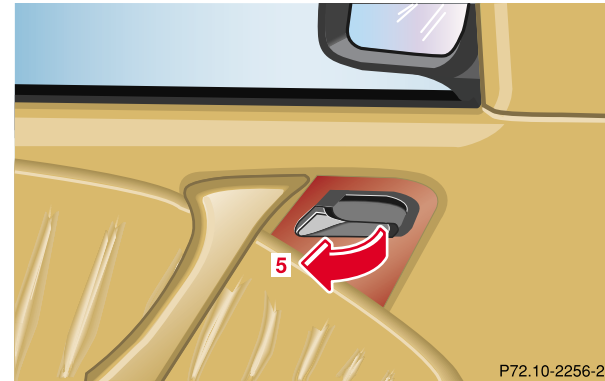

- 5 Front door from inside:
Pull handle to unlock.

Important!

The mechanical key does not operate the central locking system or arm or disarm the antitheft alarm system.

When you lock the driver's door with the mechanical key, the door lock button should move down.

Each individual door and the liftgate must be locked with the respective door lock button – the driver's door can only be locked when it is closed.

Notes:

The alarm sounds when unlocking the driver's door. Cancel alarm by turning key in steering lock to position 1, or with the remote control by pressing button .

If the vehicle has previously been locked from the outside, only the door being opened from the inside will unlock, and the alarm will come on. The remaining doors, the liftgate and fuel filler flap remain locked.

In case of a malfunction in the central locking system the doors can be locked and unlocked individually.

To lock, push down lock buttons and turn mechanical key in driver's door lock to position 3. In addition lock the liftgate.

To unlock, pull inside door handles and turn mechanical key in driver's door lock to position 2.

Rear doors, previously centrally locked, can be opened from inside by first unlocking the vehicle with the central locking switch, see page 32, or by first pulling up the door lock button.

If the fuel filler flap cannot be opened, see page 274.

Central locking system

32

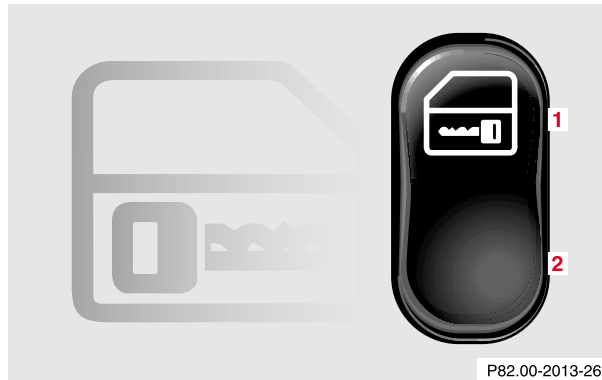
Central locking switch

P82.00-2013-26

- 1** Locking
- 2** Unlocking

The central locking switch is located on the center console.

The doors and trunk can only be locked with the central locking switch, if the front doors are closed.

If the vehicle was previously locked with the remote control, the doors and liftgate cannot be unlocked with the central locking switch.

Automatic central locking

The central locking switch also operates the automatic central locking.

With the automatic central locking system activated and the engine running, the doors and trunk are locked at vehicle speeds of approximately 9 mph (15 km/h) or more.

To activate:

With key in steering lock position 2 hold upper portion of switch (1) for a minimum of 5 seconds.

To deactivate:

With key in steering lock position 2 hold lower portion of switch (2) for a minimum of 5 seconds.

Notes:

If doors are unlocked with the central locking switch after activating the automatic central locking, and neither door is opened, then the doors remain unlocked even at vehicle speeds of approximately 9 mph (15 km/h) or more.

If a door is opened from the inside at speeds of approximately 9 mph (15 km/h) or less with the automatic central locking activated, the door will again be automatically locked at speeds of approximately 9 mph (15 km/h) or more.

Important!

When towing the vehicle, or with the vehicle on a dynamometer test stand, please, note the following:

With the engine running, the vehicle doors will lock if the left front wheel spins at vehicle speeds of approximately 9 mph (15 km/h) or more.

To prevent vehicle door locks from locking, deactivate the automatic central locking.

Emergency unlocking in case of accident

The doors unlock automatically a short time after an accident in which an airbag or emergency tensioning retractor deploys (this is intended to aid rescue and exit). However, the key must still be in the steering lock position 1 or 2.

Additionally the hazard warning flashers turn on automatically and the interior lights switch on for approximately 30 minutes.

| | | | | | | | |
|--------------------------|------------------|---------|----------------------------|-----------------|----------|----------------|-------|
| Instruments and controls | Operation | Driving | Instrument cluster display | Practical hints | Car care | Technical data | Index |
|--------------------------|------------------|---------|----------------------------|-----------------|----------|----------------|-------|

Central locking system

34

Liftgate

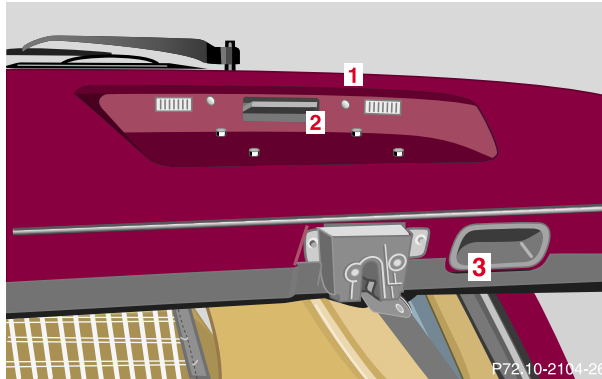

- 1 Grip molding
- 2 Handle, outside
- 3 Recessed grip

To open:

From outside of vehicle, pull on handle (2).

To close:

Pull down on recessed grip (3), and close by using the grip molding (1).



- 1 Handle, inside
- 2 Locking
- 3 Unlocking

Important!

In case of danger, the unlocked liftgate can be opened with the inside or outside handle.

Only drive with the liftgate closed as otherwise exhaust fumes may enter the vehicle interior.

Antitheft alarm system

The indicator lamp is located in the center console.

The antitheft alarm is automatically armed or disarmed with the remote control by locking or unlocking the vehicle.

The antitheft alarm is armed within approximately 15 seconds after locking the vehicle with the remote control.

A blinking lamp in the center console indicates that the alarm is armed.

Notes:

Use of the key in the front door locks does not arm or disarm the antitheft alarm system.

The alarm sounds when unlocking the driver's door with the mechanical key. Cancel alarm by turning key in steering lock to position 1, or with the remote control by pressing button .

If the vehicle battery voltage falls below 10 volts, the alarm is automatically canceled and the antitheft alarm system is disarmed. When the voltage is above this value again, the antitheft alarm system is armed again.

Operation:

Once the alarm system has been armed, the turn signal lamps will flash rapidly (approximately 3 minutes) and the horn will sound intermittently (approximately 30 seconds) when someone:

- opens a door,
- opens the liftgate,
- opens the hood,
- breaks a window,
- attempts to raise the vehicle.

The alarm will stay on even if the activating element (a door, for example) is immediately closed.

If the alarm stays on for more than 20 seconds, an emergency call is initiated automatically. See Tele Aid on page 148.

Note:

The alarm system will cycle three times when triggered.

The interior lights are automatically switched on when the alarm comes on and go out when canceling the alarm.

Tow-away protection

36

Tow-away alarm and glass breakage sensor

The switch is located in the overhead console.

The tow-away alarm and glass breakage sensor are part of the antitheft alarm system.

Once the alarm system has been armed, the turn signal lamps will flash rapidly and the horn will sound when someone attempts to raise the vehicle, or breaks a window and reaches into the passenger compartment.

The alarm will last approximately 3 minutes in the form of rapidly flashing turn signal lamps. At the same time the horn will sound for approximately 30 seconds. The alarm will stay on even if the vehicle is immediately lowered.

If the alarm stays on for more than 20 seconds, an emergency call is initiated automatically. See Tele Aid on page 148.

To prevent triggering the tow-away alarm feature, switch off the tow-away alarm and glass breakage sensor before towing the vehicle, or when parking on a surface subject to movement, such as a ferry or auto train.

To do so, turn key in steering lock to position 1, then return it to position 0 and remove key from steering lock.

Within 30 seconds, push left or right button. (On vehicles equipped with optional trip computer, push RESET or MODE button, display shows OFF.)

Exit vehicle, and lock vehicle with remote control.

The tow-away alarm and glass breakage sensor remain switched off until the key is inserted in steering lock and turned to position 1.

Seats, front

Warning!

Do not adjust the driver's seat while driving. Adjusting the seat while driving could cause the driver to lose control of the vehicle.

Never ride in a moving vehicle with the backrest reclined. Sitting in an excessively reclined position can be dangerous. You could slide under the seat belt in a collision. If you slide under it, the belt would apply force at the abdomen or neck. That could cause serious or even fatal injuries. The backrest and seat belt provide the best restraint when the wearer is in an upright position and the belt is properly positioned on the body.

Never place hands under seat or near any moving parts while a seat is being adjusted.

Warning!

When leaving the vehicle always remove the key from the steering lock, and lock your vehicle.

Do not leave children unattended in the vehicle or with access to an unlocked vehicle. Unsupervised use of vehicle equipment may cause serious personal injury.

Caution!

Do not remove head restraints except when mounting seat covers. For removal see page 43. Whenever head restraints have been removed be sure to reinstall them before driving.

Important!

Prior to operating the vehicle, the driver should adjust the seat height for proper vision as well as fore/aft placement and backrest angle to insure adequate control, reach, operation, and comfort. The head restraint should also be adjusted for proper height. See also airbag section on page 56 for proper seat positioning.

In addition, also adjust the steering wheel to ensure adequate control, reach, operation, and comfort.

Both the inside and outside rear view mirrors should be adjusted for adequate rearward vision.

Fasten seat belts. Infants and small children should be seated in a properly secured restraint system that complies with U.S. Federal Motor Vehicle Safety Standard 213 and Canadian Motor Vehicle Safety Standard 213.

All seat, head restraint, steering wheel, and rear view mirror adjustments as well as fastening of seat belts should be done before the vehicle is put into motion.

Warning!

Children 12 years old and under must never ride in the front seat, except in a Mercedes-Benz authorized BabySmart™ compatible child seat, which operates with the BabySmart™ system installed in the vehicle to deactivate the passenger side front airbag when it is properly installed. Otherwise they will be struck by the airbag when it inflates in a crash. If this happens, serious or fatal injury can result.

According to accident statistics, children are safer when properly restrained in the rear seating positions than in the front seating positions. Infants and small children must ride in the back seats and be seated in an appropriate infant or child restraint system, which is properly secured with the vehicle's seat belt, fully in accordance with the child seat manufacturer's instructions.

A child's risk of serious or fatal injuries is significantly increased if the child restraints are not properly secured in the vehicle and the child is not properly secured in the child restraint.

Manual seats (ML 320)



We recommend to adjust the manual seat in the following order:

1 Seat, fore/aft

Lift handle (1), slide seat to desired position and allow handle to reengage. Check for proper engagement before driving. The position should be as far rearward as possible, consistent with ability to properly operate controls.

2 Seat cushion inclination adjustment

Raise lever (2), move seat cushion to desired position. Release lever.

3 Backrest adjustment

Turn handwheel (3).

4 Head restraint height

Raising:

Pull up on head restraint.

Lowering:

Push button (4), located at top of seat back, and push down on head restraint.

Adjust head restraint to support the back of the head approximately at ear level. The head restraint angle can also be adjusted manually.

See page 43 for removing head restraints.

Power seats (standard; optional on model ML 320)

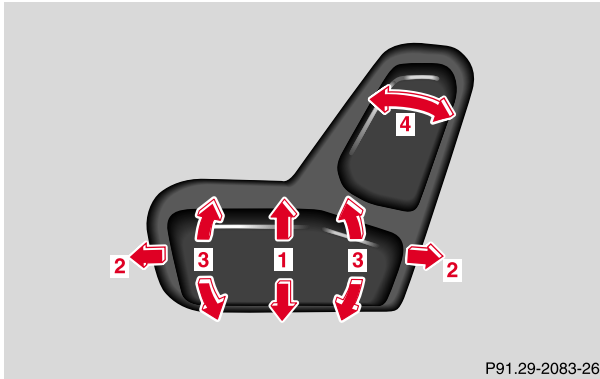

The slide switches are located on the entry side of each front seat base.

Turn key in steering lock to position 1 or 2 (with the driver's or passenger's door open, the power seats can also be operated with the key removed or in steering lock position 0).

We recommend to adjust the power seat in the following order:

- 1 Seat, up/down**
Press the switch (up/down direction) until comfortable seating position with still sufficient headroom is reached.
- 2 Seat adjustment, fore/aft**
Press the switch (fore/aft direction) until a comfortable seating position is reached that still allows you to reach the accelerator/brake pedal safely. The position should be as far rearward as possible, consistent with ability to properly operate controls.
- 3 Seat cushion tilt**
Press the switch in the direction of the arrow until your legs are lightly supported.
- 4 Backrest tilt**
Press the switch in the direction of the arrow until your arms are slightly angled when holding the steering wheel.

Only minor personal adjustments, as described below, should then be required.

For exterior rear view mirrors, see page 73;
inside rear view mirror, see page 71;
steering wheel adjustment, see page 70.

Note:

See page 42 for instructions on storing and recalling the seat position.

Warning!

When leaving the vehicle always remove the key from the steering lock, and lock your vehicle.

The power seats can also be operated with the driver's or passenger door open. Do not leave children unattended in the vehicle or with access to an unlocked vehicle. Unsupervised use of vehicle equipment may cause serious personal injury.

Head restraint

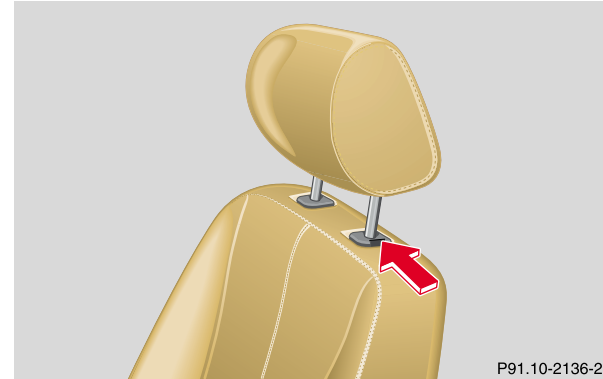

Raising:

Pull up on head restraint.

Lowering:

Push button, located at top of seat back, and push down on head restraint, see also page 43.

Adjust head restraint to support the back of the head approximately at ear level. The head restraint angle can also be adjusted manually.

See page 43 for removing head restraints.

Memory storing and recalling

(optional on model ML 320 and ML 430)



- 5 Memory button
- 6 Position buttons

Storing

Three sets of seat positions may be programmed into memory. After the seat is positioned, push memory button (5), release, and within 3 seconds push position button “1”. A second and third set of positions for the same seat can be programmed into memory by pushing first memory button (5) and then position button “2”, respectively “3”.

Recalling

To recall a seat position, push and hold one of the position buttons “1”, “2” or “3” until seat movement has stopped. The seat movement stops when the respective position button is released.

Caution!

Do not operate the power seats using the memory button if the seat backrest is in an excessively reclined position. Doing so could cause damage to front or rear seats.

First move the backrest to an upright position.

Head restraint removal

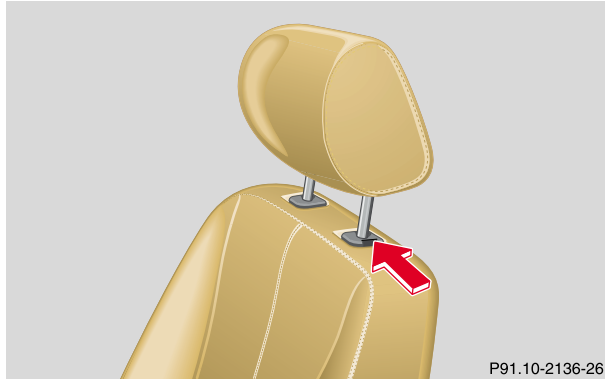

Removal:

Pull head restraint to its highest position. Push lock button (arrow) and pull out head restraint completely with both hands.

Installation:

Insert the head restraint and push it down to the stop. Push lock button (arrow) and adjust head restraint down to the desired position.

Ensure proper head restraint positioning, see above.

Warning!

For your protection, drive only with properly positioned head restraints.

Adjust head restraint to support the back of the head approximately at ear level.

Do not drive the vehicle without the seat head restraints. Head restraints are intended to help reduce injuries during an accident.

Heated seats (front, optional on ML 320)

The front seat heater switches are located on the center console.

The front seat heaters can be switched on with the engine running.

Press switch to turn on seat heater:

- 1** Normal seat heating mode. One indicator lamp in the switch lights up.
- 2** Rapid seat heating mode. Both indicator lamps in the switch light up.

After approximately 5 minutes in the rapid seat heating mode, the seat heater automatically switches to normal operation and only one indicator lamp will stay on.

Turning off seat heater:

If one indicator lamp is on, press upper half of switch.

If both indicator lamps are on, press lower half of switch.

If left on, the seat heater automatically turns off after approximately 20 minutes of operation.

Notes:

When in operation, the seat heater consumes a large amount of electrical power. It is not advisable to use the seat heater longer than necessary.

The seat heaters may automatically switch off if too many power consumers are switched on at the same time, or if the battery charge is low. When this occurs, the indicator lamps in the switch will blink for approximately 30 seconds.

Within this time the seat heaters will switch on again automatically as soon as sufficient voltage is available. After approximately 30 seconds without sufficient voltage the seat heaters switch off (indicator lamps go out).

Restraint systems

46

Seat belts and integrated restraint system

Your vehicle is equipped with seat belts for all seats, emergency tensioning retractors for front and second row outboard seat belts, dual front airbags and door mounted side impact airbags. Their protective functions are designed to complement one another.

Seat belts**Important!**

Laws in most states and all Canadian provinces require seat belt use.

All states and provinces require use of child restraints that comply with U.S. Federal Motor Vehicle Safety Standard 213 and Canadian Motor Vehicle Safety Standard 213.

All child restraint systems are designed to be secured in vehicle seats by lap belts or the lap belt portion of a lap-shoulder belt.

For your safety and that of your passengers we strongly recommend their use.

Warning!

Children 12 years old and under must never ride in the front seat, except in a Mercedes-Benz authorized BabySmart™ compatible child seat, which operates with the BabySmart™ system installed in the vehicle to deactivate the passenger side front airbag when it is properly installed. Otherwise they will be struck by the airbag when it inflates in a crash. If this happens, serious or fatal injury will result.

According to accident statistics, children are safer when properly restrained in the rear seating positions than in the front seating positions. Infants and small children must ride in back seats and be seated in an appropriate infant or child restraint system, which is properly secured with the vehicle's seat belt, fully in accordance with the child seat manufacturer's instructions.

A child's risk of serious or fatal injuries is significantly increased if the child restraints are not properly secured in the vehicle and the child is not properly secured in the child restraint.

Warning!

Never ride in a moving vehicle with the backrest reclined. Sitting in an excessively reclined position can be dangerous. You could slide under the seat belt in a collision. If you slide under it, the belt would apply force at the abdomen or neck. That could cause serious or even fatal injuries. The backrest and seat belt provide the best restraint when the wearer is in an upright position and the belt is properly positioned on the body.

Note:

For cleaning and care of the seat belts, see page 282.

Seat belt nonusage warning system

After starting the engine, a warning sounds and the seat belt warning lamp  remains illuminated for a short time if the driver's seat belt is not fastened.

Warning!

Failure to wear and properly fasten and position your seat belt greatly increases your risk of injuries and their likely severity in an accident. You and your passengers should always wear seat belts.

If you are ever in an accident, your injuries can be considerably more severe without your seat belt properly buckled. Without your seat belt buckled, you are much more likely to hit the interior of the vehicle or be ejected from it. You can be seriously injured or killed.

In the same crash, the possibility for injury or death is lessened if you are wearing your seat belt.

Warning!

Never let more people ride in the vehicle than there are seat belts available. Be sure everyone riding in the vehicle is correctly restrained with a separate seat belt.

Restraint systems

48

Fastening of seat belts

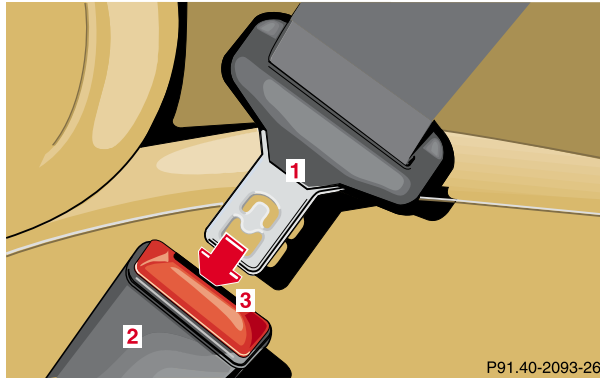

- 1 Latch plate
- 2 Buckle
- 3 Release button

Push latch plate (1) into buckle (2) until it clicks. Do not twist the belt. A twisted seat belt may cause injury.

To help avoid severe or fatal injuries, the lap belt must be positioned as low as possible on your hips and not across the abdomen.

Warning!

Always fasten your seat belt before driving off. Always make sure your passengers are properly restrained – even those sitting in the rear.

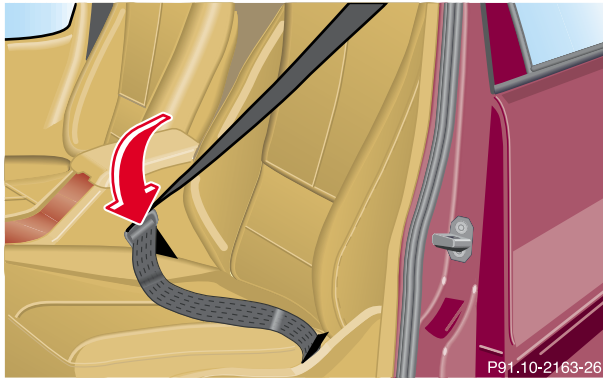

Tighten the lap portion to a snug fit by pulling shoulder portion up.

The shoulder portion of the seat belt must be pulled snug and checked for snugness immediately after engaging it.

Adjust seat belt so that shoulder portion is located as close as possible to the middle of your shoulder (it should not touch the neck). For this purpose, you can adjust the height of the belt outlet. Three positions are available.

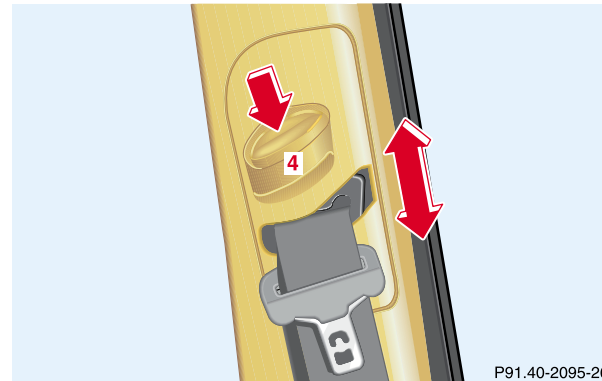

4 Button for belt outlet height adjustment

To raise, slide belt height adjustment upward.

To lower, press button (4) and slide belt outlet downward.

Caution!

For safety reasons, avoid adjusting the seat or backrest into positions which could affect the correct seat belt positioning.

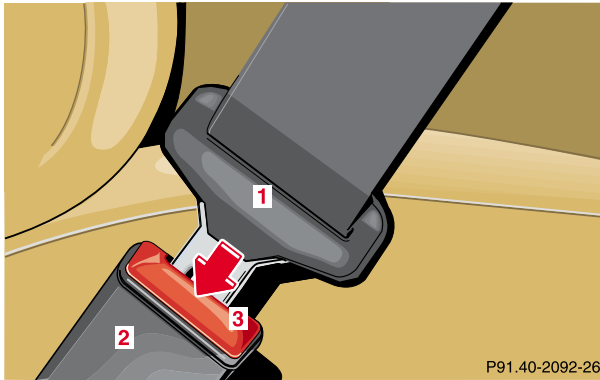

Operation

The inertia reel stops the belt from unwinding during sudden vehicle stops or when quickly pulling on the belt. The locking function of the reel may be checked by quickly pulling out the belt.

Unfastening of seat belts

Push the release button (3) in the belt buckle (2).

Allow the retractor to completely rewind the seat belt by guiding the latch plate (1).

Warning!

USE SEAT BELTS PROPERLY.

- Seat belts can only work when used properly. Never wear seat belts in any other way than as described in this section, as that could result in serious injuries in case of an accident.
- Each occupant should wear their seat belt at all times, because seat belts help reduce the likelihood of and potential severity of injuries in accidents, including rollovers. The integrated restraint system includes “SRS” (driver airbag, front passenger airbag, front and rear door mounted side impact airbags), “ETR” (seat belt emergency tensioning retractors for the outboard passenger seats [except in the optional 3rd row seats]), and front seat knee bolsters. The system is designed to enhance the protection offered to properly belted occupants in certain frontal (front airbags) and side (side impact airbags) impacts which exceed preset deployment thresholds.

- Never wear the shoulder belt under your arm, against your neck or off your shoulder. In a crash, your body would move too far forward. That would increase the chance of head and neck injuries. The belt would also apply too much force to the ribs or abdomen, which could severely injure internal organs such as your liver or spleen.
- Never wear belts over rigid or breakable objects in or on your clothing, such as eyeglasses, pens, keys etc., as these might cause injuries.
- Position the lap belt as low as possible on your hips and not across the abdomen. If the belt is positioned across your abdomen, it could cause serious injuries in a crash.

- Each seat belt should never be used for more than one person at a time. Do not fasten a seat belt around a person and another person or other objects.
- Belts should not be worn twisted. In a crash, you wouldn't have the full width of the belt to manage impact forces. The twisted belt against your body could cause injuries.
- Pregnant women should also use a lap-shoulder belt. The lap belt portion should be positioned as low as possible on the hips to avoid any possible pressure on the abdomen.
- Never place your feet on the instrument panel or on the seat. Always keep both feet on the floor in front of the seat.

| | | | | | | | |
|--------------------------|------------------|---------|----------------------------|-----------------|----------|----------------|-------|
| Instruments and controls | Operation | Driving | Instrument cluster display | Practical hints | Car care | Technical data | Index |
|--------------------------|------------------|---------|----------------------------|-----------------|----------|----------------|-------|

Restraint systems

Warning!

USE CHILD RESTRAINTS PROPERLY.

Children 12 years old and under must never ride in the front seat, except in a Mercedes-Benz authorized BabySmart™ compatible child seat, which operates with the BabySmart™ system installed in the vehicle to deactivate the passenger front airbag when it is properly installed. Otherwise they will be struck by the airbag when it inflates in a crash. If this happens, serious or fatal injury will result.

According to accident statistics, children are safer when properly restrained in the rear seating positions than in the front seating positions. Infants and small children must ride in back seats and be seated in an appropriate infant or child restraint system, which is properly secured with the vehicle's seat belt, fully in accordance with the child seat manufacturer's instructions.

A child's risk of serious or fatal injuries is significantly increased if the child restraints are not properly secured in the vehicle and the child is not properly secured in the child restraint.

Children too big for child restraint systems must ride in back seats using regular seat belts. Position shoulder belt across chest and shoulder, not face or neck. A booster seat may be necessary to achieve proper belt positioning.

BabySmart™ airbag deactivation system

Special BabySmart™ compatible child seats, designed for use with the Mercedes-Benz system and available at any authorized Mercedes-Benz Center are required for use with the BabySmart™ airbag deactivation system.

With the special child seat properly installed, the passenger front airbag will not deploy. The  indicator lamp located in the instrument cluster will be illuminated, except with key removed or in steering lock position 0. The system does not deactivate the door mounted side impact airbag.

Warning!

The BabySmart™ Airbag Deactivation System will ONLY work with a special child seat designed to operate with it. It will not work with child seats which are not BabySmart™ compatible.

Never place anything between seat cushion and child seat (e.g. pillow), since it reduces the effectiveness of the deactivation system.

Follow the manufacturer's instructions for installation of special child seats.

The passenger side front airbag will not deploy only if the  indicator lamp remains illuminated.

Please be sure to check the indicator every time you use the special system child seat.

Should the light go out while the restraint is installed, please check installation. If the light remains out, do not use the BabySmart™ restraint to transport children on the front passenger seat until the system has been repaired.

Self-test BabySmart™ without special child seat installed

After turning key in steering lock to position 1 or 2, the  indicator lamp located in the instrument cluster comes on for approximately 6 seconds, extinguishes, then blinks once.

If the indicator lamp should not come on or is continuously lit, the system is not functioning. You must see an authorized Mercedes-Benz Center before seating any child on the front passenger seat.

BabySmart™ is a trademark of Siemens Automotive Corp.

Restraint systems

54

Supplemental restraint system (SRS)

Airbags are intended as a supplement to seat belts. Airbags alone cannot protect as well as airbags plus seat belts in impacts for which the airbags were designed to operate, and do not afford any protection whatsoever in crashes for which the airbags are not designed to deploy.

The SRS uses two crash severity levels (thresholds) to activate either the Emergency Tensioning Retractor (ETR) or front airbag or both. Activation depends on the direction and severity of the impact exceeding the preset thresholds and whether the seat belt is fastened.

Seat belt fastened

- first threshold exceeded: ETR activates
- second threshold exceeded: airbag also activates

Seat belt not fastened

Front seats:

- first threshold exceeded:
airbag activates, but not ETR

Rear outer seats:

- first threshold exceeded:
ETR activates

Driver, front passenger and rear outer seat systems operate independently of each other.

Emergency tensioning retractor (ETR)

The seat belts for the outboard passenger seats (except in the optional 3rd row seats) are equipped with emergency tensioning retractors. These tensioning retractors are located in each belt's inertia reel and become operationally ready with the key in steering lock position 1 or 2.

The emergency tensioning retractors are designed to activate only when the seat belts are fastened during frontal impacts exceeding the first threshold of the SRS and in rear impacts exceeding a preset severity level. They remove slack from the belts in such a way that the seat belts fit more snugly against the body restricting its forward movement as much as possible.

In cases of other frontal impacts, angled impacts, roll-overs, certain side impacts, or other accidents without sufficient frontal or rear impact forces, the emergency tensioning retractors will not be activated. The driver and passengers will then be protected by the fastened seat belts and inertia reel in the usual manner.

For seat belt and emergency tensioning retractor see page 63.

Restraint systems

56

Airbags

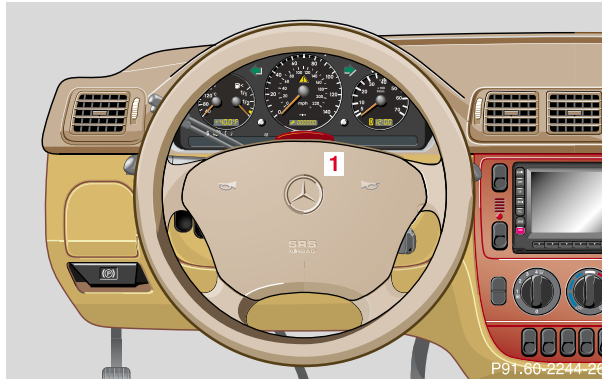
**1** Driver airbag

The most effective occupant restraint system yet developed for use in production vehicles is the seat belt. In some cases, however, the protective effect of a seat belt can be further enhanced by an airbag.

The driver airbag is located in the steering wheel hub.

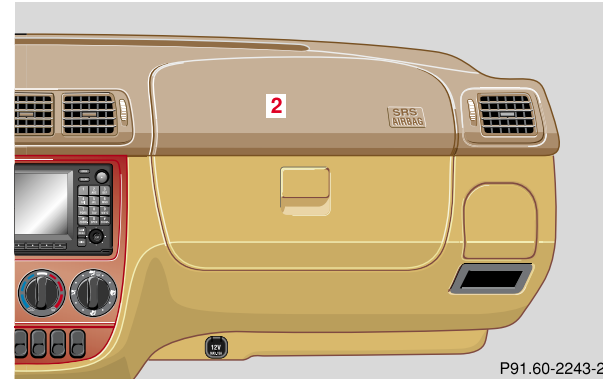
**2** Front passenger airbag

The passenger front airbag is located in the dashboard ahead of the front passenger.

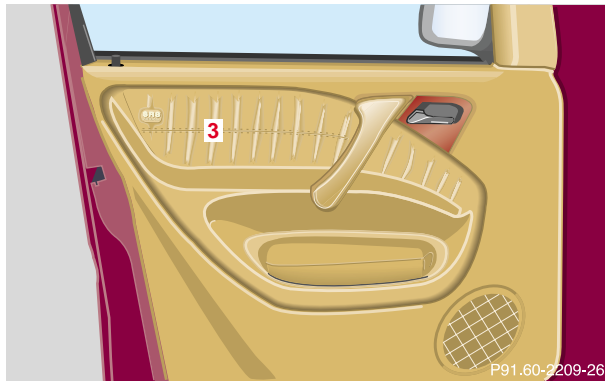

3 Side impact airbag, front

The side impact airbags are located in the front and rear doors.

In conjunction with wearing the seat belts, the driver and front passenger airbags can provide increased protection for the driver and front passenger in certain frontal impacts exceeding preset thresholds.

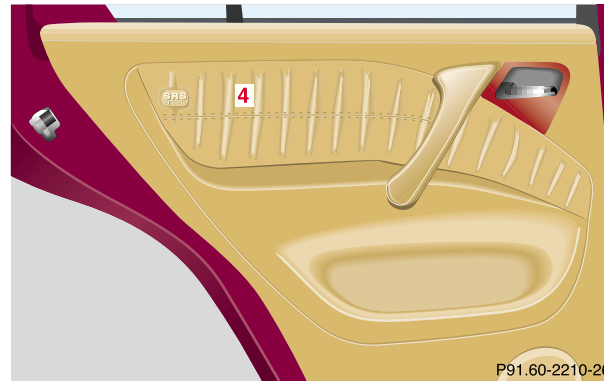

4 Side impact airbag, rear

Door mounted side impact airbags can provide increased protection to belted outboard occupants on the impacted side of the vehicle in side impacts exceeding its preset threshold.

Important!

The operational readiness of the airbag system is verified by the indicator lamp “SRS” in the instrument cluster when turning the key in steering lock to position 1 or 2. If no fault is detected, the lamp will go

Restraint systems

58

out after approximately 5 seconds; after the lamp goes out, the system continues to monitor the components and circuitry of the airbag system and will indicate a malfunction by coming on again. If the lamp does not come on at all or if it fails to extinguish after approximately 5 seconds or if it comes on thereafter, a malfunction in the system has been detected.

The following system components are monitored or undergo a self-check: crash-sensor(s), airbag ignition circuits, front seat belt buckles, emergency tensioning retractors, seat sensor.

Initially, when the key is turned from steering lock position 0 to positions 1 or 2, malfunctions in the crash-sensor are detected and indicated (the "SRS" indicator lamp stays on longer than 5 seconds or does not come on).

Have the system checked at your authorized Mercedes-Benz Light Truck Center immediately.

In the operational mode, after the indicator lamp has gone out following the initial check, interruptions or short circuits in the airbag ignition circuit and in the driver and front passenger seat belt buckle harnesses, and low voltage in the entire system are detected and indicated.

Warning!

In the event a malfunction of the "SRS" is indicated as outlined above, the "SRS" may not be operational. For your safety, we strongly recommend that you visit an authorized Mercedes-Benz Light Truck Center immediately to have the system checked; otherwise the "SRS" may not be activated when needed in an accident, which could result in serious or fatal injury, or it might deploy unexpectedly and unnecessarily which could also result in injury.

Front airbags

The driver and front passenger front airbags are designed to activate only in certain frontal impacts exceeding a preset threshold.

The front passenger airbag deploys only if the front passenger seat is occupied and the  indicator lamp in the instrument cluster is not illuminated.

Note:

Heavy objects on the front passenger seat can appear to the “SRS” to indicate the presence of an occupant in that seat which causes the passenger front airbag to deploy in a crash exceeding the appropriate threshold.

Side impact airbags

The side impact airbags are designed to activate only in certain side impacts exceeding a preset threshold. Only the side impact airbags on the impacted side of the vehicle deploy.

The side impact airbag for the front passenger deploys only if the front passenger seat is occupied.

Side impact airbags operate best in conjunction with a properly positioned and fastened seat belt.

Note:

Heavy objects on front passenger seat can cause the side impact airbag to deploy in a crash.

Important!

Airbags are designed to activate only in certain frontal (front airbags) impacts, or side (side impact airbags) impacts which exceed preset thresholds.

Only during these types of impacts, if of sufficient severity to meet the deployment thresholds, will they provide their supplemental protection.

The driver and passenger should always wear their seat belts, otherwise it is not possible for the airbags to provide their intended supplemental protection.

In cases of other frontal impacts, angled impacts, roll-overs, other side impacts, rear collisions, or other accidents in which the airbags are not designed to deploy, the airbags will not be activated. The driver and passenger will then be protected by the fastened seat belts.

We caution you not to rely on the presence of the airbags in order to avoid wearing your seat belt.

| | | | | | | | |
|--------------------------|------------------|---------|----------------------------|-----------------|----------|----------------|-------|
| Instruments and controls | Operation | Driving | Instrument cluster display | Practical hints | Car care | Technical data | Index |
|--------------------------|------------------|---------|----------------------------|-----------------|----------|----------------|-------|

Restraint systems

Warning!

Airbags are designed to reduce the potential of injury in certain frontal (front airbags) impacts, and side (side impact airbags) impacts which may cause significant injuries, however, no system available today can totally eliminate injuries and fatalities.

The activation of the “SRS” temporarily releases a small amount of dust from the airbags. This dust, however, is neither injurious to your health, nor does it indicate a fire in the vehicle. The dust might cause some temporary breathing difficulty for people with asthma or other breathing trouble. To avoid this, you may wish to get out of the vehicle as soon as it is safe to do so. If you have any breathing difficulty but cannot get out of the vehicle after the airbag inflates, then get fresh air by opening a window or door.

Your vehicle was originally equipped with airbags which are designed to activate in certain impacts exceeding a preset threshold to reduce the potential and severity of injury. It is important to your safety and that of your passenger that you replace deployed airbags and repair any malfunctioning airbags to ensure the vehicle will continue to provide crash protection for occupants.

Warning!

To reduce the risk of injury when the front airbags inflate, it is very important for the driver and front passenger to always be in a properly seated position and to wear their seat belts.

For maximum protection in the event of a collision always be in normal seated position with your back against the backrest. Fasten your seat belt and ensure that it is properly positioned on your body.

Since the airbag inflates with considerable speed and force, a proper seating and hands on steering wheel position will help to keep you at a safe distance from the airbag. Occupants who are unbelted, out of position or too close to the airbag can be seriously injured by an airbag as it inflates with great force in the blink of an eye:

- Sit properly belted in an upright position with your back against the backrest.
- Adjust the driver's seat as far as possible rearward, still permitting proper operation of vehicle controls. The distance from the center of the driver's breastbone to the center of the airbag cover on the steering wheel must be at least ten inches (25 cm) or more. You should be able to accomplish this by a combination of adjustments to the seat and steering wheel. If you have any problems, please see your authorized Mercedes-Benz Light Truck Center.
- Do not lean with your head or chest close to the steering wheel or dashboard.
- Keep hands on the outside of steering wheel rim. Placing hands and arms inside the rim can increase the risk and potential severity of hand/arm injury when the driver front airbag inflates.
- Adjust the front passenger seat as far as possible rearward from the dashboard when the seat is occupied.

- Occupants, especially children, should never lean their heads in the area of the door where the side airbag inflates. This could result in serious injuries or death should the airbag be triggered. Always sit upright, properly use the seatbelts and appropriate size infant or child restraint system.
- Children 12 years old and under must never ride in the front seat, except in a Mercedes-Benz authorized BabySmart™ compatible child seat, which operates with the BabySmart™ system installed in the vehicle to deactivate the passenger side front airbag when it is properly installed. Otherwise they will be struck by the airbag when it inflates in a crash. If this happens, serious or fatal injury can result.

Failure to follow these instructions can result in severe or fatal injuries to you or other occupants.

Warning!

Accident research shows that the safest place for children in an automobile is in the rear seat. Should you choose to place a child 12 years old or under in the front passenger seat of your vehicle, you must properly use a BabySmart™ child restraint which will turn off the passenger side front airbag. BabySmart™ will not, however, turn off the vehicle's side impact airbag.

It should be noted that with respect to both front and rear side impact airbags there is a possibility for a side airbag related injury if occupants, especially children, are not properly seated or restrained when next to a side airbag which needs to deploy rapidly in a side impact in order to do its job.

To help avoid the possibility of injury, please follow these guidelines: (1) occupants, especially children, should never place their bodies or lean their heads in the area of the door where the side airbag inflates. This could result in serious injuries or death should the side airbag be activated; (2) always sit upright, properly use the seat belts and use an appropriately sized infant or child restraint system for all children 12 years old or under; and (3) always wear seat belts properly.

If you believe that, even with the use of these guidelines, it would be safer for your rear seat occupants to have both rear door mounted side airbags deactivated, then deactivation can be accomplished upon your written election to do so at your authorized Mercedes-Benz Center at an additional cost. Please contact your local authorized Mercedes-Benz Center or call our Client Assistance Center at 1-800-FOR-MERCEDES (1-800-367-6372) for details.

**Safety guidelines for the seat belt,
emergency tensioning retractor and airbag**

Warning!

- Damaged seat belts or belts that were highly stressed in an accident must be replaced and their anchoring points must also be checked. Use only belts installed or supplied by an authorized Mercedes-Benz Light Truck Center.
- Do not pass belts over sharp edges.
- Do not make any modification that could change the effectiveness of the belts.
- Airbags and ETR's are designed to function on a one-time-only basis. An airbag or emergency tensioning retractor (ETR) that was activated must be replaced.

- An airbag system component within the steering wheel gets hot after the airbag has inflated. Do not touch.
- Improper work on the system, including incorrect installation and removal, can lead to possible injury through an unintended activation of the "SRS".
- No modifications of any kind may be made to any components or wiring of the "SRS". This includes changing or removing any component or part of the "SRS", the installation of additional trim material, badges etc. over the steering wheel hub, front passenger airbag cover, or front door trim panels, and installation of additional electrical/electronic equipment on or near "SRS" components and wiring. Keep area between airbags and occupants free of objects (e.g. packages, purses, umbrellas, etc.).

| | | | | | | | |
|--------------------------|------------------|---------|----------------------------|-----------------|----------|----------------|-------|
| Instruments and controls | Operation | Driving | Instrument cluster display | Practical hints | Car care | Technical data | Index |
|--------------------------|------------------|---------|----------------------------|-----------------|----------|----------------|-------|

Restraint systems

- In addition, through improper work there is the risk of rendering the “SRS” inoperative or causing unintended airbag deployment. Work on the “SRS” must therefore only be performed by an authorized Mercedes-Benz Light Truck Center.
- For your protection and the protection of others, when scrapping the airbag unit or emergency tensioning retractor, our safety instructions must be followed. These instructions are available at your authorized Mercedes-Benz Light Truck Center.

- Given the considerable deployment speed and the textile structure of the airbags, there is the possibility of abrasions or other injuries resulting from airbag deployment.

When you sell the vehicle we strongly urge you to give notice to the subsequent owner that it is equipped with an “SRS” by alerting him to the applicable section in the Operator’s Manual.

Infant and child restraint systems

We recommend that all infants and children be properly restrained at all times while the vehicle is in motion. All lap-shoulder belts except the driver's seat belt have special seat belt retractors for secure fastening of child restraints.

To fasten a child restraint follow child restraint instructions for routing. Then pull shoulder belt out completely and let it retract. During the seat belt retraction a ratcheting sound can be heard to indicate that the special seat belt retractor is activated. The belt is now locked. Push down on child restraint to take up any slack.

To deactivate, release seat belt buckle and let seat belt retract completely. The seat belt can again be used in the usual manner.

Note:

For child seats with mounting fittings for tether anchorages refer to page 67 (installation of infant and child restraint systems).

Warning!

Never release the seat belt buckle while vehicle is in motion, since the special seat belt retractor will be deactivated.

Important!

The use of infant or child restraints is required by law in all 50 states and all Canadian provinces.

Infants and small children should be seated in an appropriate infant or child restraint system properly secured by a lap-shoulder belt, and that complies with U.S. Federal Motor Vehicle Safety Standard 213 and Canadian Motor Vehicle Safety Standard 213.

A statement by the child restraint manufacturer of compliance with this standard can be found on the instruction label on the restraint and in the instruction manual provided with the restraint.

When using any infant or child restraint system, be sure to carefully read and follow all manufacturer's instructions for installation and use.

Please read and observe warning labels affixed to inside of vehicle and to infant or child restraints.

| | | | | | | | |
|--------------------------|------------------|---------|----------------------------|-----------------|----------|----------------|-------|
| Instruments and controls | Operation | Driving | Instrument cluster display | Practical hints | Car care | Technical data | Index |
|--------------------------|------------------|---------|----------------------------|-----------------|----------|----------------|-------|

Restraint systems

Warning!

Children 12 years old and under must never ride in the front seat, except in a Mercedes-Benz authorized BabySmart™ compatible child seat, which operates with the BabySmart™ System installed in the vehicle to deactivate the passenger front airbag when it is properly installed. Otherwise they will be struck by the airbag when it inflates in a crash. If this happens, serious or fatal injury can result.

According to accident statistics, children are safer when properly restrained in the rear seating positions than in the front seating positions. Infants and small children must ride in back seats and be seated in an infant or child restraint system, which is properly secured with the vehicle's seat belt, fully in accordance with the child seat manufacturer's instructions.

Infants and small children should never share a seat belt with another occupant. During an accident, they could be crushed between the occupant and seat belt.

Children too big for child restraint systems must ride in back seats using regular seat belts. Position shoulder belt across chest and shoulder, not face or neck. A booster seat may be necessary to achieve proper belt positioning for children from 41 lbs. to the point where a lap/shoulder belt fits properly without one.

When the child restraint is not in use, remove it from the vehicle or secure it with the seat belt to prevent the child restraint from becoming a projectile in the event of an accident.

Installation of infant and child restraint systems

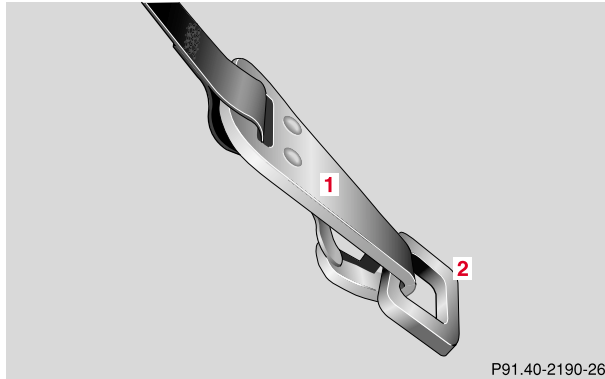

To secure a tether strap to the anchorage, securely fasten the hook (1), which is part of the tether strap, to the anchorage ring (2). For safety, please make sure that the hook has attached to the ring beyond the safety catch, as illustrated.

Vehicle without third row seats

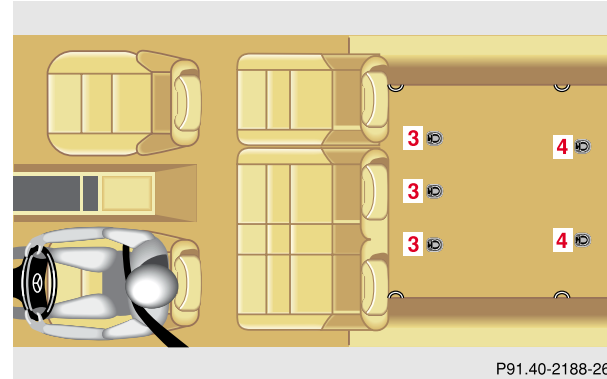

- 3 Tether anchorages for second row seats
- 4 Tether anchorages for third row seats (optional)

This vehicle is provided with three tether anchorages (3) for a top tether strap behind the second row seats.

Note:

Do not use the tether anchorages (4) for a top tether strap on a second row seat.

Restraint systems

68

Vehicle with third row seats

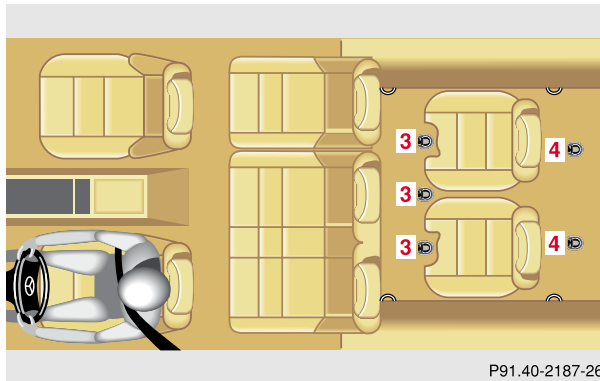

3 Tether anchorages for second row seats

4 Tether anchorages for third row seats

This vehicle is provided with tether anchorages for a top tether strap behind the second row seats (3) and the third row seats (4).

We recommend to install infant and child restraints on the third row seats.

When using the third row seats observe the following:

- Installation of infant and child restraint systems with a top tether strap is allowed only on both third row seats plus the center second row seat.
- When using the center second row seat for a top tether strap, the left third row seat should only be used for a child restraint system, since exiting the vehicle may not be possible in an emergency due to the routing of the top tether strap.

To store the left third row seat, see page 126.

Important!

An infant and child restraint system must not be installed on the right second row seat while a passenger rides in a third row seat. Use of the easy-entry/exit feature is not possible. See page 123 for easy-entry/exit feature.

Note:

When installing an infant or child restraint system with a top tether strap on the left second row seat, the left third row seat should not be occupied. For storage of the left third row seat, see page 126.

| | | | | | | | |
|--------------------------|------------------|---------|----------------------------|-----------------|----------|----------------|-------|
| Instruments and controls | Operation | Driving | Instrument cluster display | Practical hints | Car care | Technical data | Index |
|--------------------------|------------------|---------|----------------------------|-----------------|----------|----------------|-------|

Adjustable steering wheel

70

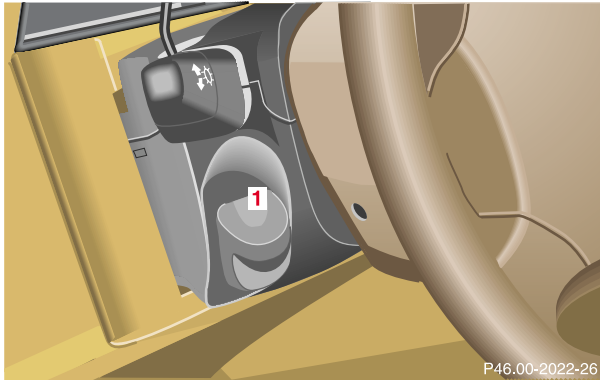
Adjustable steering wheel**Warning!**

Do not adjust the steering wheel while driving. The steering wheel must be locked while driving. Adjusting the steering wheel while driving, or driving without the steering wheel locked could cause the driver to lose control of the vehicle.

Unlocking:

Move lever (1) down. The indicator lamp, located in the instrument cluster, comes on.

Adjusting:

Move steering wheel up or down to desired position.

Locking:

Move lever (1) up. The indicator lamp, located in the instrument cluster, goes out.

Important!

With the key in steering lock position 2, the indicator lamp in the instrument cluster comes on. It should go out when the engine is running.

If the indicator lamp does not go out after starting the engine, the adjustable steering column is not locked properly.

Do not drive the vehicle until you have properly locked the steering column.

Inside rear view mirror



Use your inside mirror to determine the size and distance of objects seen in the passenger side convex mirror.

Antiglare night position

Manual:

Tilt the mirror to the antiglare night position using the lever (1) at its lower edge.

Rear view mirrors

72

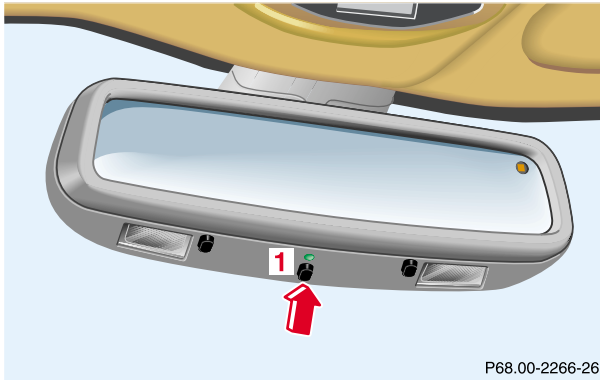

Automatic (optional on ML 320):

With the key in steering lock position 2 and the automatic antiglare function activated, the mirror reflection brightness responds to changes in light sensitivity.

To activate:

Press button (1). The green indicator lamp in the rear view mirror lights up.

To deactivate:

Press button (1) again. The indicator lamp in the rear view mirror goes out. The mirror brightness does not respond to changes in light sensitivity.

Notes:

With gear selector lever in position “R”, or with the interior lamps (except cargo compartment lamp) switched on, the mirror brightness does not respond to changes in light sensitivity.

The automatic antiglare function does not react, if incoming light is not aimed directly at sensors in the mirror.

Warning!

In the case of an accident liquid electrolyte may escape the mirror housing when the mirror glass breaks.

Electrolyte has an irritating effect. Do not allow the liquid come into contact with eyes, skin, clothing, or respiratory system. In cases it does, immediately flush affected area with water, and seek medical help if necessary.

Exterior rear view mirrors

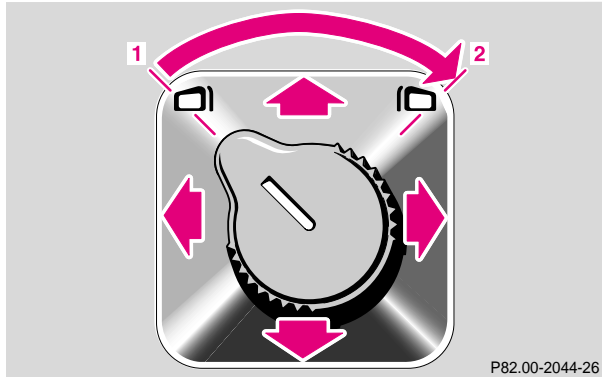

The switch is located on the center console.
Turn key in steering lock to position 1 or 2.

First select the mirror to be adjusted – turn switch:

- 1 Left mirror
- 2 Right mirror

To adjust, toggle the switch forward, backward or to either side.

Warning!

Exercise care when using the passenger-side mirror. The passenger-side exterior mirror is convex (outwardly curved surface for a wider field of view). Objects in mirror are closer than they appear. Check your inside rear view mirror or glance over your shoulder before changing lanes.

Note:

After turning off the engine the exterior rear view mirrors can be operated with a front door opened or with key in steering lock position 1 for approximately 30 minutes.

Rear view mirrors

74

Vehicles with automatic antiglare function:

With the key in steering lock position 2, the driver's side mirror reflection brightness responds to changes in light sensitivity.

With gear selector lever in position "R", or with the interior lamps (except cargo compartment lamp) switched on, the driver's side mirror brightness does not respond to changes in light sensitivity.

Warning!

In the case of an accident liquid electrolyte may escape the mirror housing when the mirror glass breaks.

Electrolyte has an irritating effect. Do not allow the liquid come into contact with eyes, skin, clothing, or respiratory system. In cases it does, immediately flush affected area with water, and seek medical help if necessary.

Important!

Electrolyte drops coming into contact with the vehicle paint finish can only be completely removed while in their liquid state, by applying plenty of water.

Notes:

The exterior mirrors have electrically heated glass. The heater switches on automatically, depending on outside temperature.

If an exterior mirror housing is forcibly pivoted from its normal position, it must be repositioned by applying firm pressure until it snaps into place.

Exterior rear view mirror, electrically folding (optional on ML 320 and ML 430)



The switch is located in the dashboard behind the steering wheel.

- 1 Press switch to fold mirror out
- 2 Press switch to fold mirror in

If an exterior mirror housing is forcibly forced forward or rearward (hit from the front or from the rear), press lower half of the switch (2) until you hear a hitting noise.

Press upper half of the switch (1) to fold mirror out.

You can adjust the exterior rear view mirrors again, see page 73.

Notes:

The exterior rear view mirrors can vibrate if they are not completely folded out.

Before running the vehicle through an automatic car wash, fold the mirrors in, otherwise they might get damaged.

After turning off the engine the exterior rear view mirrors can be operated with a front door opened or with key in steering lock position 1 for approximately 30 minutes.

Instrument cluster

76

Instrument cluster

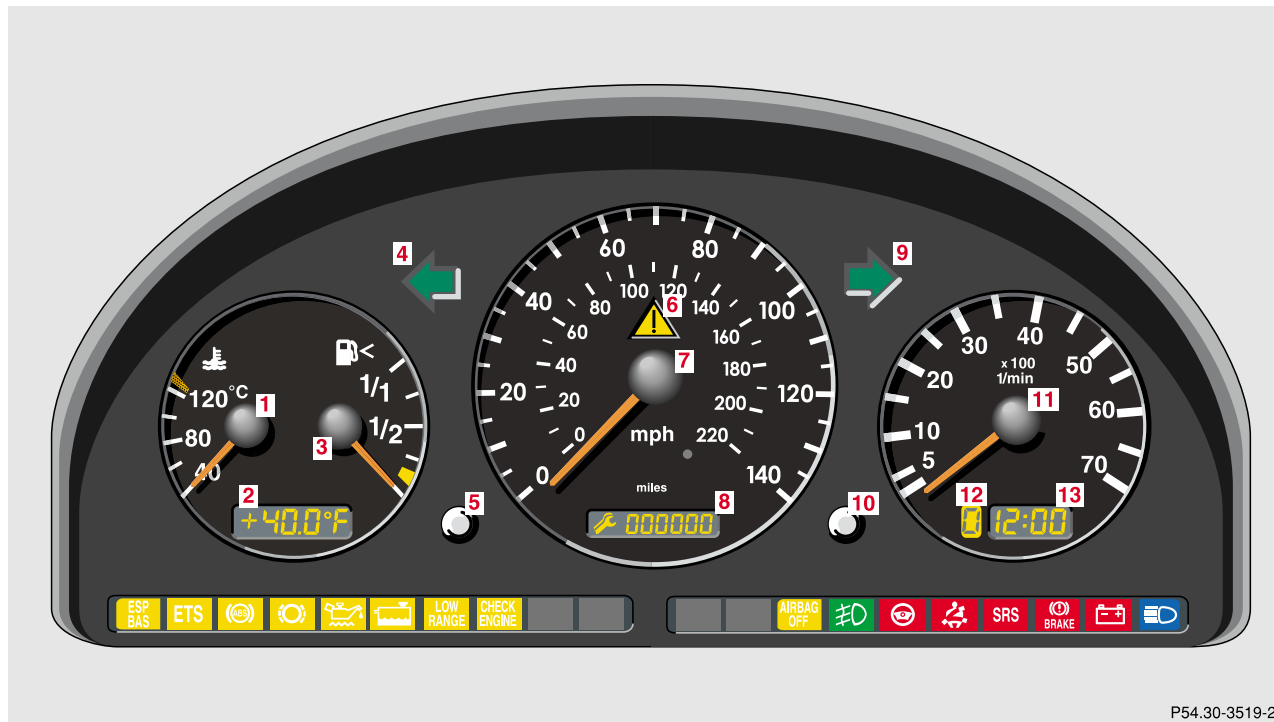

- 1** Coolant temperature gauge, see page 81
- 2** Outside temperature indicator (optional), see page 82
- 3** Fuel gauge with reserve and fuel cap placement warning lamp, see page 220
- 4** Left turn signal indicator lamp, see exterior lamp switch, page 90
- 5** Knob for odometer/trip odometer readout/reset, FSS indicator, and intensity of instrument lamps, see page 80
- 6** 4-ETS+ and ESP warning lamp, see page 221
For 4-ETS+ (four wheel electronic traction system), see page 203;
for ESP (electronic stability program), see page 205.

- 7** Speedometer
- 8** Selectable:
 - Trip odometer, see page 80
 - Main odometer, see page 80
 - FSS display, see page 87
 - Engine oil level indicator, see page 89
- 9** Right turn signal indicator lamp, see exterior lamp switch, page 90
- 10** Knob for setting clock, see page 80
- 11** Tachometer, see page 82
- 12** Gear range indicator display, see selector lever positions, page 168
- 13** Clock, see page 80

| | | | | | | | |
|--------------------------|------------------|---------|----------------------------|-----------------|----------|----------------|-------|
| Instruments and controls | Operation | Driving | Instrument cluster display | Practical hints | Car care | Technical data | Index |
|--------------------------|------------------|---------|----------------------------|-----------------|----------|----------------|-------|

Instrument cluster

78

Indicator lamps in the instrument cluster

High beam

BAS malfunction, see page 221
ESP malfunction, see page 221

4-ETS+ malfunction, see page 221



ABS malfunction, see page 222



Brake pads worn down, see page 225



Engine oil level low, see page 224



Coolant level low, see page 224

Transmission in LOW RANGE mode,
see page 221

ESP and 4-ETS+. Adjust driving to road condition, see page 221

Brake fluid low, see page 219
EBP malfunction, see page 204
Parking brake engaged, see page 173

Front passenger airbag automatically switched off, see page 53



Front fog lamp, see page 92

Steering wheel adjustment not locked,
see page 70Fasten seat belts,
see page 223Battery not being charged properly,
see page 223

SRS malfunction, see page 219

CHECK ENGINE

If the “CHECK ENGINE” malfunction indicator lamp comes on when the engine is running, it indicates a malfunction of the fuel management system, emission control system, systems which impact emissions, or the fuel cap is not closed tight. In all cases, we recommend that you have the malfunction checked as soon as possible, see page 218.

Additional function indicator lamps (in the odometer display)

FSS indicator (Service A), see page 87



FSS indicator (Service B), see page 87

The symbols appear in the main odometer display field prior to the next suggested service. Depending on operating conditions throughout the year, the next service is calculated and displayed in days or distance remaining. See page 87 for notes on the flexible service system (FSS).

Instrument cluster

80

Activating instrument cluster display

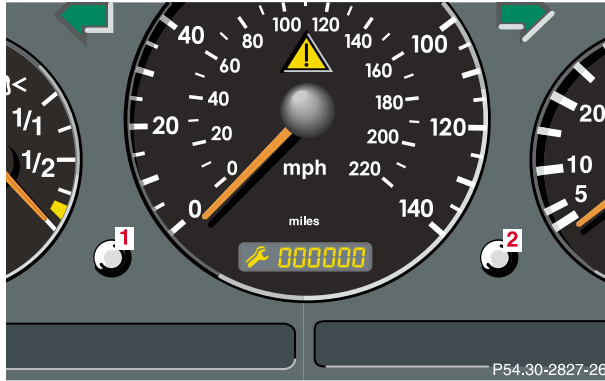

The display for temperature, odometer, oil level indicator and clock is activated by:

- Opening the driver's door.
- Pressing button (1) in the instrument cluster (with key removed or in steering lock position 0).
- Turning the key in steering lock to position 1 or 2.

Display illumination

Rotate knob (1) to vary intensity of instrument lamps:

- Clockwise - instrument lamp intensity increases.
- Counterclockwise - instrument lamp intensity decreases.

Odometer/trip odometer

Activate the instrument cluster.

- Press knob (1) once to switch to or from odometer to trip odometer readout.
- Press and hold knob (1) for more than 1 second to reset trip odometer (with trip odometer displayed).
- Press knob (1) twice to display next scheduled service.

Clock

Adjusting clock (instrument cluster activated):

Minute: Pull out knob (2) and turn it to the right.

Hour: Pull out knob (2) and turn it to the left.

Coolant temperature gauge

During severe operating conditions and stop-and-go city traffic, the coolant temperature may rise close to the red marking.

The engine should not be operated with the coolant temperature in the red zone. Doing so may cause serious engine damage which is not covered by the Mercedes-Benz Limited Warranty.

Warning!

- **Driving when your engine is badly overheated can cause some fluids which may have leaked into the engine compartment to catch fire. You could be seriously burned.**
- **Steam from an overheated engine can cause serious burns and can occur just by opening the engine hood. Stay away from the engine if you see or hear steam coming from it.**

Turn off the engine, get out of the vehicle and do not stand near the vehicle until it cools down.

Outside temperature indicator

The temperature sensor is located in the front bumper area. Due to its location, the sensor can be affected by road or engine heat during idling or slow driving. This means that the accuracy of the displayed temperature can only be verified by comparison to a thermometer placed next to the sensor, not by comparison to external displays (e.g. bank signs etc.).

Adaptation to ambient temperature takes place in steps and depends on the prevailing driving conditions (stop-and-go or moderate, constant driving) and amount of temperature change.

Warning!

The outside temperature indicator is not designed to serve as an Ice-Warning Device and is therefore unsuitable for that purpose. Indicated temperatures just above the freezing point do not guarantee that the road surface is free of ice.

Tachometer

The tachometer displays the present engine speed in revolutions per minute (RPM).

To help protect the engine, the fuel supply is interrupted if the engine is operated above its specified limit.

Trip computer (standard; optional on model ML 320)

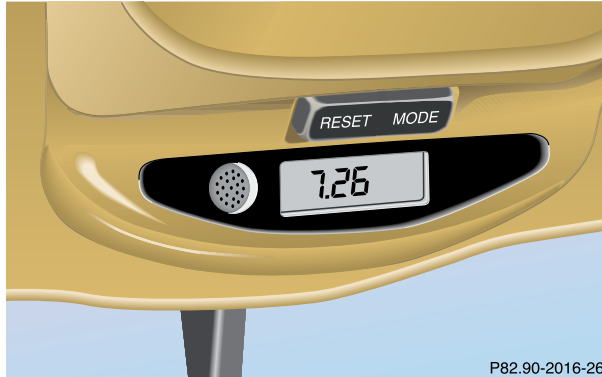

The trip computer is located in the overhead console.

Function keys are:

- RESET
- MODE

Note:

With engine not running, the display switches off automatically 30 seconds after the last entry.

To select a mode:

With key in steering lock position 1 or 2, press MODE key repeatedly to illuminate the display and scroll through menu for one of the following options:

1. Date, see page 84.
2. Compass, see page 84.
3. Stop watch, see page 86.
4. Present fuel consumption – displays miles per gallon or liters per 100 km.
5. Average fuel consumption – displays miles per gallon or liters per 100 km, see page 86.
6. Distance remaining with fuel presently in tank.

Note:

The display flashes when fuel supply drops to the reserve level. The distance remaining is no longer shown.

7. Language – Press RESET key until the desired language is displayed. Depending on language selected, information is displayed in that country's customary system. See page 86.
8. Trip computer switched off.

Trip computer

84

To change an entry, select mode to be changed:

- Date –

Press RESET key, the month shown blinks. Now press MODE key to advance to selected month.

Press RESET key again, the day shown blinks. Now press MODE key to advance to selected day.

Press RESET key again, the year shown blinks. Now press MODE key to advance to selected year.

Press RESET key again, the display stops blinking and the date is set.

- Compass –

The compass displays the direction the vehicle is traveling, such as N, NE, E, SE, S, SW, W or NW.

Note:

The presence of buildings, bridges, power lines and large antenna masts can influence the displayed values. Metallic or magnetic objects in or on the vehicle can influence the accuracy of the compass.

To change the compass zones:

Determine the geographical point of the vehicle with the aid of the zone maps below:

1. Turn key in steering lock to position 2.
2. Press MODE key repeatedly until the compass display appears in the trip computer display.
3. Press RESET key to select the compass zone mode. The zone selected last is shown in the display.
4. Press RESET key repeatedly until the correct compass zone, as determined from the zone map, is shown in the display.
5. Press MODE key twice to activate the new compass zone and change back to compass display.

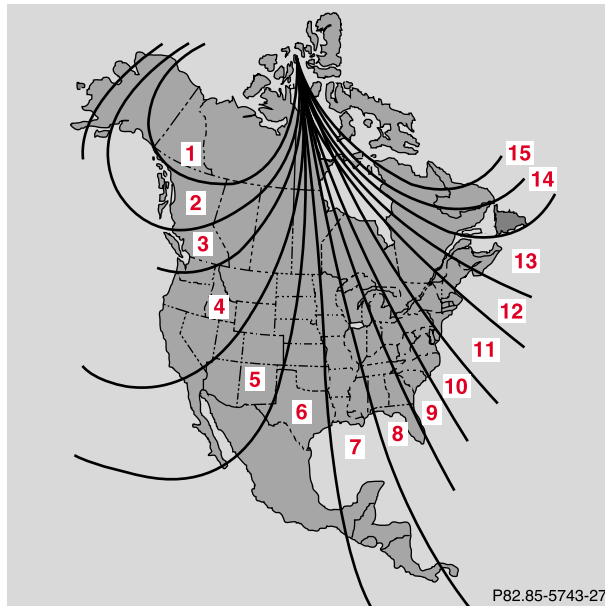

Zone map North America

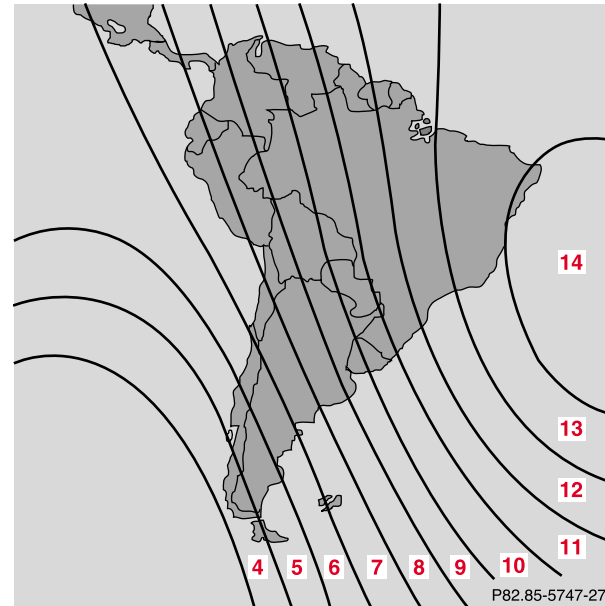

Zone map South America

Trip computer

85

| | | | | | | | |
|--------------------------|------------------|---------|----------------------------|-----------------|----------|----------------|-------|
| Instruments and controls | Operation | Driving | Instrument cluster display | Practical hints | Car care | Technical data | Index |
|--------------------------|------------------|---------|----------------------------|-----------------|----------|----------------|-------|

Trip computer

86

To calibrate the compass:

If the vehicle was exposed to a significant magnetic zone, such as high voltage power lines, the compass may have to be calibrated.

Calibration of the compass should be done in an area free of steel superstructures and power lines. All electrical consumers (e.g. exterior lamps, climate control, etc.) should be switched off, doors and liftgate closed. Do not open or close the roof. An open door or liftgate triggers the display “---”.

1. Start and run the engine.
 2. Press MODE key repeatedly until the compass display appears in the trip computer display.
 3. Press RESET key to select the compass zone display.
 4. Press RESET repeatedly until the correct zone, as determined from the zone map (see page 85), is shown in the display.
 5. Press MODE key, “CAL-” appears in the display.
 6. Press and hold RESET for a minimum of 2 seconds.
7. Without interruption drive two or more full circles at a speed between 3 mph (5 km/h) and 7 mph (10 km/h) during which the message “CAL” is replaced with a compass bearing (e.g. N, SW etc.), immediately followed by three full circles at the same speed, with only the rear window defroster switched on. The defroster can be switched off again. The calibration of the compass is now complete.

- Stop watch –

Press RESET key to start the count. Press again to stop the count. Press and hold RESET key to reset stop watch.

- Average fuel consumption –

Press RESET key to delete present reading.



- Language –

Press RESET key to set the language used in the display.



Flexible service system (FSS) (service indicator)



The FSS permits a flexible service schedule that is directly related to the operating conditions of the vehicle.

The symbol  or  appears in the main odometer field prior to the next suggested service. Depending on operating conditions throughout the year, the next service is calculated and displayed in days or distance remaining.

The display begins to appear either 30 days or 2000 miles/km prior to the next suggested service.

The symbols  or  indicate the type of service to be performed:



 Service A

 Service B

The message is displayed for approximately 10 seconds when turning the key in steering lock to position 2, or while driving when reaching the service warning threshold.

The message can be canceled manually by pressing button (1).

The next service due date is displayed either in days or in miles, depending on your driving style.

Once the suggested term has passed, the symbol  or  plus message, preceded by a – (minus symbol) blinks every time when turning the key in steering lock to position 2.

Calling up service indicator manually:

Activate the instrument cluster, see page 80.

Within 4 seconds press button (1) twice to call up the FSS display for approximately 10 seconds.

Flexible service system

88

Important!

The FSS indicator is not an engine oil level indicator. See page 89 for engine oil level indicator.

Notes:

When disconnecting vehicle battery for one or more days at a time, such days will not be counted. Any such days not counted by the FSS can be added by your Mercedes-Benz Light Truck Center.

The interval between services is determined by the type of driving for which the vehicle is used. For example, driving at extreme speeds, and cold starts combined with short distance driving in which the engine does not reach normal operating temperature, reduce the interval between services.

Following a completed A or B service the Mercedes-Benz Light Truck Center sets the counter mileage to 10 000 miles (Canada: 15 000 km) and 365 days.

The counter can also be set by any individual. To do so:

1. Turn the key in steering lock to position 2.
2. Immediately press button (1) twice within one second.

3. The present status for days or distance is displayed. Within 10 seconds turn key in steering lock to position 0.
4. Press and hold button (1), while turning key in steering lock to position 2 again. The present status for days or distance is displayed once more. Continue to hold button (1).

After approximately 10 seconds a signal sounds, and the display shows 10 000 miles (Canada: 15 000 km) for approximately 10 seconds.
5. Release button (1).

If the FSS counter was inadvertently reset, have it corrected at a Mercedes-Benz Light Truck Center.

Notes:

The FSS allows for distances between 10 000 miles (Canada: 15 000 km) and 20 000 miles (Canada: 30 000 km), or from 365 to 730 days between services.

However you choose to set your reference numbers, the scheduled services as posted in the Service Booklet must be followed to properly care for your vehicle.

Engine oil level indicator



To check the engine oil level, park vehicle on level ground, with engine at normal operational temperature.

Check oil level approximately 5 minutes after stopping the engine, allowing for the oil to return to the oil pan.

Turn the key in steering lock to position 2 and wait until the display “-----” appears in the odometer display field.

Within 1 second press button (1) twice.

The following messages are available:

“OIL i.0”

No oil needs to be added.

“-1.0 L”

“-1.5 L”

“-2.0 L”

Add oil to upper (max) mark of the dipstick.

See page 233 for instructions on adding engine oil.

“OIL HI”

Do not overfill the engine.

Excessive oil must be siphoned or drained off. It could cause damage to the engine and catalytic converter not covered by the Mercedes-Benz Limited Warranty.

The display “-----” flashes in the odometer display field if a proper oil level check cannot be performed. The engine oil level check can be repeated after a short time.

Perform the engine oil level check with the dipstick, if it cannot be completed via the odometer display field. See page 233.

In this case we recommend that you have the system checked at a Mercedes-Benz Light Truck Center.



Exterior lamp switch

90

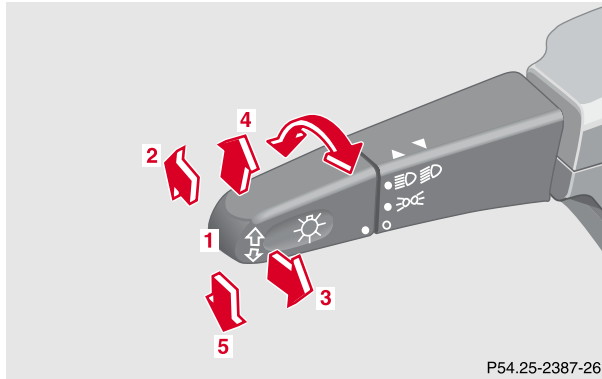
Exterior lamp switch



Rotate switch  to positions:



-  Off
-  Parking lamps (also side marker lamps, taillamps, license plate lamps, instrument panel lamps)
Canada only: When the engine is running, the low beam is additionally switched on.
-  Parking lamps plus low beam or high beam headlamps (switch pushed forward)

P Standing lamps, left or right side (depending on turn signal switch position). Turn key in steering lock to position 0 or remove.

Standing lamps, left – move stalk to position (5).

Standing lamps, right – move stalk to position (4).

Move stalk to positions:

- 1 Low beam (exterior lamp switch position )
- 2 High beam (exterior lamp switch position )
- 3 High beam flasher (high beam available independent of exterior lamp switch position)
- 4 Turn signals, right
- 5 Turn signals, left

To signal minor directional changes, such as changing lanes on a highway, move exterior lamp switch briefly to the point of resistance only and release. The turn signals blink three times.

To operate the turn signals continuously, move the exterior lamp switch past the point of resistance (up or down). The switch is automatically canceled when the steering wheel is turned to a large enough degree.

Turn signal failure

If one of the turn signals fails, the turn signal indicator system flashes and sounds at a faster than normal rate.

Standing lamps

When the vehicle is parked on the street the standing lamps (right or left side parking lamps) can be turned on, making the vehicle more visible to passing vehicles.

The standing lamps cannot be operated with the key in steering lock position 1 or 2.

Note:

With the key removed and a front door open, a warning sounds if the vehicle's exterior lamps (except standing lamps) are not switched off.

Daytime running lamps (Canada only)

When the engine is running and the selector lever is in a driving position, the low beam headlamps (includes parking lamps, side marker lamps, taillamps and license plate lamps) are automatically switched on.

When shifting from a driving position to position "N" or "P", the low beam switches off (2 seconds delay).

For nighttime driving the exterior lamp switch should be turned to position  to permit activation of the high beam headlamps.

Fog lamp switch

92

Fog lamp switch (except Canada)

The switch is located in the center console.

Press down rocker switch symbols:

- 1 Auxiliary front fog lamps on (if so equipped). Green indicator lamp  in instrument cluster comes on.

Press upper half of the switch again to switch fog lamps off. The green indicator lamp  in instrument cluster goes out.

- 2 Rear fog lamp (driver's side) on. Yellow indicator lamp in switch comes on in addition to green indicator lamp  in instrument cluster. Press lower half of the switch again to switch rear fog lamp off. The yellow indicator lamp in switch goes out.

Note:

Front fog lamps operate with the low beam headlamps on. Consult your state Motor Vehicle Regulations regarding allowable lamp operation.

Fog lamp switch (Canada only)



The switch is located in the center console.

Press down rocker switch symbols:

- 1 Front fog lamps on (if so equipped). Green indicator lamp  in instrument cluster comes on.

Press upper half of the switch again to switch fog lamps off. The green indicator lamp  in instrument cluster goes out.

- 2 Rear fog lamp (driver's side) in addition to front fog lamps on. Yellow indicator lamp in switch comes on in addition to green indicator lamp  in instrument cluster.

Press lower half of the switch again to switch rear fog lamp off. The yellow indicator lamp in switch goes out.

When pressing upper half of the switch once with front fog lamps and rear fog lamp on, first the rear fog lamp is switched off. The yellow indicator lamp in the switch goes out. Press upper half of the switch again to switch off front fog lamps. The green indicator lamp  in instrument cluster also goes out.

Note:

Front fog lamps operate with the low beam headlamps on. Consult your state Motor Vehicle Regulations regarding allowable lamp operation.

Hazard warning flasher

94

Hazard warning flasher switch

The hazard warning flasher switch is located on top of the steering column.

The hazard warning flasher can be activated either manually via the switch located in the dashboard, or it is activated automatically at the time an airbag is deployed.

To activate hazard warning flasher, press switch once. To deactivate, press switch again.

If hazard warning flasher was activated automatically, press switch twice to deactivate.

Note:

To signal turns while being towed with hazard warning flasher in use, turn key in steering lock to position 2 and activate combination switch for left or right turn signal in usual manner. Now deactivate the hazard warning flasher, only the selected turn signal will operate. Upon canceling the turn signal, the hazard warning flasher must be activated again.

**Headlamp cleaning system
(with Xenon headlamps)**

The switch is located in the instrument panel behind the steering wheel.

The headlamp washer can be activated with the key in steering lock position 2.

Briefly press symbol side of switch.

Windshield wiper/washer switch

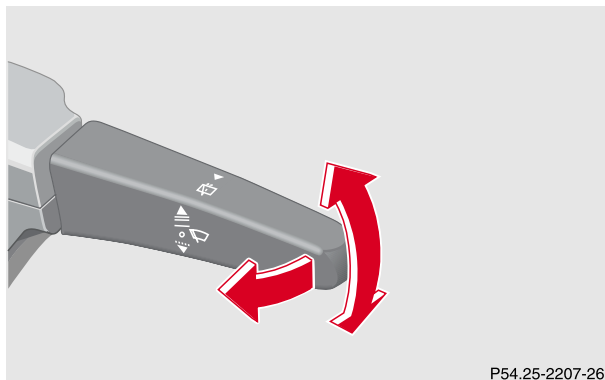

Move stalk briefly up for single wipe without adding washer fluid (use only when windshield is wet).

Pull stalk toward steering wheel and hold to activate wiper and washer.

- Wiper off

Move stalk down for:

- Intermittent wiping
(Interval is vehicle speed dependent¹.
Optional rain sensor: One initial wipe, pauses between wipes are automatically controlled by a rain sensor monitoring wetness of windshield.)

Notes:

With vehicle at a standstill, a front door open and the key in steering lock position 2 there will be no operation of windshield wipers in intermittent setting.

Optional rain sensor:

Do not leave in intermittent setting when vehicle is taken to an automatic car wash or when cleaning the windshield. Wipers will operate in presence of water spray at windshield, and wipers may be damaged as a result.

Move stalk up for:

— Normal wiper speed

== Fast wiper speed

¹ At speeds of approximately 105 mph (170 km/h) the wiper switches automatically to continuous wiping.

Rear window wiper/washer

96

Rear window wiper/washer



The rear window wiper/washer switch is located in the instrument panel.

With key in steering lock position 2:

- 1 Press for interval wiping,
- 2 Press to switch off,
or

press briefly for approx. 5 seconds wiper operation,
or

press and hold for simultaneous operation of wiper
and washer. After releasing the switch the wiper
operates for additional 5 seconds.

The rear window wiper will also automatically engage if
the windshield wiper is engaged and the gear selector
lever is placed in "R" Reverse.

Windshield wipers smear

If the windshield wipers smear the windshield, even during rain, activate the washer system as often as necessary. The fluid in the washer reservoir should be mixed in the correct ratio.

Note:

For windshield and headlamp washer fluid mixing ratio see page 237.

Blocked windshield wipers

If the windshield wipers become blocked (for example, due to snow), switch off the wipers.

For safety reasons before removing ice or snow, remove key from steering lock. Remove blockage.

Activate windshield wiper/washer switch again (key in steering lock position 1).

Climate control

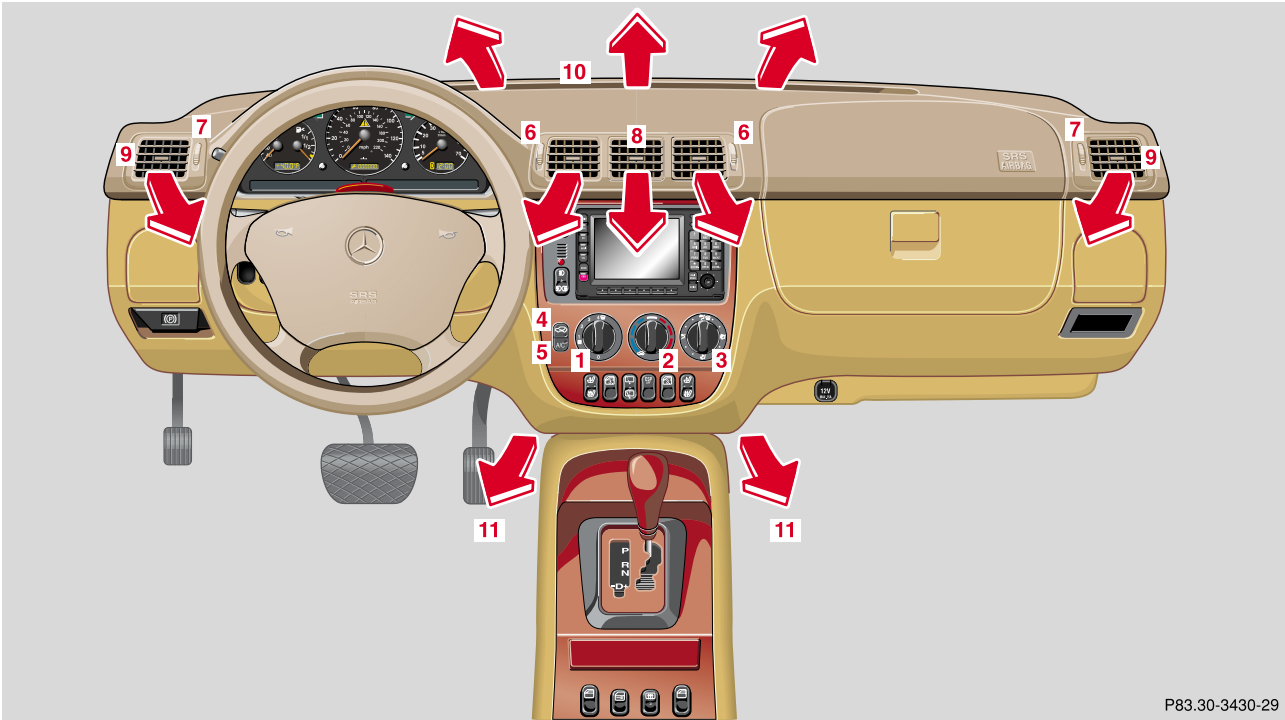

- 1 Air volume control switch
- 2 Temperature selector switch
- 3 Air distribution switch
- 4 Air recirculation
- 5 Air conditioning mode
- 6 Air volume control for center air outlets, turn wheel up to open.
- 7 Air volume control for side air outlet, turn wheel up to open.
- 8 Center air outlets, adjustable
- 9 Side air outlets, adjustable
- 10 Windshield air outlets
- 11 Floor outlets

The air conditioning mode only operates with the  button pushed, the air volume control switch set to position 1 to 4, and the engine running.

To quickly cool down the passenger compartment, turn temperature selector switch fully to the left to position . Turn temperature selector to maintain desired temperature.

The air conditioning mode removes considerable moisture from the air during operation in the cooling mode. It is normal for water to drip on the ground through ducts in the underbody.

Important!

This vehicle is equipped with an air conditioner system that uses R-134a (HFC: hydrofluorocarbon) as a refrigerant. Repairs should always be performed by a qualified technician, and refrigerant should be collected in a recovery system for recycling.

Note:

For the air flow-through system to function properly, the air vents, located in the left and right side rear passenger compartment trim panel covers, should be kept unobstructed.

Climate control

100

Basic setting - Heater

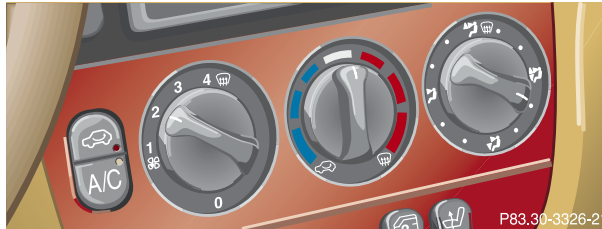

Select temperature.

Select air volume with control switch , set at least to position 2 to prevent windows from fogging up.

Set air distribution control switch to position shown above.

Turn wheels (7) to position  to open left and right side air outlets (9). Adjust air outlets upward.

Open center air outlets as desired.

Basic setting - Air Conditioner



Switch on air conditioner with control button .

Select temperature.

Select air volume with control switch , set at least to position 1.

Set air distribution control switch to position .

Open side air outlets.

Open center air outlets.

Special setting (use only for short duration)

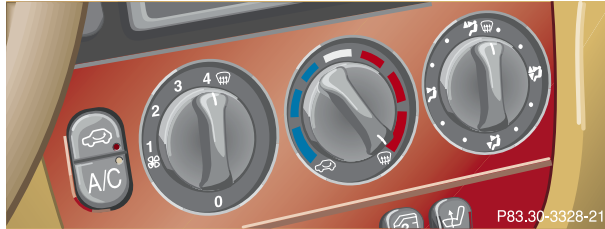

Defrosting windshield

Set temperature selector and switches for air volume and air distribution to position .

Turn wheels (7) to position  to open left and right side air outlets (9). Adjust air outlets upward.

Close center air outlets.

Defogging windows

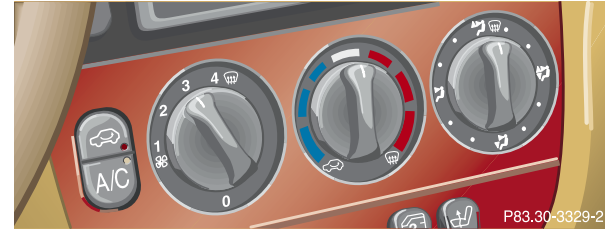

Windows fogged up on inside.

Switch on air conditioning mode with control .

Switch off air recirculation . Indicator lamp in button goes out.

Set air distribution control switch to position .

Increase air volume with control switch.

Turn side air outlet wheels (7) to position .



Close center air outlets.

Climate control

102

Windshield fogged up on outside.

Switch on wiper motor.

Set air distribution control switch to position  or .

Dust filter

Nearly all dust particles and pollen are filtered out before outside air enters the passenger compartment through the air distribution system.

Note:

Keep the air intake grille in front of windshield free of snow and debris.

Climate control – OFF

To switch the climate control off, set air volume control switch to position **0**.

Switch off air conditioning mode . Control lamp in button goes out.

Air recirculation

This mode can be selected to temporarily reduce the entry of annoying odors or dust into the vehicle's interior.

Outside air is not supplied to the vehicles's interior.

To select, press  button. Indicator lamp in button lights up.

To cancel, press  button again. Indicator lamp in button goes out.

If the windows should fog up from the inside, switch from recirculated air back to fresh air.

Rear window defroster

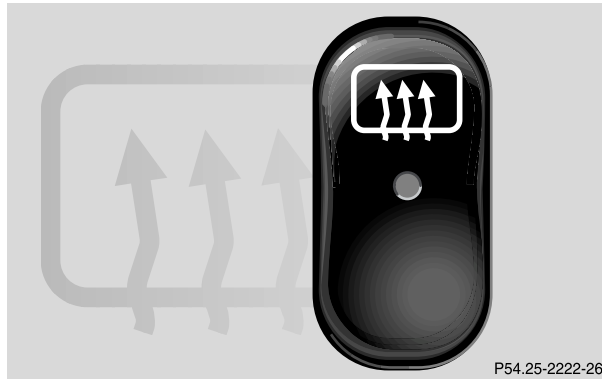

The switch is located on the center console.

With the engine running, press upper half of the switch. Indicator lamp in switch comes on.

To cancel, press upper half of the switch again. Indicator lamp in switch goes out.

Notes:

Heavy accumulation of snow and ice should be removed before activating the defroster.

The rear window defroster consumes a large amount of electrical power. To keep the battery drain to a minimum, turn off the defroster as soon as the window is clear.

The defroster is automatically turned off after approximately 10 to 18 minutes of operation, dependent on the outside temperature.

If several power consumers are turned on simultaneously, or the battery is only partially charged, it is possible that the rear window defroster will automatically turn itself off. When this happens, the indicator lamp inside the switch starts blinking for approximately 30 seconds. If within this time the battery has sufficient voltage, the rear window defroster automatically turns itself back on.

After approximately 30 seconds without sufficient voltage the rear window defroster switches off (indicator lamp goes out).

Interior equipment

104

Power windows

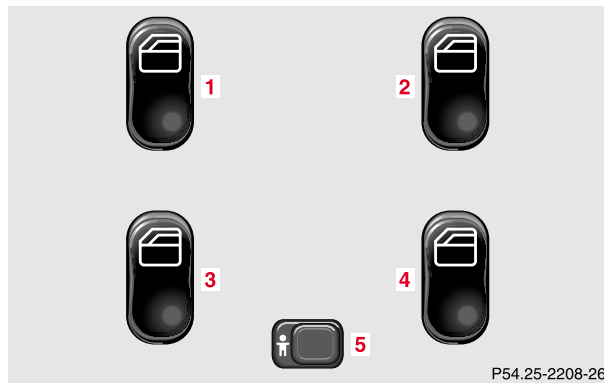

Power window switches located on front center console

- 1 left, front
- 2 right, front
- 3 left, rear
- 4 right, rear
- 5 Switch for rear door window override



Power window switches located on rear center console

- 6 individual switches (rear doors)

The windows can be operated with key in steering lock position 1 or 2.

Operation:

Press switch in to resistance point to open.

Lift switch to close.

Release switch when window is in desired position.

Warning!

When closing the windows, be sure that there is no danger of anyone being harmed by the closing procedure.

The closing procedure can be immediately reversed by pressing the power window switch.

When leaving the vehicle, always remove the key from the steering lock, and lock the vehicle. Do not leave children unattended in the vehicle, or with access to an unlocked vehicle. Unsupervised use of vehicle equipment can cause serious personal injury.

Express opening of front door windows

Press switch past resistance point and release – window lowers to fully open position. To interrupt procedure, briefly pull switch.

Blocking of rear door window operation

If no operation of the rear door windows by switch (6), located on rear center console (for instance by children) is desired, slide override switch (5) to right, symbol  becomes visible.

Warning!

When leaving the vehicle, always remove the key from the steering lock, and lock the vehicle. Do not leave children unattended in the vehicle, or with access to an unlocked vehicle. Unsupervised use of vehicle equipment can cause serious personal injury.

Note:

After turning off the engine the power windows can be operated for approximately 30 minutes or until a front door is opened.

Interior equipment

106

Rear quarter windows (optional on ML 320 and 430)

Switches located on front center console

The rear quarter windows can be operated with key in steering lock position 1 or 2.

- 1** Push to open.
- 2** Push to close.

Note:

After turning off the engine the rear quarter windows can be operated for approximately 30 minutes or until a front door is opened.

Warning!

When closing the windows, be sure that there is no danger of anyone being harmed by the closing procedure.

When leaving the vehicle, always remove the key from the steering lock, and lock the vehicle. Do not leave children unattended in the vehicle, or with access to an unlocked vehicle. Unsupervised use of vehicle equipment can cause serious personal injury.

Sliding/pop-up roof (optional)

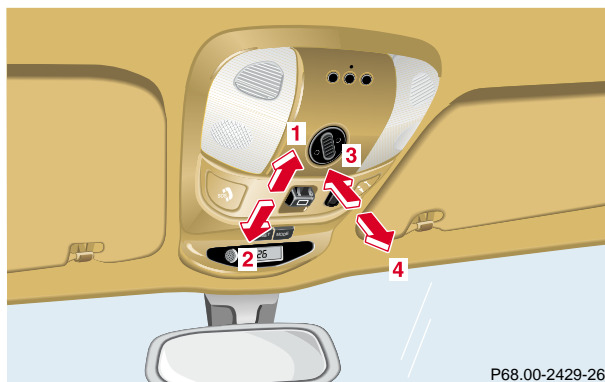

- 1 to slide roof open
- 2 to slide roof closed
- 3 to raise roof at rear
- 4 to lower roof at rear

The sliding/pop-up roof can be operated with key in steering lock position 1 or 2.

Warning!

When closing the sliding/pop-up roof, be sure that there is no danger of anyone being harmed by the closing procedure.

The closing procedure can be immediately reversed by moving the switch in direction (1) or (3).

When leaving the vehicle, always remove the key from steering lock, and lock your vehicle. Do not leave children unattended in the vehicle, or with access to an unlocked vehicle. Unsupervised use of vehicle equipment can cause serious personal injury.

Notes:

The sliding/pop-up roof can be opened or closed manually should an electrical malfunction occur, see page 272.

After turning off the engine the sliding/pop up roof can be operated for approximately 30 minutes or until a front door is opened.

Interior equipment

108



With the roof closed or tilted open, a screen can be slid into the roof opening to guard against sun rays. When sliding the roof open, the screen will also retract.

Express opening of sliding/pop-up roof

To open sliding/pop-up roof automatically, briefly move switch in direction (1) and release. The roof will not open fully. Press again to open it fully.

To interrupt procedure, briefly move switch in any direction.

Note:

For resynchronizing the express opening feature see page 272.

Skyview Top (optional)



The Skyview Top can be operated with key in steering lock position 1 or 2.

- 1** to slide roof open
- 2** to slide roof closed

To fully open Skyview Top automatically, briefly press switch in direction (1) and release. To stop the process, press switch again.

Warning!

When closing the Skyview Top, be sure that there is no danger of anyone being harmed by the closing procedure.

The closing procedure can be immediately reversed by moving the switch in direction (1).

When leaving the vehicle, always remove the key from steering lock, and lock your vehicle. Do not leave children unattended in the vehicle, or with access to an unlocked vehicle. Unsupervised use of vehicle equipment can cause serious personal injury.

Notes:

After turning off the engine the Skyview Top can be operated for approximately 30 minutes or until a front door is opened.

The Skyview Top can be opened or closed manually should an electrical malfunction occur, see page 273.

Interior equipment

110

Interior lighting

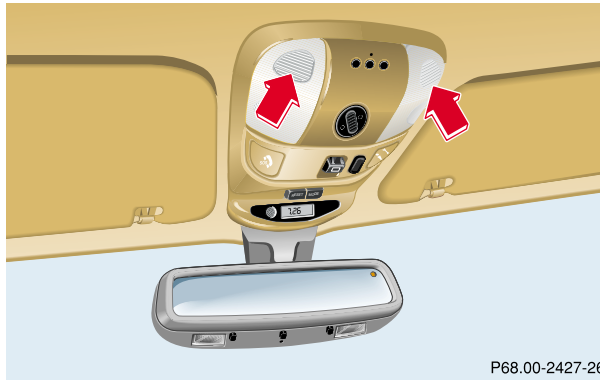

Lamps above instrument panel

Interior lamps above instrument panel are switched on, and off (soft fade) delayed, when unlocking the vehicle, or when opening a front door or closing front doors.

With doors closed, push on lamp lens to switch interior lamps on or off.

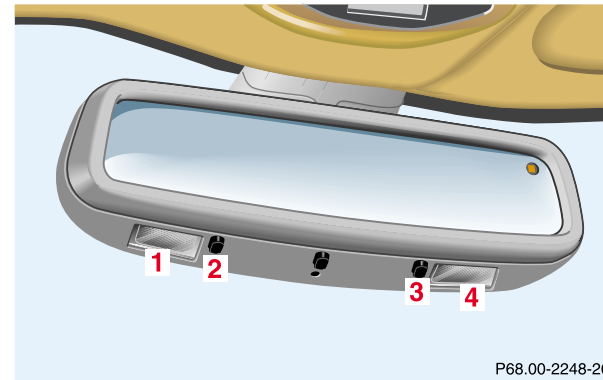

Reading lamps in inside rear view mirror

- 1 Reading lamp, left
- 2 Push button to switch left reading lamp on and off
- 3 Push button to switch right reading lamp on and off
- 4 Reading lamp, right

The reading lamps cannot be switched on and off by the door contact switches.

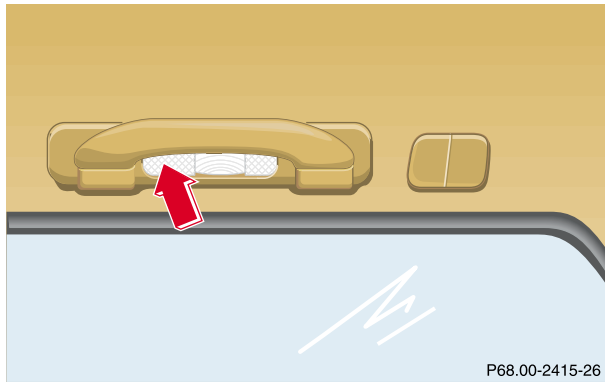

P68.00-2415-26

Lamps above rear doors

Interior lamps above rear doors are switched on, and off (soft fade) delayed, when opening a rear door or closing rear doors.

With rear doors closed, push on lamp lens to switch interior lamps on or off.

Note:

If lamp is switched on manually, it does not go out by closing the door.

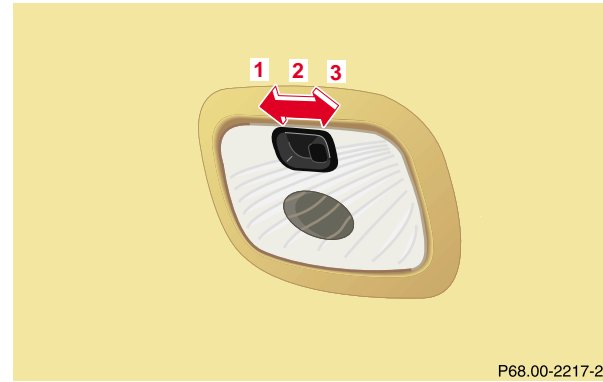

P68.00-2217-26

Cargo compartment lamp

- 1 The lamp is switched off.
- 2 The lamp is switched on continuously.

To prevent the vehicle battery from being discharged, move switch to position (1) or (3) before leaving the vehicle.

- 3 The lamp is switched on and off by the opening and closing of the liftgate.

Interior equipment

112

Switch for interior lamps/lamps above rear doors

- 1 Press to switch lamps above rear doors off.

To switch both lamps above rear doors on, briefly press upper half of switch again.

Note:

With one lamp above rear door illuminated, first the lamp goes out when pressing upper half of the switch. Press again to switch both lamps on.

- 2 Press in to switch interior lamps off (except cargo compartment lamp).

The interior lamps remain switched off, even when opening a door.

With rocker switch in center position, the interior lamps operate as described on previous pages.

Entrance lamps, exit lamps in doors

The lamps are switched on and off by the door contact switches.

Notes:

To prevent the vehicle battery from being discharged, with doors open all interior lamps (except rear cargo compartment lamp) go out after approximately 30 minutes.

If an interior lamp is switched on manually, it does not go out automatically. Before leaving the vehicle, make sure that all interior lamps are switched off.

Sun visors



Swing sun visors down to protect against sun glare.
If sunlight enters through a side window, disengage visor from inner mounting, pivot it to the side, and slide it to the desired position.

Illuminated vanity mirrors

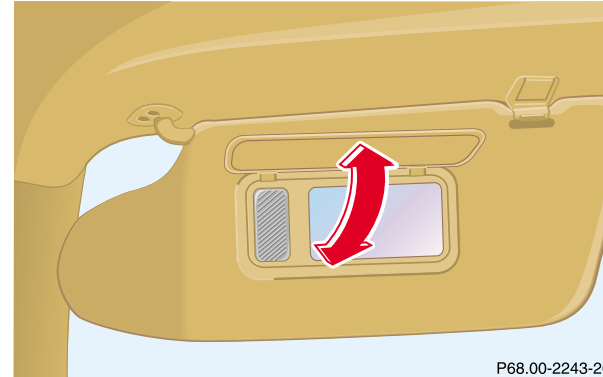

With the visor engaged in its inner mounting and with key in steering lock position 1 or 2, the lamp is switched on by opening the cover.

Warning!

Do not use the vanity mirror while driving.

| | | | | | | | |
|--------------------------|------------------|---------|----------------------------|-----------------|----------|----------------|-------|
| Instruments and controls | Operation | Driving | Instrument cluster display | Practical hints | Car care | Technical data | Index |
|--------------------------|------------------|---------|----------------------------|-----------------|----------|----------------|-------|

Interior equipment

114

Interior

Warning!

To help avoid personal injury during a collision or sudden maneuver, exercise care when stowing things. Put luggage or cargo in the trunk if possible. Do not pile luggage or cargo higher than the seat backs.

Luggage nets cannot secure hard or heavy objects.

Storage compartments, armrest and cup holder

Warning!

Keep compartment lids closed. This will help to prevent stored objects from being thrown about and injuring vehicle occupants during an accident and sudden maneuvers.

Glove box

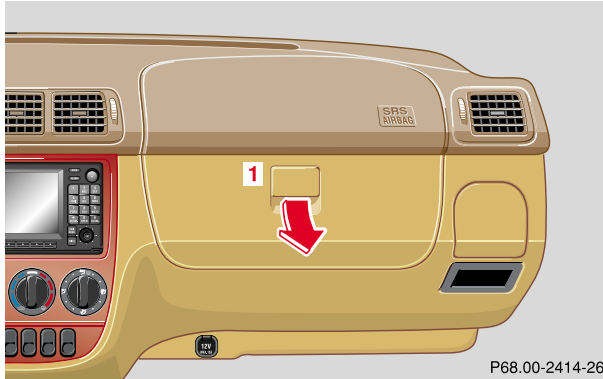

Pull handle (1) to open.

The glove box is illuminated with key in steering lock position 1 or 2 when opening the lid.

Storage compartment below center armrest

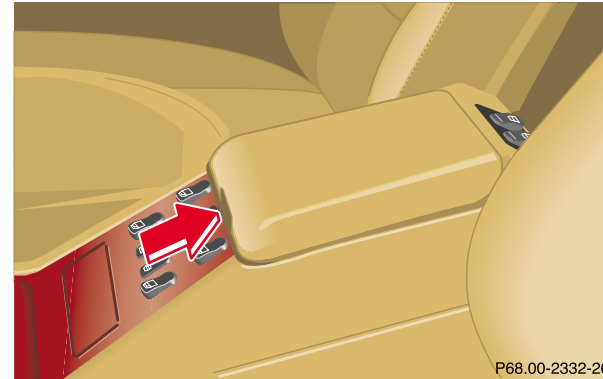

To open compartment:
Press button and lift lid.

To close:
Lower lid until it engages in lock.

Interior equipment

116

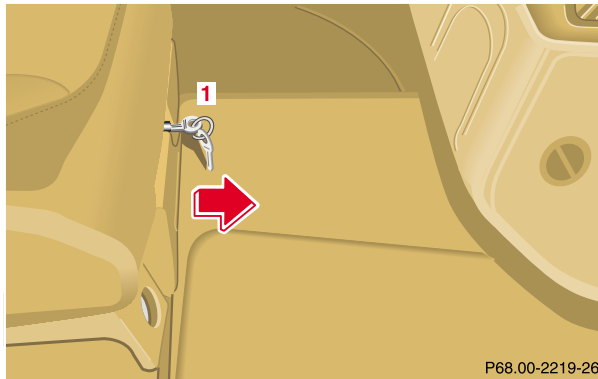
Storage compartment under front passenger seat
(standard; optional on model ML 320)

The storage compartment under the front passenger seat is lockable with its separate key (1).

Note:

Slide seat rearward to gain easier access to the storage compartment.

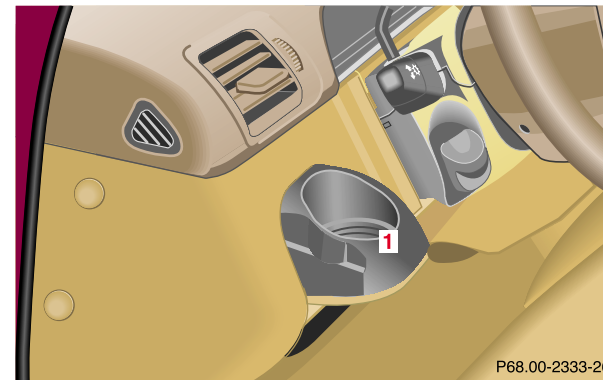
Cup holder in instrument panel

Touch top of cover. The cup holder (1) opens automatically.

Caution!

Keep cup holder closed while traveling. Place only containers that fit into the cup holder to prevent spills. Do not fill containers to a height where the contents could spill during vehicle maneuvers, especially hot liquids.

Cup holder in rear center console

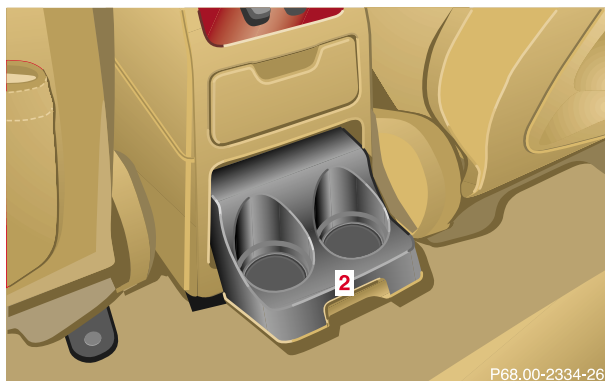

To open cup holder (2), pull down at top of cover.

Caution!

Keep cup holder closed while traveling. Place only containers that fit into the cup holder to prevent spills.

Do not fill containers to a height where the contents could spill during vehicle maneuvers, especially hot liquids.

Armrest in rear bench seat

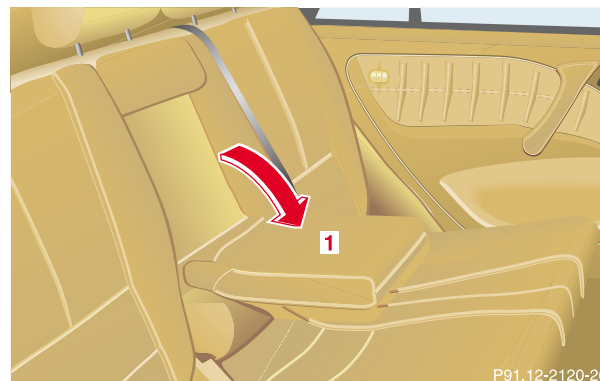

Pull down armrest (1) by its top.

Interior equipment

118

Ashtrays**Center console, front**

By touching the top of the cover lightly, the ashtray opens automatically.

To remove ashtray: Pull up and remove ashtray insert.

Warning!

Remove front ashtray only with vehicle standing still. Turn off the engine and set the parking brake. Otherwise the vehicle might move as a result of unintended contact with the gear selector lever.

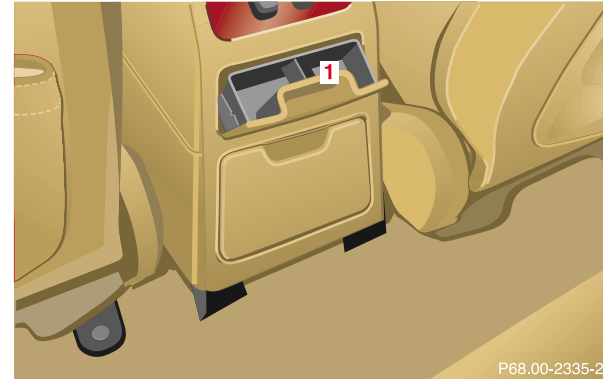
Rear passenger compartment

Pull to open.

To remove ashtray:

Open ashtray (1) and pull out the ashtray insert.

Lighter



Turn key in steering lock to position 1 or 2. Push in lighter (1); it will pop out automatically when hot.

Warning!

Never touch the heating element or sides of the lighter, they are extremely hot, hold at knob only.

When leaving the vehicle always remove the key from the steering lock. Do not leave children unattended in the vehicle, or with access to an unlocked vehicle. Unsupervised use of vehicle equipment may cause serious personal injury.

The lighter socket can be used to accommodate electrical accessories up to maximum 50 W.

Interior equipment

120

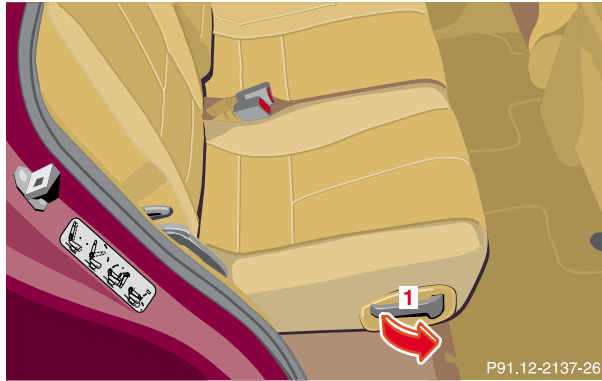
Split rear seat bench

The rear seat bench can be moved fore/aft, folded and lowered to increase the cargo area. The left, right or both seat back sections may be folded down according to need.

To slide rear seat bench fore/aft:

1. Pull lever (1) in direction of arrow, and slide seat bench section to desired position until it locks in place.

To enlarge cargo area:

1. Close cup holder in rear center console.
2. Move front seats forward, see page 39 for manual seats and page 40 for power seats.
3. Pull lever (1) in direction of arrow, and slide seat bench section forward.
4. Remove head restraint(s). The head restraint(s) should be stored beneath the cargo floor plates.

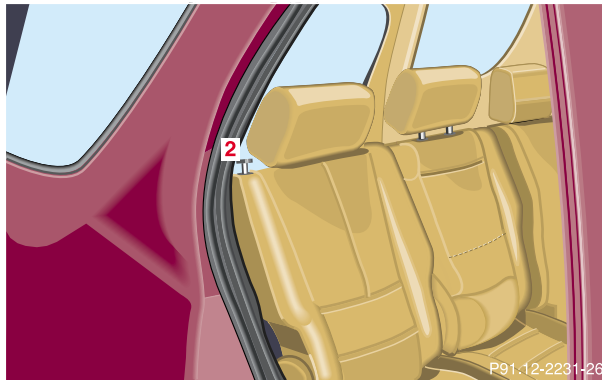

5. Pull lock button (2) up, and fold seat back forward until it locks in place.

The red backrest lock indicators at the lock buttons (2) are not visible in locked position.

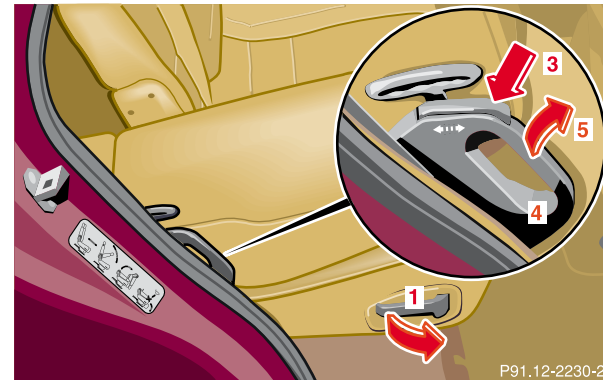

6. Press lock button (3) to unlock lever (4). Pull lever (4) in direction of arrow (5), then pull lever (1) and push down seat bench section until it locks in place.

Interior equipment

122

To return seat bench section to sitting position:

1. Pull lever (1) and raise seat bench section until it locks in place.
2. Pull lock button (2) up, and unfold seat back to upright position. Check for secure locking by pushing and pulling on the backrest. The red backrest lock indicators at the lock buttons (2) are not visible in locked position.
3. Pull lever (1) in direction of arrow, and slide seat bench section rearward to desired position.

4. Install and adjust head restraint.

For installation of head restraints see page 124.

Warning!

Failure to assure that seats are locked into place could result in an increased chance of injury in an accident.

Never place hands under seat or near any moving parts while a seat is being adjusted.

Easy entry/exit feature
(only in vehicles with third row seats)

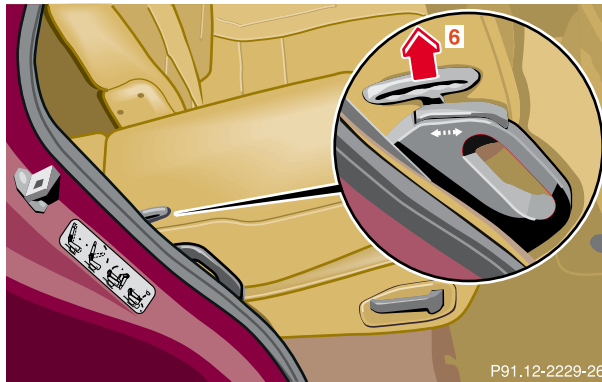

Folding right seat bench section for access to rear compartment area:

1. Move right front seat forward.
2. Slide seat bench section forward.
3. Push head restraint fully down and tilt it forward, see page 43.

4. Pull lock button (2) of seat back up, and fold seat back forward.
5. Remove respective cargo floor plate, see page 129.
6. Pull lever (6) up, and fold seat bench section forward.

Resetting seat bench:

1. Pull down on seat bench section until it locks into place.
2. Pull lock button (2) up, and unfold seat back to upright position. Check for secure locking by pushing and pulling on the backrest. The backrest lock indicators at the lock buttons (2) are not visible in locked position.
3. Pull up and adjust head restraint.

Caution!

Never drive with the second row right seat folded forward (easy entry/exit feature). It could open and fold back unintentionally.

When unfolding the seat, be sure that there is no danger of anyone being harmed by the procedure.

Interior equipment

124

Rear seat head restraints

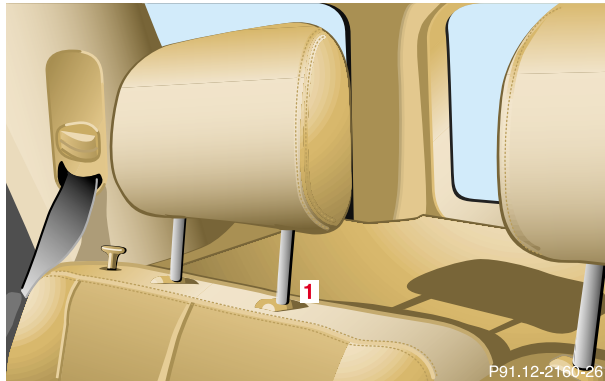

Raising:
Pull up on head restraint.

Lowering:
Push down on head restraint.

Adjust head restraint to support the back of the head approximately at ear level. The head restraint angle can also be adjusted manually.

Removal:

Pull head restraint to its highest position. Push lock button (1) and pull out head restraint completely with both hands. The head restraint(s) should be stored below the cargo floor plates.

Installation:

Insert the head restraint and push it down to the stop. Ensure proper head restraint positioning, see above.

Warning!

For your protection, drive only with properly positioned head restraints.

Adjust head restraint to support the back of the head approximately at ear level.

Do not drive the vehicle without the seat head restraints. Head restraints are intended to help reduce injuries during an accident.

Caution!

Do not remove head restraints except when mounting seat covers. Whenever head restraints have been removed be sure to reinstall them before driving.

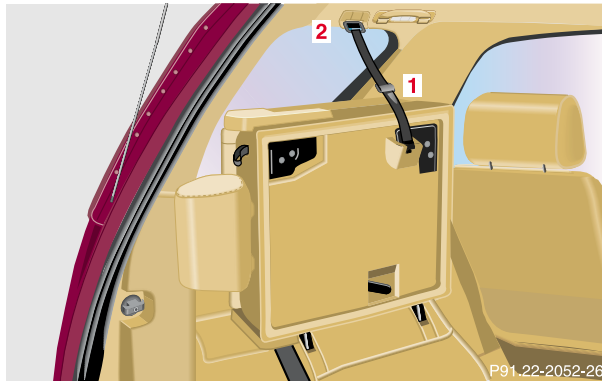
Third row seats (MB Accessory)

Two single seats can be unfolded to enlarge the seating area.

To fold seat down:

1. Remove head restraint from seat cushion.
2. Remove cargo floor plate, see page 129.
3. Lift tensioner (1) upward to a horizontal position to release tension of the strap.



4. Disengage hook (2) and attach belt at hook and loop strip on underside of seat.
5. Fold seat down until it locks securely in place.

Important!

When seat is correctly unfolded, the red marking on the seat release (4) should not be visible.

6. Store cargo floor plates inside the backrest, see page 130.

7. Pull release lever (3) and unfold seat back until it locks securely in place.
8. Install head restraint in seat back.

Note:

For removal and installation of head restraint refer to rear seat head restraints on page 124.

To store seat:

1. Remove head restraint from seat back.
2. Pull release lever (3) and fold seat back forward until it audibly locks securely in place. Place seat belt between lever (3) and backrest.
3. Remove cargo floor plates from the backrest.
4. Pull seat release (4) and fold seat up. Engage hook (2) in ceiling mount. Pull on free end of strap until tight.
5. Install head restraint in openings provided in seat cushion.
6. Install cargo floor plates, see page 129.

Warning!

Failure to assure that seats are locked into place could result in an increased chance of injury in an accident.

Never place hands under seat or near any moving parts while a seat is being adjusted.

For your protection, drive only with properly positioned head restraints.

Adjust head restraint to support the back of the head approximately at ear level.

Interior equipment

128

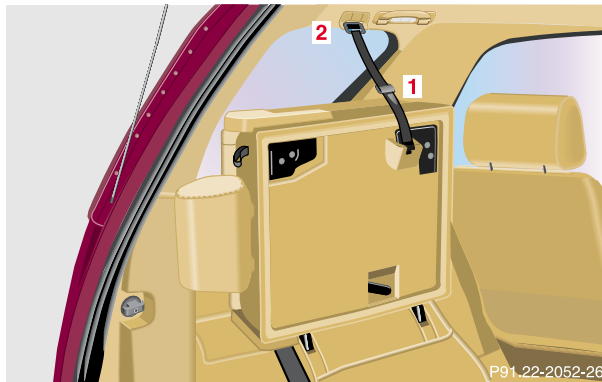

To remove seat:

1. Lift tensioner (1) upward to a horizontal position to release tension of the strap.
2. Disengage hook (2) and attach belt at hook and loop strip on underside of seat.

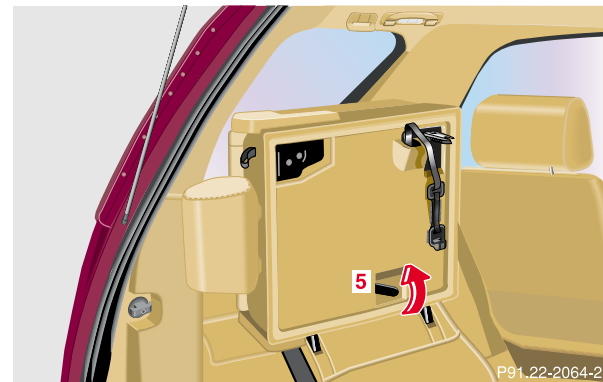

3. Move lever (5) upward and remove seat.

Removable cargo floor plates

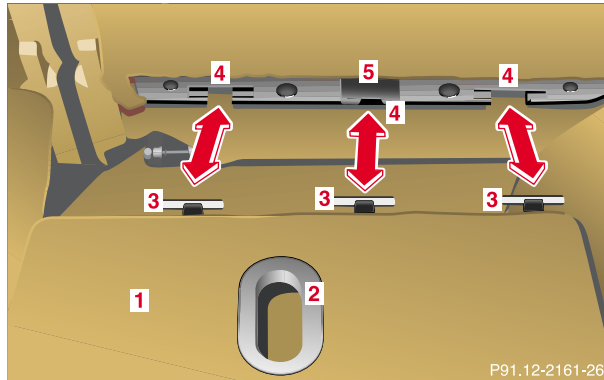

The cargo floor plates (1) behind the split rear seat bench are removable.

To remove:

Lift cargo floor plate at rear edge until it unhinges.
Remove cargo floor plate by pulling it rearward.

To install:

Grip into opening (2) and guide pins (3) into attachment openings (4) until release (5) audibly locks.

Interior equipment

130

Storage of cargo floor plates

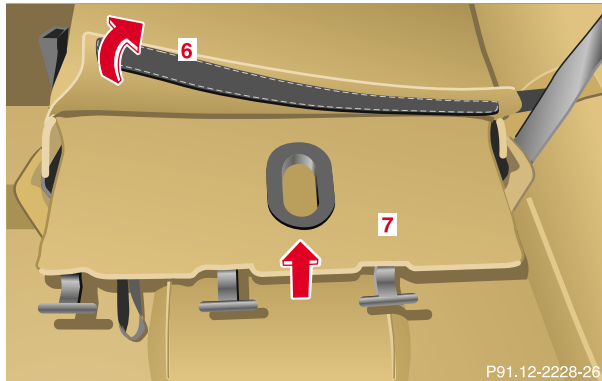

To store cargo floor plates, open hook and loop strip (6) at bottom of backrest of the split rear seat bench and insert floor plates (7, arrow).

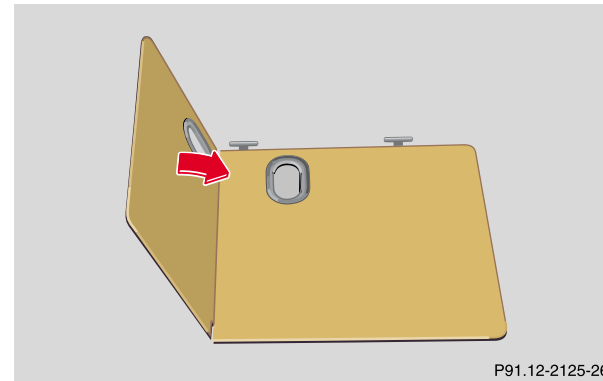

Note:

Before storing the left cargo floor plate, fold it together in direction of arrow.

Enlarged cargo area

The cargo area can be enlarged by moving the rear seat bench forward. Also, the left, the right or both sections may be folded according to need.

For folding and resetting seating to standard positions, see page 120.

Warning!

Always lock backrest in its upright position when rear seat bench is occupied by passengers, or cargo is being carried behind the seat bench.

To help avoid personal injury from smaller objects flying in the occupant area during a collision or sudden maneuver, always use partition net when transporting cargo, see page 133.

Interior equipment

132

Cargo tie-down rings

Carefully secure cargo by applying even load on all rings with rope of sufficient strength to hold down the cargo. The cargo area is provided with four tie-down anchors. Additional two rings are located at the rear of front seats.

Caution!

While the partition net will help protect you from smaller objects, it cannot prevent the movement of large, heavier objects into the passenger area in an accident. Such items must be properly secured using the cargo tie-down rings in the cargo area floor.

Hooks

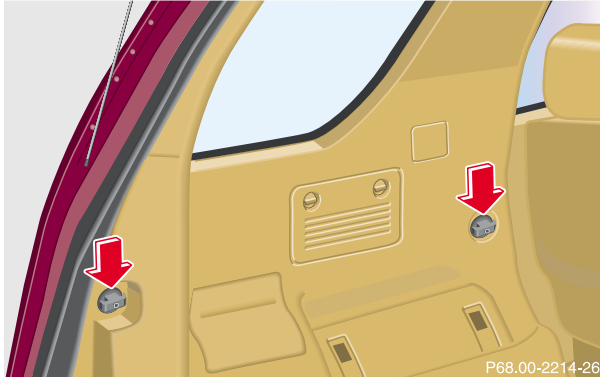

Four hooks, located on the rear compartment trim panels can be used to secure light weight items (maximum permissible weight per hook: 9 lbs. [4 kg]).

Partition net (Optional)

Use of the partition net is a particularly important safety factor when the vehicle is loaded higher than the top of the seat backrests with smaller objects.

The partition net can be installed behind the backrests of the front or rear seats.

Note:

Passenger use of seats behind installed partition net is restricted because of the footwell being taken up by the net.

Interior equipment

134

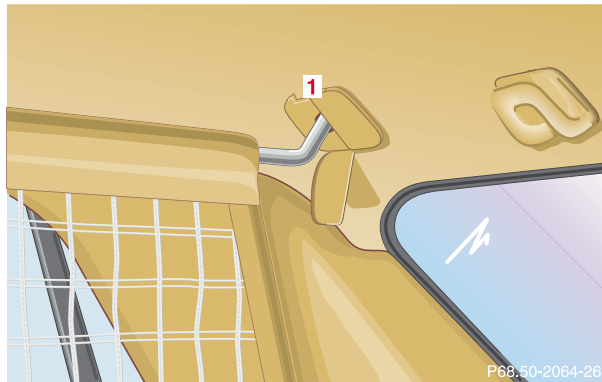

Installation:

1. Engage partition net in holders (1) and close rear cover.

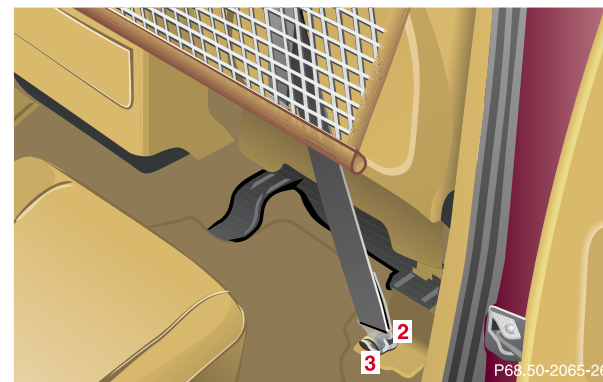

2. Insert tie down hooks (2) in rings (3) behind the front seats.
3. Pull on loose ends of tie downs until net is tight.
For installation behind the rear seats, see next page.

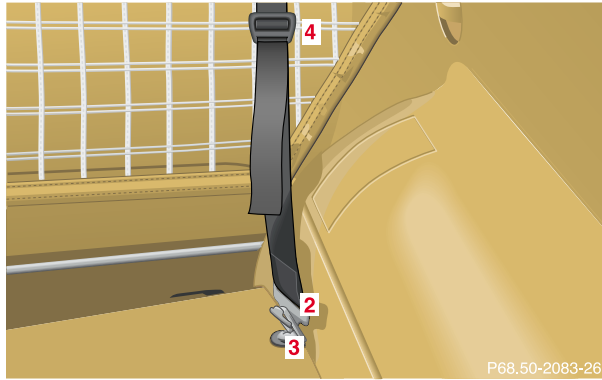

Installation behind rear seats

1. Insert tie down hooks (2) in rings (3) behind the rear seats.
2. Pull on loose ends of tie downs until net is tight.

Removal:

1. Lift tensioner (4) upward to a horizontal position to release tensioning of the strap.
2. Disengage tie down hooks (2) from rings (3).
3. Remove partition net from holders (1) and close the covers.

Storage:

1. Roll up and close partition net.
2. Store partition net behind rear seat bench.

Caution!

While the partition net will help protect you from smaller objects, it cannot prevent the movement of large, heavier objects into the passenger area in an accident. Such items must be properly secured using the cargo tie-down rings in the cargo area floor, see page 132.

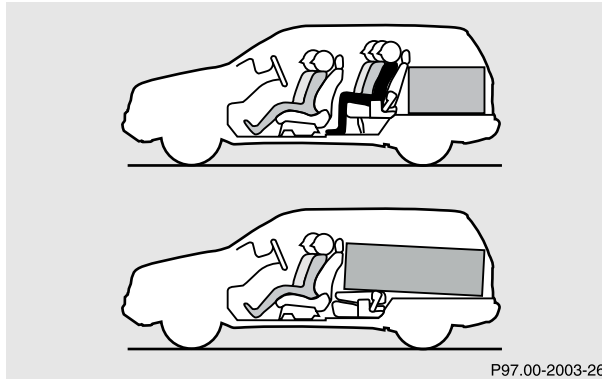
Loading instructions

The total load weight including vehicle occupants and luggage/cargo should not exceed the vehicle capacity weight indicated on the certification label which can be found on the left door pillar.

The handling characteristics of a fully loaded vehicle depend greatly on the load distribution. It is therefore recommended to load the vehicle according to the illustrations shown, with the heaviest items being placed towards the front of the vehicle.

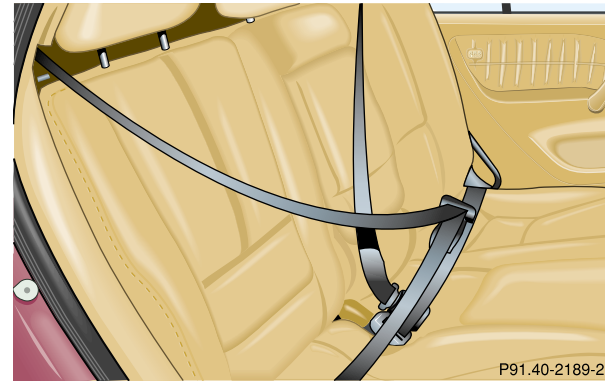

Always place items being carried against front or rear seat backrests, and fasten them as securely as possible.

The heaviest portion of the cargo should always be kept as low as possible against front or rear seat backrest since it influences the handling characteristics of the vehicle.

For additional safety when transporting cargo while the rear seats are unoccupied, fasten the outer seat belts crosswise into the opposite side buckles.

Notes:

The trunk is the preferred place to carry objects. The enlarged cargo area should only be used for items which do not fit in the trunk alone.

Warning!

Always fasten items being carried as securely as possible using cargo tie-down rings and fastening materials appropriate for the weight and size of the load.

In an accident, during hard braking or sudden maneuvers, loose items will be thrown around inside the vehicle, and can cause injury to vehicle occupants unless the items are securely fastened in the vehicle.

To help avoid personal injury during a collision or sudden maneuver, always use partition net when transporting cargo.

Never drive vehicle with the liftgate open. Deadly carbon monoxide (CO) gases may enter vehicle interior resulting in unconsciousness and death.

Cargo area cover blind

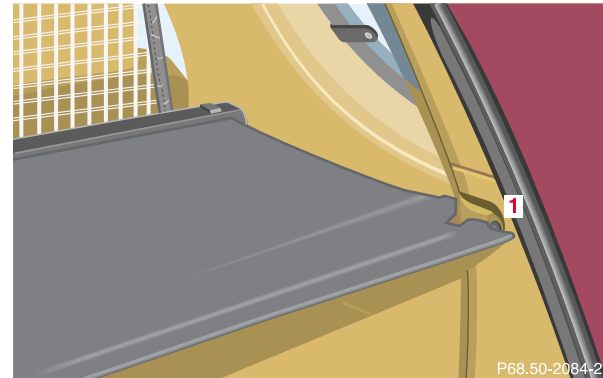

Closing blind:

Pull blind (visual protection) across luggage/ cargo area, and guide into holders (1) next to liftgate.

Opening blind:

To roll up blind, disengage blind and guide retraction by its handle.

Interior equipment

138

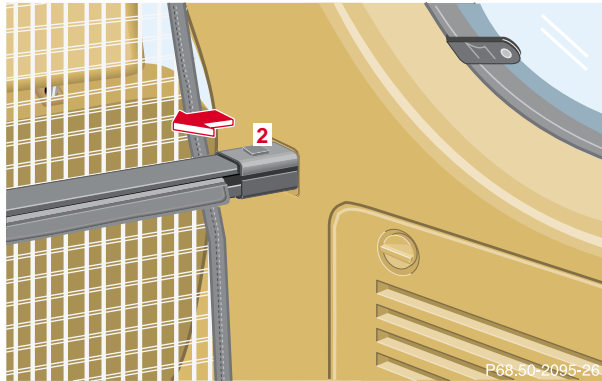

Removing blind:

Pull right side mounting sleeve toward vehicle center (arrow) until button (1) engages, and remove blind from holders.

Installing blind:

Place left side of blind in left mount. Position right side of blind over right mount. Push button (1), releasing mounting sleeve to slide into mount.

Notes:

A removable cap is fitted into the mount openings on vehicles fitted with third row seats.

Passenger use of third row seats with cargo area cover blind installed is restricted.

Telephone, general

Warning!

A driver's attention to the road must always be his/her primary focus when driving. For your safety and the safety of others, we recommend that you pull over to a safe location and stop before placing or taking a telephone call. If you choose to use the telephone while driving, please use the hands-free device and only use the telephone when road and traffic conditions permit.

Some jurisdictions prohibit the driver from using a cellular telephone while driving a vehicle.

Bear in mind that at a speed of just 30 mph (approximately 50 km/h), your vehicle is covering a distance of approximately 50 feet (approximately 14 m) every second.

Never operate radio transmitters equipped with a built-in or attached antenna (i.e. without being connected to an external antenna) from inside the vehicle while the engine is running. Doing so could lead to a malfunction of the vehicle's electronic system, possibly resulting in an accident and personal injury.

See separate instruction manual for instructions on how to operate the telephone.

Cellular telephone

Warning!

Some jurisdictions prohibit the driver from using a cellular telephone while driving a vehicle. Whether or not prohibited by law, for safety reasons, the driver should not use the cellular telephone while the vehicle is in motion.

Stop the vehicle in a safe location before answering or placing a call.

Garage door opener

140

Garage door opener



- 1 Signal transmitter keys
- 2 Portable remote control transmitter

The built-in remote control is capable of operating up to three separately controlled objects.

Warning!

When programming a garage door opener, the door moves up or down.

When programming or operating the remote control make sure there is no possibility of anyone being harmed by the moving door.

Notes:

Certain types of garage door openers are incompatible with the integrated opener. If you should experience difficulties with programming the transmitter, contact your authorized Mercedes-Benz Light Truck Center, or call Mercedes-Benz Client Assistance Center (in the USA only) at 1-800-FOR-MERCEdes, or Customer Service (in Canada) at 1-800-387-0100.

For operation in the USA only: This device complies with Part 15, Subpart C, Section 209 of the FCC Rules. Operation is subject to the following two conditions:

- (1) This device may not cause harmful interference, and
- (2) this device must accept any interference received, including interference that may cause undesired operation.

WARNING: Changes or modification not expressly approved by party responsible for compliance could void the user's authority to operate the equipment.

Programming or reprogramming the integrated remote control:

1. Turn key in steering lock to position 1 or 2.
2. Hold the end of the hand-held transmitter of the device you wish to train approximately 2 to 5 inches (5 cm to 12 cm) away from the surface of the integrated remote control located on the overhead console, keeping the indicator lamp in view.

3. Using both hands, simultaneously push the hand-held transmitter button and the desired integrated remote control button. Do not release the buttons until completing step 4.
4. The indicator lamp on the integrated remote control will flash, first slowly and then rapidly. When the indicator lamp flashes rapidly, both buttons may be released (the rapid flashing lamp indicates successful programming of the new frequency signal). To program the remaining two buttons, follow steps 1 through 4.

Note:

If after repeated attempts, you do not successfully program the integrated remote control device to learn the signal of the hand-held transmitter, the garage door opener could be equipped with the "rolling code feature".

Garage door opener

142

Rolling code programming:

To train a garage door opener (or other rolling code devices) with the rolling code feature, follow these instructions after completing the “Programming” portion of this text. (A second person may make the following training procedures quicker and easier.)

1. Locate training button on the garage door opener motor head unit. Exact location and color of the button may vary by garage door opener brand. If there is difficulty locating the transmitting button, reference to garage door opener operator’s manual.
2. Press “training” button on the garage door opener motor head unit (which activated the “training light”).

Note:

Following step 2, there are 30 seconds to initiate step 3.

3. Firmly press and release the programmed integrated remote control transmit button. Press and release same button a second time to complete the training process. (Some garage door openers may require you to do this procedure a third time to complete the training.)
4. Confirm the garage door operation by pressing the programmed button on the integrated remote control transmitter.

Canadian programming:

During programming, your hand-held transmitter may automatically stop transmitting. Continue to press and hold the integrated remote control transmitter button (note steps 1 through 4 in the “Programming” portion) while you press and re-press (“cycle”) your hand-held transmitter every two seconds until the frequency signal has been learned. The indicator lamp will flash slowly and then rapidly after several seconds upon successful training.

Operation of remote control:

1. Turn key in steering lock to position 1 or 2.
2. Select and press the appropriate button to activate the remote controlled device. The integrated remote control transmitter continues to send the signal as long as the button is pressed – up to 20 seconds.

Erasing the remote control memory:

1. Turn key in steering lock to position 1 or 2.
2. Simultaneously holding down the left and right side buttons for approximately 20 seconds, or until the control lamp blinks rapidly, will erase the codes of all three channels.

Driving

| | |
|--|-----|
| Control and operation of radio transmitters | 146 |
| The first 1 000 miles (1 500 km) | 147 |
| Maintenance | 147 |
| Tele Aid | 148 |
| Catalytic converter | 160 |
| Emission control | 161 |
| Steering lock | 162 |
| Starting and turning off the engine | 164 |
| Automatic transmission | 165 |
| Parking brake | 173 |

| | | | |
|-----------------------------------|-----|---|-----|
| Driving instructions | 174 | Off-Road driving | 183 |
| Drive sensibly – save fuel | 174 | Trailer towing | 190 |
| Drinking and driving | 174 | Cruise control | 196 |
| Pedals | 174 | Brake assist system (BAS) | 199 |
| Power assistance | 175 | Antilock brake system (ABS) | 201 |
| Brakes | 175 | Four-wheel electronic traction system (4-ETS+) | 203 |
| Driving off | 176 | Electronic brake proportioning (EBP) | 204 |
| Parking | 176 | Electronic stability program (ESP) | 205 |
| Tires | 177 | Transmission control – LOW RANGE mode | 209 |
| Snow chains | 179 | What you should know at the gas station | 212 |
| Winter driving instructions | 180 | Check regularly and before a long trip | 215 |
| Deep water | 181 | | |
| Passenger compartment | 182 | | |
| Traveling abroad | 182 | | |

| | | | | | | | |
|-----------------------------|-----------|----------------|-------------------------------|-----------------|----------|-------------------|-------|
| Instruments and controls | Operation | Driving | Instrument cluster display | Practical hints | Car care | Technical data | Index |
|-----------------------------|-----------|----------------|-------------------------------|-----------------|----------|-------------------|-------|

| | | | | | | | |
|--------------------------|-----------|----------------|----------------------------|-----------------|----------|----------------|-------|
| Instruments and controls | Operation | Driving | Instrument cluster display | Practical hints | Car care | Technical data | Index |
|--------------------------|-----------|----------------|----------------------------|-----------------|----------|----------------|-------|

Control and operation of radio transmitters

146

Control and operation of radio transmitters

MCS, radio and telephone

Warning!

Please do not forget that your primary responsibility is to drive the vehicle. Only operate the MCS, radio or telephone¹ if road and traffic conditions permit.

Bear in mind that at a speed of just 30 mph (approximately 50 km/h), your vehicle is covering a distance of approximately 50 feet (approximately 14 m) every second.

¹ Observe all legal requirements.

Telephones and two-way radio

Warning!

Never operate radio transmitters equipped with a built-in or attached antenna (i.e. without being connected to an external antenna) from inside the vehicle while the engine is running. Doing so could lead to a malfunction of the vehicle's electronic system, possibly resulting in an accident and personal injury.

Radio transmitters, such as a portable telephone or a citizens band unit should only be used inside the vehicle if they are connected to an antenna that is installed on the outside of the vehicle.

Refer to the radio transmitter operation instructions regarding use of an external antenna.

The first 1 000 miles (1 500 km)

The more cautiously you treat your vehicle during the break-in period, the more satisfied you will be with its performance later on. Therefore, drive your vehicle during the first 1 000 miles (1 500 km) at moderate vehicle and engine speeds.

During this period, avoid heavy loads (full throttle driving) and excessive engine speeds.

Avoid accelerating by kickdown. It is not recommended to brake the vehicle by manually shifting to a lower gear. We recommend that you select positions “3”, “2” or “1” only at moderate speeds (for hill driving).

After 1 000 miles (1 500 km) speeds may be gradually increased to the permissible maximum.

Maintenance

Approximately 30 days or 2 000 miles (Canada: 2000 km) prior to the next recommended service, the remaining distance or days are displayed in the multifunction indicator. See Flexible Service System (FSS) on page 87.

We strongly recommend that you have your vehicle serviced by your authorized Mercedes-Benz Light Truck Center, in accordance with the Service Booklet at the times called for by the FSS.

Failure to have the vehicle maintained in accordance with the Service Booklet at the designated times/ mileage may result in vehicle damage not covered by the Mercedes-Benz Limited Warranty.

Check regularly and before a long trip, see page 215.

Tele Aid



Important!

The initial activation of the Tele Aid system may only be performed by completing the subscriber agreement and placing an acquaintance call using the “SOS” button. Failure to complete either of these steps will result in a system that is not activated. If the system is not activated the indicator lamp in the “SOS” button stays on after turning electronic key in starter switch to position 2 and the message “TELE AID – NOT ACTIVATED” will be shown in the MCS display for approx. 10 seconds.

If you have any questions regarding activation, please call the Response Center at 1-800-756-9018 (in the USA) or 1-888-923-8367 (in Canada).

(Telematic Alarm Identification on Demand)



The Tele Aid system consists of three types of response; automatic and manual emergency, roadside assistance and information.

The Tele Aid system is operational providing that the vehicle’s battery is charged, properly connected, not damaged and cellular and GPS coverage is available. The speaker volume of a Tele Aid call can be adjusted using the volume control on the MCS unit. To activate, press the “SOS” button, the Roadside Assistance button  or the Information button , depending on the type of response required.



Shortly after the completion of your Acquaintance Call, you will receive a user ID and password via first call mail. By visiting www.mbusa.com and selecting “Tele Aid” (USA only), you will have access to account information, remote door unlock, Info Services’ profile and more.

* Optional

System self-check

Initially, after turning the key in steering lock to position 2, malfunctions are detected and indicated (the indicator lamps in the “SOS” button, the Roadside Assistance button  and Information button  stay on longer than 10 seconds or do not come on). The message “TELE AID – PLEASE VISIT WORKSHOP” appears in the MCS display.

Important!

Always make sure that the indicator lamps in the “SOS” button, the Roadside Assistance button  and the Information button  do not remain illuminated constantly in red and the message “TELE AID – VISIT WORKSHOP” is not displayed in the MCS display after the system self check.

If a malfunction is indicated as outlined above, have the system checked at the nearest Mercedes-Benz Light Truck Center as soon as possible.

Emergency calls

An emergency call is initiated automatically:

- following an accident in which the Emergency Tensioning Retractors (ETR's) or airbags deploy,
- if the antitheft alarm or the tow away alarm stays on for more than 20 seconds, see pages 35 and 36.

An emergency call can also be initiated manually by opening the cover next to the inside rear view mirror labeled “SOS”, then pressing the button (for longer than 2 seconds) located under the cover. See below for instructions on initiating an emergency call manually.

Once the emergency call is in progress, the indicator lamp in the “SOS” button will begin to flash. The message “EMERGENCY CALL – CONNECTING CALL” appears in the MCS display. When the connection is established, the message “EMERGENCY CALL – CALL CONNECTED” appears in the MCS display. All information relevant to the emergency, such as the location of the vehicle (determined by the GPS satellite location system), vehicle model, identification number and color are generated.

A voice connection between the Response Center and the occupants of the vehicle will be established automatically soon after the emergency call has been initiated. When a voice connection is established the audio system mutes and the message “TELE AID – EMERGENCY CALL ACTIVE” appears in the MCS display. The Response Center will attempt to determine more precisely the nature of the accident provided they can speak to an occupant of the vehicle.

| | | | | | | | |
|--------------------------|-----------|----------------|----------------------------|-----------------|----------|----------------|-------|
| Instruments and controls | Operation | Driving | Instrument cluster display | Practical hints | Car care | Technical data | Index |
|--------------------------|-----------|----------------|----------------------------|-----------------|----------|----------------|-------|

Tele Aid

150

The Tele Aid system is available if:

- it has been activated and is operational. Activation requires a subscription for monitoring services and cellular air time
- the relevant cellular phone network and GPS signals are available and pass the information on to the response center.

Note:

Location of the vehicle on a map is possible if the vehicle is able to receive signals from the GPS satellite network and pass the information on to the response center.

Warning!

If the indicator lamp in the “SOS” button is illuminated continuously and there was no voice connection to the Response Center established, then the Tele Aid system could not initiate an emergency call (e.g. the relevant cellular phone network is not available). The message “EMERGENCY CALL – CALL FAILED” appears in the MCS display for approx. 10 seconds.

Should this occur, assistance must be summoned by other means.

Initiating an emergency call manually

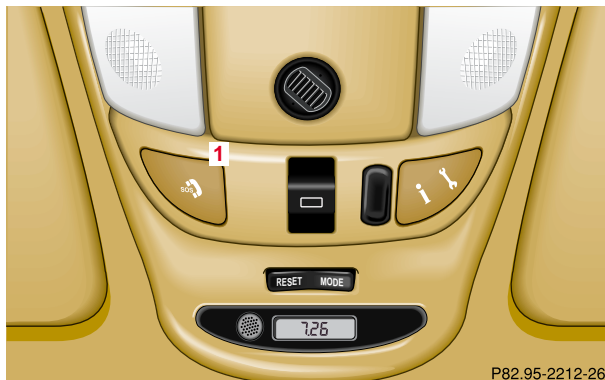

Briefly press on cover (1) – the cover will open.



Press the SOS button (2) briefly (for longer than 2 seconds). The indicator lamp in the SOS button (2) will flash until the emergency call is concluded. Wait for a voice connection to the Response Center.

Close the cover (1) after the emergency call is concluded.

Warning!

If you feel at any way in jeopardy when in the vehicle (e.g. smoke or fire in the vehicle, vehicle in a dangerous road location), please do not wait for voice contact after you have pressed the emergency button. Carefully leave the vehicle and move to a safe location. The Response Center will automatically contact local emergency officials with the vehicle's approximate location if they receive an automatic "SOS" signal and cannot make voice contact with the vehicle occupants.

Roadside Assistance button 

Located in the overhead control panel is the Roadside Assistance button . Briefly press on cover (3) – the cover will open.

Pressing and holding the Roadside Assistance button  (for longer than 2 seconds) will initiate a call to a Mercedes-Benz Roadside Assistance dispatcher. The button will flash while the call is in progress. The message "ROADSIDE ASSISTANCE – CONNECTING CALL" appears in the MCS display.

When the connection is established, the message “ROADSIDE ASSISTANCE – CALL CONNECTED” appears in the MCS display. The Tele Aid system will transmit data generating the vehicle identification number, model, color and location (subject to availability of cellular and GPS signals).



While the call is connected, you can change to navigation menu by pressing NAVI button on the MCS.

A voice connection between the Roadside Assistance dispatcher and the occupants of the vehicle will be established. When a voice connection is established the audio system mutes and the message “TELE AID – ROADSIDE ASSISTANCE CALL ACTIVE” appears in the MCS display. The nature of the need for assistance can then be described. The Mercedes-Benz Roadside assistance dispatcher will either dispatch a qualified Mercedes-Benz technician or arrange to tow your vehicle to the nearest Mercedes-Benz Center. For services such as labor and/or towing charges may apply. Refer to the Roadside Assistance manual for more information.

These programs are only available in the USA:

- Sign and Drive services: Services such as jump start, a few gallons of fuel or the replacement of a flat tire with the vehicle spare tire are obtainable,
- Remote Vehicle Diagnostics: This function permits the Mercedes-Benz Roadside Assistance dispatcher to download malfunction codes and actual vehicle data.

Notes:

The indicator lamp in the Roadside Assistance button  remains illuminated in red for approximately 10 seconds during the system self-check after turning key in steering lock to position 2 (together with the “SOS” button and the Information button ).

See system self-check on page 148 when the indicator lamp does not light up in red or stay on longer than approximately 10 seconds.

Tele Aid

154

If the indicator lamp in the Roadside Assistance button  is illuminated continuously and there was no voice connection to the Response Center established, then the Tele Aid system could not initiate an Roadside Assistance call (e.g. the relevant cellular phone network is not available). The message “ROADSIDE ASSISTANCE – CALL FAILED” appears in the MCS display.

Should this occur, assistance must be summoned by other means.

Roadside Assistance calls can be terminated using the END button on the MCS unit.

Information button 

Located in the overhead control panel is the Information button . Briefly press on cover (3) – the cover will open.

Pressing and holding the Information button  (for longer than 2 seconds) will initiate a call to the Client Assistance Center. The button will flash while the call is in progress. The message “INFO – CONNECTING CALL” appears in the MCS display. When the connection is established, the message “INFO – CALL CONNECTED” appears in the MCS display.



The Tele Aid system will transmit data generating the vehicle identification number, model, color and location (subject to availability of cellular and GPS signals).

While the call is connected, you can change to navigation menu by pressing NAVI button on the MCS.

A voice connection between the Client Assistance Center representative and the occupants of the vehicle will be established. When a voice connection is established, the audio system mutes and the message "TELE AID - INFO CALL ACTIVE" appears in the MCS display. Information regarding the operation of your vehicle, the nearest Mercedes-Benz Light Truck Center or Mercedes-Benz USA products and services is available to you.

For more details concerning Tele Aid, please visit www.mbusa.com and use your ID and password, sent to you separately, to learn more (USA only).

Notes:

The indicator lamp in the Information button  remains illuminated in red for approximately 10 seconds during the system self-check after turning key in steering lock to position 2 (together with the "SOS" button and the Roadside Assistance button ).

See system self-check on page 148 when the indicator lamps do not light up in red or stay on longer than approximately 10 seconds.

If the indicator lamp in the Information button  is illuminated continuously and there was no voice connection to the Response Center established, then the Tele Aid system could not initiate an Roadside Assistance call (e.g. the relevant cellular phone network is not available). The message "Info - CALL FAILED" appears in the MCS display.

Should this occur, information must be summoned by other means.

Information calls can be terminated using the END button on the MCS unit.

| | | | | | | | |
|--------------------------|-----------|----------------|----------------------------|-----------------|----------|----------------|-------|
| Instruments and controls | Operation | Driving | Instrument cluster display | Practical hints | Car care | Technical data | Index |
|--------------------------|-----------|----------------|----------------------------|-----------------|----------|----------------|-------|

Tele Aid

156

Important!

If the indicator lamps do not start flashing after pressing one of the buttons or remain illuminated (in red) at any time, the Tele Aid system has detected a fault or the service is not currently active, and may not initiate a call. Visit your Mercedes-Benz Light Truck Center and have the system checked or contact the Response Center at 1-800-756-9018 (in the USA) or 1-888-923-8367 (in Canada) as soon as possible.

Upgrade Signals

Tele Aid system processes calls using the following priority.

- Automatic emergency – First priority
- Manual emergency – Second priority
- Roadside assistance – Third priority
- Information – Fourth priority

Should a higher priority call be initiated while you are connected, an upgrade (alternating) tone will be heard, and the appropriate indicator lamp will flash. If certain information such as vehicle identification number or client information is not available, the operator may need to retransmit. During this time you will hear a chirp and voice contact will be interrupted. Voice contact will resume once the retransmission is completed. Once a call is concluded, a chirp will be heard and the appropriate indicator lamp will stop flashing. The MCS system operation will resume.

Important!

If the indicator lamp continues to flash or the system does not reset, contact the Response Center at 1-800-756-9018 (in the USA) or 1-888-923-8367 (in Canada), or Mercedes-Benz Client Assistance at 1-800-FOR-MERCEdes (1-800-367-6372) in the USA or Customer Service at 1-800-387-0100 in Canada.

Notes:

The indicator lamp for the respective button flashes until the call is concluded and this can only be completed by a Response Center or Client Assistance Center representative, except Roadside assistance and Information calls, which can also be terminated by using the End button on the MCS unit.

When a Tele Aid call has been initiated, the MCS system audio is muted and the selected mode (radio, tape or CD) pauses. The optional cellular phone (if installed) switches off. If you must use this phone, the vehicle must be parked. Disconnect the coiled cord and place the call. The navigation system (if engaged) will continue to run. A pop-up window will appear in the MCS display to indicate that a Tele Aid call is in progress.

Remote door unlock

In the case you have your vehicle locked unintentionally (e.g. key inside vehicle), and the reserve key is not handy, contact the Mercedes-Benz Response Center at 1-800-756-9018 (in the USA) or 1-888-923-8367 (in Canada). You will be asked to provide your password which you provided when you completed the subscriber agreement.

Then return to your vehicle and pull outside handle of liftgate for a minimum of 20 seconds until the “SOS” button is flashing.

As an alternative, you may unlock the vehicle via Internet using the ID and password sent to you shortly after the completion of your Acquaintance Call.

The Response Center will then unlock your vehicle with the remote door unlocking feature.

Note:

The remote door unlock feature is available if the relevant cellular phone network is available.

The SOS button will flash and the message “EMERGENCY CALL – CALL CONNECTED” will appear in the MCS display to indicate receipt of the door unlock command.

| | | | | | | | |
|--------------------------|-----------|----------------|----------------------------|-----------------|----------|----------------|-------|
| Instruments and controls | Operation | Driving | Instrument cluster display | Practical hints | Car care | Technical data | Index |
|--------------------------|-----------|----------------|----------------------------|-----------------|----------|----------------|-------|

Tele Aid

Once the vehicle is unlocked, a Response Center specialist will attempt to establish voice contact with the vehicle occupants.

If the outside liftgate handle was pulled for more than 20 seconds before door unlock authorization was received by the Response Center, you must wait 15 minutes before pulling the outside liftgate handle again.

158

Stolen vehicle tracking services

In the event your vehicle was stolen, report the incident to the police who will issue a numbered incident report. Pass this number on to the Mercedes-Benz Response Center.

The Response Center will then attempt to covertly contact the vehicle's Tele Aid system. Once the vehicle is located, the Response Center will contact the local Law Enforcement and you. The vehicle's location will only be provided to Law Enforcement.

Info Services (optional, except Canada)

Info Services categories include news, sports, stocks, weather and calendar reminders. Choices can be selected via www.mbusa.com or by calling 1-800-FOR-MERCEDES.

To request Info Services press the TEL button and then the SVC soft key on the MCS unit. Then select UPDT soft key. "NEW INFO SERVICE REQUEST TRANSMITTED" will appear in the MCS display and call status messages will appear in the MCS display.

Once information is available, the message "NEW INFO RECEIVED READ LATER WHEN STOPPED?" will appear. Select "Yes". With the vehicle stopped in a safe location press TEL button, SVC soft key to read messages.

Important!

Tele Aid utilizes the cellular network for communication and the GPS (Global Positioning System) satellites for vehicle location. If either of these signals are unavailable, the Tele Aid system may not function and if this occurs, assistance must be summoned by other means.

Warning!

The Tele Aid control unit is located under the front passenger seat. If there is accumulation of water or other liquid in this area, the Tele Aid control unit could suffer an electrical short circuit making the system inoperative. In this case the indicator lamp in the "SOS" button will not illuminate during or will remain illuminated after the system self-check. Have the system checked at the nearest Mercedes-Benz Light Truck Center as soon as possible.

| | | | | | | | |
|--------------------------|-----------|----------------|----------------------------|-----------------|----------|----------------|-------|
| Instruments and controls | Operation | Driving | Instrument cluster display | Practical hints | Car care | Technical data | Index |
|--------------------------|-----------|----------------|----------------------------|-----------------|----------|----------------|-------|

Catalytic converter

160

Catalytic converter

Your Mercedes-Benz is equipped with monolithic type catalytic converters, an important element in conjunction with the oxygen sensors to achieve substantial control of the pollutants in the exhaust emissions. Keep your vehicle in proper operating condition by following our recommended maintenance instructions as outlined in your Service Booklet.

Caution!

To prevent damage to the catalytic converters, use only premium unleaded gasoline in this vehicle.

Any noticeable irregularities in engine operation should be repaired promptly. Otherwise, excessive unburned fuel may reach the catalytic converter causing it to overheat, which could start a fire.

Warning!

As with any vehicle, do not idle, park or operate this vehicle in areas where combustible materials such as grass, hay or leaves can come into contact with the hot exhaust system, as these materials could be ignited and cause a vehicle fire.

Emission control

Certain systems of the engine serve to keep the toxic components of the exhaust gases within permissible limits required by law.

These systems, of course, will function properly only when maintained strictly according to factory specifications. Any adjustments on the engine should, therefore, be carried out only by authorized Mercedes-Benz Light Truck Center qualified technicians. Engine adjustments should not be altered in any way. Moreover, the specified service jobs must be carried out regularly according to Mercedes-Benz servicing requirements. For details refer to the Service Booklet.

Warning!

Inhalation of exhaust gas is hazardous to your health. All exhaust gas contains carbon monoxide, and inhaling it can cause unconsciousness and lead to death.

Do not run the engine in confined areas (such as a garage) which are not properly ventilated. If you think that exhaust gas fumes are entering the vehicle while driving, have the cause determined and corrected immediately. If you must drive under these conditions, drive only with at least one window fully open.

Steering lock

162

Steering lock

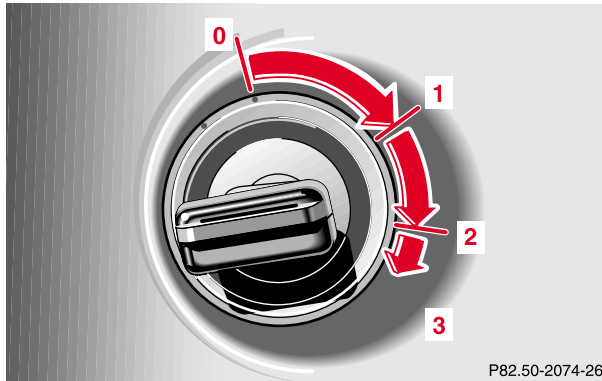

- 0** The key can be withdrawn in this position only. The steering is locked when the key is removed from the steering lock. If necessary, move steering wheel slightly to allow the locking mechanism to engage. The key can only be removed with the selector lever in position “P”. After removing the key or with the key in steering lock position 0, the selector lever is locked in position “P”.

- 1** Steering is unlocked.

(If necessary, move steering wheel slightly to allow the key to be turned clockwise to position 1.) Most electrical consumers can be operated. For detailed information see respective subjects.

- 2** Driving position.

- 3** Starting position.

See page 164 for starting and turning off the engine.

Warning!

When leaving the vehicle always remove the key from the steering lock, and lock the vehicle. Do not leave children unattended in the vehicle, or with access to an unlocked vehicle. Unsupervised use of vehicle equipment may cause serious personal injury.

Caution!

To prevent accelerated battery discharge and a possible dead battery, always remove the key from the steering lock. **Do not** leave the key in steering lock position 0.

Notes:

A warning sounds when the driver's door is opened while the key is in steering lock position 1 or 0.

With the engine at idle speed, the charging rate of the alternator (output) is limited.

It is therefore recommended that you turn off unnecessary electrical consumers while driving in stop-and-go traffic. This precaution helps to avoid draining of the battery.

Unnecessary strain on the battery and charging system may be minimized by turning off the following power consumers, for example: Heated seats, rear window defroster.

Starting and turning off the engine

164

Starting and turning off the engine**Before starting**

Ensure that parking brake is engaged and that selector lever is in position “P” or “N”. Turn key in steering lock to position 2. The charge indicator lamp should come on.

Starting

Do not depress accelerator.

Briefly turn key in steering lock clockwise to the stop and release. The starter will engage until the engine is running.

If engine will not run, and the starting procedure stops, turn key completely to the left and repeat starting the engine.

After several unsuccessful attempts, have the system checked at the nearest authorized Mercedes-Benz Light Truck Center.

A starting procedure can be interrupted by turning the key to steering lock position 0.

Important!

Due to the installed starter non-repeat feature, the key must be turned completely to the left before attempting to start the engine again.

In areas where temperatures frequently drop below -4°F (-20°C) we recommend that an engine block heater be installed. Your authorized Mercedes-Benz Light Truck Center will advise you on this subject.

Note:

In case the engine cannot be started and the messages **Start** and **Error** are shown in the odometer display field, the system is not operational. Contact an authorized Mercedes-Benz Light Truck Center or call 1-800-FOR-MERCEdes (in the USA), or 1-800-387-0100 (in Canada).

Turning off

Turn the key in the steering lock to position 0 to stop the engine.

The key can only be removed with the selector lever in position “P”.

Automatic transmission



The automatic transmission selects individual gears automatically, dependent upon

- Selector lever position
- Accelerator position
- Vehicle speed

The gear shifting process is continuously adapted, dependent on the driving style, the driving situation and the road characteristics.

Important!

When parking the vehicle or before working on the vehicle with the engine running, firmly depress the parking brake pedal and shift the selector lever into “P”.

Automatic transmission

166

Driving

The selector lever is automatically locked while in position "P". To move the selector lever out of position "P", the service brake pedal must be firmly depressed before the shift lock will release.

Shift selector lever to the desired position only when the engine is idling normally and the service brake is applied. Do not release the brake until ready to drive. The vehicle may otherwise start creeping when the selector lever is in drive or reverse position.

Warning!

It is dangerous to shift the selector lever out of "P" or "N" if the engine speed is higher than idle speed. If your foot is not firmly on the brake pedal, the vehicle could accelerate quickly forward or in reverse. You could lose control of the vehicle and hit someone or something. Only shift into gear when the engine is idling normally and when your right foot is firmly on the brake pedal.

Important!

After selecting any driving position from "N" or "P", wait a moment to allow the gear to fully engage before accelerating, especially when the engine is cold.

Accelerator position

Partial throttle = early upshifting = normal acceleration

Full throttle = later upshifting = rapid acceleration

Kickdown (depressing the accelerator beyond full throttle) = downshifting to a lower gear = maximum acceleration. Once the desired speed is attained, ease up on the accelerator – the transmission shifts up again.

Stopping

For brief stops, e.g. at traffic lights, leave the transmission in gear and hold vehicle with the service brake.

For longer stops with the engine idling, shift into "N" or "P" and hold the vehicle with the service brake.

When stopping the vehicle on an uphill gradient, do not hold it with the accelerator, use the brake. This avoids unnecessary transmission heat build up.

Maneuvering

To maneuver in tight areas, e.g. when pulling into a parking space, control the vehicle speed by gradually releasing the brakes. Accelerate gently and never abruptly step on the accelerator.

To rock a vehicle out of soft ground (mud or snow), alternately shift from forward to reverse, while applying slight partial throttle.

Rocking a vehicle free in this manner may cause the ABS or traction system malfunction indicator lamp to come on. Turn off and restart the engine to clear the malfunction indication.

Warning!

Getting out of your vehicle with the selector lever not fully engaged in position “P” is dangerous. Also, when parked on an incline, position “P” alone may not prevent your vehicle from moving, possibly hitting people or objects.

Always set the parking brake in addition to shifting to position “P”, see page 173 for parking brake.

When parked on an incline, also turn front wheel against curb.

Warning!

When leaving the vehicle always remove the key from the steering lock, and lock the vehicle. Do not leave children unattended in the vehicle, or with access to an unlocked vehicle. Children could move the gear selector lever from position “P”, which could result in an accident or serious injury.

Towing a trailer

If the transmission hunts between gears on inclines, manually shift to a lower gear (select “4”, “3”, “2” or “1”). A lower gear and reduction of speed reduces the chance of engine overloading and/or overheating.

At very steep inclines, not manageable with selector lever in position “1”, switch transfer case to LOW RANGE, see page 209 for instructions on how to engage LOW RANGE.

For instructions on trailer towing refer to page 190.

Automatic transmission

168

Selector lever position



The current selector lever position is indicated in the gear range indicator display. The automatic gear shifting process can be adapted to specific operating conditions using the selector lever.

P Park position

The park position is to be used when parking the vehicle. Engage only with the vehicle stopped. The park position is not intended to serve as a brake when the vehicle is parked. Rather, the driver should always use the parking brake in addition to placing the selector lever in park to secure the vehicle.

Notes:

The key can only be removed from the steering lock with the selector lever in position "P". With the key removed, the selector lever is locked in position "P".

With a malfunction in the vehicle's electrical system the selector lever could remain locked in position "P". To unlock the selector lever manually, see page 259.

R Reverse gear

Shift to reverse gear only with the vehicle stopped.

N Neutral

No power is transmitted from the engine to the drive axle. When the brakes are released, the vehicle can be moved freely (pushed or towed). Do not engage “N” while driving except to coast when the vehicle is in danger of skidding (e.g. on icy roads, see winter driving instructions on page 180).

Important!

Coasting the vehicle, or driving for any other reason with selector lever in “N” can result in transmission damage that is not covered by the Mercedes-Benz Limited Warranty.

D The transmission automatically upshifts through 5th gear. Position “D” provides optimum driving characteristics under all normal operating conditions.

Gear selection for special circumstances

The transmission gear ranges for special circumstances can be selected by pressing the selector lever to the right or the left with the selector lever in position “D”.

The gear range currently selected is indicated in the instrument cluster display.

Briefly press selector lever in the **–** direction:
The transmission downshifts, one gear at a time, in the order “4”, “3”, “2”, “1”.

Press and hold selector lever in the **–** direction:
The selector lever position display will switch to the gear range currently selected by the automatic transmission.

The transmission will only shift down one gear if the gear range currently selected has already shifted to its highest possible gear.

Briefly press selector lever in the **+** direction:
The transmission will shift from the current gear range to the next higher gear range. If the transmission is already in gear range “D”, an additional upshift of one gear is possible.

Automatic transmission

170

Press and hold selector lever in the **+** direction:
The transmission will shift from the current gear
directly to gear range “D”.

Warning!

On slippery road surfaces, never downshift in order to obtain braking action. This could result in drive wheel slip and reduced vehicle control. Your vehicle's ABS will not prevent this type of loss of control.

Important!

With transmission in gear range “D”, “4” or “3”,
upshifting from 1st to 2nd to 3rd gear is delayed
depending on vehicle speed and engine temperature.
This allows the catalytic converter to heat up more
quickly to operating temperatures.

During the brief warm-up period this delayed upshift
and increased engine noise might be perceived as a
malfunction. However, neither the engine nor
transmission are negatively affected by this mode of
operation.

The delayed upshift is effective with vehicle speeds
below 31 mph (50 km/h) at partial throttle and engine
temperatures below 95°F (35°C).

To avoid overrevving the engine when the selector lever
is moved to a lower gear range, the transmission will not
shift to a lower gear, if the engine's revolutions per
minute limit would be exceeded. In this case there will
be no downshift, even when the vehicle speed reaches
the engine's RPM limit of that gear, e.g. by applying the
service brakes. Continue driving in the usual manner.
The transmission will then shift down automatically.

To prevent the engine from laboring at low RPM when
driving uphill gradients or with your vehicle heavily
loaded, the automatic transmission will downshift when
necessary to maintain engine RPM within the best
torque range.

Gear ranges:

- 4** Upshift through 4th gear only. Suitable for performance driving.
- 3** Upshift through 3rd gear only. Suitable for moderately steep hills. Since the transmission does not shift higher than 3rd gear, this gear selection will allow use of the engine's braking power downhill.

- 2** Upshift through 2nd gear only. For driving in mountainous regions or under extreme operating conditions. This gear selection will allow use of the engine's braking power when descending steep grades.
- 1** Use this position, which makes maximum use of the engine's braking effect, while descending very steep or lengthy downgrades and only at speeds below 40 mph (60 km/h).

Automatic transmission

172

Emergency operation (Limp home mode)

If vehicle acceleration worsens or the transmission no longer shifts, the transmission is most likely operating in Limp home mode which engages when there is a malfunction of the transmission. This condition may be accompanied by the "CHECK ENGINE" malfunction indicator lamp in the instrument cluster coming on.

In this mode only the 2nd gear or reverse gear can be activated.

To engage 2nd gear or reverse:

1. Stop the vehicle.
2. Move selector lever to position "P".
3. Turn off the engine.
4. Wait approximately 10 seconds.
5. Restart the engine.
6. Move selector lever to position "D" (for 2nd gear), or move selector lever to position "R" (for reverse gear).

Have the transmission checked at your authorized Mercedes-Benz Light Truck Center as soon as possible.

Parking brake

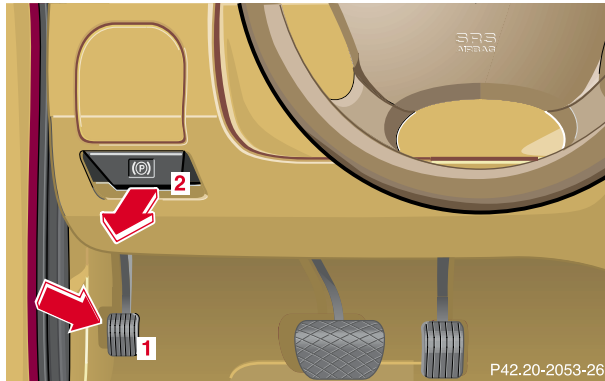

To engage, firmly depress parking brake pedal (1).
When the key is in steering lock position 2, the brake warning lamp  in the instrument cluster should come on brightly.

To release the parking brake, pull handle (2) on instrument panel. The brake warning lamp  in the instrument cluster should go out.

A warning sounds, if you start to drive without having released the parking brake.

Also see brake warning lamp on page 219.

Warning!

When leaving the vehicle always remove the key from the steering lock, and lock the vehicle. Do not leave children unattended in the vehicle, or with access to an unlocked vehicle. Children could release the parking brake, which could result in an accident or serious injury.

| | | | | | | | |
|--------------------------|-----------|----------------|----------------------------|-----------------|----------|----------------|-------|
| Instruments and controls | Operation | Driving | Instrument cluster display | Practical hints | Car care | Technical data | Index |
|--------------------------|-----------|----------------|----------------------------|-----------------|----------|----------------|-------|

Driving instructions

174

Driving instructions

Drive sensibly – save fuel

Fuel consumption, to a great extent, depends on driving habits and operating conditions.

To save fuel you should:

- keep tires at the recommended inflation pressures,
- remove unnecessary loads,
- remove roof rack when not in use,
- allow engine to warm up under low load use,
- avoid frequent acceleration and deceleration,
- have all maintenance work performed at regular intervals by an authorized Mercedes-Benz Light Truck Center.

Fuel consumption is also increased by driving in cold weather, in stop-and-go traffic, on short trips and in hilly country.

Drinking and driving

Warning!

Drinking or taking drugs and driving can be a very dangerous combination. Even a small amount of alcohol or drugs can affect your reflexes, perceptions and judgement.

The possibility of a serious or even fatal accident is sharply increased when you drink or take drugs and drive.

Please don't drink or take drugs and drive or allow anyone to drive after drinking or taking drugs.

Pedals

Warning!

Keep driver's foot area clear at all times. Objects stored in this area may impair pedal movement.

Power assistance

Warning!

When the engine is not running, the brake and steering systems are without power assistance. Under these circumstances, a much greater effort is necessary to stop or steer the vehicle.

Brakes

Warning!

After driving in heavy rain for some time without applying the brakes or through water deep enough to wet brake components, the first braking action may be somewhat reduced and increased pedal pressure may be necessary to obtain expected braking effect. Be sure to maintain a safe distance from vehicles in front.

Resting your foot on the brake pedal will cause excessive and premature wear of the brake pads.

It can also result in the brakes overheating thereby significantly reducing their effectiveness. It may not be possible to stop the vehicle in sufficient time to avoid an accident.

The condition of the parking brake system is checked each time the vehicle is in the shop for the required maintenance service.

If the parking brake is released and the brake warning lamp in the instrument cluster stays on and there is no audible warning (EBP), the brake fluid level in the reservoir is too low.

Brake pad wear or a leak in the system may be the reason for low brake fluid in the reservoir.

Have the brake system inspected at an authorized Mercedes-Benz Light Truck Center immediately.

All checks and service work on the brake system should be carried out by an authorized Mercedes-Benz Light Truck Center.

Install only brake pads and brake fluid recommended by Mercedes-Benz.

Warning!

If other than recommended brake pads are installed, or other than recommended brake fluid is used, the braking properties of the vehicle can be degraded to an extent that safe braking is substantially impaired. This could result in an accident.

Driving instructions

176

Caution!

When driving down long and steep grades, relieve the load on the brakes by shifting into a lower gear to use the engine's braking power. This helps prevent overheating of the brakes and reduces brake pad wear.

After hard braking, it is advisable to drive on for some time, rather than immediately parking, so the air stream will cool down the brakes faster.

Driving off

Apply the service brakes to test them briefly after driving off. Perform this procedure only when the road is clear of other traffic.

Warm up the engine smoothly. Do not place full load on the engine until the operating temperature has been reached.

When starting off on a slippery surface, do not allow one drive wheel to spin for an extended period with the ESP switched off. Doing so may cause serious damage to the drive train which is not covered by the Mercedes-Benz Limited Warranty.

Parking**Warning!**

To reduce the risk of personal injury as a result of vehicle movement, before turning off the engine and leaving the vehicle, always:

1. Keep right foot on the service brake pedal.
2. Firmly depress parking brake pedal.
3. Move the selector lever to position "P".
4. Slowly release the service brake pedal.
5. Turn front wheels towards the road curb.
6. Turn the key to steering lock position 0 and remove.
7. Take the key and lock vehicle when leaving.

Important!

It is advisable to set the parking brake whenever parking or leaving the vehicle. In addition, move selector lever to position "P".

When parking on hills, always set the parking brake.

Tires

Warning!

If you feel a sudden significant vibration or ride disturbance, or you suspect that possible damage to your vehicle has occurred, you should turn on the hazard warning flashers, carefully slow down, and drive with caution to an area which is a safe distance from the roadway.

Inspect the tires and under the vehicle for possible damage. If the vehicle or tires appear unsafe, have it towed to the nearest Mercedes-Benz Light Truck Center or tire dealer for repairs.

Tread wear indicators (TWI) are required by law. These indicators are located in six places on the tread circumference and become visible at a tread depth of approximately $\frac{1}{16}$ in (1.5 mm), at which point the tire is considered worn and should be replaced.

The tread wear indicator appears as a solid band across the tread.

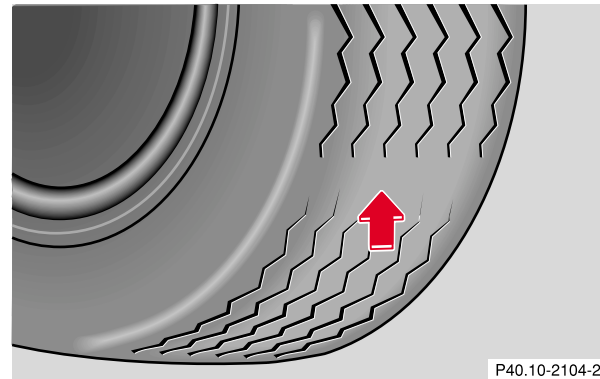

Warning!

Do not allow your tires to wear down too far. As tread depth approaches $\frac{1}{16}$ in (1.5 mm), the adhesion properties on a wet road are sharply reduced.

Depending upon the weather and/or road surface (conditions), the tire traction varies widely.

| | | | | | | | |
|--------------------------|-----------|----------------|----------------------------|-----------------|----------|----------------|-------|
| Instruments and controls | Operation | Driving | Instrument cluster display | Practical hints | Car care | Technical data | Index |
|--------------------------|-----------|----------------|----------------------------|-----------------|----------|----------------|-------|

Driving instructions

178

Specified tire pressures must be maintained. This applies particularly if the tires are subjected to high loads (e.g. high speeds, heavy loads, high ambient temperatures).

Warning!

Do not drive with a flat tire. A flat tire affects the ability to steer or brake the vehicle. You may lose control of the vehicle. Continued driving with a flat tire or driving at high speed with a flat tire will cause excessive heat build-up and possibly a fire.

Aquaplaning

Depending on the depth of the water layer on the road, aquaplaning may occur, even at low speeds and with new tires. Reduce vehicle speed, avoid track grooves in the road and apply brakes cautiously in the rain.

Tire traction

The safe speed on a wet, snow covered or icy road is always lower than on a dry road.

You should pay particular attention to the condition of the road whenever the outside temperatures are close to the freezing point.

Warning!

If ice has formed on the road, tire traction will be substantially reduced. Under such weather conditions, drive, steer and brake with extreme caution.

We recommend M+S rated radial-ply tires with a minimum tread depth of approximately 1/8 in (4 mm) for the winter season for all four wheels to insure normal balanced handling characteristics. On packed snow, they can reduce your stopping distance as compared with summer tires. Stopping distance, however, is still considerably greater than when the road is not snow or ice covered.

Tire speed rating

ML 320 and ML 430:

Your vehicle is factory equipped with “H”-rated tires, which have a speed rating of 130 mph (210 km/h).

An electronic speed limiter prevents your vehicle from exceeding the tire speed rating.

ML 55 AMG:

Your vehicle is factory equipped with “W”-rated tires, which have a speed rating of 168 mph (270 km/h).

Despite the tire rating, local speed limits should be obeyed. Use prudent driving speeds appropriate to prevailing conditions.

Warning!

Even when permitted by law, never operate a vehicle at speeds greater than the maximum speed rating of the tires.

Exceeding the maximum speed for which tires are rated can lead to sudden tire failure causing loss of vehicle control and resulting in personal injury and possible death.

Snow chains

Use only snow chains that are tested and recommended by Mercedes-Benz. Your authorized Mercedes-Benz Light Truck Center will be glad to advise you on this subject.

Snow chains should be used on all four wheels. With only two chains available, they should be mounted on the rear wheels. Follow the manufacturer’s mounting instructions.

Snow chains should only be driven on snow covered roads at speeds not to exceed 30 mph (50 km/h). Remove chains as soon as possible when driving on roads without snow.

When driving with snow chains, press the ESP control switch to OFF, refer to page 207.

Model ML 55 AMG

Use of snow chains is not permissible with tire size 285/50 R 18.

| | | | | | | | |
|--------------------------|-----------|----------------|----------------------------|-----------------|----------|----------------|-------|
| Instruments and controls | Operation | Driving | Instrument cluster display | Practical hints | Car care | Technical data | Index |
|--------------------------|-----------|----------------|----------------------------|-----------------|----------|----------------|-------|

Driving instructions

180

Winter driving instructions

The most important rule for slippery or icy roads is to drive sensibly and to avoid abrupt acceleration, braking and steering maneuvers. Do not use the cruise control system under such conditions.

When the vehicle is in danger of skidding, move selector lever to position “N”. Try to keep the vehicle under control by corrective steering action.

Caution!

Do not use LOW RANGE mode when driving on ice or packed snow. At speeds below 18 mph (30 km/h) vehicle steering is adversely affected by the LOW RANGE ABS.

Road salts and chemicals can adversely affect braking efficiency. Increased pedal force may become necessary to produce the normal brake effect. We therefore recommend depressing the brake pedal periodically when traveling at length on salt-strewn roads. This can bring road salt impaired braking efficiency back to normal. A prerequisite is, however, that this be done without endangering other drivers on the road.

If the vehicle is parked after being driven on salt treated roads, the braking efficiency should be tested as soon as possible after driving is resumed while observing the safety rules in the previous paragraph.

Warning!

If the vehicle becomes stuck in snow, make sure that snow is kept clear of the exhaust pipe and from around the vehicle with engine running. Otherwise, deadly carbon monoxide (CO) gases may enter vehicle interior resulting in unconsciousness and death.

To assure sufficient fresh air ventilation, open a window slightly on the side of the vehicle not facing the wind.

Winter driving

Have your vehicle winterized at your authorized Mercedes-Benz Light Truck Center before the onset of winter.

- Change the engine oil if the engine contains an oil which is not approved for winter operation. For viscosity (SAE/CCMC class) and filling quantity, see page 292.
- Check engine coolant anticorrosion/antifreeze concentration.
- Additive for the windshield washer and headlamp cleaning system: Add MB Concentrate "S" to a premixed windshield washer solvent/antifreeze which is formulated for below freezing temperatures see page 237.
- Test battery: Battery capacity drops with decreasing ambient temperature. A well charged battery helps to ensure that the engine can be started, even at low ambient temperatures.
- Tires: We recommend M+S rated radial-ply tires on all four wheels for the winter season. Observe permissible maximum speed for M+S rated radial-ply tires and the legal speed limit.

In winter operation, the maximum effectiveness of the antilock brake system (ABS), the four wheel electronic traction system (4-ETS+), the electronic stability program (ESP), and electronic brake proportioning (EBP) can only be achieved with M+S rated radial-ply tires and/or snow chains recommended by Mercedes-Benz. Snow chains maximize performance.

For driving instructions using snow chains see page 179.

Deep water

Caution!

Do not drive through flooded areas or water of unknown depth. Before driving through water, determine its depth. It should not be deeper than approximately 20 inches (50 cm).

If you must drive through deep water, drive slowly to prevent water from entering the engine compartment or passenger compartment, being ingested by the air intake, possibly causing damage to electrical components or wiring, to engine or transmission that is not covered by the Mercedes-Benz Limited Warranty.

Passenger compartment**Warning!**

Always fasten items being carried as securely as possible.

In an accident, during hard braking or sudden maneuvers, loose items will be thrown around inside the vehicle, and cause injury to vehicle occupants unless the items are securely fastened in the vehicle.

The trunk is the preferred place to carry objects.

Block heater (Canada only)

The engine is equipped with a block heater.

The electrical cable may be installed at your authorized Mercedes-Benz Light Truck Center.

Traveling abroad

Abroad, there is a widely-spread Mercedes-Benz service network at your disposal. If you plan to travel into areas which are not listed in the index of your Mercedes-Benz Light Truck Center directory, you should request pertinent information from your authorized Mercedes-Benz Light Truck Center.

Off-Road driving

Familiarize yourself with the vehicle characteristics and gear changing before you attempt any difficult terrain off-road driving. We recommend that you start out with easy off-road travel.

Please read this chapter carefully before you begin off-road travel.

Special driving features are available for specific kinds of operation:

- LOW RANGE mode, see page 209
- LOW RANGE - ABS, see page 202
- LOW RANGE - 4-ETS+, see page 204
- LOW RANGE - ESP, see page 208

Engage the LOW RANGE mode before driving under off-road conditions. For switching LOW RANGE mode on and off see page 209.

Fasten items being carried as securely as possible, see page 136.

We recommend to keep doors, liftgate, windows, and roof closed whenever driving in off-road mode.

Important!

Adjust vehicle speed to condition of terrain. The more uneven, rutty and steeper the terrain, the lower the speed should be.

Watch out for obstacles, such as rocks, holes, tree-stumps, ruts.

Be especially careful when driving in unknown territory. Eventually get out of the vehicle and scout the path you intend to take.

Continuous and speedy driving in sandy soil overcomes the vehicle rolling resistance, and helps to prevent the vehicle from sinking into the ground.

Do not initiate jumps with the vehicle. It interrupts the forward momentum of the vehicle.

Sand, dirt, mud and other material having friction property, can cause exceptional wear and tear as well as failure of the brakes.

In this case the brakes may be less effective or even fail when you most need them. Always clean and check the brakes following each off-road trip.

Driving instructions

184

Checklist before off-road driving

- **Tires:** Check the tread depth and maintain specified tire pressure (see tire pressure label inside the fuel filler flap). Check tires for possible damage and remove foreign objects. The valve caps must be mounted.
- **Rims:** Dented or bent rims can cause tire pressure loss and damage the tire beads. For this reason change rims before driving off-road.
- **Vehicle tool kit:** Check if the vehicle jack is functional. In all cases take the vehicle tool kit, a strong tow rope, a shovel and a small plank (to put under the vehicle jack on sandy soil) with you.

Driving in steep terrain

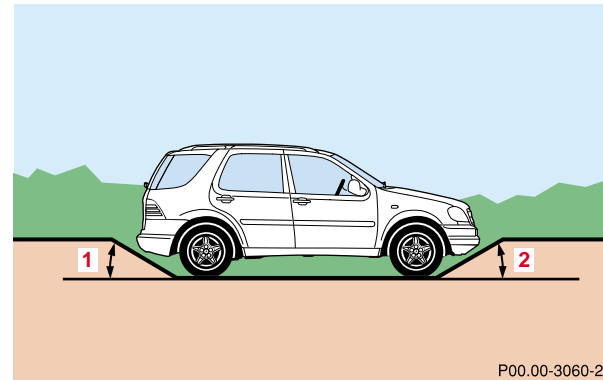

Slope angle:

- 1** 26° (ML 320 and ML 430)
23° (ML 55 AMG)
- 2** 26° (ML 320 and ML 430)
21° (ML 55 AMG)

Switch to LOW RANGE mode before starting to drive up or down steep inclines, see page 209.

Maximum vehicle climbing ability is a 60% grade.

Driving on embankments, slopes and other steep inclines should only be done straight up or downhill, i.e. in the line of gravity.

Do not drive along the side of a slope (danger of vehicle rollover). If in doing so, the vehicle begins to show a tendency to roll, immediately steer into a line of gravity (straight up or downhill).

To help avoid the vehicle rolling over, never turn it around on steep inclines. If the vehicle cannot complete the attempted climb, back it down in reverse gear.

Utilize the engine's braking power when descending a slope, observe the engine speed (do not overrev the engine). Apply the service brake as needed.

Check the brakes after a lengthy downgrade drive.

Notes:

Avoid excessive engine speeds – drive with moderate engine speeds (max. 3000 RPM).

Select gear range “2” or “1” on the automatic transmission, see page 165.

Traction in steep terrain:

Be easy on the accelerator and watch for continuous wheel traction when driving in steep terrain.

The 4-ETS+ helps greatly when starting out on a steep incline. The front wheels have then the tendency to slip due to the weight reduction over the front axle. The ETS recognizes the situation and limits the torque for the front wheels by braking them. Simultaneously the torque for the rear wheels is increased.

See page 203 for four wheel electronic traction system (4-ETS+).

Driving across a hilltop:

To prevent the vehicle from speeding up too much after climbing a hill, decelerate just ahead of a hilltop (do not select gear range “N”). Use the momentum of the vehicle to drive across the hilltop. Driving in this manner prevents the vehicle from jumping across the hilltop and thus losing its forward momentum.

| | | | | | | | |
|--------------------------|-----------|----------------|----------------------------|-----------------|----------|----------------|-------|
| Instruments and controls | Operation | Driving | Instrument cluster display | Practical hints | Car care | Technical data | Index |
|--------------------------|-----------|----------------|----------------------------|-----------------|----------|----------------|-------|

Driving instructions

186

Driving downhill:

Select gear range “1” on the automatic transmission, see page 165.

Drive downhill observing the same rules as driving uphill.

Driving on embankments, slopes and other steep inclines should only be done straight up or downhill, i.e. in the line of gravity.

Do not drive along the side of a slope (danger of vehicle rollover). If in doing so, the vehicle begins to show a tendency to roll, immediately steer into a line of gravity (straight up or downhill).

Utilize the engine’s braking power when descending a slope, observe the engine speed (do not overrev the engine). Apply the service brake as needed.

The special low range ABS setting allows for precise and brief (cyclical) blocking of the front wheels, permitting them to dig into loose ground. Remember that the front wheels when stopped, slide across a surface, thus lose their ability to steer the vehicle.

Check the brakes after a lengthy downgrade drive.

Important!

Only apply the service brake if the vehicle travels straight downhill, i.e. in the line of gravity.

Driving through water

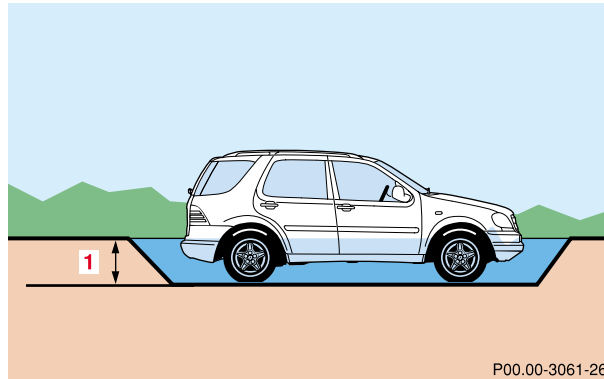

1 20 in (50 cm)

Before driving through water, determine its depth. It should not be deeper than approximately 20 inches (50 cm).

Switch to LOW RANGE mode before driving through water.

Switch off the exterior lamps as well as the climate control.

Enter the water only at a shallow spot. Never take a running start. Drive slowly, avoiding a bow wave.

Do not stop vehicle immersed in water, and do not shut off the engine.

To dry the brakes, apply pressure to the brake pedal several times after leaving the water.

Driving instructions

188



Crossing obstacles:

Select gear range “1” on the automatic transmission, see page 165.

Cross obstacles (e.g. tree stumps or big rocks) very slowly by aiming one of the front wheels at the center of the obstacle, and repeat same with the rear wheel.

Important!

Damage on the vehicle definitely increases the chance for a subsequent accident.

Notes:

Check the vehicle clearance before crossing obstacles that possibly could damage the undercarriage.

If possible use the assistance of a second person.

Special attention is needed when crossing obstacles on a steep incline. The vehicle could slide sideways as a result of its possible slanted position.

Ruts:

Select gear range “1” on the automatic transmission, see page 165.

A number of off-road tracks or other byways have deep ruts which can cause the undercarriage to come in contact with the ground.

Drive next to the ruts rather than through them if at all possible.

Notes:

Check the vehicle clearance.

Damage on the vehicle definitely increases the chance for a subsequent accident.

Returning from off-road driving

Off-road driving increases strain on the vehicle.

We recommend that you inspect the vehicle for possible damage after each off-road trip. Recognizing any damage and a subsequent timely repair reduces the chance of a possible breakdown or accident later on.

Proceed as follows:

- Switch off the LOW RANGE mode, see page 209.
- Remove excessive dirt from tires, wheels, wheel housings, and underbody. For instance, after driving in mud, clean the radiator, chassis, engine, brakes, and wheels from extreme dirt, using a strong jet of water.
- Inspect frame, oil pan, brake hoses, etc., as well as vehicle underbody for possible damage.
- Check tires for possible damage, clean all exterior lamps, and conduct a brake test.

- Check for brush or branches caught in the undercarriage. They could increase the possibility of a fire, as well as cut fuel and/or brake lines, puncture rubber bellows of the axles or drive shafts.

Warning!

If you feel a sudden significant vibration or ride disturbance, or you suspect that possible damage to your vehicle has occurred, you should turn on the hazard warning flashers, carefully slow down, and drive with caution to an area which is a safe distance from the roadway.

Inspect the tires and under the vehicle for possible damage. If the vehicle or tires appear unsafe, have it towed to the nearest Mercedes-Benz Light Truck Center or tire dealer for repairs.

Trailer towing**Warning!**

Failure to use proper equipment and driving technique can result in a loss of vehicle control when towing a trailer.

Improper towing or failure to follow the instructions contained in this guide can result in serious injury. Follow the guidelines below carefully to assure safe trailer operation.

Ask your authorized Mercedes-Benz Light Truck Center should you require an explanation of information contained in this guide.

Trailer Hitches

Only install a trailer hitch receiver approved for your vehicle. For information on availability and installation, please see your authorized Mercedes-Benz Light Truck Center.

The bumpers on your vehicle are not designed for use with clamp-type hitches. Do not attach rental hitches or other bumper-type hitches to them.

To reduce the possibility of damage, remove the hitch ball adaptor from the receiver when not in use.

Electrical connections

The vehicle is prewired to accept the seven-wire harness included in the Mercedes-Benz approved trailer hitch receiver kit. An additional four-pole conversion plug is included in the Mercedes-Benz supplied trailer hitch receiver kit. For further information, please see your authorized Mercedes-Benz Light Truck Center.

In order to prevent possible damage to the vehicle's electrical system by incorrectly installing the trailer wiring plug, we recommend having the harness connected at an authorized Mercedes-Benz Light Truck Center.

Vehicle and trailer weights and ratings

Gross Vehicle Weight Rating (GVWR) is the maximum permissible vehicle weight: 6005 lbs. (2724 kg)

Gross Vehicle Weight (GVW): comprises weight of vehicle including fuel, tools, spare wheel, installed accessories, passengers, cargo and trailer tongue. It must never exceed the GVWR.

Gross Axle Weight Rating (GAWR) is the maximum permissible axle weight:

| | | |
|-------|-----------|-----------|
| front | 2755 lbs. | (1250 kg) |
| rear | 3527 lbs. | (1600 kg) |

Gross Trailer Weight (GTW) is the maximum permissible trailer weight to be towed:
5000 lbs. (2260 kg)

Trailer Tongue Weight Rating (TWR) is the maximum permissible weight of the trailer tongue:
[500 lbs. (225 kg) limit for MB approved hitch receiver]

| | | | | | | | |
|--------------------------|-----------|----------------|----------------------------|-----------------|----------|----------------|-------|
| Instruments and controls | Operation | Driving | Instrument cluster display | Practical hints | Car care | Technical data | Index |
|--------------------------|-----------|----------------|----------------------------|-----------------|----------|----------------|-------|

Driving instructions

192

Loading a trailer

When loading a trailer, you should observe that neither the permissible GTW, nor the GVWR are exceeded.

Maximum permissible values are listed on the safety compliance certification labels for the vehicle and for the trailer to be towed. The lowest value listed must be selected when determining how the vehicle and trailer are loaded.

We recommend loading the trailer in such a manner that it has a tongue weight (TW) between 10% and 15% of the GTW.

The tongue weight at the hitch ball must be added to the GVW to prevent exceeding your Mercedes-Benz tow vehicle's rear GAWR.

Checking weights of vehicle and trailer

To assure that the tow vehicle and trailer are in compliance with the maximum permissible weight limits, and to know the actual weights, have the loaded rig (tow vehicle including driver, passengers and cargo, trailer fully loaded) weighed on a commercial scale.

Check the vehicle's front and rear Gross Axle Weight (GAW), the GTW and TW. The values as measured must not be exceeded, according to the weight listed under "Vehicle and trailer weight and ratings".

Attaching a trailer

Please observe maximum permitted trailer dimensions (width and length).

Most states and all Canadian provinces require safety chains between your tow vehicle and the trailer. The chains should be crisscrossed under the trailer tongue. They must be attached to the hitch receiver, and not to the vehicle's bumper or axle. Be sure to leave enough slack in the chains to permit turning corners.

Most states and all Canadian provinces require a separate brake system at various trailer weights.

Caution!

Do not connect a trailer brake system (if trailer is so equipped) directly to the vehicle's hydraulic brake system, as your vehicle is equipped with antilock brakes. If you do, neither the vehicle's brakes nor the trailer's brakes will function properly.

The provided vehicle electrical wiring harness for trailer towing has a brake signal wire (color orange) for hook-up to a brake controller.

Most states and all Canadian provinces require a break-away switch on trailers with a separate brake system. The switch activates the trailer brakes in the possible event that the trailer might separate from the tow vehicle.

You should consider using a trailer sway control system. For further information see your authorized Mercedes-Benz Light Truck Center.

| | | | | | | | |
|--------------------------|-----------|----------------|----------------------------|-----------------|----------|----------------|-------|
| Instruments and controls | Operation | Driving | Instrument cluster display | Practical hints | Car care | Technical data | Index |
|--------------------------|-----------|----------------|----------------------------|-----------------|----------|----------------|-------|

Driving instructions

194

Towing a trailer

There are many different laws, including speed limit restrictions, having to do with trailer towing. Make sure that your rig will be legal, not only for where you reside, but also for where you will be driving. A good source for this information can be the police or local authorities.

Before you start driving with the trailer, check the trailer hitch, break-away switch, safety chains, electrical connections, lighting and tires. Also adjust the mirrors to permit unobstructed view beyond rear of trailer.

If the trailer has electric brakes, start your vehicle and trailer moving slowly, and then apply only the trailer brake controller by hand to be sure the brakes are working properly.

When towing a trailer, check occasionally to be sure that the load is secure, and that lighting and trailer brakes (if so equipped) are functioning properly.

Always secure items in the trailer to prevent load shifts while driving.

Take into consideration that when towing a trailer, the handling characteristics are different and less stable from those when operating the vehicle without a trailer. It is important to avoid sudden maneuvers.

The vehicle and trailer combination is heavier, and therefore is limited in acceleration and climbing ability, and requires longer stopping distances. It is more prone to reacting to side wind gusts, and requires more sensitive steering input.

In order to gain skill and an understanding of the vehicle's behavior, you should practice turning, stopping and backing up in an area which is free from traffic.

If possible, do not brake abruptly, but rather engage the brake slightly at first to permit the trailer to activate its brake. Then increase the braking force.

Caution!

If the trailer should begin to sway, reduce the vehicle's speed and use the brake controller by hand to straighten out the vehicle and trailer. In no case should you attempt to straighten out the tow vehicle and trailer by increasing the speed or oversteering and stepping on the brakes.

If the transmission hunts between gears on inclines, manually shift to a lower gear (select "4", "3", "2" or "1"). A lower gear and reduction of speed reduces the chance of engine overloading and/or overheating.

At very steep inclines, not manageable with selector lever in position “1”, switch transfer case to LOW RANGE, see page 209 for instructions on how to engage LOW RANGE.

When going down a long hill, shift into a lower gear and use the engine’s braking effect. Avoid riding the brakes, thus overheating the vehicle and trailer brakes.

If the engine coolant rises to an extremely high temperature (coolant temperature needle approaching the red zone) when the air conditioner is on, turn off the air conditioner. Engine coolant heat can be additionally vented by opening the windows, switching the climate control fan speed to high and setting the temperature control to the maximum hot position.

Extreme care must be exercised since your vehicle with a trailer will require additional passing distance ahead than when driving without a trailer. Because your vehicle and trailer is longer than your vehicle alone, you will also need to go much farther ahead of the passed vehicle before you can return to your lane.

Parking

Warning!

To reduce the risk of personal injury, or damage to the vehicle powertrain, as a result of vehicle/trailer movement, always:

1. Keep right foot on brake pedal.
2. Shift gear selector lever to position “N”.
3. Have a second person place wheel chocks on downhill side of left and right trailer wheels.
4. Slowly release brake pedal and let vehicle and trailer roll into chocks until stopped.
5. Firmly depress parking brake pedal.
6. Move gear selector lever to position “P”.
7. On inclines turn front wheels towards the road curb.

Driving systems

196

Cruise control

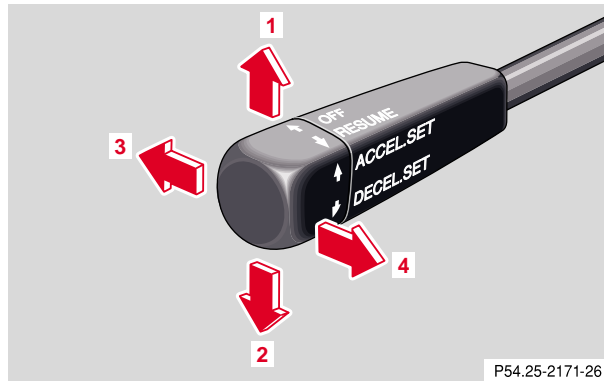

The cruise control allows you to drive in a more relaxed manner, for example over long distances, as it automatically maintains the set speed by actively regulating the throttle setting.

Any given speed above approximately 25 mph (40 km/h) can be maintained with the cruise control by operating the lever.

- 1** Accelerate and set:
Lift lever briefly to set speed.
Hold lever up to accelerate.
- 2** Decelerate and set:
Depress lever briefly to set speed.
Hold lever down to decelerate.

Normally the vehicle is accelerated to the desired speed with the accelerator.

Speed is set by briefly pushing the lever to position 1 or 2. The accelerator can then be released.

The speed can be increased (e.g. for passing) by using the accelerator. After the accelerator is released, the previously set speed will be resumed automatically.

If a set speed is to be increased or decreased slightly, e.g. to adapt to the traffic flow, hold lever in position 1 or 2 until the desired speed is reached, or briefly tip the lever in the appropriate direction for increases or decreases in 0.6 mph (1 km/h) increments. When the lever is released, the newly set speed remains.

3 Canceling

To cancel the cruise control, briefly push lever to position 3.

When you step on the brake pedal or the vehicle speed drops below approximately 25 mph (40 km/h), for example when driving upgrade, the cruise control will be canceled.

If the cruise control cancels by itself and remains inoperative until the engine is restarted, have the system checked at your authorized Mercedes-Benz Light Truck Center as soon as possible.

4 Resume

If the lever is briefly pushed to position 4 when driving at a speed exceeding approximately 25 mph (40 km/h), the vehicle resumes the speed which was set prior to the cancellation of the cruise control. The last memorized speed is canceled when the key in the steering lock is turned to position 1 or 0.

Important!

Moving gear selector lever to position “N” switches the cruise control off.

Warning!

Only use the cruise control if the traffic and weather conditions make it advisable to travel at a steady speed.

- **The use of cruise control can be dangerous on winding roads or in heavy traffic because conditions do not allow safe driving at a steady speed.**
- **The use of cruise control can be dangerous on slippery roads. Rapid changes in tire adhesion can result in wheel spin and loss of control.**

The “Resume” function should only be operated if the driver is fully aware of the previously set speed and wishes to resume this particular preset speed.

Driving systems

198

Notes:

If the engine does not brake the vehicle sufficiently while driving on a downgrade, the speed you set on the cruise control may be exceeded. In this case the automatic transmission shifts down (max. to 3rd gear) to maintain the set cruise control speed by using the engine's braking power.

As soon as the grade eases, the automatic transmission shifts up again dependent on the selector lever position.

Nevertheless, in some cases you may have to step on the brake pedal to slow down. In this case the cruise control is switched off.

Use the lever to resume the previously set speed.

Transmission in LOW RANGE mode

The cruise control should not be activated during off-road driving in the LOW RANGE mode. Doing so could reduce driving comfort.

Trailer operation

When towing a trailer, do not allow engine speed to drop too low on inclines. Select a lower range ("3", "2" or "1") in time, depending on the degree of the incline. This is also valid with cruise control activated.

At extreme inclines switch to LOW RANGE mode, see page 209.

Note:

For detailed information see trailer towing on page 190.

Brake assist system (BAS)

Warning!

BAS cannot prevent the natural laws of physics from acting on the vehicle, nor can it increase braking efficiency beyond that afforded by the condition of the vehicle brakes and tires or the traction afforded. The BAS cannot prevent accidents, including those resulting from excessive speed in turns, following another vehicle too closely, or aquaplaning. Only a safe, attentive, and skillful driver can prevent accidents. The capabilities of a BAS equipped vehicle must never be exploited in a reckless or dangerous manner which could jeopardize the user's safety or the safety of others.

The BAS is designed to maximize the vehicle's braking capability during emergency braking maneuvers by having maximum power boost applied to the brakes more quickly in emergency braking conditions than might otherwise be afforded solely by the driver's braking style. This can help reduce braking distances over what ordinary driving and braking style might do. The BAS complements the antilock brake system (ABS).

Applying the brakes very quickly results in maximum BAS assistance.

To receive the benefit of the system you must apply continuous full braking power during the stopping sequence. Do not reduce brake pedal pressure.

Once the brake pedal is released, the BAS is deactivated.

The malfunction indicator lamp for the electronic stability program (ESP) is combined with the BAS malfunction indicator lamp.

| | | | | | | | |
|--------------------------|-----------|----------------|----------------------------|-----------------|----------|----------------|-------|
| Instruments and controls | Operation | Driving | Instrument cluster display | Practical hints | Car care | Technical data | Index |
|--------------------------|-----------|----------------|----------------------------|-----------------|----------|----------------|-------|

Driving systems

200

The BAS/ESP malfunction indicator lamp in the instrument cluster comes on with the key in steering lock position 2 and should go out with the engine running.

If the BAS/ESP malfunction indicator lamp comes on permanently while the engine is running, a malfunction has been detected in either system. As a result, it is possible that now only partial engine output will be available. If the BAS malfunctions, the brake system functions in the usual manner, but without BAS.

If the charging voltage falls below 10 volts, the malfunction indicator lamp comes on and the BAS and the ESP are switched off. When the voltage is above this value again, the malfunction indicator lamp should go out and the BAS is operational.

With the ABS malfunctioning, the BAS is also switched off. Both malfunction indicator lamps come on with the engine running.

If the BAS/ESP malfunction indicator lamp stays illuminated, have the BAS or ESP checked at your authorized Mercedes-Benz Light Truck Center as soon as possible.

Antilock brake system (ABS)

Warning!

Do not pump the brake pedal, rather use firm, steady brake pedal pressure. Pumping the brake pedal defeats the purpose for ABS and significantly reduces braking effectiveness.

Important!

The ABS improves steering control of the vehicle during hard braking maneuvers.

The ABS prevents the wheels from locking up above a vehicle speed of approximately 5 mph (8 km/h) independent of road surface conditions.

At the instant one of the wheels is about to lock up, a slight pulsation can be felt in the brake pedal, indicating that the ABS is in the regulating mode. Keep firm and steady pressure on the brake pedal while experiencing the pulsation.

Continuous steady brake pedal pressure results in applying the advantages of the ABS, namely braking power and ability to steer the vehicle.

In the case of an emergency brake maneuver keep continuous full pressure on the brake pedal. In this manner only can the ABS be most effective.

On slippery road surfaces, the ABS will respond even with light brake pedal pressure because of the increased likelihood of locking wheels. The pulsating brake pedal can be an indication of hazardous road conditions and functions as a reminder to take extra care while driving.

ABS control

The ABS malfunction indicator lamp  in the instrument cluster comes on with the key in steering lock position 2 and should go out with the engine running.

When the ABS malfunction indicator lamp  in the instrument cluster comes on while the engine is running, it indicates that the ABS has detected a malfunction and has switched off. In this case, the brake system functions in the usual manner, but without antilock assistance.

With the ABS malfunctioning, the BAS, EBP, ESP and 4-ETS+ are also switched off. The malfunction indicator lamps come on with the engine running.

| | | | | | | | |
|--------------------------|-----------|----------------|----------------------------|-----------------|----------|----------------|-------|
| Instruments and controls | Operation | Driving | Instrument cluster display | Practical hints | Car care | Technical data | Index |
|--------------------------|-----------|----------------|----------------------------|-----------------|----------|----------------|-------|

Driving systems

202

If the charging voltage falls below 10 volts, the malfunction indicator lamp comes on and the ABS is switched off. When the voltage is above this value again, the malfunction indicator lamp should go out and the ABS is operational.

If the ABS malfunction indicator lamp stays illuminated, have the system checked at your authorized Mercedes-Benz Light Truck Center as soon as possible.

Warning!

ABS cannot prevent the natural laws of physics from acting on the vehicle, nor can it increase braking or steering efficiency beyond that afforded by the condition of the vehicle brakes and tires or the traction afforded. The ABS cannot prevent accidents, including those resulting from excessive speed in turns, following another vehicle too closely, or aquaplaning. Only a safe, attentive, and skillful driver can prevent accidents. The capabilities of an ABS equipped vehicle must never be exploited in a reckless or dangerous manner which could jeopardize the user's safety or the safety of others.

Notes:

To alert following vehicles to slippery road conditions you discover, operate your hazard warning flashers as appropriate.



Operating the vehicle on a single axle dynamometer should only be done for briefly testing the brakes. To do so, move selector lever to position "N". The engine must be shut off (key in steering lock position 0 or 1).

LOW RANGE – ABS

During off-road driving a special low range system for the antilock brake system (ABS) is operational with transmission in LOW RANGE mode, see page 211.

When applying the service brakes at speeds below approximately 18 mph (30 km/h), the front wheels are locked cyclically to shorten the braking distance (dig in effect). This affects steering the vehicle.

Four-wheel electronic traction system (4-ETS+)

With the key in steering lock position 2, the yellow 4-ETS+ malfunction indicator lamp  and the 4-ETS+ warning lamp  come on and should go out when the engine is running.

The 4-ETS+ improves vehicle's ability to utilize available traction, especially under slippery road conditions. The brakes are applied to the spinning wheel and power is transferred to the wheel(s) with traction.

The 4-ETS+ warning lamp , located in the speedometer dial, starts to flash at any vehicle speed, as soon as the tires lose traction and the wheels begin to spin.



Important!

If the 4-ETS+ warning lamp  flashes:

- during take-off, apply as little throttle as possible,
- while driving, ease up on the accelerator.

Adapt your speed and driving to the prevailing road conditions.

4-ETS+ Control

If the yellow 4-ETS+ malfunction indicator lamp  comes on while the 4-ETS+ warning lamp  flashes, the electronic traction system is being switched off temporarily to prevent overheating of the drive wheel brakes.

If the 4-ETS+ malfunction indicator lamp  comes on with the engine running, a malfunction has been detected.

Have the 4-ETS+ checked at your authorized Mercedes-Benz Light Truck Center as soon as possible.

With the ABS malfunctioning, the 4-ETS+ is also switched off.

Caution!

If the vehicle is towed with the front axle raised (see towing the vehicle on page 255), or when testing the parking brake on a brake test dynamometer, the engine must be shut off (key in steering lock position 0 or 1). Otherwise, the electronic traction system will immediately be engaged and will apply the rear wheel brakes.

| | | | | | | | |
|--------------------------|-----------|----------------|----------------------------|-----------------|----------|----------------|-------|
| Instruments and controls | Operation | Driving | Instrument cluster display | Practical hints | Car care | Technical data | Index |
|--------------------------|-----------|----------------|----------------------------|-----------------|----------|----------------|-------|

Driving systems

204

Note:

In winter operation, the maximum effectiveness of the electronic traction system is only achieved with Mercedes-Benz recommended M+S rated radial-ply tires and/or snow chains.



LOW RANGE – 4-ETS+

During off-road driving a special low range system for the four wheel electronic traction system (4-ETS+) is operational with transmission in LOW RANGE mode, see page 211.



If one or more tires lose traction while driving downhill (accelerator released), the 4-ETS+ engages and the warning lamp , located in the speedometer dial, starts to flash.

Electronic brake proportioning (EBP)

The EBP enhances braking effectiveness by allowing the rear brakes to supply a greater proportion of the braking effort without a loss of vehicle stability.

If a warning tone sounds for five seconds and the symbols  and  are displayed in the instrument cluster, the system has detected a malfunction and is switched off. Have the system checked immediately at an authorized Mercedes-Benz Light Truck Center. Failure to do so could result in an accident, since the enhanced braking effect is not available when the system is switched off.

Note:

When the EBP is switched off, every time the engine is started, a warning tone will sound for five seconds and the symbols  and  will light up. In addition, whenever the brakes are applied at speeds exceeding 25 mph (40 km/h), the warning tone sounds for five seconds.

Electronic stability program (ESP)

Warning!

ESP cannot prevent the natural laws of physics from acting on the vehicle, nor can it increase the traction afforded. The ESP cannot prevent accidents, including those resulting from excessive speed in turns, or aquaplaning. Only a safe, attentive, and skillful driver can prevent accidents. The capabilities of an ESP equipped vehicle must never be exploited in a reckless or dangerous manner which could jeopardize the user's safety or the safety of others.

The ESP enhances directional control and reduces driving wheel spin of the vehicle under various driving conditions.

Over-/understeering of the vehicle is counteracted by applying brakes to the appropriate wheel to create a countervailing vehicle movement. Engine torque is also limited. The ESP warning lamp, located in the speedometer dial, starts to flash when ESP is in operation.

Important!

If the ESP warning lamp  flashes:



- During take-off apply as little throttle as possible.
- While driving ease up on the accelerator.
- Adapt your speed and driving to the prevailing road conditions.
- Do not switch off the ESP.

Caution!

If the vehicle is towed with the front axle raised (see towing the vehicle on page 255), the engine must be shut off (key in steering lock position 0 or 1). Otherwise, the ESP will immediately be engaged and will apply the rear wheel brakes.

Notes:

The malfunction indicator lamp for the ESP is combined with that of the BAS.

The yellow BAS/ESP malfunction indicator lamp  in the instrument cluster and the yellow ESP warning lamp  in the speedometer dial come on with the key in steering lock position 2. They should go out with the engine running.

Driving systems

206

If the BAS/ESP malfunction indicator lamp  comes on continuously with the engine running, a malfunction has been detected in either system. Only partial engine output will be available.

If the BAS malfunctions, the brake system functions in the usual manner, but without BAS.

If the BAS/ESP malfunction indicator lamp stays illuminated, have the BAS or ESP checked at your authorized Mercedes-Benz Light Truck Center as soon as possible.

With the ABS malfunctioning, the ESP is also switched off.

Driving the vehicle with varied size tires will cause the wheels to rotate at different speeds, therefore the ESP may activate (yellow ESP warning lamp  in speedometer dial comes on). For this reason, all wheels, including the spare wheel, must have the same tire outside diameter.

When testing the parking brake on a brake test dynamometer, the engine must be shut off. Otherwise, the ESP will immediately be engaged and will apply the rear wheel brakes.

In winter operation, the maximum effectiveness of the ESP is only achieved with Mercedes-Benz recommended M+S rated radial-ply tires and/or snow chains.

Synchronizing ESP

If the power supply was interrupted (battery disconnected or empty), the BAS/ESP malfunction indicator lamp may be illuminated with the engine running.

After driving off the BAS/ESP malfunction indicator lamp should go out after approximately 110 - 220 yd (100 - 200 m).

ESP control switch



ESP control switch located in center console.

To switch ESP off, press upper half of switch.
ESP warning lamp , located in speedometer dial, comes on.

To switch ESP on again, press lower half of switch.
ESP warning lamp , located in speedometer dial, goes out.

To improve the vehicle's traction when driving with snow chains, or starting off in deep snow, sand or gravel, or off-road driving, switch off ESP by pressing the upper half of the ESP switch. The ESP warning lamp , located in the speedometer dial, is continuously illuminated.

Warning!

ESP should not be switched off during normal driving other than in circumstances described above. Disabling of the system will reduce vehicle stability in standard driving maneuvers.

When the ESP warning lamp is illuminated continuously, the ESP is switched off.

Adapt your speed and driving to the prevailing road conditions.

With the ESP system switched off, the engine torque reduction feature is cancelled. Therefore, the enhanced vehicle stability offered by ESP is unavailable.

Adapt your speed and driving to the prevailing road conditions.

A portion of the ESP system remains active, even with the switch in the OFF position.

| | | | | | | | |
|--------------------------|-----------|----------------|----------------------------|-----------------|----------|----------------|-------|
| Instruments and controls | Operation | Driving | Instrument cluster display | Practical hints | Car care | Technical data | Index |
|--------------------------|-----------|----------------|----------------------------|-----------------|----------|----------------|-------|

Driving systems

208

If one drive wheel loses traction and begins to spin, the brake is applied until the wheel regains sufficient traction.

Note:

Avoid spinning of one drive wheel. This may cause serious damage to the drive train which is not covered by the Mercedes-Benz Limited Warranty.

The ESP warning lamp, located in the speedometer dial, starts to flash at any vehicle speed as soon as the tires lose traction and the wheels begin to spin.

To return to the enhanced vehicle stability offered by ESP: press lower half of the switch (the ESP warning lamp in the speedometer dial goes out).

Important!

If the ESP warning lamp flashes:

- during take-off, apply as little throttle as possible,
- while driving, ease up on the accelerator.

LOW RANGE – ESP

During off-road driving a special low range system for the electronic stability program (ESP) is operational with transmission in LOW RANGE mode, see page 211.

In the LOW RANGE mode the electronic stability program (ESP) operates in a traction improving fashion specifically adapted for off-road driving. At speeds below 27 mph (45 km/h) the ESP assists in over-/understeering, thus improving vehicle tracking.

Transmission control – LOW RANGE mode

The switch is located in the instrument panel.

Important!

When switching to or from the LOW RANGE mode, observe the following:

- The vehicle must be at a complete standstill.
- The engine speed must not exceed 1500 rpm.

Failure to do so may result in transmission/engine damage not covered by the Mercedes-Benz Limited Warranty

The LOW RANGE mode should be switched on:

- during off-road driving,
- when crossing waters.

For additional practical hints refer to off-road driving on page 183.

Switching on:

1. Stop the vehicle.
2. Move transmission selector lever to position “N”.
3. Push top end of switch. The LOW RANGE indicator lamp in the instrument cluster blinks slowly during the changeover.

Once the changeover is complete, the indicator lamp in the instrument cluster lights up continuously.

Note:

If the indicator lamp blinks fast, one or more switching conditions were not observed, or the LOW RANGE mode is defective.

| | | | | | | | |
|--------------------------|-----------|----------------|----------------------------|-----------------|----------|----------------|-------|
| Instruments and controls | Operation | Driving | Instrument cluster display | Practical hints | Car care | Technical data | Index |
|--------------------------|-----------|----------------|----------------------------|-----------------|----------|----------------|-------|

Driving systems

210

Switching off:

1. Stop the vehicle.
2. Move transmission selector lever to position "N".
3. Push top end of switch. The LOW RANGE indicator lamp in the instrument cluster blinks slowly during the changeover.

Once the changeover is complete, the indicator lamp in the instrument cluster goes out. Use the gear selector lever normally.

Note:

If the indicator lamp blinks fast, one or more switching conditions were not observed, or the LOW RANGE mode is defective.

Important!

During off-road driving a special low range system for antilock brake system (ABS) and four-wheel electronic traction system (4-ETS+) are operational with transmission in the LOW RANGE mode.

In the low range mode the electronic stability program (ESP) operates in a traction improving fashion specifically adapted for off-road driving. At speeds below 27 mph (45 km/h) the ESP assists in over-/understeering, thus improving vehicle tracking.

If one or more tires lose traction while driving downhill (accelerator released), the 4-ETS+ engages and the warning lamp , located in the speedometer dial, starts to flash.

When applying the service brakes at speeds below approximately 18 mph (30 km/h), the front wheels are locked cyclically to shorten the braking distance (dig in effect). This affects steering the vehicle.

Notes:

Driving off or driving up to 3 mph (5 km/h) with the service brakes applied lightly (to reduce drive wheel spin), the 4-ETS+ remains engaged. Driving with the service brakes applied lightly at vehicles speeds above 3 mph (5 km/h), the 4-ETS+ will not engage.

If the indicator lamp blinks fast, one or more switching conditions were not observed, or the LOW RANGE mode is defective.

In the case of a defective in the LOW RANGE mode the transmission shifts in the usual manner. It is not possible to switch on the LOW RANGE mode.

Have the transmission checked at your authorized Mercedes-Benz Light Truck Center as soon as possible.

What you should know at the gas station

212

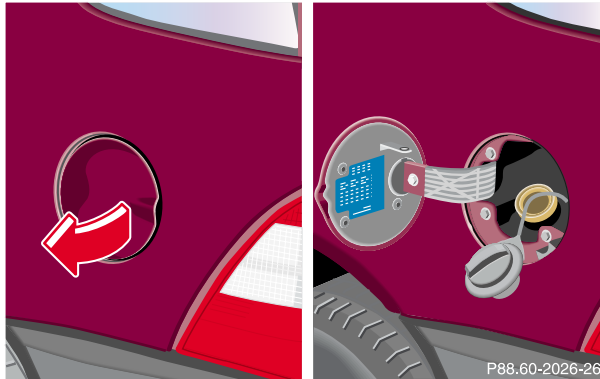
What you should know at the gas station**Fuel supply****Warning!**

Gasoline is highly flammable and poisonous. It burns violently and can cause serious injury. Whenever you are around gasoline, avoid inhaling fumes and skin contact, extinguish all smoking materials. Never allow sparks, flame or smoking materials near gasoline!

Open flap by pulling at rear (arrow). Turn fuel cap to the left and hold on to it until possible pressure in tank has been released, then remove cap. Failure to remove slowly could result in personal injury.

The fuel filler cap is tethered to the fuel filler neck. Do not drop the cap. It could damage the vehicle paint finish.

Manual release of fuel filler flap, see page 274.

Important!

When refueling vehicle make certain that no gasoline comes into contact with plastic taillamp, to prevent damaging the lens.

Fuel

To prevent fuel vapors from escaping into open air, fully insert filler nozzle unit.

Only fill fuel tank until the filler nozzle unit cuts out – do not top up or overfill.

Warning!

Overfilling of fuel tank may result in creating pressure in the system which could cause a gas discharge such as the gas spraying back out upon removing the filler nozzle which could cause personal injury.

Leaving the engine running and the fuel cap open can cause the “CHECK ENGINE” lamp to illuminate.

Fuel tank capacity approximately 19.0 US gal (72.0 l). This includes approximately 3.2 US gal (12.0 l) reserve.

Use premium unleaded gasoline: Posted Octane Index 91 (Average of 96 RON/86 MON).

- **Engine oil**

Engine oil level check, see page 89 and page 233.

Fill quantity between upper and lower dipstick marking level: 2.1 US qt (2.0 l).

Recommended engine oils, see Approved Service Products sheet.

- **Coolant**

For normal replenishing, use water (potable water quality).

For further information (e.g. anticorrosion/antifreeze), see page 292.

- **Spark plugs**

Approved spark plugs, see page 290.

- **Tire pressure**

For tire pressure, refer to tire pressure label inside the fuel filler flap. See page 250 for further details.

- **Air conditioner**

R-134a refrigerant and special PAG lubricant, see page 294.

| | | | | | | | |
|--------------------------|-----------|----------------|----------------------------|-----------------|----------|----------------|-------|
| Instruments and controls | Operation | Driving | Instrument cluster display | Practical hints | Car care | Technical data | Index |
|--------------------------|-----------|----------------|----------------------------|-----------------|----------|----------------|-------|

What you should know at the gas station

214

- **Bulbs**

high beam: H1 U (55 W),
low beam: H7 (55 W)
low beam: Xenon D2R - 35 W (optional)
fog lamps (optional): H3 U (55 W),
turn signal, parking, side marker and standing lamps, front: 1157 (32/3 cp),
turn signal lamp, side: W 5 W (168 [3 cp]),
stop lamps: P 21 W (1073 [32 cp]),
backup lamps: P 21 W (1073 [32 cp]),
turn signal lamps, rear: P Y 21 W,
tail, parking, side marker, standing, and rear fog lamp, driver's side: P 21/4 W,
license plate lamps: C 5 W (tubular),
high mounted stop lamp: P 21 W (1073 [32 cp]).

Check regularly and before a long trip

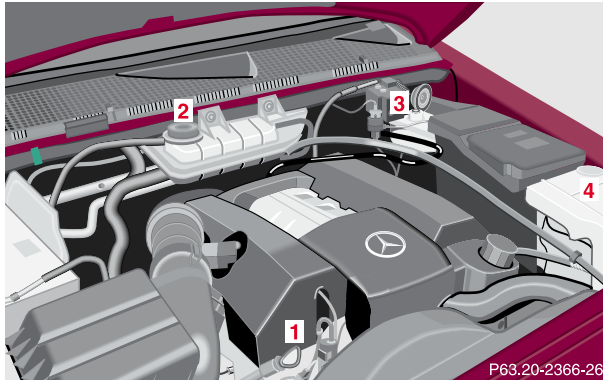

1 Engine oil level

See “Checking engine oil level” on page 233 and “Engine oil level indicator” on page 89.

2 Coolant level

See “Coolant level” on page 234.

3 Brake fluid

See “Brake fluid” on page 294.

**4 Windshield washer system/
Headlamp cleaning system/
Rear window washer system**

For refilling reservoir see page 236.

Opening hood, see page 231.

Vehicle lighting: Check function and cleanliness. For replacement of light bulbs, see “Exterior lamps” on page 260.

Exterior lamp switch, see page 90.

Instrument cluster display

| | |
|--|-----|
| Malfunction and indicator lamps in the instrument cluster | 218 |
| On-board diagnostic system – Check engine malfunction indicator lamp | 218 |
| Brake warning lamp | 219 |
| Supplemental restraint system (SRS) indicator lamp | 219 |
| Fuel reserve warning | 220 |

| | |
|--|-----|
| Electronic stability program (ESP) / Electronic traction system (ETS) – warning lamp | 221 |
| BAS/ESP malfunction indicator lamp | 221 |
| 4-ETS malfunction indicator lamp | 221 |
| LOW RANGE indicator lamp | 221 |
| ABS malfunction indicator lamp | 222 |

| | |
|--|-----|
| Adjustable steering wheel – indicator lamp | 222 |
| AIRBAG OFF indicator lamp | 222 |
| Seat belt warning lamp | 223 |
| Charge indicator lamp | 223 |
| Low engine oil level warning lamp | 224 |
| Low engine coolant level warning | 224 |
| Brake pad wear indicator lamp | 225 |
| FSS indicator | 225 |

| | | | | | | | |
|--------------------------|-----------|---------|-----------------------------------|-----------------|----------|----------------|-------|
| Instruments and controls | Operation | Driving | Instrument cluster display | Practical hints | Car care | Technical data | Index |
|--------------------------|-----------|---------|-----------------------------------|-----------------|----------|----------------|-------|

Malfunction and indicator lamps

218

Malfunction and indicator lamps in the instrument cluster

General information:

If a bulb in the instrument cluster fails to light up during the bulb self-check when turning the key in steering lock to position 2, have it checked and replaced if necessary.

On-board diagnostic system

Check engine malfunction indicator lamp



Engine malfunction indicator lamp. If the “CHECK ENGINE” malfunction indicator lamp comes on when the engine is running, it indicates a malfunction of the fuel management system, emission control system, systems which impact emissions, or the fuel cap is not closed tight (check the fuel cap). If the “CHECK ENGINE” lamp is illuminated continuously and the vehicle is driving normally, you may still drive the vehicle, however, in all cases, we recommend that you have the system checked at your authorized Mercedes-Benz Light Truck Center as soon as possible.

If the “CHECK ENGINE” lamp comes on continuously and/or the vehicle is not driving normally (e.g. malfunction of the fuel management system or running

out of fuel), serious damage can occur to the emission system. Please contact your authorized Mercedes-Benz Light Truck Center immediately.

The Sequential Multiport Fuel Injection (SFI) control module monitors emission control components that either provide input signals to or receive output signals from the control module. Malfunctions resulting from interruptions or failure of any of these components are indicated by the “CHECK ENGINE” malfunction indicator lamp in the instrument cluster and are simultaneously stored in the SFI control module.

If the “CHECK ENGINE” malfunction indicator lamp comes on, have the system checked at your authorized Mercedes-Benz Light Truck Center as soon as possible.

With some exceptions, the control module switches off the “CHECK ENGINE” malfunction indicator lamp if the condition, causing the lamp to come on, no longer exists during three consecutive cycles. See also page 220 for fuel cap placement warning.

An on-board diagnostic connector is located in the passenger compartment near to the parking brake pedal, allowing the accurate identification of system malfunctions through the readout of diagnostic trouble codes.

Brake warning lamp



When the brake warning lamp appears while the engine is running, this means:

- there is insufficient brake fluid in the reservoir (engine running and parking brake released), or
- the parking brake is set (engine running)
- the electronic brake proportioning (EBP) system is malfunctioning.

Warning!

Driving with the brake warning lamp illuminated can result in an accident. Have your brake system checked immediately if the brake warning lamp stays on. Don't add brake fluid before checking the brake system. Overfilling the brake fluid reservoir can result in spilling brake fluid on hot engine parts and the brake fluid catching fire. You can be seriously burned.

Note:

If you find that the minimum mark on the brake fluid reservoir is reached, have the brake system checked for brake pad thickness and leaks.

Supplemental restraint system (SRS) indicator lamp



The operational readiness of the airbag system is verified by the indicator lamp "SRS" in the instrument cluster when turning the key in steering lock to position 1 or 2. If no fault is detected, the lamp will go out after approximately 5 seconds; after the lamp goes out, the system continues to monitor the components and circuitry of the airbag system and will indicate a malfunction by coming on again.

Warning!

In the event a malfunction of the "SRS" is indicated as outlined above, the "SRS" may not be operational. For your safety, we strongly recommend that you visit an authorized Mercedes-Benz Light Truck Center immediately to have the system checked; otherwise the "SRS" may not be activated when needed in an accident, which could result in serious or fatal injury, or it might deploy unexpectedly and unnecessarily which could also result in injury.

See page 56 for notes on airbags, page 55 for belt tensioners, and page 65 for infant and child seat restraints.

Malfunction and indicator lamps

220

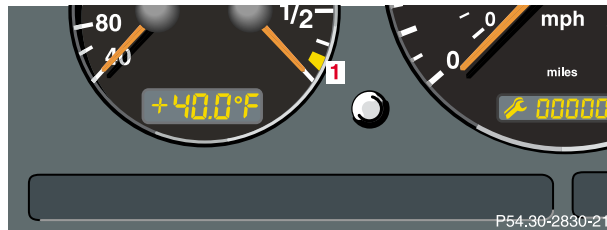
Fuel reserve warning

When the warning lamp (1) comes on after starting the engine, or if it comes on while driving, it indicates that the fuel level is down to the reserve quantity of approximately 3.2 gal (12 liters).

See page 212 for notes on refueling the vehicle.

Electronic stability program (ESP)/Electronic traction system (4-ETS+) – warning lamp



The yellow warning lamp in the speedometer dial comes on with the key in steering lock position 2. It should go out with engine running.

See page 203 for 4-ETS+ and page 205 for ESP if the warning lamp lights up or flashes when the vehicle is moving.

BAS/ESP malfunction indicator lamp



The malfunction indicator lamp for the ESP is combined with that of the BAS.

The yellow BAS/ESP malfunction indicator lamp in the instrument cluster comes on with the key in steering lock position 2. It should go out with the engine running.

If the BAS/ESP malfunction indicator lamp remains illuminated with the engine running, see page 199 for BAS and page 205 for ESP.

4-ETS+ malfunction indicator lamp



The yellow ETS malfunction indicator lamp in the instrument cluster comes on with the key in steering lock position 2. It should go out with the engine running.

If the ETS malfunction indicator lamp remains illuminated with the engine running a malfunction has been detected, see page 203 for 4-ETS+.

LOW RANGE indicator lamp



The yellow LOW RANGE indicator lamp in the instrument cluster comes on with the key in steering lock position 2. With the LOW RANGE mode deactivated it should go out with the engine running.

With the LOW RANGE mode activated the LOW RANGE indicator lamp is illuminated continuously.

If the indicator lamp blinks fast, one or more switching conditions were not observed, or the LOW RANGE mode is defective, see page 209 for LOW RANGE mode.

ABS malfunction indicator lamp

The ABS malfunction indicator lamp in the instrument cluster comes on with the key in steering lock position 2 and should go out with the engine running.

When the ABS malfunction indicator lamp in the instrument cluster comes on while the engine is running, it indicates that the ABS has detected a malfunction and has switched off. In this case, the brake system functions in the usual manner, but without antilock assistance.

With the ABS malfunctioning, the BAS, ESP and 4-ETS+ are also switched off. Both malfunction indicator lamps come on with the engine running.

If the charging voltage falls below 10 volts, the malfunction indicator lamp comes on and the ABS is switched off. When the voltage is above this value again, the malfunction indicator lamp should go out and the ABS is operational.

Have the system checked at your authorized Mercedes-Benz Light Truck Center as soon as possible.

See page 201 for notes on antilock brake system (ABS).

Adjustable steering wheel – indicator lamp

The indicator lamp in the instrument cluster comes on with the key in steering lock position 2 and should go out with the engine running.

If the indicator lamp does not go out after starting the engine, the adjustable steering column is not properly locked.

For locking the adjustable telescoping steering column, see page 70.

AIRBAG OFF indicator lamp

The indicator lamp will light up for approximately 6 seconds, extinguish, then blink once, when you turn the key in steering lock to position 1 or 2.

The  indicator lamp stays lit as long as a BabySmart™ compatible child seat is properly installed on the front passenger seat. It indicates that the front passenger airbag is switched off.

See page 53 for BabySmart™ airbag and its deactivation system.

BabySmart™ is a trademark of Siemens Automotive Corp.

Seat belt warning lamp



With the key in steering lock position 2, the seat belt warning lamp comes on for a short time if the driver's seat belt is not fastened.

After starting the engine, the warning lamp remains illuminated for a short time to remind the driver and passengers to fasten seat belts.

Charge indicator lamp



Should the charge indicator lamp fail to come on prior to starting when the key is in steering lock position 2 or should it fail to go out after starting or during operation, this indicates a malfunction which must be repaired at an authorized Mercedes-Benz Light Truck Center immediately.

If the charge indicator lamp comes on while the engine is running, this may indicate that the poly-V-belt has broken. Should this condition occur, the poly-V-belt must be replaced before continuing to operate the vehicle. Otherwise, the engine will overheat due to an inoperative water pump which may result in damage to the engine.

Do not continue to drive the vehicle with the charge indicator lamp illuminated. Doing so could result in serious engine damage that is not covered by the Mercedes-Benz Limited Warranty.

Low engine oil level warning lamp

With the key in steering lock position 2, the oil level warning lamp comes on and should go out when the engine is running.

If the warning lamp does not go out after starting the engine, or comes on with the engine running and at operating temperature, the engine oil level has dropped to approximately the minimum mark on the dipstick.

When this occurs, the warning lamp will first come on intermittently and then stay on if the oil level drops further.

If no oil leaks are noted, continue to drive to the nearest service station where the engine oil should be topped to the “full” mark on the dipstick with an approved oil.

The low engine oil level warning light should not be ignored. Extended driving with the light illuminated could result in serious engine damage that is not covered by the Mercedes-Benz Limited Warranty.

In addition to the warning lamp, the engine oil level should be periodically checked with the dipstick or via the oil level indicator in the odometer display field, for example during a fuel stop, or before a long trip (see engine oil level indicator on page 89 and checking engine oil on page 233).

Low engine coolant level warning

When the coolant level warning lamp comes on while driving, then the coolant level has dropped below the required level, or the coolant temperature is in the red zone. If no leaks are noticeable and the engine temperature does not increase, continue to drive to the nearest service station and have coolant added to the coolant system, see page 234. If the engine temperature reaches the red zone, move vehicle to an area which is in a safe distance from the roadway and turn off the engine. Also see coolant temperature gauge on page 81.

The low engine coolant level warning should not be ignored. Extended driving with the symbol displayed may cause serious engine damage not covered by the Mercedes-Benz Limited Warranty.

In cases of major or frequent minor coolant loss, have the cooling system checked at your authorized Mercedes-Benz Light Truck Center as soon as possible.

Notes:

Do not drive without coolant in the cooling system. The engine will overheat causing major engine damage.

Monitor the coolant temperature gauge while driving.

Brake pad wear indicator lamp



With the key in steering lock position 2, the indicator lamp comes on and goes out when the engine is running.

If the indicator lamp lights up during braking, this indicates that the brake pads are worn down.

Have the brake system checked at your authorized Mercedes-Benz Light Truck Center as soon as possible.

FSS indicator



FSS indicator (Service A), see page 87.



FSS indicator (Service B), see page 87.

The symbols appear in the main odometer display field prior to the next suggested service. Depending on operating conditions throughout the year, the next service is calculated and displayed in days or distance remaining. See page 87 for notes on the flexible service system (FSS).

Practical hints

| | | | | | |
|-------------------------------------|-----|--|-----|------------------------------|-----|
| First aid kit | 228 | Vehicle jack, wheel bolt wrench and screwdriver | 237 | Exterior lamps | 260 |
| Fuses | 228 | Air pump | 239 | Headlamp assembly | 261 |
| Electrical outlet | 230 | Wheels | 240 | Taillamp assemblies | 265 |
| Stowing things in the vehicle | 230 | Tire replacement | 240 | Adjusting headlamp aim | 268 |
| Hood | 231 | Rotating wheels | 241 | Remote control | |
| Checking engine oil level | 233 | Spare wheel | 242 | battery replacement | 270 |
| Automatic transmission | | Changing wheels | 245 | Synchronizing | |
| fluid level | 234 | Tire inflation pressure | 250 | remote control | 271 |
| Engine oil consumption | 234 | Battery | 251 | Emergency operation of | |
| Coolant level | 234 | Jump starting | 253 | sliding/pop-up roof | 272 |
| Adding coolant | 235 | Towing the vehicle | 255 | Emergency operation of | |
| Windshield washer/headlamp | | Transmission selector lever, | | Skyview Top | 273 |
| cleaning system | 236 | manually unlocking | 259 | Manual release for | |
| Windshield and | | Stranded vehicle | 259 | fuel filler flap | 274 |
| headlamp washer fluid | | | | Replacing wiper blades | 275 |
| mixing ratio | 237 | | | Roof rack | 276 |

| | | | | | | | |
|-----------------------------|-----------|---------|-------------------------------|------------------------|----------|-------------------|-------|
| Instruments and controls | Operation | Driving | Instrument cluster display | Practical hints | Car care | Technical data | Index |
|-----------------------------|-----------|---------|-------------------------------|------------------------|----------|-------------------|-------|

First aid kit

228

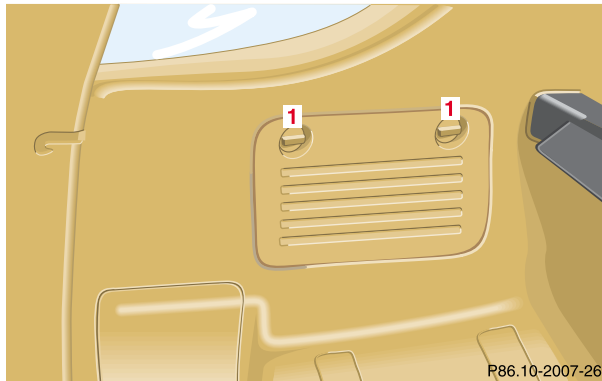
First aid kit

All except model ML 55 AMG:
The first aid kit is located behind the cover in the left rear cargo compartment trim panel.

Turn both handles (1) left and open cover.

Model ML 55 AMG:
The first aid kit is stored inside the spare wheel cover located in the cargo compartment.

Open buckles and remove spare wheel cover, see page 242.

Fuses

Before replacing a blown fuse, determine the cause of the short circuit.

Spare fuses and a special fuse puller are supplied inside the fuse box cover. Observe amperage and color of fuse.

Always use a new fuse for replacement. Never attempt to repair or bridge a blown fuse.

A fuse chart can be found inside the corresponding fuse box cover.

Fuse box in engine compartment

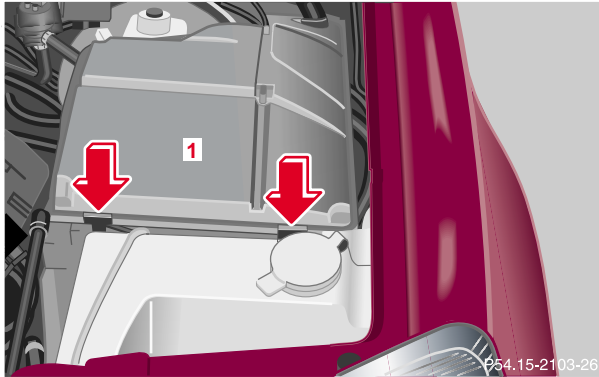

1 Fuse box in engine compartment

To gain access to the fuse box, release clamps (arrows), lift the fuse box cover (1) up and remove it.

To close the fuse box, engage back end of cover, close, and secure with clamps.

Auxiliary fuse box in front passenger footwell

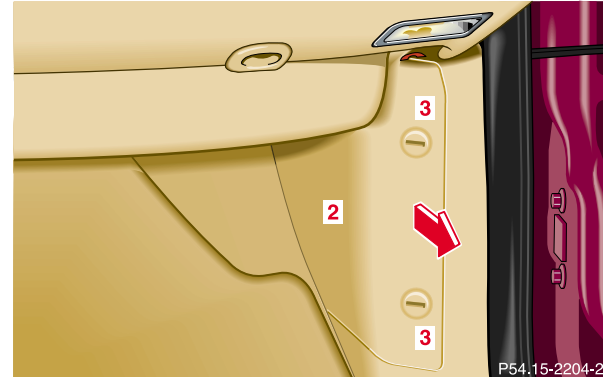

2 Auxiliary fuse box in front passenger compartment

To gain access to the fuse box, turn both locks (3) 90° counterclockwise and remove cover in direction of arrow.

To close the fuse box, engage back end of cover, slide the cover towards vehicle front and secure by turning both locks (3) clockwise to the stop.

Electrical outlet

230

Electrical outlet

Two electrical outlets can be found, one at the front passenger footwell, and the other in the rear compartment (always operational).

To open:

Flip up cover and insert electrical plug (cigar lighter type).

Note:

The electrical outlets can be used to accommodate accessories (e.g. air pump, auxiliary lamps) up to maximum 180 W.

Stowing things in the vehicle**Warning!**

To help avoid personal injury during a collision or sudden maneuver, always use partition net when transporting cargo. Always fasten items being carried as securely as possible using cargo tie-down rings and fastening materials appropriate for the weight and size of the load.

Hood

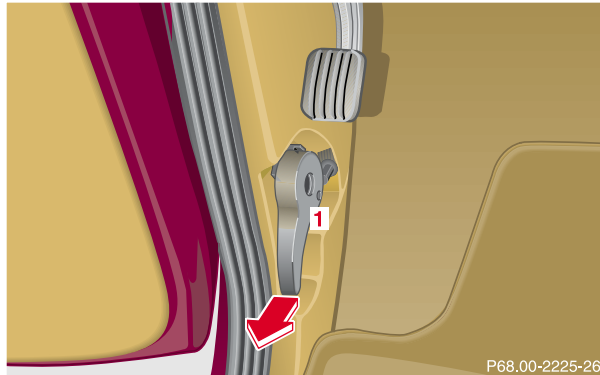

To open:

To unlock the hood, pull release lever (1) under the driver's side of the instrument panel. At the same time a handle (2) will extend out of the radiator grill (it may be necessary to lift the hood up slightly).

Caution!

To avoid damage to the windshield wipers or hood, open the hood only with wipers in the parked position.

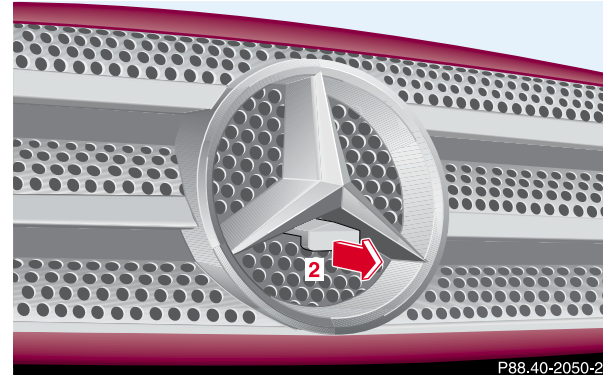

Pull handle (2) to its stop out of radiator grill and open hood (do not pull up on handle).

To close:

Lower hood and let it drop into lock from a height of approximately 1 ft. (30 cm).

To avoid hood damage, please make sure that hood is fully closed. If not, repeat closing procedure. Do not push down on hood to attempt to fully close it.

Engine compartment

232

Warning!

To help prevent personal injury, stay clear of moving parts when the hood is open and the engine is running. Be sure the hood is properly closed before driving. When closing hood, use extreme caution not to catch hands or fingers.

The radiator fan may continue to run for approximately 30 seconds or even restart after the engine has been turned off. Stay clear from fan blades.

The engine is equipped with a transistorized ignition system. Because of the high voltage it is dangerous to touch any components (ignition coils, spark plug sockets, diagnostic socket) of the ignition system

- with the engine running,
- while starting the engine,
- if ignition is “on” and the engine is turned manually.

If you see flames, steam or smoke coming from the engine compartment, or if the coolant temperature gauge indicates that the engine is overheated, do not open the hood. Move away from vehicle and do not open the hood until the engine has cooled. If necessary, call a fire department.

Checking engine oil level

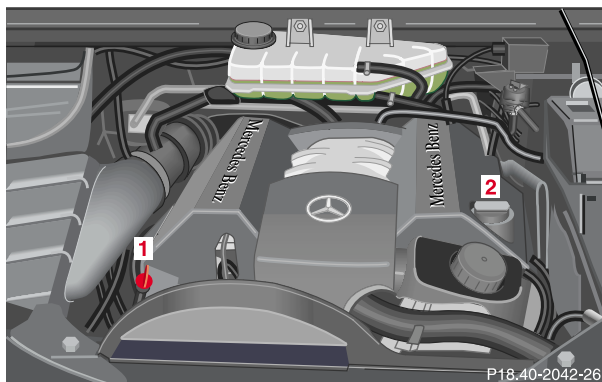

- 1 Oil dipstick
- 2 Oil filler cap

To check the engine oil level, park vehicle on level ground, with engine at normal operational temperature.

Check engine oil level approximately 5 minutes after stopping the engine, allowing for the oil to return to the oil pan.

Wipe oil dipstick clean prior to checking the engine oil level. Fully insert dipstick in tube, and remove after three seconds to obtain accurate reading.



Oil level must be between the lower (min) and upper (max) mark of the dipstick.

Fill quantity between upper and lower dipstick marking, the level is approximately 2.1 US qt (2.0 l).

Do not overfill the engine. Excessive oil must be drained or siphoned. It could cause damage to engine and catalytic converter not covered by the Mercedes-Benz Limited Warranty.

See page 224 for low engine oil level warning.

Note:

See page 89 for engine oil level indicator.

Engine compartment

234

Automatic transmission fluid level

The transmission has a permanent fill of automatic transmission fluid.

Regular automatic transmission fluid level checks and changes are not required. For this reason the dipstick is omitted.

If you notice fluid leaks or gear shifting malfunctions, have your authorized Mercedes-Benz Light Truck Center check the transmission fluid level.

Engine oil consumption

Engine oil consumption checks should only be made after the break-in period. During the break-in period, higher oil consumption may be noticed and is normal. Frequent driving at high engine speeds results in increased consumption.

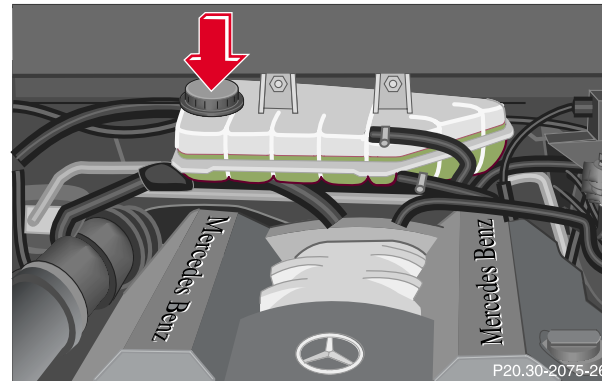
Coolant level

To check the coolant level, the vehicle must be parked on level ground and the engine stopped.

Check coolant level only when coolant is cold.

The coolant level should reach the COLD LEVEL mark in the reservoir.

Adding coolant

If coolant has to be added, a 50/50 mixture of water and MB anticorrosion/antifreeze should be added.

After adding coolant, close cap until you hear it click a few times.

The drain plugs for the cooling system are located on the left and right side of the engine block directly above the engine mounts and at the bottom of the radiator.

Anticorrosion/antifreeze mixture, see page 297.

Warning!

In order to avoid possible serious burns or injury:

- Use extreme caution when opening the hood if there are any signs of steam or coolant leaking from the cooling system, or if the coolant temperature gauge indicates that the coolant is overheated.

- Do not remove pressure cap on coolant reservoir if engine temperature is above 194°F (90°C). Allow engine to cool down before removing cap. The coolant reservoir contains hot fluid and is under pressure.
- Using a rag, slowly open cap approximately 1/2 turn to relieve excess pressure. If opened immediately, scalding hot fluid and steam will be blown out under pressure.
- Do not spill antifreeze on hot engine parts. Antifreeze contains ethylene glycol which may burn if it comes into contact with hot engine parts.

Engine compartment

236

Windshield washer/headlamp cleaning system

The reservoir should be refilled with MB Windshield washer concentrate and water (or commercially available premixed windshield washer solvent/antifreeze, depending on ambient temperatures).

Warning!

Washer solvent/antifreeze is highly flammable. Do not spill washer solvent/antifreeze on hot engine parts, because it may burn. You can be seriously burned.

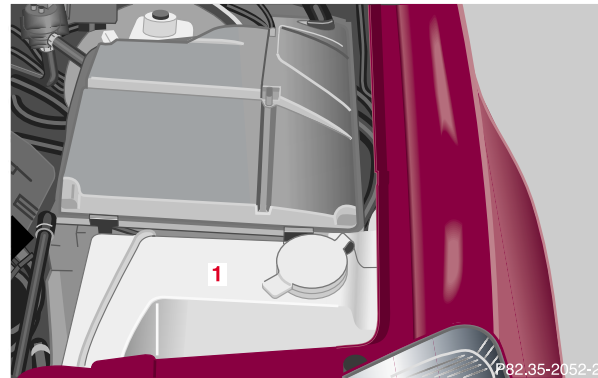

- 1** Windshield washer/headlamp cleaning/rear window wiper/washer system fluid reservoir

Vehicles without headlamp cleaning system:
Capacity approximately 5.3 US qt (5.0 l).

Vehicles with headlamp cleaning system:
Capacity approximately 8.0 US qt (7.6 l).

Windshield and headlamp washer fluid mixing ratio

For temperatures above freezing:

MB Windshield Washer Concentrate "S" and water

1 part "S" to 100 parts water
(40 ml "S" to 1 gallon water).

For temperature below freezing:

MB Windshield Washer Concentrate "S" and commercially available premixed windshield washer solvent/antifreeze

1 part "S" to 100 parts solvent
(40 ml "S" to 1 gallon solvent).

Vehicle jack, wheel bolt wrench and screwdriver

Warning!

The jack is designed exclusively for jacking up the vehicle at the jack take-up brackets built into either side of the vehicle. To help avoid personal injury, use the jack only to lift the vehicle during a wheel change. Never get beneath the vehicle while it is supported by the jack. Keep hands and feet away from the area under the lifted vehicle. Always firmly set parking brake and block wheels before raising vehicle with jack.

Do not disengage parking brake while the vehicle is raised. Be certain that the jack is always vertical when in use, especially on hills. Always try to use the jack on level surface. Be sure that the jack arm end is fully seated in the jack take-up bracket. Always lower the vehicle onto sufficient capacity jackstands before working under the vehicle.

Spare wheel, vehicle jack

238

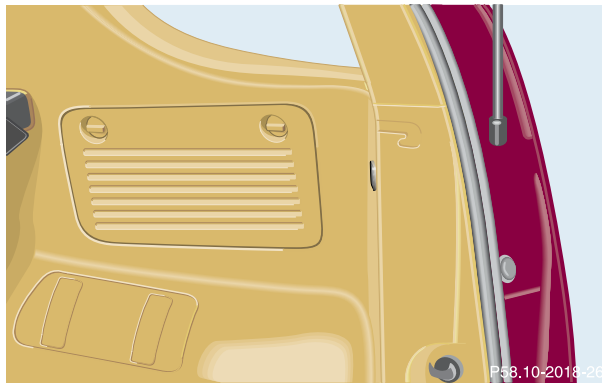

The vehicle jack, wheel bolt wrench and screwdriver are located in the rear cargo compartment behind the cover in the right side trim panel.

To get to tools, first remove trim panel cover by turning both handles to left, and then swing aside CD-player (if so equipped).

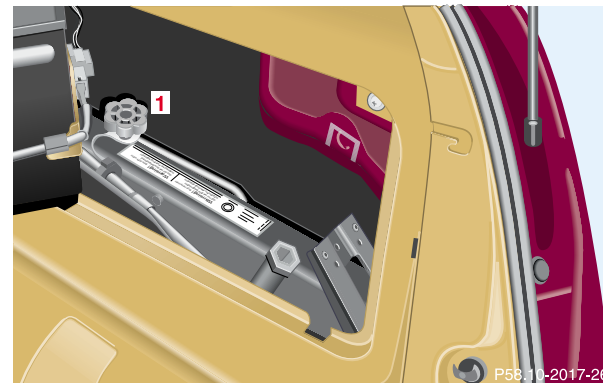

Unscrew plastic nut (1) and lift out vehicle jack.

See illustration for proper storage of jack and wheel bolt wrench.

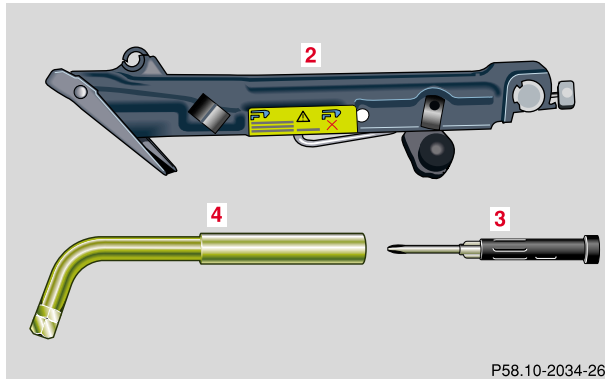

P58.10-2034-26

- 2 Vehicle jack
- 3 Screwdriver
- 4 Wheel bolt wrench

The screwdriver is placed inside the wheel bolt wrench handle.

Air pump (ML 55 AMG)

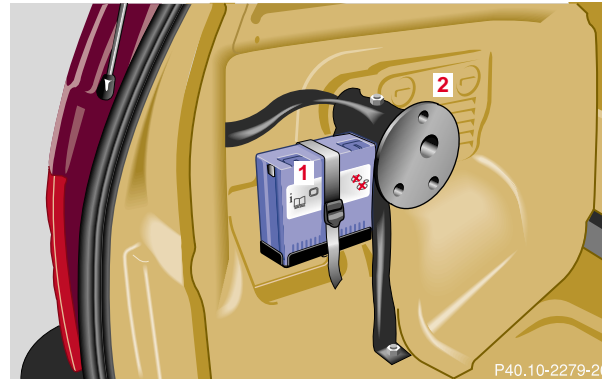

P40.10-2279-26

- 1 Air pump
- 2 Storage compartment

The air pump is located behind the space-saver spare wheel.

The air pump is secured with a strap.

Wheels

Replace rims or tires with the same designation, manufacturer and type as shown on the original part. See your authorized Mercedes-Benz Light Truck Center for further information.

Warning!

Do not mix different tire construction types (i.e. radial, bias, bias-belted) on your vehicle because handling may be adversely affected and may result in loss of control.

See your authorized Mercedes-Benz Light Truck Center for information on tested and recommended rims and tires for summer and winter operation. They can also offer advice concerning tire service and purchase.

Tire replacement

Front and rear tires should be replaced in sets. Furthermore – in the event of tire replacement – the optional regular size spare wheel should be used on the rear axle. Rims and tires must be of the correct size and type. For dimensions, see technical data on page 288.

We recommend that you break in new tires for approximately 60 miles (100 km) at moderate speed.

It is imperative that the wheel mounting bolts be fastened to a tightening torque of 110 ft.lb. (150 Nm) whenever wheels are mounted.

For rim and tire specifications, refer to technical data on page 288.

Warning!

Worn, old tires can cause accidents. If the tire tread is badly worn, or if the tires have sustained damage, replace them.

When replacing rims, use only genuine Mercedes-Benz wheel bolts specified for the particular rim type. Failure to do so can result in the bolts loosening and possibly an accident.

Rotating wheels

The wheels can be rotated according to the degree of tire wear while retaining the same direction of travel.

Rotating, however, should be carried out as recommended by the tire manufacturer, before the characteristic tire wear pattern (shoulder wear on front wheels and tread center wear on rear wheels) becomes visible, as otherwise the driving properties deteriorate.

Important!

Unidirectional tires must always be mounted with arrow on tire sidewall pointing in direction of vehicle forward movement.

Notes:

Thoroughly clean the inner side of the wheels any time you rotate the wheels or wash the vehicle underside.

The use of retread tires is not recommended. Retread tires may adversely affect the handling characteristics and safety of the vehicle.

Dented or bent rims can cause tire pressure loss and damage to the tire beads. For this reason, check rims for damage at regular intervals. The rim flanges must be checked for wear before a tire is mounted. Remove burrs, if any.

Check and ensure proper tire inflation pressure after rotating the wheels. For tire inflation pressure see page 250.

Tires, Wheels

242

Spare wheel

In the case of a flat tire or break-down, you may temporarily use the space-saver spare wheel, while observing the following restrictions:

- Do not exceed vehicle speed of 50 mph (80 km/h).
- Drive to the nearest repair facility to have the flat tire repaired or replaced as appropriate.
- Do not operate vehicle with more than one spare wheel mounted.

For rim and tire specifications, refer to “Technical data” on page 288.

Caution!

Exercise care when removing or installing spare wheel to prevent personal injury.

Space-saver tire (ML 55 AMG only)**Removing spare wheel (space-saver tire):**

1. Open buckle of clamp, then remove cover (1).
2. Unscrew the three wheel bolts using wrench supplied with vehicle tools, and take out space-saver spare wheel, and remove the air pump from its compartment.

Important!

To realize the total crumple zone in case of a rear end collision, the space-saver spare wheel must be stored in its holder with the tire deflated. Properly inflate the tire prior to mounting it on the axle. See page 249 for detailed instructions.

When storing the space-saver spare wheel in its holder, tighten the three wheel bolts with a tightening torque of 37 ft.lb. (50 Nm).

Space-saver tire (except ML 55 AMG)

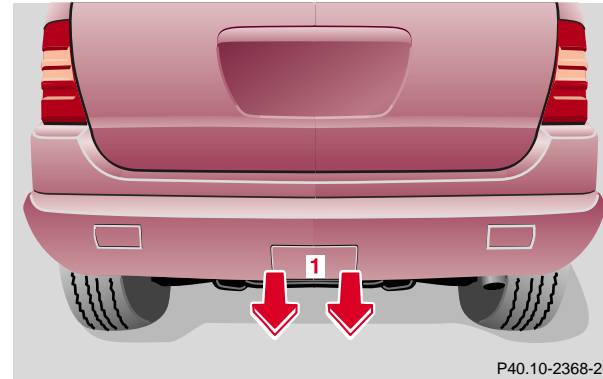

Removing spare wheel (space-saver tire):

1. Hold left and right side of cover (1) at bottom and pull away from bumper (arrows).

Tires, Wheels

244

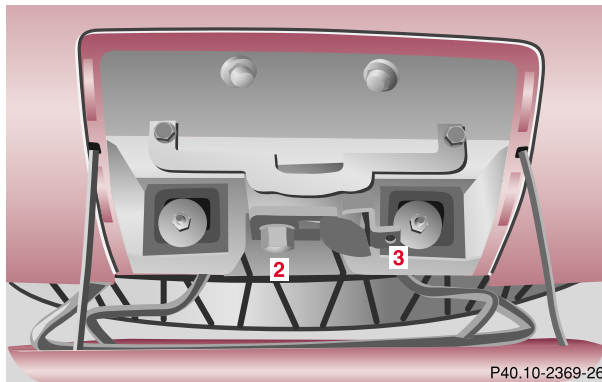

2. Loosen screw (2) using wrench supplied with vehicle tools, see page 237. The screw (2) remains in the holder.
3. Lift spare wheel carrier slightly and push lever (3) to the right using screwdriver supplied with vehicle tools, swing spare wheel carrier down and pull it out from under the bumper.
4. Remove space-saver spare wheel.

Changing wheels

Warning!

The jack is designed exclusively for jacking up the vehicle at the jack take-up brackets built into either side of the vehicle. To help avoid personal injury, use the jack only to lift the vehicle during a wheel change. Never get beneath the vehicle while it is supported by the jack. Keep hands and feet away from the area under the lifted vehicle. Always firmly set parking brake and block wheels before raising vehicle with jack.

Do not disengage parking brake while the vehicle is raised. Be certain that the jack is always vertical when in use, especially on hills. Always try to use the jack on level surface. Be sure that the jack arm end is fully seated in the jack take-up bracket. Always lower the vehicle onto sufficient capacity jackstands before working under the vehicle.

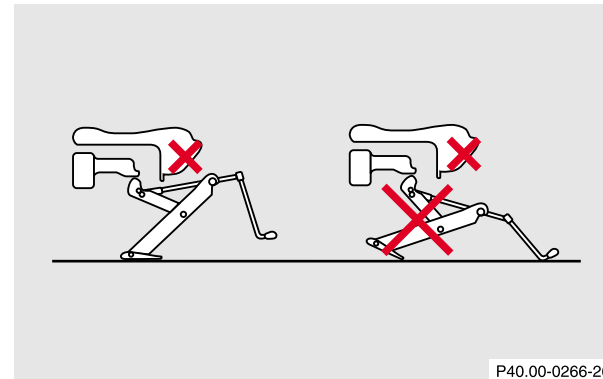

Position vehicle jack only at the jack take-up bracket when raising the vehicle.

Tires, Wheels

246

Move vehicle to a level area which is a safe distance from the roadway.

Important!

The vehicle doors lock if the left front wheel rotates with the engine running. Do not leave the engine running while changing a wheel.

1. Set parking brake and turn on hazard warning flasher.
2. Move selector lever to position "P" and turn off engine, and remove key from the steering lock.
3. Prevent vehicle from rolling away by blocking wheels with wheel chocks (not supplied with vehicle) or sizable wood block or stone. When changing a wheel on a hill, place chocks on the downhill side blocking both wheels of the other axle. On a level road, place one chock in front of and one behind the wheel that is diagonally opposite to the wheel being changed.

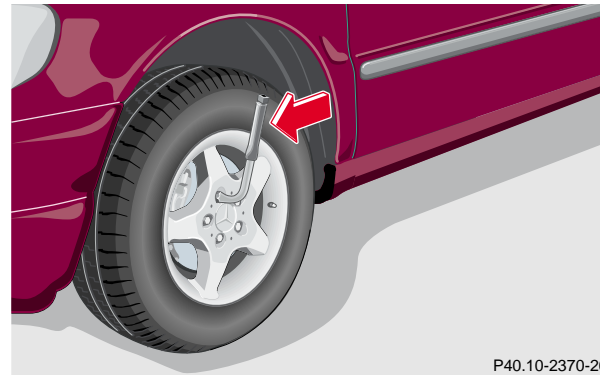

P40.10-2370-26

4. Using the wrench, loosen but do not yet remove the wheel bolts.
5. Open jack enough to fit under vehicle.

The jack take-up brackets are located directly behind the front wheel housings and in front of the rear wheel housings.

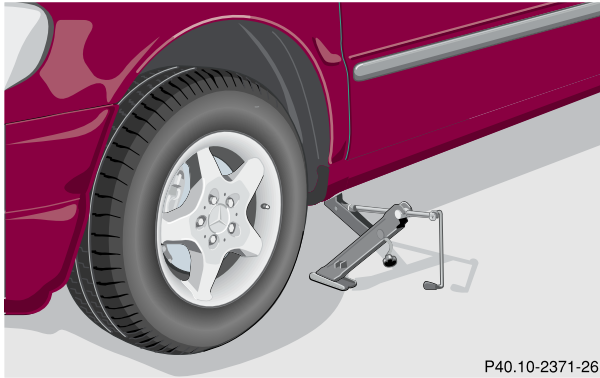

6. Place jack on firm ground. Position the jack under the take-up bracket so that it is always vertical (plumb-line) as seen from the side, even if the vehicle is parked on an incline.
7. Open jack further until jack arm end seats firmly in the take-up bracket and its base sits squarely on the ground. Jack up the vehicle until the wheel is clear of the ground. Never start engine while vehicle is raised.

8. Unscrew and remove all wheel bolts. Keep bolt threads protected from dirt and sand.
9. Remove wheel. Grip wheel from the sides. Keep hands from beneath the wheels.
Clean contact surfaces of wheel and wheel hub. Install spare wheel on wheel hub. Insert wheel bolts and tighten them slightly.
10. Lower vehicle to ground. Remove jack.

Before storing the jack, it should be fully collapsed, with handle folded in.

For proper storage of jack see page 237.

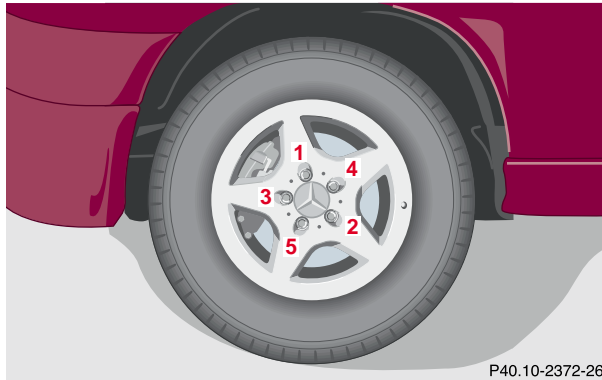

P40.10-2372-26

Using the wrench, tighten the five bolts evenly, following the sequence illustrated, until all bolts are tight. Observe a tightening torque of 110 ft.lb. (150 Nm).

Ensure proper tire pressure.

Warning!

Always replace wheel bolts that are damaged or rusted.

Never apply oil or grease to wheel bolts.

Damaged wheel hub threads should be repaired immediately.

Incorrect mounting bolts or improperly tightened mounting bolts can cause the wheel to come off. This could cause an accident. Be sure to use the correct mounting bolts.

Notes:

The removed road wheel cannot be stored in the space-saver wheel carrier or inside the storage compartment in the rear cargo area (ML 55 AMG), but should be transported in the rear cargo compartment wrapped in a protective cover supplied with the vehicle. The protective cover is located in the rear cargo compartment behind the cover in the right side trim panel.

Model ML 55 AMG:

Store air pump in its proper location. Close and latch the spare wheel cover, see page 239.

Inflating the space-saver tire (ML 55 AMG only)

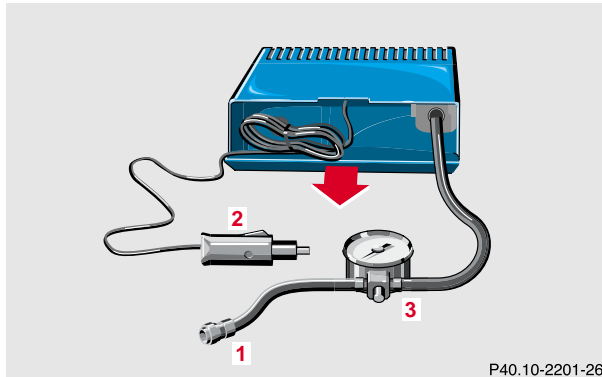

P40.10-2201-26

1. Remove air pump from compartment behind the space-saver spare wheel.
2. Open lid (arrow) and pull out filler hose (1) with pressure gauge and electrical plug (2). Observe manufacturer's instructions.
3. Unscrew tire valve cap from space-saver tire valve.
4. Screw filler hose (1) onto space-saver tire valve.

5. Plug air pump electrical plug (2) into electrical outlet in front passenger footwell or rear cargo compartment.
6. Start the engine and switch on the air pump.

Warning!

When working on the vehicle with the engine running, always set the parking brake in addition to shifting the gear selector lever to position "P".

7. Operate air pump (approximately 8 minutes) until pressure gauge displays 61 psi (4.2 bar).
8. Switch off air pump and turn off the engine.
9. Unscrew filler hose from space-saver tire. Reinstall tire valve cap.

Warning!

To prevent possible injury when unscrewing air pump filler hose from space-saver tire valve after inflating the tire, use a rag since the tire valve could be hot.

Note:

Excessive tire air pressure should be released using the vent screw.

| | | | | | | | |
|--------------------------|-----------|---------|----------------------------|------------------------|----------|----------------|-------|
| Instruments and controls | Operation | Driving | Instrument cluster display | Practical hints | Car care | Technical data | Index |
|--------------------------|-----------|---------|----------------------------|------------------------|----------|----------------|-------|

Tires, Wheels

Tire inflation pressure

A table (see fuel filler flap) lists the tire inflation pressures specified for Mercedes-Benz recommended tires as well as for the varying operating conditions.

Important!

Tire pressure changes by approximately 1.5 psi (0.1 bar) per 18°F (10°C) of air temperature change. Keep this in mind when checking tire pressure inside a garage – especially in the winter.

Example:

If garage temperature = approximately +68°F (+20°C) and ambient temperature = approximately +32°F (0°C) then the adjusted air pressure = specified air pressure +3 psi (+0.2 bar).

Tire pressures listed for light loads are minimum values offering high driving comfort. Increased inflation pressures for heavy loads produce favorable handling characteristics with lighter loads and are perfectly permissible. The ride of the vehicle, however, will become somewhat harder.

Tire temperature and pressure increase with the vehicle speed. Tire pressure should therefore only be checked and corrected on cold tires. Correct tire pressure in warm tires only if pressure has dropped below the pressure listed in the table and the respective operating conditions are taken into consideration.

An underinflated tire due to a slow leak (e.g. due to a nail in the tire) may cause damage such as tread separation, bulging etc.. Regular tire pressure checks (including the spare tire) at intervals of no more than 14 days are therefore essential.

If a tire constantly loses air, it should be inspected for damage.

The spare tire should be checked periodically for condition and inflation. Spare tire will age and become worn over time even if never used, and thus should be inspected and replaced when necessary.

Warning!

Do not overinflate tires. Overinflating tires can result in sudden deflation (blowout) because they are more likely to become punctured or damaged by road debris, potholes etc.. Follow recommended inflation pressures.

Do not overload the tires by exceeding the specified vehicle capacity weight (as indicated by the label on the driver's door latch post). Overloading the tires can overheat them, possibly causing a blowout.

Battery

Warning!

Failure to follow these instructions can result in severe injury or death.

Never lean over batteries while connecting, you might get injured.

Battery fluid contains sulfuric acid. Do not allow this fluid to come in contact with eyes, skin or clothing. In case it does, immediately flush affected area with water and seek medical help if necessary.

A battery will also produce hydrogen gas, which is flammable and explosive. Keep flames or sparks away from battery, avoid improper connection of jumper cables, smoking etc..

Important!

Battery replacement information:

The maintenance-free battery is located in the engine compartment.

The service life of the battery is dependent on its condition of charge. The battery should always be kept sufficiently charged, in order to last an optimum length of time.

Battery

252

Therefore, we strongly recommend that you have the battery charge checked frequently, and corrected if necessary, especially if you use the vehicle less than approximately 200 miles (300 km) per month, mostly for short distance trips, or if it is not used for long periods of time.

Only charge a battery with a battery charger after the battery has been disconnected from the vehicle's electrical circuit.

Always disconnect the battery negative lead first and connect last.

When removing and connecting the battery, always make sure that all electrical consumers are off and the key is in steering lock position 0. The battery must always be securely installed when the vehicle is in operation. During removal and installation always protect the disconnected battery positive (+) terminal with the cover attached to the battery.

While the engine is running the battery terminal clamps must not be loosened or detached, otherwise the generator and other electronic components would be damaged.

Note:

After reconnecting the battery also set the clock in instrument cluster (see page 80), set date in trip computer (see page 83), resynchronize the sliding/pop-up roof (see page 272), the Skyview Top (see page 273) and the electronic stability program (ESP) (see page 206).

Battery recycling

Batteries contain material that can harm the environment with improper disposal.

Large 12 Volt storage batteries contain lead.

Recycling of batteries is the preferred method of disposal.

Many states require sellers of batteries to accept old batteries for recycling.

Jump starting

Warning!

Failure to follow these directions will cause damage to the electronic components, and can lead to a battery explosion and severe injury or death.

Never lean over batteries while connecting or jump starting, you might get injured.

Battery fluid contains sulfuric acid. Do not allow this fluid to come in contact with eyes, skin or clothing. In case it does, immediately flush affected area with water, and seek medical help if necessary.

A battery will also produce hydrogen gas, which is flammable and very explosive. Keep flames or sparks away from battery, avoid improper connection of jumper cables, smoking etc..

Read all instructions before proceeding.

Important!

A discharged battery can freeze at approximately +14°F (-10°C). In that case, it must be thawed out before jumper cables are used. Attempting to jump start a frozen battery can result in it exploding, causing personal injury.

Jumper cable specifications:

- Minimum cable cross-section of 25 mm² or approximately 2 AWG
- Maximum length of 11.5 ft. (3.5 m).

If the battery is discharged, the engine should be started with jumper cables and the (12 V) battery of another vehicle.

Only use 12 V battery to jump start your vehicle. Jump starting with more powerful battery could damage the vehicle's electrical systems, which will not be covered by the Mercedes-Benz Limited Warranty.

The battery is located in the engine compartment.

Jump starting

254

Proceed as follows:

1. Position the vehicle with the charged battery so that the jumper cables will reach, but never let the vehicles touch. Make sure the jumper cables do not have loose or missing insulation.
2. On both vehicles:
 - Turn off engine and all lights and accessories, except hazard warning flashers or work lights.
 - Apply parking brake and shift selector lever to position "P".

Important!

3. Clamp one end of the first jumper cable to the positive (+) under hood terminal of the discharged battery and the other end to the positive (+) terminal of the charged battery. Make sure the cable clamps do not touch any other metal parts.
4. Clamp one end of the second jumper cable to the grounded negative (-) terminal of the charged battery and the final connection to the negative (-) terminal of the discharged battery.

Important!

5. Start engine of the vehicle with the charged battery and run at high idle. Make sure the cables are not on or near pulleys, fans, or other parts that move when the engine is started. Allow the discharged battery to charge for a few minutes. Start engine of the disabled vehicle in the usual manner.
6. After the engine has started, remove jumper cables by exactly reversing the above installation sequence, starting with the last connection made first. When removing each clamp, make sure that it does not touch any other metal while the other end is still attached.

Notes:

If engine does not run after several unsuccessful starting attempts, have it checked at the nearest authorized Mercedes-Benz Light Truck Center.

Excessive unburned fuel may damage the catalytic converter.

Towing the vehicle

Prior to towing the vehicle with all wheels on the ground, make certain that the key is in steering lock position 2.

Important!

When towing the vehicle, please, note the following:

With the automatic central locking activated and the engine running, the vehicle doors lock if the left front wheel is turning at vehicle speeds of approximately 9 mph (15 km/h) or more.

To prevent the vehicle door locks from locking, deactivate the automatic central locking, see page 32.

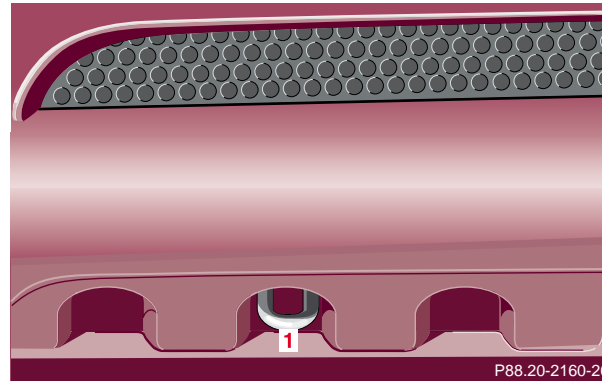

The front towing eye is located on the passenger side below the bumper.

1 Towing eye, front

Towing

256

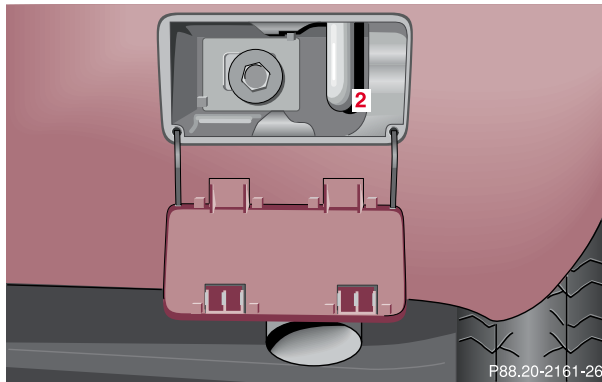

ML 320, ML 430

The rear towing eye is located behind the right side cover in the bumper panel.

2 Towing eye, rear

Cover removal:

Using a flat blade screwdriver pry out the cover.

Cover installation:

Engage cover at bottom and press in top securely.

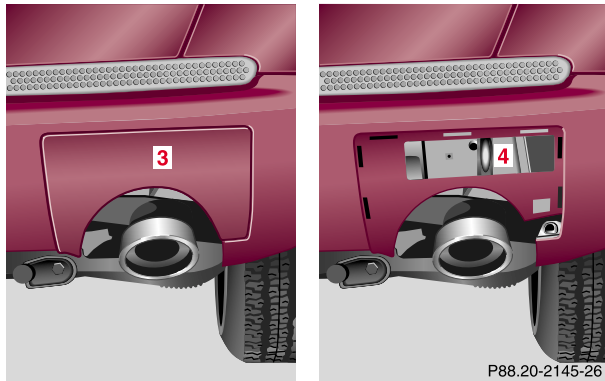

ML 55 AMG

The rear towing eye is located behind the right side cover (1) in the bumper panel.

- 3 Cover
- 4 Towing eye, rear

Warning!

In order to avoid possible serious burns or injury, use extreme caution when removing the cover, because the rear exhaust pipe is extremely hot.

Cover removal:

Grip cover at bottom and pull out.

Cover installation:

Engage cover and press in securely.

We recommend that the vehicle be transported using flat bed equipment. This method is preferable to other types of towing.

The vehicle may be towed with all wheels on the ground and the selector lever in position "N" for distances up to 30 miles (50 km) and at a speed not to exceed 30 mph (50 km/h). The key must be in steering lock position 2.

Towing

258

To be certain to avoid additional damage to the vehicle powertrain, however you should do the following:

- With damage to front axle, raise front axle. Remove flexible drive shaft between rear axle and transfer case
- With damage to rear axle, raise rear axle and tow vehicle with wheel lift or dolly placed under front wheels.
- With damage to transfer case, remove flexible drive shafts to the drive axles.

Note:

Always install new self-locking nuts when reinstalling the flexible drive shaft.

Caution!

If the vehicle is towed with the front axle raised, the engine must be shut off (key in steering lock position 1). Otherwise, the 4-ETS+ may become engaged which may cause loss of towing control. Switch off the tow-away alarm (see page 36) as well as the ESP (see page 207).

Warning!

With the engine not running, there is no power assistance for the braking and steering systems. In this case, it is important to keep in mind that a considerably higher degree of effort is necessary to brake and steer the vehicle.

Note:

To signal turns while being towed with hazard warning flasher in use, turn key in steering lock to position 2 and activate combination switch for left or right turn signal in usual manner. Now deactivate the hazard warning flasher, only the selected turn signal will operate. Upon canceling the turn signal, the hazard warning flasher must be activated again.

Transmission selector lever, manually unlocking



In the case of power failure the transmission selector lever can be manually unlocked, e.g. to tow the vehicle.

To do so, insert a pin (1), e.g. ball point pen, into the covered opening below the position “D” of the shift pattern. While pushing the pin down, move selector lever from position “P”.

After removal of the pin from the opening, the cover will not close fully. Only after moving the selector lever to positions “D+” and “D-” does the cover return to its closed position.

Stranded vehicle

Freeing a stranded vehicle, on which the wheels are dug into sand or mud, should be done with the greatest of care, especially if the vehicle is heavily loaded.

Avoid pulling the vehicle jerkily or diagonally, since it could result in damage to the chassis alignment.

Never try to free a vehicle that is still coupled to a trailer.

If possible, a vehicle equipped with trailer hitch receiver should be pulled backward in its own previously made tracks.

Exterior lamps

260

Exterior lamps**Headlamp adjustment**

Correct headlamp adjustment is extremely important. Check and readjust headlamps at regular intervals and when a bulb has been replaced.

For adjusting headlamp aim see page 268.

Warning!

Bulbs and bulb holders can be very hot. Allow the lamp to cool down before changing a bulb.

Halogen lamps contain pressurized gas. A bulb can explode if you:

- touch or move it when hot,
- drop the bulb,
- scratch the bulb.

Wear eye and hand protection.

Replacing bulbs

To prevent a possible electrical short circuit, switch off lamp prior to replacing a bulb.

When replacing bulbs, install only 12 volt bulbs with the specified watt rating.

When replacing halogen bulbs do not touch glass portion of bulb with bare hands. Use plain paper or a clean cloth.

Warning!

Because of high voltage in Xenon lamps, it is dangerous to replace the bulb or repair the lamp and its components. We recommend that you have such work done by a qualified technician.

Headlamp assembly (Halogen)

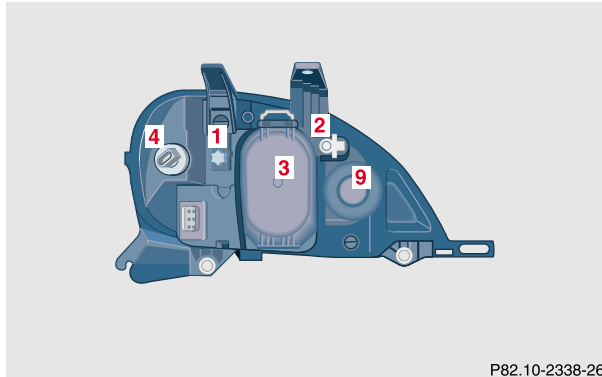

- 1 Headlamp vertical adjustment screw
- 2 Headlamp horizontal adjustment screw
- 3 Headlamp cover with locking tab
- 4 Bulb socket for turn signal, parking, standing, and side marker lamp

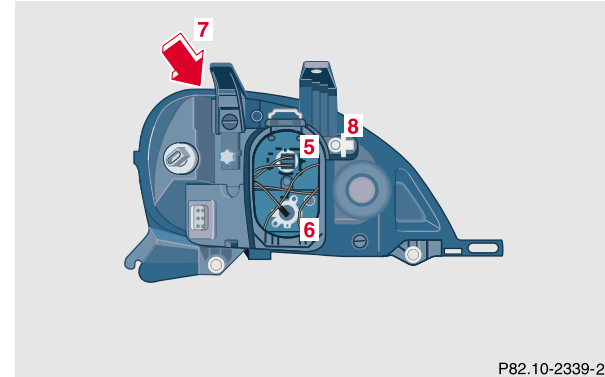

- 5 Electrical connector for low beam headlamp bulb
- 6 Electrical connector for high beam headlamp bulb
- 7 Level for headlamp vertical adjustment
- 8 Scale for headlamp horizontal adjustment
- 9 Auxiliary fog lamp (if so equipped)

Exterior lamps

262

Headlamp assembly (Xenon)

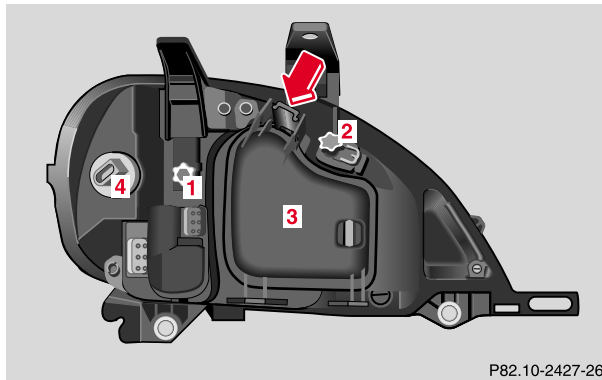

- 1 Headlamp vertical adjustment screw
- 2 Headlamp horizontal adjustment screw
- 3 Headlamp cover with locking tab
- 4 Bulb socket for turn signal, parking, standing, and side marker lamp

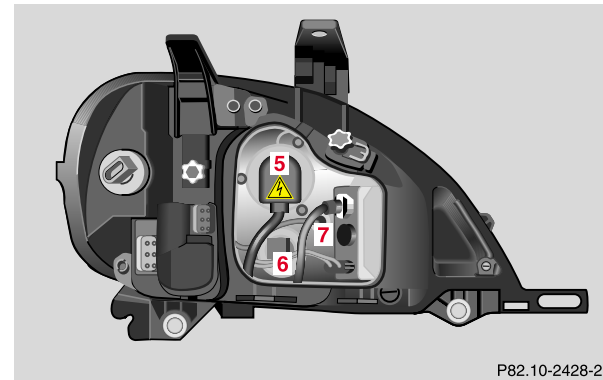

- 5 Electrical connector for low beam headlamp bulb
- 6 Electrical connector for high beam headlamp bulb
- 7 Auxiliary fog lamp (if so equipped)

Bulbs for high beam (only Halogen headlamps)

H1 U (55 W)

Bulbs for low beam

H7 (55 W)

Open hood.

Push down tab at top end of cover (3) and remove. Pull off electrical connector (5 or 6). Unhook and move aside clamping ring. Remove bulb.

Insert new bulb (seating properly in cutouts of bulb socket), mount clamping ring. Reinstall and push electrical connector on securely. Reinstall cover (3).

Xenon (optional)

Bulb for low beam

Warning!

Because of high voltage in Xenon lamps, it is dangerous to replace the bulb or repair the lamp and its components. We recommend that you have such work done by a qualified technician.

Xenon (optional)

Bulb for high beam

Note:

Vehicles with Xenon headlamps:

We recommend that you have changed the bulb for the high beam by a qualified technician.

| | | | | | | | |
|--------------------------|-----------|---------|----------------------------|------------------------|----------|----------------|-------|
| Instruments and controls | Operation | Driving | Instrument cluster display | Practical hints | Car care | Technical data | Index |
|--------------------------|-----------|---------|----------------------------|------------------------|----------|----------------|-------|

Exterior lamps

Parking, standing, side marker and turn signal lamp

1156 NA (32/4 cp bulb)

Open hood.

Twist bulb socket (4) counterclockwise and pull out. Push bulb into socket, turn counterclockwise and remove.

Insert new bulb in socket, push in and twist clockwise. Reinstall bulb socket.

Bulbs for auxiliary fog lamp (optional)

H3 U (55 W)

Open hood.

Remove cover (9). Unhook clamping ring and remove bulb. Pull off electrical connector.

Insert new bulb in socket (seating properly in cutouts of bulb socket), and mount clamping ring. Reinstall and push electrical connector on securely.

Reinstall cover (9).

Taillamp assemblies

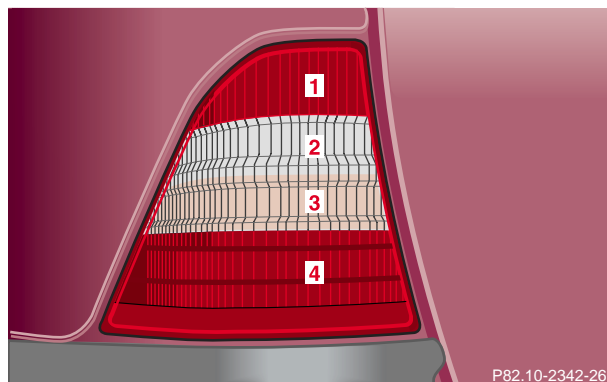

- 1 Stop lamp (1073 [32 cp bulb])
- 2 Backup lamp (1073 [32 cp bulb])
- 3 Turn signal lamp (P Y 21 W bulb)
- 4 Tail, parking, standing and side marker lamp, driver's side rear fog lamp (P 21/4 W bulb)

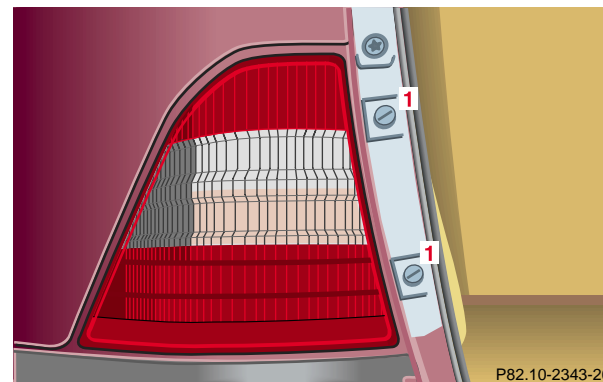

- Open liftgate.
Remove nuts (1).
Remove taillamp.

Exterior lamps

266

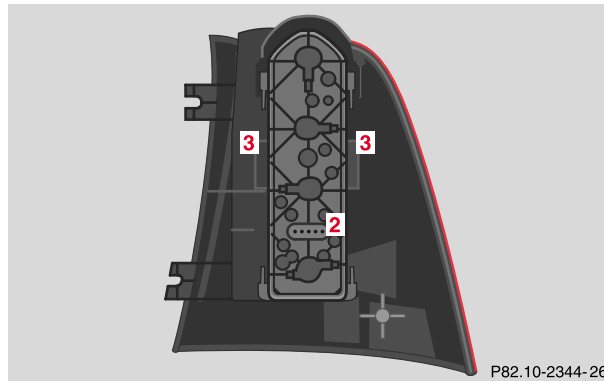

- Pull off electrical connector (2).
- Squeeze tabs (3) together and remove bulb holder.
- Push bulb into socket, turn counterclockwise and remove.
- Insert new bulb in socket, push in and twist clockwise.
- Reinstall bulb holder.
- Reinstall electrical connector (2).
- Reinstall taillamp.

Turn signal lamp, side (168 [3 cp bulb])

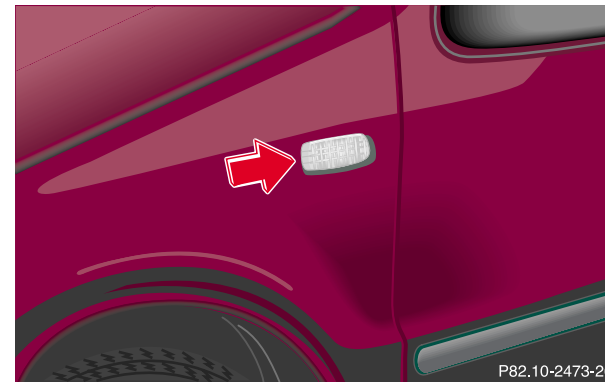

- Carefully slide lamp slightly towards rear (arrow), lift away its front end first, then remove lamp from panel.
- Twist bulb socket counterclockwise and pull out. Pull bulb out of socket.
- Insert new bulb in socket. Reinstall bulb socket.
- To reinstall lamp, set rear end of lamp into panel and let front end snap into place.

License plate lamps (C 5 W [tubular] bulb)

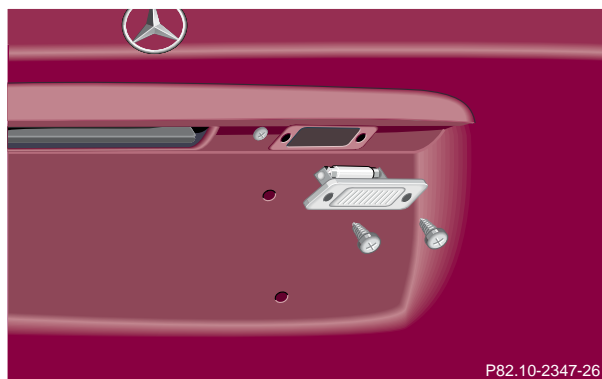

Remove both securing screws, remove lamp and take out bulb.

High mounted stop lamp (1073 [32 cp bulb])

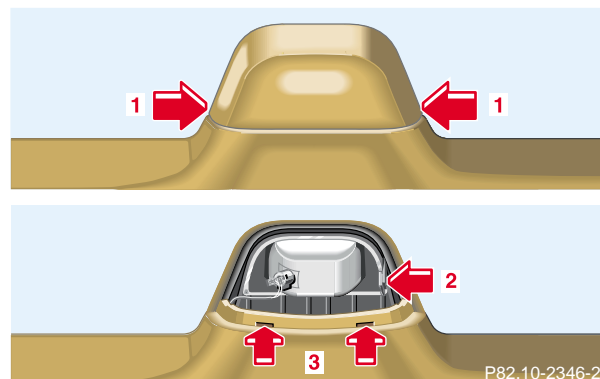

To replace bulb, squeeze both sides (1, arrows) of cover, fold forward and remove.

Press tab (2, arrow) on reflector and remove reflector.

Press bulb down, turn counterclockwise and remove.

Insert new bulb in socket, push in and twist clockwise. Reinstall reflector.

Position tabs of cover in slots (3, arrows) and reinstall cover until properly seated.

Exterior lamps

268

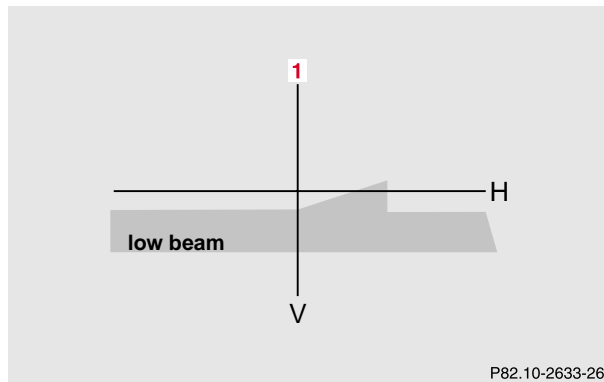
Adjusting headlamp aim

Correct headlamp adjustment is extremely important. To check and readjust a headlamp, follow steps 1 through 7.

Please note:

- High beam adjustments simultaneously aim the low beam.
- Vehicle should have a normal trunk load.

1. Park vehicle on level surface approximately 6 inches (152 mm) from a vertical test screen or wall. The centerline of the vehicle must be at a 90° angle to the test screen.
2. (High beams on):
Using a carpenter's level, align and mark a vertical centerline (1) on the test screen for each headlamp lens at a distance of 25 ³/₄ inches (654 mm) from the vertical centerline. As a check, the distance between centerlines should be 51 ¹/₂ inches (1308 mm). The star emblem on the hood may be used to determine the vehicle centerline. If the distance does not check, have the system verified at an authorized Mercedes-Benz Light Truck Center.
3. Move vehicle on the level surface 25 feet (7.6 m) straight back from the wall.
4. Open hood.

5. (High beams on):

Simultaneously turn adjusting screws (1 and 2 on page 261 or 262) counterclockwise to adjust headlamp downward, clockwise upward) equally until bubble in the level (7 on page 261) is centered on the "0" mark.

Graduations:

screw 1: 0.50° pitch,

screw 2: 0.67° pitch.

6. Horizontal headlamp aim (High beams on):

Turn adjusting screw (2) (left headlamp: counterclockwise to adjust to the left, clockwise to the right [right headlamp in opposite direction]) until the headlamp (high beam pattern) is centered about the vertical centerline (1) as shown.

The left and right headlamps must be adjusted individually.

7. For proper aim, the indicator (8 on page 261) should align with the "0" mark after horizontal adjustment.

Graduations: 0.33° pitch.

Note:

If it is not possible to obtain a proper headlamp adjustment, have the system checked at your authorized Mercedes-Benz Light Truck Center.

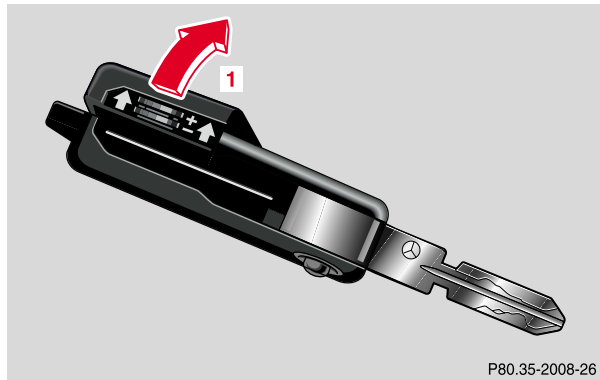
Remote control battery replacement**Changing batteries**

Unfold master key from holder by pressing key release button. Pull off battery cover (1).

Change batteries, inserting new ones with (+) side facing up.

Press battery cover onto housing until locked in place.

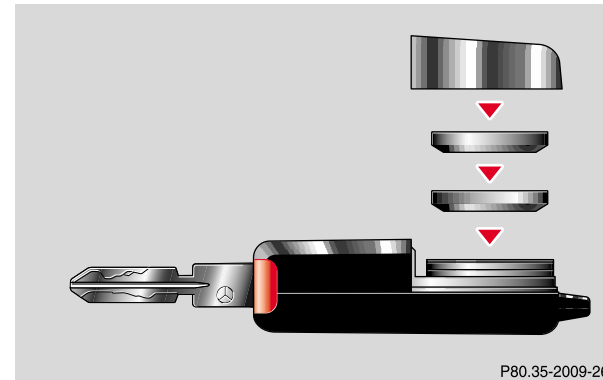
**Notes:**



To assure proper operation of the remote control, push each button. Repeat battery installation, if remote control does not function correctly.

If the remote control does not function correctly after repeating battery installation, the system may have to be resynchronized, see below.

Synchronizing remote control

If the remote control does not function correctly and the batteries are in order, the system may have to be resynchronized.

Turn key in steering lock to position 2, then to position 0 and remove.

Within 10 seconds, push and hold button  while pushing button  five times.

Release the button, and press ,  or  once.

Check all functions. The remote control should once again be operational.

Note:

If it is not possible to resynchronize the remote control, have the system checked at your authorized Mercedes-Benz Light Truck Center.

Important!

Batteries contain materials that can harm the environment if disposed of improperly. Recycling of batteries is the preferred method of disposal. For disposal, please follow manufacturer's recommendation on battery package.

Replacement Battery:
Lithium, type CR 2025 or equivalent.

Emergency operation of sliding/pop-up roof

272

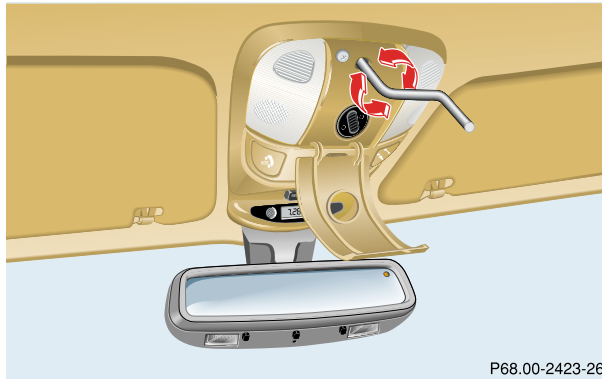
Emergency operation of sliding/pop-up roof

The sliding/pop-up roof can be opened or closed manually should an electrical malfunction occur.

The sliding/pop-up roof drive is located behind the cover between the front interior lamps.

1. Open cover by using a flat blade screw driver at top edge.
2. Obtain crank (supplied with vehicle) and insert in hexagon drive hole, located at rear end of the open cover.

Note:

Push crank upward while turning it, to disengage the electric motor.

To slide the roof closed or to raise the roof at the rear: turn crank clockwise.

To slide the roof open or to lower the roof at the rear: turn crank counterclockwise.

Important!

After manually operating the sliding/pop-up roof, a timing synchronization is needed for future electrical operation of the roof. To do so, remove fuse for sliding/pop-up roof operation, located in fuse box, for one second and reinstall. Now push and hold switch until the sliding/pop-up roof is fully raised. Continue to hold switch for another second.

Emergency operation of Skyview Top

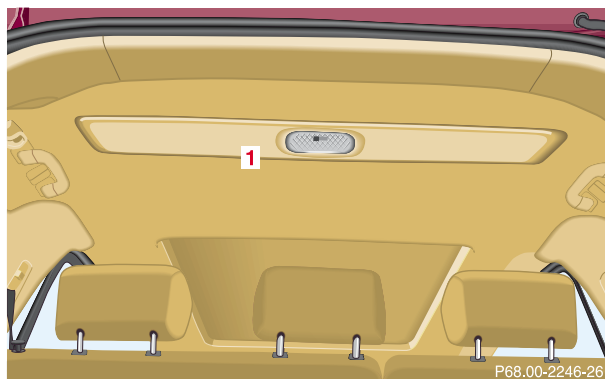

The Skyview Top can be opened or closed manually should an electrical malfunction occur.

The drive for the Skyview Top is located behind a cover (1) in the rear compartment headliner.

Remove cover to gain access to the drive motors.

Obtain crank (3) (located at left side motor).

Remove plug (2) from holder, located next to the motors, and insert into left side drive motor to declutch the motor.

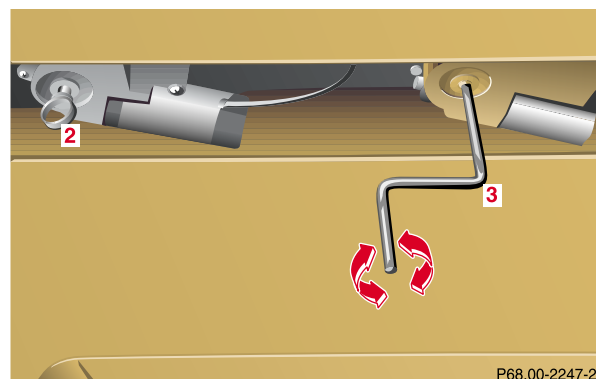

Insert crank (3) into right side motor.

Note:

Push crank upward while turning it, to disengage the electric motor.

To close the Skyview Top: turn crank clockwise.

To open the Skyview Top: turn crank counterclockwise.

Manual release for fuel filler flap

274

Important!

After manually operating the Skyview Top, a timing synchronization is needed for future electrical operation of the Skyview Top. To do so, turn key in steering lock to position 2. Now push and hold switch until the Skyview Top is fully closed. Continue to hold switch for additional 15 seconds.

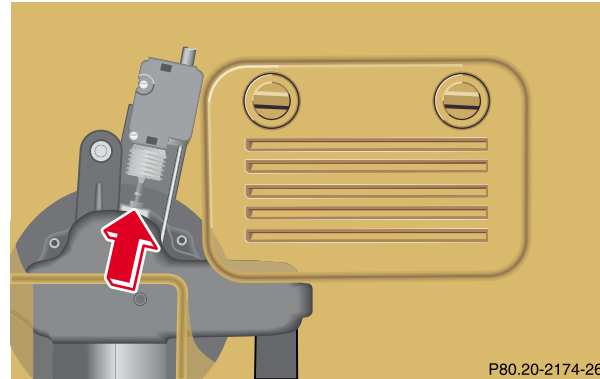
Manual release for fuel filler flap

P80.20-2174-26

The manual release is located behind the cover in the left rear compartment trim panel.

In case the central locking system does not release the fuel filler flap, pull up on the lock rod (arrow).

ML 55 AMG:

First remove the space-saver tire from its holder, see page 242.

Replacing wiper blades

For safety reasons, remove key from steering lock before replacing the wiper blade, otherwise the motor can suddenly turn on and cause injury.

Notes:

Do not open engine hood with wiper arm folded forward.

Do not allow the wiper arm to contact the windshield glass without a wiper blade inserted. The glass may be scratched or broken.

Make certain that the wiper blade is properly installed. An improperly installed wiper blade may cause windshield damage.

The wiper with air spoiler should be mounted on the driver's side.

Replacing windshield/rear window wiper blade

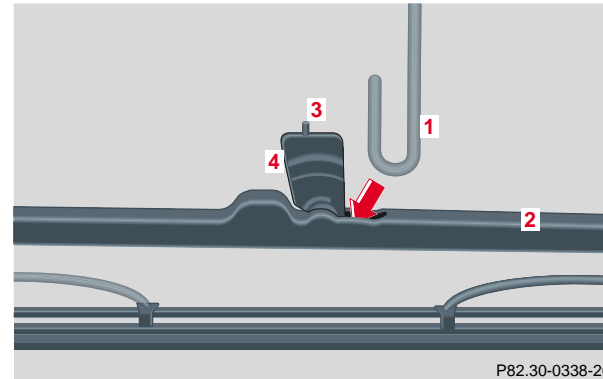

Removal:

Fold wiper arm (1) forward (windshield)/rearward (rear window) and turn wiper blade (2) at a right angle to the arm. Push safety tab (3) of attachment link (4) and slide the wiper blade from the end of the wiper arm. Remove the wiper blade.

Installation:

Slide wiper blade into end of wiper arm until it locks in place.

Roof rack

Use only those roof racks approved by Mercedes-Benz. Follow manufacturer's installation instructions. They mount to the roof rails and do not require additional supports (e.g. suction cups or legs). Such supports may lead to marring of the paint or denting the roof. For further information inquire at your Mercedes-Benz Light Truck Center.

Take into consideration that when the roof rack is loaded, the handling characteristics are different from those when operating the vehicles without the roof rack loaded.

Vehicle care

| | |
|--|-----|
| Cleaning and care of the vehicle | 278 |
| Power washer | 279 |
| Tar stains | 279 |
| Paintwork, painted body components | 279 |
| Engine cleaning | 280 |
| Vehicle washing | 280 |
| Ornamental moldings | 280 |
| Headlamps, taillamps, turn signal lenses | 280 |

| | |
|--|-----|
| Window cleaning | 281 |
| Wiper blades | 281 |
| Light alloy wheels | 281 |
| Instrument cluster | 281 |
| Steering wheel and gear selector lever | 281 |
| Cup holder | 282 |
| Seat belts | 282 |
| Headliner | 282 |
| Upholstery | 282 |
| Hard plastic trim items | 282 |
| Plastic and rubber parts | 282 |

| | | | | | | | |
|--------------------------|-----------|---------|----------------------------|-----------------|-----------------|----------------|-------|
| Instruments and controls | Operation | Driving | Instrument cluster display | Practical hints | Car care | Technical data | Index |
|--------------------------|-----------|---------|----------------------------|-----------------|-----------------|----------------|-------|

Cleaning and care of the vehicle

Warning!

Many cleaning products can be hazardous. Some are poisonous, others are flammable. Always follow the instructions on the particular container. Always open your vehicle's doors or windows when cleaning the inside.

Never use fluids or solvents that are not designed for cleaning your vehicle.

In operation, your vehicle is subjected to varying external influences which, if gone unchecked, can attack the paintwork as well as the underbody and cause lasting damage.

Such damage is caused not only by extreme and varying climatic conditions, but also by air pollution, road salt, tar, gravel and stone chipping. Grease and oil, fuel, coolant, brake fluid, bird droppings, insects, tree resins etc. should be removed immediately to avoid paint damage. Frequent washing reduces and/or eliminates the aggressiveness and potency of the above adverse influences.

More frequent washings are necessary to deal with unfavorable conditions; for example, near the ocean, in industrial areas (smoke, exhaust emissions), or during winter operation.

You should check your vehicle from time to time for stone chipping or other damage. Any damage should be repaired as soon as possible to prevent the start of corrosion.

In doing so, do not neglect the underside of the vehicle. A prerequisite for a thorough check is a washing of the underbody followed by a thorough inspection. Damaged areas need to be reundercoated.

Your vehicle has been treated at the factory with a wax-base rustproofing in the body cavities which will last for the lifetime of the vehicle. Post-production treatment is neither necessary nor recommended by Mercedes-Benz because of the possibility of incompatibility between materials used in the production process and others applied later.

We have selected car-care products and compiled recommendations which are specially matched to our vehicles and which always reflect the latest technology. You can obtain Mercedes-Benz approved car-care products at your authorized Mercedes-Benz Light Truck Center.

Scratches, corrosive deposits, corrosion or damage due to negligent or incorrect care cannot always be removed or repaired with the car-care products recommended here. In such cases it is best to seek aid at your authorized Mercedes-Benz Light Truck Center.

The following topics deal with the cleaning and care of your vehicle and give important “how-to” information as well as references to Mercedes-Benz approved car-care products.

Additional information can be found in the booklet titled “Vehicle Care Guide”.

Power washer

When using a power washer for cleaning the vehicle always observe manufacturers’ operating instructions.

Caution!

Never use a round nozzle to power wash tires. The intense jet of water can result in damage to the tire.

Always replace a damaged tire.

Always keep the jet of water moving across the surface. Do not aim directly at electrical parts, electrical connectors, seals, or other rubber parts.

Tar stains

Quickly remove tar stains before they dry and become more difficult to remove. A tar remover is recommended.

Paintwork, painted body components

Mercedes-Benz approved Paint Care should be applied when water drops on the paint surface do not “bead up”, normally in 3 to 5 months, depending on climate and washing detergent used.

Mercedes-Benz approved Paint Cleaner should be applied if paint surface shows signs of dirt embedding (i.e. loss of gloss).

Do not apply any of these products or wax if your vehicle is parked in the sun or if the hood is still hot.

Use the appropriate MB-Touch-Up Stick for quick and provisional repairs of minor paint damage (i.e. chips from stones, vehicle doors etc.).

Cleaning and care of the vehicle

280

Engine cleaning

Prior to cleaning the engine compartment make sure to protect electrical components and connectors from the intrusion of water and cleaning agents.

Corrosion protection, such as MB Anticorrosion Wax should be applied to the engine compartment after every engine cleaning. Before applying, all control linkage bushings and joints should be lubricated. The poly-V-belt and all pulleys should be protected from any wax.

Vehicle washing

Do not use hot water or wash your vehicle in direct sunlight. Use only a mild car wash detergent, such as Mercedes-Benz approved Car Shampoo.

Thoroughly spray the vehicle with a diffused jet of water. Direct only a very weak spray towards the ventilation intake. Use plenty of water and rinse the sponge and chamois frequently.

Rinse with clear water and thoroughly wipe dry with a chamois. Do not allow cleaning agents to dry on the finish.

Due to the width of the vehicle, prior to running the vehicle through an automatic car wash, fold back the outside mirrors to prevent them from getting damaged.

In the winter, thoroughly remove all traces of road salt as soon as possible.

When washing the underbody, do not forget to clean the inner sides of the wheels.

Ornamental moldings

For regular cleaning and care of very dirty chrome-plated parts, use a chrome cleaner.

Headlamps, taillamps, turn signal lenses

Use a mild car wash detergent, such as Mercedes-Benz approved Car Shampoo, with plenty of water.

To prevent scratches, never apply strong force and use only a soft, non-scratchy cloth when cleaning the lenses. Do not attempt to wipe dirty lenses with a dry cloth or sponge.

Window cleaning

Use a window cleaning solution on all glass surfaces. An automotive glass cleaner is recommended.

Note:

For safety reasons, switch off wipers and remove key from steering lock before cleaning the windshield, otherwise the wiper motor can suddenly turn on and cause injury.

Wiper blades

Clean the wiper blade rubbers with a clean cloth and detergent solution.

Note:

For safety reasons, switch off wipers and remove key from steering lock before cleaning the wiper blades, otherwise the wiper motor can suddenly turn on and cause injury.

Light alloy wheels

Mercedes-Benz approved Wheel Care should be used for regular cleaning of the light alloy wheels.

If possible, clean wheels once a week with Mercedes-Benz approved Wheel Care, using a soft bristle brush and a strong spray of water.

Follow instructions on container.

Note:

Use only acid-free cleaning materials. The acid could lead to corrosion or may damage the clear coat.

Instrument cluster

Use a gentle dishwashing detergent or mild detergent for delicate fabrics as a washing solution. Wipe with a cloth moistened in lukewarm solution. Do not use scouring agents.

Steering wheel and gear selector lever

Wipe with a damp cloth and dry thoroughly or clean with Mercedes-Benz approved Leather Care.

Cleaning and care of the vehicle

282

Cup holder

Use a gentle dishwashing detergent or mild detergent for delicate fabrics as a washing solution. Wipe with a cloth moistened in lukewarm solution. Do not use scouring agents.

Seat belts

The webbing must not be treated with chemical cleaning agents. Use only clear, lukewarm water and soap. Do not dry the webbing at temperatures above 176°F (80°C) or in direct sunlight.

Warning!

Do not bleach or dye seat belts as this may severely weaken them. In a crash they may not be able to provide adequate protection.

Headliner

Clean with soft bristle brush, or use a dry-shampoo cleaner in case of excessive dirt.

Upholstery

Using aftermarket seat covers or wearing clothing that have the tendency to give off coloring (e.g. when wet etc.) may cause the upholstery to become permanently discolored. By lining the seats with a proper intermediate cover, contact-discoloration will be prevented.

Leather Upholstery

Wipe leather upholstery with a damp cloth and dry thoroughly or clean with Mercedes-Benz approved Leather Care. Exercise particular care when cleaning perforated leather as its underside should not become wet.

Cloth Upholstery

Clean with soft bristle brush, or use a dry-shampoo cleaner in case of excessive dirt.

Hard plastic trim items

Pour Mercedes-Benz approved Interior Care onto soft lint-free cloth and apply with light pressure.

Plastic and rubber parts

Do not use oil or wax on these parts.

Technical data

| | |
|--|-----|
| Spare parts service | 284 |
| Warranty coverage | 284 |
| Identification labels | 285 |
| Layout of poly-V-belt drive | 286 |
| Technical data | 287 |
| Fuels, coolants, lubricants etc. – capacities | 292 |

| | |
|-----------------------------------|-----|
| Engine oils | 294 |
| Engine oil additives | 294 |
| Air conditioner refrigerant | 294 |
| Brake fluid | 294 |
| Premium unleaded gasoline | 295 |
| Fuel requirements | 295 |
| Gasoline additives | 296 |
| Coolants | 296 |
| Consumer information | 298 |

| | | | | | | | |
|--------------------------|-----------|---------|----------------------------|-----------------|----------|----------------|-------|
| Instruments and controls | Operation | Driving | Instrument cluster display | Practical hints | Car care | Technical data | Index |
|--------------------------|-----------|---------|----------------------------|-----------------|----------|----------------|-------|

Technical data

284

Spare parts service

All authorized Mercedes-Benz Light Truck Centers maintain a stock of original spare parts required for maintenance and repair work. In addition, strategically located parts distribution centers provide quick and reliable parts service.

More than 300 000 different spare parts, for Mercedes-Benz models, are available.

Mercedes-Benz original spare parts are subjected to stringent quality inspections. Each part has been specifically developed, manufactured or selected for and adapted to Mercedes-Benz vehicles.

Therefore, Mercedes-Benz original spare parts should be installed.

Important!

The use of non-genuine parts and accessories not authorized by Mercedes-Benz could damage the vehicle which damage is not covered by the Mercedes-Benz Limited Warranty, or compromise its durability or safety.

Warranty coverage

Your vehicle is covered under the terms of the “warranties” printed in the Service and Warranty Information booklet and your authorized Mercedes-Benz Light Truck Center will exchange or repair any defective parts originally installed on the vehicle in accordance with the terms of the following warranties:

1. New vehicle limited warranty
2. Emission system warranty
3. Emission performance warranty
4. California, Massachusetts, and Vermont emission control systems warranty

Replacement parts and accessories are covered by the Mercedes-Benz Spare Parts and Accessories warranties, copies of which are available at any Mercedes-Benz Light Truck Center.

Loss of Service and Warranty Information Booklet

Should you lose your Service and Warranty Information booklet, have your authorized Mercedes-Benz Light Truck Center arrange for a replacement. It will be mailed to you.

Identification labels

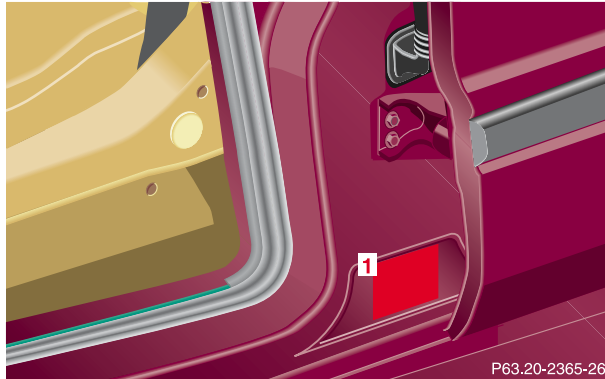

1 Certification label and Paintwork Number

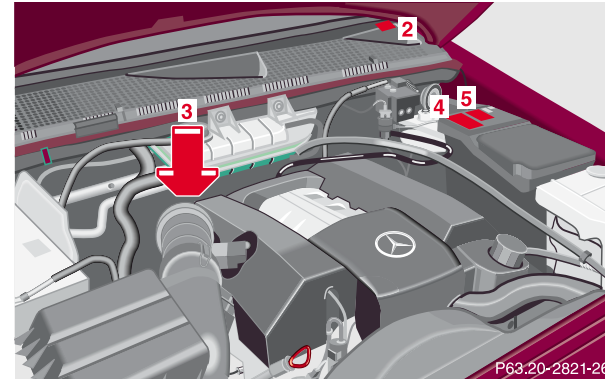

- 2 Vehicle Identification Number (VIN)
- 3 Engine number
- 4 Information label, California version
- 5 Emission control label
Vacuum line routing for emission control system

Note:

When ordering spare parts, please specify vehicle identification and engine numbers.

Technical data

285

| | | | | | | | |
|--------------------------|-----------|---------|----------------------------|-----------------|----------|----------------|-------|
| Instruments and controls | Operation | Driving | Instrument cluster display | Practical hints | Car care | Technical data | Index |
|--------------------------|-----------|---------|----------------------------|-----------------|----------|----------------|-------|

Technical data

286

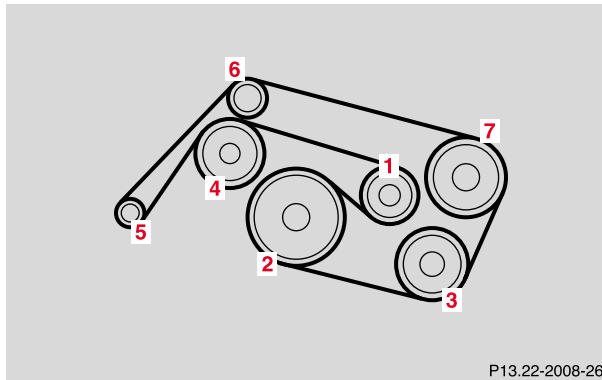
Layout of poly-V-belt drive

- 1 Automatic belt tensioner
- 2 Crankshaft
- 3 Air conditioner compressor
- 4 Coolant pump
- 5 Generator (alternator)
- 6 Idler pulley
- 7 Power steering pump

For dimensions of the poly-V-belt, see technical data.

Technical data

| Model | ML 320 (163 154)¹ | ML 430 (163 172)¹ | ML 55 AMG (163 174)¹ |
|-----------------------------------|---|---|---|
| Engine | 112 | 113 | 113 |
| Mode of operation | 4-stroke engine, gasoline injection | 4-stroke engine, gasoline injection | 4-stroke engine, gasoline injection |
| No. of cylinders | 6 | 8 | 8 |
| Bore | 3.54 in (89.90 mm) | 3.54 in (89.90 mm) | 3.82 in (97.00 mm) |
| Stroke | 3.31 in (84.00 mm) | 3.31 in (84.00 mm) | 3.62 in (92.00 mm) |
| Total piston displacement | 195.2 cu.in. (3199 cm ³) | 260.6 cu.in. (4266 cm ³) | 332.0 cu.in. (5439 cm ³) |
| Compression ratio | 10:1 | 10:1 | 10.5:1 |
| Output acc. to SAE J 1349 | 215 hp/5600 rpm (160 kW/5600 rpm) | 268 hp/5750 rpm (200 kW/5750 rpm) | 342 hp/5500 rpm (255 kW/5500 rpm) |
| Maximum torque acc. to SAE J 1349 | 233 ft.lb/3000 rpm (315 Nm/3000 rpm) | 288 ft.lb/3000 rpm (390 Nm/3000 rpm) | 376 ft.lb/2800 rpm (510 Nm/2800 rpm) |
| Maximum engine speed | 6000 rpm | 6000 rpm | 6000 rpm |
| Firing order | 1-4-3-6-2-5 | 1-5-4-2-6-3-7-8 | 1-5-4-2-6-3-7-8 |
| Poly-V-belt | 2390 mm | 2390 mm | 2390 mm |

¹ The quoted data apply only to the standard vehicle. See an authorized Mercedes-Benz Light Truck Center for the corresponding data of all special bodies and special equipment.

| Instruments and controls | Operation | Driving | Instrument cluster display | Practical hints | Car care | Technical data | Index |
|--------------------------|-----------|---------|----------------------------|-----------------|----------|----------------|-------|
|--------------------------|-----------|---------|----------------------------|-----------------|----------|----------------|-------|

Technical data

288

Rims – Tires

| Model | ML 320 | ML 430 | ML 55 AMG |
|--------------------|-------------------|---|-------------------------------|
| Rims (light alloy) | 8 J x 16 H 2 ET62 | 8 ¹ / ₂ J x17 H2 ET52 | 9 J x 18 H2 ET 52 |
| Wheel offset | 2.4 in (62 mm) | 2.0 in (52 mm) | 2.0 in (52 mm) |
| All season tires: | | | |
| Radial-ply tires | 255/65 R 16 109H | 275/55 R 17 109H | 285/50 R 18 109W ¹ |

Spare wheel

| Rim (standard equipment) | ML 320 | ML 430 | ML 55 AMG |
|--------------------------|-------------------------------|-------------------------------|-------------------------------|
| Steel | 4 J x 18 H 2 ET0 | 4 J x 18 H 2 ET0 | 4 J x 18 H 2 ET0 |
| Wheel offset | 0 in (0 mm) | 0 in (0 mm) | 0 in (0 mm) |
| Space-saver tire | T155/90 D18 113M ¹ | T155/90 D18 113M ¹ | T155/90 D18 113M ¹ |

¹ Must not be used with snow chains.

Rims – Winter tires

| | |
|--------------------|---|
| Model | ML 55 AMG |
| Rims (light alloy) | 8 ¹ / ₂ J x 17 H2 ET 52 |
| Wheel offset | 2.0 in (52 mm) |
| All season tires: | |
| Radial-ply tires | 275/55 R 17 109H |

Rims – Tires (optional)

| | | |
|--------------------|--|--|
| Model | ML 320 | ML 430 |
| Rims (light alloy) | 8 ¹ / ₂ J x 17 H2 ET52 | 8 ¹ / ₂ J x 17 H2 ET47 |
| Wheel offset | 2.0 in (52 mm) | 1.85 in (47 mm) |
| Rims (light alloy) | 8 ¹ / ₂ J x 17 H2 ET47 | |
| Wheel offset | 1.85 in (47 mm) | |
| All season tires: | | |
| Radial-ply tires | 275/55 R 17 109H | 275/55 R 17 109H |

| | | | | | | | |
|---------------------------------|------------------|----------------|-----------------------------------|------------------------|-----------------|-----------------------|--------------|
| Instruments and controls | Operation | Driving | Instrument cluster display | Practical hints | Car care | Technical data | Index |
|---------------------------------|------------------|----------------|-----------------------------------|------------------------|-----------------|-----------------------|--------------|

Technical data

290

Electrical system

| Model | ML 320 | ML 430 | ML 55 AMG |
|------------------------|--|--|----------------------------|
| Generator (alternator) | 14 V/115 A | 14 V/150 A | 14 V/150 A |
| Starter motor | 12V/1.7 kW | 12V/1.7 kW | 12V/1.7 kW |
| Battery | 12V/100 Ah | 12V/100 Ah | 12V/100 Ah |
| Spark plugs | Bosch F 8 DPER Beru 14 FGH 8 DPUR X 2 | Bosch F 8 DPER Beru 14 FGH 8 DPUR X 2 | Bosch F 8 DPER |
| Electrode gap | 0.039 in (1.0 mm) | 0.039 in (1.0 mm) | 0.039 in (1.0 mm) |
| Tightening torque | 15 – 22 ft.lb (20 – 30 Nm) | 15 – 22 ft.lb (20 – 30 Nm) | 15 – 22 ft.lb (20 – 30 Nm) |

Weights

(see certification tag)

| | |
|----------------|------------------|
| Roof load max. | 220 lbs (100 kg) |
|----------------|------------------|

Main dimensions

| Model | ML 320 | ML 430 | ML 55 AMG |
|------------------------|--------------------|--------------------|--------------------|
| Overall vehicle length | 180.6 in (4587 mm) | 180.6 in (4587 mm) | 182.5 in (4635 mm) |
| Overall vehicle width | 86.2 in (2190 mm) | 86.2 in (2190 mm) | 86.2 in (2190 mm) |
| Overall height | 71.6 in (1820 mm) | 71.6 in (1820 mm) | 71.0 in (1804 mm) |
| Wheel base | 111.0 in (2820 mm) | 111.0 in (2820 mm) | 111.0 in (2820 mm) |
| Track, front | 60.4 in (1535 mm) | 61.2 in (1555 mm) | 61.2 in (1555 mm) |
| Track, rear | 60.4 in (1535 mm) | 61.2 in (1555 mm) | 61.2 in (1555 mm) |

| | | | | | | | |
|--------------------------|-----------|---------|----------------------------|-----------------|----------|----------------|-------|
| Instruments and controls | Operation | Driving | Instrument cluster display | Practical hints | Car care | Technical data | Index |
|--------------------------|-----------|---------|----------------------------|-----------------|----------|----------------|-------|

Fuels, coolants, lubricants etc. - capacities

292

Fuels, coolants, lubricants etc. – capacities

Vehicle components and their respective lubricants must match. Therefore use only brands tested and recommended by us. Please refer to the Factory Approved Service Products pamphlet, or inquire at your Mercedes-Benz Light Truck Center.

| Fuels, coolants, lubricants etc. | Model | Capacity |
|--|----------------------------|--|
| Engine with oil filter (recommended engine oils) | ML 320/ML 430 ML 55 AMG | 8.5 US qt (8.0 l) 8.0 US qt (7.5 l) |
| Automatic transmission (automatic transmission fluid) | | 9.0 US qt (8.5 l) |
| Transfer case (Dexron 3 or Dexron 2E) | | 1.6 US qt (1.5 l) |
| Rear axle (Hypoid gear oil SAE 90, 85 W 90) | | 1.3 US qt (1.25 l) |
| Front axle (Hypoid gear oil SAE 90) | | 1.2 US qt (1.1 l) |
| Power steering (MB Power steering fluid) | | approx. 0.65 US qt (0.6 l) |
| Front wheel hubs (high temperature roller bearing grease) | | approx. 1.5 oz (43 g) each |

| Fuels, coolants, lubricants etc. | Model | Capacity |
|---|---|---|
| Brake system (MB Brake fluid [DOT 4+]) | | approx. 0.9 US qt (0.8 l) |
| Windshield/headlamp washer system (MB Windshield washer concentrate "S" ¹) | Vehicles without headlamp cleaning system | approx. 5.5 US qt (5.0 l) |
| | Vehicles with headlamp cleaning system | approx. 8.0 US qt (7.6 l) |
| Cooling system (MB Anticorrosion/antifreeze) | | approx. 12.7 US qt (12.0 l) |
| Fuel tank including a reserve of (Premium unleaded gasoline: Posted Octane 91 (Avg. of 96 RON/86 MON)) | ML 320 / ML 430 | approx. 19.2 US gal (73.0 l) approx. 3.2 US gal (12.0 l) |
| | ML 55 AMG | approx. 24.5 US gal (93.0 l) approx. 3.2 US gal (12.0 l) |
| Air conditioner system (R-134a refrigerant and special PAC lubricant (<i>Never R-12</i>)) | | |

¹ Use MB Windshield Washer Concentrate "S" and water for temperatures above freezing or MB Windshield Washer Concentrate "S" and commercially available premixed windshield washer solvent/antifreeze for temperatures below freezing. Follow suggested mixing ratios, see page 237.

| | | | | | | | |
|--------------------------|-----------|---------|----------------------------|-----------------|----------|----------------|-------|
| Instruments and controls | Operation | Driving | Instrument cluster display | Practical hints | Car care | Technical data | Index |
|--------------------------|-----------|---------|----------------------------|-----------------|----------|----------------|-------|

Fuels, coolants, lubricants etc.

294

Engine oils

Engine oils are specifically tested for their suitability in our engines. Therefore, use only engine oils recommended by Mercedes-Benz. Information on recommended brands is available at your authorized Mercedes-Benz Light Truck Center.

Please follow Service Booklet recommendations for scheduled oil changes. Failure to do so could result in engine damage not covered by the Mercedes-Benz Limited Warranty.

Engine oil additives

Do not blend oil additives with engine oil. They may be harmful to the engine operation.

Damage or malfunctions resulting from blending oil additives are not covered by the Mercedes-Benz Limited Warranty.

Air conditioner refrigerant

R-134a (HFC) refrigerant and special PAG lubricating oil is used in the air conditioner system.

Never use R-12 (CFC) or mineral-based lubricating oil, otherwise damage to the system will occur.

Brake fluid

During vehicle operation, the boiling point of the brake fluid is continuously reduced through the absorption of moisture from the atmosphere. Under extremely hard operating conditions, this moisture content can lead to the formation of bubbles in the system thus reducing the system's efficiency.

The brake fluid must therefore be replaced every two years, preferably in the spring.

It is recommended to use only brake fluid approved by Mercedes-Benz. Your authorized Mercedes-Benz Light Truck Center will provide you with additional information.

Premium unleaded gasoline

Caution!

To maintain the engine's durability and performance, premium unleaded gasoline must be used. If premium unleaded is not available and low octane fuel is used, follow these precautions:

- have the fuel tank filled only partially with unleaded regular and fill up with premium unleaded as soon as possible,
- avoid full throttle driving and abrupt acceleration,
- do not exceed an engine speed of 3000 rpm, if the vehicle is loaded with a light load such as two persons and no luggage,
- do not exceed 2/3 of maximum accelerator pedal position, if the vehicle is fully loaded or operating in mountainous terrain.

Fuel requirements

Use only Premium unleaded meeting ASTM standard D 439:

The octane number (posted at the pump) must be 91 min. It is an average of both the Research (R) octane number and the Motor (M) octane number: $[(R+M)/2]$. This is also known as ANTI-KNOCK INDEX.

Unleaded gasoline containing oxygenates such as Ethanol, IPA, IBA and TBA can be used provided the ratio of any one of these oxygenates to gasoline does not exceed 10%, MTBE not to exceed 15%.

The ratio of Methanol to gasoline must not exceed 3% plus additional cosolvents.

Using mixtures of Ethanol and Methanol is not allowed. Gasohol, which contains 10% Ethanol and 90% unleaded gasoline, can be used.

These blends must also meet all other fuel requirements such as resistance to spark knock, boiling range, vapor pressure etc..

| | | | | | | | |
|--------------------------|-----------|---------|----------------------------|-----------------|----------|----------------|-------|
| Instruments and controls | Operation | Driving | Instrument cluster display | Practical hints | Car care | Technical data | Index |
|--------------------------|-----------|---------|----------------------------|-----------------|----------|----------------|-------|

Fuels, coolants, lubricants etc.

296

Gasoline additives

A major concern among engine manufacturers is carbon build up caused by gasoline. Mercedes-Benz recommends the use of only quality gasoline containing additives that prevent the build up of carbon deposits.

After an extended period of using fuels without such additives, carbon deposits can build up especially on the intake valves and in the combustion area, leading to engine performance problems such as:

- warm-up hesitation,
- unstable idle,
- knocking/pinging,
- misfire,
- power loss.

Do not blend other specific fuel additives with fuel. They only result in unnecessary cost, and may be harmful to the engine operation.

Damage or malfunctions resulting from poor fuel quality or from blending specific fuel additives are not covered by the Mercedes-Benz Limited Warranty.

Coolants

The engine coolant is a mixture of water and anticorrosion/antifreeze, which provides:

- corrosion protection,
- freeze protection,
- boiling protection (by increasing the boiling point).

The cooling system was filled at the factory with a coolant providing freeze protection to approximately -35°F (-37°C) and corrosion protection.

If the antifreeze mixture is effective to -22°F (-30°C), the boiling point of the coolant in the pressurized cooling system is reached at approx. 266°F (130°C).

The coolant solution must be used year round to provide the necessary corrosion protection and increase in the boil-over protection. You should have it replaced every 3 years.

To provide the important corrosion protection, the solution must be at least 45% anticorrosion/antifreeze (equals a freeze protection to approx. - 22°F [-30°C]). If you use a solution that is more than 55% anticorrosion/antifreeze (freeze protection to approx. - 49°F [-45°C]),

the engine temperature will increase due to the lower heat transfer capability of the solution. Therefore, do not use more than this amount of anticorrosion/antifreeze.

If the coolant level is low, water and MB anticorrosion/antifreeze should be used to bring it up to the proper level (have cooling system checked for signs of leakage).

The water in the cooling system must meet minimum requirements, which are usually satisfied by normal drinking water. If you are not sure about the water quality, consult your authorized Mercedes-Benz Light Truck Center.

Anticorrosion/antifreeze

Your vehicle contains a number of aluminum parts. The use of aluminum components in motor vehicle engines necessitates that anticorrosion/antifreeze coolant used in such engines be specifically formulated to protect the aluminum parts. (Failure to use such anticorrosion/antifreeze coolant will result in a significantly shortened service life.)

Therefore the following product is strongly recommended for use in your vehicle: Mercedes-Benz Anticorrosion/antifreeze agent.

Before the start of the winter season (or once a year in the hot southern regions), you should have the anticorrosion/antifreeze concentration checked. The coolant is also regularly checked each time you bring your vehicle to your authorized Mercedes-Benz Light Truck Center for service.

Anticorrosion/antifreeze quantity

Approx. freeze protection

| | |
|----------|----------|
| - 35°F | - 49°F |
| (- 37°C) | (- 45°C) |

| | |
|----------------------|----------------------|
| 6.4 US qt (6.0 l) | 7.0 US qt (6.6 l) |
|----------------------|----------------------|

| | | | | | | | |
|--------------------------|-----------|---------|----------------------------|-----------------|----------|----------------|-------|
| Instruments and controls | Operation | Driving | Instrument cluster display | Practical hints | Car care | Technical data | Index |
|--------------------------|-----------|---------|----------------------------|-----------------|----------|----------------|-------|

Consumer information

Consumer information

This has been prepared as required of all manufactures of passenger cars under Title 49, Code of U.S. Federal Regulations, Part 575 pursuant to the “National Traffic and Motor Vehicle Safety Act of 1966”.

Uniform tire quality grading

Quality grades can be found where applicable on the tire sidewall between tread shoulder and maximum section width. For example:

Tread wear 200 Traction AA Temperature A

All passenger vehicle tires must conform to federal safety requirements in addition to these grades.

Treadwear

The treadwear grade is a comparative rating based on the wear rate of the tire when tested under controlled conditions on a specified government test course. For example, a tire graded 150 would wear one and one-half (1 1/2) times as well on the government course as a tire graded 100. The relative performance of tires depends upon the actual conditions of their use, however, and may depart significantly from the norm due to variations in driving habits, service practices and differences in road characteristics and climate.

Traction

The traction grades, from highest to lowest are AA, A, B, and C. Those grades represent the tire’s ability to stop on wet pavement as measured under controlled conditions on specified government test surfaces of asphalt and concrete. A tire marked C may have poor traction performance.

Warning!

The traction grade assigned to this tire is based on straight ahead braking traction tests, and does not include acceleration, cornering, hydroplaning, or peak traction characteristics.

Temperature

The temperature grades are A (the highest), B, and C, representing the tire's resistance to the generation of heat and its ability to dissipate heat when tested under controlled conditions on a specified indoor laboratory test wheel. Sustained high temperature can cause the material of the tire to degenerate and reduce tire life, and excessive temperature can lead to sudden tire failure. The grade C corresponds to a level of performance which all passenger vehicle tires must meet under the Federal Motor Vehicle Safety Standard No. 109. Grades B and A represent higher levels of performance on the laboratory test wheel than the minimum required by law.

Warning!

The temperature grade for this tire is established for a tire that is properly inflated and not overloaded. Excessive speed, underinflation, or excessive loading, either separately or in combination, can cause excessive heat build up and possible tire failure.

| | | | | | | | |
|--------------------------|-----------|---------|----------------------------|-----------------|----------|----------------|-------|
| Instruments and controls | Operation | Driving | Instrument cluster display | Practical hints | Car care | Technical data | Index |
|--------------------------|-----------|---------|----------------------------|-----------------|----------|----------------|-------|

Index

A

ABS (Antilock brake system) 201
 LOW RANGE – ABS 202
 Malfunction indicator lamp 222
 Adjustable steering wheel 70
 Indicator lamp 222
 Adjusting headlamp aim 268
 Air conditioner refrigerant 294
 Air pump 239
 Air recirculation 102
 Airbag deactivation system 53
 Airbag OFF indicator lamp 222
 Airbags 56
 Alarm system 35, 36
 Anticorrosion/antifreeze 181, 235, 293, 297
 Antiglare night position 71
 Antilock brake system (ABS) 201
 LOW RANGE – ABS 202
 Malfunction indicator lamp 222
 Antitheft alarm system 35
 Aquaplaning 178

Ashtray

Center console, front 118
 Rear passenger compartment 118
 Automatic central locking 32
 Automatic transmission 165
 Emergency Operation 172
 Fluid level 234
 Selector lever position 168
 Transmission selector lever,
 manually unlocking 259

B

BabySmart™ airbag deactivation system 53
 Self-test 53
 BAS (Brake assist system) 199
 Malfunction indicator lamp 221
 Battery 251
 Battery recycling 252
 Charge indicator lamp 223
 Battery, remote control 270
 Block heater 182
 Blocking of rear door windows 105
 Brake assist system (BAS) 199
 Malfunction indicator lamp 221

| | |
|--------------------------------|--------------------|
| Brake fluid | 175, 294 |
| Brake warning lamp | 219 |
| Capacity | 293 |
| Brake pad wear indicator | 225 |
| Brake warning lamp | 219 |
| Brake fluid low | 219 |
| Brakes | 173, 175, 293, 294 |

C

| | |
|---------------------------------------|-----|
| Capacities | |
| Fuels, coolants, lubricants etc. | 292 |
| Cargo area | 131 |
| Hooks | 133 |
| Loading instructions | 136 |
| Cargo area cover blind | 137 |
| Cargo compartment lamp | 111 |
| Cargo floor plates | |
| Removable | 129 |
| Storage | 130 |
| Cargo tie-down rings | 132 |
| Catalytic converter | 160 |
| Cellular telephone | 139 |
| Center console | 20 |
| Central locking switch | 32 |

| | |
|---|----------------|
| Central locking system | 26 |
| Automatic central locking | 32 |
| Locking and unlocking | 27 |
| Mechanical keys | 29 |
| Panic button | 28 |
| Remote control | 26 |
| Unlocking the liftgate | 28 |
| Vehicle keys | 24 |
| Changing wheels | 245 |
| Inflating the space-saver tire | 249 |
| Charge indicator lamp | 223 |
| CHECK ENGINE malfunction indicator lamp | 218 |
| Check regularly and before a long trip | 215 |
| Checking engine oil level | |
| Via engine oil level indicator | 89 |
| Via oil dipstick | 233 |
| Child restraint | 38, 46, 53, 65 |
| Cleaning and care of the vehicle | 278 |
| Climate control | 98 |
| Air recirculation | 102 |
| Basic setting | 100 |
| Defogging windows | 101 |
| Defrosting windshield | 101 |
| Dust filter | 102 |
| Rear window defroster | 103 |
| Special settings | 101 |

Index

Clock, adjusting 80
 Compartment under front passenger seat 116
 Consumer information 298
 Control and operation of radio transmitters 146
 Coolant level
 Adding 235
 Checking 234
 Low engine coolant level warning 224
 Coolant temperature gauge 81
 Coolants 296
 Anticorrosion/antifreeze quantity 296
 Low engine coolant level warning 224
 Cover blind, cargo area 137
 Cruise control 196
 Cup holder
 Instrument panel 116
 Rear center console 117

D

Daytime running lamps 91
 Deep water
 Driving instructions 181
 Defroster, rear window 103
 Display illumination 80

Doors 30
 Drinking and driving 174
 Drive sensibly - save fuel 174
 Driving instructions 174
 Driving off 176

E

EBP (Electronic brake proportioning) 204
 Electrical outlet 230
 Electronic brake proportioning (EBP) 204
 Electronic stability program (ESP) 205
 Control switch 207
 Malfunction indicator lamp 221
 Synchronizing 206
 Warning lamp 221
 Electronic traction system (4-ETS+) 203
 LOW RANGE - 4-ETS 204
 Malfunction indicator lamp 221
 Emergency call
 See Tele Aid 148
 Emergency operation of Skyview Top 273
 Emergency tensioning retractor (ETR) 55
 Emergency unlocking in case of accident 33
 Emission control 161

| | | | |
|---|---------|--|------------------------|
| Emission control label | 285 | ETR (Emergency tensioning retractor) | 55 |
| Engine compartment | 231 | ETS (4-ETS+) | 203 |
| Engine malfunction | | LOW RANGE – 4-ETS+ | 204 |
| CHECK ENGINE malfunction indicator lamp | 218 | Exterior lamp switch | 90 |
| Engine oil additives | 294 | Exterior lamps | 260 |
| Engine oil consumption | 234 | Adjusting headlamp aim | 268 |
| Engine oil level | | Auxiliary fog lamp | 92, 264 |
| Checking | 89, 233 | Fog lamps | 93 |
| Warning | 224 | Headlamp assembly | 261, 262 |
| Engine oil level indicator | 89 | Headlamps | 90, 261, 262, 268, 280 |
| Engine oils | 294 | High mounted stop lamp | 267 |
| Capacities | 292 | License plate lamps | 267 |
| Low engine oil level warning | 224 | Low and high beam | 90, 263 |
| Engine overheating | 81 | Parking lamp | 90, 264 |
| Engine speed limit | | Replacing bulbs | 260 |
| Overrevving | 82 | Side marker lamp | 264 |
| Enlarged cargo area | 131 | Standing lamp | 90, 264 |
| Entrance lamps | 112 | Taillamp assemblies | 265 |
| ESP | | Turn signal lamp | 90, 264 |
| LOW RANGE – ESP | 208 | Turn signal lamp, side | 266 |
| ESP (Electronic stability program) | 205 | Exterior rear view mirrors | 73 |
| Control switch | 207 | Electrically folding | 75 |
| Malfunction indicator lamp | 221 | | |
| Synchronizing | 206 | | |
| Warning lamp | 221 | | |

F

First aid kit228

Flexible service system (FSS) 87

 FSS indicator lamp 79, 225

Floor plates

 Removable 129

Fog lamp switch 92, 93

Four ETS

 LOW RANGE - 4-ETS+204

 Malfunction indicator lamp 221

Four wheel electronic traction system (4-ETS+)203

 Malfunction indicator lamp 221

Fuel

 Gasoline additives296

 Premium unleaded gasoline 213, 293, 295

Fuel filler flap

 Manual release 274

Fuel requirements295

Fuel reserve warning220

Fuels, coolants, lubricants etc. - Capacities292

Fuses, electrical228

G

Garage door opener 140

Gasoline

 Additives 296

 Fuel requirements 295

 Premium unleaded 295

General notes on the central locking system26

Glass breakage sensor36

Glove box 115

H

Hazard warning flasher switch 94

Head restraints

 Adjusting43

 Front43

 Front, removal43

 Rear 124

 Removal 43, 125

Headlamp aim, adjusting 268

Headlamp assembly

 Halogen261

 Xenon 262

| | |
|--------------------------------|-----|
| Headlamp cleaning system | 94 |
| Headlights | 90 |
| Heated seats | 44 |
| Hood | 231 |
| Hooks | 133 |

I

| | |
|---|-----|
| Identification labels | 285 |
| Illuminated vanity mirrors | 113 |
| Indicator lamps in the instrument cluster | 78 |
| Infant and child restraint system | |
| Installation | 67 |
| Infant and child restraint systems | 65 |
| Inflating the space-saver tire | 249 |
| Information call | |
| See Tele Aid | 148 |
| Instrument cluster | 76 |
| Activating display | 80 |
| Display illumination | 80 |
| Indicator lamps | 78 |
| Malfunction and indicator lamps | 218 |
| Instrument lamps | 80 |

| | |
|--------------------------------|-----|
| Instruments and controls | 18 |
| Interior | |
| General notes | 114 |
| Interior lighting | 110 |

J

| | |
|---------------------|-----|
| Jump starting | 253 |
|---------------------|-----|

K

| | |
|---------------------|----|
| Keys, vehicle | 24 |
|---------------------|----|

L

| | |
|------------------------------|------------------------|
| Lamps, exterior | 260 |
| Adjusting headlamp aim | 268 |
| Auxiliary fog lamp | 92, 264 |
| Fog lamps | 93 |
| Headlamp assembly | 261, 262 |
| Headlamps | 90, 261, 262, 268, 280 |
| High mounted stop lamp | 267 |
| License plate lamps | 267 |
| Low and high beam | 90, 263 |

Parking lamp 90, 264
 Replacing bulbs 260
 Side marker lamp 264
 Standing lamp 90, 264
 Taillamp assemblies 265
 Turn signal lamp 90, 264
 Turn signal lamp, side 266
 Layout of poly-V-belt 286
 Liftgate 34
 Unlocking 28
 Lighter 119
 Limp home mode (Automatic transmission) 172
 Loading instructions 136
 Lockable storage compartment 116
 Locking and unlocking the vehicle 27
 Low engine coolant level warning 224
 Low engine oil level warning 224
 LOW RANGE
 Indicator lamp 221
 LOW RANGE mode 209
 LOW RANGE - 4-ETS+ 204
 LOW RANGE - ABS 202
 LOW RANGE - ESP 208

M

Maintenance 147
 Malfunction and indicator lamps in the instrument cluster 218
 Manual locking/unlocking the doors 29
 Manual operation of Skyview Top 273
 Manual operation of sliding/pop-up roof 272
 Manual seat, front 39
 MCS, radio and telephone 146
 Mechanical keys 29
 Memory 42
 Recalling 42
 Storing 42
 Mirror, exterior, adjusting 73
 Mirror, exterior, rear view 73
 Mirror, inside, rear view 71
 Mirrors, vanity 113

O

| | |
|-------------------------------------|-----|
| Obtaining replacement keys | 25 |
| Odometer/Trip odometer | 80 |
| Off-Road driving | 183 |
| On-board diagnostic system | 218 |
| Operator's manual | 8 |
| Outside temperature indicator | 82 |
| Overhead control panel | 21 |

P

| | |
|--------------------------|------------------------------|
| Panic button | 28 |
| Parking | 176 |
| Parking brake | 118, 173, 175, 176, 219, 245 |
| Partition net | 133 |
| Poly-V-belt | |
| Layout | 286 |
| Power assistance | 175 |
| Power seats, front | 40 |
| Memory | 42 |
| Memory recalling | 42 |
| Memory storing | 42 |

| | |
|---|-----|
| Power windows | 104 |
| Blocking of rear door windows | 105 |
| Express opening of front door windows | 105 |
| Problems with your vehicle | 15 |
| Product information | 7 |

R

| | |
|--|-----|
| Radio transmitters | 146 |
| Rain sensor | |
| See windshield wiper/washer switch | 95 |
| Rear quarter windows | 106 |
| Rear seat bench | 120 |
| Easy entry/exit feature | 123 |
| Head restraints | 124 |
| Rear seat head restraints | 124 |
| Adjusting | 125 |
| Removal | 125 |
| Rear view mirrors | |
| Exterior | 73 |
| Inside | 71 |
| Rear window defroster | 103 |
| Rear window wiper/washer | 96 |

| | | | |
|--|--------|--|-----|
| Remote control | 24 | Unfastening | 50 |
| Battery replacement | 270 | Warning lamp | 223 |
| Changing batteries | 270 | Seat belts and integrated restraint system | 46 |
| Operation | 26 | Seat bench | 120 |
| Synchronizing remote control | 271 | Seats, folding (Third row seats) | 126 |
| Removable cargo floor plates | 129 | Seats, front | 37 |
| Replacement keys | 25 | Heated seats | 44 |
| Replacing bulbs | 260 | Manual seats | 39 |
| Replacing wiper blade insert | 275 | Power seats | 40 |
| Reporting safety defects | 16 | Service indicator | |
| Reserve key | 24, 25 | See Flexible service system (FSS) | 87 |
| Roadside assistance | 10 | Side marker lamp | 264 |
| Roadside assistance call | | Skyview Top | 109 |
| See Tele Aid | 148 | Emergency operation | 273 |
| Roof rack | 276 | Sliding/pop-up roof | 107 |
| | | Emergency operation | 272 |
| | | Express opening | 108 |
| | | Synchronizing | 272 |
| | | Snow chains | 179 |
| | | SOS-call | |
| | | See Tele Aid | 148 |
| | | Space-saver tire | |
| | | Air pump | 239 |
| | | Spare parts service | 284 |
| | | Spare wheel | 242 |
| | | Space-saver tire | 243 |
| S | | | |
| Safety guidelines for the seat belt, emergency | | | |
| tensioning retractor and airbag | 63 | | |
| Screwdriver | 237 | | |
| Seat belt warning lamp | 223 | | |
| Seat belts | 46 | | |
| Fastening | 48 | | |
| Seat belt nonusage warning system | 47 | | |

| | |
|--|-----|
| Special settings (Climate control) | 101 |
| Split rear seat bench | 120 |
| Easy entry/exit feature | 123 |
| Rear seat head restraints | 124 |
| SRS indicator lamp | 219 |
| SRS malfunction | 57 |
| Start lock-out | 25 |
| Starting and turning off the engine | 164 |
| Steering lock | 162 |
| Steering wheel | |
| Adjustable | 70 |
| Indicator lamp | 222 |
| Stop lamp, high mounted | 267 |
| Storage compartments | |
| Center console | 115 |
| Compartment under front passenger seat | 116 |
| Glove box | 115 |
| Stowing things in the vehicle | 230 |
| Stranded vehicle | 259 |
| Sun visors | 113 |
| Supplemental restraint system (SRS) | 54 |
| Synchronizing remote control | 271 |

T

| | |
|---|----------|
| Tachometer | 82 |
| Technical data | 287 |
| Electrical system | 290 |
| Main dimensions | 291 |
| Rims and tires | 288, 289 |
| Weights | 290 |
| Tele Aid | 148 |
| Emergency calls | 149 |
| Information | 154 |
| Initiating an emergency call manually | 151 |
| Roadside Assistance | 152 |
| Telephone, general | 139 |
| Telephones and two-way radios | 146 |
| Telescoping steering column | |
| Adjusting | 70 |
| Indicator lamp | 222 |
| The first 1 000 miles (1 500 km) | 147 |
| Third row seats | 126 |
| Tie-down rings, cargo | 132 |
| Tire inflation pressure | 250 |
| Tire traction | 178 |

Index

| | |
|---|-----|
| Tires | |
| Driving instructions | 177 |
| Rims and tires | 288 |
| Rotating wheels | 241 |
| Tire inflation pressure | 250 |
| Tire replacement | 240 |
| Winter driving instructions | 180 |
| Tow-away alarm | 36 |
| Switching off | 36 |
| Towing the vehicle | 255 |
| Stranded vehicle | 259 |
| Transmission selector lever, manually unlocking | 259 |
| Trailer operation | 198 |
| Trailer towing | 190 |
| Transmission | 165 |
| Transmission control - LOW RANGE mode | 209 |
| Transmission fluid level | 234 |
| Transmission selector lever, manually unlocking | 259 |
| Traveling abroad | 182 |
| Trip computer | 83 |
| Trip odometer | 80 |
| Trunk | 34 |
| Opening | 28 |
| Trunk lamp | 111 |
| Turn signal failure | 91 |
| Turn signal lamp, side | 266 |
| Turn signals | 90 |
| U | |
| Unlocking the vehicle | 27 |
| V | |
| Vanity mirrors | 113 |
| Vehicle jack | 237 |
| Vehicle keys | 24 |
| Vehicle tools | |
| Screwdriver | 237 |
| W | |
| Warranty coverage | 284 |
| Washing the vehicle | 280 |
| What you should know at the gas station | 212 |
| Wheel bolt wrench | 237 |
| Wheels | 240 |
| Changing wheels | 245 |

| | |
|--|-----|
| Light alloy wheels | 281 |
| Rims and tires | 288 |
| Where to find it | 14 |
| Window wiper/washer, rear | 96 |
| Windshield washer/headlamp cleaning system | |
| Refilling | 236 |
| Windshield wiper/washer switch | 95 |
| Winter driving | 181 |
| Winter driving instructions | 180 |
| Wiper blade | |
| Replacing | 275 |

Service and Literature

Your authorized Mercedes-Benz Light Truck Center has trained technicians and original Mercedes-Benz parts to service your vehicle properly. For expert advice and quality service, see your authorized Mercedes-Benz Light Truck Center.

If you are interested in obtaining service literature for your vehicle, please contact your authorized Mercedes-Benz Light Truck Center. We consider this the best way for you to obtain accurate information for your vehicle.

For further information you can find us on the Mercedes-Benz web-sites *www.mbusa.com* and *www.mbusi.com*.

Warning!

To help avoid personal injury, be extremely careful when performing any service work or repairs. Improper or incomplete service or the use of incorrect or inappropriate parts or materials may damage the vehicle or its equipment, which may in turn result in personal injury.

If you have any question about carrying out some service, turn to the advice of an authorized Mercedes-Benz Light Truck Center.

We reserve the right to modify the technical details of the vehicle as given in the data and illustrations of this Operator's Manual. Reprinting, translation and copying, even of excerpts, is not permitted without our prior authorization in writing.

Title illustration no. P00.00-3059-26

Press time 10/31/00

MBNA/TI

Printed in the U.S.A.

Order No. 6515 6246 13 Part No. 163 584 28 83 USA Edition B 2001