



Digital – in the vehicle

Familiarize yourself with the contents of the Operator's Manual directly via the vehicle's multimedia system (menu item "Vehicle information"). Start with the quick guide or broaden your knowledge with practical tips.



Vehicle document wallet

Here you can find comprehensive information about operating your vehicle and about services and guarantees in printed form.



2475844612

Order no. P247 0938 13 Part no. 247 584 46 12
Edition B 2023

GLA

Mercedes-Benz



GLA

Operator's Manual

Mercedes-Benz



Front passenger air bag warning



Air bag warning sticker for USA and Canada

⚠ WARNING Risk of injury or fatal injuries if the front passenger air bag is enabled

If the front passenger air bag is enabled, a child on the front passenger seat may be struck by the front passenger air bag in the event of an accident.

- ▶ NEVER use a rearward-facing child restraint system on a seat with an ENABLED FRONT AIR BAG. This can result in the DEATH of or SERIOUS INJURY to the CHILD.

Observe the chapter "Children in the vehicle".

Publication details

Internet

Further information about Mercedes-Benz vehicles and Mercedes-Benz AG can be found on the following websites:

<https://www.mbusa.com> (USA only)

<https://www.mercedes-benz.ca> (Canada only)

Documentation team

©Mercedes-Benz AG: Not to be reprinted, translated or otherwise reproduced, in whole or in part, without written permission from Mercedes-Benz AG.

Vehicle manufacturer

Mercedes-Benz AG

Mercedesstraße 120

70372 Stuttgart

Germany

Welcome to the world of Mercedes-Benz

Before your first drive, please read this Operator's Manual carefully and familiarize yourself with your vehicle. For your own safety and a longer service life of the vehicle, follow the instructions and warning notices in this Operator's Manual. Disregarding them may lead to damage to the vehicle or injury to people.

Damage to the vehicle resulting from the disregard of the instructions is not covered by the Mercedes-Benz Limited warranty.

The standard equipment and product description of your vehicle may vary and depends on the following factors:

- Model
- Order
- National version
- Availability

Your vehicle may therefore differ from that shown in the descriptions and illustrations in individual cases.

Mercedes-Benz reserves the right to introduce changes in the following areas:

- Design
- Equipment
- Technical features

The following documents are components of the vehicle:

- Digital operator's manual
- Printed Operator's Manual
- Maintenance Booklet
- Supplementary manuals relating to specific equipment
- Supplementary documents

Keep these documents in the vehicle at all times. Ensure that all documents are in the vehicle or passed on in the event of sale or rental.

Mercedes-Benz USA, LLC

Mercedes-Benz Canada, Inc.

A Mercedes-Benz Group AG Company

2475844612



| | | | | | |
|---|----|--|----|--|-----|
| Symbols | 5 | Declaration of conformity for wireless vehicle components | 27 | Safely transporting children in the vehicle | 54 |
| At a glance | 6 | Diagnostics connection | 28 | Brief overview of most important points | 54 |
| Cockpit | 6 | Qualified specialist workshop | 29 | Important safety notes | 55 |
| Indicator and warning lamps (widescreen cockpit) | 10 | Correct use of the vehicle | 29 | Suitable child restraint systems for the transport of children | 60 |
| Indicator and warning lamps (standard) | 12 | Sport Utility Vehicle | 29 | Securing the child restraint system | 60 |
| Overhead control panel | 14 | Notes for persons with electronic medical aids | 30 | Child-proof locks | 66 |
| Door operating unit and seat adjustment | 16 | Problems with your vehicle | 31 | Opening and closing | 69 |
| Emergencies and breakdowns | 18 | Reporting safety defects | 31 | SmartKey | 69 |
| Digital Operator's Manual | 20 | Limited Warranty | 32 | Doors | 73 |
| Calling up the Digital Operator's Manual | 20 | QR code for rescue card | 32 | Cargo compartment | 76 |
| General notes | 22 | Data storage | 32 | Side windows | 82 |
| Protecting the environment | 22 | Copyright | 36 | Sliding sunroof | 85 |
| Mercedes-Benz GenuineParts | 22 | Occupant safety | 38 | Anti-theft protection | 89 |
| Operator's Manual | 23 | Brief overview of the most important points | 38 | Seats and stowing | 92 |
| Mercedes me app | 24 | Information on the automatic functions of the restraint system | 44 | Notes on the correct driver's seat position | 92 |
| Service and vehicle operation | 24 | Purpose and function of the restraint system | 47 | Notes on grab handles | 92 |
| Operating safety | 25 | Seat belts | 53 | Seats | 93 |
| Notes on assembling the license plate on the front license plate holder | 27 | Airbags | 53 | Steering wheel | 104 |
| | | | | Easy entry and exit feature | 106 |
| | | | | Memory function | 107 |
| | | | | Stowage areas | 108 |

Sockets 120
 Wireless charging of the mobile phone
 and connection with the exterior antenna 122
 Installing/removing the floor mats 124

Light and visibility 126
 Exterior lighting 126
 Interior lighting 131
 Windshield wiper and windshield washer
 system 132
 Mirrors 136

Climate control 139
 Overview of climate control systems 139
 Operating the climate control system 139

Driving and parking 143
 Driving 143
 DYNAMIC SELECT switch 155
 Automatic transmission 158
 Function of 4MATIC 162
 Refueling 163
 Parking 165

Driving and driving safety systems 172
 Vehicle towing instructions 224

**Instrument display and on-board com-
 puter 225**
 Notes on the instrument display and on-
 board computer 225
 Overview of instrument display 226
 Overview of buttons on the steering wheel ... 227
 Operating the on-board computer 227
 Overview of displays in the instrument
 display 228
 Head-up Display 229

MBUX multimedia system 232
 Overview and operation 232
 System settings 241
 Navigation 245
 Telephone 254
 Mercedes me app 258
 Mercedes-Benz emergency call system 265
 Radio & media 269
 Sound settings 276

Maintenance and care 277
 ASSYST PLUS service interval display 277
 Maintenance Management 278
 Telediagnosis 278
 Engine compartment 279
 Checking the brake lining thickness 285
 Cleaning and care 286

Breakdown assistance 294
 Emergency 294
 Flat tire 296
 Battery (vehicle) 302
 Tow starting or towing away 306
 Electrical fuses 310

Wheels and tires 314
 Notes on noise or unusual handling char-
 acteristics 314
 Notes on regularly inspecting wheels and
 tires 314
 Notes on snow chains 315
 Tire pressure 315
 Loading the vehicle 322
 Tire labeling 326

4 Contents

| | |
|---|-----|
| Definition of terms for tires and loading | 331 |
| Changing a wheel | 333 |
| Emergency spare wheel | 343 |

| | |
|---|------------|
| Technical data | 346 |
| Notes on technical data | 346 |
| Vehicle electronics | 346 |
| Radio regulations | 348 |
| Vehicle identification plate, VIN and engine number overview | 348 |
| Operating fluids | 349 |
| Vehicle data | 356 |

| | |
|---|------------|
| Display messages and warning/indicator lamps | 358 |
| Display messages | 358 |
| Warning and indicator lamps | 408 |

| | |
|--------------------|------------|
| Index | 424 |
|--------------------|------------|

In this Operator's Manual, you will find the following symbols:

 **WARNING** Danger due to failure to observe the warning notices

Warning notices draw your attention to hazards that may endanger your health or life, or the health or life of others.

 Observe the warning notices.

 **ENVIRONMENTAL NOTE** Environmental damage due to failure to observe environmental notes

Environmental notes include information on environmentally responsible behavior or environmentally responsible disposal.

 Observe environmental notes.

 **NOTE** Damage to property due to failure to observe notes on material damage

Notes on material damage inform you of risks which may lead to your vehicle being damaged.

 Observe notes on material damage.

 These symbols indicate useful instructions or further information that could be helpful to you.

 Instruction

(→ page) Further information on a topic

Display Display field in the Instrument Display/media display







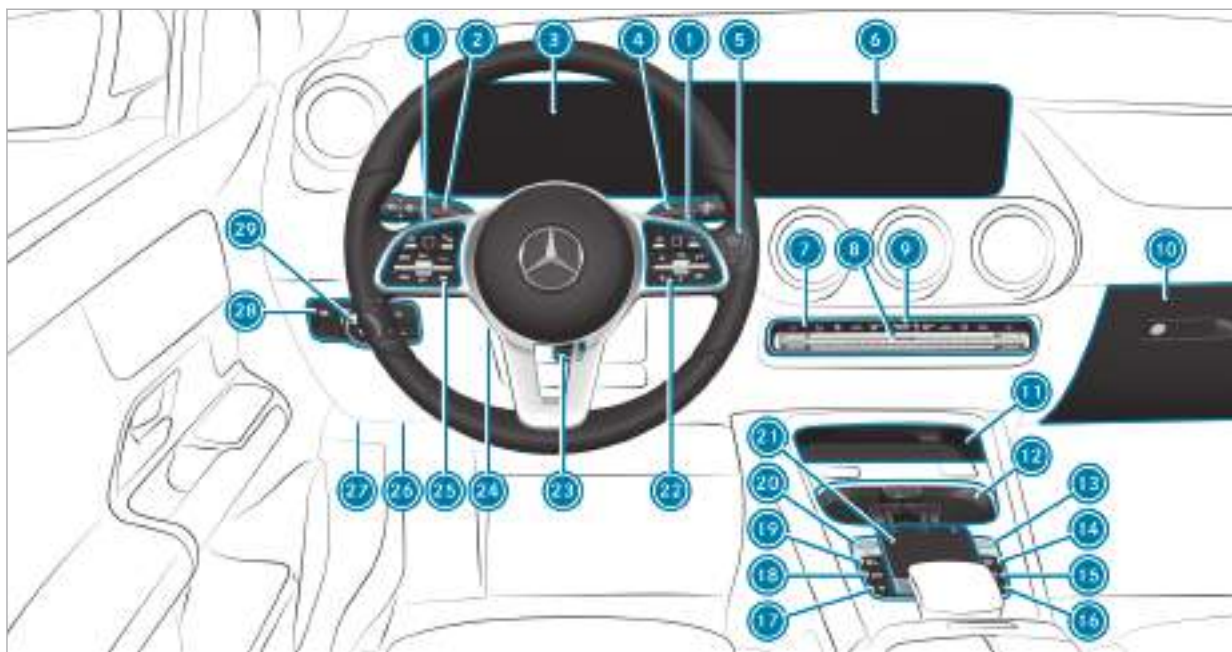





 Highest menu level, which is to be selected in the multimedia system

 Relevant submenus, which are to be selected in the multimedia system

* Indicates a cause



Left-hand drive vehicles

| | | | | | | | |
|---|--|---|-----|---|--|---|-----|
| ① | Steering wheel paddle shifters | → | 160 | ⑭ |  Calls up navigation | → | 234 |
| ② | Combination switch | → | 127 | ⑮ |  Calls up radio or media | → | 234 |
| ③ | Instrument display | → | 226 | ⑯ |  Calls up the telephone | → | 234 |
| ④ | DIRECT SELECT lever | → | 158 | ⑰ |  Calls up favorites | → | 234 |
| ⑤ |  Start/stop button | → | 144 | ⑱ |  Calls up vehicle functions | → | 234 |
| |  ECO start/stop function | → | 154 | ⑲ |  Active Parking Assist | → | 220 |
| ⑥ | Media display | → | 232 | ⑳ | DYNAMIC SELECT switch | → | 156 |
| ⑦ | Climate control systems | → | 139 | ㉑ | Touchpad | → | 234 |
| ⑧ |  Hazard warning light system | → | 128 | ㉒ | Control panel for the MBUX multimedia system | → | 227 |
| ⑨ | PASSENGER AIR BAG indicator lamp | → | 42 | ㉓ | Adjusts the steering wheel | → | 104 |
| ⑩ | Glove box | → | 111 | ㉔ |  Switches the steering wheel heater on/off | → | 105 |
| ⑪ | Storage compartment | → | 111 | ㉕ | Control panel: | | |
| ⑬ |  Controller for volume and switching sound on/off | → | 232 | | On-board computer | → | 227 |
| |  Switches the MBUX multimedia system on/off | → | 232 | | Cruise control | → | 182 |
| | | | | |  Active Distance Assist DISTRONIC | → | 186 |
| | | | | ㉖ | Diagnostics connection | → | 28 |

8 At a glance - Cockpit



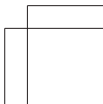
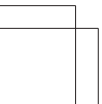
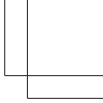
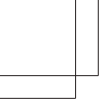



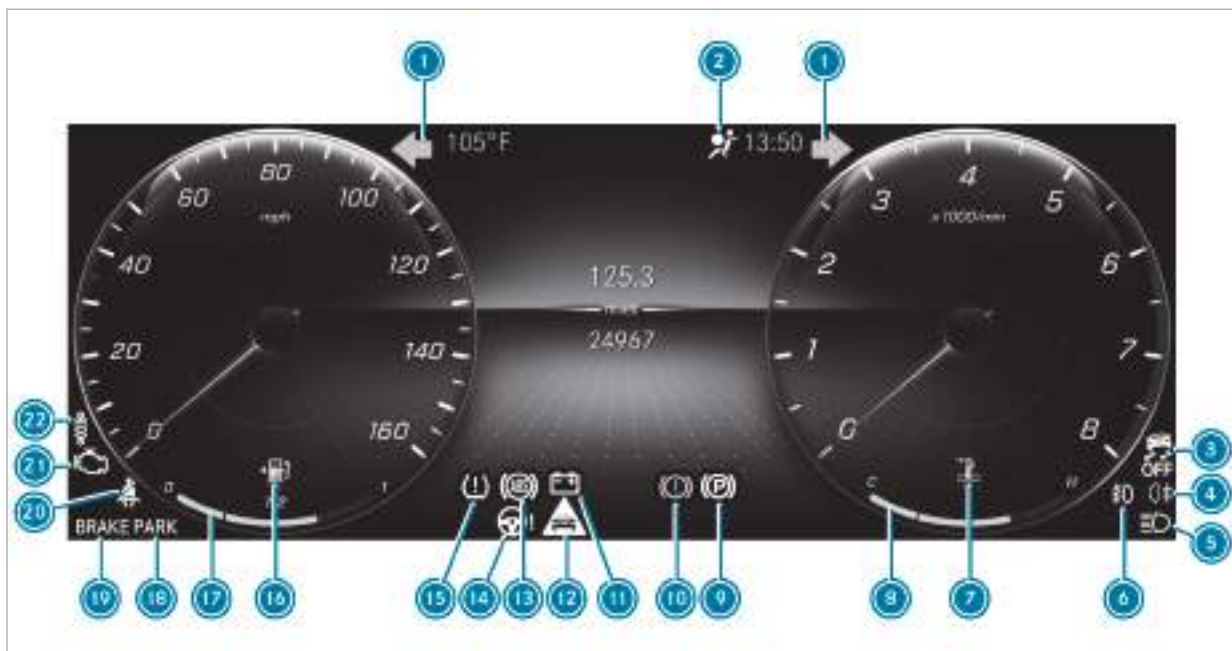

















| | | | |
|----|--|---|-----|
| 27 | Opens the hood | → | 279 |
| 28 |  Electric parking brake | → | 169 |
| 29 | Light switch | → | 126 |



10 At a glance - Indicator and warning lamps (widescreen cockpit)









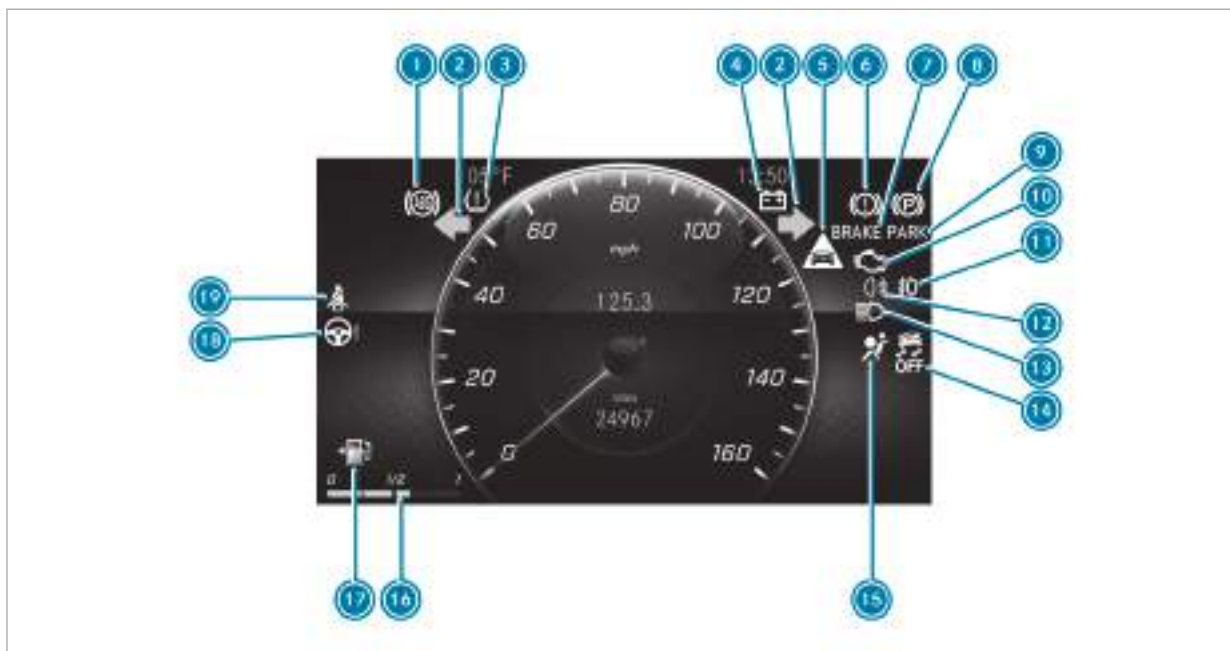















Widescreen cockpit instrument display

| | | | | | | | | | |
|----|---|-------------------------------------|---|-----|----|--|---|---|-----|
| 1 |  | Turn signal lights | → | 127 | 13 |  | ABS | → | 419 |
| 2 |  | Restraint system | → | 410 | 14 |  | Power steering | → | 411 |
| 3 |  | ESP® OFF | → | 419 | 15 |  | Tire pressure monitoring system | → | 422 |
| |  | ESP® | → | 419 | 16 |  | Reserve fuel with fuel filler flap location indicator | → | 412 |
| 4 |  | Rear fog light | → | 127 | 17 | | Fuel level | → | 226 |
| 5 |  | High-beam headlamps | → | 127 | 18 |  | Electric parking brake (red) | → | 416 |
| |  | Low beam | → | 126 | | PARK | USA only | | |
| |  | Standing lights | → | 126 | |  | Canada only | | |
| 6 |  | Front fog lamps | → | 126 | 19 | | Brakes (red) | → | 416 |
| 7 |  | Coolant temperature | | | | BRAKE | USA only | | |
| 8 | | Coolant temperature display | → | 226 | |  | Canada only | | |
| 9 |  | Electric parking brake (yellow) | → | 416 | 20 |  | Seat belt | → | 410 |
| 10 | RBS | Recuperative Brake System, USA only | → | 416 | 21 |  | Engine diagnosis | → | 412 |
| |  | Brakes (yellow), Canada only | → | 416 | 22 |  | Indicator lamp inoperative | | |
| 11 |  | Electrical malfunction | → | 412 | | | | | |
| 12 |  | Distance warning | → | 419 | | | | | |

12 At a glance - Indicator and warning lamps (standard)









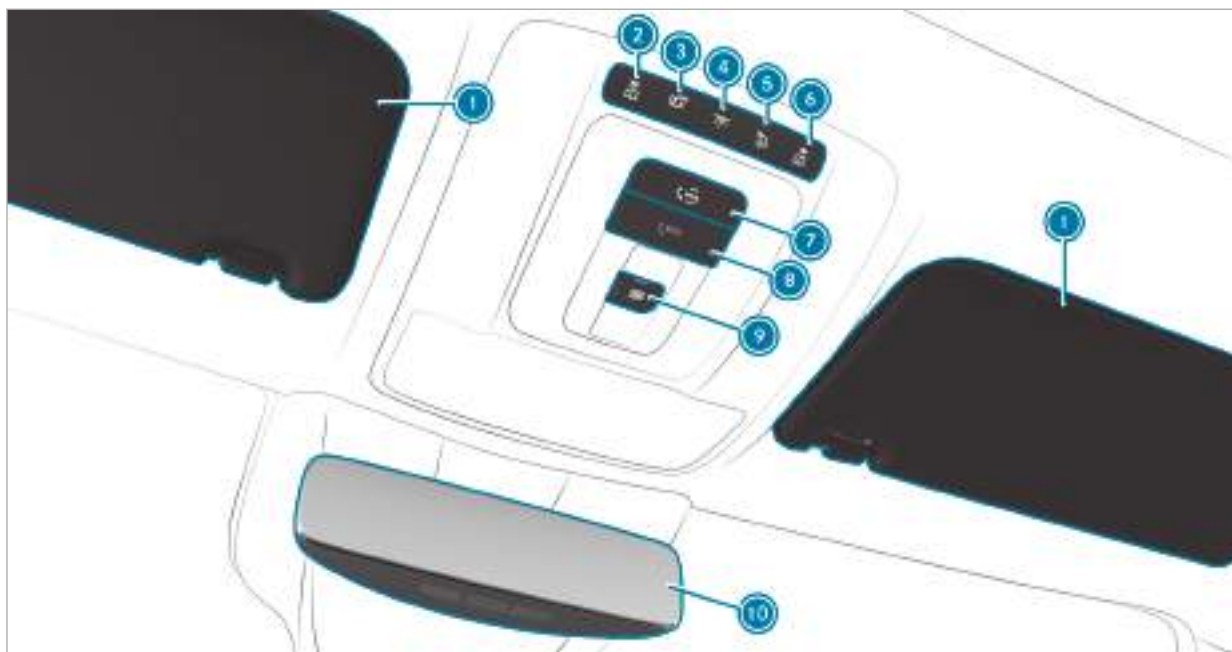

Standard instrument display

| | | | | | | | |
|---|--|---|-----|----|--|---|-----|
| 1 |  ABS | → | 419 | 10 |  Engine diagnosis | → | 412 |
| 2 |   Turn signal lights | → | 127 | 11 |  Front fog lamps | → | 126 |
| 3 |  Tire pressure monitoring system | → | 422 | 12 |  Rear fog light | → | 127 |
| 4 |  Electrical malfunction | → | 412 | 13 |  High-beam headlamps | → | 127 |
| 5 |  Distance warning | → | 419 | |  Low beam | → | 126 |
| 6 | RBS Recuperative Brake System, USA only | → | 416 | |  Standing lights | → | 126 |
| |  Brakes (yellow), Canada only | → | 416 | 14 |  ESP® OFF | → | 419 |
| 7 | Brakes (red) | → | 416 | |  ESP® | → | 419 |
| | BRAKE USA only | | | 15 |  Restraint system | → | 410 |
| |  Canada only | | | 16 | Fuel level | → | 226 |
| 8 |  Electric parking brake (yellow) | → | 416 | 17 |  Reserve fuel with fuel filler flap location indicator | → | 412 |
| 9 | Electric parking brake (red) | → | 416 | 18 |  Power steering | → | 411 |
| | PARK USA only | | | 19 |  Seat belt | → | 410 |
| |  Canada only | | | | | | |









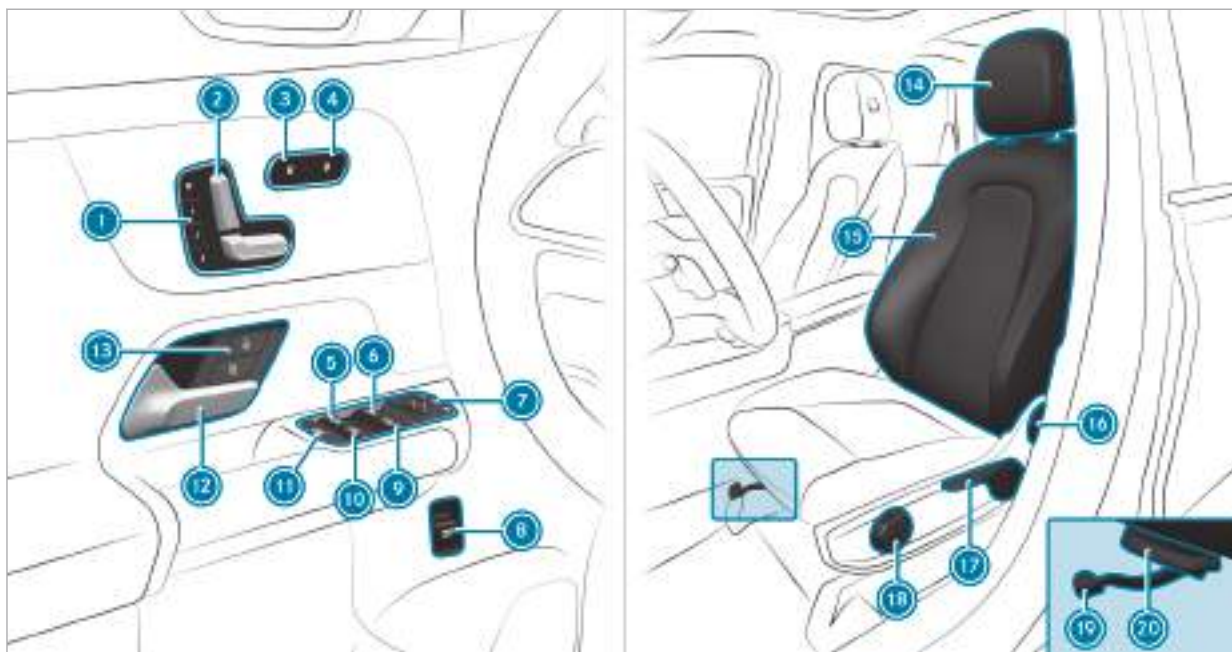

14 At a glance - Overhead control panel







| | | | |
|----|---|---|-----|
| 1 | Sun visors | | |
| 2 |  Switches the left-hand reading lamp on/off | → | 131 |
| 3 |  Switches automatic interior lighting control on/off | → | 131 |
| 4 |  Switches the front interior lighting on/off | → | 131 |
| 5 |  Switches the rear interior lighting on/off | → | 131 |
| 6 |  Switches the right-hand reading lamp on/off | → | 131 |
| 7 |  me button | → | 258 |
| 8 |  SOS button | → | 258 |
| 9 |  Opens/closes the panorama roof with power tilt/sliding panel | → | 85 |
| |  Opens/closes the roller sunblind | → | 85 |
| 10 | Inside rearview mirror | → | 137 |

16 At a glance - Door operating unit and seat adjustment

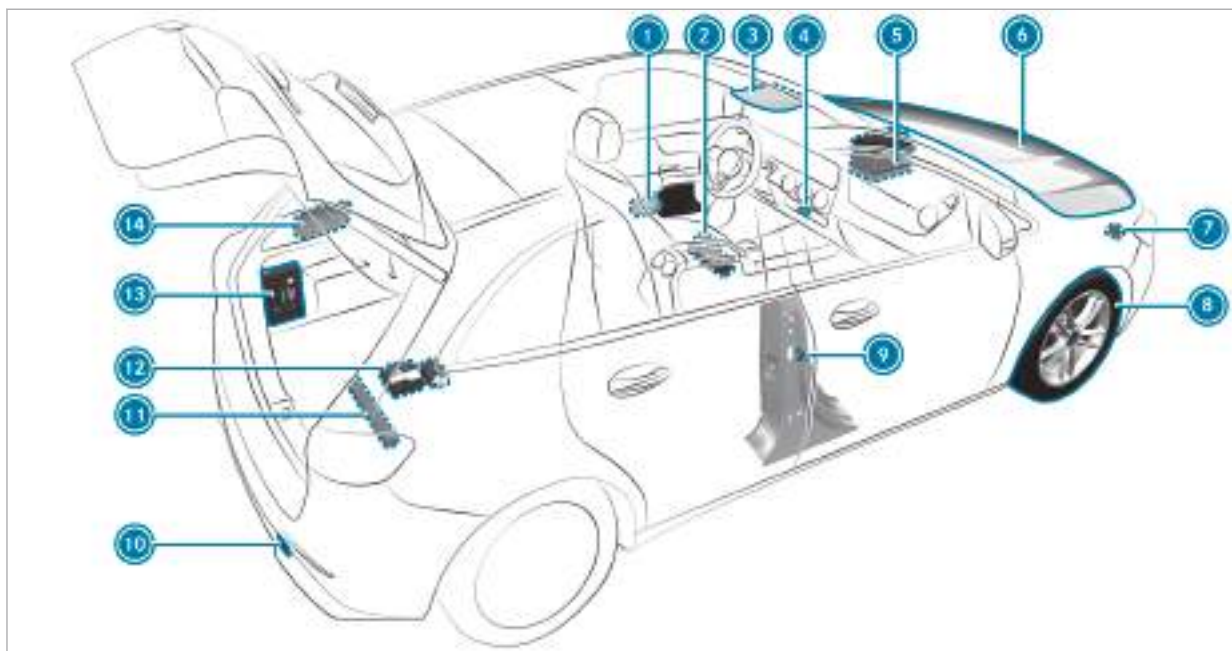

| | | | | | | | |
|---|--|---|-----|---|--|---|-----|
| ① |  Operates the memory function | → | 108 | ⑪ |  Child safety lock for the rear side windows | → | 67 |
| ② | Adjusts the seats electrically | → | 97 | ⑫ | Opens the door | → | 73 |
| ③ |  Switches the seat heating on/off | → | 103 | ⑬ |  Locks/unlocks the vehicle | → | 73 |
| ④ | Mercedes AMG vehicles only:  switches the seat ventilation on/off | → | 104 | ⑭ | Adjusts the head restraints | → | 100 |
| ⑤ |  Opens/closes the rear left side window | → | 82 | ⑮ | Configures the seat settings | → | 102 |
| ⑥ |  Opens/closes the left side window | → | 82 | ⑯ | Adjusts the seat backrest inclination | → | 95 |
| ⑦ |  Operates the outside mirrors | → | 136 | ⑰ | Adjusts the seat height | → | 95 |
| ⑧ |  Opens/closes the tailgate | → | 76 | ⑱ | Adjusts the seat cushion inclination | → | 95 |
| ⑨ |  Opens/closes the right side window | → | 82 | ⑲ | Adjusts the seat fore-and-aft position | → | 95 |
| ⑩ |  Opens/closes the rear right side window | → | 82 | ⑳ | Adjusts the seat cushion length | → | 95 |



| | | | | | | | |
|---|---|---|-----|---|---------------------------------------|---|-----|
| ① | Safety vests | → | 294 | | | | |
| ② | Fire extinguisher | → | 295 | ⑩ | Tow-starting or towing away | → | 307 |
| ③ |  me button | → | 258 | ⑪ | Warning triangle | → | 294 |
| |  SOS button | → | 258 | ⑫ | TIREFIT kit | → | 297 |
| ④ |  Hazard warning light system | → | 128 | ⑬ | First-aid kit (soft sided) | → | 295 |
| ⑤ | Jump-starting | → | 305 | ⑭ | Fuel filler flap with: | | |
| ⑥ | To check and refill operating fluids | → | 349 | | information label on fuel type | → | 163 |
| ⑦ | Tow-starting or towing away | → | 307 | | Information label on tire pressure | → | 317 |
| ⑧ | Flat tire | → | 296 | | QR code for accessing the rescue card | → | 32 |
| ⑨ | B-pillar with: | | | | | | |

Calling up the Digital Operator's Manual

Multimedia system:

→ [Home] ▶▶ Info ▶▶ Operator's Manual
▶▶ [Info]



The Digital Operator's Manual describes the functions and operation of the vehicle and the multimedia system.

▶ Select one of the following menu items in the Digital Operator's Manual:

- **Search:** search for keywords in order to find quick answers to questions about the operation of the vehicle.

- **Quick start:** here is where you find the first steps towards setting up your vehicle.
- **Tips:** find information that prepares you for certain everyday situations with your vehicle.
- **Animations:** watch animations of the vehicle functions.
- **Messages:** receive additional information about the messages on the Instrument Display.
- **Bookmarks:** gain access to your personally saved bookmarks.
- **Language:** select the language for the Digital Operator's Manual.

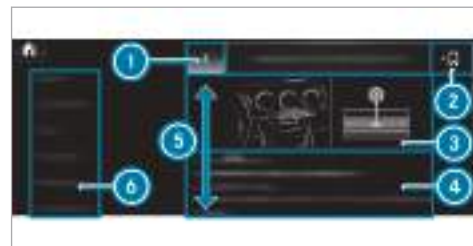

- 1 Back
- 2 Adds bookmarks
- 3 Picture
- 4 Contents section
- 5 Directions of movement of contents section
- 6 Menu

Some sections in the Digital Operator's Manual, such as warning notes, can be expanded and collapsed.

Additional methods of calling up the Digital Operator's Manual:

Direct access: open the required content in the Digital Operator's Manual by pressing and holding an entry on the tab bar in the multimedia system:



Instrument Display: call up brief information as display messages in the instrument cluster

Voice Control System: call up via the voice control system

For safety reasons, the Digital Operator's Manual is deactivated while driving.

Protecting the environment

 **ENVIRONMENTAL NOTE** Environmental damage due to operating conditions and personal driving style

The pollutant emission of the vehicle is directly related to the way you operate the vehicle.

Operate your vehicle in an environmentally responsible manner to help protect the environment. Please observe the following recommendations on operating conditions and personal driving style.

Operating conditions:

- ▶ Make sure that the tire pressure is correct.
- ▶ Do not carry any unnecessary weight (e.g. roof luggage racks once you no longer need them).
- ▶ Adhere to the service intervals. A regularly serviced vehicle will contribute to environmental protection.

- ▶ Always have maintenance work carried out at a qualified specialist workshop.

Personal driving style:

- ▶ Do not depress the accelerator pedal when starting the engine.
- ▶ Do not warm up the vehicle while stationary.
- ▶ Drive carefully and maintain a suitable distance from the vehicle in front.
- ▶ Avoid frequent, sudden acceleration and braking.
- ▶ Change gear in good time and use each gear only up to $\frac{2}{3}$ of its maximum engine speed.
- ▶ Switch off the vehicle in stationary traffic, e.g. by using the ECO start/stop function.
- ▶ Drive in a fuel-efficient manner. Observe the ECO display for an economical driving style.

Environmental issues and recommendations:

It is recommended that you re-use or recycle materials instead of just disposing of them.

The relevant environmental guidelines and regulations serve to protect the environment and must be strictly observed.

Mercedes-Benz GenuineParts

 **ENVIRONMENTAL NOTE** Environmental damage due to not using recycled reconditioned components

Mercedes-Benz AG offers recycled reconditioned components and parts with the same quality as new parts. The same entitlement from the Limited Warranty is valid as for new parts.

- ▶ Use recycled reconditioned components and parts from Mercedes-Benz AG.

! **NOTE** Impairment of the operating efficiency of the restraint systems from installing accessory parts or from repairs or welding

Air bags and Emergency Tensioning Devices, as well as control units and sensors for the restraint systems, may be installed in the following areas of your vehicle:

- doors
- door pillars
- sill
- seats
- cockpit
- instrument display
- center console
- lateral roof frame

- ▶ Do not install accessory parts such as audio systems in these areas.
- ▶ Do not carry out repairs or welding.
- ▶ Have accessories retrofitted at a qualified specialist workshop.

You could jeopardize the operating safety of your vehicle if you use parts, tires and wheels as well as accessories relevant to safety that have not been approved by Mercedes-Benz. Safety-critical systems (e.g. the brake system) may malfunction. Use only Mercedes-Benz GenuineParts or parts of equal quality. Use only tires, wheels and accessory parts that have been specifically approved for your vehicle model.

Mercedes-Benz GenuineParts are subject to strict quality inspections. Each part has been specially developed, manufactured or selected for Mercedes-Benz vehicles and adapted to them. Therefore, only Mercedes-Benz GenuineParts should be used.

More than 300,000 different Mercedes-Benz GenuineParts are available for Mercedes-Benz models.

All authorized Mercedes-Benz Service Centers maintain a supply of Mercedes-Benz GenuineParts for necessary service and repair work. In addition, strategically located parts delivery centers provide for quick and reliable parts service.

Always specify the vehicle identification number (VIN) (→ page 348) when ordering Mercedes-Benz GenuineParts.

Operator's Manual

This Operator's Manual and the Digital Operator's Manual in the vehicle describe the following models and the standard and special equipment for your vehicle:

- The models and the standard and special equipment available at the time of this Operator's Manual going to press.
- The models and the standard and special equipment only available in certain countries.
- The models and the standard and special equipment, which will only be available at a later date.

Note that your vehicle may not have all features described. This is also the case for systems relevant to safety. Therefore, the equipment on your vehicle may differ from that in the descriptions and illustrations.

The original purchase agreement for your vehicle contains a list of the equipment in your vehicle at the time of delivery.

Should you have any questions concerning equipment and operation, please consult an authorized Mercedes-Benz Center.

- ⓘ Please bear in mind that all the speed values stated in this Operator's Manual are approximate and are subject to a certain tolerance.

The Operator's Manual, Supplement, further supplementary documents and Maintenance Booklet are important documents and should be kept in the vehicle.

Mercedes me app

Notes about the on-demand feature

You can also activate various functions (on-demand feature) subsequently via Mercedes me after purchasing your vehicle.

Information is available at any authorized Mercedes-Benz Service Center.

Activating on-demand feature using Mercedes me

Requirements

- The vehicle has a wireless connection.
- The vehicle is linked to the Mercedes me user account.

Ordering and activating on-demand feature

- ▶ Add the desired on-demand feature for the vehicle to the shopping basket in the Mercedes me Store.
- ▶ Complete the order.
The on-demand feature is activated when operating the vehicle.

Speeding up activation

- ▶ Switch the vehicle off and lock it.
- ▶ Unlock the vehicle after about two minutes and switch on the vehicle.
The on-demand feature has been activated. For some features, a notification also appears in the vehicle's multimedia system.

If the activation was not successful, repeat the process.

Service and vehicle operation

Vehicle operation outside the USA or Canada

When you are abroad with your vehicle, observe the following points:

- service points or replacement parts may not be available immediately.
- unleaded fuel may not be available for vehicles with a catalytic converter. Leaded fuel may cause damage to the catalytic converter.
- the fuel may have an extremely low octane number. Unsuitable fuel can cause engine damage.

Some Mercedes-Benz models are available in Europe through our European Delivery Program. For more information, please consult an authorized Mercedes-Benz Service Center, or write to one of the following addresses:

in the USA:

Mercedes-Benz USA, LLC
European Delivery Department
One Mercedes-Benz Drive
Sandy Springs, GA 30328

in Canada:

Mercedes-Benz Canada, Inc.
 European Delivery Department
 98 Vanderhoof Avenue
 Toronto, Ontario M4G 4C9

Maintenance

Your customer advisor confirms the service in the service report.

Roadside Assistance

The Mercedes-Benz Roadside Assistance Program offers technical help in the case of a breakdown. Your calls to the toll-free Roadside Assistance Hotline are answered by our agents 24 hours a day, 365 days a year.

1-800-FOR-MERCEdes (1-800-367-6372) (USA)
 1-800-387-0100 (Canada)

You can find further information in the Mercedes-Benz Roadside Assistance Program brochure (USA) or the "Roadside Assistance" section in the

Service and Warranty booklet (Canada). You will find both in the vehicle document wallet.

Change of address or change of ownership

In the event of a change of address, please send us the "Notification of address change" in the Service and Guarantee booklet or simply call the Mercedes-Benz Customer Assistance Center (USA) on the hotline number 1-800-FOR-MERCEdes (1-800-367-6372) or Customer Service (Canada) on 1-800-387-0100. We can then reach you in a timely fashion, if necessary.

If you sell your Mercedes, please leave all literature in the vehicle so that it is available to the next owner. If you have purchased a used vehicle, please send us the "Notice of Purchase of Used Car" in the Service and Guarantee booklet or simply call the Mercedes-Benz Customer Assistance Center (USA) at the hotline number 1-800-FOR-MERCEdes (1-800-367-6372) or Customer Service (Canada) at 1-800-387-0100.

Possible danger due to substances hazardous to health

In compliance with Proposition 65 ("Prop65"), the following detachable label has been added to each vehicle sold in California:

**Operating safety**

⚠ WARNING Risk of accident due to malfunctions or system failures

If you do not have the prescribed service/maintenance work or any required repairs car-

ried out, this could result in malfunctions or system failures.

- ▶ Always have the prescribed service and maintenance work or any required repairs carried out in a qualified specialist workshop.

⚠ WARNING Risk of accident or injury due to incorrect modifications on electronic component parts

Modification of electronic components, their software or wiring could impair their function and/or the function of other networked component parts or safety-relevant systems.

This can endanger the operating safety of the vehicle.

- ▶ Never tamper with the wiring and electronic component parts or their software.
- ▶ You should have all work on electrical and electronic components carried out at a qualified specialist workshop.

Observe the "On-board electronics" section in "Technical data".

⚠ WARNING Risk of fire caused by flammable material on hot exhaust system components

Flammable material such as leaves, grass or twigs may ignite if they come into contact with hot parts of the exhaust system.

- ▶ When driving on an unpaved road or off-road, check the vehicle underside regularly.
- ▶ In particular, remove trapped plant parts or other flammable material.
- ▶ If there is damage, consult a qualified specialist workshop immediately.

! NOTE Damage to the vehicle due to driving too fast and due to impacts to the vehicle underbody or suspension components

In the following situations, in particular, there is a risk of damage to the vehicle:

- The vehicle becomes grounded, e.g. on a high curb or an unpaved road
- The vehicle is driven too fast over an obstacle, e.g. a curb, speed bump or pothole
- A heavy object strikes the underbody or suspension components

In situations such as these, damage to the body, underbody, suspension components, wheels or tires may not be visible. Components damaged in this way can unexpectedly fail or, in the case of an accident, may no longer absorb the resulting force as intended.

If the underbody paneling is damaged, flammable materials such as leaves, grass or twigs can collect between the underbody and the

underbody paneling. These materials may ignite if they come into contact with hot parts of the exhaust system.

- ▶ Have the vehicle checked and repaired immediately at a qualified specialist workshop.

or

- ▶ If driving safety is impaired while continuing your journey, pull over and stop the vehicle immediately, while paying attention to road and traffic conditions, and contact a qualified specialist workshop.

Notes on assembling the license plate on the front license plate holder

- ! **NOTE** Malfunctions and system failures due to incorrect mounting of the license plate on the front license plate holder

If the license plate is incorrectly mounted on the front license plate holder, sensors, cam-

eras or driving and safety systems may malfunction or fail.

Observe the following points when mounting the license plate on the front license plate holder:

- ▶ Mount the license plate directly on the license plate holder without advertising media or other holders.
- ▶ Mount the license plate so that it does not protrude above or to the side of the license plate adapter.

Declaration of conformity for wireless vehicle components



USA: "Radio based devices of this vehicle comply with Part 15 of the FCC Rules. Operation is subject to the following two conditions: 1) These devices may not cause harmful interference, and 2) These devices must accept any interference

received, including interference that may cause undesired operation. Changes or modifications not expressly approved by the party responsible for compliance could void the user's authority to operate the equipment."

Canada: "This vehicle contains licence-exempt transmitter(s)/receiver(s) that comply with Innovation, Science and Economic Development Canada's licence-exempt RSS(s). Operation is subject to the following two conditions: (1) These devices may not cause interference. (2) These devices must accept any interference, including interference that may cause undesired operation of the devices." "Les émetteurs/récepteurs dans ce véhicule sont conformes aux CNR d'Innovation, Sciences et Développement économique Canada applicables aux appareils radio exempts de licence. L'exploitation est autorisée aux deux conditions suivantes : 1) Ces appareils ne doivent pas produire de brouillage; 2) Ces appareils doivent accepter tout brouillage radioélectrique subi, même si le brouillage est susceptible d'en compromettre le fonctionnement."

Diagnostics connection

The diagnostics connection is a technical interface in the vehicle. It is used, for example, during repair and maintenance work or for reading out vehicle data in a specialist workshop. Diagnostic devices should therefore only be connected in a qualified specialist workshop.

⚠ WARNING Risk of accident due to connecting devices to the diagnostics connection

If you connect devices to the diagnostics connection of the vehicle, the function of vehicle systems and operating safety may be impaired.

- ▶ For safety reasons, we recommend that you use and connect only products approved by an authorized Mercedes-Benz Service Center.

⚠ WARNING Risk of accident due to objects in the driver's footwell

Objects in the driver's footwell may impede pedal travel or block a depressed pedal.

This jeopardizes the operating and road safety of the vehicle.

- ▶ Stow all objects in the vehicle securely so that they cannot get into the driver's footwell.
- ▶ Always install the floor mats securely and as prescribed in order to ensure that there is always sufficient room for the pedals.
- ▶ Do not use loose floor mats and do not place floor mats on top of one another.

! NOTE Battery discharging from using devices connected to the diagnostics connection

Using devices at the diagnostics connection drains the battery.

- ▶ Check the charge level of the battery.

- ▶ If the charge level is low, charge the battery, e.g. by driving a considerable distance.

Please also note the information about the 12 V battery and short-distance trips in the "Driving and Parking" chapter (→ page 147).

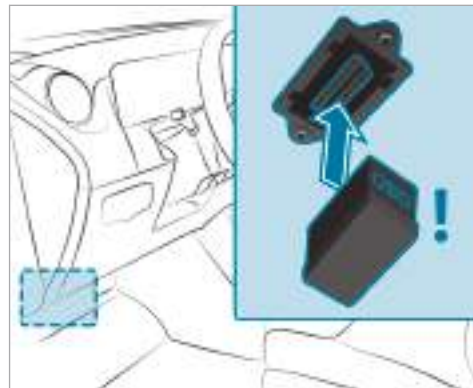

Connecting and using another device with the diagnostics connection can have the following effects:

- Malfunctions in the vehicle system
- Permanent damage to vehicle components

Please refer to the warranty terms and conditions for this matter.

Moreover, connecting equipment to the diagnostics connection can lead to emissions monitoring information being reset, for example. This may lead to the vehicle failing to meet the requirements of the next emissions inspection during the main inspection.

Qualified specialist workshop

An authorized Mercedes-Benz Service Center is a qualified specialist workshop. It has the necessary special skills, tools and qualifications to correctly carry out the work required on your vehicle. This particularly applies to safety-relevant work.

For the following, always have your vehicle checked at an authorized Mercedes-Benz Service Center:

- Safety-relevant work
- Service and maintenance work
- Repair work
- Modifications as well as installations and conversions
- Work on electronic components

Mercedes-Benz recommends a Mercedes-Benz Service Center.

Correct use of the vehicle

If you remove any warning stickers, you or others could fail to recognize certain dangers. Leave warning stickers in position.

Observe the following information in particular when driving your vehicle:

- the safety notes in this Operator's Manual, vehicle-specific supplements and further supplementary documents
- technical data for the vehicle

- traffic rules and -regulations
- laws and safety standards pertaining to motor vehicles

Sport Utility Vehicle

⚠ WARNING Risk of accident when the center of gravity is too high

The vehicle may start to skid and rollover in the event of sudden steering maneuvers and/or when the vehicle's speed is not adapted to the road conditions.

- ▶ Always adapt your speed and driving style to the vehicle's driving characteristics and to the prevailing road and weather conditions.

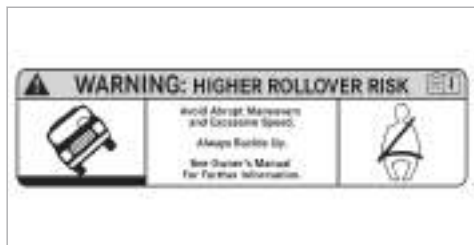

USA



Canada

Utility vehicles have a significantly higher rollover rate than other types of vehicles.

If this type of vehicle is not driven safely, an accident can occur, the vehicle can roll over and occupants can suffer serious or even fatal injuries.

In a rollover crash, an unbelted person is significantly more likely to die than a person wearing a seat belt.

You and all vehicle occupants should always wear your seat belts.

Notes for persons with electronic medical aids

Mercedes-Benz AG cannot, despite carefully developing vehicle systems, completely rule out the interaction of vehicle systems with electronic medical aids such as cardiac pacemakers.

In addition, there are components installed in the vehicle that, regardless of the operating status of the vehicle, can generate magnetic fields on a par with permanent magnets. These fields can be found, for example, in the area around the multimedia and sound system or also in the area of the seats, depending on the vehicle equipment.

For this reason, the following can occur in isolated cases, depending on the aids used:

- Medical aids malfunctioning
- Adverse health effects

Observe the notes and warnings of the manufacturer of the medical aids; if in doubt, contact the device manufacturer and/or your doctor. If there is continuing uncertainty concerning the possibility of medical aids malfunctioning, Mercedes-Benz AG recommends using only few electrical vehicle systems and/or maintaining a distance from the components.

Only have repairs and maintenance work in the area of the following components carried out at a qualified specialist workshop:

- Vehicle components carrying live voltage
- Transmission antenna
- Multimedia system and sound system

If you have any queries or suggestions, consult a qualified specialist workshop.

Problems with your vehicle

If you should experience a problem with your vehicle, particularly one that you believe may affect its safe operation, we urge you to contact an authorized Mercedes-Benz Center immediately to have the problem diagnosed and rectified. If the problem is not resolved to your satisfaction, please discuss the problem again with an authorized Mercedes-Benz Center or, if necessary, contact us at one of the following addresses:

In the USA:

Mercedes-Benz USA, LLC
Customer Assistance Center
One Mercedes-Benz Drive
Sandy Springs, GA 30328

In Canada:

Mercedes-Benz Canada, Inc.
Customer Relations Department
98 Vanderhoof Avenue
Toronto, Ontario M4G 4C9

Reporting safety defects

USA only:

The following text is published as required of manufacturers under Title 49, Code of U.S. Federal Regulations, Part 575 pursuant to the “National Traffic and Motor Vehicle Safety Act of 1966”.

If you believe that your vehicle has a defect which could cause a crash or could cause injury or death, you should immediately inform the National Highway Traffic Safety Administration (NHTSA) in addition to notifying Mercedes-Benz USA, LLC.

If NHTSA receives similar complaints, it may open an investigation, and if it finds that a safety defect exists in a group of vehicles, it may order a recall and remedy campaign. However, NHTSA cannot become involved in individual problems between you, your dealer, or Mercedes-Benz USA, LLC.

To contact NHTSA, you may call the Vehicle Safety Hotline toll-free at 1-888-327-4236 (TTY: 1-800-424-9153) ; go to <https://www.safercar.gov>; or write to: Administrator, NHTSA, 400 Seventh Street, SW., Washington, DC 20590, USA.

You can also obtain other information about motor vehicle safety from <https://www.safercar.gov>.

Canada only:

The following text is published as required of manufacturers under subsection 18.4 (4) of the Motor Vehicle Safety Regulations.

If you believe that your vehicle has a defect which could cause a crash or could cause injury or death, you should immediately inform Transport Canada in addition to notifying Mercedes-Benz Canada Inc.

If Transport Canada received similar complaints, it may open an investigation, and if it finds that a safety defect exists in a group of vehicles, it may order a recall and remedy campaign. However, Transport Canada cannot become involved in individual problems between you, your dealer, or Mercedes-Benz Canada Inc.

To contact Transport Canada, you may call the Defect Investigations and Recalls Division toll-free in Canada at 1-800-333-0510 or 819-994-3328 in the Gatineau-Ottawa area or internationally; may also go to the following websites for more information:

- English: <https://www.tc.gc.ca/recalls>
- French: <https://www.tc.gc.ca/rappels>

Limited Warranty

! **NOTE** Damage to the vehicle arising from violation of these operating instructions.

Damage to the vehicle can arise from violation of these operating instructions.

This damage is not covered either by the Mercedes-Benz implied warranty or by the New- or Used-Vehicle Warranty.

- ▶ Follow the instructions in these operating instructions on proper operation of your vehicle as well as on possible vehicle damage.

QR code for rescue card

QR codes are attached in the fuel filler flap and on the opposite side on the B-pillar. In the event of an accident, rescue services can use the QR code to quickly find the appropriate rescue card for

your vehicle. The current rescue card contains the most important information about your vehicle (e.g. the routing of the electric lines) in compact form.

Further information can be obtained at <https://www.mercedes-benz.de/qr-code>

Data storage

Data processing in the vehicle

Electronic control units

Electronic control units are installed in your vehicle. Control units process data which, for example, they receive from vehicle sensors, generate themselves or exchange between themselves. Some control units are required for the safe operation of your vehicle, some assist you when driving, such as driver assistance systems, while others enable convenience or infotainment functions.

The following provides you with general information regarding data processing in the vehicle. Additional information regarding exactly which data in your vehicle are collected, saved and transmitted to third parties, and for what purpose,

can be found in the information directly related to the functional characteristics in question in their respective operating instructions. This information is also available online and, depending on the vehicle equipment, digitally.

Personal data

Every vehicle is identified by a unique vehicle identification number. Depending on the country, this vehicle identification number can be used by, for example, governmental authorities to determine the identity of the owner. There are other possibilities to use data collected from the vehicle to identify the owner or driver, such as the license plate number.

Therefore, data generated or processed by control units may be attributable to a person or, under certain conditions, become attributable to a person. Depending on which vehicle data are available, it may be possible to make inferences about, for example, your driving behavior, your location, your route or your use patterns.

Legal requirements regarding the disclosure of data

If legally required to do so, manufacturers are, in individual cases, legally obliged to provide governmental entities, upon request and to the extent required, data stored by the manufacturer. For example, this may be the case during the investigation of a criminal offense.

Governmental entities are themselves, in individual cases and within the applicable legal framework, authorized to read out data from the vehicle. In the case of an accident, information that can help with an investigation can, therefore, be taken from the air bag control unit, for example.

Operational data in the vehicle

This is data regarding the operation of the vehicle, which have been processed by control units.

This includes the following data, for example:

- vehicle status information such as the speed, longitudinal acceleration, lateral acceleration, number of wheel revolutions or the fastened seat belts display
- ambient conditions, such as temperature, rain sensor or distance sensor

Generally, the use of these data is temporary; they will not be stored beyond the period of operation and will only be processed within the vehicle itself. Control units often contain data memories for vehicle keys, for example. Their use permits the temporary or permanent documentation of technical information about the vehicle's operating state, component loads, maintenance requirements and technical events or malfunctions.

Depending on the vehicle equipment, the following data are stored:

- operating status of system components, such as fill levels, tire pressure or battery status
- malfunctions or faults in important system components, such as lights or brakes
- system reactions in special driving situations, such as air bag deployment or the intervention of stability control systems
- information on events leading to vehicle damage

In certain cases, it may be required to store data that would have otherwise been used only temporarily. This may be the case if the vehicle has detected a malfunction, for example.

If you use services, such as repair services and maintenance work, stored operational data as well as the vehicle identification number can be read out and used. They can be read out by service network employees, such as workshops and manufacturers or third parties, such as breakdown services. The same is true in the case of warranty claims and quality assurance measures.

In general, the readout is performed via the legally prescribed port for the diagnostics connection in the vehicle. The operational data that are read out document technical states of the vehicle or of individual components and assist in the diagnosis of malfunctions, compliance with warranty obligations and quality improvement. To that end, these data, in particular information about component loads, technical events, malfunctions and other faults may be transmitted along with the vehicle identification number to the manufacturer. Furthermore, the manufacturer is subject to product liability. For this reason the manufacturer also uses operational data from the vehicle, for example, for recalls. These data can also be used to examine the customer's warranty and guarantee claims.

Malfunction memories in the vehicle can be reset by a service outlet or at your request as part of repair or maintenance work.

Convenience and infotainment functions

You can store convenience settings and individual settings in the vehicle and change or reset them at any time.

Depending on the vehicle equipment, this includes the following settings, for example:

- seat and steering wheel positions
- suspension and climate control settings
- individual settings, such as interior lighting

Depending on the selected equipment, you can import data into vehicle infotainment functions yourself.

Depending on the vehicle equipment, this includes the following data, for example:

- multimedia data, such as music, films or photos for playback in an integrated multimedia system

- address book data for use in connection with an integrated hands-free system or an integrated navigation system
- entered navigation destinations
- data about the use of Internet services

These data for convenience and infotainment functions may be saved locally in the vehicle or they may be located on a device which you have connected to the vehicle, such as a smartphone, USB flash drive or MP3 player. If you have entered these data yourself, you can delete them at any time.

This data is transmitted from the vehicle to third parties only at your request. This applies, in particular, when you use online services in accordance with the settings that you have selected.

Smartphone integration (e.g. Android Auto or Apple CarPlay®)

If your vehicle is accordingly equipped, you can connect your smartphone or another mobile end device to the vehicle. You can then control them by means of the control elements integrated in the vehicle. Images and audio from the smart-

phone can be output via the multimedia system. Certain information is simultaneously transferred to your smartphone. Depending on the type and integration, this includes position data, day/night mode and other general vehicle statuses. For more information please consult the Operator's Manual of the vehicle/infotainment system.

This integration allows the use of selected smartphone apps, such as navigation or music player apps. There is no further interaction between the smartphone and the vehicle; in particular, vehicle data is not directly accessible. The type of additional data processing is determined by the provider of the app being used. Which settings you can make, if any, depends on the specific app and the operating system of your smartphone.

Online services

Wireless network connection

If your vehicle has a wireless network connection, it enables data to be exchanged between your vehicle and additional systems. The wireless network connection is made possible by the vehicle's own transmitter and receiver or by a mobile end

device that you have brought into the vehicle, for example, a smartphone. Online functions can be used via the wireless network connection. This includes online services and applications/apps provided to you by the manufacturer or by other providers.

Manufacturer's services

Regarding the manufacturer's online services, the individual functions are described by the manufacturer in a suitable place, for example, in the Operator's Manual or on the manufacturer's website, where the relevant data protection information is also given. Personal data may be used for the provision of online services. Data is exchanged via a secure connection, such as the manufacturer's designated IT systems. Any personal data which is collected, processed and used, other than for the provision of services, is done so exclusively on the basis of legal permission. This is the case, for example, for a legally prescribed emergency call system, a contractual agreement or when consent has been given.

You can have services and functions, some of which are subject to a fee, activated or deactiva-

ted. This excludes legally prescribed functions and services, such as an emergency call system.

Third-party services

If you use online services from other providers (third parties), these services are the responsibility of the provider in question and subject to that provider's data protection conditions and terms of use. As a general rule, the manufacturer has no influence on the content exchanged.

For this reason, when services are provided by third parties, please ask the service provider in question for information about the type, extent and purpose of the collection and use of personal data.

Data protection rights

Depending on your country or the equipment and range of functions of your vehicle as well as the services you use and the services on offer, you are entitled to different data protection rights. Further information on data protection and your data protection rights can either be found on the manufacturer's website or you will receive this information as part of the various services and

service offers. There you will also find the contact information for the manufacturer and its data protection officers.

At a workshop, for example, with the support of a specialist and possibly for a fee, you can have data read out which is stored only locally in the vehicle.

MBUX multimedia system/Mercedes me connect

If the vehicle is equipped with the MBUX multimedia system or Mercedes me connect, additional data about the vehicle's operation, the use of the vehicle in certain situations, and the location of the vehicle may be compiled by the MBUX multimedia system or Mercedes me connect.

For additional information, please refer to the "MBUX multimedia system" section and/or the Mercedes me connect Terms and Conditions.

Event data recorder

USA only:

This vehicle is equipped with an event data recorder (EDR). The main purpose of an EDR is to

record, in certain crash or near crash-like situations, such as an air bag deployment or hitting a road obstacle, data that will assist in understanding how a vehicle's systems performed. The EDR is designed to record data related to vehicle dynamics and safety systems for a short period of time, typically 30 seconds or less.

The EDR in this vehicle is designed to record such data as:

- How various systems in your vehicle were operating;
- Whether or not the driver and passenger safety belts were buckled/fastened;
- How far (if at all) the driver was depressing the accelerator and/or brake pedal; and,
- How fast the vehicle was traveling.

These data can help provide a better understanding of the circumstances in which crashes and injuries occur. NOTE: EDR data are recorded by your vehicle only if a non-trivial crash situation occurs; no data are recorded by the EDR under normal driving conditions and no personal data (e.g., name, gender, age, and crash location) are recorded. However, other parties, such as law

enforcement could combine the EDR data with the type of personally identifying data routinely acquired during a crash investigation.

To read data recorded by an EDR, special equipment is required, and access to the vehicle or the EDR is needed. In addition to the vehicle manufacturer, other parties, such as law enforcement, that have the special equipment, can read the information if they have access to the vehicle or the EDR.

EDR data may be used in civil and criminal matters as a tool in accident reconstruction, accident claims, and vehicle safety. Since the Crash Data Retrieval CDR tool that is used to extract data from the EDR is commercially available, Mercedes-Benz USA, LLC („MBUSA“) expressly disclaims any and all liability arising from the extraction of this information by unauthorized Mercedes-Benz personnel.

MBUSA will not share EDR data with others without the consent of the vehicle owners or, if the vehicle is leased, without the consent of the lessee. Exceptions to this representation include responses to subpoenas by law enforcement; by federal, state or local government; in connection

with or arising out of litigation involving MBUSA or its subsidiaries and affiliates; or, as required by law.

Warning: The EDR is a component of the Restraint System Module. Tampering with, altering, modifying or removing the EDR component may result in a malfunction of the Restraint System Module and other systems.

State laws or regulations regarding EDRs that conflict with federal regulation are pre-empted. This means that in the event of such conflict, the federal regulation governs. As of Dec 2016, 17 states have enacted laws relating to EDRs.

Copyright

Free and open source software

Information on licenses for free and open-source software used in your vehicle can be found on the data carrier in your vehicle document wallet and with updates on the following website:

<https://www.mercedes-benz.com/opensource>



Registered trademarks

- Bluetooth® is a registered trademark of Bluetooth SIG, Inc.
- DTS™ is a registered trademark of DTS, Inc.
- Dolby® and MLP™ are registered trademarks of DOLBY Laboratories.
- ESP® and PRE-SAFE® are registered trademarks of Mercedes-Benz Group AG.
- HomeLink® is a registered trademark of Genex Corporation.
- iPod® and iTunes® are registered trademarks of Apple Inc.
- Burmester® is a registered trademark of Burmester Audiosysteme GmbH.
- Microsoft® and Windows Media® are registered trademarks of Microsoft Corporation.
- SIRIUS® is a registered trademark of Sirius XM Radio Inc.
- HD Radio™ is a registered trademark of iBiquity Digital Corporation.
- Gracenote® is a registered trademark of Gracenote, Inc.
- ZAGAT Survey® and related brands are registered trademarks of Zagat Survey, LLC.

Brief overview of the most important points

Basic information

Make sure that the following prerequisites in particular have been met so that the components of the restraint system are able to provide the intended level of protection:

- Sit correctly (→ page 39).
- Fasten the seat belt correctly (→ page 40).
 - Function of the seat belt warning lamp  (→ page 42).
- The restraint system warning lamp  is not lit up after the self-test (→ page 41).
- The PASSENGER AIR BAG indicator lamps display the correct status of the front passenger air bag (→ page 42).

For clear understanding

The chapter "Occupant safety" includes information on equipment, functions and behaviors that contribute directly to safety of vehicle occupants.

The information is structured as follows:

- **The most important information in brief:** in this chapter, you are provided with an overview of

the relationship between the restraint system and the correct behavior of all vehicle occupants.

- **Specific information:** in further sections of the chapter "Occupant safety", you can find specific information on the equipment and functions of the restraint system.
- **Keyword directory:** you can also find certain subjects in this Operator's Manual using the keyword directory.

Information on the following subjects, among others, are not provided in the chapter "Occupant safety":

- Children in the vehicle (→ page 54)
- Driving and driving safety systems (→ page 172)
- Stowage areas (→ page 108)

Defining generic terms clearly

In this Operator's Manual, the following generic terms are used:

- **Occupant safety:** comprises the components and system functions which help to minimize,

as much as possible, the stresses on and consequences for vehicle occupants during an accident.

- **Restraint system:** comprises those components which, along with the vehicle structure, help prevent vehicle occupants from potentially coming into contact with parts of the vehicle interior. The seat belts and air bags, for example, are components of the restraint system.
- **Child restraint system:** you can find all information on this subject in the chapter "Children in the vehicle" (→ page 54).

Be diligent

For the components of the restraint system to provide the intended level of protection, it is essential that the sitting posture is correct and that the seat belt is correctly fastened.

Note that negligence when adjusting your sitting posture and fastening the seat belt may have serious consequences. Be diligent and make sure that all vehicle occupants are sitting correctly and have fastened their seat belts properly before starting every journey.

Information on the correct seat position

The seat position must be correct in order for the components of the restraint system to provide the intended level of protection.

The seat position influences both the protection provided by the seat belt and the additional protection provided by the air bag.

The correct seat position with an almost upright posture and a correctly fastened seat belt also reduce the risk posed by the air bag when it is deployed.

When choosing the seat, take note of the available space. When you are sitting with the right posture in a nearly upright position, your head should not touch the roof.

▲ WARNING Risk of injury or death due to an incorrect seat position

If you deviate from the correct seat position, the air bag cannot provide its intended protective function.

Each vehicle occupant must make sure of the following.

- ▶ Put the seat in the correct position.
- ▶ Fasten seat belts correctly. Pregnant women must take particular care to ensure that the lap belt never lies across the abdomen.
- ▶ Observe the following information.

In order for the restraint system to provide the intended level of protection, observe the following information:

- Before starting your journey, adjust your seat correctly (→ page 92).
When doing so, make sure you are able to fasten your seat belt correctly. The shoulder belt strap must be routed forward from the seat belt outlet over the center of your shoulder.
- Keep your distance from the air bags, especially the front air bags. Set the driver's seat and front passenger seat as far back as possible while making sure the seat belt is fastened correctly.
- If persons are sitting on the rear seats, vehicle occupants should maintain a sufficient dis-

tance to the parts of the vehicle interior in front of them.

- Make sure there are no people, animals or objects between the vehicle occupants and an air bag.
- If you are the driver, observe the following information on the correct position of the driver's seat (→ page 92).
Hold the steering wheel only by the steering wheel rim. This allows the driver's air bag to fully deploy.
- Assume a nearly upright position, with your buttocks as far back as possible in the gap between the seat cushion and seat backrest.
This ensures that your back lies as flat and firmly as possible against the seat backrest.
- While driving, do not lean forward and do not lean against the door or side window. You may otherwise be in the deployment area of the air bags.
- Sit with your feet resting on the floor, if possible. Your thighs are slightly supported by the seat cushion

Do not put your feet up on the cockpit, for example. Your feet may otherwise be in the deployment area of the air bag.

- Fasten the seat belt correctly.

Notes on wearing the seat belt correctly

Always fasten your seat belt correctly before starting a journey. A seat belt can provide the best level of protection only if it is worn correctly.

⚠ WARNING Risk of injury or death due to incorrectly fastened seat belt

If the seat belt is not worn correctly, it cannot perform its intended protective function.

In addition, an incorrectly fastened seat belt can also cause injuries, for example, in the event of an accident or when braking or changing direction suddenly.

- ▶ Always ensure that all vehicle occupants have their seat belts fastened correctly and are sitting properly.

⚠ WARNING Risk of injury or death when additional restraint systems are not used for persons with a smaller stature

Persons under 5 ft (1.50 m) tall cannot wear the seat belt correctly without a suitable additional restraint system.

- ▶ Always secure persons under 5 ft (1.50 m) tall in a suitable restraint system.

Each vehicle occupant must observe the following notes in particular:

- The seat belt must not be twisted:
- The shoulder belt strap must be routed forward from the seat belt outlet over the center of your shoulder.
- The shoulder belt strap should neither touch your neck nor be routed under your arm or behind your back.
- The lap belt must be routed as low down across the hips as possible.

In addition, push the lap belt down as far as possible across your hips and pull tight with

the shoulder belt strap. Never route the lap belt across your abdomen.

Pregnant women must also take particular care with this.

- The shoulder belt strap and lap belt must fit snugly against the body after being tightened.
 - Avoid wearing bulky clothing, e.g. a winter coat.
 - Never route the seat belt across sharp, pointed, abrasive or fragile objects.
 - Only one person should use each seat belt at any one time.
 - Never secure objects with a seat belt if the seat belt is also being used by one of the vehicle's occupants.
- Also ensure that no objects, e.g. a cushion, are ever placed between a person and the seat.

Fastening seat belts

If the seat belt is pulled quickly or sharply, the seat belt retractor locks. The seat belt strap cannot be pulled out any further.



- ▶ Always engage seat belt tongue ② of the seat belt into seat belt buckle ① of the corresponding seat.

! **NOTE** Deployment of components of the restraint system when the front passenger seat is unoccupied and a seat belt is buckled

When the front passenger seat is unoccupied and the seat belt tongue of the seat belt is engaged in the seat belt buckle, components of the restraint system may deploy unnecessarily on the front passenger side, e.g. the Emergency Tensioning Device.



- ▶ Only buckle the seat belts as intended.

i Observe the information on the child seat safety feature of the seat belt (→ page 62).

Function of the restraint system warning lamp

When the vehicle is switched on, a self-test is performed, during which the restraint system warning lamp  lights up. It goes out no later than a few seconds after the vehicle is started. The components of the restraint system are then functional.

A malfunction has occurred in the restraint system if:

- the restraint system warning lamp  does not light up when the vehicle is switched on
- the restraint system warning lamp  lights up continuously or repeatedly during a journey

If components of the restraint system have been deployed, the restraint system warning lamp  lights up continuously.

! **WARNING** Risk of injury due to malfunctions in the restraint system

Components in the restraint system may be activated unintentionally or not deploy as planned in an accident.

- ▶ Have the restraint system checked and repaired immediately at a qualified specialist workshop.

Mercedes-Benz recommends that you have the vehicle towed to a qualified specialist workshop.

Function of the seat belt warning lamp

The seat belt warning lamp  on the Instrument Display is a reminder that all vehicle occupants must wear their seat belts correctly.

The seat belt warning lamp  lights up for six seconds every time the vehicle is started.

In addition, a warning tone may sound.

When the driver's and front passenger's doors are closed and the driver and front passenger have fastened their seat belts, the seat belt warning goes out.

The seat belt warning will light up during a journey if:

- The vehicle speed exceeds 15 mph (25 km/h) and the driver's or front passenger seat belt is not fastened.
- The driver or front passenger unfastens their seat belt while the vehicle is in motion.

Function of the PASSENGER AIR BAG indicator lamps (front passenger air bag)



The PASSENGER AIR BAG indicator lamps display the status of the front passenger air bag.

If the front passenger seat is occupied or a child restraint system is installed on the front passenger seat, you must make sure both before and also during the journey that the status of the front passenger air bag is correct for the situation.

⚠ WARNING Risk of potentially fatal injuries due to objects trapped under the front passenger seat

Objects trapped under the front passenger seat may interfere with the function of the automatic front passenger air bag shutoff or damage the system.

- ▶ Do not stow any objects under the front passenger seat.
- ▶ When the front passenger seat is occupied, ensure that no objects have become trapped beneath the front passenger seat.

Self-test: when the vehicle is switched on, both the PASSENGER AIR BAG ON and OFF indicator lamps light up simultaneously for several seconds.

After the self-test, you can determine the status of the front passenger air bag as follows:

- **Front passenger air bag disabled:** PASSENGER AIR BAG OFF lights up continuously.
The front passenger air bag will not be deployed in the event of an accident. If

PASSENGER AIR BAG OFF is lit, no one may use the front passenger seat.

If a rearward-facing child restraint system is installed on the front passenger seat, PASSENGER AIR BAG OFF must be lit continuously.

- **Front passenger air bag enabled:** PASSENGER AIR BAG ON lights up for up to 60 seconds or until both the PASSENGER AIR BAG ON and OFF indicator lamps go out.

The front passenger air bag may be deployed during an accident. If the front passenger air bag is in this status, no rearward-facing child restraint system may be installed on the front passenger seat.

- **i** If you are driving with a child in the vehicle, observe the information in the chapter "Children in the vehicle" (→ page 54)

⚠ WARNING Risk of injury or death due to a disabled front passenger airbag

The front passenger airbag is disabled when the PASSENGER AIR BAG OFF indicator lamp is lit.

A person in the front passenger seat could then, for example, come into contact with the vehicle interior, especially if the person is sitting too close to the cockpit.

If the front passenger seat is occupied, always ensure that:

- The classification of the person in the front passenger seat is correct and the front passenger airbag is enabled or disabled in accordance with the person in the front passenger seat.
 - The front passenger seat has been moved as far back as possible.
 - The person is seated correctly.
- ▶ Both before and during the journey, ensure that the status of the front passenger airbag is correct.

Malfunction of the automatic front passenger air bag shutoff

The PASSENGER AIR BAG OFF indicator lamp and the  restraint system indicator lamp light up simultaneously.

In this case, no one may use the front passenger seat and no child restraint system may be installed on the front passenger seat.

Have the automatic front passenger air bag shutoff checked and repaired immediately at a qualified specialist workshop.

Be sure to also observe the following further related subjects:

- Child restraint system on the front passenger seat (→ page 58)

Deactivating or activating the front passenger air bag

The automatic front passenger air bag shutoff can deactivate or activate the front passenger air bag according to the situation.

This happens automatically as a result of the classification of the person or child restraint system on the front passenger seat.

You cannot manually deactivate or activate the front passenger air bag.

Also observe the following information:

- The status of the front passenger air bag, see "Function of the PASSENGER AIR BAG indicator lamps" (→ page 42)
- Notes on using the front passenger seat, see "Information on the automatic front passenger air bag shutoff" (→ page 44)
- If you are driving with a child in the vehicle, observe the chapter "Children in the vehicle" (→ page 54)

Information on the child restraint system

When installing a child restraint system, observe the notes in "Children in the vehicle" (→ page 54).

Notes on the child restraint system on the front passenger seat

⚠ WARNING Risk of injury or fatal injuries if the front passenger air bag is enabled

If the front passenger air bag is enabled, a child on the front passenger seat may be

struck by the front passenger air bag in the event of an accident.

▶ NEVER use a rearward-facing child restraint system on a seat with an ENABLED FRONT AIR BAG. This can result in the DEATH of or SERIOUS INJURY to the CHILD.

Also pay particular attention to the notes on rearward-facing or forward-facing child restraint systems on the front passenger seat (→ page 58).

Information on the automatic functions of the restraint system

Function of the automatic front passenger air bag shutoff

A person on the front passenger seat must observe the following information:

- Sit correctly (→ page 39).
- Fasten the seat belt correctly (→ page 40).

The automatic front passenger air bag shutoff can disable or enable the front passenger air bag according to the situation.

Make sure you observe the following information:

- For the status of the front passenger air bag, see "Function of the PASSENGER AIR BAG indicator lamps" (→ page 42)
- When installing a child restraint system on the front passenger seat, observe the vehicle-specific information (→ page 58).

Status of the front passenger air bag in relation to the stature of the person:

- **Front passenger air bag disabled:** PASSENGER AIR BAG OFF lights up continuously.
The front passenger air bag will not be deployed in the event of an accident. If PASSENGER AIR BAG OFF is lit, no one may use the front passenger seat.
- **Front passenger air bag enabled:** PASSENGER AIR BAG ON lights up for up to 60 seconds or until both the PASSENGER AIR BAG ON and OFF indicator lamps go out.

The front passenger air bag may be deployed during an accident. Observe the following information on the correct seat position (→ page 39).

Vehicles with rear seats: a person of smaller stature should use a rear seat.

System limits

The front passenger air bag may otherwise be disabled by mistake, for example, in the following situation:

- The front passenger transfers their weight by supporting themselves on a vehicle armrest.
- The front passenger sits in such a way that their weight is raised from the seat surface.

! **NOTE** Deployment of components of the restraint system when the front passenger seat is unoccupied

In an accident, the components of the restraint system may deploy unnecessarily on the front passenger side if:

- There are heavy objects on the front passenger seat.
 - The seat belt tongue is engaged in the seat belt buckle of the front passenger seat and the front passenger seat is unoccupied.
- ▶ Store objects in a suitable place.
- ▶ Only one person should use each seat belt at any one time.

Depending on the detected accident situation, the window air bag on the front passenger side may deploy. The air bag is deployed regardless of whether the front passenger seat is occupied.

Function of PRE-SAFE® (anticipatory occupant protection)

PRE-SAFE® is able to detect certain critical driving situations and implement pre-emptive measures to protect the vehicle occupants.

PRE-SAFE® can implement the following measures independently of each other:

- Tightening the seat belts on the driver's seat and front passenger seat.
- Closing the side windows.
- **Vehicles with sliding sunroof:** closing the sliding sunroof.
- **Vehicles with memory function:** moving the front passenger seat to a more favorable seat position.
- **PRE-SAFE® Sound:** provided that the multimedia system is switched on, generating a brief noise signal to stimulate the innate protective mechanism of a person's hearing.

! **NOTE** Damage caused by objects in the footwell or behind the seat

The automatic adjustment of the seat position may result in damage to the seat and/or the object.

- ▶ Stow objects in a suitable place.

Backing up the PRE-SAFE® system measures

If an accident did not occur, the pre-emptive measures that were taken are reversed.

You will need to perform certain settings yourself.

- ▶ If the seat belt pre-tensioning is not reduced, move the seat backrest back slightly. The locking mechanism releases.

Function of PRE-SAFE® PLUS (anticipatory occupant protection plus)

PRE-SAFE® PLUS can detect certain impacts, particularly an imminent rear impact, and take pre-emptive measures to protect the vehicle occu-

pants. These measures cannot necessarily prevent an imminent impact.

PRE-SAFE® PLUS can implement the following measures independently of each other:

- Tightening the seat belts on the driver's seat and front passenger seat.
- Increasing brake pressure when the vehicle is stationary. This brake application is canceled automatically when the vehicle pulls away.

If an accident did not occur, the pre-emptive measures that were taken are reversed.

System limits

The system will not initiate any action in the following situations:

- when backing up

The system will not initiate any braking application in the following situations:

- whilst driving
- or
- when entering or exiting a parking space while using Active Parking Assist

Seat belt adjustment function

Vehicles with PRE-SAFE®: after you have fastened the seat belt of the front seat, it may adjust itself against your body by pulling at the shoulder until somewhat tight. Do not hold the seat belt tightly while it is adjusting.

This function is a reminder that all vehicle occupants must wear their seat belts correctly.

You can activate and deactivate the seat belt adjustment function using the multimedia system (→ page 46).

Activating/deactivating seat belt adjustment via the multimedia system

Multimedia system:

↩️ 🏠 ▶▶ Settings ▶▶ Vehicle

- ▶ Activate or deactivate **Belt Adjustment**.

Overview of the automatic measures after an accident

Depending on the type and severity of the accident, and depending on the vehicle's equipment, the following measures may be implemented, for example:

- automatic braking (post-collision brake)
- activating the hazard warning lamps
- triggering an automatic emergency call (→ page 266)
- switching off the engine

To start the vehicle again, switch the vehicle off and on once more (→ page 144). Depending on the type and severity of the accident, you may no longer be able to start the vehicle.

- switching off the fuel supply
- unlocking the vehicle doors
- lowering the side windows
- displaying the emergency guide on the multimedia system display
- switching on the interior lighting

Function of the post-collision brake after an accident

Depending on the accident situation, the post-collision brake can minimise the severity of a further collision or even avoid it.

If an accident is detected, the post-collision brake can initiate automatic braking. When the vehicle has come to a standstill, the electric parking brake is automatically applied.

The driver can cancel automatic braking by taking the following actions:

- Braking more strongly than automatic braking
- Fully depressing the accelerator pedal with force

Purpose and function of the restraint system

Overview of deployment situations (restraint system)

Make sure that the following prerequisites in particular have been met so that the components of the restraint system are able to provide the intended level of protection:

- Sit correctly (→ page 39).
- Fasten the seat belt correctly (→ page 40).
 - Function of the seat belt warning lamp (→ page 42).
- The  restraint system warning lamp is not lit up after the self-test (→ page 41).
- The PASSENGER AIR BAG indicator lamps display the correct status of the front passenger air bag (→ page 42).

Depending on the detected deployment situation, the components of the restraint system can be activated or deployed independently of each other:

- Emergency Tensioning Device: frontal impact, rear impact, side impact, rollover

- Driver's air bag, front passenger air bag: frontal impact
- Knee bag: frontal impact
- Side impact air bag: side impact
- Window curtain air bag: side impact, rollover, frontal impact

The installation location of an air bag is identified by the AIRBAG symbol (→ page 53).

Observe the information on the function of the restraint system (→ page 48).

Information on how the restraint system works

How the restraint system functions depends on the severity of the impact detected and the apparent type of accident.

For more information about types of accidents, see "Overview of deployment situations" (→ page 47).

The activation thresholds for the components of the restraint system are determined based on the evaluation of the sensor values measured at various points in the vehicle. This process is pre-emp-

tive in nature. The triggering/deployment of the components of the restraint system must take place in good time at the start of the collision.

Factors that can be seen and measured only after a collision has occurred cannot play a decisive role in air bag deployment. Nor do they provide an indication of air bag deployment.

The vehicle may be deformed significantly without an air bag being deployed. This is the case if only parts that are relatively easily deformed are affected and the rate of vehicle deceleration is not high. Conversely, an air bag may be deployed even though the vehicle suffers only minor deformation. If very rigid vehicle parts such as longitudinal members are hit, this may result in sufficiently high levels of vehicle deceleration.

Depending on the apparent type of accident and the detected deployment situation, Emergency Tensioning Devices and/or air bags supplement the protection offered by a correctly worn seat belt.

When enabled, an air bag can provide additional protection for the respective vehicle occupant.

Potential protection provided by each air bag:

- Knee bag: thigh, knee and lower leg
- Driver's air bag, front passenger air bag: head and ribcage
- Window curtain air bag: head
- Side impact air bag: ribcage and pelvis

! NOTE Mercedes-AMG vehicles

- ▶ Observe the notes in the Supplement. You could otherwise fail to recognize dangers.

However, no system available today can completely eliminate injuries and fatalities in every accident situation. In particular, the seat belt and air bag generally do not protect against objects penetrating the vehicle from the outside. It is also not possible to completely rule out the risk of injury caused by the air bag deploying.

Mercedes-Benz recommends that you have the vehicle towed to a qualified specialist workshop after an accident. Take this into account, particularly if a Emergency Tensioning Device is triggered or an air bag deployed.

If the Emergency Tensioning Devices are triggered or an air bag is deployed, you will hear a bang, and a small amount of powder may also be released:

- The bang will not generally affect your hearing.
- In general, the powder released is not hazardous to health but may cause short-term breathing difficulties to persons suffering from asthma or other pulmonary conditions.

Provided it is safe to do so, leave the vehicle immediately or open the window in order to prevent breathing difficulties.

Air bags and pyrotechnic Emergency Tensioning Devices contain perchlorate material, which may require special handling or environmental protection measures. National guidelines regarding waste disposal must be observed. In California, see <https://dtsc.ca.gov/>. Using the search function, you will find information on perchlorate, for example.

Information on the limited protection provided by the restraint system

Risk due to the incorrect behavior of vehicle occupants

Every vehicle occupant must make sure of the following in particular:

- They observe the information on the correct seat position (→ page 39).
- There are no heavy, sharp-edged or fragile objects in the pockets of their clothing. Store such objects in a suitable place.

⚠ WARNING Risk of injury or death due to an incorrect seat position

The seat belt does not offer the intended level of protection if you have not moved the seat backrest to an almost vertical position.

In particular, you could slip beneath the seat-belt and become injured.

- ▶ Adjust the seat properly before beginning your journey.
- ▶ Always ensure that the seat backrest is in an almost vertical position and that

the shoulder belt is routed across the center of your shoulder.

Risk due to objects in the vehicle interior

Every vehicle occupant must make sure of the following in particular:

- They observe the information on the correct seat position (→ page 39).
- There are no objects between the seat, door and door pillar (B-pillar).
- There are no hard objects, e.g. coat hangers, hanging on the grab handles or coat hooks.
- There are no heavy, sharp-edged or fragile objects in the pockets of their clothing. Store such objects in a suitable place.

⚠ WARNING Risk of injury or death due to blocked seat belt buckle or seat belt anchorage

Objects next to the front seat that block the seat belt buckle or the moving seat belt anchorage on the front seat impair the function of the Emergency Tensioning Devices.

- ▶ Before starting the journey, make sure that there are no objects around the seat belt buckle or between the front seat and door.

▲ WARNING Risk of injury from objects in the deployment area of an airbag

Objects in the deployment area of an airbag can hinder or prevent the correct deployment of the airbag.

The airbag may then deploy in an uncontrolled manner and may even cause additional injuries to the vehicle occupants by deploying. This may be the case in particular if the airbag is integrated into the seat.

- ▶ Always stow and secure objects correctly.
- ▶ Before commencing your journey, make sure that no objects are stowed in the deployment area of an airbag.

The installation location of an air bag is identified by the AIRBAG (→ page 53) symbol.

Risk due to installing accessories

Do not attach accessories such as mobile navigation devices, mobile phones or cup holders, within the deployment area of an air bag, e.g. on the cockpit, on the door, on the side window or on the side trim.

In addition, no connecting cables, tensioning straps or retaining straps must be routed or attached to the vehicle within the deployment area of an air bag. Always comply with the accessory manufacturer's installation instructions and, in particular, the notes on suitable places for installation.

▲ WARNING Risk of injury or death due to unsuitable protective covers

Unsuitable protective covers mean that air bags can no longer protect vehicle occupants as they are designed to do.

- ▶ Use only protective covers approved by Mercedes-Benz for the seat in question.

In addition, the function of the automatic passenger air bag deactivation may be restricted by an unsuitable protective cover. If the front

passenger seat is occupied, ensure that the PASSENGER AIR BAG indicator lamps display the correct status of the front passenger air bag (→ page 42).

Risk due to pets in the vehicle interior

▲ WARNING Risk of accident and injury due to animals left unsecured or unattended in the vehicle

If you leave animals in the vehicle unattended or unsecured, they could possibly press buttons or switches.

An animal may:

- Activate vehicle equipment and become trapped, for example
- Switch systems on or off and endanger other road users

Unsecured animals may be thrown around in the vehicle in the event of an accident or sudden steering and braking maneuvers and injure vehicle occupants in the process.

- ▶ Never leave animals in the vehicle unattended.
- ▶ Always correctly secure animals while driving, e.g. using a suitable animal carrier.

Risk due to modification, damage or wear to the components of the restraint system

! NOTE Mercedes-AMG vehicles

- ▶ Observe the notes in the Supplement. You could otherwise fail to recognize dangers.

! WARNING Risk of injury or death due to modifications to the restraint system

Vehicle occupants may no longer be protected as intended if alterations are made to the restraint system.

- ▶ Never alter the parts of the restraint system.

- ▶ Never tamper with the wiring or any electronic component parts or their software.

If it is necessary to modify the vehicle to accommodate a person with disabilities, contact an authorized Mercedes-Benz Center for details.

USA only: for details, contact our Customer Assistance Center on 1-800-FOR-MERCEDES (1-800-367-6372).

! WARNING Risk of injury or death due to damaged or modified seat belts

Seat belts cannot provide protection in the following situations:

- The seat belt is damaged, has been modified, is extremely dirty, bleached or dyed
- The seat belt buckle is damaged or extremely dirty
- Modifications have been made to the Emergency Tensioning Device, seat belt anchorage or seat belt retractor

Seat belts may sustain non-visible damage in an accident, e.g. due to glass splinters.

Modified or damaged seat belts could tear or fail in the event of an accident, for example.

Modified Emergency Tensioning Devices could accidentally trigger or fail to function as intended.

- ▶ Never modify the seat belt system, for example the seat belt, seat belt buckle, Emergency Tensioning Device, seat belt anchorage and seat belt retractor.
- ▶ Make sure that the seat belts are undamaged, not worn and clean.
- ▶ Always have the seat belts checked immediately after an accident at a qualified specialist workshop.

Use only seat belts that have been approved for your vehicle by Mercedes-Benz. The seat is designed for the standard three-point seat belt. If you install a different multipoint seat belt, for example a four-point seat belt, the restraint system cannot provide the intended level of protection.

Depending on the type of vehicle, there may be openings in the seat backrest. These openings have no function.

⚠ WARNING Risk of injury or fatal injury due to modified seat belt systems

If you feed seat belts through the opening in the seat backrest, the seat backrest may be damaged or may even break in the event of an accident.

- ▶ Only use the standard three-point seat belt.
- ▶ Never modify the seat belt system.

⚠ WARNING Risk of injury due to modifications to the cover of an airbag

If you change the cover of an airbag or attach objects, e.g. even stickers, to it, the airbag may no longer function as intended.

- ▶ Never modify the cover of an airbag.
- ▶ Do not attach any objects to the cover.

The installation location of an air bag is identified by the air bag symbol (→ page 53).

⚠ WARNING Risk of injury due to malfunctioning sensors in the door

The function of the airbags can be impaired due to modifications or incorrect work performed on the doors or door trim, or if the doors are damaged.

- ▶ Never modify the doors or parts of the doors.
- ▶ Always have work on the doors or door trim carried out at a qualified specialist workshop.

Risk due to components of the restraint system that have already been deployed

Mercedes-Benz recommends that you have the vehicle towed to a qualified specialist workshop after an accident.

⚠ WARNING Risk of burns from hot air bag components

The air bag parts are hot after an air bag has been deployed.

- ▶ Do not touch the air bag parts.
- ▶ Have a deployed air bag replaced at a qualified specialist workshop as soon as possible.

⚠ WARNING Risk of injury due to deployed airbag

A deployed airbag no longer offers any protection.

- ▶ Have the vehicle towed to a qualified specialist workshop in order to have the deployed airbag replaced.

Have deployed air bags replaced immediately.

⚠ WARNING Risk of injury or death from deployed pyrotechnic Emergency Tensioning Devices

Pyrotechnic Emergency Tensioning Devices that have been deployed are no longer operational and are unable to perform their intended protective function.

- ▶ Therefore, have deployed pyrotechnic Emergency Tensioning Devices immediately replaced at a qualified specialist workshop.

Seat belts

Releasing seat belts

- ▶ Press the release button in the seat belt buckle and guide the seat belt back with the seat belt tongue.

! NOTE Damage caused by trapping the seat belt

If an unused seat belt is not fully retracted, it may become trapped in the door or in the seat mechanism.

- ▶ Always ensure that an unused seat belt is fully retracted.

Airbags

Overview of air bags

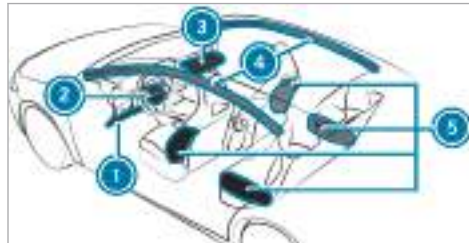

- ① Knee bag
- ② Driver's air bag

- ③ Front passenger air bag
- ④ Window curtain air bag
- ⑤ Side impact air bag

The installation location of an air bag is identified by the AIRBAG symbol.

Observe the information under "Overview of deployment situations" (→ page 47).

Brief overview of most important points

Safely transporting children in the vehicle

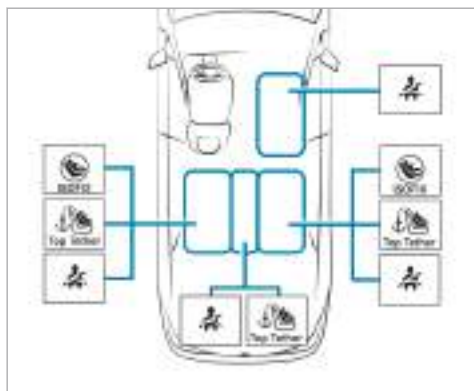

Always observe the following when transporting children:

- Never leave children unattended in the vehicle (→ page 56).

- Secure children up to a height of (1.50 m) on the respective seat (see illustration above) properly with a suitable and approved child restraint system, and secure small children in a rearward-facing child restraint system.
- Observe the child restraint system manufacturer's installation instructions.

Left/right rear seat (preferred seats)



Preferred securing system:

-  ISOFIX mounting bracket

and

-  Also secure Top Tether if present (→ page 64).

Alternative securing system:

-  Vehicle seat belt
-  Additionally attach Top Tether if recommended by the manufacturer of the child restraint system (→ page 64).

Front passenger seat

Securing system:

-  Vehicle seat belt



Be sure to observe:

- If the front passenger seat is occupied, ensure that the status of the front passenger air bag is correct for the current situation (→ page 42).

(* rearward-facing child restraint system only in combination with automatic air bag shutoff)

Center rear seat

Securing system:

-  Vehicle seat belt
-  Additionally attach Top Tether if recommended by the manufacturer of the child restraint system (→ page 64).

Important safety notes

Basic information

Be diligent

Bear in mind that negligence when securing a child in the child restraint system may have serious consequences. Always be diligent in securing a child carefully before every journey.

Never allow babies and children to travel sitting on the lap of another vehicle occupant.

To improve protection for children younger than 12 years old or under 5 ft (1.50 m) in height, Mercedes-Benz recommends you observe the following information:

- Always secure the child in a child restraint system suitable for this Mercedes-Benz vehicle.
- The child restraint system must be appropriate to the age, weight and size of the child.
- The vehicle seat must be suitable for the child restraint system to be installed:

Accident statistics show that children secured on the rear seats are generally safer than children secured on the front seats. For this reason,

Mercedes-Benz strongly advises that you install a child restraint system on a rear seat.

The generic term child restraint system

The generic term child restraint system is used in this Operator's Manual. A child restraint system is, for example:

- a baby car seat
- a rearward-facing child seat
- a forward-facing child seat
- a child booster seat – Mercedes-Benz recommends using a child booster seat **with** a backrest and seat belt guide.

Observe laws and legal requirements

Always observe the legal requirements when using a child restraint system in the vehicle.

Securing systems for child restraint systems in the vehicle

Use only the following securing systems for child restraint systems:

- the ISOFIX mounting brackets
- the vehicle's seat belt system

- the Top Tether anchorages

Simply attaching to the ISOFIX mounting brackets on the vehicle can reduce the risk of installing the child restraint system incorrectly.

When securing a child with the integrated seat belt of the ISOFIX child restraint system, always comply with the permissible gross weight for the child and child restraint system (→ page 63).

A child booster seat may be necessary to achieve proper seat belt positioning for children over 40 lbs (18 kg) in weight or until they reach a height where a three-point seat belt can be installed properly without a child booster seat.

Mercedes-Benz recommends a suitable child booster seat with a backrest and seat belt guide.

Observe standards for child restraint systems

All child restraint systems must meet the following standards:

- U.S. Federal Motor Vehicle Safety Standards 213
- Canadian Motor Vehicle Safety Standards 213

Confirmation that the child restraint system complies with the standards can be found on an instruction label on the child restraint system. This confirmation can also be found in the installation instructions that are included with the child restraint system.

Important warning notices

Always secure a child restraint system correctly

⚠ WARNING Risk of injury or death due to incorrect installation of the child restraint system

The child can then not be protected or restrained as intended.

- ▶ Be sure to comply with the manufacturer's installation instructions for the child restraint system and its correct use.
- ▶ Make sure that the entire base of the child restraint system always rests on the sitting surface of the seat.

- ▶ Never place objects (e.g. cushions) under or behind the child restraint system.
- ▶ Use child restraint systems only with the original cover designed for them.
- ▶ Always replace damaged covers with genuine covers.

- Always observe the vehicle-specific information.
 - Installing the ISOFIX child restraint system on the right and left rear seats (→ page 63).
 - Securing the child restraint system with the seat belt (→ page 65).
- Observe the warning labels in the vehicle interior and on the child restraint system.

⚠ WARNING Risk of injury or death due to unsecured child restraint systems in the vehicle

If the child restraint system is incorrectly mounted or unsecured, it may come loose.

The child can then not be protected or restrained as intended.

Unused child restraint systems could be flung around and hit vehicle occupants.

- ▶ Always comply with the manufacturer's installation instructions for the child restraint system and its correct use.
- ▶ Always fit child restraint systems correctly, even if they are transported in the vehicle unused.

Do not modify the child restraint system

⚠ WARNING Risk of injury due to modifications to the child restraint system

The child restraint system can no longer function properly. This poses an increased risk of injury.

- ▶ Never modify a child restraint system.
- ▶ Only affix accessories which have been specially approved for this child restraint system by the child restraint system's manufacturer.

Use only child restraint systems that are in proper working condition

⚠ WARNING Risk of injury or death caused by the use of damaged child restraint systems

Child restraint systems or their retaining systems that have been subjected to stress in an accident may not be able to perform their intended protective function.

It may be the case that the child cannot be properly restrained.

- ▶ Always immediately replace child restraint systems that have been damaged or involved in an accident.
- ▶ Have the securing systems for the child restraint systems checked at a qualified specialist workshop before installing a child restraint system again.

Avoid direct sunlight

⚠ WARNING Risk of burns when the child seat is exposed to direct sunlight

If the child restraint system is exposed to direct sunlight or heat, parts could heat up excessively.

Children could suffer burns from these parts, particularly the metallic parts of the child restraint system.

- ▶ Always make sure that the child restraint system is not exposed to direct sunlight.
- ▶ Cover the child restraint system with a blanket, for example.
- ▶ If the child restraint system has been exposed to direct sunlight, allow it to cool before securing a child into it.
- ▶ Never leave children unattended in the vehicle.

Observe when stopping or parking

⚠ WARNING Risk of fatal injury due to exposure to extreme heat or cold in the vehicle

If persons, particularly children, are subjected to prolonged exposure to intense heat or cold, there is a risk of severe injury or even death.

- ▶ Never leave persons, particularly children, unattended in the vehicle.

⚠ WARNING Risk of accident and injury due to children left unattended in the vehicle

If you leave children unattended in the vehicle, they could, in particular:

- open doors, thereby endangering other persons or road users.
- get out and be struck by oncoming traffic.
- operate vehicle equipment and become trapped, for example.

In addition, the children could also set the vehicle in motion by, for example:

- releasing the parking brake.
 - changing the gearbox position.
 - starting the vehicle.
- ▶ Never leave children unattended in the vehicle.
 - ▶ When leaving the vehicle, always take the key with you and lock the vehicle.
 - ▶ Keep the key out of reach of children.

Notes on rearward-facing and forward-facing child restraint systems on the front passenger seat

▲ WARNING Risk of injury or fatal injury when using a rearward-facing child restraint system while the co-driver airbag is enabled

If you secure a child in a rearward-facing child restraint system on the co-driver seat and the PASSENGER AIR BAG OFF indicator lamp is

off, the co-driver airbag can deploy in the event of an accident.

The child could be struck by the airbag.

- ▶ Always ensure that the co-driver airbag is disabled. The PASSENGER AIR BAG OFF indicator lamp must be lit.
- ▶ NEVER use a rearward-facing child restraint system on a seat with an ENABLED FRONT AIRBAG; DEATH or SERIOUS INJURY to the CHILD can occur.

Observe the specific instructions for the rearward-facing and forward-facing child restraint systems (→ page 60).

If it is absolutely necessary to install a child restraint system on the front passenger seat, always observe the additional notes.

- When using a rearward-facing child restraint system on the front passenger seat, the front passenger air bag must always be disabled. This is the case only if the PASSENGER AIR BAG OFF indicator lamp is lit continuously (→ page 42).

- The front passenger air bag is enabled when the PASSENGER AIR BAG OFF indicator lamp is not lit. The front passenger air bag may be deployed during an accident. In that case, do not use rearward-facing child restraint systems.

Information on the automatic front passenger air bag shutoff

If the front passenger seat is occupied, ensure, both before and during the journey, that the status of the front passenger air bag is correct for the current situation.

▲ WARNING Risk of injury or death due to objects between the seat surface and the child restraint system

Objects between the seat surface and the child restraint system can interfere with the function of the automatic front passenger air bag shutoff.

- ▶ Do not place any objects between the seat surface and the child restraint system.
- ▶ Make sure that the entire base of the child restraint system rests on the seat cushion of the front passenger seat.
- ▶ The backrest of a forward-facing child restraint system must, as far as possible, be resting against the seat backrest of the front passenger seat.
- ▶ Always comply with the installation instructions from the child restraint system manufacturer.

When installing a child restraint system on the front passenger seat, observe the vehicle-specific information (→ page 58).

Rearward-facing child restraint system on the front passenger seat

If a rearward-facing child restraint system is installed on the front passenger seat, the front passenger air bag must be disabled. The PASSENGER AIR BAG OFF indicator lamp must be continuously lit (→ page 42).

⚠ WARNING Risk of injury or fatal injury when using a rearward-facing child restraint system while the co-driver airbag is enabled

If you secure a child in a rearward-facing child restraint system on the co-driver seat and the PASSENGER AIR BAG OFF indicator lamp is off, the co-driver airbag can deploy in the event of an accident.

The child could be struck by the airbag.

- ▶ Always ensure that the co-driver airbag is disabled. The PASSENGER AIR BAG OFF indicator lamp must be lit.
- ▶ NEVER use a rearward-facing child restraint system on a seat with an ENABLED FRONT AIRBAG; DEATH or SERIOUS INJURY to the CHILD can occur.

- ⓘ Depending on the child restraint system and the stature of the child, the front passenger air bag is enabled. The PASSENGER AIR BAG OFF indicator lamp does not light up. The front passenger air bag may be deployed during an accident. If the front passenger air

bag is in this status, no rearward-facing child restraint system may be installed on the front passenger seat. Instead, install the rearward-facing child restraint system on a suitable rear seat.

Forward-facing child restraint system on the front passenger seat

If a forward-facing child restraint system is installed on the front passenger seat, the front passenger air bag may be automatically enabled or disabled. The status of the front passenger air bag depends on the child restraint system and the stature of the child.

The PASSENGER AIR BAG OFF indicator lamp either lights up continuously or does not light up (→ page 42). Always observe the following information.

⚠ WARNING Risk of injury or death caused by incorrect positioning of the child restraint system

If you secure a child in a forward-facing child restraint system on the front passenger seat and you position the front passenger seat too close to the cockpit, in the event of an accident, the child could:

- Come into contact with the vehicle interior if the PASSENGER AIR BAG OFF indicator lamp is lit, for example.
 - Be struck by the air bag if the PASSENGER AIR BAG OFF indicator lamp is off.
- ▶ Always move the front-passenger seat as far back as possible. Always make sure that the shoulder belt strap is correctly routed from the seat belt outlet of the vehicle to the shoulder belt guide on the child restraint system. The shoulder belt strap must be routed forwards and downwards from the seat belt outlet. If necessary, adjust the front-passenger seat accordingly.

▶ Always comply with the child restraint system manufacturer's installation instructions.

Be sure to also observe the following further related subjects:

- Function of the automatic front passenger air bag shutoff (→ page 42)

Suitable child restraint systems for the transport of children

Information on the advantage of a rearward-facing child restraint system

Transport a baby in a suitable rearward-facing child restraint system only. It is also preferable to transport a small child in a suitable rearward-facing child restraint system. In this case, the child sits in the opposite direction to the direction of travel and faces backwards.

Babies and small children have comparatively weak neck muscles in relation to the size and weight of their head. The risk of injury to the cer-

vical spine during an accident can be reduced in a rearward-facing child restraint system.

Securing the child restraint system

Adjusting the seat correctly

When installing a child restraint system on the left or right rear seat, always observe the following:

- ▶ Make sure that the child's feet do not touch the front seat. If necessary, move the front seat slightly forwards.

If the head restraint of the child restraint system cannot be fully extended when it is installed in the vehicle, this will result in restrictions on the maximum size setting for certain child restraint systems. Observe the child restraint system manufacturer's installation instructions.

- ⓘ Contact with the roof when the head restraint is fully extended and locked in place will not result in any restrictions on use.

 **When installing an ISOFIX child restraint system, also observe the following:**

- ▶ **When using a rearward-facing child restraint system on a rear seat:** adjust the front seat so that it does not touch the child restraint system.
- ▶ **When using a forward-facing child restraint system with integrated child seat belt:** adjust the head restraint of the respective seat so that it does not push the child restraint system forwards. If necessary, the respective head restraint can be removed. In addition, the backrest of the child restraint system must lie as flat as possible against the backrest of the vehicle seat. After the child restraint system has been removed, replace the vehicle head restraint immediately and adjust correctly.
- ▶ The child restraint system must not be put under strain between the roof and the seat cushion and/or be installed facing the wrong direction. Where possible, adjust the seat cushion inclination accordingly.

- ▶ Adjust the vehicle head restraints so that the child restraint system is not put under strain by the head restraint.

 **When installing a belt-secured child restraint system, also observe the following:**

- ▶ **When using a rearward-facing child restraint system on a rear seat:** adjust the front seat so that it does not touch the child restraint system.
- ▶ Also secure Top Tether if available (→ page 64)
- ▶ **When using a forward-facing child restraint system with integrated child seat belt:** adjust the head restraint of the respective seat so that it does not push the child restraint system forwards. If necessary, the respective head restraint can be removed. In addition, the backrest of the child restraint system must lie as flat as possible against the backrest of the vehicle seat. After the child restraint system has been removed, replace the vehicle head restraint immediately and adjust correctly.

- ▶ The backrest of the forward-facing child restraint system must, as far as possible, be resting on the seat backrest of the rear seat.
- ▶ The child restraint system must not be put under strain between the roof and the seat cushion and/or be installed facing the wrong direction. Where possible, adjust the seat cushion inclination accordingly.
- ▶ Adjust the vehicle head restraints so that the child restraint system is not put under strain by the head restraint.
- ▶ Make sure that the child's feet do not touch the front seat. If necessary, move the front seat slightly forwards.

 **Depending on the vehicle equipment, always observe the following when installing a belt-secured child restraint system on the front passenger seat:**

- ▶ Observe the notes on rearward-facing and forward-facing child restraint systems on the front passenger seat (→ page 58).
- ▶ **When using a forward-facing child restraint system integrated child seat belt:** remove the

head restraint from the respective seat, if possible. After the child restraint system has been removed, immediately replace the head restraint and adjust correctly.

- ▶ The backrest of the forward-facing child restraint system must, as far as possible, be resting on the seat backrest of the front passenger seat.
- ▶ The child restraint system must not be put under strain between the roof and the seat cushion and/or be installed facing the wrong direction.
- ▶ Adjust the vehicle head restraints so that the child restraint system is not put under strain by the head restraint.
- ▶ Never place objects (e.g. cushions) under or behind the child restraint system.
- ▶ Set the front passenger seat as far back as possible and move the seat into the highest possible position. Always make sure that the shoulder belt strap is correctly routed from the seat belt outlet of the vehicle to the shoulder belt guide on the child restraint system. The shoulder belt strap must be routed for-

wards from the seat belt outlet and, where possible, downwards to the child restraint system.

- ▶ Fully retract the seat cushion length adjustment.
- ▶ Adjust the seat cushion inclination so that the front edge of the seat cushion is in the highest position and the rear edge of the seat cushion is in the lowest position.
- ▶ Set the seat backrest to the most vertical position possible.

Activating or deactivating the special seat belt retractor of the seat belt

⚠ WARNING Risk of injury or death if a seat belt is unfastened while the vehicle is in motion

If the seat belt is released while the vehicle is in motion, the special seat belt retractor is deactivated and the child restraint system is no longer correctly secured. The seat belt is drawn in slightly by the inertia reel and cannot be immediately closed again.

- ▶ Stop the vehicle immediately in accordance with the traffic conditions.
- ▶ Activate the special seat belt retractor again and correctly secure the child restraint system.

When enabled, the special seat belt retractor ensures that the seat belts of the front passenger seat and rear seats do not slacken once the child restraint system is secured.

The seat belts on the following seats are equipped with a special seat belt retractor:

- Front passenger seat
- Rear seats

Installing a child restraint system

- ▶ When installing a child restraint system, always observe the manufacturer's installation and operating instructions as well as the information in this Operator's Manual.
- ▶ Pull the seat belt smoothly from the seat belt outlet.
- ▶ Engage the seat belt tongue in the seat belt buckle.

Activating the special seat belt retractor

- ▶ Pull the seat belt out fully and let the inertia reel retract it again. When the special seat belt retractor is activated, you will hear a ratcheting sound.
- ▶ Push the child restraint system down until the seat belt sits tightly.

Deactivating the special seat belt retractor

- ▶ Press the release button of the seat belt buckle.
- ▶ Hold the seat belt tongue and guide back to the seat belt outlet.

Installing an ISOFIX child restraint system

⚠ WARNING Risk of accident if the rear bench seat, rear seat and seat backrest are not engaged

The rear bench seat, rear seat and seat backrest may fold forwards, even when you are driving.

- As a result, the vehicle occupant will be pushed into the seat belt with increased force. The seat belt will not be able to protect as intended and could cause additional injury.
- Objects or loads in the trunk or cargo compartment will not be restrained by the seat backrest.
- ▶ Make sure that the rear bench seat, the rear seat and the seat backrest are engaged before every trip.

If the rear seat backrest is not engaged and locked in place, the red lock verification indicator will be visible.

⚠ WARNING Risk of injury or death if the permissible gross mass of the child and child restraint system together is exceeded.

Too much load may be placed on the LATCH-type (ISOFIX) or iSize child restraint systems and the child may not be restrained correctly in the event of an accident, for example.

- ▶ If the child is secured in a LATCH-type (ISOFIX) child restraint system with integrated seat belt, the total mass of the child and child restraint system must not exceed 73 lb (33 kg).

Always comply with the information about the mass of the child:

- in the manufacturer's installation and operating instructions for the child restraint system used
- on a label on the child restraint system, if present

Regularly check that the permissible gross mass of the child and child restraint system is still complied with.

When installing a child restraint system, observe the following:

- ✓ Always observe the correct use of the seats and consider their suitability for attaching a child restraint system.
ISOFIX mounting brackets

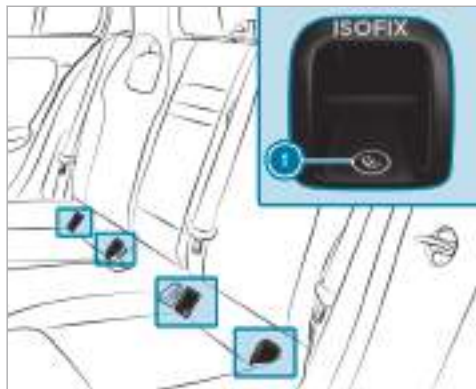

① ISOFIX mounting bracket

- ▶ Before every journey, make sure that the ISOFIX child restraint system is correctly engaged in both mounting brackets in the vehicle.

! **NOTE** Damage to the seat belt for the center seat during installation of the child restraint system

- ▶ Make sure that the seat belt is not trapped.

- ▶ Attach the ISOFIX child restraint system to both mounting brackets in the vehicle.

Fastening a Top Tether

! **WARNING** Risk of injury or death if the rear seat backrests are not locked after Top Tether belts are installed

The rear seat backrests may fold forwards when you are driving.

As a result, child restraint systems will no longer be able to perform their intended protective function. This may also cause additional injuries.

- ▶ Always lock rear seat backrests after installing Top Tether belts.

- ▶ Observe the lock verification indicator.

If the rear seat backrest is not engaged and locked in place, the red lock verification indicator will be visible.

-  If the child restraint system is equipped with a Top Tether belt:

The risk of injury may be reduced by Top Tether. The Top Tether belt enables an additional connection between the child restraint system attached with LATCH-type (ISOFIX) (left and right rear seats) or the seat belt (all rear seats) and the vehicle.

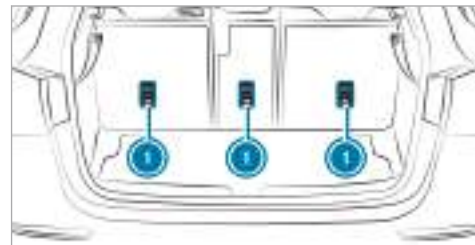



Vehicles with adjustable head restraints:

- ▶ If necessary, slide the head restraint upwards (→ page 101).
- ▶ Guide Top Tether belt ③ under head restraint between the two head restraint bars.

Vehicles without adjustable head restraints:

- ▶ Top Tether belt with one seat belt strap: guide Top Tether belt ③ over the center of the head restraint.

or

- ▶ Top Tether belt with two seat belt straps: guide one Top Tether belt ③ past the head restraint on the right and left sides respectively.

All vehicles:

- ▶ Install the LATCH-type (ISOFIX) or belt-secured child restraint system with Top Tether. In doing so, comply with the child restraint system manufacturer's installation instructions.
- ▶ Hook Top Tether hook ② into Top Tether anchorage ① without twisting.
- ▶ Tension Top Tether belt ③. In doing so, comply with the child restraint system manufacturer's installation instructions.

Vehicles with adjustable head restraints:

- ▶ If necessary, slide the head restraint downwards (→ page 101). Make sure that you do not interfere with the correct routing of Top Tether belt ③.

Securing the child restraint system with the seat belt

⚠ WARNING Risk of accident if the rear bench seat, rear seat and seat backrest are not engaged

The rear bench seat, rear seat and seat backrest may fold forwards, even when you are driving.

- As a result, the vehicle occupant will be pushed into the seat belt with increased force. The seat belt will not be able to protect as intended and could cause additional injury.
 - Objects or loads in the trunk or cargo compartment will not be restrained by the seat backrest.
- ▶ Make sure that the rear bench seat, the rear seat and the seat backrest are engaged before every trip.

If the rear seat backrest is not engaged and locked in place, the red lock verification indicator will be visible.

The seat belts on the following seats are equipped with a child seat safety feature:

- Front passenger seat
- Rear seats

When enabled, the child seat safety feature ensures that the seat belts of the front passenger seat and rear seats do not slacken once the child restraint system is secured.

- ▶ For a child restraint system in the "Universal" or "Semi-Universal" category, make sure that the system has been approved for the vehicle seat.
- ▶ Install the child restraint system. The entire base of the child restraint system must always rest on the sitting surface of the seat.
- ▶ Always make sure that the shoulder belt strap is correctly routed from the seat belt outlet of the vehicle to the shoulder belt guide on the child restraint system. The shoulder belt strap must be routed forwards from the seat belt outlet and, where

possible, downwards to the child restraint system.

- ▶ **When installing on the rear seat:** also secure Top Tether if present.
- ▶ **When installing on the front passenger seat:** if necessary, adjust the seat belt outlet and the front passenger seat accordingly.

Child-proof locks

Activating or deactivating the child safety lock for the rear doors

⚠ WARNING Risk of accident and injury due to children left unattended in the vehicle

If you leave children unattended in the vehicle, they could, in particular:

- open doors, thereby endangering other persons or road users.
- get out and be struck by oncoming traffic.
- operate vehicle equipment and become trapped, for example.

In addition, the children could also set the vehicle in motion by, for example:

- releasing the parking brake.
- changing the gearbox position.
- starting the vehicle.
- ▶ Never leave children unattended in the vehicle.
- ▶ When leaving the vehicle, always take the key with you and lock the vehicle.
- ▶ Keep the key out of reach of children.

⚠ WARNING Risk of fatal injury due to exposure to extreme heat or cold in the vehicle

If persons, particularly children, are subjected to prolonged exposure to intense heat or cold, there is a risk of severe injury or even death.

- ▶ Never leave persons, particularly children, unattended in the vehicle.

⚠ WARNING Risk of accident and injury due to children left unattended in the vehicle

If children are traveling in the vehicle, they could, in particular:

- Open doors, thereby endangering other persons or road users.
 - Get out and be struck by oncoming traffic.
 - Operate vehicle equipment and become trapped, for example.
- ▶ Always activate the installed child safety locks if children are traveling in the vehicle.
- ▶ Never leave children unattended in the vehicle.
- ▶ When leaving the vehicle, always take the SmartKey with you and lock the vehicle.

There are child safety locks for the rear doors and the rear side windows.

The child safety lock on the rear doors secures each door separately. The doors can no longer be opened from the inside.

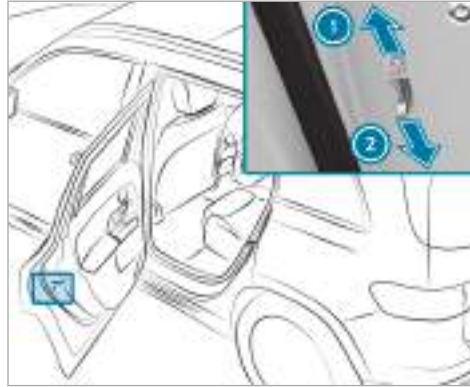

- ▶ Press the lever in direction ① (activate) or ② (deactivate).
- ▶ Make sure that the child safety locks are working properly.

Activating and deactivating the child safety lock for the rear side windows

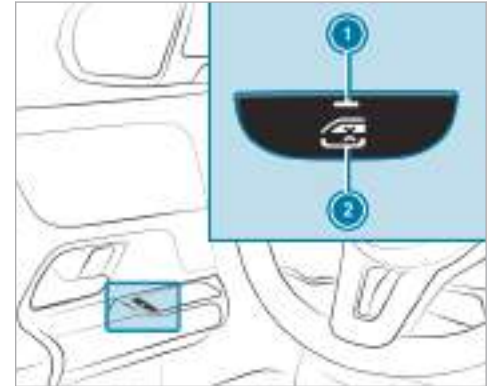

- ▶ **To activate/deactivate:** press button ②.
- The rear side window can be opened or closed in the following cases:
- indicator lamp ① is lit: via the switch on the driver's door

68 Safely transporting children in the vehicle

- indicator lamp  is off: via the switch on the corresponding rear door or driver's door

SmartKey

Overview of SmartKey functions

⚠ WARNING Risk of accident and injury due to children left unattended in the vehicle

If you leave children unattended in the vehicle, they could, in particular:

- open doors, thereby endangering other persons or road users.
- get out and be struck by oncoming traffic.
- operate vehicle equipment and become trapped, for example.

In addition, the children could also set the vehicle in motion by, for example:

- releasing the parking brake.
- changing the gearbox position.
- starting the vehicle.

▶ Never leave children unattended in the vehicle.

- ▶ When leaving the vehicle, always take the key with you and lock the vehicle.
- ▶ Keep the key out of reach of children.

! NOTE Damage to the SmartKey caused by magnetic fields



- ▶ Keep the SmartKey away from strong magnetic fields.



Vehicle key with panic alarm

- ① Locks
- ② Indicator lamp
- ③ Unlocks

- ④ Opens/closes the tailgate
- ⑤ Panic alarm

ⓘ If indicator lamp ② does not light up when the  or  button is pressed, the battery is weak or possibly discharged. Replace the battery as soon as possible.

Replace the SmartKey battery (→ page 71).

The SmartKey locks and unlocks the following components:

- Doors
- Fuel filler flap
- Tailgate

If the vehicle is not opened within approximately 40 seconds after unlocking, it locks again. Anti-theft protection is armed again.

Do not keep the SmartKey together with electronic devices or metal objects. This can affect the SmartKey's functionality.

Activating/deactivating the acoustic locking verification signal

Multimedia system:

→  → Settings → Vehicle

- ▶ Activate or deactivate **Acoustic Lock**.

Activating/deactivating the panic alarm

Requirements

- The vehicle is switched off.



- ▶ **To activate:** press button  for approximately one second. A visual and audible alarm is triggered.



- ▶ **To deactivate:** briefly press button  again. or

- ▶ Press the start/stop button. A key belonging to the vehicle must be detected in the vehicle.

Changing the unlocking settings

Possible unlocking functions of the SmartKey:

- Central unlocking
- Unlocking the driver's door and fuel filler flap

- ▶ **To switch between settings:** press the  and  buttons simultaneously for approximately six seconds until the indicator lamp flashes twice.



Options when the unlocking function for the driver's door and fuel filler flap has been selected:

- **To unlock the vehicle centrally:** press the  button twice.
- **Vehicles with KEYLESS-GO:** if you touch the inner surface of the door handle on the driver's door, only the driver's door and the fuel filler flap will be unlocked.

Deactivating the function of the key

Vehicles with KEYLESS-GO: if you deactivate the function of the key, the KEYLESS-GO functions are also deactivated. Access or drive authorization by KEYLESS-GO is then no longer possible with that particular key. Activate the function of the key so that all its functions will again be available.

You can also deactivate the function of the key to reduce the energy consumption of the key if you do not use the vehicle or a key for an extended period of time.

- ▶ Press and hold the  button on the key.
- ▶ With the key button  pressed, immediately press key button  twice in quick succession. The indicator light of the key lights up once briefly and once for a long time.

- ▶  You have the following options to reactivate the key:
 - Press any button on the key.
 - Start the vehicle with the key in the center console stowage space (→ page 144).

Removing/inserting the emergency key

Removing the emergency key



- ▶ Press release button ①. Emergency key ② will be pushed out slightly.
- ▶ Pull out emergency key ② until it engages in the intermediate position.
- ▶ Press release button ① again and fully remove emergency key ②.

Inserting the emergency key

- ▶ Press release button ①.
- ▶ Insert emergency key ② to the intermediate position or fully until it engages.

- ① You can use the intermediate position of emergency key ② to attach the SmartKey to a key ring.

Replacing the SmartKey battery

⚠ DANGER Risk of fatal injury due to swallowing batteries

Batteries contain toxic and corrosive substances. If batteries are swallowed or otherwise enter the body, severe internal burns can occur within two hours.

There is a risk of fatal injury!

- ▶ Keep the batteries out of the reach of children.
- ▶ If the lid and/or the battery compartment do not close securely, stop using the key and keep it away from children.
- ▶ If batteries are swallowed or otherwise enter the body, seek immediate medical attention.

🔥 ENVIRONMENTAL NOTE Environmental damage due to improper disposal of batteries



Batteries contain pollutants. It is illegal to dispose of them with the household rubbish.



Dispose of batteries in an environmentally responsible manner. Take discharged batteries to a qualified specialist workshop or to a collection point for used batteries.

Requirements

- You require a CR 2032 3 V cell battery.

Mercedes-Benz recommends that you have the battery replaced at a qualified specialist workshop.

- ▶ Remove the emergency key element (→ page 71).



- ▶ Press release knob ② down fully and slide cover ① in the direction of the arrow.
- ▶ Fold out cover ① in the direction of the arrow and remove.
- ▶ Remove battery compartment ③ and take out the discharged battery.
- ▶ Insert the new battery into battery compartment ③. Observe the positive pole marking in the battery compartment and on the battery when doing this.
- ▶ Push in battery compartment ③.
- ▶ Re-attach cover ① and push it until it engages.

Problems with the key, troubleshooting

You can no longer lock or unlock the vehicle

Possible causes are:

- The key battery is weak or discharged.
- ▶ Check the battery using the indicator lamp (→ page 69).
- ▶ Replace the key battery, if necessary (→ page 71).
- ▶ Use the replacement key.
- ▶ Use the mechanical key to lock or unlock (→ page 75).
- ▶ Have key checked at a qualified specialist workshop.

There is interference from a powerful radio signal source

Possible causes if the function of the key is impaired:

- high voltage power lines
- mobile phones
- electronic devices (notebooks, tablets)

- shielding due to metal objects or induction loops for electrical gate systems or automatic barriers

- ▶ Make sure that there is sufficient distance between the key and the potential source of interference.

You have lost a key

- ▶ Have the key deactivated at a qualified specialist workshop.
- ▶ If necessary, have the mechanical lock replaced as well.

Doors

Unlocking/opening the doors from the inside



- ▶ **To unlock and open a front door:** pull door handle ①.
- ▶ **To unlock a rear door:** pull the rear door handle.
- ▶ **To open a rear door:** pull the rear door handle again.

Centrally locking and unlocking the vehicle from the inside

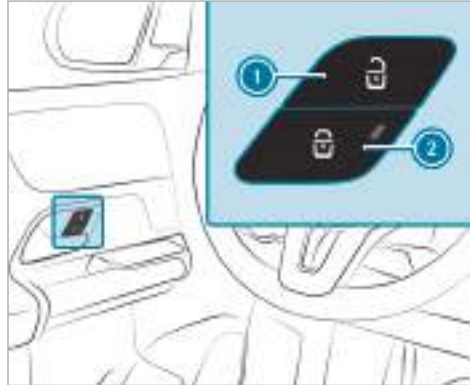

- ▶ **To unlock:** press button ①.
 - ▶ **To lock:** press button ②.
The red indicator lamp on button ② will light up once the vehicle is locked.
- ① The buttons are also on the front passenger door.

This does not lock or unlock the fuel filler flap.

The vehicle will not be unlocked:

- if you have locked the vehicle using the key
- if you have locked the vehicle using KEYLESS-GO

Locking/unlocking the vehicle with KEYLESS-GO

Requirements

- The SmartKey is outside the vehicle.
- The distance between the SmartKey and the vehicle does not exceed 3 ft (1 m).
- The driver's door and the door on which the door handle is operated are closed.

! **NOTE** Vehicle damage due to unintentional opening of the tailgate

- When using an automatic car wash
- When using a high pressure cleaner

▶ Deactivate the function of the SmartKey in these situations.

or

- ▶ Make sure that the SmartKey is at a minimum distance of 10 ft (3 m) away from the vehicle.

Observe the notes:

- on washing the vehicle in a car wash (→ page 286)
- on using a high-pressure cleaner (→ page 288)

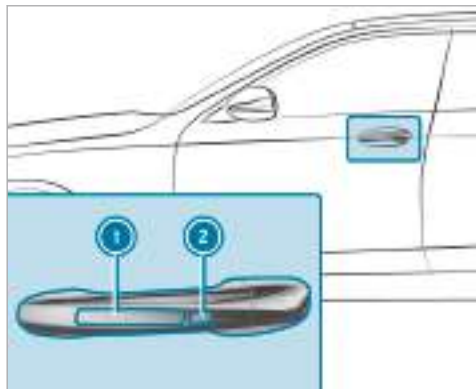

- ▶ **To unlock the vehicle:** touch the inner surface of the door handle.
- ▶ **To lock the vehicle:** touch sensor surface ① or ②.
- ▶ **Convenience closing:** touch recessed sensor surface ② until the closing process has been completed.
- ① Further information on convenience closing (→ page 84).

If you open the tailgate from outside, it is automatically unlocked.

Problems with KEYLESS-GO, troubleshooting

You can no longer lock or unlock the vehicle using KEYLESS-GO

Possible causes:

- The function of the SmartKey has been deactivated.
- The SmartKey battery is weak or discharged.
- ▶ Activate the function of the SmartKey (→ page 70).

- ▶ Check the battery using the indicator lamp (→ page 69).
- ▶ Replace the SmartKey battery, if necessary (→ page 71).
- ▶ Use the replacement SmartKey.
- ▶ Use the emergency key to lock or unlock (→ page 75).
- ▶ Have the vehicle and SmartKey checked at a qualified specialist workshop.

There is interference from a powerful radio signal source

Possible causes if the function of KEYLESS-GO is impaired:

- High voltage power lines
- Mobile phones
- Electronic devices (notebooks, tablets)
- Shielding due to metal objects or induction loops for electrical gate systems or automatic barriers
- ▶ Make sure that there is sufficient distance between the SmartKey and the potential source of interference.

Activating/deactivating the automatic locking feature

The vehicle is locked automatically when the vehicle is switched on and the wheels are turning faster than walking pace.

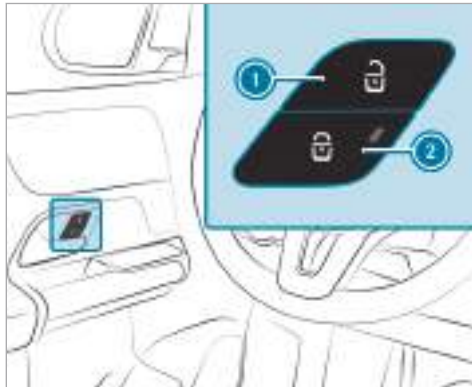

- ▶ **To activate:** press and hold button ② for approximately five seconds until an acoustic signal sounds.

- ▶ **To deactivate:** press and hold button ① for approximately five seconds until an acoustic signal sounds.

The red indicator lamp on button ② lights up once the vehicle is locked.

In the following situations, there is a danger of being locked out when the function is activated:

- while the vehicle is being tow-started or pushed
- if the vehicle is being tested on a roller dynamometer

Locking/unlocking the vehicle with the emergency key element

Locking/unlocking the driver's door with the emergency key element

- ① If you wish to lock the vehicle entirely using the emergency key element, first press the button for locking from the inside while the driver's door is open. Then proceed to lock the driver's door using the emergency key element.

- ① If you unlock and open the driver's door with the emergency key element, this will trigger the anti-theft alarm system.

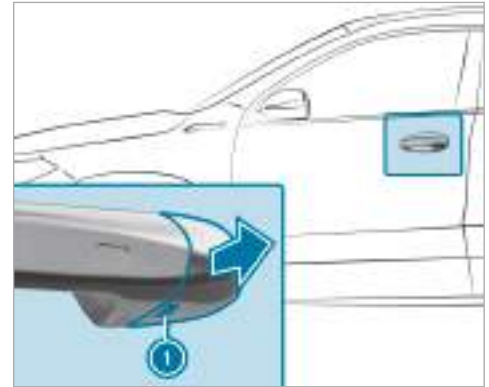

- ▶ Remove the emergency key element (→ page 71).
- ▶ Insert the emergency key element as far as it will go into opening ① in the cover.
- ▶ Pull and hold the door handle.

- ▶ Pull the cover on the emergency key element as straight as possible away from the vehicle until it releases.
- ▶ Release the door handle.

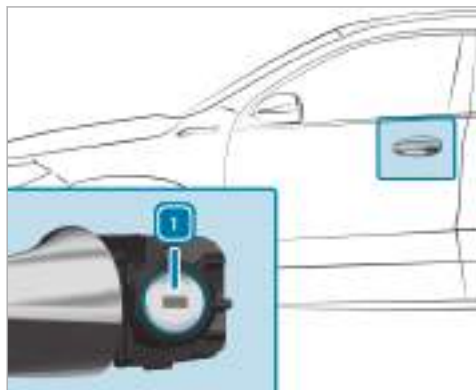

- ▶ **To unlock:** turn the emergency key element counter-clockwise to position **1**.
- ▶ **To lock:** turn the emergency key element clockwise to position **1**.

- ▶ Carefully press the cover onto the lock cylinder until it engages and is seated firmly.

Locking the front passenger door and rear doors

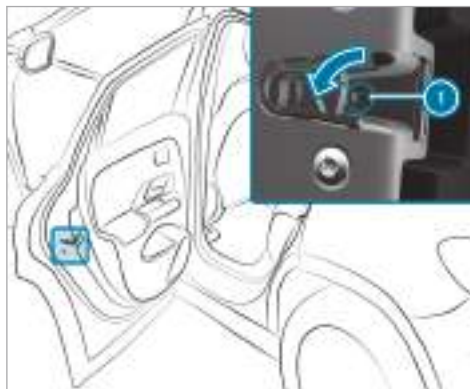

- ▶ Insert a suitable object, e.g. the emergency key element, into opening **1** on the door lock.

- ▶ **To lock the left-hand side of the vehicle:** turn the emergency key element counter-clockwise as far as it will go.
- ▶ **To lock the right-hand side of the vehicle:** turn the emergency key element clockwise as far as it will go.

If the locked door is then closed, it can no longer be opened from the outside.

Cargo compartment

Opening the tailgate

⚠ DANGER Risk of exhaust gas poisoning

Combustion engines emit poisonous exhaust gases such as carbon monoxide. Exhaust gases can enter the vehicle interior if the tailgate is open when the engine is running, especially if the vehicle is in motion.

- ▶ Always switch off the engine before opening the tailgate.
- ▶ Never drive with the tailgate open.

- !** **NOTE** Damage to the tailgate caused by obstacles above the vehicle

The tailgate swings rearwards and upwards when it is opened.

- ▶ Make sure that there is sufficient space behind and above the tailgate.

- ▶ Pull the tailgate handle.
- ▶ **Vehicles with HANDS-FREE ACCESS:** Make a kicking movement with your foot below the bumper (→ page 80).

Vehicles with an EASY-PACK tailgate



- ▶ Pull remote operating switch ① until the tailgate opens.
- or
- ▶ Press and hold the  button on the Smart-Key.
 - ▶ If the tailgate is unlocked, pull the tailgate handle and release it again immediately.

- ▶ If the tailgate has stopped in an intermediate position, pull it upwards. Release it as soon as it begins to open.

If an obstacle obstructs the tailgate during the automatic opening process, blockage detection will stop the tailgate. The automatic blockage detection function is only an aid. It is not a substitute for your attentiveness.

Closing the tailgate

- !** **WARNING** Risk of injury from unsecured items in the vehicle

If objects, luggage or loads are not secured or not secured sufficiently, they could slip, tip over or be thrown around and thereby hit vehicle occupants.

There is a risk of injury, particularly in the event of sudden braking or a sudden change in direction.

- ▶ Always stow objects in such a way that they cannot be thrown around.

- ▶ Before the journey, secure objects, luggage or loads against slipping or tipping over.

Observe the notes on loading the vehicle.

Notes on closing the tailgate: your vehicle is equipped with automatic SmartKey recognition. If a SmartKey belonging to the vehicle is detected in the vehicle, the tailgate will not be locked.

Note that the tailgate will not be locked in the following situation:

- You have locked the vehicle and close the tailgate while a SmartKey belonging to the vehicle is inside the vehicle.
and
- A second SmartKey belonging to the vehicle is not detected outside the vehicle.

Automatic SmartKey recognition is only an aid and is not a substitute for your attentiveness.

- ▶ Before locking, ensure that at least one SmartKey belonging to the vehicle is outside the vehicle.

- ▶ **To close the tailgate:** pull the tailgate downwards with the handle and let it drop into the lock.

Vehicles with an EASY-PACK tailgate

⚠ WARNING Risk of becoming trapped during automatic closing of the tailgate

Body parts may become trapped. There may be people in the closing area.

- ▶ Make sure that nobody is in the vicinity of the closing area during the closing process.

Use one of the following options to stop the closing process:

- Press the  button on the SmartKey.
- Press or pull the remote operating switch on the driver's door.
- Press the closing or locking button on the tailgate.
- Pull the tailgate handle.

Vehicles with HANDS-FREE ACCESS: it is also possible to stop the closing process by making a kicking movement below the rear bumper.

- ▶ **To close the tailgate:** pull the tailgate downwards slightly. Release it as soon as it begins to close.



- ▶ Switch on the power supply or the vehicle.

- ▶ Push remote operating switch ① until the tailgate is fully closed.

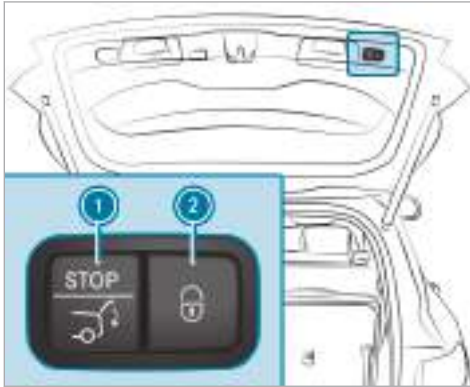

- ▶ Press closing button ② on the tailgate.

Vehicles with KEYLESS-GO

- ▶ Press locking button ② on the tailgate. If a SmartKey is detected outside the vehicle, the tailgate will close and the vehicle will be locked.
- ▶ Press and hold the  button on the SmartKey. The SmartKey must be in the vicinity of the vehicle.

Vehicles with HANDS-FREE ACCESS

- ▶ Make a kicking movement with your foot below the bumper (→ page 80).

Automatic reversing function for the tailgate

The tailgate is equipped with automatic blockage detection with a reversing function. If an obstacle obstructs the tailgate during the automatic closing process, it will automatically open again slightly. Automatic blockage detection with the reversing function is only an aid and is not a substitute for your attentiveness.

- ▶ During the closing process, make sure that no body parts are in the closing area.

⚠ WARNING Risk of becoming trapped despite reversing function

The reversing function will not react:

- To soft, light and thin objects, e.g. fingers
- Towards the end of the closing procedure

In these situations in particular, the reversing function cannot prevent someone being trapped.

- ▶ Ensure that no body parts are in the closing area.

If someone is trapped, either:

- Press the  button on the SmartKey.
- Press or pull the remote operating switch on the driver's door.
- Press the closing or locking button on the tailgate.
- Pull the tailgate handle.

HANDS-FREE ACCESS function

With HANDS-FREE ACCESS you can open, close or stop the closing process of the tailgate by performing a kicking movement under the rear bumper.

The kicking movement triggers the opening or closing process alternately.

Observe the notes when opening (→ page 76) and closing (→ page 77) the tailgate.

- ① Two warning tones sound when the tailgate is opening or closing.

⚠ WARNING Risk of burns caused by a hot exhaust system

The vehicle exhaust system can become very hot. If you use HANDS-FREE ACCESS, you could burn yourself by touching the exhaust system.

- ▶ Always ensure that you only make a kicking movement within the detection range of the sensors.

! NOTE Vehicle damage due to unintentional opening of the tailgate

- When using an automatic car wash
 - When using a high pressure cleaner
- ▶ Deactivate the function of the SmartKey in these situations.

or

- ▶ Make sure that the SmartKey is at a minimum distance of 10 ft (3 m) away from the vehicle.

When making the kicking movement, make sure that you are standing firmly on the ground. You could otherwise lose your balance, e.g. on ice.

Observe the following notes:

- The key is behind the vehicle.
- Stand at least 12 in (30 cm) away from the vehicle while performing the kicking movement.
- Do not come into contact with the bumper while making the kicking movement.
- Do not carry out the kicking movement too slowly.
- The kicking movement must be towards the vehicle and back again.

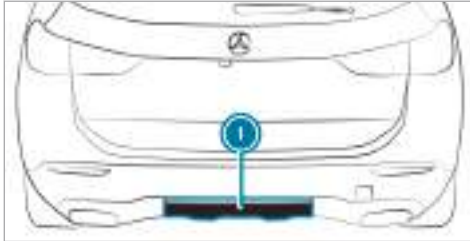

① Detection range of the sensors

If several consecutive kicking movements are not successful, wait ten seconds.

System limits

The system may be impaired or may not function in the following cases:

- The sensors are dirty, e.g. due to road salt or snow.
- The kicking movement is made using a prosthetic leg.

The tailgate can open or close unintentionally in the following situations:

- A person's arms or legs are moving in the sensor detection range, e.g. when polishing the vehicle or picking up objects.
- Objects are moved or placed behind the vehicle, e.g. the hose of a fuel dispenser, a charging cable or luggage
- Clamping straps, tarp or other coverings are pulled over the bumper.
- A protective mat with a length reaching over the trunk sill down into the detection range of the sensors is used.
- The protective mat is not secured correctly.

Deactivate the function of the key (→ page 70) or do not carry the key about your person in such situations.

Limiting the opening angle of the tailgate

Activating the opening angle limiter

You can limit the opening angle of the tailgate in the top half of its opening range up to a point shortly before the end position.

- ▶ Stop the opening procedure of the tailgate at the desired position.
- ▶ Press and hold the closing button on the tailgate until you hear a short acoustic signal. The opening angle limiter will be activated. The tailgate will then stop in the stored position when opened.

To open the tailgate fully, pull the handle on the outside of the tailgate again after it has stopped automatically.

Deactivating the opening angle limiter

- ▶ Press and hold the closing button on the tailgate until two short acoustic signals sound.

Unlocking the tailgate with the emergency key

Requirements

- The rear seat backrest has been folded forward.
- The cargo compartment cover has been removed.

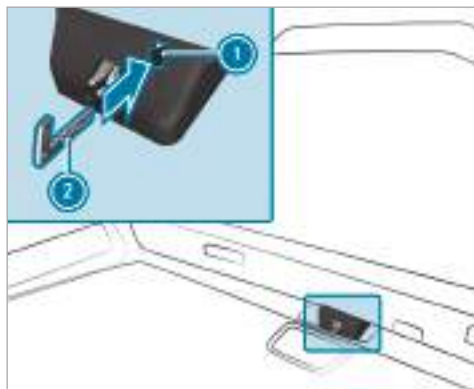

- ▶ Remove the emergency key (→ page 71).

- ▶ Insert emergency key ② into opening ① in the trim and push it in. The tailgate will be unlocked.

Side windows

Opening and closing the side windows

- ⚠ **WARNING** Risk of entrapment when opening a side window

When opening a side window, parts of the body could be drawn in or become trapped between the side window and window frame.

- ▶ When opening, make sure that nobody is touching the side window.
- ▶ If someone is trapped, release the button immediately or pull it in order to close the side window again.

- ⚠ **WARNING** Risk of becoming trapped when closing a side window

When closing a side window, body parts could be trapped in the closing area in the process.

- ▶ When closing, make sure that no body parts are in the closing area.
- ▶ If someone is trapped, release the button immediately or press the button in order to reopen the side window.

- ⚠ **WARNING** Risk of becoming trapped when children operate the side windows

Children could become trapped if they operate the side windows, particularly when unattended.

- ▶ Activate the child safety lock for the rear passenger compartment side windows.
- ▶ When leaving the vehicle, always take the SmartKey with you and lock the vehicle.
- ▶ Never leave children unattended in the vehicle.

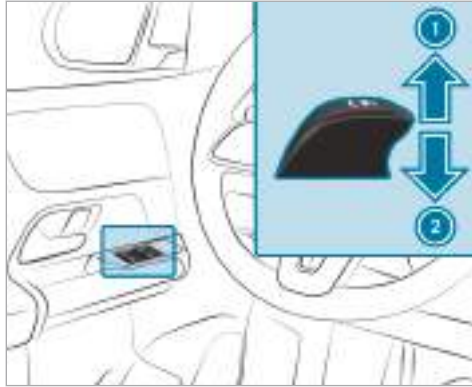

Requirements

- The power supply or the vehicle has been switched on.



- ① Closing
- ② Opening

The buttons on the driver's door take precedence.

- ▶ **To start automatic operation:** press the  button beyond the point of resistance or pull and release it.
- ▶ **To interrupt automatic operation:** press or pull the  button again.

When the vehicle is switched off, you can continue to operate the side windows.

This function is available for around four minutes or until a front door is opened.

Automatic reversing function of the side windows

If an obstacle impedes a side window during the closing process, the side window will open again automatically. The automatic reversing function is only an aid and is not a substitute for your attentiveness.

- ▶ During the closing process, make sure that no body parts are in the closing area.

⚠ WARNING Risk of becoming trapped despite there being reversing protection on the side window

The reversing function does not react:

- To soft, light and thin objects, e.g. fingers.
- During resetting.

The reversing function cannot prevent someone from becoming trapped in these situations.

- ▶ During the closing process, make sure that no body parts are in the closing area.
- ▶ If someone becomes trapped, press the  button to open the side window again.

Convenience opening (ventilating the vehicle before starting a journey)

⚠ WARNING Risk of entrapment when opening a side window

When opening a side window, parts of the body could be drawn in or become trapped between the side window and window frame.



- ▶ When opening, make sure that nobody is touching the side window.
- ▶ Release the button immediately if somebody becomes trapped.

Requirements

- The SmartKey is in the immediate vicinity of the vehicle.

- ▶ Press and hold the  button on the Smart-Key.

The following functions are performed:

- The vehicle is unlocked.
 - The side windows are opened.
 - The panoramic sliding roof is opened.
 - The seat ventilation of the driver's seat is switched on.
- ◻ If the roller sunblind of the panoramic sliding sunroof is closed, the roller sunblind is opened first.
- ▶ **To interrupt convenience opening:** release the  button.
 - ▶ **To continue convenience opening:** press and hold the  button again.

Convenience closing (closing the vehicle from outside)

⚠ WARNING Risk of entrapment due to not paying attention during convenience closing

When the convenience closing feature is operating, parts of the body could become trapped in the closing area of the side window and the sliding sunroof.

- ▶ When the convenience closing feature is operating, monitor the entire closing process and make sure that no body parts are in the closing area.

Requirements

- The key is in the immediate vicinity of the vehicle.
- ▶ Press and hold the  button on the key. The following functions will be performed:
 - The vehicle will be locked.
 - The side windows will be closed.
 - The panoramic sliding roof will be closed.

- ▶ **To interrupt convenience closing:** release the  button.

- ▶ **To continue convenience closing:** press and hold the  button again.

- ◻ Convenience closing also functions with KEY-LESS-GO (→ page 73).

Resolving problems with the side windows

⚠ WARNING Risk of becoming trapped or fatally injured if reversing protection is not activated

If you close a side window again immediately after it has been blocked, the side window will close with increased or maximum force. The reversing function is then not active and body parts may become trapped.

- ▶ Make sure that no parts of the body are in the closing area.
- ▶ To stop the closing process, release the button or press the button again to reopen the side window.

A side window cannot be closed and you cannot see the cause.

- ▶ Check to see whether any objects are in the window guide.
- ▶ Adjust the side windows.

Adjusting the side windows

If a side window is obstructed during closing and reopens again immediately:

- ▶ Immediately after this, pull and hold the corresponding button again until the side window has closed and hold the button for at least one more second (re-adjustment).
The side window will be closed without the automatic reversing function.

If the side window is obstructed again and reopens again immediately:

- ▶ Immediately after this, pull and hold the corresponding button again until the side window has closed and hold the button for at least one more second (follow-up adjustment).
The side window will be closed without the automatic reversing function.

The side windows cannot be opened or closed using the convenience opening feature.

Possible causes:

- The key battery is weak or discharged.
- ▶ Check the battery using the indicator lamp (→ page 69).
- ▶ Replace the key battery, if necessary (→ page 71).

Sliding sunroof

Opening and closing the sliding sunroof

- ⓘ The term "sliding sunroof" also refers to the panorama roof with power tilt/sliding panel.

⚠ WARNING Risk of becoming trapped when the sliding sunroof is being opened and closed

Body parts may become trapped in the range of movement.

- ▶ During opening and closing, make sure that no body parts are in the range of movement.
- ▶ Release the button immediately if somebody becomes trapped.

or

- ▶ Briefly press the button in any direction during automatic operation.
The opening or closing process will be stopped.

⚠ WARNING Risk of becoming trapped if the sliding sunroof is operated by children

Children operating the sliding sunroof could get caught in the moving parts, particularly if unattended.

- ▶ Never leave children unattended in the vehicle.
- ▶ When leaving the vehicle, always take the key with you and lock the vehicle.

⚠ WARNING Risk of becoming trapped when the roller sunblind is being opened and closed

Body parts may become trapped between the roller sunblind and frame or sliding roof.

- ▶ When opening or closing, make sure that no body parts are in the roller sunblind's range of movement.
- ▶ Release the button immediately if somebody becomes trapped.

or

- ▶ Briefly press the button in any direction during automatic operation. The opening or closing process will be stopped.

⚠ NOTE Malfunction due to snow and ice

Snow and ice may cause the sliding sunroof to malfunction.

- ▶ Open the sliding sunroof only if it is free of snow and ice.

⚠ NOTE Damage caused by protruding objects

Objects that protrude from the sliding sunroof may damage the seals.

- ▶ Do not allow anything to protrude from the sliding sunroof.

⚠ NOTE Damage to the sliding sunroof when a roof luggage rack is installed

When a roof luggage rack is installed, raising or opening the sliding sunroof may be restricted.

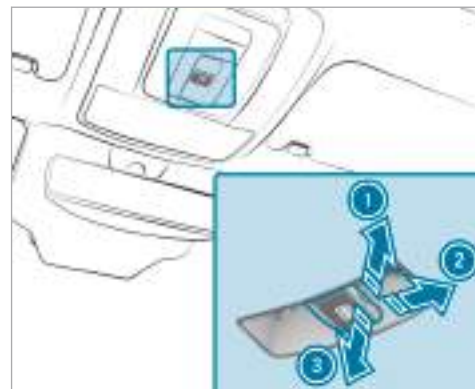

- ▶ Check whether the sliding sunroof can be raised or opened when a roof luggage rack is installed.
- ▶ If in doubt, do not raise or open the sliding sunroof.



- ① Raise
- ② Open
- ③ Close/lower

Use the  button to operate the panorama roof with power tilt/sliding panel and the roller sunblind.

The panorama roof with power tilt/sliding panel can be operated only when the roller sunblind is open.

- ▶ Check whether the sliding sunroof can be raised or opened when a roof luggage rack is installed.
- ▶ **To start automatic operation:** press the  button beyond the point of resistance or pull and release it.
- ▶ **To interrupt automatic operation:** briefly press the  button in any direction. The opening/closing process will be stopped.

Vehicles with a panorama roof with power tilt/sliding panel: the automatic raising feature is available only when the sliding sunroof is closed or raised.

Automatic reversing function of the sliding sunroof

If an obstacle obstructs the sliding sunroof during the closing process, the sliding sunroof will open again automatically. The automatic reversing function is only an aid and is not a substitute for your attentiveness.

- ▶ During the closing process, make sure that no body parts are in the closing area.

WARNING Risk of becoming trapped despite the reversing function being active

In particular, the reversing function does not react:

- To soft, light and thin objects, e.g. fingers.
- Towards the end of the closing procedure.
- During resetting.

- ▶ During the closing process, make sure that no body parts are in the closing area.
 - ▶ Release the button immediately if somebody becomes trapped.
- or
- ▶ Briefly press the button in any direction during automatic operation. The closing process will be stopped.

Automatic reversing function of the roller sunblind

If an obstacle obstructs the roller sunblind during the closing process, the roller sunblind will open

again automatically. The automatic reversing function is only an aid and is not a substitute for your attentiveness.

- ▶ When closing the roller sunblind, make sure that no body parts are in the area of movement.

WARNING Risk of becoming trapped despite reversing function

In particular, the reversing function does not react to soft, light and thin objects, e.g. fingers.

- ▶ When closing the roller sunblind, make sure that no body parts are in the range of movement.
 - ▶ Release the button immediately if somebody becomes trapped.
- or
- ▶ Briefly press the button in any direction during the automatic closing process. The closing process will be stopped.

Automatic functions of the sliding sunroof

- ① The term "sliding sunroof" also refers to the panoramic sliding sunroof.

Rain closing function when driving

Vehicles with a panoramic sliding sunroof: if it starts to rain, the raised sliding sunroof will automatically be lowered while the vehicle is in motion.

Automatic lowering function

Vehicles with a panoramic sliding sunroof: if the sliding sunroof is raised at the rear, it will automatically be lowered slightly at higher speeds. At low speeds, it will be raised again automatically.

⚠ WARNING Risk of becoming trapped by automatic lowering of the sliding sunroof

At higher speeds, the raised sliding sunroof will automatically be lowered slightly at the rear.

- ▶ Make sure that nobody reaches into the sliding sunroof's range of movement while the vehicle is in motion.

- ▶ If somebody becomes trapped, briefly push the sliding sunroof button forwards or backwards.

- ① By pushing or pulling the  button, you can interrupt the automatic functions "Rain closing function when driving" and "Automatic lowering".

Rectifying problems with the sliding sunroof

⚠ WARNING Risk of becoming trapped or fatal injuries when the sliding sunroof is closed again

If the sliding sunroof is closed again immediately after it has been blocked or reset, it will close with increased force.

- ▶ Make sure that no parts of the body are in the closing area.
- ▶ Release the button immediately if somebody becomes trapped.

or

- ▶ Briefly press the button in any direction during the automatic closing process. The closing process will be stopped.

The sliding sunroof cannot be closed and you cannot see the cause.

- ① The term "sliding sunroof" also refers to the panorama roof with power tilt/sliding panel.

If the sliding sunroof is obstructed during closing and reopens again slightly:

- ▶ Immediately after automatic reversing, pull and hold the  button down again to the point of resistance until the sliding sunroof is closed. The sliding sunroof will be closed with increased force.



If the sliding sunroof is obstructed again and opens again slightly:

- ▶ Repeat the previous step. The sliding sunroof will be closed again with increased force.

Vehicles with a panorama roof with power tilt/sliding panel: The sliding sunroof or the roller sunblind is not operating smoothly.

- ▶ Reset the sliding sunroof and the roller sunblind.

Resetting the sliding sunroof and the roller sunblind

- ▶ Pull and hold the  button little by little until the sliding sunroof is fully closed.
- ▶ Pull and hold the  button little by little until the roller sunblind is fully closed.
- ▶ Use automatic operation to fully open and then close the sliding sunroof.

Anti-theft protection

Function of the immobilizer

The immobilizer prevents your vehicle from being started without the correct key.

The immobilizer is automatically activated when the vehicle is switched off and deactivated when the vehicle is switched on.

When leaving the vehicle, always take the key with you and lock the vehicle. Anyone can start the vehicle if a valid key has been left inside the vehicle.

- ❗ In the event the engine cannot be started (yet the vehicle's battery is charged), the system is not operational. Contact an authorized Mercedes-Benz center or call 1-800-FOR-MERCEDES (in the USA) or 1-800-387-0100 (in Canada).

ATA (anti-theft alarm system)

Function of the ATA system

If the ATA system is armed, a visual and audible alarm is triggered in the following situations:

- when a door is opened
- when the tailgate is opened
- when the hood is opened
- when interior protection is triggered (→ page 90)
- when tow-away alarm is triggered (→ page 90)

The ATA system is armed automatically after approximately ten seconds in the following situations:

- after locking the vehicle with the key
- after locking the vehicle using KEYLESS-GO

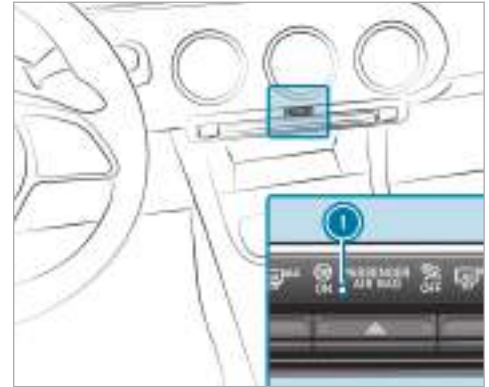

Indicator lamp ❶ flashes when the ATA system is armed.

The ATA system is deactivated automatically in the following situations:

- after unlocking the vehicle with the key
- after unlocking the vehicle using KEYLESS-GO
- after pressing the start/stop button with the key in the stowage compartment (→ page 144)

i If the battery is heavily discharged, the burglar alarm system is automatically deactivated in favor of the next engine start.

Deactivating the ATA

▶ Press the ,  or  button on the key.

or

▶ Press the start/stop button with the key in the stowage compartment (→ page 144)

Deactivating the alarm using KEYLESS-GO

▶ Grasp the outside door handle with the key outside the vehicle.

Function of the tow-away alarm

i This function may not be available in all countries.

An audible and visual alarm is triggered if an alteration to your vehicle's angle of inclination is detected while the tow-away alarm is armed.



The tow-away alarm is automatically armed after approximately 60 seconds:

- after locking the vehicle with the key
- after locking the vehicle using KEYLESS-GO

The tow-away alarm is armed only when the following components are closed:

- Doors
- Tailgate

The tow-away alarm is automatically deactivated:

- after pressing the  or  button on the key
- after pressing the start/stop button with the key in the stowage compartment (→ page 144)
- after unlocking the vehicle using KEYLESS-GO

- when using HANDS-FREE ACCESS

Information on collision detection on a parked vehicle (→ page 171).

Activating/deactivating the tow-away alarm

Multimedia system:

 **▶▶ Settings ▶▶ Quick Access**

▶ Activate or deactivate **Tow-away Protection**.

The tow-away alarm is activated again in the following cases:

- The vehicle is unlocked again.
- A door is opened.
- The vehicle is locked again.

i If quick access is unavailable, select the **Vehicle** submenu in the **Settings** main menu to activate or deactivate the tow-away alarm.

Function of interior protection

i This function may not be available in all countries.

When interior protection is armed, a visual and audible alarm is triggered if movement is detected in the vehicle interior.



Interior protection is armed automatically after approximately ten seconds:

- after locking the vehicle with the key
- after locking the vehicle using KEYLESS-GO

Interior protection is armed only when the following components are closed:

- Doors
- Tailgate

Interior protection is automatically deactivated:

- after pressing the  or  button on the key
- after pressing the start/stop button with the key in the stowage compartment (→ page 144)
- after unlocking the vehicle using KEYLESS-GO
- when using HANDS-FREE ACCESS

The following situations can lead to a false alarm:

- when there are moving objects such as mascots in the vehicle interior
- if a side window is open
- if the panorama roof with power tilt/sliding panel is open

Activating/deactivating interior protection

Multimedia system:

  **▶▶ Settings ▶▶ Quick Access**

 Activate or deactivate **Interior Motion Sensor**.

Interior protection is activated again in the following cases:

- The vehicle is unlocked again.
- A door is opened.
- The vehicle is locked again.

 If quick access is unavailable, select the **Vehicle** menu under **Settings** to activate or deactivate interior protection.

Notes on the correct driver's seat position

⚠ WARNING Risk of accident due to adjusting the vehicle settings while the vehicle is in motion

You could lose control of the vehicle in the following situations in particular:

- If you adjust the driver's seat, the head restraint, the steering wheel or the mirror while the vehicle is in motion
 - If you fasten your seat belt while the vehicle is in motion
- Before starting the vehicle: in particular, adjust the driver's seat, head restraint, steering wheel and mirror, and fasten your seat belt.



Ensure the following when adjusting steering wheel ①, seat belt ② and driver's seat ③:

- You are sitting as far away from the driver's airbag as possible, taking the following points into consideration:
- You are sitting in an upright position
- Your thighs are slightly supported by the seat cushion

- Your legs are not fully extended and you can depress the pedals properly
- The back of your head is supported at eye level by the center of the head restraint
- You can hold the steering wheel with your arms slightly bent
- You can move your legs freely
- You can see all the displays on the driver's display clearly
- You have a good overview of the traffic conditions
- Observe the notes on fastening the seat belt correctly .

Notes on grab handles

⚠ WARNING Risk of injury due to excessive load on the grab handles

If you apply your full body weight to the grab handle or pull it abruptly, the grab handle may be damaged or come loose from its anchorage. This may result in injuries.

- ▶ Use the grab handles only to stabilize the seating position or to assist in getting in and out of the seat.

Seats

Adjusting the front seat mechanically (without Seat Comfort Package)

- ⚠ **WARNING** Risk of becoming trapped if the seats are adjusted by children

Children could become trapped if they adjust the seats, particularly when unattended.

- ▶ When leaving the vehicle, always take the SmartKey with you and lock the vehicle.
- ▶ Never leave children unattended in the vehicle.

This also applies to the Digital Vehicle Key.

- ⚠ **WARNING** Risk of becoming trapped when adjusting the seat

When you adjust a seat, you or other vehicle occupants could become trapped, e.g. on the seat guide rail.

- ▶ When adjusting a seat, make sure that no one has any part of their body within the sweep of the seat.

Observe the safety notes on "Airbags" and "Children in the vehicle".

- ⚠ **WARNING** Risk of accident due to the driver's seat not being engaged

The driver's seat may move unexpectedly while driving.

This could cause you to lose control of the vehicle.

- ▶ Always make sure that the driver's seat is engaged before starting the vehicle.

- ⚠ **WARNING** Risk of accident due to adjusting the vehicle settings while the vehicle is in motion

You could lose control of the vehicle in the following situations in particular:

- If you adjust the driver's seat, the head restraint, the steering wheel or the mirror while the vehicle is in motion
- If you fasten your seat belt while the vehicle is in motion

- ▶ Before starting the vehicle: in particular, adjust the driver's seat, head restraint, steering wheel and mirror, and fasten your seat belt.

- ⚠ **WARNING** Risk of becoming trapped if the seat height is adjusted carelessly

If you adjust the seat height carelessly, you or other vehicle occupants could be trapped and thereby injured.

Children in particular could accidentally press the electrical seat adjustment buttons and become trapped.

- ▶ While moving the seats, make sure that hands or other body parts do not get under the lever assembly of the seat adjustment system.

⚠ WARNING Risk of injury due to head restraints not being installed or being adjusted incorrectly

If head restraints have not been installed or have not been adjusted correctly, there is an increased risk of injury in the head and neck area, e.g. in the event of an accident or when braking.

- ▶ Always drive with the head restraints installed.
- ▶ Before driving off, make sure for every vehicle occupant that the center of the head restraint supports the back of the head at about eye level.

Do not interchange the head restraints of the front and rear seats. Otherwise, you will not be able to adjust the height and angle of the head restraints correctly.

Adjust the head restraint fore-and-aft position so that it is as close as possible to the back of your head.

⚠ WARNING Risk of injury or death due to an incorrect seat position

The seat belt does not offer the intended level of protection if you have not moved the seat backrest to an almost vertical position.

In particular, you could slip beneath the seat-belt and become injured.

- ▶ Adjust the seat properly before beginning your journey.
- ▶ Always ensure that the seat backrest is in an almost vertical position and that the shoulder belt is routed across the center of your shoulder.

⚠ WARNING Risk of injury due to excessive load on the grab handles

If you apply your full body weight to the grab handle or pull it abruptly, the grab handle may be damaged or come loose from its anchorage. This may result in injuries.

- ▶ Use the grab handles only to stabilize the seating position or to assist in getting in and out of the seat.

⚠ WARNING Risk of potentially fatal injuries due to objects trapped under the front passenger seat

Objects trapped under the front passenger seat may interfere with the function of the automatic front passenger air bag shutoff or damage the system.

- ▶ Do not stow any objects under the front passenger seat.
- ▶ When the front passenger seat is occupied, ensure that no objects have become trapped beneath the front passenger seat.

Adjusts the seat fore-and-aft position



- ▶ Lift lever ① and slide the seat into the desired position.
- ▶ Make sure that the seat is engaged.
- ▶ **To adjust the seat height:** push or pull lever ② until the desired position has been reached.

- ▶ **To adjust the seat backrest inclination:** turn handwheel ③ forwards and backwards until the desired position has been reached.

Adjusting the front seat mechanically (with Seat Comfort Package)

- ⚠ **WARNING** Risk of becoming trapped if the seats are adjusted by children

Children could become trapped if they adjust the seats, particularly when unattended.

- ▶ When leaving the vehicle, always take the SmartKey with you and lock the vehicle.
- ▶ Never leave children unattended in the vehicle.

This also applies to the Digital Vehicle Key.

- ⚠ **WARNING** Risk of becoming trapped when adjusting the seat

When you adjust a seat, you or other vehicle occupants could become trapped, e.g. on the seat guide rail.

- ▶ When adjusting a seat, make sure that no one has any part of their body within the sweep of the seat.

Observe the safety notes on "Airbags" and "Children in the vehicle".

- ⚠ **WARNING** Risk of accident due to the driver's seat not being engaged

The driver's seat may move unexpectedly while driving.

This could cause you to lose control of the vehicle.

- ▶ Always make sure that the driver's seat is engaged before starting the vehicle.

⚠ WARNING Risk of accident due to adjusting the vehicle settings while the vehicle is in motion

You could lose control of the vehicle in the following situations in particular:

- If you adjust the driver's seat, the head restraint, the steering wheel or the mirror while the vehicle is in motion
 - If you fasten your seat belt while the vehicle is in motion
- ▶ Before starting the vehicle: in particular, adjust the driver's seat, head restraint, steering wheel and mirror, and fasten your seat belt.

⚠ WARNING Risk of becoming trapped if the seat height is adjusted carelessly

If you adjust the seat height carelessly, you or other vehicle occupants could be trapped and thereby injured.

Children in particular could accidentally press the electrical seat adjustment buttons and become trapped.

- ▶ While moving the seats, make sure that hands or other body parts do not get under the lever assembly of the seat adjustment system.

⚠ WARNING Risk of injury due to head restraints not being installed or being adjusted incorrectly

If head restraints have not been installed or have not been adjusted correctly, there is an increased risk of injury in the head and neck area, e.g. in the event of an accident or when braking.

- ▶ Always drive with the head restraints installed.
- ▶ Before driving off, make sure for every vehicle occupant that the center of the head restraint supports the back of the head at about eye level.

Do not interchange the head restraints of the front and rear seats. Otherwise, you will not be able to adjust the height and angle of the head restraints correctly.

Adjust the head restraint fore-and-aft position so that it is as close as possible to the back of your head.

⚠ WARNING Risk of injury or death due to an incorrect seat position

The seat belt does not offer the intended level of protection if you have not moved the seat backrest to an almost vertical position.

In particular, you could slip beneath the seat-belt and become injured.

- ▶ Adjust the seat properly before beginning your journey.
- ▶ Always ensure that the seat backrest is in an almost vertical position and that the shoulder belt is routed across the center of your shoulder.

⚠ WARNING Risk of injury due to excessive load on the grab handles

If you apply your full body weight to the grab handle or pull it abruptly, the grab handle may be damaged or come loose from its anchorage. This may result in injuries.

- ▶ Use the grab handles only to stabilize the seating position or to assist in getting in and out of the seat.

⚠ WARNING Risk of potentially fatal injuries due to objects trapped under the front passenger seat

Objects trapped under the front passenger seat may interfere with the function of the automatic front passenger air bag shutoff or damage the system.

- ▶ Do not stow any objects under the front passenger seat.
- ▶ When the front passenger seat is occupied, ensure that no objects have become trapped beneath the front passenger seat.

Adjusting the seat fore-and-aft position

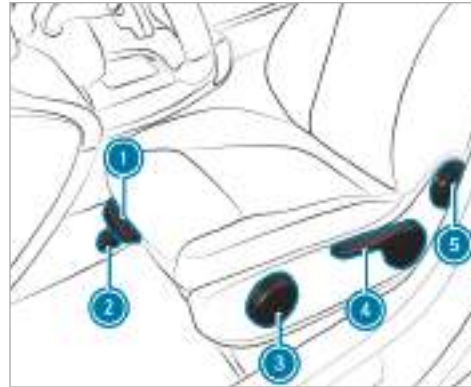

- ▶ Lift lever ② and slide the seat into the desired position.
- ▶ Make sure that the seat is engaged.
- ▶ **To adjust the seat cushion length (driver's seat only):** lift lever ① and slide the front section of the seat cushion forwards or backwards.

- ▶ **To adjust the seat cushion inclination:** turn handwheel ③ forwards and backwards until the desired position has been reached.
- ▶ **To adjust the seat height:** push or pull lever ④ until the desired position has been reached.
- ▶ **To adjust the seat backrest inclination:** turn handwheel ⑤ forwards and backwards until the desired position has been reached.

Adjusting the front seat electrically

You can adjust the seats when the vehicle is switched off.



- ① Seat backrest inclination
- ② Seat height
- ③ Seat cushion inclination
- ④ Seat fore-and-aft position

► Save the settings with the memory function (→ page 108).

Adjusting the 4-way lumbar support

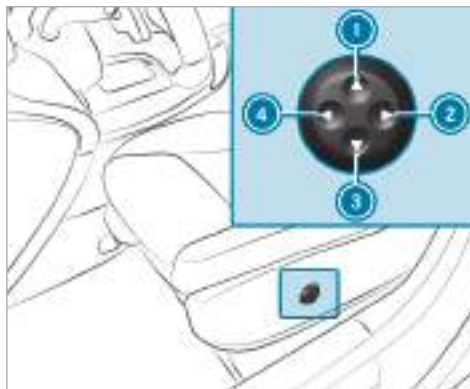

- ① Higher
- ② Softer
- ③ Lower
- ④ Firmer

► Use buttons ① to ④ to adjust the contour of the backrest.

Adjusting rear seats mechanically

▲ WARNING Risk of becoming trapped when adjusting the seats

When you adjust a seat, you may trap yourself or a vehicle occupant.

- When adjusting a seat, make sure that no one has any body parts in the sweep of the seat.

▲ WARNING Risk of accident if the seat and seat backrest are not engaged

The seat and seat backrest can fold forwards. There is a risk of the following, in particular:

- The vehicle occupant may be pressed against the seat belt. The seat belt cannot protect as intended and could cause additional injury.
- A child restraint system will no longer be properly supported or positioned and will no longer fulfill its function as intended.

- The seat backrest will not be able restrain objects or goods in the cargo compartment.

Always ensure that the seat and seat backrest are engaged, in particular:

- Before persons travel in the vehicle while sitting on a seat with the easy entry and exit feature
- After the seat has been adjusted.
- After the easy entry and exit feature has been used
- After the cargo compartment enlargement has been folded forwards

⚠ WARNING Risk of injury from adjusting the rear seats while driving

You can trap yourself or other vehicle occupants and injure them.

- ▶ Adjust the rear seats before starting the vehicle.

! **NOTE** Damage caused by objects in the footwell or behind the rear seats

When adjusting the fore-and-aft position, the rear seats and/or the object can be damaged.

- ▶ Stow objects in a suitable place.

This function is available only for vehicles with a movable rear bench seat.

The components of the rear bench seat can be moved. You can move the right-hand and left-hand parts together with the center part independently of each other.



- ▶ Lift release handle ① and slide the corresponding part of the bench seat into the desired position.
- ▶ Let go of release handle ①.
- ▶ Make sure that the seat is engaged.

Adjusting the rear seat backrests mechanically

▲ WARNING Risk of becoming trapped if the seat is not engaged

The seat does not engage when folded forwards. The seat can fold backwards unexpectedly, e.g. when accelerating, braking or in the event of an abrupt change of direction or an accident.

People in the seat's sweep can become trapped.

- ▶ If a seat is folded forwards, always fold it back before driving off.
- ▶ Make sure that the seat is engaged.

Requirements:

- The area into which the seat is folded is clear.

Adjusting the seat backrest

You can fold the seat backrests on the second row of seats forwards for the following situations:

- For easier access to the cargo compartment

You can set the seat backrest to different angles.

If you no longer require the seat backrest to be folded down for getting in and out, fold it back into place.



- ▶ Hold the seat backrest in place with your hand or back.
- ▶ Gently pull one of release loops ① and fold the seat backrest forwards or backwards.
- ▶ Ensure that the seat backrest is engaged.

Head restraints

Adjusting the front seat head restraints manually

▲ WARNING Risk of accident due to adjusting the vehicle settings while the vehicle is in motion

You could lose control of the vehicle in the following situations in particular:

- If you adjust the driver's seat, the head restraint, the steering wheel or the mirror while the vehicle is in motion
- If you fasten your seat belt while the vehicle is in motion
- ▶ Before starting the vehicle: in particular, adjust the driver's seat, head restraint, steering wheel and mirror, and fasten your seat belt.

▲ WARNING Risk of injury due to head restraints not being installed or being adjusted incorrectly

If head restraints have not been installed or have not been adjusted correctly, there is an increased risk of injury in the head and neck area, e.g. in the event of an accident or when braking.

- ▶ Always drive with the head restraints installed.
- ▶ Before driving off, make sure for every vehicle occupant that the center of the head restraint supports the back of the head at about eye level.

Do not interchange the head restraints of the front and rear seats. Otherwise, you will not be able to adjust the height and angle of the head restraints correctly.

Adjust the head restraint fore-and-aft position so that it is as close as possible to the back of your head.

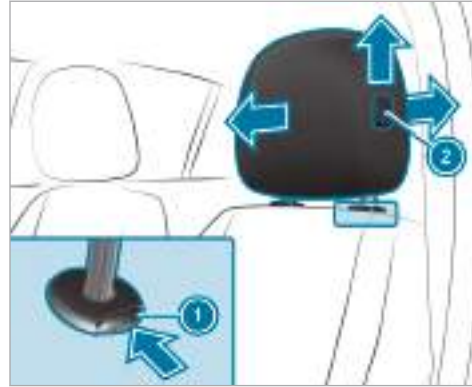

- ▶ **To raise:** pull the head restraint up.
- ▶ **To lower:** press release knob ① in the direction of the arrow and push the head restraint down.
- ▶ **To move the driver's head restraint forwards:** press release knob ② and pull the head restraint forwards.

- ▶ **To move the driver's head restraint backwards:** press release knob ② and push the head restraint backwards.

▶ Adjusting the head restraints of the rear seats manually

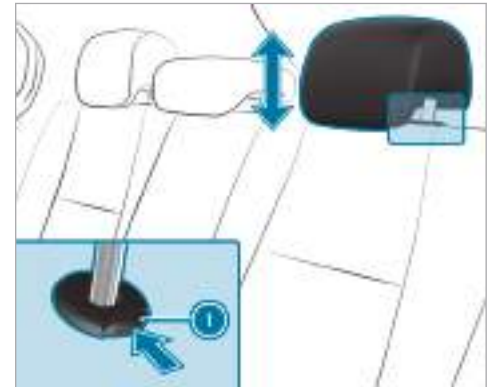

- ▶ **To raise:** pull the head restraint up.

- ▶ **To lower:** press release knob ① in the direction of the arrow and push the head restraint down.
- ▶ **If the center seat on the second row of seats is not occupied:** press the head restraint down all the way.

Installing/removing the rear seat head restraints

Removing

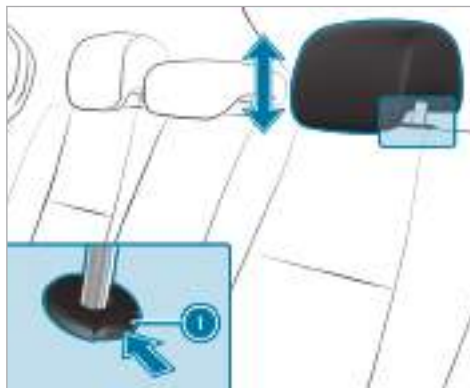

- ▶ Release the rear seat backrest and fold it forwards slightly (→ page 111).
- ▶ Pull the head restraint upwards as far as it will go.

- ▶ Push release knob ① in the direction of the arrow and pull out the head restraint.

Installing

- ▶ Insert the head restraint such that the notches on the bar are on the left when viewed in the direction of travel.
- ▶ Push the head restraint down until it engages.
- ▶ Fold the rear seat backrest back until it engages.

Configuring the seat settings

Multimedia system:

→  ▶ **Comfort** ▶ **Seat Comfort**

Adjusting the backrest contour in the lumbar region of the seat backrest (lumbar)

- ▶ Select **Lumbar**.
- ▶ Select the settings  for the desired seat.
- ▶ Adjust the air cushions.



Adjusting the backrest side bolsters

- ▶ Select **Side Bolsters**.

- ▶ Adjust the air cushions for the desired seat.



Selecting the massage program for the front seats

Multimedia system:

- ▶  ▶▶ Comfort ▶▶ Massage
- ▶ Select **Wave Massage** or **Pulsating Massage**.
- ▶ Start the program for the desired seat .
- ▶ **To set the massage intensity: switch High Intensity** on or off .

Resetting seat settings

Multimedia system:

- ▶  ▶▶ Comfort ▶▶ Seat Comfort
- ▶ Select  for the desired seat.
- ▶ Confirm the prompt.

Switching the seat heating on/off

⚠ WARNING Risk of burns due to repeatedly switching on the seat heating

Repeatedly switching on the seat heating can cause the seat cushion and seat backrest padding to become very hot.

In particular, the health of persons with limited temperature sensitivity or a limited ability to react to high temperatures may be affected or they may even suffer burn-like injuries.

- ▶ Do not repeatedly switch on the seat heating.

To protect against overheating, the seat heating may be temporarily deactivated after it has been switched on repeatedly.

! NOTE Damage to the seats caused by objects or documents when the seat heating is switched on

When the seat heating is switched on, overheating may occur due to objects or docu-

ments placed on the seats, e.g. seat cushions or child seats. This could cause damage to the seat surface.

- ▶ Make sure that no objects or documents are on the seats when the seat heating is switched on.

Requirements

- The power supply is switched on.

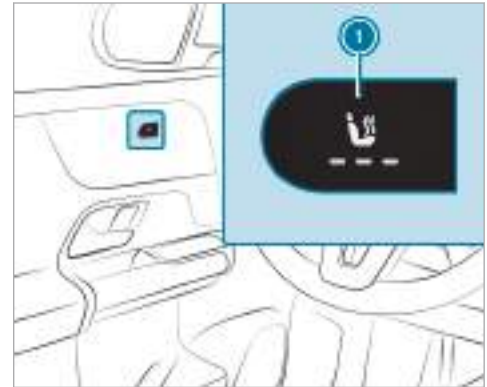

- ▶ Press button ❶ repeatedly until the desired heating level is set. Depending on the heating level, up to three indicator lamps will light up. If all indicator lamps are off, the seat heating is switched off.
- ❶ The seat heating will automatically switch down from the three heating levels after 8, 10 and 20 minutes until the seat heating switches off.

Switching the seat ventilation on/off

Requirements:

- The power supply is switched on.



- ▶ Press button ❶ repeatedly until the desired blower setting has been reached. Depending on the blower setting, up to three indicator lamps will light up. If all indicator lamps are off, the seat ventilation is switched off.

Steering wheel

Adjusting the steering wheel manually

- ⚠ **WARNING** Risk of accident due to adjusting the vehicle settings while the vehicle is in motion

You could lose control of the vehicle in the following situations in particular:

- If you adjust the driver's seat, the head restraint, the steering wheel or the mirror while the vehicle is in motion
- If you fasten your seat belt while the vehicle is in motion

- ▶ Before starting the vehicle: in particular, adjust the driver's seat, head restraint, steering wheel and mirror, and fasten your seat belt.

- ⚠ **WARNING** Risk of entrapment for children when adjusting the steering wheel

Children could injure themselves if they adjust the steering wheel.

- ▶ Never leave children unattended in the vehicle.
- ▶ When leaving the vehicle, always take the key with you and lock the vehicle.

Unlocking



- ▶ Fold release lever ① down as far as it will go.

- ▶ Adjust height ② and distance ③ to the steering wheel.

Locking

- ▶ Fold release lever ① up as far as it will go.
- ▶ Check and make sure that the steering column is locked by moving the steering wheel.

Switching the steering wheel heater on/off

Depending on the vehicle version, the steering wheel heater can be switched on and off using a switch on the steering wheel.

Requirements

- The vehicle is switched on.

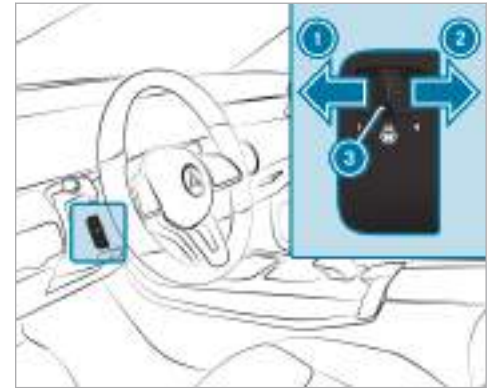

- ▶ Push the switch into position ① or ②. If indicator lamp ③ lights up, the steering wheel heater is switched on.

When you switch the vehicle off, the steering wheel heater will switch off.

Easy entry and exit feature

Using the easy entry and exit feature

⚠ WARNING Risk of accident when pulling away during the adjustment process of the easy entry and exit feature

You could lose control of the vehicle.

- ▶ Always wait until the adjustment process is complete before driving off.

⚠ WARNING Risk of becoming trapped during adjustment of the easy entry and exit feature

You and other vehicle occupants could become trapped.

- ▶ Ensure that no-one has any body parts in the range of movement of the seat.

If there is a risk of becoming trapped by the driver's seat:

- ▶ Press the seat adjustment switch. The adjustment process will be stopped.

You can stop the adjustment process by pressing one of the memory function position switches.

⚠ WARNING Risk of becoming trapped if children activate the easy entry and exit feature

Children could become trapped if they activate the easy entry and exit feature, particularly when unattended.

- ▶ Never leave children unattended in the vehicle.
- ▶ When leaving the vehicle, always take the key with you and lock the vehicle.

When the easy entry and exit feature is active, the driver's seat will move backwards and the backrest will be moved to a steeper position when:

- You switch off the vehicle when the driver's door is open.
- You open the driver's door when the vehicle is switched off.

i The driver's seat will then move backwards only if it is not already at the rear of the seat adjustment range. The seat backrest will then move forwards only if it is not already at the front of the backrest adjustment range.

The driver's seat will move back to the last drive position when:

- You switch the vehicle on when the driver's door is closed.
- You close the driver's door when the vehicle is switched on.

The last drive position will be saved when:

- You switch off the vehicle.
- You call up the seat settings via the memory function.
- You save the seat settings via the memory function.

Setting the easy entry and exit feature

Multimedia system:

- 
 Settings >> Vehicle
 >> Automatic Seat Adjustment
 >> Easy Entry/Exit
- ▶ Activate or deactivate the function.

Memory function

Memory function

⚠ WARNING Risk of an accident if the memory function is used while driving

If you use the memory function on the driver's side while driving, you could lose control of the vehicle as a result of the adjustments being made.

- ▶ Only use the memory function on the driver's side when the vehicle is stationary.

⚠ WARNING Risk of entrapment when adjusting the seat with the memory function

When the memory function adjusts the seat, you and other vehicle occupants – particularly children – could become trapped.

- ▶ During the adjustment process of the memory function, make sure that no one has any body parts in the sweep of the seat.
- ▶ If someone becomes trapped, press a preset position button or seat adjustment switch immediately.

⚠ WARNING Danger of entrapment when memory function is activated by children

When children activate the memory function, they can get trapped, especially if they are unsupervised.

- ▶ Never leave children unattended in the vehicle.

- ▶ When leaving the vehicle, always take the key with you and lock the vehicle.

You can use the memory function when the vehicle is switched off.

Seat adjustments for up to three people can be stored and called up using the memory function.

You can save settings for the following systems:

- Seat
- Seat contour
- Outside mirrors
- Head-up display

Operating the memory function

Storing

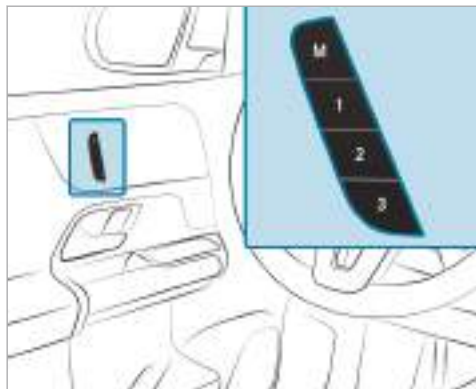

- ▶ Set the desired position for all systems.
- ▶ Briefly press memory button **M** and then press preset position **1**, **2** or **3** within three seconds.

- ▶ **To call up:** press and briefly hold one of preset position buttons **1**, **2** or **3**. After releasing the button, all systems are moved into the stored position.

Stowage areas

Notes on loading the vehicle

⚠ DANGER Risk of exhaust gas poisoning

Combustion engines emit poisonous exhaust gases such as carbon monoxide. Exhaust gases can enter the vehicle interior if the tailgate is open when the engine is running, especially if the vehicle is in motion.

- ▶ Always switch off the engine before opening the tailgate.
- ▶ Never drive with the tailgate open.

Objects in the deployment area of an air bag may prevent the air bag from functioning correctly. Observe the notes on protection provided by the air bag .

⚠ WARNING Risk of injury from unsecured items in the vehicle

If objects, luggage or loads are not secured or not secured sufficiently, they could slip, tip over or be thrown around and thereby hit vehicle occupants.

There is a risk of injury, particularly in the event of sudden braking or a sudden change in direction.

- ▶ Always stow objects in such a way that they cannot be thrown around.
- ▶ Before the journey, secure objects, luggage or loads against slipping or tipping over.

⚠ WARNING Risk of injury due to objects being stowed incorrectly

If objects in the vehicle interior are stowed incorrectly, they can slide or be thrown around and hit vehicle occupants. In addition, cup holders, open storage spaces and mobile phone receptacles cannot always retain all objects within.

There is a risk of injury, particularly in the event of sudden braking or abrupt changes in direction.

- ▶ Always store objects such that they cannot be thrown around in such situations.
- ▶ Always make sure that objects do not protrude from storage spaces, parcel nets or storage nets.
- ▶ Close the lockable storage spaces before starting a journey.
- ▶ Stow and secure objects that are heavy, hard, pointed, sharp-edged, fragile or too large in the cargo compartment.

⚠ WARNING Risk of accident from objects in the driver's footwell and front-passenger footwell

Objects in the driver's footwell and front-passenger footwell may impede pedal travel or block a depressed pedal.

This jeopardizes the operating and road safety of the vehicle.

- ▶ Stow all objects in the vehicle securely so that they cannot get into the driver's footwell or front-passenger footwell.
- ▶ Always install the floor mats securely and as prescribed in order to ensure that there is always sufficient clearance for the pedals.
- ▶ Do not use loose floor mats and do not lay multiple floor mats on top of one another.

Vehicles with automatic front-passenger air bag shutoff: objects trapped under the front-passenger seat may interfere with the function of the automatic front-passenger air bag shutoff or damage the system. Please observe the notes on the function of the automatic front-passenger air bag shutoff (→ page 43).

⚠ WARNING - Risk of accident or injury when using the cup holder while the vehicle is moving

The cup holder cannot secure containers while the vehicle is moving.

If you use a cup holder while the vehicle is moving, the container may be flung around and liquids may be spilled. The vehicle occupants may come into contact with the liquid and if it is hot, they could be scalded. You could be distracted from traffic conditions and you may lose control of the vehicle.

- ▶ Only use the cup holder when the vehicle is stationary.
- ▶ Only use the cup holder for containers of the right size.
- ▶ Close the container, particularly if the liquid is hot.

! NOTE Damage to the cup holder

The cup holder can be damaged when folding back the rear armrest. When open, the cup holder can be damaged by body weight.

- ▶ The rear armrest can only be folded back when the cup holder is closed.
- ▶ Do not sit or support yourself on the cup holder when it is open.

! **NOTE** Damage to the rear armrest due to body weight

When folded out, the rear armrest can be damaged by body weight.

- ▶ Do not sit or support yourself on the rear seat armrest.

! **WARNING** Risk of injury due to an open cargo compartment floor

If you drive with the cargo compartment floor open, objects could be flung around and hit vehicle occupants as a result. There is a risk of injury, particularly in the event of sudden braking or a sudden change in direction.

- ▶ Always close the cargo compartment floor before a journey.

! **WARNING** Risk of fire and injury from hot cigarette lighter

You can suffer burns if you touch the hot heating element or the hot socket of the cigarette lighter.

In addition, flammable materials can catch fire if:

- you drop the hot cigarette lighter.
 - children e.g. hold the hot cigarette lighter to objects.
- ▶ Always hold the cigarette lighter by the knob.
 - ▶ Always make sure that the cigarette lighter is out of the reach of children.
 - ▶ Never leave children unattended in the vehicle.

! **WARNING** Risk of burns from the tailpipe and tailpipe trims

The exhaust tailpipe and tailpipe trims can become very hot. If you come into contact with these parts of the vehicle, you could burn yourself.

- ▶ Always be particularly careful around the tailpipe and the tailpipe trims and supervise children especially closely in this area.

- ▶ Allow vehicle parts to cool down before touching them.

i Leather is a natural product. It exhibits natural surface properties such as differences in structure, marks caused by growth and injury or subtle color differences. These surface properties are characteristics of leather and not material faults. Leather is also subject to a natural aging process during which the surface properties change.

The handling characteristics of your vehicle are dependent on the distribution of the load within the vehicle. You should bear the following in mind when loading the vehicle:

- Do not exceed the permissible total mass or the gross axle weight rating of the vehicle (including load and occupants). The values are specified on the vehicle identification plate on the vehicle's B-pillar.
- The load must not protrude above the upper edge of the seat backrests.
- Always use the partition net when transporting objects in the cargo compartment.

- Always place the load behind unoccupied seats if possible.
- Secure the load using the cargo tie-down rings and distribute the load evenly.

Notes on driving with a roof load

- Distribute the roof load and the load inside the vehicle evenly, placing heavy objects at the bottom. Also comply with the notes on loading the vehicle.
 - Drive attentively, and avoid abrupt starts, braking and steering as well as rapid cornering.
 - When transporting roof loads and when the vehicle is fully loaded or fully occupied, select drive programs **E** and **C**. These are designed to focus on stability (→ page 155).
- i** For more information on stowage compartments and stowage areas, please refer to the Digital Operator's Manual.

Stowage spaces in the vehicle interior

Overview of the front stowage compartments



- 1 Stowage spaces in the doors
- 2 Stowage compartment in the armrest with a multimedia and USB connection
- 3 Stowage compartment in the front center console with a USB port
- 4 Glove box

Through-loading feature in the rear bench seat (EASY-PACK Quickfold)

Folding the rear seat backrest forwards

⚠ WARNING Risk of becoming trapped when adjusting the seats

When you adjust a seat, you may trap yourself or a vehicle occupant.

- ▶ When adjusting a seat, make sure that no one has any body parts in the sweep of the seat.

⚠ WARNING Risk of accident if the rear bench seat, rear seat and seat backrest are not engaged

The rear bench seat, rear seat and seat backrest may fold forwards, even when you are driving.

- As a result, the vehicle occupant will be pushed into the seat belt with increased force. The seat belt will not be able to pro-

tect as intended and could cause additional injury.

- Objects or loads in the trunk or cargo compartment will not be restrained by the seat backrest.
- ▶ Make sure that the rear bench seat, the rear seat and the seat backrest are engaged before every trip.

If the seat backrests are not engaged and locked in place, the lock verification indicator will be red.

Always ensure that all vehicle occupants have their seat belts fastened correctly and are sitting properly. Particular attention must be paid to children.

If you no longer require the folded-down seat backrest as a loading area, fold the backrest back into place.

Requirements:

- The area into which the seat backrest is folded is clear.
- To fold the center seat backrest forwards: the center seat backrest has been unlocked.

- The armrest on the second row of seats is folded back and the cup holders are empty.

Folding the left and right seat backrests forwards

You can fold the center and outer seat backrests forwards.



- ▶ If necessary, fully insert the seat backrest head restraints (→ page 101).
- ▶ Pull release lever ①.

Folding the center seat backrest forwards



- ▶ Pull release catch ③ for seat backrest ② forwards.
- ▶ Fold the corresponding seat backrest forwards.

Folding the rear seat backrest back

⚠ WARNING Risk of becoming trapped when adjusting the seats

When you adjust a seat, you may trap yourself or a vehicle occupant.

- ▶ When adjusting a seat, make sure that no one has any body parts in the sweep of the seat.

! NOTE Damage caused by trapping the seat belt when folding back the seat backrest

The seat belt could become trapped and thus damaged when the seat backrest is folded back.

- ▶ Make sure that the seat belt is not trapped when folding back the seat backrest.

- ▶ Move the driver's or front passenger seat forwards, if necessary.



- ▶ Fold the corresponding seat backrest ① back until it engages.

Vehicles without a movable rear bench seat: if a rear seat backrest is not engaged and locked in place, red lock verification indicator ② or ③ will be visible.

Vehicles with a movable rear bench seat: if the center rear seat backrest is not engaged and locked in place, red lock verification indicator ③

will be visible. The outer seat backrests lock automatically when they are not in the folded down position.

Locking the release catch of the center rear seat backrest

Requirements:

- The left and center seat backrests are engaged and joined together.

You can lock the center seat backrest. The center seat backrest can then be folded forwards only together with the left seat backrest.

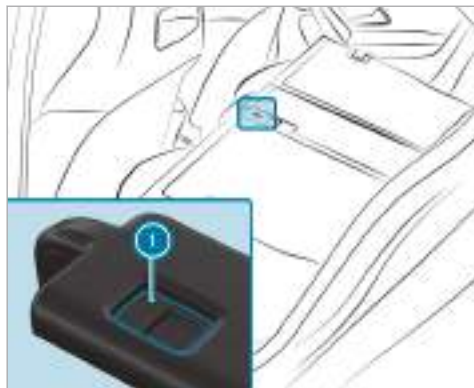

- ▶ Fold the center and left seat backrests forwards.
- ▶ **To lock or unlock:** slide catch ① upwards or downwards.

Adjusting the angle of the rear seat backrests

⚠ WARNING Risk of an accident from the rear bench seat and seat backrest not being engaged

The rear bench seat and seat backrest can fold forwards, even when the vehicle is in motion.

- As a result, vehicle occupants will be pressed more strongly against the seat belt. The seat belt cannot protect as intended and could cause additional injury.
 - Objects or cargo in the trunk/cargo compartment cannot be restrained by the seat backrest.
- ▶ Before starting every journey, ensure that the rear bench seat and seat backrests are engaged.

For vehicles with longitudinally adjustable rear seats, you can also adjust the angle of the rear seat backrests. There are several possible detent positions.

! **NOTE** Damage to the release loops due to the attachment of objects

The release loops of the seat backrests in the rear passenger compartment may be damaged due to the attachment of objects.

- ▶ Only attach objects to the tie-down eyes.



- ▶ Pull right or left release loop ② forwards in the direction of the arrow. Corresponding seat backrest ① will be unlocked.
- ▶ Move seat backrest ① to the desired angle.
- ▶ Let go of the release loop ②.
- ▶ Ensure that the seat backrest is engaged.

Vehicles without a movable rear bench seat: if a rear seat backrest is not engaged and locked in place, the red lock verification indicator will be visible.

Vehicles with a movable rear bench seat: if the center rear seat backrest is not engaged and locked in place, the red lock verification indicator will be visible. The outer seat backrests lock automatically when they are not in the folded down position.

Cargo compartment cover

Installing and removing the cargo compartment cover

⚠ WARNING Risk of injury or death due to poorly secured objects

The cargo compartment cover alone cannot secure or restrain heavy objects, items of luggage or heavy loads.

You could be hit by an unsecured load, particularly in the event of abrupt changes in direction, sudden braking or an accident.

- ▶ Always stow objects in such a way that they cannot be thrown around.
- ▶ Secure objects, luggage or loads against slipping or tipping over, e.g. by using tie downs, even if you are using the cargo compartment cover.

Requirements

- Do not load the cargo compartment cover with more than 5.5 lb (2.5 kg).

Removing

- ① Please note that the cargo compartment cover must not be pushed further upwards when the tailgate is open.

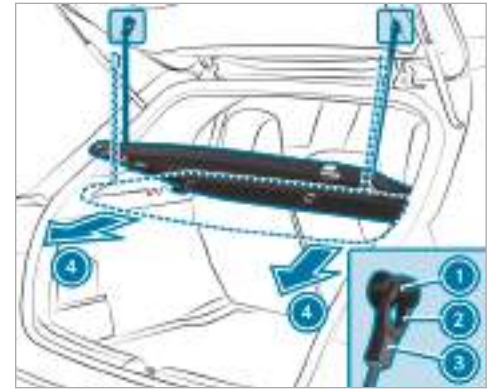

- ▶ Pull hanger ③ on the tailgate upwards out of eyelet ① and unhook it.
- ▶ Swivel the cargo compartment cover downwards and pull it evenly out of the guide rails

on the right and left in the direction of arrow ④.

Installing

- ▶ Place the load compartment cover onto the guide rails on the left and right.
 - ▶ Slide the cargo compartment cover forwards evenly in the guide rails on the right and left with both hands until it engages.
 - ▶ Swivel the cargo compartment cover upwards and hook hanger ③ through eyelet ②.
 - ▶ Pull hanger ③ downwards into eyelet ① until it engages.
- ① Please ensure that the cargo compartment cover is lying flat on the guide rails on the right and left when the tailgate is closed.

Overview of the tie-down eyes

Observe the notes on loading the vehicle (→ page 108).

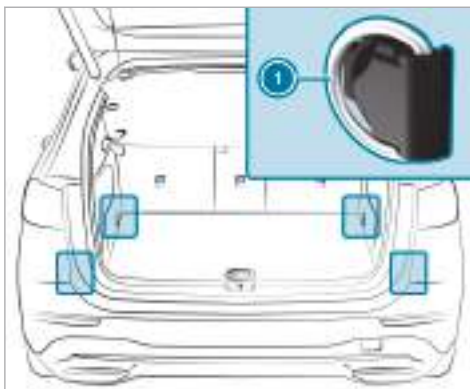

- ① Tie-down eyes (vehicles with through-loading feature in the rear bench seat)

Overview of bag hooks

⚠ WARNING Risk of injury when using bag hooks with heavy objects

The bag hooks cannot restrain heavy objects or items of luggage.

Objects or items of luggage may be flung around and hit vehicle occupants.

- ▶ Only hang light objects on the bag hooks.
- ▶ Never hang hard, sharp-edged or fragile objects on the bag hooks.

Observe the notes on loading the vehicle (→ page 108).

Subject the bag hooks to a maximum load of 6.6 lbs (3 kg) and do not attach any goods to them.



① Bag hook

Overview of clothes hooks on the tailgate

Observe the notes on loading the vehicle (→ page 108).

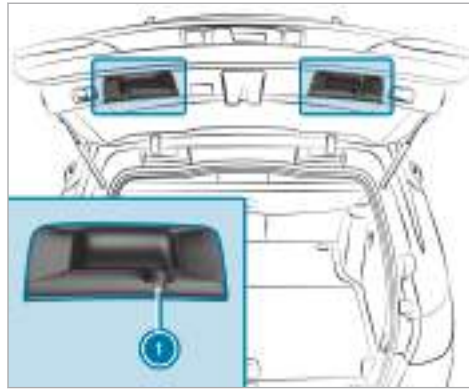

① Clothes hook

The clothes hooks are not suitable for hanging heavy objects as this can cause the tailgate to lower automatically. Use the clothes hooks only for light objects such as jackets.

Attaching the parcel net

⚠ WARNING Risk of injury due to objects being stowed incorrectly

If objects in the vehicle interior are stowed incorrectly, they can slide or be thrown around and hit vehicle occupants. In addition, cup holders, open storage spaces and mobile phone receptacles cannot always retain all objects within.

There is a risk of injury, particularly in the event of sudden braking or abrupt changes in direction.

- ▶ Always store objects such that they cannot be thrown around in such situations.
- ▶ Always make sure that objects do not protrude from storage spaces, parcel nets or storage nets.
- ▶ Close the lockable storage spaces before starting a journey.
- ▶ Stow and secure objects that are heavy, hard, pointed, sharp-edged, fragile or too large in the cargo compartment.

Observe the notes on loading the vehicle.

⚠ WARNING Risk of injury due to an open cargo compartment floor

If you drive with the cargo compartment floor open, objects could be flung around and hit vehicle occupants as a result. There is a risk of injury, particularly in the event of sudden braking or a sudden change in direction.

- ▶ Always close the cargo compartment floor before a journey.
- ▶ Lift the cargo compartment floor upwards using the handle, remove it from the cargo compartment and put it down on a clean surface.

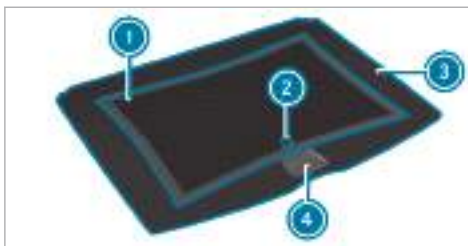

- ▶ Align parcel net ① on cargo compartment floor ③ so that strap ② is positioned at handle ④ and points upwards.



- ▶ Pull rubber sections ⑤ and ⑥ over cargo compartment floor ③ as shown.
- ▶ Align parcel net ① so that
 - Rubber section ⑤ runs underneath recesses ⑦ and beads ⑥ on the left and right are placed on the lower edge of cargo compartment floor ③.
 - Rubber section ⑥ runs above handle ④ and beads ⑧ on the left and right are

placed on the lower edge of cargo compartment floor ③.

❗ Ensure that the parcel net does not block the locking mechanism of the cargo compartment floor.

▶ Close the cargo compartment floor.

Adjusting the cargo compartment floor

Adjusting the height

❗ **NOTE** Damage to the cargo compartment floor due to loading in the upper position with the mounting support removed.

If the cargo compartment floor is loaded in the upper position and the mounting support has been removed, the cargo compartment floor may be damaged.

▶ Make sure that the cargo compartment floor is not loaded in the upper position when the mounting support is removed.

The cargo compartment can be made larger or smaller depending on requirements. To this end,

you can lock the cargo compartment floor at two different heights. The higher position provides a flat surface when the rear seat backrests are folded forward. Furthermore, you can remove a mounting support at the rear to create additional space lengthways.

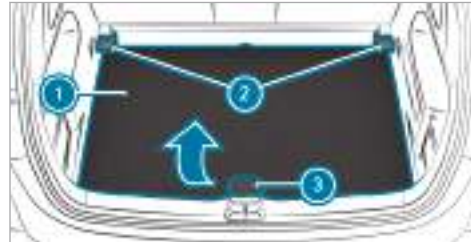

- ▶ Lift cargo compartment floor ① (in the bottom position in the example) only slightly using handle ③ and pull it towards you.
- ▶ Insert cargo compartment floor ① into rear fixtures ②.
- ▶ Fold cargo compartment floor ① down.

Adjusting the length

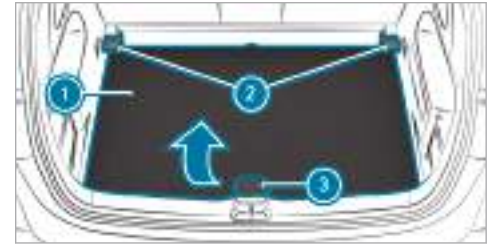

- ▶ Lift cargo compartment floor ① (in the bottom position in the example) only slightly using handle ③ and pull it towards you.
- ▶ Insert cargo compartment floor ① into rear fixtures ②.
- ▶ Fold cargo compartment floor ① down.

Attaching a roof luggage rack

⚠ WARNING Risk of accident due to exceeding the maximum roof load

The vehicle center of gravity and the usual driving characteristics as well as the steering and braking characteristics alter.

If you exceed the maximum roof load, the driving characteristics, as well as steering and braking, will be greatly impaired.

- ▶ Never exceed the maximum roof load and adjust your driving style.

You will find information on the maximum roof load in the "Technical data" section.

! NOTE Damage to the vehicle due to not observing the maximum permitted headroom clearance

If the vehicle height is greater than the maximum permitted headroom clearance, the roof and other parts of the vehicle may be damaged.

- ▶ Observe the signposted headroom clearance.
- ▶ If the vehicle height is greater than the permitted headroom clearance, do not enter.
- ▶ Observe the changed vehicle height with add-on roof equipment.

! NOTE Damage to the panorama roof with power tilt/sliding panel due to non-approved roof luggage racks

The panorama roof with power tilt/sliding panel may be damaged by the roof luggage rack if you attempt to open it when using a roof luggage rack not tested and approved for Mercedes-Benz.

- ▶ When a roof luggage rack is installed, open the panorama roof with power tilt/sliding panel only if this has been tested and approved for Mercedes-Benz.

The panorama roof with power tilt/sliding panel may be raised to allow ventilation of the vehicle interior.

Notes on driving with a roof load

- Evenly distribute the roof load, and place heavy objects at the bottom. Also comply with the notes on loading the vehicle (→ page 108).
- Drive attentively, and avoid suddenly pulling away, braking and steering as well as rapid cornering.
- When transporting roof loads and when the vehicle is fully loaded or fully occupied, select drive programs **E** and **C**. These are designed to focus on stability (→ page 155).

- ▶ Secure the roof luggage rack to the roof railing.
- ▶ Observe the manufacturer's installation instructions.

Sockets

Using the 12 V socket

Requirements

- Only devices up to a maximum of 180 W (15 A) are permissible.

Depending on the vehicle equipment, the vehicle has the following 12 V sockets:

- In the stowage compartment in the front center console
- In the cargo compartment

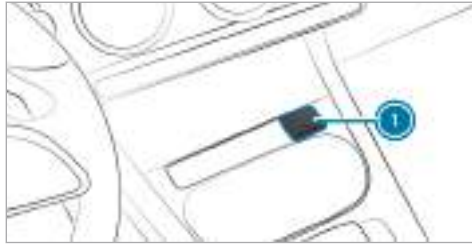

Example: 12 V socket in the stowage compartment in the front center console

- ▶ Fold up socket cap ①.
- ▶ Insert the plug of the device.

12 V socket in the stowage compartment with cover: if you have connected a device to the 12 V socket, leave the cover of the stowage compartment open.

Using the 115 V socket in the rear passenger compartment

⚠ DANGER Risk of fatal injuries due to a damaged connecting cable or a damaged socket

You could receive an electric shock if the connecting cable or the 115 V power socket is pulled out of the trim or is damaged or wet.

- ▶ Use only connecting cables that are dry and free of damage.
- ▶ When the vehicle is switched off, make sure that the 115 V power socket is dry.
- ▶ Immediately have the 115 V power socket checked or replaced at a qualified specialized workshop if it is damaged or has been pulled out of the trim.
- ▶ Never plug the connecting cable into a 115 V power socket that is damaged or has been pulled out of the trim.

⚠ DANGER Risk of death due to using the socket incorrectly

In particular, you could receive an electric shock:

- If you touch the inside of the socket
- If you insert unsuitable devices or objects into the socket
- ▶ Do not touch the inside of the socket.
- ▶ Only connect suitable devices to the socket.

Make sure that no liquids get into the 115 V socket.

When the 115 V socket is not in use, keep the socket flap closed.

Requirements

- The device is equipped with a suitable plug which conforms to the standards specific to the country you are in.
- A device up to a maximum of 150 W (1.3 A) is used.
- Do not use multiple socket outlets.



- ▶ Open socket flap ③.
 - ▶ Insert the plug of the device into 115 V socket ①.
- When the on-board electrical system voltage is sufficient, indicator lamp ② lights up.

USB port in the rear passenger compartment

- ① Depending on the vehicle equipment, the design of the stowage compartment and the number of USB ports in the rear passenger compartment center console may vary.

When the vehicle is switched on, you can charge a USB device, such as a mobile phone, at the USB port using a suitable charging cable.

Wireless charging of the mobile phone and connection with the exterior antenna

Notes on wirelessly charging a mobile phone

⚠ WARNING Risk of injury due to objects being stowed incorrectly

If objects in the vehicle interior are stowed incorrectly, they can slide or be thrown around and hit vehicle occupants. In addition, cup holders, open stowage spaces and mobile phone receptacles cannot always retain all objects within.

There is a risk of injury, particularly in the event of sudden braking or a sudden change in direction.

- ▶ Always stow objects so that they cannot be thrown around in such situations.
- ▶ Always make sure that objects do not protrude from stowage spaces, parcel nets or stowage nets.
- ▶ Close the lockable stowage spaces before starting a journey.
- ▶ Always stow and secure heavy, hard, pointed, sharp-edged, fragile or bulky objects in the trunk/cargo compartment.

Observe the notes on loading the vehicle.

⚠ WARNING Risk of fire from placing objects in the mobile phone storage compartment

Placing other objects in the mobile phone storage compartment could constitute a fire hazard.

- ▶ Apart from a mobile phone, do not place any other objects in the mobile phone storage compartment, especially those made of metal.

! **NOTE** Damage to objects caused by placing them in the mobile phone storage compartment

If objects are placed in the mobile phone storage compartment, these may be damaged by electromagnetic fields.

- ▶ Do not place credit cards, storage media, ski passes or other objects sensitive to electromagnetic fields in the mobile phone storage compartment.

! **NOTE** Damage to the mobile phone storage compartment caused by liquids

If liquids enter the mobile phone storage compartment, the compartment may be damaged.

- ▶ Ensure that no liquids enter the mobile phone storage compartment.

The following notes on wirelessly charging the mobile phone must be observed:

- Depending on the vehicle equipment, the mobile phone is connected to the vehicle's exterior antenna via the charging module.
- The charging function and wireless connection of the mobile phone to the vehicle's exterior antenna are available only if the vehicle is switched on.
- Small mobile phones may not be able to be charged in every position of the mobile phone storage compartment.
- Large mobile phones that do not rest flat in the mobile phone storage compartment may not be able to be charged or connected with the vehicle's exterior antenna.
- The mobile phone may heat up during the charging process. This may particularly depend on the applications (apps) currently open in the background.
- To ensure more efficient charging and connection with the vehicle's exterior antenna, remove the protective cover from the mobile

phone. Protective covers which are necessary for wireless charging are an exception.

Charging a mobile phone wirelessly

Requirements

- The mobile phone is suitable for wireless charging.

A list of compatible mobile phones can be found at: <https://www.mercedes-benz-mobile.com>.



- ▶ Place the mobile phone as close to the center of the marked surface on mat ❶ as possible with the display facing upwards. When a message is shown in the multimedia system, the mobile phone is being charged. Malfunctions during the charging process are shown on the central display.

❶ The mat can be removed for cleaning, e.g. using clean, lukewarm water.

Stowage compartment without cover

Make sure the mobile phone is properly stored and secured to prevent it from falling out while you are driving.



- ▶ To secure the mobile phone: swing lever ❷ out.

Installing/removing the floor mats

⚠ WARNING Risk of accident due to objects in the driver's footwell

Objects in the driver's footwell may impede pedal travel or block a depressed pedal.

This jeopardizes the operating and road safety of the vehicle.

- ▶ Stow all objects in the vehicle securely so that they cannot get into the driver's footwell.
- ▶ Always install the floor mats securely and as prescribed in order to ensure that there is always sufficient room for the pedals.
- ▶ Do not use loose floor mats and do not place floor mats on top of one another.

Installing floor mats

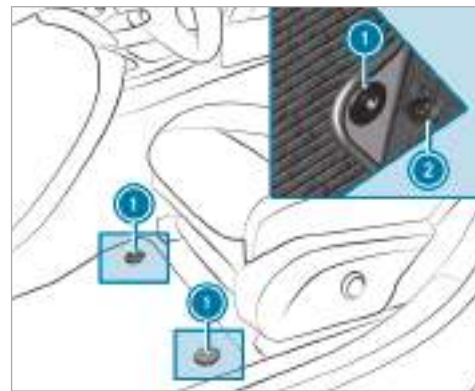

- ▶ Slide the corresponding seat backwards and lay the floor mat in the footwell.
- ▶ Press studs ❶ onto holders ❷.
- ▶ Adjust the corresponding seat.

Removing floor mats

- ▶ Pull the floor mat off holders ❷.

- ▶ Remove the floor mat.

Exterior lighting





Information about lighting systems and your responsibility

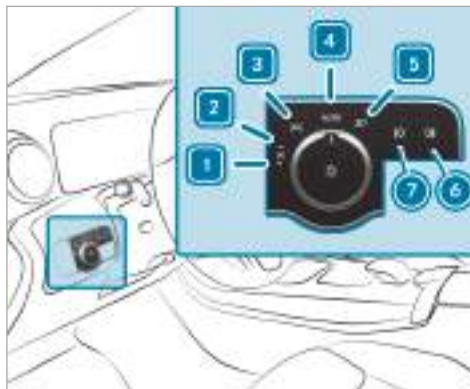

The various lighting systems of the vehicle are only aids. The driver of the vehicle is responsible for correct vehicle illumination in accordance with the prevailing light and visibility conditions, legal requirements and traffic situation.



Light switch

Operating the light switch



- 1  Left-hand parking lights
- 2  Right-hand parking lights
- 3  Side lamps and license plate lamp
- 4  Automatic driving lights (preferred light switch position)

- 5  Low beam/high beam
- 6  Switches the rear fog light on/off.
- 7  Switches the front fog lamps on/off.

When low beam is activated, the  indicator lamp for the side lamps will be deactivated and replaced by the  low-beam indicator lamp.

▶ Always park your vehicle safely using sufficient lighting, in accordance with the relevant legal stipulations.

! **NOTE** Battery discharging by operating the parking lamps

Do not have the parking lamps switched on over a period of several hours.

If the battery is insufficiently charged, the side lamps or parking lights will be switched off automatically to facilitate the next engine start.

The exterior lighting (except side lamps and parking lights) will switch off automatically when the driver's door is opened.

- Observe the notes on surround lighting (→ page 130).

Automatic driving lights function

When the vehicle is switched on, the parking lamps, low beam and daytime running lights will be switched on automatically depending on the ambient light.

⚠ WARNING Risk of accident when the low beam is switched off in poor visibility



When the light switch is set to **AUTO**, the low beam may not be switched on automatically if there is fog, snow or other causes of poor visibility such as spray.

▶ In such cases, turn the light switch to .

The automatic driving lights are only an aid. You are responsible for the vehicle lighting.

Switching the rear fog light on/off

Requirements:

- The light switch is in the  or **AUTO** position.
- ▶ Press button .

Please observe the country-specific laws on the use of rear fog lamps.



Operating the combination switch for the lights



- ① High beam
- ② Turn signal light, right
- ③ Headlamp flashing
- ④ Turn signal light, left

- ▶ Use the combination switch to select the desired function.

Switching on high beam

- ▶ Turn the light switch to the  or **AUTO** position.
- ▶ Push the combination switch in the direction of arrow ①. When high beam is activated, the indicator lamp for low beam  will be deactivated and replaced by the indicator lamp for high beam .

Switching off high beam

- ▶ Push the combination switch in the direction of arrow ① or pull it in the direction of arrow ③.

Headlamp flashing

- ▶ Pull the combination switch in the direction of arrow ③.

Turn signals

▶ **To indicate briefly:** push the combination switch briefly to the point of resistance in the direction of arrow ② or ④. The corresponding turn signal light will flash three times.

▶ **To indicate permanently:** push the combination switch beyond the point of resistance in the direction of arrow ② or ④.

Vehicles with Active Lane Change Assist:

- A turn signal indicator activated by the driver may continue to operate for the duration of the lane change.
- If the driver indicated directly beforehand but a lane change was not immediately possible, the turn signal indicator may activate automatically.

Activating/deactivating the hazard warning lights

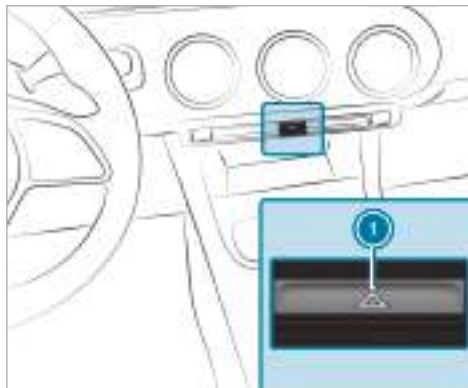

▶ Press button ①.

The hazard warning lights will switch on automatically if:

- the air bag has been deployed.

Cornering light

▶ Cornering light function

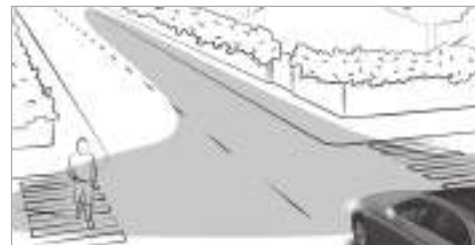

The cornering light improves the illumination of the road over a wide angle in the turning direction, enabling better visibility on tight bends, for example. The cornering light will be activated only when low beam is switched on.

The function will be active in the following cases:

- At speeds below 25 mph (40 km/h) when the turn signal light is switched on or the steering wheel is turned

- At speeds between 25 mph (40 km/h) and 43 mph (70 km/h) and when the steering wheel is turned

Traffic circle and intersection function: the cornering light will be activated on both sides based on an evaluation of the vehicle's current navigation position. It will remain active until after the vehicle has left the traffic circle or intersection.

Active headlamps

Active headlamps function



- The headlamps follow the steering movements.

- Relevant areas are better illuminated during a journey.

The functions are active when the high beam is switched on.

Adaptive Highbeam Assist

Adaptive Highbeam Assist function

⚠ WARNING Risk of accident despite Adaptive Highbeam Assist

Adaptive Highbeam Assist does not react to:

- Road users without lights, e.g. pedestrians
- Road users with poor lighting, e.g. cyclists
- Road users whose lighting is obstructed, e.g. by a barrier

On very rare occasions, Adaptive Highbeam Assist may fail to recognize other road users with their own lighting, or may recognize them too late.

In these, or in similar situations, the automatic high beam will not be deactivated or will be

activated despite the presence of other road users.

- ▶ Always observe the road and traffic conditions carefully and switch off the high beam in good time.

Adaptive Highbeam Assist cannot take into account road, weather or traffic conditions.

Detection may be restricted in the following cases:

- In poor visibility, e.g. fog, heavy rain or snow
- if there is dirt on the sensors or the sensors are obscured

Adaptive Highbeam Assist is only an aid. You are responsible for adjusting the vehicle's lighting to the prevailing light, visibility and traffic conditions.

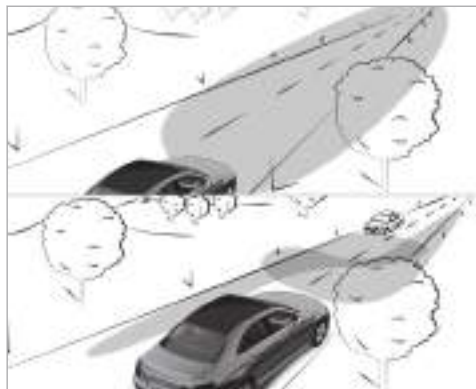

Adaptive Highbeam Assist automatically switches between the following types of light:

- Low-beam headlamps
- High beam

At speeds greater than 19 mph (30 km/h):

- If no other road users are detected, high beam will switch on automatically.

The high beam will switch off automatically in the following cases:

- At speeds below 16 mph (25 km/h)
- If other road users are detected
- If street lighting is sufficient

i The system's optical sensor is located behind the windshield near the overhead control panel.

Switching Adaptive Highbeam Assist on/off

Switching on

- ▶ Turn the light switch to the **AUTO** position.
- ▶ Switch on high beam using the combination switch.

If Adaptive Highbeam Assist is activated, the  indicator lamp will light up in the central display section of the instrument display.

Switching off

- ▶ Switch off high beam using the combination switch.

Setting the exterior lighting switch-off delay time

Requirements:

- The light switch is in the **AUTO** position.

Multimedia system:

 **▶ Settings ▶ Light**
▶ Exterior Lighting Delay

- ▶ Set the switch-off delay time.
When the vehicle's engine is switched off, the exterior lighting will be activated for the set time.

Switching the surround lighting on/off

Multimedia system:

 **▶ Settings ▶ Light**
▶ Locator Lighting

When **Locator Lighting** is active, the exterior lights up for 40 seconds after the vehicle is unlocked. When you start the vehicle, the surround lighting is deactivated and the automatic driving lights are activated.





- ▶ Activate or deactivate the function.

Interior lighting

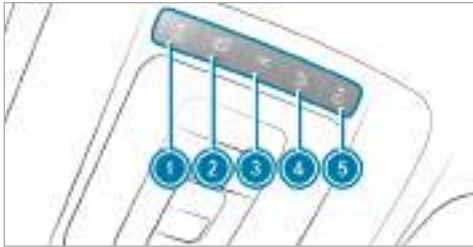
Adjusting the interior lighting

Front overhead control panel



- ①  Rear reading lamp
- ②  Automatic interior lighting control
- ③  Front interior lighting
- ④  Rear interior lighting
- ⑤  Front right reading lamp

▶ **To switch on or off:** press button ① - ⑤ accordingly.

Control panel in the grab handle



- ①  Rear reading lamp

▶ **To switch on or off:** press the ① button.

Adjusting the ambient lighting

Multimedia system:

→  ▶ **Comfort** ▶ **Ambient Lighting**

Setting the color

- ▶ Select **Color**.
- ▶ Set the desired color.

Adjusting the brightness

- ▶ Select **Brightness**.
- ▶ Adjust the brightness.

Activating the brightness for zones

- ▶ Select **Brightness**.
- ▶ Select **Brightness Zones**.
- ▶ Activate or deactivate the function.

or

- ▶ Set the brightness for the desired zones.

Activating multi-color lighting

- ▶ Select **Color**.
- ▶ Select **Multi-color**.
- ▶ Select a color combination.

Activating multi-color animation

- ▶ Select **Color**.
- ▶ Select **Multi-color Animation**.
The chosen color combination will change at predefined intervals.

Activating welcome lighting

- ▶ Select **Color**.
- ▶ Select **Welcome**.
When the vehicle is unlocked, a special ambient lighting sequence will run.

Activating dependency on air conditioning settings

- ▶ Select **Color**.
- ▶ Select **Climate**.
If changes are made to the temperature setting in the vehicle, the color of the ambient lighting will change briefly.





Switching the interior lighting switch-off delay time on/off

Multimedia system:

-  ▶ **Settings** ▶ **Light**
- ▶ **Interior Lighting Delay**
- ▶ Switch the switch-off delay time on or off.
When this function is active, the interior lighting lights up for a short time after the vehicle is locked.



Windshield wiper and windshield washer system**Switching the windshield wipers on/off**

- | | | |
|---|------|----------------------------|
| 1 | 0 | Windshield wipers off |
| 2 | ••• | Automatic wiping, normal |
| 3 | •••• | Automatic wiping, frequent |
| 4 | — | Continuous wiping, slow |
| 5 | = | Continuous wiping, fast |

- ▶ Turn the combination switch to the corresponding position **1** - **5**.
- ▶ **Single wipe/washing:** push the button on the combination switch in the direction of arrow .
 -  Single wipe
 -  Wipes with washer fluid
- ▶  Observe the notes on washing the vehicle in a car wash (→ page 286).

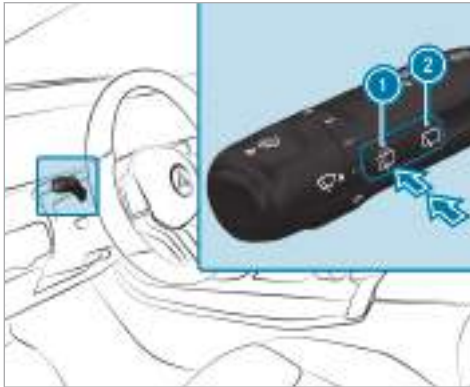
Switching the rear window wiper on/off



- ①  Single wipe/washing
- ②  Intermittent wiping

- ▶ **Single wipe:** press button ① as far as the point of resistance.
- ▶ **Wiping with washer fluid:** press button ① beyond the point of resistance.

- ▶ **Switching intermittent wiping on/off:** press button ②. The  symbol will appear on the instrument display when the rear window wiper is switched on.

Changing the windshield wiper blades

⚠ WARNING Risk of becoming trapped if the windshield wipers are switched on while wiper blades are being replaced

If the windshield wipers begin to move while you are changing the wiper blades, you can be trapped by the wiper arm.

- ▶ Always switch off the windshield wipers and vehicle before changing the wiper blades.

Moving the wiper arms into the replacement position

- ▶ Switch the vehicle on and then off again immediately.

- ▶ Within around 15 seconds, press and hold the  button on the combination switch for approximately three seconds (→ page 132). The wiper arms will move into the replacement position.

Removing the wiper blades

- ▶ Fold the wiper arms away from the windshield.

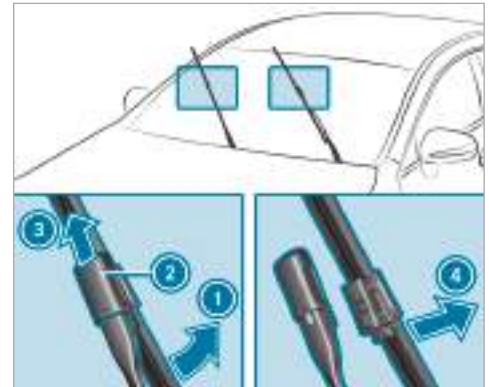

- ▶ Hold the wiper arm with one hand. With the other hand, turn the wiper blade away from the wiper arm in the direction of arrow ① as far as it will go.
- ▶ Slide catch ② in the direction of arrow ③ until it engages in the removal position.
- ▶ Remove the wiper blade from the wiper arm in the direction of arrow ④.

Installing the wiper blades

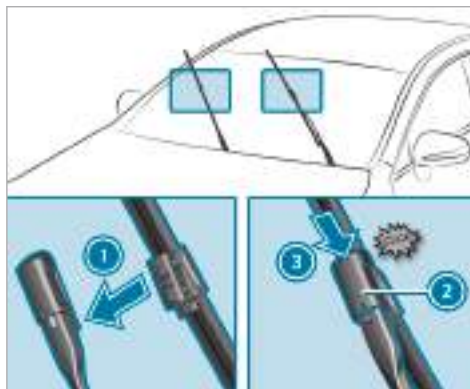

- ▶ Insert the new wiper blade into the wiper arm in the direction of arrow ①.
- ▶ Slide catch ② in the direction of arrow ③ until it engages in the locking position.
- ▶ Make sure that the wiper blade is seated correctly.
- ▶ Fold the wiper arms back onto the windshield.

- ▶ Switch on the vehicle.
- ▶ Press the  button on the combination switch (→ page 132). The wiper arms will return to their original positions.
- ▶ Switch off the vehicle.
- ⓘ Check the condition of the wiper blades regularly and replace them in the event of visible damage or ongoing smearing.

Maintenance display



- ▶ Remove protective film ❶ from the maintenance displays on the tips of the newly installed wiper blades.

When the color of the maintenance displays changes from black to yellow, replace the wiper blades.

- ❶ The duration until the color changes varies depending on the usage conditions.

Replacing the rear window wiper blade

⚠ WARNING Risk of becoming trapped if the windshield wipers are switched on while wiper blades are being replaced

If the windshield wipers begin to move while you are changing the wiper blades, you can be trapped by the wiper arm.

- ▶ Always switch off the windshield wipers and vehicle before changing the wiper blades.

Removing the wiper blade

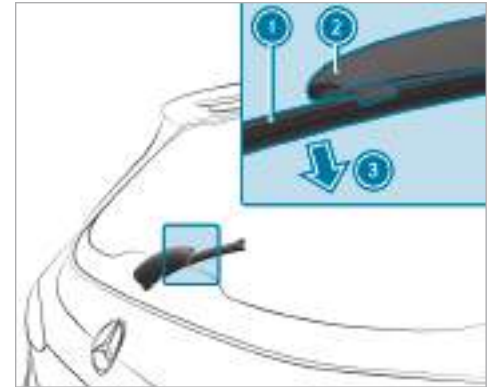

- ▶ Switch off the vehicle.
- ▶ Fold wiper arm ❷ away from the rear window until it engages in the replacement position.
- ▶ Unclip wiper blade ❶ from wiper arm ❷ and remove it in the direction of arrow ❸.

Installing the wiper blades

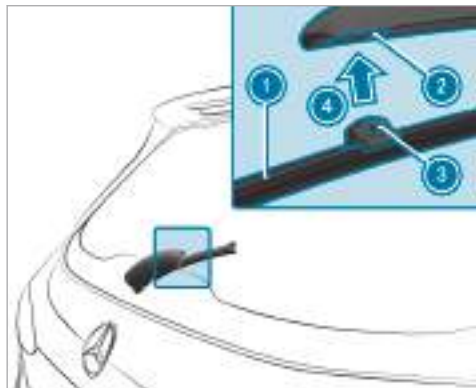

- ▶ Position wiper blade ① with both lugs ③ on holder ② on the wiper arm.
- ▶ Push wiper blade ① in the direction of arrow ④ until it engages in holder ②.
- ▶ Make sure that wiper blade ① is seated correctly.

- ▶ Fold the wiper arm from the replacement position back onto the rear window.

Mirrors

Operating the outside mirrors

- ⚠ **WARNING** Risk of accident due to adjusting the vehicle settings while the vehicle is in motion

You could lose control of the vehicle in the following situations in particular:

- If you adjust the driver's seat, the head restraint, the steering wheel or the mirror while the vehicle is in motion
- If you fasten your seat belt while the vehicle is in motion
- ▶ Before starting the vehicle: in particular, adjust the driver's seat, head restraint, steering wheel and mirror, and fasten your seat belt.

- ⚠ **WARNING** Risk of accident due to misjudgment of distance when using the front-passenger mirror

The outside mirror on the front passenger side reflects objects on a smaller scale. The objects in view are in fact closer than they appear.

- ▶ Therefore, always look over your shoulder to check the actual distance between you and the road users traveling behind you.



- ▶ **To fold in or out:** briefly press button ②.
 - ▶ **To set:** press button ① or ③ to select the outside mirror to be adjusted.
 - ▶ Use button ④ to adjust the position of the mirror glass.
- ⓘ If the battery has been disconnected or completely discharged, you will have to reset the

outside mirrors. Only then will the automatic mirror folding function work properly.

- ▶ **To reset:** briefly press button ②.
An outside mirror that has been pushed out of position can be engaged in position again as follows:
- ▶ **Vehicles without electrically folding outside mirrors:** Manually move the outside mirror into the correct position.
- ▶ **Vehicles with electrically folding outside mirrors:** Press and hold button ②.
You will hear a click and the mirror will audibly click into place. The outside mirror will now be set to the correct position.

Automatic anti-glare mirrors function

⚠ WARNING Risk of acid burns and poisoning due to the anti-glare mirror electrolyte

Electrolyte may escape if the glass in an automatic anti-glare mirror breaks.

The electrolyte is hazardous to health and causes irritation. It must not come into contact

with your skin, eyes, respiratory organs or clothing or be swallowed.

- ▶ If you come into contact with electrolyte, observe the following:
 - Immediately rinse the electrolyte from your skin with water and seek medical attention.
 - If electrolyte comes into contact with your eyes, immediately rinse them thoroughly with clean water and seek medical attention.
 - If the electrolyte is swallowed, immediately rinse your mouth out thoroughly. Do not induce vomiting. Seek medical attention immediately.
 - Immediately change out of clothing which has been contaminated with electrolyte.
 - If an allergic reaction occurs, seek medical attention immediately.

The inside rearview mirror and the outside mirror on the driver's side will automatically go into anti-

glare mode if light from a headlamp hits the sensor on the inside rearview mirror.

System limits

The system will not go into anti-glare mode if:

- The vehicle is switched off.
- Reverse gear is engaged.
- The interior lighting is switched on.

Front-passenger outside mirror parking position function

The parking position makes parking easier.

The front-passenger outside mirror will swivel downwards in the direction of the rear wheel on the front passenger's side when:

- The parking position is stored (→ page 138).
- The front-passenger mirror is selected.
- Reverse gear is engaged.

The front-passenger outside mirror will move back to its original position when:

- You shift the transmission to another transmission position.

- You are traveling at a speed greater than 9 mph (15 km/h).
- You press the button for the outside mirror on the driver's side.

Storing the parking position of the front-passenger outside mirror using reverse gear

Storing

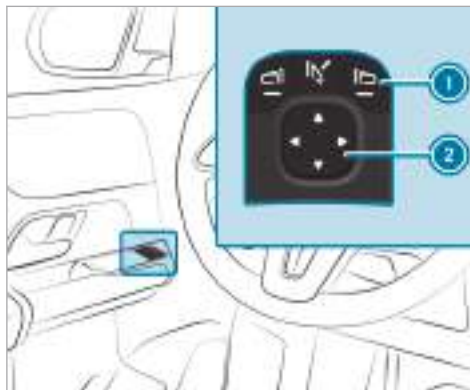

- ▶ Press button ① to select the front-passenger outside mirror.
- ▶ Engage reverse gear.
- ▶ Move the front-passenger outside mirror into the desired parking position using button ②.

Calling up

- ▶ Press button ① to select the front-passenger outside mirror.
- ▶ Engage reverse gear. The front-passenger outside mirror will move into the stored parking position.

Activating/deactivating the automatic mirror folding function

Multimedia system:

→ ▶ Settings ▶ Vehicle

- ▶ Activate or deactivate Automatic Folding.

Overview of climate control systems

Notes on climate control





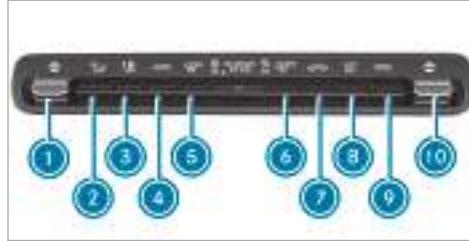

For the air-conditioning system, pollution level monitoring and air filtration to function correctly, an interior air filter must always be used. Make sure that the filter is installed correctly. Use filters recommended and approved by Mercedes-Benz. Always have maintenance work carried out at a qualified specialist workshop.



Overview of the air conditioning control panel

The indicator lamps on the buttons indicate that the corresponding functions are activated.





THERMOTRONIC air conditioning control panel

- ①  Sets the temperature on the driver's side
- ②  Sets the air distribution
- ③  Sets the airflow or switches off climate control
- ④ **AUTO** Sets climate control to automatic mode (→ page 140)
- ⑤  Defrosts the windshield
- ⑥  Switches the rear window defroster on/off
- ⑦  Switches air-recirculation mode on/off (→ page 141)

- ⑧  Switches the A/C function on/off (→ page 140)
Switches the residual heat on/off (→ page 141)
 - ⑨ **SYNC** Activates or deactivates synchronization (→ page 140)
 - ⑩  Sets the temperature on the front passenger side
- ⓘ Residual heat can be used only for vehicles with a diesel engine or with a stationary heater in conjunction with the THERMOTRONIC air conditioning control panel.

Operating the climate control system



Switching climate control on/off

- ▶ **To switch on:** set the airflow to level 1 or higher using the  button.
- ▶ **To switch off:** set the airflow to level 0 using the  button.

If climate control is switched off, the windows may fog up more quickly. Switch climate control off only briefly.

Switching the A/C function on/off using the air conditioning control panel

The A/C function heats, cools and dehumidifies the vehicle's interior air.

- ▶ Press the  /  button.

Switch off the A/C function only briefly; otherwise, the windows may fog up more quickly.

Condensation may drip from the underside of the vehicle when cooling mode is active. This is not indicative of a malfunction.

Calling up the air conditioning menu

Calling up the air conditioning menu using the multimedia system

- ▶ Select one of the temperature displays at the lower edge of the media display.

Activating/deactivating the A/C function via the multimedia system

Multimedia system:



- ▶  Climate Menu ▶▶ First Row of Seats

The A/C function heats, cools and dehumidifies the vehicle's interior air.

- ▶ Select A/C.

Sets climate control to automatic mode

In automatic mode, the set temperature is controlled and maintained at a constant level by the air supply.

- ▶ Press button  .
- ▶ To switch to manual mode: press the  or  button.

In automatic mode, you can choose between five different air quantities using the  button. Automatic mode is retained.

Setting the air distribution

Multimedia system:



- ▶  Climate Menu

- ▶ Call up the air conditioning menu (→ page 140).

- ▶ Select a row of seats.

- ▶ To set the air distribution: select ,  or .

- ▶ Set the airflow.

- ▶  Several air distributions can be selected at the same time, e.g. to air-condition both the windshield and the footwell. The  climate control for the windshield can only be selected for the first seat row.

Switching the synchronization function on/off via the air conditioning control panel

Climate control can be set centrally using the synchronization function. The temperature and air distribution settings for the driver's side will be adopted automatically for the front passenger side.

- ▶ Press the **SYNC** button.

The synchronization function will be deactivated if the settings for one of the other climate zones are changed.

Switching the synchronization function on/off via the multimedia system

Multimedia system:

- ▶ **Climate Menu** ▶ **First Row of Seats**

Climate control can be set centrally using the synchronization function. The driver's settings for temperature, air quantity and air distribution will be adopted automatically for all climate zones.

- ▶ Select **SYNC** and switch it on or off.

Defrosting the windows

Windows fogged up on the inside

- ▶ Press the **AUTO** button.
- ▶ If the windows remain fogged up: press the **MAX** button.

Windows fogged up on the outside

- ▶ Switch on the windshield wipers.
- ▶ Press the **AUTO** button.

Switching air-recirculation mode on/off

- ▶ Press the  button.
The interior air will be recirculated.

Air-recirculation mode automatically switches to fresh air mode after a while.

- ⓘ If air-recirculation mode is switched on, the windows may fog up more quickly. Switch on air-recirculation mode only briefly.

Switching the residual heat on/off (Canada)

Requirements:

- The vehicle is parked.
- ⓘ Only vehicles with a diesel engine can use residual heat.

It is possible to make use of the residual heat from the engine to continue heating or ventilating the front compartment of the vehicle for approx-

imately 30 minutes, depending on the temperature set.

- ▶ **To activate:** press the **A/C** button.

Residual heat will be switched off automatically.

Air vents

Adjusting the front air vents

- ⚠ **WARNING** Risk of burns or frostbite due to being too close to the air vents

Very hot or very cold air can flow from the air vents.

- ▶ Make sure that all vehicle occupants always maintain a sufficient distance from the air vents.
- ▶ If necessary, direct the airflow to another area of the vehicle interior.

To guarantee the flow of fresh air through the air vents into the vehicle interior, note the following:

- Always keep the vents and ventilation grilles in the vehicle interior clear.

- Keep the air inlet free of residue build-up (→ page 285).



- ▶ **To open or close:** hold the center of air vent ❶ and turn it to the left (open) or right (closed) as far as it will go.
- ▶ **To set the airflow direction:** hold the center of air vent ❶ and move it up or down or to the left or right.

Adjusting the rear air vents



- ▶ **To open or close:** hold the center of air vent ❶ and turn it to the left or right as far as it will go.
- ▶ **To set the airflow direction:** hold the center of air vent ❶ and move it up or down or to the left or right.

Driving

Notes on Mercedes-AMG vehicles

Observe the notes on the following additional topics in the Supplement, as you may otherwise fail to recognize dangers:

- Emotion Start
- AMG exhaust system
- RACE START
- DRIFT MODE
- AMG adaptive sport suspension system
- AMG steering-wheel buttons

Switching on the power supply or the vehicle

⚠ WARNING Risk of accident and injury due to children left unattended in the vehicle

If you leave children unattended in the vehicle, they could, in particular:

- open doors, thereby endangering other persons or road users.

- get out and be struck by oncoming traffic.
- operate vehicle equipment and become trapped, for example.

In addition, the children could also set the vehicle in motion by, for example:

- releasing the parking brake.
 - changing the gearbox position.
 - starting the vehicle.
- ▶ Never leave children unattended in the vehicle.
 - ▶ When leaving the vehicle, always take the key with you and lock the vehicle.
 - ▶ Keep the key out of reach of children.

Requirements

- The key is in the vehicle and is recognized.
- **Vehicles with automatic transmission:** The brake pedal is not depressed.

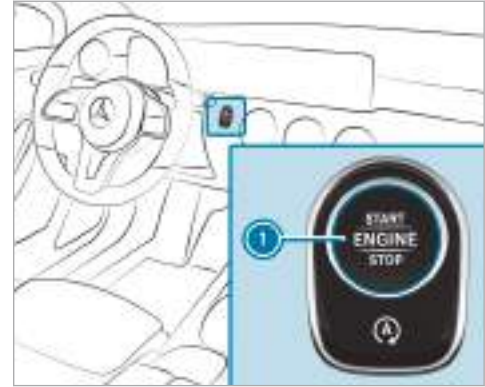

- ▶ **To switch on the power supply:** press button ① once. You can, for example, switch on the windshield wipers.

The power supply will be switched off again if the following conditions are met:

- You open the driver's door.
- You press button ① twice more.

- ▶ **To switch on the vehicle:** press button ① twice. Indicator and warning lamps will light up on the instrument display.

The vehicle will be switched off again if one of the following conditions is met:

- **Vehicles with automatic transmission:** You do not start the vehicle within 15 minutes and the transmission is in position **P** or the electric parking brake is applied.
- You press button ① once.

Starting the vehicle

Starting the vehicle with the start/stop button

⚠ DANGER Risk of death caused by exhaust gases

Combustion engines emit poisonous exhaust gases such as carbon monoxide. Inhaling these exhaust gases is hazardous to health and leads to poisoning.

- ▶ Never leave the engine or, if present, the auxiliary heating running in an enclosed space without sufficient ventilation.

⚠ WARNING Risk of fire due to flammable materials in the engine compartment or on the exhaust system

Flammable materials may ignite.

- ▶ Therefore, regularly check that there are no flammable foreign materials in the engine compartment or on the exhaust system.

Requirements

- The key is in the vehicle and is recognized.
- ▶ Shift the transmission to position **P** or **N**.
- ▶ Depress the brake pedal and press button ① once.
- ▶ Keep the brake pedal depressed until the vehicle starts.

- ▶ If the vehicle does not start: switch off non-essential consumer equipment and press button ① once.

- ▶ If the vehicle still does not start and the **Place the Key in the Marked Space See Operator's Manual** display message appears on the instrument display: start the vehicle with the key in the marked space (emergency operation mode) (→ page 144).

- ① You can switch off the vehicle while driving. To do this, press and hold button ① for approx. three seconds or press button ① three times within three seconds. Observe the safety notes concerning this under "Driving tips" (→ page 147).

Observe any information regarding display messages that may be shown on the instrument display.

Starting the vehicle with the key in the marked space (emergency operation mode)

If the vehicle does not start and the **Place the Key in the Marked Space See Operator's Manual** message appears on the instrument display, you can start the vehicle in emergency mode.

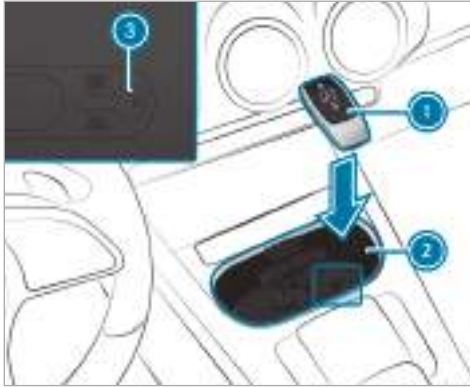

Marked space (example with cup holder without cover)

- ▶ Open the cover of marked space ② if necessary.
- ▶ Make sure that marked space ② is empty.
- ▶ Remove key ① from the key ring.

- ▶ Place key ① on symbol ③ in marked space ②.
The vehicle will start after a short time.
If you remove key ① from marked space ②, the vehicle can still be driven. For further engine starts, however, key ① must be located on symbol ③ in marked space ② during the entire journey.
- ▶ Have key ① checked at a qualified specialist workshop.

If the vehicle does not start:

- ▶ Place key ① in marked space ② and leave it there.
 - ▶ Depress the brake pedal and start the vehicle using the start/stop button.
 - ▶ Keep the brake pedal depressed until the vehicle has started.
- ⓘ You can switch on the power supply or the vehicle with the start/stop button.

Observe any information regarding display messages that may be shown on the instrument display.

Starting the vehicle via Remote Online Services

■ Cooling or heating the vehicle interior before starting the journey

Ensure the following before starting the engine:

- The legal stipulations in the area where your vehicle is parked allow engine starting via smartphone.
- It is safe to start and run the engine where your vehicle is parked.
- The fuel tank is sufficiently full.
- The starter battery is sufficiently charged.

■ Charging the starter battery before starting the journey

You can receive a message on your smartphone when the state of charge of the starter battery is low. You can then start the vehicle with the smartphone to charge the battery. The vehicle is automatically switched off after ten minutes.

Ensure the following before starting the engine:

- The legal stipulations in the area where your vehicle is parked allow engine starting via smartphone.

- It is safe to start and run the engine where your vehicle is parked.
- The fuel tank is sufficiently full.

Starting the vehicle (Remote Online)

⚠ WARNING Risk of crushing or entrapment due to unintentional starting of the engine

Limbs could be crushed or trapped if the engine is started unintentionally during service or maintenance work.

- ▶ Always secure the engine against unintentional starting before carrying out maintenance or repair work.



Requirements

- Park position **P** is selected.
- The anti-theft alarm system is not activated.
- The panic alarm is not activated.
- The hazard warning light system is switched off.
- The hood is closed.
- The doors are closed and locked.

- The windows and sliding sunroof are closed.
- ▶ Start the vehicle using the smartphone. After every engine start, the engine runs for ten minutes.

You can carry out a maximum of two consecutive starting attempts. You must start the engine with the key before trying to start the vehicle again with the smartphone.

You can switch off the vehicle at any time as follows:

- Via the Smartphone App
 - By pressing the  or  button on the key
- i** Further information can be found in the smartphone app.

Securing the vehicle against starting before carrying out maintenance or repair work:

- ▶ Switch on the hazard warning light system.
- or
- ▶ Unlock the doors.
- or

- ▶ Open a side window or the sliding sunroof.

Notes on breaking in a new vehicle

To preserve the engine during the first 1000 miles (1500 km):

- Drive at varying road speeds and engine speeds.
- No faster than 85 mph (140 km/h).
- Drive the vehicle in drive mode **C** or **E**.
- Shift to the next higher gear at the very latest when the needle reaches the last third before the red area in the tachometer.
- Do not shift down manually in order to brake.
- Avoid overstraining the vehicle, e.g. driving at full throttle.
- Increase the engine speed only gradually and accelerate the vehicle to full speed after 1000 miles (1500 km).

This also applies when the engine or parts of the drivetrain have been replaced.

Please also observe the following breaking-in notes:

- In certain handling and driving safety systems, the sensors adjust automatically while a certain distance is being driven after the vehicle has been delivered or after repairs. Full system effectiveness is reached only when this teaching-in process has concluded.
- Brake pads, brake disks and tires that are either new or have been replaced achieve optimum braking effect and grip only after driving several hundred kilometers. Compensate the reduced braking effect by applying greater force to the brake pedal.

Notes on driving

⚠ WARNING Risk of accident due to objects in the driver's footwell

Objects in the driver's footwell may impede pedal travel or block a depressed pedal.

This jeopardizes the operating and road safety of the vehicle.

- ▶ Stow all objects in the vehicle securely so that they cannot get into the driver's footwell.
- ▶ Always install the floor mats securely and as prescribed in order to ensure that there is always sufficient room for the pedals.
- ▶ Do not use loose floor mats and do not place floor mats on top of one another.

⚠ WARNING Risk of accident due to incorrect footwear

Incorrect footwear includes, for example:

- Shoes with platform soles
- Shoes with high heels
- Slippers

There is a risk of an accident.

- ▶ Always wear suitable footwear so that you can operate the pedals safely.

⚠ WARNING Risk of accident if the vehicle is switched off while driving

If you switch off the vehicle while driving, safety functions are restricted or no longer available.

This may affect the power steering system and the brake force boosting, for example.

You will need to use considerably more force to steer and brake, for example.

- ▶ Do not switch off the vehicle while driving.

⚠ DANGER Risk of death caused by exhaust gases

Combustion engines emit poisonous exhaust gases such as carbon monoxide. Inhaling these exhaust gases is hazardous to health and leads to poisoning.

- ▶ Never leave the engine or, if present, the auxiliary heating running in an enclosed space without sufficient ventilation.

⚠ WARNING Risk of skidding and of an accident due to shifting down on slippery road surfaces

If you shift down on slippery road surfaces to increase the engine braking effect, the drive wheels may lose traction.

- ▶ Do not shift down on slippery road surfaces to increase the engine braking effect.

⚠ DANGER Risk of fatal injury due to poisonous exhaust gases

If the tailpipe is blocked or sufficient ventilation is not possible, poisonous exhaust gases such as carbon monoxide may enter the vehicle. This is the case, for example, if the vehicle gets stuck in the snow.

- ▶ Keep the tailpipe and the area around the vehicle free from snow when the engine or the stationary heater is running.

- ▶ Open a window on the side of the vehicle facing away from the wind to ensure an adequate supply of fresh air.

⚠ WARNING Risk of accident and injury due to being under the influence of alcohol and drugs while driving

Drinking and driving and/or taking drugs and driving are very dangerous combinations. Even a small amount of alcohol or drugs can affect your reflexes, perceptions and judgment.

The possibility of a serious or even fatal accident are greatly increased when you drink or take drugs and drive.

- ▶ Do not drink or take drugs and drive or allow anyone to drive who has been drinking or taking drugs.

⚠ WARNING Risk of accident due to the brake system overheating

If you leave your foot on the brake pedal when driving, the brake system may overheat.

This increases the braking distance and the brake system can even fail.

- ▶ Never use the brake pedal as a footrest.
- ▶ Do not depress the brake pedal and the accelerator pedal at the same time while driving.

! NOTE Engine damage due to excessively high engine speeds

The engine will be damaged if you drive with the engine in the overrevving range.

- ▶ Do not drive with the engine in the overrevving range.

! NOTE Wearing out the brake linings by continuously depressing the brake pedal

- ▶ Do not depress the brake pedal continuously whilst driving.
- ▶ To use the braking effect of the engine, shift to a lower gear in good time.

! **NOTE** Damage to the drivetrain and engine when pulling away

- ▶ Do not warm up the engine while the vehicle is stationary. Pull away immediately.
- ▶ Avoid high engine speeds and driving at full throttle until the engine has reached its operating temperature.

! **NOTE** Damage to the catalytic converter due to non-combusted fuel

The engine is not running smoothly and is misfiring.

Non-combusted fuel may get into the catalytic converter.

- ▶ Only depress the accelerator pedal slightly.
- ▶ Have the cause rectified immediately at a qualified specialist workshop.

! **NOTE** Reduced battery life due to frequent short-distance trips

The 12 V battery may not be sufficiently charged when the vehicle is used only for short-distance trips. This reduces the life of the battery.

- ▶ Drive longer distances regularly to charge the battery.

! **NOTE** Damage to the vehicle due to not observing the maximum permitted headroom clearance

If the vehicle height is greater than the maximum permitted headroom clearance, the roof and other parts of the vehicle may be damaged.

- ▶ Observe the signposted headroom clearance.
- ▶ If the vehicle height is greater than the permitted headroom clearance, do not enter.

- ▶ Observe the changed vehicle height with add-on roof equipment.

i Please bear in mind that all the speed values stated in this Operator's Manual are approximate and are subject to a certain tolerance.

Notes on driving with a roof load, trailer or fully laden vehicle

When driving with a loaded roof luggage rack or trailer as well as with a fully laden or fully occupied vehicle, the vehicle's driving and steering characteristics change.

You should therefore bear the following in mind:

- Do not exceed the permissible roof load and towing capacity. Also observe the information in the Technical Data.
- Distribute the roof load and the load inside the vehicle evenly, placing heavy objects at the bottom. Also comply with the notes on loading the vehicle (→ page 108).
- Drive attentively, and avoid abrupt starts, braking and steering as well as rapid cornering.

Advice on driving on salt-strewn roads

The braking effect is limited on salt-strewn road surfaces.

Therefore, observe the following notes:

- Due to salt build-up on the brake disks and brake pads, the braking distance can increase considerably or result in one-sided braking.
- Maintain a much greater safety distance to the vehicle traveling in front.

Remove salt build-up as follows:

- Brake occasionally, paying attention to the traffic conditions
- Carefully depress the brake pedal at the end of the journey and when starting the next journey

Notes on hydroplaning

Hydroplaning can take place if a certain depth of water has built up on the road surface.

Observe the following notes during heavy precipitation or in conditions in which hydroplaning may occur:

- Reduce speed

- Avoid tire ruts
 - Avoid sudden steering movements
 - Brake carefully
-  Also observe the notes on regularly checking wheels and tires (→ page 314).

Notes on driving through water on the road

Water ingress can damage the engine, electrics and transmission.

Water can also enter the air intake of the engine and cause engine damage.

Observe the following if you have to drive through water:

- The water, when calm, may reach no higher than the lower edge of the vehicle body.
- Drive at a walking pace at most; water can otherwise enter the vehicle interior or engine compartment.
- Vehicles traveling in front, or oncoming vehicles, can create waves which may exceed the maximum permissible depth of water.

The braking effect of the brakes is reduced after fording. Brake carefully, paying attention to the

traffic conditions until braking power has been fully restored.

Notes on off-road driving

 **WARNING** Risk of accident if you do not keep to line of fall on inclines

If you drive at an angle or turn on an incline, the vehicle could slip sideways, tip and roll-over.

- ▶ Always drive on inclines in the line of fall (straight up or down) and do not turn.

 **WARNING** Risk of fire caused by flammable material on hot exhaust system components

Flammable material such as leaves, grass or twigs may ignite if they come into contact with hot parts of the exhaust system.

- ▶ When driving on an unpaved road or off-road, check the vehicle underside regularly.

- ▶ In particular, remove trapped plant parts or other flammable material.
- ▶ If there is damage, consult a qualified specialist workshop immediately.

When driving off-road, sand, mud and water or water mixed with oil, etc., may get into the brakes. This may lead to a reduction in braking effect or even a total brake failure as a result of increased wear. The braking characteristics will vary depending on the material that has entered the system. Clean the brakes after driving off-road. If you then notice reduced braking effect or hear scraping noises, have the brake system checked at a qualified specialist workshop. Adapt your driving style to the changed braking characteristics.

! **NOTE** Damage caused by driving over obstacles

The vehicle can be damaged by:

- Driving onto high curbs or unpaved roads.
- Quickly driving over obstacles such as curbs, speed bumps or potholes.

- Heavy objects hitting the underbody or chassis components.
- ▶ Do not drive over obstacles that could damage the vehicle.
- ▶ Check the vehicle regularly for damage during off-road driving.
- ▶ Adjust the vehicle speed to suit the road surface conditions.
- ▶ If there is damage, consult a qualified specialist workshop immediately.



ENVIRONMENTAL NOTE Environmental damage due to non-observance of prohibition signs

Environmental protection has priority. Treat nature with respect.

- ▶ Be sure to observe prohibition signs.

- ① The vehicle is designed for easily negotiable and moderate off-road terrain. When driving off-road, make sure there is sufficient ground clearance.

Checklist before driving off-road

Check the following points before driving off-road:

- Fuel level
- Engine oil level: fill engine oil to the maximum level to ensure full gradeability (→ page 281)
- Tire-change tool kit and spare wheel
- Tires and wheels
- ① Further information about special all-terrain tires for retrofitting can be obtained from a qualified specialist workshop.

Off-road driving

Read this section before driving your vehicle off-road. Practice by driving over gentler off-road terrain first.

- Observe the notes on the cross-country ABS (→ page 175).
- Select the  (→ page 156) drive program before driving off-road.
- Always keep the engine running and in gear when driving on downhill gradients and slopes. Observe the notes on driving in mountainous terrain.

- Do not drive on unknown terrain that is not easily visible and stay on marked paths.
- Always keep the doors and windows closed while the vehicle is in motion.
- Deactivate Active Distance Assist DISTRONIC and cruise control.
- Adapt your driving style to the terrain.
- Do not use the HOLD function on steep downhill or uphill gradients with slippery or loose surfaces.

Driving on sand

When driving on sand, also observe the following instructions:

- Select the  drive program.
- Shift to a lower gear.
- Drive quickly to overcome the rolling resistance; the vehicle may otherwise dig itself in.
- Drive in the tracks of other vehicles if possible. Make sure that the following prerequisites are met:
 - the tire ruts are not too deep.
 - the sand is firm enough.

- there is sufficient ground clearance.

Fording

Also observe the following information when fording:

- Drive no faster than 6 mph (10 km/h).
- The water, when calm, may reach no higher than the lower edge of the vehicle body.
- Switch off automatic climate control (→ page 140).
- Ensure that a bow wave does not form as you drive.
- Do not stop in the water and do not switch off the engine. Ensure the ECO start/stop function is switched off (→ page 154).

Driving in mountainous terrain

Also observe the following information when driving in mountainous terrain:

- Avoid high engine speeds.
- Use the braking power of the engine when driving downhill.

- Shift to a lower gear on uphill gradients and on long, steep downhill gradients.
- Activate DSR before driving downhill, if necessary (→ page 190).

Check-list after driving off-road

Driving off-road places greater demands on your vehicle than driving on normal roads. Check the entire vehicle for damage and foreign bodies every time after driving off-road. Foreign bodies in the wheels or drivetrain can lead to imbalances and therefore vibrations.

- If the  driving mode is selected: select another driving mode.
- Deactivate DSR.
- Apply the brakes to dry them after fording.
- Check that the service brake is working normally after a long downhill stretch.
- Clean the following components every time after driving off-road:
 - license plate number
 - headlamps and tail lamps
 - tires, wheels and wheel arches

- underbody
- After driving through sand, mud, water or gravel, have the following components checked and cleaned:
 - brake disks and brake pads
 - tires and wheels
 - axle joints

ECO start/stop function

■ ECO start/stop function

- ① The ECO start/stop function is not available in all drive programs, depending on the engine. Observe the status display on the instrument display concerning this.

If all vehicle conditions for an automatic engine stop are met, the engine will be switched off automatically:



- You brake the vehicle to a standstill in transmission position **D** or **N**.
- You activate the HOLD function or engage transmission position **P**.



- ① If the system detects an intelligent stop inhibitor, e.g. a stop sign, the engine will not stop. If you activate the HOLD function or engage the park position **P**, the engine can be switched off in spite of an intelligent stop inhibitor.
- ① In transmission position **R**, the engine will not be switched off automatically even when the HOLD function is switched on.

The engine will restart automatically in the following cases:

- You engage transmission position **D** or **R**.
- You depress the accelerator pedal.
- The vehicle requires an automatic engine start.

Status display on the instrument display:

- The  symbol (green) appears when the vehicle is at a standstill: the engine was switched off by the ECO start/stop function.
- The  symbol (yellow) appears when the vehicle is at a standstill: not all vehicle conditions for an engine stop have been met.

- Neither the  symbol nor the  symbol appears when the vehicle is at a standstill: an intelligent stop inhibitor, e.g. a stop sign, has been detected
- The  symbol appears: the ECO start/stop function is deactivated or there is a malfunction.

If the engine was switched off by the ECO start/stop function and you leave the vehicle, a warning tone will sound and the engine will not be restarted. In addition, the following display message will appear on the instrument display:

Vehicle Ready to Drive Switch the Ignition Off Before Exiting

If you do not switch off the vehicle, it will automatically be switched off after three minutes.

Switching the ECO start/stop function on/off

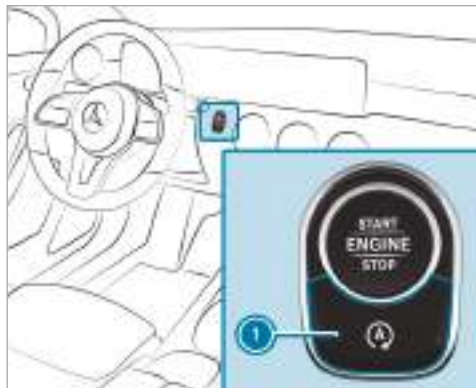

- ▶ Press button ①.
A display will appear on the instrument cluster when you switch the ECO start/stop function on/off.

- ①  will be continuously shown on the instrument cluster while the ECO start/stop function is deactivated.

ECO display function

The ECO display summarizes your driving characteristics from the start of the journey to its completion and assists you in achieving the most economical driving style.

You can influence consumption by doing the following:

- Driving with particular care.
- **Vehicles with automatic transmission:** Driving in drive program **E**.
- Following the gearshift recommendations.



The lettering in the segment will light up brightly, the outer edge will light up and the segment will fill up when the following driving style is adopted:

- ① Steady speed
- ② Gentle deceleration and rolling
- ③ Moderate acceleration

The lettering in the segment will be gray, the outer edge will be dark and the segment will empty when the following driving style is adopted:

- ① Fluctuations in speed
- ② Heavy braking
- ③ Sporty acceleration

The ECO display will show you when you have driven economically:

- The three segments will fill up completely at the same time
- The edges around all three segments will light up

The additional range achieved as a result of your driving style in comparison with a driver with a very sporty driving style will be shown in the cen-

ter of display  4). The range displayed does not indicate a fixed reduction in consumption.

DYNAMIC SELECT switch

Function of the DYNAMIC SELECT switch

NOTE Mercedes-AMG vehicles

- ▶ Observe the notes in the Supplement. You could otherwise fail to recognize dangers.

 Depending on the engine and equipment, the vehicle has different drive programs.

Use the DYNAMIC SELECT switch to change between the following drive programs.

The drive program selected appears on the instrument display.

Individual

- Individual settings

Sport

- Continues to offer stability but with a sporty setup

- Enables a sporty driver to adopt a more active driving style
- Suitable only for good road conditions, a dry surface and a clear stretch of road

Comfort



- Comfortable and economical driving
- Balance between traction and stability
- Recommended for all road conditions

Eco

- Available only for vehicles with automatic transmission
- Particularly economical driving
- Balance between traction and stability
- Recommended for all road conditions

Offroad

- Intervenes later if there is oversteer or understeer, thus improving traction
- Suitable for easily negotiable off-road terrain, such as dirt tracks, gravel or sandy surfaces
- Not suitable for use on public roads

 The ESP[®] settings in the drive programs  and  are designed for stability. Therefore, choose one of these drive programs especially when transporting roof loads, in trailer operation and when the vehicle is fully loaded or fully occupied.

Depending on the drive program, the following systems will change their characteristics:

- Drive
 - Engine and transmission management
 - Active Distance Assist DISTRONIC
- ESP[®]
- **Vehicles with adaptive damping adjustment:** suspension
- Electric power steering

Notes on the roof load display

Certain drive programs and ESP[®] settings are unsuitable for transporting a roof load.

If one of these drive programs is set or selected, the  symbol is shown as a warning. When

this symbol is shown, the selected drive program is not suitable for transporting a load on the roof. The following drive programs are affected:

- **Sport** drive program
 - **Individual** drive program with the Sport ESP® setting
- ① The symbol is also shown in the following situations:
- Within the themes if a corresponding drive program is saved
For more information on themes see .
 - Within the reset display if the previously active drive program is unsuitable for the transport of a roof load
For further information on the reset display, see (→ page 157).

Selecting the drive program

- ① Depending on the equipment, the vehicle will be installed with either a switch or a button.



- ▶ Push DYNAMIC SELECT switch ① forwards or backwards.
The drive program selected will appear on the Instrument Display.



- ▶ Press DYNAMIC SELECT button ②.
The DYNAMIC SELECT menu will appear on the Instrument Display.
- ▶ Press DYNAMIC SELECT button ② again.
The chosen drive program will appear.

Configuring DYNAMIC SELECT (multimedia system)

Multimedia system:

-  ➤ Settings ➤ Vehicle
- DYNAMIC SELECT

Setting drive program I

- ▶ Select **Individual Configuration**.
- ▶ Select and set a category.

Switching the reset display on or off

- ▶ Switch **Request at Start** on or off.

Function on: the next time the vehicle is started a prompt appears asking whether the last active drive program should be restored. If the ECO start/stop function was deactivated, an additional prompt appears asking if the function should remain deactivated.

- ⓘ The prompt only appears if the previously active settings deviate from the standard settings.

Function off: the next time the vehicle is started the  drive program is set automatically. The

ECO start/stop function is activated automatically.

- ⓘ This function must be activated for each user profile separately. Only when this function is activated will the drive program and ECO start/stop setting for the previous journey be saved for the respective user profile.

Displaying vehicle data

Multimedia system:

-  ➤ Info

- ▶ Select **Vehicle**.
The vehicle data is displayed.

Displaying engine data

Multimedia system:

-  ➤ Info

- ▶ Select **Engine**.
The engine data is displayed.

- ⓘ The actual (maximum) values that can be achieved for engine output and engine torque may deviate from the certified values within

the country-specific guidelines for permissible tolerances (basis: UN-ECE No. 85 or country-specific guidelines).

Influencing variables that can influence this are, for example:

- Sea level
- Fuel grade
- Outside temperature
- Operating temperature of the engine

- ⓘ The values displayed serve only as orientation. The values for engine output and engine torque shown on the media display may deviate from the actual values.

Calling up the fuel consumption indicator

Multimedia system:

-  ➤ Info

- ▶ Select **Consumption**.
The current and average fuel consumption is displayed.

Automatic transmission

DIRECT SELECT lever

Function of the DIRECT SELECT lever

⚠ WARNING Risk of accident due to incorrect gearshifting

If the engine speed is higher than the idle speed and you engage the transmission position **D** or **R**, the vehicle may accelerate sharply.

- ▶ If you engage the transmission position **D** or **R** when the vehicle is at a standstill, always depress the brake pedal firmly and do not accelerate at the same time.

⚠ WARNING Risk of accident and injury due to children left unattended in the vehicle

If you leave children unattended in the vehicle, they could, in particular:

- open doors, thereby endangering other persons or road users.
- get out and be struck by oncoming traffic.
- operate vehicle equipment and become trapped, for example.

In addition, the children could also set the vehicle in motion by, for example:

- releasing the parking brake.
 - changing the gearbox position.
 - starting the vehicle.
- ▶ Never leave children unattended in the vehicle.
 - ▶ When leaving the vehicle, always take the key with you and lock the vehicle.
 - ▶ Keep the key out of reach of children.

Use the DIRECT SELECT lever to switch the transmission position. The current transmission position will be shown on the instrument display.

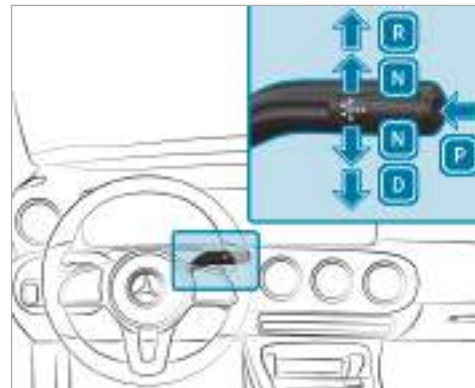

- P** Park position
- R** Reverse gear
- N** Neutral
- D** Drive position

Engaging reverse gear R

- ▶ Depress the brake pedal and push the DIRECT SELECT lever upwards past the first point of resistance.

Engaging neutral N

- ▶ Depress the brake pedal and push the DIRECT SELECT lever up or down to the first point of resistance.

- ⓘ To shift into neutral **N** with the vehicle switched on, push the selector lever up or down for several seconds to the first point of resistance.

Subsequently releasing the brake pedal will allow you to move the vehicle freely, e.g. to push it or tow it away.

Proceed as follows if you want the automatic transmission to remain in neutral **N even if the vehicle is switched off or the driver's door is opened:**

- ▶ Depress the brake pedal and engage neutral **N** when the car is stationary.
- ▶ Release the brake pedal.
- ▶ Switch off the vehicle.

- ⓘ If you then exit the vehicle leaving the key in the vehicle, the automatic transmission remains in neutral **N**.

Engaging park position P

! **NOTE** Damage due to engaging park position **P** while the vehicle is rolling

If you shift the transmission into park position **P** while the vehicle is rolling, the transmission may be damaged.

- ▶ If the vehicle is rolling, do not open a door.
- ▶ Only engage park position **P** when the vehicle is stationary.

- ▶ Observe the notes on parking the vehicle (→ page 165).
- ▶ Depress the brake pedal until the vehicle comes to a standstill.
- ▶ When the vehicle is stationary, press button **P**.
When the transmission position display shows **P**, the park position is engaged. If the trans-

mission position display **P** does not appear, apply the parking brake and secure the vehicle to prevent it from rolling away.

- ⓘ Depending on the situation, it may take a short time until **P** is engaged. Therefore, always pay attention to the transmission position display.

Park position **P** will be engaged automatically if one of the following conditions is met:

- You switch the stationary vehicle off in transmission position **D** or **R**.
- You open the driver's door when the vehicle is stationary in transmission position **D** or **R**.
- When the vehicle is rolling, you switch it off in transmission position **D** or **R** and bring it to a standstill.
- When the vehicle is rolling, you shift to transmission position **N**, bring the vehicle to a standstill and open the driver's door when the vehicle is stationary.
- Engaging park position **P** automatically is required by the vehicle.

- ❶ To maneuver with an open driver's door, open the driver's door while the vehicle is stationary and engage transmission position **[D]** or **[R]** again.
- ❷ At very low outside temperatures below approximately -4°F (-20°C), it may not be possible to shift the transmission from **[P]** to another transmission position when the vehicle is switched off. If this is the case, change the transmission position only while the vehicle is switched on.

Engaging drive position D

- ▶ Depress the brake pedal and push the DIRECT SELECT lever down past the first point of resistance.

When the automatic transmission is in transmission position **[D]**, it will shift gears automatically. This depends, among other things, on the following factors:

- The selected drive program
- The position of the accelerator pedal
- The driving speed

Problems with the transmission

The transmission has a faulty gear shift

Possible cause:

- the transmission is losing oil.
- ▶ Have the transmission checked at a qualified specialist workshop immediately.

The acceleration characteristics worsen, and the transmission no longer shifts.

Possible cause:

- the transmission is in emergency operation mode.
- ▶ Pull over and stop the vehicle safely as soon as possible, paying attention to road and traffic conditions.
- ▶ Shift the transmission to position **[P]**.
- ▶ Switch off the vehicle.
- ▶ Wait at least ten seconds.
- ▶ Start the vehicle again.
- ▶ Shift the transmission to position **[D]**.

- ▶ Have the transmission checked at a qualified specialist workshop immediately.

Manual gearshifting

! NOTE Mercedes-AMG vehicles

- ▶ Observe the notes in the Supplement. You could otherwise fail to recognize dangers.

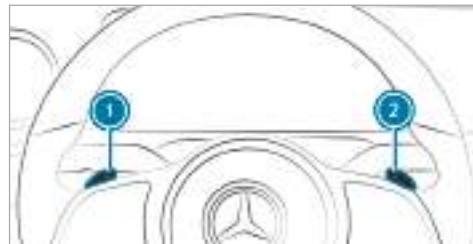

When the automatic transmission is shifted to position **[D]**, you can manually shift it with the steering wheel paddle shifter. If permitted, the automatic transmission will shift to a higher or

lower gear depending on the steering wheel paddle shifter being pulled.

You have two options for manually shifting the automatic transmission:

- Temporary setting
- Permanent setting

The gears will shift automatically when manual shifting is deactivated.

Temporary setting:

- ▶ **To activate:** pull steering wheel paddle shifter ① or ②.

Manual shifting will be activated for a short time. The transmission position display will show **M** and the current gear.

- ① How long manual shifting stays activated depends on various factors.

Manual shifting can be deactivated automatically in the following cases:

- When the drive program is changed
- When the vehicle is restarted
- When transmission position **D** is engaged again

- Driving style

- ▶ **To shift up:** pull steering wheel paddle shifter ②.
- ▶ **To shift down:** pull steering wheel paddle shifter ①.
If you pull and hold steering wheel paddle shifter ①, the transmission will shift to the lowest possible gear.
- ▶ **To deactivate:** pull and hold steering wheel paddle shifter ②.
The transmission position display will show **D**.

Permanent setting:

- ▶ Change to drive program **I** (→ page 156).
- ▶ Select drive setting **M** (→ page 157).

Gearshift recommendation

The gearshift recommendation assists you in adopting an economical driving style.



- ▶ If gearshift recommendation ① appears next to the transmission position display, shift to the recommended gear.

Using kickdown

- ▶ **Maximum acceleration:** depress the accelerator pedal beyond the point of resistance.

To protect against excessively high engine speeds, the automatic transmission will shift up to the next gear when maximum engine speed has been reached.

Glide mode function

I NOTE Mercedes-AMG vehicles

- ▶ Observe the notes in the Supplement. You could otherwise fail to recognize dangers.

With an anticipatory driving style, glide mode helps you to reduce fuel consumption.

Glide mode is characterized by the following:

- The combustion engine is disconnected from the drivetrain and is still running in neutral.
- The transmission position display **D** is shown in green.

Glide mode will be activated if the following conditions are met:

- Drive program **E** is selected.
- The speed is within a suitable range.
- The road's course is suitable, e.g. no steep uphill or downhill gradients or tight bends.
- You do not depress the accelerator or brake pedal (except for light brake applications).

- **i** Glide mode can also be activated if you have selected the "Eco" setting for the drive in drive program **I**.

Glide mode will be deactivated again if one of the conditions is no longer met.

Vehicles with Active Distance Assist DISTRONIC: when Active Distance Assist DISTRONIC is active, the glide mode function will not be available.

Glide mode can also be prevented by the following parameters:

- Incline
- Downhill gradient
- Temperature
- Height
- Speed
- Operating status of the engine
- Traffic situation

- **i** You can end glide mode by operating a steering wheel paddle shifter (→ page 160).

Function of 4MATIC

4MATIC ensures that all four wheels are driven. Together with ESP® and 4ETS, 4MATIC improves the traction of your vehicle whenever a driven wheel spins due to insufficient traction.



You can display the current distribution of drive torque to all four wheels on the head-up display and in the right-hand display range of the instru-

ment display. The fuller the respective scale, the higher the corresponding drive torque.

If you fail to adapt your driving style, 4MATIC can neither reduce the risk of an accident nor override the laws of physics. 4MATIC cannot take account of road, weather and traffic conditions. 4MATIC is only an aid. You are responsible especially for maintaining a safe distance from the vehicle in front, for vehicle speed, for braking in good time and for staying in lane.

- ① In wintry road conditions, the maximum effect of 4MATIC can be achieved only if you use winter tires (M+S tires), with snow chains if necessary.

Refueling

Refueling the vehicle

⚠ WARNING Risk of fire or explosion from fuel

Fuels are highly flammable.

- ▶ Fire, open flames, smoking and creating sparks must be avoided.
- ▶ Before refueling, switch off the vehicle and, if installed, the stationary heater, and leave them switched off during refueling.

⚠ WARNING Risk of injury from fuels

Fuels are poisonous and hazardous to your health.

- ▶ Do not swallow fuel or let it come into contact with skin, eyes or clothing.
- ▶ Do not inhale fuel vapor.
- ▶ Keep children away from fuel.
- ▶ Keep doors and windows closed during the refueling process.

If you or other people come into contact with fuel, observe the following:

- ▶ Immediately rinse fuel off your skin with soap and water.
- ▶ If fuel comes into contact with your eyes, immediately rinse them thoroughly with

clean water. Seek medical attention immediately.

- ▶ If you swallow fuel, seek medical attention immediately. Do not induce vomiting.
- ▶ Change immediately out of clothing that has come into contact with fuel.

⚠ WARNING Risk of fire and explosion due to electrostatic charge

Electrostatic charge can ignite fuel vapor.

- ▶ Before you open the fuel filler cap or take hold of the pump nozzle, touch the metallic vehicle body.
- ▶ To avoid creating another electrostatic charge, do not get into the vehicle again during the refueling process.

! NOTE Damage caused by the wrong fuel

Vehicles with a gasoline engine:

Even small amounts of the wrong fuel could result in damage to the fuel system, the engine and the emission control system.

- ▶ Only refuel with low-sulfur spark-ignition engine fuel.

This fuel may contain up to 10% ethanol. Your vehicle is suitable for use with E10 fuel.

Never refuel with one of the following fuels:

- Diesel
- Gasoline with more than 10% ethanol by volume, e.g. E15, E85, E100
- Gasoline with more than 3% methanol by volume, e.g. M15, M30, M85, M100
- Gasoline with additives containing metal

If you have accidentally refueled with the wrong fuel:

- ▶ Do not switch on the vehicle.
- ▶ Consult a qualified specialist workshop.

! **NOTE** Do not use diesel to refuel vehicles with a gasoline engine

If you have accidentally refueled with the wrong fuel:

- Do not switch on the vehicle. Otherwise fuel can enter the engine.

Even small amounts of the wrong fuel could result in damage to the fuel system and the engine. The repair costs are high.

- ▶ Consult a qualified specialist workshop.
- ▶ Have the fuel tank and fuel lines drained completely.

! **NOTE** Damage to the fuel system due to overfilling the fuel tank

- ▶ Only fill the fuel tank until the pump nozzle switches off.

If too much fuel has been added due, for example, to a faulty filling pump:

- ▶ Do not switch on the vehicle.

- ▶ Consult a qualified specialist workshop.

! **NOTE** Fuel may spray out when you remove the fuel pump nozzle

- ▶ Only fill the fuel tank until the pump nozzle switches off.

Requirements

- The vehicle is unlocked.

Observe the notes on service fluids and fuel.

Only refuel with fuel that has at least the octane rating specified in the information label in the fuel filler flap. Otherwise, engine output may be reduced and fuel consumption increased.

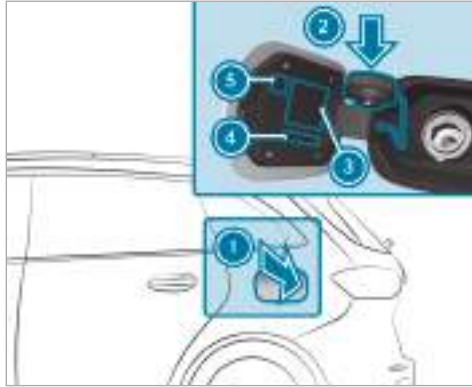

- ① Fuel filler flap
- ② Bracket for fuel filler cap
- ③ Tire pressure table
- ④ Fuel type
- ⑤ QR code for rescue card

- ▶ Press on the rear part of fuel filler flap ①.
- ▶ Turn the fuel filler cap counter-clockwise and remove it.

- ▶ Insert fuel filler cap ② from above into bracket.
- ▶ Completely insert the pump nozzle into the tank filler neck, hook in place and refuel.
- ▶ Only fill the fuel tank until the pump nozzle switches off.
- ▶ Replace the cap on the filler neck and turn clockwise until it engages audibly.
- ▶ Close fuel filler flap ①.

Parking

Parking the vehicle

- ⚠ **WARNING** Risk of accident and injury caused by an insufficiently secured vehicle rolling away

If the vehicle is not securely parked sufficiently, it can roll away in an uncontrolled way even at a slight downhill gradient.

- ▶ On uphill or downhill gradients, turn the front wheels so that the vehicle rolls towards the curb if it starts moving.

- ▶ Apply the parking brake.
- ▶ Switch the transmission to position **P**.

- ⚠ **WARNING** Risk of fire caused by hot exhaust system parts

Flammable materials such as leaves, grass or twigs may ignite.

- ▶ Park the vehicle so that no flammable material can come into contact with hot vehicle components.
- ▶ In particular, do not park on dry grass-land or harvested grain fields.

- ⚠ **WARNING** Risk of accident and injury due to children left unattended in the vehicle

If you leave children unattended in the vehicle, they could, in particular:

- open doors, thereby endangering other persons or road users.
- get out and be struck by oncoming traffic.

- operate vehicle equipment and become trapped, for example.

In addition, the children could also set the vehicle in motion by, for example:

- releasing the parking brake.
- changing the gearbox position.
- starting the vehicle.

- ▶ Never leave children unattended in the vehicle.
- ▶ When leaving the vehicle, always take the key with you and lock the vehicle.
- ▶ Keep the key out of reach of children.

! **NOTE** Damage to the vehicle due to it rolling away

- ▶ Always secure the vehicle against rolling away.

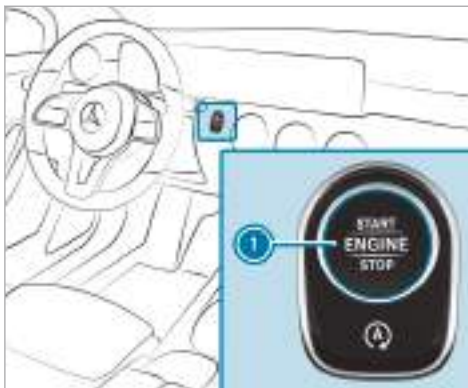

- ▶ Bring the vehicle to a standstill by depressing the brake pedal.
- ▶ On uphill or downhill gradients, turn the front wheels so that the vehicle rolls towards the curb if it starts moving.
- ▶ Apply the electric parking brake.

- ▶ Engage transmission position **P** in a stationary vehicle with the brake pedal depressed (→ page 159).

- ▶ Switch off the vehicle by pressing button **1**.
- ▶ Release the service brake slowly.
- ▶ Get out of the vehicle and lock it.

i When you park the vehicle, you can still operate the side windows and the panoramic sliding sunroof for approximately four minutes if the driver's door is closed.

Garage door opener

Programming buttons for the garage door opener

! **DANGER** Risk of death caused by exhaust gases

Combustion engines emit poisonous exhaust gases such as carbon monoxide. Inhaling these exhaust gases is hazardous to health and leads to poisoning.

- ▶ Never leave the engine or, if present, the auxiliary heating running in an enclosed space without sufficient ventilation.

▲ WARNING Risk of injury by becoming trapped when opening and closing a garage door

When you operate or program a garage door with an integrated garage door opener, persons can become trapped or struck by the garage door if they stand within its range of movement.

- ▶ Always make sure that nobody is within the range of the garage door's movement.

Only operate the following doors using the garage door opener:

- Doors with a safety stop and reversing function
- Doors which conform to the current U.S. safety standards

Before programming the garage door opener, park the vehicle outside the garage. Make sure that the vehicle is switched on but not started.

Requirements

- The vehicle has been parked outside the garage or outside the range of movement of the door.
 - The vehicle is switched on.
 - The vehicle has not been started.
- ⓘ The garage door opener function is always available when the vehicle is switched on.

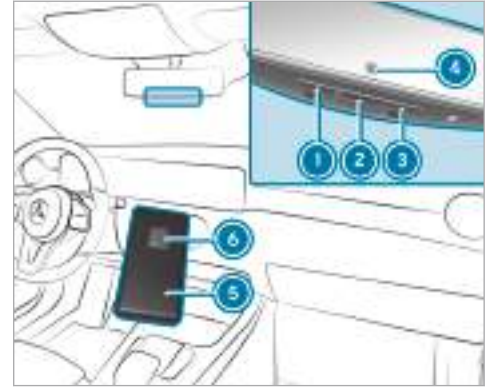

- ▶ Check if the transmitter frequency of the remote control has the frequency range of 280 to 868 MHz.

Radio equipment approval number:

- NZLMUAHL5 (USA)
- 4112A-MUAHL5 (Canada)

▶ Press and hold button ①, ② or ③ that you wish to program.
Indicator lamp ④ flashes yellow.

① It can take up to 20 seconds before the indicator lamp flashes yellow.

▶ Release the previously pressed button.
Indicator lamp ④ continues to flash yellow.

▶ Point remote control ⑤ from a distance of 0.4 in (1 cm) to 3 in (8 cm) towards button ①, ② or ③.

▶ Press and hold button ⑥ of remote control ⑤ until one of the following signals appears:

- Indicator lamp ④ lights up green continuously. Programming is complete.
- Indicator lamp ④ flashes green. Programming was successful. Additionally, synchronization of the rolling code with the door system must be carried out.

▶ If indicator lamp ④ does not light up or flash green: repeat the procedure.

▶ Release all of the buttons.

① The remote control for the door drive is not included in the scope of delivery of the garage door opener.

■ Synchronizing the rolling code

Requirements

- The door system uses a rolling code.
- The vehicle must be within range of the garage or door drive.
- The vehicle as well as persons and objects are located outside the range of movement of the door.

▶ Press the programming button on the door drive unit.
Initiate the next step within approximately 30 seconds.

▶ Press previously programmed button ①, ② or ③ repeatedly until the door closes.
When the door closes, programming is completed.

① Please also read the operating instructions for the door drive.

■ Troubleshooting when programming the remote control

▶ Check if the transmitter frequency of remote control ⑤ is supported.

▶ Replace the batteries in remote control ⑤.

▶ Hold remote control ⑤ at various angles from a distance of 0.4 in (1 cm) to 3 in (8 cm) in front of the inside rearview mirror. You should test every position for at least 25 seconds before trying another position.

▶ Hold remote control ⑤ at the same angles at various distances in front of the inside rearview mirror. You should test every position for at least 25 seconds before trying another position.

▶ On remote controls that transmit only for a limited period, press button ⑥ on remote control ⑤ again before transmission ends.

▶ Angle the antenna line of the garage door opener unit towards the remote control.

- ❗ It is possible that older garage doors cannot be operated using the remote control in the inside rearview mirror even after you have successfully performed the measures described above. If this is the case, contact the HomeLink® Hotline.
- ❗ Support and additional information on programming:
 - on the toll free HomeLink® Hotline on 1-800-355-3515
 - online at the <https://www.homelink.com/mercedes>

■ Opening or closing a garage door

Requirements

- The corresponding button is programmed to operate the door.
- ▶ Press and hold buttons ①, ② or ③ until the door opens or closes.
 - ▶ If indicator lamp ④ flashes yellow after approx. 20 seconds: Press the previously pressed button again and keep it pressed until the door opens or closes.

■ Clearing the garage door opener memory

- ▶ Press and hold buttons ① and ③. Indicator lamp ④ lights up yellow.
- ▶ If indicator lamp ④ flashes green: release buttons ① and ③. The entire memory has been deleted.

Electric parking brake

■ Function of the electric parking brake (applying automatically)

⚠ WARNING Risk of accident and injury due to children left unattended in the vehicle

If you leave children unattended in the vehicle, they could, in particular:

- open doors, thereby endangering other persons or road users.
- get out and be struck by oncoming traffic.
- operate vehicle equipment and become trapped, for example.

In addition, the children could also set the vehicle in motion by, for example:

- releasing the parking brake.
 - changing the gearbox position.
 - starting the vehicle.
- ▶ Never leave children unattended in the vehicle.
 - ▶ When leaving the vehicle, always take the key with you and lock the vehicle.
 - ▶ Keep the key out of reach of children.

The electric parking brake is applied if the transmission is in position **P and one of the following conditions is fulfilled:**

- The vehicle is switched off.
 - The seat belt tongue is not inserted in the seat belt buckle of the driver's seat and the driver's door is opened.
- ❗ To prevent application: pull the handle of the electric parking brake (→ page 170).

In the following situations, the electric parking brake is also applied:

- The HOLD function is keeping the vehicle stationary.
- Active Parking Assist is keeping the vehicle stationary.
- Active Distance Assist DISTRONIC is bringing the vehicle to a standstill.
- **In addition, one of the following conditions must be fulfilled:**
 - The vehicle is switched off.
 - The seat belt tongue is not inserted in the seat belt buckle of the driver's seat and the driver's door is opened.
 - There is a system malfunction.
 - The power supply is insufficient.
 - The vehicle is stationary for a lengthy period.

When the electric parking brake is applied, the red **PARK** (USA) or **(P)** (Canada) indicator lamp lights up in the Instrument Display.

- ① The electric parking brake is not automatically applied if the vehicle is switched off by the ECO start/stop function.

Function of the electric parking brake (releasing automatically)

The electric parking brake is released when the following conditions are fulfilled:

- The driver's door is closed.
- The vehicle has been started.
- The transmission is in position **D** or **R** and you depress the accelerator pedal or you shift from transmission position **P** to **D** or **R** when on level ground.
- If the transmission is in position **R**, the tail-gate must be closed.
- The seat belt tongue is inserted into the seat belt buckle of the driver's seat.

If the seat belt tongue is not inserted into the seat belt buckle of the driver's seat, one of the following conditions must be fulfilled:

- You shift from transmission position **P**.
- or

- You have previously driven at speeds greater than 2 mph (3 km/h).

When the electric parking brake is released, the red **PARK** (USA) or **(P)** (Canada) indicator lamp in the Instrument Display goes out.

Applying/releasing the electric parking brake manually

Applying

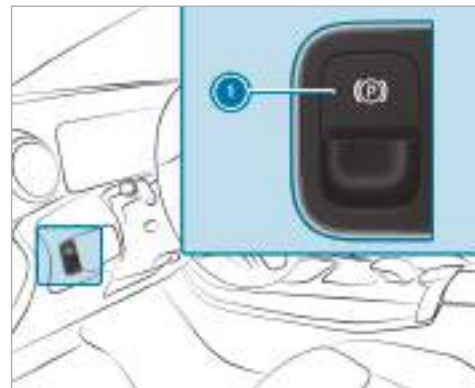

- ▶ Push handle ①.
The red **PARK** (USA) or **(P)** (Canada) indicator lamp lights up in the Instrument Display.
- ① The electric parking brake is only securely applied if the red **PARK** (USA) or **(P)** (Canada) indicator lamp is lit continuously.

Releasing

- ▶ Switch on the vehicle.
- ▶ Pull handle ①.
The red **PARK** (USA) or **(P)** (Canada) indicator lamp in the Instrument Display goes out.

Emergency braking

- ▶ Press and hold handle ①.
As long as the vehicle is in motion, the **Please Release Parking Brake** message is displayed and the red **PARK** (USA) or **(P)** (Canada) indicator lamp flashes.
- When the vehicle has been braked to a standstill, the electric parking brake is applied. The red **PARK** (USA) or **(P)** (Canada) indicator lamp lights up in the Instrument Display.

Information on collision detection on a parked vehicle

If a collision is detected on the locked vehicle when towing protection is switched on and collision detection is switched on, you will receive a message in the multimedia system when the vehicle is switched on.

You will receive information about the following points:

- The area of the vehicle that may have been damaged.
- The force of the impact.

The following situation can lead to inadvertent activation:

- The parked vehicle is moved, foreexample, in a two-storey garage.
- ① Deactivate the tow-away alarm in order to prevent inadvertent activation. If you deactivate the tow-away alarm, collision detection will also be deactivated.
- ① If the battery is severely discharged, the function for detecting a collision on a parked vehicle

is automatically deactivated to facilitate the next engine start.

System limits

Detection may be restricted in the following situations:

- the vehicle is damaged without impact, foreexample, if an outside mirror is torn off or the paint is damaged by a key
- an impact occurs at low speed
- the electric parking brake is not applied
- ① You are responsible for your vehicle. Convince yourself that your vehicle is free of damage and roadworthy.

Notes on parking the vehicle for an extended period

If you leave the vehicle parked for longer than six weeks, it may suffer damage through disuse.

The 12 V battery may also be impaired or damaged by heavy discharging.

Vehicles with automatic transmission: Do not disconnect the 12 V battery even if the vehicle is left idle for a lengthy period.

- ① Further information can be obtained at a qualified specialist workshop.

Standby mode (extension of the starter battery's period out of use)

Standby mode function

① This function is not available for all models. If standby mode is activated, energy loss will be minimized during extended periods of non-operation.

Standby mode is characterized by the following:

- The starter battery is preserved.
- The maximum non-operational time appears on the media display.
- The connection to online services is interrupted.
- The ATA (anti-theft alarm system) is not available.

- The interior protection and tow-away alarm functions are not available.
- The function for detecting collisions for a parked vehicle is not available.

If the following conditions are fulfilled, standby mode can be activated or deactivated using the multimedia system:

- The vehicle is switched on.
- The vehicle has not been started.

Exceeding the vehicle's displayed non-operational time may cause inconvenience; i.e. it cannot be guaranteed that the starter battery will reliably start the vehicle.

Charge the starter battery in the following situations:

- The vehicle's non-operational time must be extended.
 - The state of charge of the starter battery is insufficient for standby mode.
- ① Standby mode is automatically deactivated when the vehicle is switched on.

Activating/deactivating standby mode (parking up the vehicle)

Requirements

- The vehicle is switched off.

Multimedia system:

→  » Settings » Vehicle

- ▶ Activate or deactivate **Standby Mode**.
- ▶ Select **Yes**.

Driving and driving safety systems

Driving systems and your responsibility

Your vehicle is equipped with driving systems that assist you in driving, parking and maneuvering the vehicle. The driving systems are only aids. They are not a substitute for you paying attention to your surroundings and do not relieve you of your responsibility pertaining to road traffic law. The driver is always responsible for maintaining a safe distance to the vehicle in front, for vehicle speed, for braking in good time and for staying in lane. Pay attention to the traffic conditions at all times and intervene when necessary. Be aware of the

limitations regarding the safe use of these systems.

Driving systems can neither reduce the risk of an accident if you fail to adapt your driving style nor override the laws of physics. They cannot always take into account road, weather or traffic conditions.

- ① Some driving systems can regulate or limit the speed to a previously set value. Draw attention to the stored speed when changing drivers.

Information on vehicle sensors and cameras

Some driving and driving safety systems use cameras as well as radar or ultrasonic sensors to monitor the area in front of, behind or next to the vehicle.

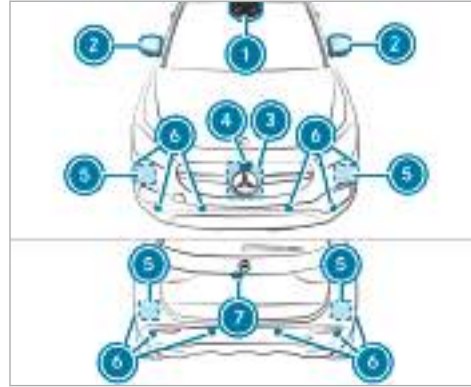

- ① Multifunction camera
- ② Cameras in the outside mirrors
- ③ Front radar
- ④ Front camera
- ⑤ Corner radars
- ⑥ Ultrasonic sensors
- ⑦ Rear-view camera

⚠ WARNING Risk of accident due to restricted detection performance of vehicle sensors and cameras

If the area around vehicle sensors or cameras is covered, damaged or dirty, certain driving and safety systems cannot function correctly. There is a risk of an accident.

- ▶ Keep the area around vehicle sensors or cameras clear of any obstructions and clean.
- ▶ Have damage to the bumper, radiator grille or stone chipping in the area of the front and rear windows repaired at a qualified specialist workshop.

Keep the areas around the sensors and cameras in particular free of dirt, ice and slush (→ page 290). The sensors and cameras must not be covered and the detection areas around them must be kept clear. Do not attach additional license plate bracket, advertisements, stickers, wraps or stone chip protection films in the detection range of the sensors and cameras. Make sure

174 Driving and parking

that there are no overhanging loads protruding into the detection area.

If there is damage to a bumper or the radiator grille, or after an impact, have the function of the sensors checked at a qualified specialist workshop. Have damage or stone chipping around the cameras on the front and rear passenger compartment windows repaired at a qualified specialist workshop.

Overview of driving systems and driving safety systems

- ABS (**A**nti-**l**ock **B**raking **S**ystem) (→ page 174)
- Off-road ABS (→ page 175)
- BAS (**B**rake **A**ssist **S**ystem) (→ page 175)
- ESP® (**E**lectronic **S**tability **P**rogram) (→ page 175)
- ESP® Crosswind Assist (→ page 177)
- EBD (**E**lectronic **B**rakeforce **D**istributon) (→ page 177)
- STEER CONTROL (→ page 177)
- HOLD function (→ page 178)
- Hill Start Assist (→ page 179)
- Start-off assist (→ page 179)
- ATTENTION ASSIST (→ page 180)
- Cruise control (→ page 181)
- Traffic Sign Assist (→ page 200)

Driving Assistance Package

The following functions are part of the Driving Assistance Package. Certain functions are only available in some countries. Some functions are also available without the Driving Assistance Package, albeit with restricted functionality.

- Active Distance Assist DISTRONIC (→ page 183)
- Active Speed Limit Assist (country-dependent) (→ page 187)
- Route-based speed adaptation (country-dependent) (→ page 188)
- DSR (**D**ownhill **S**peed **R**egulation) (→ page 190)
- Active Brake Assist (→ page 195)
- Active Steering Assist (country-dependent) (→ page 191)
- Active Emergency Stop Assist (country-dependent) (→ page 193)
- Active Lane Change Assist (country-dependent) (→ page 194)
- Blind Spot Assist and Active Blind Spot Assist with exit warning (→ page 204)
- Active Lane Keeping Assist (→ page 207)

Parking Package

- Rear view camera (→ page 209)
- 360° Camera (→ page 211)
- Parking Assist PARKTRONIC (→ page 213)
- Active Parking Assist (→ page 218)

Functions of ABS

The Anti-lock Brake System (ABS) regulates the brake pressure in critical driving situations:



- During braking, for instance, at maximum full-stop braking or if there is insufficient tire traction, the wheels are prevented from locking.
- Vehicle steerability while braking is ensured.

If ABS intervenes when braking, you will feel a pulsing in the brake pedal. The pulsating brake pedal can be an indication of hazardous road conditions and can serve as a reminder to take extra care while driving.

System limits

- ABS is active from speeds of approx. 3 mph (5 km/h).
- ABS may be impaired or may not function if a malfunction has occurred and the yellow  ABS warning lamp lights up continuously after the vehicle is started.

Functions of Off-road ABS

 Off-road ABS is activated automatically when you select the  drive program.

Off-road ABS is specially adapted for driving off-road:

- The front wheels lock cyclically during braking.
- The braking distance is shortened due to the digging-in effect.

System limits

- Off-road ABS functions at speeds below 25 mph (40 km/h).
- If Off-road ABS intervenes, the ability to steer may be restricted.

Function of BAS

 **WARNING** Risk of an accident caused by a malfunction in BAS (Brake Assist System)

If BAS is malfunctioning, the braking distance in an emergency braking situation is increased.

- ▶ Depress the brake pedal with full force in emergency braking situations. ABS prevents the wheels from locking.

The Brake Assist System (BAS) supports your emergency braking situation with additional brake force.

If you depress the brake pedal quickly, BAS is activated:

- BAS automatically boosts the brake pressure.

- BAS can shorten the braking distance.
- ABS prevents the wheels from locking.

The brakes will function as usual once you release the brake pedal. BAS is deactivated.

Functions of ESP®

 **WARNING** Risk of skidding if ESP® is deactivated

If you deactivate ESP®, ESP® cannot carry out vehicle stabilization.

- ▶ ESP® should only be deactivated in the following situations.

 **NOTE** Mercedes-AMG vehicles

- ▶ Observe the notes in the Supplement. You could otherwise fail to recognize dangers.

The Electronic Stability Program (ESP®) can monitor and improve driving stability and traction in the following situations within physical limits:

- When pulling away on wet or slippery roads.
- When braking.
- In strong side winds when you are driving faster than 50 mph (80 km/h).

If the vehicle deviates from the direction desired by the driver, ESP® can stabilize the vehicle by intervening in the following ways:

- One or more wheels are braked.
- The engine output is adapted according to the situation.

ESP® is deactivated if the  ESP® OFF warning lamp lights up continuously on the instrument display:

- Driving stability will no longer be improved.
- Crosswind Assist is no longer active.
- The drive wheels could spin.
- ETS/4ETS traction control is still active.

 When ESP® is deactivated, you are still assisted by ESP® when braking.

If the  ESP® warning lamp flashes on the instrument display, one or several wheels has reached its grip limit:

- Adapt your driving style to suit the current road and weather conditions.
- Do not deactivate ESP®.
- Only depress the accelerator pedal as far as is necessary when pulling away.

Deactivate ESP® in the following situations to improve traction:

- When using snow chains.
- In deep snow.
- On sand or gravel.

 Spinning the wheels results in a cutting action, which enhances traction.

If the  ESP® warning lamp lights up continuously, ESP® is not available due to a malfunction.

ETS/4ETS (Electronic Traction System)

ETS/4ETS traction control is part of ESP® and makes it possible to pull away and accelerate on a slippery road.

If you select the  drive program, a special ETS system specifically suited to off-road terrain is automatically activated.

ETS/4ETS can improve the vehicle's traction by intervening in the following ways:

- The drive wheels are braked individually if they spin.
- More drive torque is transferred to the wheel or wheels with traction.

Influence of drive programs on ESP®

The drive programs enable ESP® to adapt to different weather and road conditions as well as the driver's preferred driving style. Depending on the selected drive program, the appropriate ESP® mode will be activated. You can select the drive programs using the DYNAMIC SELECT switch (→ page 156).

Function of ESP® Crosswind Assist

ESP® Crosswind Assist detects sudden gusts of side wind and helps the driver to keep the vehicle in the lane:

- ESP® Crosswind Assist is active at vehicle speeds between approx. 50 mph (80 km/h) and 125 mph (200 km/h) when driving straight ahead or cornering slightly.
- The vehicle is stabilized by means of individual brake application on one side.

Activating/deactivating ESP® (Electronic Stability Program)

Multimedia system:

→  » Settings » Quick Access

- i** ESP® can only be activated/deactivated using quick access when at least one other function is available in quick access. ESP® can otherwise be found in the [Assistance](#) menu.

! NOTE Mercedes-AMG vehicles

▶ Observe the notes in the Supplement. You could otherwise fail to recognize dangers.

- ▶ Select **ESP**.
- ▶ Select **On** or  **Off**.

ESP® is deactivated if the  ESP® OFF warning lamp lights up continuously in the instrument cluster.

Observe the information on warning lamps and display messages which may be shown in the instrument cluster.

Function of EBD

Electronic Brakeforce Distribution (EBD) is characterized by the following:

- Monitoring and regulating the brake pressure on the rear wheels.
- Improved driving stability when braking, especially on bends.

Function of STEER CONTROL

STEER CONTROL assists you by transmitting a noticeable steering force to the steering wheel in the direction required for vehicle stabilization.

This steering recommendation is given in the following situations:

- both right wheels or both left wheels are on a wet or slippery road surface when you brake
- the vehicle starts to skid

System limits

STEER CONTROL may be impaired or may not function in the following situations:

- ESP® is deactivated.
- ESP® is malfunctioning.
- The steering is malfunctioning.

If ESP® is malfunctioning, you will be assisted further by the electric power steering.

HOLD function

HOLD function

The HOLD function holds the vehicle at a standstill without requiring you to depress the brake pedal, e.g. while waiting in traffic.

The HOLD function is only an aid. The responsibility for the vehicle safely standing still remains with the driver.

System limits

The HOLD function is only intended to provide assistance when driving and is not a sufficient means of safeguarding the vehicle against rolling away when stationary.

- The incline must not be greater than 30%.

Activating/deactivating the HOLD function

⚠ WARNING Risk of an accident due to the HOLD function being active when you leave the vehicle

If the vehicle is only braked with the HOLD function it could, in the following situations, roll away:

- If there is a malfunction in the system or in the power supply.
- If the HOLD function is deactivated by depressing the accelerator pedal or brake pedal, e.g. by a vehicle occupant.

▶ Always secure the vehicle against rolling away before you leave it.

Requirements

- The vehicle is stationary.
- The driver's door is closed or the seat belt on the driver's side is fastened.
- The vehicle has been started or has been automatically switched off by the ECO start/stop function.

- The electric parking brake is released.
- Active Distance Assist DISTRONIC is deactivated.
- The transmission is in position **D**, **R** or **N**.

Activating the HOLD function

- ▶ Depress the brake pedal, and after a short time quickly depress further until the **HOLD** display appears in the Instrument Display.
- ▶ Release the brake pedal.

Deactivating the HOLD function

- ▶ Depress the accelerator pedal to pull away.
- or
- ▶ Depress the brake pedal until the **HOLD** display disappears from the Instrument Display.

The HOLD function is deactivated in the following situations:

- Active Distance Assist DISTRONIC is activated.
- The transmission is shifted to position **P**.
- The vehicle is secured with the electric parking brake.

In the following situations, the vehicle is held by transmission position **P** and/or by the electric parking brake:

- The seat belt is unfastened and the driver's door is opened.
- The vehicle is switched off.
- There is a system malfunction.
- The power supply is insufficient.

Function of Hill Start Assist

Hill Start Assist holds the vehicle for a short time when you pull away on a hill under the following conditions:

- The transmission is in position **D** or **R**.
- The electric parking brake is released.

This gives you enough time to move your foot from the brake pedal to the accelerator pedal and depress it before the vehicle begins to roll away.

⚠ WARNING Risk of accident and injury due to the vehicle rolling away

After a short time, Hill Start Assist no longer holds the vehicle.

- ▶ Swiftly move your foot from the brake pedal to the accelerator pedal. Do not leave the vehicle when it is being held by Hill Start Assist.

Start-off assist

Function of the start-off assist

The start-off assist enables optimal vehicle acceleration from a standstill. For this, a suitably high-grip road surface is required and the tires and vehicle must also be in good condition.

Do not activate the start-off assist on public roads.

Be sure to observe the safety notes and information on ESP® (→ page 175).

Activating the start-off assist

⚠ WARNING Risk of skidding and having an accident from wheels spinning

When you use start-off assist, individual wheels could spin and you could lose control of the vehicle.

If ESP® is deactivated, there is a risk of skidding and accident!

- ▶ Make sure that no persons or obstacles are in the close vicinity of your vehicle.

- ▶ Deactivating ESP® (→ page 177).
- ▶ Move the steering wheel to the straight-ahead position.
- ▶ Depress the brake pedal firmly with your left foot and keep it depressed.
- ▶ Engage the **D** drive position (→ page 160).
- ▶ Select the sportiest available drive program **S'** or **S** (→ page 156).
- ▶ Rapidly depress the accelerator pedal fully.

- ▶ Take your foot off the brake, but keep the accelerator pedal depressed. The vehicle pulls away at maximum acceleration.
- ▶ Switch on ESP® once the acceleration procedure is complete. ESP® will otherwise not be able to stabilize the vehicle if the vehicle starts to skid or a wheel starts to spin.

Canceling the start-off assist

- ▶ Remove your foot from the accelerator pedal.
- ▶ Reactivate the ESP®.

ATTENTION ASSIST

Function of ATTENTION ASSIST

ATTENTION ASSIST assists you on long, monotonous journeys, e.g. on highways and trunk roads. If ATTENTION ASSIST detects indicators of fatigue or increasing lapses in concentration on the part of the driver, it suggests taking a break.

ATTENTION ASSIST is only an aid. It cannot always detect fatigue or lapses in concentration in time. The system is not a substitute for a well-res-

ted and attentive driver. On long journeys, take regular breaks in good time that allow for adequate recuperation.

You can choose between two settings:

- **Standard:** normal system sensitivity.
- **Sensitive:** higher system sensitivity. The driver is warned earlier and the attention level detected by ATTENTION ASSIST is adapted accordingly.

If drowsiness or increasing lapses in concentration are detected, the **ATTENTION ASSIST: Take a Break!** warning appears in the Instrument Display. You can acknowledge the message and take a break where necessary. If you do not take a break and ATTENTION ASSIST continues to detect increasing lapses in concentration, you will be warned again after a minimum of 15 minutes.



You can have the following status information for ATTENTION ASSIST displayed in the assistance menu of the on-board computer:

- The length of the journey since the last break.
- The attention level determined by ATTENTION ASSIST:
 - the fuller the circle, the higher the attention level determined
 - as your attention wanes, the circle in the center of the display becomes smaller

If ATTENTION ASSIST is unable to calculate the attention level and cannot issue a warning, the **System Suspended** message appears.

If a warning is given in the Instrument Display, the multimedia system offers to search for a rest area. You can select a rest area and start navigation to this rest area. This function can be activated and deactivated in the multimedia system.

If ATTENTION ASSIST is deactivated, the  symbol appears in the assistance graphic in the Instrument Display. After the vehicle is started, ATTENTION ASSIST is automatically activated. The last selected sensitivity level remains stored.

System limits

ATTENTION ASSIST is active in the 37 mph (60 km/h) to 124 mph (200 km/h) speed range.

Particularly in the following situations, ATTENTION ASSIST only functions in a restricted manner and warnings may be delayed or not occur:

- If you have been driving for less than approximately 30 minutes.
- If the road condition is poor (uneven road surface or potholes).
- If there is a strong side wind.
- If you adopt a sporty driving style (high cornering speeds or high rates of acceleration).
- If Active Steering Assist is activated and active (→ page 191).
- If the time has been set incorrectly.
- If you change lanes and vary your speed frequently in active driving situations.

The ATTENTION ASSIST drowsiness or alertness assessment is reset and restarted when continuing the journey in the following situations:

- If you switch off the vehicle.
- If you unfasten your seat belt and open the driver's door (e.g. to change drivers or take a break).

Setting ATTENTION ASSIST

Multimedia system:

→  » Settings » Assistance
» Attention Assist

Setting options

▶ Select **Standard**, **Sensitive** or **Off**.

Suggesting rest areas

▶ Select **Suggest Rest Area**.

- ▶ Activate or deactivate the function. If ATTENTION ASSIST detects fatigue or an increasing lack of attention, it will suggest a rest area in the vicinity.
- ▶ Select the suggested rest area. You will be guided to the selected rest area.

Speed control cruise control

Function of cruise control

Cruise control regulates the speed to the value selected by the driver.



If you accelerate to overtake, for example, the stored speed is not deleted. If you remove your foot from the accelerator pedal after overtaking, cruise control will resume speed regulation back to the stored speed.

You can store any speed above 15 mph (20 km/h) up to the maximum design speed.

Observe the notes on driving systems and your responsibility; you may otherwise fail to recognize dangers (→ page 172).

Mercedes-AMG vehicles: cruise control is available up to a maximum speed of 155 mph (250 km/h).

Displays on the instrument display

-  (gray): cruise control is selected but not yet activated.
-  (green): cruise control is active.

A stored speed appears along with the  display.

-  The segments between the stored speed and the end of the segment display light up in the speedometer.

System limits

Cruise control may be unable to maintain the stored speed on uphill gradients. The stored speed is resumed when the gradient evens out.

Change to a lower gear in good time on long and steep downhill gradients. Take particular note of this when driving a laden vehicle. By doing so, you will make use of the braking effect of the engine. This relieves the load on the brake system and prevents the brakes from overheating and wearing too quickly.

Do not use cruise control in the following situations:

- in traffic situations which require frequent changes of speed, e.g. in heavy traffic, on winding roads
- on slippery roads. Accelerating can cause the drive wheels to lose traction and the vehicle could then skid.
- when visibility is poor

Operating cruise control

⚠ WARNING Risk of accident due to stored speed

If you call up the stored speed and this is lower than your current speed, the vehicle decelerates.

- ▶ Take into account the traffic situation before calling up the stored speed.

Requirements:

- ESP® must be activated, but not intervening.
- The vehicle speed is at least 15 mph (20 km/h).

- The transmission is in position **D**.



Operating cruise control

- ▶ Press the rocker switches on the steering wheel control panel up or down to the desired position.

Activating cruise control

- ▶ Select  with the right rocker switch.

Activating cruise control

▶ Press rocker ① switch **SET/+** up or **SET/-** down.
The current speed is stored and maintained by the vehicle.

or

▶ Select **RES/Ⓜ** with the left rocker switch.
The last stored speed is called up and maintained by the vehicle.

If the last stored speed has previously been deleted, the current vehicle speed is stored.

ⓘ When you switch off the vehicle, the last speed stored is deleted.

Increasing or decreasing the stored speed

▶ 1 mph (1 km/h): press rocker switch ① up **SET/+** or down **SET/-** to the pressure point.

or

▶ 5 mph (10 km/h): press rocker switch ① up **SET/+** or down **SET/-** beyond the pressure point.

or

▶ Accelerate the vehicle to the desired speed and press rocker switch ① up **SET/+**.

Adopting a detected speed

▶ Activate cruise control.

▶ If a traffic sign has been detected and is displayed in the instrument cluster: select **RES/Ⓜ** with the left rocker switch.
The maximum permissible speed shown by the traffic sign is stored and the vehicle maintains or does not exceed this speed.

Deactivating cruise control

▶ Select **CNCL** with the left rocker switch.

Deactivating cruise control

▶ Select **ESP OFF** with the right rocker switch.

ⓘ If you brake, deactivate ESP® or if ESP® intervenes, cruise control is deactivated.

Active Distance Assist DISTRONIC

■ **Function of Active Distance Assist DISTRONIC**
DISTRONIC Active Distance Assist maintains the set speed when driving freely. If vehicles are

detected ahead, the set distance is maintained, if necessary until the vehicle comes to a standstill. The vehicle accelerates or brakes depending on the distance to the vehicle in front and the set speed. The speed and distance to the vehicle in front are set and saved using the steering wheel.

Available speed range:

- **Vehicles without Driving Assistance Package:**
15 mph (20 km/h) - 120 mph (200 km/h)
- **Vehicles with Driving Assistance Package:**
15 mph (20 km/h) - 130 mph (210 km/h)

Other features of Active Distance Assist DISTRONIC:

- Adjusts the driving style depending on the selected drive program (fuel-saving, comfortable or dynamic)
- Initiates acceleration to the stored speed if the turn signal indicator is switched on to change to the overtaking lane
- **Vehicles with Driving Assistance Package:**
 - Reacts to stationary vehicles detected in urban speed ranges (except bicycles and motorcycles)

- Takes one-sided overtaking restrictions into account on highways or on multi-lane roads with separate roadways (country-dependent)

Vehicles with Driving Assistance Package and Parking Package:

if the vehicle has been braked to a standstill on multi-lane, separate roadways by Active Distance Assist DISTRONIC, it can automatically follow the vehicle in front when driving off again within 30 seconds. If a critical situation is detected when driving off, a visual and acoustic warning is given indicating that the driver must now take control of the vehicle. The vehicle is not accelerated any further.

Observe the notes on driving systems and your responsibility; you may otherwise fail to recognize dangers (→ page 172).

Active Distance Assist DISTRONIC displays in the instrument display



Assistant display

- 1 Route-based speed adaptation: type of route event (→ page 188)
- 2 Vehicle in front
- 3 Distance indicator
- 4 Set specified distance
- 5 Active Lane Change Assist lane change display

Permanent status display of Active Distance Assist DISTRONIC

- (white): Active Distance Assist DISTRONIC selected, specified distance set
- (white vehicle, green speedometer): Active Distance Assist DISTRONIC active, specified distance set and no vehicle detected
- (green): Active Distance Assist DISTRONIC active, specified distance set and vehicle detected
- : Route-based speed adaptation active (→ page 188).

The stored speed is shown along with the permanent status display and highlighted on the speedometer. When Active Distance Assist DISTRONIC is passive, the speed is grayed out.

- On highways or high-speed major roads, the green vehicle symbol is displayed cyclically when the vehicle is ready to pull away.

- i** If you depress the accelerator pedal beyond the setting of the Active Distance Assist DISTRONIC, the system is switched to passive mode. The  **Suspended** message will appear on the instrument display.

Display on the speedometer

The stored speed is highlighted on the speedometer. If the speed of the vehicle in front or the speed adjustment for the route event ahead is less than the stored speed, the segments in the speedometer light up. The instrument display shows the deactivation of Active Distance Assist DISTRONIC, as well as alterations to the speed due to manual or automatic adoption of the maximum permissible speed.

System limits

The system may be impaired or may not function in the following situations, for example:

- In snow, rain, fog, heavy spray, if there is glare, in direct sunlight or in greatly varying ambient light.
- If there is swirling dust, e.g. when driving off-road or on sandy surfaces.
- The windshield in the area of the camera is dirty, fogged up, damaged or covered.
- If the radar sensors are dirty or covered.
- In parking garages or on roads with steep uphill or downhill gradients.
- If there are narrow vehicles in front, such as bicycles or motorcycles.

In addition, on slippery roads, braking or accelerating can cause one or several wheels to lose traction and the vehicle could then skid.

Do not use Active Distance Assist DISTRONIC in these situations.

⚠ WARNING Risk of accident from acceleration or braking by Active Distance Assist DISTRONIC

Active Distance Assist DISTRONIC may accelerate or brake in the following cases, for example:

- If the vehicle pulls away using Active Distance Assist DISTRONIC.

- If the stored speed is called up and is considerably faster or slower than the currently driven speed.
- If Active Distance Assist DISTRONIC no longer detects a vehicle in front or does not react to relevant objects.

- ▶ Always carefully observe the traffic conditions and be ready to brake at all times.
- ▶ Take into account the traffic situation before calling up the stored speed.

⚠ WARNING Risk of accident due to insufficient deceleration by Active Distance Assist DISTRONIC

Active Distance Assist DISTRONIC brakes your vehicle with up to 50% of the possible deceleration. If this deceleration is not sufficient, Active Distance Assist DISTRONIC alerts you with a visual and acoustic warning.

- ▶ Adjust your speed and maintain a suitable distance from the vehicle in front.

- ▶ Brake the vehicle yourself and/or take evasive action.

⚠ WARNING Risk of accident if detection function of Active Distance Assist DISTRONIC is impaired

Active Distance Assist DISTRONIC does not react or has a limited reaction:

- when driving on a different lane or when changing lanes
- to pedestrians, animals, bicycles or stationary vehicles, or unexpected obstacles
- to complex traffic conditions
- to oncoming vehicles and crossing traffic

As a result, Active Distance Assist DISTRONIC may neither give warnings nor intervene in such situations.

- ▶ Always observe the traffic conditions carefully and react accordingly.

■ Operating Active Distance Assist DISTRONIC

Requirements

- The electric parking brake is released.
- ESP® is activated and is not intervening.
- The transmission is in position **D**.
- The driver's door is closed.
- Check of the radar sensor system has been successfully completed.
- Parking Assist PARKTRONIC is not being used to park the vehicle or to exit from a parking space.
- DSR is deactivated.



- ▶ **To operate Active Distance Assist DISTRONIC:** press the rocker switches on the steering wheel control unit up or down to the desired position.

Activating/deactivating Active Distance Assist DISTRONIC

- ▶ Press button .

Activating Active Distance Assist DISTRONIC

- ▶ **To activate without a stored speed:** press rocker switch ① up **SET/+** or down **SET/-**, or select **RES/Ⓟ** with the left rocker switch.

or

- ▶ **To activate with a stored speed:** select **RES/Ⓟ** with the left rocker switch.
- ▶ Remove your foot from the accelerator pedal. The current speed is stored and maintained by the vehicle.

Adopting a detected speed limit

- ▶ Activate Active Distance Assist DISTRONIC.
- ▶ If a traffic sign has been detected and is displayed in the instrument display: select **RES/Ⓟ** with the left rocker switch. The maximum permissible speed on the traffic sign is adopted as the stored speed. The vehicle adapts its speed to that of the vehicle in front, but only up to the stored speed.

Pulling away with Active Distance Assist DISTRONIC

- ▶ Activate Active Distance Assist DISTRONIC and remove your foot from the brake pedal.

- ▶ Select **RES/Ⓟ** with the left rocker switch.
- or

- ▶ Depress the accelerator pedal briefly and firmly. The functions of Active Distance Assist DISTRONIC continue to be carried out.

Deactivating Active Distance Assist DISTRONIC

⚠ WARNING Risk of an accident due to Active Distance Assist DISTRONIC being active when you leave the driver's seat

If you leave the driver's seat while the vehicle is being braked by Active Distance Assist DISTRONIC only, the vehicle can roll away.

- ▶ Always deactivate Active Distance Assist DISTRONIC and secure the vehicle to prevent it from rolling away before you leave the driver's seat.

- ▶ Select **CNCL** with the left rocker switch.

- ① If you brake, deactivate ESP® or if ESP® intervenes, Active Distance Assist DISTRONIC is deactivated.

Increasing or decreasing the speed

- ▶ 1 mph (1 km/h): press rocker switch ① up **SET/+** or down **SET/-** to the pressure point.



or

- ▶ 5 mph (10 km/h): press rocker switch ① up **SET/+** or down **SET/-** beyond the pressure point.

or

- ▶ Accelerate the vehicle to the desired speed and press rocker switch ① up **SET/+**.

Changing the specified distance to the vehicle in front

- ▶ **To reduce the specified distance:** press the right rocker switch up (.
- ▶ **To increase the specified distance:** press the right rocker switch down (.

Function of Active Speed Limit Assist

If a change in the speed limit of 12 mph (20 km/h) or more is detected and automatic adoption of speed limits is activated, the new speed limit is automatically adopted as the stored speed (→ page 201).

The driven speed is adjusted when the vehicle is level with the traffic sign at the latest. In the case of signs indicating entry into an urban area, the speed is adapted according to the speed permitted within the urban area. The speed limit display on the instrument display is always updated when the vehicle is level with the traffic sign.

If there is no speed restriction on an unlimited stretch of road (e.g. on a freeway), the recommended speed is automatically adopted as the stored speed. The system uses the speed stored on an unlimited stretch of road as the recommended speed. If you do not alter the stored speed on an unlimited stretch of road, the recommended speed is 80 mph (130 km/h).

If Active Distance Assist DISTRONIC has been put into passive mode by pressing the accelerator pedal, only speed limits which are higher than the set speed are adopted.

Observe the notes on driving systems and your responsibility; you may otherwise fail to recognize dangers (→ page 172).

System limits

The system limits of Traffic Sign Assist apply to the detection of traffic signs (→ page 200).

Speed limits below 12 mph (20 km/h) are not automatically adopted by the system as the stored speed. Temporary speed restrictions (e.g. applicable for a certain time or due to weather conditions) cannot be properly detected by the system. The maximum permissible speed applying to a vehicle with a trailer is not detected by the system.

Adjust the speed in these situations.

⚠ WARNING Risk of accident due to Active Speed Limit Assist adapting the vehicle's speed

The speed adopted by Active Speed Limit Assist may be too high or incorrect in some individual cases, such as:

- at speed limits below 12 mph (20 km/h)
- in wet conditions or in fog
- when towing a trailer

- ▶ Ensure that the driven speed complies with traffic regulations.
- ▶ Adjust the driving speed to suit current traffic and weather conditions.

Function of route-based speed adaptation

When Active Distance Assist DISTRONIC is activated, the vehicle speed will be adapted accordingly to the route events ahead. Depending on the drive program selected, the vehicle negotiates a route event ahead in an economical, comfortable or dynamic manner. When the route event has been passed, the vehicle accelerates again to the stored speed. The set distance to the vehicle in front, vehicles detected ahead and speed restrictions ahead are taken into account.

You can activate and deactivate route-based speed adaptation in the multimedia system (→ page 189).

The following route events are taken into account:

- Bends
- T-intersections, traffic circles and toll stations
- Turns and exits

- Traffic jams ahead (only with Live Traffic Information)
- ❗ When the toll station is reached, Active Distance Assist DISTRONIC adopts the speed as the stored speed.

Also, the speed is reduced if the turn signal indicator to change lanes is switched on and one of the following situations is detected:

- Turning at intersections
- Driving on slowing-down lanes
- Driving on lanes adjacent to slowing-down lanes

The driver is responsible for choosing the right speed and observing other road users. This applies in particular to intersections, traffic circles and traffic lights because route-based speed adaptation does not brake the vehicle to a standstill.

When route guidance is active, the first speed adjustment is carried out automatically. If the turn signal indicator is switched on, the selected route is confirmed and further speed adjustment is activated.

Speed adaptation is canceled in the following cases:

- If the turn signal indicator is switched off before the route event.
- If the driver depresses the accelerator or brake pedal during the process.

System limits

Route-based speed adaptation does not take right of way regulations into account. The driver is responsible for complying with road traffic regulations and driving at a suitable speed.

The speed adaptation made by the system may not always be suitable, particularly in the following situations:

- the road's course not clearly visible
- Road narrowing
- varying maximum permissible speeds in individual lanes, foreexample at toll stations
- wet road surfaces, snow or ice

In these situations the driver must intervene accordingly.

⚠ WARNING Risk of accident in spite of route-based speed adaptation

Route-based speed adaptation can malfunction or be temporarily unavailable in the following situations:

- If the driver does not follow the calculated route
- If map data is not up-to-date or available
- In the event of roadworks
- In bad weather or road conditions
- If the accelerator pedal is depressed
- In the event of electronically displayed speed limitations

▶ Adapt the speed to the traffic situation.

■ Setting route-based speed adaptation

Requirements

- Active Distance Assist DISTRONIC is activated.
- ECO Assist is active.

Multimedia system:

→  ▶ Settings ▶ Assistance
▶ Route-based Speed

- ▶ Activate or deactivate the function. When the function is active, the vehicle speed is adjusted depending on the route events ahead.
- ❶ Further information on route-based speed adaptation (→ page 188).



DSR (Downhill Speed Regulation)

Function of DSR

DSR is an aid to assist you when driving downhill. It keeps the speed of travel at the selected target speed. The steeper the downhill gradient, the greater the DSR braking effect on the vehicle. On flat stretches of road and uphill gradients, the DSR brakes the vehicle minimally or not at all.

When DSR is activated and the transmission is in position **D**, **R** or **N**, DSR controls the driving speed. The target speed can be set to a value between 1 mph (2 km/h) and 11 mph (18 km/h). By braking or accelerating, you can drive at a

higher or lower speed than the target speed at any time.

If you drive faster than 28 mph (45 km/h) or change the drive program (except in ) , DSR switches off automatically. The  Off message will then appear on the instrument display. The status indicator on the instrument display goes out. You also hear a warning tone.

Information on DSR

⚠ WARNING Risk of skidding and accident when DSR is activated on slippery road surfaces

If the driven speed and the target speed differ, the wheels may lose traction.

- ▶ Take into account the road surface and the difference between the driving speed and target speed before activating DSR.

Observe the notes on driving systems and your responsibility; you may otherwise fail to recognize dangers (→ page 172).

You are always responsible for keeping control of the vehicle and for assessing whether the downhill

gradient can be negotiated. Depending on road surface and tires, DSR may not always be able to keep to the target speed. Select a target speed suitable for the environmental conditions and also apply the brakes yourself if required.



Activating or deactivating DSR (Downhill Speed Regulation)

Requirements:

- You are driving at a speed of 25 mph (40 km/h) or lower. If the current vehicle speed is too high, the **Max. Speed 24 mph** message appears in the multifunction display.
- Active Distance Assist DISTRONIC is deactivated.



Multimedia system:

→  ▶ Settings ▶ Quick Access

- ▶ Select  . A status display appears in the multifunction display when the function is activated.
- ❶ When you switch to the  drive program, the function is automatically activated.

Changing the target speed



- ▶ **To increase/reduce the target speed:** press rocker switch  up **SET+** or down **SET-** to the point of resistance. The selected target speed increases or decreases by 1 mph (1 km/h) and appears along with the  symbol in the multifunction display.

Active Steering Assist



Function of Active Steering Assist



Active Steering Assist is only available up to a speed of 130 mph (210 km/h). The system helps you to stay in the center of the lane by means of moderate steering interventions. Depending on the speed driven, Active Steering Assist uses the vehicles ahead and lane markings as a reference.

- ① Depending on the country, in the lower speed range Active Steering Assist can use the surrounding traffic as a reference. If necessary, Active Steering Assist can then also provide assistance when driving outside the center of the lane, for example, to form a rescue lane.

If the detection of lane markings and vehicles ahead is impaired, Active Steering Assist switches to passive mode. The system provides no support in this case.

Status display of the active steering assistant

-  (gray): activated and passive
-  (green): activated and active
-  (red): system limits detected

-  (white, red hands): "hands on the steering wheel" prompt
- ① During the transition from active to passive status, the  symbol is shown as enlarged and flashing. When the passive state is reached, the symbol  is displayed in gray.
- ① Depending on the selected vehicle settings, Active Steering Assist may be unavailable.

Steering and touch detection

The driver is required to keep their hands on the steering wheel at all times and be able to intervene at any time to correct the course of the vehicle and keep it in lane. The driver must expect a change from active to passive mode or vice versa at any time.



If the system detects that the driver has not steered the vehicle for a considerable period of time or has removed their hands from the steering wheel, display  appears. If the driver still does not steer the vehicle, a warning tone sounds in addition to the visual warning message.

If the driver does not react to the warning for a considerable period, the system can initiate an emergency stop (→ page 193).

The warning is not issued or is stopped when the driver gives confirmation to the system:

- The driver steers the vehicle.

- **Depending on the country:** the driver presses a steering wheel button or operates Touch Control

If Active Steering Assist detects that a system limit has been reached, a visual warning is issued and a warning tone sounds.

Observe the notes on driving systems and your responsibility; you may otherwise fail to recognize dangers (→ page 172).

System limits

Active Steering Assist has a limited steering torque for lateral guidance. In some cases, the steering intervention is not sufficient to keep the vehicle in the lane or to drive through exits.

The system may be impaired or may not function in the following instances:

- There is poor visibility, e.g. due to snow, rain, fog, heavy spray, greatly varying ambient light or strong shadows on the road.
- There is glare, e.g. from oncoming traffic, direct sunlight or reflections.
- Insufficient road illumination.

- The windshield is dirty, fogged up, damaged or covered in the vicinity of the camera, e.g. by a sticker.
- No, or several, unclear lane markings are present for one lane, or the markings change quickly, for example, in a construction area or intersections.
- The lane markings are worn away, dark or covered up, e.g. by dirt or snow.
- If the distance to the vehicle in front is too short and thus the lane markings cannot be detected.
- The road is narrow and winding.
- There are obstacles on the lane or projecting out into the lane, such as object markers.

The system does not provide assistance in the following conditions:

- On tight bends and when turning.
- When crossing intersections.
- At traffic circles or toll stations.
- When the tire pressure is too low.

⚠ WARNING Risk of accident if Active Steering Assist unexpectedly stops functioning

If the system limits of Active Steering Assist are reached there is no guarantee that the system will remain active or will keep the vehicle in lane.

- ▶ Always keep your hands on the steering wheel and observe the traffic carefully.
- ▶ Always steer the vehicle paying attention to traffic conditions.

⚠ WARNING Risk of accident if Active Steering Assist unexpectedly intervenes

The detection of lane markings and objects may malfunction and cause unexpected steering interventions.

- ▶ Steer according to traffic conditions.



■ Activating/deactivating Active Steering Assist

Requirements

- ESP® is activated, but is not intervening.

- Active Distance Assist DISTRONIC is activated.

Multimedia system:

- ➔  ➔ Settings ➔ Quick Access
- ▶ Select  Steering Assist.

Function of Active Emergency Stop Assist



If the system detects that the driver has not steered the vehicle for a considerable period of time or has removed their hands from the steering wheel, display  appears. If the driver still does not steer the vehicle, or gives no confirmation to

the system, a warning tone sounds in addition to the visual warning message.

If the driver still does not respond to the warning, the **Beginning Emergency Stop** message appears in the Instrument Display. If the driver still does not respond, Active Distance Assist DISTRONIC reduces the speed. The vehicle is decelerated in stages to a standstill.

Depending on the country, at speeds below 40 mph (60 km/h) the hazard warning lights switch on automatically.

When the vehicle is stationary, the following actions are carried out:

- The vehicle is secured with the electric parking brake.
- Active Distance Assist DISTRONIC is ended.
- The vehicle is unlocked.
- If possible, an emergency call is placed to the Mercedes-Benz emergency call center.

The driver can cancel the deceleration at any time by performing one of the following actions:

- Steering

- Braking or accelerating
- Deactivating Active Distance Assist DISTRONIC

Active Lane Change Assist

Function of Active Lane Change Assist



Active Lane Change Assist supports the driver when changing lanes by applying steering torque if the driver activates a turn signal indicator.

Observe the notes on driving systems and your responsibility; you may otherwise fail to recognize dangers (→ page 172).

Assistance when changing lanes is provided if all the following conditions are met:

- You are driving on a freeway or road with multiple lanes in the direction of travel.
- The neighboring lane is separated by a broken lane marking.
- No vehicle is detected in the adjacent lane.
- The vehicle speed is between 50 mph (80 km/h) and 110 mph (180 km/h).

- Active Lane Change Assist is switched on in the multimedia system.
- Active Steering Assist is activated and active.

If no vehicle is detected in the adjacent lane and a lane change is permitted, the lane change begins after the driver has activated the turn signal indicator. This is shown to the driver with a green arrow next to the  steering wheel symbol. The message **Lane Change to the Left**, for example, also appears. If Active Lane Change Assist has been activated with the turn signal indicator but a lane change is not immediately possible, a gray arrow appears next to the  steering wheel symbol, which remains green.

As soon as the lane change assistance starts, the turn signal indicator is automatically activated.

If the assistant display is shown when changing lanes, an additional arrow appears on it pointing towards the adjacent lane (→ page 183).

If a lane change is not possible, the arrow is faded out after a few seconds and a new lane change must be initiated. An immediate lane change is only possible on freeway sections without speed limits.

If the system is impaired, Active Lane Change Assist may be canceled. If it is canceled, the **Lane Change Canceled** message appears on the instrument display.

In addition, a warning tone may sound, depending on the situation.

WARNING Risk of accident when changing lane to an occupied adjacent lane

Lane Change Assist cannot always clearly detect if the adjacent lane is free.

The lane change might be initiated although the adjacent lane is not free.

- ▶ Before changing lanes, make sure that the neighboring lane is free and there is no danger to other road users.
- ▶ Monitor the lane change.

WARNING Risk of accident if Lane Change Assist unexpectedly stops functioning

If the system limitations for Lane Change Assist have been reached, there is no guarantee that the system will remain active.

Lane Change Assist cannot then assist you by applying steering torque.

- ▶ Always monitor the lane change and keep your hands on the steering wheel. Observe the traffic conditions and steer and/or brake if necessary.

System limits

The system limits of Active Steering Assist apply to Active Lane Change Assist (→ page 191).

The system may also be impaired or may not function in the following situations:

- The sensors in the rear bumper are dirty, damaged or covered by a sticker or ice and snow, for example.
 - The exterior lighting shows a defect.
- i** The Active Lane Change Assist sensors adjust automatically while a certain distance is being driven after the vehicle has been delivered. Active Lane Change Assist is unavailable during this teach-in process; no arrow appears next to the Active Steering Assist symbol



when the turn signal indicator is activated.

Selecting Active Lane Change Assist

Multimedia system:

- ▶ Settings ▶ Assistance
- ▶▶ Active Lane Change Assist

- ▶ Select the function.

Active Brake Assist

Function of Active Brake Assist

Active Brake Assist consists of the following functions:

- Collision warning
- Autonomous braking function
- Situation-dependent brake force boosting
- **Vehicles with Driving Assistance Package:** Evasive Steering Assist and cornering function

Active Brake Assist can help you to minimize the risk of a collision with vehicles, cyclists or pedestrians or to reduce the effects of such a collision.

If Active Brake Assist has detected a risk of collision, a warning tone sounds and the warning lamp lights up.

Vehicles with PRE-SAFE®: depending on the country, an additional haptic warning occurs in the form of slight, repeated tensioning of the seat belt.

If you do not react to the warning, autonomous braking can be initiated in critical situations.

In especially critical situations, Active Brake Assist can initiate autonomous braking directly. In this case, the warning lamp and warning tone occur simultaneously with the braking application.

If you apply the brake yourself in a critical situation or apply the brake during autonomous braking, situation-dependent brake force boosting. The brake pressure increases up to maximum full-stop braking if necessary.

Observe the notes on driving systems and your responsibility; you may otherwise fail to recognize dangers (→ page 172).



If autonomous braking or situation-dependent brake force boosting has occurred, display  appears in the instrument display and then automatically goes out after a short time.

If the autonomous braking function or the situation-dependent brake force boosting is triggered, additional preventive measures for occupant protection (PRE-SAFE®) may also be initiated.

▲ WARNING Risk of an accident caused by limited detection performance of Active Brake Assist

Active Brake Assist cannot always clearly identify objects and complex traffic situations.

In such cases, Active Brake Assist might:

- Give a warning or brake without reason
- Not give a warning or not brake

Active Brake Assist is only an aid. The driver is responsible for maintaining a sufficiently safe distance to the vehicle in front, vehicle speed and for braking in good time.

- ▶ Always pay careful attention to the traffic situation; do not rely on Active Brake Assist alone.
- ▶ Be prepared to brake or swerve if necessary.

If Active Brake Assist is deactivated or the functions are restricted, e.g. due to activation of another driving system, the  display message appears on the instrument display.

If the system is unavailable due to dirty or damaged sensors or due to a malfunction, or if the functions are restricted, the  warning lamp appears in the driver's display.

Also observe the system limits of Active Brake Assist.

The individual subfunctions are available in various speed ranges:

The distance warning function can issue a warning in the following situations:

- From approximately 4 mph (7 km/h), if your vehicle is critically close to a vehicle, cyclist or pedestrian, you will hear an intermittent warning tone and the  distance warning lamp lights up on the instrument display.

Vehicles with PRE-SAFE®: depending on the country, an additional haptic warning occurs in the form of slight, repeated tensioning of the seat belt.

Brake immediately or take evasive action, provided it is safe to do so and the traffic situation allows this.

Collision warning (vehicles without Driving Assistance Package)

The collision warning can aid you in the following situations with an intermittent warning tone and a warning lamp:

- From approximately 4 mph (7 km/h), if your vehicle is critically close to a vehicle, cyclist or

pedestrian, you will hear an intermittent warning tone and the  distance warning lamp lights up on the instrument display.

Vehicles with PRE-SAFE®: depending on the country, an additional haptic warning occurs in the form of slight, repeated tensioning of the seat belt.

- at speeds up to approximately 155 mph (250 km/h) when approaching vehicles ahead
- at speeds up to approximately 50 mph (80 km/h) when approaching stationary vehicles, moving pedestrians, and cyclists ahead
- at speeds up to approximately 37 mph (60 km/h) when approaching crossing cyclists

Collision warning (vehicles with Driving Assistance Package)

The collision warning can aid you in the following situations with an intermittent warning tone and a warning lamp:

- at speeds up to approximately 155 mph (250 km/h) when approaching vehicles ahead

- at speeds up to approximately 62 mph (100 km/h) when approaching stationary vehicles
- at speeds up to approximately 50 mph (80 km/h) when approaching moving pedestrians and cyclists ahead
- at speeds up to approximately 43 mph (70 km/h) when approaching stationary pedestrians, crossing vehicles and stationary and crossing cyclists

Autonomous braking function (vehicles without Driving Assistance Package)

If the vehicle is traveling at speeds above approximately 4 mph (7 km/h), the autonomous braking function may intervene in the following situations:

- at speeds up to approximately 124 mph (200 km/h) when approaching vehicles ahead
- at speeds up to approximately 50 mph (80 km/h) when approaching cyclists ahead
- at speeds up to approximately 37 mph (60 km/h) when approaching moving pedestrians, crossing cyclists, and stationary vehicles

Autonomous braking function (vehicles with Driving Assistance Package)

If the vehicle is traveling at speeds above approximately 4 mph (7 km/h), the autonomous braking function may intervene in the following situations:

- at speeds up to approximately 155 mph (250 km/h) when approaching vehicles ahead
- at speeds up to approximately 62 mph (100 km/h) when approaching stationary vehicles
- at speeds up to approximately 50 mph (80 km/h) when approaching cyclists ahead
- at speeds up to approximately 43 mph (70 km/h) when approaching stationary and moving pedestrians, crossing vehicles and stationary and crossing cyclists

Situation-dependent brake force boosting (vehicles without Driving Assistance Package)

The situation-dependent brake force boosting can intervene from a speed of approximately 4 mph (7 km/h) in the following situations:

- at speeds up to approximately 155 mph (250 km/h) when approaching vehicles ahead

- at speeds up to approximately 50 mph (80 km/h) when approaching stationary vehicles and cyclists ahead
- at speeds up to approximately 37 mph (60 km/h) when approaching moving pedestrians and crossing cyclists

Situation-dependent brake force boosting (vehicles with Driving Assistance Package)

The situation-dependent brake force boosting can intervene from a speed of approximately 4 mph (7 km/h) in the following situations:

- at speeds up to approximately 155 mph (250 km/h) when approaching vehicles ahead
- at speeds up to approximately 62 mph (100 km/h) when approaching stationary vehicles
- at speeds up to approximately 50 mph (80 km/h) when approaching cyclists ahead
- at speeds up to approximately 37 mph (60 km/h) when approaching stationary and moving pedestrians, crossing vehicles, and stationary and crossing cyclists

Canceling a brake application of Active Brake Assist

You can cancel a brake application of Active Brake Assist at any time by:

- sharply depressing the accelerator pedal or with kickdown
- releasing the brake pedal

Active Brake Assist may cancel the brake application when one of the following conditions is fulfilled:

- you maneuver to avoid the obstacle
- there is no longer a risk of collision
- an obstacle is no longer detected in front of your vehicle

Evasive Steering Assist (only vehicles with Driving Assistance Package)

Evasive Steering Assist has the following characteristics:

- The ability to detect stationary or moving pedestrians.
- Assistance through power-assisted steering if it detects a swerving maneuver.

- Activation by an abrupt steering movement during a swerving maneuver.
- Assistance during swerving and straightening of the vehicle.
- Reaction from a speed of approximately 12 mph (20 km/h) up to a speed of approximately 43 mph (70 km/h).

You can prevent the assistance at any time by actively steering.

Cornering function (only vehicles with Driving Assistance Package)

If the system detects a risk of a collision with an oncoming vehicle when turning across an oncoming lane, autonomous braking can be initiated at speeds below 9 mph (15 km/h) before you have left the lane in which you are driving.

⚠ WARNING Risk of accident despite Evasive Steering Assist

Evasive Steering Assist cannot always recognize objects or complex traffic situations clearly.

Moreover, the steering support provided by Evasive Steering Assist is not sufficient to avoid a collision.

- ▶ Always pay careful attention to the traffic situation; do not rely on Evasive Steering Assist alone.
- ▶ Be prepared to brake or swerve if necessary.
- ▶ End the support by actively steering in non-critical situations.
- ▶ Drive at an appropriate speed if there are pedestrians close to the path of your vehicle.

System limits

Full system performance is not available for a short time after switching on the vehicle or after driving off. Depending on the environmental conditions, it may take a few minutes before full system performance is available.

The system may be impaired or may not function, particularly in the following situations:

- In snow, rain, fog, heavy spray, if there is glare, in direct sunlight or in greatly varying ambient light.
- If the sensors are dirty, fogged up, damaged or covered.
- If the sensors are impaired due to interference from other radar sources, e.g. strong radar reflections in parking garages.
- If a loss of tire pressure or a defective tire has been detected and displayed.
- If DSR is active.
- In complex traffic situations where objects cannot always be clearly identified.
- If pedestrians or vehicles move quickly into the sensor detection range.
- If pedestrians are hidden by other objects.
- If the typical outline of a pedestrian cannot be distinguished from the background.
- If a pedestrian is not detected as such, e.g. due to special clothing or other objects.

- If the driver's seat belt is not fastened.
 - On bends with a tight radius.
- ❗ The Active Brake Assist sensors adjust automatically while a certain distance is being driven after the vehicle has been delivered. Active Brake Assist is unavailable or available only partially during the teach-in process.

■ Activating/deactivating Active Brake Assist

Requirements

- The vehicle is switched on.

Multimedia system:

➔  ➔ [Settings](#) ➔ [Assistance](#)
➔ [Active Brake Assist](#)

- ▶ Select the desired setting.

Deactivating Active Brake Assist

- ❗ It is recommended that you always leave Active Brake Assist activated.
- ▶ Select **Off**.
The distance warning function, the autonomous braking function and Evasive Steering Assist are deactivated.

The system is switched on again the next time the vehicle is started.

- ❶ If Active Brake Assist is deactivated, the  symbol appears in the status bar of the Instrument Display.

Traffic Sign Assist

Function of Traffic Sign Assist

Traffic Sign Assist detects traffic signs with the multifunction camera (→ page 173). It assists you by displaying detected speed limits and overtaking restrictions in the Instrument Display.

Observe the notes on driving systems and your responsibility; you may otherwise fail to recognize dangers (→ page 172).

Since Traffic Sign Assist also uses the data stored in the navigation system, it can update the display in the following situations without detecting traffic signs.

The camera also detects traffic signs with a restriction indicated by an additional sign (e.g. when wet). These are only displayed if a restric-

tion applies or if the system cannot clearly determine whether the restriction applies.

Warning when the maximum permissible speed is exceeded

The system can warn you if you unintentionally exceed the maximum permissible speed. Depending on the country, you can set in the multimedia system by how much the maximum permitted speed may be exceeded before a warning is given. You can specify whether the warning is to be just a visual warning or an acoustic one as well.

Display in the Instrument Display



Instrument display in the widescreen cockpit

- ❶ Maximum permissible speed
- ❷ Maximum permissible speed when there is a restriction
- ❸ Additional sign with restriction

The system can show up to two traffic signs simultaneously. The system always prioritizes displaying speed limits. Up to one traffic sign with a maximum permissible speed can be shown in the head-up display. If two speed signs are shown in the driver display, e.g. in the case of detected restrictions, the value of the left-hand speed limit ❶ is always transmitted to the TEMPOMAT or

Active Distance Assist DISTRONIC for acceptance and shown in the head-up display.

- i **Vehicles with a standard Instrument Display:** a + symbol next to a traffic sign in the Instrument Display indicates that additional traffic signs have been detected. These can also be displayed in the media display and optionally in the head-up display.

If Traffic Sign Assist cannot determine the maximum permissible speed (e.g. due to missing signs), the following display appears:



This is displayed continuously if the vehicle is in a country where Traffic Sign Assist is not supported. Traffic Sign Assist is not available in all countries.

- i Also observe the information on display messages in Traffic Sign Assist (→ page 358).

System limits

The system may be impaired or may not function particularly in the following situations:

- If there is poor visibility, e.g. due to insufficient illumination of the road, highly variable shade conditions, rain, snow, fog or heavy spray.
- If there is glare, e.g. from oncoming traffic, direct sunlight or reflections.
- If there is dirt on the windshield in the vicinity of the multifunction camera or if the camera is fogged up, damaged or obscured.
- If the traffic signs are hard to detect, e.g. due to dirt, snow or insufficient lighting, or because they are obscured.
- If the information on the navigation system's digital map is incorrect or out of date.
- If signs are ambiguous, e.g. road signs in roadworks or in adjacent lanes.
- If you turn sharply when passing traffic signs outside the camera's field of vision.

Setting Traffic Sign Assist

Requirements:

- **Only vehicles with Driving Assistance Package:** Active Distance Assist DISTRONIC and ECO Assist must be activated for the automatic adoption of speed limits.

Multimedia system:

- 🏠 » [Settings](#) » [Assistance](#) » [Traffic Sign Assist](#)

Activating or deactivating automatic adoption of speed limits (only vehicles with Driving Assistance Package)

- ▶ Select [Limit Adoption](#).

- ▶ Switch the function on or off. The speed limits detected by Traffic Sign Assist are automatically adopted by Active Distance Assist DISTRONIC.

- i If one of the following systems is activated, the detected speed can be manually adopted as the speed limit:
 - Active Distance Assist DISTRONIC
 - Cruise control

- Variable limiter

Further information about Active Distance Assist DISTRONIC: (→ page 186).

Displaying detected traffic signs in the media display

- ▶ Select **Display in Central Display**.
- ▶ Switch the function on or off.

Setting the type of warning

- ▶ Select **Visual & Audible**, **Visual** or **Off**.

Setting the warning threshold

This value determines the speed at which a warning is issued when exceeded.

- ▶ Select **Warning Threshold**.
- ▶ Set the desired speed.

Traffic Light Information service

⚠ WARNING Risk of an accident or injury due to distraction, incorrect or missing data

The traffic light information display is an aid and cannot replace the observation of the actual driving situation.

- ▶ Keep the actual traffic situation constantly in view when approaching a traffic light and when changing lanes.
- ▶ Avoid looking at the Instrument Display and Head-up Display for a long time.

The Instrument Display and Head-up Display (if available) show the traffic light icon and remaining time until the next green phase as a countdown.



Example representation in the Instrument Display

- ① Traffic light icon and countdown of remaining time until the next green phase time

The display is hidden about five seconds before the traffic lights change to green.

- ① The display also goes out in the following cases:
 - When turning off before the intersection into a cross or side street
 - When turning before the intersection
- ① The direction arrows are displayed depending on the following functions:
 - A turn signal is set

- A lane is recommended during active route guidance

If neither function is active, the remaining time until the next green phase for the lane straight ahead is displayed.

- ① Use of the traffic light information service requires the regular transmission of vehicle positions and driving directions to Mercedes-Benz. The data is immediately anonymized by Mercedes-Benz and forwarded to the provider of the traffic light information service. The vehicle positions and driving directions are deleted after a very short time (a few seconds) and are not permanently saved.

If you do not want to transmit the vehicle positions and driving directions, you have the following options:

- You deactivate the service in the Mercedes me portal.
- You have the service deactivated at an authorized Mercedes-Benz Center.

- You deactivate the service in the **Assistance** menu in the multimedia system (→ page 204).

- ① This traffic light information service is only available in certain cities and regions.

The function is supported under the following conditions:

- The vehicle is equipped with a multimedia system featuring navigation and a communication module with an activated, integrated SIM card.
- You have a user account for the Mercedes me Portal.
- The vehicle has been connected with the user account.
- The navigation services option is available, subscribed to and activated in the Mercedes me Portal.
- The traffic light data service belongs to the scope of the navigation services.

The current vehicle position and the direction of travel are transmitted via the communication module and aligned with the data from the traffic light data service provider. The provider gathers

data from traffic lights which transmit their changing phases. When the vehicle approaches an intersection with networked traffic lights, data is transmitted to the vehicle.

A set turn signal left or right and lane recommendations during active route guidance are taken into account for the display.

The service is for information purposes only and is not linked to any other vehicle functions, systems or components. Please note that the displayed data is not available in all traffic areas and may be incorrect.

Certain light signal systems automatically adapt their switching times to the current traffic situation. This can lead to a sudden change in the countdown display.

The information in the Instrument Display is shown after selecting the display contents in the **Assistance** menu. If another menu is selected, the traffic light countdown is not displayed.

Also observe the following information:

- select a speed adapted to the traffic, surroundings and weather conditions

- Observe actual traffic signs
- Observe applicable traffic rules and regulations

Please observe the notes on driving systems and your responsibility. You could otherwise fail to recognize dangers.

System limits

The display does not appear in the following situations, for example:

- There is no traffic light data available.
- The time remaining until the next green phase is less than ten seconds.
- Emergency vehicles or local public transport are located in the vicinity of the intersection.
- The data transmission from the vehicle has been interrupted.
- The traffic light systems are located in a construction site area or are undergoing maintenance.
- The light signal system is malfunctioning.
- The subscription to the service has expired.

Switching the traffic light information display on or off

Multimedia system:

  **▶ Settings ▶ Assistance**

 Switch **Traffic Light Information** on  or off .



Blind Spot Assist and Active Blind Spot Assist with exit warning

Function of Blind Spot Assist and Active Blind Spot Assist with exit warning

Blind Spot Assist and Active Blind Spot Assist use two lateral, rear-facing radar sensors to monitor the area up to 130 ft (40 m) behind and 10 ft (3 m) next to your vehicle.

If a vehicle is detected at speeds above approximately 8 mph (12 km/h) and this vehicle subsequently enters the monitoring range directly next to your vehicle, the warning lamp in the outside mirror lights up red.

Status display:

-  (gray): system is activated but inoperative
-  (green): system is activated and operational

If a vehicle is detected close to your vehicle and you switch on the turn signal indicator in the corresponding direction, a double warning tone sounds and the red warning lamp in the outside mirror flashes. If the turn signal indicator remains switched on, all other detected vehicles are indicated only by the flashing of the red warning lamp.

If you overtake a vehicle quickly, no warning is given.

⚠ WARNING Risk of accident despite Active Blind Spot Assist

Active Blind Spot Assist does not react to the following:

- if you overtake a vehicle too closely so that it is in the blind spot area

- if vehicles traveling at a much faster speed approach and then overtake

Active Blind Spot Assist may not give warnings or intervene in such situations.

- ▶ Always pay careful attention to the traffic situation and maintain a safe distance at the side of the vehicle.

Observe the notes on driving systems and your responsibility; you may otherwise fail to recognize dangers (→ page 172).

Exit warning

The exit warning is an additional function of Blind Spot Assist and can warn vehicle occupants about approaching vehicles when leaving the vehicle when stationary.

⚠ WARNING Risk of accident despite exit warning

The exit warning neither reacts to stationary objects nor to persons or road users approaching you at a greatly differing speed.

The exit warning cannot warn drivers in these situations.

- ▶ Always pay particular attention to the traffic situation when opening the doors and make sure there is sufficient clearance.

If there is a vehicle in the monitoring range, this is indicated in the outside mirror. If a vehicle occupant opens the door on the side with the warning, a warning tone sounds and the warning lamp in the outside mirror starts to flash.

This additional function is available only when Blind Spot Assist is active. When the exit warning is activated, it can warn vehicle occupants for up to three minutes after switching the vehicle off. The exit warning is no longer available once the warning lamp in the outside mirror flashes three times.

The exit warning is only an aid and not a substitute for the attention of vehicle occupants. The responsibility for opening and closing the doors and for leaving the vehicle remains with the vehicle occupants.

System limits

Blind Spot Assist and Active Blind Spot Assist may be limited in the following situations, in particular:

- if there is dirt on the sensors or the sensors are obscured
- in poor visibility, e.g. due to fog, heavy rain or snow
- if there are narrow vehicles, e.g. bicycles or motorbikes
- if the road has very wide or narrow lanes
- if vehicles are not driving in the middle of their lane

Warnings may be issued in error when driving close to crash barriers or similar continuous lane borders. Always make sure that there is sufficient distance to the side for other traffic or obstacles.

Warnings may be interrupted when you are driving alongside long vehicles (e.g. trucks) for a prolonged time.

Blind Spot Assist is not operational when reverse gear is engaged.

The exit warning may be limited in the following situations:

- when the sensors are covered by adjacent vehicles in narrow parking spaces
- when people approach the vehicle
- in the event of stationary or slowly moving objects

Function of brake application (Active Blind Spot Assist)

If Active Blind Spot Assist detects a risk of a side impact in the monitoring range, a course-correcting brake application is carried out. This is designed to help you avoid a collision.

The course-correcting brake application is available in the speed range between approximately 20 mph (30 km/h) and 125 mph (200 km/h).

⚠ WARNING Risk of accident despite brake application of Active Blind Spot Assist

A course-correcting brake application cannot always prevent a collision.

- ▶ Always steer, brake or accelerate yourself, especially if Active Blind Spot Assist

warns you or makes a course-correcting brake application.

- ▶ Always maintain a safe distance at the sides.



If a course-correcting brake application occurs, the red warning lamp flashes in the outside mirror and a warning tone sounds. In addition, display **!** indicating the danger of a side collision appears in the Instrument Display.

In rare cases, the system may make an inappropriate brake application. This brake application may be interrupted at any time if you steer slightly in the opposite direction or accelerate.

System limits

Note the system limitations of Active Blind Spot Assist; you may otherwise not recognize the dangers (→ page 204).

Either a course-correcting brake application appropriate to the driving situation, or none at all, may occur in the following situations:

- Vehicles or obstacles, e.g. crash barriers, are located on both sides of your vehicle.
- A vehicle approaches too closely on the side.
- You have adopted a sporty driving style with high cornering speeds.
- You brake or accelerate significantly.
- A driving safety system intervenes, e.g. ESP® or Active Brake Assist.
- ESP® is deactivated.
- A loss of tire pressure or a defective tire is detected.

■ Activating/deactivating Blind Spot Assist or Active Blind Spot Assist

Multimedia system:

→  » Settings » Assistance

▶ Activate or deactivate **Blind Spot Assist**.
or

▶ Activate or deactivate **Act. Blind Spot Assist**.

Active Lane Keeping Assist

■ Function of Active Lane Keeping Assist



Active Lane Keeping Assist monitors the area in front of your vehicle by means of a multifunction camera (→ page 173). It serves to protect you against unintentionally leaving your lane. You will be warned by vibration pulses in the steering wheel and guided back into your lane by a course-correcting brake application.

Active Lane Keeping Assist is available in the speed range between 37 mph (60 km/h) and 124 mph (200 km/h).

Active Lane Keeping Assist can neither reduce the risk of an accident if you fail to adapt your driving style nor override the laws of physics. It cannot

take into account road, weather or traffic conditions. Active Lane Keeping Assist is only an aid. You are responsible for maintaining a safe distance, for vehicle speed, for braking in good time and for staying in lane.

The status of Active Lane Keeping Assist is displayed in the on-board computer:

-  (green): Active Lane Keeping Assist is active and operating.
-  (gray): Active Lane Keeping Assist is active but not operating.
-  (OFF): Active Lane Keeping Assist is deactivated or there is a malfunction.



If a lane-correcting brake application occurs, display  will appear on the instrument display.

The system does not apply the brake on the corresponding side if you activate the turn signal indicator.

Vehicles with Driving Assistance Package: if the system detects an obstacle, such as another vehicle in the adjacent lane, it will apply the brake regardless of the turn signal indicator.

You will be warned by vibrations in the steering wheel in the following circumstances:

- Active Lane Keeping Assist detects a lane marking.
- A front wheel drives over this lane marking.

Conditions for a course-correcting brake application (vehicles without Driving Assistance Package)

Lane markings were detected on both sides of the lane. The front wheel drives over a continuous lane marking.

-  A brake application may be interrupted at any time by steering slightly in the opposite direction.

Conditions for a course-correcting brake application (vehicles with Driving Assistance Package)

- A continuous lane marking was detected and driven over with the front wheel.
 - A lane marking and an oncoming vehicle, an overtaking vehicle or vehicles driving parallel to your vehicle were detected in the adjacent lane. The front wheel drives over the lane marking.
-  A brake application may be interrupted at any time by steering slightly in the opposite direction.

System limits

No lane-correcting brake application will occur in the following situations:

- You clearly and actively steer, brake or accelerate.
 - If a driving safety system intervenes, such as ESP®, Active Brake Assist or Active Blind Spot Assist.
 - You have adopted a sporty driving style with high cornering speeds or high rates of acceleration.
- When ESP® is deactivated.
 - If a loss of tire pressure or a defective tire is detected and displayed.

If you deactivate the Active Lane Keeping Assist warning and the lane markings were not clearly detected, it is possible that no lane-correcting brake application will take place (→ page 209).





The system may be impaired or may not function particularly in the following situations:

- If there is poor visibility, e.g. due to insufficient illumination of the road, highly variable shade conditions, rain, snow, fog or heavy spray.
- If there is glare, e.g. from oncoming traffic, the sun or reflections.
- If there is dirt on the windshield in the vicinity of the multifunction camera or if the camera is fogged up, damaged or obscured.
- If there are no lane markings or several unclear lane markings are present for one lane, e.g. around roadworks.
- If the lane markings are worn, dark or covered.

- If the distance to the vehicle in front is too short and thus the lane markings cannot be detected.
- If the lane markings change quickly, e.g. lanes branch off, cross one another or merge.
- If the road is very narrow and winding.
- **Vehicles with Driving Assistance Package:** if the radar sensors in the rear bumper are dirty or covered in snow and an obstacle is detected in your lane, no lane-correcting brake application takes place.

■ Activating/deactivating Active Lane Keeping Assist

Multimedia system:

-   [Settings](#)  [Quick Access](#)
 [Active Lane Keeping Assist](#)
 Activate or deactivate the function.

Setting Active Lane Keeping Assist

Multimedia system:

-  >> Settings >> Assistance
>> Active Lane Keeping Assist

Activating or deactivating the haptic warning

- ▶ Select **Warning**.
- ▶ Activate or deactivate the function.

Rear view camera

Function of the rear view camera

The rear view camera is only an aid. It is not a substitute for your attention to the surroundings. Responsibility for safe maneuvering and parking remains with you. Make sure that there are no persons, animals, objects, etc. in the maneuvering area while maneuvering and parking.

- ⓘ You can open the cover of the rear view camera manually (→ page 213).

The guide lines in the media display show the distances to your vehicle. The distances displayed apply only to road level.

Depending on the vehicle equipment, you can select from the following views:

- Normal view
- Wide-angle view

The area behind the vehicle is displayed as a mirror image, as in the inside rear-view mirror.

Vehicles without Parking Assist PARKTRONIC

The following camera views are available in the multimedia system:

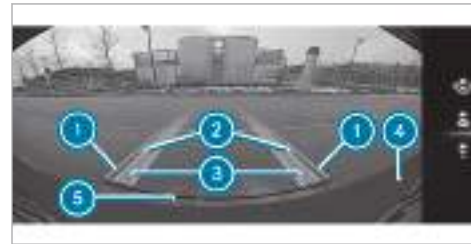

Normal view

- ① Yellow guide line, vehicle width (driven surface) depending on the current steering angle (dynamic)

- ② Yellow guide line at a distance of approximately 3.3 ft (1.0 m) from the rear area
- ③ Yellow lanes marking the course the tires will take with the current steering angle (dynamic)
- ④ Bumper
- ⑤ Red guide line at a distance of approximately 1.0 in (0.3 m) from the rear area



Wide-angle view

Vehicles with Parking Assist PARKTRONIC

The following camera views are available in the multimedia system:

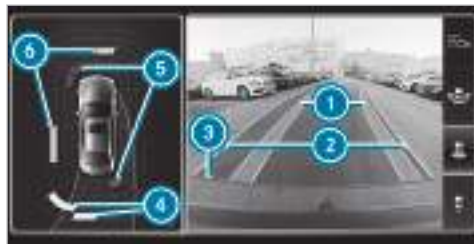

Normal view

- ① Yellow lanes marking the course the tires will take with the current steering angle (dynamic)
- ② Yellow guide line, vehicle width (driven surface) depending on the current steering angle (dynamic)
- ③ Red guide line at a distance of approximately 1.0 in (0.3 m) from the rear area
- ④ Yellow warning indicator of Parking Assist PARKTRONIC: obstacles at a distance between approximately 2.0 ft (0.6 m) and 3.3 ft (1.0 m)

- ⑤ Red warning display of Parking Assist PARKTRONIC: obstacles are very close (approximately 1.0 ft (0.3 m) or less)
- ⑥ Orange warning display of Parking Assist PARKTRONIC: obstacles are a medium distance away (between approximately 1.0 ft (0.3 m) and 2.0 ft (0.6 m))



Wide-angle view

System failure

If the rear view camera is not operational, the following display appears in the multimedia system.



System limits

The rear view camera will not function or will function only partially in the following situations:

- The tailgate is open.
 - There is heavy rain, snow or fog.
 - The ambient light is poor, e.g. at night.
 - Cameras, or vehicle components in which the cameras are installed, are damaged, dirty or covered. Observe the information on vehicle sensors and cameras (→ page 173).
- ⓘ Do not use the rear view camera in these types of situations. You could otherwise injure others or collide with objects when parking the vehicle.
- ⓘ The contrast of the display may be impaired by direct sunlight or by other light sources, e.g. when driving out of a garage. In this case, pay particular attention.

- ❗ Have the display repaired or replaced if, for example, pixel errors considerably restrict its use.

360° camera

Function of the 360° Camera

The 360° Camera is a system that consists of four cameras. The cameras cover the immediate vehicle surroundings. The system assists you when you are parking or at exits with reduced visibility, for example.

The views of the 360° Camera are always available when the vehicle is being driven forwards up to a speed of approx. 10 mph (16 km/h) and when it is being backed up.

The 360° Camera is only an aid and may show a distorted view of obstacles, show them incorrectly or not show them at all. It is not a substitute for your attention to the surroundings. Responsibility for safe maneuvering and parking remains with you. Make sure that there are no persons, animals or objects etc., in the maneuvering area while maneuvering and parking.

The system evaluates images from the following cameras:

- Rear view camera
- Front camera
- Two side cameras in the outside mirrors

- ❗ You can open the cover of the rear view camera manually (→ page 213).

Views of the 360° Camera

You can select from different views:



- ❶ Wide-angle view, front
- ❷ Top view with image from the front camera

- ❸ Top view with images from the side cameras in the outside mirrors
- ❹ Wide-angle view, rear
- ❺ Top view with image from the rear view camera
- ❻ Top view with trailer view (vehicles with a trailer hitch)

Top view



- ❶ Lane indicating the route that the vehicle will take at the current steering wheel angle
- ❷ Warning display of Parking Assist PARKTRONIC
- ❸ Your vehicle from above

The color of the individual segments of warning display ② is based on the distance to the detected obstacle:

- **Yellow segments:** obstacles at a distance between approx. 2.0 ft (0.6 m) and 3.3 ft (1.0 m)
- **Orange segments:** obstacles at a distance between approx. 1.0 ft (0.3 m) and 2.0 ft (0.6 m)
- **Red segments:** obstacles at a very short distance of approx. 1.0 ft (0.3 m) or less

When Parking Assist PARKTRONIC is operational and no object is detected, the segments of the warning display are shown in gray.

Guide lines

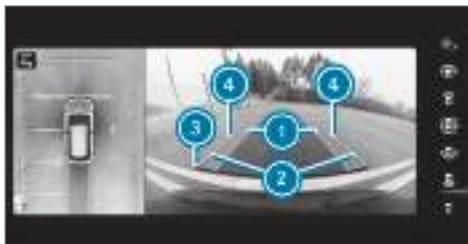

- ① Yellow lane marking the course that the tires will take at the current steering wheel angle (dynamic)
 - ② Yellow guide line, vehicle width (driven surface) depending on the current steering wheel angle (dynamic)
 - ③ Red guide line at a distance of approximately 1.0 in (0.3 m) from the rear area
 - ④ Mark at a distance of approx. 3.3 ft (1.0 m)
- ① When Active Parking Assist is active, lanes ① are displayed in green.

The guide lines in the media display show the distances to your vehicle. The distances apply to road level.

Side view of the mirror cameras

The sides of the vehicle can be seen in this view.

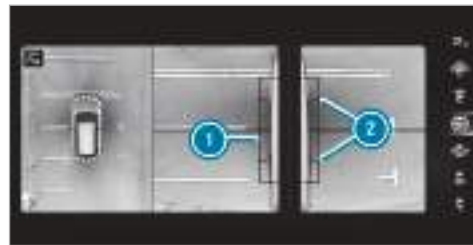

- ① Guide line of external vehicle dimensions with outside mirrors folded out
- ② Marker of the wheel contact points

System failure

If the system is not ready for operation, the following message appears in the media display:



System limits

The 360° Camera will not function or will function only partially in the following situations:

- The doors are open.
 - The outside mirrors are folded in.
 - The tailgate is open.
 - There is heavy rain, snow or fog.
 - The ambient light is poor, e.g. at night.
 - Cameras – or the vehicle components in which the cameras are installed – are damaged, dirty or covered. Observe the information on vehicle sensors and cameras (→ page 173).
- i** Do not use the 360° Camera under such circumstances. You could otherwise injure others or collide with objects when parking the vehicle.

For technical reasons, the standard height of the vehicle may be altered if the vehicle is carrying a heavy load and can result in inaccuracies in the guide lines and in the display of the generated images.

- i** The contrast of the display may be impaired by abrupt, direct sunlight or by other light sources, e.g. when you are driving out of a garage. In this case, pay particular attention.
- i** Have the display repaired or replaced if, for example, pixel errors considerably restrict its use.

See the notes on cleaning the 360° Camera (→ page 290).

Calling up the view of the 360° Camera using reverse gear

- ▶ Engage reverse gear.
- ▶ Select the desired view in the multimedia system (→ page 211).
- ▶ If the image from the rear view camera is not shown after reverse gear is engaged: switch off the vehicle, press and hold the  but-

ton, switch on the vehicle and engage reverse gear again.

Opening the camera cover of the rear view camera

Multimedia system:

 **▶▶ Settings ▶▶ Assistance**
▶▶ Camera & Parking

▶ Select **Open Camera Cover**.

- i** The camera cover closes automatically after a while or after an ignition cycle.

Parking Assist PARKTRONIC

Function of Parking Assist PARKTRONIC

Parking Assist PARKTRONIC is an electronic parking assistance system with ultrasound. It monitors the area around your vehicle using multiple sensors on the front bumper and on the rear bumper. Parking Assist PARKTRONIC shows you the distance between your vehicle and a detected obstacle visually and audibly.

Parking Assist PARKTRONIC is only an aid. It is not a substitute for your attention to the surroundings. The responsibility for safe maneuvering and

parking remains with you. Make sure that there are no persons, animals or objects in the maneuvering area while maneuvering and parking in/exiting parking spaces.

In the standard setting, an intermittent warning tone sounds from a distance of approximately 1.0 ft (0.3 m) to an obstacle in front and approximately 3.3 ft (1.0 m) to an obstacle behind. A continuous warning tone sounds from a distance of approximately 0.7 ft (0.2 m). Using the **Warn Early All Around** setting in the multimedia system, the warning tones for front and side impact protection can be set to sound at a greater distance of approximately 3.3 ft (1.0 m) in front and 2.0 ft (0.6 m) on the sides (→ page 218).

i The **Warn Early All Around** setting is always active in the rear of the vehicle.

Parking Assist PARKTRONIC display in the multimedia system



Vehicles without 360° Camera



Vehicles with 360° Camera

If you have not selected the menu **Camera & Parking** and an obstacle is detected in the path of travel, a PARKTRONIC Parking Assist pop-up window is displayed in the multimedia system at speeds below 6 (10 km/h) mph **i**.

The color of the individual segments of the warning display is based on the distance to the detected obstacle:

- **Yellow segments:** obstacles at a distance between approx. 2.0 ft (0.6 m) and 3.3 ft (1.0 m)

- **Orange segments:** obstacles at a distance between approx. 1.0 ft (0.3 m) and 2.0 ft (0.6 m)
- **Red segments:** obstacles at a very short distance of approx. 1.0 ft (0.3 m) or less

Display of Parking Assist PARKTRONIC in the head-up display



Optionally, obstacles detected by Parking Assist PARKTRONIC from a distance of approximately 3.3 ft (1.0 m) in front ② and 2.0 ft (0.6 m) on the sides ③ can also be displayed in the head-up display.

System limits

Parking Assist PARKTRONIC does not necessarily take into account the following obstacles:

- Obstacles below the detection range, e.g. persons, animals or objects.
- Obstacles above the detection range, e.g. overhanging loads, overhangs or loading ramps of truck.

The sensors must be free of dirt, ice and slush. Otherwise, they may not function correctly. Clean the sensors regularly, especially after driving off-road, taking care not to scratch or damage them (→ page 173).

Problems with Parking Assist PARKTRONIC



Example: vehicles with 360° Camera

When rear segments ① or all-round segments ② light up red and the  symbol appears in the Instrument Display, Parking Assist PARKTRONIC may have been deactivated due to signal interference. Start the vehicle again and check if Parking Assist PARKTRONIC is working at a different location.

If a warning tone also sounds for approximately two seconds every time the vehicle is started, it may be due to one of the following causes:

- **The sensors are dirty:** clean the sensors and observe the notes on care of vehicle parts (→ page 290).
- **Parking Assist PARKTRONIC has been deactivated due to a malfunction:** restart the vehicle. If the problem persists, consult a qualified specialist workshop.

■ Function of the passive side impact protection

Passive side impact protection is an additional Parking Assist PARKTRONIC function that warns the driver about obstacles at the side of the vehicle. A warning is issued when obstacles are detected between the front and rear detection range. In order for an object on the side to be detected, the sensors in the front and rear bumper must first detect the object while you are driving past it.

During the parking procedure or maneuvering, objects are detected as the vehicle drives past. If you steer in the direction of a detected obstacle and there is a risk of a lateral collision, a warning

is issued and the segments light up in color on the display.

The segment color changes depending on the distance to the detected obstacle:

- **Yellow:** approximately 1.0 - 2.0 ft (30 - 60 cm)
- **Red:** less than approximately 1.0 ft (30 cm)

In order for lateral front or rear segments to be displayed, the vehicle must first travel a distance of at least half a vehicle's length. Once the vehicle has traveled the length of the vehicle, all of the lateral front and rear segments can be displayed.



Parking Assist PARKTRONIC display: vehicles without a 360° camera

- ① Operational front and rear
- ② Operational front, rear and sides
- ③ Obstacle detected at the front right (yellow) and rear (red)



Parking Assist PARKTRONIC display: vehicles with a 360° camera

- ① Operational front and rear
- ② Operational front, rear and sides
- ③ Obstacles detected at the front right (red)

Saved obstacles at the sides are deleted in the following situations, for example:

- You park the vehicle and switch it off.
- You open the doors.

After the engine is restarted, obstacles at the sides must be detected again before a new warning can be issued.

System limits

The system limits for Parking Assist PARKTRONIC apply to passive side impact protection.

The following objects are not detected, for example:

- Pedestrians who approach the vehicle from the side
- Objects placed next to the vehicle

Activating/deactivating Parking Assist PARKTRONIC using the multimedia system

! **NOTE** Risk of an accident from objects at close range

Parking Assist PARKTRONIC may not detect certain objects at close range.

- ▶ When parking or maneuvering the vehicle, pay particular attention to any objects which are above or below the sensors, e.g. flower pots or drawbars. The vehicle or other objects could otherwise be damaged.

Requirements

- The camera menu is open.
 - Or: Active Parking Assist is active.
 - Or: the PARKTRONIC pop-up window appears.
- ▶ Tap **P** on the media display.

If the indicator lamp in the **P OFF** button is not lit, Parking Assist PARKTRONIC is active. If the indicator lamp is lit or the **P OFF** symbol appears on the instrument cluster, Parking Assist PARKTRONIC is not active.

- ① Parking Assist PARKTRONIC is automatically activated when the vehicle is started.

Alternatively, Parking Assist PARKTRONIC can be activated or deactivated in the quick access menu.

■ Setting the warning tones of Parking Assist PARKTRONIC

Multimedia system:

- ➔ ➔  ➔ Settings ➔ Assistance
- ➔ ➔ Camera & Parking

Adjusting the volume of the warning tones

- ▶ Select **Warning Tone Volume**.
- ▶ Set a value.

Adjusting the pitch of the warning tones

- ▶ Select **Warning Tone Pitch**.
- ▶ Set a value.

Specifying the starting point for the warning tones

You can specify whether the Parking Assist PARKTRONIC warning tones should commence when the vehicle is further away from an obstacle.

- ▶ Select **Warn Early All Around**.
- ▶ Activate or deactivate the function.

Activating/deactivating audio fadeout

You can specify whether the volume of a media source in the multimedia system is to be reduced

when Parking Assist PARKTRONIC sounds a warning tone.

- ▶ Select **Audio Fadeout During Warning Tones**.
- ▶ Activate or deactivate the function.

Active Parking Assist

■ Function of Active Parking Assist

Active Parking Assist is an electronic parking assistance system, which uses ultrasound with the assistance of the rear view camera and 360° Camera. When you are driving forwards up to approximately 22 mph (35 km/h), the system automatically measures parking spaces on both sides of the vehicle.

Active Parking Assist offers the following functions:

- Parking in parking spaces parallel to the road
- Parking in parking spaces perpendicular to the road (optionally either forwards or reverse)
- Exiting parking spaces if you have parked using Active Parking Assist

As soon as all requirements are met for searching for parking spaces, the  display appears in the Instrument Display.

When Active Parking Assist has detected parking spaces, the  display appears in the Instrument Display. The arrows show on which side of the road detected parking spaces are located. They are then shown in the media display.

The parking space can be selected as desired. Depending on the location of the parking space, the parking direction (rearwards or forwards) can also be selected as desired.

When Active Parking Assist is activated, the turn signal indicators are activated based on the calculated path of your vehicle.

The parking procedure is assisted by accelerating, braking, steering and gear changes.

Active Parking Assist is only an aid. It is not a substitute for your attention to the surroundings. Responsibility for safe maneuvering and parking remains with you. Make sure that no persons, animals, objects, etc. are in the maneuvering range.

Active Parking Assist will be canceled in the following situations:

- Parking Assist PARKTRONIC is deactivated.
- You begin steering.
- You apply the electric parking brake.
- You engage transmission position **P**.
- ESP® intervenes.
- You open the doors or the tailgate while driving.

System limits

If the exterior lighting is faulty, the active parking assistant may be out of function, depending on the defect.

Also observe the system limits of the following systems:

- Rear view camera (→ page 209)
- 360° Camera (→ page 211)

Objects located above or below the detection range of the sensors, e.g. overhanging loads, overhangs or loading ramps of goods vehicles, or the borders of parking spaces, are not detected during measurement of the parking space. These

are also then not taken into account when calculating the parking procedure. In some circumstances, Active Parking Assist may therefore guide you into the parking space incorrectly.

⚠ WARNING Risk of accident due to objects located above or below the detection range of Active Parking Assist

If there are objects above or below the detection range, the following situations may arise:

- Active Parking Assist may steer too early.
- The vehicle may not stop in front of these objects.

There is a danger of collision!

▶ In these situations, do not use Active Parking Assist.

Extreme weather conditions, such as snow or heavy rain, may lead to a parking space being measured inaccurately. Parking spaces that are partially occupied by trailer drawbars might not be identified as such or be measured incorrectly. Only use Active Parking Assist on level, high-grip ground.

Do not use Active Parking Assist in the following situations:

- In extreme weather conditions such as ice, packed snow or in heavy rain.
- When transporting a load that protrudes beyond the vehicle.
- On steep uphill or downhill gradients of more than approximately 15 %.
- When snow chains are installed.
- Directly after a tire change or when spare tires are installed.
- If the tire pressure is too low or too high.
- If the suspension is out of alignment, e.g. after bottoming out on a curb.

Active Parking Assist may also display parking spaces that are not suitable for parking, such as:

- Parking spaces where parking is prohibited.
- Parking spaces on unsuitable surfaces.

Parking with Active Parking Assist

- ① Depending on the vehicle's equipment, the button may also be located at a different position in the center console.

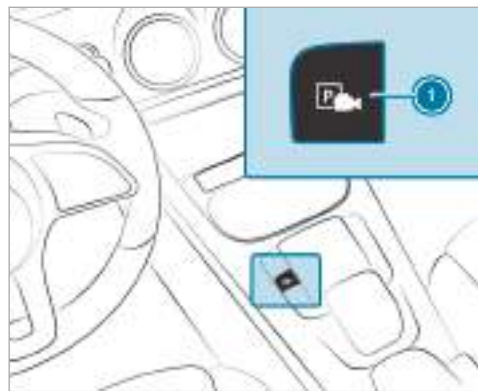

- ▶ Press the ① button.



The media display shows the view of Active Parking Assist. Area ② displays detected parking spaces ④ and vehicle path ③.

- ① The vehicle path ③ shown on the media display may differ from the actual vehicle path.
- ▶ If a parking space is displayed: stop the vehicle.
- ▶ Select desired parking space ④ and confirm.
- ▶ If necessary, select the parking direction (forwards or reverse), and confirm. Vehicle path ③ is shown, depending on selected parking space ④ and the parking direction.

- ① The turn signal indicator is switched on automatically when the parking procedure begins.

You are responsible for selecting the turn signal indicator in accordance with the traffic conditions. If necessary, select the turn signal indicator accordingly.

⚠ WARNING Risk of accident due to vehicle swinging out while parking or pulling out of a parking space

While parking or exiting a parking space, the vehicle swings out and can drive onto areas of the oncoming lane.

This could cause you to collide with objects or other road users.

- ▶ Pay attention to objects and other road users.
- ▶ Where necessary, stop the vehicle or cancel the parking procedure with Active Parking Assist.

- ▶ If, for example, the **Please Engage Reverse Gear** message

appears in the media display: select the corresponding transmission position.

Vehicles with automatic transmission: the vehicle drives into the selected parking space.

- ① During the parking procedure with Active Parking Assist, the lane markings are displayed in green in the camera image.

On completion of the parking procedure, the  **Parking Assist Finished, Take Control of Vehicle** display message appears. Further maneuvering may still be necessary.

- ▶ After completion of the parking procedure, safeguard the vehicle against rolling away. When required by legal requirements or local conditions: turn the wheels towards the curb.
- ① You can stop the vehicle and change the transmission position during the parking procedure. The system then calculates a new vehicle path. If no new vehicle path is available, the system can change the transmission position again or cancel the parking procedure.

Exiting a parking space with Active Parking Assist

Requirements

- The vehicle has been parked with Active Parking Assist.

Please note that you are responsible for the vehicle and surroundings during the entire parking procedure.

- ▶ Start the vehicle.

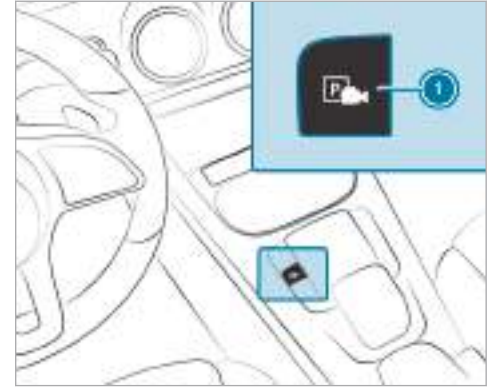

- ▶ Press button ①. The media display shows the view of Active Parking Assist.



- ▶ If the vehicle has been parked perpendicular to the direction of travel: in area ②, select direction of travel ③ **Left** or **Right**.
- ① The vehicle path shown on the media display may differ from the actual vehicle path.
- ▶ Confirm direction of exit ③ to drive out of the parking space.
- ① The turn signal indicator is switched on automatically when the exiting procedure begins. You are responsible for selecting the turn signal indicator in accordance with the traffic conditions. If necessary, select the turn signal indicator accordingly.

⚠ WARNING Risk of accident due to vehicle swinging out while parking or pulling out of a parking space

While parking or exiting a parking space, the vehicle swings out and can drive onto areas of the oncoming lane.

This could cause you to collide with objects or other road users.

- ▶ Pay attention to objects and other road users.
- ▶ Where necessary, stop the vehicle or cancel the parking procedure with Active Parking Assist.

- ▶ If, for example, the **Please Engage Forward Gear** message appears in the media display: select the corresponding transmission position. The vehicle moves out of the parking space. The turn signal indicator is switched off automatically.

After the parking space has been exited, a warning tone and the  **Parking Assist Finished**,

Take Control of Vehicle message prompt you to take control of the vehicle.

The vehicle is not automatically braked and can roll away. You have to accelerate, brake, steer and change gear yourself again.

Maneuvering assistance

Function of Drive Away Assist

Drive Away Assist can reduce the severity of an impact when pulling away. If an obstacle is detected in the direction of travel, the vehicle's speed is briefly reduced to approx. 1 mph (2 km/h). If a critical situation is detected, the  symbol appears in the media display.

Drive Away Assist can be deactivated or activated in the **Maneuvering Assistance** menu .

- ① You can cancel an intervention by Drive Away Assist at any time by deactivating Parking Assist PARKTRONIC .

⚠ WARNING Risk of accident caused by limited detection performance of Drive Away Assist

Drive Away Assist cannot always clearly identify objects and traffic situations.

- ▶ Always pay careful attention to the traffic situation; do not rely on Drive Away Assist alone.
- ▶ Be prepared to brake or swerve as necessary, provided the traffic situation permits and that it is safe to take evasive action.

Drive Away Assist is only an aid. It is not a substitute for your attention to the surroundings. Responsibility for safe maneuvering and parking remains with you. Make sure that there are no persons, animals, objects, etc. in the maneuvering range.

A risk of collision may occur in the following situations, for example:

- If the accelerator and brake pedals are rotated.

- If an incorrect transmission position is engaged.

Drive Away Assist is active under the following conditions:

- If Parking Assist PARKTRONIC is activated.
- If you shift the transmission position to **R** or **D** when the vehicle is stationary.
- If the detected obstacle is less than approx. 3.3 ft (1.0 m) away.
- If the maneuvering assistance function is activated in the multimedia system.

System limits

The performance of Drive Away Assist is limited on inclines.

- ⓘ Also observe the system limits of Parking Assist PARKTRONIC (→ page 213).

Function of Cross Traffic Alert

- ⓘ Cross Traffic Alert is available only for vehicles with Blind Spot Assist or Active Blind Spot Assist.

Cross Traffic Alert can warn drivers of any crossing traffic when backing up and maneuvering out

of a parking space. The radar sensors in the bumper also monitor the area adjacent to the vehicle. If a critical situation is detected, the  symbol appears in the media display and the vehicle can be braked automatically.

If the radar sensors are obstructed by vehicles or other objects, detection is not possible.

Cross Traffic Alert is active under the following conditions:

- if the vehicle is backing up at a walking pace.
- Maneuvering assistance is activated (→ page 224).
- ⓘ Also observe the instructions on Blind Spot Assist and Active Blind Spot Assist (→ page 204).

System limits

Cross Traffic Alert is not available on inclines.

■ Activating/deactivating the maneuvering assistant

Multimedia system:

→  >> Settings >> Assistance

>> Camera & Parking

▶ Switch **Maneuvering Assistance** on or off.

- ⓘ The maneuvering assistant must be active for the function of Drive Away Assist (→ page 222) and Cross Traffic Alert (→ page 223).

- The notes on towing the vehicle with both axles on the ground (→ page 307)

Vehicle towing instructions

The vehicle is not suitable for the use of tow bar systems that are used for flat towing or dinghy towing, for example. Attaching and using tow bar systems can result in damage to the vehicle.

When you are towing a vehicle with tow bar systems, safe driving characteristics cannot be guaranteed for the towing vehicle or the towed vehicle. The vehicle-trailer combination may swerve from side to side.

Observe the following information:

- Permitted towing methods (→ page 306)

Notes on the instrument display and on-board computer

⚠ WARNING Risk of accident if the instrument display fails

If the instrument display has failed or is malfunctioning, function restrictions in systems relevant to safety cannot be detected.

The operating safety of your vehicle may be impaired.

- ▶ Drive on carefully.
- ▶ Have the vehicle checked immediately at a qualified specialist workshop.

⚠ WARNING Risk of distraction from information systems and communications equipment

If you operate information systems and communication devices integrated in the vehicle when driving, you could be distracted from the traffic situation. This could also cause you to lose control of the vehicle.

- ▶ Only operate this equipment when the traffic situation permits.
- ▶ If you cannot be sure of this, stop the vehicle whilst paying attention to road and traffic conditions and operate the equipment with the vehicle stationary.

! NOTE Mercedes-AMG vehicles

- ▶ Observe the notes in the Supplement. You could otherwise fail to recognize dangers.

You must observe the legal requirements for the country in which you are currently driving when operating the on-board computer.

The on-board computer shows only display messages and warnings from specific systems on the instrument display. You must therefore ensure that your vehicle is always safe to operate.

If the operating safety of your vehicle is impaired, park the vehicle immediately and in accordance with the traffic conditions. Contact a qualified specialist workshop.

Overview of instrument display



- ① Left display area of the instrument display (example: speedometer): speedometer/time/date/trip computer **From Start** and **From Reset**/range/audio

The segments on the speedometer indicate the statuses of the following systems: cruise control/limiter/Active Distance Assist DISTRONIC

- ② Outside temperature
③ Digital speedometer
④ Time

- ⑤ Right display area of the instrument display (example: tachometer): tachometer/average fuel consumption/ECO display/navigation/G-meter/assistant display/4MATIC/power

meter/power availability display of the electric motor (equipment-dependent)
The fuel supply will be interrupted to protect the engine when the red mark on the tachometer (overrevving range) is reached.



- ⑥ Index points
These show the selected display or menu content.

- ⑦ Coolant temperature display
During normal operation, the coolant temperature display is permitted to rise to 248°F (120°C).
- ⑧ Selected drive program
- ⑨ Selected transmission position
- ⑩ Center display area of the instrument display (example: standard display for trip): Assistance/Telephone/Navigation/Trip/Media/Radio/Styles and displays/Service/Power meter (equipment-dependent)
- ⑪ Fuel level, fuel filler flap location indicator, range

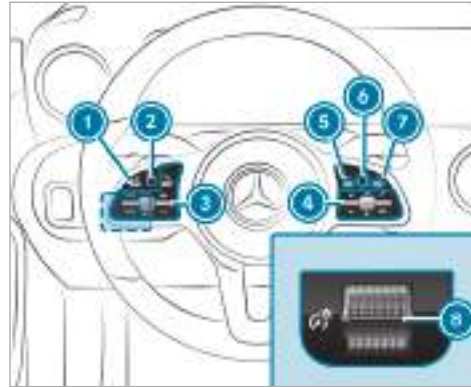
Overview of buttons on the steering wheel



- ①  Back/Home button (press and hold), on-board computer
- ② Touch Control, on-board computer
- ③ Control panel for cruise control or Active Distance Assist DISTRONIC
- ④ Control panel for the MBUX multimedia system (→ page 234)

-  Voice Control System
- ⑤  Home screen, MBUX multimedia system
- ⑥ Touch Control, MBUX multimedia system
- ⑦  Back button, MBUX multimedia system
- ⑧ Brightness control to adjust the lighting in the Instrument Display and in the control elements of the vehicle interior

Operating the on-board computer

Observe the legal requirements for the country in which you are currently driving when operating the on-board computer.

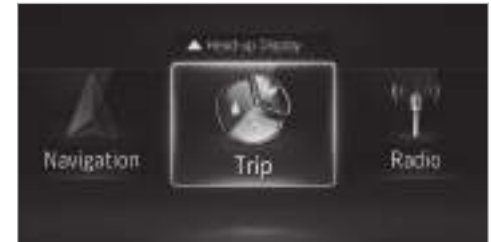

The on-board computer is operated using the left-hand Touch Control and the left-hand back/home button.

When the on-board computer is being operated, different acoustic signals will sound as operating feedback, e.g. when you reach the end of a list.

The following menus are available:

- Assistance
- Phone
- Navigation
- Trip
- Radio
- Media
- Designs & Disp.
- Service

i You can find information about the possible settings and selections on the menus in the Digital Operator's Manual.

The menus can be called up from the menu bar on the instrument display.

▶ **To call up the menu bar:** press the left-hand back button until the menu bar is displayed.

i **Vehicles without Active Distance Assist DISTRONIC:** press the  button to call up the menu bar of the on-board computer.

▶ **To scroll on the menu bar:** swipe to the left or right on the left-hand Touch Control.

▶ **To call up a menu, submenu or possible settings on the menu, or confirm a selection or setting:** press the left-hand Touch Control.

▶ **To scroll through displays or lists on the menu, or select display content, a function, an entry or a display:** swipe upwards or downwards on the left-hand Touch Control.

▶ **To exit a submenu:** press the left-hand back button.

Operating the head-up display

▶ **To switch on the head-up display:** swipe upwards on the menu bar on the left-hand Touch Control.

▶ **To switch to the head-up display:** swipe upwards on the left-hand Touch Control.

▶ **To set the display areas of the head-up display:** swipe upwards or downwards on the left-hand Touch Control.

Displaying full-screen menus

Vehicles with an instrument display in the wide-screen cockpit: the following menus can be shown full-screen on the instrument display:

- Assistance
- Trip
- Navigation

▶ On the corresponding menu, use the left-hand Touch Control to scroll to the end of the list.











▶ Press the left-hand Touch Control. The selected menu will be displayed full-screen.

Overview of displays in the instrument display

Displays on the instrument display:

 Active Parking Assist (→ page 220)

 Parking Assist PARKTRONIC switched off (→ page 217)

-  DSR (→ page 190)
-  Cruise control (→ page 181)
-  Active Distance Assist DISTRONIC (→ page 183)
-  Active Brake Assist (→ page 195)
-  Active Steering Assist (→ page 191)
-  Active Lane Keeping Assist (→ page 207)
-  Active Lane Change Assist (→ page 194)
-  ECO start/stop function (→ page 153)
-  HOLD function (→ page 178)
-  Adaptive Highbeam Assist (→ page 129)

Vehicles with Traffic Sign Assist: detected instructions and traffic signs (→ page 200).

Head-up Display

Function of the head-up display

! NOTE Mercedes-AMG vehicles

- ▶ Observe the notes in the Supplement. You could otherwise fail to recognize dangers.

The head-up display projects the following information into the driver's field of vision above the cockpit, for example:

- Driving speed
- Information from the navigation system
- Information from the driving systems and driving safety systems
- Some warning messages

Depending on the vehicle's equipment, different content may be shown in the three areas of the head-up display (→ page 230).

Display content

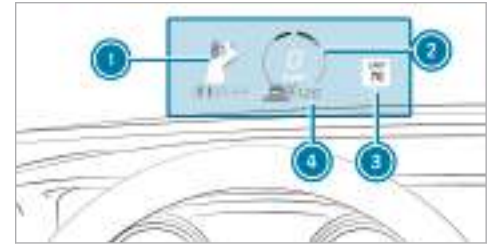

- ① Navigation instructions
- ② Current speed
- ③ Detected instructions and traffic signs
- ④ Set speed in the driving system (e.g. cruise control)

System limits

The visibility of the displays will be affected by the following conditions:

- Seat position
- Image position setting
- Ambient light

- Wet road surface
 - Objects on the display cover
 - Polarization in sunglasses
- ❗ In extreme sunlight, sections of the display may appear washed out. You can correct this by switching the head-up display off and on again.

Setting the head-up display using the on-board computer

On-board computer:

➔ HEAD-UP DISPLAY

The following head-up display settings or displays can be selected or shown:

- Position
- Brightness
- Messages
- Assistance status
- Telephone
- Audio
- Voice Control System

- ▶ **To select the settings menu:** swipe to the right on the left-hand Touch Control. Settings menu ⑤ will be selected.
- ▶ **To call up the Settings menu:** press the left-hand Touch Control.
- ▶ **To adjust the position:** swipe upwards or downwards on the left-hand Touch Control.
- ▶ **To adjust the brightness:** swipe to the left or right on the left-hand Touch Control.

Setting messages, assistance status, telephone, audio and the Voice Control System

- ▶ Press the left-hand Touch Control. The list of setting options will be displayed.
- ▶ Swipe upwards or downwards on the left-hand Touch Control.
- ▶ **To choose settings:** press the left-hand Touch Control.

Selecting what the head-up display shows



(Example)

- ① Switching the head-up display on/off
- ② Left display area
 - Navigation system
 - Average consumption
 - G-meter
- ③ Central display area
 - Speedometer
 - Set speed in the driver assistance system, e.g. cruise control
 - Warnings from driver assistance systems, e.g. distance warning

- ④ Right display area
 - Traffic Sign Assist
 - Distribution of the drive torques, 4MATIC (→ page 162)
 - Assistant display
- ⑤ To configure settings
- ⑥ Index points

You can hide display areas ② to ④ that are not required.

- ⓘ In audio mode, the station name or track will be shown temporarily when the audio source is being actively operated. In addition, the latest calls will be displayed when the telephone list on the instrument display is actively operated.
- ▶ Swipe upwards or downwards on the left-hand Touch Control.

Switching the Head-up Display on/off via the multimedia system

Multimedia system:

→  ▶ Settings ▶ Quick Access

- ▶ Select HUD.
The Head-up Display is activated.

Overview and operation

Notes on the MBUX multimedia system

⚠ WARNING Risk of distraction from information systems and communications equipment

If you operate information systems and communication devices integrated in the vehicle when driving, you could be distracted from the traffic situation. This could also cause you to lose control of the vehicle.

- ▶ Only operate this equipment when the traffic situation permits.
- ▶ If you cannot be sure of this, stop the vehicle whilst paying attention to road and traffic conditions and operate the equipment with the vehicle stationary.

You must observe the legal requirements for the country in which you are currently driving when operating the multimedia system. Depending on the equipment, the scope of function and product designation of your MBUX multimedia system may differ from the description and

images in this Operator's Manual. For example, route guidance with augmented reality is not available in all equipment variants.

Overview of the MBUX multimedia system

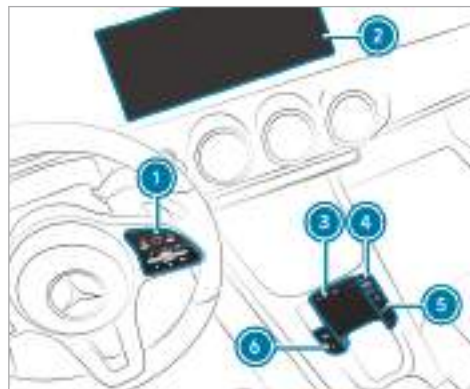

- ① Touch Control and control panel for the MBUX multimedia system
- ② Media display with touch functionality

- ③ Touchpad
- ④ Controller
Turn: adjusts the volume
Press briefly: switches the mute function on/off
Press and hold: switches the MBUX multimedia system or media display on or off
- ⑤ Buttons for navigation, radio/media and telephone
- ⑥ Buttons for vehicle functions/system settings and favorites/themes

Further operating options:

- Conducting a voice dialog with the Voice Control System.
- Operating functions contact-free with the MBUX Interior Assistant.
- ⓘ You can find further information about operation as well as about applications and services in the Digital Operator's Manual.

Anti-theft protection

This device is equipped with technical provisions to protect it against theft. Further information on

anti-theft protection can be obtained from an authorized Mercedes-Benz Center.

Home screen overview



- ① Depending on the display, calls up the first three applications or the home screen
- ② Calls up the profile
- ③ Calls up the global search
- ④ SOS NOT READY (only when the Mercedes-Benz emergency call system is not available)
- ⑤ Mercedes me connect active
- ⑥ Transmission of vehicle position active
- ⑦ Signal strength of the mobile phone network, network display, battery status of the mobile phone connected, time
- ⑧ Calls up the Notifications Center
- ⑨ Calls up an application using the symbol

- ⑩ Application and current information
 - ⑪ Quick-access, e.g. enter home address
 - ⑫ Index points and selected display area
 - ⑬ Calling up the air conditioning menu
 - ⑭ Calls up **SUGGESTIONS**, **THEMES** and **FAVORITES**
- ① If Mercedes me connect ⑤ is active, the vehicle is linked with Mercedes me connect. Vehicle data is then transmitted to the back end system. What data is transmitted depends on which services are activated. Further details can be found in the Mercedes me connect terms and conditions and data protection information. The function is country-dependent.
- If transmission of vehicle position ⑥ is active, Mercedes me connect services have been activated for this vehicle which access the vehicle's geolocation. In which instances the geolocation is transmitted depends on the particular services. Further details can be found in the Mercedes me connect terms and conditions and data protection information. The function is country-dependent.

Operating the MBUX multimedia system

Using Touch Control

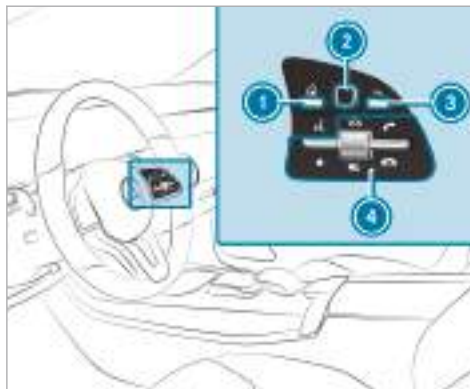

- ① Calls up the home screen
- ② Touch Control
- ③ Press briefly: returns to the previous display
- ④ Press the rocker switch down briefly: shows favorites

- ★ Press the rocker switch down and hold: adds favorites and themes
- VOL Turn controller: adjusts the volume
- Press controller: switches off the sound
- Press the rocker switch up: makes or accepts a call
- Press the rocker switch down: rejects or ends a call

Navigation through the menus is carried out with Touch Control ② with single-finger swipes.

- ▶ **To select a menu option:** swipe and press.
- ▶ **To move the digital map:** swipe in any direction.

Using the touchscreen



- ▶ Select menu options, symbols or characters by pressing briefly.
- ▶ **To navigate in menus:** swipe up, down, left or right.
- ▶ **To use handwriting to enter characters:** write the character with one finger on the touchscreen.

- ▶ **To zoom in and out of the map:** move two fingers together or apart.
- ▶ **To call up the global menu:** press and hold on the touchscreen until the **OPTIONS** menu appears.

i For more information on operation, please refer to the Digital Operator's Manual.

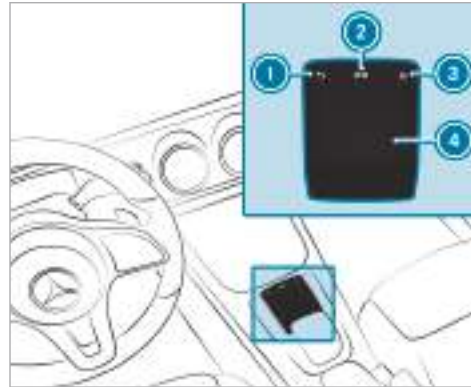
Using the touchpad





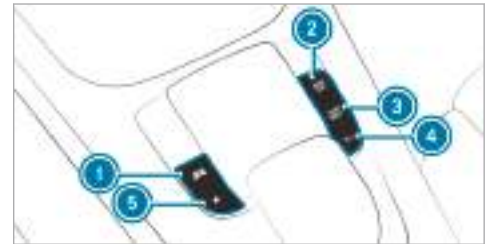

- ①  Returns to the previous display
- ②  Calls up the audio control menu
Swiping to the left of right: selects the previous or next radio station/music track
- ③  Calls up the home screen
- ④ Touchpad

- ▶ **To select a menu option:** swipe and press.
- ▶ **To use handwriting recognition:** write a character on the touchpad.
- ▶ **To open or close the Notifications Center:** swipe down or up with two fingers.
- ▶ **To zoom in and out of the map:** move two fingers together or apart.

Calling up applications using buttons



- ①  Calls up vehicle functions
- ②  Calls up navigation
- ③  Calls up radio or media
- ④  Calls up the telephone

- S ★ Press briefly: calls up favorites
 Press and hold: adds a favorite or theme
- ▶ Alternatively, tap 🏠 on the touchscreen.
- ▶ Call up the application (→ page 233).

Functions of the Voice Control System

⚠ WARNING Risk of distraction from information systems and communications equipment

If you operate information systems and communication devices integrated in the vehicle when driving, you could be distracted from the traffic situation. This could also cause you to lose control of the vehicle.

- ▶ Only operate this equipment when the traffic situation permits.
- ▶ If you cannot be sure of this, stop the vehicle whilst paying attention to road and traffic conditions and operate the equipment with the vehicle stationary.

For your own safety, always observe the following points when operating mobile communications equipment and especially your voice control system:

- Observe the legal requirements for the country in which you are driving.
- If you use the voice control system in an emergency your voice can change and your telephone call, e.g. an emergency call, can thereby be delayed.
- Familiarize yourself with the voice control system functions before starting the journey.

With the Voice Control System, various applications in the MBUX multimedia system are operable using voice input. The Voice Control System is operational approximately thirty seconds after the ignition is switched on and is available for the driver's seat and front passenger seat.

The following multimedia system applications can be operated:

- Telephone
- Text messages
- Navigation

- Address book
- Radio
- Media
- Vehicle functions

Starting the Voice Control System



- ▶ Press rocker switch 1 up.

or

- ▶ Say "Hello Mercedes".

Overview of the MBUX Interior Assistant

⚠ WARNING Risk of injury from the camera's laser radiation

This product uses a classification 1 laser system. If the housing is opened or damaged, laser radiation may damage your retina.

- ▶ Do not open the housing.
- ▶ Always have maintenance work and repairs carried out by a qualified specialist workshop.

This product complies with the requirements of the FDA 21 CFR 1040.10 and 1040.11 with exception of the variations according to the FDA Laser Notice No. 50 from 24. June 2007.

The camera is located in the overhead control panel.

If the vehicle is equipped with the MBUX Interior Assistant, selected functions of the multimedia system can be operated contact-free. The MBUX Interior Assistant can differentiate between driver and front passenger interactions and detects specific hand positions (poses).

System limits, display messages and notes for rectification

The system may be impaired or may not function in the following situations:

- The camera in the overhead control panel may heat up due to operating conditions. As a result the camera may switch off temporarily, particularly during longer periods of operation and at high outside temperatures.

Do not touch or cover the camera and wait until the camera has cooled down and is available again.

- The camera is covered, dirty, fogged up or scratched.

Wait until the camera has cooled down before cleaning the camera lens.

Clean the outside of the camera lens with a dry or damp cotton cloth. Do not use micro-fiber cloths. Do **not** remove the cover when cleaning.

- Recognition can be impaired by reflective clothing, an adverse color of clothing or by accessories, for example.
- Clothing being worn (hat, shawl, scarf) may be limiting the detection area of the camera. Keep the camera's field of vision clear.
- The camera is not operational. Consult an authorized Mercedes-Benz Center.

The MBUX Interior Assistant supports the following interactions:

| Interaction area | Interaction | Description |
|---|--|---|
| In front of the media display or above the touchpad | Proximity to the control element | The Interior Assistant recognizes the approach of the hand towards a control element. Depending on the active application, the display will be adjusted in the media display. Some functions differentiate between driver and front passenger. No specific hand position is required. |
| Above the center console | Defined pose | A favorite is called up with a defined pose. |
| Below the inside rearview mirror | Brief up and down movements | With brief up and down movements below the inside rearview mirror the reading light for the driver or the front passenger is switched on or off. |
| Above the front passenger seat | Stretching out a hand above the front passenger seat | By stretching out a hand above the front passenger seat the search light is switched on. If you withdraw a hand from this area, the search light is switched off again. |

Switching the reading light and search light and on or off

Requirements

- **For the reading light:**
 - The function is available when it is dark.
- **For the search light:**
 - The hand movement takes place in the interaction area below the inside rearview mirror.
 - The hand movement takes place in the interaction area above the front passenger seat.
 - The seat belt on the front passenger seat must **not** be inserted in the seat belt buckle.
 - The function is available when it is dark.

Switching the reading light on and off



- ▶ Briefly move a hand up or down beneath the inside rearview mirror.
The reading light is switched on or off for the driver or the front passenger.

Switching the search light on and off



- ▶ **To switch on:** reach across the front passenger seat with a hand.
The search light is switched on for the driver.
- ▶ **To switch off:** take a hand back away from the front passenger seat.
The search light is switched off again.

Information on profiles, themes, suggestions and favorites

For electrically adjustable seats observe the following notes.

⚠ WARNING Risk of becoming trapped during adjustment of the driver's seat after calling up a driver profile

Selecting a user profile may trigger an adjustment of the driver's seat to the position saved under the user profile. You or other vehicle occupants could be injured in the process.

- ▶ Make sure that when the position of driver's seat is being adjusted using the multimedia system, no people or body parts are in the seat's range of movement.

If there is a risk of someone becoming trapped, immediately stop the adjustment process by:

- ▶ a) Pressing the warning message on the media display.

or

- ▶ b) Pressing a position button of the memory function or a seat adjustment switch in the driver's door.
The adjustment process is stopped.

The driver's seat is equipped with an access preventer.

If the driver's door is open, the driver's seat will **not** be set after calling up the driver's profile.

Profiles store your vehicle settings and settings for the multimedia system. If the vehicle is used by several drivers, the driver can select their own profile without changing the stored profile settings of other drivers.

 Information on profiles from Mercedes me connect can be found in the Digital Operator's Manual.

Vehicle settings are, for example, driver's seat, steering wheel and mirror settings, climate control and ambient lighting. For the settings of the multimedia system, you can select, for example, radio stations, previous destinations as well as themes, suggestions and favorites.

For recurring driving situations, such as long drives on the freeway, you can save your preferred settings in a theme in the vehicle. In a theme you can save the display of the digital map, your preferred radio station and preferred drive program, for example.

The vehicle can learn the habits of the driver. It then offers suggestions for the most probable navigation destinations, media sources, radio stations or contacts. The requirements for that are the selection of a profile, your consent to the recording of data and sufficient collected data.



Favorites provide quick access to applications that are used often. You can select favorites from categories or add them directly to an application.

Configuring profiles, themes and suggestions

Multimedia system:



Creating a new profile

- ▶ Select  **Create Profile**.
- ▶ Select an avatar.
- ▶ Enter the name and confirm with .
- ▶ Select **Continue** .
- ▶ Select **Current Settings**.
- ▶ Select **Save**.

- ▶ Activate Bluetooth® and select **Connect Phone**, to connect a mobile phone with the user profile.
- ▶ Select **Finish**.

Selecting profile options







- ▶ Select  for a profile.
- The following functions are available:
- Editing, resetting or deleting a profile
 - Resetting themes or favorites
 - Configuring suggestions

Configuring suggestions

- ▶ Select  for a profile.
- ▶ Select **Suggestion Settings**.
- ▶ Switch **Allow Destination Suggestions**, **Allow Music Suggestions** and **Allow Contact Suggestions** on or off.
- ▶ **To deactivate the learning function for one day:** activate **Deact. Learning for 24 h**. For 24 hours no new actions will be trained and no data recorded for the active profile. Suggestions will continue to be shown.

Example: if the option is switched on and a route to a new destination has been calculated, this destination would not be taken into account for the learning function.

Creating new themes

- ▶ Select .
- ▶ Select **THEMES**.
- ▶ Select  **Create Theme**.
The settings saved in the theme are shown.
- ▶ Select **Continue** .
- ▶ Select **Audio** and **Navigation** and store the active settings in the theme.
- ▶ Select **Continue** .
- ▶ Select an entry screen.
- ▶ Select **Continue** .
- ▶ Select an image.
- ▶ Enter the names into the entry field and confirm with .
- ▶ Select **Save**.

System settings

Overview of the system settings menu

In the system settings menu, you can make settings in the following menus and control elements:

- Display
 - Styles
 - Instrument lighting
 - Display brightness
 - Edge lighting
 - Day/night design
- Control elements:
 - Keyboard language and handwriting recognition
 - Sensitivity of the touchpad
 - Sensitivity of the Touch Controls
- Voice Control System
- Sound
 - Entertainment
 - Navigation and traffic announcements

- Telephone
- Voice amplification to the rear
- Connectivity:
 - Wi-Fi, Bluetooth®, NFC
- Time & date
- Language
- Units for distance
- Software updates
- Data import/export
- PIN protection
- System reset

Information on important system updates

Important system updates may be necessary for the security of your multimedia system's data. Install these updates, or else the security of your multimedia system cannot be ensured.

A system update consists of three steps:

- Downloading or copying of the data required for installation
- Installation of the downloaded system update

- Activation of the downloaded system update by restarting the system
- ① If automatic software updates are activated, the system updates will be downloaded automatically.

The multimedia system provides a message when a system update is available.

You have the following selection options:

- **Accept and Install**
The system update will be downloaded in the background.
- **Information**
Information about the pending system update is displayed.
- **Later**
The system update can be downloaded manually at a later time.

Deep system updates

Deep system updates access vehicle or system settings and can therefore only be carried out when the vehicle is stationary and the ignition is switched off.

If the download of a deep system update is complete and the downloaded system update is ready for installation, you will be informed of this after the next ignition cycle, for example.

- ① Park the vehicle safely in a suitable location before starting the installation.

Requirements for the installation:

- The vehicle is switched off.
- Notes and warnings have been read and accepted.
- The electric parking brake has been applied.

If all requirements have been fulfilled, the downloaded system update is installed. The multimedia system cannot be operated while the downloaded system update is being installed and vehicle functions are restricted.

If errors should occur during the installation, the multimedia system automatically attempts to restore the previous version. If restoration of the previous version is not possible, a symbol appears on the media display. Consult a qualified specialist workshop to resolve the problem.

Setting up a Wi-Fi hotspot

Requirements:

- **To set up the Wi-Fi connection of the multimedia system with external hotspots:** your vehicle does not have a permanently installed communication module.
- The device to be connected supports at least one of the types of connection described.

Multimedia system:

→  → Settings → System
→ Wi-Fi & Bluetooth

Activating/deactivating Wi-Fi

- ▶ Select **Wi-Fi**.

Connecting the multimedia system with an external hotspot using Wi-Fi

The type of connection established must be selected on the multimedia system and on the device to be connected.

i The connection procedure may differ depending on the device. Follow the instructions that are shown in the display. Further information can be found in the manufacturer's operating instructions.

- ▶ Select **Internet Settings**.
- ▶ Select **Connect via Wi-Fi**.
- ▶ Select **Add Hotspot**.

Connecting using a QR code

- ▶ Select the options of the desired Wi-Fi network.
- ▶ Select **Connect using QR code**.
- ▶ Scan the displayed QR code with the device to be connected.
The Wi-Fi connection is established.

Connecting using a security key

- ▶ Select the options of the desired Wi-Fi network.
- ▶ Select **Connect Using Security Key**.

- ▶ Have the security key displayed on the device to be connected (see the manufacturer's operating instructions).
- ▶ Enter this security key on the multimedia system.
- ▶ Confirm the entry with .

Connecting using a WPS PIN

- ▶ Select the options of the desired Wi-Fi network.
- ▶ Select **Connect via WPS PIN Input**.
The multimedia system generates an eight-digit PIN.
- ▶ Enter this PIN on the device to be connected.
- ▶ Confirm the entry.

Connecting using a button

- ▶ Select the options of the desired Wi-Fi network.
- ▶ Select **Connect via WPS PBC**.
- ▶ Select "Connect via WPS PBC" in the options on the device to be connected (see the manufacturer's operating instructions).

- ▶ Press the WPS button on the device to be connected.
- ▶ Select **Continue** in the multimedia system.

Activating automatic connection

- ▶ Select **Connect via Wi-Fi**.
- ▶ Select the options of the desired Wi-Fi network.
- ▶ Activate **Permanent Internet Connection**.

Connecting with a known Wi-Fi network

- ▶ Select **Connect via Wi-Fi**.
- ▶ Select a Wi-Fi network.
The connection is established again.

Configuring the multimedia system as a Wi-Fi hotspot for external devices

The type of connection established depends on the device to be connected. The function must be supported by the multimedia system and by the device to be connected. The type of connection established must be selected on the multimedia system and on the device to be connected.

- ▶ Select **Vehicle Hotspot**.

- ▶ Select **Connect Device to Vehicle Hotspot**.

Connecting using WPS PIN generation

- ▶ Select **Connect via WPS PIN Generation**.
- ▶ Enter the PIN shown in the media display on the device to be connected and confirm.

Connecting using WPS PIN entry

- ▶ Select **Connect via WPS PIN Input**.
- ▶ Enter the PIN that is shown on the external device's display on the multimedia system.

Connecting using a button

- ▶ Select **Connect via WPS PBC**.
- ▶ Press the push button on the device to be connected (see the manufacturer's operating instructions).
- ▶ Select **Continue**.

Connecting using a security key

- ▶ Select **Connect Device to Vehicle Hotspot**. A security key is displayed.

- ▶ Select the vehicle from the device to be connected. The vehicle is displayed with the **DIRECT-MBUX XXXXX** network name.
- ▶ Enter the security key which is shown in the media display on the device to be connected.
- ▶ Confirm the entry.

Connecting using NFC

- ▶ Select **Connect via NFC**.
- ▶ Activate NFC on the mobile device (see the manufacturer's operating instructions).
- ▶ Hold the device to be connected at the vehicle's NFC interface.
- ▶ Select **Finished**. The mobile device is now connected to the multimedia system hotspot via NFC.

Generating a new security key

- ▶ Select **Vehicle Hotspot**.
- ▶ Select **Generate Security Key**. A connection will be established with the newly created security key.

- ▶ **To save a security key:** select **Save**. When a new security key is saved, all existing Wi-Fi connections are then disconnected. If the Wi-Fi connections are being re-established, the new security key must be entered.

System language

Notes on the system language

This function allows you to determine the language for the menu displays and the navigation announcements. The selected language affects the characters available for entry. The navigation announcements are not available in all languages. If a language is not available, the navigation announcements will be in English.

Setting the system language

Multimedia system:

▶  ▶ Settings ▶ System

▶  Language

- ▶ Set the language.

- ① If you are using Arabic map data, the text information can also be shown in Arabic on the navigation map. To do so, select العربية as the language from the language list. Navigation announcements are then also made in Arabic.

Resetting the multimedia system (reset function)

⚠ WARNING Risk of accidents due to failure of multimedia display functions

While the multimedia system is being reset, its functions such as the rear view camera are not available.

- ▶ Only reset the multimedia system when the vehicle is stationary.

Multimedia system:

→  ▶▶ Settings ▶▶ System ▶▶ Reset

Personal data is deleted, for example:

- Vehicles with rear telephony: handset connection
 - Individual user profiles
 - ① The guest profile is reset when the settings are restored to the factory settings.
 - ① Vehicles with rear telephony: The handset must be in the cradle while the system is reset.
- A prompt appears again asking whether you really wish to reset.
- ▶ Select **Yes**.
The multimedia system is reset to the factory settings. If you have set a PIN for your system, this will also be reset.

Navigation

Notes on navigation

Route guidance with augmented reality

⚠ WARNING Risk of accident and injury as a result of distraction, incorrect depiction or wrong interpretation of the display

The camera image of the augmented reality display is not suitable as a guide for driving.

- ▶ Always keep an eye on the actual traffic situation.
- ▶ Avoid extended observation of the camera image.

⚠ WARNING Risk of accident and injury due to imprecise positioning of additional information

The additional information from the augmented reality display may be inaccurate and is not a substitute for observing and assessing the actual driving situation.

- ▶ Always keep an eye on the actual traffic situation when carrying out all driving maneuvers.

Switching navigation on

Multimedia system:

→  → Navigation

- ▶ Alternatively: press the  button.
The map displays the current vehicle position.
The navigation menu is shown.
The navigation menu is hidden if route guidance is active.
- ▶ **To show:** tap on the touchscreen.
The menu is hidden automatically.

Navigation overview

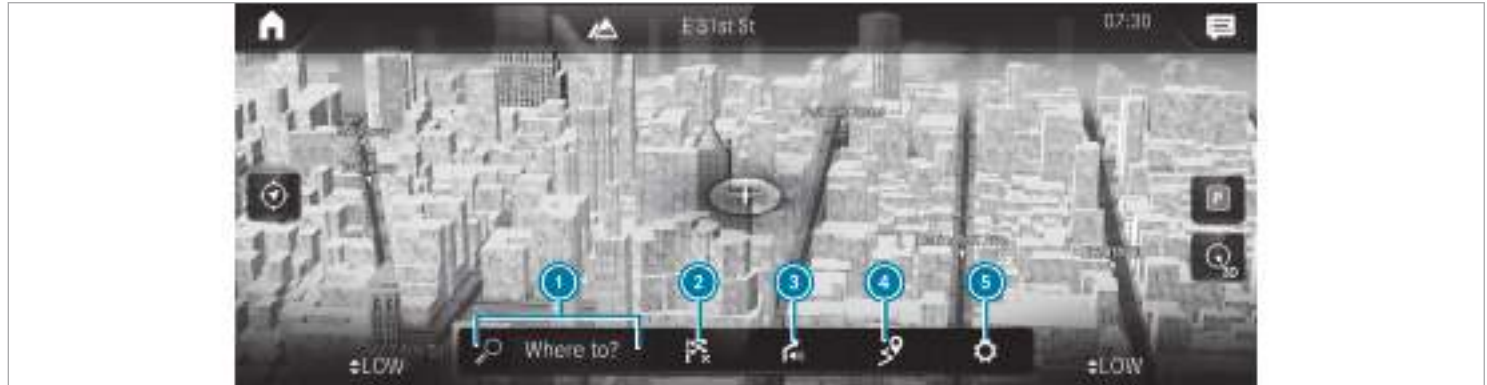

Example: digital map with navigation menu

- ① Enters a POI or address and additional destination entry options
- ② Interrupts route guidance (if route guidance is active)
- ③ Repeats a navigation announcement and switch navigation announcements on or off
- ④ Calls up the **ON THE WAY** menu

- To show **Route Overview**
- To select **Alternative Routes**
- **Report Traffic Incident** (Car-to-X)
- To call up the **TRAFFIC** menu
 - To display **Traffic Announcements**
 - To display **Area Alerts**
 - To display **Provider Information**

- To show **Route List**
- To call up the **POSITION** menu
 - **Save Position**
 - To display **Compass**
- ⑤ Quick-access and settings
 - To show **Traffic**
 - To show **Parking**

- To show **Highway Information**
- Via **Advanced** options to use **View, Announcements** and **Route**

Entering a destination

Multimedia system:

Navigation >> Where to?



- | | | |
|---|---------------------------------------|---|
| ① Federal state or province in which the vehicle is located | ⑤ OK Confirms an entry | ⑩ Switches to digits, special characters and symbols |
| ② Enters a POI or address | ⑥ Switches to handwriting recognition | ▶ Enter the destination in ②. The entries can be made in any order. |
| ③ List with additional destination entry options | ⑦ Enters a space | |
| ④ Deletes an entry | ⑧ Switches to voice input | |
| | ⑨ Sets the written language | |

The following entries can be made, for example:

- City, street, house number
- Street, city
- ZIP code
- POI name or POI category, e.g. **Parking**
- Contact name

- ▶ Select a search result in list ③.
- ▶ Calculate the route (→ page 249).

① You can find further information about destination entry, e.g. three-word addresses, in the Digital Operator's Manual.

Changing country

- ▶ Select the indicator for federal state or province ①.
- ▶ Select the federal state or the province in ①.
- ▶ Enter the country indicator.
- ▶ Select the country on list ③.
- ▶ Select the federal state or the province from list ③.

Using online search

① Requirements: the media display shows an Internet connection in the status line with the  symbol.

Destination entry uses online map services. If the on-board search finds no suitable destinations or if you change countries, the online search is available.

For the destination you can enter an address, a POI or a three-word address.

- ▶ Enter the destination in input line ②. The search results are displayed.
- ▶ Select the destination in the list. The detailed view for the route is displayed.

or

- ▶ Select country indicator ①.
- ▶ Select the provider for the online service from the countries list.
- ▶ Enter the destination in input line ②.
- ▶ Select the destination in the list.

Calculating a route and using settings for route guidance



Requirements

- The destination has been entered.
- The destination address is shown.

Multimedia system:

   **Navigation**



- ①  No route yet.
-  A route has been mapped.

- ▶ Select . The route to the destination is calculated. Route guidance begins.



or

- ▶ Select .
- ▶ Select **Set as Waypoint**. The destination address is set as the next intermediate destination.

or

- ▶ Select **Start New Route Guidance**. The destination address is set as the new destination. The previous destination and the intermediate destinations are deleted. Route guidance to the new destination begins.

Selecting route settings

- ▶ Select .
- ▶ Select **Advanced**.
- ▶ Select **Route**.
- ▶ Select the route type.
- ▶ Take traffic information into consideration with **Dynamic Route Guidance** .

- ▶ Select route options with **Avoid Options**.
- ▶ Activate **Suggest Alternative Route**. Alternative routes are calculated for every route.
- ▶ Activate **Activate Commuter Route**. If the requirements are met, the multimedia system automatically detects that the vehicle is on a commuter route. Route guidance begins without voice output.

Activating route guidance with augmented reality

- ▶ During route guidance, tap on the camera symbol on the media display. The camera image will be shown instead of the navigation map before a turning maneuver and will show additional information.
- ▶ **To return to the navigation map:** tap on the camera symbol again.

Displaying additional information in the camera image

- ▶ Select .
- ▶ Select **Advanced**.
- ▶ Select **Augmented Reality**.

- ▶ Activate **Street Names** and **House Numbers**. During route guidance, street names and house numbers are shown in the camera image.

Using map functions

Multimedia system:

  **▶▶ Navigation**

Setting the map scale

- ▶ **To zoom in:** tap twice quickly with one finger on the media display.
- ▶ **To zoom out:** tap with two fingers on the media display.

Moving the map

- ▶ Move one finger in any direction on the touchscreen.
- ▶ **To reset the map to the current vehicle position:** press  briefly.

Selecting map orientation

- ▶ Tap repeatedly on the  compass symbol on the map.
The view changes in the sequence **3D**, **2D Heading Up** to **2D North Up**.

Switching freeway information on/off

- ▶ Select .
- ▶ Activate or deactivate **Highway Information**.

Using services

Requirements

- There is an Internet connection.
- Mercedes me connect is available.
- You have set up a user account in the Mercedes me Portal.
- The vehicle is connected to a user account and you have accepted the conditions of use for the service.
Further information can be found at: <https://www.mercedes.me>
- The service is available.

- The service has been activated at an authorized Mercedes-Benz Center.
- The following additional conditions apply to the Parking service:
 - The navigation services option is available, subscribed to and activated in the Mercedes me Portal.
 - The parking service is part of the scope of the Navigation Services.

Multimedia system:

  **Navigation**

Displaying the traffic situation with Live Traffic Information

- ▶ Select .
- ▶ Activate **Traffic**.
- ▶ Select **Advanced**.
- ▶ Select **View**.
- ▶ Select **Map Elements**.

- ▶ Activate **Traffic Incidents**, **Free Flowing Traffic** and **Delay**.

If traffic information has been received, then traffic incidents such as roadworks, road blocks, local reports (e.g. fog) and warning messages are displayed.

The traffic delay is displayed for the current route. Traffic delays lasting one minute or longer are taken into consideration.

Displaying hazard warnings with Car-to-X-Communication

If hazard warnings are available these can be shown as symbols on the map. The display depends on the settings for the **Traffic** and **Traffic Incidents** options.

- ▶ Set the options.
If **Traffic** is switched off and **Traffic Incidents** is switched on, the symbols are shown on the prospective route.

Displaying weather information and other map contents

- ▶ Select .
- ▶ Select **Advanced**.

- ▶ Select **View**.
- ▶ Select **Map Elements**.
- ▶ Scroll up and show the **ONLINE MAP CONTENT** category.
- ▶ Switch on a service, e.g. **Weather**.
Current weather information is displayed on the navigation map, e.g. temperature or cloud cover.

Parking service

! **NOTE** Damage to the vehicle due to not observing the maximum permitted headroom clearance

If the vehicle height is greater than the maximum permitted headroom clearance, the roof and other parts of the vehicle may be damaged.

- ▶ Observe the signposted headroom clearance.
- ▶ If the vehicle height is greater than the permitted headroom clearance, do not enter.

- ▶ Observe the changed vehicle height with add-on roof equipment.



! **NOTE** Vehicle damage due to failure to observe local information and parking conditions

The data is based on the information provided by the respective service providers.

Mercedes-Benz does not guarantee the accuracy of the information provided in relation to the car park or parking area.

- ▶ Always observe the local information and conditions.

i This service is not available in all countries.

- ▶ Select  and activate **Parking**.
- ▶ Tap on  in the map.
- ▶ Select a parking option.
The map shows the parking options in the vicinity.

The following information is displayed (if available):

- Destination address, distance from current vehicle position and arrival time
- Information on the car park, e.g.
 - Opening times
 - Parking charges
 - Current occupancy
 - Maximum parking time
 - **Maximum access height**
The maximum access height shown by the parking service does not replace the need for observation of the actual circumstances.
- Available payment options (Mercedes pay, coins, bank notes, cards)
- Details on parking tariffs
- Number of available parking spaces
- Payment method (e.g. at parking meters)
- Services/facilities at the parking option
- Telephone number

- ▶ Calculate the route (→ page 249).

Notes on the dashcam

! **NOTE** Risk of legal consequences due to violation of legal regulations and data protection provisions

You are legally responsible for operation and use of the dashcam functions.

The legal requirements relating to operation and use of the dashcam can vary depending on the country in which the dashcam is operated.

This function is not permitted in all countries.

- ▶ Before using the dashcam, read up on the content of the legal regulations, in particular the data protection requirements in the respective country of use.
- ▶ Observe the legal regulations, in particular the data protection requirements.

- ⓘ Observe the following notes for safe operation:
 - Use USB-IF certified USB storage media. The USB-IF is a non-profit society and stands for USB Implementers Forum. Based on the USB specification, the USB-IF certifies e.g. USB versions, corresponding cables and plugs as well as methods for supplying energy via the USB interface.
 - Frequent and continuous high-speed overwriting can damage the USB storage media.

Selecting a USB device for a video recording with the dashcam

Requirements:

- At least one USB device is connected with the multimedia system .

Multimedia system:

- ➔  ▶ Mercedes me & Apps
- ▶▶ Dashcam
- ▶ Select the USB device.

- ⓘ When USB devices contain multiple partitions, recorded video files are not always displayed in the recording list. Mercedes-Benz recommends that you use USB devices with one partition.

Starting or stopping video recording with the dashcam

Requirements

- A USB device is connected with the multimedia system .
- The vehicle is switched on.

Multimedia system:

- ➔  ▶▶ Mercedes me & Apps
- ▶▶ Dashcam

- ▶ If several USB devices are connected with the multimedia system, select a USB device (→ page 253).
- ▶ Select the **Individual Recording** or **Loop Recording** recording mode. If **Individual Recording** is selected and the memory is full the recording stops.

If **Loop Recording** has been selected, several short video files are recorded. When the memory limit is reached, the oldest video file is deleted and recording is continued automatically.

i If **Loop Recording** is selected, the dashcam app can only overwrite the last 100 video files due to the system limit.

▶ **To start:** select **Start Recording**.

The length of the recording is shown. The **Please do not remove the storage medium** message appears. The video file is stored on the USB device.

▶ **To end:** select **End Recording**.

A report may appear in the following cases:

- For the **Individual Recording** recording mode: the memory is full or there are only a few minutes recording time available. The video recording stops or will be stopped imminently. Change the USB device or delete a video file.
- If a video recording has started and a national border is detected, the **National Border Crossed. Please observe the country-spe-**

cific regulations on video recording message appears.

This function is not available in all countries.

- The camera is not functional, the **Camera Unavailable** message appears.

Have the camera checked in an authorized Mercedes-Benz Center.

Telephone

Telephony

Notes on telephony

⚠ WARNING Risk of distraction from operating integrated communication equipment while the vehicle is in motion

If you operate communication equipment integrated in the vehicle when driving, you could be distracted from the traffic situation. This could also cause you to lose control of the vehicle.

- ▶ Only operate this equipment when the traffic situation permits.
- ▶ If you cannot be sure of this, stop the vehicle whilst paying attention to road and traffic conditions and operate the equipment with the vehicle stationary.

⚠ WARNING Risk of accident from operating mobile communication equipment while the vehicle is in motion

Mobile communication devices distract the driver from the traffic situation. This can also cause the driver to lose control of the vehicle.

- ▶ As a driver, only operate mobile communication devices when the vehicle is stationary.
- ▶ As a vehicle occupant, use mobile communication devices only in the designated area, e.g. in the rear passenger compartment.

You must observe the legal requirements for the country in which you are currently driving when

operating mobile communication equipment in the vehicle.

⚠ WARNING Risk of injury due to objects being stowed incorrectly

If objects in the vehicle interior are stowed incorrectly, they can slide or be thrown around and hit vehicle occupants. In addition, cup holders, open stowage spaces and mobile phone receptacles cannot always retain all objects within.

There is a risk of injury, particularly in the event of sudden braking or a sudden change in direction.

- ▶ Always stow objects so that they cannot be thrown around in such situations.
- ▶ Always make sure that objects do not protrude from stowage spaces, parcel nets or stowage nets.
- ▶ Close the lockable stowage spaces before starting a journey.
- ▶ Always stow and secure heavy, hard, pointed, sharp-edged, fragile or bulky

objects in the trunk/cargo compartment.

Observe the additional information on stowing mobile communications devices correctly:

- Loading the vehicle (→ page 108)
- Stowing and securing the mobile phone (→ page 123)

Bluetooth® connection:

The menu view and the available functions in the telephone menu are in part dependent on the Bluetooth® profile of the connected mobile phone. Full functionality is only available if the mobile phone supports both of the following Bluetooth® profiles:

- PBAP (Phone Book Access Profile)
 - The contacts on the mobile phone are shown automatically on the multimedia system.
- MAP (Message Access Profile)
 - The mobile phone message functions can be used on the multimedia system.

Irrespective of this, Bluetooth® audio functionality can be used with any mobile radio unit.

For information on the range of functions of the mobile radio unit to be connected, see the manufacturer's operating instructions.

Network connection:

The following cases can lead to the call being disconnected while the vehicle is in motion:

- You switch into a transmission/reception station, in which no communication channel is free.
- The SIM card used is not compatible with the network available
- A mobile phone with "Twincard" is logged into the network with the second SIM card at the same time

The multimedia system supports calls in HD Voice® for improved speech quality. A requirement for this is that the mobile phone and the mobile phone network provider of the person you are calling support HD Voice®.

Depending on the quality of the connection, the voice quality may fluctuate.

Further information can be obtained from an authorized Mercedes-Benz Center or at: <https://www.mercedes-benz.com/connect>

Telephone menu overview



- ① Bluetooth® device name of the currently connected mobile phone/of the mobile phone
- ② Bluetooth® device name of the currently connected mobile phone/of the mobile phone (two phone mode)
- ③ Battery status of the connected mobile phone
- ④ Signal strength of the mobile phone network
- ⑤ Options
- ⑥ Device manager
- ⑦ Messages

- 8 Numerical pad
- 9 Contact search

Telephony operating modes overview

Depending on your equipment, the following telephony operating modes are available:

- A mobile phone is connected to the multimedia system via Bluetooth®.
- Two mobile phones are connected with the multimedia system via Bluetooth® (two phone mode).
 - You can use all the functions of the multimedia system with the mobile phone in the foreground.
 - You can receive incoming calls and messages with the mobile phone in the background.

You can interchange the mobile phone in the foreground and background.

Connecting a mobile phone

Requirements

- Bluetooth® is activated on the mobile phone (see the manufacturer's operating instructions).
- Bluetooth® is activated on the multimedia system.

Multimedia system:



Searching for a mobile phone

- ▶ Select .
- ▶ Select **Connect New Device**.

Connecting a mobile phone



Authorization follows using secure simple pairing.

- ▶ Select a mobile phone.

A code is displayed in the multimedia system and on the mobile phone.
- ▶ If both codes match, confirm the code on the mobile phone.

Functions in the telephony menu

In the telephony menu you have the following functions, for example:

- Making calls, e.g.:
 -  Accepting a call
 -  **End Call**
 -  **Create Confer. Call**
 - Accepting or rejecting a waiting call
- Managing contacts, e.g.:
 - Downloading mobile phone contacts
 - Managing the format of a contact's name
 - Saving a contact as a favorite
- Receiving and sending messages, e.g.:
 - Using the read-aloud function
 - Dictating a new message

Mercedes me app

Mercedes me calls

■ Making a call via the overhead control panel

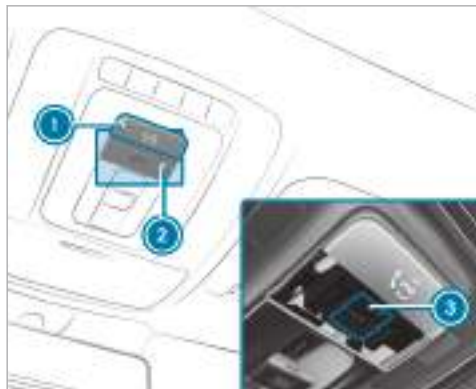

- ① me button for service or information calls
- ② SOS button cover
- ③ SOS button (emergency call system)

Making a Mercedes me call

- ▶ Press me button ①.

Making an emergency call

- ▶ To open the cover of SOS button ②, press it briefly.
- ▶ Press and hold SOS button ③ for at least one second.

If a Mercedes me call is active, an emergency call can still be triggered. This has priority over all other active calls.

■ Information about the Mercedes me call

A call to the Mercedes-Benz Customer Center has been initiated via the me button in the overhead control panel or the multimedia system (→ page 258).

Using the voice dialog system you access the desired service:

- Accident and Breakdown Management
- Mercedes-Benz Customer Center for general information about the vehicle

You can find information on the following topics:

- Activation of Mercedes me connect

- Operating the vehicle
- Nearest authorized Mercedes-Benz Center
- Other products and services from Mercedes-Benz

Data is transferred during the connection to the Mercedes-Benz Customer Center (→ page 260).

■ Calling the Mercedes-Benz Customer Center using the multimedia system

Requirements

- Access to a mobile phone network is available.
- The contract partner's mobile network coverage is available in the respective region.
- The vehicle must be switched on so that vehicle data can be transferred automatically.

Multimedia system:



- ▶ Call **Mercedes me connect**. After confirmation, the multimedia system sends the required vehicle data. The data transfer is shown in the media display.

Then you can select a service and be connected to a specialist at the Mercedes-Benz Customer Center.

■ Calling the Mercedes-Benz customer center after automatic accident or breakdown detection

Requirements:

- The vehicle has detected an accident or breakdown situation.
- The vehicle is stationary.
- The hazard warning lights are switched on.

i This function is not available in all countries.

The vehicle can detect accident or breakdown situations under certain circumstances.

Requirements for collision detection in the context of accident management:

- The vehicle is equipped with an anti-theft alarm system (ATA) (code 551).
- The vehicle is equipped with the interior protection (code 882).
- The vehicle is equipped with the Anti-Theft Protection Package (code P54).

- The collision detection service with theft notification has been activated on Mercedes me connect.

If a collision is detected when the tow-away alarm is armed on a locked vehicle, you will receive a notification in the multimedia system when you switch the vehicle on.

Find out at an authorized Mercedes-Benz Center if this functions is available in your country.

In the event an accident or breakdown is detected, the emergency guide shows safety notes in the multimedia system display. This may take a few seconds.

i The availability of collision detection depends on the vehicle.

In the event an accident or breakdown is detected, the emergency guide shows safety notes in the multimedia system display.

After quitting the emergency guide display on the multimedia system, a prompt appears asking whether you would like to get support from the Mercedes-Benz customer center.

▶ Select **Call**.

- The vehicle data is sent automatically (→ page 262).
- The Mercedes-Benz customer center takes your call and organizes the breakdown and accident assistance.

You may be charged for these services.

i Depending on the severity of the accident, an automatic emergency call can be initiated. This has priority over all other active calls (→ page 266).

i In addition, if the Mercedes me connect service "Telediagnosics" is active, a similar prompt can appear after a delay in the event of a breakdown. If you are already in contact with the Mercedes-Benz customer center or have already received support, this prompt can be ignored or declined.

i If you answer the prompt for support from the Mercedes-Benz customer center with **Later**, the message will be hidden and appear again later.

The prompt triggered by the Mercedes me connect service "Telediagnosics", can either be confirmed or declined. After being declined, this will not be shown again.

■ Arranging a service appointment via a Mercedes me call

If you have activated the maintenance management service, relevant vehicle data is transferred automatically to the Mercedes-Benz customer center. You will then receive individual recommendations regarding the maintenance of your vehicle.

Regardless of whether you have consented to the maintenance management service, the multimedia system reminds you after a certain amount of time that a service is due. A prompt appears asking if you would like to make an appointment.

▶ **To arrange a service appointment:** select **Call**. After your agreement, the vehicle data is transferred and the Mercedes-Benz customer center takes your preferred appointment date. The information is then sent to your desired service outlet.

This will contact you to confirm the appointment and if necessary consult about the details.

❗ If you select **Later** after the service message appears, the message is hidden and reappears at a later time.

■ Data transferred during a Mercedes me call

When you make a service call via Mercedes me, data is transmitted. This enables targeted advice and a smooth service.

The following requirements must be fulfilled for the transfer of the data:

- The vehicle is switched on.
- The required data transfer technology is supported by the mobile phone network provider.
- The quality of the mobile connection is sufficient.

Multi-stage transfer depends on the following factors:

- Reason for the initiation of the call
- The available mobile phone transmission technology

- The activated Mercedes me connect services
- The service selected in the voice control system

❗ The scope of the transmitted data depends on the vehicle model and equipment. For technical reasons, not all data is available at all times.

Data transfer if Mercedes me connect services are not activated

If no Mercedes me connect services are activated, the following data is transferred:

- Vehicle identification number
- Time of the call
- Reason for the initiation of the call
- Country indicator of the vehicle
- Set language for the multimedia system
- Telephone number of the communication platform installed in the vehicle

If a call is made for a service appointment via the service reminder, the following data is also transmitted:

- Current mileage and maintenance data

If a call is made after automatic accident or breakdown detection using the multimedia system, the following data is also transmitted:

- Current mileage and maintenance data
- Current vehicle location

If Accident and Breakdown Management is called via the voice control system, the following data can also be called up from the vehicle by the Mercedes-Benz Customer Center:

- Current vehicle location

Data transfer if Mercedes me connect services are activated

An overview of the data transmitted can be found in the respective terms of use for Mercedes me connect services. These can be obtained in the Mercedes me Portal: <https://me.secure.mercedes-benz.com>

Data processing

The data transmitted within the scope of the call is deleted from the processing system after the call is finished, in so far as this data is not being used for other activated Mercedes me connect services.

The incident-specific data is processed and stored in the Mercedes-Benz Customer Center and, if required to process the incident, forwarded to the service partner authorized by the Mercedes-Benz Customer Center. Please take note of the data protection information on the Mercedes me Internet page <https://www.mercedes.me> or in the recorded message immediately after calling the Mercedes-Benz Customer Center.

 The recorded message is not available in every country.

Mercedes me connect

Information on Mercedes me connect

Mercedes me connect consists of multiple services.

You can use the following services via the multimedia system and the overhead control panel, for example:

- Accident and Breakdown Management (me button or situation-dependent display in the multimedia system)
- Mercedes-Benz Emergency Call System (automatic emergency call and SOS button)

The Mercedes me connect Accident and Breakdown Management and the Mercedes-Benz emergency call centers are available to you around the clock.

The me button and the SOS button can be found on the vehicle's overhead control panel (→ page 258).

You can also call the Mercedes-Benz customer center using the multimedia system (→ page 258).

Please note that Mercedes me connect is a Mercedes-Benz service. In emergencies, first call the national emergency services using the standard national emergency service telephone numbers. In emergencies, you can also use the

Mercedes-Benz emergency call system (→ page 266).

Observe the conditions of use for Mercedes me connect and other services. These can be obtained in the Mercedes me Portal: <https://me.secure.mercedes-benz.com>

Further information about Mercedes me connect services can be obtained in the Mercedes me Portal: <https://me.secure.mercedes-benz.com>

■ Information on Mercedes me connect Accident and Breakdown Management

i Accident and Breakdown Management is not available in every country. Contact an authorized Mercedes-Benz Center to find out whether this function is available in your country.

The Accident and Breakdown Management can include the following functions:

- Supplement to the Mercedes-Benz emergency call system (→ page 266)
If necessary, the contact person at the Mercedes-Benz emergency call center forwards the call to Mercedes me connect Acci-

dent and Breakdown Management. Forwarding the call is however not possible in all countries.

- Breakdown assistance by a technician on location and/or the towing away of the vehicle to the nearest authorized Mercedes-Benz Center

You may be charged for these services.

- Addition to the emergency guide after automatic accident or breakdown detection (→ page 259)

In the event of a breakdown or accident, further vehicle data is sent which enables optimal support by the Mercedes-Benz customer center and the authorized service partner or breakdown assistance.

- Addition to the Mercedes me connect service Telediagnosics

With the Telediagnosics function, specific wear and failure reports are recorded by the service provider, in so far as these can be clearly interpreted and are available through the monitoring of components that are subject to diagnostics.

If your vehicle detects a breakdown or threat of a breakdown, you may be prompted via the multimedia system to contact the Mercedes-Benz customer center for further help. This prompt in the multimedia system only appears when the vehicle is stationary.

i These services are subject to technical restrictions such as the mobile phone coverage, mobile network quality and the ability of the processing systems to interpret the transferred data. In some circumstances, this can result in delays or the failure of the information to appear in the multimedia system.

Please note that the service and breakdown call is a Mercedes-Benz service. In emergencies, be sure to contact the usual national emergency number first or use the Mercedes-Benz emergency call system (→ page 265).

More information about Mercedes me connect services can be obtained in the Mercedes me Portal: <https://me.secure.mercedes-benz.com>

■ Data transferred during Mercedes me connect call services

The data transferred during a Mercedes me connect call depends on:

- The reason for initiation of the call
- The service that is selected in the voice control system
- The activated Mercedes me connect services

You can find out which data is transferred when using the services in the currently valid Mercedes me connect terms of use and the data protection information for Mercedes me connect. You can find these in your Mercedes me user account.

Overview of the Mercedes me & Apps menu

When you log in with a user account to the Mercedes me Portal, then services and offers from Mercedes-Benz will be available to you.

For more information consult an authorized Mercedes-Benz Center or visit the Mercedes me Portal: <https://me.secure.mercedes-benz.com>

① Make sure you always keep the Mercedes me Apps updated.

You can call up the menu using [Mercedes me & Apps](#) in the multimedia system.

In the [Mercedes me & Apps](#) menu, the following options can be available:

- Connecting the vehicle with the [Mercedes me](#) user account

- Deleting a connection between a user account [Mercedes me](#) and the vehicle
- Calling up the Mercedes me services
- Calling up apps such as In-Car Office or the web browser depending on availability

Web browser overview

The web browser is started using the [Mercedes me & Apps](#) menu.

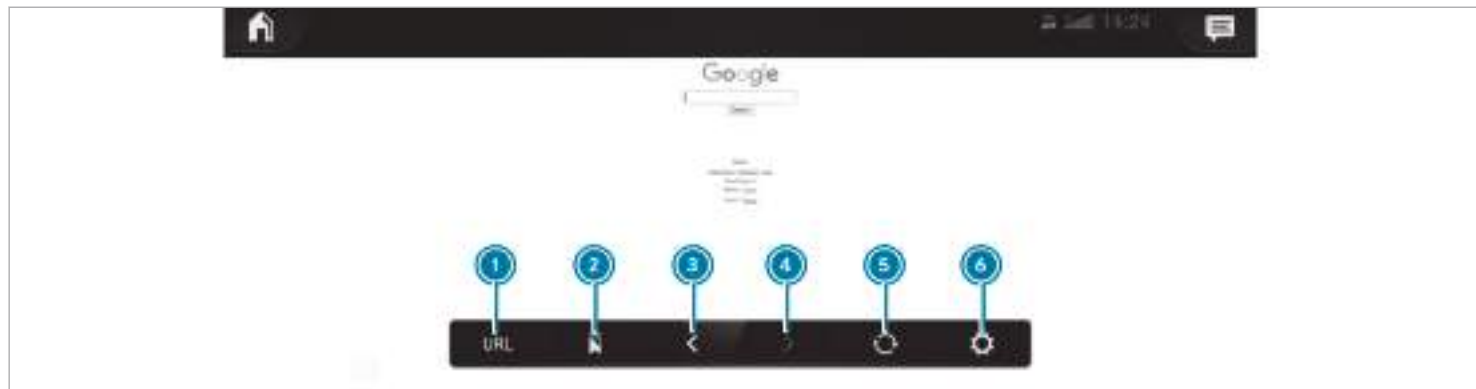

- ① URL entry
 - ② Bookmarks
 - ③ Web page, back
 - ④ Web page, forwards
 - ⑤ To refresh/stop
 - ⑥ Options
- ⓘ Websites cannot be shown while the vehicle is in motion.

Overview of Smartphone Integration

With Smartphone Integration, you can use certain functions on your mobile phone via the multimedia system display.

Only one mobile phone at a time can be connected via Smartphone Integration to the multimedia system. Also for use with two phone mode with Smartphone Integration, only one additional

mobile phone can be connected via Bluetooth® to the multimedia system.

The full range of functions for Smartphone Integration is only possible with an internet connection. The appropriate application must be downloaded on the mobile phone to use Smartphone Integration. The mobile phone must be switched on and connected to a USB port with the  symbol on the multimedia system using a suitable cable.

Apps for Smartphone Integration

- Apple CarPlay®
 - Android Auto
- i** For safety reasons, the first activation of Smartphone Integration on the multimedia system must be carried out when the vehicle is stationary and the parking brake is applied.

You can start Apple CarPlay® or Android Auto from the device manager.

- i** Mercedes-Benz recommends disconnecting the connecting cable only when the vehicle is stationary.

Overview of transferred vehicle data

When using Smartphone Integration, certain vehicle data is transferred to the mobile phone. This enables you to get the best out of selected mobile phone services. Vehicle data is not directly accessible.

The following system information is transmitted:

- Software release of the multimedia system
- System ID (anonymized)

The transfer of this data is used to optimize communication between the vehicle and the mobile phone.

To do this, and to assign several vehicles to the mobile phone, a vehicle identifier is randomly generated.

This has no connection to the vehicle identification number (VIN) and is deleted when the multimedia system is reset (→ page 245).

The following driving status data is transmitted:

- Transmission position engaged
- Distinction between parked, standstill, rolling and driving
- Day/night mode of the instrument display
- Drive type

The transfer of this data is used to alter how content is displayed to correspond to the driving situation.

The following position data is transmitted:

- Coordinates
- Speed
- Compass direction

- Acceleration direction

This data is used by the mobile phone to improve the accuracy of the navigation (e.g. for continuation in a tunnel).

Mercedes-Benz emergency call system

Information on the Mercedes-Benz emergency call system

Your vehicle is equipped with the Mercedes-Benz emergency call system ("eCall"). This feature can help save lives in the event of an accident. eCall in no way replaces assistance provided from dialing 911.

Mercedes-Benz eCall only functions in areas where mobile phone coverage is available from the wireless service providers. Insufficient network coverage from the wireless service providers may result in an emergency call not being transmitted.

eCall is a standard feature in your Mercedes-Benz vehicle. In order to function as intended, the system relies on the transmission of data detailed in

the "Mercedes-Benz emergency call system data transmission" section that follows (→ page 267).

To disable eCall, a customer must visit an authorized Mercedes-Benz Service department to deactivate the vehicle's communication module.

Deactivation of this module prevents the activation of any and all Mercedes me connect services. After the deactivation of eCall, automatic emergency call and manual emergency call will not be available.

The vehicle must be switched on before an automatic emergency call can be made.

- ① eCall is activated at the factory.
- ① eCall can be deactivated by an authorized Mercedes-Benz dealer. Please note that in the event ownership of the vehicle is transferred to another owner in its deactivated state, eCall will remain deactivated unless the new owner visits an authorized Mercedes-Benz dealership to reactivate the system.

Overview of the Mercedes-Benz emergency call system

eCall can help to reduce the time between an accident and the arrival of emergency services at the site of the accident. It helps locate an accident site in places that are difficult to access. However, even if a vehicle is equipped with eCall, this does not mean the system is ON. As such, eCall does not replace dialing 911 in the event of an accident.

An emergency call can be made automatically or manually.

Only make emergency calls if you or others are in need of rescue. Do not make an emergency call in the event of a breakdown or a similar situation.

Messages on the display

SOS NOT READY: the vehicle is not on or eCall not available.

During an active emergency call, <schar> appears in the display.

You can find more information on the regional availability of eCall at: <https://www.mercedes-benz-mobile.com/extra/ecall/>

- ① If there is a malfunction of the emergency call system, the loudspeakers, microphone, airbag or the SOS button, for example, are faulty.

You can recognize a malfunction in the emergency call system by the following displays:

- A corresponding message will also appear in the Instrument Display.
- The SOS button lights up red continuously.

Triggering an automatic Mercedes-Benz emergency call

Requirements:

- The vehicle is switched on.
- The starter battery is sufficiently charged.

The Mercedes-Benz emergency call system triggers an emergency call automatically in the following cases:

- After activation of the restraint systems such as airbags or Emergency Tensioning Devices after an accident
- After an emergency stop automatically initiated by Active Emergency Stop Assist

The emergency call has been made:

- A voice connection is made to the Mercedes-Benz emergency call center.
- A message with accident data is transmitted to the Mercedes-Benz emergency call center.

The Mercedes-Benz emergency call center can transmit the vehicle position data to one of the emergency call centers.

The SOS button in the overhead control panel flashes until the emergency call is finished.

It is not possible to immediately end an automatic emergency call.

If no connection can be made to the emergency services either, a corresponding message appears in the media display.

- ▶ Dial the local emergency number on your mobile phone.

If an emergency call has been initiated:

- Remain in the vehicle if the road and traffic conditions permit you to do so until a voice connection is established with the emergency call center operator.

- Based on the call, the operator decides whether it is necessary to call rescue teams and/or the police to the accident site.
- If no vehicle occupant answers, an ambulance is sent to the vehicle immediately.

Triggering a manual Mercedes-Benz emergency call

- ▶ **To use the SOS button in the overhead control panel:** press the SOS button at least one second long (→ page 258).
- ▶ **To use voice control:** use the Voice Control System voice commands.

The emergency call has been made:

- A voice connection is made to the Mercedes-Benz emergency call center.
- A message with accident data is transmitted to the Mercedes-Benz emergency call center.

The Mercedes-Benz emergency call center can transmit the vehicle position data to one of the emergency call centers.

- Remain in the vehicle if the road and traffic conditions permit you to do so until a voice connection is established with the emergency call center operator.
- Based on the call, the operator decides whether it is necessary to call rescue teams and/or the police to the accident site.

If no connection can be made to the emergency services either, a corresponding message appears in the media display.

- ▶ Dial the local emergency number on your mobile phone.

Ending an unintentionally triggered manual Mercedes-Benz emergency call

- ▶ **Using the multifunction steering wheel:** select . Depress the button for several seconds.

Data transfer of the Mercedes-Benz emergency call system

In the event of an automatic or manual emergency call the following data is transmitted, for example:

- Vehicle's GPS position data

268 MBUX multimedia system

- GPS position data on the route (a few 300 feet (100 m) before the incident)
- Direction of travel
- Vehicle identification number
- Vehicle drive type
- Number of people detected in the vehicle
- Whether Mercedes me connect is available or not
- Whether the emergency call was initiated manually or automatically
- Time of the accident
- Language setting on the multimedia system

Data transmitted is vehicle information. For any questions about the collection, use and sharing of the eCall system data, please contact MBUSA's Customer Assistance Center at 800-FOR-MERC.

For Canada, please contact MBC's Customer Assistance Center at 1-800-387-0100.









Customer requests for covered information should be submitted via the same channels.





For accident clarification purposes, the following measures can be taken up to an hour after the emergency call has been initiated:

- The current vehicle position can be determined.
- A voice connection to the vehicle occupants can be established.

Radio & media

Overview of the symbols and functions in the media menu

| Symbol | Designation | Function |
|---|--------------------|--|
|  | Play | Select to start or continue playback. |
|  | Rest | Select to pause the playback. |
|  | Repeat a track | Select to repeat the current track or the active playlist. <ul style="list-style-type: none"> • Select once: the active playlist is repeated. • Select twice: the current track is repeated. • Select three times: the function is deactivated. |
|  | Random playback | Select to play back the tracks in random order. |
|  | Skip forwards/back | Select to skip to the next or to the previous track. |
|  | Options | Select to show additional options. |
|  | Categories | Select to show or search through available categories (e.g. playback lists, albums, artists, etc.). |
|  | Search | Select to search in the active menu. You can search for artists, genres or moods, for example. |

| Symbol | Designation | Function |
|---|-------------|---------------------------------------|
|  | Settings | Select to make settings. |
|  | Home | Select to return to the home screen. |
|  | Messaging | Select to call up messaging. |
|  | Full screen | Select to switch to full screen mode. |

The following functions and settings are available in the media menu:

- Connecting external data storage media with the multimedia system (e.g. using USB or Bluetooth®)
- Playing back audio or video files

Authorizing a Bluetooth® audio device for media playback

Requirements:

- Bluetooth® is activated on the multimedia system and audio equipment.

- The audio equipment supports the Bluetooth® audio profiles A2DP and AVRCP.
- The audio equipment is "visible" for other devices.

Multimedia system:



With Bluetooth® audio, you can play back music files from an external data storage medium, e.g. your smartphone, using the MBUX multimedia system.

- ▶ To play back audio files using the multimedia system, authorize the external data storage medium on the MBUX multimedia system.





Authorizing a new Bluetooth® audio device





- ▶ Select **Connect New Device**.
- ▶ Select an audio device. Authorization starts. A code is displayed on the multimedia system and on the mobile phone.
- ▶ If the codes are identical, confirm on the audio equipment.
- ▶ Select **Only as Bluetooth Audio Device**. The Bluetooth® audio equipment is connected with the multimedia system.

Connecting previously authorized Bluetooth® audio equipment

- ▶ Select a Bluetooth® audio device from the list.
The connection is being established.





Overview of the symbols and functions in the radio menu

| Symbol | Designation | Function |
|---|--------------------|---|
|  | Home | Select to return to the home screen. |
|  | Messaging | Select to call up messaging. |
|  | Skip forwards/back | Select to skip to the next or to the previous station. |
|  | Settings | Select to have further options shown. Settings can be made to the following additional functions, for example: <ul style="list-style-type: none"> • Navigation and traffic announcements • Frequency fix function • Radio additional text • Emergency warnings The setting options are country-dependent. |

| Symbol | Designation | Function |
|---|----------------------|--|
| HD | HD radio™ | Select to switch the HD Radio™ function on or off. This function is not available in all countries. |
|  | Silent function | Select to switch off the sound. |
|  | Store radio stations | Select to save a station in the presets. |
|  | Station list | Select to have the station list shown. |
|  | Search | Select to search in the active menu. You can search for artists, genres or moods, for example. |

Additional functions of TuneIn radio

-  A relatively large volume of data can be transmitted when using TuneIn radio.





| Symbol | Designation | Function |
|---|-------------|--|
|  | Settings | The following additional settings are available in the TuneIn Radio menu: <ul style="list-style-type: none"> • Selecting stream • Logging on to or out of the TuneIn account |
|  | Favourites | Select during playback to save the station currently set as a favorite. |
|  | Play/Pause | Select to start, stop or continue playback. |
|  | Browse | Select to choose a category and then a radio station. |

Additional functions of the satellite radio

SIRIUS XM[®] satellite radio offers more than 175 digital-quality radio channels providing commercial-free music, sports, news and entertainment, for example. SIRIUS XM[®] satellite radio employs a fleet of high-performance satellites to broadcast

around the clock throughout the USA and Canada. The satellite radio program is available for a monthly fee. Information about this can be obtained from a Sirius XM[®] Service Center and at <https://www.siriusxm.com> (USA) or <https://www.siriusxm.ca> (Canada).

 Sirius, XM and all related marks and logos are trademarks of Sirius XM Radio Inc. and its subsidiaries. All other marks, channel names and logos are the property of their respective owners. All rights reserved.

| Symbol | Designation | Function |
|---|------------------|---|
|  | Settings | The following additional settings are available in the satellite radio menu: <ul style="list-style-type: none"> • Activate child safety lock to lock channels with adult content • Set alarm program for music and sport alerts • Create TuneMix lists to listen to music seamlessly |
|  | Playback control | Select to show the timeline. Tap any point on the timeline to skip forwards or back. Navigate to the end of the timeline to return to live mode. |
|  | Play | Select to start or continue playback. |
|  | Rest | Select to pause the playback. |

Depending on the frequency band selected, different functions are available to you.

Select the desired frequency band in the radio menu head runner.

Calling up TuneIn Radio

Requirements

- The TuneIn Radio service is activated in the Mercedes me Portal.
 - The data volume is available.
Depending on the country, data volume may need to be purchased.
 - A fast Internet connection for data transmission free of interference.
- i** Data volume can be purchased **directly from a mobile phone network provider** via the Mercedes me Portal.
- i** The functions and services are country-dependent. For more information, consult an authorized Mercedes-Benz Center.

Multimedia system:

 **»» Radio**

- ▶ Select **TuneIn Radio**.
The TuneIn menu appears. The last station set starts playing.
- i** The connection quality depends on the local mobile phone reception.

Setting up satellite radio

Requirements:

- Satellite radio equipment is available.
- Registration with a satellite radio provider has been completed.
- If registration is not included when purchasing the system, your credit card details will be required to activate your account.

Multimedia system:

 **»» Radio »» SiriusXM**
»»  Options

- ▶ Select **Service Information**.
The service information screen appears showing the radio ID and the current subscription status.
- ▶ Establish a telephone connection.
- ▶ Follow the service staff's instructions.
The activation process may take up to ten minutes.
- i** You can also have the satellite service activated online. To do so, please visit <https://www.siriusxm.com> (USA) or <https://www.siriusxm.ca> (Canada).

www.siriusxm.com (USA) or <https://www.siriusxm.ca> (Canada).

Music and sport alerts

Multimedia system:

 **»» Radio »» SiriusXM »» **
»» Alerts

Setting music and sport alerts

This function enables you to program an alert for your favorite artists, tracks or sporting events. Music alerts can be saved whilst a track is being played and sport alerts can be saved during a live game. You can also specify sport alerts via the menu option. The system then continuously searches through all the channels.

- ▶ Set a music or sports alert, to be informed of matches in the Live program.

Activating the music information function

- ▶ Activate **Music Alerts** .

Setting a music alert

- ▶ Select **Add Alert**.

- ▶ Select **Artists** or **Song** in the dialog window. The alert is set for the current artist or track. If a match is found, a prompt appears asking whether you wish to change to the station.

Activating sports information

- ▶ Activate **Activate Sports Alerts** .

Setting a sport alert

- ▶ Select **Add Alert**.
- ▶ Select the team name or league in the dialog window.

Deleting individual sports and music alerts

- ▶ Select **Manage Music Alerts**.

or

- ▶ Select **Manage Sports Alerts**.
- ▶ Select an artist or track.

or

- ▶ Select a team.
- ▶ Select **Delete Selected Entries**. All highlighted alerts are deleted.

Deleting all sports and music alerts

- ▶ Select **Manage Music Alerts**.

or

- ▶ Select **Manage Sports Alerts**.
- ▶ Select **Delete All Entries**. All alerts are deleted.

Sound settings

Overview of functions in the sound menu

The setting options and functions available depend on the sound system installed. You can find out which sound system is installed in your vehicle in the Digital Operator's Manual.

Standard sound system and Advanced sound system

The following functions are available:

- Equalizer
 - Treble, mid-range and bass
- Balance and fader
- Volume
 - Automatic adjustment

Burmester® surround sound system and Burmester® high-end 3D surround sound system

The following functions are available:

- Equalizer
 - Treble, mid-range and bass
- Balance and fader
- Sound focus
- VIP seat (Burmester® high-end 3D surround sound system only)
- Sound profiles
- Volume
 - Automatic adjustment

ASSYST PLUS service interval display

Function of the ASSYST PLUS service interval display

The ASSYST PLUS service interval display on the instrument display informs you of the time or distance remaining before the next service due date.

You can hide this service display using the back button  on the steering wheel.

Depending on how the vehicle is used, the ASSYST PLUS service interval display may shorten the service interval, e.g. in the following cases:

- Mainly short-distance driving
- When the engine is often left idling for long periods
- In the event of frequent cold start phases

Mercedes-Benz recommends avoiding such operating conditions.

You can obtain information concerning the servicing of your vehicle from a qualified specialist workshop, e.g. an authorized Mercedes-Benz Center.

Displaying the service due date

On-board computer:

 Service  ASSYST PLUS

The next service due date is displayed.

 **To exit the display:** press the back button  on the steering wheel.

Bear in mind the following related topic:

- Operating the on-board computer (→ page 227).

Information on regular maintenance work

 **NOTE** Premature wear through failure to observe service due dates

Maintenance work which is not carried out at the right time or incompletely can lead to increased wear and damage to the vehicle.

 Adhere to the prescribed service intervals.

 Always have the prescribed maintenance work carried out at a qualified specialist workshop.

Notes on special service requirements

The prescribed service interval is based on normal operation of the vehicle. Have the maintenance work carried out more often than prescribed if operating conditions are difficult or the vehicle is subject to increased stress.

The ASSYST PLUS service interval display is only an aid. It is the responsibility of the driver of the vehicle to have maintenance work carried out more often than prescribed due to actual operating conditions and/or stresses.

Examples of arduous operating conditions:

- Regular city driving with frequent intermediate stops
- Mainly short-distance driving
- Frequent operation in mountainous terrain or on poor road surfaces

- When the engine is often left idling for long periods
- Operation in particularly dusty conditions and/or if air-recirculation mode is frequently used

In these or similar operating conditions, have the interior air filter, air filter, engine oil and oil filter, for example, changed more frequently. If subject to increased stress, check the tires more. Further information can be obtained at a qualified specialist workshop.

Battery disconnection periods

The ASSYST PLUS service interval display can calculate the service due date only when the battery is connected.

- ▶ Display and note down the service due date on the instrument display before disconnecting the battery (→ page 277).

Maintenance Management

Notes about Maintenance Management

If the Maintenance Management service is activated, relevant data is automatically transferred to the Mercedes-Benz customer center.

The customer center transmits the data to the service partner that you have entered on the Mercedes me website at: <http://www.mercedes.me>. You will then receive individual recommendations regarding the maintenance of your vehicle.

- ⓘ The calculation of the optimal transmission time of the maintenance request to the service partner is subject to technical limitations that may cause the maintenance recommendation to be perceived as too early or too late or not to be made at all. In this case, you can conveniently arrange a maintenance appointment with the customer center via the maintenance reminder in the multimedia system.
- ⓘ Maintenance Management and the maintenance reminder in the multimedia system are not available in every country. Contact an

authorized Mercedes-Benz Center to find out whether this function is available in your country.

Data transferred when using Maintenance Management

When the service is activated, relevant data is automatically transferred to determine the required scope of maintenance as well as malfunction detection and malfunction rectification.

Details on data transfer can be found in the data protection information for the Mercedes me connect services. These can be found at: <https://www.mercedes.me> under "My Mercedes me account", "Terms of use".

- ⓘ Maintenance Management and the maintenance reminder in the multimedia system are not available in every country.

Telediagnosis

Notes about Telediagnosis

- ⓘ This service is not available in all countries.

The vehicle can detect if certain wear parts need to be replaced or if malfunctions have occurred in vehicle systems. If the Telediagnosis service is activated, relevant data is automatically transmitted to the manufacturer. If fault conditions are detected by the vehicle system self-diagnosis, the system transmits recommendations for action to the Mercedes-Benz customer center depending on the fault detected. The customer center transmits the data to the service partner that you have entered on the Mercedes me website at: <http://www.mercedes.me>.

For selected faults, the notification that a malfunction has been detected may appear in the multimedia system with a request to contact the Mercedes-Benz customer center. From this message, a call can be made directly to the customer center for assistance.

- i The transmission of a notification to the multimedia system depends on the country, vehicle model and equipment and requires a fast data connection, over which the service provider has no influence.
- i Reliable fault detection is subject to technical limitations. Therefore, only a limited selection

of faults can be detected and recommendations for action transmitted to the customer center and the service partners. Mercedes-Benz AG is continuously working on the expansion of this service. The fault detection depends on the country, vehicle model and equipment.

Data transferred when using Telediagnosics

When the service is activated, relevant data is automatically transferred to determine the required scope of maintenance as well as malfunction detection and malfunction rectification.

Details on data transfer can be found in the data protection information for the Mercedes me connect services. These can be found at: <https://www.mercedes.me> under "My Mercedes me account", "Terms of use".

- i The scope of the data transmitted depends on the vehicle model and equipment. For technical reasons, not all data is available at all times.

Engine compartment

Opening and closing the hood

⚠ WARNING Risk of accident due to driving with the hood unlocked

The hood may open and block your view.

- ▶ Never release the hood when driving.
- ▶ Before every trip, ensure that the hood is locked.

⚠ WARNING Risk of accident and injury when opening and closing the hood

The hood may suddenly drop into the end position.

There is a risk of injury for anyone in the hood's range of movement.

- ▶ Do not open or close the hood if there is a person in the hood's range of movement.

⚠ WARNING Risk of burns when opening the hood

If you open the hood in the event of an overheated engine or fire in the engine compartment, the following situations may occur:

- You may come into contact with hot gases.
 - You may come into contact with other escaping hot operating fluids.
- ▶ Before opening the hood, allow the engine to cool down.
 - ▶ In the event of a fire in the engine compartment, keep the hood closed and call the fire service.

⚠ WARNING Risk of injury due to moving parts

Components in the engine compartment may continue to run or start unexpectedly even when the drive system is switched off. Observe the following if you must open the hood:

- ▶ Switch off the vehicle.
- ▶ Never touch the danger zones surrounding moving components, e.g. the rotation area of the fan.
- ▶ Remove jewellery and watches.
- ▶ Keep items of clothing and hair away from moving parts.

⚠ WARNING Risk of injury from touching live components

The ignition system and the fuel injection system operate with a high voltage. You could receive an electric shock.

- ▶ Never touch components of the ignition system or fuel injection system when the vehicle is switched on.

The live components include the following, for example:

- Ignition coils
- Fuel injectors

- Electric lines to the ignition coils and the fuel injectors

⚠ WARNING Risk of burns from hot component parts in the engine compartment

Certain component parts in the engine compartment can be very hot, e.g. the engine, the cooler and parts of the exhaust system.

- ▶ Allow the engine to cool down and only touch component parts described in the following.

⚠ WARNING Risk of injury from using the windshield wipers when the hood is open

If the windshield wipers start moving when the hood is open, you could be trapped by the wiper linkage.

- ▶ Always switch off the windshield wipers and the vehicle first if you need to open the hood.

Opening the hood

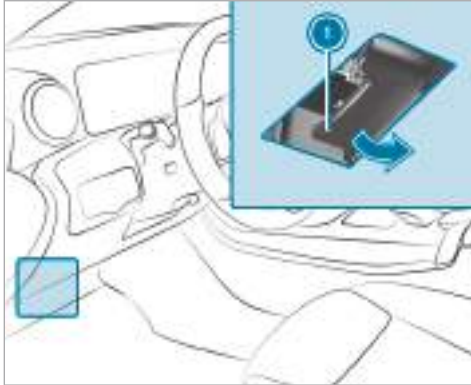

- ▶ To release the hood, pull on handle ①.

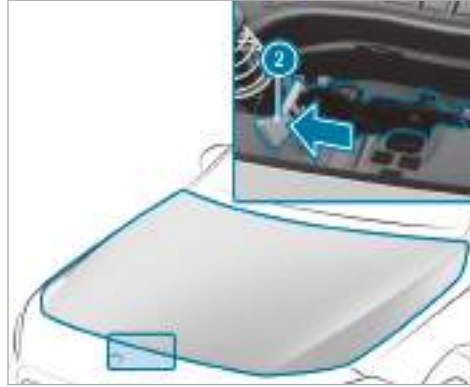

- ▶ Push yellow handle ② on the hood catch to the left as far as it will go (palm downwards). Lift the hood until it is automatically raised by the pneumatic spring.

Closing the hood

- ▶ Lower the bonnet and let it drop from a height of approximately 8 in (20 cm).

- ▶ If the hood can still be lifted slightly, open the hood again and close it with a little force until it engages correctly.

Engine oil

■ Checking the engine oil level using the on-board computer

Requirements

- The engine has been warmed up.
- The vehicle is parked on a level surface.
- The engine is running at idle speed.
- The hood is closed.

The engine oil level is determined during driving. Determining the engine oil level can take up to 30 minutes with a normal driving style and even longer with an active driving style.

On-board computer:

➔ **Service** ➔ **Engine Oil Level**

One of the following messages will appear on the instrument display:

- **Measuring Engine Oil Level...:** measurement of the oil level is not yet possible.
- ▶ Repeat the request after a maximum of 30 minutes' driving.
- **Engine Oil Level OK** and the bar display for indicating the oil level on the instrument display is green and is between "min" and "max": the oil level is correct.
- **Engine Oil Level Add 1,1 qts.** and the bar display for indicating the oil level on the instrument display is orange and is below "min":
- ▶ Add 1.1 US qt (1 l) of engine oil.
- **Reduce Engine Oil Level** and the bar display for indicating the oil level on the instrument display is orange and is above "max":

▶ Drain off any excess engine oil that has been added. To do so, consult a qualified specialist workshop.

- **For Engine Oil Level Switch Ignition On**

▶ Switch on the vehicle to check the engine oil level.

- **Engine Oil Level System Inoperative:** The oil level sensor is defective or not connected.

▶ Consult a qualified specialist workshop.

- **Engine Oil Level System Currently Unavail.**

▶ Close the hood.

■ **Top up engine oil**

⚠ WARNING Risk of burns from hot component parts in the engine compartment

Certain component parts in the engine compartment can be very hot, e.g. the engine, the cooler and parts of the exhaust system.

- ▶ Allow the engine to cool down and only touch component parts described in the following.

⚠ WARNING Risk of fire and injury from engine oil

If engine oil comes into contact with hot component parts in the engine compartment, it may ignite.

- ▶ Make sure that no engine oil is spilled next to the filler opening.
- ▶ Allow the engine to cool off and thoroughly clean the engine oil from component parts before starting the vehicle.

! NOTE Engine damage caused by an incorrect oil filter, incorrect oil or additives

- ▶ Do not use engine oils or oil filters which do not correspond to the specifications explicitly prescribed for the service intervals.
- ▶ Follow the instructions on the service interval display for changing the engine oil and observe the prescribed change intervals.
- ▶ Do not use additives.

! **NOTE** Damage caused by refilling too much engine oil

Too much engine oil can damage the engine or the catalytic converter.

- ▶ Have excess engine oil removed at a qualified specialist workshop.

i Depending on driving style, the vehicle consumes up to 0.9 US qt (0.8 liters) of oil per 600 miles (1,000 km). The oil consumption may also be higher than this when the vehicle is new or if you frequently drive at high engine speeds.

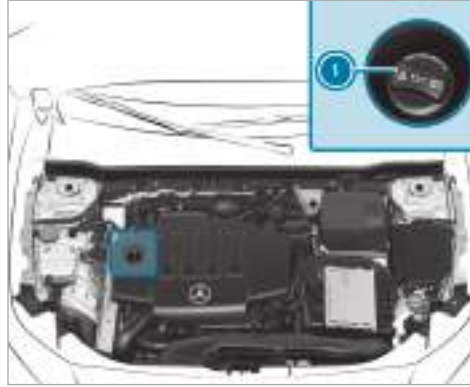

- ▶ Turn cap **1** counter-clockwise and remove it.
- ▶ Add engine oil.
- ▶ Replace cap **1** and turn it clockwise until it engages.
- ▶ Check the oil level again (→ page 281).

Checking the coolant level

! **WARNING** Risk of scalding from hot coolant

If you open the cap, you could be scalded.

- ▶ Let the motor cool down before opening the cap.
- ▶ When opening the cap, wear protective gloves and safety glasses.
- ▶ Open the cap slowly to release pressure.

! **WARNING** Risk of burns from hot component parts in the engine compartment

Certain component parts in the engine compartment can be very hot, e.g. the engine, the cooler and parts of the exhaust system.

- ▶ Allow the engine to cool down and only touch component parts described in the following.

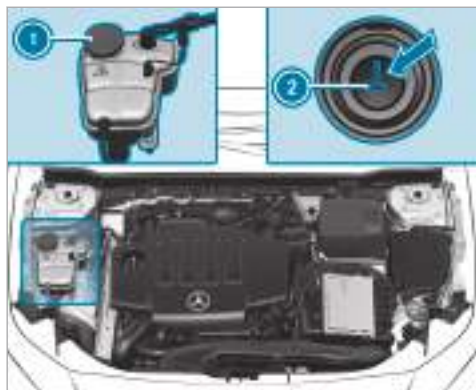

- ▶ Park the vehicle on a level surface.
- ▶ Check the coolant temperature display on the instrument display. The coolant temperature must be in the bottom quarter of the temperature indicator.
- ▶ Slowly turn cap ① counter-clockwise to release overpressure.

- ▶ Continue turning cap ① counter-clockwise and remove it.

The coolant level is correct in the following cases:

- If the engine is cold, the coolant is up to marker bar ②.
- If the engine is warm, the coolant is up to 0.6 in (1.5 cm) over the marker bar ②.
- ▶ If necessary, refill with coolant that has been approved for Mercedes-Benz.
- ① Further information on coolant (→ page 354).

Refilling the windshield washer system

- ⚠ **WARNING** Risk of burns from hot component parts in the engine compartment

Certain component parts in the engine compartment can be very hot, e.g. the engine, the cooler and parts of the exhaust system.

- ▶ Allow the engine to cool down and only touch component parts described in the following.

- ⚠ **WARNING** - Risk of fire and injury from windshield washer concentrate

Windshield washer concentrate is highly flammable. It could ignite if it comes into contact with hot engine component parts or the exhaust system.

- ▶ Make sure that no windshield washer concentrate spills out next to the filler opening.

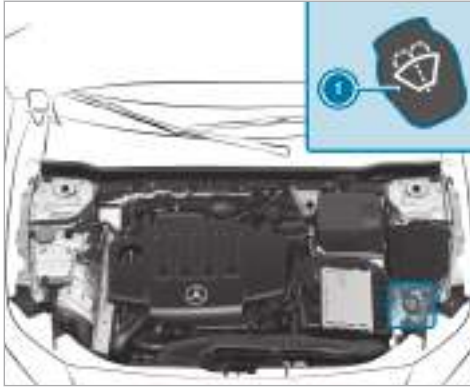

- ▶ Remove cap ① by the tab.
- ▶ Add washer fluid.
- ⓘ Further information about the windshield washer fluid (→ page 354)

Keeping the air/water duct free

- ▶ Keep the area between the hood and the windshield free of deposits, e.g. ice, snow or leaves.

Checking the brake lining thickness



- ▶ Bring the vehicle and wheels into a suitable position so that you can position the gage.
- ⓘ Measuring point ③ for the test gage depends on the equipment. The gage is positioned at point ③, which is located either in the center of the brake lining or at the upper end to the side, depending on the brake caliper.
- ▶ Switch off the vehicle.
- ▶ Secure the vehicle against rolling away.
- ▶ Take the gage out of the vehicle document wallet in the glove compartment.
- ▶ Place the test gage between the wheel spokes at measuring point ③ on the brake lining.
- ▶ Hold the gage vertically to brake disc ① and slide measuring pin ② onto brake disc ①.
- ▶ Check which color field ④ the arrow on measuring pin ② is pointing to.
 - Green:** the brake lining thickness is sufficient.
 - Red:** the brake lining thickness is not sufficient. Have the brake linings checked at a qualified specialist workshop.

- i** To avoid an inaccurate measurement:
- Make sure the wheels are suitably positioned.
 - In the case of perforated brake discs, do not put the measuring pin on one of the bores in the brake disc.

Cleaning and care

Information on washing the vehicle in a car wash

⚠ WARNING Risk of accident due to reduced braking effect after washing the vehicle

The braking effect is reduced after washing the vehicle.

- ▶ After the vehicle has been washed, brake carefully while paying attention to the traffic conditions until the braking effect has been fully restored.

! NOTE Damage from automatic braking

If one of the following functions is activated, the vehicle will brake automatically in certain situations:

- Active Brake Assist
- Active Distance Assist DISTRONIC
- HOLD function
- Active Parking Assist

To avoid damage to the vehicle, deactivate these systems in the following or similar situations:

- ▶ During towing.
- ▶ In a car wash.

! NOTE Damage due to unsuitable car wash

- ▶ Before driving into a car wash make sure that the car wash is suitable for the vehicle dimensions.

- ▶ Ensure there is sufficient ground clearance between the underbody and the guide rails of the car wash.
- ▶ Ensure that the clearance width of the car wash, in particular the width of the guide rails, is sufficient.

To avoid damage to your vehicle when using a car wash, ensure the following beforehand:

- Active Distance Assist DISTRONIC is deactivated.
- The HOLD function is switched off.
- The side windows and sliding sunroof are completely closed.
- The blower for the ventilation and heating is switched off.
- The windshield wiper switch is in position **0**.
- The key is at a minimum distance of 10 ft (3 m) away from the vehicle. Otherwise, the tailgate could open unintentionally.
- For car washes with a conveyor system:
 - Neutral **N** is engaged.

- **For vehicles with automatic transmission:** If you leave the vehicle while it is being washed, make sure the key is located in the vehicle. Park position **P** will otherwise be engaged automatically.

i If, after the car wash, you remove the wax from the windshield and wiper rubbers, this will prevent smearing and reduce wiper noise.

Automatic car wash mode

In car wash mode, the vehicle is prepared for driving into an automatic car wash. Car wash mode can be activated at a speed of up to 12 mph (20 km/h) (→ page 287).

The following settings are adjusted when car wash mode is activated:

- The outside mirrors will be folded in.
- To prevent the windshield washer system from starting up automatically, the rain sensor will be deactivated.
- The rear window wiper will be deactivated.
- The air conditioning system will be set to air-recirculation mode.

- Parking Assist PARKTRONIC will be deactivated.
- **Vehicles with 360° camera:** The front image will be activated after approximately eight seconds.

If one of the settings cannot be selected, this will be shown by the **X** symbol next to the respective setting.

Above a speed of 12 mph (20 km/h), car wash mode will be deactivated automatically.

The following settings will be reset when car wash mode is deactivated:

- The outside mirrors will be folded out.
- The rain sensor will be activated.
- The rear window wiper will be activated.
- The air conditioning system will be set to fresh air mode.
- Parking Assist PARKTRONIC will be reset to the previously selected setting.
- **Vehicles with 360° camera:** The front image will be deactivated at speeds above 11 mph (18 km/h).

Activating/deactivating automatic car wash mode

Requirements:

- The vehicle is stationary.
- The engine is running.

Multimedia system:

  **» Settings » Quick Access**

Activating automatic car wash mode

- ▶ Select **Automatic Car Wash Mode**.
- ▶ Select **Start**.

If one of the settings cannot be selected, this is displayed by an **X** behind the respective setting.

i For an overview of the settings made when activating automatic car wash mode (→ page 286).

Deactivating automatic car wash mode

- ▶ Select **Stop**.
- The automatic car wash settings are reset.

- ① The automatic car wash mode is automatically deactivated as soon as a speed of 12 mph (20 km/h) is exceeded.

Information on using a power washer

⚠ WARNING Risk of an accident when using power washers with round-spray nozzles

The water jet can cause externally invisible damage.

Components damaged in this way may unexpectedly fail.

- ▶ Do not use a power washer with round-spray nozzles.
- ▶ Have damaged tires or chassis parts replaced immediately.

To avoid damage to your vehicle, observe the following when using a power washer:

- The key is at a minimum distance of 10 ft (3 m) away from the vehicle. Otherwise, the tailgate could open unintentionally.
- Maintain a distance of at least 11.8 in (30 cm) to the vehicle.
- **Vehicles with decorative films:** parts of your vehicle are covered with a decorative film. Maintain a distance of at least 27.6 in (70 cm) between the film-covered parts of the vehicle and the nozzle of the power washer. Move the power washer nozzle around while cleaning. The water temperature of the power washer must not exceed 140°F (60°C).
- Observe the information on the correct distance in the equipment manufacturer's operating instructions.
- Do not direct the nozzle of the power washer directly at sensitive parts, e.g. tires, gaps, electrical components, batteries, illuminants or louvers.

Washing the vehicle by hand

! **NOTE** Engine damage due to water ingress

- ▶ Take care not to point the water jet directly towards the air inlet grille below the hood.

Observe the relevant legal requirements (e.g. in some countries, washing by hand is permitted only in specially designated wash bays).

- ▶ Use a mild cleaning agent (e.g. car shampoo).
- ▶ Wash the vehicle with lukewarm water using a soft car sponge. When doing so, do not expose the vehicle to direct sunlight.
- ▶ Carefully hose the vehicle off with water and dry using a chamois.

- ① Observe the notes on the care of car parts (→ page 290).

Notes on paintwork/matt finish paintwork care

To avoid damaging the paintwork and interfering with the driving assistance systems, please observe the following notes:

Paint

- Insect remains: soak with insect remover and rinse off the treated areas afterwards.
- Bird droppings: soak with water and rinse off afterwards.
- Tree resin, oils, fuels and greases: remove by rubbing gently with a cloth soaked in petroleum ether or lighter fluid.
- Coolant and brake fluid: remove with a damp cloth and clean water.
- Tar stains: use tar remover.
- Wax: use silicone remover.
- Do not attach stickers, films or similar materials. Have film attached to the bumper only at a qualified specialist workshop.
- Remove dirt immediately, where possible.

Matt finish

- Use only care products approved for Mercedes-Benz.
- Do not attach stickers, films or similar materials. Have film attached to the bumper only at a qualified specialist workshop.

- Do not polish the vehicle and alloy wheels.
- Use only car washes that correspond to the latest engineering standards.
- Do not use any car wash program with a final hot wax treatment.
- Do not use paint cleaners, buffing or polishing products or gloss preservers, e.g. wax.

In the event of paintwork damage:

- Always have paintwork repairs carried out at a qualified specialist workshop.
- Make sure the radar sensors function (→ page 173).

Notes on cleaning decorative films

Observe the "Notes on paintwork /matte finish paintwork care" (→ page 288). They also apply to matte decorative films.

Observe the notes on cleaning decorative films to avoid damage.

Cleaning

- For cleaning, use plenty of water and a mild cleaning agent without additives or abrasive

substances (e.g. a car shampoo approved for Mercedes-Benz).

- Remove dirt as soon as possible. Avoid rubbing too hard in order not to damage the decorative film irreparably.
- If there is dirt on the finish or if the decorative film is dull: use the paint cleaner recommended and approved for Mercedes-Benz.
- Insect remains: soak with insect remover and rinse off the treated areas afterwards.
- Bird droppings: soak with water and rinse off afterwards.
- To prevent water stains, dry a film-wrapped vehicle with a soft, absorbent cloth after every car wash.

Avoiding damage to the decorative film

- The service life and color of decorative films are impaired by:
 - Sunlight
 - Temperature (e.g. hot air blower)
 - Weather conditions
 - Stone chippings and dirt

- Chemical cleaning agents
- Oily products
- Do not use polish on matte decorative film. Polishing will have the effect of shining the film-wrapped surface.
- Do not treat matte or structured decorative films with wax. Permanent stains may occur.

Scratches, corrosive deposits, areas affected by corrosion and damage caused by incorrect care cannot always be completely repaired. In this case, contact a qualified specialist workshop.

You can obtain more information on care and cleaning agents from the manufacturer.

In the case of film-wrapped surfaces, visual differences may occur between the surfaces that were not protected by a decorative film after a decorative film has been removed.

- ① Have work or repairs to decorative films carried out at a qualified specialist workshop (e.g. at an authorized Mercedes-Benz Center).

Notes on care of car parts

⚠ WARNING Risk of entrapment if the windshield wipers are switched on while the windshield is being cleaned

If the windshield wipers are set in motion while you are cleaning the windshield or wiper blades, you can be trapped by the wiper arm.

- ▶ Always switch off the windshield wipers and the vehicle before cleaning the windshield or wiper blades.

To avoid damage to the vehicle, observe the notes on cleaning and care of the following car parts:

Wheels and rims

- Use water and acid-free alloy wheel cleaners.
- Do not use acidic alloy wheel cleaners to remove brake dust. This could damage wheel bolts and brake components.
- To avoid corrosion of the brake discs and pads, drive the vehicle for a few minutes after cleaning before parking it. The brake discs and pads will warm up and dry out.

Windows

! NOTE Damage to electronic components due to excess fluids

When cleaning the windows from the inside, fluids such as cleaning agents or water may run down and get behind trim parts of the vehicle interior and cause damage to electronic components.

- ▶ Use cleaning agents as sparingly as possible.
- ▶ Immediately absorb any excess fluids.

- Clean the windows inside and outside with a damp cloth and with a cleaning agent recommended for Mercedes-Benz.
- Do not use dry cloths or abrasive or solvent-based cleaning agents to clean the insides of windows.

- ❶ After changing the wiper blades or treating the vehicle with wax, clean the windshield thoroughly with cleaning agents recommended for Mercedes-Benz. Failure to observe the application instructions may result in damage, smear marks or glare spots.
- ❷ Remove external fogging or dirt on the windshield in front of the multifunction camera. Otherwise, driving systems and driving safety systems may be impaired or unavailable (→ page 173).

Wiper blades

- Move the wiper arms into the replacement position (→ page 133).
- With the wiper arms folded out, clean the wiper blades with a damp cloth.
- ❶ Make sure that the wiper blades are coated. The coating may leave residue on a cloth. Do not rub the wiper blades excessively or clean them too often.

Exterior lighting

- Clean the lenses with a wet sponge and mild cleaning agent (e.g. car shampoo).

- Use only cleaning agents or cleaning cloths that are suitable for plastic lenses.

Sensors

- Clean the sensors in the front and rear bumpers with a soft cloth and car shampoo (→ page 173).
- When using a power washer, maintain a minimum distance of 11.8 in (30 cm).

Reversing camera and 360° Camera

- Use clean water and a soft cloth to clean the camera lens.
- Do not use a power washer.

Notes on care of the interior

- ⚠ **WARNING** Risk of injury from plastic parts breaking off after the use of solvent-based care products

Care and cleaning products containing solvents can cause surfaces in the cockpit to become porous. When the airbags are deployed, plastic parts may break away.

- ▶ Do not use any care or cleaning products containing solvents to clean the cockpit.

- ⚠ **WARNING** Risk of injury or fatal injuries from bleached seat belts

Bleaching or dyeing seat belts can severely weaken them.

This can, for example, cause seat belts to tear or fail in an accident.

- ▶ Never bleach or dye seat belts.

To avoid damage to the vehicle, observe the following notes on cleaning and care:

Seat belts

- Clean with lukewarm soapy water.
- Do not use chemical cleaning agents.
- Do not dry by heating them to over 176°F (80°C) or exposing them to direct sunlight.

Display

- Switch off the display and let it cool down.

- Clean the surface carefully with a microfiber cloth and a suitable display care product (TFT-LCD).
- Do not use any other agents.

Head-up display

- Clean with a soft, non-static, lint-free cloth.
- Do not use cleaning agents.

Plastic trim

- Clean with a damp microfiber cloth.
- For heavy soiling: use a cleaning agent recommended for Mercedes-Benz.
- Do not attach stickers, films or similar materials.
- Do not allow cosmetics, insect repellent or sun cream to come into contact with the plastic trim.

Real wood and trim elements

- Clean with a microfiber cloth.
- Black piano-lacquer look: clean with a damp cloth and soapy water.
- For heavy soiling: use a cleaning agent recommended for Mercedes-Benz.

- Do not use solvent-based cleaning agents, polishes or waxes.

Headliner

- Clean with a brush or dry shampoo.

Carpet

- Use a carpet and textile cleaning agent recommended for Mercedes-Benz.

Steering wheel made of genuine leather or DINAMICA

! NOTE Damage caused by wrong cleaners

▶ Do not use solvent-based cleaning agents such as tar remover or wheel cleaner; neither should you use polishes or waxes. Otherwise you may damage the finish.

- Clean with a damp cloth and 1% soapy water solution and then wipe with a dry cloth.
- For heavy soiling: use a cleaning agent recommended for Mercedes-Benz.
- Leather care: use a leather care agent that has been recommended for Mercedes-Benz.

- Do not allow the leather to become too damp.
- Do not use a microfiber cloth.

i Leather is a natural product. It exhibits natural surface properties such as differences in structure, marks caused by growth and injury or subtle color differences. These surface properties are characteristics of leather and not material defects. Leather is also subject to a natural aging process during which the surface properties change.

Genuine leather seat covers

- Vacuum up dirt such as crumbs or dust and then clean the seat covers with a damp cotton cloth and wipe down with a dry cloth. Regularly clean the seat covers.
- For heavy soiling: use a leather care agent recommended for Mercedes-Benz aftercare.
- Leather care: use a leather care agent that has been recommended for Mercedes-Benz.
- Do not use a microfiber cloth.
- Do not allow the leather to become too damp.
- Do not use oil-based cleaning and care products.

i Leather is a natural product. It exhibits natural surface properties such as differences in structure, marks caused by growth and injury or subtle color differences. These surface properties are characteristics of leather and not material defects. Leather is also subject to a natural aging process during which the surface properties change.

Waves or wrinkling in the seat cover may occur due to the stress on the seat; this is caused by the natural leather material.

Regular cleaning and care of the leather reduces soiling, wear marks and aging damage and thus significantly extends its life span. Clothing that can leave stains (e.g. jeans) may discolor the leather.

DINAMICA seat covers

- Vacuum up dirt such as crumbs or dust and then use a damp cloth to clean.
- Do not use a microfiber cloth.

Imitation leather seat covers

- Vacuum up dirt such as crumbs or dust and then use a damp cotton cloth and a 1% soap

solution to clean the entire seat cover. Do not spot clean.

- Use cleaning and care products recommended for Mercedes-Benz.
- Do not use a microfiber cloth.
- Do not use oil-based cleaning and care products.

Fabric seat covers

- Vacuum up dirt such as crumbs or dust and then use a damp microfiber cloth and a 1% soap solution to clean the entire seat cover. Do not spot clean.
- Use cleaning and care products recommended for Mercedes-Benz.
- Do not use oil-based cleaning and care products.

Emergency

Removing the safety vest

The safety vests are located in the stowage compartments in the driver's and front passenger door.

- ▶ Pull out the safety vest bag by the loop.
 - ▶ Open the safety vest bag and pull out the safety vest.
- ⓘ There are also safety vest compartments in the rear door stowage compartments in which safety vests can be stored.

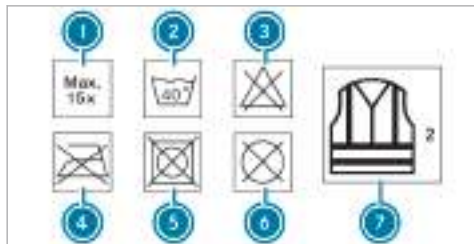

- ① Maximum number of washes
- ② Maximum wash temperature

- ③ Do not bleach
- ④ Do not iron
- ⑤ Do not tumble dry
- ⑥ Do not dry clean
- ⑦ Class 2 safety vest

The requirements defined by the legal standard are only fulfilled if the safety vest is the correct size and is fully closed.

Replace the safety vest in the following cases:

- The reflective strips are damaged or dirty
- The maximum permissible number of washes is exceeded
- The fluorescence has faded, e.g. due to continuous exposure to sunlight.

Dispose of the safety vest in an environmentally responsible manner.

- To do so, contact your local waste disposal company.

Warning triangle

Removing the warning triangle

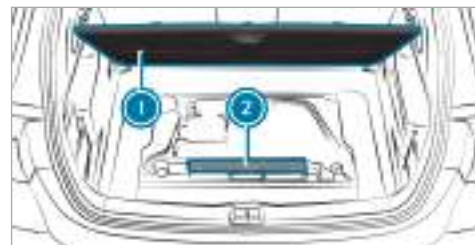

- ▶ Open cargo floor ①.
- ▶ Remove warning triangle ②.

Setting up the warning triangle



- ▶ Fold side reflectors ① upwards to form a triangle and attach at the top using upper press-stud ②.
- ▶ Fold legs ③ down and out to the side.

First-aid kit (soft sided) overview



First-aid kit ① is located in the stowage net on the left in the cargo compartment.

Removing the fire extinguisher

⚠ WARNING Risk of accident due to an incorrectly secured fire extinguisher in the driver's footwell

A fire extinguisher may impede pedal travel or block a depressed pedal.

This jeopardizes the operating and road safety of the vehicle.

The fire extinguisher can be flung around and injure the driver or other vehicle occupants.

- ▶ Always store and secure the fire extinguisher in the bracket.
- ▶ Do not remove the fire extinguisher while driving.



- ▶ **Left-hand drive vehicle:** Pull tab ① upwards.
- ▶ Remove fire extinguisher ②.

Flat tire

Notes on flat tires

⚠ WARNING Risk of accident due to a flat tire

A flat tire severely affects the driving characteristics as well as the steering and braking of the vehicle.

Tires without run-flat characteristics:

- ▶ Do not drive with a flat tire.
- ▶ Change the flat tire immediately with an emergency spare wheel or spare wheel. Alternatively, consult a qualified specialist workshop.

Tires with run-flat characteristics:

- ▶ Observe the information and warning notes on MOExtended tires (run-flat tires).

In the event of a flat tire, the following options are available depending on your vehicle's equipment:

- **Vehicles with MOExtended tires:** it is possible to continue the journey for a short period of time. Make sure you observe the notes on MOExtended tires (run-flat tires) (→ page 296).
 - **Vehicles with a TIREFIT kit:** you can seal the tire so that it is possible to continue the journey for a short period of time. To do this, use the TIREFIT kit (→ page 297).
 - **Vehicles with Mercedes me connect:** you can make a call for breakdown assistance via the overhead control panel in the case of a breakdown (→ page 258).
 - **All vehicles:** change the wheel (→ page 338).
- i** The emergency spare wheel is only available in certain countries.

Notes on MOExtended tires (run-flat tires)

⚠ WARNING Risk of accident when driving in limp-home mode

When driving in emergency mode the handling characteristics are impaired.

- ▶ Do not exceed the specified maximum speed of the MOExtended tires.
- ▶ Avoid any abrupt steering and driving maneuvers as well as driving over obstacles (curbs, pot holes, off-road). This applies, in particular, to a loaded vehicle.
- ▶ Stop driving in the emergency mode if you notice:
 - Banging noise
 - Vehicle vibration
 - Smoke which smells like rubber
 - Continuous ESP® intervention
 - Cracks in the tire side walls
- ▶ After driving in emergency mode, have the rims checked by a qualified specialist

workshop with regard to their further use.

- ▶ The defective tire must be replaced in every case.

With MOExtended tires (run-flat tires), you can continue to drive your vehicle even if there is a total loss of pressure in one or more tires. However, the tire affected must not show any clearly visible damage.

You can recognize MOExtended tires by the MOExtended marking which appears on the side wall of the tire.

Vehicles with tire pressure loss warning system: MOExtended tires may only be used in conjunction with an activated tire pressure loss warning system.

Vehicles with tire pressure monitoring system: MOExtended tires may only be used in conjunction with an activated tire pressure monitoring system.

If a pressure loss warning message appears in the driver's display, proceed as follows:

- Check the tire for damage.

- If driving on, observe the following notes.

Driving distance possible in emergency mode after the pressure loss warning:

| Load condition | Driving distance possible in emergency mode |
|-----------------|---|
| Partially laden | 50 miles (80 km) |
| Fully laden | 19 miles (30 km) |

The driving distance possible in emergency mode may vary depending on the driving style. Observe the maximum permissible speed of 50 mph (80 km/h).

If a tire has gone flat and cannot be replaced with an MOExtended tire, you can use a standard tire as a temporary measure.

Storage location of the TIREFIT kit (not plug-in hybrid)

The TIREFIT kit is located under the cargo floor.

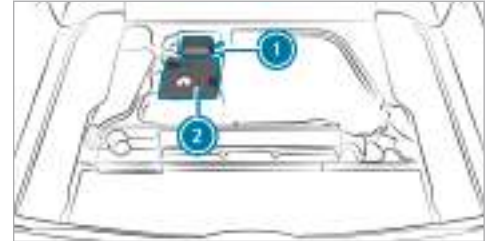

- ① Tire sealant bottle
- ② Tire inflation compressor

Depending on the vehicle version, the TIREFIT kit may be located in another position under the cargo floor.

Using the TIREFIT kit

Requirements

- The tire sealant bottle and tire inflation compressor are ready for use (→ page 297).
- TIREFIT sticker is present.
- Gloves are present.

You can use TIREFIT tire sealant to seal perforation damage of up to 0.16 in (4 mm), particularly those in the tire tread. You can use TIREFIT in outside temperatures down to -4 °F (-20 °C).

⚠ WARNING Risk of accident when using tire sealant

The tire sealant may be unable to seal the tire properly, especially in the following cases:

- There are large cuts or punctures in the tire (larger than damage previously mentioned)
 - The wheel rims have been damaged
 - After journeys with very low tire pressure or with flat tires
- ▶ Do not continue driving.
▶ Consult a qualified specialist workshop.

⚠ WARNING Risk of injury and poisoning from tire sealant

The tire sealant is harmful and causes irritation. Do not allow it to come into contact with

the skin, eyes or clothing, and do not swallow it. Do not inhale tire sealant fumes. Keep the tire sealant away from children.

If you come into contact with the tire sealant, observe the following:

- ▶ Rinse off the tire sealant from your skin immediately using water.
- ▶ If tire sealant gets into your eyes, thoroughly rinse out the eyes using clean water.
- ▶ If tire sealant has been swallowed, immediately rinse out the mouth thoroughly and drink plenty of water. Do not induce vomiting and seek medical attention immediately.
- ▶ Change out of any clothes contaminated with tire sealant immediately.
- ▶ If allergic reactions occur, seek medical attention immediately.

! NOTE Overheating due to the tire inflation compressor running too long

- ▶ Do not run the tire inflation compressor for longer than ten minutes without interruption.

Comply with the manufacturer's safety notes on the sticker on the tire sealant bottle.

Have the tire sealant bottle replaced at a qualified specialist workshop every five years.

- ▶ Do not remove any foreign objects that have entered the tire.



- ▶ Remove sticker ① from the housing of the tire inflation compressor and affix it to the instrument cluster within the driver's field of vision.



- ▶ Remove sticker ② from the tire sealant bottle and affix it near the valve on the wheel with the defective tire.



- ▶ Pull plug ⑦ with the cable and filling hose ③ out of the housing of the tire inflation compressor.
- ▶ Insert tire sealant bottle ⑨ in socket ⑥ of the tire inflation compressor in such a way that the red arrow on tire sealant bottle ⑨ aligns with the red arrow on the tire inflation compressor.

- ▶ Turn tire sealant bottle ⑨ a quarter turn clockwise.
- ▶ Insert the plug of filling hose ③ in socket ⑤ of tire sealant bottle ⑨.
- ▶ Turn filling hose ③ a quarter turn clockwise.



- ▶ Remove the valve cap from valve ⑩ on the defective tire.
- ▶ Screw union nut ④ of filling hose ③ onto valve ⑩.
- ▶ Insert plug ⑦ into a 12-V-socket in your vehicle.
- ▶ Turn the key to position ① in the ignition lock.

- ▶ Press on and off switch  on the tire inflation compressor.
The tire inflation compressor is switched on. The tire is inflated. First, tire sealant is pumped into the tire. The pressure may briefly rise to approximately 500 kPa (5 bar/73 psi).

Do not switch off the tire inflation compressor during this phase!

- ▶ Let the tire inflation compressor run for a maximum of ten minutes.
The tire should then have attained a tire pressure of at least 200 kPa (2.0 bar/29 psi).

If tire sealant leaks out, make sure you clean the affected area as quickly as possible. It is preferable to use clean water.

If you get tire sealant on your clothing, have it cleaned as soon as possible with perchloroethylene.

If, after ten minutes, a tire pressure of 200 kPa (2.0 bar/29 psi) has not been attained:

- ▶ Switch off the tire inflation compressor.

- ▶ Unscrew the filling hose from the valve of the defective tire.

Please note that tire sealant may leak out when you unscrew the filling hose.

- ▶ Drive forwards or in reverse very slowly for approximately 33 ft (10 m).
- ▶ Pump up the tire again.
After a maximum of ten minutes, the tire pressure must be at least 200 kPa (2.0 bar/29 psi).

⚠ WARNING Risk of accident due to the specified tire pressure not being achieved

If the specified tire pressure is not achieved after the specified time, the tire is too badly damaged. The tire sealant cannot repair the tire in this instance.

The braking characteristics as well as the driving characteristics may be greatly impaired.

- ▶ Do not continue driving.
- ▶ Consult a qualified specialist workshop.

! NOTE Staining caused by leaking tire sealant

After use, excess tire sealant may leak out from the filling hose.

- ▶ Therefore, place the filling hose in the plastic bag that contained the TIREFIT kit.

If, after ten minutes, a tire pressure of 200 kPa (2.0 bar/29 psi) has been attained:

- ▶ Switch off the tire inflation compressor.
- ▶ Unscrew the filling hose from the valve of the defective tire.

Please note that tire sealant may leak out when you unscrew the filling hose.

⚠ WARNING Risk of accident from driving with sealed tires

A tire temporarily sealed with tire sealant impairs the handling characteristics and is not suitable for higher speeds.

- ▶ Adapt your driving style accordingly and drive carefully.
- ▶ Do not exceed the maximum speed limit with a tire that has been repaired using tire sealant.

- ▶ Observe the maximum permissible speed of 50 mph (80 km/h) for a tire sealed with tire sealant.
- ▶ The sticker with details of the maximum permissible speed must be affixed to the instrument cluster where it can be easily seen by the driver.

! **NOTE** Staining caused by leaking tire sealant

After use, excess tire sealant may leak out from the filling hose.

- ▶ Therefore, place the filling hose in the plastic bag that contained the TIREFIT kit.

🔥 ENVIRONMENTAL NOTE Environmental pollution caused by environmentally irresponsible disposal

Tire sealant contains pollutants.

- ▶ Have the tire sealant bottle disposed of professionally, e.g. at an authorized Mercedes-Benz Center.

- ▶ Stow the tire sealant bottle and the tire inflation compressor.
- ▶ **Pull away immediately.**
- ▶ Pull over after approximately ten minutes and check the tire pressure using the tire inflation compressor.
The tire pressure must now be at least 130 kPa (1.3 bar/19 psi).

⚠️ WARNING Risk of accident due to the specified tire pressure not being attained

If the specified tire pressure is not reached, the tire is too badly damaged. The tire sealant cannot repair the tire in this instance.

The braking and driving characteristics may be greatly impaired.

- ▶ Do not continue driving.
- ▶ Consult a qualified specialist workshop.

In cases such as the one mentioned above, contact an authorized Mercedes-Benz Center. Or call 1-800-FOR-MERCEDES (in the USA) or 1-800-387-0100 (in Canada).

- ▶ Correct the tire pressure if it is still at least 130 kPa (1.3 bar/19 psi). See the Tire and Loading Information placard on the B-pillar on the driver's side or the tire pressure table on the fuel filler flap for values.

Increasing the tire pressure

- ▶ Switch on the tire inflation compressor.

Reducing the tire pressure

- ▶ Remove the tire sealant bottle from the tire inflation compressor.
- ▶ Insert the filling hose in the socket of the tire inflation compressor and turn it a quarter turn clockwise.



- ▶ Press pressure release button **12** next to manometer **11**.

If the tire pressure is correct

- ▶ Unscrew the filling hose from the valve of the sealed tire.
- ▶ Screw the valve cap onto the valve of the sealed tire.
- ▶ Stow the tire sealant bottle and the tire inflation compressor.
- ▶ Drive to the nearest qualified specialist workshop and have the tire, tire sealant bottle and filling hose replaced there.

Battery (vehicle)

Notes on the 12 V battery

⚠ WARNING Risk of explosion due to electrostatic charge

Electrostatic charge can ignite the highly explosive gas mixture in the battery.

- ▶ To discharge any electrostatic charge that may have built up, touch the metal vehicle body before handling the battery.

The highly flammable gas mixture is created while the battery is charging and during starting assistance.

For safety reasons, Mercedes-Benz recommends that you only use batteries which have been tested and approved for your vehicle by Mercedes-Benz.

⚠ WARNING Danger of chemical burns from the battery acid

Battery acid is caustic.

- ▶ Avoid contact with the skin, eyes or clothing.
- ▶ Do not lean over the battery.
- ▶ Do not inhale battery gases.
- ▶ Keep children away from the battery.
- ▶ Immediately rinse battery acid off thoroughly with plenty of clean water and seek medical attention immediately.

🔥 ENVIRONMENTAL NOTE Environmental damage due to improper disposal of batteries



Batteries contain pollutants. It is illegal to dispose of them with the household rubbish.



Dispose of batteries in an environmentally responsible manner. Take discharged batteries to a qualified

specialist workshop or to a collection point for used batteries.

If you have to disconnect the 12 V battery, contact a qualified specialist workshop.

Comply with safety notes and take protective measures when handling batteries.



Risk of explosion.



Fire, naked flames and smoking are prohibited when handling the battery. Avoid creating sparks.



Electrolyte or battery acid is corrosive. Avoid contact with the skin, eyes or clothing. Wear suitable protective clothing, in particular gloves, an apron and a face mask. Immediately rinse electrolyte or acid splashes off with clean water. Consult a doctor immediately.



Wear safety glasses.



Keep children away.



Observe this Operator's Manual.

If you do not intend to use the vehicle over an extended period of time:

- Activate standby mode.
- Connect the battery to a charger approved by Mercedes-Benz.
- Consult a qualified specialist workshop to disconnect the battery.

Notes on starting assistance and charging the 12 V battery

When charging the battery and during starting assistance, always use the jump-start connection point in the engine compartment.

! **NOTE** Damage to the battery due to over-voltage

When charging using a battery charger without a maximum charging voltage, the battery or the on-board electronics may be damaged.

- ▶ Only use battery chargers with a maximum charging voltage of 14.8 V.

! **WARNING** Risk of explosion due to the ignition of hydrogen gas

If there is a short circuit or sparks are created, there is a danger of hydrogen gas igniting when you charge the battery.

- ▶ Make sure that the POSITIVE terminal of a connected battery does not come into contact with vehicle parts.

- ▶ Never place metal objects or tools on a battery.
- ▶ When connecting and disconnecting the battery, always observe the sequence of battery terminals described.
- ▶ During starting assistance, always take care to connect only battery terminals of identical polarity.
- ▶ During starting assistance, observe the sequence described for connecting and disconnecting the jumper cables.
- ▶ Do not connect or disconnect the battery terminals with the engine running.

⚠ WARNING Risk of explosion due to a mixture of explosive gases

A mixture of explosive gases can escape from the battery during charging and jump starting.

- ▶ Fire, open flames, smoking and creating sparks must be avoided.
- ▶ Make sure that there is sufficient ventilation.

- ▶ Do not stand over the battery.

⚠ WARNING Risk of explosion from a frozen battery

A discharged battery may freeze at temperatures slightly above or below freezing point.

During starting assistance or battery charging, battery gas can be released.

- ▶ Always allow a battery to thaw before charging it or performing starting assistance.

If the indicator/warning lamps on the instrument cluster do not light up at low temperatures, it is very likely that the discharged battery has frozen. In this case you may neither jump-start the vehicle nor charge the battery.

The service life of a battery that has been thawed may be dramatically shortened. The starting characteristics may be impaired, especially at low temperatures.

It is recommended that you have a thawed battery checked at a qualified specialist workshop.

! NOTE Damage caused by numerous or extended attempts to start the engine

Numerous or extended attempts to start the engine may damage the catalytic converter due to non-combusted fuel.

- ▶ Avoid numerous and extended attempts to start the engine.

Observe the following points during starting assistance and when charging the battery:

- Only use undamaged jumper cables/charging cables with a sufficient cross-section and insulated terminal clamps.
- Non-insulated parts of the terminal clamps must not come into contact with other metal parts while the jumper cable/charging cable is connected to the battery/jump-start connection point.
- The jumper cables/charging cables must not come into contact with any parts that may move when the engine is running.
- Always make sure that neither you nor the battery is electrostatically charged.

- Keep away from fire and naked flames.
- Do not lean over the battery.

Observe the additional following points when charging the battery:

- Only use chargers tested and approved for Mercedes-Benz.
- Read the charger's operating instructions before charging the battery.

Observe the additional following points during starting assistance:

- For starting assistance, only use batteries with a nominal voltage of 12 V.
- The vehicles must not touch.
- **Gasoline engines:** only accept starting assistance if the engine and exhaust system are cold.

Starting assistance and charging the 12 V battery

Requirements

- The vehicle is secured with the electric parking brake.

- **Automatic transmission:** the transmission is in position **P**.
- The vehicle and all electrical consumers are switched off.
- The hood is open.

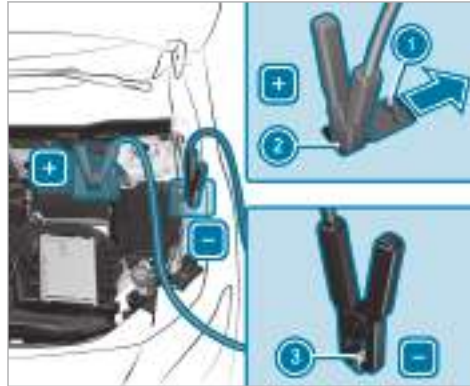

- ▶ Slide cover **1** of positive contact **2** on the jump-starting connection point in the direction of the arrow.

- ▶ Connect positive contact **2** on your vehicle to the positive terminal of the donor battery using the jumper cable/charging cable. Always begin with positive contact **2** on your own vehicle first.
- ▶ **During starting assistance:** start the engine of the donor vehicle and run it at idle speed.
- ▶ Connect the negative terminal of the donor battery and ground point **3** of your own vehicle using the jumper cable/charging cable. Begin with the donor battery first.
- ▶ **During starting assistance:** start the engine of your own vehicle.
- ▶ **During the charging process:** start the charging process.
- ▶ **During starting assistance:** let the engines run for several minutes.
- ▶ **During starting assistance:** before disconnecting the jumper cable, switch on an electrical consumer in your own vehicle, e.g. the rear window defroster or lighting.

When the starting assistance/charging process is complete:

- ▶ First, remove the jumper cables/charging cables from ground point ③ and the negative terminal of the donor battery, then from positive contact ② and the positive terminal of the donor battery. Begin each time with the contacts on your own vehicle first.
- ▶ After removing the jumper cables/charging cables, close cover ① of positive contact ②.

Further information can be obtained at a qualified specialist workshop.

Replacing the 12 V battery

- ▶ Observe the notes on the 12 V battery (→ page 302).

Mercedes-Benz recommends that you have the 12 V battery replaced at a qualified specialist workshop, e.g. at an authorized Mercedes-Benz Center.

Observe the following notes if you want to replace the battery yourself:

- Always replace a faulty battery with a battery that meets the specific vehicle requirements.

The vehicle is equipped with a fleece battery. Full vehicle functionality is only guaranteed with a fleece battery. For safety reasons, Mercedes-Benz recommends that you only use batteries which have been tested and approved for your vehicle by Mercedes-Benz.

- Use detachable parts such as the vent hose, elbow fitting or terminal cover from the battery that is to be replaced.
 - Make sure that the vent hose is always connected to the original opening on the side of the battery.
- Install any existing or supplied cell caps. Otherwise, gases or battery acid could escape.
- Make sure that detachable parts are reconnected in the same way.

Tow starting or towing away

Overview of permitted towing methods (not plug-in hybrid)

Permitted towing methods

Mercedes-Benz recommends transporting your vehicle in the case of a breakdown, rather than towing it away.

For towing with both axles on the ground, use a tow rope or tow bar. Do not use tow bar systems.

⚠ WARNING Risk of accident when towing with steering wheel locking

When the steering wheel locking is engaged, you can no longer steer the vehicle.

- ▶ Always switch on the vehicle when towing with a tow rope or tow bar.

! **NOTE** Damage to the vehicle due to towing away incorrectly

- ▶ Observe the instructions and notes on towing away.

Vehicles with automatic transmission

| | |
|--------------------------|--|
| Both axles on the ground | Yes, for a maximum of 31 miles (50 km) at 31 mph (50 km/h) |
| Front axle raised | Yes, for a maximum of 31 miles (50 km) at 31 mph (50 km/h) |
| Rear axle raised | Yes, for a maximum of 31 miles (50 km) at 31 mph (50 km/h) |

4MATIC vehicles

| | |
|--------------------------|--|
| Both axles on the ground | Yes, for a maximum of 31 miles (50 km) at 31 mph (50 km/h) |
| Front axle raised | No |
| Rear axle raised | No |

Towing with a raised axle: towing should be performed by a towing company.

Towing the vehicle with both axles on the ground

- ▶ Observe the notes on the permitted towing methods.
- ▶ Make sure that the battery is connected and charged.

Observe the following points when the battery is discharged:

- the vehicle cannot be started.
- the electric parking brake cannot be released or applied
- **Vehicles with automatic transmission:** the transmission cannot be shifted to position **N** or **P**.

i **Vehicles with automatic transmission:** if the transmission cannot be shifted to position **N** or if the display does not show anything, transport the vehicle (→ page 308). A towing vehicle with lifting equipment is required for vehicle transportation.

! **NOTE** Damage due to towing away at excessively high speeds or over long distances

The drivetrain could be damaged when towing at excessively high speeds or over long distances.

- ▶ A towing speed of 30 mph (50 km/h) must not be exceeded.
- ▶ A towing distance of 30 miles (50 km) must not be exceeded.

! **WARNING** Risk of accident when towing a vehicle which is too heavy

If the vehicle to be tow-started or towed away is heavier than the permissible gross mass of your vehicle, the following situations can occur:

- The towing eye may become detached.
- The vehicle/trailer combination may swerve or rollover.
- ▶ Before tow-starting or towing away, check if the vehicle to be tow-started or

towed away exceeds the permissible gross mass.

If a vehicle has to be tow-started or towed away, its permissible gross mass must not exceed the permissible gross mass of the towing vehicle.

▶ Information on the permissible gross mass of the vehicle can be found on the vehicle identification plate (→ page 348).

▶ **Vehicles with automatic transmission:** do not open the driver's door or front passenger door; the transmission otherwise automatically shifts to position **P**.

▶ Install the towing eye (→ page 310).

▶ Fasten the towing device.

! **NOTE** Damage due to incorrect connection of the tow bar

▶ Only connect the tow rope or tow bar to the towing eyes.

▶ Deactivate the automatic locking mechanism .

▶ Do not activate the HOLD function.

▶ Deactivate the tow-away alarm (→ page 90).

▶ Deactivate Active Brake Assist (→ page 199).

▶ **Vehicles with automatic transmission:** shift to position **N**.

▶ Release the electric parking brake.

! **WARNING** Risk of accident due to limited safety-related functions during the towing process

Safety-related functions are limited or no longer available in the following situations:

- The vehicle is switched off.
- The brake system or power steering system is malfunctioning.
- The energy supply or the on-board electrical system is malfunctioning.

When your vehicle is towed away, significantly more effort may be required to steer and brake than is normally required.

▶ Use a tow bar.

▶ Make sure that the steering wheel can move freely before towing the vehicle away.

! **NOTE** Damage due to excessive tractive power

If you pull away sharply, the tractive power may be too high and the vehicles could be damaged.

▶ Pull away slowly and smoothly.

Loading the vehicle for transport

▶ Observe the notes on towing away (→ page 307).

▶ Connect the towing device to the towing eye in order to load the vehicle.

▶ **Vehicles with automatic transmission:** shift the automatic transmission to position **N**.

i **Vehicles with automatic transmission:** the automatic transmission may be locked in position **P** in the event of damage to the electrical system. To shift to **N**, supply the on-board electrical system with power (→ page 305).

- ▶ Load the vehicle onto the transporter.
- ▶ **Vehicles with automatic transmission:** shift the automatic transmission to position **P**.
- ▶ Use the electric parking brake to secure the vehicle against rolling away.
- ▶ Only secure the vehicle by the wheels.

Vehicles with adaptive damping adjustment

⚠ WARNING Risk of an accident when transporting vehicles with adaptive damping adjustment

When transporting vehicles with adaptive damping adjustment, the vehicle/trailer combination may begin to rock and start to skid.

- ▶ Load the vehicle correctly onto the transporter.

- ▶ Secure the vehicle on all four wheels with suitable tensioning straps.

! **NOTE** Damage to the vehicle from securing it incorrectly

- ▶ After loading, the vehicle must be secured on all four wheels. Otherwise, the vehicle could be damaged.
- ▶ A minimum distance of 8 in (20 cm) upwards and 4 in (10 cm) downwards must be kept to the transport platform.

- ▶ Secure the vehicle on all four wheels after loading.

4MATIC vehicles/vehicles with automatic transmission

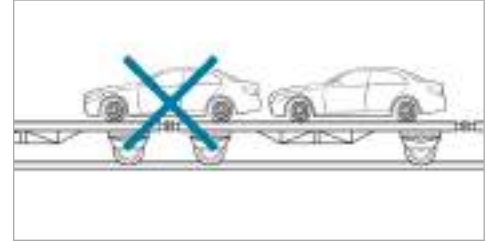

- ▶ Make sure that the front and rear axles come to rest on the same transportation vehicle.

! **NOTE** Damage to the drive train due to incorrect positioning of the vehicle

- ▶ Do not position the vehicle above the connection point of the transport vehicle.

Towing eye storage location

The towing eye is under the cargo floor.

Depending on the vehicle version, the towing eye may be located in a different position in the cargo compartment.

Installing and removing the towing eye

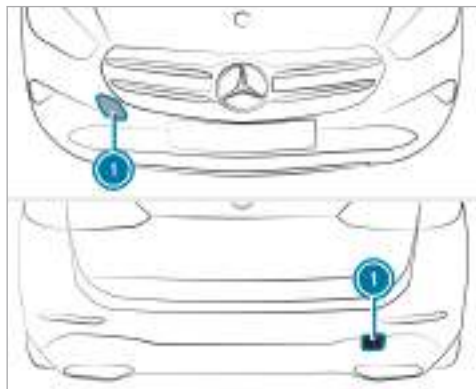

- ▶ Press the mark on cover ① inwards and remove.
- ▶ Screw in the towing eye clockwise as far as it will go and tighten.
- ▶ After removing the towing eye, snap cover ① into the bumper.

! **NOTE** Damage to the vehicle due to incorrect use of the towing eye or trailer hitch

When a towing eye or trailer hitch is used to recover a vehicle, the vehicle may be damaged in the process.

- ▶ Only use the towing eye or trailer hitch to tow away or tow start the vehicle.
- ▶ Do not use the towing eye or trailer hitch to tow the vehicle during recovery.

Tow-starting the vehicle

Vehicles with automatic transmission

! **NOTE** Damage to the automatic transmission due to tow starting

The automatic transmission may be damaged in the process of tow starting vehicles with automatic transmission.

- ▶ Vehicles with automatic transmission must not be tow started.

- ▶ Vehicles with automatic transmissions must not be tow-started.

Electrical fuses

Notes on electrical fuses

! **WARNING** Risk of accident and injury due to overloaded lines

If you manipulate or bridge a faulty fuse or if you replace it with a fuse with a higher amperage, the electric line could be overloaded.

This could result in a fire.

- ▶ Always replace faulty fuses with specified new fuses containing the correct amperage.

! NOTE Damage due to incorrect fuses

Using incorrect fuses can result in damage to electrical components or systems or their functions being considerably restricted.

- ▶ Use only fuses approved for Mercedes-Benz with the respective specified fuse rating.

Blown fuses must be replaced with fuses of the same rating, which you can recognize by the color and the label. The fuse ratings and further information to be observed can be found in the fuse assignment diagram.

Fuse assignment diagram: on the fuse box in the engine compartment (→ page 311).

! NOTE Damage or malfunctions caused by moisture

Moisture may cause damage to the electrical system or cause it to malfunction.

- ▶ When the fuse box is open, make sure that no moisture can enter the fuse box.
- ▶ When closing the fuse box, make sure that the seal of the lid is positioned correctly on the fuse box.

If the newly inserted fuse also blows, have the cause traced and rectified at a qualified specialist workshop.

Ensure the following before replacing a fuse:

- The vehicle is secured against rolling away.
- All electrical consumers are switched off.
- The vehicle is switched off.

The electrical fuses are located in various fuse boxes:

- Fuse box in the engine compartment on the left-hand side of the vehicle, when viewed in the direction of travel (→ page 311)

- Fuse box in the front passenger footwell (→ page 312)
- Fuse box in the center of the cargo compartment (→ page 313)

Opening and closing the fuse box in the engine compartment

Requirements:

- A dry cloth and a screwdriver are available.

Observe the notes on electrical fuses (→ page 310).

Opening

! WARNING Risk of injury from using the windshield wipers when the hood is open

If the windshield wipers start moving when the hood is open, you could be trapped by the wiper linkage.

- ▶ Always switch off the windshield wipers and vehicle before opening the hood.

- ▶ Open the hood.

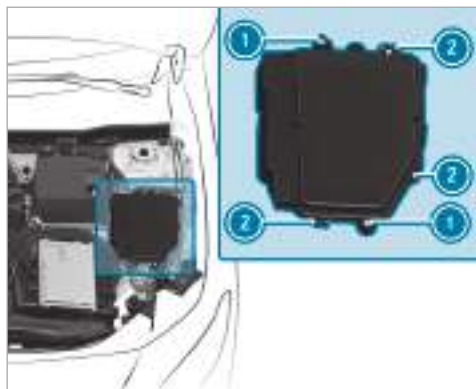

- ▶ Remove any existing moisture from the fuse box using a dry cloth.
- ▶ Loosen screws ①.
- ▶ Press clips ② and lift the fuse box lid up and out.

The fuse assignment diagram is in a recess on the side of the fuse box.

Closing

- ▶ Check whether the seal is positioned correctly in the lid.
- ▶ Place the lid on the fuse box.
- ▶ Make sure that clips ② engage.
- ▶ Tighten screws ①.
- ▶ Close the hood.

Opening and closing the fuse box in the front passenger footwell

Observe the notes on electrical fuses (→ page 310).

Opening

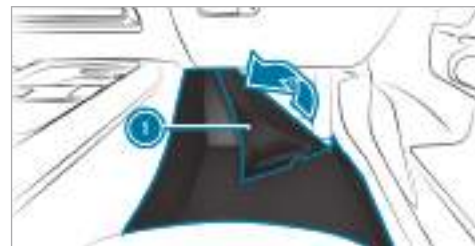

- ▶ Lift carpet ① in the direction of the arrow.

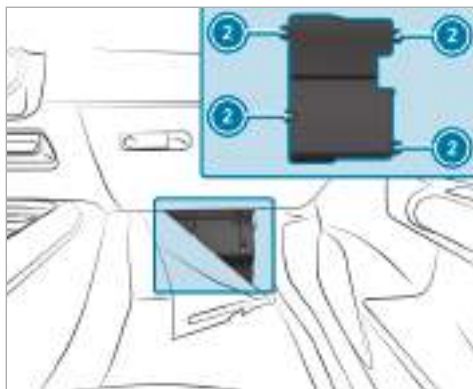

- ▶ Loosen screws ② and remove the fuse box lid from the top.

Closing

- ▶ Place the lid on the fuse box.
- ▶ Tighten screws ②.
- ▶ Fold back the carpet.

Opening and closing the fuse box in the cargo compartment

Observe the notes on electrical fuses
(→ page 310).

- ▶ Open the cargo floor.



Fuse box ① is located underneath the cargo floor.

Notes on noise or unusual handling characteristics

Make sure there are no vibrations, noises or unusual handling characteristics when the vehicle is in motion. This may indicate that the wheels or tires are damaged. Hidden tire damage could also be causing the unusual handling characteristics.

If you suspect that a tire is defective, reduce your speed immediately and have the tires and wheels checked at a qualified specialist workshop.

Notes on regularly inspecting wheels and tires

⚠ WARNING Risk of injury through damaged tires

Damaged tires can cause tire pressure loss.

- ▶ Check the tires regularly for signs of damage and replace any damaged tires immediately.

⚠ WARNING Risk of hydroplaning due to insufficient tire tread

Insufficient tire tread will result in reduced tire grip.

In heavy rain or slush the risk of hydroplaning is increased, in particular where speed is not adapted to suit the conditions.

- ▶ Thus, you should regularly check the tread depth and the condition of the tread across the entire width of all tires.

Minimum tread depth for:

- Summer tires: $\frac{1}{8}$ in (3 mm)
- M+S tires: $\frac{1}{6}$ in (4 mm)

- ▶ For safety reasons, replace the tires before the legally-prescribed limit for the minimum tread depth is reached.

Carry out the following checks on all wheels regularly, at least once a month or as required, for example, prior to a long journey or driving off-road:

- Check the tire pressure (→ page 315).

- Visually inspect wheels and tires for damage.
- Check the valve caps.
- Visual check of the tire tread depth and the tire contact surface across the entire width.

The minimum tread depth for summer tires is $\frac{1}{8}$ in (3 mm) and for winter tires $\frac{1}{6}$ in (4 mm).



Six marks ① show where the bar indicators (arrow) are integrated into the tire tread. They are visible once a tire tread depth of approximately $\frac{1}{16}$ in (1.6 mm) has been reached.

Notes on snow chains

⚠ WARNING Risk of accident due to incorrectly installed snow chains

If you have installed snow chains to the rear wheels, they may drag against the vehicle body or chassis components.

- ▶ Never install snow chains on the rear wheels.
- ▶ Only install snow chains on the front wheels in pairs.

! **NOTE** Damage to vehicle body or suspension components caused by installed snow chains

On 4MATIC vehicles, if you install snow chains on the rear wheels, you can damage vehicle body or suspension components.

- ▶ On 4MATIC vehicles, only install snow chains on the front wheels.

! **NOTE** Damage to the wheel trim from mounted snow chains

If snow chains are mounted to steel wheels, the wheel trims can be damaged.

- ▶ Remove the wheel trims of steel wheels before mounting snow chains.

Observe the following notes when using snow chains:

- Snow chains are only permissible for certain wheel/tire combinations. You can obtain information about this from an authorized Mercedes-Benz Center.
- For safety reasons, only use snow chains that have been specifically approved for your vehicle by Mercedes-Benz, or snow chains with the same quality standard.
- If snow chains are installed, the maximum permissible speed is 30 mph (50 km/h).
- **Vehicles with Active Parking Assist:** do not use Active Parking Assist when snow chains are installed.

i You can deactivate ESP® to pull away (→ page 177). This allows the wheels to spin, achieving an increased driving force.

Tire pressure

Notes on tire pressure

⚠ WARNING Risk of accident due to insufficient or excessive tire pressure

Underinflated or overinflated tires pose in particular the following risks:

- The tires can burst.
- The tires can wear excessively and/or unevenly.
- The driving characteristics as well as the steering and braking characteristics may be greatly impaired.

- ▶ Comply with the recommended tire pressures and check the tire pressure of all tires, including the spare wheel, regularly:

- Monthly
 - When the load changes
 - Before embarking on a longer journey
 - If operating conditions change, e.g. off-road driving
- ▶ Adjust the tire pressure, if necessary.

Tire pressure which is too high or too low can:

- Shorten the service life of the tires.
- Cause increased tire damage.
- Adversely affect driving characteristics and thus driving safety, e.g. due to hydroplaning.

⚠ WARNING Risk of accident due to too low a tire pressure

Tires with pressure that is too low can overheat and burst as a consequence.

In addition, they also suffer from irregular wear, which can significantly impair the braking properties and the handling characteristics.

- ▶ Avoid excessively low tire pressure.

Tire pressure which is too low can cause:

- Tire defects as a result of overheating
- Impaired handling characteristics
- Irregular wear
- Increased fuel consumption

⚠ WARNING Risk of accident due to too high a tire pressure

Tires with excessively high pressure can burst. In addition, they also suffer from irregular wear, which can significantly impair the braking properties and the handling characteristics.

- ▶ Avoid excessively high tire pressures.

Tire pressure which is too high can cause:

- Increased braking distance
- Impaired handling characteristics
- Irregular wear
- Impaired driving comfort
- Susceptibility to damage

⚠ WARNING Risk of accident due to repeated pressure drop in the tires

The wheels, valves or tires could be damaged. Too low a tire pressure can lead to the tires bursting.

- ▶ Examine the tires for foreign objects.
- ▶ Check whether the tire has a puncture or the valve has a leak.
- ▶ If you are unable to rectify the damage, contact a qualified specialist workshop.

You can find information on tire pressure for the vehicle's factory-installed tires on the following labels:

- Tire and loading information placard on the B-pillar of your vehicle (→ page 322).
- Tire pressure table on the inside of the fuel filler flap (→ page 317).

Observe the maximum tire pressure (→ page 328).

Use a suitable pressure gauge to check the tire pressure. The outer appearance of a tire does not

permit any reliable conclusion about the tire pressure.

Only correct the tire pressure when the tires are cold. Conditions for cold tires:

- The vehicle has been parked with the tires out of direct sunlight for at least three hours.
- The vehicle has traveled less than 1 mile (1.6 km).

The vehicle's tires heat up when driving. As the temperature of the tires increases, so too does the tire pressure.

Vehicles with a tire pressure monitoring system: you can also check the tire pressure using the on-board computer (→ page 319).

The tire pressure recommended for increased load/speed in the tire pressure table can affect the ride comfort.

⚠ WARNING Risk of accident due to unsuitable accessories on tire valves

If you mount unsuitable accessories onto tire valves, the tire valves may be overloaded and

malfunction, which can cause tire pressure loss.

- ▶ Only screw standard valve caps or valve caps specifically approved by Mercedes-Benz for your vehicle onto the tire valve.

Tire pressure table

The tire pressure table is on the inside of the fuel filler flap.

- ⓘ The data shown in the images is example data.



The tire pressure table shows the recommended tire pressure for all tires approved for this vehicle. The recommended tire pressures are valid for cold tires under various operating conditions according to the load and/or speed of the vehicle.

If one or more tire sizes precede a tire pressure, the following tire pressure information is only valid for those tire sizes and their respective load condition.

The load conditions "partially laden" and "fully laden" are defined in the table for different numbers of passengers and amounts of luggage. The actual number of seats may differ from this.

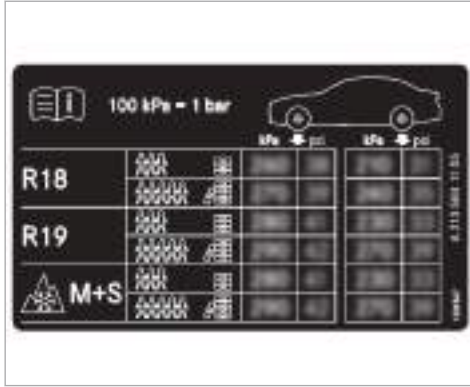

Some tire pressure tables only show the rim diameter instead of the complete tire size, e.g. **R18**. The rim diameter is part of the tire size and can be found on the tire side wall (→ page 329).

- Tire and loading information placard (→ page 322)
- Maximum tire pressure (→ page 328)

Checking the tire pressure manually

- ▶ Read the tire pressure recommended for the current operating conditions from the tire and loading information placard or the tire pressure table. Observe the notes on tire pressure.
- ▶ Remove the valve cap of the tire to be checked.
- ▶ Press the tire pressure gauge securely onto the valve.
- ▶ Read the tire pressure.
- ▶ If the tire pressure is lower than the recommended value, increase the tire pressure to the recommended value.
- ▶ If the tire pressure is higher than the recommended value, release air. To do so, press down the metal pin in the valve, e.g. using the tip of a pen. Then check the tire pressure again using the tire pressure gauge.
- ▶ Screw the valve cap onto the valve.

Further related subjects:

- Notes on tire pressure (→ page 315)
- Tire pressure table (→ page 317)

- Tire and loading information placard (→ page 322)

Tire pressure monitoring system

Function of the tire pressure monitor

⚠ DANGER Risk of accident due to incorrect tire pressure

Each tire, including the spare (if provided), should be checked monthly when cold and inflated to the inflation pressure recommended by the vehicle manufacturer on the vehicle placard or tire inflation pressure label. (If your vehicle has tires of a different size than the size indicated on the vehicle placard or tire inflation pressure label, you should determine the proper tire inflation pressure for those tires.)

As an added safety feature, your vehicle has been equipped with a tire pressure monitoring system (TPMS) that illuminates a low tire pressure telltale when one or more of your tires is significantly under-inflated. Accordingly, when

the low tire pressure telltale illuminates, you should stop and check your tires as soon as possible, and inflate them to the proper pressure. Driving on a significantly under-inflated tire causes the tire to overheat and can lead to tire failure. Under-inflation also reduces fuel efficiency and tire tread life, and may affect the vehicle's handling and stopping ability. Please note that the TPMS is not a substitute for proper tire maintenance, and it is the driver's responsibility to maintain correct tire pressure, even if under-inflation has not reached the level to trigger illumination of the TPMS low tire pressure telltale.

Your vehicle has also been equipped with a TPMS malfunction indicator to indicate when the system is not operating properly. The TPMS malfunction indicator is combined with the low tire pressure telltale. When the system detects a malfunction, the telltale will flash for approximately one minute and then remain continuously illuminated. This sequence will continue upon subsequent vehicle start-ups as long as the malfunction exists.

When the malfunction indicator is illuminated, the system may not be able to detect or signal low tire pressure as intended. TPMS malfunctions may occur for a variety of reasons, including the installation of replacement or alternate tires or wheels on the vehicle that prevent the TPMS from functioning properly.

The system checks the tire pressure and the temperature of the tires fitted to the vehicle by means of a tire pressure sensor.

The tire pressure and tire temperature appear in the on-board computer (→ page 319).

If there is a substantial pressure loss or if the tire temperature is excessive, you will be warned with display messages (→ page 401) or the  warning lamp in the instrument cluster (→ page 422).

The tire pressure monitor is only an aid. It is the driver's responsibility to set the tire pressure to the recommended cold tire pressure suitable for the operating situation.

In most cases, the tire pressure monitor will automatically update the new reference values after you have changed the tire pressure. You can, however, also update the reference values by restarting the tire pressure monitor manually (→ page 320).

System limits

The system may be impaired or may not function particularly in the following situations:

- Incorrect reference values were taught in
- Sudden pressure loss caused by a foreign object penetrating the tire, for example
- Malfunction caused by another radio signal source

■ Checking the tire pressure with the tire pressure monitoring system

Requirements

- The vehicle is switched on.

On-board computer:

➔ [Service](#) ➔ [Tires](#)

One of the following displays will appear:

- Current tire pressure and tire temperature on the individual wheels:



- **Tire pressure will be displayed after driving a few minutes**
- **Tire Pressure Monitor Active:** the teach-in process of the system is not yet complete. The tire pressures are already being monitored.

▶ Compare the tire pressure with the recommended tire pressure for the current operating

condition (→ page 317). Additionally, observe the notes on cold tires (→ page 315).

- ① The values displayed in the on-board computer may deviate from those of the tire pressure gauge as they refer to sea level. At high elevations, the tire pressure values indicated by a pressure gauge will be higher than those shown by the on-board computer. In this case, do not reduce the tire pressure.

■ Restarting the tire pressure monitoring system

Requirements

- The recommended tire pressure is correctly set for the respective operating status on all of the wheels (→ page 315).

Restart the tire pressure monitoring system in the following situations:

- The tire pressure has changed.
- The wheels or tires have been changed or newly fitted.

On-board computer:

➔ [Service](#) ➔ [Tires](#)

▶ Swipe downwards on Touch Control on the left-hand side of the steering wheel. The **Use Current Pressures as New Reference Values** message will be shown on the instrument display.

▶ To restart, press Touch Control on the left-hand side of the steering wheel. The **Tire Press. Monitor Restarted** message will be shown on the instrument display.

Current warning messages will be deleted and the yellow  warning lamp will go out.

After you have been driving for a few minutes, the system will check whether the current tire pressures are within the specified range. The current tire pressures will then be accepted as reference values and monitored.

Be sure also to pay attention to the following related topic:

- Notes on tire pressure (→ page 315)

Tire pressure loss warning system

Function of the tire pressure loss warning system

The tire pressure loss warning system warns the driver by means of display messages when there is a severe tire pressure loss.

System limits

The system may be impaired or may not function particularly in the following situations:

- incorrect reference values were taught in
- sudden pressure loss caused by a foreign object penetrating the tire, for example
- an even pressure loss on more than one tire occurs

The system has a restricted or delayed function particularly in the following situations:

- poor ground conditions, e.g. snow or gravel
- driving with snow chains
- when adopting a very sporty driving style with high cornering speeds or sudden acceleration
- driving with a high load

The tire pressure loss warning system is only an aid. It is the driver's responsibility to set the tire pressure to the recommended cold tire pressure suitable for the operating situation and to check it.

Be sure to also observe the following further related subjects:

- Notes on tire pressure (→ page 315)
- Display messages about the tires (→ page 401)

Restarting the tire pressure loss warning system

Requirements

- The recommended tire pressure is correctly set for the respective operating status on all wheels.

Restart the tire pressure loss warning system in the following situations:

- The tire pressure has changed.
- The wheels or tires have been changed or newly fitted.

On-board computer:

↳ Service ▶ Tires

- ▶ Swipe downwards on Touch Control on the left-hand side of the steering wheel. The **Tire Pressure Control System Active Restart** message will be shown on the display.
- ▶ To begin restart, press Touch Control on the left-hand side of the steering wheel. The **Tire Pressure Now OK?** message will be shown on the display.
- ▶ Select **Yes**.
- ▶ To confirm restart, press Touch Control on the left-hand side of the steering wheel. The **Run Flat Indicator Restarted** message will be shown on the display. After you have driven for a few minutes, the tire pressure loss warning system will monitor the set pressures of all the tires.

Be sure also to pay attention to the following related topic:

- Notes on tire pressure (→ page 315)

Loading the vehicle

Notes on Tire and Loading Information placard

⚠ WARNING Risk of accident from overloaded tires

Overloaded tires may overheat and burst as a consequence. Overloaded tires can also impair the steering and handling characteristics and lead to brake failure.

- ▶ Observe the load rating of the tires.
- ▶ The load rating must be at least half the permissible axle load of the vehicle.
- ▶ Never overload the tires by exceeding the maximum load.

The Tire and Loading Information placard is on the B-pillar on the driver's side of the vehicle.



① Tire and Loading Information placard

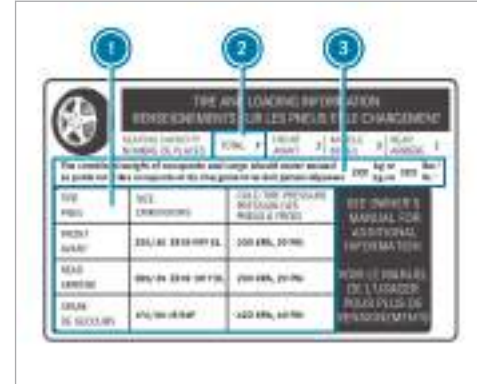

① The data shown in the illustration is example data.

The Tire and Loading Information placard shows the following information:

- Maximum number of seats ② according to the maximum number of people permitted to travel in the vehicle.

- Maximum permissible load **(3)** comprises the gross weight of all vehicle occupants, load and luggage.
- Recommended tire pressure **(1)** for cold tires. The recommended tire pressures are valid for the maximum permissible load and up to the maximum permissible vehicle speed.

Please also note:

- Information on permissible weights and loads on the vehicle identification plate (→ page 348).
- Information on tire pressure in the tire pressure table (→ page 317).

Further related subjects:

- Determining the maximum permissible load (→ page 323)
- Notes on tire pressure (→ page 315).

Steps for Determining Correct Load Limit

The following steps have been developed as required of all manufacturers under Title 49, Code of U.S. Federal Regulations, Part 575, pursuant to

the "National Traffic and Motor Vehicle Safety Act of 1966".

- ▶ **(1):** Locate the statement "The combined weight of occupants and cargo should never exceed XXX kg or XXX lbs." on your vehicle's placard.
- ▶ **(2):** Determine the combined weight of the driver and passengers that will be riding in your vehicle.
- ▶ **(3):** Subtract the combined weight of the driver and passengers from XXX kg or XXX lbs.
- ▶ **(4):** The resulting figure equals the available amount of cargo and luggage load capacity. For example, if the "XXX" amount equals 1,400 lbs. and there will be five 150 lb passengers in your vehicle, the amount of available cargo and luggage load capacity is 650 lbs. (1,400 - 750 (5 x 150) = 650 lbs.)
- ▶ **(5):** Determine the combined weight of luggage and cargo being loaded on the vehicle. That weight may not safely exceed the available cargo and luggage load capacity calculated in Step 4.

- ▶ **(6):** If your vehicle will be towing a trailer, load from your trailer will be transferred to your vehicle. Consult this manual to determine how this reduces the available cargo and luggage load capacity of your vehicle.

- ▶ **(i)** Not all vehicles are permitted to tow a trailer. Towing a trailer is only permitted if a trailer-hitch is installed. Please consult an authorized Mercedes-Benz dealer if you have any questions about towing a trailer with your vehicle.

Even if you have calculated the total load carefully, you should still make sure that the maximum permissible gross weight and the maximum gross axle weight rating of your vehicle are not exceeded. Details can be found on the vehicle identification plate.

- ▶ Have your loaded vehicle – including driver, occupants and load – weighed on a vehicle weighbridge. The measured values may not exceed the maximum permissible values stated on the vehicle identification plate.

324 Wheels and tires

Further related subjects:

- Calculation example for determining the maximum load (→ page 324)
- Tire and Loading Information placard (→ page 322)
- Tire pressure table (→ page 317)
- Vehicle identification plate (→ page 348)

Calculation example for determining the maximum load

The following table shows examples of how to calculate total and load capacities with varying seating configurations and different numbers and sizes of occupants. The following examples use a maximum load of 1500 lbs (680 kg). **This is for**

illustration purposes only. Make sure you are using the actual load limit for your vehicle stated on your vehicle's Tire and Loading Information placard (→ page 322).

The higher the weight of all the occupants, the smaller the maximum load for luggage.

Step 1

| | Example 1 | Example 2 |
|--|-------------------|-------------------|
| Combined maximum weight of occupants and load (data from the Tire and Loading Information placard) | 1500 lbs (680 kg) | 1500 lbs (680 kg) |

Step 2

| | Example 1 | Example 2 |
|--|---|-----------------------------|
| Number of people in the vehicle (driver and occupants) | 5 | 1 |
| Distribution of the occupants | Front: 2 Rear: 3 | Front: 1 |
| Weight of occupants | Occupant 1: 150 lbs (68 kg) Occupant 2: 180 lbs (82 kg) Occupant 3: 160 lbs (73 kg) Occupant 4: 140 lbs (63 kg) Occupant 5: 120 lbs (54 kg) | Occupant 1: 200 lbs (91 kg) |
| Total weight of all occupants | 750 lbs (340 kg) | 200 lbs (91 kg) |

Step 3

| | Example 1 | Example 2 |
|--|---|---|
| Permissible load (maximum gross vehicle weight rating from the Tire and Loading Information placard minus the gross weight of all occupants) | 1500 lbs (680 kg) - 750 lbs (340 kg) = 750 lbs (340 kg) | 1500 lbs (680 kg) - 200 lbs (91 kg) = 1300 lbs (589 kg) |

Tire labeling

Overview of tire labeling

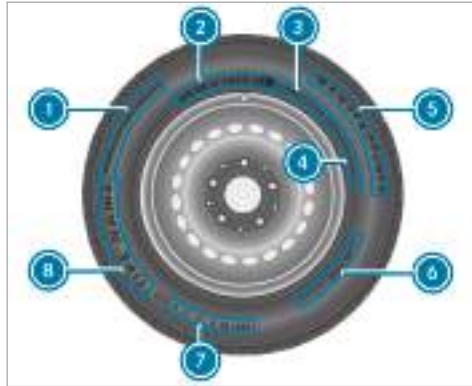

- ① Uniform Tire Quality Grading Standards
- ② DOT (Department of Transportation), (TIN) Tire Identification Number
- ③ Maximum tire load (→ page 328)
- ④ Maximum tire pressure (→ page 328)

- ⑤ Manufacturer
- ⑥ Characteristics of the tire (→ page 329)
- ⑦ Tire size designation, load-bearing capacity, speed rating and load index (→ page 329)
- ⑧ Tire name
- ⓘ The data shown in the illustration is example data.

Tire Quality Grading

In accordance with the US Department of Transportation's "Uniform Tire Quality Grading Standards", tire manufacturers are required to grade their tires on the basis of the following three performance factors:



- ① Tread wear grade
- ② Traction grade
- ③ Temperature grade
- ⓘ The data shown in the illustration is example data.
- ⓘ The classification is not legally stipulated for Canada, but it is generally stated.

Tread wear grade

The treadwear grade is a comparative rating based on the wear rate of the tire when tested under controlled conditions on a specified government test course. For example, a tire graded 150 would wear one and one-half (1 1/2) times as

well on the government course as a tire graded 100.

The relative performance of tires depends upon the actual conditions of their use, however, and may depart significantly from the norm due to variations in driving habits, service practices and differences in road characteristics and climate.

Traction grade

⚠ DANGER Risk of accident due to inadequate traction

The traction grade assigned to this tire is based on straight-ahead braking traction tests.

- ▶ Always adapt your driving style and drive at a speed to suit the prevailing traffic and weather conditions.

! NOTE Damage to the drivetrain from wheelspin

- ▶ Avoid wheelspin.

The traction grades, from highest to lowest, are AA, A, B, and C. Those grades represent the tire's ability to stop on wet pavement as measured under controlled conditions on specified government test surfaces of asphalt and concrete. A tire marked C may have poor traction performance.

Temperature grade

⚠ WARNING Risk of accident from tire overheating and tire failure

Excessive speed, underinflation, or excessive loading, either separately or in combination, can cause excessive heat build-up and possible tire failure.

- ▶ Observe the recommended tire pressure.
- ▶ Regularly check the pressure of all the tires.
- ▶ Adjust the tire pressure, if necessary.

The temperature grades are A (the highest), B, and C, representing the tire's resistance to the generation of heat and its ability to dissipate heat when tested under controlled conditions on a specified indoor laboratory test wheel. Sustained

high temperature can cause the material of the tire to degenerate and reduce tire life, and excessive temperature can lead to sudden tire failure. The grade C corresponds to a level of performance which all passenger car tires must meet under the Federal Motor Safety Standard No. 109. Grades B and A represent higher levels of performance on the laboratory test wheel than the minimum required by law.

DOT, Tire Identification Number (TIN)

US tire regulations stipulate that every tire manufacturer or retreader must imprint a TIN in or on the side wall of each tire produced.



i The data shown in the image is example data. The TIN is a unique identification number to identify tires and comprises the following:

- **DOT (Department of Transportation):** tire symbol marks **1** indicating that the tire complies with the requirements of the US Department of Transportation.
- **Manufacturer identification code:** manufacturer identification code **2** contains details of the tire manufacturer. New tires have a code with two symbols. Retreaded tires have a code with four symbols. Further information on retreaded tires (→ page 333).
- **Tire size:** identifier **3** describes the tire size.
- **Tire type code:** tire type code **4** can be used by the manufacturer as a code to describe specific characteristics of the tire.
- **Manufacturing date:** manufacturing date **5** provides information about the age of a tire. The 1st and 2nd positions represent the calendar week and the 3rd and 4th positions state the year of manufacture (e.g. "3208" represents the 32nd week of 2008).

Information on the maximum tire load



i The data shown in the illustration is example data.

Maximum tire load **1** is the maximum permissible weight for which the tire is approved.

Do not overload the tires by exceeding the specified load limit. The maximum permissible load can be found on the vehicle's tire and loading information placard on the B-pillar on the driver's side (→ page 322).

Specifications for maximum tire pressure



i The data shown in the illustration is example data.

Never exceed maximum tire pressure **1** specified for the tire. Always observe the recommended tire pressure for your vehicle when adjusting the tire pressure (→ page 317).

Information on tire characteristics



i The data shown in the image is example data. This information describes the type of tire cord and the number of layers in side wall **1** and under tire tread **2**.

Tire size designation, load-bearing capacity, speed rating and load index

⚠ WARNING Risk of injury through exceeding the specified tire load-bearing capacity or the permissible speed rating

Exceeding the specified tire load rating or the permissible speed rating may lead to tire damage and to the tires bursting.

- ▶ Therefore, only use tire types and sizes approved for your vehicle model.
- ▶ Observe the tire load rating and speed rating required for your vehicle.



- 1** First letter(s)
- 2** Nominal tire width in millimeters
- 3** Aspect ratio in %
- 4** Tire code
- 5** Rim diameter
- 6** Load-bearing index
- 7** Speed rating
- 8** Load index

i The data shown in the illustration is example data.

Information about reading tire data can be obtained from any qualified specialist workshop.

First letter(s) 1:

- Without: passenger vehicle tires according to European manufacturing standards.
- "P": passenger vehicle tires according to US manufacturing standards.
- "LT": light truck tires according to US manufacturing standards.
- "T": compact emergency spare wheels with high tire pressure that are only designed for temporary use in an emergency.

Aspect ratio 3:

Ratio between tire height and tire width in percent (tire height divided by tire width).

Tire code 4 (tire type):

- "R": radial tire
- "D": bias ply tire
- "B": bias radial tires
- "ZR": radial tire with a maximum speed above 149 mph (240 km/h) (optional)

Rim diameter 5:

The diameter of the bead seat (not the diameter of the rim flange). The rim diameter is specified in inches (in).

Load-bearing index 6:

Numerical code that specifies the maximum load-bearing capacity of a tire (e.g. "91" corresponds to 1,356 lbs (615 kg)).

The load-bearing capacity of the tire must be at least half the gross axle weight rating of your vehicle. Do not overload the tires by exceeding the specified load limit.

See also:

- Maximum permissible load on the tire and loading information placard (→ page 322)
- Maximum tire load (→ page 328)
- Load index

Speed rating 7:

Specifies the approved maximum speed of the tire.

- **i** An electronic speed limiter prevents your vehicle from exceeding a speed of 130 mph (210 km/h).

Make sure that your tires have the required speed rating. You can obtain information on the required speed rating from an authorized Mercedes-Benz Service Center.

Summer tires

| Index | Speed rating |
|-------|--------------------------|
| Q | up to 100 mph (160 km/h) |
| R | up to 106 mph (170 km/h) |
| S | up to 112 mph (180 km/h) |
| T | up to 118 mph (190 km/h) |
| H | up to 130 mph (210 km/h) |
| V | up to 149 mph (240 km/h) |
| W | up to 168 mph (270 km/h) |
| Y | up to 186 mph (300 km/h) |

| Index | Speed rating |
|-------------------------|--------------------------|
| ZR...Y ¹ | up to 186 mph (300 km/h) |
| ZR...(..Y) ¹ | over 186 mph (300 km/h) |
| ZR ¹ | over 149 mph (240 km/h) |

- Specifying the speed rating as the "ZR" index in tire code ④ is optional for tires up to 186 mph (300 km/h).
- If your tire code ④ includes "ZR" and there is no speed rating ⑦, find out what the maximum speed is from the tire manufacturer.
- If load-bearing index ⑥ and speed rating ⑦ are in brackets, the maximum speed rating of your tire is above 186 mph (300 km/h). To find out the maximum speed, ask the tire manufacturer.

¹ "ZR" stated in the tire code.

² Or "M+S"  " for winter tires.

All-weather tires and winter tires

| Index | Speed rating |
|--------------------|--------------------------|
| Q M+S ² | up to 100 mph (160 km/h) |
| T M+S ² | up to 118 mph (190 km/h) |
| H M+S ² | up to 130 mph (210 km/h) |
| V M+S ² | up to 149 mph (240 km/h) |

Winter tires bear the  snowflake symbol and fulfill the requirements of the Rubber Manufacturers Association (RMA) and the Rubber Association of Canada (RAC) regarding the tire traction on snow.

Load index ⑧:

- No specification given: standard load (SL) tire
- "XL" or "Extra Load": extra load tire or reinforced tire
- "Light Load": light load tire

- "C", "D", "E": a load range that depends on the maximum load that the tire can carry at a certain pressure

Definition of terms for tires and loading

Tire structure and characteristics: describes the number of layers or the number of rubber-coated belts in the tire contact surface and the tire wall. These are made of steel, nylon, polyester and other materials.

Bar: metric unit for tire pressure. 14.5038 pounds per square inch (psi) and 100 kilopascal (kPa) is the equivalent of one bar.

DOT (Department of Transportation): DOT-marked tires fulfill the requirements of the U.S. Department of Transportation.

Average weight of the vehicle occupants: the number of vehicle occupants for which the vehicle is designed, multiplied by 150 lb (68 kg).

Uniform Tire Quality Grading Standards: a uniform standard to grade the quality of tires with regard

to tread quality, tire traction and temperature characteristics. The quality grading assessment is made by the manufacturer following specifications from the U.S. government. The quality grade of a tire is printed on the side wall of the tire.

Recommended tire pressure: the recommended tire pressure is the tire pressure specified for the tires mounted on the vehicle at the factory.

The tire and information placard contains the recommended tire pressure for cold tires, the maximum permissible load and the maximum permissible vehicle speed.

The tire pressure table contains the recommended tire pressure for cold tires under various operating conditions, i.e. loading and/or speed of the vehicle.

Increased vehicle weight due to optional equipment: the combined weight of all standard and optional equipment available for the vehicle, regardless of whether it is actually installed on the vehicle or not.

Rim: the part of the wheel on which the tire is installed.

GAWR (Gross Axle Weight Rating): the GAWR is the maximum gross axle weight rating. The actual load on an axle must never exceed the gross axle weight rating. The gross axle weight rating can be found on the vehicle identification plate on the B-pillar on the driver's side.

Speed rating: the speed rating is part of the tire identification. It specifies the speed range for which a tire is approved.

GVW (Gross Vehicle Weight): the gross vehicle weight comprises the weight of the vehicle including fuel, tools, the spare wheel, any accessories installed, occupants, luggage and the trailer nose-weight, if applicable. The gross vehicle weight must not exceed the gross vehicle weight rating GVWR as specified on the vehicle identification plate on the B-pillar on the driver's side.

GVWR (Gross Vehicle Weight Rating): the GVWR is the maximum permitted gross weight of the fully laden vehicle (weight of the vehicle including all accessories, occupants, fuel, luggage and the trailer drawbar noseweight if applicable). The gross vehicle weight rating is specified on the vehicle identification plate on the B-pillar on the driver's side.

Maximum weight of the laden vehicle: the maximum weight is the sum of the curb weight of the vehicle, the weight of the accessories, the maximum load and the weight of optional equipment installed at the factory.

Kilopascal (kPa): metric unit for tire pressure. 6.9 kPa corresponds to 1 psi. Another unit for tire pressure is bar. 100 kilopascal (kPa) equals 1 bar.

Load index: in addition to the load-bearing index, the load index may also be printed on the side wall of the tire. This specifies the load-bearing capacity of the tire more precisely.

Curb weight: the weight of a vehicle with standard equipment including the maximum capacity of fuel, oil and coolant. It also includes the air conditioning system and optional equipment if these are installed on the vehicle, but does not include passengers or luggage.

Maximum tire load: the maximum tire load is the maximum permissible weight in kilograms or lbs for which a tire is approved.

Maximum permissible tire pressure: maximum permissible tire pressure for one tire.

Maximum load on one tire: maximum load on one tire. This is calculated by dividing the maximum axle load of one axle by two.

PSI (pounds per square inch): standard unit of measurement for tire pressure.

Aspect ratio: ratio between tire height and tire width in percent.

Tire pressure: the pressure inside the tire which applies an outward force to every square inch of the tire. The tire pressure is specified in pounds per square inch (psi), in kilopascals (kPa) or in bar. The tire pressure should only be corrected when the tires are cold.

Cold tire pressure: the tires are cold when the vehicle has been parked for at least 3 hours without direct sunlight on the tires or the vehicle has been driven for less than 1 mile (1.6 km).

Tire contact surface: the part of the tire that comes into contact with the road.

Tire bead: the purpose of the tire bead is to ensure that the tire sits securely on the wheel rim. There are several wire cores in the tire bead to prevent the tire from changing length on the wheel rim.

Side wall: the part of the tire between the tread and the tire bead.

Weight of optional equipment: the combined weight of the optional equipment weighing more than the replaced standard parts and more than 5 lbs (2.3 kg). This optional equipment, such as high-performance brakes, level control system, a roof luggage rack or high-performance batteries, is not included in the curb weight and the weight of the accessories.

TIN (Tire Identification Number): a unique identification number which can be used by a tire manufacturer to identify tires, for example, in a product recall, and thus identify the purchasers. The TIN is made up of the manufacturer's identity code, tire size, tire type code and the manufacturing date.

Load-bearing index: the load-bearing index is a code that contains the maximum load-bearing capacity of a tire.

Traction: traction is the grip resulting from friction between the tires and the road surface.

Wear indicator: narrow bars (tread wear bars) that are distributed over the tire contact surface. If the

tire tread is level with the bars, the wear limit of 1/16 in (1.6 mm) has been reached.

Distribution of vehicle occupants: distribution of vehicle occupants over designated seat positions in a vehicle.

Maximum permissible payload weight: nominal load and luggage load plus 150 lb (68 kg) multiplied by the number of seats in the vehicle.

Changing a wheel

Notes on selecting, installing and replacing tires

! **NOTE** Mercedes-AMG vehicles

▶ Observe the notes in the Supplement. You could otherwise fail to recognize dangers.

⚠ **WARNING** Risk of accident due to incorrect wheel and tire dimensions

If wheels and tires of the wrong size are installed, the service brakes or components in the

brake system and in the wheel suspension may be damaged.

- ▶ Always replace wheels and tires with ones that fulfill the specifications of the original part.

For wheels, pay attention to the following:

- Designation
- Type

For tires, pay attention to the following:

- Designation
- Manufacturer
- Type

⚠ WARNING Risk of injury through exceeding the specified tire load-bearing capacity or the permissible speed rating

Exceeding the specified tire load rating or the permissible speed rating may lead to tire damage and to the tires bursting.

- ▶ Therefore, only use tire types and sizes approved for your vehicle model.
- ▶ Observe the tire load rating and speed rating required for your vehicle.

! NOTE Vehicle and tire damage caused by non-approved tire types and sizes

For safety reasons, only use tires, wheels and accessories which have been specially approved by Mercedes-Benz for your vehicle.

These tires are specially adapted to the active safety systems, such as ABS, ESP® and 4MATIC, and marked as follows:

- MO = Mercedes-Benz Original
- MOE = Mercedes-Benz Original Extended (run-flat tires only for certain wheels)
- MO1 = Mercedes-Benz Original (only certain AMG tires)

Otherwise, certain properties, such as handling characteristics, vehicle noise emissions, consumption, etc. could be adversely affected. Furthermore, other tire sizes could result

in the tires rubbing against the body and axle components when loaded. This could result in damage to the tire or the vehicle.

Only use tires, wheels and accessories that have been checked and recommended by Mercedes-Benz.

! NOTE Risk to driving safety from retreaded tires

Retreaded tires are neither tested nor recommended by Mercedes-Benz, since previous damage cannot always be detected on retreaded tires.

For this reason driving safety cannot be guaranteed.

- ▶ Do not use used tires if you have no information about their previous usage.

! NOTE Possible wheel and tire damage when driving over obstacles

Large wheels have a smaller section width. As the section width decreases, the risk of

wheels and tires being damaged when driving over obstacles increases.

- ▶ Avoid obstacles or drive especially carefully.
- ▶ Reduce your speed when driving over curbs, speed bumps, manhole covers and potholes.
- ▶ Avoid particularly high curbs.

! **NOTE** Possible wheel and tire damage when parking on curbs or in potholes

Parking on curbs or in potholes can damage the wheels and tires.

- ▶ Only park on as level a surface as possible.
- ▶ Avoid curbs and potholes when parking.

! **NOTE** Damage to electronic component parts due to the use of tire-installing tools

Vehicles with tire pressure monitoring system: There are electronic component parts in the wheel.

If tire-installing tools are positioned in the area of the valve, the electronic components could be damaged.

- ▶ Tire-installing tools should not be applied in the area of the valve.
- ▶ Always have tires change at a qualified specialist workshop.

! **NOTE** Damage to summer tires at low ambient temperatures

At low ambient temperatures, tears could form when driving with summer tires, causing permanent damage to the tires.

- ▶ At temperatures below 45 °F (7 °C) use  M+S tires.

Accessory parts which are not approved for your vehicle by Mercedes-Benz, or which are not used correctly, can impair the operating safety.

Before purchasing and using non-approved accessories, visit a qualified specialist workshop and inquire about:

- Suitability

- Legal stipulations
- Factory recommendations

! **WARNING** Risk of accident with high performance tires

The special tire tread in combination with the optimized tire compound means that the risk of skidding and hydroplaning on wet roads is increased.

In addition, the tire grip is greatly reduced at a low outside temperature and tire running temperature.

- ▶ Switch on the ESP[®] and adapt your driving style accordingly.
- ▶ Use  M+S tires at outside temperatures of less than 50 °F (10 °C).
- ▶ Only use the tires for their intended purpose.

Observe the following when selecting, installing and replacing tires:

- Furthermore, the use of certain tire types in certain regions and areas of operation can be highly beneficial.
- Only use tires and wheels of the same type (summer tires, winter tires, MOExtended tires) and the same make.
- Only install wheels of the same size (left and right) on each axle.

It is only permissible to install a different wheel size in the event of a flat tire in order to drive to the specialist workshop.

- **Vehicles with a tire pressure monitoring system:** all installed wheels must be equipped with functioning sensors for the tire pressure monitoring system.
- At temperatures below 45°F (7°C) use winter tires or all-season tires marked  M+S for all wheels.

Winter tires provide the best possible grip in wintry road conditions.

- For M+S tires, only use tires with the same tread.
- Observe the maximum permissible speed for the M+S tire which is installed.
If the tire's maximum speed is below that of the vehicle, this must be indicated by an appropriate label in the driver's field of vision.
- Break in new tires at moderate speeds for the first 60 miles (100 km).
- Replace the tires after six years at the latest, regardless of wear.
- **When replacing with tires that do not feature run-flat characteristics:** vehicles with MOExtended tires are not equipped with a TIREFIT kit at the factory. Equip the vehicle with a TIREFIT kit after replacing with tires that do not feature run-flat characteristics, e.g. winter tires.

For more information on wheels and tires, contact a qualified specialist workshop.

Be sure to also observe the following further related subjects:

- Notes on tire pressure (→ page 315)

- Tire and loading information placard (→ page 322)
- Tire size designation, load-bearing capacity, speed rating and load index (→ page 329)
- Tire pressure table (→ page 317)
- Notes on the emergency spare wheel (→ page 343)

Notes on rotating wheels

 **WARNING** Risk of injury through different wheel sizes

Rotating the front and rear wheels can severely impair the driving characteristics. The wheel brakes or suspension components may also be damaged.

 Rotate front and rear wheels only if the wheels and tires are of the same dimensions.

Observe the instructions and safety notes on "Changing a wheel" (→ page 333)

The wear patterns on the front and rear wheels differ:

- Front wheels wear more on the tire shoulder
- Rear wheels wear more in the center of the tire

Do not drive with tires that have too little tread depth. This significantly reduces traction on wet roads (hydroplaning).

On vehicles that have the same size front and rear wheels, rotate the wheels according to the intervals in the tire manufacturer's warranty book in your vehicle documents. If this is not available, rotate the tires every 3,000 to 6,000 miles (5,000 to 10,000 km), depending on the wear. Ensure that the direction of rotation is maintained.

Notes on storing wheels

When storing wheels, observe the following notes:

- After removing wheels, store them in a cool, dry and preferably dark place.
- Protect the tires from contact with oil, grease or fuel.

Overview of the tire-change tool kit

! NOTE Mercedes-AMG vehicles

- ▶ Observe the notes in the Supplement. You could otherwise fail to recognize dangers.

Apart from some country-specific variants, vehicles are not equipped with a tire-change tool kit. For more information on which tire-changing tools are required and approved for performing a wheel change on your vehicle, consult a qualified specialist workshop.

You require the following tools, foreexample, to change a wheel:

- Jack
- Chock
- Lug wrench
- Alignment bolt

The tire-change tool kit is located in tool bag ① in the cargo compartment.

- ① Depending on the vehicle equipment, the tool bag may be located in other positions in the cargo compartment.
- ① When stowing the tool bag, make sure that it is adequately secured.

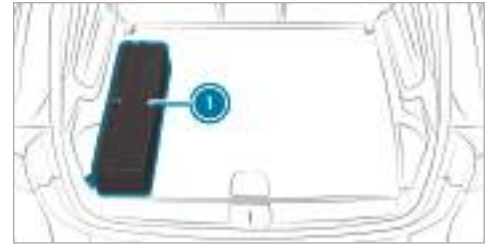

The tool bag contains:

- Jack
- Gloves
- Lug wrench
- Alignment bolt
- Folding chock
- Ratchet for jack

Preparing the vehicle for a wheel change

Requirements

- The vehicle is not on a slope.
 - The vehicle is on solid, non-slippery and level ground.
 - The required tire-change tool kit is available.
- ❗ If your vehicle is not equipped with the tire-change tool kit, consult a qualified specialist workshop to find out about suitable tools.
- ▶ Apply the electric parking brake manually.
 - ▶ Move the front wheels to the straight-ahead position.
 - ▶ Shift the transmission to position **P**.
 - ▶ Switch off the vehicle.
 - ▶ Make sure that the vehicle cannot be started.
 - ▶ Place chocks or other suitable items under the front and rear of the wheel that is diagonally opposite the wheel you wish to change.
 - ▶ If necessary, remove the wheel trim/hub caps (→ page 338).
 - ▶ Raise the vehicle (→ page 338).

Removing and installing the wheel trim/hub caps

Requirements

- The vehicle is prepared for a wheel change (→ page 338).

Plastic hub cap

To remove:

- ▶ Turn the center cover of the hub cap counter-clockwise and remove the hub cap.

To install:

- ▶ Make sure that the center cover of the hub cap is turned counter-clockwise.
- ▶ Position the hub cap and turn the center cover clockwise until the hub cap engages physically and audibly.

Raising the vehicle when changing a wheel

Requirements

- There are no persons in the vehicle.
- The vehicle has been prepared for a wheel change (→ page 338).

- The wheel trims and hub caps have been removed (→ page 338).

Important notes on using the jack:

- Use only a vehicle-specific jack that has been approved by Mercedes-Benz to raise the vehicle.
- The jack is only designed for raising and holding the vehicle for a short time while a wheel is being changed and not for maintenance work under the vehicle.
- The jack must be placed on a firm, flat and non-slip surface. If necessary, use a large, flat, load-bearing, non-slip underlay.
- The foot of the jack must be positioned vertically under the jack support point.

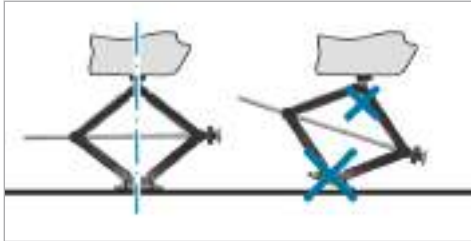

Rules of conduct when the vehicle is raised:

- Never place your hands or feet under the vehicle.
- Never lie under the vehicle.
- Do not start the vehicle and do not release the electric parking brake.
- Do not open or close any doors or the tailgate.



- ▶ Using the lug wrench, loosen the wheel bolts on the wheel you wish to change by about one full turn. Do not unscrew the screws completely.

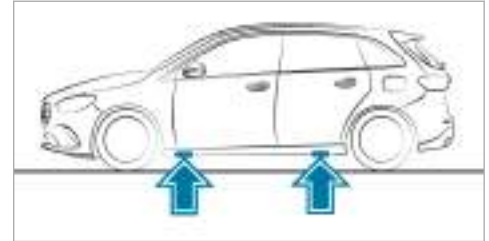

Position of the jack support points

! NOTE Mercedes-AMG vehicles

- ▶ Observe the notes in the Supplement. You could otherwise fail to recognize dangers.

! WARNING Risk of injury from incorrect positioning of the jack

If you do not position the jack correctly at the appropriate jacking point of the vehicle, the jack could tip with the vehicle raised.

- ▶ Only position the jack at the appropriate jacking point of the vehicle. The base of

the jack must be positioned vertically under the jacking point of the vehicle.

! **NOTE** Damage to the vehicle due to the jack

If you do not position the jack at the jack support points provided for this purpose, you could damage your vehicle.

▶ Only position the jack at the jack support points provided for this purpose.

▶ Take the ratchet out of the tire-change tool kit and place it on the hexagon nut of the jack so that the letters "AUF" are visible.

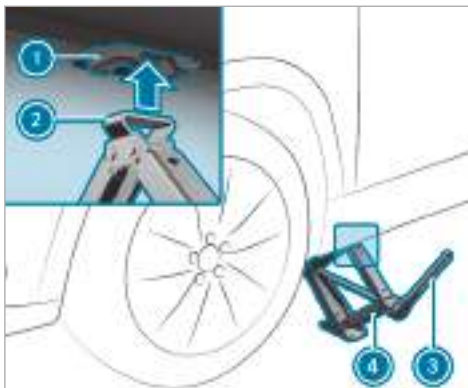

- ▶ Position support ② of jack ④ on jack support point ①.
- ▶ Turn ratchet ③ clockwise until support ② sits completely on jack support point ① and the base of the jack lies evenly on the ground.
- ▶ Turn ratchet ③ until the tire is raised a maximum of 1.2 in (3 cm) from the ground.
- ▶ Loosen and remove the wheel (→ page 340).

Removing a wheel

Requirements

- The vehicle is raised (→ page 338).

! **NOTE** Mercedes-AMG vehicles

▶ Observe the notes in the Supplement. You could otherwise fail to recognize dangers.

When changing a wheel, avoid applying any force to the brake disks, as this could impair the level of comfort when braking.

! **NOTE** Damage to threading from dirt on wheel bolts

▶ Do not place wheel bolts in sand or on a dirty surface.

▶ Unscrew the uppermost wheel bolt completely.



- ▶ Screw centering pin ① into the thread instead of the wheel bolt.
- ▶ Unscrew the remaining wheel bolts completely.
- ▶ Remove the wheel and, if necessary, store it in the load compartment.
- ▶ Notes on removing an emergency spare wheel (→ page 343).

Changing the tire

Requirements:

- The wheel to be changed is removed and the centering pin is screwed in (→ page 340).

! NOTE Mercedes-AMG vehicles

- ▶ Observe the notes in the Supplement. You could otherwise fail to recognize dangers.

⚠ WARNING Risk of accident from losing a wheel

Oiled, greased or damaged wheel bolt/wheel nut threads or wheel hub/wheel mounting bolt threads can cause the wheel bolts/wheel nuts to come loose.

- ▶ Never oil or grease the threads.
- ▶ In the event of damage to the threads, contact a qualified specialist workshop immediately.
- ▶ Have the damaged wheel bolts or damaged hub threads replaced.
- ▶ Do not continue driving.

- ▶ Observe the information on the choice of tires (→ page 333).

For tires with a specified direction of rotation, an arrow on the side wall of the tire indicates the correct direction of rotation. Observe the direction of rotation when changing the tire.

- ▶ Slide the wheel to be mounted onto the centering pin and push it on.
- ▶ Observe the notes on mounting an emergency spare wheel (→ page 343).

⚠ WARNING Risk of injury from tightening wheel bolts and nuts

If you tighten the wheel bolts or wheel nuts when the vehicle is raised, the jack could tip.

- ▶ Only tighten wheel bolts or wheel nuts when the vehicle is on the ground.
- ▶ Observe the instructions and safety notes on "Changing a wheel" (→ page 333).
- ▶ For safety reasons, only use wheel bolts which have been approved by Mercedes-Benz and for the wheel in question.

! **NOTE** Damage to paintwork of the wheel rim when screwing in the first wheel bolt

If the wheel has too much play when screwing in the first wheel bolt, the wheel rim paint can be damaged.

- ▶ Press the wheel firmly against the wheel hub when screwing in the first wheel bolt.

- ▶ Tighten the wheel bolts evenly in a diagonal pattern in the order indicated until they are finger-tight.
- ▶ Unscrew and remove the centering pin.
- ▶ Tighten the last wheel bolt until it is finger-tight.
- ▶ Lower the vehicle (→ page 342).

Lowering the vehicle after a wheel change

Requirements

- The new wheel has been installed (→ page 341).

- ▶ **To lower the vehicle:** place the ratchet onto the hexagon nut of the jack so that the letters "AB" are visible and turn counter-clockwise.

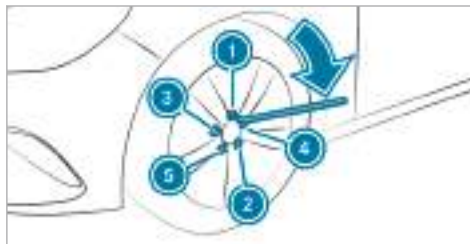

- ▶ Tighten the wheel bolts evenly in a diagonal pattern in the order indicated ① to ⑤ with an initial maximum force of 59 lb-ft (80 Nm).
- ▶ Tighten the wheel bolts evenly in a diagonal pattern in the order indicated ① to ⑤ with the specified tightening torque of 96 lb-ft (130 Nm).

! **WARNING** Risk of accident due to incorrect tightening torque

The wheels could come loose if the wheel bolts or wheel nuts are not tightened to the prescribed torque.

- ▶ Ensure that the wheel bolts or wheel nuts are tightened to the prescribed tightening torque.
- ▶ If you are not sure, do not move the vehicle. Contact a qualified specialist workshop and have the tightening torque checked immediately.

- ▶ Check the tire pressure of the newly installed wheel and adjust it if necessary.

i The following does not apply if the new wheel is an emergency spare wheel.

- ▶ **Vehicles with a tire pressure loss warning system:** restart the tire pressure loss warning system (→ page 321).
- ▶ **Vehicles with a tire pressure monitoring system:** restart the tire pressure monitoring system (→ page 320).

Emergency spare wheel

Notes on the emergency spare wheel

⚠ WARNING Risk of accident caused by incorrect wheel and tire dimensions

The wheel or tire sizes and the tire type of the emergency spare wheel or spare wheel and the wheel to be replaced may differ. The emergency spare wheel or spare wheel can significantly impair driving characteristics of the vehicle.

To prevent hazardous situations:

- ▶ Drive carefully.
- ▶ Never install more than one emergency spare wheel or spare wheel that differs in size.
- ▶ Only use an emergency spare wheel or spare wheel briefly.
- ▶ Do not deactivate ESP®.
- ▶ Have the emergency spare wheel or spare wheel of a different size replaced at the nearest qualified specialist work-

shop. The new wheel must have the correct dimensions.

- ① The deflated emergency spare wheel is secured in the emergency spare wheel bag in the cargo compartment and is secured to the adjustable cargo floor in the lower position.

Observe the following notes on removing an emergency spare wheel:

- Before stowing the emergency spare wheel, make sure there is no air left in the tire. If necessary, allow the air to escape.
- **To release air from the tire:** remove the valve cap of the tire.
- Press down the metal insert in the valve using a pointed object, e.g. a pen.
- Screw the valve cap onto the valve.
- ① **Vehicles with adjustable cargo floor:** always stow the deflated emergency spare wheel in the lower position on the adjustable cargo floor.

Observe the following notes on installing an emergency spare wheel:

- The maximum permissible speed with an emergency spare wheel installed is 50 mph (80 km/h).
- Do not install the emergency spare wheel with snow chains.
- Replace the emergency spare wheel after six years at the latest, regardless of wear.
- Use the wheel bolts that are included with the emergency spare wheel.
- Check the tire pressure of the emergency spare wheel installed. Correct the pressure as necessary.
- ① The specified tire pressure is stated on the label of the emergency spare wheel.
- ① **Vehicles with a tire pressure loss warning system:** if an emergency spare wheel is installed, the tire pressure loss warning system cannot function reliably. Only restart the system again when the emergency spare wheel has been replaced with a new wheel.

Vehicles with a tire pressure monitoring system: if an emergency spare wheel is installed, the tire pressure monitoring system cannot function reliably. For a few minutes after an emergency spare wheel is installed, the system may still display the tire pressure of the removed wheel. Only restart the system again when the emergency spare wheel has been replaced with a new wheel.

Be sure to also observe the following further related subjects:

- Notes on tire pressure (→ page 315)
- Tire and Loading Information placard (→ page 322)
- Tire pressure table (→ page 317)
- Notes on installing tires (→ page 333)
- Installing an emergency spare wheel (→ page 338)

Inflating the emergency spare wheel

! **NOTE** Overheating due to the tire inflation compressor running too long

▶ Do not run the tire inflation compressor for longer than ten minutes without interruption.

Requirements:

- The emergency spare wheel has been installed correctly. (→ page 338)
- ① Comply with the manufacturer's safety notes on the sticker of the emergency spare wheel and on the tire inflation compressor.
- ▶ Remove the sticker with the label 50 mph (80 km/h) from the tire inflation compressor housing and affix it to the instrument cluster within the driver's field of vision.
- ▶ Remove the tire inflation compressor from the stowage space under the trunk floor. (→ page 297)



- ▶ Pull filler hose ① and plug ③ out of the tire inflation compressor housing.
- ▶ Insert plug ⑦ of filler hose ① in the socket on the tire inflation compressor and then turn it until plug ⑦ engages.
- ▶ Unscrew the cap from the valve on the emergency spare wheel.
- ▶ Screw union nut ② of filler hose ① onto the valve.
- ▶ Make sure on and off switch ④ of the tire inflation compressor is set to 0.
- ▶ Insert plug ③ in a socket in your vehicle.
 - 12 V socket: (→ page 120)

- Observe the notes on sockets: (→ page 120)
 - ▶ Press the start/stop button once to switch on the power supply (→ page 143).
 - ▶ Press On/Off switch ④ on the tire inflation compressor to **I**.
The tire inflation compressor is switched on. The tire is inflated. The tire pressure appears on manometer ⑤.
 - ▶ Pump the tire to the specified tire pressure.
 - ① The specified tire pressure is stated on the label of the emergency spare wheel.
 - ▶ When the specified tire pressure has been reached, press on and off switch ④ on the tire inflation compressor to **0**.
The tire inflation compressor is switched off.
 - ▶ Press the start/stop button to switch off the power supply.
 - ▶ If the tire pressure is higher than the specified pressure, press pressure release valve button ⑥ until the correct tire pressure has been reached.
- ▶ Unscrew union nut ② of filler hose ① from the valve.
 - ▶ Screw the valve cap of the emergency spare wheel onto the valve again.
 - ▶ Stow filler hose ① and plug ③ in the lower section of the tire inflation compressor housing.
 - ▶ Stow the tire inflation compressor in the vehicle.

Notes on technical data

! NOTE Mercedes-AMG vehicles

- ▶ Observe the notes in the Supplement. You could otherwise fail to recognize dangers.

The data stated only applies to vehicles with standard equipment. You can obtain further information from an authorized Mercedes-Benz Center.

Vehicle electronics

Two-way radios

Notes on installing two-way radios

⚠ WARNING Risk of accident due to improper work on two-way radios

If two-way radios are manipulated or retrofitted incorrectly, the electromagnetic radiation from the two-way radios can interfere with the vehicle electronics and jeopardize the operating safety of the vehicle.

- ▶ You should have all work on electrical and electronic components carried out at a qualified specialist workshop.

⚠ WARNING Risk of accident due to improper operation of two-way radios

If you use two-way radios in the vehicle improperly, their electromagnetic radiation can disrupt the vehicle's electronics. This is the case in the following situations, in particular:

- The two-way radio is not connected to an exterior antenna.
- The exterior antenna is installed incorrectly or is not a low-reflection antenna.

This could jeopardize the operating safety of the vehicle.

- ▶ Have the low-reflection exterior antenna installed at a qualified specialist workshop.

- ▶ When operating two-way radios in the vehicle, always connect them to the low-reflection exterior antenna.

! NOTE Invalidation of the operating permit due to failure to comply with the instructions for installation and use

The operating permit may be invalidated if the instructions for installation and use of two-way radios are not observed.

- ▶ Only use approved frequency bands.
- ▶ Observe the maximum permissible output power in these frequency bands.
- ▶ Only use approved antenna positions.

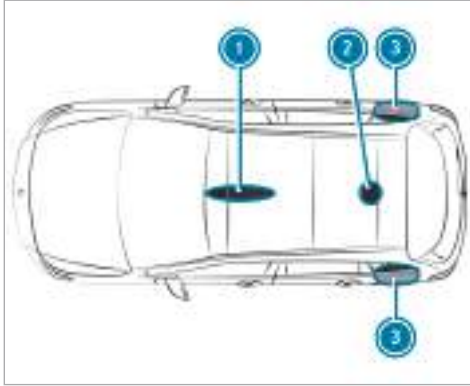

- ① Front roof area
- ② Rear roof area
- ③ Rear fenders

On vehicles with a panorama roof with power tilt/sliding panel, installing an antenna to the front or rear roof area is not permitted.

On the rear fenders, it is recommended that you install the antenna on the side of the vehicle closest to the center of the road.

Use Technical Specification ISO/TS 21609 (Road Vehicles - "EMC guidelines for installation of aftermarket radio frequency transmitting equipment") when retrofitting two-way radios. Comply with the legal requirements for detachable parts.

If your vehicle has a pre-installation for two-way radio equipment, use the power supply and antenna connectors provided in the pre-installation. Observe the manufacturer's supplements when installing.

Two-way radio transmission output

The maximum transmission output (PEAK) at the base of the antenna must not exceed the values in the following table.

Frequency band and maximum transmission output

| Frequency band | Maximum transmission output |
|--|-----------------------------|
| 2-m- frequency band 144 - 174 MHz | 50 W |
| Terrestrial Trunked Radio (TETRA) 380 - 460 MHz | 10 W |
| 70-cm- frequency band 430 - 470 MHz | 35 W |
| Two-way radio 2G | 2 W |
| Two-way radio 3G/4G/5G | 0.5 W |

The following devices can be used in the vehicle without restrictions:

- two-way radios with a maximum transmission output of up to 100 mW
- two-way radios with transmitter frequencies in the 380 - 420 MHz frequency band and a maximum transmission output of up to 2 W (TETRA)
- mobile phones (2G/3G/4G/5G)

There are no restrictions regarding the position of the antenna on the outside of the vehicle for the following frequency bands:

- TETRA
- 2G/3G/4G/5G

Radio regulations

Regulatory radio identification and specific notes

Manufacturer information about radio-based vehicle components can be found using the key phrase "Regulatory radio information" in the Digital Operator's Manual in the vehicle, on the internet and in the app.

Vehicle identification plate, VIN and engine number overview

Vehicle identification plate

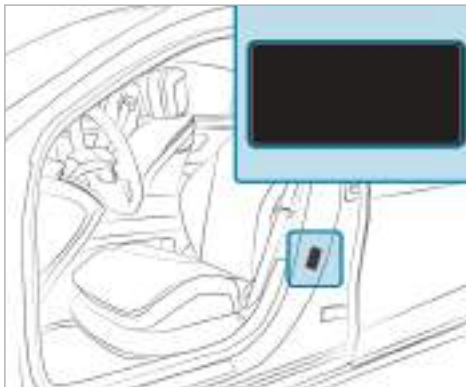

Vehicle identification plate (USA only)

- 1 Maximum permissible gross vehicle weight
- 2 Maximum permissible front axle load
- 3 Maximum permissible rear axle load
- 4 Paint code
- 5 VIN (vehicle identification number)



Vehicle identification plate (Canada only)

- ① Maximum permissible gross vehicle weight
- ② Maximum permissible front axle load
- ③ Maximum permissible rear axle load
- ④ Paint code
- ⑤ VIN (vehicle identification number)

The maximum permissible gross vehicle weight is made up of the vehicle weight, all vehicle occupants, the fuel and the load. The maximum gross axle weight rating is the maximum weight that can be carried on one axle (front or rear axle).

Do not exceed the maximum permissible gross vehicle weight or the maximum gross axle weight rating for the front or rear axle.

VIN, engine number and other signs

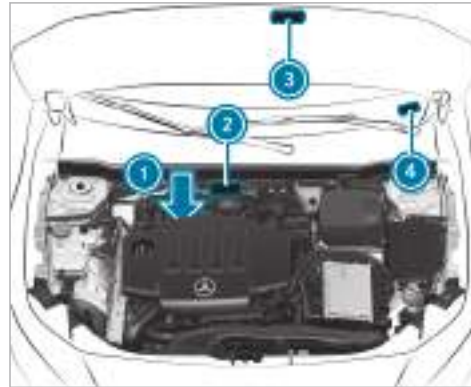

- ① Engine number stamped into the crankcase
- ② VIN (vehicle identification number) stamped into the crossmember

- ③ Plate with information about emissions testing, including confirmation of emissions guidelines at the U.S. federal level as well as for California
- ④ VIN as a label at the lower edge of the windshield

Operating fluids

Notes on operating fluids

! NOTE Mercedes-AMG vehicles

- ▶ Observe the notes in the Supplement. You could otherwise fail to recognize dangers.

! WARNING Risk of injury due to harmful operating fluids

Operating fluids can be toxic.

- ▶ When using, storing and disposing of operating fluids, observe the imprints on the respective original containers.

- ▶ Always keep operating fluids in the sealed original container.
- ▶ Always keep children away from operating fluids.



ENVIRONMENTAL NOTE Pollution of the environment due to irresponsible disposal of operating fluids

Incorrect disposal of operating fluids can cause considerable damage to the environment.

- ▶ Dispose of operating fluids in an environmentally responsible manner.

Operating fluids include the following:

- Fuels
- Lubricants
- Coolant
- Brake fluid
- Windshield washer fluid
- Climate control system refrigerant

Only use products approved by Mercedes-Benz. Damage caused by the use of products that have not been approved is not covered by the Mercedes-Benz warranty or goodwill gestures.

The operating fluids approved by Mercedes-Benz can be identified by the following inscriptions on the container:

- MB-Freigabe (e.g. MB-Freigabe 229.51)
- MB-Approval (e.g. MB-Approval 229.51)

Further information on approved operating fluids:

- in the Mercedes-Benz Specifications for Operating Fluids by entering the designation
 - At <https://operatingfluids.mercedes-benz.com>
- At a qualified specialist workshop



WARNING Risk of fire or explosion from fuel

Fuels are highly flammable.

- ▶ Fire, open flames, smoking and creating sparks must be avoided.

- ▶ Before and during refueling, switch off the vehicle and, if installed, the stationary heater.



WARNING Risk of injury from fuels

Fuels are poisonous and hazardous to your health.

- ▶ Do not swallow fuel or let it come into contact with skin, eyes or clothing.
- ▶ Do not inhale fuel vapor.
- ▶ Keep children away from fuel.
- ▶ Keep doors and windows closed during the refueling process.

If you or other people come into contact with fuel, observe the following:

- ▶ Immediately rinse fuel off your skin with soap and water.
- ▶ If fuel comes into contact with your eyes, immediately rinse them thoroughly with clean water. Seek medical attention immediately.

- ▶ If you swallow fuel, seek medical attention immediately. Do not induce vomiting.
- ▶ Change immediately out of clothing that has come into contact with fuel.

Flexible-fuel vehicles can be refueled with the following fuel types:

- premium-grade unleaded gasoline
- E85 fuel
- a mixture of E85 fuel and premium-grade unleaded gasoline

Flexible-fuel vehicles can be identified by the **Ethanol up to E85** sticker on the inside of the fuel filler flap.

Depending on the country, the fuels you can use in your vehicle may differ from the information in the Operator's Manual. The fuels that have been approved for your vehicle can be found on the instruction label on the inside of the fuel filler flap.

Fuel

Information on fuel quality for vehicles with gasoline engine

Observe the instructions about operating fluids (→ page 349).

! NOTE Damage caused by the wrong fuel

Even small amounts of the wrong fuel could result in damage to the fuel system, the engine and the emission control system.

- ▶ Only refuel with low-sulfur spark-ignition engine fuel.

This fuel may contain up to 10% ethanol by volume. Your vehicle is suitable for use with E10 fuel.

Never refuel with one of the following fuels:

- diesel
- Gasoline with more than 10% ethanol by volume, e.g. E15, E85, E100
- Gasoline with more than 3% methanol by volume, e.g. M15, M30, M85, M100

- Gasoline with additives containing metal

If you have accidentally refueled with the wrong fuel:

- ▶ Do not switch on the vehicle.
- ▶ Consult a qualified specialist workshop.

If the available fuel is not sufficiently low in sulfur, it may produce unpleasant odors.

Only refuel with fuel that has at least the octane number specified in the information label on the fuel filler flap. Otherwise, engine output may be reduced and fuel consumption increased.

For maximum engine output: Only refuel using premium-grade unleaded gasoline with at least 91 AKI/95 RON.

If the recommended fuel is not available, you may also temporarily use regular unleaded gasoline with an octane number of at least 87 AKI/91 RON. This may reduce engine output and increase fuel consumption.

Never refuel using gasoline with an even lower RON.

! **NOTE** Premature engine wear through unleaded regular gasoline

Impairment of the longevity and performance of the engine.

If unleaded premium grade gasoline is unavailable and you have to refuel using unleaded regular gasoline:

- ▶ Only fill the fuel tank to half full with unleaded regular gasoline and refill as soon as possible with unleaded premium grade gasoline.
- ▶ Do not drive at the maximum design speed.
- ▶ Avoid sudden acceleration and engine speeds over 3000 rpm.

Further information on fuel is available at the following locations:

- At a gas station
- At a qualified specialist workshop
- **USA only:** On the <https://www.mbusa.com>

Information on additives in gasoline (vehicles with gasoline engine)

Observe the notes on operating fluids (→ page 349).

! **NOTE** Damage from use of unsuitable additives

Even small amounts of the wrong additive may lead to malfunctions occurring.

- ▶ Only add cleaning additives recommended by Mercedes-Benz to the fuel.

Mercedes-Benz recommends that you use brand-name fuels with additives.

In some countries, the fuel available may not have sufficient additives. Deposits could build up in the fuel injection system as a result. In this case, in consultation with a qualified specialist workshop (e.g. an authorized Mercedes-Benz Service Center), mix the fuel with the cleaning additive recommended by Mercedes-Benz. Observe the notes and mixing ratios indicated on the tank.

Tank content and fuel reserve

Total fuel tank capacity

Model

| | |
|------------|------------------------|
| All models | 13.5 gal (51.0 liters) |
|------------|------------------------|

Fuel tank reserve

Model

| | |
|------------|----------------------|
| All models | 1.3 gal (5.0 liters) |
|------------|----------------------|

Engine oil

Notes on engine oil

Observe the notes on operating fluids (→ page 349).



! **NOTE** Engine damage caused by an incorrect oil filter, incorrect oil or additives

- ▶ Do not use engine oils or oil filters other than those which meet the specifications necessary for the prescribed service intervals.
- ▶ Do not alter the engine oil or oil filter in order to achieve longer change intervals than prescribed.
- ▶ Do not use additives.
- ▶ Have the engine oil changed after the prescribed intervals.

Mercedes-Benz recommends having the oil changed at a qualified specialist workshop.

Only use engine oils approved for your vehicle by Mercedes-Benz.

■ Engine oil quality and filling capacity

Engine oil specification

| Model | MB-Freigabe or MB-Approval |
|---|--|
| All models | 229.51, 229.52, 229.61, 229.71, 229.72 ¹⁾ |
| <small>1) Recommended for the lowest possible fuel consumption (lowest SAE viscosity class in each case; observe possible restrictions of the approved SAE viscosity classes)</small> | |

To achieve the lowest possible fuel consumption, it is recommended to use the engine oil specifications marked in the table with the lowest SAE viscosity class. Observe any possible restrictions of the approved SAE viscosity classes.

Engine oil filling capacity

| Model | Capacity |
|------------|------------------------|
| All models | 5.8 US qt (5.5 liters) |

The specified filling capacity refers to an oil change with the oil filter.

Notes on brake fluid

Observe the notes on operating fluids (→ page 349).

⚠ WARNING Risk of an accident due to vapor pockets forming in the brake system

The brake fluid constantly absorbs moisture from the air. This lowers the boiling point of the brake fluid. If the boiling point is too low, vapor pockets may form in the brake system when the brakes are applied hard.

This causes the braking effect to be impaired.

- ▶ Have the brake fluid renewed at the specified intervals.

Have the brake fluid regularly replaced at a qualified specialist workshop.

Only use a brake fluid approved by Mercedes-Benz according to MB-Freigabe or MB-Approval 331.0.

Coolant

Notes on coolant

Observe the notes on operating fluids (→ page 349).

⚠ WARNING – Risk of fire and injury from antifreeze

If antifreeze comes into contact with hot component parts in the engine compartment, it may ignite.

- ▶ Allow the engine to cool down before adding antifreeze.
- ▶ Make sure that no antifreeze spills out next to the filler opening.
- ▶ Thoroughly clean off any antifreeze from component parts before starting the vehicle.

! **NOTE** Damage caused by incorrect coolant

- ▶ Only use coolant that has been premixed with the required antifreeze protection.

Information on coolant is available at the following locations:

- In the Mercedes-Benz Specification for Operating Fluids 320.1
 - At <https://operatingfluids.mercedes-benz.com>
- At a qualified specialist workshop

! **NOTE** Overheating at high outside temperatures

If an inappropriate coolant is used, the cooling system is not sufficiently protected against overheating and corrosion at high outside temperatures.

- ▶ Only use coolant approved for Mercedes-Benz.

- ▶ Observe the instructions in the Mercedes-Benz Specifications for Operating Fluids 320.1.

Have the coolant regularly replaced at a qualified specialist workshop.

Proportion of antifreeze concentrate in the cooling system:

- A minimum of 50% (antifreeze protection down to about -35°F (-37°C))
- A maximum of 55% (antifreeze protection down to -49°F (-45°C))

Coolant filling capacity

Coolant (engine)

| Model | Capacity |
|------------|------------------------|
| All models | 9.4 US qt (8.9 liters) |

Notes on windshield washer fluid

Observe the notes on operating fluids (→ page 349).

⚠ WARNING - Risk of fire and injury from windshield washer concentrate

Windshield washer concentrate is highly flammable. It could ignite if it comes into contact with hot engine component parts or the exhaust system.

- ▶ Make sure that no windshield washer concentrate spills out next to the filler opening.

! NOTE Damage to the exterior lighting due to unsuitable windshield washer fluid

Unsuitable windshield washer fluid may damage the plastic surface of the exterior lighting.

- ▶ Only use windshield washer fluid which is also suitable for use on plastic surfaces, e.g. MB SummerFit or MB WinterFit.

! NOTE Blocked spray nozzles caused by mixing windshield washer fluids

- ▶ Do not mix MB SummerFit and MB WinterFit with other windshield washer fluids.

Do not use distilled or de-ionised water. Otherwise, the fill level sensor may be triggered erroneously.

Recommended windshield washer fluid:

- Above freezing point: e.g. MB SummerFit
- Below freezing point: e.g. MB WinterFit

For the correct mixing ratio, refer to the information on the antifreeze container.

Mix washing water with windshield washer fluid all year round.

Refrigerant

! Notes on refrigerant

Observe the notes on operating fluids (→ page 349).

! NOTE Damage due to incorrect refrigerant

If a non-approved refrigerant is used, the climate control system may be damaged.

- ▶ **USA:** use only R-134a refrigerant.
- ▶ **Canada:** use only R-1234yf refrigerant.

! NOTE Damage to the climate control system due to incorrect refrigerant compressor oil

- ▶ Only use refrigerant compressor oil that has been approved by Mercedes-Benz.
- ▶ Do not mix the approved refrigerant compressor oil with a different refrigerant compressor oil.

Work on the climate control system may be carried out only at a qualified specialist workshop. All applicable regulations as well as SAE standard J639 must be adhered to.

The information label for the climate control system regarding the refrigerant type and the refrigerant compressor oil (PAG oil) is located on the inside of the hood.



Information label (example - USA)

- ① Hazard and service warning symbols
- ② Refrigerant filling capacity
- ③ Applicable standards
- ④ PAG oil part number
- ⑤ GWP (global warming potential) of the refrigerant used
- ⑥ Refrigerant type



Information label (example - Canada)

- ① Hazard and service warning symbols
- ② Refrigerant filling capacity
- ③ Applicable standards
- ④ PAG oil part number
- ⑤ GWP (global warming potential) of the refrigerant used
- ⑥ Refrigerant type

Symbols ① indicate the following:

- Possible dangers
- Having maintenance work carried out at a qualified specialist workshop

Filling capacity for refrigerant and PAG oil

Refrigerant filling capacity

| Model | |
|------------|-------------------------------|
| All models | 20.8 ± 0.4 oz (590 ± 10 g) |

Filling capacity for PAG oil

| Model | |
|------------|-----------------------------|
| All models | 2.8 ± 0.4 oz (80 ± 10 g) |

Vehicle data

Vehicle dimensions

The heights specified may vary as a result of the following factors:

- Tires
- Load
- Condition of the suspension
- Optional equipment

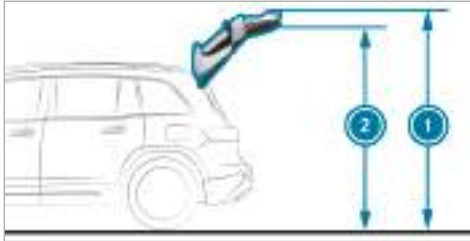

- ① Height when opened
- ② Headroom

Height when opened and headroom

| Model | ① Height when opened | ② Headroom |
|------------|----------------------|----------------------|
| All models | 83.3 in (2117 mm) | 75.0 in (1905 mm) |

Vehicle dimensions

| All models | |
|--|--------------------|
| Vehicle length | 173.6 in (4410 mm) |
| Vehicle width including exterior mirrors | 79.5 in (2020 mm) |
| Vehicle height | 63.7 in (1618 mm) |
| Wheelbase | 107.4 in (2729 mm) |
| Turning circle | 37.40 ft (11.40 m) |

Weights and loads

Bear in mind that items of optional equipment increase the curb weight and reduce the payload. Vehicle-specific weight information can be found on the vehicle identification plate.

Display messages

Introduction



Information about display messages

Display messages appear on the instrument display.

Display messages with graphic symbols are simplified in the Operator's Manual and may differ from the symbols on the instrument display. The instrument display shows high-priority display messages in red. Certain display messages are accompanied by a warning tone.

Please act in accordance with the display messages and follow the additional notes in the Operator's Manual.

For some display messages, symbols will also be shown:

-  Further information
-  Hide display message

With the left-hand Touch Control, you can select the respective symbol by swiping to the left or right. Pressing  displays further information on

the media display. Press the  symbol to hide the display message.

Display messages to be acknowledged can be hidden by pressing the back button  or with the left-hand Touch Control. The display messages will then be stored in the message memory.

Rectify the cause of a display message as quickly as possible.

High-priority display messages cannot be hidden. The instrument display will show these display messages permanently until the cause of the display message has been rectified.



Calling up saved display messages

On-board computer:



 **Service**  **1 Message**

If there are no display messages, **No Messages** will appear on the instrument display.

 Scroll through the display messages by swiping upwards or downwards on the left-hand Touch Control.

 **To exit the message memory:** press the back button .



Occupant safety



| Display messages | Possible causes/consequences and ► Solutions |
|--|--|
|  <p data-bbox="195 381 445 433">SRS Malfunction Service Required</p> | <p data-bbox="524 288 1055 313">* The restraint system is malfunctioning (→ page 41).</p> <div data-bbox="550 332 1696 448" style="border: 1px solid gray; padding: 5px;"> <p data-bbox="559 339 1262 365">▲ WARNING Risk of injury due to malfunctions in the restraint system</p> <p data-bbox="559 379 1628 405">Components in the restraint system may be activated unintentionally or not deploy as planned in an accident.</p> <p data-bbox="559 415 1522 441">► Have the restraint system checked and repaired immediately at a qualified specialist workshop.</p> </div> |
|  <p data-bbox="195 557 469 609">Front Left Malfunction Service Required (example)</p> | <p data-bbox="524 464 1055 490">* The restraint system is malfunctioning (→ page 41).</p> <div data-bbox="550 508 1696 624" style="border: 1px solid gray; padding: 5px;"> <p data-bbox="559 515 1262 541">▲ WARNING Risk of injury due to malfunctions in the restraint system</p> <p data-bbox="559 555 1628 581">Components in the restraint system may be activated unintentionally or not deploy as planned in an accident.</p> <p data-bbox="559 591 1522 617">► Have the restraint system checked and repaired immediately at a qualified specialist workshop.</p> </div> |
|  <p data-bbox="195 733 439 811">Left Side Curtain Airbag Malfunction Service Required (example)</p> | <p data-bbox="524 640 1055 666">* The restraint system is malfunctioning (→ page 41).</p> <div data-bbox="550 684 1696 821" style="border: 1px solid gray; padding: 5px;"> <p data-bbox="559 692 1461 717">▲ WARNING Risk of injury or fatal injury due to a malfunction in the window curtain airbag</p> <p data-bbox="559 731 1628 783">The window curtain airbag might be triggered unintentionally or might not be triggered at all in the event of an accident.</p> <p data-bbox="559 793 1578 819">► Have the window curtain airbag checked and repaired immediately at a qualified specialist workshop.</p> </div> |

| Display messages | Possible causes/consequences and ► Solutions |
|--|--|
| <p>Front Passenger Airbag Disabled See Operator's Manual</p> | <p>* The front passenger air bag has been disabled even though an adult or a person of adult build is on the front passenger seat. If additional forces are applied to the seat, the weight the system detects may be too low.</p> <div data-bbox="500 319 1648 522" style="border: 1px solid gray; padding: 5px;"> <p>▲ WARNING Risk of injury or fatal injury due to a disabled front passenger airbag</p> <p>If the front passenger airbag is disabled, the front passenger airbag will not be deployed in the event of an accident and cannot perform its intended protective function.</p> <p>A person in the front passenger seat could then, for example, come into contact with the vehicle's interior, especially if the person is sitting too close to the cockpit.</p> <p>► Make sure, both before and during the journey, that the status of the front passenger airbag is correct.</p> </div> <ul style="list-style-type: none"> ► Stop the vehicle immediately in accordance with the traffic conditions. ► Make sure that no objects are trapped under the front passenger seat. ► Check the status of the automatic front passenger air bag shutoff (→ page 42). ► If necessary, consult a qualified specialist workshop immediately. |
| <p>Front Passenger Airbag Enabled See Operator's Manual</p> | <p>* The front passenger air bag will be enabled while the vehicle is in motion in the following situations:</p> <ul style="list-style-type: none"> • even when a child, a small adult or an object weighing less than the system weight threshold is located on the front passenger seat • even when the front passenger seat is not occupied <p>The system may detect objects or forces that are adding to the weight applied to the seat.</p> |

| Display messages | Possible causes/consequences and ► Solutions |
|------------------|--|
| | <p data-bbox="554 253 1690 315">▲ WARNING Risk of injury or death when using a child restraint system while the front passenger airbag is enabled</p> <p data-bbox="554 321 1690 378">If you secure a child in a child restraint system on the front passenger seat and the front passenger airbag is enabled, the front passenger airbag can deploy in the event of an accident.</p> <p data-bbox="554 383 1690 409">The child could be struck by the airbag.</p> <p data-bbox="554 414 1690 445">► Ensure, both before and during the journey, that the status of the front passenger airbag is correct.</p> <p data-bbox="554 455 1690 512">NEVER use a rearward facing child restraint on a seat protected by an ACTIVE AIRBAG in front of it, DEATH or SERIOUS INJURY to the CHILD can occur.</p> <ul data-bbox="554 533 1690 663" style="list-style-type: none">► Stop the vehicle immediately in accordance with the traffic conditions.► Make sure that no objects are trapped under the front passenger seat.► Check the status of the automatic front passenger air bag shutoff (→ page 42).► If necessary, consult a qualified specialist workshop immediately. |

SmartKey





| Display messages | Possible causes/consequences and ► Solutions |
|---|---|
|  <p data-bbox="144 381 325 407">Obtain a New Key</p> | <ul style="list-style-type: none"> <li data-bbox="469 291 778 317">* Have the SmartKey replaced. <li data-bbox="495 322 916 348">► Consult a qualified specialist workshop. |
|  <p data-bbox="144 526 349 552">Replace Key Battery</p> | <ul style="list-style-type: none"> <li data-bbox="469 436 846 462">* The SmartKey battery is discharged. <li data-bbox="495 467 861 493">► Replace the battery (→ page 71). |
|  <p data-bbox="144 671 389 717">Key Not Detected (white display message)</p> | <ul style="list-style-type: none"> <li data-bbox="469 581 864 607">* The SmartKey is currently undetected. <li data-bbox="495 612 1027 638">► Change the location of the SmartKey in the vehicle. <li data-bbox="495 643 753 669">► Try to start the vehicle. <li data-bbox="495 674 1609 700">► If the SmartKey is still not detected, place it in the marked space for starting with the SmartKey (→ page 144). <li data-bbox="495 705 694 731">► Start the vehicle. |



| Display messages | Possible causes/consequences and ► Solutions |
|---|---|
|  <p data-bbox="194 341 471 393">Key Not Detected (red display message)</p> | <p data-bbox="517 248 1404 274">* The key can no longer be detected during a journey and may no longer be in the vehicle.</p> <p data-bbox="545 284 1191 310">If the key is no longer in the vehicle and you switch off the vehicle:</p> <ul data-bbox="545 321 942 378" style="list-style-type: none"> <li data-bbox="545 321 924 347">• You can no longer start the vehicle. <li data-bbox="545 352 942 378">• You cannot centrally lock the vehicle. <p data-bbox="545 393 933 419">► Ensure that the key is in the vehicle.</p> <p data-bbox="545 445 1034 471">If the key is in the vehicle and is still not detected:</p> <ul data-bbox="545 481 1312 538" style="list-style-type: none"> <li data-bbox="545 481 1265 507">► Stop the vehicle immediately in accordance with the traffic conditions. <li data-bbox="545 512 1312 538">► Place the key in the slot for starting the engine with the key (→ page 144). <p data-bbox="545 564 924 590">The key battery is weak or discharged.</p> <ul data-bbox="545 600 1136 657" style="list-style-type: none"> <li data-bbox="545 600 1136 626">► Check the battery using the indicator lamp (→ page 69). <li data-bbox="545 631 1081 657">► Replace the key battery, if necessary (→ page 71). |
|  <p data-bbox="194 771 471 818">Key Being Initialized Please Wait</p> | <p data-bbox="517 678 1173 704">* The vehicle is processing in order to teach in the new SmartKey.</p> <ul data-bbox="545 709 914 735" style="list-style-type: none"> <li data-bbox="545 709 914 735">► Wait until processing is complete. |

| Display messages | Possible causes/consequences and ► Solutions |
|--|--|
|  <p data-bbox="144 339 369 366">Don't Forget Your Key</p> | <p data-bbox="473 249 1641 276">* A warning tone will also sound. This message reminds you to take your SmartKey with you when you leave the vehicle.</p> |
| <p data-bbox="144 389 412 464">Place the Key in the Marked Space See Operator's Manual</p> | <p data-bbox="473 389 864 416">* SmartKey detection is malfunctioning.</p> <ul style="list-style-type: none"> <li data-bbox="495 422 1031 449">► Change the location of the SmartKey in the vehicle. <li data-bbox="495 455 1382 482">► Place the SmartKey in the slot for starting the engine with the SmartKey (→ page 144). |

Lights

| Display messages | Possible causes/consequences and ► Solutions |
|--|---|
|  <p data-bbox="144 717 306 769">Check Left Low Beam (example)</p> | <p data-bbox="473 627 975 654">* The corresponding light source is malfunctioning.</p> <ul style="list-style-type: none"> <li data-bbox="495 660 705 687">► Drive on carefully. <li data-bbox="495 694 1038 721">► Consult a qualified specialist workshop immediately. <p data-bbox="495 727 1641 779">ⓘ LED light sources: the display message for the corresponding light appears only when all the light-emitting diodes in the light are faulty.</p> |



| Display messages | Possible causes/consequences and ► Solutions |
|--|--|
|  <p data-bbox="195 339 436 388">Malfunction See Operator's Manual</p> | <ul style="list-style-type: none"> <li data-bbox="517 248 960 305">* The exterior lighting is malfunctioning. <ul style="list-style-type: none"> <li data-bbox="545 284 960 305">► Consult a qualified specialist workshop. |
|  <p data-bbox="195 510 471 559">Automatic Headlamp Mode Inoperative</p> | <ul style="list-style-type: none"> <li data-bbox="517 419 1136 476">* The light sensor for automatic driving lights is malfunctioning. <ul style="list-style-type: none"> <li data-bbox="545 455 960 476">► Consult a qualified specialist workshop. |
|  <p data-bbox="195 681 471 730">Active Headlamps Inoperative</p> | <ul style="list-style-type: none"> <li data-bbox="517 590 960 647">* The active headlamps are malfunctioning. <ul style="list-style-type: none"> <li data-bbox="545 621 960 642">► Consult a qualified specialist workshop. |
|  <p data-bbox="195 852 415 870">Switch On Headlamps</p> | <ul style="list-style-type: none"> <li data-bbox="517 761 1071 813">* You are driving without low-beam headlamps. <ul style="list-style-type: none"> <li data-bbox="545 792 1071 813">► Turn the light switch to the  or AUTO position. |



| Display messages | Possible causes/consequences and ► Solutions |
|---|---|
|  <p data-bbox="144 339 319 365">Switch Off Lights</p> | <ul style="list-style-type: none"> * You are leaving the vehicle and the lights are still switched on. <ul style="list-style-type: none"> ► Turn the light switch to the AUTO position. |
|  <p data-bbox="144 484 421 531">Intell. Light System Inoperative</p> | <ul style="list-style-type: none"> * The Intelligent Light System is malfunctioning. The lighting system continues to function properly without the functions of the Intelligent Light System. <ul style="list-style-type: none"> ► Consult a qualified specialist workshop. |
| <p data-bbox="144 560 412 635">Adaptive Highbeam Assist Currently Unavailable See Operator's Manual</p> | <ul style="list-style-type: none"> * Adaptive Highbeam Assist is temporarily unavailable. The system limits have been reached (→ page 129). Once the cause of the problem is no longer present, the system will be available again. The Adaptive Highbeam Assist Now Available display message will appear. <ul style="list-style-type: none"> ► Drive on ► Operate the high beam manually until Adaptive High Beam Assist is available again. |
| <p data-bbox="144 767 412 814">Adaptive Highbeam Assist Inoperative</p> | <ul style="list-style-type: none"> * Adaptive Highbeam Assist is malfunctioning. <ul style="list-style-type: none"> ► Drive on or |



| Display messages | Possible causes/consequences and ► Solutions |
|--|---|
| | <ul style="list-style-type: none"> ► Stop the vehicle in accordance with the traffic conditions and restart the vehicle. ► If the display message does not disappear: consult a qualified specialist workshop. ► Until then, operate the high beam manually. |
| Hazard Warning Flashers Malfunctioning | <ul style="list-style-type: none"> * The hazard warning lamp switch is malfunctioning. ► Consult a qualified specialist workshop. |



Vehicle



| Display messages | Possible causes/consequences and ► Solutions |
|--|--|
|  Vehicle Ready to Drive Switch the Ignition Off Before Exiting | <ul style="list-style-type: none"> * You are leaving the vehicle in a ready-to-drive state. <ul style="list-style-type: none"> ► Get out of the vehicle, secure it against rolling away and take the key with you. ► If you do not leave the vehicle, switch off the electrical consumers, e.g. the seat heating. Otherwise, the 12 V battery may discharge and starting the engine may be possible only with the help of a second battery (jump start). |
| Head-up Display Currently Unavailable See Operator's Manual | <ul style="list-style-type: none"> * The head-up display is temporarily unavailable. Possible causes: <ul style="list-style-type: none"> • Malfunctions in the power supply • Signal interference |

| Display messages | Possible causes/consequences and ► Solutions |
|---|---|
| | <ul style="list-style-type: none"> ► Stop in accordance with the traffic conditions and switch the vehicle off and on again. ► If the display message still appears, consult a qualified specialist workshop. |
| Head-up Display Inoperative | <ul style="list-style-type: none"> * The head-up display has an internal error. <ul style="list-style-type: none"> ► Consult a qualified specialist workshop. |
|  <p>Steering Malfunction Increased Physical Effort See Operator's Manual</p> | <ul style="list-style-type: none"> * The power steering assistance is malfunctioning. <div style="border: 1px solid black; padding: 5px; margin-top: 10px;"> <p>▲ WARNING Risk of an accident due to altered steering characteristics</p> <p>If the power assistance of the steering fails partially or completely, you will need to use more force to steer.</p> <ul style="list-style-type: none"> ► If safe steering is possible, drive on carefully. ► Visit or consult a qualified specialist workshop immediately. </div> |
|  <p>Steering Malfunction Stop Immediately See Operator's Manual</p> | <ul style="list-style-type: none"> * The steering is malfunctioning. Steering capability is significantly impaired. <div style="border: 1px solid black; padding: 5px; margin-top: 10px;"> <p>▲ WARNING Risk of accident if steering capability is impaired</p> <p>If the steering does not function as intended, the vehicle's operating safety is jeopardized.</p> <ul style="list-style-type: none"> ► Pull over and stop the vehicle safely as soon as possible, paying attention to road and traffic conditions. Do not continue driving under any circumstances. ► Consult a qualified specialist workshop. </div> |

| Display messages | Possible causes/consequences and ► Solutions |
|--|--|
|  <p data-bbox="194 341 462 393">Steering Malfunction See Operator's Manual</p> | <p data-bbox="526 248 1524 274">* The electric steering lock is malfunctioning. The steering may be locked by the electric steering lock.</p> <div data-bbox="545 290 1690 471" style="border: 1px solid gray; padding: 5px;"> <p data-bbox="554 300 1182 326">▲ WARNING Risk of accident if steering capability is impaired</p> <p data-bbox="554 336 1441 362">If the steering does not function as intended, the vehicle's operating safety is jeopardized.</p> <ul style="list-style-type: none"> <li data-bbox="563 372 1644 424">▶ Pull over and stop the vehicle safely as soon as possible, paying attention to road and traffic conditions. Do not continue driving under any circumstances. <li data-bbox="563 435 988 461">▶ Consult a qualified specialist workshop. </div> <ul style="list-style-type: none"> <li data-bbox="545 486 1506 512">▶ Stop the vehicle immediately in accordance with the traffic conditions. Do not continue driving. <li data-bbox="545 523 970 549">▶ Consult a qualified specialist workshop. |
|  <p data-bbox="194 652 471 704">Before Starting the Engine, Turn Steering Wheel</p> | <p data-bbox="526 559 1090 585">* The electric steering lock could not unlock the steering.</p> <ul style="list-style-type: none"> <li data-bbox="545 595 803 621">▶ Switch off the vehicle. <li data-bbox="545 631 1321 657">▶ To unlock the steering, move the steering wheel slightly to the left and right. <li data-bbox="545 668 859 694">▶ Switch on the vehicle again. |
|  | <p data-bbox="526 730 803 756">* At least one door is open.</p> <ul style="list-style-type: none"> <li data-bbox="545 766 739 792">▶ Close all doors. |



| Display messages | Possible causes/consequences and ► Solutions |
|---|---|
|  | <p>* The hood is open.</p> <p>▲ WARNING Risk of accident due to driving with the hood unlocked</p> <p>The hood may open and block your view.</p> <ul style="list-style-type: none">▶ Never release the hood when driving.▶ Before every trip, ensure that the hood is locked. <p>► Stop the vehicle immediately in accordance with the traffic conditions.</p> <p>► Close the hood.</p> |
|  | <p>* The tailgate is open.</p> <p>▲ DANGER Risk of exhaust gas poisoning</p> <p>Combustion engines emit poisonous exhaust gases such as carbon monoxide. Exhaust gases can enter the vehicle interior if the tailgate is open when the engine is running, especially if the vehicle is in motion.</p> <ul style="list-style-type: none">▶ Always switch off the engine before opening the tailgate.▶ Never drive with the tailgate open. <p>► Close the tailgate.</p> |



| Display messages | Possible causes/consequences and ► Solutions |
|---|---|
|  <p data-bbox="194 341 434 393">2nd Seat Row, Left Not Locked</p> | <ul style="list-style-type: none">* The left-hand seat or the seat backrest in the second row of seats is not engaged.<ul style="list-style-type: none">► Fold the corresponding seat backrest back until it engages and push the row of seats back (→ page 100).► Make sure that the seat is engaged (→ page 100). |
|  <p data-bbox="194 512 434 564">2nd Seat Row, Right Not Locked</p> | <ul style="list-style-type: none">* The right-hand seat or the seat backrest in the second row of seats is not engaged.<ul style="list-style-type: none">► Fold the corresponding seat backrest back until it engages and push the row of seats back (→ page 100).► Make sure that the seat is engaged (→ page 100). |
|  <p data-bbox="194 678 434 730">3rd Seat Row, Left Not Locked</p> | <ul style="list-style-type: none">* The left-hand seat or the seat backrest in the third row of seats is not engaged.<ul style="list-style-type: none">► Fold the corresponding seat backrest back until it engages and push the row of seats back (→ page 100).► Make sure that the seat is engaged (→ page 100). |

| Display messages | Possible causes/consequences and ► Solutions |
|---|--|
|  <p data-bbox="144 339 391 389">3rd Seat Row, Right Not Locked</p> | <ul style="list-style-type: none">* The right-hand seat or the seat backrest in the third row of seats is not engaged.<ul style="list-style-type: none">► Fold the corresponding seat backrest back until it engages and push the row of seats back (→ page 100).► Make sure that the seat is engaged (→ page 100). |
|  <p data-bbox="144 508 347 532">Check Washer Fluid</p> | <ul style="list-style-type: none">* The washer fluid level in the washer fluid reservoir has dropped below the minimum.<ul style="list-style-type: none">► Add washer fluid (→ page 284). |
| <p data-bbox="144 555 362 583">Wiper Malfunctioning</p> | <ul style="list-style-type: none">* The windshield wiper is malfunctioning.<ul style="list-style-type: none">► Restart the vehicle. <p data-bbox="495 643 842 667">If the display message still appears:</p> <ul style="list-style-type: none">► Consult a qualified specialist workshop. |

Engine

| Display messages | Possible causes/consequences and ► Solutions |
|--|---|
| To switch engine off, press and hold Start/Stop button for at least 3 seconds or press 3 times. | <ul style="list-style-type: none"> * You have pressed the start/stop button while the vehicle is in motion. <ul style="list-style-type: none"> ► Information about switching off the vehicle while driving (→ page 144). |
| Cannot Start Engine See Operator's Manual | <ul style="list-style-type: none"> * The vehicle cannot be started. <ul style="list-style-type: none"> ► Switch the vehicle off and switch it back on ► If the display message still appears, consult a qualified specialist workshop. |
|  <p>Check Coolant Level See Operator's Manual</p> | <ul style="list-style-type: none"> * The coolant level is too low. <div style="border: 1px solid black; padding: 5px; margin: 10px 0;"> <p>! NOTE Engine damage due to insufficient coolant</p> <ul style="list-style-type: none"> ► Avoid long journeys with insufficient coolant. </div> <ul style="list-style-type: none"> ► Add coolant (→ page 283). ► Have the engine cooling system checked at a qualified specialist workshop. |

| Display messages | Possible causes/consequences and ► Solutions |
|---|--|
|  <p data-bbox="144 339 421 391">Coolant Too Hot Stop Vehicle Turn Engine Off</p> | <p data-bbox="476 249 713 270">* The coolant is too hot.</p> <ul style="list-style-type: none"> <li data-bbox="495 280 1356 306">► Stop immediately in accordance with the traffic conditions and switch off the vehicle. <div data-bbox="495 332 1648 588" style="border: 1px solid gray; padding: 5px;"> <p data-bbox="506 339 1023 365">⚠ WARNING Risk of burns when opening the hood</p> <p data-bbox="506 381 1604 433">If you open the hood in the event of an overheated engine or fire in the engine compartment, the following situations may occur:</p> <ul style="list-style-type: none"> <li data-bbox="519 443 962 464">• You may come into contact with hot gases. <li data-bbox="519 474 1208 495">• You may come into contact with other escaping hot operating fluids. <ul style="list-style-type: none"> <li data-bbox="506 519 1097 539">► Before opening the hood, allow the engine to cool down. <li data-bbox="506 550 1474 570">► In the event of a fire in the engine compartment, keep the hood closed and call the fire service. </div> <ul style="list-style-type: none"> <li data-bbox="495 601 907 622">► Wait until the engine has cooled down. <li data-bbox="495 632 1134 653">► Make sure that the air supply to the radiator is not obstructed. <li data-bbox="495 664 1622 715">► Avoiding high loads on the engine, drive to the nearest qualified specialist workshop. In doing so, ensure that the coolant temperature display remains below the red marking. |
|  | <p data-bbox="476 743 999 764">* There is a malfunction in the engine cooling system.</p> <ul style="list-style-type: none"> <li data-bbox="495 774 1622 826">► Avoiding high loads on the engine, drive to the nearest qualified specialist workshop. In doing so, ensure that the coolant temperature display remains below the red marking. |



| Display messages | Possible causes/consequences and ► Solutions |
|---|---|
|  <p>Fuel Level Low</p> | <ul style="list-style-type: none"> * The fuel supply has dropped into the reserve range. <ul style="list-style-type: none"> ► Refuel. |
|  <p>Gas Cap Loose</p> | <ul style="list-style-type: none"> * The fuel filler cap is not closed correctly or the fuel system is leaking. <ul style="list-style-type: none"> ► Close the fuel filler cap. ► If the fuel filler cap was already properly closed: Consult a qualified specialist workshop. |

Transmission

| Display messages | Possible causes/consequences and ► Solutions |
|---|--|
| <p>Only Shift to 'P' when Vehicle is Stationary</p> | <ul style="list-style-type: none"> * It is possible to select the park position P only if the vehicle is stationary. <ul style="list-style-type: none"> ► Depress the brake pedal to stop. ► Shift the transmission to park position P when the vehicle is stationary. |
| <p>Apply Brake to Shift from 'P'</p> | <ul style="list-style-type: none"> * You have attempted to shift the transmission out of park position P and into another transmission position. <ul style="list-style-type: none"> ► Depress the brake pedal. ► Select transmission position D, R or neutral N. |





| Display messages | Possible causes/consequences and ► Solutions |
|---|--|
| To Deselect P or N, Depress Brake and Start Engine | <p>* You have attempted to shift the transmission out of park position P or neutral N and into another transmission position.</p> <ul style="list-style-type: none"> ► Depress the brake pedal. ► Start the vehicle. ► Change the transmission position. |
| Apply Brake to Shift to D or R | <p>* You have attempted to select transmission position D or R.</p> <ul style="list-style-type: none"> ► Depress the brake pedal. ► Select transmission position D or R. |
| Apply Brake to Shift to 'R' | <p>* You have attempted to select transmission position R.</p> <ul style="list-style-type: none"> ► Depress the brake pedal. ► Select transmission position R. |
| Driver's Door Open & Transmission Not in P Risk of Vehicle Rolling Away | <p>* The driver's door is not fully closed and transmission position D, R or neutral N is selected.</p> <p>The vehicle may roll away.</p> <ul style="list-style-type: none"> ► Select park position P when switching off the vehicle. |
| N Permanently Active Risk of Rolling Away | <p>* While the vehicle is rolling or while you are driving, neutral N has been engaged.</p> <ul style="list-style-type: none"> ► Depress the brake pedal to stop. ► Shift the transmission to park position P when the vehicle is stationary. ► To continue driving, select transmission position D or R. |





| Display messages | Possible causes/consequences and ► Solutions |
|--|---|
| Service Required Do Not Shift Gears Visit Dealer | <ul style="list-style-type: none"> * The transmission is malfunctioning. It is no longer possible to change the transmission position. <ul style="list-style-type: none"> ► If transmission position D is selected, consult a qualified specialist workshop and do not change the transmission position. ► For all other transmission positions, park the vehicle safely. ► Consult a qualified specialist workshop or breakdown service. |
| Reversing Not Possible Service Required | <ul style="list-style-type: none"> * The transmission is malfunctioning. It is not possible to select transmission position R. <ul style="list-style-type: none"> ► Consult a qualified specialist workshop. |
| Transmission Malfunction Stop | <ul style="list-style-type: none"> * The transmission is malfunctioning. The transmission shifts to neutral N automatically. <ul style="list-style-type: none"> ► Stop the vehicle immediately in accordance with the traffic conditions. ► Depress the brake pedal. ► Engage park position P. ► Consult a qualified specialist workshop. |
| Transmission Malfunction | <ul style="list-style-type: none"> * The transmission is malfunctioning. The cause could be an overheated clutch or blocked gears. <ul style="list-style-type: none"> ► Let the transmission cool down. ► If the display message still appears following a restart, consult a qualified specialist workshop. |

| Display messages | Possible causes/consequences and ► Solutions |
|---|--|
|  <p data-bbox="144 342 410 389">Transmission Oil Overheated Drive with Caution</p> | <p data-bbox="473 249 1637 301">* The transmission is overheating. When the display message is active, start-up and driving characteristics may be temporarily impaired.</p> <ul style="list-style-type: none"> <li data-bbox="495 311 787 332">► Drive at low engine speed. <li data-bbox="495 342 728 363">► Avoid sporty driving. <li data-bbox="495 373 1581 394">► Before pulling away on uphill gradients, let the transmission cool down until the display message disappears. |
|  <p data-bbox="144 513 395 560">Parking Lock Inoperative Apply Parking Brake</p> | <p data-bbox="473 420 1203 441">* The transmission is malfunctioning. Park position P cannot be selected.</p> <ul style="list-style-type: none"> <li data-bbox="495 451 750 472">► Park the vehicle safely. <li data-bbox="495 482 1230 503">► Use the electric parking brake to secure the vehicle against rolling away. |
| <p data-bbox="144 589 402 687">Teaching in Transmission Operate Selector Lever Apply Brake for XX s Risk of Vehicle Rolling Away</p> | <p data-bbox="473 586 1240 607">* The transmission is being taught in. There is a risk of the vehicle rolling away.</p> <ul style="list-style-type: none"> <li data-bbox="495 617 1319 669">► Depress and hold the brake pedal until the teach-in process has been completed. The electric parking brake is applied automatically during the teach-in process. <li data-bbox="495 679 741 700">► Switch on the vehicle. <li data-bbox="495 710 1156 731">► Select park position P, transmission position R or neutral N. |
| <p data-bbox="144 760 417 832">Apply Parking Brake Risk of Rolling Away See Operator's Manual</p> | <p data-bbox="473 757 1023 778">* The transmission position cannot be reliably identified.</p> <ul style="list-style-type: none"> <li data-bbox="495 788 1230 809">► Use the electric parking brake to secure the vehicle against rolling away. |





| Display messages | Possible causes/consequences and ► Solutions |
|---|--|
| Teaching in Transmission Complete | <ul style="list-style-type: none"> * The transmission's teach-in process is complete. All transmission positions can be selected again. |
| Transmission Malfunction Service Required | <ul style="list-style-type: none"> * The transmission is malfunctioning. Consult a qualified specialist workshop. |
| Auxiliary Battery Malfunction (white display message) | <ul style="list-style-type: none"> * The auxiliary battery for the automatic transmission is no longer being charged. <ul style="list-style-type: none"> ► Consult a qualified specialist workshop. ► Until then, always select park position P manually before you switch off the vehicle. ► Before leaving the vehicle, apply the electric parking brake. |
| Auxiliary Battery Malfunction (red display message) | <ul style="list-style-type: none"> * Vehicles with automatic transmission: The auxiliary battery for the transmission is no longer being charged. <ul style="list-style-type: none"> ► Consult a qualified specialist workshop. ► Vehicles with automatic transmission: Until then, always select park position P before you switch off the vehicle. ► Before leaving the vehicle, apply the electric parking brake. |

Brakes

| Display messages | Possible causes/consequences and ► Solutions |
|---|--|
| <div data-bbox="155 291 310 373" data-label="Image"> </div> <p data-bbox="155 381 255 407">(USA only)</p> <div data-bbox="155 418 310 501" data-label="Image"> </div> <p data-bbox="155 508 284 534">(Canada only)</p> <p data-bbox="144 541 406 591">Parking Brake See Operator's Manual</p> | <p data-bbox="476 288 1289 313">* The yellow  indicator lamp is lit. The electric parking brake is malfunctioning.</p> <p data-bbox="495 324 583 350">To apply:</p> <ul data-bbox="495 358 1086 417" style="list-style-type: none"> <li data-bbox="495 358 957 384">► Switch the vehicle off and switch it back on. <li data-bbox="495 391 1086 417">► Apply the electric parking brake manually (→ page 170). <p data-bbox="495 443 1018 469">If it is not possible to apply the electric parking brake:</p> <ul data-bbox="495 477 1206 536" style="list-style-type: none"> <li data-bbox="495 477 916 503">► Consult a qualified specialist workshop. <li data-bbox="495 510 1206 536">► Where necessary, also secure the parked vehicle against rolling away. <p data-bbox="476 547 1641 598">* The yellow  indicator lamp and the red  (USA only) or  (Canada only) indicator lamp are lit. The electric parking brake is malfunctioning.</p> <p data-bbox="495 609 602 635">To release:</p> <ul data-bbox="495 643 1108 702" style="list-style-type: none"> <li data-bbox="495 643 957 669">► Switch the vehicle off and switch it back on. <li data-bbox="495 676 1108 702">► Release the electric parking brake manually (→ page 170). <p data-bbox="495 712 513 738">or</p> <ul data-bbox="495 746 1151 772" style="list-style-type: none"> <li data-bbox="495 746 1151 772">► Release the electric parking brake automatically (→ page 170). <p data-bbox="495 774 1077 800">If it is still not possible to release the electric parking brake:</p> <ul data-bbox="495 809 1156 835" style="list-style-type: none"> <li data-bbox="495 809 1156 835">► Do not continue driving. Consult a qualified specialist workshop. |

| Display messages | Possible causes/consequences and ► Solutions |
|------------------|--|
| | <p>* The yellow  indicator lamp is lit and the red PARK (USA only) or  (Canada only) indicator lamp is flashing. The electric parking brake is malfunctioning.</p> <p>The electric parking brake could not be applied or released.</p> <ul style="list-style-type: none">► Switch the vehicle off and switch it back on. <p>To apply:</p> <ul style="list-style-type: none">► Release and then apply the electric parking brake manually (→ page 170). <p>To release:</p> <ul style="list-style-type: none">► Apply and then release the electric parking brake manually. <p>If the electric parking brake cannot be applied or the red PARK (USA only) or  (Canada only) indicator lamp continues to flash:</p> <ul style="list-style-type: none">► Do not continue driving. Consult a qualified specialist workshop.► Where necessary, also secure the parked vehicle against rolling away. <p>* The yellow  indicator lamp is lit and the red PARK (USA only) or  (Canada only) indicator lamp flashes for approximately ten seconds after the electric parking brake has been applied or released. It then remains lit or goes out. The electric parking brake is malfunctioning.</p> <p>If the state of charge is too low:</p> <ul style="list-style-type: none">► Charge the 12 V battery. |

| Display messages | Possible causes/consequences and ► Solutions |
|------------------|---|
| | <p>To apply:</p> <ul style="list-style-type: none">► Switch off the vehicle. The electric parking brake will be applied automatically. <p>If you do not want the electric parking brake to be applied, e.g. at an automatic car wash or when the vehicle is being towed, leave the vehicle switched on. This does not include having the vehicle towed with the rear axle raised.</p> <p>If the electric parking brake is not applied automatically:</p> <ul style="list-style-type: none">► Switch the vehicle off and switch it back on.► Release and then apply the electric parking brake manually (→ page 170). <p>If it is still not possible to apply the electric parking brake:</p> <ul style="list-style-type: none">► Consult a qualified specialist workshop.► Where necessary, also secure the parked vehicle against rolling away. <p>To release:</p> <ul style="list-style-type: none">► If the conditions for automatic release are fulfilled and the electric parking brake is not released automatically, release the electric parking brake manually (→ page 170). <p>If it is still not possible to release the electric parking brake:</p> <ul style="list-style-type: none">► Do not continue driving. Consult a qualified specialist workshop. |



| Display messages | Possible causes/consequences and ► Solutions |
|--|---|
|  <p>(USA only)</p>  <p>(Canada only)</p> <p>Please Release Parking Brake</p> | <p>* The red  indicator lamp (USA only) or  indicator lamp (Canada only) is flashing. The electric parking brake is applied while you are driving:</p> <ul style="list-style-type: none">• A condition for automatic release of the electric parking brake has not been fulfilled (→ page 170).• You are performing emergency braking using the electric parking brake (→ page 171). <p>► Check the conditions for automatic release of the electric parking brake.</p> <p>► Release the electric parking brake manually.</p> |

| Display messages | Possible causes/consequences and ► Solutions |
|--|---|
| <div data-bbox="155 252 310 332" data-label="Image"></div> <div data-bbox="155 342 255 366" data-label="Text"><p>(USA only)</p></div> <div data-bbox="155 379 310 458" data-label="Image"></div> <div data-bbox="155 469 284 493" data-label="Text"><p>(Canada only)</p></div> <div data-bbox="147 503 410 552" data-label="Text"><p>Turn On the Ignition to Release the Parking Brake</p></div> | <div data-bbox="473 249 1332 339" data-label="List-Group"> <ul style="list-style-type: none"> * The red PARK (USA only) or (P) (Canada only) indicator lamp is lit. You have attempted to release the electric parking brake with the vehicle switched off. <ul style="list-style-type: none"> ► Switch on the vehicle. </div> |
| <div data-bbox="155 584 310 664" data-label="Image"></div> <div data-bbox="147 671 247 695" data-label="Text"><p>(USA only)</p></div> <div data-bbox="155 707 310 787" data-label="Image"></div> <div data-bbox="147 797 277 821" data-label="Text"><p>(Canada only)</p></div> <div data-bbox="147 831 384 855" data-label="Text"><p>Check Brake Fluid Level</p></div> | <div data-bbox="473 578 1055 601" data-label="List-Group"> <ul style="list-style-type: none"> * There is insufficient brake fluid in the brake fluid reservoir. </div> <div data-bbox="500 622 1650 835" data-label="Complex-Block"> <div style="background-color: #f0f0f0; padding: 5px;"> <p>▲ WARNING Risk of an accident due to low brake fluid level</p> <p>If the brake fluid level is too low, the braking effect and the braking characteristics may be impaired.</p> <ul style="list-style-type: none"> ► Pull over and stop the vehicle safely as soon as possible, paying attention to road and traffic conditions. Do not continue driving under any circumstances. ► Consult a qualified specialist workshop. ► Do not add brake fluid. </div> </div> |



| Display messages | Possible causes/consequences and ► Solutions |
|---|--|
| <p>Check Brake Pads See Operator's Manual</p> | <p>* The brakepads have reached the wear limit. ► Consult a qualified specialist workshop.</p> |



Driving and driving safety systems

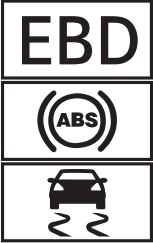

| Display messages | Possible causes/consequences and ► Solutions |
|--|--|
| <div data-bbox="203 450 360 533" data-label="Image"> </div> <div data-bbox="203 538 360 621" data-label="Image"> </div> <p>Currently Unavailable See Operator's Manual</p> | <p>* ABS and ESP[®] are temporarily unavailable. Other driving systems and driving safety systems (e.g. BAS) may also be temporarily unavailable. The brake system will continue to operate normally. Braking distance may increase in an emergency braking situation.</p> <div data-bbox="545 564 1690 606" data-label="Text"> <p>⚠ WARNING Risk of skidding if ABS and ESP[®] are malfunctioning</p> </div> <p>The wheels may lock during braking and ESP[®] does not perform any vehicle stabilization. The steerability and braking characteristics are heavily impaired and the braking distance may increase. In addition, other driving safety systems are switched off.</p> <ul style="list-style-type: none"> ► Drive carefully on a suitable stretch of road, making slight steering movements at a speed above 19 mph (30 km/h). ► If the display message does not disappear, consult a qualified specialist workshop immediately. Drive carefully. |

| Display messages | Possible causes/consequences and ► Solutions |
|--|---|
|  <p data-bbox="144 425 417 474">Inoperative See Operator's Manual</p> | <p data-bbox="476 249 1641 346">* ABS and ESP® are malfunctioning. Other driving systems and driving safety systems (e.g. BAS) may also be malfunctioning. The brake system will continue to operate normally. Braking distance may increase in an emergency braking situation.</p> <div data-bbox="500 363 1646 581" style="border: 1px solid gray; padding: 5px;"> <p data-bbox="506 370 1166 399">▲ WARNING Risk of skidding if ABS and ESP® are malfunctioning</p> <p data-bbox="513 415 1387 439">The wheels may block during braking and ESP® does not perform any vehicle stabilization.</p> <p data-bbox="513 449 1600 498">The steerability and braking characteristics are heavily impaired and the braking distance may increase. In addition, other driving safety systems are switched off.</p> <ul data-bbox="513 508 1289 570" style="list-style-type: none"> <li data-bbox="513 508 722 532">► Drive on carefully. <li data-bbox="513 542 1289 570">► Have ABS and ESP® checked immediately at a qualified specialist workshop. </div> |
|  <p data-bbox="144 692 408 740">Currently Unavailable See Operator's Manual</p> | <p data-bbox="476 598 1350 660">* ESP® is temporarily unavailable. Other driving systems and driving safety systems (e.g. BAS) may also be malfunctioning.</p> <div data-bbox="500 678 1646 850" style="border: 1px solid gray; padding: 5px;"> <p data-bbox="506 685 1060 714">▲ WARNING Risk of skidding if ESP is malfunctioning®</p> <p data-bbox="513 730 1618 779">If ESP® is malfunctioning, ESP® cannot carry out vehicle stabilization. In addition, other driving safety systems are switched off.</p> <ul data-bbox="513 789 1563 841" style="list-style-type: none"> <li data-bbox="513 789 1563 841">► Drive carefully on a suitable stretch of road, making slight steering movements at a speed above 19 mph (30 km/h). </div> |



| Display messages | Possible causes/consequences and ► Solutions |
|--|---|
| | <ul style="list-style-type: none"> ► If the display message does not disappear, consult a qualified specialist workshop immediately. Drive carefully. |
|  <p data-bbox="195 425 469 474">Inoperative See Operator's Manual</p> | <p data-bbox="526 334 778 360">* ESP® is malfunctioning.</p> <p data-bbox="543 368 1400 394">Other driving systems and driving safety systems (e.g. BAS) may also be malfunctioning.</p> <p data-bbox="543 403 1692 428">The brake system will continue to operate normally. Braking distance may increase in an emergency braking situation.</p> <div data-bbox="550 446 1700 487" style="background-color: #f0f0f0; padding: 5px;"> <p data-bbox="559 454 1114 480">▲ WARNING Risk of skidding if ESP® is malfunctioning</p> </div> <p data-bbox="559 498 1670 550">If ESP® is malfunctioning, ESP® cannot carry out vehicle stabilization. In addition, other driving safety systems are switched off.</p> <ul style="list-style-type: none"> ► Drive on carefully. ► Have ESP® checked at a qualified specialist workshop. |

| Display messages | Possible causes/consequences and ► Solutions |
|--|---|
|  <p data-bbox="144 511 417 560">Inoperative See Operator's Manual</p> | <p data-bbox="473 249 1350 311">* EBD, ABS and ESP® are malfunctioning. Other driving systems and driving safety systems (e.g. BAS) may also be malfunctioning.</p> <div data-bbox="500 327 1648 547" style="border: 1px solid gray; padding: 5px;"> <p data-bbox="506 337 1221 365">▲ WARNING Risk of skidding if EBD, ABS and ESP® are malfunctioning</p> <p data-bbox="511 381 1391 407">The wheels may block during braking and ESP® does not perform any vehicle stabilization.</p> <p data-bbox="511 415 1600 467">The steerability and braking characteristics are heavily impaired and the braking distance may increase. In addition, other driving safety systems are switched off.</p> <ul style="list-style-type: none"> <li data-bbox="511 477 722 503">▶ Drive on carefully. <li data-bbox="511 511 1313 537">▶ Have the brake system checked immediately at a qualified specialist workshop. </div> |
|  <p data-bbox="144 677 181 703">Off</p> | <p data-bbox="473 588 1541 614">* The HOLD function is deactivated because the vehicle is slipping or a condition for activation is not fulfilled.</p> <ul style="list-style-type: none"> <li data-bbox="491 622 1578 648">▶ Reactivate the HOLD function later or check the activation conditions for the HOLD function (→ page 178). |
|  <p data-bbox="144 822 417 871">ATTENTION ASSIST Inoperative</p> | <p data-bbox="473 729 861 755">* ATTENTION ASSIST is malfunctioning.</p> <ul style="list-style-type: none"> <li data-bbox="491 763 916 789">▶ Consult a qualified specialist workshop. |

| Display messages | Possible causes/consequences and ► Solutions |
|--|--|
|  <p data-bbox="194 341 471 393">ATTENTION ASSIST: Take a Break!</p> | <ul style="list-style-type: none"> * ATTENTION ASSIST has detected fatigue or an increasing lack of concentration on the part of the driver (→ page 180). <ul style="list-style-type: none"> ► If necessary, take a break. |
|  <p data-bbox="194 512 286 533">--- mph</p> | <ul style="list-style-type: none"> * Cruise control cannot be activated as not all activation conditions are fulfilled. <ul style="list-style-type: none"> ► Observe the activation conditions for cruise control (→ page 182). |
| <p data-bbox="194 559 462 580">Cruise Control Inoperative</p> | <ul style="list-style-type: none"> * Cruise control is malfunctioning. <ul style="list-style-type: none"> ► Consult a qualified specialist workshop. |
| <p data-bbox="194 637 378 657">Cruise Control Off</p> | <ul style="list-style-type: none"> * Cruise control has been deactivated. <ul style="list-style-type: none"> If there is an additional warning tone, cruise control has been deactivated automatically (→ page 181). |
| <p data-bbox="194 709 425 782">Traffic Sign Assist Currently Unavailable See Operator's Manual</p> | <ul style="list-style-type: none"> * Traffic Sign Assist is temporarily unavailable. <ul style="list-style-type: none"> Once the cause of the problem is no longer present, the system will be available again. ► Continue driving in compliance with traffic regulations. |
| <p data-bbox="194 818 462 870">Traffic Sign Assist Inoperative</p> | <ul style="list-style-type: none"> * Traffic Sign Assist is malfunctioning. <ul style="list-style-type: none"> ► Continue driving in compliance with traffic regulations. |

| Display messages | Possible causes/consequences and ► Solutions |
|---|--|
| | <p>or</p> <ul style="list-style-type: none"> ► Stop the vehicle in accordance with the traffic conditions and restart the vehicle. ► If the display message does not disappear: consult a qualified specialist workshop. |
|  <p>Inoperative</p> | <ul style="list-style-type: none"> * The Downhill Speed Regulation is malfunctioning. ► Consult a qualified specialist workshop. |
|  <p>Max. Speed 25 mph</p> | <ul style="list-style-type: none"> * The maximum speed of 25 mph (40 km/h) for the Downhill Speed Regulation has been exceeded. ► Drive more slowly. |
|  <p>Not in the Current Drive Program</p> | <ul style="list-style-type: none"> * The Downhill Speed Regulation is not available in the currently selected drive program. ► Change the drive program. |

Driver assistance systems





| Display messages | Possible causes/consequences and ► Solutions |
|--|--|
|  <p>--- mph</p> | <ul style="list-style-type: none"> * Active Distance Assist DISTRONIC cannot be activated as not all activation conditions are fulfilled. <ul style="list-style-type: none"> ► Comply with the activation conditions of Active Distance Assist DISTRONIC (→ page 186). |
|  <p>Suspended</p> | <ul style="list-style-type: none"> * If you depress the accelerator pedal beyond the setting of Active Distance Assist DISTRONIC, the system will switch to passive mode (→ page 183). |
|  <p>Off</p> | <ul style="list-style-type: none"> * Active Distance Assist DISTRONIC was deactivated. If a warning tone also sounds, Active Distance Assist DISTRONIC has deactivated automatically (→ page 186). |
| <p>Active Distance Assist Currently Unavailable See Operator's Manual</p> | <ul style="list-style-type: none"> * Active Distance Assist DISTRONIC is temporarily unavailable. The ambient conditions are outside the system limits (→ page 183). As soon as the ambient conditions are within the system limits, the system will become available again. <ul style="list-style-type: none"> ► Drive on carefully. or |







| Display messages | Possible causes/consequences and ► Solutions |
|--|---|
| | <p>► If the display message does not disappear, stop the vehicle in accordance with the traffic conditions and restart the vehicle.</p> |
| <p>Active Distance Assist Inoperative</p> | <p>* Active Distance Assist DISTRONIC is malfunctioning. Other driving systems and driving safety systems may also be malfunctioning.</p> <p>► Drive on carefully. or ► Stop the vehicle in accordance with the traffic conditions and restart the vehicle. ► If the display message does not disappear: consult a qualified specialist workshop.</p> |
| <p>Active Distance Assist Now Available</p> | <p>* Active Distance Assist DISTRONIC is operational again. ► Switch on Active Distance Assist DISTRONIC (→ page 186).</p> |
| <p>Active Brake Assist Functions Limited See Operator's Manual</p> | <p>* For vehicles with the Driving Assistance Package, the following functions may be temporarily unavailable or only partially available:</p> <ul style="list-style-type: none"> • Active Brake Assist with cross-traffic function • Evasive Steering Assist • PRE-SAFE® PLUS <p>Vehicles without the Driving Assistance Package: Active Brake Assist is temporarily unavailable or only partially available.</p> <p>► Drive on carefully.</p> |

| Display messages | Possible causes/consequences and ► Solutions |
|--|--|
| | <p>or</p> <ul style="list-style-type: none"> ► Stop the vehicle in accordance with the traffic conditions and restart the vehicle. ► If the display message does not disappear: consult a qualified specialist workshop. |
| <p>Active Steering Assist Currently Unavailable See Operator's Manual</p> | <ul style="list-style-type: none"> * Active Steering Assist is temporarily unavailable. The ambient conditions are outside the system limits (→ page 191). As soon as the ambient conditions are within the system limits, the system will become available again. ► Drive on ► Check the tire pressure if necessary. |
| <p>Active Steering Assist Inoperative</p> | <ul style="list-style-type: none"> * Active Steering Assist is malfunctioning. Active Distance Assist DISTRONIC remains available. ► Drive on <p>or</p> <ul style="list-style-type: none"> ► Stop the vehicle in accordance with the traffic conditions and restart the vehicle. ► If the display message does not disappear: consult a qualified specialist workshop. |
| <p>Active Steering Asst. Currently Unavailable Due to Multiple Emergency Stops</p> | <ul style="list-style-type: none"> * Active Steering Assist is temporarily unavailable due to multiple emergency stops. ► Take over the steering and stop in accordance with the traffic conditions. ► Switch the vehicle off and switch it back on. Active Steering Assist is available once more. |
| <p>Beginning Emergency Stop</p> | <ul style="list-style-type: none"> * Your hands are not on the steering wheel. An emergency stop is being initiated (→ page 193). |

| Display messages | Possible causes/consequences and ► Solutions |
|---|---|
| | <ul style="list-style-type: none"> ► Put your hands back on the steering wheel. <p>You can cancel the deceleration at any time by performing one of the following actions:</p> <ul style="list-style-type: none"> • Steering • Braking or accelerating • Deactivating Active Distance Assist DISTRONIC |
|  | <ul style="list-style-type: none"> * Active Steering Assist has reached the system limits (→ page 191). You have not steered independently for a considerable period of time. ► Take over the steering and drive on in accordance with the traffic conditions. |
| <p>Blind Spot Assist Currently Unavailable See Operator's Manual</p> | <ul style="list-style-type: none"> * Blind Spot Assist is temporarily unavailable. The system limits have been reached (→ page 204). Once the cause of the problem is no longer present, the system will be available again. ► Drive on or ► If the display message does not disappear, stop the vehicle in accordance with the traffic conditions and restart the vehicle. |
| <p>Blind Spot Assist Inoperative</p> | <ul style="list-style-type: none"> * Blind Spot Assist is malfunctioning. ► Drive on or |

| Display messages | Possible causes/consequences and ► Solutions |
|---|---|
| <p>Active Blind Spot Assist Currently Unavailable See Operator's Manual</p> | <ul style="list-style-type: none"> ► Stop the vehicle in accordance with the traffic conditions and restart the vehicle. ► If the display message does not disappear: consult a qualified specialist workshop. <p>* Active Blind Spot Assist is temporarily unavailable. The system limits have been reached (→ page 204). Once the cause of the problem is no longer present, the system will be available again.</p> <ul style="list-style-type: none"> ► Drive on or ► If the display message does not disappear, stop the vehicle in accordance with the traffic conditions and restart the vehicle. |
| <p>Active Blind Spot Assist Inoperative</p> | <p>* Active Blind Spot Assist is malfunctioning.</p> <ul style="list-style-type: none"> ► Drive on or ► Stop the vehicle in accordance with the traffic conditions and restart the vehicle. ► If the display message does not disappear: consult a qualified specialist workshop. |
| <p>Active Lane Keeping Assist Currently Unavailable See Operator's Manual</p> | <p>* Active Lane Keeping Assist is temporarily unavailable. The ambient conditions are outside the system limits (→ page 207). As soon as the ambient conditions are within the system limits, the system will become available again.</p> <ul style="list-style-type: none"> ► Drive on |

| Display messages | Possible causes/consequences and ► Solutions |
|---|--|
| <p>Active Lane Keeping Assist Inoperative</p> | <p>* Active Lane Keeping Assist is malfunctioning.</p> <ul style="list-style-type: none"> ► Drive on <p>or</p> <ul style="list-style-type: none"> ► Stop the vehicle in accordance with the traffic conditions and restart the vehicle. ► If the display message does not disappear: consult a qualified specialist workshop. |
| <div style="display: flex; flex-direction: column; align-items: center;">     </div> <p>Temporarily Unavailable Sensors are Dirty</p> | <p>* Front and corner radar sensors (hereafter "sensors") are malfunctioning. Possible causes:</p> <ul style="list-style-type: none"> • The sensors are dirty • Heavy rain or snow • Extended country driving without other traffic, e.g. in the desert <p>Driving systems and driving safety systems may be malfunctioning or temporarily unavailable. The brake system, steering and drive system will continue to function normally.</p> <ul style="list-style-type: none"> ► Drive on carefully. <p>Once the causes of the problem are no longer present, the driving systems and driving safety systems will be available again and the corresponding symbols will be switched off.</p> <p>If the display message does not disappear:</p> <ul style="list-style-type: none"> ► Pull over and stop the vehicle safely as soon as possible, paying attention to road and traffic conditions. ► Clean all sensor covers from outside (→ page 173). ► Restart the vehicle. |

| Display messages | Possible causes/consequences and ► Solutions |
|---|--|
|  <p data-bbox="194 678 443 730">Temporarily Unavailable Camera View Restricted</p> | <p data-bbox="526 248 1201 274">* The view of the multifunction camera is restricted. Possible causes:</p> <ul data-bbox="545 279 1663 404" style="list-style-type: none"> • Dirt on the windshield in the field of vision of the multifunction camera • Heavy rain, snow or fog • Fog on the inside of the windshield: in certain weather conditions, fog can form on the inside of the windshield during cold times of year in particular. <p data-bbox="545 414 1681 471">  This fog on the windshield will be removed automatically within a short time with the aid of a heater. The restriction is temporary. </p> <p data-bbox="545 481 1700 533">Driving systems and driving safety systems may be malfunctioning or temporarily unavailable. The brake system, steering and drive system will continue to function normally.</p> <p data-bbox="545 538 757 564">  Drive on carefully. </p> <p data-bbox="545 590 1700 642">Once the causes of the problem are no longer present, the driving systems and driving safety systems will be available again and the corresponding symbols will be switched off.</p> <p data-bbox="545 652 960 678">If the display message does not disappear:</p> <ul data-bbox="545 683 1589 782" style="list-style-type: none">  Pull over and stop the vehicle safely as soon as possible, paying attention to road and traffic conditions.  Clean the windshield, especially in the position of the multifunction camera (→ page 173).  Restart the vehicle. |
| <p data-bbox="194 797 471 875">Active Brake Assist Functions Currently Limited See Operator's Manual</p> | <p data-bbox="526 797 1700 849">* Vehicles with the Driving Assistance Package: Active Brake Assist with cross-traffic function, Evasive Steering Assist or PRE-SAFE® PLUS are temporarily unavailable or only partially available.</p> <p data-bbox="545 859 1478 885">Vehicles without the Driving Assistance Package: Active Brake Assist is temporarily unavailable.</p> |

398 Display messages and warning/indicator lamps

| Display messages | Possible causes/consequences and ► Solutions |
|--|---|
| | <ul style="list-style-type: none">► Drive on carefully. As soon as the ambient conditions are within the system limits, the system will become available again.or► If the display message does not disappear, stop the vehicle in accordance with the traffic conditions and restart the vehicle. |
| PRE-SAFE Inoperative See Operator's Manual | <ul style="list-style-type: none">* The PRE-SAFE® functions are malfunctioning.► Consult a qualified specialist workshop. |

Parking assistance systems



| Display messages | Possible causes/consequences and ► Solutions |
|---|--|
| Parking Assist and PARKTRONIC Inoperative See Operator's Manual | <ul style="list-style-type: none">* Vehicles with Active Parking Assist: Active Parking Assist and Parking Assist PARKTRONIC are malfunctioning.Vehicles without Active Parking Assist: Parking Assist PARKTRONIC is malfunctioning.► Stop the vehicle in accordance with the traffic conditions and restart the vehicle.► If the display message still appears, consult a qualified specialist workshop. |

Mercedes-Benz emergency call system

| Display messages | Possible causes/consequences and ► Solutions |
|--|---|
|  <p>Inoperative</p> | <p>* The Mercedes-Benz emergency call system is malfunctioning. The Mercedes me connect system is also malfunctioning.</p> <ul style="list-style-type: none"> ► Consult a qualified specialist workshop. |
| <p>Device Detected at Diagnostics Connection See Operator's Manual</p> | <p>* The vehicle functions for malfunction detection are restricted. At least one of the main functions of the Mercedes me connect system is malfunctioning.</p> <ul style="list-style-type: none"> ► Observe the notes on the diagnostics connection (→ page 28). ► Consult a qualified specialist workshop. |

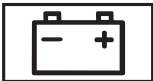
Battery



| Display messages | Possible causes/consequences and ► Solutions |
|---|---|
|  <p>12 V Battery See Operator's Manual</p> | <p>* The vehicle is off and the state of charge of the 12 V battery is too low.</p> <ul style="list-style-type: none"> ► Switch off electrical consumers that are not required. ► Drive for 30–60 mins. <p>or</p> <ul style="list-style-type: none"> ► Charge the 12 V battery when stationary (→ page 305). |

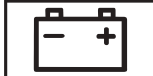

| Display messages | Possible causes/consequences and ► Solutions |
|---|--|
|  <p>See Operator's Manual</p> | <p>* If the message appears while the vehicle is switched on, this indicates an on-board electrical system malfunction.</p> <ul style="list-style-type: none"> ► Consult a qualified specialist workshop. <p>* The 12 V battery is not being charged.</p> <div style="border: 1px solid black; padding: 5px; margin-bottom: 10px;"> <p>! NOTE Possible engine damage if you continue driving</p> <ul style="list-style-type: none"> ► Do not continue driving under any circumstances. ► Consult a qualified specialist workshop. </div> <ul style="list-style-type: none"> ► Stop immediately in accordance with the traffic conditions and switch off the vehicle. ► Consult a qualified specialist workshop. |
|  <p>Stop Vehicle See Operator's Manual</p> | <p>* The 12 V battery is no longer being charged and the condition of charge is too low.</p> <div style="border: 1px solid black; padding: 5px; margin-bottom: 10px;"> <p>! NOTE Possible engine damage if you continue driving</p> <ul style="list-style-type: none"> ► Do not continue driving under any circumstances. ► Consult a qualified specialist workshop. </div> <ul style="list-style-type: none"> ► Stop the vehicle immediately in accordance with the traffic conditions. Do not continue driving under any circumstances. ► Switch off the vehicle. ► Consult a qualified specialist workshop. |

| Display messages | Possible causes/consequences and ► Solutions |
|--|---|
|  <p data-bbox="194 341 462 388">Stop Vehicle Leave Engine Running</p> | <ul style="list-style-type: none"> <li data-bbox="526 248 1025 274">* The state of charge of the 12 V battery is too low. <li data-bbox="545 284 1681 331">► Stop the vehicle immediately in accordance with the traffic conditions. Do not continue driving under any circumstances. <li data-bbox="545 347 831 372">► Leave the engine running. <li data-bbox="545 383 1007 409">► If the display message disappears: drive on. <li data-bbox="545 419 1376 445">► If the display message does not disappear: consult a qualified specialist workshop. |



Tire pressure monitor

| Display messages | Possible causes/consequences and ► Solutions |
|--|--|
| <p data-bbox="194 580 434 626">Tire Press. Monitor Currently Unavailable</p> | <ul style="list-style-type: none"> <li data-bbox="526 580 1644 631">* There is interference from a powerful radio signal source As a result, no signals from the tire pressure sensor are being received. The tire pressure monitoring system is temporarily unavailable. The tire pressure monitoring system will restart automatically as soon as the cause has been rectified. <li data-bbox="545 673 665 699">► Drive on |
| <p data-bbox="194 714 471 761">Tire Press. Monitor Inoperative</p> | <ul style="list-style-type: none"> <li data-bbox="526 714 1071 740">* The tire pressure monitoring system is malfunctioning. <div data-bbox="545 761 1690 859" style="border: 1px solid gray; padding: 5px;"> <p data-bbox="554 766 1533 792">⚠ WARNING There is a risk of an accident if the tire pressure monitoring system is malfunctioning</p> <p data-bbox="554 802 1644 859">The tire pressure monitoring system cannot issue a warning if there is pressure loss in one or more of the tires. Tires with insufficient tire pressure may impair the driving characteristics as well as steering and braking.</p> </div> |

| Display messages | Possible causes/consequences and ► Solutions |
|--|---|
| | <p>► Have the tire pressure monitoring system checked at a qualified specialist workshop.</p> |
| <p>Tire Pressure Monitor Inoperative No Wheel Sensors</p> | <p>* The wheels installed do not have suitable tire pressure sensors. The tire pressure monitoring system is deactivated.</p> <p>► Install wheels with suitable tire pressure sensors.</p> |
|  <p>Wheel Sensor(s) Missing</p> | <p>* There is no signal from the tire pressure sensor in at least one wheel. No pressure value is displayed for the affected tire.</p> <p>► Have the faulty tire pressure sensor replaced at a qualified specialist workshop.</p> |
|  <p>Check Tires</p> | <p>* The tire pressure in one or more tires has dropped significantly. The wheel position is displayed. A warning tone will also sound.</p> <p>⚠ WARNING Risk of an accident due to insufficient tire pressure</p> <ul style="list-style-type: none"> • The tires can burst. • The tires can wear excessively and/or unevenly. • The driving characteristics as well as the steering and braking may be greatly impaired. <p>You could then lose control of the vehicle.</p> <p>► Observe the recommended tire pressures.</p> <p>► Adjust the tire pressure if necessary.</p> |

| Display messages | Possible causes/consequences and ► Solutions |
|---|--|
|  <p data-bbox="195 417 445 466">Please Correct Tire Pressure</p> | <ul style="list-style-type: none"> ► Stop the vehicle in accordance with the traffic conditions. ► Check the tire pressure (→ page 315) and the tires. <p data-bbox="526 325 1690 373">* The tire pressure is too low in at least one of the tires, or the difference in tire pressure between the individual wheels is too great.</p> <ul style="list-style-type: none"> ► Check the tire pressure and add air, if necessary. ► When the tire pressure is correct, restart the tire pressure monitor (→ page 320). |
|  <p data-bbox="195 585 445 609">Warning Tire Malfunction</p> | <p data-bbox="526 493 1406 518">* The pressure in one or more tires has dropped suddenly. The wheel position is displayed.</p> <div data-bbox="550 533 1696 823" style="border: 1px solid gray; padding: 5px;"> <p data-bbox="559 543 1160 569">⚠ WARNING Risk of an accident from driving with a flat tire</p> <ul style="list-style-type: none"> • The tires can overheat and be damaged. • The driving characteristics as well as the steering and braking characteristics may be greatly impaired. <p data-bbox="559 660 972 683">You could then lose control of the vehicle.</p> <ul style="list-style-type: none"> ► Do not drive with a flat tire. ► Do not exceed the maximum permissible driving distance in emergency mode and the maximum permissible speed with a flat MOExtended tire. ► Observe the notes on flat tires. </div> <p data-bbox="545 842 872 865">Notes on flat tires (→ page 296).</p> |

404 Display messages and warning/indicator lamps



| Display messages | Possible causes/consequences and ► Solutions |
|---|--|
| | <ul style="list-style-type: none">► Stop the vehicle in accordance with the traffic conditions.► Check the tires. |
|  <p>Tires Overheated</p> | <p>* At least one tire is overheating. The affected tires are displayed in red. At temperatures close to the limit value, the tires are displayed in yellow.</p> <p>▲ WARNING Risk of an accident from driving with overheated tires</p> <p>Overheated tires can burst.</p> <ul style="list-style-type: none">► Reduce speed so that the tires cool down. |
|  <p>Decrease Speed</p> | <p>* At least one tire is overheating. The affected tires are displayed in red. At temperatures close to the limit value, the tires are displayed in yellow.</p> <p>▲ WARNING Risk of an accident from driving with overheated tires</p> <p>Overheated tires can burst.</p> <ul style="list-style-type: none">► Reduce speed so that the tires cool down. |

Tire pressure loss warning system

| Display messages | Possible causes/consequences and ► Solutions |
|--------------------------|--|
| Check Tire Pressure Soon | * Canada only: |

| Display messages | Possible causes/consequences and ► Solutions |
|---|--|
| | <p>The tire pressure loss warning system has detected a significant loss of pressure.</p> <div style="border: 1px solid gray; padding: 5px;"> <p>▲ WARNING Risk of an accident due to insufficient tire pressure</p> <ul style="list-style-type: none"> • The tires can burst. • The tires can wear excessively and/or unevenly. • The driving characteristics as well as the steering and braking may be greatly impaired. <p>You could then lose control of the vehicle.</p> <ul style="list-style-type: none"> ► Observe the recommended tire pressures. ► Adjust the tire pressure if necessary. </div> <ul style="list-style-type: none"> ► Stop the vehicle in accordance with the traffic conditions. ► Check the tire pressure (→ page 315) and the tires. ► When the tire pressure is correct, restart the tire pressure loss warning system (→ page 321). |
| Check Tire Pressure Then Restart Run Flat Indicator | <p>* Canada only: The tire pressure loss warning system generated a display message and has not been restarted since.</p> <ul style="list-style-type: none"> ► When the tire pressure is correct, restart the tire pressure loss warning system (→ page 321). |
| Run Flat Indicator Inoperative | <p>* Canada only: The tire pressure loss warning system is malfunctioning.</p> <ul style="list-style-type: none"> ► Consult a qualified specialist workshop. |

Engine oil

| Display messages | Possible causes/consequences and ► Solutions |
|--|---|
|  <p data-bbox="144 408 376 456">Check Engine Oil Level (Add 1 quart)</p> | <p data-bbox="476 314 1023 335">* The engine oil level has dropped to the minimum level.</p> <div data-bbox="500 356 1646 439" style="border: 1px solid gray; padding: 5px;"> <p data-bbox="506 366 1203 387">! NOTE Engine damage caused by driving with insufficient engine oil</p> <p data-bbox="506 408 1005 428">► Avoid long journeys with insufficient engine oil.</p> </div> <p data-bbox="495 459 1193 480">► When next refueling, add 1.1 US qt (1 l) of engine oil (→ page 282).</p> <p data-bbox="495 501 833 522">Notes on engine oil (→ page 352).</p> |
|  <p data-bbox="144 636 421 656">Engine Oil Reduce Oil Level</p> | <p data-bbox="476 542 796 563">* The engine oil level is too high.</p> <div data-bbox="500 584 1646 667" style="border: 1px solid gray; padding: 5px;"> <p data-bbox="506 594 1160 615">! NOTE Engine damage caused by driving with excess engine oil</p> <p data-bbox="506 636 962 656">► Avoid long journeys with excess engine oil.</p> </div> <p data-bbox="495 687 1406 708">► Consult a qualified specialist workshop immediately and have the engine oil level reduced.</p> |
|  <p data-bbox="144 822 408 871">Engine Oil Level Low Stop Vehicle Turn Engine Off</p> | <p data-bbox="476 729 783 750">* The engine oil level is too low.</p> <div data-bbox="500 770 1646 853" style="border: 1px solid gray; padding: 5px;"> <p data-bbox="506 781 1203 801">! NOTE Engine damage caused by driving with insufficient engine oil</p> <p data-bbox="506 822 1005 843">► Avoid long journeys with insufficient engine oil.</p> </div> |

| Display messages | Possible causes/consequences and ► Solutions |
|--|---|
| | <ul style="list-style-type: none"> ► Stop the vehicle immediately in accordance with the traffic conditions. Do not continue driving under any circumstances. ► Switch off the vehicle. ► Add 1.1 US qt (1 l) of engine oil (→ page 282). ► Check the engine oil level. <p>Notes on engine oil (→ page 352).</p> |
| <div style="text-align: center;">  </div> <p>Engine Oil Pressure Stop Switch Off Engine</p> | <p>* The oil pressure is too low.</p> <div style="border: 1px solid black; padding: 5px; margin: 5px 0;"> <p>! NOTE Engine damage caused by driving with insufficient oil pressure</p> <ul style="list-style-type: none"> ► Avoid driving with insufficient oil pressure. </div> <ul style="list-style-type: none"> ► Stop the vehicle immediately in accordance with the traffic conditions. Do not continue driving under any circumstances. ► Switch off the vehicle. ► Consult a qualified specialist workshop. |

| Display messages | Possible causes/consequences and ► Solutions |
|--|--|
|  <p data-bbox="144 339 417 391">Engine Oil Level Cannot Be Measured</p> | <ul style="list-style-type: none"> <li data-bbox="473 249 1461 275">* The electrical connection to the oil level sensor has been interrupted or the oil level sensor is faulty. <li data-bbox="495 283 916 309">► Consult a qualified specialist workshop. |

Warning and indicator lamps

Overview of indicator and warning lamps

Some systems will perform a self-test when the vehicle is switched on. Some indicator and warning lamps may briefly light up or flash. This behavior is non-critical. These indicator and warning lamps indicate a malfunction only if they light up or flash after the vehicle has been started or during a journey.

Standard instrument display



Widescreen cockpit instrument display



Indicator and warning lamps

Occupant safety

 Restraint system (→ page 410)

 Seat belt (→ page 410)

Vehicle

 Power steering (→ page 411)

Engine

 Vehicles with a widescreen cockpit: coolant temperature (→ page 412)

 Engine diagnosis (→ page 412)

 Electrical malfunction (→ page 412)

 Reserve fuel with fuel filler flap location indicator (→ page 412)

Braking

 Electric parking brake (yellow) (→ page 416)

PARK USA: electric parking brake (red) (→ page 416)

 Canada: electric parking brake (red) (→ page 416)

RBS USA: Recuperative Brake System (→ page 416)

 Canada: brakes (yellow)(→ page 416)

BRAKE USA: brakes (red) (→ page 416)

 Canada: brakes (red) (→ page 416)

Driving and driving safety systems

 ABS (→ page 419)

 ESP® (→ page 419)

 ESP® OFF (→ page 419)

 Distance warning (→ page 419)

 Active Brake Assist (→ page 419)

 Active Brake Assist (→ page 419)

Tire pressure monitoring system

 Tire pressure monitoring system (→ page 422)

Exterior lighting

 Standing lights (→ page 126)

 Low-beam headlamps (→ page 126)

 High-beam headlamps (→ page 127)

 Turn signal lights (→ page 127)

 Front fog lamps (→ page 126)



 Rear fog light (→ page 126)

Symbols on the media display

 Drive Away Assist (→ page 222)

 Cross Traffic Alert (→ page 223)

Occupant safety

| Warning/indicator lamp | Possible causes/consequences and ► Solutions |
|---|--|
|  <p data-bbox="144 381 395 433">Restraint system warning lamp</p> | <p data-bbox="463 288 1123 339">* The restraint system red warning lamp is lit while the vehicle is on. The restraint system is malfunctioning (→ page 41).</p> <div data-bbox="482 360 1646 474"><p data-bbox="491 365 1193 394">▲ WARNING Risk of injury due to malfunctions in the restraint system</p><p data-bbox="495 405 1559 433">Components in the restraint system may be activated unintentionally or not deploy as planned in an accident.</p><p data-bbox="495 438 1456 467">► Have the restraint system checked and repaired immediately at a qualified specialist workshop.</p></div> <ul data-bbox="476 490 1018 588" style="list-style-type: none">► Drive on carefully.► Note the messages on the instrument display.► Consult a qualified specialist workshop immediately. |
|  <p data-bbox="144 695 371 746">Seat belt warning lamp flashes</p> | <p data-bbox="463 601 1387 653">* The red seat belt warning lamp flashes and an intermittent warning tone sounds. The driver or front passenger has not fastened his/her seat belt while the vehicle is in motion.</p> <ul data-bbox="476 664 1009 749" style="list-style-type: none">► Fasten your seat belt (→ page 40). There are objects on the front passenger seat.► Remove the objects from the front passenger seat. |

| Warning/indicator lamp | Possible causes/consequences and ► Solutions |
|---|---|
|  <p data-bbox="194 341 425 393">Seat belt warning lamp lights up</p> | <p data-bbox="508 248 1358 274">* The red seat belt warning lamp lights up for six seconds once the vehicle has started.</p> <p data-bbox="526 284 1044 310">In addition, an intermittent warning tone may sound.</p> <p data-bbox="526 310 1469 336">The red seat belt warning lamp reminds the driver and front passenger to fasten their seat belts.</p> <ul style="list-style-type: none"> <li data-bbox="526 341 914 367">► Fasten your seat belt (→ page 40). <p data-bbox="526 383 1524 409">If you have placed objects on the front passenger seat, the red seat belt warning lamp may remain lit.</p> |



Vehicle

| Warning/indicator lamp | Possible causes/consequences and ► Solutions |
|--|--|
|  <p data-bbox="194 645 425 697">Power steering warning lamp (red)</p> | <p data-bbox="508 552 1210 578">* The red power steering warning lamp is lit while the vehicle is running.</p> <p data-bbox="526 578 1118 603">The power assistance or the steering itself is malfunctioning.</p> <div data-bbox="526 621 1700 802" style="border: 1px solid gray; padding: 5px;"> <p data-bbox="535 626 1173 652">▲ WARNING Risk of accident if steering capability is impaired</p> <p data-bbox="545 668 1432 694">If the steering does not function as intended, the vehicle's operating safety is jeopardized.</p> <ul style="list-style-type: none"> <li data-bbox="545 704 1672 756">► Pull over and stop the vehicle safely as soon as possible, paying attention to road and traffic conditions. Do not continue driving under any circumstances. <li data-bbox="545 766 970 792">► Consult a qualified specialist workshop. </div> <ul style="list-style-type: none"> <li data-bbox="526 813 1007 839">► Note the messages on the instrument display. |

Engine

| Warning/indicator lamp | Possible causes/consequences and ► Solutions |
|---|--|
|  <p data-bbox="144 381 413 407">Coolant warning lamp (red)</p> | <p data-bbox="463 291 1086 313">* The red coolant warning lamp is lit while the engine is running.</p> <p data-bbox="476 324 680 347">Possible causes are:</p> <ul data-bbox="482 357 925 521" style="list-style-type: none"><li data-bbox="482 357 920 380">• The temperature sensor is malfunctioning<li data-bbox="482 390 778 413">• The coolant level is too low<li data-bbox="482 423 925 446">• The air supply to the radiator is obstructed<li data-bbox="482 456 750 479">• The radiator fan is faulty<li data-bbox="482 490 842 512">• The engine coolant pump is faulty <p data-bbox="476 536 1609 559">If there is an additional warning tone, the coolant temperature has exceeded the maximum permissible temperature.</p> <div data-bbox="482 581 1646 835"><p data-bbox="491 588 1005 611">▲ WARNING Risk of burns when opening the hood</p><p data-bbox="495 627 1628 677">If you open the hood in the event of an overheated engine or fire in the engine compartment, the following situations may occur:</p><ul data-bbox="500 687 1193 747" style="list-style-type: none"><li data-bbox="500 687 949 710">• You may come into contact with hot gases.<li data-bbox="500 721 1193 743">• You may come into contact with other escaping hot operating fluids.<p data-bbox="495 764 1079 787">► Before opening the hood, allow the engine to cool down.</p><p data-bbox="495 797 1456 820">► In the event of a fire in the engine compartment, keep the hood closed and call the fire service.</p></div> <p data-bbox="476 851 1578 874">► Stop immediately in accordance with the traffic conditions and switch off the vehicle. Do not continue driving.</p> |

| Warning/indicator lamp | Possible causes/consequences and ► Solutions |
|--|--|
| | <p>► Note the messages on the instrument display.</p> <p>If the coolant temperature display is at the lower end of the temperature scale:</p> <p>► Consult a qualified specialist workshop.</p> <p>If the coolant temperature display is at the upper end of the temperature scale:</p> <p>► Exit the vehicle and keep a safe distance from it until the engine has cooled down.</p> <p>► Check the coolant level (→ page 283).</p> <p>► Make sure that the air supply to the radiator is not obstructed.</p> <p>► Avoiding high loads on the engine, drive to the nearest qualified specialist workshop. In doing so, ensure that the coolant temperature display remains below the red area.</p> |
|  <p>Coolant warning lamp (yellow)</p> | <p>* The yellow coolant warning lamp is lit while the engine is running.</p> <p>Possible causes are:</p> <ul style="list-style-type: none"> • The temperature sensor is malfunctioning • The charge air, transmission oil or battery cooling is faulty • The radiator shutters are blocked or defective <p>► Avoiding high loads on the engine, drive to the nearest qualified specialist workshop.</p> |

| Warning/indicator lamp | Possible causes/consequences and ► Solutions |
|--|--|
|  <p data-bbox="144 342 417 366">Check Engine warning lamp</p> | <p data-bbox="463 249 1626 394">* The yellow Check Engine warning lamp is lit while the engine is running. A malfunction has occurred in the engine, the exhaust system or the fuel system. The emissions limit value may have been exceeded and the engine may be running in emergency operation mode. In some states, legal requirements stipulate that you must immediately consult a qualified specialist workshop as soon as the yellow Check Engine warning lamp lights up.</p> <p data-bbox="476 405 1289 428">► Have the vehicle checked as soon as possible at a qualified specialist workshop.</p> |
|  <p data-bbox="144 539 417 588">Electrical malfunction warning lamp</p> | <p data-bbox="463 446 957 495">* The red electrical malfunction warning lamp is lit. There is a malfunction in the electrics.</p> <p data-bbox="476 505 957 529">► Note the messages on the instrument display.</p> |
|  <p data-bbox="144 695 417 743">Fuel reserve warning lamp flashes</p> | <p data-bbox="463 601 1626 653">* The yellow fuel reserve warning lamp lights up while you are driving. There has been pressure loss in the fuel system. The fuel filler cap is not closed correctly or the fuel system is leaking.</p> <p data-bbox="476 664 741 687">► Close the fuel filler cap.</p> <p data-bbox="476 715 999 739">If the fuel filler cap has already been closed correctly:</p> <p data-bbox="476 750 898 773">► Consult a qualified specialist workshop.</p> |

Warning/indicator lamp



Fuel reserve warning lamp
lights up





Possible causes/consequences and ► Solutions

* The yellow fuel reserve warning lamp lights up while the engine is running.
The fuel supply has dropped into the reserve range.

► Refuel.



Brakes



| Warning/indicator lamp | Possible causes/consequences and ► Solutions |
|---|---|
| <p data-bbox="155 291 310 373"></p> <p data-bbox="144 381 413 433">Electric parking brake indicator lamp (red) (USA only)</p> <p data-bbox="155 439 310 522"></p> <p data-bbox="144 529 413 607">Electric parking brake indicator lamp (red) (Canada only)</p> <p data-bbox="155 613 310 696"></p> <p data-bbox="144 703 413 750">Electric parking brake indicator lamp (yellow)</p> | <p data-bbox="463 289 1068 314">* The red electric parking brake indicator lamp flashes or is lit.</p> <p data-bbox="476 322 1326 348">The yellow electric parking brake indicator lamp is also lit in the event of a malfunction.</p> <ul data-bbox="476 355 962 381" style="list-style-type: none"><li data-bbox="476 355 962 381">► Note the messages on the instrument display. |



| Warning/indicator lamp | Possible causes/consequences and ► Solutions |
|--|---|
|  <p>RBS warning lamp (USA only)</p>  <p>Brakes warning lamp (yellow) (Canada only)</p> | <p>*The yellow  warning lamp (USA only) or the yellow  brake warning lamp (Canada only) is lit while the vehicle is running.</p> <p>▲ WARNING Risk of an accident due to a brake system malfunction</p> <p>If the brake system is malfunctioning, braking characteristics may be impaired.</p> <ul style="list-style-type: none">▶ Drive on carefully.▶ Have the brake system checked immediately at a qualified specialist workshop. <p>► Adjust your speed and drive on carefully, leaving a suitable distance to the vehicle in front.</p> <p>► If the instrument display shows a display message, observe it.</p> <p>► Consult a qualified specialist workshop.</p> |

| Warning/indicator lamp | Possible causes/consequences and ► Solutions |
|--|--|
| <div data-bbox="155 252 310 332" data-label="Image"> </div> <p data-bbox="144 342 408 391">Brakes warning lamp (USA only)</p> <div data-bbox="155 397 310 477" data-label="Image"> </div> <p data-bbox="144 487 408 536">Brakes warning lamp (Canada only)</p> | <p data-bbox="458 249 1068 273">* The red brake warning lamp is lit while the vehicle is running.</p> <p data-bbox="476 283 680 307">Possible causes are:</p> <ul data-bbox="482 318 1406 377" style="list-style-type: none"> <li data-bbox="482 318 1406 341">• The brake force boosting is malfunctioning and the braking characteristics may be affected. <li data-bbox="482 349 1079 372">• There is insufficient brake fluid in the brake fluid reservoir. <p data-bbox="476 392 962 416">► Note the messages on the instrument display.</p> <div data-bbox="482 439 1646 477" data-label="Section-Header"> <p>▲ WARNING Risk of accident and injury if brake force boosting is malfunctioning</p> </div> <p data-bbox="495 484 1591 533">If brake force boosting is malfunctioning, increased brake pedal force may be necessary for braking. The braking characteristics may be impaired. The braking distance can increase in emergency braking situations.</p> <ul data-bbox="495 543 1116 602" style="list-style-type: none"> <li data-bbox="495 543 1116 567">► Stop in a safe location immediately. Do not continue driving. <li data-bbox="495 574 916 598">► Consult a qualified specialist workshop. <div data-bbox="482 632 1646 671" data-label="Section-Header"> <p>▲ WARNING Risk of an accident due to low brake fluid level</p> </div> <p data-bbox="495 678 1467 702">If the brake fluid level is too low, the braking effect and the braking characteristics may be impaired.</p> <ul data-bbox="495 712 1609 833" style="list-style-type: none"> <li data-bbox="495 712 1609 761">► Pull over and stop the vehicle safely as soon as possible, paying attention to road and traffic conditions. Do not continue driving under any circumstances. <li data-bbox="495 768 916 792">► Consult a qualified specialist workshop. <li data-bbox="495 799 753 823">► Do not add brake fluid. |

Driving and driving safety systems

| Warning/indicator lamp | Possible causes/consequences and ► Solutions |
|--|---|
|  <p data-bbox="194 378 369 409">ABS warning lamp</p> | <p data-bbox="508 284 1136 341">* The yellow ABS warning lamp is lit while the vehicle is running. ABS is malfunctioning.</p> <p data-bbox="526 347 1118 378">If an additional warning tone sounds, EBD is malfunctioning.</p> <p data-bbox="526 383 1284 414">Other driving systems and driving safety systems may also be malfunctioning.</p> <p data-bbox="526 419 1007 450">► Note the messages on the instrument display.</p> <div data-bbox="526 461 1690 673" style="border: 1px solid gray; padding: 5px;"> <p data-bbox="535 466 1256 497">⚠ WARNING There is a risk of skidding if EBD or ABS is malfunctioning</p> <p data-bbox="545 507 905 538">The wheels may lock during braking.</p> <p data-bbox="545 543 1672 595">The steerability and braking characteristics are heavily impaired and the braking distance may increase. In addition, other driving safety systems are switched off.</p> <ul style="list-style-type: none"> <li data-bbox="545 600 757 631">► Drive on carefully. <li data-bbox="545 637 1349 668">► Have the brake system checked immediately at a qualified specialist workshop. </div> |
|  <p data-bbox="194 782 462 813">ESP® warning lamp flashes</p> | <p data-bbox="508 688 1191 745">* The yellow ESP® warning lamp flashes while the vehicle is in motion. One or more wheels have reached their grip limit (→ page 175).</p> <p data-bbox="526 751 1191 782">► Adapt your driving style to suit the road and weather conditions.</p> |

| Warning/indicator lamp | Possible causes/consequences and ► Solutions |
|--|--|
|  <p>ESP® warning lamp lights up</p> | <p>* The yellow ESP® warning lamp is lit while the vehicle is running. ESP® is malfunctioning. Other driving systems and driving safety systems (e.g. BAS) may also be malfunctioning.</p> <ul style="list-style-type: none"> ► Note the messages on the instrument display. <div style="background-color: #f0f0f0; padding: 5px; margin-top: 10px;"> <p>▲ WARNING Risk of skidding if ESP® is malfunctioning</p> <p>If ESP® is malfunctioning, ESP® cannot carry out vehicle stabilization. In addition, other driving safety systems are switched off.</p> <ul style="list-style-type: none"> ► Drive on carefully. ► Have ESP® checked at a qualified specialist workshop. </div> |
|  <p>ESP® OFF warning lamp</p> | <p>* The yellow ESP® OFF warning lamp is lit while the vehicle is running. ESP® is deactivated. Other driving systems and driving safety systems may also be inoperative.</p> <div style="background-color: #f0f0f0; padding: 5px; margin-top: 10px;"> <p>▲ WARNING Risk of skidding when driving with ESP® deactivated</p> <p>ESP® does not act to stabilize the vehicle. The availability of further driving safety systems is also limited.</p> <ul style="list-style-type: none"> ► Drive on carefully. ► Deactivate ESP® only for as long as the situation requires. </div> |

| Warning/indicator lamp | Possible causes/consequences and ► Solutions |
|---|--|
| | <p>If ESP® cannot be activated, ESP® is malfunctioning.</p> <ul style="list-style-type: none"> ► Have ESP® checked immediately at a qualified specialist workshop. <p>► Observe the notes on deactivating ESP® (→ page 175).</p> |
|  <p>Distance warning lamp</p> | <p>* The red distance warning lamp lights up while the vehicle is in motion. The distance to the vehicle in front is too small for the speed selected. If there is an additional warning tone, you are approaching an obstacle at too high a speed.</p> <ul style="list-style-type: none"> ► Be prepared to brake immediately. ► Increase the distance. <p>Function of Active Brake Assist (→ page 195).</p> |
|  <p>Active Brake Assist warning lamp</p> | <p>* The Active Brake Assist warning lamp is on. Due to dirty sensors or a malfunction, the system is not available or the range of functions is restricted.</p> <ul style="list-style-type: none"> ► Note the messages on the instrument display. |

422 Display messages and warning/indicator lamps

| Warning/indicator lamp | Possible causes/consequences and ► Solutions |
|---|---|
|  <p data-bbox="144 342 417 395">Active Brake Assist warning lamp</p> | <p data-bbox="458 249 1319 332">* The Active Brake Assist warning lamp is on. The system is switched off or the range of functions has been automatically restricted. This may be the case if another driving system has been activated.</p> <p data-bbox="476 342 1068 368">► Observe the notes on Active Brake Assist (→ page 195).</p> |

Tire pressure monitor

| Warning/indicator lamp | Possible causes/consequences and ► Solutions |
|---|--|
|  <p data-bbox="144 628 426 681">Tire pressure monitoring system warning lamp flashes</p> | <p data-bbox="458 535 1615 614">*The yellow tire pressure monitor warning lamp (pressure loss/malfunction) flashes for approximately one minute and then remains lit. The tire pressure monitoring system is malfunctioning.</p> <div data-bbox="476 628 1652 784"><p data-bbox="489 636 1467 666">▲ WARNING There is a risk of an accident if the tire pressure monitoring system is malfunctioning</p><p data-bbox="489 676 1578 739">The tire pressure monitoring system cannot issue a warning if there is pressure loss in one or more of the tires. Tires with insufficient tire pressure may impair the driving characteristics as well as steering and braking.</p><p data-bbox="489 750 1356 775">► Have the tire pressure monitoring system checked at a qualified specialist workshop.</p></div> |

Warning/indicator lamp



Tire pressure monitoring system warning lamp lights up

Possible causes/consequences and ► Solutions

* The yellow tire pressure monitoring system warning lamp (pressure loss/malfunction) is lit.
The tire pressure monitoring system has detected tire pressure loss in at least one of the tires.

▲ WARNING Risk of an accident due to insufficient tire pressure

- The tires can burst.
- The tires can wear excessively and/or unevenly.
- The driving characteristics as well as the steering and braking may be greatly impaired.

You could then lose control of the vehicle.

- Observe the recommended tire pressures.
 - Adjust the tire pressure if necessary.
-
- Stop the vehicle in accordance with the traffic conditions.
 - Check the tire pressure and the tires.

| | | | |
|---|-----|--|--|
| 1, 2, 3 ... | | | |
| (SmartKey) battery | 71 | | |
| 4MATIC | 162 | | |
| 360° Camera | | | |
| Function..... | 211 | | |
| A | | | |
| A/C function | | | |
| Activating/deactivating (operating unit)..... | 140 | | |
| Switching on/off (MBUX)..... | 140 | | |
| ABS | 174 | | |
| Acceleration | | | |
| Kickdown..... | 161 | | |
| Accident, emergency call | 266 | | |
| Activating/deactivating the acoustic locking verification signal | 70 | | |
| Active Blind Spot Assist | | | |
| Brake application..... | 206 | | |
| Exit warning..... | 204 | | |
| Function..... | 204 | | |
| Active Brake Assist | | | |
| Function..... | 195 | | |
| Setting..... | 199 | | |
| Active Distance Assist DISTRONIC | | | |
| Activating/deactivating..... | 186 | | |
| Active Emergency Stop Assist..... | 193 | | |
| Active Lane Change Assist..... | 194 | | |
| Calling up a speed..... | 186 | | |
| Function..... | 183 | | |
| Increases/decreases the speed..... | 186 | | |
| Route-based speed adaptation..... | 188 | | |
| Storing a speed..... | 186 | | |
| Active Emergency Stop Assist | 193 | | |
| Active headlamps | 129 | | |
| Active Lane Change Assist | | | |
| Activating/deactivating..... | 195 | | |
| Function..... | 194 | | |
| Active Lane Keeping Assist | | | |
| Activating/deactivating..... | 208 | | |
| Function..... | 207 | | |
| Setting the sensitivity..... | 209 | | |
| Active light function | 129 | | |
| Active Parking Assist | | | |
| Exiting a parking space..... | 221 | | |
| Function..... | 218 | | |
| Parking..... | 220 | | |
| Active Service System PLUS | 277 | | |
| Active Speed Limit Assist | 187 | | |
| Active Steering Assist | | | |
| Activating/deactivating..... | 193 | | |
| Active Emergency Stop Assist..... | 193 | | |
| Active Lane Change Assist..... | 194 | | |
| Function..... | 191 | | |
| Adaptive cruise control | 188 | | |
| Adaptive Highbeam Assist | | | |
| Activating/deactivating..... | 130 | | |
| Additives | | | |
| Engine oil..... | 352 | | |
| Fuel..... | 352 | | |
| After-sales service | 277 | | |
| Air bag | | | |
| Front air bag..... | 53 | | |
| Inflating..... | 47 | | |
| Overview..... | 53 | | |
| PASSENGER AIR BAG indicator lamp..... | 42 | | |
| Warning lamp..... | 41 | | |

- Air conditioning menu**
 - Air distribution..... 140
 - Calling up..... 140
 - Climate control..... 140
- Air distribution**
 - Adjusting..... 140
 - Setting..... 139
- Air inlet**..... 285
- Air pressure**..... 315
- Air vents**
 - Adjusting..... 141
- Air/water duct**..... 285
- Airflow**
 - Setting..... 139
- Alarm system**..... 89
- All-wheel drive**..... 162
- Alternative route**..... 249
- Ambient lighting**..... 131
- Animals**..... 49
- Anti-lock braking system**..... 174
- Anti-theft alarm system**..... 89
- Anti-theft protection**
 - Immobilizer..... 89
- Apps, Mercedes me**
 - Mercedes me calls..... 258
 - Mercedes me connect..... 261
- Assistance system**..... 174
- ASSYST PLUS**
 - Battery disconnection periods..... 278
 - Service interval display..... 277
 - Service requirements..... 277
- ATA**
 - Deactivating the alarm..... 90
 - Function..... 89
 - Interior protection..... 91
 - Interior protection function..... 90
 - Tow-away alarm function..... 90
 - Tow-away protection..... 90
- ATTENTION ASSIST**
 - Function..... 180
 - Setting..... 181
- Attention assistant**..... 180
- Authorized Mercedes-Benz Service Center**..... 29
- Authorized workshop**..... 29
- Automatic car wash**..... 286
- Automatic car wash mode**..... 287
- Automatic climate control**..... 140
- Automatic distance control**..... 183
- Automatic driving lights**..... 127
- Automatic emergency call**..... 266
- Automatic engine start/stop**..... 153
- Automatic front passenger air bag shutoff**
 - Function..... 44
 - Information (child restraint system on the front passenger seat)..... 58
 - PASSENGER AIR BAG indicator lamp..... 42
- Automatic measures after an accident**..... 47
- Automatic mirror folding function**..... 138
- Automatic transmission**
 - DIRECT SELECT lever..... 158
 - Drive programs..... 155
 - DYNAMIC SELECT switch..... 155
 - Engages neutral..... 159
 - Engaging drive position..... 160
 - Engaging reverse gear..... 159
 - Faulty gear shift..... 160
 - Kickdown..... 161































- Manual gear shifting..... 160
 Selecting park position..... 159
 Steering wheel paddle shifters..... 160
 Switching gears..... 158
 Transmission position display..... 158
 Transmission positions..... 158
Autonomous braking..... 195
- B**
- Bag hook**..... 116
BAS..... 175
Basic information..... 38
Battery (12 V battery)
 Charging..... 305
 Notes..... 302
 Notes (starting assistance and charging)..... 303
 Replacing..... 306
 Starting assistance..... 305
Battery (starter battery)
 charging, Remote Online..... 145
Belt
 Fastening..... 40
 Notes on wearing correctly..... 40
 Releasing..... 53
Blind Spot Assist
 Activating/deactivating..... 207
 Function..... 204
Bluetooth®
 Connecting a mobile phone..... 257
Brake Assist
 Active Brake Assist..... 195
 Brake Assist System..... 175
Brake Assist System..... 175
Brake disks..... 146
Brake fluid..... 353
Brake force distribution..... 177
Brake pads..... 146
Brakepad gauge..... 285
Brakes
 ABS (Anti-lock Braking System)..... 174
 Active Brake Assist..... 195
 BAS (Brake Assist System)..... 175
 Checking the brakepad thickness..... 285
 Driving tips..... 147
 EBD (Electronic Brakeforce Distribution)..... 177
 Electric parking brake..... 169, 170, 171
 Handbrake..... 169, 170, 171
 HOLD function..... 178
 Limited braking effect (salt-treated roads)..... 147
 New/replaced brake pads/brake discs.. 146
 Notes on breaking in a new vehicle..... 146
 Parking brake..... 169, 170, 171
 Post-collision brake..... 47
Braking assistance
 Brake Assist System..... 175
Breakdown
 Changing a wheel..... 338
 Flat tire..... 296
 Overview of aids..... 18
 Tow-starting..... 310
 Towing methods..... 307
 Transporting the vehicle..... 308
Breakdown (Roadside Assistance)..... 25







































C

- Calling the customer center for Mercedes-Benz**..... 258
- Calls**
 - Mercedes me..... 258
 - Telephone menu..... 257
 - Using overhead control panel..... 258
- Camera**
 - 360° Camera..... 211
 - Cleaning..... 290
 - Information..... 173
 - Opening the camera cover (rear view camera)..... 213
 - Rear view camera..... 209
 - Select view..... 213
- Car key**..... 69
- Car wash**
 - Automatic car wash..... 286
 - Power washer..... 288
 - Washing by hand..... 288
- Car-to-X-Communication**
 - Display on map..... 251
- Care**
 - Air/water duct..... 285
 - Automatic car wash..... 286
 - Camera..... 290
 - Car parts..... 290
 - Decorative foil..... 289
 - Display..... 291
 - Exterior lighting..... 290
 - Head-up display..... 291
 - Headliner..... 291
 - Paint..... 288
 - Plastic trim..... 291
 - Power washer..... 288
 - Real wood/trim elements..... 291
 - Seat belts..... 291
 - Steering wheel..... 291
 - Vehicle interior..... 291
 - Washing by hand..... 288
 - Wheels/rims..... 290
- Cargo compartment cover**
 - Removing/installing..... 115
- Cargo compartment floor**
 - Setting..... 119
- Cargo tie-down rings**..... 116
- Caring for plastic trim**..... 291
- Caring for rims**..... 290
- Central locking system**
 - Button..... 73
 - SmartKey..... 70
- Change of address**..... 25
- Change of ownership**..... 25
- Changing a wheel**
 - Preparation..... 338
 - Raising the vehicle..... 338
 - Removing a wheel..... 340
 - Removing/installing hub caps..... 338
- Charging**
 - 12 V battery..... 305
 - USB port..... 111, 122
- Checking the brakepad thickness**..... 285
- Checking the coolant level**..... 283
- Child safety lock**
 - Rear door..... 66
 - Side windows (rear passenger compartment)..... 67
- Child seat**
 - Adjusting the vehicle seat..... 60

- Basic instructions..... 55
- Front passenger seat..... 58
- Installing ISOFIX..... 63
- Rearward-facing..... 60
- Risks/dangers..... 56
- Securing on the rear seat with the seat belt..... 65
- Securing to the front passenger seat with the seat belt..... 65
- The most important information in brief... 54
- Top Tether..... 64
- Children**
- Avoiding dangers in the vehicle..... 56
- Basic instructions..... 55
- Special seat belt retractor..... 62
- Chock**..... 337
- Clean varnish**..... 288
- Cleaning**
- Air/water duct..... 285
- Automatic car wash..... 286
- Car parts..... 290
- Decorative foil..... 289
- Paint..... 288
- Power washer..... 288
- Real wood/trim elements..... 291
- Sensors..... 290
- Vehicle interior..... 291
- Washing by hand..... 288
- Cleaning carpets**..... 291
- Cleaning seat covers**..... 291
- Climate control**
- Activating/deactivating..... 139
- Activating/deactivating the A/C function (control panel)..... 140
- Activating/deactivating the synchronization function (control panel)..... 140
- Air vents (front)..... 141
- Air vents (rear passenger compartment)..... 142
- Automatic control..... 140
- Calling up the air conditioning menu..... 140
- Control panel for 3-zone automatic climate control..... 139
- Control panel for dual-zone automatic climate control..... 139
- Defrosting the windshield..... 139
- Defrosting windows..... 141
- Filling capacity for refrigerant and PAG oil..... 356
- Notes..... 139
- Refrigerant..... 355
- Residual heat..... 141
- Setting (MBUX multimedia system)..... 140
- Setting the air distribution..... 139
- Setting the airflow..... 139
- Setting the vehicle interior temperature..... 139
- Switching air-recirculation mode on/off..... 141
- Switching the A/C function on/off (MBUX)..... 140
- Switching the rear window heater on/off..... 139
- Synchronization function..... 141
- Ventilating with convenience opening..... 83
- Clothes hook**..... 117
- COC papers, CERTIFICATE OF CONFORMITY**..... 346
- Cockpit**
- Dashboard overview..... 6
- Coffee cup symbol**..... 180
- Collision detection (parked vehicle)**
- Setting..... 171

- Combination switch
 - Lights..... 127
 - Windshield wipers..... 132
- Commuter route..... 249
- Connecting the parcel net..... 117
- Convenience closing..... 84
- Convenience opening..... 83
- Coolant
 - Capacity..... 354
 - Notes..... 354
- Copyright
 - License..... 36
- Copyrights
 - Trademarks..... 37
- Cornering light..... 128
- Correct use..... 29
- Cover..... 85
- Cross traffic (warning)..... 223
- Cross Traffic Alert, Cross traffic warning..... 223
- Crosswind Assist..... 177
- Cruise control
 - Activating/deactivating..... 182
 - Calling up a speed..... 182
 - Function..... 181
 - Requirements:..... 182
 - Setting a speed..... 182
 - Storing a speed..... 182
- Customer Assistance Center (CAC)..... 31
- Customer Relations Department..... 31
- D**
- Damage
 - Limited protection..... 49
- Dashboard
 - Cockpit overview..... 6
- Dashcam
 - Selecting a USB device..... 253
 - Starting/stopping a video recording..... 253
- Data processing in the vehicle..... 32
- Data protection rights..... 35
- Data storage
 - Data protection rights..... 35
 - Electronic control units..... 32
- Event Data Recorder..... 35
- MBUX multimedia system/Mercedes me connect..... 35
- Online services..... 34
- Deactivating the alarm..... 90
- Dealership..... 29
- Declaration of conformity
 - Wireless vehicle components..... 27
- Decorative foil..... 289
- Definitions
 - Tires and loading..... 331
- Deployed components
 - Limited protection..... 49
- Deployment situations..... 47
- Destination entry..... 248
- Detecting inattentiveness..... 180
- Diagnostics connection..... 28
- Digital Operator's Manual..... 20
- Dinghy towing
 - Pulling/towing..... 224
- DIRECT SELECT lever
 - Automatic transmission..... 158

- Engages neutral..... 159
Engaging drive position..... 160
Engaging park position automatically..... 159
Engaging reverse gear..... 159
Function..... 158
Gearshift recommendation..... 161
Manual gearshifting..... 160
Selecting park position..... 159
- Display**
Care..... 291
- Display (on-board computer)**
Displays on the instrument display..... 228
- Display message**
Calling up in the on-board computer..... 358
Notes..... 358
- Display messages**
-  --- mph..... 391
 -  --- mph..... 389
 -  2nd Seat Row, Left Not Locked... 371
 -  2nd Seat Row, Right Not Locked.. 371
 -  3rd Seat Row, Left Not Locked.... 371
 -  3rd Seat Row, Right Not Locked... 372
-  12 V Battery See Operator's Manual..... 399
 -  Active Headlamps Inoperative..... 365
 -  ATTENTION ASSIST Inoperative... 388
 -  ATTENTION ASSIST: Take a Break!..... 389
 -  Automatic Headlamp Mode Inoperative..... 365
 -  Before Starting the Engine, Turn Steering Wheel..... 369
 -  Check Brake Fluid Level..... 384
 -  Check Coolant Level See Operator's Manual..... 373
 -  Check Engine Oil Level (Add 1 quart)..... 406
 -  Check Left Low Beam (example).. 364
 -  Check Tires..... 402
 -  Check Washer Fluid..... 372
 -  Coolant Too Hot Stop Vehicle Turn Engine Off..... 374
 -  Currently Unavailable See Operator's Manual..... 385
 -  Currently Unavailable See Operator's Manual..... 386
 -  Decrease Speed..... 404
 -  Don't Forget Your Key..... 364
 -  Engine Oil Level Cannot Be Measured..... 408
 -  Engine Oil Level Low Stop Vehicle Turn Engine Off..... 406
 -  Engine Oil Pressure Stop Switch Off Engine..... 407
 -  Engine Oil Reduce Oil Level..... 406
 -  Front Left Malfunction Service Required (example)..... 359
 -  Fuel Level Low..... 375
 -  Gas Cap Loose..... 375
 -  Inoperative See Operator's Manual..... 386

-  Inoperative See Operator's Manual..... 387
-  Inoperative See Operator's Manual..... 388
-  Inoperative..... 399
-  Inoperative..... 390
-  Intell. Light System Inoperative.... 366
-  Key Being Initialized Please Wait... 363
-  Key Not Detected (red display message)..... 363
-  Key Not Detected (white display message)..... 362
-  Left Side Curtain Airbag Malfunction Service Required (example)..... 359
-  Malfunction See Operator's Manual..... 365
-  Max. Speed 25 mph..... 390
-  Not in the Current Drive Program..... 390
-  Obtain a New Key..... 362
-  Off..... 391
-  Off..... 388
-  Parking Brake See Operator's Manual..... 380
-  Parking Lock Inoperative Apply Parking Brake..... 378
-  Please Correct Tire Pressure..... 403
-  Please Release Parking Brake..... 383
-  Replace Key Battery..... 362
-  See Operator's Manual..... 400
-  SRS Malfunction Service Required..... 359
-  Steering Malfunction Increased Physical Effort See Operator's Manual... 368
-  Steering Malfunction See Operator's Manual..... 369
-  Steering Malfunction Stop Immediately See Operator's Manual..... 368
-  Stop Vehicle Leave Engine Running..... 401
-  Stop Vehicle See Operator's Manual..... 400
-  Suspended..... 391
-  Switch Off Lights..... 366
-  Switch On Headlamps..... 365
-  Temporarily Unavailable Camera View Restricted..... 397
-  Temporarily Unavailable Sensors are Dirty..... 396
-  Tires Overheated..... 404
-  Transmission Oil Overheated Drive with Caution..... 378
-  Turn On the Ignition to Release the Parking Brake..... 384
-  Vehicle Ready to Drive Switch the Ignition Off Before Exiting..... 367
-  Warning Tire Malfunction..... 403
-  Wheel Sensor(s) Missing..... 402
- Active Blind Spot Assist Currently Unavailable See Operator's Manual..... 395

- Active Blind Spot Assist Inoperative..... 395
- Active Brake Assist Functions Currently Limited See Operator's Manual..... 397
- Active Brake Assist Functions Limited See Operator's Manual..... 392
- Active Distance Assist Currently Unavailable See Operator's Manual..... 391
- Active Distance Assist Inoperative..... 392
- Active Distance Assist Now Available..... 392
- Active Lane Keeping Assist Currently Unavailable See Operator's Manual..... 395
- Active Lane Keeping Assist Inoperative... 396
- Active Steering Assist Currently Unavailable See Operator's Manual..... 393
- Active Steering Assist Inoperative..... 393
- Active Steering Asst. Currently Unavailable Due to Multiple Emergency Stops..... 393
- Adaptive Highbeam Assist Currently Unavailable See Operator's Manual..... 366
- Adaptive Highbeam Assist Inoperative.... 366
- Apply Brake to Shift from 'P'..... 375
- Apply Brake to Shift to 'R'..... 376
- Apply Brake to Shift to D or R..... 376
- Apply Parking Brake Risk of Rolling Away See Operator's Manual..... 378
- Auxiliary Battery Malfunction (red display message)..... 379
- Auxiliary Battery Malfunction (white display message)..... 379
- Beginning Emergency Stop..... 393
- Blind Spot Assist Currently Unavailable See Operator's Manual..... 394
- Blind Spot Assist Inoperative..... 394
- Cannot Start Engine See Operator's Manual..... 373
- Check Brake Pads See Operator's Manual..... 385
- Check Tire Pressure Soon..... 404
- Check Tire Pressure Then Restart Run Flat Indicator..... 405
- Cruise Control Inoperative..... 389
- Cruise Control Off..... 389
- Device Detected at Diagnostics Connection See Operator's Manual..... 399
- Driver's Door Open & Transmission Not in P Risk of Vehicle Rolling Away..... 376
- Front Passenger Airbag Disabled See Operator's Manual..... 360
- Front Passenger Airbag Enabled See Operator's Manual..... 360
- Hazard Warning Flashers Malfunctioning..... 367
- Head-up Display Currently Unavailable See Operator's Manual..... 367
- Head-up Display Inoperative..... 368
- N Permanently Active Risk of Rolling Away..... 376

- Only Shift to 'P' when Vehicle is Stationary..... 375
- Parking Assist and PARKTRONIC Inoperative See Operator's Manual..... 398
- Place the Key in the Marked Space See Operator's Manual..... 364
- PRE-SAFE Inoperative See Operator's Manual..... 398
- Reversing Not Possible Service Required..... 377
- Run Flat Indicator Inoperative..... 405
- Service Required Do Not Shift Gears Visit Dealer..... 377
- Teaching in Transmission Complete..... 379
- Teaching in Transmission Operate Selector Lever Apply Brake for XX s Risk of Vehicle Rolling Away..... 378
- Tire Press. Monitor Currently Unavailable..... 401
- Tire Press. Monitor Inoperative..... 401
- Tire Pressure Monitor Inoperative No Wheel Sensors..... 402
- To Deselect P or N, Depress Brake and Start Engine..... 376
- To switch engine off, press and hold Start/Stop button for at least 3 seconds or press 3 times..... 373
- Traffic Sign Assist Currently Unavailable See Operator's Manual..... 389
- Traffic Sign Assist Inoperative..... 389
- Transmission Malfunction..... 377
- Transmission Malfunction Service Required..... 379
- Transmission Malfunction Stop..... 377
- Wiper Malfunctioning..... 372
- Displaying road names/house numbers..... 249**
- Distance control..... 183**
- Distance warning..... 195**
- DISTRONIC..... 183**
- Door**
- Child safety lock (rear door)..... 66
- Emergency key..... 75
- Opening (from the inside)..... 73
- Unlocking (inside)..... 73
- Door operating unit**
- Function seat..... 16
- DOT, Tire Identification Number (TIN)..... 327**
- Downhill Speed Regulation..... 190**
- Drinking and driving..... 147**
- Drive Away Assist..... 222**
- Drive position..... 160**
- Drive program display..... 156**
- Drive programs**
- Selecting..... 156
- Driver's seat**
- Adjusting (Seat Comfort)..... 95
- Adjusting (without seat comfort)..... 93
- Adjusting electrically..... 97
- Easy entry and exit feature..... 106
- Seat heating..... 103
- Driving off-road..... 150**

- Driving safety system**
- ABS (Anti-lock Braking System)..... 174
 - Active Brake Assist..... 195
 - ATTENTION ASSIST..... 180
 - BAS (Brake Assist System)..... 175
 - Blind Spot Assist/Active Blind Spot Assist..... 204
 - Cameras..... 173
 - Cruise control..... 181
 - EBD (Electronic Brakeforce Distribution)..... 177
 - ESP® (Electronic Stability Program)..... 175
 - Hill Start Assist..... 179
 - HOLD function..... 178
 - Off-road ABS..... 175
 - Overview..... 174
 - Radar and ultrasonic sensors..... 173
 - STEER CONTROL..... 177
 - Traffic Sign Assist..... 200
 - Your responsibility..... 172
- Driving system**..... 174
- Driving tips**
- Drinking and driving..... 147
 - General driving tips..... 147
 - Notes on breaking in a new vehicle..... 146
 - Off-road driving..... 150
- Drowsiness detection**..... 180
- DSR**
- Activating/deactivating..... 190
 - Changing the target speed..... 191
 - Function..... 190
 - Notes..... 190
- Duplicate key**..... 72
- Dynamic handling control system**..... 175
- DYNAMIC SELECT**
- Calling up the fuel consumption indicator..... 157
 - Configuring drive program I..... 157
 - Displaying engine data..... 157
 - Displaying vehicle data..... 157
 - Drive program display..... 156
 - Drive programs..... 155
 - Function..... 155
 - Selecting the drive program..... 156
- E**
- E10**..... 351
- Easy entry feature**..... 106, 107
- Easy exit feature**..... 106, 107
- EBD, Electronic Brakeforce Distribution**..... 177
- ECO display**..... 154
- ECO start/stop button**
- Automatic engine start/stop..... 154
- ECO start/stop function**
- Automatic engine start..... 153
 - Automatic engine stop..... 153
 - Function..... 153
 - Switching off/on..... 154
- Electric parking brake**
- Applying automatically..... 169
 - Emergency braking..... 171
 - Manually applying/releasing..... 170
 - Releasing automatically..... 170
- Electrical fuses**..... 310
- Electronic Stability Program**..... 175
- Emergency**
- Fire extinguisher..... 295
 - First-aid kit (soft sided)..... 295
 - Overview of aids..... 18
 - Reflective safety vest..... 294
 - Warning triangle..... 295

- Emergency braking**
 Active Brake Assist..... 195
 Brake Assist System..... 175
 Carrying out..... 171
 Electric parking brake/handbrake..... 169
- Emergency call**
 Automatic..... 266
 Manual..... 267
- Emergency call system**
 Mercedes me connect..... 266
- Emergency key**
 Door..... 75
 Tailgate..... 82
- Emergency operation mode**
 Starting the vehicle..... 144
- Emergency spare wheel**
 Inflating..... 344
- Emergency stop assistant**..... 193
- Emergency Tensioning Devices**
 Inflating..... 47
- Engine**
 Emergency operation mode..... 144
 Emergency start..... 310
 Engine number..... 348
 Jump-starting..... 303
 Parking (start/stop button)..... 165
- Engine data**
 Displaying..... 157
 DYNAMIC SELECT..... 157
- Engine number**..... 348
- Engine oil**
 Additives..... 352
 Capacity..... 353
 Checking the oil level using the on-board computer..... 281
 MB-Freigabe or MB-Approval..... 353
 Quality..... 353
 Refilling..... 282
- Environmentally friendly driving**..... 22
- ESC, Electronic Stability Control**..... 175
- ESP®**
 Crosswind Assist..... 177
 Function..... 175
 Setting..... 177
- Event Data Recorder**..... 35
- Exit warning**..... 204
- Exiting a parking space**
 Active Parking Assist..... 218
 Drive Away Assist..... 222
 PARKTRONIC..... 213
- Exterior lighting**
 Care..... 290
- Exterior mirrors**
 Parking position..... 138
- F**
- Factory settings**
 MBUX reset function..... 245
- Fire extinguisher**..... 295
- First aid**
 First-aid kit (soft sided)..... 295
- First-aid kit (soft sided)**..... 295
- Fitting accessories**
 Limited protection..... 49
- Flat tire**
 Changing a wheel..... 338
 MOExtended..... 296
 Notes..... 296
 TIREFIT kit..... 297

| | |
|--|-----|
| Flat towing | |
| Pulling/towing..... | 224 |
| Floor mats | 124 |
| Fog lamp | 127 |
| Foil covering | |
| On camera/sensors..... | 173 |
| Radar and ultrasonic sensors..... | 173 |
| Free software | 36 |
| Frequencies | |
| Mobile phone..... | 347 |
| Two-way radio..... | 347 |
| Front air bag | |
| Inflating..... | 47 |
| Front headlamps | 126 |
| Front passenger air bag | |
| Disabling/enabling..... | 43 |
| Front passenger air bag shutoff, PASSENGER AIR BAG OFF | |
| Information (child restraint system on the front passenger seat)..... | 58 |
| Front passenger seat | |
| Adjusting (Seat Comfort)..... | 95 |
| Adjusting (without seat comfort)..... | 93 |

| | |
|---|-----|
| Adjusting electrically..... | 97 |
| Fuel | |
| Additives..... | 352 |
| E10..... | 351 |
| Gasoline..... | 351 |
| Quality (gasoline)..... | 351 |
| Refilling..... | 163 |
| Reserve..... | 352 |
| Sulfur content..... | 351 |
| Tank content..... | 352 |
| Fuel consumption indicator | 157 |
| Fuel reserve | 352 |
| Function in the event of an accident | 48 |
| Function seat | 16 |
| Fuses | |
| Cargo compartment..... | 313 |
| Engine compartment..... | 311 |
| Front passenger footwell..... | 312 |
| Fuse assignment diagram..... | 310 |
| Notes..... | 310 |

G**Garage door opener**

| | |
|-----------------------------|-----|
| Clearing the memory..... | 169 |
| Opening/closing a door..... | 169 |
| Problem..... | 168 |

Garage door openers

| | |
|-------------------------------------|-----|
| Programming buttons..... | 166 |
| Synchronizing the rolling code..... | 168 |

Gasoline.....

351

Gearshift

| | |
|--------------------------|-----|
| DIRECT SELECT lever..... | 158 |
| Manual..... | 160 |

General driving tips.....

147

Genuine parts.....

22

Glide mode.....

162

Glove box.....

111

Grab handles

| | |
|------------|----|
| Notes..... | 92 |
|------------|----|

H**Handbrake**.....

169

- Handling characteristics**
 Unusual..... 314
- HANDS-FREE ACCESS**..... 80
- Hazard warning lights**..... 128
- Hazard warnings**
 Car-to-X-Communication..... 251
- Head restraint**
 Adjusting (rear passenger compartment)..... 101
 Adjusting manually (front)..... 100
 Removing/installing (rear passenger compartment)..... 102
- Head-up display, Display in the windshield**
 Adjusting brightness (on-board computer)..... 230
 Adjusting display elements (on-board computer)..... 230
 Care..... 291
 Function..... 229
 Memory function..... 108
 Setting the position (on-board computer)..... 230
 Switching on/off..... 231
- Headlamp flashing**..... 127
- Headlamps**..... 126
- Heating**
 Activating/deactivating..... 139
 Seat..... 103
- Help call**
 Mercedes-Benz emergency call system.. 266
- High beam**..... 127
- Hill descent control**..... 190
- Hill Start Assist**..... 179
- HOLD function**
 Function..... 178
 Switching on/off..... 178
- Home screen**
 Media display..... 233
- Hood**
 Opening/closing..... 279
- Identification plate**
 Engine..... 348
 Refrigerant..... 355
 Vehicle..... 348
- Immobilizer**..... 89
- Incorrect behavior by vehicle occupants**
 Limited protection..... 49
- Indicator/warning lamps**
 PASSENGER AIR BAG..... 42
- Individual drive program**
 Configuring..... 157
- Inside rearview mirror**..... 137
- Installing**
 Snow chains..... 315
 Tires..... 341
 Wheels..... 341
- Instrument cluster**
 Function/notes..... 226
- Instrument display**
 Buttons..... 227
 Function/notes..... 226
 Head-up display..... 229
 Head-up display menu..... 230
 Instrument cluster..... 12
 Notes..... 225
 Overview of displays..... 228
 Warning/indicator lamps..... 408
- Intelligent Light System**
 Active headlamps..... 129

- Adaptive Highbeam Assist..... 129
- Cornering light..... 128
- Interior lighting**
 - Adjusting..... 131
 - Ambient lighting..... 131
 - MBUX reading light..... 238
 - Switch-off delay time..... 132
- Interior protection**..... 91
- Internet**
 - Mercedes me connect..... 261
 - Setting up a Wi-Fi hotspot..... 242
 - Web browser..... 263
- ISOFIX child seat anchor**
 - Installing..... 63
- J**
- Jack**
 - Storage location..... 337
- Jump-start connection**..... 305
- K**
- Key**
 - Problem..... 72
 - Replacement key..... 72
- KEYLESS-GO**
 - Deactivating..... 70
 - Locking/unlocking the vehicle..... 73
 - Problem..... 74
 - Unlocking setting..... 70
- Kickdown**..... 161
- Knee air bag**..... 53
- L**
- Lane change assist**..... 194
- Lane Keeping Assist**..... 207
- Lane recognition**
 - Active Lane Change Assist..... 194
- Lane recognition (automatic)**
 - Active Lane Keeping Assist..... 207
- Language**
 - Notes..... 244
 - Setting..... 244
- License plate (front)**..... 27
- License plate assembly (front)**..... 27
- Light switch**..... 126
- Lighting**
 - Interior lighting..... 131
- Lights**
 - Activating/deactivating the surround lighting..... 130
 - Active headlamps..... 129
 - Adaptive Highbeam Assist..... 129
 - Automatic driving lights..... 127
 - Combination switch..... 127
 - Cornering light..... 128
 - Hazard warning lights..... 128
 - High beam..... 127
 - Interior lighting..... 131
 - Reading lamp..... 131
 - Reading light..... 238
 - Rear fog light..... 127
 - Responsibility for lighting systems..... 126
 - Switch-off delay time..... 130
 - Turn signals..... 127
- Limited Warranty**..... 32
- Live Traffic Information**..... 251
- Load index**
 - Tires..... 329

- Load-bearing capacity**
 - Tires..... 329
 - Loading**
 - Adjusting the cargo compartment floor.. 119
 - Bag hook..... 116
 - Cargo tie-down rings..... 116
 - Clothes hook..... 117
 - Definitions..... 331
 - Roof luggage rack..... 120
 - Loading guidelines**..... 108
 - Loading information table**..... 322
 - Loads**..... 108
 - Locking/unlocking**
 - Automatic locking (MMS)..... 75
 - Doors (from the inside)..... 73
 - Emergency key..... 75
 - KEYLESS-GO..... 73
 - Loud sound**
 - PRE-SAFE® Sound..... 45
 - Low-beam headlamps**
 - Activating/deactivating..... 126
 - Lubricants**..... 349
 - Luggage**
 - Parcel net..... 117
 - Luggage rack**..... 108
 - Lumbar support**..... 98
- M**
- Maintaining safe distance**
 - Active Distance Assist DISTRONIC..... 186
 - Maintaining the headliner**..... 291
 - Maintaining the steering wheel**..... 291
 - Maintenance**
 - Vehicle..... 25
 - Maintenance Management**
 - Notes..... 278
 - Transferred data..... 278
 - Malfunction**
 - Restraint system..... 41
 - Malfunction message**
 - Instrument display..... 358
 - Maneuvering assistance**
 - Activating/deactivating..... 224
 - Maneuvering assistant**
 - Drive Away Assist..... 222
 - Map**
 - Displaying online map contents..... 251
 - Displaying weather information..... 251
 - Moving..... 250
 - Selecting the map orientation..... 250
 - Setting the map scale..... 250
 - Switching freeway information on/off.... 250
 - Map functions**..... 250
 - Massage program**..... 103
 - Maximum full-stop braking**..... 175
 - Maximum load rating**..... 328
 - Maximum permissible load**
 - Calculation example..... 324
 - Determining..... 323
 - Maximum tire pressure**..... 328
 - MBUX Interior Assistant**
 - Overview..... 237
 - Reading light..... 238
 - Search light..... 238
 - MBUX multimedia system**
 - Activating/deactivating standby mode... 172

- Drive programs..... 157
- Factory setting..... 245
- Home screen..... 233
- MBUX Interior Assistant..... 237
- Media..... 269
- Mercedes me & Apps..... 263
- Navigation..... 245
- Notes..... 232
- Overview..... 232
- Setting route-based speed adaptation... 189
- Standby mode function..... 172
- System settings..... 241
- Touchscreen..... 234
- MBUX reading light**..... 238
- MBUX search light**..... 238
- Mechanical key**
 - Inserting/removing..... 71
- Media**
 - Overview of functions/symbols..... 269
- Media display**
 - Operating..... 234
- Media mode**
 - Connecting Bluetooth® audio equip-
ment..... 270
- Medical aids**..... 30
- Memory function**
 - Head-up display..... 108
 - Outside mirrors..... 108
 - Seat..... 108
- Menu (on-board computer)**
 - Head-up display..... 230
 - Overview..... 227
- Mercedes me App**
 - Activating on-demand features..... 24
- Mercedes me Apps**..... 263
- Mercedes me calls**
 - Arranging a service appointment..... 260
 - Calling the Mercedes-Benz customer
center after automatic accident/
breakdown detection..... 259
 - Calls via the overhead control panel..... 258
 - Information..... 258
 - Mercedes-Benz customer center..... 258
 - Transferred data..... 260
- Mercedes me connect**
 - Accident/Breakdown Management..... 262
 - Information..... 261
 - Transferred data..... 263
- Mercedes-AMG vehicles**
 - Notes..... 143
- Mercedes-Benz emergency call system**
 - Automatic emergency call..... 266
 - Data transfer..... 267
 - Information..... 265
 - Manual emergency call..... 267
 - Overview..... 266
- Mercedes-Benz GenuineParts**..... 22
- Message memory**..... 358
- Mirrors**
 - Mirror folding function..... 138
 - Outside mirrors..... 136
 - Rearview mirror..... 137
- Mobile phone**
 - Frequencies..... 347
 - Maximum transmission output..... 347
 - Notes on wireless charging..... 122
- Model series**..... 348
- Modification**
 - Limited protection..... 49
- MOExtended tires, Run-flat tires**..... 296

- Multimedia system**
 Activating/deactivating DSR..... 190
- N**
- Navigation**
 Activating..... 246
 Destination entry..... 248
 Displaying/hiding the menu..... 246
 Live Traffic Information..... 251
 Map..... 250
 Notes..... 245
 Overview..... 247
- Neutral**..... 159
- Non-operational time**
 Activating/deactivating standby mode... 172
- Notes on breaking in a new vehicle**..... 146
- O**
- Objects in the vehicle interior**
 Limited protection..... 49
- Occupant safety**
 Air bag..... 53
 Basic information..... 38
 Child seat..... 55
- Information on the child restraint system..... 44
 Information on the correct seat position... 39
 Pets in the vehicle..... 49
 PRE-SAFE®..... 45
- Off-road ABS**..... 175
- Off-road driving**..... 150
- On-board computer, Operating system**
 Displaying the service due date..... 277
 Instrument display..... 228
 Menu overview..... 227
 Operating..... 227
- On-board diagnostics interface**..... 28
- On-board electronics**
 Two-way radios..... 346
- On-demand feature**..... 24
- Online services**..... 34
- Open Source Software**..... 36
- Opening angle**
 Limiting (tailgate)..... 81
- Opening the tailgate using your foot**
 HANDS-FREE ACCESS..... 80
- Opening/closing a door**..... 169
- Opening/closing a garage door**..... 169
- Operating fluids**
 Additives..... 352
 Brake fluid..... 353
 coolant..... 354
 Engine oil..... 352
 Fuel (gasoline)..... 351
 Notes..... 349
 Refrigerant (air conditioning system)..... 355
 Windshield washer fluid..... 354
- Operating safety**..... 25
- Operator's manual**..... 23
- Operator's Manual digital**..... 20
- Outside mirrors**
 Automatic anti-glare mode..... 137
 Automatic mirror folding function..... 138
 Blind Spot Assist/Active Blind Spot Assist..... 204
 Folding in/out..... 136
 Memory function..... 108
 Setting..... 136
 Warning lamp..... 204
- Overhead control panel**..... 14

- Overview of air bags..... 53
- P**
- Paddle shifters**
Steering wheel paddle shifters..... 160
- Paint code**..... 348
- Panic alarm, Alarm**
Activating/deactivating..... 70
- Park position**
DIRECT SELECT lever..... 158
- Parking**
Active Parking Assist..... 218
PARKTRONIC..... 213
- Parking aid**
PARKTRONIC..... 213
- Parking Assist**
Active Parking Assist..... 218
PARKTRONIC..... 213
- Parking Assist PARKTRONIC**
Activating/deactivating..... 217
Adjusting warning tones..... 218
Function..... 213
Side impact protection..... 216
- Parking assistance systems**
Active Parking Assist..... 218
Drive Away Assist..... 222
PARKTRONIC..... 213
- Parking brake**..... 169
- Parking for an extended period**..... 171
- Parking lamps**..... 126
- Parking lights**..... 126
- Parking option**
Selecting..... 251
- Parking position**
Exterior mirrors..... 138
Storing the position of the front-passenger outside mirror using reverse gear..... 138
- Parking service**
Selecting parking options..... 251
- Parking space**
Finding..... 251
- PARKTRONIC**..... 213
- PASSENGER AIR BAG**
Status display, front passenger air bag..... 42
- Payload**
Calculation example..... 324
Determining the maximum..... 323
- Permitted towing methods**
Overview..... 306
- Personalization**..... 240
- Pets in the vehicle**..... 49
- Post-collision brake**..... 47
- Power supply**
Start/stop button..... 143
Switching on (start/stop button)..... 143
- Power washer**..... 288
- PRE-SAFE®**, Anticipatory occupant protection
Function..... 45
PRE-SAFE® Sound..... 45
Reverting measures..... 46
- PRE-SAFE® PLUS**
Backing up measures..... 46
Function..... 46
- Preventative occupant protection system**
..... 45, 46

| | | | |
|---|-----|--|--|
| Profile, User profiles | | | |
| Creating a new profile..... | 240 | | |
| Selecting profile options..... | 240 | | |
| Programs..... | 155 | | |
| Protection | | | |
| Limited..... | 49 | | |
| Protection of the environment | | | |
| Driving style..... | 22 | | |
| Pulling away | | | |
| Hill Start Assist..... | 179 | | |
| Start-off assist..... | 179 | | |
| Q | | | |
| QR code rescue card..... | 32 | | |
| Qualified specialist workshop..... | 29 | | |
| R | | | |
| Radar and ultrasonic sensors..... | 173 | | |
| Radio | | | |
| Overview of functions/symbols..... | 271 | | |
| Radio regulations | | | |
| Regulatory radio identification..... | 348 | | |
| Rain closing function | | | |
| Sliding sunroof..... | 88 | | |
| Rain sensor | | | |
| Sliding sunroof..... | 88 | | |
| Windshield wipers..... | 132 | | |
| Reading lamp | | | |
| Interior lighting..... | 131 | | |
| Rear door (child safety lock) | | | |
| Securing..... | 66 | | |
| Rear fog light..... | 127 | | |
| Rear passenger compartment seat | | | |
| Adjusting the backrest angle..... | 114 | | |
| Rear seat | | | |
| Adjusting the backrest..... | 100 | | |
| Rear view camera | | | |
| 360° Camera..... | 209 | | |
| Function..... | 209 | | |
| Opening the camera cover..... | 213 | | |
| Rear window | | | |
| Replacing wiper blade..... | 135 | | |
| Rear window heater..... | 139 | | |
| Rear window wiper | | | |
| Activating/deactivating..... | 133 | | |
| Rearview mirror | | | |
| Automatic anti-glare mode..... | 137 | | |
| Rearward-facing child seat | | | |
| Information..... | 60 | | |
| Reflective safety vest..... | 294 | | |
| Refrigerant..... | 355 | | |
| Refueling | | | |
| Fuel..... | 163 | | |
| Refueling the vehicle..... | 163 | | |
| Remote Online | | | |
| Charging the starter battery..... | 145 | | |
| Cooling/heating the vehicle interior..... | 145 | | |
| Starting the vehicle..... | 146 | | |
| Replacement key..... | 72 | | |
| Reporting safety defects..... | 31 | | |
| Reserve | | | |
| Fuel..... | 352 | | |
| Resetting | | | |
| MBUX reset function..... | 245 | | |
| Residual heat..... | 141 | | |
| Responsibility | | | |
| Driving safety systems..... | 172 | | |

- Restraint system**
 Basic information..... 38
 Basic instructions for children..... 55
 Deployment situations..... 47
 Functionality..... 41
 Information on function..... 48
 Information on the correct seat position... 39
 Limited protection..... 49
 Malfunction..... 41
 Protection..... 39
 Self-test..... 41
 Warning lamp..... 41
- Reverse gear**
 DIRECT SELECT lever..... 158
- Reversing camera**
 Care..... 290
- Roadside Assistance (breakdown)**..... 25
- Roll away protection**..... 178
- Roller sunblind**
 Sliding sunroof..... 85
- Rollover crash**..... 29
- Roof load display**
 Information..... 155
- Roof luggage rack**
 Loading..... 120
 Securing..... 120
- Route**
 Alternative route..... 249
 Calculating..... 249
 Commuter route..... 249
 Navigation..... 247
 Selecting options..... 249
- Route guidance with augmented reality**
 Activating..... 249
 Displaying road names/house numbers..... 249
- Route-based speed adaptation**
 Function..... 188
 Setting..... 189
- Run-flat characteristics**..... 296
- S**
- Safety system**..... 174
- Satellite radio**
 Logging in..... 275
 Setting music and sport alerts..... 275
- Screen**
 MBUX (multimedia system)..... 233
- Seat**
 Adjusting (Seat Comfort)..... 95
 Adjusting (without seat comfort)..... 93
 Adjusting backrests (rear passenger compartment)..... 100
 Adjusting electrically..... 97
 Adjusting manually (rear passenger compartment)..... 98
 Adjusting the angle of the backrests (rear passenger compartment)..... 114
 Configuring settings..... 102
 Correct driver's seat position..... 92
 Folding back the backrest (rear passenger compartment)..... 113
 Locking the backrest (rear passenger compartment)..... 113
 Lumbar support..... 98
 Memory function..... 108
 Resetting the settings..... 103
 Settings..... 16
 Side impact air bag..... 53
- Seat belt**
 Automatic tightening..... 46

- Warning lamp..... 42
- Seat belt adjustment**
- Activating/deactivating..... 46
- Function..... 46
- Seat belt warning**..... 42
- Seat belts**
- Activating/deactivating seat belt adjustment..... 46
- Care..... 291
- Fastening..... 40
- Notes on wearing correctly..... 40
- Releasing..... 53
- Seat heating**
- Activating/deactivating..... 103
- Seat height**..... 97
- Seat ventilation**..... 104
- Seats**, Back seat, Through-loading feature
- Folding the backrest forwards (rear passenger compartment)..... 111
- Selecting a gear**..... 160
- Selector lever**..... 158
- Self-test**
- Automatic front passenger air bag shut-off..... 42
- Restraint system..... 41
- Sensors**
- Cleaning..... 290
- Service**..... 277
- Service center**..... 29
- Service interval display**..... 277
- Shifting**
- Automatic transmission..... 160
- Gearshift recommendation..... 161
- Manual..... 160
- Steering wheel paddle shifters..... 160
- Shortening the braking distance**
- Brake Assist System..... 175
- Shunting support**..... 223
- Side impact air bag**..... 53
- Side impact protection**..... 216
- Side windows**
- Child safety lock (rear passenger compartment)..... 67
- Closing with SmartKey..... 84
- Convenience closing..... 84
- Convenience opening..... 83
- Opening with the SmartKey..... 83
- Opening/closing..... 82
- Problem..... 84
- Size designation**
- Tires..... 329
- Skid chains**..... 315
- Sliding sunroof**
- Automatic functions..... 88
- Closing with SmartKey..... 84
- Opening with the SmartKey..... 83
- Opening/closing..... 85
- Problem..... 88
- Rain closing function..... 88
- SmartKey**
- Acoustic locking verification signal..... 70
- Battery..... 71
- Deactivating a function..... 70
- Function..... 69
- Key ring attachment..... 71
- Mechanical key..... 71
- Panic alarm..... 70
- Power consumption..... 70

- Unlocking setting..... 70
- Smartphone Integration, iPhone®**
 - Android Auto..... 264
 - Apple CarPlay®..... 264
- Snow chains**..... 315
- Socket**
 - 12 V (front center console)..... 120
 - 12 V (trunk/cargo compartment)..... 120
 - 115 V (rear passenger compartment).... 121
- Sound**
 - Menu..... 276
 - PRE-SAFE® Sound..... 45
 - Wheels/tires..... 314
- Sound settings**..... 276
- Spare parts**..... 22
- Spare wheel**
 - Emergency spare wheel..... 343
- Special seat belt retractor**..... 62
- Specialist workshop**..... 29
- speed**
 - Save, cruise control..... 186
 - Save, DISTRONIC..... 186
- Speed adaptation, Route-based**..... 188
- Speed control**
 - Active Distance Assist DISTRONIC..... 183
 - Cruise control..... 181
- Speed rating**
 - Tires..... 329
- Sport Utility Vehicle**..... 29
- Start-off assist**
 - Activating..... 179
 - Function..... 179
 - Hill Start Assist..... 179
- Start/stop button**
 - Parking the vehicle..... 165
 - Starting the vehicle..... 144
 - Switching on the power supply / vehicle..... 143
- Start/stop function**..... 153
- Starter battery**
 - charging, Remote Online..... 145
- Starting**
 - Remote Online..... 146
 - Start/stop button..... 144
- Starting assistance**..... 305
- Starting the engine**
 - Emergency operation mode..... 144
 - Remote Online..... 146
 - Start/stop button..... 144
- Starting-off aid**
 - Drive Away Assist..... 222
 - Hill Start Assist..... 179
 - Start-off assist..... 179
- Status display**
 - Front passenger air bag..... 42
- Steer Assist**
 - Active Steering Assist..... 191
 - STEER CONTROL..... 177
- STEER CONTROL**..... 177
- Steering wheel, Multifunction steering wheel**
 - Buttons..... 227
 - Driver's air bag..... 53
 - Manually adjusting..... 104
 - Steering wheel heater..... 105
- Steering wheel heater**..... 105
- Steering wheel paddle shifters**..... 160

- Stop and go**
ECO start/stop function..... 154
- Stopping**
Parking the vehicle..... 165
- Stowage areas**..... 111
- Stowage spaces**
Armrest..... 111
Center console (front)..... 111
Door..... 111
Glove box..... 111
- Substances hazardous to health**..... 25
- Suggestions**
Configuring..... 240
- Sulfur content**..... 351
- Surround lighting**..... 130
- Surround sound system**
Information..... 276
- Switch-off delay time**
Exterior..... 130
Interior..... 132
- Switching air-recirculation mode on/off**..... 141
- Synchronization function**
Activating/deactivating (control panel)... 140
- System settings**
Language setting..... 244
MBUX reset function..... 245
- System updates**..... 241
- T**
- Tailgate, Trunk lid**
Closing..... 77
Emergency key..... 82
HANDS-FREE ACCESS..... 80
Limiting the opening angle..... 81
Opening..... 76
- Tank content**
Fuel..... 352
Reserve..... 352
- Tank filler cap / flap**..... 163
- Technical data**
Information..... 346
Radio frequencies..... 347
Radio regulations..... 348
Vehicle dimensions..... 356
- Telediagnosis**
Diagnostic data..... 278
- Telediagnosics**
Transferred data..... 279
- Telephone**
Bluetooth®..... 257
Charging wirelessly (mobile phone)..... 123
Connecting a mobile phone..... 257
Emergency call..... 266
Menu..... 257
Notes..... 254
Notes on wireless charging (mobile phone)..... 122
Operating modes..... 257
Secure Simple Pairing..... 257
Telephone menu overview..... 256
- Telephony operating modes**
Bluetooth® telephony..... 257
- Temperature**
Setting the vehicle interior temperature..... 139
- Temperature grade**..... 326
- Themes**
Fastening..... 240

- TIN (Tire Identification Number)**..... 327
- Tire and Loading Information placard**..... 322
- Tire characteristics**..... 329
- Tire information table**..... 322
- Tire labeling**
- Characteristics..... 329
 - DOT, Tire Identification Number (TIN)..... 327
 - Load index..... 329
 - Load-bearing capacity..... 329
 - Maximum tire load..... 328
 - Maximum tire pressure..... 328
 - Size designation..... 329
 - Speed rating..... 329
 - Temperature grade..... 326
 - Tire Quality Grading..... 326
 - Traction grade..... 326
 - Tread wear grade..... 326
- Tire pressure**
- Checking..... 319
 - Checking manually..... 318
 - Maximum..... 328
 - Restarting the tire pressure loss warning system..... 321
- Tire pressure loss warning system, function..... 321
 - Tire pressure table..... 317
 - TIREFIT kit..... 297
- Tire pressure loss warning system**
- Function..... 321
 - Restarting..... 321
- Tire pressure monitor**
- Function..... 318
- Tire pressure monitoring system**
- Restarting..... 320
- Tire pressure table**..... 317
- Tire Quality Grading**..... 326
- Tire sealant**..... 297
- Tire tread**..... 314
- Tire-change tool**..... 337
- Tire-change tool kit**..... 337
- TIREFIT kit, Tire inflation compressor**
- Storage location..... 297
- Tires**
- Breakdown..... 296
 - Characteristics..... 329
 - Checking..... 314
 - Checking the temperature..... 319
 - Checking the tire pressure manually..... 318
 - Definitions..... 331
 - DOT, Tire Identification Number (TIN)..... 327
 - Installing..... 341
 - Labeling..... 326
 - Load index..... 329
 - Load-bearing capacity..... 329
 - Maximum pressure..... 328
 - Maximum tire load..... 328
 - MOExtended..... 296
 - Noise..... 314
 - Notes on installing..... 333
 - Removing..... 340
 - Removing/installing hub cap..... 338
 - Replacing..... 333, 338
 - Restarting the tire pressure loss warning system..... 321
 - Rotating..... 336
 - Selection..... 333
 - Size designation..... 329
 - Snow chains..... 315
 - Speed rating..... 329
 - Storing..... 337
 - Temperature grade..... 326

- Tire and Loading Information placard..... 322
- Tire pressure loss warning system,
function..... 321
- Tire pressure table..... 317
- Tire Quality Grading..... 326
- TIREFIT kit..... 297
- Traction grade..... 326
- Tread wear grade..... 326
- Unusual handling characteristics..... 314
- Toll system**
- Debiting toll fees..... 247
- Top Tether**..... 64
- Touch Control**
- MBUX..... 234
- On-board computer..... 227
- Touchpad**
- Operating..... 234
- Touchscreen**..... 234
- Tow bar system**
- Towing away..... 224
- Tow-away protection**..... 90
- Tow-starting**..... 310
- Towing**
- Towing methods..... 306
- Towing eye**
- installing/removing..... 309
- Storage location..... 309
- Towing methods**
- Both axles on the ground..... 307
- Overview..... 306
- Traction grade**..... 326
- Traffic information**..... 251
- Traffic light data service**
- Display in the Instrument Display..... 202
- Turning the display on/off..... 204
- Traffic light warning/display**..... 200
- Traffic Sign Assist**
- Function..... 200
- Setting..... 201
- Trailer drawbar, Pulling/towing**..... 224
- Transmission position display**..... 158
- Transmission positions**
- DIRECT SELECT lever..... 158
- Transporting**
- Vehicle..... 308
- Tread wear grade**..... 326
- Tuneln**
- Calling up..... 274
- Turn signal indicator**..... 127
- Turn signals**..... 127
- Two-way radios**
- Frequencies..... 347
- Installation..... 346
- Transmission output..... 347
- U**
- Unfastening**..... 53
- Unlocking setting**..... 70
- USB port**
- Rear passenger compartment..... 122
- Stowage compartments (front)..... 111
- V**
- Vehicle**
- Activating, Remote Online..... 146
- Activating/deactivating standby mode... 172

- Correct use..... 29
Data storage..... 32
Diagnostics connection..... 28
Emergency key..... 75
Equipment..... 23
KEYLESS-GO..... 73
Limited Warranty..... 32
lock automatically (MMS)..... 75
Locking/unlocking (from inside)..... 73
Locking/unlocking emergency key..... 75
Lowering..... 342
Maintenance..... 25
Medical aids..... 30
Parking..... 165
Parking for an extended period..... 171
Problem notification..... 31
Pulling..... 224
QR code rescue card..... 32
Raising..... 338
Set collision detection..... 171
Standby mode function..... 172
Starting (start/stop button)..... 144
starting, emergency operation mode..... 144
Stopping..... 165
Switching off (start/stop button)..... 165
Switching on (start/stop button)..... 143
- Towing away..... 306
Transporting..... 308
ventilating / convenience opening..... 83
- Vehicle cameras**..... 173
- Vehicle data**
- Display, MBUX..... 157
 - Displaying, DYNAMIC SELECT..... 157
 - Turning circle..... 356
 - Vehicle height..... 356
 - Vehicle length..... 356
 - Vehicle width..... 356
 - Weights..... 357
 - Wheelbase..... 356
- Vehicle dimensions**..... 356
- Vehicle emergency start**..... 310
- Vehicle equipment**..... 23
- Vehicle identification plate**
- Model series..... 348
 - Paint code..... 348
 - VIN..... 348
- Vehicle interior**
- Cooling/heating (Remote Online)..... 145
- Vehicle key**..... 69
- Vehicle operation outside the USA or Canada**..... 24
- Vehicle sensors**..... 173
- Vehicle start**
- Emergency operation mode..... 144
 - Remote Online..... 146
 - Start/stop button..... 144
- Vehicle tool kit**
- TIREFIT kit..... 297
 - Towing eye..... 309
- Vehicle with a high center of gravity**..... 29
- Ventilating**..... 83
- Ventilation**..... 141
- Vents**
- Air vents..... 141
- VIN**, Vehicle identification number
- Engine compartment..... 348
 - Identification plate..... 348
 - Windshield..... 348
- Vision**
- Defrosting windows..... 141
- Voice Control System**
- Function..... 236

Starting..... 236

W

Warning system..... 89

Warning triangle..... 294, 295

Warning/indicator lamp

 ABS warning lamp..... 419

 Active Brake Assist warning lamp..... 421, 422

 Brakes warning lamp (Canada only)..... 418

 Brakes warning lamp (USA only)... 418

 Brakes warning lamp (yellow) (Canada only)..... 417

 Check Engine warning lamp..... 414

 Coolant warning lamp (red)..... 412

 Coolant warning lamp (yellow)..... 413

 Distance warning lamp..... 421

 Electric parking brake indicator lamp (red) (Canada only)..... 416

 Electric parking brake indicator lamp (red) (USA only)..... 416

 Electric parking brake indicator lamp (yellow)..... 416

 Electrical malfunction warning lamp..... 414

 ESP® OFF warning lamp..... 420

 ESP® warning lamp flashes..... 419

 ESP® warning lamp lights up..... 420

 Fuel reserve warning lamp flashes..... 414

 Fuel reserve warning lamp lights up..... 415

 Power steering warning lamp (red)..... 411

 RBS warning lamp (USA only)..... 417

 Restraint system warning lamp.... 410

 Seat belt warning lamp flashes.... 410

 Seat belt warning lamp lights up... 411

 Tire pressure monitoring system warning lamp flashes..... 422

 Tire pressure monitoring system warning lamp lights up..... 423

Warning/indicator lamps

Instrument display..... 408

PASSENGER AIR BAG..... 42

Washer fluid

Topping up..... 284

Windshield washer fluid..... 354

Washing by hand..... 288

Water tank..... 285

Wear

Limited protection..... 49

Weather information..... 251

Web browser..... 263

Weight information..... 348

Wheel change

Installing a new wheel..... 341

Lowering the vehicle..... 342

Wheel rotation..... 336

- Wheels**
- Breakdown..... 296
 - Care..... 290
 - Checking..... 314
 - Checking the tire pressure manually..... 318
 - Checking the tire temperature..... 319
 - Definitions..... 331
 - DOT, Tire Identification Number (TIN)..... 327
 - Installing..... 341
 - Load index..... 329
 - Load-bearing capacity..... 329
 - Maximum tire load..... 328
 - Maximum tire pressure..... 328
 - MOExtended..... 296
 - Noise..... 314
 - Notes on installing..... 333
 - Removing..... 340
 - Removing/installing hub cap..... 338
 - Replacing..... 333, 338
 - Rotating..... 336
 - Selection..... 333
 - Size designation..... 329
 - Snow chains..... 315
 - Speed rating..... 329
 - Storing..... 337
 - Temperature grade..... 326
 - Tire and Loading Information placard..... 322
 - Tire characteristics..... 329
 - Tire labeling..... 326
 - Tire pressure..... 315
 - Tire pressure monitor..... 318
 - Tire Quality Grading..... 326
 - TIREFIT kit..... 297
 - Traction grade..... 326
 - Tread wear grade..... 326
 - Unusual handling characteristics..... 314
- Wi-Fi**
- Setting up a hotspot..... 242
- Windscreen cockpit instrument display**
- Instrument cluster..... 10
- Window curtain air bag**..... 53
- Windows**
- Care..... 290
 - Opening/closing..... 82
 - Removing mist..... 141
- Windshield**
- Defrosting..... 139
 - Replacing the wiper blades..... 133
- Windshield washer fluid**..... 354
- Windshield washer system**..... 284
- Windshield wipers**
- Activating/deactivating..... 132
 - Replacing the windshield wiper blades.... 133
 - Replacing the wiper blades..... 133
- Winter operation**
- Snow chains..... 315
- Wiper blades**
- Care..... 290
 - Replacing (windshield)..... 133
- Wipers**..... 132
- Wireless charging**
- Mobile phone..... 123
 - Overview..... 122
- Wireless vehicle components**
- Declaration of conformity..... 27
- Workshop**..... 29