

TABLE OF CONTENTS

SECTION

PAGE

1	INTRODUCTION	3	1
2	THINGS TO KNOW BEFORE STARTING YOUR VEHICLE.....	11	2
3	UNDERSTANDING THE FEATURES OF YOUR VEHICLE.....	57	3
4	UNDERSTANDING YOUR INSTRUMENT PANEL	89	4
5	STARTING AND OPERATING.....	141	5
6	WHAT TO DO IN EMERGENCIES.....	231	6
7	MAINTAINING YOUR VEHICLE	251	7
8	MAINTENANCE SCHEDULES	303	8
9	IF YOU NEED CONSUMER ASSISTANCE	311	9
10	INDEX	317	10

INTRODUCTION

CONTENTS

■ Introduction.....	4	■ Environmental Concerns and Recommendations	9
■ How to Use this Manual	5	■ Drinking Alcohol or taking Drugs while driving	9
■ Warnings and Cautions	5	■ Information Regarding Electronic Recording Devices	10
■ Vehicle Identification Number, Sample and Location	5	■ Stickers	10
■ Vehicle Safety Certification Label, Sample and Location	6		
■ Vehicle / Engine Emission Label, Sample and Location	8		

INTRODUCTION

This manual provides information needed to operate and understand the vehicle and its components. Additional detailed information is contained in the Owner's Warranty Information Book and the Sprinter Service Booklet.

WARNING!

Be sure to read the Operating Instructions. Otherwise you may not be aware of certain risks and could injur yourself or others.

Sprinter vehicles are equipped with a variety of components. Not all of the information contained in this manual applies to every vehicle.

IMPORTANT: Descriptions and specifications in this manual were in effect at the time of printing.

For your reference, keep this manual in the vehicle at all times.

DaimlerChrysler Vans LLC reserves the right to discontinue models and to change specifications or design at any time without notice and without incurring any obligation. Descriptions and specifications contained in this publication provide no warranty, expressed or implied, and are subject to revisions and publication of new editions without notice.

WARNING!

Engine exhaust, some of its constituents, and certain vehicle components contain or emit chemicals known to the State of California to cause cancer and birth defects or other reproduction harm. In addition, certain fluids contained in vehicles, and certain products of component wear, contain chemicals known to the State of California to cause cancer and birth defects or other reproductive harm.

HOW TO USE THIS MANUAL

Consult the table of contents to determine which section contains the information you desire.

The detailed index, at the rear of this manual, contains a complete listing of all subjects.

WARNINGS AND CAUTIONS

This manual contains **WARNINGS** against operating procedures which could result in an accident or bodily injury. It also contains **CAUTIONS** against procedures which could result in damage to your vehicle. If you do not read this entire manual you may miss important information. Observe all Warnings and Cautions.

VEHICLE IDENTIFICATION NUMBER, SAMPLE AND LOCATION

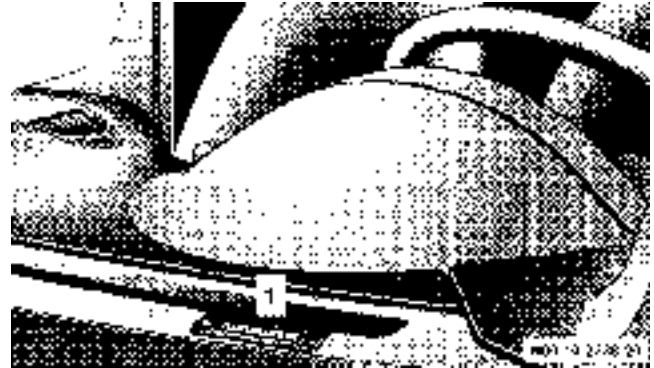

Vehicle identification number, visible (location: lower edge of windshield) (1)

NOTE: Data shown on placards are for illustration purposes only. Refer to placards on vehicle for actual data specific to your vehicle.

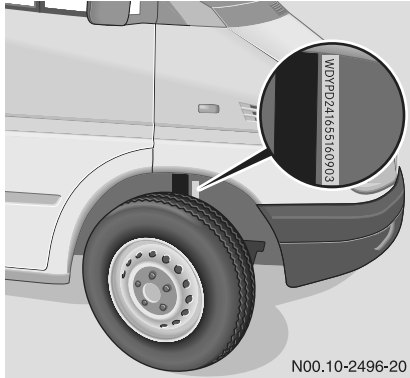

Vehicle identification number (location: on the chassis, right hand).

VEHICLE SAFETY CERTIFICATION LABEL, SAMPLE AND LOCATION

Location: below the driver's seat on an outward facing position of the mounting pillar.

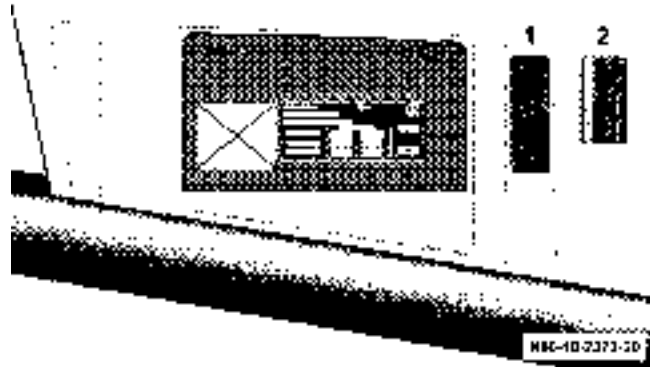

Incomplete vehicle certification label for chassis/cab.
(1)

Certification Label (vehicle identification number,
permissible weights) (2)

Sample Incomplete Vehicle Certification Label (Label 1)

CHASSIS-CAB MFD BY DAIMLERCHRYSLER AG WDPDP64465281063
 THIS CHASSIS-CAB CONFORMS TO FEDERAL MOTOR VEHICLE SAFETY
 STANDARDS NOS. 101-106, 108, 111, 113, 114, 116, 118-120, 124, 201-
 210, 212, 214, 219, 301&302. IF IT IS COMPLETED IN ACCORDANCE
 WITH THE INSTRUCTIONS CONTAINED IN THE INCOMPLETE VEHICLE
 DOCUMENT FURNISHED PURSUANT TO 49 CFR PART 568.4. CONFORMITY
 TO THE OTHER SAFETY STANDARDS APPLICABLE TO THIS VEHICLE WHEN
 COMPLETED IS NOT SUBSTANTIALLY AFFECTED BY THE DESIGN OF THE
 CHASSIS-CAB, AND THAT THE INCOMPLETE VEHICLE MANUFACTURER
 MAKES NO REPRESENTATION AS TO CONFORMITY WITH THE STANDARDS.

N00.10-2497-20

Sample Certification Label (Label 2)



N00.10-2574-20

NOTE: Data shown on label are for illustration purposes only. Data are specific to each vehicle and may vary from data shown in the illustrations. Refer to label on vehicle for actual data specific to your vehicle.

VEHICLE/ENGINE EMISSION LABEL, SAMPLE AND LOCATION

Location: on valve cover of the engine

NOTE: Data shown on label are for illustration purposes only. Data are specific to each vehicle and may vary from data shown in the illustrations. Refer to label on vehicle for actual data specific to your vehicle.

Sample:

Important Engine Information

This is a LOW EMISSION VEHICLE engine and meets all applicable requirements of US EPA CFFV as "ULEV" per 40 CFR 88 and CARB as "ULEV" per CCR 1956.8

DaimlerChrysler AG, Stuttgart, Germany

Mercedes-Benz Engine, Model	OM 647 LA	CID 164
Engine Family / Engine Code	4 MBXH2.69DJB / Code I	
Exhaust Emission Control System	TC, EMC, CAC, OC, EGR	

Date of engine manufacture	2004
Advertised output (SAE gr.)	115 kW (154 HP) / 3800 rpm
Fuel rate at adv. Output	55 - 63 mm ³ / stroke
Valve lash cold (ins.)	n.a. int. / n.a. exh..
Basic injection timing	14.5 ± 1 degrees BTDC
Idle speed	680 ± 50 rpm

This engine conforms to US, EPA, CARB and Canada regulations applicable to 2004 Model Year.

This engine has a primary intended service application as a light HD diesel engine.

This engine is not certified for use in an urban bus as defined at 40 CFR 86.093.-2. Sales of this engine for use in an urban bus is a violation of Federal Law under the Clean Air Act.

This engine is certified to be operated on diesel fuel.

ENVIRONMENTAL CONCERNS AND RECOMMENDATIONS

In this manual, whenever you see instructions to discard materials, you should first attempt to reclaim and recycle them. To preserve our environment, follow appropriate environmental rules and regulations when disposing of materials.

DRINKING ALCOHOL OR TAKING DRUGS WHILE DRIVING

WARNING!

Drinking or taking drugs and driving can be a very dangerous combination. Even a small amount of alcohol or drugs can affect your reflexes, perceptions and judgement.

The possibility of a serious or even fatal accident is sharply increased when you drink or take drugs and drive.

Never drink or take drugs and drive or allow anyone to drive after drinking or taking drugs.

INFORMATION REGARDING ELECTRONIC RECORDING DEVICES

(Including notice pursuant to California Code § 9951)

Please note that your vehicle is equipped with devices that can record vehicle systems data.

This information helps, for example, to diagnose vehicle systems after a collision and to continuously improve vehicle safety. DaimlerChrysler may access the information and share it with others

- for safety research or vehicle diagnosis purposes
- with the consent of the vehicle owner or lessee
- in response to an official request by law enforcement or other government agency
- for use in dispute resolution involving DaimlerChrysler, its affiliates or sales/service organization and/or
- as otherwise required or permitted by law.

STICKERS

There are various warning stickers affixed to the motor home. Their purpose is to make you and others aware of various dangers.

WARNING!

Do not remove any warning stickers.

If you remove the warning stickers, you or others may not be aware of certain dangers and could be injured.

THINGS TO KNOW BEFORE STARTING YOUR VEHICLE

CONTENTS

■ Ignition Lock / Starter Switch	13	■ Security System with Towing and Passenger Compartment Protection (Optional)	23
□ Immobilizer	14	□ Audible Alarm	24
■ Central Locking (Optional)	15	□ Visual Alarm	24
□ Unlocking:	16	□ Switching off the Alarm	24
□ Locking:	16	■ Towing Protection and Passenger Compartment Protection Switch (Optional)	24
□ Central Locking Switch	17	□ Towing Protection	24
□ Locking Status Display	18	□ Switching off the Towing Protection	24
□ Locking and Unlocking	19	□ Passenger Compartment Protection	25
□ To Program the Automatic Lock Feature when Starting the Engine	19	□ Switching off the Passenger Compartment Protection	25
■ Remote Keyless Entry (Optional)	20	□ Alarm Pushbutton (Vehicles with Security Systems only)	26
□ Unlocking with Remote Keyless Entry	21		
□ Locking with Remote Keyless Entry	22		
■ Replacing Batteries in Remote Keyless Entry	22		

12 THINGS TO KNOW BEFORE STARTING YOUR VEHICLE

- Opening/Closing doors 27
 - Sliding Door 30
 - Rear Cargo Doors 33
 - Passenger/Cargo Area Door 37
- Occupant Restraints 39
- Seat Belts 41
 - Seat Belt Warning Lamp and
Airbag Malfunction 44
 - Fastening and Removing 45
 - Belt Height Adjustment 46
- Driver's Airbag 47
- Front Seat Passenger Airbag (not in conjunction
with folding seat in partition wall) 48
- Airbag and Belt Tensioners 49
 - SRS Malfunction Indicator Lamp 49
 - Belt Tensioners 49
 - Safety Precautions for the Airbag 50
- Pedals 52
- Engine Break-In Specifications 52
 - The first 1,000 miles (about 1,500 km) 52
 - Engine Oil Consumption 53
- Safety Tips 53
- Inhalation of Exhaust Gas 54
- Tie Down Rings (Optional) 54

IGNITION LOCK/STARTER SWITCH

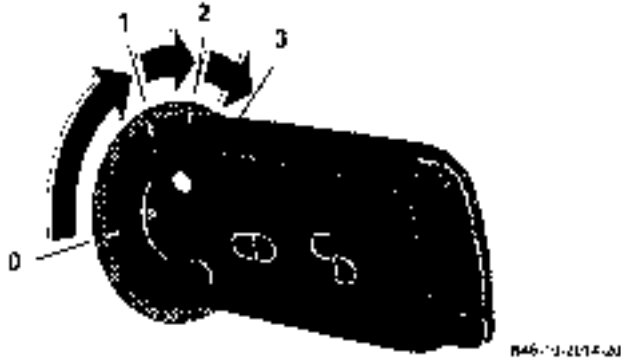

The steering wheel is locked when the key is removed (0)

To remove the key, place the gear selector lever in position "P"; rotate the key in the ignition lock to position 0; and remove the key.

The steering wheel is unlocked (1)

Preheating and driving position (2)

Start position (3)

To engage the steering wheel lock:

After removing the key, turn the steering wheel until the steering wheel lock engages.

To release the steering wheel lock:

Turn the steering wheel slightly while turning the key to position 1.

NOTE: If the driver's or passenger's door is opened with the key in position 0 or 1 in the ignition lock, a warning buzzer sounds.

WARNING!

Do not remove the key from the ignition lock unless the vehicle is stationary. Always remove the key from the ignition lock when leaving the vehicle to prevent children or unauthorized persons from starting the engine.

Immobilizer

The immobilizer is automatically activated when the key is removed from the ignition lock. The engine cannot be started. As soon as the correct key is inserted into the ignition lock, the immobilizer is deactivated.

For notes on the remote keyless entry, refer to "Remote Keyless Entry".

NOTE: If the engine cannot be started and the displays **START** and **Error** appear alternately in the multi-function indicator when the key is in position 2 in the ignition lock, a fault has developed or the key used has not been activated.

Remove the key and repeat the starting procedure. If the engine still cannot be started, consult an authorized Sprinter Dealer.

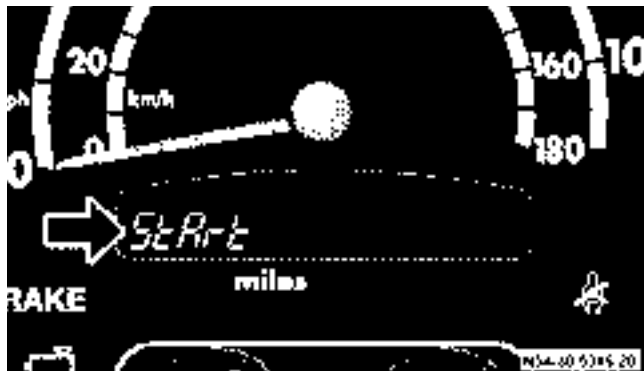

CENTRAL LOCKING (OPTIONAL)

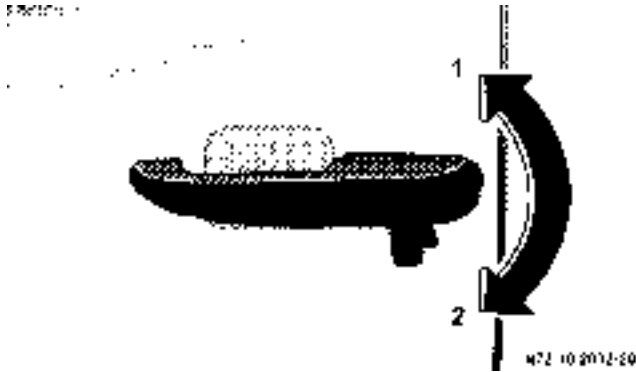

To unlock (1)

To lock (2)

CAUTION!

An unlocked vehicle is an invitation to thieves. Always remove the key from the ignition and lock all doors when leaving the vehicle unattended.

WARNING!

For personal security and safety in the event of an accident, lock the vehicle doors when you drive as well as when you park and leave the vehicle.



To unlock (1)

To lock (2)

WARNING!

When leaving the vehicle always remove the key from the ignition lock, and lock your vehicle.

Do not leave children unsupervised in the vehicle, even if they are secured by a child restraint system. The children could

- injure themselves on parts of the vehicle
- release the child-proof locks by pressing the central locking button and could thereby open the doors and
- cause injury to others as a result
- get out of the vehicle and could either injure themselves when doing so or they could be injured by the traffic approaching from the rear
- suffer serious or fatal effects in the event of long periods of hot weather
- release the parking brake. The vehicle could then start moving of its own accord.

Unsupervised use of vehicle equipment may cause severe personal injuries, death and property damage.

Unlocking:

If a door lock or interior handle on the driver or front seat passenger door is unlocked, only the driver or front seat passenger door will be unlocked.

NOTE: If a door lock or interior handle on the sliding door or tailgate is unlocked, only the sliding door or tailgate will be unlocked.

Locking:

All doors are automatically locked if a door lock or interior handle is locked.

NOTE: If the central locking automatically unlocks again after having been locked, at least one door is closed incorrectly.

If it then locks again within about 5 seconds, then all closed doors are locked.

The central locking displays vehicle locking with one or more open doors by means of a special function sequence (locking, unlocking, locking). Once closing has been completed, an open door will not automatically be locked.

After the engine is started (about 1 second), all doors with the exception of the driver-side door are locked automatically.

NOTE: In vehicles without central locking only the respective door will be locked or unlocked.

CAUTION!

In case of an accident, rescue from the outside may be more difficult if the vehicle is locked.

To unlock the vehicle after the engine is started, refer to "Central Locking Switch".



Central Locking Switch

The central locking switch is located on the center section of the dashboard.

The entire vehicle or just the passenger door and the cargo doors can be locked or unlocked from inside the vehicle with the central locking switch.

After the engine is started (about 1 second), all doors with the exception of the driver-side door are locked (standard setting).

WARNING!

When leaving the vehicle always remove the key from the ignition lock, and lock your vehicle.

Do not leave children unsupervised in the vehicle, even if they are secured by a child restraint system. The children could

- injure themselves on parts of the vehicle
- release the child-proof locks by pressing the central locking button and could thereby open the doors and
- cause injury to others as a result
- get out of the vehicle and could either injure themselves when doing so or they could be injured by the traffic approaching from the rear
- suffer serious or fatal effects in the event of long periods of hot weather
- release the parking brake. The vehicle could then start moving of its own accord.

Unsupervised use of vehicle equipment may cause severe personal injuries, death and property damage.

Locking Status Display

Left-hand indicator lamp is illuminated:
The driver's door is locked.

Right-hand indicator lamp is illuminated:
Front-seat passenger door and rear-seat passenger area/cargo area are locked.

Both indicator lamps are illuminated:
The entire vehicle is locked.

If an indicator lamp flashes:
At least one door has not been properly closed.

NOTE: The indicator lamps go out, once the remote keyless entry transmitter has been used to completely lock the vehicle; if the ignition lock is in the position 0, and once the interior handles/closing cylinders have been used to completely lock the vehicle; after about 15 minutes in position 0 in the ignition lock.

The display can be reactivated by pressing the central locking switch, located on the center section of the dashboard.

Locking and Unlocking

To lock entire vehicle:

Press top of central locking switch.
The left and the right indicator lamp in the switch illuminate. If one of the two indicator lamps blinks, at least one door is not closed properly.

To unlock entire vehicle:

Press top of central locking switch again.
To lock the front-seat passenger door and the rear-seat passenger area/cargo area:
Press bottom of central locking switch.
The right indicator lamp in the switch illuminates. If the indicator lamp blinks, at least one door is not closed properly.
To unlock the front-seat passenger door and the rear-seat passenger area/cargo area:
Press bottom of central locking switch again.

CAUTION!

In case of an accident, rescue from the outside may be more difficult if the vehicle is locked.

To unlock the vehicle after the engine is started, refer to "Central Locking Switch".

2

To Program the Automatic Lock Feature when Starting the Engine

Place the key in position 2 in the ignition lock and close all doors.

To switch off automatic locking of the front-seat passenger door and the rear-seat passenger area/cargo area:

Press the central locking switch at the bottom and hold it there for about 5 seconds. The right indicator lamp flashes twice. Automatic locking when the engine is started is switched off.

To switch on automatic locking of the front-seat passenger door and the rear-seat passenger area/cargo area:

Press the central locking switch at the bottom and hold it there for about 5 seconds. The right indicator lamp

20 THINGS TO KNOW BEFORE STARTING YOUR VEHICLE

flashes four times. Automatic locking when the engine is started is switched on (standard setting).

NOTE: A door which is closed after the engine has been started will not be locked automatically.

CAUTION!

In case of an accident, rescue from the outside may be more difficult if the vehicle is locked.

To unlock the vehicle after the engine is started, refer to "Central Locking Switch".

Automatic Unlocking in Case of an Accident

The doors will unlock in the event of certain accidents, provided that the power supply is still maintained.

REMOTE KEYLESS ENTRY (OPTIONAL)

NOTE: This device complies with Part 15 Subpart C Section 231 of the FCC Rules. Operation is subject to the following two conditions:

This device may not cause harmful interference, and this device must accept any interference received

including interference that may cause undesired operation.

NOTE: Any unauthorized modification to this device could void the user's authority to operate the equipment.

NOTE: Included with your vehicle are 2 remote keyless entry transmitters plus removable mechanical key.

Keys which were not included with delivery must be activated at an authorized Sprinter Dealer before they can be used.



If a non-activated key is used, after the fourth attempt to start, the starting process will be blocked for 1 minute.

The multi-function display will alternately show  and , refer to "Immobilizer".

Malfunctions could occur if the remote keyless entry transmitter is exposed to moisture. As a precaution, both remote keyless entry transmitters should always be carried.

The remote keyless entry transmitter transmits in all directions. It does not have to be pointed at the vehicle. Do not expose the remote keyless entry transmitter to high levels of electromagnetic radiation in order to avoid the risk of malfunctions.

The remote keyless entry transmitter has an average range of about 32 ft (about 10 m). Always verify the correct operation of the remote keyless entry transmitter by listening for the locking noise and by checking that the white patch on the interior door handle is visible.

When pressing the  or  buttons, the indicator lamp illuminates. If the indicator lamp does not illuminate, the batteries must be replaced.

The remote keyless entry transmitter will not function when there is a vehicle key inserted in the ignition lock.



MOG-25-2RC7-20

Release button for mechanical key (1)

Indicator lamp (2)

Lock button  (3)

Unlock button  (4)

Unlocking with Remote Keyless Entry

Press the  button once. The driver's door is unlocked and the hazard warning lamp, as well as the remote keyless entry transmitter indicator lamp, blink once.

Press the  button a second time. The passenger door and cargo doors are unlocked and the turn signal lamps, as well as the remote keyless entry transmitter indicator lamp, blink once again. The button must be pressed a second time within about 2.5 seconds, otherwise the second request to open can not be performed.

NOTE: The vehicle is automatically locked again, if within about 40 seconds of unlocking with the remote keyless entry transmitter, none of the doors are opened. The hazard warning lamp does not blink.

Locking with Remote Keyless Entry

Press the  button. The entire vehicle is locked and the hazard warning lamp blinks three times. The remote keyless entry transmitter indicator lamp blinks once.

If the hazard warning lamp does not blink, at least one door is improperly closed. Check to see if there is a door that is not properly closed or if there is a key in the ignition lock. Remove key from ignition lock and/or close doors properly and press the  button again.

REPLACING BATTERIES IN REMOTE KEYLESS ENTRY

Do not touch the battery contact surfaces (insert the batteries with a lint-free cloth).

WARNING!

Keep batteries away from children.

Consult a doctor immediately if a battery is swallowed.

Dispose of used batteries in an environmentally responsible manner.

Danger of explosion if the battery is not correctly replaced. Replacements should always be either of the same type or one which has been recommended by the manufacturer.

NOTE: Do not operate the remote control while the battery is being replaced.

Replacing Batteries



Rated voltage: 6 V
DC (2x 3V)

Rated current: 10 mA

1. Release the mechanical key by pressing the release button.
2. Remove the battery cover.

4B000-0278-2D



3. Remove the battery and install new one (note correct polarity; positive terminal up).
4. Press on the battery cover until it snaps into place.

SECURITY SYSTEM WITH TOWING AND PASSENGER COMPARTMENT PROTECTION (OPTIONAL)

The security system is ready for operation, if the vehicle is locked with the remote keyless entry transmitter.

If a door is open, the security system is not switched on during the locking process.

Security system activation is indicated by the turn signal lamps flashing three times in succession.

For a function check, when the security system is switched on, the indicator lamps in the towing protection/passenger compartment protection switch flash.

The security system will switch off if the vehicle is unlocked using the remote keyless entry transmitter. The turn signal lamps flash once.

The alarm is triggered if the security system has been activated and

- A door is opened,
- a door is unlocked from inside,
- the engine cover is opened,
- the key is used to unlock the vehicle at any door,
- the key is turned to position 2 in the ignition lock.

Audible Alarm

The horn sounds for about 25 seconds.

Visual Alarm

The turn signal lamps flash for about 4 minutes.

Switching off the Alarm

The alarm will switch off immediately if the vehicle is unlocked using the remote keyless entry transmitter.

NOTE: Do not manually unlock the doors as this will trigger the alarm.

TOWING PROTECTION AND PASSENGER COMPARTMENT PROTECTION SWITCH (OPTIONAL)

See Section 4, Understanding Your Instrument Panel, for switch locations.



Switch off the towing protection

Indicator lamp

As a function check, (1) the indicator lamp (2) flashes when the security system is switched on.

Switch off the passenger compartment protection (3).

Towing Protection

The towing protection is ready for operation after 30 seconds as the security system has been activated. The alarm is triggered if the vehicle is lifted while the security system is activated.

Switching off the Towing Protection

If the vehicle is to be transported or loaded, the towing protection must be switched off in order to avoid a false alarm.

1. Place the key in position 0 or 1 in the ignition lock.
2. Press the switch up (1) to switch off the towing protection.
The indicator lamp (2) is briefly illuminated.

If passenger compartment protection will be switched off as well, wait until the indicator lamp (2) goes out, and

3. Press switch (3) downward.
The indicator lamp (2) flashes about 10 times.

To activate the setting (towing protection/passenger compartment protection switched off):

4. Keep the key in locking position in the driver's door lock for more than 2 seconds or
5. lock the vehicle using the remote keyless entry transmitter.

The towing protection will remain switched off until the vehicle is locked again with the remote keyless entry transmitter.

NOTE: The alarm will switch off immediately if the vehicle is centrally unlocked using the remote keyless entry transmitter.

Passenger Compartment Protection

The passenger compartment protection is ready for operation 30 seconds after the security system has been activated. The alarm is triggered if movement inside the vehicle is registered while the security system is activated.

NOTE: Close the side windows and the glass tilting roof.

Do not leave any objects (mascots, hangers) on the interior mirror or on the roof grab handles, as these could trigger a false alarm.

Switching off the Passenger Compartment Protection

If persons or animals remain in the locked vehicle, switch off the passenger compartment protection to prevent a false alarm.

1. Place the key in position 0 or 1 in the ignition lock.
2. Press the switch downward (3) to switch off the passenger compartment protection. The indicator lamp (2) flashes about 10 times.

If towing protection is to be switched off as well, wait until the indicator lamp (2) goes out, and

3. Press switch up (1).

The indicator lamp (2) is briefly illuminated.

To activate the setting (passenger compartment/towing protection switched off):

4. Lock the vehicle using the remote keyless entry transmitter.

The passenger compartment protection will remain switched off until the vehicle is locked again with the remote keyless entry transmitter.

NOTE: The alarm will switch off immediately if the vehicle is centrally unlocked using the remote keyless entry transmitter.

Alarm Pushbutton (Vehicles with Security Systems only)

See Section 4, Understanding Your Instrument Panel, for switch locations.



W54-25-2344-20

Trigger the alarm manually/lock the vehicle.

The audible and visual alarm can be triggered manually by using the alarm pushbutton.

Audible Alarm

The horn sounds until the alarm is switched off.

Visual Alarm

The turn signal lamps flash until the alarm is switched off.

Trigger the alarm manually and lock the vehicle.

Press the alarm pushbutton upward once.

The indicator lamp flashes in the towing/passenger compartment protection switch.

The vehicle will be centrally locked if all doors are closed.

Switching Off the Alarm and Unlocking the Vehicle

Press the alarm pushbutton up one more time.

The vehicle will be centrally unlocked if it was not centrally locked before the alarm was manually triggered.

OPENING/CLOSING DOORS

Front Doors

WARNING!

Do not leave children unsupervised in the vehicle, even if they are secured by a child restraint system. The children could

- injure themselves on parts of the vehicle
- release the child-proof locks by pressing the central locking button and could thereby open the doors and
- cause injury to others as a result
- get out of the vehicle and could either injure themselves when doing so or they could be injured by the traffic approaching from the rear
- suffer serious or fatal effects in the event of long periods of hot weather
- release the parking brake. The vehicle could then start moving of its own accord.

Unsupervised use of vehicle equipment may cause severe personal injuries, death and property damage.

WARNING!

Only drive with the doors properly closed. You could lose the load, for example, and endanger vehicle occupants or other road users if the doors are open.

Only open the doors when road and traffic conditions permit.

Do not leave children alone in the vehicle. They could open a locked door from the inside despite the road and traffic conditions, thereby endangering themselves and others.

To prevent severe personal injuries, always keep hands and fingers away from the door opening when closing a door. Be especially careful when small children are around.

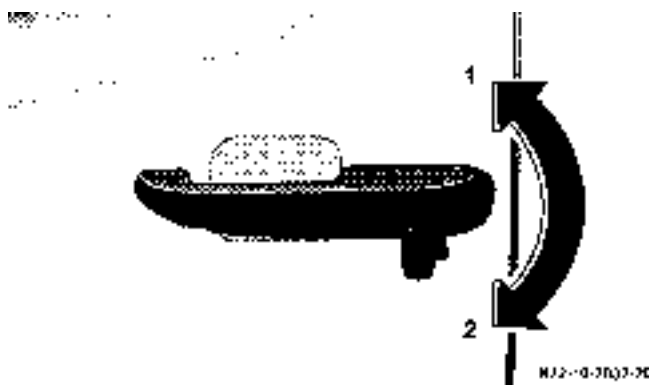
From the Outside

To unlock (1)

To lock (2)

To open the door:

Pull the handle to open the door.

From the Inside



To unlock (1)

To lock (2)

To unlock and open

Pull handle.

To lock:

Press the handle in. All closed doors will be locked.

The door is locked when the white patch in the handle can be seen. If an open door is detected, refer to "Central Locking".

CAUTION!

In case of an accident, rescue from the outside may be more difficult if the vehicle is locked.

To unlock the vehicle after the engine is started, refer to "Central Locking Switch".

NOTE: The driver's and passenger's doors cannot be locked when they are open (lockout protection).

In vehicles without central locking only the respective door will be locked or unlocked.

Please note anti-theft alarm system: The anti-theft alarm will be triggered when the doors are manually unlocked. Cancel alarm by pressing button . The anti-theft alarm system will not be activated when the doors are manually locked.

Sliding Door

WARNING!

Only drive with the doors properly closed. You could lose the load, for example, and endanger vehicle occupants or other road users if the doors are open.

To prevent possible personal injury, always keep hands and fingers away from the door opening when closing a door. Be especially careful when small children are around.

Only open the doors when road and traffic conditions permit.

Do not leave children alone in the vehicle. They could open a locked door from the inside despite the road and traffic conditions, thereby endangering themselves and others.

Do not leave doors open on uphill or downhill grades. Doors could be released from the door support and slam shut. If they are not closed properly, sliding doors can open on their own. This could result in severe injury. Be especially careful when small children are around.

From the Outside

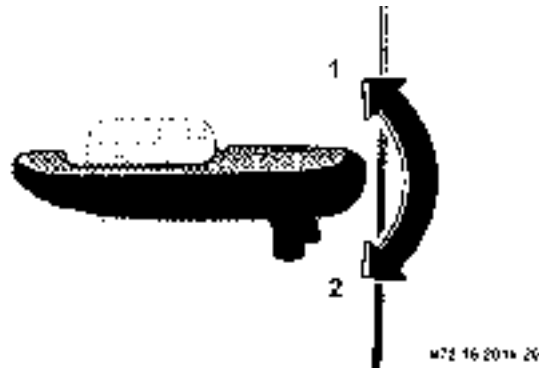

To unlock (1)

To lock (2)

To open the door:

Pull the handle and slide the door back to the stop.

To close the door:

Slide it forwards by the handle until it latches.

From the Inside without Lock Button

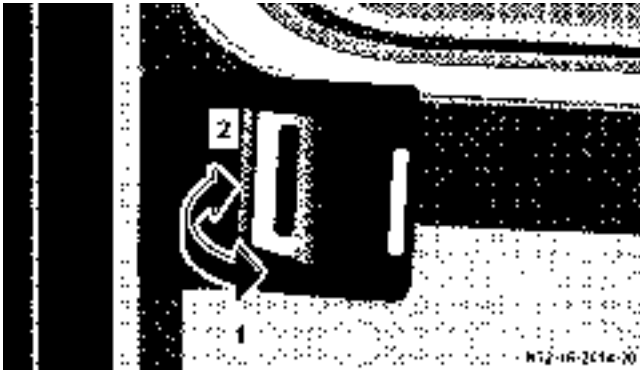

To unlock (1)

To lock (2)

To unlock and open:

Pull handle.

To lock:

Press the handle in.

The door is locked when the white patch in the handle can be seen. If an open door is detected, refer to "Central Locking".

From the Inside with Lock Button

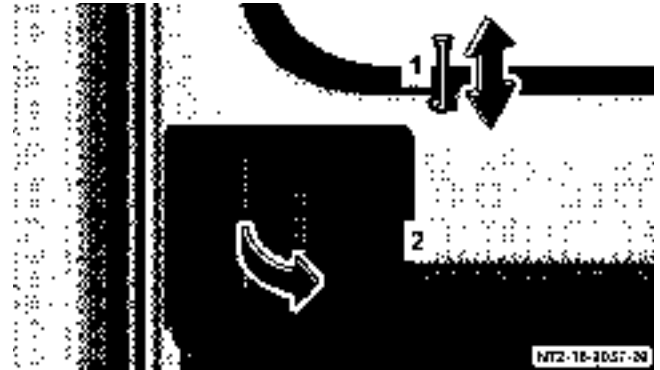

Lock button (1)

Handle (2)

To unlock and open:

Pull lock button (1)

(the door is unlocked, all other doors remain locked).

Pull handle (2).

To lock:

Press lock button (1)
(all doors are locked)

If the central locking automatically unlocks again after having been locked, at least one door is closed incorrectly.

If it then locks again within about 5 seconds, then all closed doors are locked.

The central locking displays vehicle locking with one or more open doors by means of a special function sequence (locking, unlocking, locking). Once closing has been completed, an open door will not automatically be locked.

CAUTION!

In case of an accident, rescue from the outside may be more difficult if the vehicle is locked.

To unlock the vehicle after the engine is started, refer to "Central Locking Switch".

In vehicles without central locking only the respective door will be locked or unlocked.

Please note anti-theft alarm system: The anti-theft alarm will be triggered when the doors are manually unlocked. Cancel alarm by pressing button . The anti-theft alarm system will not be activated when the doors are manually locked.

NOTE: If an open sliding door is locked before being closed, then only the sliding door will be locked.

Rear Cargo Doors

WARNING!

Only drive with the doors properly closed. You could lose the load, for example, and endanger vehicle occupants or other road users if the doors are open.

To prevent possible personal injury, always keep hands and fingers away from the door opening when closing a door. Be especially careful when small children are around.

Only open the doors when road and traffic conditions permit.

Do not leave children alone in the vehicle. They could open a locked door from the inside despite the road and traffic conditions, thereby endangering themselves and others.

When the rear cargo doors are opened to an angle of 90° (catch position), more than 50% of the rear lamps are concealed. When the door is open in this manner, you should warn others in accordance with legal requirements.

From the Outside

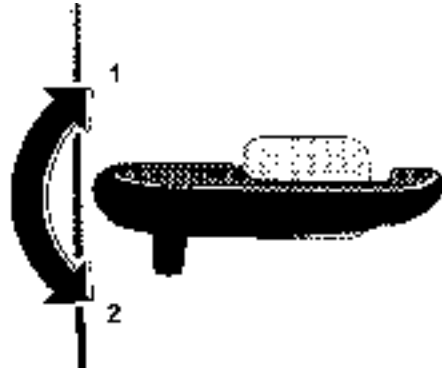

To unlock (1)

To lock (2)

To open the door:

Pull the handle to open the door.

W72-28-2091-23

From the Inside without Lock Button

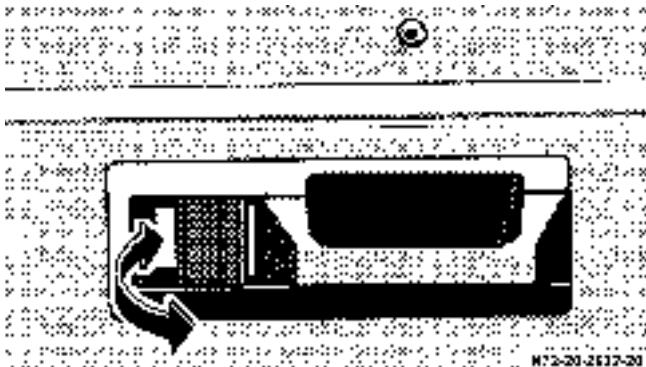

To unlock and open:

Pull handle.

To lock:

Press the handle in.

The door is locked when the white patch in the handle can be seen. If an open door is detected, refer to "Central Locking".

From the Inside with Lock Button



Lock button (1)

Handle (2)

To unlock and open:

Pull lock button (1)

(the door is unlocked, all other doors remain locked).

Pull handle (2).

To lock:

Press lock button (1)

(all doors are locked).

If the central locking automatically unlocks again after having been locked, at least one door is closed incorrectly.

If it then locks again within about 5 seconds, then all closed doors are locked.

The central locking displays vehicle locking with one or more open doors by means of a special function sequence (locking, unlocking, locking). Once closing has been completed, an open door will not automatically be locked.

NOTE: In vehicles without central locking only the respective door will be locked or unlocked.

Opening Left-Hand Door

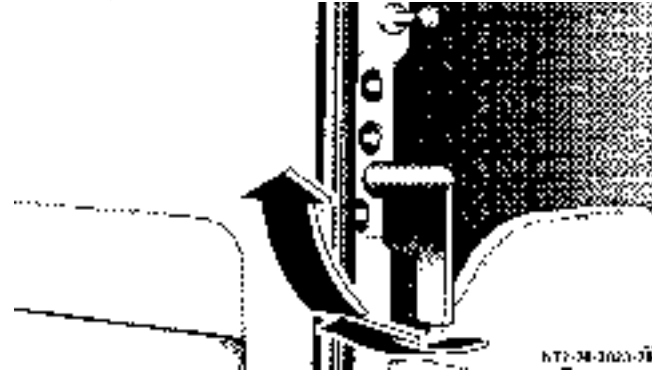

To open:

Move the handle up.

To close:

Close the door until it engages.

To lock manually:

Move the handle down until it is in the vertical position.

Automatic locking:

If the left-hand door is closed, it will be automatically locked as soon as the right-hand door has been closed.

NOTE: If an open tailgate is locked before being closed, then only the tailgate will be locked.

Please note anti-theft alarm system: The anti-theft alarm system will be triggered when the doors are manually unlocked. Cancel alarm by pressing button . The anti-theft alarm system will not be activated when the doors are manually locked.

Opening Angle 270°

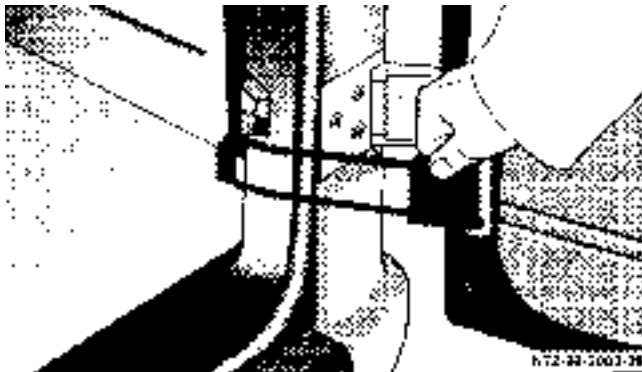

To open:

Unhinge the door check strap.

Open the door 270° and press the door stay against the outer sidewalls. The doors will be kept in this position by retaining plates.

To close:



Pull the doors away from the retaining plates on the outer sidewalls.

Passenger/Cargo Area Door

WARNING!

Always drive with the doors properly closed, because if the vehicle is operated with the doors open, serious personal injury may result.

To prevent possible personal injury, always keep hands and fingers away from the door opening when closing a door. Be especially careful when small children are around.

NOTE: The maximum cargo area door height is 5 feet 7 inches (176 cm).

To Unlock the Door from the Passenger Area

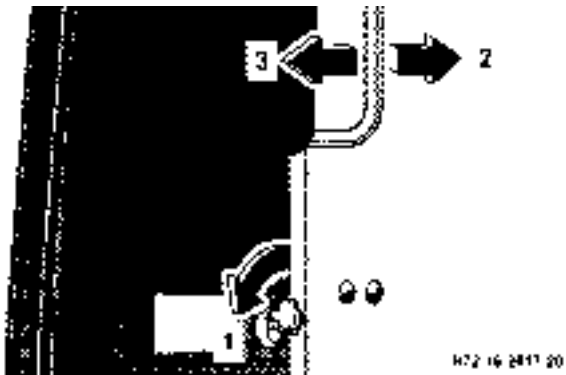

To unlock, turn key to left (1)

To open door (2)

To close door and lock (3)

To Unlock the Door from the Cargo Area (Optional)

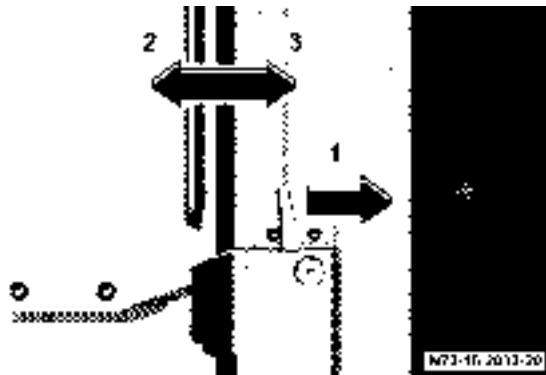

To unlock, press latch in direction (1)

To open door (2)

To close door and lock (3)

OCCUPANT RESTRAINTS

Seat belts, belt tensioners, airbag and child restraint systems are independent restraint systems whose functions complement each other.

All states and provinces require use of child restraints that comply with U.S. Federal Motor Vehicle Safety Standard 213 and Canadian Motor Vehicle Safety Standard 213.

All child restraint systems are designed to be secured in vehicle seats by lap belts or the lap belt portion of a lap-shoulder belt.

For your safety and that of your passengers, you must use the seat belts and child restraint systems and use them properly. We strongly recommend their use.

WARNING!

In a collision, you and your passengers can suffer injuries, including fatalities, if you are not properly buckled up. You can strike the interior of your vehicle or other passengers, or you can be thrown out of the vehicle. Always be sure you and others in your vehicle are buckled up properly.

WARNING!

Do not modify the components or electrical wiring of the restraint systems. This includes the installation of additional trim material, badges etc. over the steering wheel hub, or front door trim panels, and installation of additional electrical/electronic equipment on or near restraint system components and wiring.

Any work on the restraint systems should only be carried out by an authorized Sprinter Dealer.

Unprofessional work can lead to the restraint systems triggering incorrectly or failing.

Damaged seat belts or belts that were highly stressed in an accident must be replaced and their anchoring points must also be checked. Use only belts installed or supplied by an authorized Sprinter Dealer.

Do not pass belts over sharp edges.

Do not make any modification that could change the effectiveness of the belts.

WARNING!

Airbag and belt tensioners are designed to function on a one-time-only basis. An airbag or belt tensioner that was activated must be replaced.

An airbag system component integrated in the steering wheel gets hot after the airbag has inflated. Do not touch.

No modifications of any kind may be made to any components or wiring of the restraint system.

Keep area between airbag and occupants free of objects (e.g. packages, purses, umbrellas, etc.).

In addition, through improper work there is the risk of rendering the restraint system inoperative. Work on the restraint system must therefore only be performed by an authorized Sprinter Dealer.

WARNING!

When discarding of the airbag unit or emergency tensioning retractor, you must follow our safety instructions. These instructions are available at your Sprinter Dealer.

Given the considerable deployment speed and the textile structure of the airbag, there is the possibility of injuries and even death resulting from being positioned too close to the airbag when it deploys.

Do not seat children less than 5 feet tall or 12 years and under in the front. The back seat is the safest place for children. If the vehicle is not equipped with a back seat, children less than 5 feet tall or 12 years and under must never ride in this vehicle. Never place an infant seat on the front passenger seat.

Children less than 5 feet tall or 12 years and under require a special restraint system for protection in the event of an accident as they may be too small to wear seat belts properly.

WARNING!

Children should never ride sitting on the lap of another occupant. In an accident they will be completely without protection and could even be injured by the person they are sitting on. For the safety of all occupants read the child restraint system manufacturer's instructions carefully when fitting any child restraint system.

When the child restraint is not in use, remove it from the vehicle or secure it with the seat belt to prevent the child restraint from becoming a projectile in the event of an accident.

Do not leave children unsupervised in the vehicle, even if they are secured by a child restraint system.

SEAT BELTS**WARNING!**

Always wear the seat belts, even for very short-trips.

Wearing a seat belt incorrectly is dangerous. Seat belts are designed to go around the large bones of your body. These are the strongest parts of your body and can take the forces of a collision the best.

Wearing your belt in the wrong place could make your injuries in a collision much worse. You might suffer internal injuries, or you could even slide out of part of the belt. Follow these instructions to wear your seat belt safely and to keep your passengers safe, too.

A belt that is buckled into the wrong buckle will not protect you properly. The lap portion could ride too high on your body, possibly causing injuries. Always buckle your belt into the buckle nearest you.

A belt that is too loose will not protect you as well. In a sudden stop you could move too far forward, increasing the possibility of injury.

WARNING!

Wear your seat belt snugly.

A belt that is worn under your arm is very dangerous. Your body could strike the inside surfaces of the vehicle in a collision, increasing head and neck injury. A belt worn under the arm can cause internal injuries. Ribs aren't as strong as shoulder bones. Wear the belt over your shoulder so that your strongest bones will take the force in collision.

A shoulder belt placed behind you will not protect you from injury during a collision. You are more likely to hit your head in a collision if you do not wear your shoulder belt. The lap and shoulder belt are meant to be used together.

Pregnant women should also use a lapshoulder belt. The lap belt portion should be positioned as low as possible on the hips to avoid any possible pressure on the abdomen.

Two people should never be belted into a single seat belt. People belted together can crash into one another in an accident, hurting one another badly.

WARNING!

Do not secure any objects with a seat belt if it is also being used for one of the vehicle's occupants.

Do not allow the seat belt straps to become caught or to be damaged by sharp objects. A frayed or torn belt could rip apart in a collision and leave you with no seat belt protection. Inspect the belt system periodically, checking for cuts, frays, or loose parts. Damaged parts must be replaced immediately.

Do not disassemble or modify the system. Seat belt assemblies must be replaced after a collision if they have been damaged (bent retractor, torn webbing, etc.). Have damaged seat belt assemblies replaced by an authorized Sprinter Dealer. Only use seat belt assemblies approved by the manufacturer.

Keep the backrest upright or nearly upright.

WARNING!

Never ride in a moving vehicle with the backrest reclined. Sitting in an excessively reclined position can be dangerous. You could slide under the seat belt in a collision. If you slide under it, the belt would apply force at the abdomen or neck. This could result in severe personal injuries and death.

The backrest and seat belt provide the best restraint when the wearer is in an upright position and the belt is properly positioned on the body.

Failure to wear and properly fasten and position your seat belt greatly increases your risk of injuries and their likely severity in an accident. You and your passengers should always wear seat belts.

If you are ever in an accident, your injuries can be considerably more severe without your seat belt properly buckled. Without your seat belt buckled, you are much more likely to hit the interior of the vehicle or to be ejected from it. You can be seriously injured or killed.

WARNING!

In the same crash, the possibility for injury or death is lessened with your seat belt buckled.

Seat belts which have been subjected to heavy loads in an accident must be replaced and their anchorages must also be checked. Only use seat belts which have been supplied and installed by an authorized Sprinter Dealer.



No modifications are to be made to the seat belts, their anchorages, the inertia reels or belt buckles.



Seat Belt Warning Lamp and Airbag Malfunction



When the key is in position 2 in the ignition lock, the warning lamp  lights up for about 6 seconds; this takes place whether or not the driver's seat belt is fastened.

The warning lamp  must go out after about 6 seconds if the driver's safety belt is fastened, or the vehicle is standing still and the driver's door is opened.

If after about 6 seconds, the driver's safety belt is not fastened with all doors closed,

- and the vehicle speed does not exceed 15 mph (25 km/h), the warning lamp  remains on for as long as the driver's safety belt is not fastened.
- and the vehicle speed exceeds 15 mph (25 km/h), the warning lamp  flashes and a warning signal sounds, which is repeated increasingly frequently until the driver's safety belt is fastened, or for a maximum of 153 seconds from the time the vehicle speed exceeded 15 mph (25 km/h) if the driver's safety belt remains unfastened.

If the driver's safety belt remains unfastened after 153 seconds, the warning lamp  stops flashing and the warning signal stops sounding. The warning lamp  lights up for as long as the driver's safety belt is not fastened.

If the warning lamp  flashes after the first 6 seconds and no warning signal is audible, the malfunction indicator lamp  is defective.

Have the malfunction indicator lamp  checked and repaired by an authorized Sprinter Dealer as soon as possible.

Malfunction indicator lamp , refer to "SRS Malfunction Indicator Lamp".

Fastening and Removing

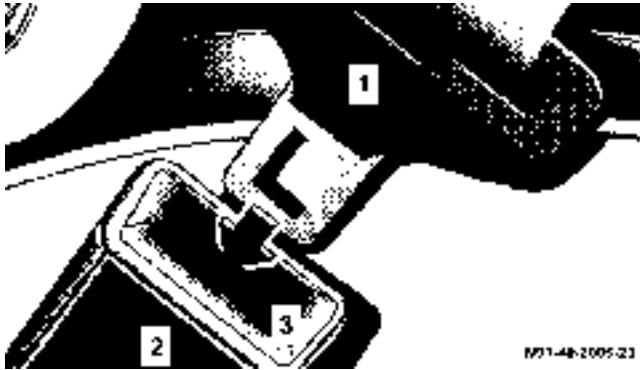

Belt tongue (1)

Belt buckle (2)

Release button (3)

1971-48-2005-23

Fastening Seat Belts

1. Pull the seat belt over the body. The seat belt must not be twisted or you could be injured.
2. Press the tongue into the buckle and make sure that it is heard to engage.
3. The seat belt must be tight across the body. Check this immediately after fastening the seat belt, and at regular intervals during the trip.
If necessary, tension the lap belt by pulling the shoulder strap up in front of the body.

2

WARNING!

A lap belt worn too high can increase the risk of internal injury in a collision. The belt forces won't be at the strong hip and pelvic bones, but across your abdomen. Always wear the lap part as low as possible and keep it snug.

In an accident a twisted belt cannot fulfill its protective function. In a collision it could even cut into you. Be sure the belt is straight. If you cannot straighten a belt in your vehicle, take it to an authorized Sprinter dealer and have it fixed.

Removing Seat Belts

1. Press the release button in the belt buckle.
2. Guide the seat belt back to its rest position.

WARNING!

A frayed or torn belt could rip apart in a collision and leave you with no protection. Inspect the belt system periodically, checking for cuts, frays, or loose parts. Damaged parts must be replaced immediately. Do not disassemble or modify the system. Seat belt assemblies must be replaced after a collision if they have been damaged (bent retractor, torn webbing, etc.).

Seat Belt Warning System

When the key is turned to position 2 in the ignition lock, a warning buzzer sounds for about 6 seconds if the driver's safety belt is not pressed into the belt buckle. The buzzer stops as soon as the safety belt is fastened. Press the safety belt into the belt buckle.

Belt Height Adjustment

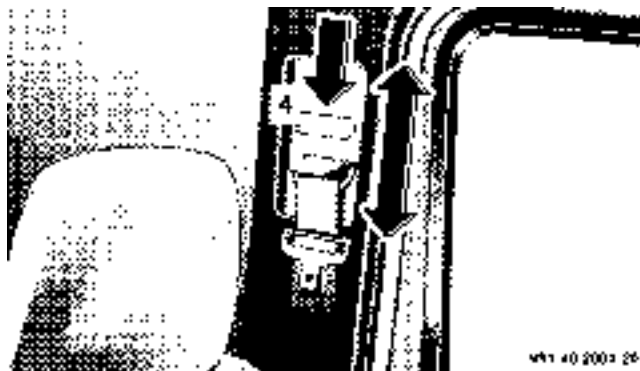

Belt height adjustment button (4)

Do not adjust the belt height while the vehicle is moving.

To lower:

Press the button and move the belt sash guide down.

To raise:

Move the belt sash guide up.

The shoulder strap must pass between the neck and the shoulder.

DRIVER'S AIRBAG



The driver's airbag is located within the padded center of the steering wheel.

WARNING!

To reduce the risk of injury when the front airbag inflates, it is very important for the driver to always be in a properly seated position and to wear the seat belt. Since the airbag inflates with considerable speed and force, a proper seating position with hands on the steering wheel will help to keep you in a safe distance from the airbag. Keep hands on the outside of the steering wheel rim. Placing hands and arms inside the rim can increase the risk and the potential severity of hand/arm injury when the driver front airbag inflates.

FRONT SEAT PASSENGER AIRBAG (NOT IN CONJUNCTION WITH FOLDING SEAT IN PARTITION WALL)

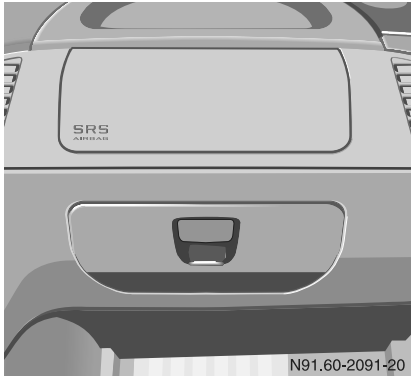

WARNING!

To reduce the risk of injury when the front airbag inflates, it is very important for the driver to always be in a properly seated position and to wear the seat belt. Since the airbag inflates with considerable speed and force, a proper seating position with hands on the steering wheel will help to keep you in a safe distance from the airbag.

Do not place any pieces on the top of the mounting lid above the airbag. If the airbag is activated the pieces could be thrown into the passenger compartment. This could result in severe personal injuries and death.

AIRBAG AND BELT TENSIONERS

The vehicle is equipped with an airbag for the driver and the front seat passenger as well as belt tensioners for the driver and the front passenger. The system is known as a Supplemental Restraint System (SRS). It has been designed to work together with the seat belt and to supplement.

WARNING!

Do not put anything on or around the front airbag covers or attempt to manually open them. You may damage the airbags and you could be injured because the airbags are not there to protect you. These protective covers for the airbag cushions are designed to open only when the airbags are inflating.

SRS Malfunction Indicator Lamp

When the key is in position 2 in the ignition lock, the malfunction indicator lamp **SRS** will light up in the instrument cluster for about 4 seconds as a function check.

WARNING!

If the malfunction indicator lamp **SRS** does not light up when the key is in position 2 in the ignition lock, if it flickers or lights up while the vehicle is moving, there might be a problem in the airbag system. There is then a danger that the airbag will not deploy in the event of an accident or will deploy when it should not do so. Have the vehicle inspected and repaired by an authorized Sprinter Dealer without delay.

Belt Tensioners

The belt tensioners are located on the three-point seat belts of the driver's and front passenger seats.

The belt tensioners will not operate unless the key has been turned to position 1 or 2 in the ignition lock.

The airbag and / or belt tensioners are designed to only trigger in certain frontal impacts as not all accidents call for airbag and / or belt tensioner deployment.

Safety Precautions for the Airbag

WARNING!

Airbags can seriously injure or kill you, especially if you are close to the airbag when it deploys.

Always wear your seat belt. Airbags do not replace seat belts but instead supplement the protection offered by seat belts. Wearing a seat belt also makes it less likely that you will be out of position and will not be injured or killed as the airbag deploys.

Never place an infant seat which faces to the rear on the front passenger seat. Children 12 years old and under, and any child who cannot wear a seat belt properly, must never ride in the front of this vehicle.

The airbag does offer an additional degree of protection, especially to belted occupants, but the following precautions should still be taken to prevent injuries when the airbag is inflating.

Do not position the seat closer than necessary to the airbag inflation point.

WARNING!

Do not lean forward when the vehicle is in motion.

Do not lean on the doors from inside the vehicle.

Do not put your feet on the dashboard.

Only hold the steering wheel by the outer rim so that the airbag can inflate unhindered.

No objects should be positioned on the airbag or between the airbag and the vehicle's occupants.

If children are traveling, they should always use an appropriate child restraint system.

Do not touch any hot parts after the airbag has inflated. Airbags which have triggered in an accident must be replaced.

The center of the padded steering wheel must not be covered by any materials or have any labels or stickers attached to it, or else the airbag may not function reliably.

WARNING!

Do not attempt to manually open the front airbag covers. You may damage the airbags and you could be injured because the airbags may not function as designed. These protective covers for the airbag cushions are designed to open only when the airbags are inflating.

Do not modify any components of the restraint systems or their wiring.

Observe relevant safety precautions when discarding off airbag units. Any authorized Sprinter Dealer can provide information and assistance.

Make sure to give any new owner of your vehicle this Owner's Manual so that the new owner will be aware of all safety warnings.

WARNING!

If the instrument cluster indicates a malfunction of the "SRS", as explained above, we strongly recommend that you visit an authorized Sprinter Dealer immediately to have the system checked; otherwise the "SRS" may not be activated when needed in an accident, which could result in serious or fatal injury, or it might deploy unexpectedly and unnecessarily, which could also result in injury or death.

The activation of the "SRS" temporarily releases a small amount of dust from the airbag. This dust, however, is neither injurious to your health, nor does it indicate a fire in the vehicle. The dust might cause some temporary breathing difficulty for people with asthma or other breathing trouble. To avoid this, you may wish to get out of the vehicle as soon as it is safe to do so. If you have any breathing difficulty but cannot get out of the vehicle after the airbag inflates, then get fresh air by opening a window or door.

Given the considerable deployment speed and the textile structure of the airbag, there is a risk of abrasions and injuries due to airbag deployment.

PEDALS

The freedom of movement of the pedals must not be impaired in any way, such as by floormats.

WARNING!

Do not lay any objects in the driver's footwell. Be careful that floor mats or carpets in the driver's footwell have sufficient clearance for the pedals.

During sudden driving or braking maneuvers the objects could get caught between the pedals. You could then no longer brake or accelerate. This could cause an accident which could in turn lead to injuries.

ENGINE BREAK-IN SPECIFICATIONS

The first 1,000 miles (about 1,500 km)

The more cautiously you treat your vehicle during the break-in period, the more satisfied you will be with its performance later on. Therefore, drive your vehicle during the first 1,000 miles (1,500 km) at moderate vehicle and engine speed.

Avoid depressing the accelerator pedal beyond the pressure point (kickdown). Do not manually shift down.

Avoid accelerating by kickdown. It is not recommended to brake the vehicle by manually shifting to a lower gear. We recommend that you select positions "3", "2" or "1" only at moderate speeds (for hill driving).

After 1,000 miles (about 1,500 km) you can gradually increase road and engine speeds to normal driving and requirements.

Engine Oil Consumption

When the engine has passed the break-in period, oil consumption may reach 0.5 % of the fuel consumption recorded in actual operating circumstances. In isolated cases and in arduous operating conditions, oil consumption may increase to 1 % of the fuel consumption recorded in actual operating circumstances.

Engine oil consumption depends on the driving style adopted and the operating conditions. It can only be judged after the engine has passed the break-in period.

SAFETY TIPS

- Check the vehicle's lights and the general condition of the vehicle before each trip.
- Keep tires at the recommended tire inflation pressure.
- All occupants should fasten their seat belts before each trip.
- Driving in an environmentally responsible manner will reduce noise, fuel consumption and exhaust emissions.
- Allow the engine to warm up under low load use.
- Avoid unnecessarily hard acceleration, driving with the throttle fully open, and carrying loads not specifically needed on the journey.
- Stop the engine during lengthy waiting periods, for example at traffic lights.
- Remove ancillary parts, such as wind deflectors and roof racks, as soon as they are no longer needed.

INHALATION OF EXHAUST GAS

WARNING!

When driving or parking the vehicle, make sure that its exhaust system does not come into contact with flammable material (such as dry leaves) as these materials may otherwise catch fire.

Inhalation of exhaust gas is hazardous to your health. All exhaust gas contains carbon monoxide and inhaling it can cause unconsciousness and lead to death.

Do not run the engine in confined areas (such as a garage) which are not properly ventilated. If you think that exhaust gas fumes are entering the vehicle while driving, have the cause determined and corrected immediately. If you must drive under these conditions, drive only with at least one window fully open.

TIE DOWN RINGS (OPTIONAL)



Tie Down Rings (1)

The rings (1) are used to attach the load with the help of tension belts. Place the tension belt around the load, secure it on the rings (1) and tie it down.

WARNING!

If you tension the tensioning belts between the sidewalls, the maximum permissible load for the lashing rings could be exceeded if the brakes are applied suddenly or in the event of an accident. The load would no longer be secured, which could result in serious injuries caused by the load slipping.

For this reason, do not tension a tensioning belt between the side walls.

Observe the loading guidelines.

NOTE: Use neither elastic fastening straps nor nets when lashing down the load. These are only intended as anti-slip protection for lighter loads.

The means used to tie down the load must not be run over sharp edges or corners. Sharp edges or corners should be given protective padding. Observe the operating instructions for the material used to tie down the material. Spread the load evenly between the anchorages. If using a tensioning device, do not overstress the lashing rings.

UNDERSTANDING THE FEATURES OF YOUR VEHICLE

CONTENTS

■ Mirror Adjustment	59	■ Fog Lamp Switch (Optional)	68
□ Interior Mirror (Optional)	59	■ Interior Lighting	69
□ Electrically Adjustable Exterior Mirror (Optional)	59	□ Interior Lamps in the Driver and Rear-Seat Passenger Area/Cargo Area	69
■ Seat Adjustment	60	□ Interior Lamps with Interior Sensor Protection (Optional)	69
□ Driver's and Front Passenger's Seat	60	□ Interior Lighting with Reading Lamp, Front Passenger Space Only	70
□ Lumbar Support	61	□ Interior Cargo Area Lighting (Optional)	71
□ Armrest (Optional)	62	■ Multifunction Switch	72
□ Head Restraint	62	■ Window Operation	74
□ Folding Seat at Partition (Optional)	63	□ Mechanical Window Operation	74
■ Seat Heater (Optional)	63	□ Electric Window Operation (Optional)	74
■ Rear Seat Bench Removal and Installation	64	■ Windshield Wiper Switch	75
□ Retrofitting Seat Mounting Cups	65	□ Windshield wipers with rain sensor (Optional)	76
■ Hood	66		
■ Headlamp Range Control	68		

□ Headlamp Cleaning System (Optional)	77	■ Control and Operation of Radio Transmitters . . .	84
■ Speed Control (Optional)	77	□ Radio, Telephone and Two Way Radio	84
■ Sunroof (Optional)	80	■ Mobile and Two Way Radio and Fax Machines. .	85
□ Manual Sun Roof (Optional)	80	■ Cup Holder	85
□ Electric Sun Roof (Optional)	81	■ Glove Compartment.	87
□ Mechanical Operation of Electric Sun Roof . .	81	■ Compartments in Front Doors	87
■ Ashtray/Cigar Lighter.	82		
■ Electrical Outlet.	84		

MIRROR ADJUSTMENT Interior Mirror (Optional)



Normal position (DAY) (1)

Anti-glare position (NIGHT) (2)

Electrically Adjustable Exterior Mirror (Optional)



The switch is located in the door lining next to the door handle.

Mirror adjustment, left (1)

Mirror adjustment, right (2)

When the key is in position 2 in the ignition lock, each mirror may be adjusted by pressing the adjustment button.

NOTE: The exterior mirror is heated automatically (optional equipment) when outdoor temperatures are low.

SEAT ADJUSTMENT**Driver's and Front Passenger's Seat****WARNING!**

Do not adjust the driver's seat while driving. Adjust the seat only while the vehicle is parked.

Adjusting the seat while driving could cause the driver to lose control of the vehicle. The seat belt might not be properly adjusted and you could be injured. Avoid seat positions in which you cannot wear your seat belt correctly. They are a safety hazard and must therefore be avoided; refer to "Seat Belts".

Never ride in a moving vehicle with the backrest reclined. Sitting in an excessively reclined position can be dangerous. You could slide under the seat belt in a collision. If you slide under it, the belt would apply force at the abdomen or neck as this could result in severe personal injuries and death.

The backrest and seat belt provide the best restraint when the wearer is in an upright position and the belt is properly positioned on the body. Use the recliner only when the vehicle is parked.

WARNING!

Never place hands under seat or near any moving parts while a seat is being adjusted. If the seat is moved, to ensure engagement, the seat catches must be heard.

The arms should be slightly bent when you are holding the steering wheel. The distance from the pedals should be such that you can depress them fully.

The rear area of the vehicle should not be used as a play area by children when the vehicle is in motion. They could be seriously injured in an accident. Children should be seated and using the proper restraint system.

It is extremely dangerous to ride in a cargo area, inside or outside of a vehicle. In a collision, people riding in these area are more likely to be seriously injured or killed.

Do not allow people to ride in any area of your vehicle that is not equipped with seats and seat belts.

Be sure everyone in your vehicle is in a seat and using a seat belt properly.

Comfortseat (Optional)



Seat adjustment, fore/aft (1)

Seat cushion depth (Optional) (2)

Seat height adjustment, front (3)

Seat height adjustment, rear (4)

Backrest tilt (5)

Lumbar Support

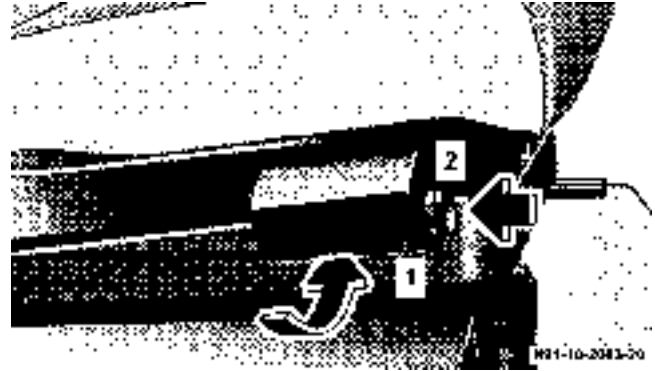

Hand pump (1)

Bleeder valve (2)

Reinforce support:

Use hand pump (1).

Relieve support:

Press bleeder valve (2).

Armrest (Optional)



Tilt adjustment (1)

By adjusting the tilt adjustment (thumbwheel) (1) the tilt of the armrest can be changed.

Head Restraint

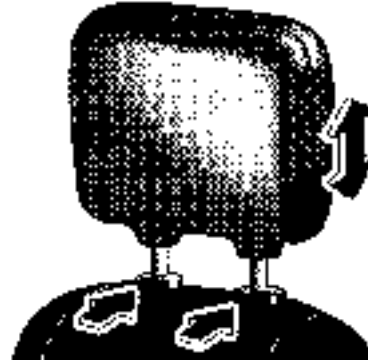

HD1 1G-2584-20

If you need to remove the head restraint, press the catch at the head restraint socket and pull the head restraint up and out.

WARNING!

You should never drive the vehicle if the head restraint has been removed for an occupied seat. This could result in severe personal injuries and death in case of an accident. Adjust the head restraint so that it touches the back of the head at about ear level.

Folding Seat at Partition (Optional)

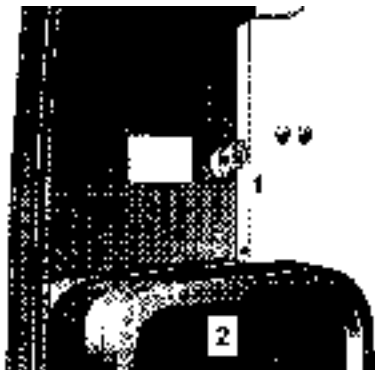

1991-10-2022-23

Key (1)

Seat cushion (2)

Fold down the seat cushion of the folding seat.

WARNING!

When folding down the seat cushion, make sure that nobody can become trapped.

The risk of injury to the front-passenger is increased in the event of sharp steering movements or an accident if a key is inserted in the passenger/cargo area sliding door lock. Remove the key from the load compartment sliding door before using the folding seat.

3



454 25-2075-20

SEAT HEATER (OPTIONAL)

The seat heater switch is located on the center section of the dashboard.

The seat heater only works when the key is in position 2 in the ignition lock .

Low heating output, press top of the seat heater switch. The left indicator lamp in the switch illuminates.

High heating output, press bottom of seat heater switch. The right indicator lamp in the switch illuminates.

REAR SEAT BENCH REMOVAL AND INSTALLATION

WARNING!

The integrated seat belt can only offer the degree of protection for which it is designed if you install the specified rear bench seats correctly. Never operate vehicle unless all rear bench seats are properly installed and all release levers are locked.

When retrofitting seat benches, make sure that the exterior seat shells have four cross-ribs.

Keep the seat bench mounting cups in the vehicle floor free from dirt and foreign objects. This is the only way to guarantee that the locking mechanisms will engage securely.

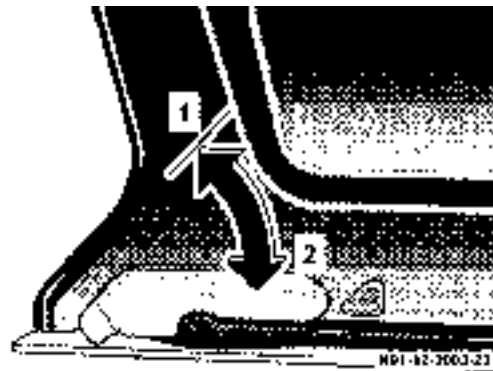

Unlocked (1)

Locked (2)

To remove:

1. Turn all release levers on the legs of the appropriate rear bench seat up. The rear bench seat can then move in the seat mounting cups.
2. Lift the rear bench seat up and out of the seat mounting cups.



To install:

1. With the rear bench seat facing in the direction of travel, insert the legs of the rear bench seat in the respective seat mounting cups on the floor.
2. Slide the rear bench seat forwards with some force as far as it will go, until the release levers are heard to engage and all release levers are parallel to the vehicle floor.

HOOD

WARNING!

When the hood is open, there is a risk of injury due to very hot engine components.

When the engine is running or the key is in position 2 in the ignition lock, there is a risk of injury due to moving engine components and the electrical system.

The engine is equipped with a transistorized ignition system. Because of the high voltage it is dangerous to touch any components (ignition coils, spark plug sockets, diagnostic socket) of the ignition system with the engine running, while starting or if the ignition is on and the engine is turned manually.

To help prevent severe personal injuries and death, stay clear of moving parts when the hood is open and the engine is running.

If you see flames or smoke coming from the engine compartment, or if the coolant\temperature gauge indicates that the engine is overheated, do not open the hood. Move away from vehicle and do not open the hood until the engine has cooled. If necessary, call the fire department.

To open:



1. Pull the release lever (1).
The hood then opens slightly and is restrained by the safety catch.

WARNING!

Do not pull the release lever (1) while the vehicle is in motion. Otherwise the hood could be forced open by passing air flow.



To close:



2. Open the safety catch (2).
3. Swing the hood up until the support strut (3) engages.

1. Lift the hood up slightly.
2. Press the support strut (3) down.
3. Swing the hood down and make sure that it engages in its retaining catch.
4. Check that the hood is engaged properly by pulling on the front edge.

WARNING!

Be sure the hood is properly closed before driving. If the hood is not fully latched, it could fly up when the vehicle is moving and block your forward vision. Be sure all hood latches are latched fully before driving.

When closing the hood, use extreme caution not to catch hands or fingers.

HEADLAMP RANGE CONTROL

See Section 4, Understanding Your Instrument Panel, for switch locations.



N54-25-2071-20

The range of the headlamps can be adjusted to the load in the vehicle.

Turn the thumbwheel down to headlamp beam down.

Turn the thumbwheel up to headlamp beam up.

When the vehicle is not loaded (driver only), the thumbwheel must be in position 0.

Where necessary, adjust the headlamp range with the thumbwheel to 82 yards (75 m).

Always keep the headlamp range less than 110 yards (100 m), so that oncoming traffic is not blinded.

FOG LAMP SWITCH (OPTIONAL)

See Section 4, Understanding Your Instrument Panel, for switch locations.



N52-10-2103-20

Lamp switch position 

To switch on:

Press the upper section of the switch.

To switch off:

Press the lower section.

INTERIOR LIGHTING

Interior Lamps in the Driver and Rear-Seat Passenger Area/Cargo Area

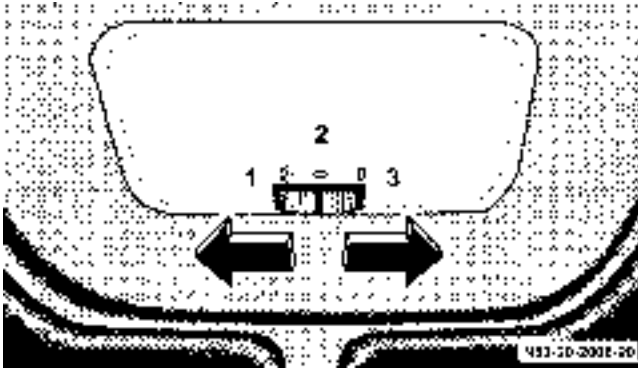

Permanently on (1)

Off (2)

Interior lamps are switched on/off by the door contact switches (3)

Interior Lamps with Interior Sensor Protection (Optional)



Interior lamp switch (1)

Reading lamp switch (2)

Operation of Interior Lamps

Position 1: Continuous operation



Position 2: The door contact switches are used to switch the interior lamps on and off

Position 3: Switched off

MS4-36-4345-20

Operation of Reading Lamps

Position 1: Left-hand reading lamp switched on

Position 2: Switched off

Position 3: Right-hand reading lamp switched on

Interior Lighting with Reading Lamp, Front Passenger Space Only

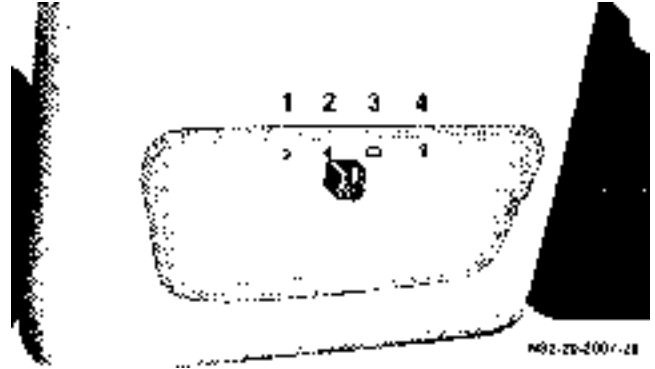

Continuous operation (1)

The door contact switches are used to switch the interior lamps on and off (2)

Switched off (3)

Reading lamp (4)

Interior Cargo Area Lighting (Optional)



M92-20-2045-20

The switch is located on the center section of the dashboard.

To switch on:

Press top of switch:

The indicator lamp in the switch will illuminate.

To switch off:

Press bottom of switch.

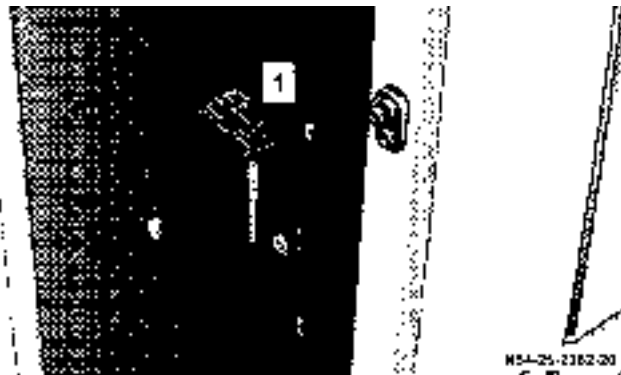

The switch (1) is located on the right side of the cargo area at the entrance for the sliding door.

To switch on:

Press top of switch – the indicator lamp in the switch will illuminate.

To switch off:

Press bottom of switch.

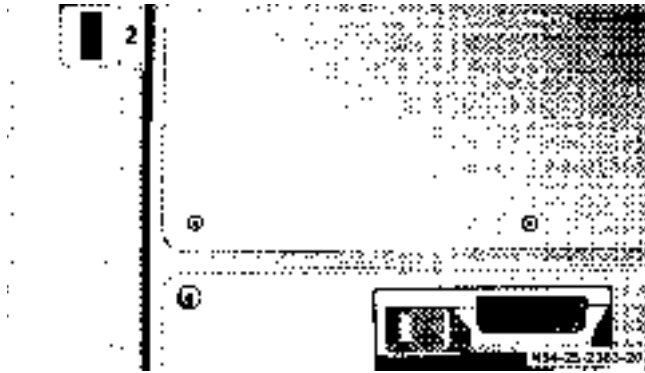

The switch (2) is located in the right rear of the cargo area.

To switch on:

Press top of switch, the indicator lamp in the switch will illuminate.

To switch off:

Press bottom of switch.

NOTE: The interior cargo area lighting will shut off automatically after 15 min.

MULTIFUNCTION SWITCH

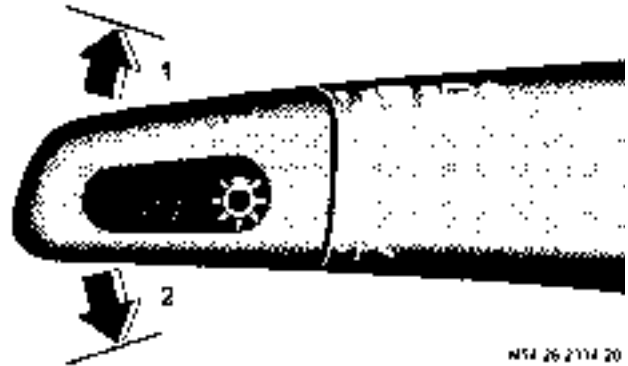

Turn signal indicator lamp, right (1)

Turn signal indicator lamp, left (2)



Short turn signal, press combination switch to pressure point.

Continuous turn signal, engage combination switch.

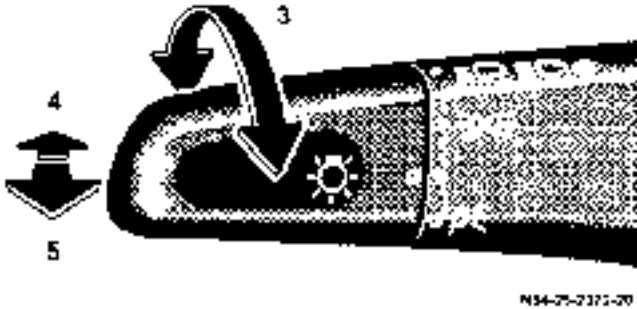
If a turn signal on the vehicle fails, the indicator lamp in the instrument cluster flashes at twice the normal rate.



Lamp switch (3)

-  Side lamps, license plate and instrument lighting
-  Low beam headlamps, high beam headlamps
-  Marker lamps, right, combination switch up (1)
Marker lamps, left, combination switch down (2)

High beam headlamps (lamp switch position ) (4)

Headlamp flasher (also when turn signals are on) (5)

NOTE: When the key is in the ignition lock in the 0 position and the driver's or passenger's door is open, a warning buzzer sounds, if the vehicle exterior lighting (except for the marker lamps) has been switched on.

On vehicles with automatic switching-off of high beam, with the key in 0 position and the lamp switch position  on low and high beam, parking lamps are automatically switched on. When the driver's or passenger's door is opened, a warning buzzer also sounds.

For high beam (4) and headlamp flasher (5), the indicator lamp  in the combination instrument lights up.

WINDOW OPERATION

Mechanical Window Operation



To open the window:

Turn the manual window control in a counterclockwise direction.

To close the window:

Turn the manual window control in a clockwise direction.

Electric Window Operation (Optional)



NM-25-2077-20

The window operation switches are located on the driver's and front-passenger doors.

WARNING!

Make certain that no one gets caught when the side windows are closed.

The key should be removed from the ignition lock even if the vehicle will only be left for a short time to prevent situations such as children or unauthorized persons opening and closing the windows and becoming caught.

Place the key in position 2 in the ignition lock.

To open the window:

Keep switch pressed downward until the window has reached the desired position.

To close the window:

Keep switch pressed upward until the window has reached the desired position.

WINDSHIELD WIPER SWITCH

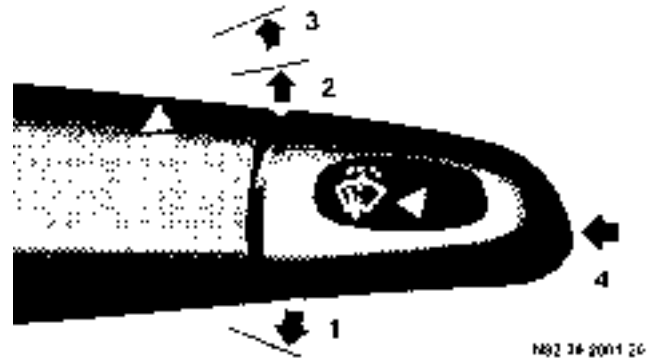

Intermittent wipe and rain sensor (optional) (1)

Normal wipe (2)

Rapid wipe (3)

Windshield wiper system and headlamp cleaning system (optional) (4)

WARNING!

Sudden loss of visibility through the windshield caused by e. g. ice, steam, fog or water could lead to an accident. You might not see other vehicles or other obstacles. To avoid sudden icing of the windshield during freezing weather, warm the windshield with the defroster or with the windshield heater (optional) before and during windshield washer use.

Follow the recommended settings for de-fogging and de-icing the front windows given in Section 4.

Touch-wipe:

Press the windshield wiper switch up to the pressure point.

NOTE: Smears may form on the glass when the windshield wipers are in use. In this case, operate the windshield washer, even in rainy weather.

Check wiper blades regularly for damage and contamination.

Windshield wipers with rain sensor (Optional)

To switch on:

Turn the windshield wiper switch to Intermittent wipe.

When switched on, the windshield wipers wipe one time. After that the wiping interval and wiping speed (normal and rapid), depend on wetness of the windshield and are controlled automatically.

CAUTION!

Do not leave windshield wipers in intermittent setting when vehicle is taken to an automatic car wash or during windshield cleaning and/or de-icing. Wipers will operate if the windshield gets wet, and wipers may be damaged as a result.

Headlamp Cleaning System (Optional)

The headlamps will be cleaned with a high-pressure water jet when

- the headlamps are switched on
- and

- the windshield wipers operate with washer fluid.

NOTE: Fluid for the headlamp cleaning system is also supplied from the washer system fluid reservoir.

SPEED CONTROL (OPTIONAL)

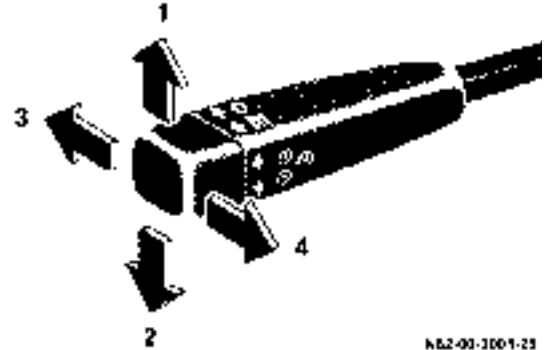

Set / accelerate speed (1)

Set / decelerate speed (2)

Off (3)

Resume set speed (4)

H&Z-03-1001-23

The speed control allows you to drive in a more relaxed manner, for example over long distances, as it automatically maintains the set speed by actively regulating the throttle setting.

The speed control lever on the steering column is used to activate and operate the speed control.

NOTE: The responsibility for the driving speed is always that of the driver. The cruise control is only an aid for the driver.

NOTE: A change of gear does not shut off the cruise control.

Every speed traveled above 25 mph (40 km/h) can be set.

Once the speed is set, it is maintained constant by the speed control, the accelerator pedal can be released.

WARNING!

Leaving the Speed Control on when not in use is dangerous. You could accidentally set the system or cause it to go faster than you want. You could lose control and have an accident. Always turn the system off when you are not using it.

Setting momentary speed

Briefly push speed control lever up (1) or down (2).

Cancel speed control

Push speed control lever forwards (3) or step on the brake pedal.

Increase set speed

Push up speed control lever (1) briefly – speed increase of 0.6 mph (1 km/h) each time.

To increase speed steadily = hold the speed control lever in the push-up position.

Decrease set speed

Push down speed control lever (2) briefly – speed decrease of 0.6 mph (1 km/h) each time.

To decrease speed steadily, hold the speed control lever in the push-down position.

Resume set speed (after shutting off)

Push speed control lever back (4).

With the accelerator pedal the set speed can be increased (for passing).

When the accelerator pedal is released again, the set speed regulates itself again.

With the key in position 0 or 1 in the ignition lock the set speed is cancelled.

WARNING!

The speed control does not adapt itself automatically to road conditions; therefore do not use cruise control on icy roads. There is a risk of skidding and loss of vehicle control. This could cause an accident resulting in severe personal injuries, death and property damage.

NOTE: On uphill and downhill grades it may not be possible to maintain set speed.

SUNROOF (OPTIONAL)**WARNING!**

In an accident, there is a greater risk of being thrown from a vehicle with an open sun roof. You could also be seriously injured or killed. Always fasten your seatbelt properly and make sure all passengers are properly secured too.

Do not allow small children to operate the electric sun roof.

Never allow fingers or other body parts, or any object to project through the sun roof opening. Injury may result.

Make certain that no one gets caught when the electric sun roof is closed. The key should be removed from the ignition lock even if the vehicle will only be left for a short time to prevent situations such as children or unauthorized persons opening and closing the electric sun roof and becoming caught.

Manual Sun Roof (Optional)

- To open, turn the handwheel counterclockwise. Maximum opening = turn until the stop is reached.
- To close, turn the handwheel clockwise until the stop is reached.

WARNING!

Never allow fingers or other body parts, or any object to project through the sun roof opening. Injury may result.

Make sure that nobody can be trapped when closing the sun roof.

Mechanical Operation of Electric Sun Roof

The sun roof does not open or close:

Check electrical fuse. Electrical fuses refer to “Electrical Fuses”.

If the fuse works correctly, the sun roof can also be closed or opened manually.

3**Electric Sun Roof (Optional)**

See Section 4, Understanding Your Instrument Panel, for switch locations.



WT-25-2141-20

Place the key in position 2 in the ignition lock.

To open the electric sun roof:

Keep switch pressed upward until the sun roof has reached the desired position or the end position.

To close the electric sun roof:

Keep switch pressed downward until the sun roof has reached the desired position or is completely closed.



WT-33-3E10-20

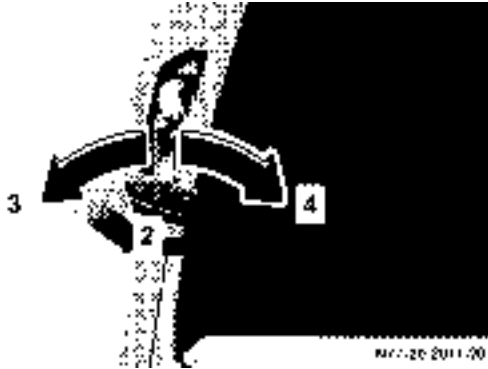

ASHTRAY/CIGAR LIGHTER

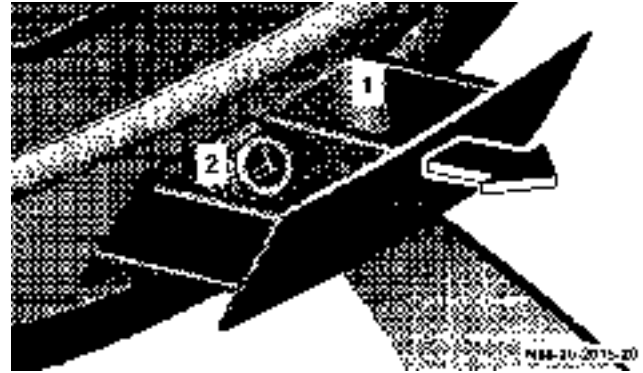

Ashtray in the driver's compartment.

Ashtray (1)

Cigar lighter (2)

Remove cover (1) at the front frame of the sun roof.

Remove tool (2) from the cover (1) and insert.

Open manually:

Press in tool (2) and turn counterclockwise (3).

Close manually:

Press in tool (2) and turn clockwise (4).

Have malfunctions rectified by an authorized Sprinter Dealer.

To open the ashtray (1):

Pull the ashtray (1) out until it locks into place.

To close the ashtray (1):

Push the ashtray (1) forward over the working point until it reaches the stop.

To switch on the cigar lighter (2):

Press in the cigar lighter (2), it will automatically spring back as soon as the filament begins to glow.

Ashtray in the rear passenger compartment.

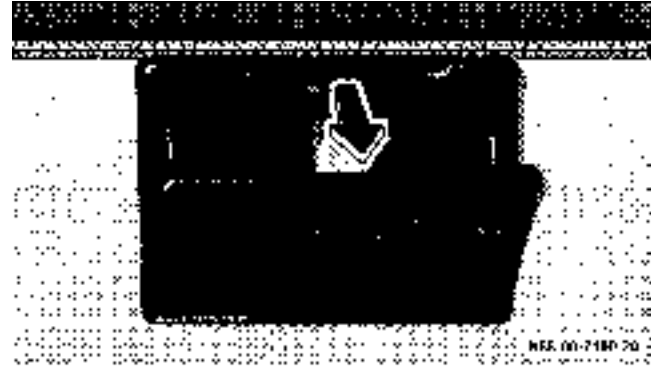

The ashtrays are located in the side linings in the passenger compartment.



ELECTRICAL OUTLET

The electrical outlet is located on the lower right in the center of the dashboard.

NOTE: Maximum capacity: 180 VA

CAUTION!

- Many accessories that can be plugged in draw power from the vehicle's battery, even when not in use (i.e. cellular phones, etc.). Eventually, if plugged in long enough, the vehicle's battery will discharge sufficiently to degrade battery life and/or prevent engine starting.
- Accessories that draw higher power (i.e., coolers, vacuum cleaners, lights, etc.), will degrade the battery even more quickly. Only use these intermittently and with greater caution.
- After the use of high power draw accessories, or long periods of the vehicle not being started (with accessories still plugged in), the vehicle must be driven a sufficient length of time to allow the alternator to recharge the vehicle's battery.

CONTROL AND OPERATION OF RADIO TRANSMITTERS

Radio, Telephone and Two Way Radio

WARNING!

Please do not forget that your primary responsibility is to drive the vehicle. Only operate the radio, telephone, navigation system, two-way radio or fax when road and traffic conditions permit. Otherwise you could be distracted from the traffic and cause an accident. Always obey local laws and regulations.

Remember that at a speed of just 30 mph (about 50 km/h), your vehicle is covering a distance of 50 feet (about 14 m) every second.

MOBILE AND TWO WAY RADIO AND FAX MACHINES

WARNING!

Never operate radio transmitters equipped with a built-in or attached antenna (i.e., without being connected to an external antenna) from inside the vehicle while the engine is running. Doing so could lead to a malfunction of the vehicle's electronic system, possibly resulting in severe personal injuries and death.

Radio transmitters, such as a mobile phone or a citizens band unit should only be used inside the vehicle they are connected to an antenna that is installed on the outside of the vehicle.

Refer to the radio transmitter operation instructions regarding use of an external antenna.

CUP HOLDER

The cup holder in the driver's compartment is located below the instrument panel between the driver's and front passenger's seats.



4111-10-2007-20

The cup holders in the passenger compartment are located in the center below the seat benches.

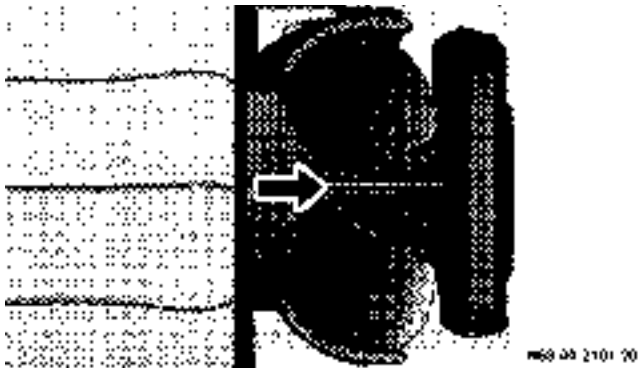

Pull out cup holder in the direction of arrow.

WARNING!

Your primary responsibility is to drive the vehicle.

Do not use cup holder while the vehicle is in motion. Otherwise you could be distracted from traffic and cause an accident or liquid could spill from the containers due to for example breaking or other vehicle movement.

Place only containers that fit into the cup holder to prevent spills.

Do not fill containers to a height where the contents could spill, especially hot liquids. Otherwise you may scald yourself.

GLOVE COMPARTMENT

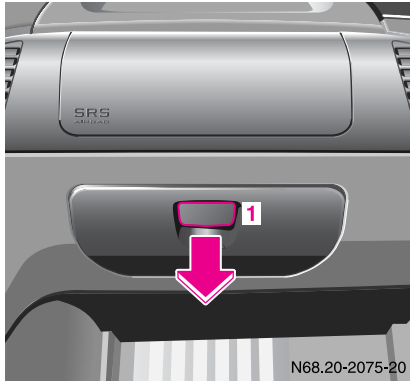

To open glove compartment:

Pull handle (1)

COMPARTMENTS IN FRONT DOORS

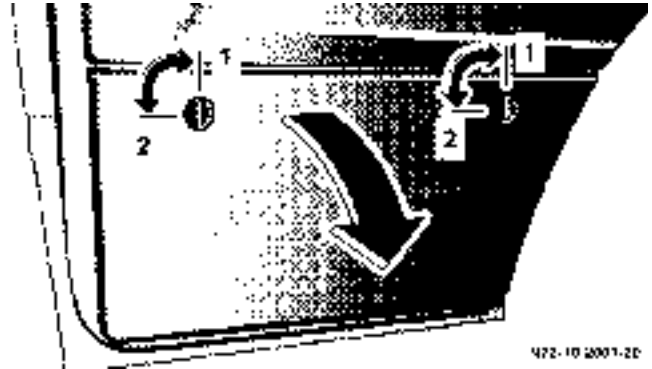

Locked (1)

Unlocked (2)

UNDERSTANDING YOUR INSTRUMENT PANEL

CONTENTS

- Instruments and Controls 91
- Instrument Cluster and Indicator Lamps 93
 - Indicator Lamp Symbols 95
 - Multi-Function Indicator 96
 - Clock 98
 - Odometer and Trip Meter 99
 - Instrument and Display Lighting 99
 - Outside Temperature Display 100
 - Reversing Aid Distance Display (Optional) . . 101
 - Tachometer (Engine rpm) 103
 - Coolant Temperature Gauge 103
 - Fuel Gauge with Reserve Fuel Indicator Lamp 105
 - Battery Charge Indicator Lamp 106
 - Water in Fuel Indicator Lamp 106
 - Engine Oil Level Indicator Lamp 107
 - Coolant Level Indicator Lamp 108
 - Engine Control Unit Indicator Lamp 109
- Switch Locations 110
- ASSYST Maintenance Computer (Optional). . . . 112
 - Engine Oil Level – Display in Instrument Cluster (Vehicles with ASSYST Maintenance Computer only) 114
 - Displaying Engine Oil Level with Engine Off 115
- Engine Oil Level Indicator in Instrument Cluster (Vehicles without ASSYST Maintenance Computer) 117
- Heating, Ventilation 118
 - Ventilation 119
 - Air Recirculation 119
 - Heating 120
 - De-Fogging and De-Icing The Front Windows 121
 - Side Air Vents and Center Air Vents 122

- Upper Air Vents 122
- Heated Rear Window (Optional) 123
- Windshield Heater (Optional) 123
- Residual Engine Heat Utilization (REST) 124
- Air Conditioning, Regulated (Optional) 124
 - Climate Control (on Vehicles with Air Conditioning) 125
 - Dehumidification (on Vehicles with Air Conditioning) 126
 - Air Conditioner for the Rear Passenger Compartment (Optional) 127
 - Air Recirculation 128
 - Air Strainer 129
- Electric Blower (Optional) 130
- Heater Booster 131
- Auxiliary Heater – Water or Air Heater (Optional) 132
 - Auxiliary Heater Switch 134
 - Timer Auxiliary Heater 134
 - Settings with the Auxiliary Heater switched on 138
- Auxiliary Heat Exchanger in Load Compartment, only with Auxiliary Heater (Optional) 139
- Auxiliary Heater – Tips for Coping with Problems 140
 - Overheating 140

INSTRUMENTS AND CONTROLS

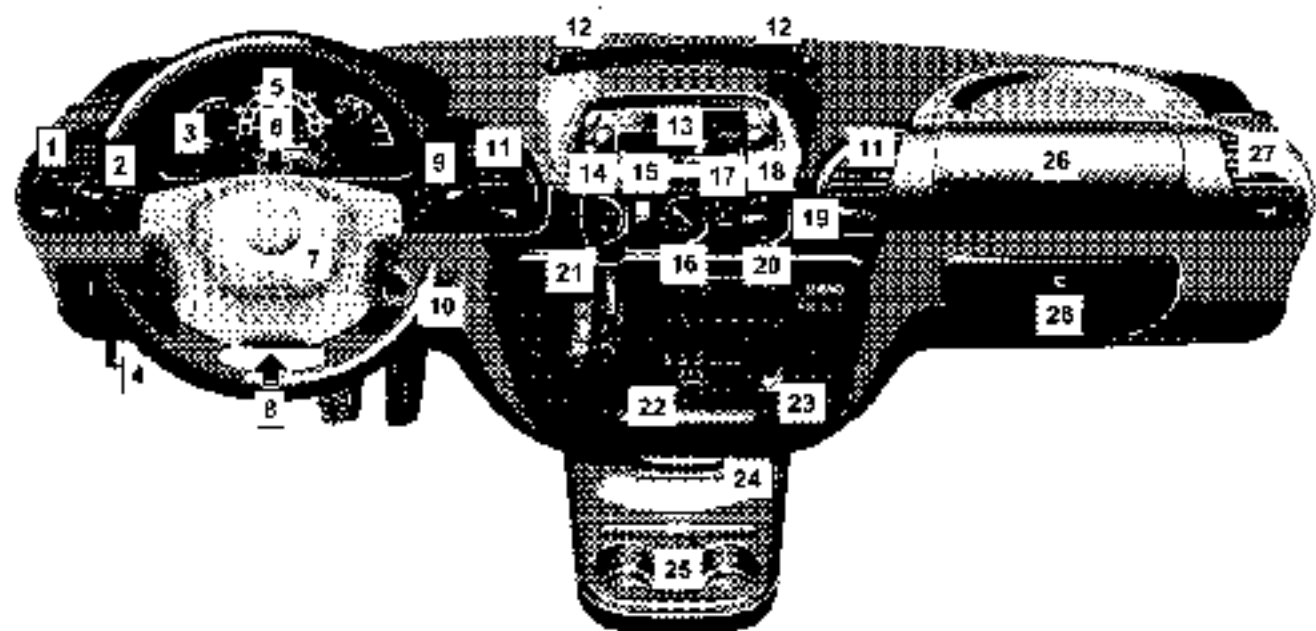

Legend For Instruments And Controls

1. Left-hand air vent.
2. Multifunction switch.
3. Speed control.
4. Hood release lever.
5. Instrument cluster, refer to "Instrument Cluster and Indicator Lamps".
6. Hazard warning flasher switch.
7. Steering wheel with horn, front driver airbag.
8. Fuse box.
9. Windshield wiper switch, refer to "Windshield Wiper Switch".
10. Ignition lock/starter switch.
11. Center air vents.
12. Upper air vents.
13. Radio, see individual manual.
14. Temperature control switch.
15. Airflow control switch.
16. Air distribution switch.
17. Temperature sensor, automatic heating control / air conditioning, regulated.
18. Air conditioning switch.
19. Heater booster switch.
20. Residual engine heat utilization switch.
21. Gear selector lever (automatic transmission)
22. Timer for auxiliary heater.
23. Electrical outlet.
24. Ashtray.
25. Cup holder.
26. Front passenger airbag.
27. Right-hand air vent.
28. Glove compartment.

NOTE: For layout of switches, see previous page.

INSTRUMENT CLUSTER AND INDICATOR LAMPS

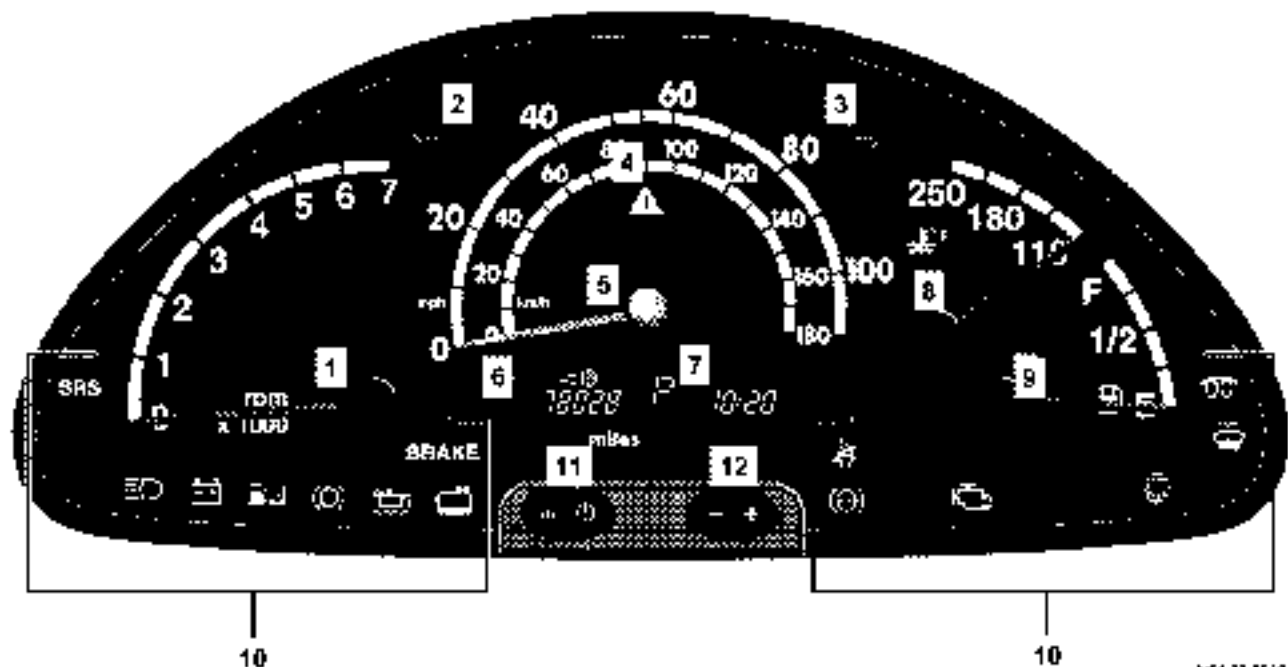







Legend For Instrument Cluster And Indicator Lamps







1. Tachometer (Engine rpm), refer to "Tachometer (Engine rpm)".
2. Turn signal indicator lamp (left), refer to "Multifunction Switch".
3. Turn signal indicator lamp (right), refer to "Multifunction switch".
4. ASR warning lamp or ESP[®]* warning lamp.
5. Speedometer.
6. Multi-function indicator, refer to "Multi-Function Indicator".
7. Gear selector lever position.
8. Coolant temperature gauge, refer to "Coolant Temperature Gauge".

* 2500 Type vehicles only

9. Fuel gauge with reserve fuel indicator lamp (yellow), refer to "Fuel Gauge with Reserve Fuel Indicator Lamp".
10. Warning and indicator lamps.
11. Odometer/trip meter selector, refer to "Odometer and Trip Meter".
Clock/outside temperature display selector, refer to "Clock and Outside Temperature Display".
12. Instrument lighting brighter/dimmer, refer to "Instrument Lighting".

Indicator Lamp Symbols

-  Acceleration skid control (ASR) or electronic stability program (ESP®)* or slippery surface warning.
- SRS** Airbag Malfunction (USA only).
- PARK** Parking brake applied.
-  High beam on, refer to "Multifunction Switch".
-  Battery not being charged, refer to "Battery Charge Indicator Lamp".
-  Water in fuel filter, refer to "Water in Fuel Indicator Lamp".
-  Brake pads worn.
-  Engine oil level too low, refer to "Engine Oil Level Indicator Lamp".
-  Coolant level too low, refer to "Coolant Level Indicator Lamp".
- BRAKE** Brake fluid level too low and electronic brake force distribution (EBD) malfunction (USA only).

-  Brake fluid level too low and electronic brake force distribution (EBD) malfunction (Canada only).
-  Seat belt warning lamp.
-  Anti-lock brake system (ABS) malfunction.
- ESP** Electronic stability program (ESP®)* malfunction.
-  Engine control unit malfunction.
-  Acceleration skid control (ASR) malfunction and brake assist system (BAS)¹ malfunction.
- ADR** Constant RPMs on.
-  Fluid level in windshield washer low.
-  Preheating.

*2500 Type Vehicles only.

Multi-Function Indicator

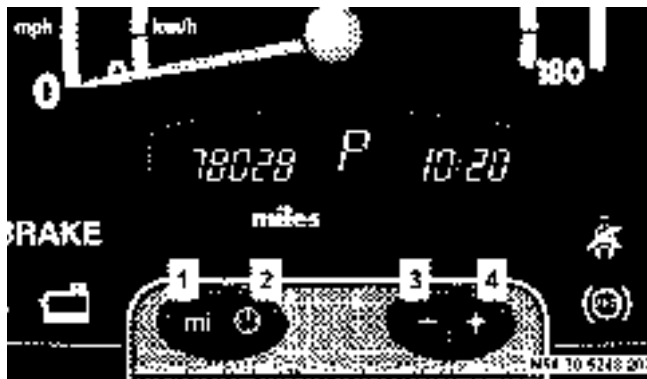

WARNING!

Never operate buttons (1, 2, 3 and 4) in the multi-function indicator while driving.

To operate these buttons the driver must reach through the steering wheel, which could significantly impede its movement.

Your attention will also be diverted from the road and traffic conditions.

This could cause you to lose control of the vehicle and could lead to an accident and result in severe personal injuries or death.

For this reason, make sure that the traffic conditions are safe before pressing the buttons, so that nobody may be endangered.

When possible, reach around the steering wheel to operate the multi-function indicator buttons. Do not rest your head or chest on the steering wheel or dashboard when operating the buttons.

The multi-function indicator can be used to call up the odometer, trip meter, clock and outside temperature, or information such as remaining time/distance until the next service is due, or the engine oil level.

If your vehicle is equipped with reversing aid, the multi-function indicator also displays the distance between your vehicle and a detected obstacle.

The multi-function indicator is activated by:

Turning the key to position 2 in the ignition lock,

opening the driver's door,

pressing one of the buttons **mi (km)**, **⊖**, **—** or **+**,

switching the side lights on, refer to "Combination Switch".

1. Press the button **mi (km)** to switch between the odometer and the trip meter, and to reset the trip meter.
Press the button **mi (km)** to activate the ASSYST maintenance computer.
2. Press the **⊖** button to switch between the time and outside temperature and to activate the time adjustment.
3. Press the **—** to adjust (dim) the display and instrument lighting and to adjust the clock.
4. Press the **+** to adjust (brighten) the display and instrument lighting and to adjust the clock.

Clock

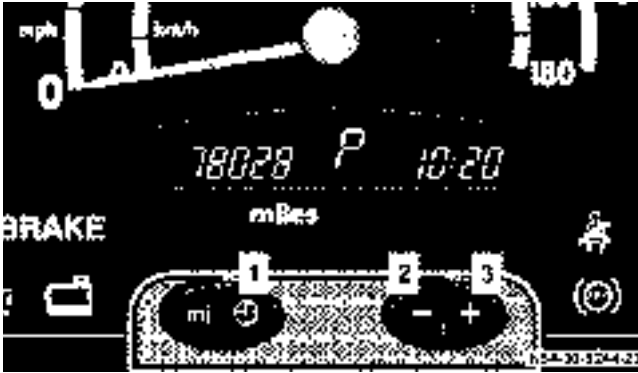

Activate the multi-function indicator, refer to "Multi-Function Indicator".

Button **↻** – to reverse the time adjustment/switch between hours and minutes (1)

Button **-** – to turn the time back (2)

Button **+** – to advance the time (3)

To switch between Time and Outside Temperature Display (Optional)

Press the **⊖** button briefly.

If button **⊖** is pressed twice within one second, the display will revert to the original mode after 20 seconds.

To Adjust the Time

Call up time display:

1. Press button **⊖** and hold – the hours display will flash.
To change the time by one hour = briefly press button **+** or **-**.
To change the time by several hours = press and hold button **+** or **-**.
2. Briefly press button **⊖** – the minutes display will flash.
To change the time by one minute = briefly press button **+** or **-**.
To change the time by several minutes = press and hold button **+** or **-**.
3. Briefly press button **⊖** – the set time is accepted.

Odometer and Trip Meter

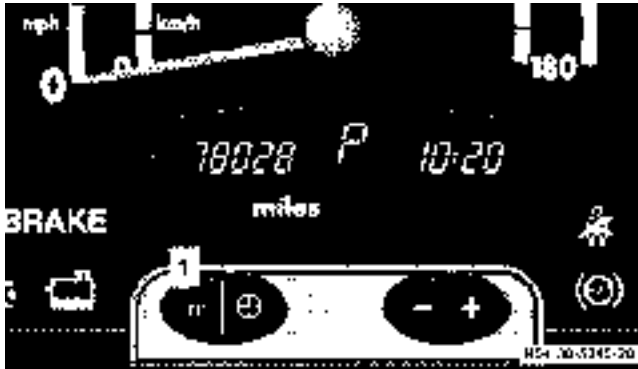

Activate the multi-function indicator. The total distance covered by the vehicle will be shown.

1. To switch between the odometer and the trip meter, press button (1) briefly.
2. To reset the trip meter, call up trip meter. Press button (1) and hold until the trip meter shows 0000.

NOTE: Odometer and trip meter display

- "mi" in USA only.
- "km" in Canada only.

Instrument and Display Lighting



Display lighting:

3. Press button **-**, to display lighting dimmer
4. Press button **+**, to display lighting brighter

Instrument and display lighting:

1. Switch on the marker lamps, refer to "Combination Switch"
2. Press button **-**, to make instrument and display lighting dimmer
3. Press button **+**, to make instrument display lighting brighter

Outside Temperature Display

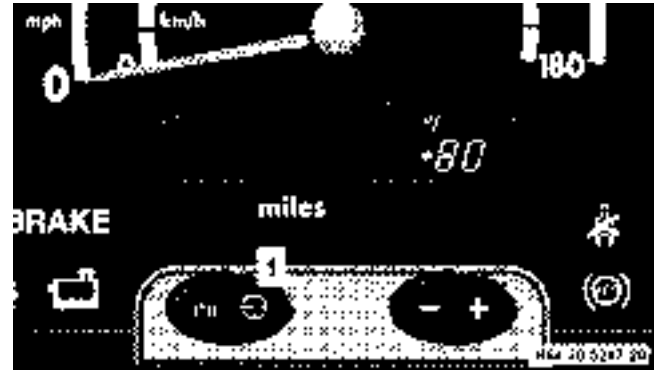

Clock/outside temperature display selector (1)

Press button **⊖** briefly. The display will switch to the required mode.

If button **⊖** is pressed twice within one second, the display will revert to the original mode after 20 seconds.

The outside temperature is displayed when the multi-function indicator is activated. Sudden changes in temperature, for instance when leaving a garage, are only shown after a certain delay.

NOTE: Outside temperature display

°F in USA only.

°C in Canada only.

WARNING!

Even if the display still reads a few degrees above 32°F (0°C), the road surface may be icy, particularly in woods or on bridges. You could skid and lose control over your vehicle and thereby cause an accident.

Adapt your speed and driving style to the prevailing road and weather conditions to prevent an accident and possible personal injury or property damage.

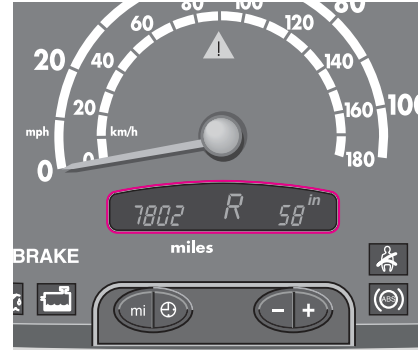

Reversing Aid Distance Display (Optional)

When the key is in position 2 in the ignition lock and the reverse gear is engaged, the reversing aid automatically begins to monitor the area to the rear of the vehicle.

The following display appears if the reversing aid does not detect an obstacle.

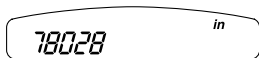

NOTE: Distance display

- "in" in USA only.
- "cm" in Canada only.

The distance between the sensors and an obstacle detected within the monitoring range is displayed in increments of 2 in (5 cm).

If the distance is less than 40 in (100 cm), a warning signal also sounds, which is repeated increasingly frequently as the vehicle approaches the obstacle.

A continuous warning signal sounds if the distance undershoots 20 in (50 cm).

When a continuous warning signal sounds for approximately three seconds and the error code

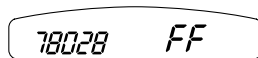

appears in the multi-function indicator, the reversing aid is malfunctioning.

Maneuver with particular care, if interference from an external source of ultrasonic waves (compressed-air brakes of trucks, a car wash or a pneumatic drill) is causing the reversing aid to malfunction.

Dirty reversing aid sensors or malfunctioning backup lamps could also cause the reversing aid to malfunction. Clean the reversing aid sensors and check the backup lamps.

Otherwise have the malfunction traced and rectified by an authorized Sprinter Dealer.

Tachometer (Engine rpm)



Do not exceed the maximum permissible engine speed.

NOTE: To protect the engine, its fuel supply is interrupted when the maximum rpm is reached. Despite this, the maximum rpm can still be exceeded in overrun mode (e.g. when driving downhill).

Coolant Temperature Gauge



The coolant temperature is displayed when the key is in position 2 in the ignition lock.

If corrosion inhibitor/antifreeze is present in the correct concentration in the coolant, the coolant temperature will be between 185 °F (+85 °C) and 250 °F (+120 °C), depending on operating conditions.

If the needle reaches the red section, do not continue to drive the vehicle.

CAUTION!

Do not leave your vehicle unattended with the engine running as you would not be able to react to the temperature indicator if the engine overheats. This would lead in turn to engine damage.

For coolant level indicator lamp , refer to "Coolant Level Indicator Lamp".

NOTE: Coolant temperature display

°F in USA only.

°C in Canada only.

WARNING!

Driving when your engine is badly overheated can cause some fluids which may have leaked into the engine compartment to catch fire. You could be seriously burned. Steam from an overheated engine can cause serious burns and can occur just by opening the engine hood. Stay away from the engine if you see or hear steam coming from it. Turn off the engine, get out of the vehicle and do not stand near the vehicle until it cools down.

Fuel Gauge with Reserve Fuel Indicator Lamp



The fuel level is displayed when the key is in position 2 in the ignition lock.

The reserve fuel indicator lamp (1) lights up for about 2 seconds.

If the reserve fuel indicator lamp remains on or lights up again when the engine is running, the fuel in the tank has reached reserve level.

Reserve level: about 2.8 US gal (10.5 liters).

NOTE: If the fuel gauge sensor is damaged, the reserve fuel indicator lamp (1) will light up and the needle will vary its position between the maximum and minimum marks. Have the malfunction traced and rectified by an authorized Sprinter Dealer.

Battery Charge Indicator Lamp

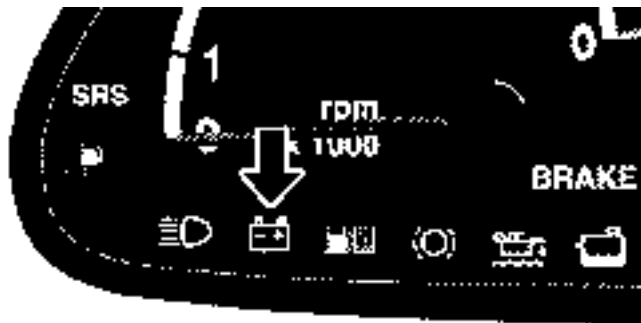



M54 3B-5251-23

Water in Fuel Indicator Lamp





M54 3B-5251-20

When the key is in position 2 in the ignition lock, the battery charge indicator lamp  will light up in the instrument cluster. It must go out when the engine is running.

If the battery charge indicator lamp  remains on or lights up again while the vehicle is moving, a fault has developed in the battery charge circuit.

Do not drive on. Take your vehicle to an authorized Sprinter Dealer to have the problem corrected.

When the key is turned to position 2 in the ignition lock, the fuel filter indicator lamp  in the instrument cluster lights up for about 2 seconds. It must go out when the engine is running.

If water in fuel indicator lamp  does not go out or comes on with the engine running, drain the water from the fuel filter as soon as possible.

NOTE: Should the water in fuel indicator lamp  still not go out after the fuel filter has been drained, the cause should be examined by an authorized Sprinter Dealer.

If the indicator lamp  does not light up for about 2 seconds with the key in the ignition lock in position 2, there is a malfunction in the water separator system. Have the cause rectified by an authorized Sprinter Dealer.

Engine Oil Level Indicator Lamp



M54 20-5353-20

The engine oil level indicator lamp  lights up in the instrument cluster when the key is turned to position 2 in the ignition lock. It must go out when the engine is running.

If the engine oil level indicator lamp  does not go out, or if it lights up again while the vehicle is moving, the engine oil level has dropped to a point close to the minimum level mark on the dipstick.

The indicator lamp  lights up only briefly at first, becoming permanent as the oil level drops further.

Stop the engine immediately and check the engine oil level. If no obvious leak is visible, correct the oil level.

If the engine oil level indicator lamp  lights up, even if the engine oil level is sufficient, have the cause traced and rectified by an authorized Sprinter Dealer.

For approved engine oils, please contact your authorized Sprinter Dealer.

Coolant Level Indicator Lamp



M54 20-5254-20

When the key is turned to position 2 in the ignition lock, the coolant level indicator lamp  in the instrument cluster lights up for about 2 seconds. It must go out when the engine is running.

If the coolant level indicator lamp  remains on or lights up again when the engine is running, the coolant level is too low.

Do not drive on. Switch the engine off and add coolant.

If a large quantity of coolant is being lost, or if smaller amounts are lost at regular intervals, have the engine cooling system examined by an authorized Sprinter Dealer.

CAUTION!

Never run the engine if the coolant level is too low. This could cause the engine to overheat, leading in turn to engine damage.

WARNING!

Driving when your engine is badly overheated can cause some fluids which may have leaked into the engine compartment to catch fire. You could be seriously burned. Steam from an overheated engine can cause serious burns and can occur just by opening the engine hood. Stay away from the engine if you see or hear steam coming from it. Turn off the engine, get out of the vehicle and do not stand near the vehicle until it cool downs.

Engine Control Unit Indicator Lamp



When the key is in position 2 in the ignition lock, the engine control unit indicator lamp  will light up in the instrument cluster. It must go out when the engine is running.

If the engine control unit indicator lamp  remains on or lights up again while the vehicle is moving, the fuel tank was run empty or a fault has developed in the engine control unit. The engine's power output may be reduced.

Refuel and bleed the fuel system or have the cause traced and rectified by an authorized Sprinter Dealer.

SWITCH LOCATIONS

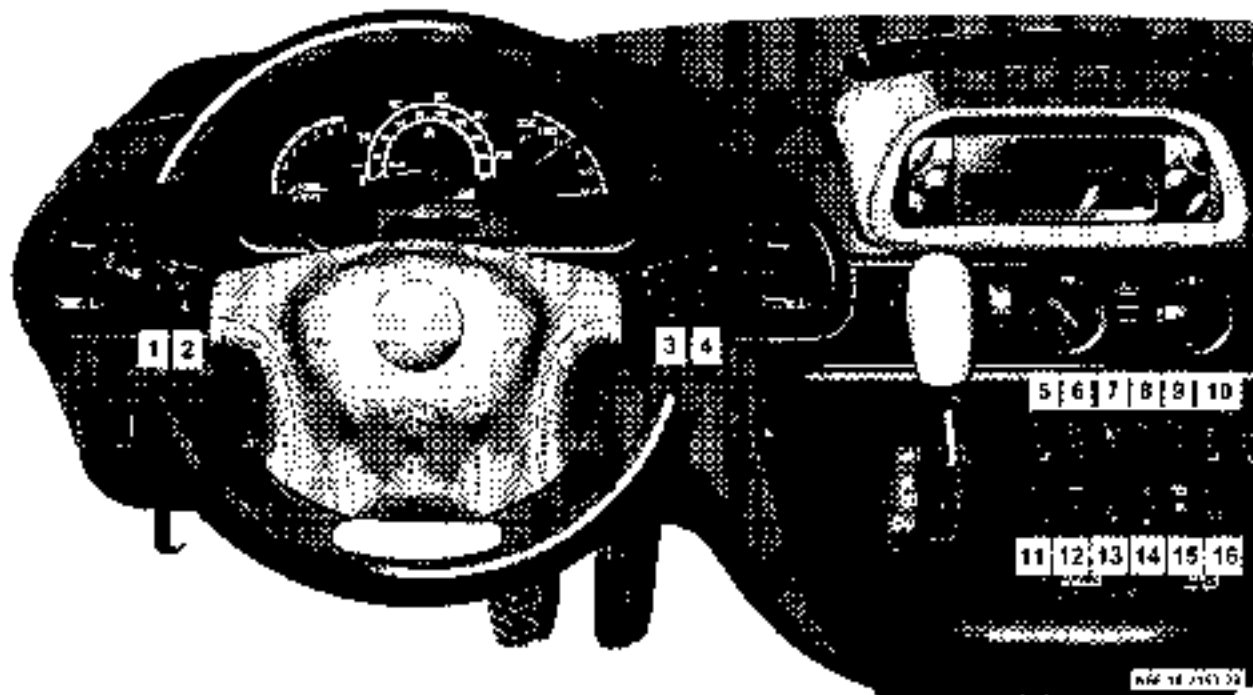

Legend for Switch Locations

1. Fog lamp switch (Optional), refer to "Fog Lamp Switch".
2. Headlamp range control, refer to "Headlamp Range Control".
3. Auxiliary heat exchanger switch (Optional).
4. Heated rear window (Optional).
5. Left-hand seat heater switch (Optional).
6. Central locking switch with load compartment lock (Optional).
7. Alarm pushbutton.
8. Deactivate Acceleration skid control (ASR) switch.
9. Switch for auxiliary heater (Optional)
10. Right-hand seat heater switch (Optional),
11. Sun roof operation switch (Optional).
12. Interior cargo area lighting (Optional), refer to "Interior Cargo Area Lighting".
13. Towing/passenger compartment protection switch (Optional).
14. Airflow switch for the air conditioner for rear passenger compartment (Optional).
15. Temperature control (Optional).
16. Electric blower switch (Optional).
17. Windshield heater switch (Optional).
18. Constant RPM switch (Optional).

ASSYST MAINTENANCE COMPUTER (OPTIONAL)

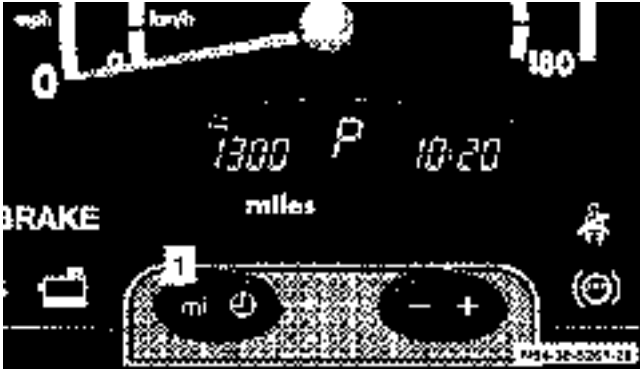

Function button **mi** (**km**) (1)

Approximately one month or 2,000 miles (3,000 km) before a service is due, the maintenance symbol

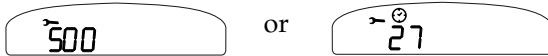

lights up when the key is turned to position 2 in the ignition lock.

If the remaining time (in days) is shown, the additional symbol  also appears in the multi-function indicator.

If additional maintenance operations are due, the maintenance indicator

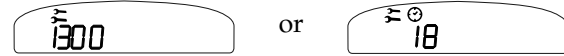

lights up when the key is turned to position 2 in the ignition lock.

For additional maintenance operations, see Sprinter Service Booklet.

If a service deadline is exceeded, the display will flash with a minus sign in front when the key is turned to position 2 in the ignition lock.

The display will be cancelled when the button **mi** (**km**) is pressed, or automatically after 10 seconds.

The remaining time or remaining distance can also be called up manually.

To manually call up the remaining time/distance:

Activate the multi-function indicator, refer to "Multi-Function Indicator".

Briefly press the button **mi** (**km**) twice.

Depending on the driving style, the mileage covered and the operating conditions, the next service due is displayed either as a remaining distance in "mi" (in km) or as a remaining time in "days". The length of time between services should not exceed 2 years.

The display will be cancelled when the button **mi (km)** is pressed, or automatically after 10 seconds.

When a service has been performed, have the ASSYST maintenance computer reset by an authorized Sprinter Dealer.

Should your Sprinter for any reason not be serviced by an authorized Sprinter Dealer, the ASSYST maintenance computer can, in exceptional circumstances, be reset as follows:

Turn the key to position 2 in the ignition lock and immediately press the button **mi (km)** twice.

Within 10 seconds, return the key to position 0 in the ignition lock.

Press and hold the button **mi (km)**. Turn the key to position 2 in the ignition lock. Keep the button **mi (km)** pressed.

The maintenance indicator with the current remaining time/distance is shown.

After about 10 seconds, an acoustic signal will sound and the maintenance indicator is displayed with the new remaining time/distance.

Release the button **mi (km)**.

NOTE: The ASSYST maintenance computer provides information on the optimum maintenance requirements.

If maintenance intervals are not observed, resulting damage will not be covered by Warranty.

The ASSYST maintenance computer is not an engine oil gauge.

Engine oil level – for display in instrument cluster, see next page.

If the engine oil level indicator lamp lights up, refer to "Engine Oil Level Indicator Lamp".

If the battery is disconnected, the time is not recorded by the ASSYST maintenance computer. Such periods must be considered if maintenance intervals are measured by time.

Engine Oil Level – Display in Instrument Cluster (Vehicles with ASSYST Maintenance Computer only)

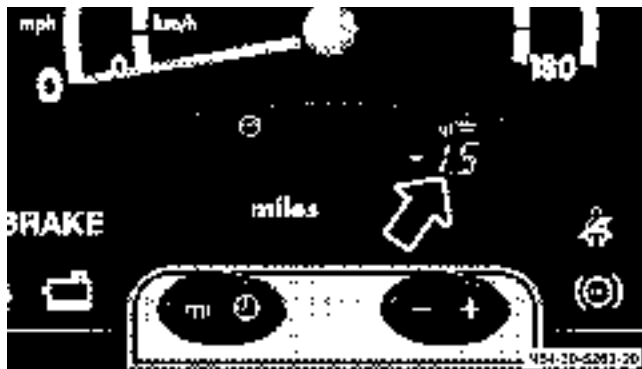

If the  indicator lamp lights up briefly when the engine is running, the engine oil level has dropped to the minimum mark. Check the engine oil level without delay and add oil to the upper mark on the dipstick.

If no engine oil is added and the engine oil level drops further, a warning buzzer will also sound and



will appear in the multi-function indicator. 2.0 quarts (about 1.9 liters) of oil must be added.

NOTE: Engine oil level display

- "qt" in USA only.
- "l" in Canada only.

CAUTION!

If the  indicator lamp lights up, the warning symbol in the multi-function indicator appears and the warning buzzer sounds, the operating safety of the engine is endangered (possibility of engine damage).

A sudden decrease or absence of oil pressure may indicate a mechanical failure. Bring the vehicle to a safe stop, and investigate the cause to prevent further damage. Do not operate the engine until the cause has been determined and corrected.

If the warning



is displayed in the multi-function indicator while the engine is running, the engine oil level is above maximum.

CAUTION!

Do not operate the engine if the oil level is above maximum. There is a danger of damage to the engine or catalytic converter.

Siphon or drain off engine oil until the engine oil level is between the lower and upper marks on the dipstick. Check the engine oil level again.



must be displayed.

NOTE: If the oil level is correct and a fault warning is still given, have the fault traced and rectified by an authorized Sprinter Dealer.

Displaying Engine Oil Level with Engine Off

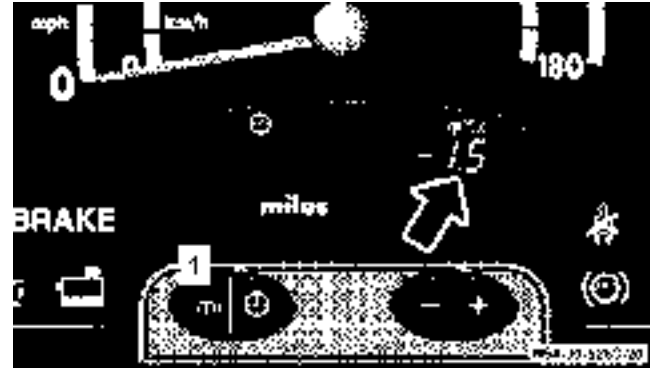

If the engine has reached normal operating temperature, the engine oil level can be displayed on the multi-function indicator for about 5 minutes after the engine has been switched off.

The vehicle must be standing on a level surface when the engine oil is being checked.

Turn the key to position 2 in the ignition lock and wait about 10 seconds until the multi-function indicator shows the  symbol.

Briefly press button (1) twice within 1 second.

The following displays can then appear in the multi-function indicator:



It is not necessary to add engine oil.



1 quart (about 1 liter) of engine oil must be added.



1.5 quarts (about 1.4 liters) of engine oil must be added.



2 quarts (about 1.9 liters) of engine oil must be added.



Excess engine oil must be drained or siphoned off.

NOTE: Engine oil level display

- "qt" in USA only.
- "l" in Canada only.

CAUTION!

If the engine oil level is too high or too low the engine can be damaged.

Add engine oil or siphon or drain off engine oil until the engine oil level is between the lower and upper marks on the dipstick. Only add engine oil up to the upper mark-do not overfill.

If the engine oil level is above maximum, there is a danger of damage to the engine or catalytic converter.

NOTE: If the engine oil level is correct and a warning that the engine oil level is too high or too low is still given, have the fault traced and rectified by an authorized Sprinter Dealer.

If it is not possible to measure the engine oil level correctly, the  symbol will flash in the multi-function indicator – repeat the measurement after waiting a short time.

If no engine oil level reading is shown again, the engine oil level can still be checked with the dipstick.

Consult an authorized Sprinter Dealer to have the system checked.

ENGINE OIL LEVEL INDICATOR IN INSTRUMENT CLUSTER (VEHICLES WITHOUT ASSYST MAINTENANCE COMPUTER)

If the  indicator lamp lights up when the engine is running, the engine oil level has dropped to the minimum mark. Check the engine oil level without delay and add engine oil up to the upper mark on the dipstick.

If there is no engine oil in the oil sump, a warning buzzer will sound if the key is turned to position 2 in the ignition lock or if the vehicle is being driven, and the warning



will appear in the multi-function indicator. About 2 quarts (1.9 liters) of oil must be added.

Check the engine oil level without delay and add engine oil to the upper mark on the dipstick.

NOTE: Engine oil level display

- "qt" in USA only.
- "l" in Canada only.

CAUTION!

If the  indicator lamp lights up, the warning symbol in the multi-function indicator appears and the warning buzzer sounds, the operating safety of the engine is endangered (possibility of engine damage).

Safely pull off the road and turn off the engine (do not restart the engine). Determine the cause of the problem. If there are no obvious signs of leakage, add engine oil. The engine oil level must be between the lower and upper marks on the dipstick. Only add engine oil up to the upper mark – do not overfill.

If the engine oil level is above maximum, there is a danger of damage to the engine or catalytic converter.

HEATING, VENTILATION







MFD-00-2002 22

Temperature control (1)

Airflow control (2)

Air distribution control (3)

-  Air to the windshield and from the air vents
-  Air to the windshield and footwell and from the air vents
-  Air to the footwell and from the air vents
-  Air from the air vents

NOTE: If the vehicle interior has been heated up by intense sunlight, ventilate the interior briefly before driving the vehicle.

Only with automatic heater control (Optional):
The selected temperature is reached as quickly as possible in heater mode and then held constant.

WARNING!

Follow the recommended settings for heating and cooling given on the following pages. Otherwise the windows could fog up, impairing visibility and endangering you and others.

Ventilation

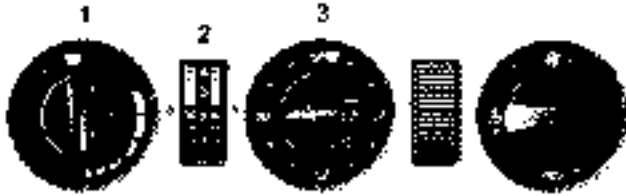

HEI 20-2993-22

1. Set the airflow control (2) to position 3 or 4.
2. Set the temperature control (1) as illustrated (heater switched off).
3. Set the air distribution control (3) to .

NOTE: Adjust the air vents as required, refer to "Side Air Vents and Center Air Vents".

Air Recirculation



HEI 20-2934-22

- Air recirculation indicator lamp (1)
- Air recirculation button (2)

To switch on air recirculation:

- Press the air recirculation button – the indicator lamp lights up.

To switch off air recirculation:

- Press the air recirculation button again – the indicator lamp goes out.

Select air recirculation if dust or unpleasant odors enter the vehicle.



NOTE: Prolonged air recirculation can worsen the air quality and lead to fogging up of the windows. Shut off air recirculation as soon as possible.

Only with automatic heat regulation and regulated air conditioning (Optional):
Air recirculation is automatically switched off after about 15 minutes or when engine is shut off.

Heating





MSJ-2B 2005-22

1. Set the airflow control (2) as required.
2. Set the temperature control (1) as required.
3. Set the air distribution control (3) between  and .
4. Switch off air recirculation, refer to "Air Recirculation".
5. Adjust the air vents as required, refer to "Side Air Vents and Center Air Vents".

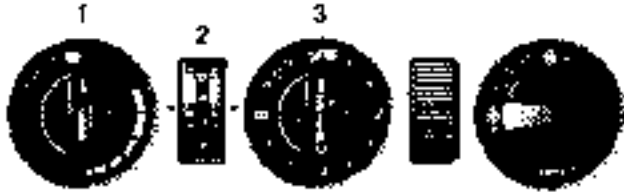
De-Fogging and De-Icing The Front Windows



101-20-2156-22

1. Set the airflow control (2) to position 3 or 4.
2. Set the temperature control (1) to .
3. Set the air distribution control (3) to .
4. Switch off air recirculation, refer to "Air Recirculation".

NOTE: On vehicles with auxiliary heater (water heater):

The additional heat exchanger in the load compartment should be switched off to quickly de-fog and de-ice the windshield and front side windows, refer to "Auxiliary Heat Exchanger in Load Compartment".

For how to switch on heater booster mode, refer to "Heater Booster".

On vehicles with air conditioner (Optional):

At outside temperatures above 41 °F (+5 °C), switch on the air conditioner for quicker dehumidification, refer to "Air Conditioning, Regulated".

Side Air Vents and Center Air Vents

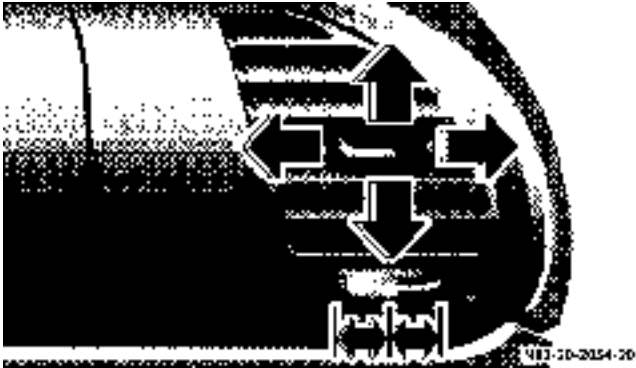

To open, turn the thumbwheel outwards.

To close, turn the thumbwheel inwards.

Intermediate settings are possible.

Upper Air Vents

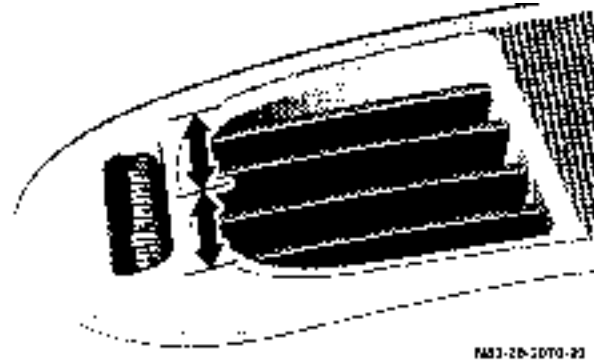

The upper air vents supply fresh air (not heated) to the passenger/load compartment.

To open, turn the thumbwheel forwards.

To close, turn the thumbwheel rearwards.

Heated Rear Window (Optional)



N34-35-2074-2B

The switch for the heated rear window is located on the right-hand side next to the steering column.

It can be used only when the engine is running.

To switch it on:

- Press upward; the indicator lamp in the switch will light up.

To switch off:

- Press upward one more time.

NOTE: The heated rear window will automatically switch off after about 15 minutes or when the engine is turned off.

Windshield Heater (Optional)



N34-23-2633-20

The switch for the windshield heater is located on the center section of the dashboard.

It can be used only when the engine is running.

To switch it on:

- Press upward; the indicator lamp in the switch will light up.

To switch off:

- Press upward one more time.

NOTE: The windshield heater will automatically switch off after about 5 minutes or when the engine is turned off.

Residual Engine Heat Utilization (REST)



The REST switch (1) is located on the center section of the dashboard.

The residual engine heat utilization system can be used to keep the vehicle interior warm for some time after the engine is switched off.

Turn the key to position 0 in the ignition lock or remove it altogether.

To switch on:

1. Press the residual engine heat utilization switch (1), the indicator lamp (2) lights up.
The blower will run at speed 1 regardless of the setting of the airflow control.
2. Set the temperature control as required, refer to "Heating, Ventilation".

To switch off:

Press the residual engine heat utilization switch (1) again, the indicator lamp (2) goes out.

The residual engine heat utilization is automatically switched off if:

1. the key is turned to position 2 in the ignition lock,
2. after about 30 minutes,
3. if the battery voltage is too low.

AIR CONDITIONING, REGULATED (OPTIONAL)



The air conditioning switch (1) is located on the center section of the dashboard.

The air conditioning can be used to cool or dehumidify the air in the vehicle. The selected temperature is reached as quickly as possible and then held constant.

The air conditioning is only operational when the engine is running.

Climate Control (on Vehicles with Air Conditioning)

To switch on:

Press switch (1), the indicator lamp (2) in the switch lights up.

To switch off:

Press switch (1) again, the indicator lamp (2) goes out.

NOTE: Run the air conditioning at least once a month for about 10 minutes.

It is possible that the air conditioning will automatically switch off at outside temperatures below 41 °F (+5 °C). Dehumidification is then also not possible.

Condensation may emerge from the underside of the vehicle.

The air conditioner only uses the refrigerant R-134a. This refrigerant does not damage the earth's ozone layer.

WARNING!

While driving, deactivate the air conditioning only temporarily to prevent window fogging.



NEJ-J0-Z001-22

1. Set the airflow control (2) to position 1 to 4. Position 4 gives maximum cooling.
2. Set the temperature switch (1) as required (The interior temperature is regulated by the Tempmatik. If the interior temperature falls below the preset temperature, warm air is automatically supplied).
3. Set the air distribution control (3) to .
4. To switch on air conditioning, press switch (4).



NOTE: Open and adjust the air vents as required, refer to "Side Air Vents and Center Air Vents".

At high outside temperatures, a better cooling performance is achieved by switching on air recirculation. For note on air recirculation, refer to "Air Recirculation".

Dehumidification (on Vehicles with Air Conditioning)



MS-23-2696-22

1. Set the airflow control (2) to position 3 or 4.
2. Set the temperature control (1) as required.
3. Set the air distribution control (3) between  and .

NOTE: It is possible that the air conditioning will automatically switch off at outside temperatures below 41 °F (+5 °C). Dehumidification is then also not possible.

To switch on air conditioner, press switch (4).

Open the side air vents as required, refer to "Side Air Vents and Center Air Vents".

Air Conditioner for the Rear Passenger Compartment (Optional)



H50-25 2363-20

The air conditioner for the rear passenger compartment must be used in conjunction with "Air Conditioning, Regulated", refer to "Air Conditioning, Regulated".

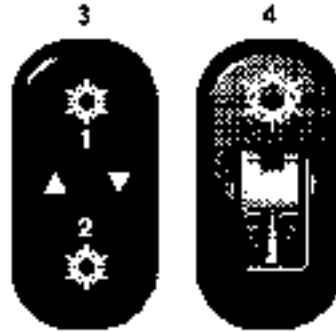

H50-25 2379-20

1. Air conditioning, regulated switch
2. Air conditioning, regulated indicator lamp
3. Airflow switch
4. Temperature control

To switch it on:

1. Press switch (1) on air conditioning, regulated.
The indicator lamp (2) will light up.
2. Operate the airflow switch (3).
Blower level 1, press the airflow switch (3) upwards; the left-hand indicator lamp will light up.
Blower level 2, press the airflow switch (3) downwards; the right-hand indicator lamp will light up.
3. Set temperature control (4) as needed.
Increase cooling turn upwards.
Decrease cooling turn downwards.

To switch off:

1. Switch the airflow switch (3) to the center position.
2. Press switch (1) air conditioning, regulated; the indicator lamp (2) will go out.

Air Recirculation

Recirculation mode can now be assisted by the air conditioner for rear passenger compartment.

To switch it on:

Operate the airflow switch (3)
Blower level 1, press the airflow switch (3) upwards; the left-hand indicator lamp will light up.
Blower level 2, press the airflow switch (3) downwards; the right-hand indicator lamp will light up.

To switch off:

Switch the airflow switch (3) to the center position.

Air Strainer

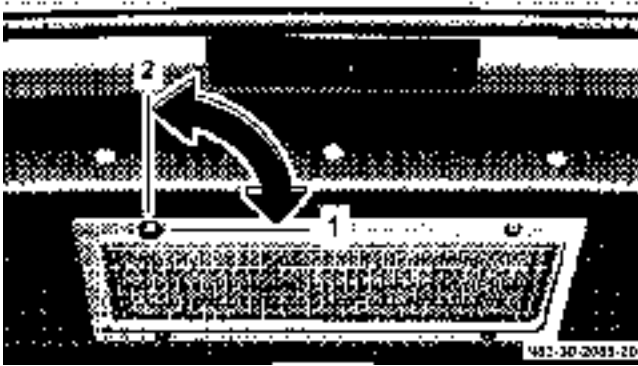

To lock fasteners (1)

To unlock fasteners (2)

The air strainer is located at the rear of the air conditioner for rear passenger compartment.

Increased quantities of sand or dust may settle on the air conditioner for rear passenger compartment air strainer when driving on dusty or sandy streets. The air strainer must be either cleaned or replaced in the event of visible contamination.

Removing and Cleaning the Air strainer



481-30-2090-3D

1. Unlock all quick-acting fasteners (2).
2. Remove the cover and air strainer (3).
3. Remove the Velcro closure (4) from the cover (6) and the grating (5).
4. Remove the air strainer (3) from the grating.
5. Wash out the air strainer (3) with clean water.
6. Let the air strainer (3) dry.

NOTE: The air strainer (3) must not be cleaned or dried by machine.

Installing the Air Strainer

1. Affix the air strainer (3) to the grating (5) (make certain that the ends project evenly).
2. Replace the air strainer (3) and grating (5) on the cover and press the Velcro closure (4) on the cover (6).
3. Insert the air strainer (3) with the cover and grating (5).
4. Lock (1) all quick-acting fasteners.

CAUTION!

Never operate the air conditioner for rear passenger compartment without an air strainer.

Never install a damaged air strainer.

If the air strainer with visible contamination is neither cleaned nor replaced, damage to the air conditioner for rear passenger compartment may result; such damage is not covered by the Warranty.

ELECTRIC BLOWER (OPTIONAL)

See Section 4, Understanding Your Instrument Panel, for switch locations.



The electric blower can be used to aerate or deaerate the cargo area. This feeds fresh air into the cargo area or extracts warm air.

Deaeration:

Press switch upward.

Aeration:

Press switch downward.

To switch off:

Switch the airflow switch to the center position.

HEATER BOOSTER



The switch (1) for activating the heater booster system is located in the center section of the dashboard. The heater booster system can be switched on while the vehicle is being driven to help the engine to reach its normal operating temperature more quickly, which will help to heat up the passenger compartment as quickly as possible when the heating is switched on.

To switch on with the engine running:

Press switch (1), the indicator lamp (2) lights up.

To switch off:

Press switch (1) again or switch the engine off. The heater booster will then switch to run-on mode (about 2 minutes).

NOTE: When the vehicle is being driven and a coolant temperature of over 185 °F (+80 °C) is reached, the heater booster system will switch to regulation mode. If the coolant temperature drops to below 167 °F (+75 °C) with the heater booster system switched on, heat output is increased again.

If the key is turned to position 0 in the ignition lock (run-on for about 2 minutes), the last setting selected at switch (1) is retained when the engine is restarted (memory function).

The operation of the heater booster system is usually not required at outside temperatures above 41 °F (+5 °C).

AUXILIARY HEATER – WATER OR AIR HEATER (OPTIONAL)

WARNING!

The auxiliary heating must not be operated at gas stations due to the risk of fire and explosion. For this reason, switch off the auxiliary heating before refuelling.

Auxiliary heaters emit fumes when in operation, including carbon monoxide.

Inhaling carbon monoxide is a health hazard and can result in unconsciousness and death.

For this reason, do not operate auxiliary heating in enclosed spaces without ventilation or an extractor system, e.g. in a garage. Otherwise you could endanger yourself and others.

Always keep the ground under the vehicle as clear as possible so that the auxiliary heater can receive enough combustion air and exhaust fumes can escape. Otherwise you could endanger yourself and others.

WARNING!

**Vehicles for transporting hazardous goods:
Observe the relevant safety regulations.**

NOTE: The auxiliary heater (water or air heating device) can be used whether or not the engine is running.

After you have filled your vehicle's gas tank with winterized diesel fuel for the first time, it is recommended that you operate the auxiliary heater before beginning a journey or operating the heater continuously so that any summer diesel fuel left in the auxiliary heater can combust.

Before switching the auxiliary heater on make sure that the battery is sufficiently charged and that there is enough fuel in the tank. At least a quarter of the tank should be filled up. See Fuel Gauge.

NOTE: After three successive attempts to start the heater, a malfunction will be recorded in the integrated diagnostic system and no further operation on auxiliary heater will be available (lock-out). The work to annul the lock-out must be carried out at an authorized Sprinter Dealer.

The auxiliary heater should be run at least once a month for about 10 minutes.

The maximum heating period is 120 minutes. For more information, refer to "Switching the Auxiliary Heater On and Off - Ignition On".

The auxiliary heater will automatically switch off if the fuel level is under about 4 US gal (15 l).

In case of faults, refer to "Auxiliary Heater – Tips for Coping with Problems".

WARNING!

Aerosols, gas cartridges and other pressurized containers transported in the vehicle may be highly flammable and could explode when heated.

Make sure, particularly on vehicles with an air heater, that such containers are not placed in the flow of hot air of the auxiliary heating system

Otherwise there is a risk of severe personal injuries, death and property damage due to explosion.

4

WARNING!

Vehicles with air heater:

For safety reasons, we strongly recommend that the heat exchanger be replaced by an authorized Sprinter Dealer after 10 years of use.

If the vehicle is sold, the owner is required to inform the buyer of this requirement. This should be done when the Operator's Manual is transferred to the buyer.

Auxiliary Heater Switch



MS4-25-2005-03

To switch it on:

Press the switch upward.
The indicator lamp in the switch will light up.

The auxiliary heater will automatically switch off after about 120 minutes. The auxiliary heater

will switch over to after-running mode (about 2 minutes).

To switch off:

Press the switch downward.
The indicator lamp in the switch will go out.

Timer Auxiliary Heater



MS4-25-2005-03

NOTE: The timer water heater has no adjustable temperature selection transformer (10).

Memory location (1 – 3) (1)

Current day or preselected day (2)

Current time or preselected time (3)

Symbol  – Status display (4)

Button  – Set time and day (5)

Button **P** – Select memory (1 – 3), activate preselected time (6)

Button **☰** – Switch on heater (7)

Button **◀** – Set time, day, and preselected time; shorten heating period (min. 1 minute) (8)

Button **▶** – Set time, day, and preselected time; lengthen heating period (max. 120 minutes) (9)

Air Heater only, adjustable temperature selection transformer – adjustment range from 50 °F to 86 °F (+10 °C to +30 °C) (10)

NOTE: All symbols and digits in the display will flash if the battery voltage has been interrupted over a longer period of time. The timer must be reset.

The heater cannot be switched on until the time of day has been set.

The timer lights up when the heater is switched on.

Switching the Auxiliary Heater On and Off - Ignition Off

To switch it on:

Press button **☰**.

The vehicle-side blower automatically switches on.

Display: Symbol **☰** and remaining heating period. The remaining heating period can be lengthened by using the button **▶** (max. of 120 minutes); it may be shortened by using the button **◀** (min. of 1 minute).

To switch off:

Press button **☰** again.

The blower inside the vehicle automatically switches off. The auxiliary heater will automatically switch off after about 3 minutes.

Display: Current time and current day of the week (about 15 seconds).



Switching the Auxiliary Heater On and Off - Ignition On

To switch it on:

Press the button **☰**.

The auxiliary heater is running.

Display: Symbol , current time and current day of the week.

If the ignition is switched off, the auxiliary heater will remain on for another 15 minutes before automatically switching off. The remaining heating period can be lengthened by using the button  (max. of 120 minutes); it may be shortened by using the button  (min. of 1 minute).

To switch off:



Press the button  again.

The auxiliary heater will automatically switch off after about 3 minutes.



Display: Current time and current day of the week.

Setting the time and day

Press the button  until the "Time" display begins to flash.

Use either the button  or  to set the current time. The current time has been saved when the display stops flashing or the button  is used for confirmation.

The "Day" display then flashes.

Use either the button  or  to set the current day of the week. The current day has been saved when the display stops flashing or the button  is used for confirmation.

When the ignition is switched on, the current time and day remain on display. When the ignition is switched off, the display disappears after about 15 seconds.



Setting/Activating Preselected Times

3 preselected times may be saved.

Setting preselected times:

Press the button  repeatedly until the desired memory (1 – 3) flashes.

Briefly press the button  or  – the preselected time will flash.

Use either the button  or  to set the preselected time. The current preselected time has been saved when the display stops flashing.

Activate the preselected time (up to 24 hours):

Press the button **P** until the desired memory (1 – 3) and the preselected time both flash.

The preselected time has been activated when the display stops flashing. Within the next 24 hours, the heater will switch on at the preselected time displayed.

Activate the preselected time (from 24 hours to a max. of 7 days):

A preselected time may be chosen up to 7 days beforehand.

Press the button **P** until the desired memory (1 – 3) and the preselected time both flash.

After about 5 seconds, the "Preselected Day" display will appear – use either the button **<** or **>** to set the preselected day.

The preselected time and day have been activated when the display stops flashing and when the current time, activated memory, and the flashing symbol **SSS** appear in the display.

To call up the activated memory:

Briefly press the button **P** – the preselected day and time will be displayed for about 5 seconds.

Switching off preselected times:

Press the button **P** repeatedly until no memory is displayed – no preselected time is activated.

Setting the Heating Period

Settings between 1 minute and 120 minutes may be set for heating periods to run when the ignition is switched off.

Do not switch on the heater.

Press the button **<** until the current heating period begins to flash.

Use either the button **<** or **>** to set the desired heating period. The new heating period will be saved as soon as the display disappears.

Auxiliary Heater Operation

The symbol **SSS** appears in the timer display as soon as the heater is switched on. After about 20 to 50 seconds, the heater runs with the complete flow of heat, so that the operating temperature is reached as soon as possible.

Heat operation:

Different operating conditions will be in effect depending on the heat level required.

The integrated control unit adjusts the heat flow using the following operating levels:

High – Low – Off

Safety Equipment

For safety reasons, the heater will automatically switch off if faults occur which cause the device to overheat.

Tips for Coping with Problems; refer to "Auxiliary Heater – Tips for Coping with Problems".

The integrated control unit contains a diagnostic system which detects and stores faults. The error can be read by means of the vehicle diagnosis. If a fault occurs while the heater is switched on, the symbol  will flash and the error code for that fault will be displayed in the timer.

The fault should be corrected as soon as possible by an authorized Sprinter Dealer.

Settings with the Auxiliary Heater switched on



h03-33-3199-22

In preheat mode, the blower is automatically switched on at blower speed 1 when the water heater is switched on. When driving, the airflow control switch (2) can be set as desired.

NOTE: Only on vehicles with automatic heater control/regulated air conditioner:

Before switching on the heater or entering the switch-on time, the temperature control (1) must be set to maximum heater output (as illustrated).

Set the air distribution control (3) as required between  and .

AUXILIARY HEAT EXCHANGER IN LOAD COMPARTMENT, ONLY WITH AUXILIARY HEATER (OPTIONAL)



454-279-20176-201

The auxiliary heat exchanger switch is located on the right next to the steering column.

To switch on at blower speed 1:

Press the upper section, the left-hand indicator lamp in the switch lights up.

To switch on at blower speed 2:

Press the lower section, the right-hand indicator lamp in the switch lights up.

To switch off :

Press the switch to the middle position.

Operation is only possible when the key is turned to position 2 in the ignition lock.

NOTE: The auxiliary heat exchanger in the load compartment should be switched off at coolant temperatures below 176 °F (+80 °C) to quickly de-fog and de-ice the windshield and front side windows.

AUXILIARY HEATER – TIPS FOR COPING WITH PROBLEMS

NOTE: After three successive attempts to start the heater, a malfunction will be recorded in the integrated diagnostic system and no further operation on auxiliary heater will be available (lock-out). The work to annul the lock-out must be carried out at an authorized Sprinter Dealer.

The heater either does not switch on or automatically switches off:

- Insufficient fuel, fill up the fuel tank. Start up heater two times, until the fuel lines are filled.
- The auxiliary heater will automatically switch off if the fuel level is under about 4 US gal (15 l).
- The fuses in the fuse box are damaged. Electric fuses.
- The battery voltage is too low, an undervoltage protector switches off the heater if the battery voltage falls below about 10 volts.

The heater motor does not run

- The battery voltage is too low, check the battery. Batteries.
- The fuses in the fuse box are damaged. Electric fuses.
- The heater motor is damaged.

Overheating

- The air channels are clogged.
The heater can be restarted once the fault has been repaired. When this is done, the heater should be switched on and off.
- The heater will remain switched off after it has been overheated a number of times (about 10 times in succession). Have the fault repaired by an authorized Sprinter Dealer.

NOTE: Repairs should only be made by an authorized Sprinter Dealer.

STARTING AND OPERATING

CONTENTS

■ Power Assistance	144	■ Brakes	158
■ Starting the Engine	144	□ Service Brake	158
□ Maximum Engine Speed	145	□ Brake Pad Wear Indicator	159
□ Constant RPMs (Optional)	146	□ Brake Indicator and Electronic Brake Force Distribution (EBD) Indicator Lamp . . .	160
■ Stopping the Engine	147	□ Parking Brake Indicator Lamp	161
■ Automatic Transmission	148	□ Parking Brake	162
□ Driving	148	□ Driving Safety Systems	163
□ Accelerator Position	149	□ Anti-Lock Brake System (ABS) Indicator Lamp	164
□ Stopping	149	□ Anti-Lock Brake System (ABS)	165
□ Maneuvering	149	□ Electronic Brake Force Distribution (EBD) . . .	167
□ Gear Selector Lever Position	150	□ Acceleration Skid Control Indicator Lamp (ASR) and Brake Assist System (BAS) ¹ if equipped	167
□ Gear Selection for Special Circumstances	151	□ Acceleration Skid Control (ASR) Warning Lamp and Electronic Stability Program (ESP®)* – if equipped	169
■ Transmission Selector Lever, Manually Unlocking	153	□ Acceleration Skid Control (ASR)	170
□ Reversing Aid (Optional)	153		
■ Loading the Vehicle	156		
□ Loading Guidelines	157		

- Deactivating the Acceleration Skid Control (ASR) 171
- Brake Assist System (BAS) (vehicle type 2500 only) 172
- Indicator Lamp Electronic Stability Program (ESP®) (vehicle type 2500 only) 173
- Electronic Stability Program (ESP®) (vehicle type 2500 only) 174
- Auxiliary Drive (Optional) 175
- Steering 176
- Wheels and Tires 176
 - Radial-Ply Tires 179
 - Important Guidelines 179
 - Tire Care and Maintenance 180
 - Tire Inspection 180
 - Life of Tire 181
 - Tread Depth 181
 - Storing Tires 182
 - Cleaning Tires 182
 - Direction of Rotation 182
 - Vehicles type 2500 C/HC/SHC 185
 - Vehicles type 3500 C/HC/SHC 185
 - Tire Grip 185
 - Hydroplaning 185
 - Recommended Tire Inflation Pressure 186
 - Important Notes on Tire Inflation Pressure .. 187
 - Checking Tire Inflation Pressure 188
 - Potential Problems associated with Underinflated and Overinflated Tires 190
 - Tire Labeling 191
 - Tire Size Designation, Load and Speed Rating 192
 - Tire Sizes for Sprinter Vehicles 193
 - Design Standard 193
 - Tire Width 193
 - Aspect Ratio 193
 - Tire Code 193
 - Rim Diameter 193
 - Tire Load Rating 193
 - Tire Speed Rating 195
 - DOT, Tire Identification Number (TIN) 196
 - DOT (Department Of Transportation) 197
 - Manufacturer's Identification Mark 197
 - Tire Size 197
 - Tire Type Code 197
 - Date of Manufacture 197
 - Maximum Tire Load 198
 - Maximum Tire Inflation Pressure 199
 - Tire Ply Material 200
 - Tire and Loading Terminology 200
 - Rotating Tires 204
 - Alignment and Balance 206

- Winter tires 206
- Snow Chains 207
- Fuel Requirements 209
 - Fuel Filter with Water Separator 210
 - Diesel Fuels for Use at Very Low Temperatures 211
- Refueling 212
 - Capacity 213
- Programmed Top Speed (Optional) 213
- Bleeding Diesel Fuel System 214
- Draining Fuel Filter with Water Separator 214
 - Bleeding the Diesel Fuel System 216
- Permissible Roof Load 216
- Loading the Vehicle 216
 - Tire and Loading Information 217
- Trailer Towing 221
 - Trailer Hitches (Optional) 222
 - Electrical Connections (Optional) 222
 - Vehicle and Trailer Weights and Ratings 222
 - Trailer Tongue Load 223
 - Loading a Trailer 223
 - Checking Weights of Vehicle and Trailer 224
 - Attaching a Trailer 224
 - Towing a Trailer 225
 - Parking a Trailer 227
- Emissions Control System (Catalytic Converter) 228
- Inhalation of Exhaust Gas 228
- Fording (Wading Capability) 228
- Body Builder Guideline 229
 - A Special Note Concerning Vehicle Alteration 230

POWER ASSISTANCE

WARNING!

When the engine is not running, there is no power assistance for the brake and steering system. In this case, it is important to keep in mind that a considerably higher degree of effort is necessary to brake and steer the vehicle.

STARTING THE ENGINE

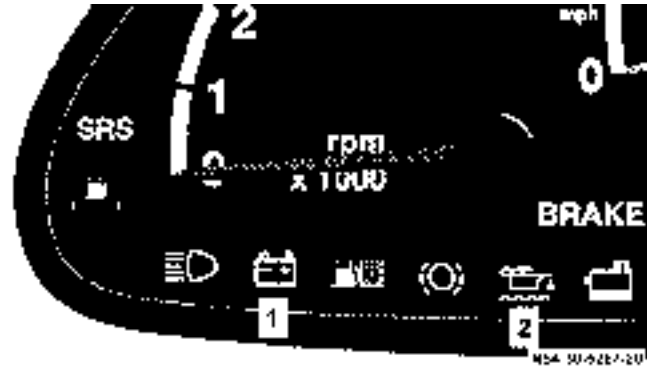



Battery charge warning lamp (1)

Engine oil level indicator lamp (2)







Preheater indicator lamp (3)

1. Apply the parking brake.
2. Automatic transmission, shift selector lever to "P" or "N" position, refer to "Automatic Transmission".
3. Do not depress the accelerator pedal.
4. Turn the key to position 2 in the ignition lock. The preheater indicator lamp  lights up.
5. Turn the key clockwise to the stop as soon as the preheater indicator lamp  goes out. If the engine is at its normal operating temperature, the preheater indicator lamp will only light up briefly.

Release the key as soon as the engine is running.

NOTE: The key must be returned to position 0 in the ignition lock before repeating the starting procedure.

If the display  lights up alternately with  in the multi-function display, there is an immobilizer malfunction or the key used has not been programmed.

The  engine oil level warning lamp and the  battery charge warning lamp must go out after the engine is started.

If either lamp remains on, stop the engine at once and have the cause traced and repaired by an authorized Sprinter Dealer.

During the trip, check the displays and the warning/indicator lamps in the instrument cluster at regular intervals.

Maximum Engine Speed

The maximum engine speed for all vehicles is 4,200 rpm.



N54-23-7634-20

Constant RPMs (Optional)

The switch for the Constant RPMs is located on the center section of the dashboard.

Constant RPMs increases the engine-idling RPMs to a set working-RPM level and maintains this level regardless of work load.

It can only be used when the vehicle is stationary, the parking brake is engaged and the gear selector lever is in position "P".



N54-31-2547-20

Constant RPMs indicator lamp

To switch it on:

- Press the top of the switch; the indicator lamp in the switch and the constant RPMs indicator lamp **ADR** will light up.

To switch off

- Press bottom of switch.

NOTE: The Constant RPMs will automatically switch off when the parking brake is released, the vehicle is in motion or the control unit detects a malfunction.

The Constant RPMs will also automatically switch off when you depress the brake pedal. In this case it will automatically switch on again as soon as you release the brake pedal.

STOPPING THE ENGINE

After having brought the vehicle to a stop:

1. Do not depress the accelerator pedal.
2. Apply the parking brake.
3. Turn the key back to position 0 in the ignition lock.

NOTE: When the engine is very hot, such as after climbing a long steep slope, allow the engine to idle for 1 to 2 minutes so that it can return to its normal operating temperature.

AUTOMATIC TRANSMISSION



W27-00-2E40-00

The automatic transmission selects individual gears automatically, dependent upon:

- Gear Selector lever position
- Accelerator position
- Vehicle speed

The gear shifting process is continuously adapted, dependent on the driving style, the driving situation and the road characteristics.

NOTE: When parking the vehicle or before working on the vehicle with the engine running, apply the parking brake and shift the gear selector lever into "P".

Driving

The gear selector lever is automatically locked while in position "P". To move the gear selector lever out of position "P", the service brake is applied and the key in position 2 in the ignition lock or the engine running before the shift lock will release.

Shift gear selector lever to the desired position only when the engine is idling normally and the service brake is applied. Do not release the brake until ready to drive. The vehicle may otherwise start creeping when the gear selector lever is in drive or reverse position.

WARNING!

It is dangerous to shift the gear selector lever out of "P" or "N" if the engine speed is higher than idle speed. If your foot is not firmly on the brake pedal, the vehicle could accelerate quickly forward or in reverse. You could lose control of the vehicle and hit someone or something. Only shift into gear when the engine is idling normally and when your right foot is firmly on the brake pedal.

NOTE: After selecting any driving position from "N" or "P", wait a moment to allow the gear to fully engage before accelerating, especially when the engine is cold.

Accelerator Position

Partial throttle, for early upshifting and normal acceleration

Full throttle, for later upshifting and rapid acceleration

Kickdown, (depressing the accelerator beyond full throttle) for downshifting to a lower gear and maximum acceleration. Once the desired speed is attained, ease up on the accelerator, the transmission shifts up again.

Stopping

For brief stops, such as at traffic lights, leave the transmission in gear and hold vehicle with the service brake.

For longer stops with the engine idling, shift into "N" or "P" and hold the vehicle with the service brake.

When stopping the vehicle on an uphill grade, do not hold it with the accelerator, use the brake. This avoids unnecessary transmission heat build up.

Maneuvering

To maneuver in tight areas, such as when pulling into a parking space, control the vehicle speed by gradually releasing the brakes. Accelerate gently and never abruptly step on the accelerator.

To rock a vehicle out of soft ground (mud or snow), alternately shift from forward to reverse, while applying slight partial throttle.

WARNING!

Getting out of your vehicle with the gear selector lever not fully engaged in position "P" is dangerous. Also, when parked on an incline, position "P" alone may not prevent your vehicle from moving, possibly hitting people or objects.

Always set the parking brake in addition to shifting to position "P".

When parked on an incline, also turn front wheel against curb.

Gear Selector Lever Position



The current gear selector lever position (1) is indicated in the gear range indicator display. The automatic gear shifting process can be adapted to specific operating conditions using the gear selector lever.

P Park Position

The park position is to be used when parking the vehicle. Engage only with the vehicle stopped. The park position is not intended to serve as a brake when the vehicle is parked. Rather, the driver should always use the parking brake in addition to placing the gear selector lever in park position to secure the vehicle.

NOTE: With a malfunction in the vehicle's electrical system the gear selector lever could remain locked in position "P". To unlock the gear selector lever manually, refer to "Transmission Gear Selector Lever, Manually Unlocking".

R Reverse Gear

Shift to reverse gear only with the vehicle stopped.

N Neutral

No power is transmitted from the engine to the drive axle. When the brakes are released, the vehicle can be moved freely (pushed or towed). Do not engage "N" while driving as you may otherwise lose control of the vehicle.

NOTE: Coasting the vehicle, or driving with gear selector lever in "N" can result in transmission damage that is not covered by the Sprinter Warranty.

f The transmission automatically upshifts through 5th gear. Position "D" provides optimum driving characteristics under all normal operating conditions.

Gear Selection for Special Circumstances

The transmission gear ranges for special circumstances can be selected by pushing the gear selector lever to the right or the left with the gear selector lever in position "D".

The gear range currently selected is indicated in the instrument cluster display.

Briefly press gear selector lever in the **←** direction: The transmission downshifts, one gear range at a time, in the order "4", "3", "2", "1".

Press and hold gear selector lever in the **←** direction: The transmission will shift to a gear range which favorably accelerates or decelerates the vehicle. This way downshiftings can be caused.

Briefly press gear selector lever in the **→** direction: The transmission will shift from the current gear range to the next higher gear range. If the transmission is already in gear range "D", an additional upshift of one gear is not possible.

Press and hold gear selector lever in the **→** direction: The transmission will shift from the current gear range directly to gear range "D".

WARNING!

On slippery road surfaces, never downshift in order to slow the vehicle down. This could result in drive wheel slip and reduced vehicle control. Your vehicle's ABS will not prevent this type of loss of control.

NOTE: With transmission in gear range "D", "4" or "3", upshifting from 1st to 2nd to 3rd gear is delayed depending on vehicle speed and engine temperature. This allows the catalytic converter to heat up more quickly to operating temperatures.

During the brief warm-up period this delayed upshift and increased engine noise might be perceived as a malfunction. However, neither the engine nor

transmission are negatively affected by this mode of operation.

The delayed upshift is effective with vehicle speeds below 31 mph (50 km/h) at partial throttle and engine temperatures below 95 °F (+35 °C).

To avoid overrevving the engine when the gear selector lever is moved to a lower gear, the transmission will not shift to a lower gear if the engine's revolutions per minute limit would be exceeded. In this case there will be no downshift, even when the vehicle speed reaches the engine's rpm limit of that gear, for example by applying the service brakes.

To prevent the engine from laboring at low rpm when driving uphill grades or with your vehicle heavily loaded, the automatic transmission will downshift when necessary to maintain engine rpm within the best torque range.

Gear

- 4** Upshift through 4th gear only. Suitable for performance driving.
- 3** Upshift through 3rd gear only. Suitable for moderately steep hills. Since the transmission does not shift higher than 3rd gear, this gear selection will allow use of the engine's braking power downhill.
- 2** Upshift through 2nd gear only. For driving in mountainous regions or under extreme operating conditions. This gear selection will allow use of the engine's braking power when descending steep grades.
- 1** Use this position, which makes maximum use of the engine's braking effect, while descending very steep or lengthy downgrades and only at speeds below 25 mph (38 km/h).

TRANSMISSION SELECTOR LEVER, MANUALLY UNLOCKING



MZ-100 2014-20

In the case of power failure the transmission selector lever can be manually unlocked (for vehicle towing).

To do so, insert a pin (1) (ball point pen), into the covered opening below the position "D" of the shift pattern. While pushing the pin down, move selector lever from position "P".

After removal of the pin from the opening, the cover will not close fully. Only after moving the selector lever to positions "D+" and "D-" does the cover return to its closed position.

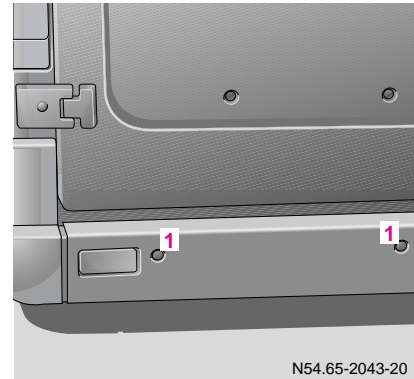

N54.65-2043-20

Reversing Aid (Optional)

Reversing aid sensors (1)

The reversing aid monitors the rear area of the vehicle by means of four sensors in the rear bumper.

The reversing aid automatically provides you with a visual and audible indication of the distance between your vehicle and an obstacle, when the key is in position 2 in the ignition lock and the reverse gear is engaged.

The system is operational if after reverse gear is engaged:

- an acknowledgement tone sounds
- the multi-function indicator shows the distance to an obstacle that has been detected.

WARNING!

The reversing aid is feature designed to provide assistance and may not detect all obstacles. The system is not a replacement for your own diligence.

The reversing aid does not detect people and/or objects within a range of approximately 12 in (30 cm). There is a possibility that certain objects which could come into contact with the vehicle at the rear will not be detected by the system's sensors. This could cause an accident resulting in severe personal injuries, death and property damage.

For this reason, you should make sure before maneuvering that no people or animals are in the maneuvering range of the vehicle.

Pay particular attention to people and/or objects above or below sensors when parking, such as small children, toddlers, flower pots or trailer towbars.

You are always responsible for safety at all times and must continue to pay attention to your immediate surroundings when manoeuvring. A second person should assist you in manoeuvring if necessary.

WARNING!

Ultrasonic sources, such as the compressed-air brakes of heavy trucks, a car wash or a pneumatic drill, and other parts attached to the vehicle, such as load carriers, could cause the reversing aid to malfunction.

The reversing aid sensors must not be scratched or damaged. They must be free from dirt, ice and slush, otherwise they might not function correctly.

The rear area sensors will be restricted in all of these cases. This will increase the risk of damage to the vehicle or the object and the risk of injury to other persons.

Clean the sensors regularly, taking care not to scratch or damage them.

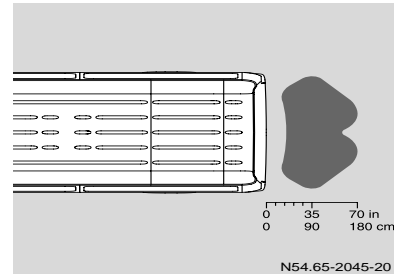
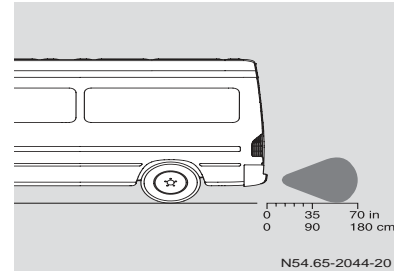
**Range of Sensors**

The sensors are able to detect a distance within a range of up to 70 in (180 cm) centrally or up to 40 in (100 cm) laterally behind the bumper.

For all sensors, the minimum distance between sensor and obstacle is 12 in (30 cm).

In the event of a malfunction, a continuous warning signal sounds for approximately three seconds when the vehicle is reversing

NOTE: Distance display

- "in" in USA only
- "cm" in Canada only

LOADING THE VEHICLE

WARNING!

Do not overload the tires by exceeding the specified vehicle capacity weight (as indicated by the label on the base of the driver's seat). Overloading the tires can overheat them, possibly causing a blowout, which could cause an accident and personal injury.

In addition, braking and stopping distances can be significantly longer if the vehicle is overloaded.

WARNING!

Always close the sliding and rear doors when driving.

Otherwise exhaust fumes could enter the vehicle interior and poison you.

WARNING!

Unsecured or poorly secured loads, and seats that have been removed, could move around the vehicle interior uncontrollably in the event of sudden braking, a rapid change in direction or an accident. This increases the risk of injury to occupants in these situations.

Secure and position a load as described in the following loading guidelines.

Piling up heavy objects or placing them on upper shelves or loading them otherwise high up in the vehicle will significantly raise the center of gravity of the vehicle. Placing excessive loads on individual points of the load surface or behind the rear axle will also adversely affect the handling characteristics of your vehicle and may lead to loss of control over the vehicle.

Road safety and tire durability are adversely affected if the permissible axle loads or gross vehicle weight are exceeded due to the vehicle's load. Braking and stopping distances can be significantly longer.

The handling characteristics of a vehicle when laden are dependent on the type of load and the distribution of the load within the vehicle.

Carrying heavy or bulky loads may alter the vehicle's handling characteristic.

Loading Guidelines

Please note and comply with the following information when loading and transporting goods.

- Do not allow the load, including passengers, to exceed the permitted gross vehicle weight or the permitted axle loads for the vehicle. Bear in mind that the unladen weight could be increased by installing items of optional equipment and accessories.
- Distribute the load uniformly. Excessive loads on individual points of the load surface could cause damage to the floor covering.
- Transport heavy loads between the axles near the rear axle as low as possible in the vehicle.
- Secure any kind of load with sufficient wear and tear-resistant load restraints. See tie-down rings.

- Protect sharp edges with padding.
- Check the tire pressures after loading the vehicle.

For passenger vans:

- Do not stack loads higher than the upper edge of the backrests.
- Always place the load against the backrests of the seat benches.
- Whenever possible, transport loads behind seats that are not occupied.
- Distribute the load in such a way that the permissible axle loads are not exceeded when the vehicle is equipped with the maximum number of seats. Loading the luggage compartment up to the maximum payload would cause the permissible rear axle load to be exceeded.

BRAKES

Service Brake

WARNING!

When the engine is not running, the brake and steering systems are without power assistance. Under these circumstances, a much greater effort is necessary to stop or steer the vehicle.

After driving in heavy rain for some time without applying the brakes or through water deep enough to wet brake components, the first braking action may be somewhat reduced and increased pedal pressure may be necessary. Be sure to maintain a safe distance from vehicles in front.

Resting your foot on the brake pedal will cause excessive and premature wear of the brake pads. It can also result in the brakes overheating, thereby significantly reducing their effectiveness. It may not be possible to stop the vehicle in sufficient time to avoid an accident.

NOTE: On long and steep downhill slopes, reduce the load on the brakes by shifting down a gear to utilize the braking effect of the engine.

To prevent corrosion on the brake pads, after driving on very wet roads, especially if road salts have been used, apply brakes before parking the vehicle. The heat generated will help to dry the brake disks.

Brake Pad Wear Indicator

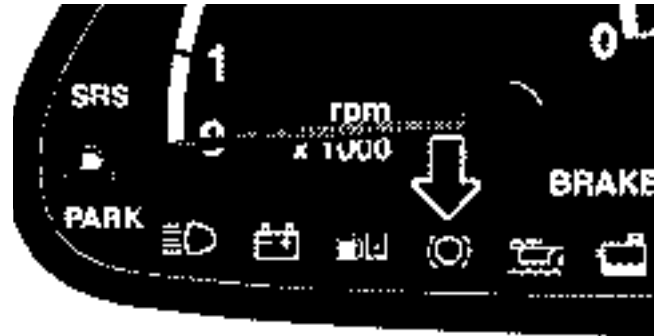

H54-30-3322-20

When the key is turned to position 2 in the ignition lock, the indicator lamp  in the instrument cluster lights up for about 2 seconds. It must go out when the engine is running.

If the  indicator lamp lights up while the engine is running, the brake pads are worn almost to their limit.

Have the brake system examined as soon as possible by an authorized Sprinter Dealer.

Brake Indicator and Electronic Brake Force Distribution (EBD) Indicator Lamp



H5A-70-8323-20

BRAKE USA only

(ⓘ) Canada only

With the key in position 2 in the ignition lock and the parking brake released, the indicator lamp **BRAKE** **(ⓘ)** lights up for about 2 seconds.

If the indicator lamp does not go out after about 2 seconds, the brake fluid level has sunk below the minimum filling capacity.

If the brake indicator lamp comes on while driving, the brake fluid level is below the minimum filling capacity or the electronic brake force distribution (EBD) is malfunctioning.

For information on the electronic brake force distribution, refer to "Electronic Brake Force Distribution (EBD)".

WARNING!

Driving with the brake indicator lamp **BRAKE** () illuminated can result in an accident. There may be a malfunction in the brake system or in the electronic brake force distribution. The braking characteristics are affected and the vehicle could skid if it is braked hard.

Have your brake system checked immediately if the brake indicator lamp **BRAKE** () stays on. Do not add brake fluid before checking the brake system. Overfilling the brake fluid reservoir can result in spilling brake fluid on hot engine parts and the brake fluid catching fire. There is a risk of injury due to hot engine parts or hot steam.

NOTE: If you find that the minimum mark on the brake fluid reservoir is reached, have the brake system checked for pad thickness and leaks.

Parking Brake Indicator Lamp

MS4-30-6J24-270

With the key in position 2 in the ignition lock and the parking brake released, the indicator lamp **PARK** lights up for about 2 seconds.

If the parking brake is on, the indicator lamp **PARK** does not go out before the parking brake is released.

Parking Brake

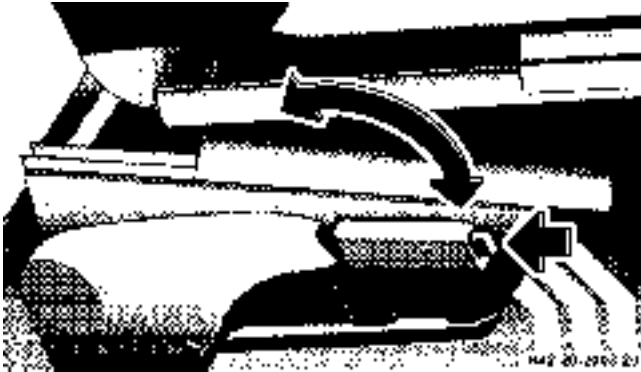

Only apply the parking brake when the vehicle is stationary.

To apply:

Pull the lever up as many notches as possible. When the key is in position 2 in the ignition lock, the parking brake indicator lamp **PARK** will light up in the instrument cluster.

To release:

Lift the lever up slightly, press the button on the lever in and move the lever down to the stop. The parking brake indicator lamp **PARK** should go out.

WARNING!

Always fully apply the parking brake when leaving your vehicle, or vehicle may roll and cause damage or injury.

On uphill or downhill grades steeper than 15% the vehicle must be safeguarded. Vehicles which are not secured could roll away and result in severe personal injuries, death and property damage.

Safeguard an unloaded vehicle by chocking the front axle.

Safeguard a loaded vehicle by chocking the rear axle.

WARNING!

When leaving the vehicle always remove the key from the ignition lock, and lock your vehicle.

Do not leave children unsupervised in the vehicle, even if they are secured by a child restraint system. The children could

- injure themselves on parts of the vehicle
- release the child-proof locks by pressing the central locking button and could thereby open the doors and
- cause injury to others as a result
- get out of the vehicle and could either injure themselves when doing so or they could be injured by the traffic approaching from the rear
- suffer serious or fatal effects in the event of long periods of hot weather
- release the parking brake. The vehicle could then start moving of its own accord.

Unsupervised use of vehicle equipment may cause severe personal injuries, death and property damage.

Driving Safety Systems

The vehicle can be equipped with the following Driving Safety Systems:

- Anti-lock brake system (ABS)
- Electronic brake force distribution (EBV)
- Acceleration skid control (ASR)
- Brake assist system (BAS)¹
- Electronic stability program (ESP[®])*

NOTE: The maximum effectiveness of ABS, EBV, ASR and ESP[®]* is only achieved if you drive with correct tire pressures and adjust tire pressures to correspond with the vehicle's load. In winter operation, the maximum effectiveness of the ABS and the ESP[®]* is only achieved with winter tires (M+S tires), or snow chains as required.

*Vehicle type 2500 only

WARNING!

The following factors increase the risk of accidents:

- Excessive speed, especially in turns
- Wet and slippery road surfaces
- Following another vehicle too closely

The ABS, EBV, ASR, BAS and ESP[®] cannot reduce this risk nor can they prevent the natural laws of physics from acting on the vehicle.

Always adapt your speed and driving style to the prevailing road, traffic and weather conditions and maintain a safe distance between your vehicle and other road users as well as objects on the road.

Anti-Lock Brake System (ABS) Indicator Lamp

When the key is in position 2 in the ignition lock, the ABS indicator lamp  will light up in the instrument cluster. It goes out after about 2 seconds.

If the ABS indicator lamp  remains on or lights up when the engine is running, the ABS is malfunctioning.

NOTE: If the voltage in the vehicle's electrical system drops below 10 volts, the ABS indicator lamp  will also light up in the instrument cluster and the ABS will be deactivated. The indicator lamp will go out as soon

as the voltage reaches this level again – the ABS is then reactivated.

If ABS malfunctions, the other driving safety systems are deactivated. The handling and braking characteristics of your vehicle change. The other braking and driving systems still function normally.

WARNING!

If the ABS indicator lamp  does not go out or lights up again while driving, the ABS is malfunctioning. If ABS malfunctions, the other driving safety systems are deactivated. The vehicle's braking characteristics may be affected. There is an increased risk that your vehicle could skid in the event of sharp braking. Have the malfunction traced and repaired without delay by an authorized Sprinter Dealer.

Adapt your speed and driving style to the prevailing road, traffic and weather conditions. Driving too fast increases the risk of an accident.

Anti-Lock Brake System (ABS)

ABS prevents the wheels from locking at any speed above about 5 mph (8 km/h), regardless of road surface conditions. The vehicle remains steerable even if the brakes are applied fully.

A light vibrating of the steering wheel and pulsating of the brake pedal indicate that the ABS is working.

On slippery road surfaces, the ABS will respond even with light brake pedal pressure because of the increased likelihood of locking wheels. The pulsating brake pedal can be an indication of hazardous road conditions and works as a reminder to take extra care while driving.

WARNING!

Do not reduce the force applied to the brake pedal if it is necessary to brake the vehicle further. This will negate the main benefit of ABS – the ability to brake without affecting the steerability of the vehicle.

In the event of an emergency stop, fully depress the brake pedal. Do not pump the brake pedal, rather use firm, steady brake pedal pressure. Pumping the pedal defeats the purpose of ABS and significantly reduces braking effectiveness.

WARNING!

Anti-lock brake system (ABS) cannot prevent the natural laws of physics from acting on the vehicle, nor can it increase braking or steering efficiency beyond that afforded by the condition of the vehicle brakes and tires or the traction afforded.

The ABS cannot prevent accidents, including those resulting from excessive speed in turns, following another vehicle too closely, or hydroplaning. Only a safe, attentive, and skillful driver can prevent accidents.

The capabilities of an ABS equipped vehicle must never be exploited in a reckless or dangerous manner which could jeopardize the user's safety or the safety of others.

Adapt your speed and driving style to the prevailing road, traffic and weather conditions. Driving too fast increases the risk of an accident.

Electronic Brake Force Distribution (EBD)

The electronic brake force distribution (EBD) prevents the rear wheels from being overbraked when there is little load on the rear axle or if there is not much friction between the tires and road (e.g., if the road is wet).

WARNING!

If the brake indicator lamp **BRAKE** () does not go out or lights up again while driving, the brake fluid level may not necessarily have dropped below the minimum filling capacity but a malfunction may have occurred in the EBD. In this case continue driving, but with even greater care.

The wheels of the rear axle could lock if the vehicle is braked hard. This could lead to a skidding of the vehicle. Have the malfunction traced and repaired without delay by an authorized Sprinter Dealer.

Adapt your speed and driving style to the prevailing road, traffic and weather conditions. Driving too fast increases the risk of an accident.

Acceleration Skid Control Indicator Lamp (ASR) and Brake Assist System (BAS)¹ if equipped



124-18-5253-20

When the key is in position 2 in the ignition lock, the indicator lamp  will light up in the instrument cluster as a function check. It goes out when the engine is running.

¹Vehicle type 2500 only

If the indicator lamp  remains on or lights up when the engine is running, the acceleration skid control (ASR) or the brake assist system (BAS)¹ is malfunctioning.

Then the ASR will be switched off automatically.

NOTE: If the ABS is malfunctioning or the voltage in the vehicle's electrical system drops below 10 volts, the indicator lamp  will also light up in the instrument cluster and the ASR and the BAS¹ will be deactivated. The indicator lamp will go out as soon as the voltage reaches this level again or the ABS is operational again – the ASR and the BAS¹ are then reactivated.

If a malfunction is present in the acceleration skid control (ASR), the engine's power output may be reduced.

WARNING!

If the indicator lamp  remains on, the acceleration skid control (ASR) or the brake assist system (BAS)¹ is malfunctioning.

Your vehicle's handling characteristics can change. Drive with extra caution.

Have the malfunction traced and repaired as soon as possible by an authorized Sprinter Dealer.

¹Vehicle type 2500 only

Acceleration Skid Control (ASR) Warning Lamp and Electronic Stability Program (ESP®)* – if equipped



When the key is in position 2 in the ignition lock, the warning lamp  in the speedometer will light up for about 2 seconds. It must go out when the engine is running.

The warning lamp  flashes when:

- The ASR or ESP®* is activated.
- The drive wheels spin with the ASR shut off.

*Vehicle type 2500 only

The warning lamp  lights up when the ASR is shut off.

Deactivate the acceleration skid control, refer to "Deactivating Acceleration Skid Control (ASR)".

WARNING!

If the warning lamp  in the speedometer lights up or flashes:

- Do not deactivate the acceleration skid control (ASR).
- Only depress the accelerator pedal as far as necessary when pulling away.
- Ease off on the accelerator pedal when driving at a steady speed.
- Adapt your speed and driving style to the prevailing road, traffic and weather conditions.

Failure to heed these warnings could cause the vehicle to enter a skid and may result in an accident.

Acceleration Skid Control (ASR)

ASR makes it possible to pull away and accelerate on a slippery surface. A spinning wheel is braked and its tractive power is transferred to the wheel with full grip.

The acceleration skid control (ASR) improves driving stability at all speeds only on vehicles of the chassis and cargo/passenger vans type 3500 C/HC/SHC (without ESP®).

The engine's torque is limited to improve driving stability. When this is happening, the warning lamp  in the speedometer flashes.

If the road surface is not capable of providing traction, bearing in mind the tires, load and grade, it may not be possible to pull away even with ASR.

If wheels with tires of a different size than those offered by an authorized Sprinter Dealer are used, the correct operation of the ASR cannot be guaranteed.

WARNING!

ASR cannot prevent the natural laws of physics from acting on the vehicle, nor can it increase the traction afforded.

The ASR cannot prevent accidents, including those resulting from excessive speed in turns, following another vehicle too closely, or hydroplaning. Only a safe, attentive, and skillful driver can prevent accidents.

The capabilities of an ASR equipped vehicle must never be exploited in a reckless or dangerous manner which could jeopardize the user's safety or the safety of others.

If the ASR function is used for a prolonged period of time, the rear axle brakes may fail due to overheating.

If the vehicle is to be towed away with the front wheels clear of the ground, or if the brakes are to be tested on a brake dynamometer, do not pull the key in position 2 in the ignition lock, because the drive wheels could lock.

Deactivating the Acceleration Skid Control (ASR)

See Section 4, Understanding Your Instrument Panel, for switch locations.



When driving with snow chains, in deep snow, or on sand or gravel, it can be beneficial to deactivate the acceleration skid control (ASR).

The engine's torque is then no longer limited and the drive wheels are free to spin, which can help them cut into loose surfaces.

The ASR can only be shut off with the engine running.

If the engine is shut off with the ASR deactivated, the ASR is automatically re-activated after the engine is started again.

WARNING!

On a slippery road surface if both drive wheels start to spin there is a risk of skidding. Adapt your speed and driving style to the prevailing road, traffic and weather conditions.

Vehicle Type 2500 only:

If there is a danger of skidding, and/or starting at a speed of 38 mph (60 km/h) ESP[®] activates ASR automatically.

WARNING!

Vehicle type 2500 only:

Even when ASR is deactivated, ESP[®] remains active and regulates braking to improve stability as necessary. The warning lamp  flashes in the speedometer.

The danger of your vehicle's brake system overheating and being damaged is increased during long, demanding application of the brakes. Furthermore, an overheated brake system could result in a longer stopping distance.

Thus, only deactivate ASR if it is absolutely necessary.

To deactivate the ASR:

- Press the upper section of the switch – the warning lamp  in the speedometer lights up.

Traction control continues to cut in if, for example, a wheel on one side of the vehicle reaches its limit of adhesion. The wheel is then braked to increase the vehicle's overall traction.

The warning lamp  will flash in the speedometer at any speed when a tire reaches its limit of adhesion and spins.

To activate the ASR:

- Press the upper section of the switch again – the warning lamp  in the speedometer goes out.

Brake Assist System (BAS) (vehicle type 2500 only)

The Brake Assist System (BAS) operates in emergency situations. If you apply the brakes very quickly, the BAS automatically provides full brake boost, thereby potentially reducing braking distance.

Apply continuous full braking pressure until the emergency braking situation is over.

The ABS will prevent the wheels from locking.

When you release the brake pedal, the brakes function again as normal. The BAS is then deactivated.

WARNING!

If the indicator lamp  remains on, a malfunction may not only have occurred in the ASR system but also in the BAS.

The handling and braking characteristics of your vehicle change. Drive with extra caution.

Have the malfunction traced and repaired as soon as possible by an authorized Sprinter Dealer.

For the indicator lamp  refer to "Indicator Lamp Acceleration Skid Control (ASR) and Brake Assist System (BAS)".

WARNING!

The Brake Assist system (BAS) cannot prevent the natural laws of physics from acting on the vehicle, nor can it increase braking efficiency beyond that afforded by the condition of the vehicle brakes and tires or the traction afforded.

The BAS cannot prevent accidents, including those resulting from excessive speed in turns, following another vehicle too closely, or hydroplaning. Only a safe, attentive, and skillful driver can prevent accidents.

The capabilities of an BAS equipped vehicle must never be exploited in a reckless or dangerous manner which could jeopardize the user's safety or the safety of others.

Adapt your speed and driving style to the prevailing road, traffic and weather conditions. Driving too fast increases the risk of an accident.

Indicator Lamp Electronic Stability Program (ESP®) (vehicle type 2500 only)



MSM-3B-632 23

When the key is in position 2 in the ignition lock, the ESP® indicator lamp  will light up in the instrument cluster as a function check. It goes out when the engine is running.

If the indicator lamp  remains on or lights up when the engine is running, the electronic stability program (ESP®) is malfunctioning and switched off automatically. The engine's power output may be then reduced.

NOTE: If the ABS is malfunctioning or the voltage in the vehicle's electrical system drops below 10 volts, the indicator lamp  will also light up in the instrument cluster and the ESP[®] will be deactivated. The indicator lamp will go out as soon as the voltage reaches this level again or the ABS is operational again – the ESP[®] is then reactivated.

WARNING!

If the ESP[®] indicator lamp  remains on, the electronic stability program (ESP[®]) is malfunctioning. The vehicle stability will no longer be automatically regulated in good time.

The danger that your vehicle breaks into a skid, is increased in certain driving situations. Drive with extra caution.

Have the ESP[®] repaired as soon as possible by an authorized Spinter Dealer.

Electronic Stability Program (ESP[®]) (vehicle type 2500 only)

The Electronic Stability Program (ESP[®]) monitors the vehicle's traction (force of adhesive friction between the tires and the road surface) and handling.

The ESP[®] recognizes when a wheel is spinning or if the vehicle starts to skid. By applying brakes to the appropriate wheel and by limiting engine output, the ESP[®] works to stabilize the vehicle. The ESP[®] is especially useful while driving off and on wet or slippery road surfaces.

The warning lamp  in the speedometer flashes when the ESP[®] is engaged, refer also to "Warning Lamp Acceleration Skid Control (ASR) and Electronic Stability Program (ESP[®])".

If wheels with tires of a different size than those offered by an authorized Sprinter Dealer are used, the correct operation of the ESP[®] cannot be guaranteed.

WARNING!

ESP[®] cannot prevent the natural laws of physics from acting on the vehicle, nor can it increase the traction afforded.

The ESP[®] cannot prevent accidents, including those resulting from excessive speed in turns, following another vehicle too closely, or hydroplaning. Only a safe, attentive, and skillful driver can prevent accidents.

The capabilities of an ESP[®] equipped vehicle must never be exploited in a reckless or dangerous manner which could jeopardize the user's safety or the safety of others.

If the vehicle is to be towed away with the front wheels clear of the ground, or if the brakes are to be tested on a brake dynamometer, do not put the key in position 2 in the ignition lock because the ESP[®] would engage the brakes to stabilize the vehicle.

If the ESP[®] function is used for a prolonged period of time, the rear axle brakes may fail due to overheating.

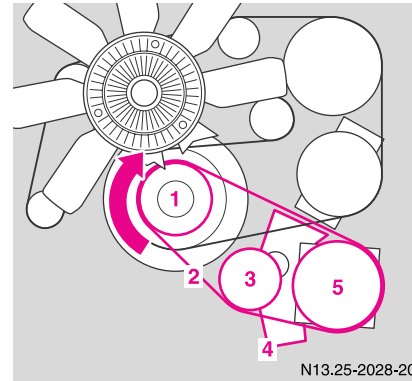
AUXILIARY DRIVE (OPTIONAL)

Auxiliary drive (1)

Ribbed V-belt (not part of factory package) (2)

Tensioner pulley (3)

Support (4)

Unit (not part of factory package) (5)

NOTE: When retrofitting a unit pay attention to the running direction of the engine.

CAUTION!

Power take off must not exceed 10 kW. Exceeding the power take off may cause damage to the auxiliary drive and/or ribbed V-belt.

STEERING

When the engine is not running, there is no power assistance for the steering. Greater force will be required to steer the vehicle.

WHEELS AND TIRES

The tires on a new vehicle provide a balance of many characteristics. They should be inspected regularly for wear and correct cold tire inflation pressure. The vehicle manufacturer strongly recommends to use tires equivalent to the originals in size, quality and performance when replacement is needed. Refer to the Tire and Loading Information placard on the driver's door B-pillar for the size designation of your tire.

The service description and load identification will be found on the original equipment tire. Failure to use equivalent replacement tires may adversely affect the safety, handling, and ride of your Sprinter vehicle.

Contact an authorized Sprinter Dealer or an authorized tire dealer with any questions you may have on tire specifications or capability.

WARNING!

Only use tires which have been tested and approved for your Sprinter vehicle by the vehicle manufacturer. Tires approved by the vehicle manufacturer are developed to provide best possible performance in conjunction with the driving safety systems on your Sprinter vehicle such as ABS or ESP[®].

Using tires other than those approved by the vehicle manufacturer may result in damage that is not covered by Warranty.

WARNING!

Using tires other than those approved by the vehicle manufacturer can have detrimental effects, such as

- poor handling characteristics
- increased noise
- increased fuel consumption

Moreover, tires and rims not approved by the vehicle manufacturer may, under load, exhibit dimensional variations and different tire deformation characteristics that could cause them to come into contact with the vehicle body or axle parts. Damage to the tires or the vehicle may be the result.

For more information on tire size designation, load and speed rating, refer to "Tire Labeling". See an authorized Sprinter Dealer for information on tested and recommended rims and tires for summer and winter operation. They can also offer advice concerning tire service and purchase.

WARNING!

Do not use a tire, wheel size or rating other than that specified for your Sprinter vehicle. Some combinations of unapproved tires and wheels may change suspension dimensions and performance characteristics, resulting in changes to steering, handling, and braking of your Sprinter vehicle. This can cause unpredictable handling and stress to steering and suspension components. You could lose control and have an accident resulting in serious injury or death. Use only the tire and wheel sizes with load ratings approved for your Sprinter vehicle, refer to "Tire and Loading Information". Never use a tire with a smaller load index or speed index or capacity, other than what was originally equipped on your Sprinter vehicle. Using a tire with a smaller load index could result in tire overloading and failure. You could lose control and have an accident.

Failure to equip the vehicle with tires having adequate speed capability can result in sudden tire failure and loss of vehicle control.

WARNING!

Replace rims or tires with the same designation, manufacturer and type as shown on the original part. See an authorized Sprinter Dealer for further information. If incorrectly sized rims and tires are mounted:

- The wheel brakes or suspension components can be damaged.
- The operating clearance of the wheels and the tires may no longer be correct.

WARNING!

Sprinter tire valves are tested and approved under rough operating conditions.

The installation of additional hub caps or other wheel simulators could cause damage to the tire valve and lead to a loss of tire pressure at the valve stem.

Do not install any of these parts on your Sprinter vehicle. To help ensure safe and reliable operation of your Sprinter vehicle, only use parts and accessories tested and approved by the vehicle manufacturer for your Sprinter vehicle.

WARNING!

Replacing original tires with tires of a different size may result in false speedometer and odometer readings.

WARNING!

Worn, old tires can cause accidents. If the tire tread is badly worn, or if the tires have sustained damage, replace them.

When replacing rims, only use genuine wheel bolts approved from the vehicle manufacturer and specified for the particular rim type. Failure to do so can result in the bolts loosening and possibly an accident.

Do not use retreaded/remolded tires. This process does not always permit previous damage to be detected. Therefore vehicle safety cannot be guaranteed if retreaded/remolded tires are fitted.

Use only wheels and tires which have been tested and approved by the vehicle manufacturer.

WARNING!

Fitting other wheel sizes to the vehicle will change the vehicle's handling characteristics and may lead to an accident resulting in death, severe personal injuries and property damage.

Only certain tires meeting the tire size/load/speed rating specifications are certified to conform to FMVSS 110 for the Sprinter vehicle at this time. Please check your side walls of your originally equipped tires for specific makes/sizes, and speed load ratings when you need to replace your tires. To prevent accidents resulting in possible death, severe injury or property damage, use only the tire and wheel sizes with load ratings approved for your Sprinter vehicle for your tire replacement.

Refer to "Tire and Loading Information"

Radial-Ply Tires**WARNING!**

Combining radial ply tires with other types of tires on your Sprinter vehicle will cause your vehicle to handle poorly. The instability could cause an accident.

Always use radial ply tires in sets of 4 (or 6, in case of vehicles with dual rear wheels).

Never combine them with other types of tires.

Cuts and punctures in radial tires are repairable only in the tread area because of sidewall flexing. Consult an authorized tire dealer for radial tire repairs.

Important Guidelines

- Only use sets of tires and rims of the same type and make.
- Tires must be of the correct size for the rim.
- Break in new tires for approximately 65 miles (100 km) at moderate speeds.

- Regularly check the tires and rims for damage. Dented or bent rims can cause tire inflation pressure loss and damage to the tire beads.
- If vehicle is heavily loaded, check tire inflation pressure and correct as required.
- Do not allow your tires to wear down too far. Adhesion properties on wet roads are sharply reduced at tread depths under 1/8 in (3 mm) for summer tires and 1/6 in (4 mm) for winter tires.
- When replacing individual tires, you should mount new tires on the front wheels first.

Tire Care and Maintenance

WARNING!

Regularly check the tires for damage. Damaged tires can cause tire inflation pressure loss. As a result, you could lose control of your Sprinter vehicle.

Worn, old tires can cause accidents. If the tire tread is badly worn, or if the tires have sustained damage, replace them.

The tire inflation pressure should be checked regularly, i.e. at least each time you refuel the vehicle. The preferred interval for checking the tire inflation pressure, however, is before each trip.

For more information on checking tire inflation pressure, refer to "Recommended Tire Inflation Pressure".

Tire Inspection

Every time when checking the tire inflation pressure, the tires should also be inspected for the following:

- excessive treadwear, refer to "Tread Depth"
- cord or fabric showing through the tire's rubber
- bumps, bulges, cuts, cracks or splits in the tread or side of the tire

Replace the tire if any of the above conditions is found.

Also inspect the spare tire periodically for condition and inflation. Spare tires will age and become worn over time even if never used, and thus should be inspected and replaced when necessary.

Life of Tire

The service life of a tire is dependent upon varying factors including but not limited to:

- driving style
- tire inflation pressure
- distance driven

WARNING!

Tires and spare tire should be replaced after 6 years, regardless of the remaining tread.

Tread Depth



Tread Wear Indicator (TWI) (1)

The treadwear indicator appears as a solid band across the tread.

Do not allow tires to wear down too far. Adhesion properties on wet roads are sharply reduced at tread depths under 1/8 in (3 mm) for summer tires and 1/6 in (4 mm) for winter tires.

Treadwear indicators (TWI) are required by law. These indicators are located in six places on the tread circumference and become visible at a tread depth of approximately 1/16 in (1.6 mm), at which point the tire is considered worn and should be replaced.

Recommended minimum tire tread depth:

- Summer tires 1/8 in (3 mm)
- Winter tires 1/6 in (4 mm)

WARNING!

Although the applicable federal motor vehicle safety laws consider a tire to be worn when the treadwear indicators (TWI) become visible at approximately 1/16 in (1.6 mm), do not allow your tires to wear down to that level. As tread depth approaches 1/8 in (3 mm) for summer tires or 1/6 in (4 mm) for winter tires, the adhesion properties on a wet road are sharply reduced.

Depending upon the weather and/or road surface conditions, the tire traction varies widely.

Storing Tires

WARNING!

Keep unmounted tires in a cool, dry place with as little exposure to light as possible. Protect tires from contact with oil, grease and diesel fuel.

Cleaning Tires

WARNING!

Never use a round nozzle to power wash tires. The intense jet of water can result in damage to the tire.

Always replace a damaged tire.

Direction of Rotation

An arrow on the sidewall indicates the intended direction of rotation (spinning) of the tire which means, the wheel must mounted in the direction of rotation.

If a tire does not have an arrow on the sidewall indicating the direction of rotation, the wheel can be mounted either way.

NOTE: The Tire Identification Number (TIN) must always be visible on the outboard side of the tire.

WARNING!

Spare wheels may be mounted against the direction of rotation (spinning) even with a unidirectional tire for temporary use only until the regular drive wheel has been repaired or replaced.

Always observe and follow applicable temporary use restrictions and speed limitations indicated on the spare wheel.

Have a spare wheel that was mounted against the direction of rotation replaced with a regular road wheel as soon as possible.

WARNING!

If you feel a sudden significant vibration or ride disturbance, or you suspect that possible damage to your vehicle has occurred, you should turn on the hazard warning flashers, carefully slow down, and drive with caution to an area which is a safe distance from the road.

Inspect the tires and the vehicle underbody for possible damage. If the vehicle or tires appear unsafe, have the vehicle towed to the nearest authorized Sprinter dealer or tire dealer for repairs.

Treadwear indicators (TWI) are required by law. These indicators are located in six places on the tread circumference and become visible at a tread depth of approximately 1/16 in (1.6 mm), at which point the tire is considered worn and should be replaced.

The treadwear indicator appears as a solid band across the tread.

WARNING!

Although the applicable federal motor vehicle safety laws consider a tire to be worn when the treadwear indicators (TWI) become visible at approximately 1/16 in (1.6 mm), do not allow your tires to wear down to that level. As tread depth approaches 1/8 in (3 mm) for summer tires or 1/6 in (4 mm) for winter tires, the adhesion properties on a wet road are sharply reduced.

Depending upon the weather and/or road surface (conditions), the tire traction varies widely.

Specified tire inflation pressures must be maintained. This applies particularly if the tires are subjected to high loads (e.g. high speeds, heavy loads, high ambient temperatures).

WARNING!

Do not drive with a flat tire. A flat tire affects the ability to steer or brake the vehicle. You may lose control of the vehicle. Continued driving with a flat tire or driving at high speed with a flat tire will cause excessive heat build-up and possibly a fire.

WARNING!

Even when permitted by law, never operate a vehicle at speeds greater than the maximum speed rating of the tires.

Exceeding the maximum speed for which tires are rated can lead to sudden tire failure, causing loss of vehicle control and possibly resulting in an accident and/or serious injury and possible death, for you and for others.

Vehicles type 2500 C/HC/SHC

The vehicles are factory equipped with "L" or "N"-rated tires, which have a speed rating of 74 mph (120 km/h) or 87 mph (140 km/h) respectively.

Vehicles type 3500 C/HC/SHC

The vehicles are factory equipped with "L", "N" or "R"-rated tires, which have a speed rating of 74 mph (120 km/h), 87 mph (140 km/h) or 106 mph (170 km/h) respectively.

Tire Grip

Tire grip is greatly reduced on a wet, snow covered or icy road. Speed and driving style must therefore be adapted to suit road conditions. The safe speed on a wet, snow covered or icy road is always lower than on a dry road.

Below a tread depth of 1/8 in (3 mm), tire grip begins to decrease rapidly on wet roads.

Pay particular attention to the condition of the road whenever the outside temperatures are close to the freezing point.

Hydroplaning

Depending on the depth of the water layer on the road, hydroplaning may occur, even at low speeds and with new tires. Reduce vehicle speed, avoid track grooves in the road, and apply brakes cautiously in the rain.

WARNING!

If ice has formed on the road, tire traction will be substantially reduced. Under such weather conditions, drive, steer and brake with extreme caution.

5

In winter, install M+S radial tires with a minimum tread depth of approximately 1/6 in (4 mm) on all wheels to ensure normal balanced handling characteristics. On packed snow, they can reduce your stopping distance compared to summer tires.

Stopping distance, however, is still considerably greater than when the road is not covered with snow or ice. Exercise appropriate caution.

For information on winter tires, refer to "Winter Operation".

WARNING!

Avoid spinning of one drive wheel. This may cause serious damage to the drivetrain which is not covered by the Warranty.

Recommended Tire Inflation Pressure**WARNING!**

Follow recommended tire inflation pressures.

Do not underinflate tires. Underinflated tires wear excessively and/or unevenly, adversely affect handling and fuel economy, and are more likely to fail from being overheated.

Do not overinflate tires. Overinflated tires can adversely affect handling and ride comfort, wear unevenly, increase stopping distance, and result in sudden deflation (blowout) because they are more likely to become punctured or damaged by road debris, potholes etc.

The tire inflation pressure (including the spare wheel) should be checked regularly and adjusted as well as

inspecting for signs of tire wear or visible damage. Use a good quality pocket-type gauge to check tire inflation pressure.

Do not make a visual judgement when determining proper inflation. Radial tires may look properly inflated even when they are underinflated.

The tire inflation pressure should be checked regularly, i.e. at least each time you refuel the vehicle, and should only be adjusted on cold tires. The preferred interval for checking the tire inflation pressure, however, is before each trip.

The tires can be considered cold if the vehicle has been parked for at least 3 hours or driven less than 1 mile (1.6 km) at an ambient temperature of approximately 68 °F (20 °C).

Follow recommended cold tire inflation pressures listed on Tire and Loading Information placard on the driver's door B-pillar.

Keeping the tires properly inflated provides the best handling, tread life and riding comfort.

The pressure difference between the tires on a single axle should not exceed 1.5 psi (10 kPa).

For more information, refer to "Important Notes on Tire Inflation Pressure".



1 Recommended cold tire inflation pressures

NOTE: Data shown on placard are for illustration purposes only. Tire data are specific to each vehicle and may vary from data shown in the illustration.

Refer to placard on vehicle for actual data specific to your vehicle.

The Tire and Loading Information placard on the driver's door B-pillar lists the recommended cold tire inflation pressures for all load conditions up to the maximum permissible weight limits (GAWR). The tire inflation pressures listed apply to the tires installed as original equipment.

Important Notes on Tire Inflation Pressure

WARNING!

If the tire inflation pressure drops repeatedly:

- Check the tires for punctures from foreign objects.
- Check to see whether air is leaking from the valves or from around the rim.

Tire temperature and tire inflation pressure are also increased while driving, depending on the driving speed and the tire load.

Tire inflation pressure changes by approximately 1.5 psi (10 kPa) per 18 °F (10 °C) of air temperature change.

Keep this in mind when checking tire inflation pressure where the temperature is different from the outside temperature.

For example:

If inside temperature is 68 °F (20 °C) and the outside temperature is 32 °F (0 °C) then the cold tire inflation pressure should be increased by 3 psi (0.2 bar), which equals 1.5 psi (0.1 bar) for every 18 °F (10 °C) for this outside temperature condition.

Check tire pressures more often if subject to a wide range of outdoor temperatures, as tire pressures vary with temperature changes.

WARNING!

Tire pressure may increase during operation.

Never reduce this normal pressure build up or your tire pressure will be too low.

Underinflated tires wear excessively and/or unevenly, adversely affect handling and fuel economy, and are more likely to fail from being overheated.

Checking Tire Inflation Pressure

The tire inflation pressure should be checked regularly, i.e. at least each time you refuel the vehicle. The preferred interval for checking the tire inflation pressure, however, is before each trip.

Inflation pressures specified on the Tire and Loading Information placard on the driver's door B-pillar are always cold tire inflation pressures. Check and adjust the tire inflation pressure when the tires are cold. Cold tire inflation pressure is defined as the tire pressure after the vehicle has been parked for at least 3 hours or driven less than 1 mile (1.6 km) at an ambient temperature of approximately 68 °F (20 °C).

The cold tire inflation pressure must not exceed the maximum tire inflation pressure molded into the tire side wall, refer to "Tire Labeling".

If you check the tire inflation pressure when the tires are warm (the vehicle has been driven for several miles or sitting less than 3 hours), the reading will be higher than the cold reading. This is normal. Do not let air out to match the specified cold tire inflation pressure. Otherwise, the tire will be underinflated.

WARNING!

Follow recommended tire inflation pressures.

Do not underinflate tires. Underinflated tires wear excessively and/or unevenly, adversely affect handling and fuel economy, and are more likely to fail from being overheated.

Do not overinflate tires. Overinflated tires can adversely affect handling and ride comfort, wear unevenly, increase stopping distance, and result in sudden deflation (blowout) because they are more likely to become punctured or damaged by road debris, potholes etc.

Do not overload the tires by exceeding the specified load limit as indicated on the Tire and Loading Information placard on the driver's door B-pillar. Overloading the tires can overheat them, possibly causing a blowout.

Follow the steps below to achieve correct tire inflation pressure:

- Remove the cap from the valve on one tire.

- Firmly press a tire gauge onto the valve.
- Read tire inflation pressure on tire gauge and check against the recommended tire inflation pressure on the Tire and Loading Information placard on the driver's door B-pillar. If necessary, add air to achieve the recommended tire inflation pressure.

NOTE: If you have overfilled the tire, release tire inflation pressure by pushing the metal stem of the valve with e.g. a tip of a pen. Then recheck the tire inflation pressure with the tire gauge.

- Install the valve cap.

WARNING!

After inspecting or adjusting the tire inflation pressure always reinstall the valve cap if equipped.

This will prevent moisture and dirt from entering the valve stem, which could damage the valve stem.

- Repeat this procedure for each tire.

Potential Problems associated with Underinflated and Overinflated Tires

Proper tire inflation pressure is essential to the safe and satisfactory operation of your vehicle. Three primary areas are affected by improper tire inflation pressure:

1. Safety

WARNING!

Improperly inflated tires are dangerous and can cause accidents.

- **Underinflation increases tire flexing and can result in tire failure.**
- **Overinflation reduces a tire's ability to cushion shock. Objects on the road and chuck holes can cause damage that results in tire failure.**
- **Unequal tire inflation pressures can cause steering problems. You could lose control of your vehicle.**
- **Overinflated or underinflated tires can affect vehicle handling and can fail suddenly, resulting in loss of vehicle control.**
- **Unequal tire pressures from one side of the vehicle to the other can cause the vehicle to drift to the right or left. Always drive with each tire inflated to the recommended cold tire inflation pressure.**

2. Economy

Improper inflation pressures can cause uneven wear patterns to develop across the tire tread. These abnormal wear patterns will reduce tread life resulting in a need for earlier tire replacement. Underinflation also increases tire rolling resistance and results in higher fuel consumption.

3. Ride Comfort and Vehicle Stability

Proper tire inflation contributes to a comfortable ride. Overinflation produces a jarring and uncomfortable ride.

Tire Labeling



Besides tire name (sales designation) and manufacturer name, a number of markings can be found on a tire.

NOTE: Data shown on tire are for illustration purposes only. Actual data on tires are specific to each vehicle and may vary from data shown in the illustration.

- (1) DOT, Tire Identification Number (TIN)
- (2) Maximum tire load

- (3) Maximum tire inflation pressure
- (4) Manufacturer
- (5) Tireplymaterial
- (6) Tire size designation, load and speed rating
- (7) Tire name

Tire Size Designation, Load and Speed Rating



- (1) Design standard
- (2) Tire width
- (3) Aspect ratio in %
- (4) Radial tire code
- (5) Rim diameter
- (6) Tire load rating
- (7) Tire speed rating

NOTE: Data shown on tires are for illustration purposes only. Actual data on tires are specific to each vehicle and may vary from data shown in the illustration.

Tire Sizes for Sprinter Vehicles

Sprinter type	
2500 C/HC/SHC	3500 C/HC/SHC
225/70 R 15 C 112/110 R (115 N)	195/70 R 15 C 104/102 R
LT 225/75 R 16 115/112 N	LT 225/75 R 16 115/112 N
LT 225/75 R 16 115/112 L ¹	LT 225/75 R 16 115/112 L ¹

1. Vehicles with programmed top speed limit of 68 mph (109 km/h) only.

Design Standard

Depending on the design standards used, the tire size molded into the sidewall may have no letter or a letter (1) preceding the tire width or the tire load rating designation.

Letter "LT" preceding the tire width designation:
Light Truck tire based on U.S. design standards.

Letter "C" preceding the tire load rating designation:
Commercial vehicle tire based on European design standards.

Tire Width

The tire width (2) indicates the nominal tire width in mm.

Aspect Ratio

The aspect ratio (3) is the dimensional relationship between tire section height and section width and is expressed in percentage. The aspect ratio is arrived at by dividing section height by section width.

Tire Code

The tire code (4) indicates the tire construction type. The "R" stands for radial tire type. Letter "D" means diagonal or bias ply construction; letter "B" means belted-bias ply construction.

Rim Diameter

The rim diameter (5) is the diameter of the bead seat, not the diameter of the rim edge. Rim diameter is indicated in inches (in).

Tire Load Rating

The tire load rating (6) is a numerical code associated with the maximum load a tire can support.

For example, a load rating of 115 corresponds to a maximum load of 2680 lbs (1215 kg) the tire is designed to support.

If two values are given (as illustrated), the first value, preceding the slash "/", applies to single tires (rear axle).

The second value, succeeding the slash "/", applies to twin tires (dual wheel rear axle).

The commercial vehicle tires based on European standards may have an additional value in the parentheses (as illustrated). In such case, the value preceding the parentheses is valid for European countries and the parenthesized for the USA and Canada.

Refer also to "Maximum Tire Load" where the maximum load associated with the load index is indicated in kilograms and lbs.

WARNING!

The tire load rating must always be at least half of the GAWR of your vehicle. Otherwise, tire failure may be the result which may cause an accident and/or serious personal injury to you or others.

For information on GAWR, refer to "Tire and Loading Terminology".

Always replace rims and tires with the same designation, manufacturer and type as shown on the original part.

WARNING!

Do not overload the tires by exceeding the specified load limit as indicated on the Tire and Loading Information placard on the driver's door B-pillar.

Overloading the tires can overheat them, possibly causing a blowout.

Overloading the tires can also result in handling or steering problems, or brake failure.

NOTE: Tire load rating (6) and tire speed rating (7) are also referred to as "service description".

Tire Speed Rating

The tire speed rating (7) indicates the approved maximum speed for the tire.

The commercial vehicle tires based on European standards may have an additional index in the parentheses (as illustrated). In such case, the index preceding the parentheses is valid for European countries and the parenthesized for the USA and Canada.

WARNING!

Even when permitted by law, never operate a vehicle at speeds greater than the maximum speed rating of the tires.

Exceeding the maximum speed for which tires are rated can lead to sudden tire failure, causing loss of vehicle control and possibly resulting in an accident and/or personal injury and possible death, for you and for others.

NOTE: Always observe the speed rating of the winter tires installed on your Sprinter vehicle. If the maximum speed for which your tires are rated is below

the speed rating of your Sprinter vehicle, you must place a notice to this effect where it will be seen by the driver.

Such notices are available at your tire dealer or any authorized Sprinter Dealer.

Index	Speed Rating
F	up to 50 mph (80 km/h)
G	up to 56 mph (90 km/h)
J	up to 62 mph (100 km/h)
K	up to 68 mph (110 km/h)
L	up to 74 mph (120 km/h)
M	up to 80 mph (130 km/h)
N	up to 87 mph (140 km/h)
P	up to 93 mph (150 km/h)
Q	up to 100 mph (160 km/h)
R	up to 106 mph (170 km/h)

NOTE: Tire load rating (6) and tire speed rating (7) are also referred to as "service description".

DOT, Tire Identification Number (TIN)



- (1) DOT
- (2) Manufacturer's identification mark
- (3) Tire size
- (4) Tire type code (at the option of the tire manufacturer)
- (5) Date of manufacture

NOTE: Data shown on tire are for illustration purposes only. Actual data on tires are specific to each vehicle and may vary from data shown in the illustration.

U.S. tire regulations require each new tire manufacturer or tire retreader to mold a TIN into or onto a sidewall of each tire produced.

The TIN is a unique identifier which facilitates efforts by tire manufacturers to notify purchasers in recall situations or other safety matters concerning tires and gives purchasers the means to easily identify such tires.

The TIN is comprised of "Manufacturer's identification mark", "Tire size", "Tire type code" and "Date of manufacture".

The TIN may be found on one or both sides of the tire however the date code may only be on one side. Tires with white sidewalls will have the full TIN including date code located on the white sidewall side of the tire. Look for the TIN on the outboard side of black sidewall tires as mounted on the vehicle.

If the TIN is not found on the outboard side then you will find it on the inboard side of the tire. In this case, the tire must be remounted. Make sure the TIN is

visible on the outboard side of the tire and if applicable that the direction of rotation is correct when remounting the tire.

Rotation (spinning) direction, refer to "Direction of Rotation".

DOT (Department Of Transportation)

A tire branding symbol (1) which denotes the tire meets requirements of the U.S. Department of Transportation.

Manufacturer's Identification Mark

The manufacturer's identification mark (2) denotes the tire manufacturer.

New tires have a mark with two symbols.

Retreaded tires have a mark with four symbols. For more information on retreaded tires, refer to "Tires and Wheels".

Tire Size

The code (3) indicates the tire size.

Tire Type Code

The code (4) may, at the option of the manufacturer, be used as a descriptive code for identifying significant characteristics of the tire.

Date of Manufacture

The date of manufacture (5) identifies the week and year of manufacture.

The first two figures identify the week, starting with "01" to represent the first full week of the calendar year. The second two figures represent the year.

For example, "0301" represents the 3rd week of 2001.

NOTE: Prior to July 2000, tire manufacturers were only required to have 1 number to represent the year in which the tire was manufactured.

For example, "031" could represent the 3rd week of 1981 or 1991.

NOTE: If the date of manufacture code indicated on the tire is less than 4 figures, do not use it.

WARNING!

Tires and spare tire should be replaced after 6 years, regardless of the remaining tread.

Maximum Tire Load

(1) Maximum tire load rating

NOTE: Data shown on tire are for illustration purposes only. Actual data on tires are specific to each vehicle and may vary from data shown in the illustration.

The maximum tire load is the maximum weight the tires are designed to support.

WARNING!

Do not overload the tires by exceeding the specified load limit as indicated on the Tire and Loading Information placard on the driver's door B-pillar. Overloading the tires can overheat them, possibly causing a blowout. Overloading the tires can also result in handling or steering problems, or brake failure.

For more information on tire load rating, refer to "Tire Size Designation, Load and Speed Rating".

For information on calculating total and cargo load capacities, refer to "Tire and Loading Information".

Maximum Tire Inflation Pressure



(1) Maximum permissible tire inflation pressure

NOTE: Data shown on tire are for illustration purposes only. Actual data on tires are specific to each vehicle and may vary from data shown in the illustration.

This is the maximum permissible tire inflation pressure for the tire.

Always follow the recommended tire inflation pressure for proper tire inflation, refer to "Recommended Tire Inflation Pressure".

WARNING!

Never exceed the max. tire inflation pressure. Follow recommended tire inflation pressures.

Do not underinflate tires. Underinflated tires wear excessively and/or unevenly, adversely affect handling and fuel economy, and are more likely to fail from being overheated.

Do not overinflate tires. Overinflated tires can adversely affect handling and ride comfort, wear unevenly, increase stopping distance, and result in sudden deflation (blowout) because they are more likely to become punctured or damaged by road debris, potholes etc.

Tire Ply Material



- (1) Plies in sidewall
- (2) Plies under tread

NOTE: Data shown on tire are for illustration purposes only. Actual data on tires are specific to each vehicle and may vary from data shown in the illustration.

This marking tells you about the type of cord and number of plies in the sidewall and under the tread.

Tire and Loading Terminology

Accessory Weight

The combined weight (in excess of those standard items which may be replaced) of automatic transmission, power steering, power brakes, power windows, radio, and heater, to the extent that these items are available as factory-installed equipment (whether installed or not).

Air Pressure

The amount of air inside the tire pressing outward on each square inch of the tire. Air pressure is expressed in pounds per square inch (psi), or kilopascal (kPa) or bars.

Aspect Ratio

Dimensional relationship between tire section height and section width expressed in percentage.

Bar

Another metric unit for air pressure. There are 14.5038 pounds per square inch (psi) to 1 bar; there are 100 kilopascals (kPa) to 1 bar.

Bead

The tire bead contains steel wires wrapped by steel cords that hold the tire onto the rim.

Cold Tire Inflation Pressure

Tire inflation pressure when your vehicle has been sitting for at least 3 hours or driven no more than 1 mile (1.6 km).

Curb Weight

The weight of a motor vehicle with standard equipment including the maximum capacity of fuel, oil, and coolant, and, if so equipped, air conditioning and additional optional equipment, but without passengers and cargo.

DOT (Department of Transportation)

A tire branding symbol which denotes the tire meets requirements of the U.S. Department of Transportation.

GAWR (Gross Axle Weight Rating)

The GAWR is the maximum permissible axle weight. The gross vehicle weight on each axle must never exceed the GAWR for the front and rear axle indicated

on the Certification Label located below the driver's seat on an outward facing position of the mounting pillar.

GTW (Gross Trailer Weight)

The GTW is the weight of the trailer plus the weight of all cargo, equipment, luggage etc. loaded on the trailer.

GVW (Gross Vehicle Weight)

The GVW comprises the weight of the vehicle including fuel, tools, spare wheel, installed accessories, passengers and cargo and, if applicable, trailer tongue load. The GVW must never exceed the GVWR indicated on the Certification Label located below the driver's seat on an outward facing position of the mounting pillar.

GVWR (Gross Vehicle Weight Rating)

This is the maximum permissible vehicle weight of the fully loaded vehicle (weight of the vehicle including all options, passengers, fuel, and cargo and, if applicable, trailer tongue load). It is indicated on the Certification Label located below the driver's seat on an outward facing position of the mounting pillar.

Kilopascal (kPa)

Themetric unit for air pressure. There are 6.9 kPa to 1 psi; another metric unit for air pressure is bars. There are 100 kilopascals (kPa) to 1 bar.

Maximum Load Rating

The maximum load in kilograms and pounds that can be carried by the tire.

Maximum Loaded Vehicle Weight

The sum of curb weight, accessory weight, vehicle capacity weight and production options weight.

Maximum Tire Inflation Pressure

This number is the greatest amount of air pressure that should ever be put in the tire under normal driving conditions.

Normal Occupant Weight

The number of occupants the vehicle is designed to seat, multiplied by 68 kilograms (150 lbs).

Occupant Distribution

The distribution of occupants in a vehicle at their designated seating positions.

Production Options Weight

The combined weight of those installed regular production options weighing over 5 lbs (2.3 kilograms) in excess of those standard items which they replace, not previously considered in curb weight or accessory weight, including heavy duty brakes, ride levelers, roof rack, heavy duty battery, and special trim.

PSI (Pounds per Square Inch)

A standard unit of measure for air pressure. Another metric unit for air pressure is bars or kilopascal (kPa).

Recommended Tire Inflation Pressure

Recommended tire inflation pressure listed on Tire and Loading Information placard on the driver's door B-pillar for normal driving conditions. Provides best handling, tread life and riding comfort.

Rim

A metal support for a tire or a tire and tube assembly upon which the tire beads are seated.

Sidewall

The portion of a tire between the tread and the bead.

TIN (Tire Identification Number)

Unique identifier which facilitates efforts by tire manufacturers to notify purchasers in recall situations or other safety matters concerning tires and gives purchasers the means to easily identify such tires. The TIN is comprised of "Manufacturer's identification mark", "Tire size", "Tire type code" and "Date of manufacture".

Tire Load Rating

Numerical code associated with the maximum load a tire can support.

Tire Ply Composition and Material used

This indicates the number of plies or the number of layers of rubber-coated fabric in the tire tread and sidewall. Tire manufacturers also must indicate the ply materials in the tire and sidewall, which include steel, nylon, polyester, and others.

Tire Speed Rating

Part of tire designation; indicates the speed range for which a tire is approved.

Traction

Force exerted by the vehicle on the road via the tires. The amount of grip provided.

Tread

The portion of a tire that comes into contact with the road.

Treadwear Indicators

Narrow bands, sometimes called "wear bars" that show across the tread of a tire when only 1/16 in (1.6 mm) of tread remains.

TWR (Tongue Weight Rating)

Maximum permissible weight on trailer tongue.

Uniform Tire Quality Grading Standards

A tire information system that provides consumers with ratings for a tire's traction, temperature and treadwear.

Ratings are determined by tire manufacturers using government testing procedures. The ratings are molded into the sidewall of the tire.

Vehicle Capacity Weight

Rated cargo and luggage load plus 68 kilograms (150 lbs) times the vehicle's designated seating capacity.

Vehicle Maximum Load on the Tire

Load on an individual tire that is determined by distributing to each axle its share of the maximum loaded vehicle weight and dividing it by two.

Rotating Tires

WARNING!

Rotate front and rear wheels only if the tires are of the same dimension.

Tires on the front and rear axles of vehicles operate at different loads and perform different steering, driving and braking functions. For these reasons, they wear at unequal rates, and develop irregular wear patterns. These effects can be reduced by timely rotation of tires.

The benefits of rotation are especially worthwhile with aggressive tread designs such as those on On/Off Road type tires. Rotation will increase tread life, help to

maintain mud, snow, and wet traction levels, and contribute to a smooth, quiet ride.

If applicable to your vehicle's tire configuration, tires can be rotated according to the tire manufacturer's recommended intervals in the tire manufacturer's warranty pamphlet located in your vehicle literature portfolio. If none is available, tires should be rotated every 10000 miles (16000 km), or sooner if necessary, according to the degree of tire wear.

The same rotation (spinning) direction must be maintained when fitted, see "Direction of Rotation".

Rotate tires before the characteristic tire wear pattern becomes visible (shoulder wear on front tires and treadcenter wear on rear tires).

The reasons for any rapid or unusual wear should be corrected prior to rotation being performed.

Thoroughly clean the mounting face of wheels and brake disks, i.e. the inner side of the wheels/tires, during each rotation. Check for and ensure proper tire inflation pressure, refer to "Recommended Tire Inflation Pressure".

WARNING!

In order to avoid loosing a wheel and in order to reduce the risk of fatal or serious injuries or vehicle damage, please follow these safety instructions:

- Always replace wheel bolts that are damaged or rusted.
- Never apply oil or grease to wheel bolts.
- If a wheel hub thread is damaged, you must not drive the vehicle. Consult a qualified specialist workshop.
- Only use genuine wheel bolts approved from the vehicle manufacturer and specified for your vehicle's rims. Check tightness of wheel bolts or nuts regularly and retighten with a torque wrench, if necessary. Tighten wheel bolts or nuts in a cross-pattern sequence. After changing a wheel, the wheel bolts or nuts must be tightened once the vehicle has been driven for about 30 miles (50 km). If new or repainted wheels are fitted, the wheel bolts or nuts must be retightened again after about 600 to 3000 miles (about 1000 to 5000 km).

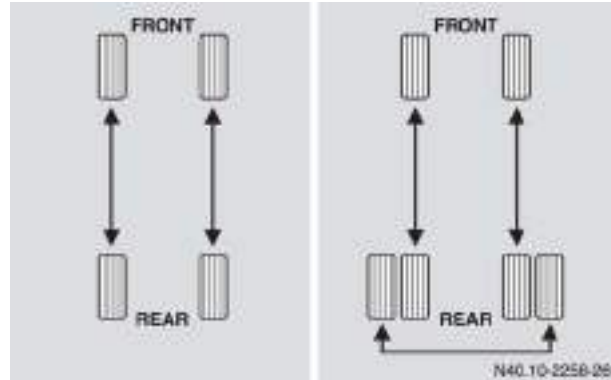

Rotation pattern for single and dual rear wheels

Single Rear Wheels:

- Rotate the tires by axle. Never change the direction of rotation of your tires. Make sure that on one axle just one type of tire (same size, type construction, load and speed rating) is used.

Dual Rear Wheels:

- Rotate front tires by axle and the outer rear tire side to side if there is no approved direction of rotation. The tires used on dual wheel assemblies should be

matched for wear to prevent overloading one tire in a set.

- To check if tires are even, lay a straight edge across all four tires.
The straight edge should touch all the tires.

WARNING!

3500 Dual Rear Tires have only one approved direction of rotation. This is to accommodate the asymmetrical design (tread pattern) of the ON/OFF road tire and the use of Outline White Letter (OWL) tires.

When replacing a flat tire, the spare tire may have to be remounted on the rim or installed at a different location to maintain the correct placement of the tire on the wheel relative to the tire/wheel position on the vehicle. For example, if the spare is used to replace an outer rear tire it will have to be remounted on the rim so that the wheel is dished inward. That way the tread design of asymmetrical tires and the white writing of the OWL tires will maintain proper position.

Alignment and Balance

Poor suspension alignment may result in:

- Fast tire wear
- Uneven tire wear, such as feathering and one-sided wear
- Vehicle pull to right or left

Tires may also cause the vehicle to pull to the left or right.

Alignment will not correct this condition. See an authorized Sprinter Dealer for proper diagnosis.

Improper alignment will not cause vehicle vibration. Vibration may be a result of tire and wheel out-of-balance.

Proper balancing will reduce vibration and avoid tire cupping and spotty wear.

Winter tires

Always use winter tires at temperatures below 45°F (7°C) and whenever wintry road conditions prevail. Winter tires should be of the same size and type construction as the summer tires. Winter tires should also be operated as printed at the Tire and Loading

Information placard, refer to "Tires and Wheels". Not all M+S rated radial-ply tires provide special winter performance. Make sure the tires you use show M+S and the mountain/snowflake marking on the tire sidewall. These tires meet specific snow traction performance requirements of the Rubber Manufacturers Association (RMA) and the Rubber Association of Canada (RAC) and have been designed specifically for use in snow conditions. Use of winter tires is the only way to achieve the maximum effectiveness of the ABS and ESP® in winter operation.

For safe handling, make sure all winter tires mounted are of the same make and have the same tread design.

WARNING!

Winter tires with a tread depth under 1/6 in (4 mm) must be replaced. They are no longer suitable for winter operation.

Always observe the speed rating of the winter tires installed on your vehicle. If the maximum speed for which your tires are rated is below the speed rating of your vehicle, you must place a notice to this effect

where it will be seen by the driver. Such notices are available at your tire dealer or any authorized Sprinter Dealer.

While studded tires improve performance on ice, skid and traction capability on wet or dry surfaces may be poorer than that of non-studded tires. Some states prohibit studded tires; therefore, local laws should be checked before using these tire types.

WARNING!

If you use your spare tire when winter tires are fitted on the other wheels, be aware that the difference in tire characteristics may very well impair turning stability and that overall driving stability may be reduced. Adapt your driving style accordingly.

Have the spare tire replaced with a winter tire at the nearest authorized Sprinter Dealer.

SNOW CHAINS

Use "Class U" chains, or other traction aids that meet SAE Type "U" specifications.

NOTE: Chains must be the proper size for the vehicle, as recommended by the chain manufacturer.

Snow chains should only be driven on snow-covered roads at speeds not to exceed 30 mph (50 km/h). Remove chains as soon as possible when driving on roads without snow.

WARNING!

Use snow chains on rear wheels only.

Some tire sizes do not leave adequate clearance for snowchains. To help avoid serious damage to your vehicle or tires, use of snow chains is not permissible with the spare wheel.

NOTE: When driving with snow chains, you may wish to deactivate the ASR before setting the vehicle in motion. This will improve the vehicle's traction.

Please observe the following guidelines when using snow chains:

- Snow chains should only be used on rear wheels. In vehicles with dual rear wheels, they should be mounted on the exterior wheels. Follow the manufacturer's mounting instructions.
- Only use snow chains that are approved by the vehicle manufacturer. For approved snow chains, please contact your authorized Sprinter Dealer.
- Use of snow chains may be prohibited depending on location. Always check local and state laws before installing snow chains.

To avoid damage to your vehicle, tires or chains, observe the following precautions:

- Because of limited chain clearance between tires and other suspension components, it is important that only chains in good condition are used. Broken chains can cause serious vehicle damage. Stop the vehicle immediately if noise occurs that could suggest chain breakage. Remove the damaged parts of the chain before further use.
- Install chains as tightly as possible and then retighten after driving about 1/2 mile (0.8 km).
- Do not exceed 30 mph (50 km/h).
- Drive cautiously and avoid severe turns and large bumps, especially with a loaded vehicle.
- Do not install tire chains on front wheels.
- Do not drive for a prolonged period on dry pavement.
- Observe the tire chain manufacturer's instructions on method of installation, operating speed, and conditions for usage. Always use the lower suggested operating speed of the chain manufacturer if different than the speed recommended by the manufacturer.

FUEL REQUIREMENTS

Use only commercially available vehicular diesel fuels No. 2 or No. 1 (ASTM D 975 No. 2-D or No. 1-D).

NOTE: Because of its better quality the manufacturer recommends the use of commercially available vehicular diesel fuel No. 2.

For information on cold weather operation, contact your authorized Sprinter Dealer.

WARNING!

Marine diesel fuel, Bio diesel fuel, heating oil or the like must not be used.

Do not blend diesel fuel with marine diesel fuel, Bio diesel fuel or heating oil.

The use of such non-approved fuels or blending diesel fuel may result in malfunction or cause engine damage. Damage or malfunctions resulting from poor fuel quality or from blending specific fuel additives are not covered by the Sprinter Warranty.

If diesel fuels are used with a sulphur content exceeding 0.5 % by weight, engine oil change intervals must be shortened. Please contact your Sprinter Dealer to obtain the necessary information.

Refueling from drums or canisters may lead to the fuel becoming contaminated. This in turn can cause faults in the fuel system. Always filter the fuel before adding it to the vehicle's tank.

WARNING!

Under no circumstances should gasoline be mixed with diesel fuel.

Due to the high pressure and high temperature in the injection system, there is a risk of fire and explosion.

In addition, there is a risk of engine damage.

Always follow basic safety rules when working with any combustible material.

Fuel Filter with Water Separator

Check the water separator when the fuel indicator lamp  does not go out or comes on while the engine is running.

The interval for changing the fuel filter is reduced to 10,000 miles (about 15,000 km).

Diesel Fuels for Use at Very Low Temperatures

At very low temperatures the fluidity of No. 2 diesel fuel may become insufficient due to paraffin separation. For this reason the vehicle comes equipped with a fuel preheater. It permits a troublefree engine operation to a temperature of approximately 14 °F (-10 °C) when using No. 2 diesel fuel.

To avoid malfunctions, No. 2 diesel fuel of a lowered cloud point is marketed during the cold season.

At temperatures below 14 °F (-10 °C) use winterized or No. 1 diesel fuel only. If not available, a certain quantity of fuel flow improver may be added. Mixing only to be done within the vehicle's fuel tank.

Engine power may drop according to the proportion of fuel flow improver. For this reason, keep percentage of fuel flow improver added to the minimum necessitated by the ambient temperature.

Even in extreme climatic conditions, the maximum mixture ratio should not exceed 50%

Adding of kerosene to diesel fuel is not recommended even at low temperatures.

The following information can be used as a reference, if adding of kerosene becomes necessary. The mixing ratios shown refer to the total mixture.

Ambient temperature:
14 °F to -4 °F (-10 °C to -20 °C)
 No. 2 Diesel Fuel: 70%
 Kerosene: 30%

Ambient temperature:
below -4 °F to (-20 °C)
 No. 2 Diesel Fuel: 50 %
 Kerosene: 50 %

Even in extreme climatic conditions, the maximum mixture ratio should not exceed 50 %.

Adding of kerosene to No. 1 diesel fuel is not recommended even at low temperatures.

Do not blend other specific fuel additives with diesel fuel except for fuel flow improver. They only result in unnecessary cost, and may be harmful to the engine operation.

CAUTION!

Damage or malfunctions resulting from poor fuel quality or from blending specific fuel additives are not covered by the Sprinter Warranty.

REFUELING

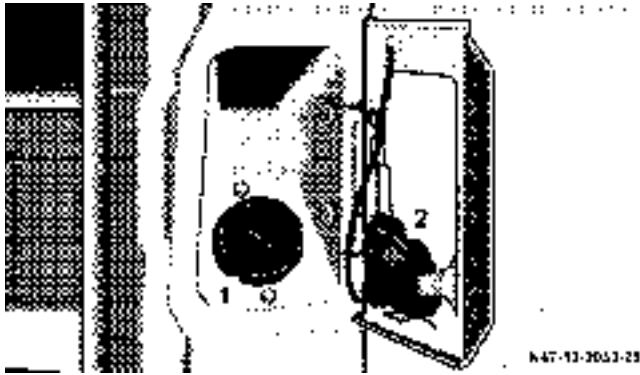

1. Fuel filler neck
2. Fuel filler cap

The fuel filler neck (1) is located behind the fuel filler flap next to the driver's door. The fuel filler flap can be opened when the driver's door is open. Turn the fuel filler cap (2) on the fuel filler neck (1) counterclockwise and take it off. For cargo/passenger vans, place the fuel filler cap (2) in the holder on the inside of the fuel filler flap.

When you have finished refueling, install the fuel filler cap (2).

NOTE: Only fill the fuel tank until the fill nozzle cuts off, do not overfill.

NOTE: Holder on the inside of the fuel filler flap only for cargo/passenger vans.

WARNING!

Always handle fuel with great care.

Shut off the engine and the auxiliary heater before refueling.

Fuel is flammable and explosive. Keep open flames away from the fuel.

Refrain from smoking as well as use of any electrical equipment (such as cell phones). This also applies to places where the characteristic smell of fuel is evident.

If diesel fumes are noticed inside the vehicle, have the cause traced and rectified immediately by an authorized Sprinter Dealer.

Capacity

Fuel tank including reserve fuel about 26.4 US gal (100 l).

PROGRAMMED TOP SPEED (OPTIONAL)

NOTE: The top speed of this vehicle can be electronically limited to a speed between 19 mph (30 km/h) and 82 mph (132 km/h). The vehicle's electronic speed controller should be programmed only by a qualified technician by an authorized Sprinter Dealer.

When programming the electronic speed controller, the circumference of the specific tires actually mounted on the vehicle must be determined and that circumference must be correctly programmed into the vehicle's electronic speed controller. It is critical that the correct tire circumference be programmed accurately into the vehicle's electronic speed controller. Accurate tire circumference information should be confirmed each time the electronic speed controller is programmed and each time new wheels or tires are mounted on the vehicle.

WARNING!

Possible tire damage resulting in serious personal injury or death may occur if the vehicle's electronic speed controller is programmed at a speed above the maximum speed allowed by the manufacturer of the specific tires mounted on the vehicle. The maximum speed of the tires prescribed by the tire manufacturer must be determined and accurately programmed into the electronic speed controller. The electronic speed controller must never be programmed at a speed greater than the maximum allowable tire speed as prescribed by the manufacturer of the specific tires mounted on the vehicle.

BLEEDING DIESEL FUEL SYSTEM

If the fuel tank was run empty, the diesel fuel system must be bled after refueling before starting the engine.

- Turn the key in the ignition lock to position 2 for at least 30 seconds.
- Return the key to position 0.
- Start the engine three to four times.
The malfunction indicator light (MIL)  must go out.

NOTE: Too many attempts to start the engine could drain the battery. If the engine does not start after several attempts, consult an authorized Sprinter Dealer.

DRAINING FUEL FILTER WITH WATER SEPARATOR

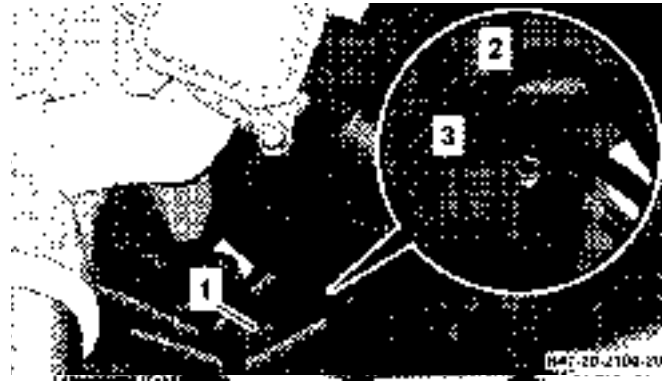

1. Fuel filter
2. Drain hose
3. Water drain screw

The fuel filter (1) is located in the engine compartment.

NOTE: The fuel filter must be drained as soon as the water in fuel indicator lamp  lights up.

CAUTION!

Delaying draining of the fuel filter for a considerable time after the indicator lamp lights up may lead to engine damage.

NOTE: Prior to opening water drain screw (3), place a suitable receptacle underneath the drain hose (2). Turn water drain screw (3) on and off only by hand.

Diesel fuels and diesel fuel mixtures must be disposed of properly; we recommend water be drained from fuel filters by an authorized Sprinter Dealer.

Draining Fuel Filter

- Stop the engine.
- Shift gear selector lever to “P” position.
- Open the hood.
- Place a suitable receptacle underneath the drain hose (2).
- Turn the key in the ignition lock to position 2.

- Open immediately the water drain screw (3) about 1 turn (counterclockwise) until fluid emerges. Ensure that the fluid is collected in the receptacle.
- Close the water drain screw (3) as soon as about 0.25 US qt (0.2 liters) are emerged.
- After draining, return the key in the ignition lock to position 0.
- Dispose of the collected fluid in an environmentally responsible manner.
- If the filter is still saturated, drain the filter once more.

After draining, the engine may run briefly but stall for lack of fuel. If this occurs, bleed the system.

NOTE: Should the water in the fuel indicator lamp  still not go out after the fuel filter has been drained twice, the cause should be examined by an authorized Sprinter Dealer.

Bleeding the Diesel Fuel System

The diesel fuel system must be bled before starting the engine.

- Turn the key in the ignition lock position 2 for at least 30 seconds.
- Return the key to position 0.
- Start the engine three to four times. The engine control unit indicator lamp  must go out.

NOTE: Too many attempts to start the engine could drain the battery. If the engine does not start after several attempts, consult an authorized Sprinter Dealer.

PERMISSIBLE ROOF LOAD

The maximum permissible roof load is:

- Vehicles with low roof 660 lbs (300 kg)
- Vehicles with high roof 330 lbs (150 kg)
- The weight of any load carried on the roof, including the roof rack, must not exceed the maximum permissible roof load.

LOADING THE VEHICLE

Two labels on the vehicle show how much weight it may properly carry.

- The Tire and Loading Information placard can be found on the driver's door B-pillar. This placard tells you important information about the number of people that can be in the vehicle and the total weight that can be carried in the vehicle. It also contains information on the proper size and recommended tire inflation pressures for the original equipment tires on the vehicle.
- The Certification Label can be found below the driver's seat on an outward facing position of the mounting pillar. It tells you about the gross weight

capacity of your vehicle, called the Gross Vehicle Weight Rating (GVWR). The GVWR includes the weight of the vehicle, all occupants, fuel and cargo. The Certification Label also tells you about the front and rear axle weight capacity, called the Gross Axle Weight Rating (GAWR). The GAWR is the total allowable weight that can be carried by a single axle (front or rear). Never exceed the GVWR or GAWR for either the front axle or rear axle.

Following is a discussion on how to work with the information contained on the two placards with regards to loading your Sprinter vehicle.

Tire and Loading Information

WARNING!

Do not overload the tires by exceeding the specified load limit as indicated on the Tire and Loading Information placard on the driver's door B-pillar. Overloading the tires can overheat them, possibly causing a blowout. Overloading the tires can also result in handling or steering problems, or brake failure.

Overloading of tires is dangerous. Overloading can cause tire failure, affect vehicle handling, and increase the stopping distance. Use tires of the recommended load capacity for the vehicle. Never overload them.

The vehicle maximum load on the tire must not exceed the load carrying capacity of the tire on your vehicle. You will not exceed the tire's load carrying capacity if you adhere to the loading conditions, tire size and cold tire inflation pressures specified on the Tire and Loading Information placard and this section.

Tire and Loading Information placard



Seating capacity (1)

Load limit information (2)

NOTE: Data shown on placard are for illustration purposes only. Load limit data and seating data are specific to each vehicle and may vary from data shown in the illustration.

Refer to placard on vehicle for actual data specific to your vehicle.

Seating Capacity

The seating capacity (2) gives you important information on the number of occupants that can be in the vehicle.

Observe front and rear seating capacity.

Never let more people ride in the vehicle than there are designated seating positions and seat belts available. Be sure everyone riding in the vehicle is correctly restrained with a separate seat belt.

Load Limit Information

Locate the statement "The combined weight of occupants and cargo should never exceed XXX kilograms or XXX lbs." (1) on the Tire and Loading Information placard. The combined weight of all occupants, cargo/luggage and trailer tongue load (if applicable) should never exceed the weight referenced in that statement.

Steps for Determining Correct Load Limit

The following steps have been developed as required of all manufacturers under Title 49, Code of U.S. Federal Regulations, Part 575 pursuant to the "National Traffic and Motor Vehicle Safety Act of 1966".

Step 1

- Locate the statement "The combined weight of occupants and cargo should never exceed XXX kg or XXX lbs." on your vehicle's placard.

Step 2

- Determine the combined weight of the driver and passengers that will be riding in your vehicle.

Step 3

- Subtract the combined weight of the driver and passengers from XXX kilograms or XXX lbs.

Step 4

- The resulting figure equals the available amount of cargo and luggage load capacity. For example, if the "XXX" amount equals 1400 lbs. and there will be five 150 lbs. passengers in your vehicle, the amount of available cargo and luggage load capacity is 650 lbs. (1400 – 750 (5 x 150) = 650 lbs.)

Step 5

- Determine the combined weight of luggage and cargo being loaded on the vehicle. That weight may not safely exceed the available cargo and luggage load capacity calculated in step 4.

Step 6 (if applicable)

- If your vehicle will be towing a trailer, load from your trailer will be transferred to your vehicle. Refer to "Trailer Tongue Load" to determine how this reduces the available cargo and luggage load capacity of your vehicle.

The following table shows examples on how to calculate total load, cargo load and towing capacities with varying seating configurations and number and size of occupants.

The following examples use a load limit of 1500 lbs.

NOTE: This is for illustration purposes only. Make sure you are using the actual load limit for your vehicle stated on the vehicle's Tire and Loading Information placard.

Example	Combined weight limit of occupants and cargo from placard	Number of occupants (driver and passengers)	Seating configuration	Occupants weight	Combined weight of all occupants	Available cargo/luggage and trailer tongue weight (total load limit from placard minus combined weight of all occupants)
1	1500 lbs	5	front: 2 rear: 3	Occupant 1: 150 lbs Occupant 2: 180 lbs Occupant 3: 160 lbs Occupant 4: 140 lbs Occupant 5: 120 lbs.	750 lbs	1500 lbs – 750 lbs = 750 lbs
2	1500 lbs	3	front: 1 rear: 2	Occupant 1: 200 lbs Occupant 2: 190 lbs Occupant 3: 150 lbs	540 lbs	1500 lbs – 540 lbs = 960 lbs
3	1500 lbs	1	front: 1	Occupant 1: 150 lbs	150 lbs	1500 lbs – 150 lbs = 1350 lbs

The higher the weight of all occupants, the less cargo and luggage load capacity is available.

For more information, refer to "Trailer Tongue Load".

Certification Label

Even after careful determination of the combined weight of all occupants, cargo and the trailer tongue load (if applicable) as to not exceed the permissible load limit, you must make sure that your vehicle never exceeds the Gross Vehicle Weight Rating (GVWR) and the Gross Axle Weight Rating (GAWR) for either the front or rear axle.

Under a maximum loaded vehicle condition, gross axle weight ratings (GAWR's) for the front and rear axles must not be exceeded.

To determine the maximum loading conditions of your vehicle, locate the statement "The combined weight of occupants and cargo should never exceed XXX kg or XXX lbs." on the Tire and Loading Information placard. The combined weight of occupants, cargo/luggage and trailer tongue weight (if applicable) should never exceed the weight referenced here.

You can obtain the GVWR and GAWR from the Certification label. The Certification Label can be found below the driver's seat on an outward facing position of the mounting pillar.

For more information on the trailer tongue load, refer to "Trailer Tongue Load".

TRAILER TOWING

WARNING!

Failure to use proper equipment and driving technique can result in a loss of vehicle control when towing a trailer.

Improper towing or failure to follow the instructions contained in this guide can result in serious injury. Follow the guidelines below carefully to assure safe trailer operation.

Ask your authorized Sprinter Dealer, if you require an explanation of information contained in this guide.

Trailer Hitches (Optional)

Only install a trailer hitch receiver approved for your vehicle. For information on availability and installation, please see your authorized Sprinter Dealer.

The bumpers on your vehicle are not designed for use with clamp-type hitches. Do not attach rental hitches or other bumper-type hitches to them.

To reduce the possibility of damage, remove the hitch ball adaptor from the receiver when not in use.

Electrical Connections (Optional)

The Sprinter is available with a variety of pre-installed conditions (lines and turn signal indicator and brake module installed and / or not installed). Make sure that the correct trailer hitch receiver kit is used. For further information, please see your authorized Sprinter Dealer.

In order to prevent possible damage to the vehicle's electrical system by incorrectly installing the trailer wiring plug, we recommend having the harness connected at an authorized Sprinter Dealer.

Vehicle and Trailer Weights and Ratings

Gross Vehicle Weight Rating (GVWR) is the maximum permissible vehicle weight: 8,550 lbs (3,878 kgs), 9,990 lbs (4,531 kgs) or 10,200 lbs (4,627 kgs).

NOTE: The weight of your Sprinter is indicated on the type plate. For type plate, see Identification Labels.

Gross Vehicle Weight (GVW): comprises weight of vehicle including fuel, tools, spare wheel, installed accessories, passengers, cargo and trailer tongue. It must never exceed the GVWR.

Gross Axle Weight Rating (GAWR) is the maximum permissible axle weight:

Type	GVWR	GAWR (FA)	GAWR (RA)
2500 C/HC/ SHC	8,550 lbs 3,878 kgs	3,860 lbs (1,751 kgs)	5,360 lbs (2,431 kgs)
3500 C/HC/ SHC	9,990 lbs 4,531 kgs	3,860 lbs (1,751 kgs)	7,060 lbs (3,202 kgs)
	10,200 lbs 4,627 kgs	3,860 lbs (1,751 kgs)	7,060 lbs (3,202 kgs)

Gross Trailer Weight (GTW) is the maximum permissible trailer weight to be towed: 5,000 lbs. (2,260 kgs)

Trailer Tongue Weight Rating (TWR) is the maximum permissible weight of the trailer tongue: 500 lbs. (225 kgs) limit for Sprinter approved hitch receiver.

NOTE: The GVWR and GAWR of your vehicle is indicated on the Certification Label.

Trailer Tongue Load

The tongue load (tongue weight at the hitch ball) of any trailer is an important weight to measure because it affects the load you can carry in your vehicle. If a trailer is towed, the tongue load must be added to the weight of all occupants riding and any cargo you are carrying in the vehicle to prevent exceeding your Sprinter tow vehicle's rear GAWR. The tongue load typically is between 10 % and 15 % of the trailer weight and everything loaded in it.

For example, if the trailer tongue load equals 140 lbs. and the determined available cargo/luggage and trailer tongue weight equals 750 lbs., the amount of available cargo and luggage load capacity is 610 lbs. (750 – 140 = 610 lbs.)

Loading a Trailer

When loading a trailer, you should observe that neither the permissible GTW, nor the GVWR are exceeded.

Maximum permissible values are listed on the safety compliance certification labels for the vehicle and for the trailer to be towed. The lowest value listed must be selected when determining how the vehicle and trailer are loaded.

Load the trailer in such a manner that it has a tongue weight (TW) between 10% and 15% of the GTW.

The tongue weight at the hitch ball must be added to the GVW to prevent exceeding your Sprinter tow vehicle's rear GAWR.

Checking Weights of Vehicle and Trailer

To assure that the tow vehicle and trailer are in compliance with the maximum permissible weight limits, and to know the actual weights, have the loaded vehicle-trailer combination (tow vehicle including driver, passengers and cargo, trailer fully loaded) weighed on a commercial scale.

Check the vehicle's front and rear Gross Axle Weight (GAW), the GTW and TW. The values as measured must not be exceeded, according to the weight listed under "Vehicle and trailer weight and ratings".

Attaching a Trailer

Please observe maximum permitted trailer dimensions (width and length).

Most states and all Canadian provinces require safety chains between your tow vehicle and the trailer. The chains should be crisscrossed under the trailer tongue. They must be attached to the hitch receiver, and not to the vehicle's bumper or axle. Be sure to leave enough slack in the chains to permit turning corners.

Most states and all Canadian provinces require a separate brake system at various trailer weights.

WARNING!

Do not connect a trailer brake system (if trailer is so equipped) directly to the vehicle's hydraulic brake system as your vehicle is equipped with anti-lock brakes. If you do, neither the vehicle's brakes nor the trailer's brakes will function properly. This could cause an accident resulting in property damage, injury or death to you or others.

The provided vehicle electrical wiring harness for trailer towing has a brake signal wire for hook-up to a brake controller.

Most states and all Canadian provinces require a break-away switch on trailers with a separate brake system. The switch activates the trailer brakes in the possible event that the trailer might separate from the tow vehicle.

You should consider using a trailer sway control system. For further information see your authorized Sprinter Dealer.

Towing a Trailer

There are many different laws, including speed limit restrictions, having to do with trailer towing. Make sure that your vehicle-trailer combination will be legal, not only for where you reside, but also for where you will be driving. A good source for this information can be the police or local authorities.

Before you start driving with the trailer, check the trailer hitch, break-away switch, safety chains, electrical connections, lighting and tires. Also adjust the mirrors to permit unobstructed view beyond rear of trailer.

If the trailer has electric brakes, start your vehicle and trailer moving slowly, and then apply only the trailer brake controller by hand to be sure the brakes are working properly.

When towing a trailer, check occasionally to be sure that the load is secure, and that lighting and trailer brakes (if so equipped) are functioning properly.

Always secure items in the trailer to prevent load shifts while driving.

Take into consideration that when towing a trailer, the handling characteristics are different and less stable from those when operating the vehicle without a trailer. It is important to avoid sudden maneuvers. The vehicle and trailer combination is heavier, and therefore is limited in acceleration and climbing ability, and requires longer stopping distances. It is more prone to reacting to side wind gusts, and requires more sensitive steering input.

In order to gain skill and an understanding of the vehicle's behavior, you should practice turning, stopping and backing up in an area which is free from traffic.

If possible, do not brake abruptly, but rather engage the brake slightly at first to permit the trailer to activate its brake. Then increase the braking force.

WARNING!

Take into consideration that when towing a trailer, the handling characteristics are different and less stable from those when operating the vehicle without a trailer.

It is important to avoid sudden maneuvers. Sudden maneuvers may lead to loss of control over the vehicle-trailer combination. This could cause an accident resulting in property damage or injury to you or others.

CAUTION!

If the transmission hunts between gears on inclines, manually shift to a lower gear (select "4", "3", "2" or "1"). A lower gear and reduction of speed reduces the chance of engine overloading and/or overheating.

When going down a long hill, shift into a lower gear and use the engine's braking effect. Avoid riding the brakes, thus overheating the vehicle and trailer brakes.

If the engine coolant rises to an extremely high temperature (coolant temperature needle approaching the red zone) when the air conditioner is on, turn off the air conditioner. Engine coolant heat can be additionally vented by opening the windows, switching the climate control fan speed to high and setting the temperature control to the maximum hot position.

CAUTION!

Extreme care must be exercised since your vehicle with a trailer will require additional passing distance ahead than when driving without a trailer. Because your vehicle and trailer is longer than your vehicle alone, you will also need to go much farther ahead of the passed vehicle before you can return to your lane.

Parking a Trailer**WARNING!**

To reduce the risk of personal injury, or damage to the vehicle powertrain, as a result of vehicle/trailer movement, always:

Keep right foot on brake pedal.

Shift gear selector lever to position "N".

Have a second person place wheel chocks on downhill side of left and right trailer wheels.

Slowly release brake pedal and let vehicle and trailer roll into chocks until stopped.

Firmly depress parking brake pedal.

Move gear selector lever to position "P".

On inclines turn front wheels towards the road curb.

EMISSIONS CONTROL SYSTEM (CATALYTIC CONVERTER)**WARNING!**

When driving or parking the vehicle, make sure that its exhaust system does not come into contact with flammable material (such as dry leaves) as these materials may otherwise catch fire.

INHALATION OF EXHAUST GAS**WARNING!**

Inhalation of exhaust gas is hazardous to your health. All exhaust gas contains carbon monoxide and inhaling it can cause unconsciousness and lead to death.

Do not run the engine in confined areas (such as a garage) which are not properly ventilated. If you think that exhaust gas fumes are entering the vehicle while driving, have the cause determined and corrected immediately. If you must drive under these conditions, drive only with at least one window fully open.

FORDING (WADING CAPABILITY)

Avoid fording flooded roads or passing through water unless you are certain as to how deep it is. Driving through deep water can cause damage to the vehicle, including but not limited to the electrical components, engine, transmission, etc. This type of damage is not covered under the Warranty.

BODY BUILDER GUIDELINE

If you intend on making any alterations to the vehicle, we strongly recommend that you select one of the following options in order to obtain all necessary information:

1. Contact the authorized Sprinter Dealer nearest you to obtain a copy of the Sprinter Body Builder Guideline.
2. Call DaimlerChrysler Vans LLC at telephone (800) 992-1997 to request a copy of the Sprinter Body Builder Guideline (there may be a charge).
3. Write to the following address and order the Sprinter Body Builder Guideline (there may be a charge).

DaimlerChrysler Vans LLC
P.O. Box 21-8004
Auburn Hills, MI 48321-8004
United States of America

WARNING!

Any modifications or alterations of the Sprinter vehicle not in compliance with the Sprinter Body Builder Guideline and the Sprinter Operator's Manual may seriously inhibit its roadworthiness and safety and may lead to an accident resulting in serious personal injury or death. Consult the Sprinter Body Builder Guideline and the Sprinter Operator's Manual prior to initiating any alterations or modifications.

Body Builders and Dealers who makes any modifications which may affect the final certification of the engine, vehicle or equipment assume the sole responsibility for the vehicle, including labeling and documentation, affected by their modifications.

It is their responsibility to certify that the altered vehicle conforms to all applicable standards and regulations affected by the vehicle alteration or continues to comply with the Motor Vehicle Safety standards and Emissions regulations.

They are responsible for ensuring that modifications or equipment installation does not affect the safety of the vehicle.

A Special Note Concerning Vehicle Alteration

WARNING!

Any modifications or alterations of the Sprinter vehicle not in compliance with the Sprinter Body Builder Guideline and the Sprinter Operator's Manual may seriously inhibit its roadworthiness and safety and may lead to an accident resulting in serious personal injury or death. Consult the Sprinter Body Builder Guideline and the Sprinter Operator's Manual prior to initiating any alterations or modifications.

The Manufacturer is not responsible for any final certification or claims sounding in product liability, or warranty claims, which result from any component, assembly, or system being altered, or which cause non-compliance with any of the emission control standards or motor vehicle safety standards, or which would otherwise cause the vehicle to be or become defective or unsafe.

The Manufacturer does not assume the responsibility as the final stage manufacturer or the consequential product liability.

- Hazard Warning Flasher Switch 232
- Fire Extinguisher (Optional) 233
- Vehicle Tool Kit 233
- Changing the Tire 234
 - Spare Wheel Location 236
- Jack 239
 - Using the Jack 239
- Removing a Wheel 242
- Installing a Wheel 242
- Jump Starting 246
- Towing the Vehicle 248
 - If the Engine is Damaged 249
 - If the Transmission is Damaged 249
 - If the Front Axle is Damaged 249
 - If the Rear Axle is Damaged 249

HAZARD WARNING FLASHER SWITCH



The switch is located on top of the steering column housing.

When the hazard warning flasher switch is switched on, the indicator lamp in the switch and the turn signal indicator lamp in the instrument cluster both flash.

WARNING!

If the rear cargo doors are opened to 90° (detent position), the rear lights will be concealed. The vehicle is then not sufficiently safeguarded at the rear and may only be seen by other road users when they are close to the vehicle. This could lead to an accident.

The vehicle must then be clearly marked in accordance with state and local laws, e.g., with a warning triangle.

FIRE EXTINGUISHER (OPTIONAL)



1. Fire extinguisher
2. Locking mechanism

The fire extinguisher is located in the driver's side entrance area.

Pull locking mechanism (2) on the side marked with an arrow to release the tether. Take the fire extinguisher (1) from the holder with an upward movement.

NOTE: Read the manufacturer's instructions on the fire extinguisher carefully and make yourself familiar with the operation of the fire extinguisher.

VEHICLE TOOL KIT

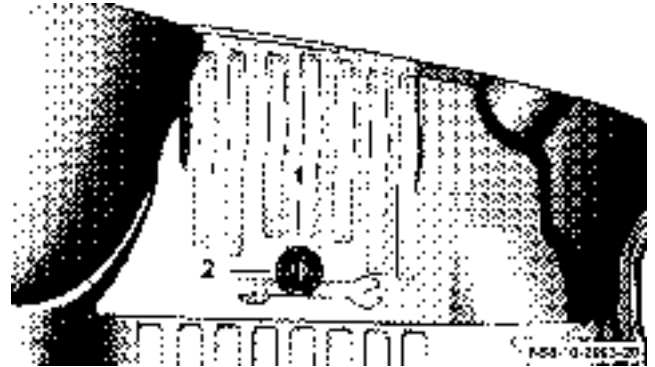

1. Locked
2. Unlocked

The vehicle tool kit and the jack are located under the hatch in the front passenger footwell.

CHANGING THE TIRE

If you get a flat tire while driving, gradually decrease your speed. Hold the steering wheel firmly and slowly move to a safe place on the side of the road. The pressure of the spare wheel always has to be checked regularly (at least after every tenth time at the filling station).

WARNING!

Fitting other wheel sizes to the vehicle will change the vehicle's handling characteristics and may lead to an accident resulting in death, severe personal injuries and property damage.

Only certain tires meeting the tire size/load/speed rating specifications contained in the Tire Pressure Tables are certified to conform to FMVSS 110 for the Sprinter vehicle at this time. Please check your side walls of your originally equipped tires for specific makes/sizes, and speed load ratings when you need to replace your tires.

To prevent accidents resulting in possible death, severe injury or property damage, use only the correct tire and wheel sizes with load ratings approved for your vehicle for your tire replacement.

WARNING!

The jack is designed exclusively for jacking up the vehicle at the jack take-up brackets built into either side of the vehicle. To help avoid personal injury, use the jack only to lift the vehicle during a wheel change. Never get beneath the vehicle while it is supported by the jack only.

Keep hands and feet away from the area under the lifted vehicle. Always firmly set parking brake and block wheels before raising vehicle with jack. Do not disengage parking brake while the vehicle is raised.

Always use the jack on a level surface.

Do not change wheels on either steep uphill or downhill grades. Be sure that the jack arm end is fully seated in the jack take-up bracket. The vehicle may begin to move and fall from the jack which could cause serious or fatal personal injury and property damage.

Always lower the vehicle onto sufficient capacity jack stands before working under the vehicle.

WARNING!

Do not jack the vehicle up more than 1.2 in (30 mm) between the tire and the surface. Otherwise, the vehicle may tip over and may cause serious injury or death to you or others.

Always lower the vehicle onto sufficient capacity jack stands before working under the vehicle.

Precautions when changing a wheel:

For tire inflation pressures, see "Tire Pressures"

For the torque, refer to "Installing a wheel";

Do not damage, grease or oil wheel bolts or their threads.

3. Everyone must leave the vehicle before you jack it up.
4. Everyone must leave the danger zone, before jacking the vehicle.
5. The vehicle must be safeguarded in accordance with legal regulations (such as using a warning triangle).
6. Prevent vehicle from rolling away by blocking wheels with wheel chocks (not supplied with vehicle) or sizable wood block or stone.
On a level road, place one chock in front of and one behind the wheel that is diagonally opposite to the wheel being changed.
When changing a wheel on mild uphill or downhill grades, place chocks on the downhill side blocking both wheels of the other axle.

Procedure:

1. Park the vehicle on a firm, level, non-slippery surface.
2. Switch on the hazard warning flasher switch, apply the parking brake, and place the transmission selector in "P".

WARNING!

Do not change wheels on either steep uphill or downhill grades. The vehicle may begin to move and fall from the jack which could cause personal injury and property damage.

Spare Wheel Location

WARNING!

If the rear cargo doors are opened to 90° (detent position), the rear lights will be concealed. The vehicle is then not sufficiently safeguarded at the rear and may only be seen by other road users when they are close to the vehicle. This could lead to an accident.

The vehicle must then be clearly marked in accordance with state and local laws, e.g., with a warning triangle.

WARNING!

The spare wheel holder should be reattached once the wheel has been changed.

Regularly check the spare wheel fastening.

A loose spare wheel or spare wheel holder could be loosen or could move around the vehicle interior uncontrollably in the event of sudden braking, a rapid change in direction or an accident. This increases the risk of injury to vehicle occupants and other road users in these situations.

Do not use retreaded/remolded tires. This process does not always permit previous damage to be detected. Therefore vehicle safety cannot be guaranteed if retreaded/remolded tires are fitted.

NOTE: Lug wrench and jack, refer to "Vehicle Tool Kit". For reasons of safety, check at regular intervals that the spare wheel is properly secured.

Spare Wheel Beneath the End of the Frame

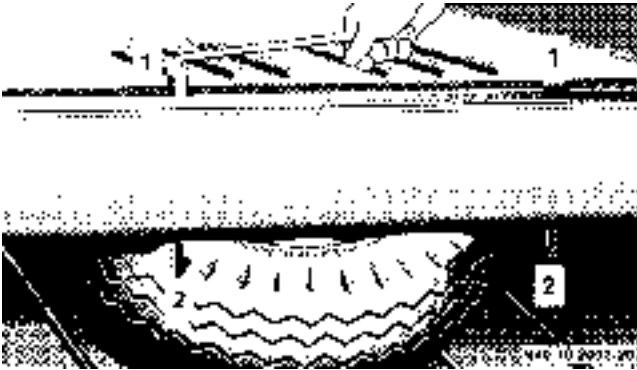

Retaining screws for the spare wheel structural member (1)

Hook (2)

1. Open the cargo doors and remove the retaining screws (1) with the lug wrench from the vehicle tool kit.
2. Lift the spare wheel structural member, unhinge the hooks (2), and lower the spare wheel structural member. Remove the spare wheel.

Spare Wheel in Cargo Area (Optional)

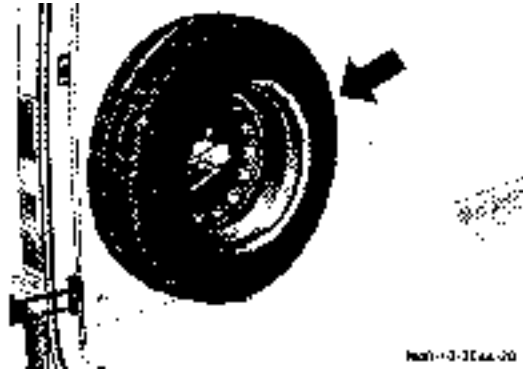

1. Open the rear cargo doors.

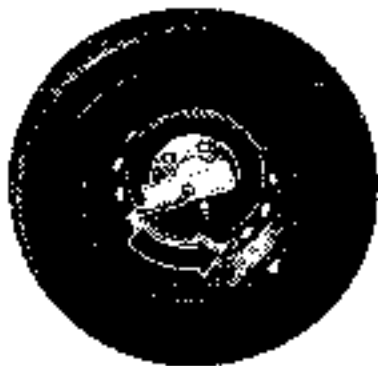

M40-10-2343-3U

2. Turn spare wheel holder to loosen.
3. Remove the spare wheel.

Spare Wheel Location for Chassis



1. Loosen thumb nuts by hand and remove.
2. Use wrench to loosen fixing nut to the thread end.
3. Lift spare wheel holder.
4. Turn hooks to the side and lower spare wheel holder. Remove the spare wheel.

JACK

WARNING!

To avoid the risk of serious or fatal injuries or vehicle damage, please bear the following points in mind:

- The jack is intended only for raising the vehicle briefly, for instance, when changing a wheel. If it is not designed to enable work to be carried out underneath the vehicle.

Do not crawl under the jacked-up vehicle. For work under the vehicle, stands must be used.

- The jack must be placed on a firm, flat surface only.
- Do not change wheels on uphill or downhill gradients under any circumstances.
- Make sure that no persons are present in the vehicle when jacking up the vehicle.
- Do not start the engine while the vehicle is raised.
- Make sure that the distance between the underside of the tires and the ground does not exceed 1.2 in (30 mm). Otherwise the vehicle may tip over.

Using the Jack

The jack is located together with the vehicle tool kit under the hatch in the front passenger footwell, refer to "Vehicle Tool Kit".

1. Loosen the wheel bolts before raising the vehicle.
2. Close the release valve on the jack.
3. Assemble the pump lever provided and insert it into the socket on the jack.
4. Secure the lever by turning it clockwise in the socket.

Position the jack under the appropriate jack point and raise the vehicle by pumping the lever.

Front Axle Jack Point (All Vehicles)

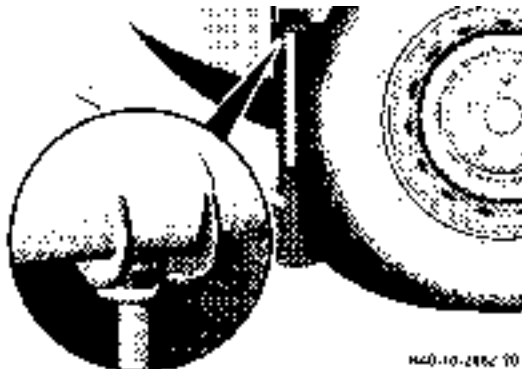

The vehicle jacking point is located under the longitudinal member in front of the front axle.

Rear Axle Jack Point for 8,550 lbs (3,880 kgs) (Vehicle type 2500 HC/SHC)

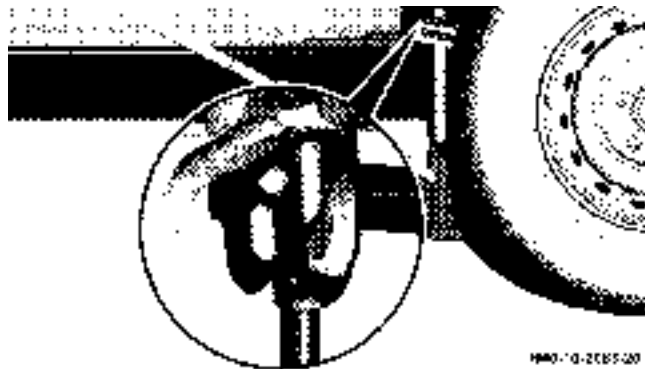

The vehicle jacking point is located under the longitudinal member in front of the rear axle.

CAUTION!

Do not position the jack at the leaf spring or the differential housing.

**Rear Axle Jack Point for 9,990 lbs (4,530 kgs)
(Vehicle type 3500 HC/SHC)**

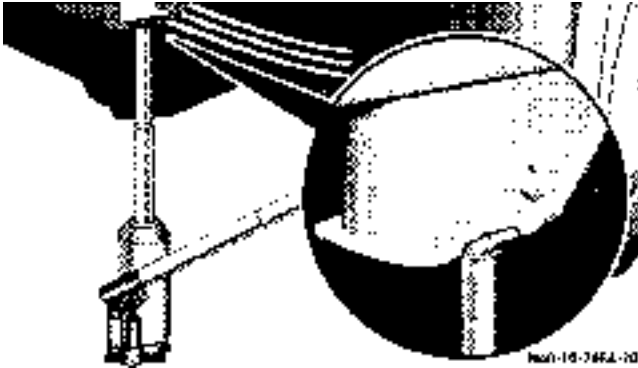

The vehicle jacking point is located under the longitudinal member in front of the rear axle.

CAUTION!

Do not position the jack at the leaf spring or the differential housing.

**Rear Axle Jack Point for Chassis
(Vehicle type 2500 C and 3500 C)**

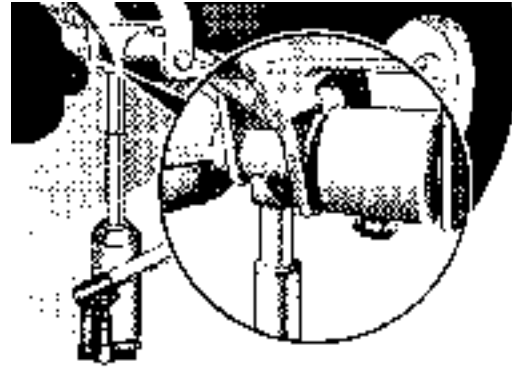

The vehicle jacking point is locked next to the front recess for the leaf spring.

CAUTION!

Do not position the jack at the leaf spring or the differential housing.

REMOVING A WHEEL

1. Loosen the wheel bolts/nuts.
2. Jack up the vehicle until the wheel is clear of the ground.
3. Unscrew the wheel bolts and remove the wheel (keep the wheel bolts clean).

NOTE: If the vehicle moves forwards or backwards while it is being jacked-up, lower it again and reposition the jack. When the vehicle is jacked-up, the jack must stand vertically (plumb-line).

INSTALLING A WHEEL



Wheel bolts for pressed steel wheels (1)

Wheel bolts for light-alloy wheels (Optional) (2)

WARNING!

Different wheel bolts are required for pressed steel and light-alloy wheels.

Incorrect wheel lug bolts for the wheels could work loose, thereby causing you to lose control of the vehicle. This could cause an accident resulting in severe personal injuries and and property damage.

NOTE: The optional light alloy wheels are supplied with 5 short wheel lug bolts enclosed for the steel spare wheel in the vehicle tool kit.

- Before fitting the spare wheel, clean rust and dirt off the contact surfaces of the wheel and the wheel hub, and from the wheel bolts.
- Note the specified wheel and tire size, tire load capacity and speed code.
- Do not change the tire's direction of rotation.
- Do not damage, grease or oil wheel bolts or their threads.

WARNING!

Incorrect mounting bolts or improperly tightened mounting bolts can cause the wheel to come off. To avoid the risk of serious or fatal injuries or vehicle damage, please bear the following points in mind:

- Always replace wheel bolts that are damaged or rusted.
- Never apply oil or grease to wheel bolts
- If a wheel hub thread is damaged, you must not drive the vehicle. Consult a qualified specialist workshop.
- Only use genuine DaimlerChrysler wheel bolts specified for your vehicle's rims.

Centering wheels with wheel bolts/nuts

- If dual assemblies are used, before placement the inner wheel should be inspected to ensure that all ball bearing rings are in proper position.
- Install the wheel and snug the wheel bolts/nuts.
- Slightly tighten wheel bolts/nuts.
- Slowly open jack release valve to lower vehicle until tire is resting on ground.

WARNING!

Do not tighten the wheel bolts and wheel nuts completely while the vehicle is still jacked up. The vehicle could tip.

- Tighten the wheel bolts/nuts in a crosswise pattern to the specified torque with a torque wrench.

Vehicle Type	2500 C/H/SHC				3500 C/HC/SHC	
Tire	225/70 R 15 C		LT 225/775 R 16		195/70 R 15 C	LT 225/75 R 16
Rim	steel 6J x 15 ET75	light-alloy 7J x 15 ET76	steel 6J x 15 ET75	light-alloy 6.5J x 16 ET70	steel 5.5J x 15 HMA115	steel 6J x 16 HMA129.5
Wheel fitting	wheel bolts				wheel nuts	
Tightening torque	133 lbf.ft \pm 7 lbf.ft (180 N.m \pm 10 N.m)		177 lbf.ft \pm 7 lbf.ft (240 N.m \pm 10 N.m)		133 lbf.ft \pm 7 lbf.ft (180 N.m \pm 10 N.m)	

- Remove jack and stow it in the vehicle tool kit.
- Check the tire inflation pressure.
- Re-tighten the wheel bolts/nuts to the specified torque with a torque wrench after a distance of 30 miles (about 50 km).

WARNING!

After changing a wheel, you must, for safety reasons,

- have the specified tightening torque checked. The wheels could otherwise work loose.
- check the tire inflation pressure and correct it if necessary.
- retighten the wheel bolts and wheel nuts to the specified tightening torque once the vehicle has been driven for 30 miles (50 km). If new or repainted wheels are fitted, the wheel bolts or nuts must be retightened again after about 600 to 3,000 miles (about 1,000 to 5,000 km).
- have a reversed direction of tire rotation corrected as soon as possible at a qualified specialist workshop. The vehicle handling characteristics could otherwise be affected.

JUMP STARTING

If the battery is dead, the engine can be started with jumper cables from another vehicle's battery.

WARNING!

A battery will produce hydrogen gas, which is flammable and very explosive. Avoid open flames and the formation of sparks in the vicinity of the batteries. Refrain from smoking or cell phone use. Avoid improper connection of jumper cables.

Observe safety precautions when handling batteries.

Exercise care near moving engine components and electrical cables.

Failure to follow these directions will cause damage to the electronic components and can lead to a battery explosion and severe injury or death.

WARNING!

Battery fluid contains sulfuric acid. Do not allow this fluid to come in contact with eyes, skin or clothing. In case it does, immediately flush affected area with water, and seek medical help.

The battery housing could be damaged. Never lean over batteries while connecting or jump-starting. You might get injured.

Read all instructions before proceeding.

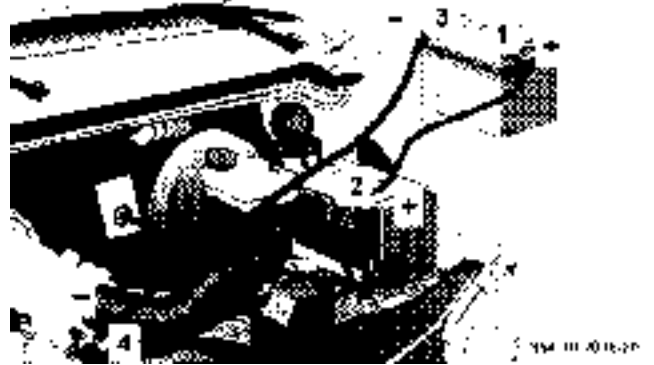
**6**

- A dead battery can freeze at a temperature of 14 °F (-10 °C). Never try to start the engine if the battery is frozen. Thaw the battery out first.
- Only use a battery of the same rated voltage and of approximately the same capacity for jump-starting.
- The two vehicles must not touch.
- Switch off all electrical accessories.
- Run the vehicle with the booster battery at idle.
- Connect the jumper cables in the sequence given in the illustration.

1. First connect the positive terminals of the two batteries (see illustration, Items 1 + 2). Start with the booster battery.
2. Then connect the negative terminal of the vehicle with the booster battery to a vehicle ground point of the vehicle with the discharged battery, such as to the engine block (see illustration, Items 3 + 4). Start with the booster battery.
3. Start the engine in the customary manner.
4. Allow the engine to run for a short time.
5. Before disconnecting the jumper cables from the vehicle with the booster battery, switch on an electrical consumer (e.g. the blower, but not the lamps).
6. Disconnect the jumper cables in the reverse order to that in which they were connected.
7. Disconnect the jumper cable from negative terminal and vehicle ground point first (see illustration, items 3 + 4), then from positive terminals of the batteries (see illustration 1 + 2).

NOTE: Never try to start the engine with the aid of a battery quick-charge unit.

TOWING THE VEHICLE



F43-80-2001

WARNING!

Do not tow the vehicle if the key cannot be turned in the ignition lock.

If the key cannot be turned, the ignition lock remains locked and the vehicle cannot be steered.

With the engine not running there is no power assistance for the braking and steering systems.

In this case, it is important to keep in mind that a considerably higher degree of effort is necessary to brake and steer the vehicle.

The vehicle must not be towed with the front axle raised and the key in position 2 in the ignition lock as the drive wheels could then lock due to the acceleration skid control (ASR) or the optional Electronic Stability Program (ESP®)*.

*Vehicle Type 2500 only

If the Engine is Damaged

For towing distances up to 30 miles (about 50 km)

- Shift gear selector lever to "N" position.
- Do not exceed a towing speed of 30 mph (50 km / h).

For towing distances greater than 30 miles (about 50 km)

- Remove the propeller shafts leading to the drive axles.
The vehicle can be towed without restriction.

If the Transmission is Damaged

- Remove the propeller shafts leading to the drive axles.

If the Front Axle is Damaged

- Raise the front axle.
- Observe the same towing restrictions as for engine damage.

If the Rear Axle is Damaged

- Raise the rear axle.

NOTE: Comply with local legal regulations regarding towing vehicles.

MAINTAINING YOUR VEHICLE

CONTENTS

- Engine Compartment 253
- Sprinter Original Parts 255
- Service Products 255
 - Disposal of Service Products 256
- Emission Related Component Warranty Statement 256
- Regular Checks 256
 - Windshield Washer System Fluid Reservoir 257
 - Air Filter Restriction Indicator (Optional) 258
 - Approved Engine Oils 258
 - Engine Oil Level 259
 - Ribbed V-Belt 260
 - Hydraulic Brake System, Clutch Mechanism Fluid Level 261
 - Brake fluid 261
 - Engine Cooling System 261
 - Engine Coolant 262
 - Checking Coolant Level 263
- Winter Operation 265
- Batteries 265
 - Disconnecting the Battery 266
 - Reconnecting the Battery 266
 - Charging the Battery 267
- Replacing Wiper Blades 268
 - Appearance Care and Corrosion Protection 269
 - Power Washer 271
 - Automatic Car Wash 271
 - Tar Stains 272
 - Paintwork, Painted Body Components 272
 - Engine Cleaning 272
 - Vehicle Washing 272
 - Ornamental Moldings 273

- Headlamps, Taillamps, Identification Lamps, Turn Signal Lenses 273
- Reversing Aid Sensors 273
- Window Cleaning 274
- Wiper Blade 274
- Light Alloy Wheels 275
- Instrument Cluster 275
- Steering Wheel and Gear Selector Lever 275
- Cup Holder 275
- Seat Belts 275
- Headliner and Shelf Below Rear Window 275
- Upholstery 276
- Hard Plastic Trim Items 276
- Plastic and Rubber Parts 276
- Electrical Fuses 276
 - Standard Fuse and Relay Equipment 277
 - Relay Assignment, Standard Equipment 281
 - Fuse and Relay Optional Equipment 281
- Bulb Replacement 284
 - Front Lamp Unit 284
 - Taillamps 289
 - License Plate Lamps (Cargo/Passenger Vans Only) 291
 - Additional Brake Lamp (Cargo/Passenger Vans Only) 291
 - Side-Mounted Turn Signals 292
 - Side-Marker Lamps, Standing Lamps (Optional) 292
 - Identification Lamps (Cargo/passenger vans only) 293
 - Interior Lighting in Passenger Compartment and Load Compartment 293
 - Interior Lighting with Reading Lamp 294
 - Interior Lighting with Interior Sensor Protection 294
 - Exit Lamps (Optional) 295
- Capacities 296
 - Recommended Fluids and Lubricants 297

ENGINE COMPARTMENT

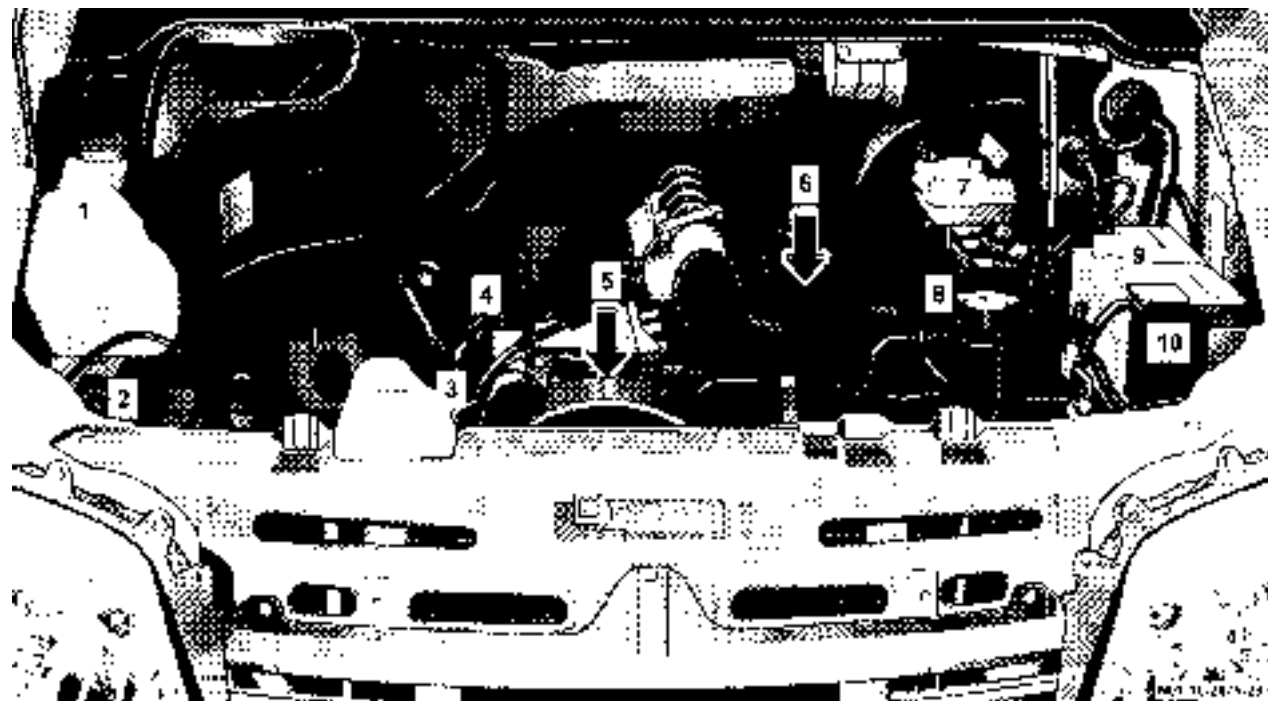

Legend For Engine Compartment

1. Washer system fluid reservoir.
2. Maintenance indicator for air cleaner element (Optional).
3. Oil dipstick.
4. Oil filler neck.
5. Ribbed V-belt.
Auxiliary drive (Optional) refer to "Auxiliary drive".
6. Fuel filter with water separator.
7. Hydraulic brake fluid reservoir.
8. Coolant reservoir.
9. Battery
The auxiliary battery is located underneath the front passenger seat (optional equipment).
10. Fuse box
(These special fuses should only be replaced at by an authorized Sprinter Dealer).

SPRINTER ORIGINAL PARTS

Every authorized Sprinter Dealer maintains a stock of Sprinter original parts for maintenance and repair work.

Over 6,000 retailers around the world guarantee that you can be supplied with Sprinter original parts wherever you are. Over 300,000 different parts and assemblies, including parts for older vehicle models, are distributed from a central parts warehouse using an optimally tuned logistics concept.

Sprinter original parts are subjected to the most stringent quality inspections and will ensure that the vehicle is maintained at a high level of operating efficiency and safety, and that it maintains its value. Each part has been specifically designed and manufactured or selected and approved for use in Sprinter vehicles.

It is therefore best to use only Sprinter original parts.

For cost-effective repairs in accordance with sound recycling principles, the use of non-genuine parts and accessories not authorized by the manufacturer could damage the vehicle or compromise its durability or safety.

When ordering original parts, always provide the vehicle identification number and the engine number.

SERVICE PRODUCTS

Mechanical elements and the lubricants used for them must be carefully matched.

For this reason, only brands tested and approved by the manufacturer should be used. Please contact your Sprinter Dealer to obtain the necessary information. No lubricant additives should be used.

The use of such additives could affect your warranty rights. Information is available from any authorized Sprinter Dealer.

For specifications of engine oils, coolant and brake fluid, contact your authorized Sprinter Dealer.

WARNING!

If handled incorrectly, service products can constitute a health risk for people and an environmental hazard.

Always observe relevant guidelines for handling, storing and disposing of service products.

Disposal of Service Products

Dispose of service products and of parts which come into contact with them (e.g. filters) in an environmentally responsible manner. Comply with applicable laws and regulations.

EMISSION RELATED COMPONENT WARRANTY STATEMENT

The Manufacturer warrants to the original and each subsequent owner of a Sprinter heavy-duty on highway diesel engine that:

- (1) the engine was designed, built and equipped so as to conform at the time of sale with the applicable regulations adopted by the Federal Environmental Protection Agency, and
- (2) the emission control system of such engine is free from defects in materials and workmanship which would cause it not to conform with those regulations for a period of use of five years or 100 000 miles or 3 000 hours of engine operation, whichever occurs first.

REGULAR CHECKS

WARNING!

When the hood is open, there is a risk of injury due to very hot engine components.

When the engine is running or the key is in position 2 in the ignition lock, there is a risk of injury due to moving engine components and the electrical system.

If you see flames or smoke coming from the engine compartment, or if the coolant temperature gauge indicates that the engine is overheated, do not open the hood. Move away from vehicle and do not open the hood until the engine has cooled. If necessary, call the fire department.

The following checks should be performed at regular intervals (for example once a week or each time the vehicle is refueled):

- Windshield washer system/headlamp cleaning system (optional) – washer system fluid reservoir.
- Air strainer, in vehicles with an air strainer element maintenance indicator (optional equipment).
- Engine oil level.
- Checking ribbed V-belt.
- Hydraulic brake system, clutch mechanism fluid level.
- Coolant level.
- Tire and spare wheel condition and pressures of the same. For more information, refer to "Wheels and Tires".
- Spare wheel location.
- Vehicle lighting.

Windshield Washer System Fluid Reservoir



1. Washer system fluid reservoir

When topping off, add windshield washer fluid ("S" for summer or "W" for winter) to the water.

Capacity of fluid reservoir (1): about 7.4 US qt (7 liters).

Air Filter Restriction Indicator (Optional)



The indicator on the air filter housing in the engine compartment shows the degree of contamination in the air filter element. If the red field reaches the 100 % range, the air filter element should be replaced as soon as possible.

Approved Engine Oils

NOTE: Use only engine oils that are labeled on the container as meeting the specifications of API (American Petroleum Institute) and/or DaimlerChrysler specification sheets MB 228.3, 228.5, 229.3 and 229.5, such as MOPAR® SAE 15W-40 HD Diesel Engine Oil (e.g. MOPAR® Part No. 04798231AD), or equivalent.

Always refer to the following viscosity chart for the proper viscosity grade based on ambient temperature. Select oil viscosity according to the lowest air temperature expected before the next oil change.

For further information, contact your authorized Sprinter Dealer.

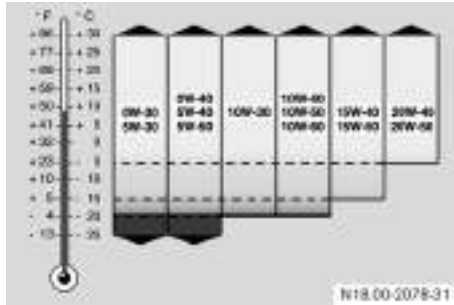

Engine Oil Level



1. Oil dipstick
2. Oil filler neck

NOTE: This chart supercedes ALL previously published viscosity charts.

Check the engine oil level at regular intervals with the vehicle standing on a level surface.

- Check engine oil level about 5 minutes after stopping the engine, which should have reached its regular operating temperature. The normal operating temperature should have been reached and maintained for some time.
- Wipe the dipstick clean with a lint-free cloth before checking.



The engine oil level must be between the lower (MIN) and upper (MAX) marks on the dipstick.

Add engine oil only up to the MAX mark. Excess oil must be drained or siphoned off.

Ribbed V-Belt

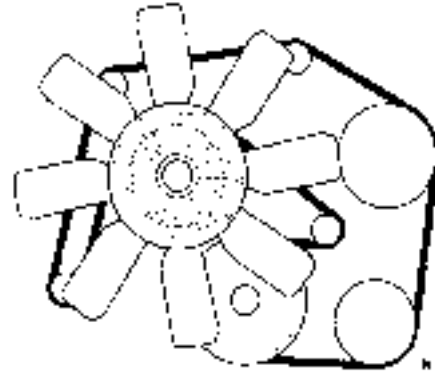

The ribbed V-belt drives the accessories, such as generator, coolant pump and hydraulic steering pump.

The ribbed V-belt is automatically tensioned.

Check the state of the ribbed V-belt regularly, such as at every engine oil level check.

The belt must not be damaged, worn, oiled or glazed. There must be no cracks in the belt running surface.

Replace damaged belts.

Hydraulic Brake System, Clutch Mechanism Fluid Level



1. Brake fluid reservoir

Brake fluid level must be between the MIN and MAX marks in the reservoir (1).

If the brake fluid is below the MIN mark, there may be a fault in the hydraulic system. Have the system checked as soon as possible by an authorized Sprinter Dealer.

Brake fluid

Refer to the "Recommended Fluids" chart later in this section for recommended brake fluids.

In the course of its service life, the boiling point of the brake fluid will fall due to the continuous absorption of moisture from the atmosphere.

If the brakes are placed under heavy loads (e.g., on steep hills) bubbles of steam can then form in the brake system.

This will adversely affect the brakes' effectiveness.

Engine Cooling System

The use of aluminum components in Sprinter engines requires that anticorrosive/antifreeze specifically formulated to protect aluminum parts be used. The factory approved Service Products are suitable for Sprinter engines and can be mixed with the original anticorrosion/antifreeze filled in at factory.

Cooling system design and anticorrosion/antifreeze agent used stipulate the replacement interval for the coolant solution in your vehicle. Please observe the replacement interval specified in the Service Booklet for your vehicle.

Failure to use MB 325.0 anticorrosion/antifreeze and/or equivalent to DaimlerChrysler material standard MS-9769 and/or adhere to the specified replacement interval may result in a significantly shortened service life.

For coolant composition and water quality, contact your authorized Sprinter Dealer.

Engine Coolant

The coolant is a mixture of water and a corrosion inhibitor/antifreeze additive. Within the cooling system, the corrosion inhibitor/antifreeze ensures

- anti-corrosion protection
- antifreeze protection
- a higher boiling point.

The coolant added in the factory ensures adequate antifreeze and anti-corrosion protection.

Refer to the "Recommended Fluids" chart for coolant recommendations.

For reasons of anti-corrosion protection and to increase the boiling point, the coolant added to the cooling system is designed for all year round operation – even in countries with high prevailing temperatures.

Have the coolant renewed at least every 15 years or after 160,000 miles.

When the coolant is renewed, the new coolant should contain 50% antifreeze/corrosion inhibitor by volume. This corresponds to antifreeze protection down to -37 °C/-35°F.

Do not exceed a proportion of about 55 % by volume (antifreeze protection down to about -45 °C/-49 °F) as the heat dissipation properties then deteriorate.

In the event of coolant loss, do not add water only, but sufficient antifreeze/corrosion inhibitor to maintain the correct concentration.

The water in the coolant must satisfy certain requirements. These are often met by tap supply drinking water.

The water must be specially prepared if the water quality does not come up to the required standards.

Have the corrosion inhibitor/antifreeze concentration in the coolant checked at the outset of winter, respectively once a year in countries with high prevailing temperatures.

A regular check is included in the maintenance service.

Checking Coolant Level

Pressure cap on coolant reservoir (1)



The cooling system is pressurized. Only check the coolant level with the vehicle parking on a level surface and with the engine switched off.

- Wait until the coolant temperature has dropped below 194 °F (+90 °C).

WARNING!

In order to avoid any possibly serious burns:

- If you see flames or smoke coming from the engine compartment, or if the coolant temperature gauge indicates that the engine is overheated, do not open the hood. Move away from the vehicle and do not open the hood until the engine has cooled. If necessary, call the fire department.
- Do not remove pressure cap on coolant reservoir if engine temperature is above 194 °F (+90 °C). Allow engine to cool down before removing cap. The coolant reservoir contains hot fluid and is under pressure.
- Using a rag, slowly open cap approximately 1/2 turn to relieve excess pressure. If opened immediately, scalding hot fluid and steam will be blown out under pressure.

WARNING!

- **Do not spill antifreeze on hot engine parts. Antifreeze contains ethylene glycol which may burn if it comes into contact with hot engine parts.**
- **Check coolant level only with the engine switched off and the key in position 0 in the ignition lock.**

- Open the hood.
- At first, only turn the pressure cap on coolant reservoir to the first detent to release the pressure from the cooling system. Only then should the pressure cap be removed completely.
- To add coolant:
If the engine is cold:
Add coolant until the coolant level reaches the base area which is visible through the filler opening (area moistened).

If the engine is already at its regular operating temperature:

Add coolant until the coolant level is about 0.6 inch (1.5 cm) above the base area which is visible through the filler opening.

- Replace and tighten the pressure cap on coolant reservoir.

If a large quantity of coolant has been lost, or if smaller amounts are lost at regular intervals, have the engine cooling system examined by an authorized Sprinter Dealer.

For coolant composition and water quality, contact your Sprinter Dealer.

WINTER OPERATION

Have your vehicle winterized by an authorized Sprinter Dealer before the onset of winter.

- Have the engine oil changed, if the engine oil filled is not approved for winter use.
- Coolant: antifreeze/anti-corrosion concentration in the coolant checked.
- Windshield washer system and headlamp cleaning system (optional): add windshield washer fluid "winter wash" to the water, depending on ambient temperatures.
- Battery: the battery will lose capacity as temperatures drop. Only a well-charged battery will ensure reliable engine starting even at low outside temperatures.
- Tires: fit M+S radial tires with a minimum tread depth of approximately 1/6 in (4 mm) on all wheels for the winter season.

BATTERIES

WARNING!

Failure to follow these instructions can result in severe personal injuries and death.

Never lean over batteries while connecting, you might get injured, if the battery explodes.

Battery fluid contains sulfuric acid. Do not allow this fluid to come in contact with eyes, skin or clothing. In case it does, immediately flush affected area with water and seek medical help if necessary.

A battery will also produce hydrogen gas, which is flammable and explosive. Keep flames or sparks away from battery, avoid improper connection of jumper cables, smoking etc.

Use only impact-resistant batteries with a central gas release cover to prevent corrosion damage and to prevent occupants from caustic burns in the event of an accident.

The standard battery is located in the engine compartment.

The auxiliary battery is located underneath the front passenger seat (optional equipment).

The battery will not achieve its maximum service life unless it is kept adequately charged at all times. If the vehicle is used primarily for short distances, or left parked for lengthy periods, have the battery charge checked more frequently.

Disconnecting the Battery

CAUTION!

Do not loosen or remove the battery terminal clamps while the engine is running or the key is in the ignition lock as this could damage electrical or electronic equipment beyond repair. All electrical consumers must be switched off.

Do not place any metal objects on the battery. Doing so may cause a short-circuit.

Loosen and remove the negative terminal clamp first, then the positive terminal.

Afterwards disconnect vent tube from the fitting.

Reconnecting the Battery

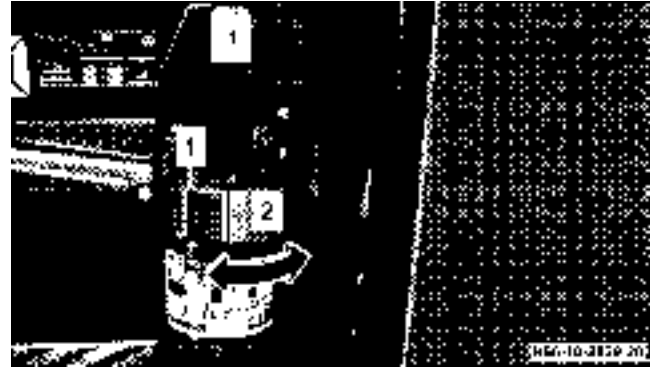

Vent tube (1)

Fitting (2)

All electrical consumers must be switched off. First connect and tighten the positive terminal clamp, then the negative terminal. Make sure that the terminal clamps are not switched.

NOTE: If batteries have to be replaced, only use batteries with a central vent cap as this will prevent corrosion damage.

Connect the battery vent tube (1) to the fitting (2).

Charging the Battery

Disconnect the battery before charging it with a battery charger.

Comply with the operating instructions for the battery charger.

To ensure that the battery is disposed of in an environmentally responsible manner, it should only be replaced by an authorized Sprinter Dealer.

Batteries contain material that can harm the environment with improper disposal.

Large 12 volt storage batteries contain lead.

Recycling of batteries is the preferred method of disposal.

Many states require sellers of batteries to accept old batteries for recycling.

WARNING!

- Use only refrigerants and compressor lubricants approved by the manufacturer for your air conditioning system. Some unapproved refrigerants are flammable and can explode, injuring you. Other unapproved refrigerants or lubricants can cause the system to fail, requiring costly repairs. Refer to Section 3 of the Warranty Information Book for additional warranty information.
- The air conditioning system contains refrigerant under high pressure. To avoid risk of personal injury or damage to the system, adding refrigerant or any repair requiring lines to be disconnected should be done by an experienced repairman.

Refrigerant Recovery and Recycling

R-134a Air Conditioning Refrigerant is a hydrofluorocarbon (HFC) that is endorsed by the Environmental Protection Agency and is an ozone-saving product. However, the manufacturer recommends that air conditioning service be performed by dealers or other service facilities using recovery and recycling equipment.

REPLACING WIPER BLADES

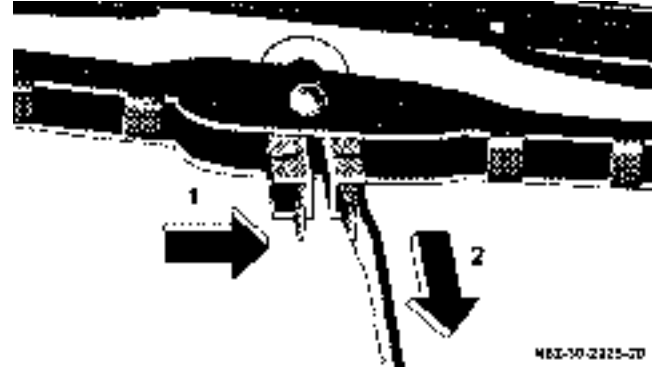

1. Fold over the wiper arm (2) and place the wiper blade crosswise.
2. Press the retaining spring (1) and push the wiper blade out of the end of the wiper arm (2).
3. Remove the wiper blade.

Appearance Care and Corrosion Protection



4. Insert the end of the wiper arm (2) into the larger cutout (3) of the wiper blade.
5. Push the wiper blade into the end of the wiper arm (2) until the retaining spring (1) engages.

WARNING!

Many cleaning products can be hazardous. Some are poisonous, others are flammable. Always keep cleaning products sealed and out of the reach of children. Always follow the instructions on the particular container. Always open your vehicle's doors or windows when cleaning the inside.

Never use fluids or solvents that are not designed for cleaning your vehicle. Do not use fuel as a cleaning agent. Fuel is flammable and constitutes a health hazard.

In operation, your vehicle is subjected to varying external influences which, if gone unchecked, can attack the paintwork as well as the underbody and cause lasting damage.

Such damage is caused not only by extreme and varying climatic conditions, but also by air pollution, road salt, tar, gravel and stone chipping. Grease and oil, fuel, coolant, brake fluid, bird droppings, insects,

tree resins etc. should be removed immediately to avoid paint damage. Frequent washing reduces and/or eliminates the aggressiveness and potency of the above adverse influences.

More frequent washings are necessary to deal with unfavorable conditions; for example operation near the ocean, in industrial areas (smoke, exhaust emissions), or during the winter months.

You should check your vehicle from time to time for stone chipping or other damage. Any damage should be repaired as soon as possible to prevent the start of corrosion.

In doing so, do not neglect the underside of the vehicle. A prerequisite for a thorough check is a washing of the underbody followed by a thorough inspection. Damaged areas need to be undercoated again.

Your vehicle has been treated at the factory with a wax-base rustproofing in the body cavities which will last for the lifetime of the vehicle. Post-production treatment is neither necessary nor recommended by DaimlerChrysler Corporation.

Because of the possibility of incompatibility between materials used in the production process and others applied later.

WARNING!

Never use openings in the bodywork as steps. You could otherwise damage the vehicle and it could lead to an accident.

CAUTION!

Do not use abrasive or strong cleaning materials such as steel wool or scouring powder, which will scratch metal and painted surfaces.

Scratches, corrosive deposits, corrosion or damage due to negligent or incorrect care cannot always be removed or repaired with car-care products. In such cases it is best to seek aid by your authorized Sprinter Dealer.

The following topics deal with the cleaning and care of your vehicle and give important "how-to" information as well as references to car-care products.

Power Washer

When using a power washer for cleaning the vehicle always observe manufacturers' operating instructions.

CAUTION!

Never use a round nozzle to power wash tires. The intense jet of water can result in damage to the tire. Always replace a damaged tire.

Always keep the jet of water moving across the surface. To avoid damaging the vehicle, do not aim the water jet directly at electrical components, end of electrical lines, electrical connectors, intake or ventilation openings, brake hoses, door joints, seals, other rubber parts.

Automatic Car Wash

If the vehicle is very dirty, prewash it before you drive into the car wash.

WARNING!

Smears impair visibility, which is impaired further by unfavourable conditions (e.g. fog, darkness, driving snow).

If a wax preservative is sprayed on after washing the vehicle, wipe off the wax from the windshield and the wiper blade rubbers. This will prevent smears forming on the windshield.

Fold in the exterior mirrors before washing the vehicle in an automatic car wash and make sure that the windshield wiper switch is in position 0.

The exterior mirrors and windshield wipers could otherwise be damaged.

Make sure that mirrors are fully folded out after leaving the automatic car wash.

Tar Stains

Quickly remove tar stains before they dry and become more difficult to remove. A tar remover is recommended.

Paintwork, Painted Body Components

Paint care should be applied when water drops on the paint surface do not "bead up", normally every 3 to 5 months, depending on climate and washing detergent used.

Paint cleaner should be applied if paint surface shows signs of dirt embedding (i.e. loss of gloss).

Do not apply any of these products or wax if your vehicle is parked in the sun or if the hood is still hot.

Use the appropriate paint stick for quick and provisional repairs of minor paint damage (i.e., chips from stones, vehicle doors etc.).

Engine Cleaning

Prior to cleaning the engine compartment, make sure to protect electrical components and connectors from the intrusion of water and cleaning agents.

Corrosion protection, such as anticorrosion wax should be applied to the engine compartment after every engine cleaning. Before applying, all control linkage bushings and joints should be lubricated. The poly-V-belt and all pulleys should be protected from any wax.

Vehicle Washing

Do not use hot water or wash your vehicle in direct sunlight. Use only a mild car wash detergent.

Thoroughly spray the vehicle with a diffused jet of water. Direct only a very weak spray towards the ventilation intake. Use plenty of water and rinse the sponge and chamois frequently.

Rinse with clear water and thoroughly wipe dry with a chamois. Do not allow cleaning agents to dry on the finish.

Due to the width of the vehicle, prior to running the vehicle through an automatic car wash, fold back the outside mirrors to prevent them from getting damaged.

In the winter, thoroughly remove all traces of road salt as soon as possible.

When washing the underbody, do not forget to clean the inner sides of the wheels.

WARNING!

Dirty or iced-up steps and entrances create a risk of slipping or falling.

Keep steps, entrances and footwear free from dirt (e.g. mud, clay, snow and ice).

Ornamental Moldings

For regular cleaning and care of very dirty chrome-plated parts, use a chrome cleaner.

Headlamps, Taillamps, Identification Lamps, Turn Signal Lenses

Use a mild car wash detergent with plenty of water.

To prevent scratches, never apply strong force and use only a soft, non-scratchy cloth when cleaning the lenses. Do not attempt to wipe dirty lenses with a dry cloth or sponge.

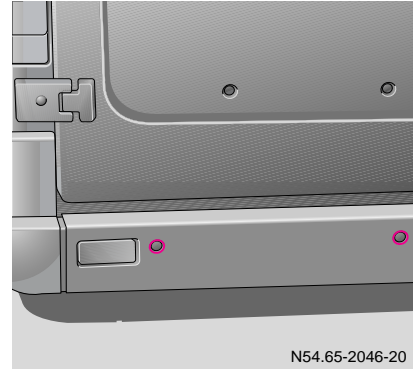

Reversing Aid Sensors

Use a mild car wash detergent with plenty of water.

To prevent scratches, never apply strong force and use only a soft, non-scratchy cloth when cleaning the sensors. Do not attempt to wipe dirty sensors with dry, coarse or hard cloths and do not scrub. You will otherwise scratch or damage the sensors.

If you clean the sensors using a high-pressure cleaner, only direct it at the sensors for a short period and maintain a minimum distance of 4 in (10 cm) from the sensors.

Window Cleaning

Use a window cleaning solution on all glass surfaces. An automotive glass cleaner is recommended.

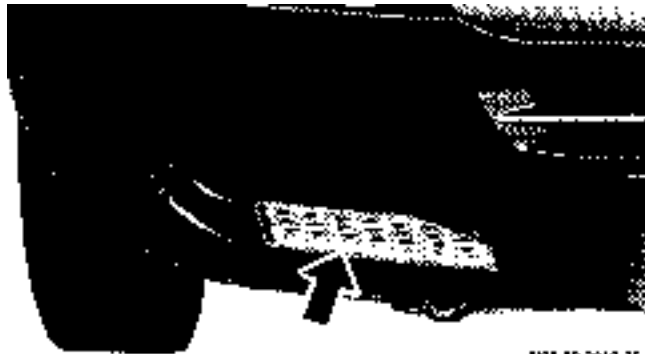

F438-80-2010-25

There are 2 steps in the front bumper. This makes it easier to clean the windshield.

WARNING!

For safety reasons, remove key from ignition lock before cleaning the windshield, otherwise the wiper motor can suddenly turn on and cause injury.

Dirty or iced-up steps create a risk of slipping or falling. Do not use the step in the front bumper when it is icy or dirty.

Wiper Blade

Clean the wiper blade rubber with a clean cloth and detergent solution.

WARNING!

For safety reasons, remove key from ignition lock before cleaning the wiper blade, otherwise the wiper motor can suddenly turn on and cause severe personal injuries and death.

Light Alloy Wheels

A wheel care product should be used for regular cleaning of the light alloy wheels.

If possible, clean wheels once a week, using a soft bristle brush and a strong spray of water.

Follow instructions on container.

NOTE: Use only acid-free cleaning materials. The acid could lead to corrosion.

Instrument Cluster

Use a gentle dishwashing detergent or mild detergent for delicate fabrics as a washing solution. Wipe with a cloth moistened in lukewarm solution. Do not use scouring agents.

Steering Wheel and Gear Selector Lever

Wipe with a damp cloth and dry thoroughly or clean with a leather care product.

Cup Holder

Use a gentle dishwashing detergent or mild detergent for delicate fabrics as a washing solution. Wipe with a cloth moistened in lukewarm solution. Do not use scouring agents.

Seat Belts

The webbing must not be treated with chemical cleaning agents. Use only clear, lukewarm water and soap. Do not dry the webbing at temperatures above 176 °F (+80 °C) or in direct sunlight.

WARNING!

Do not bleach or dye seat belts as this may severely weaken them. Due to this treatment they may not be able to provide adequate protection. For example, in a crash the belts can be torn.

Headliner and Shelf Below Rear Window

Clean with soft bristle brush, or use a dry-shampoo cleaner in case of excessive dirt.

Upholstery

Using aftermarket seat covers or wearing clothing that have the tendency to give off coloring (e.g. when wet etc.) may cause the upholstery to become permanently discolored. By lining the seats with a proper intermediate cover, contact discoloration will be prevented.

Leather Upholstery

Wipe leather upholstery with a damp cloth and dry thoroughly or clean with a leather care product. Exercise particular care when cleaning perforated leather as its underside should not become wet.

Cloth Upholstery

Clean with soft bristle brush, or use a dry-shampoo cleaner in case of excessive dirt.

Tex Upholstery

Pour an interior care product onto soft lint-free cloth and apply with light pressure.

Hard Plastic Trim Items

Pour an interior care product onto soft lint-free cloth and apply with light pressure.

Plastic and Rubber Parts

Do not use oil or wax on these parts.

Do not use any caustic or alcohol-based or solvent-based substances to clean plastic surfaces.

Avoid the use of stain removers, iodine tincture, nail varnish and nail varnish remover, acetone, methylated spirits, chlorine or ammonium-based cleaning agents, cleaning agents containing abrasive substances.

ELECTRICAL FUSES

Damaged fuses are recognizable from their burnt-out filament.

Prior to exchanging a fuse, turn the key in the ignition-column lock to the 0 position and switch off the consumer involved.

NOTE: Fuses must not be bridged. Replace fuses with specified rated current. Only replace fuses when the cause of the malfunction has been rectified.

NOTE: Fuses and relays (standard equipment) are on the underside of the ignition column, refer to "Fuses and Relays Standard Equipment".

Fuses, relays and diodes (optional equipment) are below the driver's seat, refer to "Optional Fuse and Relay Equipment".

CAUTION!

When replacing a blown fuse, it is important to use only a fuse having the correct amperage rating. The use of a fuse with a rating other than indicated may result in a dangerous electrical system overload. If a properly rated fuse continues to blow, it indicates a problem in the circuit that must be corrected.

Standard Fuse and Relay Equipment



Locked (1)

Unlocked (2)

Detent spring – engage when the cover is fitted (3)

Position of fuses and relays



Fuses (4)

Relays (5)

Fuse Assignment, Standard Equipment

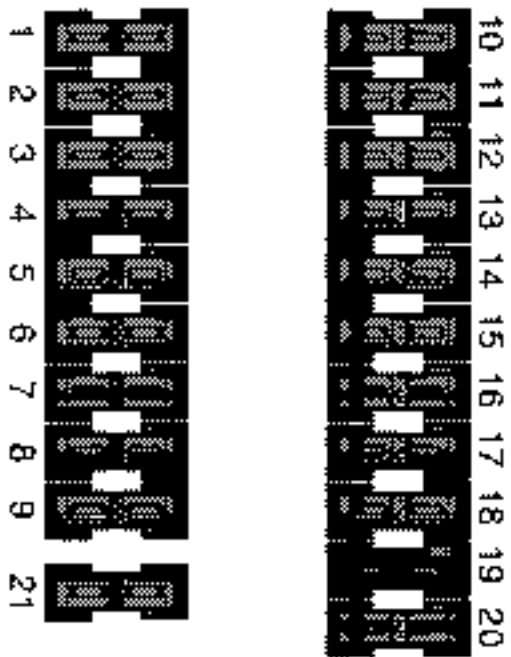

N54-15-2002-20

280 MAINTAINING YOUR VEHICLE

No.	Rated	Circuit	10.	10A	Instrument lighting, license plate lamp daytime driving lamps
1.	10A	Parking lamp right, taillamp right	11.	10A	Side lamp, left; taillamp, left
2.	10A	High beam head lamp, right	12.	10A	Low beam headlamp, right
3.	10A	High beam head lamp, left, high beam indicator lamp	13.	10A	Low beam headlamp, left
4.	10A	Backup lamp	14.	15A	Fog lamp
5.	10A	Brake lamp	15.	10A	Radio (terminal 15)
6.	20A	Windshield wiper motor	16.	25A	Engine control unit
7.	15A	Horn, heated rear window, air recirculation switch, optional equipment relay (terminal 15)	17.	15A	Engine control unit
8.	20A	Interior lighting, cigarette lighter, radio (terminal 30)	18.	15A	Ignition (terminal 15)
9.	15A	Clock, hazard warning lamps, parking lamps	19.	15A	Not in use
			20.	15A	Heater controls (terminal 30)
			21.	30A	Heater blower (terminal 30)

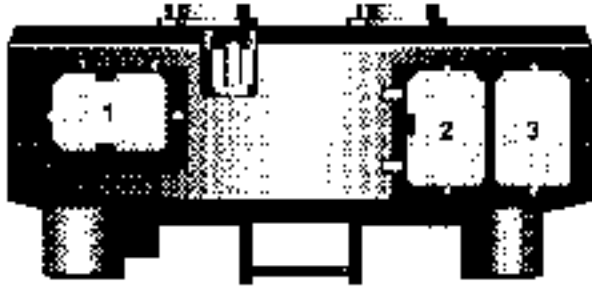

H6a : 5 2c14 70

Relay Assignment, Standard Equipment

- Windshield wiper motor (W) (1)
- Diesel engine control unit (M) (2)
- Turn signals (B) (3)



Fuse and Relay Optional Equipment

The cover is located below the driver's seat.

Remove cover:

1. Press both detent springs down and remove cover.
- Install cover:
2. Position cover at bottom and engage both detent springs.

Fuse, Relay, and Diode Assignments – Optional Equipment

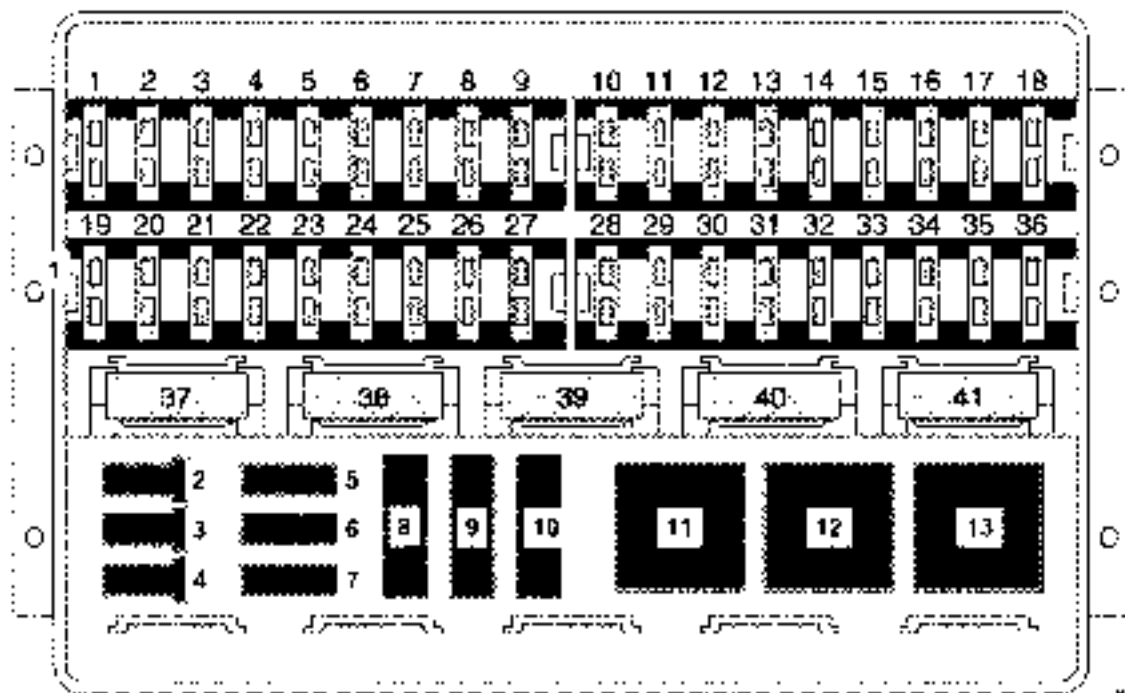

NOTE: The arrangement of the fuses (1) depends on the optional equipment installed on the vehicle. The assignments are shown on the inside of the cover of the fuse box.

Diodes:

No.	Circuit
1.	Not in use
2.	Not in use
3.	Not in use
4.	Not in use

Fuses:

No.	Rated	Circuit
5.	10A	Immobilizer
6.	7.5A	Anti-lock brake system (ABS) Electronic Stability program (ESP®)*
7.	25A	Anti-lock brake system (ABS) Electronic Stability program (ESP®)*
8.	40A	Not in use Electronic Stability program (ESP®)*
9.	40A	Anti-lock brake system (ABS)
10.		Not in use

Relays:

No.	Circuit
11.	Not in use
12.	Starter relay
13.	Not in use

* 2500 Type Vehicles only

BULB REPLACEMENT

WARNING!

Bulbs and bulb holders can become very hot. Allow the lamp to cool down before changing the bulb.

Keep bulbs out of reach of children.

Do not use bulbs which have been dropped or which show signs of scratches on the glass. They could explode.

Changing an H7 bulb:

The bulb is pressurized. Always wear eye and hand protection.

Switch the lights off to prevent short circuits.

Only touch new bulbs with a clean, lint-free cloth. Do not touch bulbs with wet or greasy fingers.

Only fit 12 volt bulbs of the same type as before and with the correct wattage rating.

Front Lamp Unit



H&D-10-2165-02

Bulbs are changed from inside the engine compartment.

Move the retainer bar to the side and remove the housing cover.

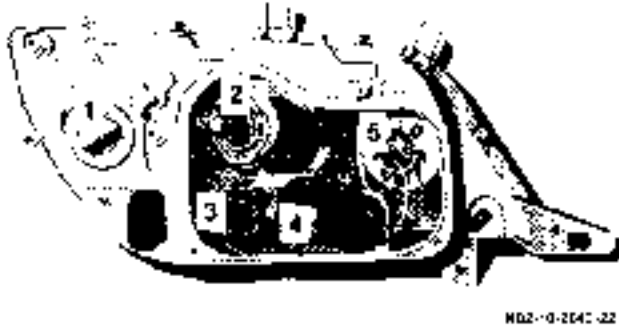

Turn Signal Lamps and Side-Marker Lamps

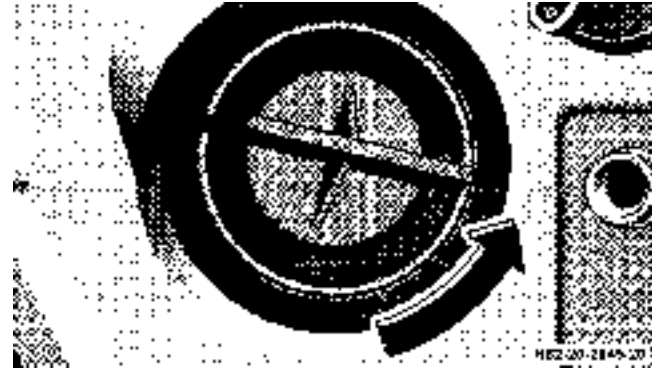

1. Turn bulb holder, together with bulb, counterclockwise and remove.
2. Remove the bulb from the bulb holder.
3. Insert a new bulb in the bulb holder.
4. Insert the bulb holder together with the bulb and turn clockwise to the stop.

Turn signal lamp and sidemarker lamp,
3457 NA – 12V 28 / 7.5W, yellow glass (1)

Low beam headlamp, H7 – 12V 55W (2)

Fog lamp, H1 – 12V 55W (3)

Side and parking lamps, W5W – 12V 5W (4)

High beam headlamps, H1 – 12V 55 (5)

Low Beam Headlamps

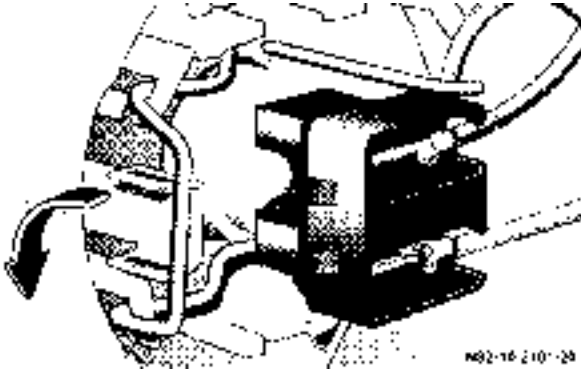

1. Unplug the cable connector from the bulb.
2. Unclip in the retaining springs. Press the retaining springs towards the headlamps and down (direction of arrow).

3. Remove the bulb.
4. Insert the new bulb so that the retaining lugs are fed into the recesses in the reflector section of the bulb holder.
5. Clip in the retaining springs.
6. Press on the cable connector.
7. Secure the housing cap.

Fog Lamp (Optional)

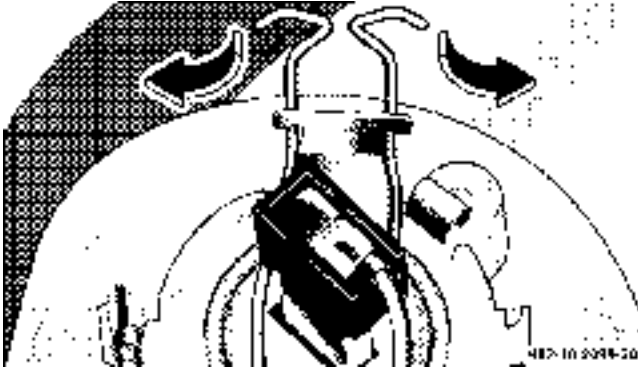

1. Remove the cable connector from the bulb holder.
2. Press both retaining springs in the direction of the headlamps and then outward (in the direction of the arrow).
3. Remove the bulb.
4. Put in the new bulb so that the retaining lugs on the bulb holder are inserted into the recesses in the bulb holder reflector section.
5. Secure both retaining springs.
6. Press on the cable connector.
7. Secure the housing cap.

Side and Parking Lamps



1. Pull out the bulb holder with the bulb.
2. Replace the bulb.
3. Insert the bulb holder.
4. Secure the housing cap.

High Beam Headlamp

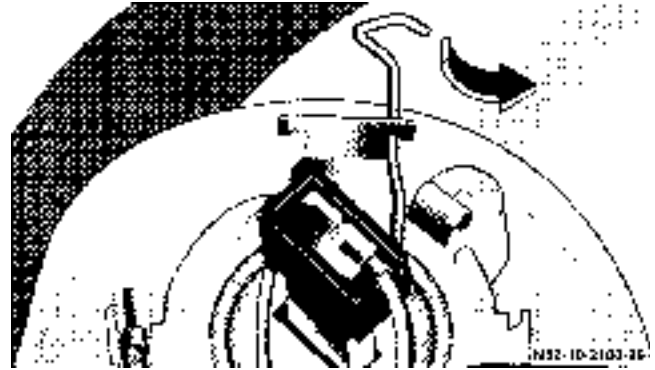

1. Unplug the cable connector from the bulb.
2. Press the retaining spring towards the headlamps and outwards (direction of arrow).
3. Remove the bulb.
4. Insert the new bulb so that the retaining lugs are fed into the recesses in the reflector section of the bulb holder.
5. Clip in the retaining springs.
6. Press on the cable connector.
7. Secure the housing cap.

Taillamps

Cargo/Passenger Van

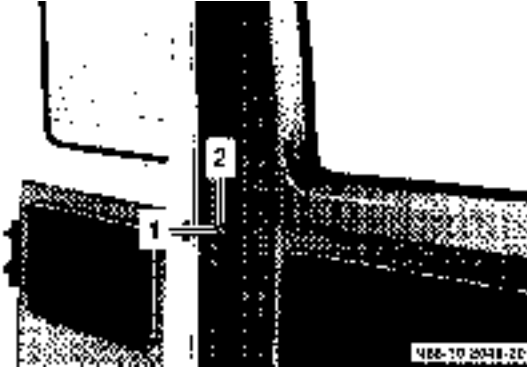

Locked (1)

Unlocked (2)

Bulbs are changed from inside the cargo area.

The rear lamp cluster bulb holder is located behind the interior paneling. Remove the paneling.

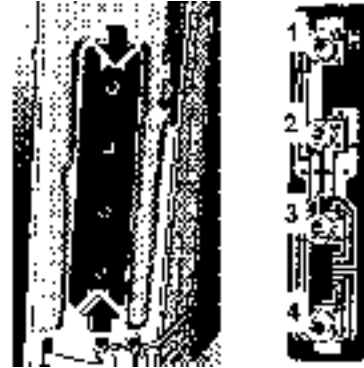

442-10 2021-20

Brake lamp, taillamp, standing lamp,
P21/5W – 12V 21/5W (1)

Backup lamp, P21W – 12V 21W (2)

Turn signal lamp, P21W – 12V 21W (3)

Side-marker lamp, R5W – 12V 5W (4)

1. Unclip and remove the bulb socket.
2. To change a bulb, press the bulb into the bulb socket, turn it counterclockwise and remove.
3. Insert the new bulb.
4. Clip the bulb socket into place.

Chassis



1. Loosen retaining screw a and remove lamp housing.
2. To change a bulb, press the bulb into the bulb socket, turn it counterclockwise and remove.
3. Insert the new bulb.
4. Install lamp housing.

- (1) Retaining screws
- (2) Clearance lamp, R5W - 12V 5W
- (3) Turn signal lamp, P21W - 12V 21W
- (4) Stop lamp, P21W - 12V 21W
- (5) Taillamp, R5W - 12V 5W
- (6) Backup lamp, P21W - 12V 21W
- (7) License plate lamp (driver's side only), R5W - 12V 5W

License Plate Lamps (Cargo/Passenger Vans Only)

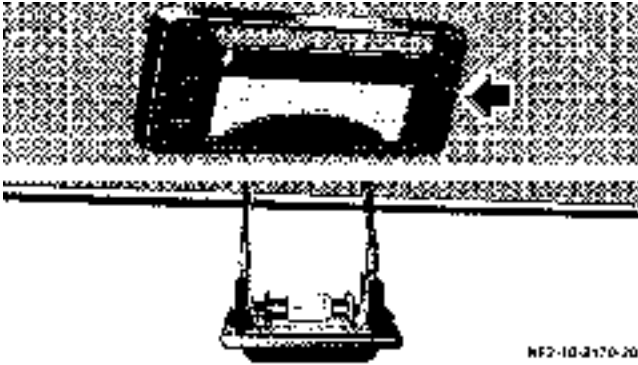

1. Press the bulb socket to the left, against the force of the spring, and remove.
2. Replace the bulb, C5W – 12V 5W.
3. Install the cover.
4. Re-install the bulb socket.

Additional Brake Lamp (Cargo/Passenger Vans Only)



- (1) Retaining screws
 1. Take out the retaining screws (1) and remove the lamp housing.
 2. To change a bulb, P21W – 12V 21W
Press the bulb into the bulb socket, turn it counterclockwise and remove.
 3. Insert the new bulb.
 4. Install the lamp housing.

Side-Mounted Turn Signals

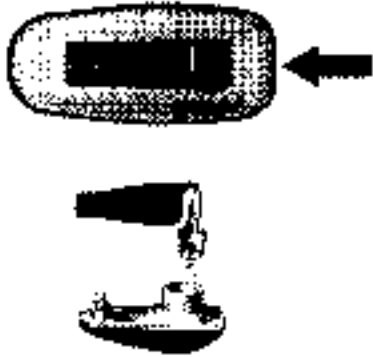

ME2-10-2027-23

1. Press the lamp housing to the front, against the force of the spring, and remove.
2. Replace the bulb, W5W - 12V 5W
3. Install the bulb socket.

Side-Marker Lamps, Standing Lamps (Optional)



ME2-10-2041-20

Retaining screws (1) Bulb socket (2)

1. Take out the retaining screws (1) and remove the lamp housing.
2. Turn the bulb socket (2) counterclockwise and remove.
3. Replace the bulb, W3W - 12V 3W.
4. Install the bulb socket (2).

Identification Lamps (Cargo/passenger vans only)



(1) Retaining screw

1. Take out the retaining screw (1) and remove the lamp housing.
2. To change a bulb, 12V 4CP
Press the bulb into the bulb socket, turn it counterclockwise and remove.
3. Insert the new bulb.
4. Install the lamp housing.

Interior Lighting in Passenger Compartment and Load Compartment



N82.20-2334-20

1. Align a screwdriver on the retaining spring, press it in and pry the lamp housing out.
2. Replace the bulb, K – 12V 18W
3. Install the lamp housing.

Interior Lighting with Reading Lamp



HEV-20-2985-20

1. Use a screwdriver on the catch spring to press in and remove the bulb housing.
2. Replace the bulb, K – 12V 10W.
3. Install the lamp housing.

Interior Lighting with Interior Sensor Protection



HEV-20-2847-20

1. Use a screwdriver on the catch spring, remove the bulb housing.
2. Turn the bulb holder with the bulb in the direction of the arrow and remove it.
3. Replace the bulb holder and bulb, K – 12V 6W
4. Install the lamp housing.

Exit Lamps (Optional)

1. Use a screwdriver on the catch spring to remove the lamp housing (1).
2. Press the locating spring on the cable connector (2), hold it down, and remove the cable connector (2).
3. Turn the bulb holder (3) to the left and remove it.
4. Replace the bulb, W5W - 12V 5W.
5. Install the bulb holder (3) and attach the cable connector (2).

- (1) Lamp housing
- (2) Cable connector
- (3) Bulb holder

H62-00-294-20

CAPACITIES

	Engine with oil filter Engine oil	Fuel tank		Cooling system	Windshield washer system
			Including reserve fuel		
All vehicles	about 9.5 US qt (9.0 l)	about 26.4 US gal (100 l)	about 2.8 US gal (10.5 l)	about 2.7 US gal (10.0 l)	about 7.4 US qt (7.0 l)

Recommended Fluids and Lubricants

The manufacturer recommends for your vehicle model the use of DaimlerChrysler approved fluids and lubricants, e.g. engine oil, gear oil, automatic transmission fluid, brake fluid, power steering fluid, coolant and anti-corrosion/anti-freeze fluid only.

WARNING!

Failure to use fluids and lubricants which meet the standards and specifications described in this booklet or failure to adhere to the specified replacement intervals may result in damage to safety-related systems of your vehicle, such as the brake system, which could cause an accident and/or serious injury to you and others.

Use only fluids and lubricants meeting the standards and specifications and adhere to specified replacement intervals.

CAUTION!

Failure to use fluids and lubricants which meet the standards and specifications described in this booklet or failure to adhere to the specified replacement intervals may result in a significantly shortened service life and/or damage to components of your vehicle, the repair of which will not be covered by Warranty.

Use only fluids and lubricants meeting the standards and specifications and adhere to specified replacement intervals.

The following oils have been determined to meet DaimlerChrysler requirements.

MB approved Engine Oil	SAE	MB Sheet
76 Pure Synthetic Motor Oil	5W-40	229.3
76 Royal Triton QLT	15W-40	228.3
Agip All Guard Motor Oil	15W-40	228.3
Agip Eurosport	5W-40	229.3
Agip Synthetic PC	5W-40	229.3
Akron Ultra Clear C1-4 ¹	15W-40	228.3
BP Vanellus C6 Global Plus	10W-40	228.3
Brad Penn Euro-Diesel LD	15W-40	228.3
Castrol Elixion ¹	5W-30	228.5
Castrol Tecton S ¹	15W-40	228.3
Chevron Delo 400 Multigrade	15W-40	228.3
Diesel Special Benz M&A	15W-40	228.3
Dislub Premium	15W-40	228.3
Exxon XD-3 Extra ¹	15W-40	228.3
FormulaShell Ultra	5W-40	229.3
FormulaShell Ultra AB	5W-30	229.5
Gonher Super Fleet MB-III	15W-40	228.3
Hydroclear Power-D Engine Oil	15W-40	228.3
IDO Premium 15W-40	15W-40	228.3
Kendall GT-1 Full Synthetic Motor Oil	5W-40	229.3

Long Life EF Diesel Engine Oil Multi-grade	15W-40	228.3
Lubral Super Diesel MB-III	15W-40	228.3
Max Raloy Diesel	5W-30	228.5
MB Motorenöl 000 989 60 01 13	10W-40	228.5
Mexlub CF-4 MB-3P	15W-40	228.3
Mobil 1 0W-40	0W-40	229.5
Mobil Delvac 1	5W-40	228.5
Mobil Delvac 1300 Super ¹	15W-40	228.3
Mobil SHC Formula MB	5W-30	229.5
MOPAR® Part No. 04798231AD	15W-40	228.3
Motul 8100 E-Tech 0W-40	0W-40	229.3
Motul 8100 X-cess 5W-40	5W-40	229.3
Panolin Indy SV	5W-40	229.3
Pennzoil European Formula Ultra	5W-30	229.5
Pennzoil Synthetic European Formula	5W-40	229.3
Premium Synthetik Motorenöl	5W-30	229.5
QS Superfleet	15W-40	228.3
Quaker State European Formula Ultra	5W-30	229.5
Quaker State Full Synthetic European Formula	5W-40	229.3
Quaker State Super Series III ¹	15W-40	228.3
Raloy Diesel Turbo MX	15W-40	228.3

Raloy Motor Diesel	15W-40	228.3
Repsol Turbo UHPD	10W-40	228.5
Roshfrans Voltro Diesel ¹	15W-40	228.3
Shell Helix Ultra	5W-30	229.3
Shell Helix Ultra	5W-40	229.3
Shell Rimula X CH-4	15W-40	228.3
Shell Rimula X CH-4	20W-50	228.3
Shell Rotella T Multigrade ¹	15W-40	228.3
Super Diesel Oil MB-3	15W-40	228.3
Supreme Duty Diesel Engine Oil Multi-grade	15W-40	228.3
Unoil GX-7	5W-40	229.3
Ursa Premium TDX	10W-30	228.3
Ursa Premium TDX	15W-40	228.3
Valvoline SynPower MXL	0W-30	229.3

1. Engine oil also meets API classification CI-4.
Other oils may meet requirements - see oil label to determine.

300 MAINTAINING YOUR VEHICLE

COMPONENT	SERVICE INTERVAL	PRODUCT NAME/PRODUCT NUMBER	MB SHEET
Air Conditioning The air conditioning system of your vehicle contains R-134a, a refrigerant that does not deplete the ozone layer in the upper atmosphere.			
Refrigerant R-134a	—	Refrigerant R-134a	361.0
Automatic Transmission Fluid	once only at 80,000 mi (128,000 km)	Shell ATF 3403/M-115	236.10
		MOPAR® Part No. 05127382AA, or equivalent Fuchs/Shell ATF 3353	236.12
Brakes Use brake fluid approved to DaimlerChrysler standard MB 331.0 and/or DaimlerChrysler material standard MS-9971, brake fluid certified to DOT 4 Plus standards, that also maintains a minimum dry boiling point (ERBP) of 500°F (260°C), a minimum wet boiling point (WERBP) of 356°F (180°C) and maximum viscosity of 1500 mm ² /s, conforming to FMVSS 116 and ISO 4925.			
Brake Fluid	2 years	Intac B026D Dry boiling point: 500°F (260°C) Wet boiling point: 356°F (180°C), MOPAR® MS-9971 Part No. 04549625AC, or equivalent	331.0
Engine Oil	12 months or 10,000 mi (16,000 km)	See "Approved Engine Oils"	

COMPONENT	SERVICE INTERVAL	PRODUCT NAME/PRODUCT NUMBER	MB SHEET
Engine Coolant, Anticorrosion/ Antifreeze Fluid	15 years or 160,000 mi (256,000 km)	EURO Peak Coolant/Anti-freeze, OLD WORLD INDUSTRIES Zerex G05, The Valvoline Company Zerex G48, The Valvoline Company Glysantin G05, BASF AG MOPAR® Part No. 05066386AA, or equivalent	325.0
Power Steering Power Steering, no fluid service required			
Power Steering fluid	—	Mobil ATF-D, Exxon Mobil Corporation, or equivalent	236.3
Rear Axle			
Gear Oil	120,000 mi (192,000 km)	Shell Spirax MB 90 MOPAR® Part No. 05136033AA, or equivalent	235.0

MAINTENANCE SCHEDULES

CONTENTS

<ul style="list-style-type: none"> ■ Introduction 304 ■ Warranty 304 ■ Maintenance - Without ASSYST <ul style="list-style-type: none"> Maintenance Computer 305 □ Maintenance Intervals 305 ■ Maintenance - With ASSYST <ul style="list-style-type: none"> Maintenance Computer 306 ■ Regular Check-Ups. 306 	<ul style="list-style-type: none"> ■ Special Maintenance Requirements 307 <ul style="list-style-type: none"> □ Brake Fluid 307 □ Coolant 307 □ Dust Filter for Heating/Ventilation Replacement 307 ■ Engine Oil Change and Filter Replacement . . . 307 <ul style="list-style-type: none"> □ Once a Year 307 ■ Scope of Work for Maintenance service 308 <ul style="list-style-type: none"> □ Oil Service 308 □ Additional Maintenance Work 310 □ Additional Maintenance Work After ... Years 310
---	--

INTRODUCTION

This is intended as a guide to the service requirements of your vehicle.

It contains all necessary instructions concerning service intervals and operations which have to be carried out.

Scope and frequency of maintenance work primarily depend on the vehicle's operating conditions.

In the interest of maintaining the vehicle's operating safety, the specified work should be performed regularly and in good time.

Our vehicles are subject to ongoing development. Technical progress may also affect the scope of service work performed.

"Daily vehicle checks" before starting a journey are the responsibility of the driver.

WARRANTY

The Sprinter Dealer network is at your disposal for maintenance work. Each of these workshops has the equipment and tools, the specially trained, skilled and experienced personnel and receives regular technical instruction from DaimlerChrysler Corporation to ensure that your vehicle is inspected and maintained thoroughly and in accordance with the latest procedures.

Please follow the instructions given in this Owner's Manual and ensure that they are observed, even if you hand the vehicle over to a third party for use or care. By not observing these instructions you may void your warranty rights.

If the specified oil and maintenance services are not carried out regularly or at the time intervals specified, a decision as to the validity of a warranty claim can only be made after DaimlerChrysler Corporation has investigated your claim.

The use of Special lubricant additives is not recommended. The use of such additives may affect your warranty rights. With regard to legal stipulations concerning emissions control, please note that engines have to be serviced and adjusted in accordance with special instructions and using special measuring equipment. Modifications to or interference with the emissions control systems are not permissible.

All Sprinter Dealer are familiar with the relevant and applicable regulations.

MAINTENANCE - WITHOUT ASSYST MAINTENANCE COMPUTER

Maintenance Intervals

	Normal Operation
Oil service and fuel filter replacement – Refer to	every 10,000 miles or 16,000 km or 12 months
Maintenance service	every 30,000 miles or 48,000 km

Additional work must be carried out at yearly intervals.

As a general rule, to avoid unnecessary visits to the workshop you should try to have necessary repair work performed together with other maintenance work.

MAINTENANCE - WITH ASSYST MAINTENANCE COMPUTER

ASSYST provides you with information on the best possible timing for maintenance work.

When the next maintenance service is due, this will be indicated in the multi-function display with the symbol



Oil service and fuel filter replacement



Maintenance service - displayed in km/miles or days.



If the display shows the number of days, the symbol  will also appear in the multi-function display.

You should have the maintenance performed within the stated period/distance.

The service indicator will be reset by your Sprinter Dealer after an oil service and/or maintenance service has been performed.

REGULAR CHECK-UPS

To maintain the safe operation of your vehicle, it is recommended that you perform the following tasks on a regular basis (i.e., weekly or whenever the vehicle is refueled). Check:

- Engine oil level
- Brake system, clutch mechanism – fluid level
- Battery – acid level
- Windshield washer system and headlamp cleaning system – fluid level
- Mechanical assemblies (e. g. ,engine, transmission, etc.) – check for leaks
- Condition of tires and tire pressures
- All exterior lights

SPECIAL MAINTENANCE REQUIREMENTS

If bodies built by manufacturers other than DaimlerChrysler Corporation are fitted to the vehicle, the maintenance requirements and lubrication intervals specified by the body manufacturer must be adhered to, in addition to all standard maintenance requirements.

Brake Fluid

Only use brake fluids approved by the manufacturer (DOT 4 plus). Information about brake fluids is available from your Sprinter Dealer.

Coolant

Have the corrosion inhibitor/antifreeze concentration in the coolant checked before the onset of winter (once a year in countries with high prevailing temperatures).

Have the coolant renewed every fifteen years or 100,000 miles.

Dust Filter for Heating/Ventilation Replacement

The dust filter and the tailgate interior filter are renewed during routine maintenance service. However, if operating conditions are dusty, these filters should be renewed more frequently.

ENGINE OIL CHANGE AND FILTER REPLACEMENT

In a minimum, change the engine oil and oil filter once a year - even if the vehicle mileage per year is extremely low. For standard oil service schedules, please see the chapter oil service and maintenance service.

Once a Year

Select the viscosity of the engine oil (SAE classes) according to the outside air temperature.

Only use engine oil approved by DaimlerChrysler Corporation if following the ASSYST system guidelines.

Information is available from your Sprinter Dealer.

If the fuel used has a sulphur content exceeding 0.05 % by weight, the service intervals should be split in half.

If the sulphur content of the fuel used is between 0.3% and 0.8% by weight, the service intervals should be split in half (i.e. every 5,000 miles instead of every 10,000 miles).

SCOPE OF WORK FOR MAINTENANCE SERVICE**Oil Service****Oil change**

Engine:

Oil change and filter replacement

Check fluid levels of the following system, refill as necessary.

If fluid is lost, trace and eliminate cause – as a separate order.

Power-assisted steering

Lubrication work:

Trailer tow hitch (original equipment)

Maintenance

ASSYST maintenance computer reset

Function check

Signalling system,
warning and indicator lamps

Headlamps, exterior lighting

Windscreen wipers,
windscreen washer system

Check for leaks and damage.

Check for abrasion points and ensure that lines are correctly routed!

All assemblies:

Engine, transmission, transfer case, front axle, rear axle, steering, power steering pump

All lines and hoses, sensor cables

Rubber boots on front axle drive shafts,
rubber boots on front axle suspension ball joints, shock absorbers

Check fluid levels for the following systems, correct as necessary.

Should there be a loss of fluid which cannot be explained by regular use, trace and eliminate the cause.

Engine cooling system

Check corrosion inhibitor/antifreeze, refill as necessary.

Hydraulic brake system

Battery

Windscreen washer system

Engine

Fuel filter renewal

Air cleaner with maintenance indicator:

Check degree of contamination.

Air cleaner filter element renewed as necessary.

Chassis and body

Trailer coupling:

Check operation, play and retaining fixtures

Secondary rubber springs:

Visual check

Tire pressures:

Correct as necessary, including spare tyre

Check thickness of brake pads

Brake test

Check condition of brake disks. Brake disks renewal as necessary – as a separate order

Check condition of steering mechanism

Heating/ventilation dust filter renewal

310 MAINTENANCE SCHEDULES

Additional Maintenance Work

**Automatic transmission once only at 80,000 miles/
128000km**

Oil and filter change

During every second maintenance service

Air cleaner without maintenance indicator:

Air cleaner filter element renewal

Check poly-V-belt for wear and signs of damage

During every fourth maintenance service

Change rear axle fluid

Additional Maintenance Work After ... Years

Every 2 years

Change brake fluid

Every 3 years

Air cleaner filter element renewal
(note installation date)

Every 15 years or 100,000 miles

Coolant renewal

Note coolant composition

IF YOU NEED CONSUMER ASSISTANCE

CONTENTS

■ Suggestions For Obtaining Service For Your Vehicle	312	■ If You Need Assistance	312
□ Prepare for the Appointment	312	■ Warranty Information	315
□ Prepare a List	312	■ Mopar® Parts	315
□ Be Reasonable with Request	312	■ Reporting safety Defects	315

SUGGESTIONS FOR OBTAINING SERVICE FOR YOUR VEHICLE

Prepare for the Appointment

If you're having warranty work done, be sure to have the right papers with you. Take your warranty folder. All work to be performed may not be covered by the warranty, discuss additional charges with the service manager. Keep a maintenance log of your vehicle's service history. This can often provide a clue to the current problem

Prepare a List

Make a written list of your vehicle's problems or the specific work you want done. If you've had an accident, or work done that is not on your maintenance log, let the service advisor know.

Be Reasonable with Request

If you list a number of items, and you must have your vehicle by the end of the day, discuss the situation with the service advisor and list the items in order of priority. At many dealers you may obtain a rental vehicle at a minimal daily charge. If you need a rental, it is advisable to make these arrangements when you call for an appointment.

IF YOU NEED ASSISTANCE

The manufacturer and its dealers are vitally interested in your satisfaction. We want you to be happy with our products and services.

Your selling dealer is best equipped and most anxious to provide prompt resolution for any warranty issue or related matter that you may experience. The manufacturer's dealer have the facilities, factory-trained technicians, special tools, and the latest information to assure your vehicle is fixed correctly and in a timely manner. The manufacturer has empowered its dealers to make warranty and repair decisions that ensure you are not inconvenienced. There are no need for you to wait for a decision from the manufacturer. If a special circumstance occurs that requires information from the manufacturer, we have asked the dealer's service management to make the contact on your behalf.

This is why you should always talk to your dealer's service manager first. Most matters can be resolved with this process.

- If for some reason you are still not satisfied, talk to the general manager or owner of the dealership. They want to know if you need assistance.
- If your dealership is unable to resolve the concern, you may contact the Manufacturer's Customer Center.

Any communication to the Manufacturer's Customer Center should include the following information:

- Owner's name and address
- Owner's telephone number (home and office)
- Dealership name
- Vehicle identification number
- Vehicle delivery date and mileage

DaimlerChrysler Motors Corporation Customer Center

P.O. Box 21-8004

Auburn Hills, MI 48321-8004

Phone: (800) 992-1997

DaimlerChrysler Canada, Inc. Customer Center

P.O. Box 1621

Windsor, Ontario N9A 4H6

Phone: (800) 465-2001

In Mexico contact:

Av. Prolongacion Paseo de la Reforma, 1240

Sante Fe C.P. 05109

Mexico, D.F.

In Mexico (915) 729-1248 or 729-1240

Outside Mexico (525) 729-1248 or 729-1240

Customer Assistance For The Hearing Impaired Or Speech Impaired (TDD/TTY)

To assist customers who have hearing difficulties, the manufacturer has installed special TDD (Telecommunication Devices for the Deaf) equipment at its Customer Center. Any hearing or speech impaired customer who has access to a TDD or a conventional teletypewriter (TTY) in the United States can communicate with the manufacturer by dialing 1-800-380-CHRY.

Service Contract

You may have purchased a service contract for your vehicle to help protect you from the high cost of unexpected repairs after your manufacturer's new vehicle limited warranty expires. The manufacturer stands behind only the manufacturer's Service Contracts. If you purchased a manufacturer's Service Contract, you will receive Plan Provisions and an Owner Identification Card in the mail within three weeks of your vehicle delivery date. If you have any questions about your service contract, call the manufacturer's Service Contract National Customer Hotline at 1-800-521-9922.

The manufacturer will not stand behind any service contract that is not the manufacturer's Service Contract. It is not responsible for any service contract other than the manufacturer's Service Contract. If you purchased a service contract that is not a manufacturer's Service Contract, and you require service after your manufacturer's new vehicle limited warranty expires, please refer to your contract documents and contact the person listed in those documents.

We appreciate that you have made a major investment when you purchased your new vehicle. Your dealer has also made a major investment in facilities, tools, and training to assure that you are absolutely delighted with your ownership experience. You'll be pleased with their sincere efforts to resolve any warranty issues or related concerns.

WARRANTY INFORMATION

See your manufacturer's Warranty Information Booklet for information on your warranty coverage and transfer of warranty.

MOPAR® PARTS

Mopar® fluids, lubricants, parts, and accessories are available from your dealer. They will help you keep your vehicle operating at its best.

REPORTING SAFETY DEFECTS

In the 50 United States and Washington D.C.: If you believe that your vehicle has a defect which could cause a crash or cause injury or death, you should immediately inform the National Highway Traffic Safety Administration (NHTSA) in addition to notifying the manufacturer.

If NHTSA receives similar complaints, it may open an investigation, and if it finds that a safety defect exists in a group of vehicles, it may order a recall and remedy campaign. However, NHTSA cannot become involved in individual problems between you, your dealer, and the manufacturer.

To contact NHTSA, you may either call the Auto Safety Hotline toll free at 1-888-327-4236 (TTY: 1-800-424-9153) or go to <http://www.NHTSA.gov> or write to: NHTSA, U.S. Department of Transportation, Washington, D.C. 20590. You can also obtain other information about motor vehicle safety from the Hotline.

In Canada:

If you believe that your vehicle has a safety defect, you should contact the Customer Service Department immediately. Canadian customers who wish to report a safety defect to the Canadian government should write to: Transport Canada, Motor Vehicle Defect Investigations and Recalls, 2780 Sheffield Road, Ottawa, Ontario, K1B 3V9.

INDEX

A Special Note Concerning Vehicle Alteration	230	Air Recirculation	119
Acceleration Skid Control	167	Air Vents	
Deactivating	171	Center	122
Indicator Lamp	167	Side	122
Warning Lamp	146, 169	Upper	122
Acceleration Skid Control (ASR)	169, 170	Airbag	47
Air Conditioner for the Rear Passenger		Malfunction	44
Compartment	127	Safety Precautions	50
Air Recirculation	128	Airbag and Belt Tensioners	49
Air Strainer	129	Airbag Malfunction	44
Air Conditioning		Alarm Pushbutton	26
Climate Control	125	Alignment and Balance	206
Dehumidification	126	Anti-Lock Brake System (ABS) Indicator Lamp . . .	164
Rear Passenger Compartment	126	Appearance and Care	269
Air Conditioning, Regulated	124	Armrest	62
Air Filter Restriction Indicator	258	Ashtray	82

ASSYST	305	Battery Charge Indicator Lamp	106
ASSYST Maintenance Computer	112	Belt Tensioners	
Automatic Lock Feature	19	Location	49
Automatic Transmission	148	Belt Tensioners and Airbag	49
Accelerator Position	149	Bleeding the Diesel Fuel System	216
Driving	148	Body Builder Guideline	229
Gear Selector Lever Position	150	Brake Assist System (BAS)	172
Maneuvering	149	Brake fluid	261
Selector Lever Manually Unlocking	153	Brake Fluid Reservoir	261
Stopping	149	Brake Indicator Lamp	160
Auxiliary Drive	175	Brake Pad Wear Indicator	159
Auxiliary Heat Exchanger	139	Brake System	167
Auxiliary Heater		Fluid Level	261
Settings	138	Brake System, Anti-Lock	165
Timer Auxiliary Heater (Water and Air Heater)	134	Brakes	158
Tips for Coping with Problems	140	Brake Fluid	261
Batteries	265	Service Brake	158
Charging the Battery	267	Bulbs	
Disconnecting the Battery	266	Bulb Replacement	284
Reconnecting the Battery	266	Front Lamp Unit	284
Replacing Batteries in Remote Keyless Entry	22	Capacities	296

- Care of Vehicle
 - Engine Cleaning 272
 - Headlamps, Taillamps, Turn Signal Lenses 273
 - Vehicle Washing 272
- Care of vehicle
 - Paintwork, painted body components 272
 - Power washer 271
 - Tar stains 272
- Catalytic Converter 228
- Central Locking 15
 - Locking 16
- Central Locking Switch 17
 - Locking and Unlocking 19
 - Locking Status Display 18
 - To Program the Automatic Lock Feature 19
- Changing a Bulb
 - Additional Brake Lamp 291
 - Exit Lamps 295
 - Front Lamp Unit 284
 - Interior Lighting 293
 - Interior Lighting with Interior Sensor Protection 294
 - License Plate Lamp 291
 - Reading Lamp 294
 - Side-Marker Lamp 292
 - Side-Mounted Turn Signal 292
 - Taillamp 289
- Changing the Tire 234
- Charging the Battery 267
- Checking Coolant Level 263
- Checking Weights of Vehicle and Trailer 224
- Cigar Lighter 82
- Cleaning
 - Cup Holder 275
 - Hard Plastic Trim Items 276
 - Instrument Cluster 275
 - Light Alloy Wheels 275
 - Plastic and Rubber Parts 276
 - Seat Belts 275
 - Steering Wheel and Gear Selector Lever 275
 - Upholstery 276
 - Wiper Blade 274
- Cleaning Tires 182

Climate Control	125	Direction of Rotation	182
Clock	98	Displaying Engine Oil Level	115
Comfortseat	61	Doors	
Comfortseat (Optional)	61	Front Doors	27
Compartments in Front Doors	87	Rear Cargo Doors	33
Constant RPMs	146	Sliding Door	30
Consumer Assistance		Draining Fuel Filter with Water Separator	214
Be Reasonable with Request	312	Driver's Airbag	47
If You Need Assistance	312	Driving Safety Systems	163
Prepare a List	312	Electric Sun Roof	81
Prepare for the Appointment	312	Electrical Fuses	276
Coolant Level Indicator Lamp	108	Fuse and Relay Optional Equipment	281
Coolant Temperature Gauge	103	Fuse, Relay, and Diode Assignments - Optional Equipment	282
Coolant, Engine	262	Relay Assignment, Standard Equipment	281
Cooling System, Engine	261	Standard Fuse and Relay Equipment	277
Corrosion Protection	269	Electrical Outlet	84
Cup Holder	85	Electronic Brake Force Distribution	167
De-Fogging	121	Electronic Brake Force Distribution Lamp	160
Dehumidification	126	Electronic Stability Program	169
De-Icing	121	Emission Label, Vehicle/Engine	8
Diesel Fuels for Use at Very Low Temperatures	211		

Emission Related Component	256	Folding Seat at Partition	63
Emissions Control System	228	Fording	228
Engine Break-in Recommendations	52	Front Seat Passenger Airbag	48
Engine Cleaning	272	Fuel Filter	214
Engine Control Unit Indicator Lamp	109	Fuel Filter with Water Separator	210
Engine Coolant	262	Fuel Gauge	105
Engine Cooling System	261	Fuel Tank Capacity	213
Engine Oil Consumption	53	Fuels	209
Engine Oil Level	259	Bleeding the Diesel Fuel System	216
Indicator in Instrument Cluster	117	Diesel Fuels for Use at Very Low Temperatures	211
Engine Oil Level - Display in Instrument Cluster	114	Draining Fuel Filter with Water Separator	214
Engine Oil Level Indicator Lamp	107	Fuel Filter with Water Separator	210
Engine Oils	258	Fuel Tank Capacity	213
Engine oils	259	Refueling	212
Engine Speed, Maximum	145	Fuse and Relay Optional Equipment	281
Engine, Stopping	147	Fuse, Relay, and Diode Assignments - Optional Equipment	281
Exhaust Gas	228	Fuses, Electrical	276
Exhaust Gas, Inhalation of	54, 228	Gear Selector Lever Position	150
Fax Machines	85	Glove Compartment	87
Fire Extinguisher	233	Lockable Glove Compartment	87
Fog Lamp Switch	68		

- Hazard Warning Flasher Switch 232
- Head Restraint 62
- Headlamp Cleaning System 77
- Headlamp Range Control 68
- Headlamps, taillamps, turn signal lenses 273
- Heated Rear Window 123
- Heater, Seat 63
- Heating 118, 120
- Hood 66
- Hydroplaning 185
- Ignition
- Lock 13
- Starter Switch 13
- Immobilizer 14
- Important Guidelines 179
- Indicator Lamp Symbols 110
- Inhalation of Exhaust Gas 54
- Installing a Wheel 242
- Instrument and Display Lighting 99
- Instrument Cluster
- Battery Charge Indicator Lamp 106
- Clock 98
- Coolant Level Indicator Lamp 108
- Coolant Temperature Gauge 103
- Engine Control Unit Indicator Lamp 109
- Engine Oil Level Indicator Lamp 107
- Tachometer 103
- Trip Meter 99
- Water in Fuel Indicator Lamp 106
- Instrument Cluster and Indicator Lamps 93
- Instruments and Controls 91
- Interior Lighting 69
- Cargo Area 71
- Driver and Rear-Seat Passenger/Cargo Area 69
- Interior Sensor Protection 69
- Reading Lamp 70
- Intervals, Maintenance 305
- Introduction 4
- Intrument Cluster
- Fuel Gauge 105
- Jack 239

- Location 239
- Jump Starting 246
- Lamps
- Acceleration Skid Control 167
 - Acceleration Skid Control Warning Lamp . 146, 169
 - Additional Brake Lamp 291
 - Anti-Lock Brake System (ABS) Indicator Lamp. 164
 - Battery Charge Indicator Lamp 106
 - Brake Lamp 160
 - Brake System 167
 - Coolant Level Indicator Lamp 108
 - Electronic Brake Force Distribution 160
 - Engine Control Unit Indicator Lamp 109
 - Engine Oil Level 117
 - Engine Oil Level Indicator Lamp 107
 - Exit Lamps 295
 - Indicator Lamps 93
 - License Plate Lamp 291
 - Reading Lamp 294
 - Reserve Fuel Indicator Lamp 105
 - Seat Belt Warning Lamp 44
 - Side-Marker Lamp 292
 - SRS Malfunction Indicator Lamp 49
 - Taillamp 289
 - Water in Fuel Indicator Lamp 106
- Lifting Points 239
- Lighter, Cigar 82
- Lighting, Interior 69
- Loading 153
- Loading the Vehicle 216
- Lock, Ignition 13
- Locking, Central 15
- Lumbar Support 61
- Maintenance Computer 112
- Maintenance Intervals 305
- Maintenance Schedules
- Additional Maintenance Work After ... Years . . 310
 - Brake Fluid 307
 - Coolant 307
 - Dust Filter for Heating/Ventilation Replacement 307
 - Engine Oil Change and Filter Replacement 307

Introduction	304	Occupant Restraints	39
Oil Service	308	Odometer	99
Once a Year	307	Opening/Closing doors	27
Regular Check-Ups	306	Operation, Window	74
Scope of Work for Maintenance service	308	Ornamental Moldings	273
Warranty	304	Outlet, Electrical	84
With ASSYST Maintenance Computer	306	Outside Temperature Display	100
Without ASSYST Maintenance Computer	305	Overheating (Air Heater)	140
Maximum Engine Speed	145	Passenger Airbag	48
Maximum Tire Inflation Pressure	199	Passenger Airbag, Front Seat	48
Mechanical Sun Roof	81	Passenger Compartment Protection	25
Mechanical Sun Roof Operation	81	Alarm Pushbutton	26
Mirror Adjustment	59	Switching off	25
Mirrors		Pedals	52
Adjustment	59	Permissible Roof Load	216
Exterior	59	Power	144
Interior	59	Power Assistance	144
Mobile Phone	85	Programmed Top Speed	213
Mopar® Parts	315	Radial-Ply Tires	179
Multi-Function Indicator	96	Radio	84
Multifunction Switch	72		

Radio Transmitters	84	Reversing Aid	
Rear Cargo Doors	33	Audible Warning	102
Rear Seat Bench	64	Ribbed V-Belt	260
Removal and Installation	64	Roof Load	216
Recommended Fluids and Lubricants	297	Rotating Tires	204
Recommended Tire Inflation Pressure	186	RPMs, Constant	146
Refueling	212	Safety Tips	53
Regular Checks	256	Seat Belt Warning Lamp and Airbag Malfunction . .	44
Relay Assignment, Standard Equipment	281	Seat Belts	
Remote Keyless Entry	20	Belt Tensioners	49
Locking	22	Fastening and Removing	45
Replacing Batteries	22	Height Adjustment	46
Unlocking	21	Seat Heater	63
Removing a Wheel	242	Seats	
Replacing Wiper Blades	268	Adjustment	60
Reporting safety Defects	315	Armrest	62
Reserve Fuel Indicator Lamp	105	Driver's and Front Passenger's Seat	60
Residual Engine Heat Utilization	124	Folding Seat	63
Residual Engine Heat Utilization (REST)	124	Head Restraint	62
Restraints, Occupant	39	Heater	63
Retrofitting Seat Mounting Cups	65	Lumbar Support	61

Rear Seat Bench	64	Suggestions For Obtaining Service For Your Vehicle	312
Security System with Towing and Passenger Compartment Protection	23	Sun Roof	
Audible Alarm	24	Electrical	81
Switching off the Alarm	24	Mechanical Operation	81
Visual Alarm	24	Sun Roof, Electrical	81
Service Products	255	Switch Locations	110
Disposal of Service Products	256	Switch, Starter	13
Skid Control, Acceleration	167	Tachometer	101, 103
Sliding Door	30	Telephone	84
Snow Chains	207	Tie Down Rings	54
Spare Wheel Location	236	Tire	
Special Maintenance Requirements	307	Size	197
Speed Control	77	Tire and Loading Information	217
Sprinter Original Parts	255	Tire Care and Maintenance	180
SRS Malfunction Indicator Lamp	49	Tire Grip	176
Standard Fuse and Relay Equipment	277	Tire Inspection	180
Starter Switch	13	Tire Sizes for Sprinter Vehicles	193
Starting the Engine	144	Tires	183
Stopping the Engine	147	Alignment and Balance	206
Storing Tires	182	Aspect Ratio	193

Care and Maintenance	180	Rotating	204
Changing the Tire	234	Size Designation	192
Cleaning	182	Sizes	193
Date of Manufacture	197	Snow Chains	207
Design Standard	193	Spare Wheel Location	236
Direction of Rotation	182	Speed Rating	192, 195
DOT, Tire Identification Number (TIN)	196	Storing	182
Hydroplaning	185	Tire and Loading Information	217
Important Notes on Tire Inflation Pressure	187	Tire and Loading Terminology	200
Inspection	180	Tire Code	193
Installing	242	Tire Grip	185
Jack	239	Tire Ply Material	200
Labeling	191	Tire Width	193
Life of	181	Tread Depth	181
Load	192	Type Code	197
Load Rating	193	Vehicles type 2500 C/HC/SHC	185
Maximum Inflation Pressure	199	Vehicles type 3500 C/HC/SHC	185
Maximum Load	198	Winter Tires	206
Recommended Tire Inflation Pressure	186	Tires, Wheels	176
Removing	242	Towing	221
Rim Diameter	193	Towing a Trailer	225

Towing Protection	24	Transmission, Automatic	148
Switching off	24	Trip Meter	99
Towing Protection and Passenger Compartment Protection Switch	24	Two Way Radio	84
Towing the Vehicle	248	Using the Jack	239
If the Engine is Damaged	249	Vehicle / Engine Emission Label	8
If the Front Axle is Damaged	249	Vehicle Alteration	230
If the Rear Axle is Damaged	249	Vehicle and Trailer Weights	222
If the Transmission is Damaged	249	Vehicle and Trailer Weights and Ratings	221
Trailer	221	Vehicle Loading	155
Attaching a Trailer	224	Vehicle Safety Certification Label	6
Checking Weights of Vehicle and Trailer	224	Vehicle Tool Kit	233
Electrical Connections	222	Vehicle Washing	272
Loading a Trailer	223	Vehicles type 2500 C/HC/SHC	185
Parking a Trailer	227	Vehicles type 3500 C/HC/SHC	185
Towing	221	Ventilation	119
Towing a Trailer	225	Ventilation, Heating	118
Trailer Hitches	222	Wading Capability	228
Trailer Tongue Load	223	Warning Buzzer	102, 156
Vehicle and Trailer Weights	222	Warnings and Cautions	5
Trailer Tongue Load	223	Warranty Information	315

Water in Fuel Indicator Lamp	106
Wheels and Tires	176
Window Cleaning	274
Window Operation	74
Electric	74
Mechanical	74
Windows	
De-Fogging	121
De-Icing	121
Windshield Heater	123
Windshield Washer System Fluid Reservoir	257
Windshield Wiper Switch	75
Windshield wipers with rain sensor	76
Winter Operation	265
Winter tires	206

