

HANDBOOK  
FOR  
BENTLEY 4 $\frac{1}{4}$  LITRE  
MK. VI

WITH INSTRUCTIONS FOR RUNNING  
AND MAINTENANCE

---

*Liable to Alteration without Notice*

Number VIII

*PRICE £1. 5. 0*

Published by  
BENTLEY MOTORS (1931) LTD.  
DERBY, CREWE  
AND 16 CONDUIT STREET, W.I.

# BENTLEY MOTORS (1931) LIMITED

## Directors:

Capt. E. C. Eric Smith, M.C.  
W. A. Robotham

Dr. F. Llewellyn Smith  
D. R. McDonald

## London Office and Showroom:

**16 Conduit Street, London W.1**

TELEGRAMS: "BENSPORT, PICCOY, LONDON"

TELEPHONE: MAYFAIR 4412 (3 LINES)

CODES USED: A B C (5TH EDITION), BENTLEY'S, MARCONI,  
MOTOR TRADE, WESTERN UNION

## Main Service Station:

**Hythe Road, Willesden, London N.W.10**

TELEGRAMS: "BENSERDEP, 'PHONE, LONDON"

TELEPHONE: LADBROKE 2444

## Crewe Repair Depot:

**Pym's Lane, Crewe**

TELEGRAMS: "BENSPORT, CREWE"

TELEPHONE: CREWE 3271

**Works - - - CREWE**

TELEGRAMS: 'BENSPORT, CREWE'

TELEPHONE: CREWE 3271 (10 LINES)

## Authorised Paris Service Station:

**Franco-Britannic Autos Ltd.**

**25 Rue Paul Vaillant Couturier, Levallois, Seine**

TELEGRAMS: "FRANCOBRIT-LEVALLOIS-PERRETT-FRANCE"

TELEPHONE: PEREIRE 31-04 AND 38-68

**T**HE information contained in this book has been arranged to facilitate reference, by condensing all essential driving and upkeep instructions in the first two chapters. Numerous references to other parts are provided, whereby any particular instruction may be amplified if required.

Subsequent chapters include explanations of the working of the various units or components, of the chassis, and include detailed directions for lubrication and maintenance.

Owners and drivers should, therefore, familiarise themselves with the first two chapters in order to operate the car successfully, referring to the remainder of the book at leisure, or if necessary.

A set of special spanners and tools is supplied with the chassis. It is most desirable that these should be used when effecting any adjustment, as otherwise vital parts may be seriously damaged.

*It is strongly recommended that this book be carefully studied, and the instructions faithfully followed, to ensure the greatest satisfaction.*

# CONTENTS

	PAGE
CHAPTER I.—STARTING THE ENGINE AND DRIVING THE CAR ...	21
Starting the Engine—Throttle Control—Mixture Control—Ignition Control—Fuel Feed—Fuel Gauge—Maximum Engine Speed—Gear Changing—Controllable Shock Dampers—Battery Charging—Lighting Control and Switch—Accessories—Radiator Thermostat and Thermometer—Overheating—Coolant Level in Radiator—Frost—Fitting of Snow Chains.	
CHAPTER II.—PERIODIC LUBRICATION AND ATTENTION ...	27
Lubricants Recommended—Capacities—Points for Regular Attention according to Use of Car—Adjusting Valve Rocker Clearances.	
CHAPTER III.—CENTRALISED CHASSIS LUBRICATION ...	35
General—Foot-operated Oil Pump—Drip Plugs.	
CHAPTER IV.—ENGINE LUBRICATION SYSTEM ...	37
Filling the System—Oil Pump—Crankshaft—Connecting Rods—Relief Valves—Valve Rockers, Push Rods and Tappets—Camshaft—By-pass Filter—Oil Sump—Oil Level Indicator—Oil Pressure.	
CHAPTER V.—THE FUEL SYSTEM ...	43
The Fuel System—Fuel Pumps—Faulty Operation of Pumps—Fuel Tank—Strainers—Fuel Gauge—The Carburetters (Action)—Hand Starting Control—Adjustment of Carburetters—Automatic Air Valve—Throttle Control—Mixture Control and Slow Running—Float Feed Mechanisms—Further Dismantling of Carburetter—Air Cleaner and Silencer—Warning.	
CHAPTER VI.—THE BRAKING SYSTEM ...	53
General Description—Possible Variations—Adjustments—Adjustment of Hand Brake—Adjustment of Servo—Lubrication—Bleeding the Hydraulic System—Hydraulic Master Cylinder.	
CHAPTER VII.—CLUTCH, GEARBOX, PROPELLER SHAFT AND REAR AXLE ...	59
The Clutch—Clutch Pedal Mechanism—Clutch Pedal Adjustment—Gearbox—Universal Joints—Rear Axle.	
CHAPTER VIII.—STEERING, SHOCK DAMPERS, ROAD SPRINGS, WHEELS AND TYRES ...	65
Steering Box and Column—Front Suspension—Warning, Front Suspension Springs—Steering Arms and Joints—Front Stabiliser—Rear Hydraulic Shock Dampers—Rear Road Springs—Wheels—Wheel Discs—Lubrication of Wheel Bearings—Tyres—The Jacking System—Wheel Changing—Fitting and Removing Tyres—Inflation of Tyres—Balancing Road Wheels.	

Contents—continued.

	PAGE
CHAPTER IX.—ENGINE COOLING SYSTEM ... ..	77
Coolant—Coolant Pump and Fan—Fan Belt Adjustment—Overheating—Radiator Thermostat—Radiator Mounting—Coolant Level—Frost and Anti-freeze Mixtures—Car Heater—Mascots.	
CHAPTER X.—THE ELECTRICAL SYSTEM ... ..	83
General—Dynamo—Fuse Box—Fuse Data—Output Regulator and Cut-out—Switchbox—Ammeter—Battery and Connections—Ignition—Ignition Coil—Ignition Timing—Firing Order of Cylinders—Sparking Plugs—Starter Motor—Starter Motor Switch—Use of Starter Motor—Electric Fuel Pumps and Gauge—Electric Horns—De-mister and De-froster—Electrical Fault Location—Recommended Lamp Bulbs—Headlamps—Replacing a Headlamp Bulb—Aligning the Headlamps—Side Lamps—Radio.	
CHAPTER XI.—THE BODY AND COACHWORK ... ..	105
General—Washing and Polishing—Doors—Seat Slides—Upholstery and Carpets—Sliding Roof—Luggage and Spare Wheel Compartments—Tools.	
CHAPTER XII.—STORAGE AND RECOMMISSIONING OF CARS ...	109
CHAPTER XIII.—BENTLEY SCHOOL OF INSTRUCTION ... ..	III

## INDEX

---

	PAGE
Acid in Battery, Inspection of ... ..	29, 88
Adjustment of Contact Breakers ... ..	93
Adjustment of Carburetter ... ..	47
Adjustment, Clutch Pedal ... ..	59
Adjustment of Fan Belt ... ..	78
Adjustment of Brakes ... ..	30, 55
Adjustment of Hand Brake... ..	56
Adjustment of Ignition Plugs ... ..	31, 93
Adjustment of Servo Motor ... ..	57
Adjustment of Valve Rockers ... ..	31
Aerial, Operation of ... ..	103
Air Silencer and Cleaner ... ..	33, 51
Aligning the Headlamps ... ..	100
Ammeter ... ..	87
Anti-Freeze Mixtures... ..	29, 80
Automatic Air Valve, Carburetter ... ..	30, 47
Axle, Lubrication of Rear ... ..	27, 30, 33, 63
Axle, Oil Capacity of Rear ... ..	28
Battery, Care of ... ..	89
Battery, Charging ... ..	24, 89
Battery, Topping up... ..	29, 88
Belt, Adjustment of Fan ... ..	78
Body, Washing and Polishing ... ..	105
Brakes, Adjustment of ... ..	30, 55
Brake, Adjustment of Hand ... ..	56
Brushes, Dynamo ... ..	31, 84
Brushes, Motor ... ..	93
By-pass Oil Filter ... ..	31, 40

	PAGE
Camshaft ... ..	40
Carburetter, Action of ... ..	46
Carburetter, Adjustment ... ..	47
Carburetter, Automatic Air Valve... ..	30, 47
Carburetter, Float Feed Mechanism ... ..	50
Carburetter, Hand Starting Control ... ..	21, 22, 46
Carburetter, Needle Valve ... ..	49
Centralised Chassis Lubrication ... ..	35
Chains on Road Wheels ... ..	26
Changing Gear ... ..	23
Changing a Wheel ... ..	70
Chassis, Leading Particulars of ... ..	17
Chassis Lubrication, Centralised ... ..	35
Clutch ... ..	59
Clutch Pedal Adjustment ... ..	59
Clutch Spigot Bearing ... ..	59
Coil, Ignition ... ..	92
Cold Weather, Water in Cooling System ... ..	26, 80
Condenser of Contact Breaker ... ..	90
Connecting Rods ... ..	38
Contact Breaker ... ..	90
Control Mechanism, Lubrication of ... ..	30
Coolant Level in Radiator ... ..	25, 29, 79
Coolant Mixture ... ..	80
Coolant Temperature ... ..	25, 78
Crankshaft ... ..	38
Cut-out, Automatic ... ..	85
Cylinders, Firing Order of ... ..	93
Dampers, Hydraulic Shock ... ..	24, 31, 66, 67
Dampers, Governor for Hydraulic Shock... ..	67
De-froster and De-mister, Operating ... ..	26, 96
Distributor, Ignition ... ..	90
Doors ... ..	33, 106
Draining Engine Crankcase ... ..	31
Draining Cooling System ... ..	26, 78
Drip Plugs ... ..	36
Dynamo ... ..	31, 83
Dynamo Brushes ... ..	31, 84
Dynamo Connections... ..	84
Dynamo Output Regulator ... ..	86

	PAGE
Earth Connection of Battery ... ..	83
Electric Fuel Gauge ... ..	22, 46, 95
Electric Horns ... ..	95
Electric Lighting, Starting and Ignition System ... ..	83
Electrical Fault Location ... ..	97
Electrolyte, Inspection of ... ..	29, 88
Engine Cooling System, Capacity ... ..	28
Engine Lubrication System... ..	37
Engine, Maximum Speed ... ..	22
Engine, Quantity of Oil in ... ..	28
Engine, Starting the ... ..	21
Exhaust Fumes in Garage, Danger of ... ..	51
Fan, Engine Cooling ... ..	77
Fan Belt Adjustment ... ..	25, 78
Filler Plug, Gearbox ... ..	30, 33, 60
Filling Rear Axle Casing ... ..	27, 30, 33, 62
Filter, By-pass Oil ... ..	31, 40
Filter, Cleaning Fuel ... ..	33, 45
Firing Order of Cylinders ... ..	93
Float Feed Mechanism, Carburetter ... ..	50
Frost, Precautions during ... ..	26, 80
Fuel, Failure of Supply of ... ..	44
Fuel Feed System ... ..	22, 43
Fuel Gauge ... ..	22, 46, 95
Fuel Pumps ... ..	44, 95
Fuel Strainers... ..	33, 45
Fuel Tank ..... ..	28, 45
Fuse Box ... ..	84
Fuse Data ... ..	85
Fuse Wire ... ..	84
Fuses, Failure of ... ..	95
Fuses, Replacing ... ..	84
Fuses, Spare ... ..	84
Gearbox ... ..	27, 28, 30, 33, 60
Gearbox, Oil for ... ..	27
Gearbox, Oil Capacity of ... ..	28
Gear Changing ... ..	23
Glycol in Cooling System ... ..	25, 77
Governor Controlling Hydraulic Shock Dampers ... ..	70
Greases, Recommended ... ..	27



	PAGE
Hand Starting Control ... ..	21
Headlamps ... ..	99
Headlamps, Alignment ... ..	100
Headlamps, Replacing Bulb ... ..	100
Heater, Car ... ..	25, 81
Horns, Electric ... ..	95
Hubs, Wheel ... ..	69
Hydraulic Brakes, Bleeding ... ..	57
Hydraulic Shock Dampers ... ..	24, 31, 66, 67
Hydraulic Master Cylinder ... ..	33, 58
Ignition, Battery ... ..	90
Ignition Coil ... ..	92
Ignition Control ... ..	22
Ignition Plugs... ..	31, 93
Ignition Switch ... ..	21, 24, 87
Ignition, Timing ... ..	92
Instruction Class, Bentley ... ..	111
Jack, Portable Wheel ... ..	70
Joints, Universal ... ..	31, 62
Lamp Bulbs, Recommended ... ..	98
Lamps, Head ... ..	99
Leads, Colour of Dynamo ... ..	84
Lighting, Control ... ..	24, 87
Lubricating Oils and Greases Recommended ... ..	27
Lubrication, Centralised Chassis ... ..	35
Lubrication, Engine ... ..	27, 37
Lubrication, Gearbox ... ..	27, 28, 60
Lubrication, Periodic ... ..	27
Lubrication, Rear Axle ... ..	27, 30, 33, 63
Lubrication, Wheel Bearings ... ..	69
Luggage and Spare Wheel ... ..	107
Mascots ... ..	81
Maximum Engine Speed ... ..	22
Missing Fire ... ..	97
Mixture Control ... ..	21, 22
Motor, Servo ... ..	57
Motor, Starter ... ..	31, 92
Oil in Engine, Quantity of ... ..	28
Oil in Gearbox and Back Axle ... ..	28
Oil Level Indicator, Engine... ..	25, 41

	PAGE
Oil Pressure ... ..	42
Oil Relief Valve ... ..	39
Oil Relief Valve, Dismantling ... ..	39
Oil Pump, Chassis ... ..	36
Oil System, Engine ... ..	37
Oils, Recommended for Bentley Cars ... ..	27
Output Regulator, Dynamo... ..	86
Overheating ... ..	25, 78
Pivots, Steering ... ..	66
Plugs, Standard Settings for ... ..	31, 93
Propeller Shaft Sliding Joint ... ..	31, 62
Pump, Engine Oil ... ..	38
Pumps, Fuel ... ..	44, 95
Pump, Coolant ... ..	75
Radiator, Draining ... ..	25, 80
Radiator Mounting ... ..	79
Radiator Thermostat ... ..	25, 76
Radiator, Coolant Level in ... ..	25, 29, 79
Radio ... ..	101
Rear Axle, Quantity of Oil ... ..	28
Replacing a Headlamp Bulb ... ..	100
Road Springs, Lubrication of ... ..	35, 68
Road Wheel, Balancing ... ..	72
Rocker Shaft ... ..	39
Rockers, Valve ... ..	39
Seat Slides ... ..	106
Service Facilities ... ..	16
Servo Motor, Action of ... ..	53
Servo Motor, Adjustment of ... ..	57
Shock Dampers, Hydraulic ... ..	24, 31, 66, 67
Side Lamps ... ..	100
Slow Running... ..	50
Sliding Roof ... ..	107
Snow, Use of Chains for Driving on ... ..	26
Spare Wheel Compartment ... ..	107
Spark Gaps, Standard ... ..	31, 93
Spring Shackles, Lubrication of ... ..	35, 68
Springs, Road ... ..	35, 68
Stabiliser, Front ... ..	67
Starter Motor ... ..	31, 93

	PAGE
Starter Motor Bearings ... ..	31, 93
Starter Motor Brushes ... ..	93
Starter Motor Connections ... ..	93
Starter Motor, Failure of Operation of ... ..	97
Starter Motor Lubrication ... ..	31, 93
Starter Motor Switch ... ..	94
Starter Motor, Use of ... ..	94
Starting, Control Settings for ... ..	21
Starting the Engine ... ..	21
Steering Box, Oiling ... ..	28, 30, 65
Steering Joints ... ..	66
Steering Pivots ... ..	66
Storage of Car ... ..	109
Strainer, Chassis Oil Pump ... ..	36
Suspension, Independent Front ... ..	65
Switchbox ... ..	86
Switch, Ignition ... ..	21, 24, 87
Switch, Starter Motor ... ..	94
Temperature of Coolant ... ..	25, 78
Thermometer, Coolant Temperature ... ..	25, 79
Thermostat, Radiator ... ..	25, 78
Throttle Control ... ..	22, 49
Tools ... ..	108
Tyres, Sizes of ... ..	19, 69
Tyres, Removal and Fitting ... ..	71
Upholstery and Carpets ... ..	106
Universal Joints ... ..	31, 62
Valves, Oil Relief ... ..	39
Valve Rockers... ..	39
Valve Rocker Adjustment ... ..	31
Valve Tappets... ..	39
Wheels, Balancing Road ... ..	72
Wheel, Changing a ... ..	70
Wheel Hubs ... ..	69
Wheel Nuts ... ..	69
Wheel, Removing a ... ..	69

## INDEX OF ILLUSTRATIONS

	FIG. No.	PAGE No.
Adjustment, Clutch Pedal ... ..	19	60
Adjusting the Inlet Valve Rocker Clearances...	3	32
Air Collector—De-mister ... ..	42	96
Axle Casing, Rear ... ..	22	62
Box, Fuse, Output Regulator and Cut-out ... ..	36	85
Brakes, Adjustment of Front ... ..	16	56
Brakes, Adjustment of Rear ... ..	17	56
Braking System, Diagram of ... ..	15	52
Carburetters, in Position on Engine ... ..	13	47
Carburetter, Exploded View ... ..	14	48
Chassis Lubrication System, Diagram of ... ..	4	34
Chassis Oil Pump ... ..	5	35
Contact Breaker and Distributor ... ..	37	90
Contact Breaker, Interior View ... ..	38	91
Controls, Driver's ... ..	1	20
Controls, Radio ... ..	48	102
Crankcase Drain Plug ... ..	10	41
Damper, Rear Hydraulic Shock ... ..	23	67
De-mister and De-froster ... ..	41	96
Diagram of Braking System ... ..	15	52
Diagram, Electrical Wiring ... ..	35	83
Door Hinges ... ..	49	106
Drain Tap, Cylinder Jacket ... ..	33	80
Engine Lubrication System ... ..	6	37
Engine Oil Filler Cap and Dipstick ... ..	7	37
Engine Oil, Relief Valves... ..	8	39
Entered Stud at Top ... ..	29	71
Fan Belt Adjustment ... ..	32	78
Fitting Jack to Slide ... ..	24	70
Front Brake Adjustment ... ..	16	56
Front Hub and Wheel, Section of ... ..	30	73
Fuel Pumps... ..	11	43
Fuel Tank and Strainer ... ..	12	45
Fuse Box, Output Regulator and Cut-out ... ..	36	85
Gearbox ... ..	20	61
Gear Lever and Gate ... ..	2	23
Guide to Crewe Service Station ... ..	53	113

	FIG. No.	PAGE No.
Guide to Main Service Station ... ..	52	112
Headlamp ... ..	43	98
Headlamp, Changing the Bulb ... ..	45	99
Headlamp, with Rim Removed ... ..	44	98
Heater, Car, Connection and Isolating Tap ... ..	34	81
Hydraulic Shock Damper, Rear ... ..	23	67
Hydraulic Master Cylinder and Reservoir ... ..	18	57
Ignition Coils ... ..	39	92
Lubrication System, Chassis ... ..	4	34
Lubrication System, Engine ... ..	6	37
Motor, Starter ... ..	40	94
Mounting Rear Wheel ... ..	26	71
Oil Filter, By-pass ... ..	9	40
Oil Relief Valves, Engine ... ..	8	39
Operating Wheel Jack ... ..	25	70
Positioning Rear Wheel ... ..	27	71
Propeller Shaft ... ..	21	61
Pump, Chassis Oil ... ..	5	35
Radiomobile Controls ... ..	48	102
Rear Brake Adjustment ... ..	17	56
Rear Hub and Wheel, Section of ... ..	31	74
Rockers, Adjusting Valve ... ..	3	32
Rotating Front Wheel ... ..	28	71
Shock Damper, Rear Hydraulic ... ..	23	67
Side Lamp ... ..	46	101
Side Lamp ... ..	47	101
Spare Wheel Compartment ... ..	50	107
Starter Motor ... ..	40	94
Tools, Spare Wheel Compartment ... ..	51	108
Wiring Diagram, Electrical ... ..	35	83

## THE SECRET OF SUCCESSFUL RUNNING

---

Before a Bentley car is sold, it is very carefully tested and adjusted by experts. It will run best if no attempt is made to interfere unnecessarily with adjustments.

An owner would do well to instruct his driver as follows:—

Lubricate effectively, in strict accordance with the advice given in this book, and do not neglect *any* part.

Use only those oils which are recommended by Bentley Motors (1931) Ltd., who have made prolonged and searching tests of oils. Considerable harm and expense may result from the use of unsuitable oils.

Inspect all parts regularly, but take care not to alter any adjustments unless really necessary.

## **SERVICE FACILITIES FOR BENTLEY CARS**

Our interest in your Bentley car does not cease when you take delivery of the car. It is our ambition that every purchaser of a Bentley car shall continue to be more than satisfied.

With this end in view, the "Special Retailer", through whom the car was purchased, has established a properly equipped Service Station, staffed by men who have been specially trained in servicing Bentley cars.

In addition, on the staff of Bentley Motors (1931) Ltd., there are experts whose sole duty it is to maintain contact with the "Special Retailers", and they are available, at all times, to be called in for consultation on any matters affecting your car.

If, therefore, you require any assistance, we ask that you should immediately contact the "Special Retailer", who will be only too pleased to place his facilities at your disposal. If necessary he will call in for consultation our expert in that area. It is earnestly hoped that this arrangement will prove of mutual benefit, as we shall thus be kept in constant touch with our Customers, who may be spared the trouble of a long journey to one of our Company's Service Stations.

In the event of it being more convenient to call on us direct for assistance, our main Service Station at Hythe Road, Willesden, London N.W.10, and the one at our factory at Crewe, will be ready at all times to help. (See maps at end of Handbook.)

## LEADING PARTICULARS OF CHASSIS

### Engine.

Six cylinders,  $3\frac{1}{2}$ " (89 m/m.) bore,  $4\frac{1}{2}$ " (114 m/m.) stroke, 4,257 c.c., cubic capacity.

Mono-bloc casting, detachable cylinder head, overhead inlet valves, side exhaust valves.

Pistons of patented aluminium alloy.

### Engine Lubrication.

Pressure feed to all crankshaft and connecting rod bearings.

Pressure relief valve accessibly located, providing positive low-pressure supply to the valve rocker shaft, from which the inlet valves, push rods and tappets are lubricated.

Two-gallon capacity sump.

### Carburetter.

Two special type S.U.

Air intake silencer, with which is incorporated a special air cleaner element.

### Fuel System.

Eighteen-gallon tank at rear of chassis. Supply by electric pumps. Fuel level gauge and warning light on instrument board. The warning light indicates when fuel is low.

### Cooling System.

By centrifugal pump circulation and fan. Thermostatically controlled. Coolant temperature thermometer on instrument board.

### Electrical Equipment.

Twelve-volt system with automatic regulation of dynamo output by vibrator control. Separate starter motor with reduction gear and pinion providing gentle engagement. Battery of 55 ampere-hour capacity approximately.



### **Gearbox.**

Four forward speeds and reverse. Synchromesh on second, third and fourth speeds. Right-hand control lever.

### **Gear Ratios.**

Rear Axle Ratio.	1st Speed.	2nd Speed.	3rd Speed.	4th Speed. (Direct.)	Reverse.
3.73 : 1	11.11 : 1	7.52 : 1	5.0 : 1	3.73 : 1	11.76 : 1

### **Propeller Shaft.**

Large diameter, open, fitted with grease-retaining needle-bearing universal joints.

### **Rear Axle.**

Semi-floating type. Hypoid gears with differential. Torque and brake reactions taken by road springs.

### **Rear Suspension.**

By long semi-elliptic springs enclosed in leather gaiters, and lubricated from the centralised chassis system. Controllable hydraulic shock dampers.

### **Front Suspension.**

Independent, open helical springs in combination with hydraulic shock dampers.

### **Hydraulic Shock Dampers.**

Of Bentley design and manufacture, degree of damping of rear dampers adjustable by hand control on steering wheel.

### **Steering.**

Cam-and-roller type.

### **Brakes.**

Internal expanding on all four wheels, hydraulic operation on front wheels, mechanical operation on rear wheels.

Brake operation assisted by mechanical servo, which is equally effective for both forward and reverse movement of car.

Hand brake operates on rear wheels.

### **Chassis Lubrication.**

Centralised chassis lubrication system supplied by foot-operated pump and reservoir on dashboard.

**Road Wheels.**

Detachable steel wheels, fitted with 6.50" by 16" India Super Silent Rayon tyres.

**Dimensions.**

Total length overall, including bumpers ...	...	191½"	—	15'	11½"
Width of car ...	...	69"	—	5'	9"
Wheelbase ...	...	120"	—	10'	0"
Track—Front ...	...	56½"	—	4'	8½"
Rear ...	...	58½"	—	4'	10½"
Turning circle, outside edge of tyre ...	...			41'	2"

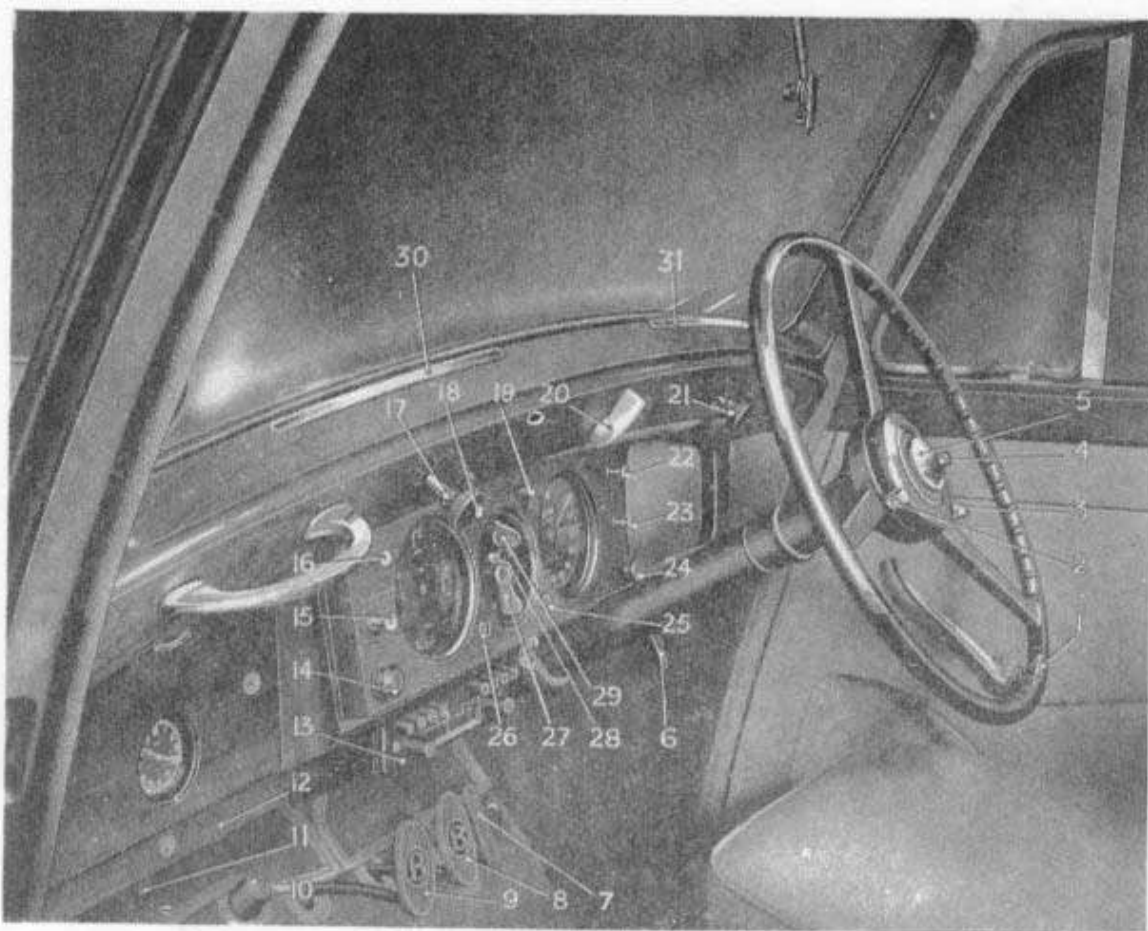

FIG. 1.—GENERAL VIEW OF DRIVER'S CONTROLS.

- |                               |                                    |
|-------------------------------|------------------------------------|
| 1. Steering wheel.            | 16. Windscreen wiper switch.       |
| 2. Throttle control.          | 17. Windscreen wiper parking knob. |
| 3. Mixture control.           | 18. Fuel/oil level switch.         |
| 4. Ride control.              | 19. Map lamp switch.               |
| 5. Horn push.                 | 20. Trafficator switch.            |
| 6. Hand brake.                | 21. Windscreen wiper parking knob. |
| 7. Accelerator pedal.         | 22. Fog lamp switch.               |
| 8. Brake pedal.               | 23. De-mister switch.              |
| 9. Clutch pedal.              | 24. Car heater rheostat.           |
| 10. Dip-switch.               | 25. Ignition warning.              |
| 11. Chassis lubrication pump. | 26. Fuel warning light.            |
| 12. Small tool drawer.        | 27. Master switch.                 |
| 13. Radio.                    | 28. Starter motor switch.          |
| 14. Cigar lighter.            | 29. Ignition switch.               |
| 15. Instrument light switch.  | 30. Air vent cover.                |
|                               | 31. Air vent cover.                |

## CHAPTER I

# Starting the Engine and Driving the Car

*Starting the Engine—Throttle Control—Mixture Control—Ignition Control—Fuel Feed—Fuel Gauge—Maximum Engine Speed—Gear Changing—Controllable Shock Dampers—Battery Charging—Lighting Control and Switch—Accessories—Radiator Thermostat and Thermometer—Overheating—Coolant Level in Radiator—Frost—Fitting of Snow Chains.*

### Starting the Engine.

Switch on the ignition by turning master and ignition switches on the instrument board to **On**.

The master switch controls all the electrical system, excepting the inspection lamp and the roof lamp, the latter being left always available for convenience when entering the car in the dark.

The action of switching on the ignition also switches on the electric fuel pumps, and a few pulsations of the latter may then be heard.

A small red warning light on the instrument board will be illuminated when the ignition is switched on, but will be extinguished when the engine speed is sufficient to cause the cutout contacts to close.

Set the mixture control to **"START"**; it must not be maintained in this position. As soon as the engine starts running, gradually reset the control to **"RUN"**.

With a cold engine the hand throttle control should be opened about one third of its range, but should be re-set to the closed position when the engine has warmed up.

Re-starting with a warm engine, the above is not necessary as the carburetter slow running adjustment has been set to give an adequate idling speed.

Depress the starter button firmly, *an appreciable pause must be made between the operations of switching on the ignition and depressing the starter button, especially when making a start from cold.* This is necessary in order to give the pumps time to fill the float chambers of the carburetters.

When starting the engine for the first time in the day it is a good plan to form the habit of depressing the chassis oil pump pedal once at this stage. Subsequently it should be depressed once every 100 miles. If the car is to be driven only a few miles, however, half a pump-full will be sufficient at the first starting.

When the engine is cold a high oil pressure will be shown on the gauge, due to the greater viscosity of the oil at low temperatures. The pressure will fall, however, as soon as the oil becomes warmer.

A starting handle is carried in the tool kit; in the event of it being used, it should be removed afterwards from the bracket and returned to the tool kit.

### **Throttle Control.**

Under normal running conditions, the hand throttle control should be carried right back at the closed position. An adjustable stop is provided on the carburetter for the throttle lever, which is so adjusted that the engine will idle reliably in these circumstances when the accelerator pedal is released.

### **Mixture Control.**

Under normal running conditions the lever should stand at "**RUN**". This control is only intended for use when starting from cold, and should not be used for varying the mixture strength under running conditions. Actually, its effect decreases rapidly as the throttle is opened.

### **Ignition Control.**

Control of the ignition timing is entirely automatic, no hand control being provided.

### **Fuel Feed.**

Fuel is supplied from the main tank to the carburetter by means of a dual electric pump mounted in the frame (See Fig. 11). The total capacity of the main tank is 18 gallons.

### **Fuel Gauge.**

The electric fuel gauge on the instrument board is graduated to register the total quantity of fuel in the main tank. The gauge is inoperative when the ignition is switched off.

Special contacts carried by the tank unit cause the green warning lamp to light when only about three gallons of fuel remain in the tank.

### **Maximum Engine Speed.**

*The engine speed must never be allowed to exceed 4,500 r.p.m. It is, therefore, recommended that as a safe guide, the following speeds should not be exceeded:—*

1st Gear	...	...	...	...	27 miles per hour.
2nd Gear	...	...	...	...	43 miles per hour.
3rd Gear	...	...	...	...	65 miles per hour.

The quietness of the Bentley engine and chassis, and the smoothness of the ride provided by the Bentley suspension, make it difficult to judge speed. *Keep an eye on your speedometer.*

### Gear Changing.

The position of the gear lever for each of the four speeds and reverse is shown in Fig. 2.

When reverse is required, the top of the lever must be depressed, this operates a catch, and allows the lever to be moved into the reverse gate.

A special synchronising device is fitted to second, third and fourth gears.

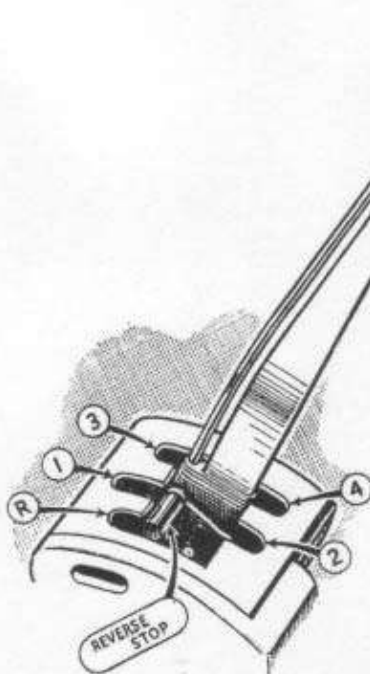

Fig. 2.—GEAR CHANGE LEVER AND GATE.

Any change into these gears—up or down—is facilitated by this easy change mechanism. All that it is possible to ensure by such a synchronising mechanism is that the gear members to be engaged cannot be brought together until they are both rotating at the same speed. It does not synchronise the engine and clutch shaft speeds. This must be done by the driver before re-engaging the clutch, otherwise there will be an unpleasant jerk, causing unnecessary wear and tear of the clutch and strain on the transmission.

It is necessary to depress the clutch pedal fully when changing gear. The gear lever should then be moved gently into the required gear position and, before re-engaging the clutch, the engine should be speeded up when changing down, or allowed to slow down when changing up, so that its speed shall suit the car speed on the required gear.

The change from second to first must be made in the usual manner by double de-clutching.

If an owner prefers to start from rest in second speed, this is in no way detrimental to the transmission or clutch, and, in fact, with the Bentley Mk. VI is the recommended procedure under normal conditions.

### **Controllable Shock Dampers.**

In order to provide comfortable riding at all speeds, controllable shock dampers are fitted to the rear axle.

The control is effected by the lever, mounted above the steering wheel, and marked **Ride Control**.

For ordinary town work, or touring with moderate loads, it will be found that the damper loadings as set by the pump are adequate when the hand lever is at **Normal**.

With heavy loads, improved riding comfort will be obtained by moving the lever towards **Hard**, the control being progressive.

### **Battery Charging.**

This is entirely automatic, as the provision of an automatic output regulator in conjunction with a shunt wound dynamo, adjusts the charge rate to suit the state of the battery.

When the battery is low in charge, the ammeter on the instrument board will show a higher reading towards **Charge** than it will when the battery is well charged. In making such a comparison, however, other factors which affect the ammeter reading must be taken into account, chiefly engine speed and current-consuming apparatus in use at the time.

Whenever the master switch and the ignition switch are **On**, and the engine running above idling speed, the battery is being charged. This should be checked by reference to the ammeter.

Further information regarding the electrical system is given in Chapter X.

### **Lighting Control and Switch.**

As already mentioned, the movement of the master switch and the ignition switch to **On** not only switches on the ignition and charge, but brings into operation the electric fuel pumps and fuel gauge.

The ignition switch also switches on a red warning light on the instrument board, which is automatically extinguished when the engine is running at a speed sufficient to cause the dynamo to excite up to battery voltage.

This red lamp consequently serves two purposes, viz.:—

- (a) When alight it shows the driver that the ignition switch is on, and, therefore, warns him to switch off if he is leaving the car, and

- (b) When it becomes extinguished this indicates that the dynamo is exciting. (It does not follow that the dynamo is charging the battery. This should be ascertained by reference to the ammeter.)

The master switch controls the head, side and tail lamps, alternative **On** positions being provided, viz.:—

**S** and **T**.—Side and Tail lamps on.

**H, S** and **T**.—Head, Side and Tail lamps on.

**PL**.—"Parking" lights on, e.g. Side and Tail lamps on, accessories off.

In addition, a foot operated switch is provided, by means of which, the beam of the driving lights is altered to allow anti-dazzle precautions to operate, thus extending courtesy and safety to passing traffic.

### Accessories.

The control of the Windscreen Wiper and De-mister is provided by means of switches on the instrument board.

A press button switch is also available for ascertaining the engine oil level which reads on the fuel gauge. (See Fig. 1.)

These are all controlled by the master switch, and it is recommended that the master switch be regularly used to avoid leaving the car with one of the accessories in operation.

### Radiator Thermostat and Thermometer.

A thermostat is provided in the upper radiator coolant pipe which automatically restricts the flow through the radiator, until the coolant in the system attains a temperature of about 78° C.

A thermometer is provided on the instrument board to indicate that the thermostat is operating properly and that there is no shortage of coolant.

### Overheating.

If on long ascents which call for full throttle, "boiling" should occur due to abnormal conditions of atmospheric temperature, and/or, following winds, etc., it is preferable to change into a lower gear and reduce the throttle opening.

Adjustment of the fan belt may be necessary, and this should receive attention.

### Coolant Level in Radiator.

The radiator filler cap, which is located beneath the bonnet on the left-hand side, should be removed occasionally for inspection of the coolant level, but it *must not be removed when the engine is running*.

The level of the coolant should be maintained at approximately one inch below the bottom of the filling orifice. Top up if necessary with the correct anti-freeze mixture. (See page 80.)



**Frost.**

The car is delivered with a suitable anti-freeze mixture in the cooling system. (See page 77.)

If the original coolant has been replaced with water, and the car has to stand exposed to frost with the engine not running, it is of vital importance that the system should be drained by opening the drain taps on the water pump inlet pipe, and on the cylinder block (1, Fig. 33), and releasing the filler cap. The car heater must also be drained by opening the tap on the return pipe.

*Before attempting to start, or even move the engine again,* hot water should first be poured over the water pump, as otherwise damage may be caused to the pump rotor by the presence of particles of ice within the casing. Warm water can be used with advantage for refilling the radiator.

**Fitting of Snow Chains.**

In the event of snow chains being necessary, they should be fitted to the rear wheels only.

A Parsons chain, known as the "Special Bentley Type", is available. It is recommended that these be obtained through Messrs. Bentley Motors (1931) Ltd., or one of their "Special Retailers", in order to ensure the supply of the correct type.

When fitting these special chains, it is *essential* to commence by fastening the one hook on the inside of the wheel and always to take up the adjustment on the outside, where two fastening clips are provided. The tensioning springs which are supplied to go on the outside of the wheel must always be fitted.

## CHAPTER II

### Periodic Lubrication and Attention

#### LUBRICANTS RECOMMENDED

Bentley Motors (1931) Ltd. recommend a first quality oil of viscosity S.A.E. 20 for the engine all the year round, and viscosity 30 for the gearbox.

Any of the following oils are suitable:—

			"A"	"B"
			Engine.	Gearbox.
Price's Motorine ...	...	...	E.	M.
Wakefield's Castrol ...	...	...	Castrolite.	XL.
Vacuum Mobiloil ...	...	...	Arctic.	A.
Shell ...	...	...	Single.	Double.
Duckham's Adcoidised ...	...	...	NP. "Twenty"	NP. "Thirty"
Essolube ...	...	...	20.	30.
Silvertown Speedolene ...	...	...	20.	T.
Sternol ...	...	...	WW.20.	WW.30.

In the instructions which follow, reference is made to Oil "A" or "B" as above, i.e., viscosity 20 or 30.

#### Rear Axle.

Wakefield's Special Castrol Hi-press S.C. (If circumstances make this unobtainable, any one of the following may be used. Do **not** mix these oils; drain and refill.)

Price's ...	...	...	...	Motorine Hypoid.
Wakefield's ...	...	...	...	Castrol Hypoy.
Vacuum ...	...	...	...	Mobilube GX.
Shell ...	...	...	...	Spirax E.P.90.
Duckham's ...	...	...	...	Adcol Hypoid 90.
Essolube ...	...	...	...	Essoleum Expee Compound 90.
Silvertown ...	...	...	...	Speedolene Hypoid 90.
Sternol ...	...	...	...	Hypoid 90.

#### Carburetter Air Valve Damper.

Viscosity 10 oil, any of the following may be used:—

Price's ...	...	...	...	Motorine U.C.L.
Wakefield's ...	...	...	...	Wakefield Oilit.
Vacuum ...	...	...	...	Mobil Handy Oil.
Shell ...	...	...	...	Donax A.I.
Essolube ...	...	...	...	Esso Shock Absorber Light.

**Steering Box—Chassis Oil Pump—Starter Motor Gears.**

Viscosity 30 oil, as under "B" above.

**Hydraulic Shock Dampers.**

Viscosity 20 oil, as under "A" above.

**Propeller Shaft—Contact Breaker Cam.**

Vacuum Mobilgrease No. 2.

**Distributor Grease Cup.**

High Melting Point Grease.

**Hydraulic Brake Fluid.**

Lockheed Brake Fluid—Orange.

**CAPACITIES**

Engine ...	...	...	...	...	...	16 pints approx.
Gearbox	...	...	...	...	...	6 pints "
Rear Axle	...	...	...	...	...	1¼ pints "
Chassis Oil Pump	...	...	...	...	...	2 pints "
Cooling System	...	...	...	...	...	3¼ gallons "
Fuel Tank	...	...	...	...	...	18 gallons "

**GENERAL**

In addition to the points supplied with oil by the centralised system, there are others which, for various reasons, cannot be fed in this way and must, therefore, be lubricated by hand.

In the notes which follow, these points are classified as far as possible under mileages, or according to the usage of the car.

It is important that careful attention should be given to their lubrication so as to reduce wear and eliminate mysterious squeaks and rattles.

Further notes are included covering the periodic operations and adjustments which are necessary.

## Points for Regular Attention according to Use of Car

### FREQUENTLY, OR DAILY IF LONG JOURNEYS ARE CARRIED OUT

#### 1.—Engine Oil.

Inspect oil level on dip-stick or electric gauge **when engine is not running**, and top up as necessary with correct oil. Do not run engine with oil level down to "Min." mark. (See page 41.)

#### 2.—Chassis Lubrication.

Use foot-operated pump according to mileage travelled. Depress pedal once when car is being started for the first time each day, and then once every 100 miles. Use the pump more frequently during bad weather.

Replenish reservoir as necessary, but do not overfill. Leave one inch between oil level and bottom of filler orifice.

### WEEKLY

#### 3.—Radiator Coolant.

Inspect coolant level and, if necessary, top up with the correct anti-freeze mixture to maintain the level at about one inch below the bottom of the filling orifice.

#### 4.—Tyres.

Check the tyre pressures.

These should be:—Front, 25 lbs./sq. in. } Cold.  
Rear, 30 lbs./sq. in. }

#### 5.—Distributor Grease Cup.

Give grease cup one turn; when empty, fill with the correct grease. (See page 28.)

### MONTHLY

#### 6.—Battery.

Check level of acid in each cell and top up with distilled water if necessary. Check more frequently when big mileages are covered or when the car is being run during hot weather.

### 7.—Brakes.

See Chapter VI for description.

To check the adjustment, rotate the adjusters in a clockwise direction until obvious resistance is felt. This resistance should be equal for all four brakes, and should the last "click" on any one adjuster require noticeably greater force to obtain, this adjuster should be turned back to the previous "click". (See page 55.)

### 8.—Carburettors.

Inspect oil level in oil reservoir of automatic air valve guide, and top up with the recommended oil. (See page 27.)

## Lubrication and Maintenance

### EVERY 5,000 MILES

#### 1.—Gearbox.

Inspect oil level in the gearbox by means of dipstick. If necessary replenish with the correct oil to level of mark on dipstick. (See page 60.)

#### 2.—Rear Axle.

Inspect oil level in rear axle when warm, by removing level plug (Fig. 22), and, if necessary, top up with correct oil to level of hole. (See page 63.)

*If the correct oil is not obtainable, do not add a different oil, but if replenishment is necessary, drain off and refill with an alternative oil as directed on page 27.*

#### 3.—Steering Box.

Remove plug and fill casing with correct oil to mouth plug of orifice. (See page 65.)

#### 4.—Ignition Governor.

Remove the distributor cover and lift off rotor. Apply two or three drops of oil "A" to governor spindle. (See page 91.)

#### 5.—Contact Breakers.

Apply one drop of oil "A" with oil-can to the pivot pin of each rocker arm. (See page 91.)

#### 6.—Distributor Cam.

Smear a trace of grease on the cam surface. (See page 91.)

#### 7.—Control Mechanism.

Apply a few drops of oil "A" with oil-can to controls on steering wheel (oil hole), accelerator pedal mechanism, clutch pedal mechanism, and all other control points and bearings.

**8.—Brake Connections, etc.**

Apply liberally oil "A" with oil-can to all joints and pins of brake rods and connections, or spray with penetrating oil.

**9.—Bonnet Fasteners and Locks.**

Carefully lubricate with oil "A" bonnet fasteners and locks.

**10.—Sparking Plugs.**

Alternative plugs are Champion Type N8, or Lodge Type CLN, 14 m/m. non-detachable. Plugs should be serviced on special plug cleaning and testing machine, which should be available in all service stations. Set gaps to .025" (.635 m/m.)

**EVERY 10,000 MILES****1.—Starter Motor.**

Remove plug on side of reduction gear casing, and fill to plug orifice with oil "B". (See Fig. 40.)

**2.—Engine Oil Sump.**

When engine is warm drain crankcase and refill with oil "A" to the correct level.

**3.—Dynamo.**

Inspect brushes for wear; to do this, unscrew securing screws and remove cover to expose brushes. (See page 84.)

If renewal is necessary, remove dynamo, clean out dust and fit new brushes, making sure that they are bedding correctly on the commutator. Refit dynamo. (See page 84.)

**4.—Hydraulic Shock Dampers.**

Inspect oil level and add more oil if necessary.

*Use only correct oil.* (See page 28.)

**5.—Universal Joints and Propeller Shaft.**

Inject grease by means of grease-gun into lubricator located at centre of each universal joint, and also into the lubricator on the sliding joint. (See Fig. 21.)

**6.—By-Pass Oil Filter.**

Replace by-pass oil filter element, on right-hand side of engine, with a new one. See that the cover joint is oil-tight thereafter. (See page 40.)

**7.—Valve Rocker Clearances.**

Check the inlet valve rocker clearances and re-set if necessary. This operation should be performed *when the engine is cold.*

The method of adjusting the valve rocker clearances is illustrated in Fig. 3.

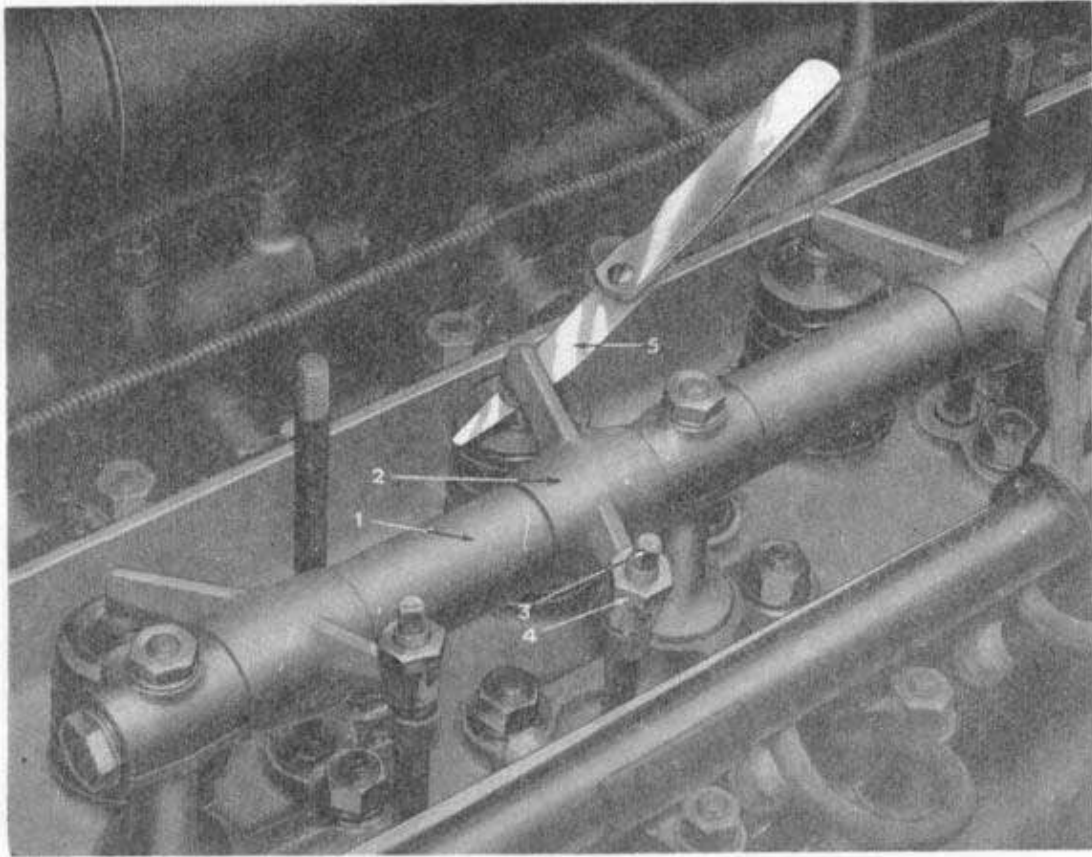

Fig. 3—ADJUSTING THE INLET VALVE ROCKER CLEARANCES.

- |                              |                  |
|------------------------------|------------------|
| 1. Rocker shaft.             | 4. Locknut.      |
| 2. Rocker.                   | 5. Feeler gauge. |
| 3. Ball ended contact screw. |                  |

Before commencing to adjust a tappet, it should be ascertained that the lower tappet operating the push rod is on the base circle of its operating cam. This is best done by turning the crankshaft by hand until the valve has opened and closed, and then cranking round half a revolution beyond this point.

The ball ended contact screw (3) is screwed into the rocker and locked with a nut (4). On releasing the nut the screw can be turned by means of the special spanner provided.

The correct clearance for the inlet rockers is .006" (.152 m/m.). A feeler gauge is provided in the tool kit, and is shown in position (5), for measuring the clearances.

As each contact screw is adjusted, its locknut should be securely tightened up.

The correct clearance for the exhaust tappets is .012" (.305 m/m.), *with the engine cold*. These should need no attention between de-carbonising periods of the engine.

**8.—Air Cleaner.**

Remove cleaner element from front end of silencer, after unscrewing the wing-nut and taking off end cover. Carefully wash element in petrol or paraffin and afterwards oil with oil "A". Drain off excess oil before re-fitting.

It should be noted that if the car is being run under particularly dusty conditions, the element may need cleaning more frequently. (See page 51.)

**9.—Doors.**

Oil lock bolts and hinges with oil "A". (See page 106.)

**10.—Hydraulic Master Cylinder.**

Remove the filler plug (2), Fig. 18, and check the fluid level, top up if necessary with the recommended fluid (see page 27) so as to maintain the level at one inch below the filler cap.

**EVERY 20,000 MILES****1.—Gearbox.**

Drain out all the oil, by removing the drain plug, and refill with oil "B", up to the mark on the dipstick. (See page 60.)

This operation is more easily performed when the gearbox is warm.

**2.—Fuel Strainers.**

Remove and clean gauzes of strainer, located on cross-member of frame in front of main tank. Drain and clean strainer sump. (See page 45.)

Also, remove and clean gauze strainer on fuel inlet to carburetter float chamber, taking care, first, to see that the ignition is switched off, and fuel pumps are therefore inoperative. (See page 46.)

**3.—Fuel Tank.**

*Release*—but do not remove—drain plug at bottom of main tank to allow any accumulated water to escape. (See page 45.)

**4.—Rear Axle.**

Drain axle when warm, and refill. Approximately  $1\frac{3}{4}$  pints of oil will be required.

*None but the recommended oil should be used*, and this should be warmed before inserting.

**5.—Chassis Lubrication System.**

Remove and discard felt strainer pad, located at base of chassis oil pump. (See page 36.) Replace with new pad.



**DIAGRAM**  
**CHASSIS LUBRICATION SYSTEM**

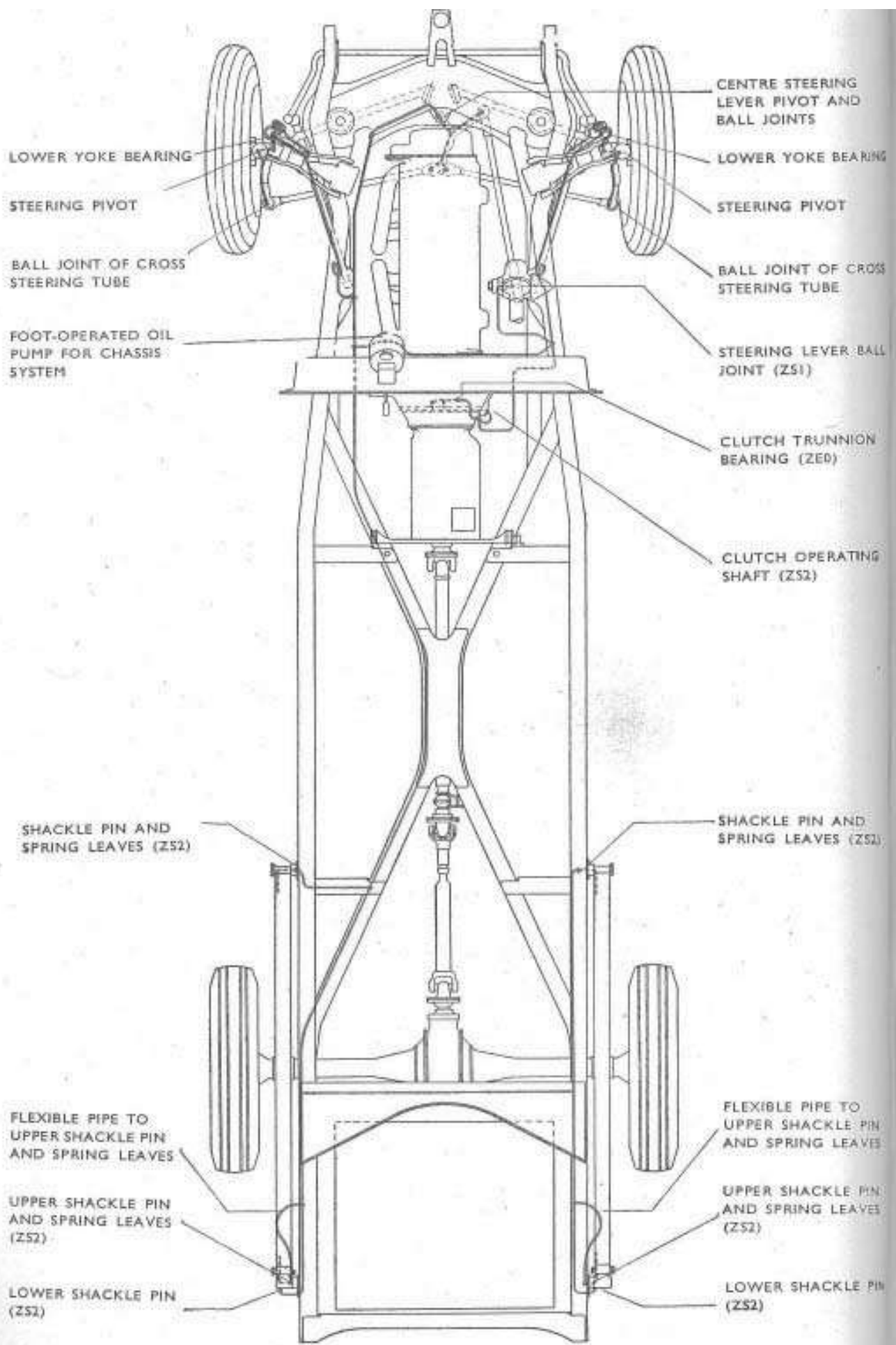

Fig. 4.—DIAGRAM OF CHASSIS LUBRICATION SYSTEM.

## CHAPTER III

**Centralised Chassis Lubrication**

*General — Foot operated Oil Pump — Drip Plugs.*

**General.**

A foot-operated pump, with which is combined an oil reservoir, is located on the front of the dashboard, and supplies oil under pressure for chassis lubrication.

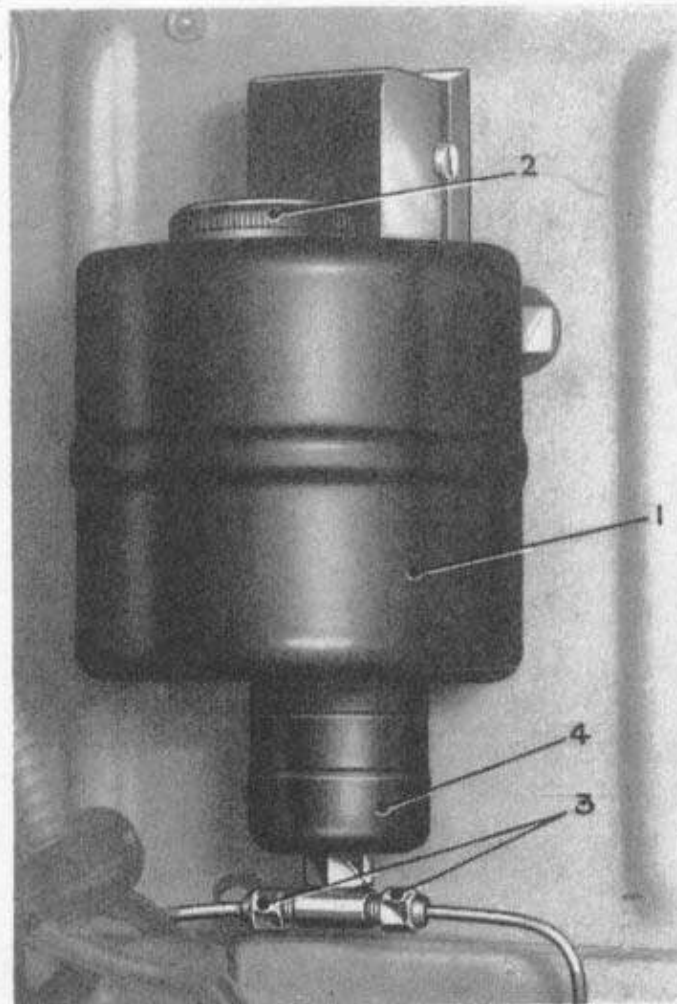
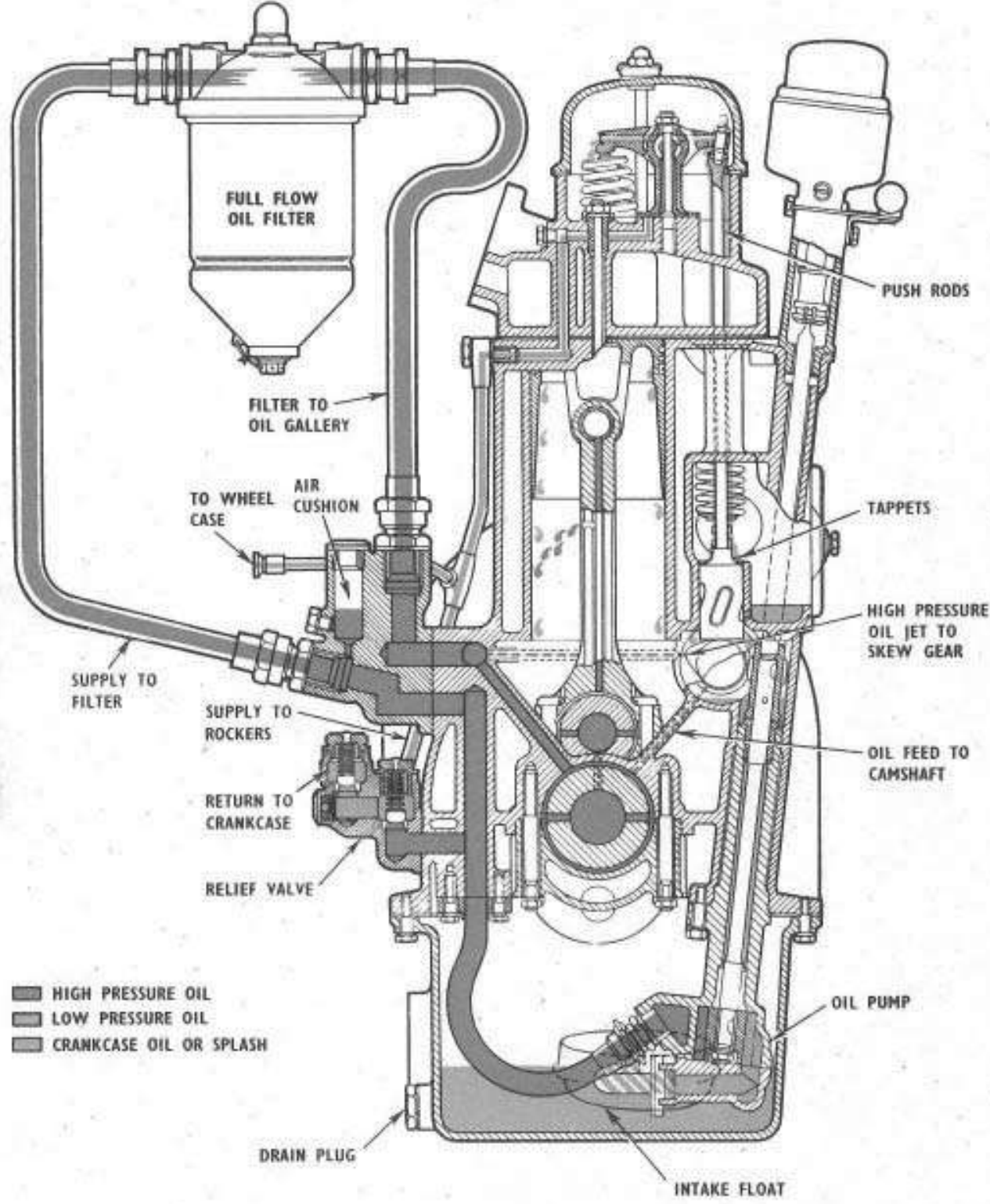

Fig. 5.—CHASSIS OIL PUMP AND RESERVOIR.

- |                |                 |
|----------------|-----------------|
| 1. Reservoir.  | 3. Pipe unions. |
| 2. Filler cap. | 4. Strainer.    |

A diagram of the complete system is given in Fig. 4, the piping being coloured red. Red discs indicate the positions of drip plugs, and the rating of each is given in parentheses against the description of the part lubricated.



**FIG. 6. ENGINE LUBRICATION SYSTEM**

## CHAPTER IV

**Engine Lubrication System**

*Filling the System—Oil Pump—Crankshaft—Connecting Rods—Relief Valves—Valve Rockers, Push Rods and Tappets—Camshaft—By-pass Oil Filter—Oil Sump—Oil Level Indicator—Oil Pressure.*

The engine lubrication system is diagrammatically illustrated in Fig. 6.

Recommended oils will be found on page 27.

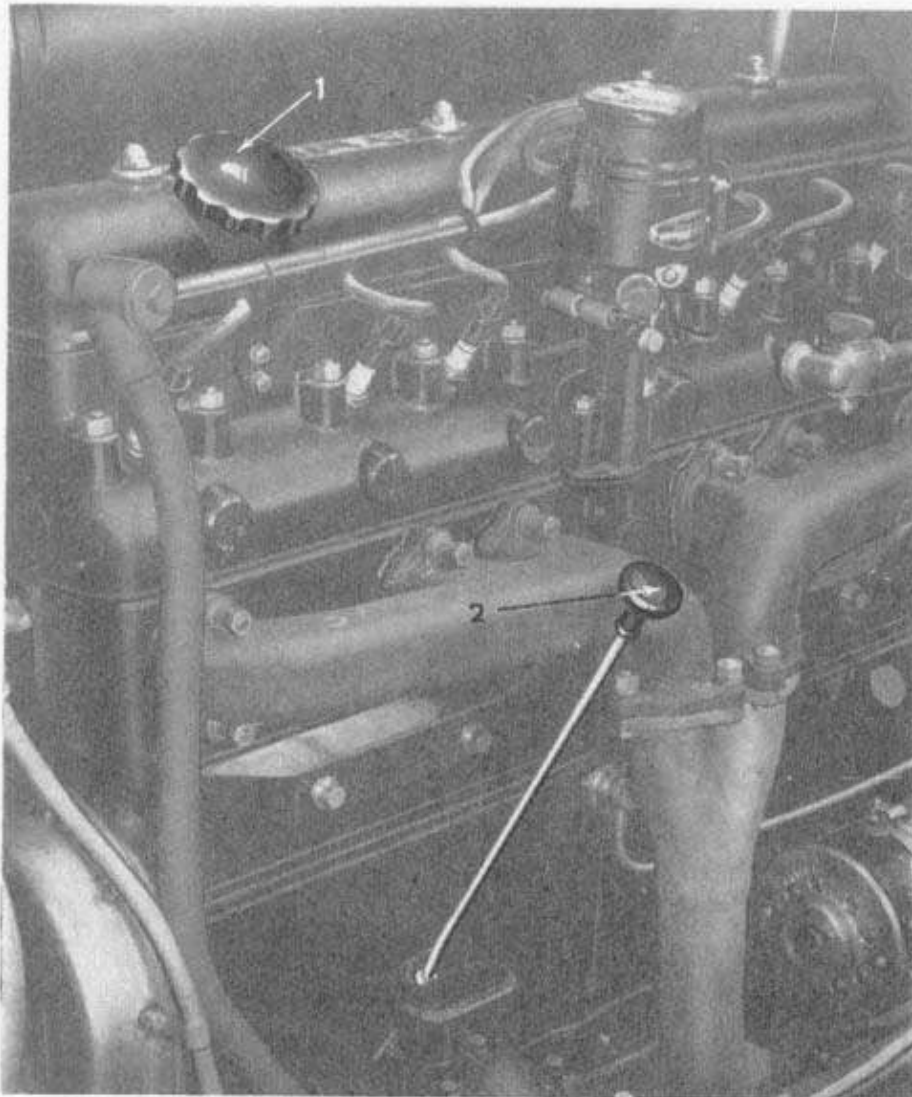

Fig. 7.—FILLER CAP AND DIPSTICK.  
1. Engine oil filler cap.      2. Dipstick.

### Filling the System.

The system is filled, or topped up, by removing the oil filler cap (1, Fig. 7), located on the inlet rocker cover, and pouring in the required amount of recommended oil.

It should be appreciated that it takes a little time for the oil to drain through to the sump, especially if the oil is cold.

The level of the oil should be frequently checked with the dipstick **when the engine is not running** (2, Fig. 7), and the system regularly topped up as required (see page 29), so as to keep the level of the oil up to the "Max" mark.

### Oil Pump.

A gear type pump is mounted in the lower half of the crankcase, and is driven by means of a vertically-mounted shaft and skew gears from the centre of the camshaft, a coupled extension of which drives the ignition distributor.

The oil intake from the sump is of the floating gauze filter type, ensuring the collection of clean oil, free from sludge, water or grit.

Oil is drawn by the pump through the floating intake and is delivered direct to the oil gallery, which is incorporated in the crankcase casting.

### Crankshaft.

From the internal oil gallery, oil is fed through oil ways drilled in the crankcase webs to each of the seven main crankshaft bearings, which are of the copper-lead-indium lined, steel shell type.

The crankshaft journals and crankpins are bored for lightness and to act as oil conduits, the ends of the holes being plugged with caps.

All the main bearings have circumferential oil grooves, and radial holes are drilled in the crank journals to register with these grooves.

Oil from the main bearings passes to the bore of each journal through the radial transfer holes, and thence to the crankpins through diagonal ducts drilled in the crankshaft webs. Oil from each crankpin bore issues through radial holes in the crankpins to lubricate the big end bearings.

### Connecting Rods.

The big end bearings are of similar type and material to that of the main bearings.

Each connecting rod is drilled to convey oil to the gudgeon pin bearing, the drilling passing through the big end bearing shell.

Two radial holes in the crankpin ensures communication, twice per revolution, with the oil way up the connecting rod. Thus, all the crankshaft bearings, and all the connecting rod bearings, are supplied with oil under pressure.

### Relief Valves.

A drilling through the casting conveys oil to a double relief valve located in an accessible position on the right-hand side of the crankcase. (See Fig. 8.)

The two valves are in series, and their combined effect is to regulate the pressure of the main high-pressure supply to the crankshaft and connecting rod bearings to approximately 25 lbs. per square inch.

Oil passing the high-pressure valve (3, Fig. 8) enters the low-pressure chamber, and from there via pipe (4) to the inlet valve rocker shaft.

In order to ensure a supply of oil to the low-pressure system under all conditions of running, small slots are cut in the seating of the high-pressure valve (3).

If it should be suspected that the relief valves are not working properly, they can be inspected by removing the plugs (3), above the high-pressure valve, and (2), above the low-pressure valve (Fig. 8).

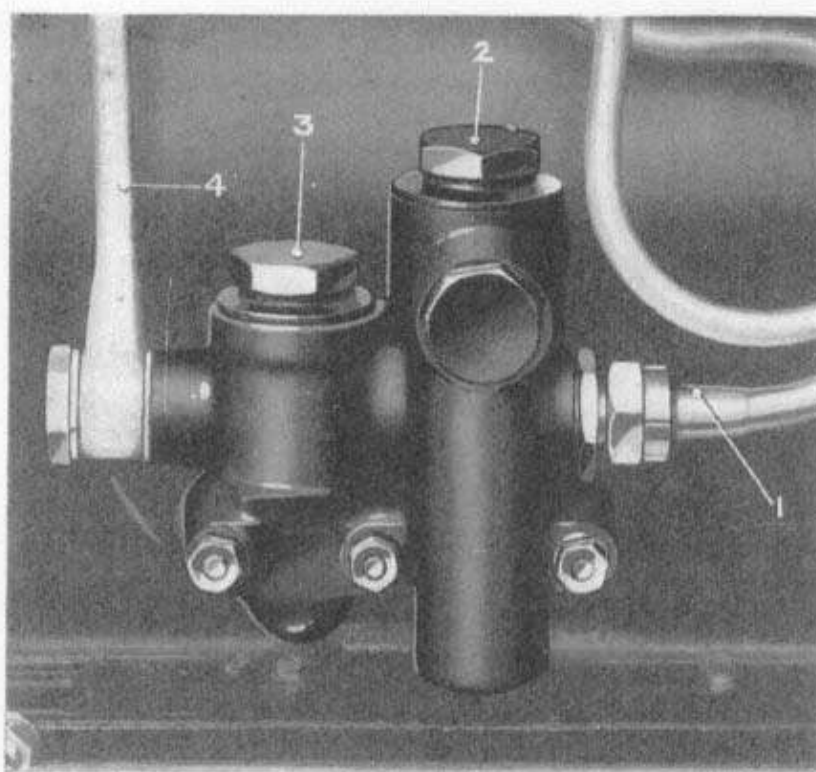

Fig. 8.—OIL RELIEF VALVES.

- |                                |                        |
|--------------------------------|------------------------|
| 1. Return from by-pass filter. | 2. Low-pressure valve. |
| 3. High-pressure valve.        | 4. Outlet to rockers.  |

In each case the valve spring will be found retained on the plug. The valves can then be lifted out and the valves and seats cleaned and inspected.

No attempt must be made to alter the spring settings by interfering with the springs themselves, or by varying the washers under the plugs.

Care must be taken to replace all parts in a perfectly clean state.

### Valve Rockers, Push Rods and Tappets.

The centre pedestal of the inlet valve rocker shaft is drilled and communicates through an oil hole in the head with a union on the right-hand side, to which pipe (4, Fig. 8) is connected.

The rocker shaft is drilled radially where each rocker works to lubricate the bearings of the latter. The rocker arms are also drilled, the holes running through the bearing bushes. By this means oil is fed on to the push-rod ball ends and the ends of the valve stems.

Each valve guide is provided with a packing gland, held in position by the valve spring, which prevents excess oil from percolating down the valve guides. Oil is returned from the rocker casing to the crankcase through the push-rod tunnels.

### Camshaft.

The camshaft is driven by single helical gears and carried in four plain bearings, the latter being lubricated with high-pressure oil through drillings in the crankcase webs.

### By-Pass Filter.

A special filter is provided on the right-hand side of the crankcase, as shown at (1, Fig. 9), which is fed with oil under maximum pressure from a bleed hole in the high-pressure oil gallery, via pipe (5). The filter element restricts the flow of the by-passed oil, and so ensures that the by-passing effect of the filter shall not appreciably rob the main pressure system.

A proportion of high-pressure oil being thus continuously forced through the filter, it follows that the whole of the

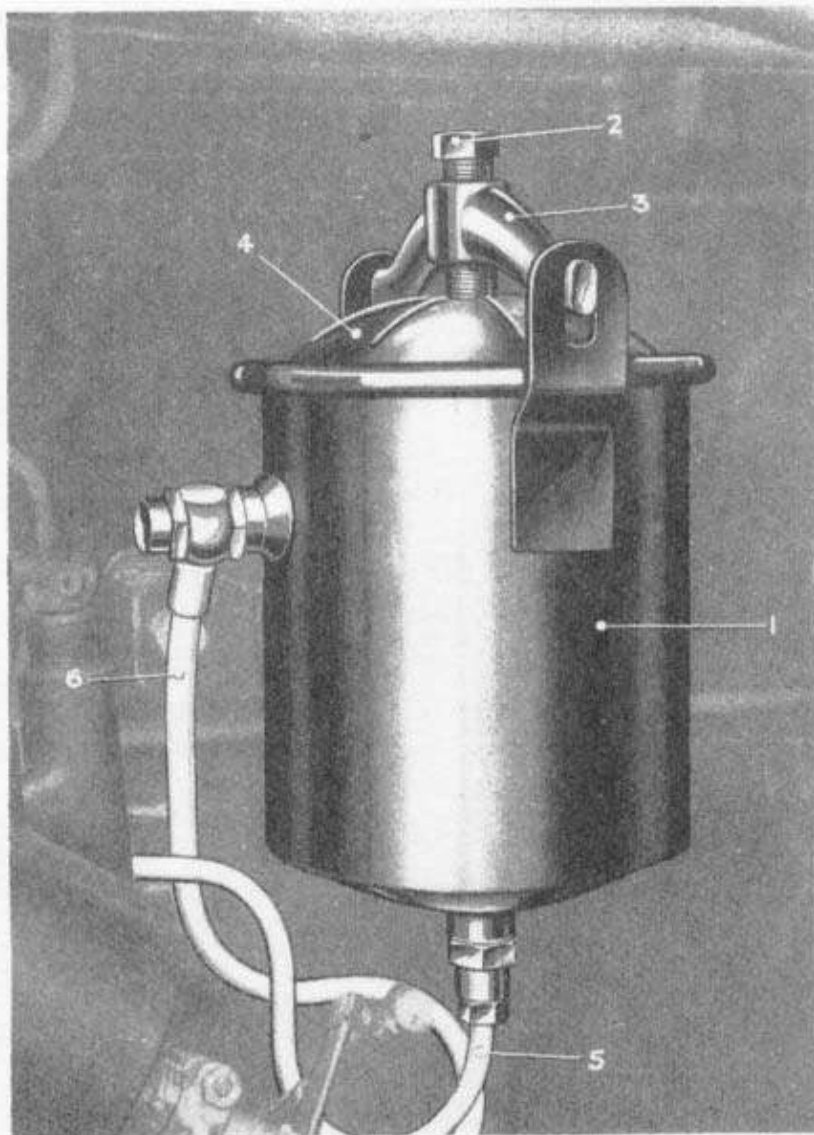

Fig. 9.—BY-PASS FILTER.

- |                 |                        |
|-----------------|------------------------|
| 1. Filter.      | 4. Cover.              |
| 2. Cover screw. | 5. Supply to filter.   |
| 3. Yoke.        | 6. Return from filter. |

crankcase oil passes through the filter in a short time.



Oil from the filter is conveyed back to the crankcase via pipe (6), which is connected to the low-pressure chamber of the relief valve.

Every 10,000 miles, as directed on page 31, the filter element should be discarded and replaced with a new one. It is not practicable to clean the filter element, and no attempt must be made to do so.

To remove the element, the screw (2) should be released, and the yoke (3) removed. The cover (4) can then be taken off and the element removed.

When fitting the new element, care must be taken to ensure that the cork washer, under the cover (4), is in position, and that the screw (2) is well tightened. On next running the engine, it should be inspected for oil leaks around the filter cover.

### Oil Sump.

Under normal circumstances, and with proper attention, the by-pass filter will maintain the oil in a clean condition.

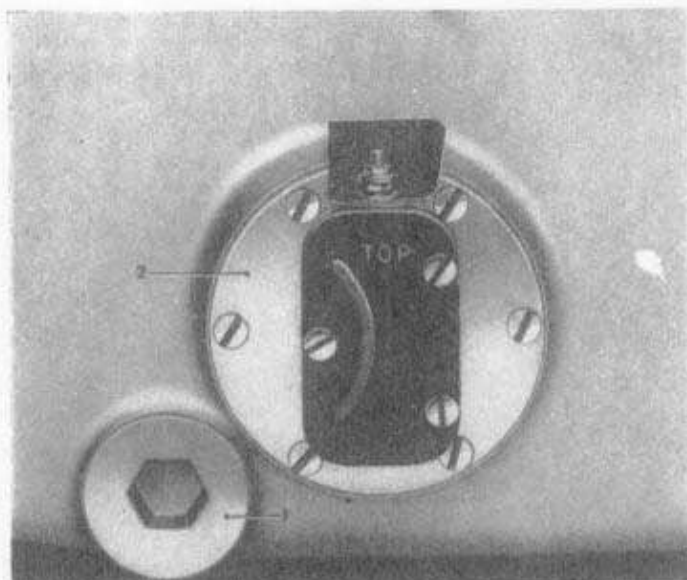

Fig. 10.—CRANKCASE DRAIN PLUG.

1. Drain plug. 2. Oil level indicator float unit.

Owing to the risk of dilution of the oil, however, it is advisable to drain the sump and renew the oil every 10,000 miles, as directed on page 31.

To drain the oil, a plug (1, Fig. 10) is provided, which should be unscrewed and the oil allowed to drain out. On replacing the plug, care must be taken that the joint washer is also refitted in position.

### Oil Level Indicator.

In order that a quick check may be obtained, the petrol gauge on the instrument panel has been so arranged that by depressing the switch (see Fig. 1), it will register the approximate quantity of oil in the engine sump.

The gauge is electrically connected to a float unit fitted into the right-hand side of the crankcase sump (2, Fig. 10.)

The reading should be taken when the car is standing as nearly level as possible.

The amount of oil should be maintained at "Full", this corresponding with the "Max" mark on the dipstick, and showing that there is approximately 16 pints of oil present. A red line on the gauge indicates "minimum", and the engine should never be run with the oil level below this mark.

**Oil Pressure.**

Under normal conditions of engine temperature and speed, the instrument board pressure gauge should read approximately 25 lbs.

On starting the engine from cold, however, a higher oil pressure will be indicated, but this need not cause alarm, as the pressure will fall when the engine becomes warmed up.

When the engine is idling and hot, the pressure may fall to 4 lbs., but provided that it increases as the engine speed increases, this is in order.

The car must on no account be run if the gauge reads as low as this *continuously*.

Such a persistently low pressure, which may be accompanied by fluctuations of the gauge needle, may be due to one or more causes.

In the first place, it should be ascertained that there is sufficient oil in the sump by referring to the oil level indicator.

If this is found to be in order, the trouble may be due to a particle of foreign matter having lodged on one of the relief valve seatings and preventing the valve from closing. If the latter is suspected, the relief valve should be inspected and cleaned as directed on page 39.

## CHAPTER V

## The Fuel System

*The Fuel System—Fuel Pumps—Faulty Operation of Pumps—Fuel Tank—Strainers—Fuel Gauge—The Carburetters (Action)—Hand Starting Control—Adjustment of Carburetters—Automatic Air Valve—Throttle Control—Mixture Control and Slow Running—Float Feed Mechanisms—Further Dismantling of Carburetter—Air Cleaner and Silencer—Warning.*

**The Fuel System.**

The fuel supply from the 18-gallon tank at the rear of the chassis is by means of a double electric pump (1 and 2, Fig. 11), mounted inside the right-hand side chassis frame member below the rear floor.

A pipe is arranged along the right-hand side frame member conveying fuel from the tank to the pumps. The pipe is seen at (4). A strainer is provided on this pipe line, being located on the frame cross member immediately in front of the tank, as shown in Fig. 12.

Location of a strainer on the suction side of the pumps ensures that the latter, as well as the carburetter, are protected from the deleterious effects of dirt or sediment in the fuel.

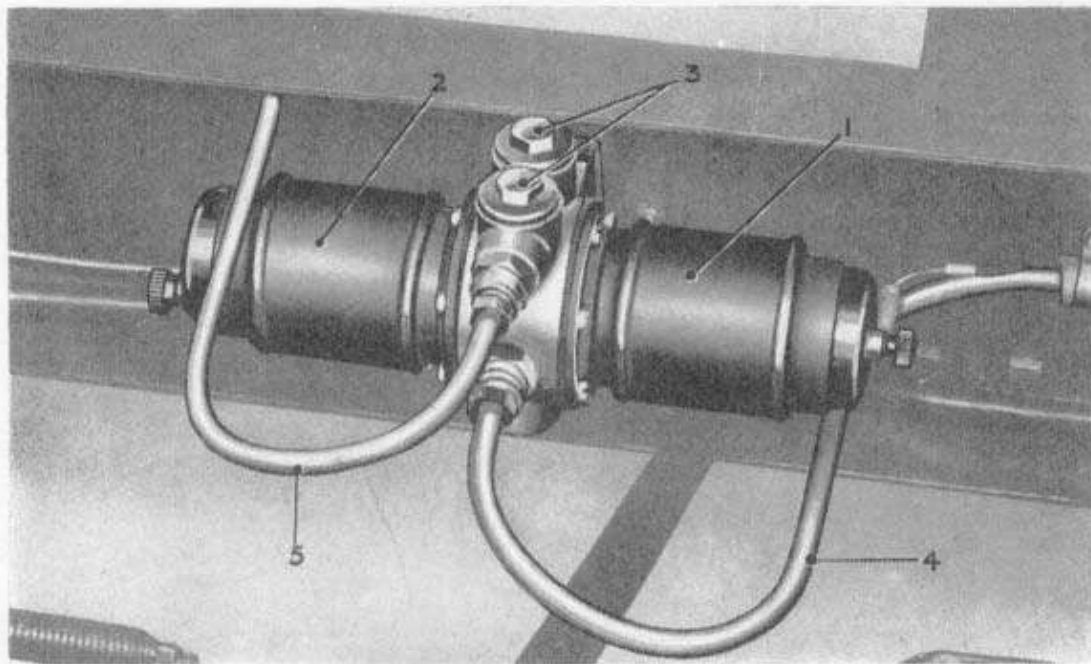

Fig. 11.—FUEL PUMPS.

- |                |                 |
|----------------|-----------------|
| 1. Fuel pump.  | 4. Inlet pipe.  |
| 2. Fuel pump.  | 5. Outlet pipe. |
| 3. Valve caps. |                 |

From the strainer the fuel passes to the suction side of the pumps, and is delivered to the carburetter float chamber by way of a pipe (5), and another strainer located at the float chamber.

### Fuel Pumps.

The fuel pumps (1 and 2, Fig. 11) are of the electric, solenoid-operated, diaphragm type, and comprise two independent pumps complete with diaphragms, solenoids, contact trip mechanisms, and suction and delivery valves.

Both pumps deliver into a common chamber and are simultaneously rendered operative when the ignition and master switches are "On".

Duplicate pumps are provided primarily to ensure reliability. They also ensure that there shall be no starvation of fuel at maximum engine demands.

If it should ever be necessary to disconnect the fuel pipes at the pumps, it is important first to release the cover of the suction strainer (See page 46.) This will prevent loss of fuel by syphoning, due to the location of the pumps below the level of the main tank.

The current supply for the pumps is taken through the ignition fuse, No. 5, in the fuse box.

### Faulty Operation of Pumps.

This would cause failure, or shortage, of fuel supply to the carburetter, and may be due to one or more of the following causes:—

1. *Shortage of fuel in the tank.*—This should have caused the green warning lamp to light, but if the tank has been allowed to run dry, the pumps will tick continuously and noisily. On severe gradients and side slopes, these symptoms may occur before the tank is completely empty, due to surging of fuel in the tank, which may uncover the suction pipe.
2. *Air leak on the suction side.*—Either at the strainer or on the pipe line. A slight air leak will cause the pumps to work rather faster than normal, but if sufficiently bad to cause a complete air lock, the pumps will tick continuously and noisily as if short of petrol.
3. *Pump valves not seating.*—The delivery valves do not give any easily detectable signs of their functioning. If a suction valve is not seating, the pump will tick continuously when the engine is switched on but not running. It is probable that foreign matter is lodged under one of the valves.

If the above is suspected, remove the caps (3, Fig. 11), the valves and valve cap assemblies may then be lifted out and cleaned.

4. *Sluggish operation of the pumps.*—Check that the electrical connection and contact points are clean and in proper order. Verify, by alternately disconnecting the pipes at the unions, that it is the pump, and not due to a blockage in the pipe line. If with the pipes disconnected the pumps still work sluggishly, the unit should be removed and returned to Messrs. Bentley Motors (1931) Ltd., or one of their "Special Retailers" for overhaul.

**Note**—The pumps will not work with both petrol pipes disconnected; in such circumstances, the pumps must be earthed to the chassis frame.

### Fuel Tank.

The 18-gallon tank is shown in Fig. 12. The fitting (9) carries the suction pipe. Normally there should be no occasion to disturb these parts.

Every 20,000 miles as directed on page 33, the drain plug at the bottom of the tank should be released. It is not necessary to remove the plug. It need only be unscrewed a turn or two, and must afterwards be securely retightened. This will flush out any accumulation of sediment or water.

### Strainers.

The rear strainer shown in Fig. 12, is provided with two circular gauzes located above a large settling sump. Fuel passes upwards through these gauzes, and dirt settles on their lower faces and in the sump.

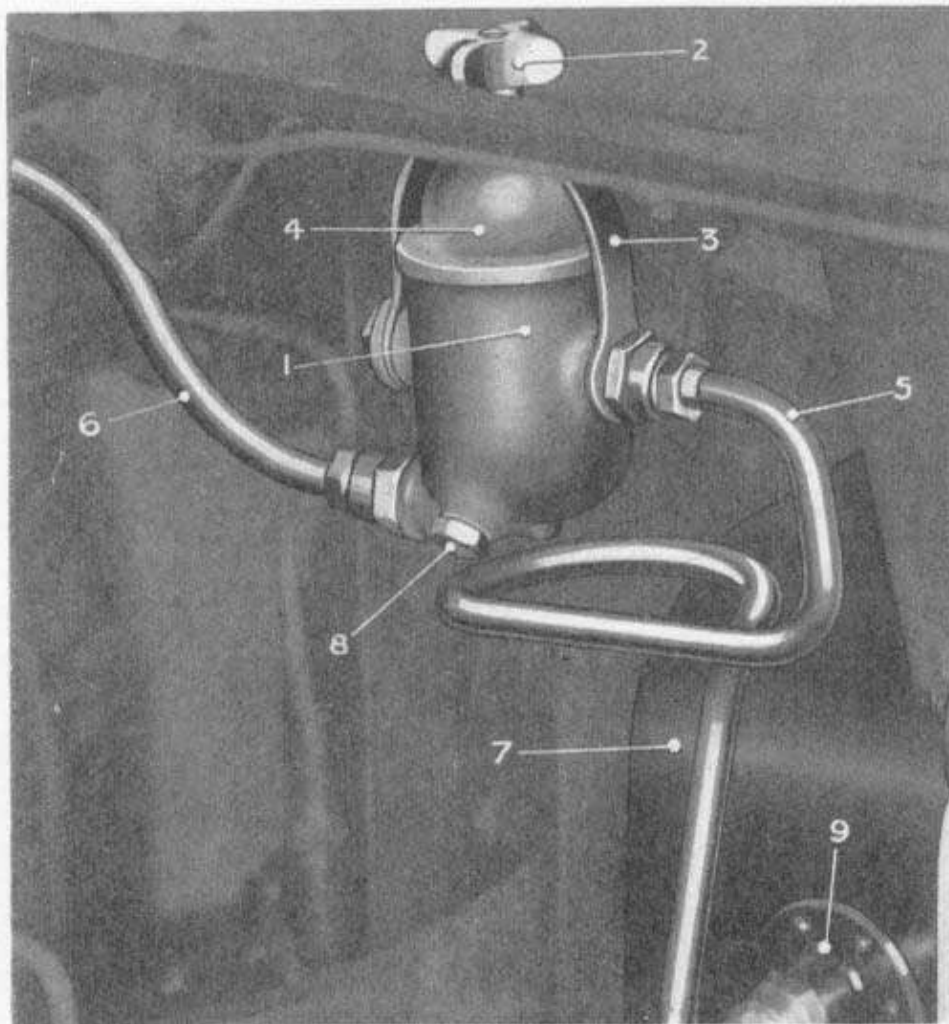

Fig. 12.—FUEL TANK AND STRAINER.

- |               |                         |
|---------------|-------------------------|
| 1. Body.      | 5. Inlet pipe.          |
| 2. Cover nut. | 6. Outlet pipe.         |
| 3. Yoke.      | 7. Main fuel tank.      |
| 4. Cover.     | 8. Strainer drain plug. |

The filter should be cleaned every 20,000 miles, as directed on page 33.

When refitting the cover, care must be taken that the cork washer is sound, and properly in position, and the nut (2, Fig. 12) tightly screwed up. Any leaks on this—the suction side of the pumps—although they may not be apparent by leakage of fuel, will impair the proper functioning of the pumps by admitting air.

In addition a small gauze strainer, shown at (12, Fig. 14), is arranged on each carburetter. These should be removed and cleaned every 20,000 miles, as directed on page 33.

Removal is effected by unscrewing the two union nuts (2, Fig. 13). The strainer gauzes can then be removed and cleaned in petrol.

When refitting the parts, care must be taken to replace each gauze with its open end outwards and that the aluminium joint washers are in position on the unions.

### **Fuel Gauge.**

The fuel gauge registers when the master and ignition switches are "On".

As mentioned on page 41, this gauge also registers the amount of oil in the engine sump, when the appropriate switch is depressed.

### **The Carburetters (Action).**

Two carburetters of the S.U. controllable jet type are fitted as shown in Figs. 13 and 14, one being shown in section to illustrate the principal parts.

This type of carburetter automatically adjusts both its choke area and its jet to suit the engine demands. This is effected by using the manifold depression to operate a piston or air valve, which carries a tapered needle to regulate the fuel passage. The upper side of the piston is connected by passage ways to the base of the piston facing the throttle valves, and is subject to the depressions in the throttle body.

As the air flow through the carburetter increases, so the depression between the piston and the throttle valve increases, thereby causing the piston to rise and admit more air, and consequently the needle to be withdrawn from the jet, thus allowing more fuel to flow. Similarly, as the air flow falls, due to reduced engine requirements, so the piston falls. In this way, a state of balance is maintained whereby the piston keeps at a certain height, dependent on the engine speed and the throttle opening. Thus the carburetter automatically adjusts itself to the varying requirements of the engine under all conditions.

### **Hand Starting Control.**

The jet is so mounted that it is vertically adjustable by hand from the steering wheel.

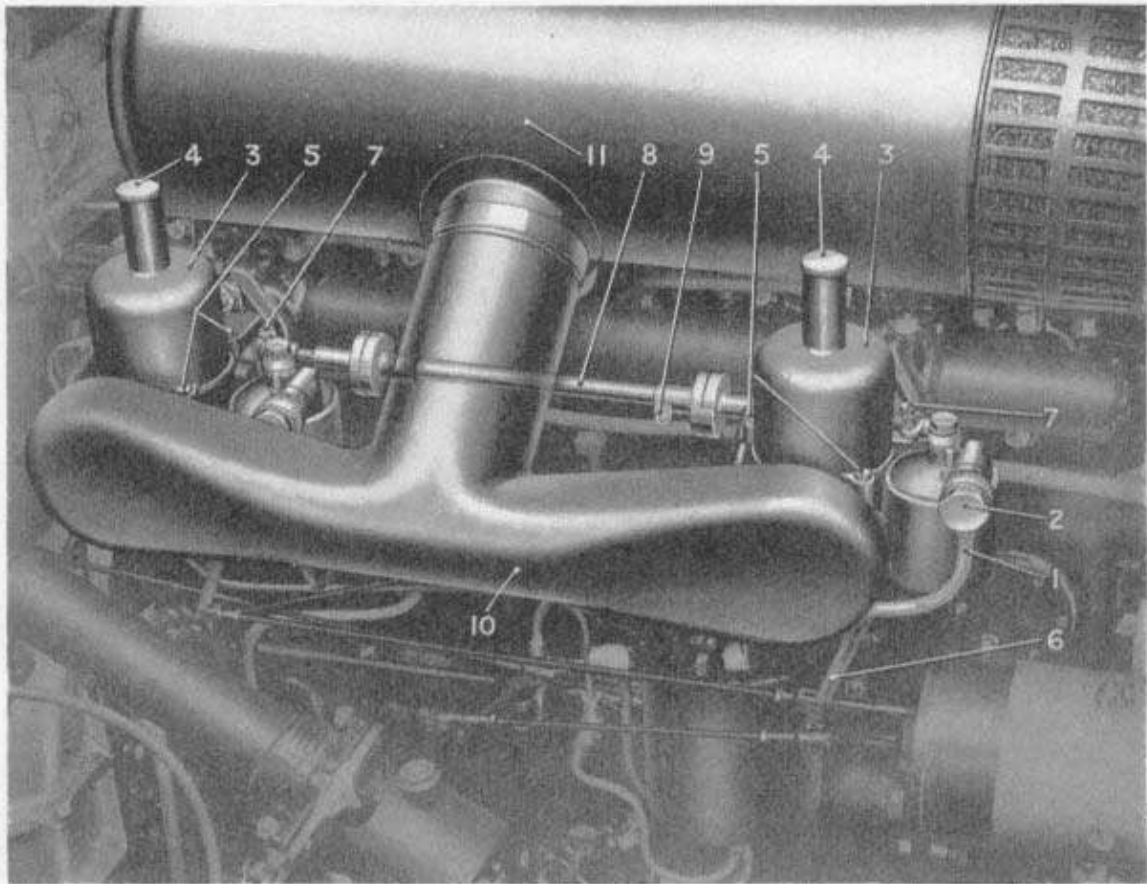

Fig. 13. CARBURETTERS IN POSITION ON ENGINE.

- |                               |                               |
|-------------------------------|-------------------------------|
| 1. Fuel pipe.                 | 7. Throttle stop.             |
| 2. Union.                     | 8. Throttle coupling rod.     |
| 3. Air valve cylinder         | 9. Pinch bolt.                |
| 4. Oil cap nut.               | 10. Air intake.               |
| 5. Cylinder retaining screws. | 11. Air silencer and cleaner. |
| 6. Mixture lever.             |                               |

For starting, the jet is lowered away from the needle by setting the mixture control to **"Start"**. This provides an enriched mixture to ensure easy starting and even running when the engine is cold. As soon as the engine has warmed up, the control lever should gradually be re-set to **"Run"**.

#### **Adjustment of Carburetters.**

There should be no necessity for any variation of the adjustment of the carburetters as fixed by the makers.

It is realised, however, that information as to the methods for restoring adjustments may prove valuable under special circumstances, and is consequently given, as far as practicable, in the paragraphs which follow.

#### **Automatic Air Valve.**

The automatic air valve is of the conventional S.U. pattern, and includes a hydraulic suction piston damper to delay the rise of the air valve piston during acceleration and when starting the engine

from cold. The damper consists of a small cylindrical brass plunger (2, Fig. 14), attached by a thin steel rod to the oil cap nut (4, Fig. 13). Inside the plunger is a one-way ball valve which seats in an upward direction. The plunger is a free fit in the hollow guide rod of the automatic air valve piston, the chamber being filled with a thin oil. The action of the device being as follows:—

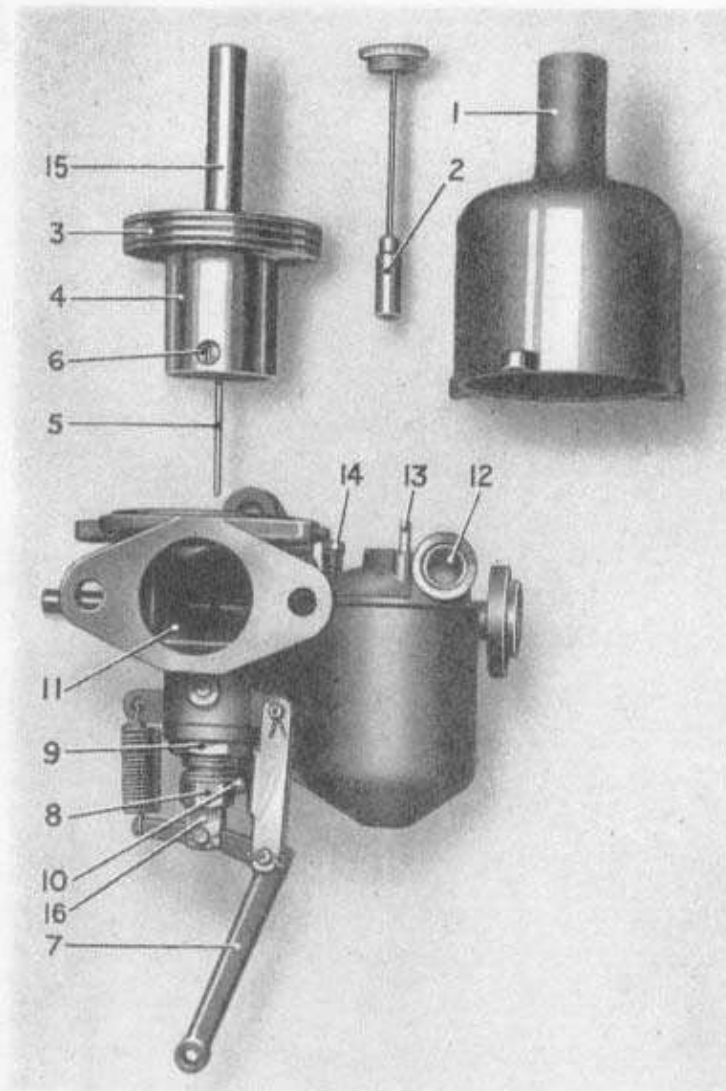

Fig. 14.—CARBURETTER—EXPLODED VIEW.

- |                             |                                  |
|-----------------------------|----------------------------------|
| 1. Air valve cylinder.      | 9. Nut (not to be disturbed).    |
| 2. Hydraulic damper piston. | 10. Plug securing float chamber. |
| 3. Suction disc.            | 11. Throttle valve.              |
| 4. Piston, air valve.       | 12. Gauze strainer.              |
| 5. Needle valve.            | 13. Float depressing plunger.    |
| 6. Grub screw.              | 14. Throttle stop.               |
| 7. Mixture lever.           | 15. Piston guide rod.            |
| 8. Adjustable stop.         | 16. Jaw, jet head.               |

When the automatic air valve piston rises in accordance with the demands of the engine, the movement is retarded due to the displacement of oil through the clearance existing between the damper plunger and the guide rod. The fall of the automatic air valve is unimpeded due to the ball valve being opened, which allows the unrestricted passage of the displaced oil. No attention should be necessary other than the replenishment of the oil in the reservoir.

Every month, as directed on page 30, the oil reservoir cap nut (4) (Fig. 13), should be unscrewed and the plunger withdrawn, *great care being taken to avoid damage to the plunger rod by bending*, the reservoir should be topped up, if required, with the recommended oil, so as to maintain the level of the oil to the

top of the guide rod only. The plunger should then be replaced, taking care that no dirt or grit is present. A slight steady pressure may be required to displace the oil sufficiently to allow the engagement of the thread of oil reservoir cap nut.



If it is suspected that the automatic air valve is not working correctly, the air intake (10, Fig. 13), should be removed, and a check made by lifting the piston with the fingers, when it should be noted that the piston falls quite freely on to its seat when released.

If any sticking or sluggishness is apparent, it will be necessary to dismantle the air valve assembly; first remove the hydraulic piston damper, next remove the three screws (5, Fig. 13), and lift off the cylinder (3). The piston valve can be then lifted out, *the utmost care being taken not to bend or damage its depending needle valve* (5, Fig. 14), *or to bruise the valve in any way*. The valve, cylinder and guide, should be carefully wiped with a piece of clean cloth dipped in petrol, and the piston rod ONLY lubricated with a few drops of thin oil.

*No polishing paste or abrasives should be used to clean the valve or cylinder.*

The suction disc (3, Fig. 14), does not touch the walls of the cylinder, there being a small clearance, and it is centralised solely by the piston rod working in the guide. Therefore, any sluggishness in movement is probably due to dirt in the guide, or on the cylinder walls.

When replacing the valve, it will be noticed that there is a slot which must engage a tongue provided on the carburetter body. The cylinder can only be replaced in one position, the three screw holes being unevenly spaced to ensure this.

If the above treatment does not effect a cure, the fault may be due to a bent jet needle or alternatively to the needle fouling the jet. If this is suspected it is recommended that communication is made with Messrs. Bentley Motors (1931) Ltd., or one of their Special Retailers.

The needle valve is secured in position by means of a grub screw, (6, Fig. 14), and if it should be necessary to remove this, as, for instance, when replacing an accidently damaged needle, it must be particularly noticed that the location of the valve is determined by a shoulder. The valve should be pushed into the piston until this shoulder is just flush with the lower face and the grub screw tightened.

If a needle should be accidently damaged, a new one must be obtained from either Messrs. Bentley Motors (1931) Ltd., or one of their "Special Retailers". A number is stamped on the end of the needle, denoting the size, and it is essential that only one of the same number is refitted.

### **Throttle Control.**

The quantity of mixture for slow running is determined by means of an adjustable screw stop on the front carburetter (7, Fig. 13), which limits the closing movement of both throttles. This is so adjusted that the engine will idle slowly but reliably when the hand throttle lever on the steering wheel is set right to the bottom of its range and the accelerator pedal released. The stop on the rear carburetter is normally inoperative, and is only used to help initial adjustment.

Re-adjustment of the jets, and of the control shaft between the carburetters, should not normally be required. If, however, the whole adjustment has been disturbed, first adjust the throttles so that both carburetters function equally at "fast idle". An indication that both pistons have risen can be felt by depressing the top of the piston guide rod (15, Fig. 14) by means of a small rod inserted through the top of the cylinder (3, Fig. 13), after removal of the oil cap nut and hydraulic piston damper (4, Fig. 13). The jets should then be adjusted subsequent to this operation, as described below.

### Mixture Control and Slow Running.

The mixture control lever on the steering wheel operates to raise or lower the actual fuel orifice or jet, through the medium of the levers (6, Fig. 13). Raising the jet causes the taper needle to sink further into the orifice, so weakening the mixture. Conversely, lowering the jet enriches the mixture. This control is only intended to provide a means of strengthening the mixture for starting from cold, for normal running the jets must be in their highest position, the back of both the jaws (16, Fig. 14), abutting against the adjustable stops (8, Fig. 14), simultaneously.

The strength or quality of the mixture for slow running is set by means of these adjustable stops, the procedure being as follows:—

With the engine warm, the control rods should be disconnected from the ends of the levers (6, Fig. 13), and the latter pushed up until the jaws (16, Fig. 14), are against the stops (8, Fig. 14). Then, with the engine running, the stops should be manipulated until the engine runs regularly. Any sign of "hunting" is due to the mixture being too rich, and one or both of the stops must be screwed further in and the lever pushed up so that the jaw is against it.

On the other hand, irregular firing, indicated by irregular pulsations from the exhaust pipe, shows the mixture to be weak, and one or both stops must be screwed out a little.

The correct positions for the stops having been found, the control rods must be adjusted so that the jaws of both jets are definitely against the stops when the lever on the steering wheel is at "Run".

### Float Feed Mechanisms.

These are of the usual "top feed" pattern, whereby, as the level of the petrol rises in the float chamber, a lever bearing on the top of the float moves the conical seat "needle" upwards on to its seating, so shutting off the supply.

If it is required to dismantle the float chambers, it will be most convenient to remove them bodily—after removing the fuel pipes—by unscrewing the hexagon plugs (10, Fig. 14), which secure each to its carburetter body.

When the covers are removed, care must be taken that the fulcrum pins of the levers do not fall out. They are normally retained by means of the walls of the float chambers.

The chambers should be wiped out with a piece of clean wash-leather before being refitted. When replacing them, care must be taken to see that the packing washers are in position, one above and one below the boss which couples each to the carburetter body.

#### **Further Dismantling of Carburetter.**

It should never be necessary to remove any other parts of the carburetters than those referred to in the foregoing pages.

The large hexagon (9, Fig. 14), should not be disturbed, as the refitting of this requires special tools to ensure that the jet is accurately centralised relative to the taper needle valve.

#### **Air Cleaner and Silencer.**

A cleaner is provided within the front end of the air silencer to prevent the passage of dust and grit to the engine.

The cleaner comprises a composite steel-wool element through which the air passes on its way to the carburetter. It is removed by unscrewing the wing nut in the centre of the end cover, and removing the cover, the element may then be withdrawn.

Every 10,000 miles, unless the car is being operated under particularly dusty conditions, when the cleaning must be carried out at 5,000 miles intervals or even less, depending upon the dust concentration, the cleaner element should be removed and carefully washed in petrol or paraffin, and afterwards oiled with engine oil. It should be thoroughly drained before re-fitting.

#### **Warning.**

On no account should the engine be kept running for any appreciable period with the car in a closed garage. There is a grave danger of people in the garage being asphyxiated, owing to the presence of poisonous gases in the exhaust.

Consequently, particular care should be taken always to open the garage doors wide before starting the engine.

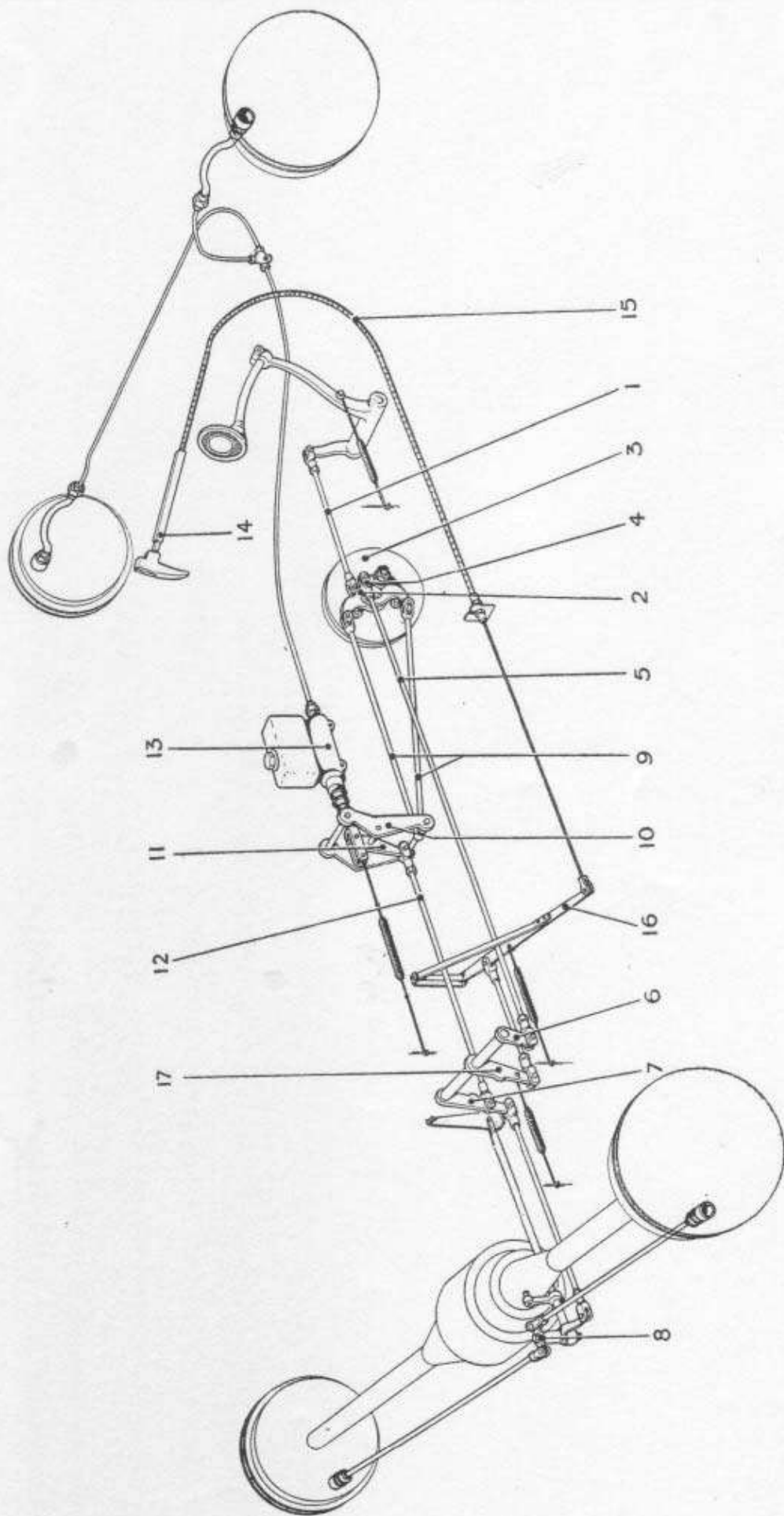

FIG. 15.—DIAGRAM OF BENTLEY BRAKING SYSTEM.

## CHAPTER VI

# The Braking System

*General Description—Possible Variations—Adjustments—Adjustment of Hand Brake—Adjustment of Servo—Lubrication—Bleeding the Hydraulic System—Hydraulic Master Cylinder.*

### General Description.

The Bentley four-wheel braking system is of the Servo assisted type, and comprises a mechanically driven servo motor of the dry disc-brake type, which is equally effective for either forward or backward movement of the car. Further, even should the servo be out of action, the rod operated rear brakes are still directly coupled to the pedal.

Pressure on the pedal applies the rear brakes direct in the usual manner, and also engages the servo, but the front brakes which are of the hydraulically operated type are actuated entirely by the servo acting through the medium of a balance lever and hydraulic master cylinder.

The servo effect is distributed between the front and rear brakes, being added therefore to the direct pedal effect in the case of the rear brakes. With the leverages provided, this results in about 55 per cent. of the total braking being imposed on the front wheels, which allows for the fact that greater weight is thrown upon the front wheels during braking.

The proportioning of the servo pull to the front and rear brakes respectively is effected by a balancing lever. A separate equaliser is provided for the two rear brakes, which, with the hydraulic operation of the front brakes, ensures even braking on either side of the car.

The hand brake lever operates the rear brakes only and uses the same linkage as the foot pedal.

A diagrammatic representation of the whole system is shown in Fig. 15.

A pull rod (1, Fig. 15), operated by the pedal, is coupled to a lever (2), on the servo motor shaft, the motor itself (3) being mounted on the off-side of the gearbox, and driven at approximately one-tenth of the propeller shaft speed.

The lever (2) has inclined cams formed on the face of its boss, these cams engaging through the medium of steel balls, similar cams formed on the boss of another lever (4). From the latter a rod (5) directly actuates the rear brakes through the medium of the levers (6) and (7), which are pivoted on a bracket bolted to the "X" member of the frame, and finally, through the rear equaliser (8) mounted on a bracket suspended from the axle.

The output from the servo is taken by one of the two rods (9), according to whether the car is moving forwards or backwards, to the lever (10). This lever carries, in turn, a balance lever (11), the lower end of which is connected by the rod (12) to the rear brake lever (7), thus augmenting the direct pedal effort, while its upper end is coupled to the master cylinder (13), which actuates the front brakes.

The dashboard hand brake (14), is mounted under the facia board, convenient to the driver's right hand. The ratchet release is so arranged that should it be inadvertently knocked or pressed, the brakes will not be released. In order to release the brakes, the trigger must be fully depressed and held in this position. The hand brake is then pulled, as if applying the brakes, and this action frees the ratchet permitting the brakes to be released, provided that the trigger is still held. This device is particularly useful in preventing accidental release of the brakes when the car is parked.

To obtain this action, the trigger is not directly connected to the ratchet pawl, but compresses a spring. This spring, in turn, operates the pawl, but is only strong enough to move it out of engagement when the load has been removed by pulling on the hand brake.

The hand brake is connected by an enclosed cable (15), to a horizontal lever (16), mounted on the "X" section of the frame which provides the required leverage, and is in turn coupled to the rear brakes, through the lever (7) and (17) and the rear equaliser. The same rear brake-shoes are used, therefore, as for the pedal operation, and the application and release of the hand brake can be lightened accordingly by simultaneous application of the foot brake.

### **Possible Variations.**

As already mentioned, the leverages are so proportioned that the total braking effort is distributed in a predetermined ratio between the front and rear brakes.

This distribution will be upset if the servo brakes are allowed to become badly out of adjustment, or if the servo, for any reason, fails to give its correct output. A less likely cause would be oil or grease on the brake linings.

The need for adjustment of the rear brakes will be indicated by excessive travel of the hand brake lever, whereas the front brakes, which are operated by the servo motor only, will not affect the hand brake or pedal travel.

It is unlikely, however, that the front brakes will wear more rapidly than the rear brakes, so, provided that they are adjusted whenever adjustment of the rear brakes is required, no trouble in this respect need be expected.

Low or inconsistent output from the servo would be indicated by heavy or non-progressive brake pedal action, together with insufficient front braking, in which case the servo would have to be dismantled to ascertain the cause of the trouble. As this is a delicate operation, it is recommended that Messrs. Bentley Motors (1931) Ltd., or one of their "Special Retailers" be entrusted with this work.

A light pedal action, accompanied by defective front braking, resulting in the rear wheels locking, would indicate a fault in the front braking system. An excess of front braking would indicate a fault in the rear brakes.

In the unlikely event of oil reaching either of the rear brakes, the self-seal bearing on the rear axle half shaft will be at fault. Grease catchers are provided for the front hubs, and provided that the recommended grease be used and the quantity limited to  $1\frac{1}{2}$  ozs., in each hub, this should not be able to reach the brake linings.

### Adjustments.

A separate adjustment is provided on each brake carrier plate to compensate for wear of the brake shoe linings, and is the only adjustment provided on the whole system.

It is important to note that in no circumstances should adjustments be attempted at any other point, for instance, by altering the lengths of the brake rods. These are all carefully determined during erection of the chassis, with a view to synchronisation of the front and rear safety stops, which ensure that in the event of failure of any part of the system, at least one pair of brakes will remain available.

The method of adjustment is the same for both front and rear brakes, with the exception that a hand wheel is provided on the rear brake adjusters, while a  $\frac{1}{4}$ " B.S.F. open-ended spanner must be used on the squared end of the front brake adjusters. The rear adjusters (2, Fig. 17) are located forward of the axle tubes, and the front adjusters (1, Fig. 16) directly below the steering pivot pins.

For each complete turn of the adjusters, four "clicks" will be felt, and between each "click" the brake shoes are expanded towards the drum, approximately .014", and then moved back .010", giving an incremental adjustment of .004", and a running clearance of .010".

To adjust the brakes, rotate the adjusters in a clockwise direction until considerable resistance is felt. This resistance must be equal for all four brakes, and should the last "click" on any one adjuster require noticeably greater force to obtain, the adjuster should be turned back to the previous "click". This will give the correct brake adjustment.

It is not necessary to jack up the car to adjust the brakes, as the adjusters are so designed to give the correct shoe clearances automatically.

If, after long service, the brake linings require renewal, this will be apparent by the adjusters coming to the end of their travel, and will have a solid feel quite distinct from the resistance felt when the brake shoes are correctly adjusted.

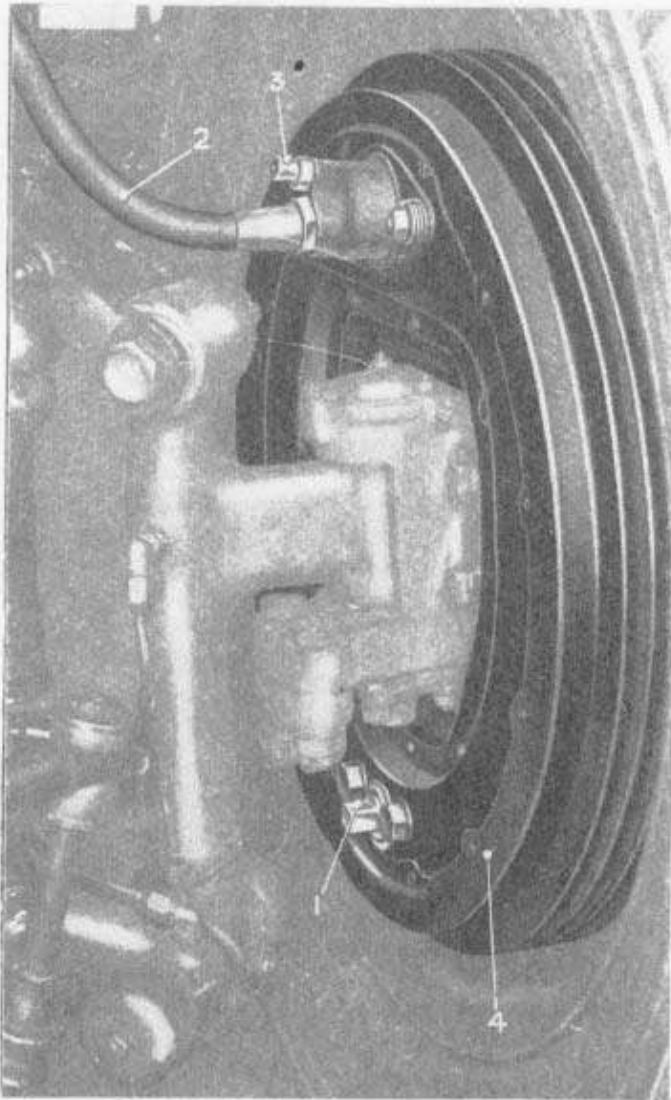

Fig. 16.—FRONT BRAKE ADJUSTMENT.

1. Adjuster screw.
2. Hydraulic pipe.
3. Bleeder connection.
4. Brake drum.

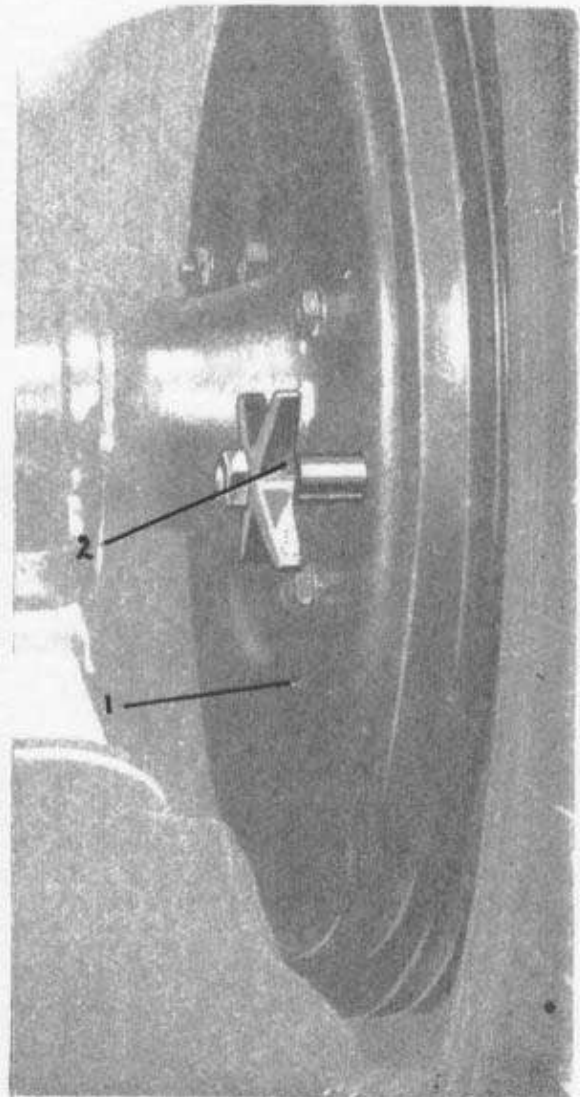

Fig. 17.—REAR BRAKE ADJUSTMENT.

1. Brake drum.
2. Adjuster screw.

### Adjustment of Hand Brake.

Adjustment of the rear brakes takes up both the pedal and hand brake clearance in the same operation. No other adjustment is required.



### Adjustment of the Servo.

The servo is of the dry disc-brake type, and is shown in Fig. 15. An adjustment is provided for the initial setting and wear of the friction surfaces, but once correctly set, should require no further attention for a considerable period, as very little wear occurs. As the operation is of a delicate nature it is advised that this adjustment should be effected by Messrs. Bentley Motors (1931) Ltd., or one of their "Special Retailers".

### Lubrication.

The need for hand lubrication of various parts of the mechanism has been reduced to a minimum, by the use of self-lubricating bearing bushes at the fulcrum of practically all levers.

The only points that require attention are the jaws and pins of the pull rods and intermediate levers (6, 7 and 17, Fig. 15). Oil should be applied to these points every 5,000 miles, as directed on page 31. The ball bearing cams which actuate the servo (as described earlier in this chapter) are filled with lubricant upon initial build, and require no attention between overhauls of the chassis.

### Bleeding the Hydraulic System.

Bleeding, that is to say expelling air from the system, should only be necessary when completely recharging the system with fluid following the removal of a component or the disconnection of a pipe joint. Under normal conditions air does not enter the system as a result of brake application.

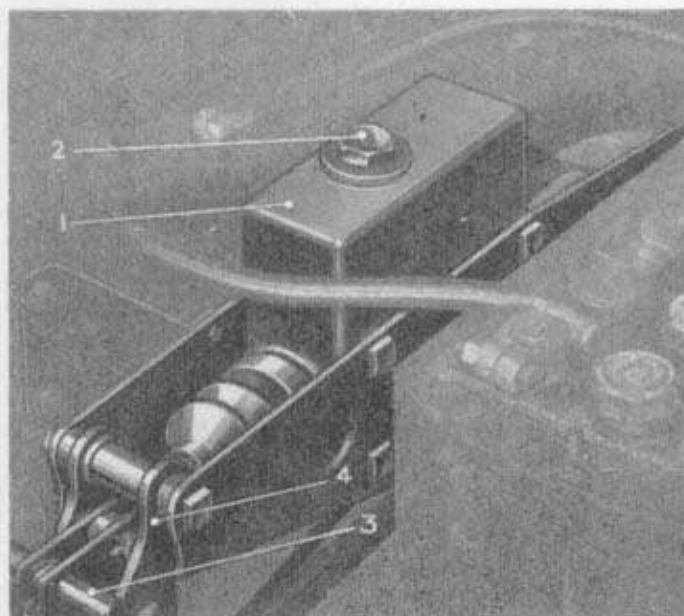

Fig. 18.—THE HYDRAULIC MASTER CYLINDER AND RESERVOIR.

- |                                   |                     |
|-----------------------------------|---------------------|
| 1. Master cylinder and reservoir. | 3. Extended pin.    |
| 2. Filler plug.                   | 4. Support bracket. |

To bleed the system, proceed as follows:—

1. Attach a clean rubber drain tube to one front brake bleeder screw (3, Fig. 16), and immerse the other end in a clean glass jar in which there is sufficient hydraulic brake fluid to submerge the end of the tube.
2. Release the bleeder screw (3) half to one turn.
3. Remove the filler plug (2, Fig. 18) and fill the reservoir integral with the master cylinder, with the recommended fluid. (See page 28.)
4. Push the joint forward until the extended pin (3) abuts against the master cylinder support brackets (4).
5. Release, pause slightly, and repeat until the reservoir is nearly empty, but taking care not to empty it completely.
6. Tighten the bleeder screw and transfer drain tube to the other front brake.
7. Refill the reservoir and bleed this brake in a similar manner.
8. Finally, refill the reservoir and replace the filler plug.

#### **Hydraulic Master Cylinder.**

The fluid level in the master cylinder should be examined every 10,000 miles, as directed on page 33, and topped up if necessary so as to maintain the level at one inch below the filler cap.

A rapid fall in the fluid level indicates a leak at some point in the system, and must be traced and rectified.

## CHAPTER VII

---

# Clutch, Gearbox, Propeller Shaft and Rear Axle

*The Clutch—Clutch Pedal Mechanism—Clutch Pedal Adjustment—Gearbox—Universal Joints—Rear Axle.*

### **The Clutch.**

The clutch is of the single dry-plate type and requires no special attention.

The clutch shaft is spigoted at its forward end in the crankshaft on a ball bearing. This bearing is filled with grease during erection, and requires no attention between overhauls of the chassis.

The withdrawal thrust ball race, and its associated moving parts, are lubricated from the centralised chassis lubrication system.

### **Clutch Pedal Mechanism.**

It is important that the various joints should be lubricated with the oil-can every 5,000 miles, as directed on page 30.

The fulcrum of the pedal lever is fitted with self-lubricating bearing bushes, and requires no external lubrication.

### **Clutch Pedal Adjustment.**

The only point where any adjustment is provided, or is ever likely to be necessary, is at the coupling (see Fig. 19), connecting the clutch pedal intermediate lever with the clutch external operating lever.

There must always be  $1\frac{1}{4}$ " to  $1\frac{1}{2}$ " of "free" or idle movement of the pedal before the withdrawal sleeve is felt to be in contact with the toggle levers, as is easily tested by pressing the pedal lightly.

The coupling comprises a jaw (1), and a jaw (2), united by a turnbuckle (3), having a left-hand and a right-hand threaded end, and locked with locknuts (4).

To effect an adjustment, release the two locknuts (4) and rotate the turnbuckle (3) with a spanner, to obtain the correct free movement. The locknuts being subsequently re-tightened.

When testing and setting this adjustment, the aluminium pedal plate must be in position, because it is this part which acts as a stop, limiting upward movement of the pedal under the action of its external spring (5).

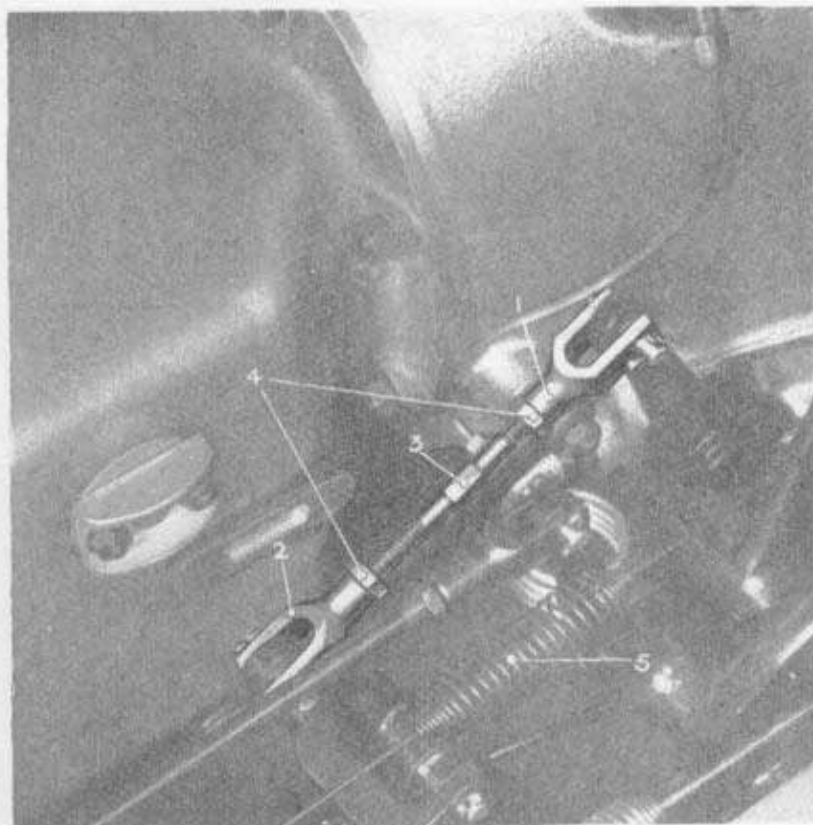

Fig. 19.—ADJUSTMENT CLUTCH PEDAL

- |         |                   |
|---------|-------------------|
| 1. Jaw. | 3. Turnbuckle.    |
| 2. Jaw. | 4. Locknuts.      |
|         | 5. Return spring. |

### Gearbox.

Synchromesh of the "positive" type is provided to facilitate engagement of second, third and fourth speeds.

The first and third motion shafts of the gearbox are supported in three bearings, thus contributing to the permanent silence of the gears, and in the case of the third motion shaft, relieving the spigot bearing of much of its load.

Oil is inserted into the gearbox by removing the dipstick shown at (2, Fig. 20). Recommended oils are given on page 27.

Oil should be poured in until the level reaches the mark on the dipstick, taking care that the box is not over-filled.

The oil level should be inspected every 5,000 miles as directed on page 30.

Every 20,000 miles, all oil should be drained from the gearbox, by removing the drain plug, with the special spanner provided, and fresh oil inserted, as directed on page 33.

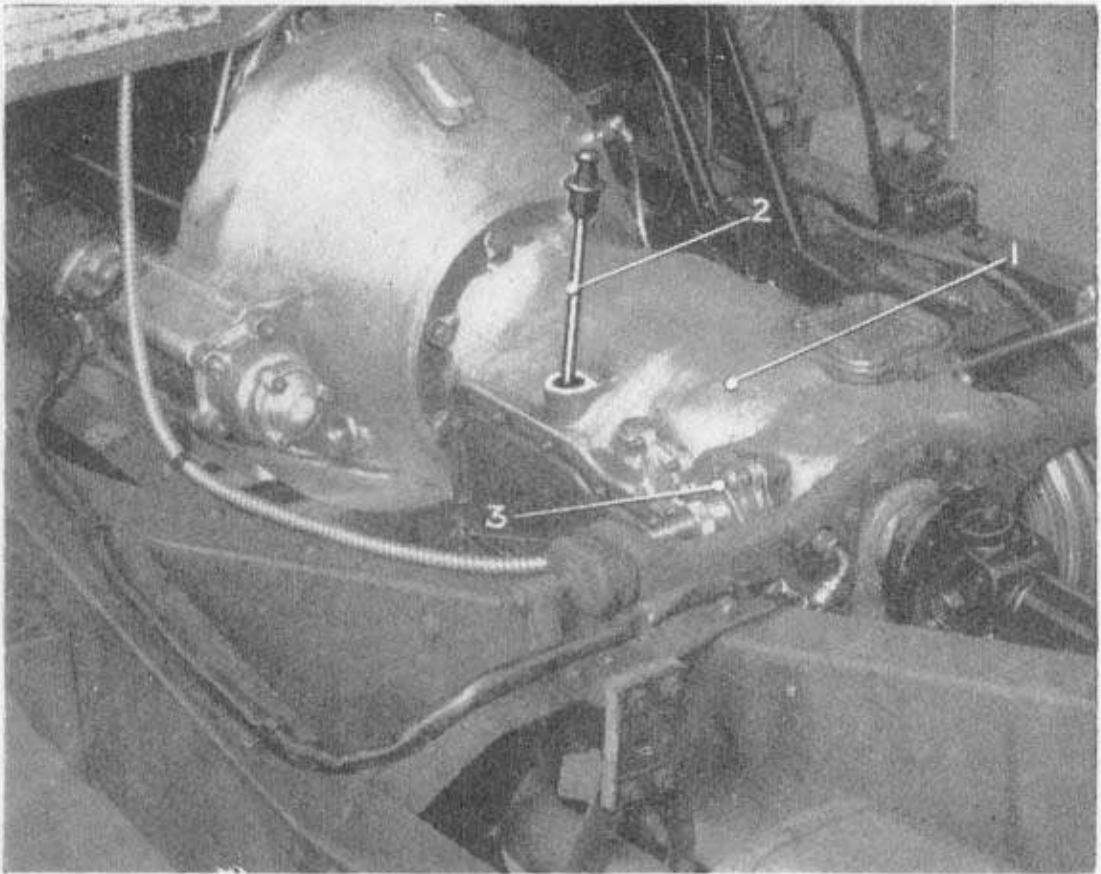

Fig. 20.—GEARBOX.

1. Gearbox.      2. Dipstick.      3. Speedometer connection.

A worm-driven connection is provided on the gearbox for the speedometer, the drive ratio being suitable for the speedometer which is supplied.

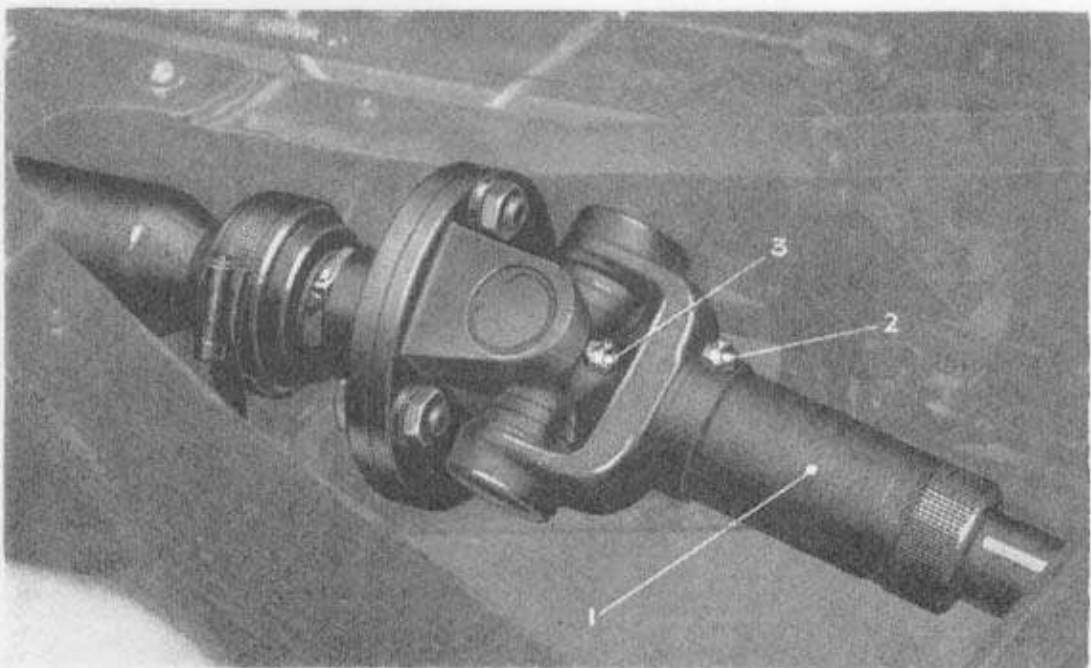

Fig. 21.—PROPELLER SHAFT.

1. Sliding joint.      2. Grease nipple sliding joint.      3. Grease nipple universal joint.

### Universal Joints.

The propeller shaft universal joints are fitted with needle roller bearings, and each joint is provided with a grease-gun lubricator (3, Fig. 21), located at the centre of the cross-piece.

The driven portion of the centre joint is provided with serrations which engage similar serrations within the propeller shaft to permit the necessary degree of telescoping movement.

This sliding joint is also lubricated by means of a grease-gun lubricator, shown at (2, Fig. 21). Every 10,000 miles, as directed on page 31, the correct grease should be injected by means of the grease-gun into all the four lubricators.

### Rear Axle.

The rear axle is of the semi-floating type.

The final drive is by offset hypoid bevel gears, which possess the advantages of being silent in running, and, owing to the offset disposition of the pinion, of enabling a lower body position to be obtained without decreasing the ground clearance.

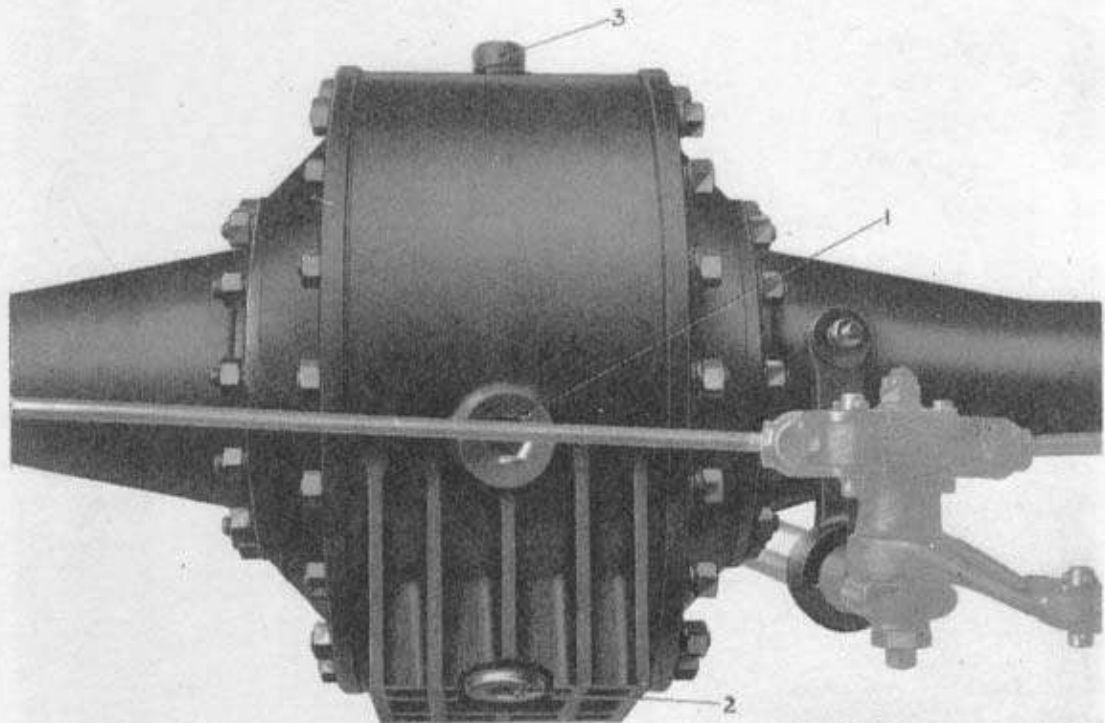

Fig. 22.—REAR AXLE CASING.

- |                           |              |
|---------------------------|--------------|
| 1. Filler and level plug. | 3. Breather. |
| 2. Drain plug.            |              |

*It is important that no other oil than that recommended should be used in the rear axle. (See page 27.)*

Every 5,000 miles, as directed on page 30, the level of the oil should be inspected, and topped-up if necessary.

Every 20,000 miles, as directed on page 33, the casing must be drained, and refilled with fresh oil to the correct level.

The drain plug (2, Fig. 22) should be removed, with the special spanner provided, preferably when the casing is warm; and all the oil allowed to drain out.

Plug (1) may then be removed for filling purposes. One-and-three-quarter ( $1\frac{3}{4}$ ) pints of fresh oil should be inserted, using a syringe. This quantity should just cause oil to overflow from the filling orifice.

Care must be taken to see that the washer is in position when replacing the plug.

**BLANK PAGE**



## CHAPTER VIII

---

# Steering, Shock Dampers, Road Springs, Wheels and Tyres

*Steering Box and Column—Front Suspension—Warning, Front Suspension Springs—Steering Arms and Joints—Front Stabiliser—Rear Hydraulic Shock Dampers—Rear Road Springs—Wheels—Wheel Discs—Lubrication of Wheel Bearings—Tyres—The Jacking System—Wheel Changing—Fitting and Removing Tyres—Inflation of Tyres—Balancing Road Wheels.*

### **Steering Box and Column.**

The steering mechanism is of the cam-and-roller type, and requires no attention beyond inspection of the oil level.

The cover of the box is provided with a filling plug. Every 5,000 miles, as directed on page 30, this plug should be removed, preferably when the box is warm, and the level of the oil inspected. If necessary oil should be poured in until it is on the point of overflowing from the plug orifice.

For correct oils, see page 28.

With the steering wheel in its normal central position, a hole will be found in its boss, adjacent to the upper arm, into which the nozzle of the oil-can should be inserted to reach an oil hole provided in the control carrier. This operation should be included when lubricating the controls every 5,000 miles, as directed on page 30.

### **Front Suspension.**

Each wheel is independently sprung, the suspension consisting of the two upper and two lower radius arms of different lengths set at a leading angle, between which a vertical yoke is carried, and on this the stub axles are pivoted.

The upper radius arms are connected to and operate the special Bentley shock damper, which effectively dampens excessive spring action.

The main helical coil spring is mounted between the forward lower radius arm and a seat formed as an integral part of the chassis frame.

The ball joints and the steering pivot bearings are lubricated from the central chassis system. (See Fig. 4.)

The shock damper consists of two pistons operating in cylinders full of oil. The oil being displaced from one cylinder to the other through drilled passages, the degree of damping being controlled by spring-loaded valves.

Until it is obvious that the effectiveness of the shock damper has become reduced, or undue leakage is apparent, no attention whatever will be necessary for 10,000 miles, when the level of the oil in the shock damper should be inspected, as directed on page 31.

It is of vital importance that only perfectly clean oil of the correct grade should be used, and this should be strained through a fine gauze before using.

Straining is facilitated if the oil be first warmed to about 75° C.

The importance of the above cannot be over-emphasised, as a very small particle of foreign matter in the oil may lodge under one of the valves and impair the effectiveness of the shock damper.

## **WARNING.**

### **Front Suspension Springs.**

No attempt must be made to remove the coil springs of the front suspension.

Special appliances are required because the powerful springs are compressed even when in the rebound position.

Any necessary dismantling or adjustment of the suspension must be effected by Messrs. Bentley Motors (1931) Ltd., or one of their "Special Retailers". (See page 16.)

### **Steering Arms and Joints.**

The steering gear should be examined occasionally to see that all bolts are tight and joints well lubricated.

If any of the nuts are found loose, and only retained by their split pins, the latter should be removed, the nuts screwed up tightly and new split pins fitted.

The ball joints of the cross and side steering tubes are lubricated from the centralised chassis system, as described in Chapter I, and illustrated in Fig. 4.

The bearing pads of all joints are spring-loaded, being self-adjusting for wear. They should not normally require attention except when the car is undergoing a general overhaul.

### Front Stabiliser.

In order to reduce the tendency of the car to "roll" on corners, a steel torsion-rod stabiliser is provided at the front end of the chassis.

The stabiliser is carried in rubber bearings, and is coupled to the wheel mountings by links with rubber pads.

No attention is necessary.

### Rear Hydraulic Shock Dampers.

Hydraulic shock dampers of Bentley design and manufacture are fitted to the rear axle, one of the dampers being shown in Fig. 23.

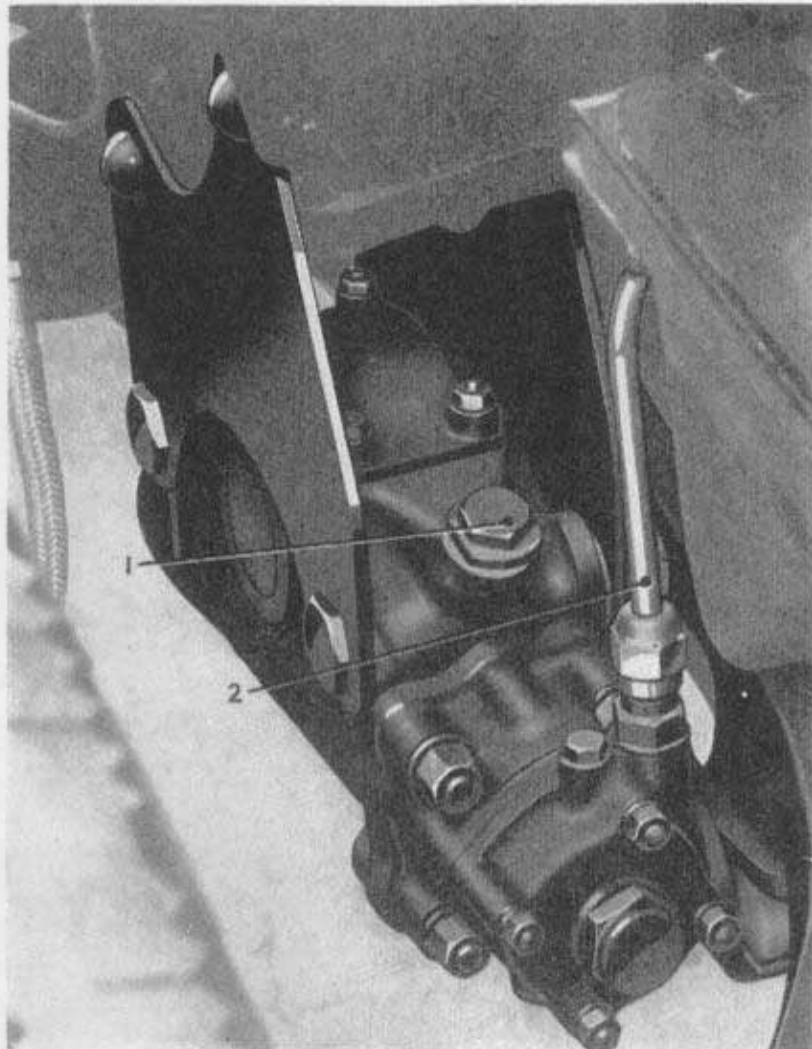

Fig. 23.—REAR HYDRAULIC SHOCK DAMPER.

1. Filler plug.                      2. "Ride Control" oil pipe.

Unless it is obvious that the effectiveness of the shock damper has become reduced, or undue leakage of oil is apparent, no attention will be necessary for 10,000 miles of running.

After 10,000 miles, it is necessary to inspect the oil level in the shock dampers as directed on page 31.

For this purpose a filling plug (1, Fig. 23) is provided, arranged at such a height in the casing as to control the maximum oil level.

It is of vital importance that only perfectly clean oil of the correct grade should be used. The following precautions must be observed:—

1. Before attempting to remove the plug (1), both the plug and the shock damper casing adjacent to it must be cleaned very carefully with a brush dipped in paraffin, in order to avoid the possibility of dirt entering the hole when the plug is removed.
2. Only a recommended oil must be used (see page 28), and before inserting this, it must be strained through a fine gauze. Straining is greatly facilitated if the oil be first warmed to about 75°C.

The importance of such cleanliness cannot be over-emphasised. A small particle of foreign matter may lodge under a valve and impair the effectiveness of the shock damper.

The plug (1) can then be removed with a box-spanner, and the oil level restored, if necessary, to the bottom of the plug hole, the oil being poured in very slowly to avoid entrapping bubbles of air. It will be found most convenient to add oil by means of small syringe provided in the tool kit. When replacing the plug, care must be taken that its washer is in position.

The shock damper consists of a piston assembly operating in a cylinder which is maintained full of oil, the latter being displaced from one end of the cylinder to the other, past spring-loaded valves.

The loading of these valves, and hence the degree of damping is controllable through the "**Ride Control**" lever, by means of a small pump carried in a casing bolted to the gearbox, which maintains a pressure of oil in a system of piping. This pressure is variable, and is controlled through a relief valve, operated by the aforementioned lever.

The pump is charged with oil from the gearbox. It must be observed that oil is not actually pumped into the dampers, and there should be no wastage of oil from the pump unit or pipe line. Such wastage or leakage will impair the functioning of the control.

As it is of such importance that the shock dampers, and also the pump and pipe line, should be maintained full of oil, evidence of undue leakage should be at once reported to Messrs. Bentley Motors (1931) Ltd., or one of their "Special Retailers". (See page 16.)

### **Rear Road Springs.**

The forward ends of the rear springs are pivoted to the frame by means of steel bushes. The shackle pins at the front and rear ends are of the threaded type, and both bushes and shackle pins are lubricated from the centralised chassis system

The advantage of threaded bearing pins is that they do not develop end-play as the result of wear.

The springs themselves are encased in leather gaiters, and by means of a special arrangement of oil holes and grooves in the leaves, the ends of the three longest leaves of each spring are lubricated by surplus oil from the eye of the master leaf.

Owing to this arrangement, in combination with absorbent material inside the gaiter, the springs are entirely self-lubricating and remain free from squeaks.

### **Wheels.**

All wheels are of heavy gauge pressed steel, with 16" by 5" well-base rims, and are secured with five nuts.

The securing nuts for the "off-side" or R.H. wheels have right-hand threads, and those for the "near-side" or L.H. have left-hand threads.

The nuts must be tightened, with the wheel-brace provided, evenly and securely, and the threads must be kept clean and greased.

If any difficulty is experienced in removing the nuts with the wheel-brace, extra leverage can be applied by using the  $\frac{1}{2}$ " spanner, provided in the tool kit, on the squared section of the wheel-brace spanner head.

### **Wheel Discs.**

When fitting the wheel discs, care must be taken to get the valve centered in the hole provided.

The outer nuts, having right-hand threads for both "off-side and near-side" wheels, are necessary only to retain the disc, and should therefore not be overtightened.

The correct tension is attained by giving the nut **one complete turn** with the special spanner provided after the disc has been felt to be in light contact with the rubber stops on the wheel centre.

There should be a small gap, approximately .100", between the edge of the disc and the wheel. Overtightening distorts and brings the disc in contact with the wheel, thus causing creaks and rattles.

### **Lubrication of Wheel Bearings.**

The wheel bearings are correctly packed with ball-bearing grease in the first instance, and should need no attention between general overhauls of the chassis.

### **Tyres.**

The tyres fitted are India Super Silent Rayon, size 6.50" by 16".

When ordering new covers, the above should be specified. With regard to the inner tubes, it is necessary to state the size and mention "well-base".

Tubes for flat base rims should not be used.

### The Jacking System.

A portable jack is provided in the tool kit and is operated as shown in Figs. 24 and 25.

The jack is fitted on to a slide arranged on the side frame member near the centre body pillar, and is used either side of the car as required.

To operate, push the jack **right home** on the slide, spin the body of the jack to the ground, insert handle and use as shown in Fig. 25.

It is important, before operating the jack, that the handbrake is pulled well on.

It is convenient to note that the jack may be used in other suitable positions, such as under the rear springs or front jacking pad if required.

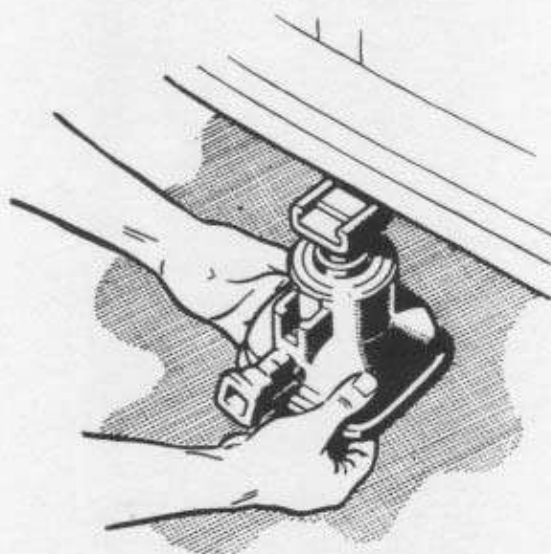

Fig. 24.—FITTING JACK TO SLIDE.



Fig. 25.—OPERATING JACK.

### Wheel Changing.

No difficulty should be experienced in wheel changing, the spare wheel can be put on the rear or front hub with very little effort as follows:—

**Rear.**—Having jacked up the car, applied the hand brake and removed the rear wheel:—

1. Roll the spare wheel under the hub, the top of the wheel being inclined outwards, then with a foot at the bottom of the wheel, lift by the rim on to the hub extension, as shown in Fig. 26.

2. One of the five wheel studs will be found to be nearly on the horizontal halfway line, either to the front or rear. Rotate and tilt the wheel until this stud protrudes through the nearest stud hole.

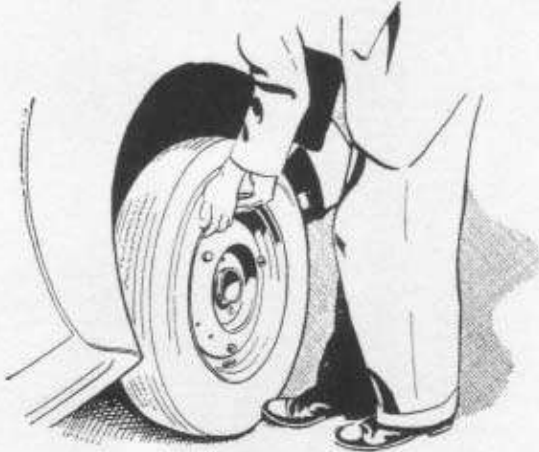

Fig. 26.—MOUNTING REAR WHEEL.



Fig. 27.—POSITIONING REAR WHEEL.

3. Using the one entered stud as a fulcrum, raise the wheel until the other studs enter their respective holes. (See Fig. 27.)

Replace wheel nuts, wheel disc and retaining nut as previously described.

**Front.**—Position the wheel on the hub extension as described for the rear wheel (1). (See Fig. 26.)

1. Rotate the wheel, which also rotates the hub, until a stud enters at the halfway line. (See Fig. 28.)



Fig. 28.—ROTATING FRONT WHEEL.

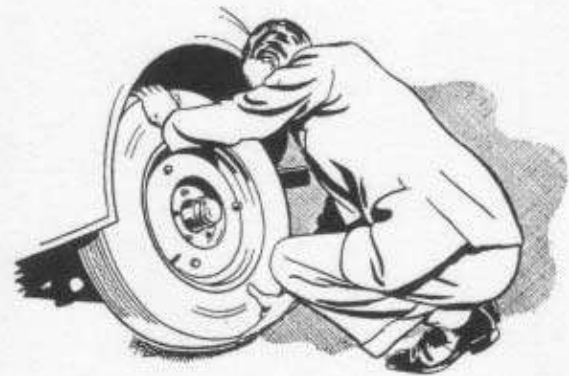

Fig. 29.—ENTERED STUD AT TOP.

2. Rotate the wheel until the entered stud is at the top, when it will be found that the other four will go home. (See Fig. 29.)

Replace wheel nuts, wheel disc and retaining nut as previously described.

### FITTING AND REMOVING TYRES.

Inextensible steel wires are incorporated in the edges of the tyres. Therefore, do not attempt to stretch the wire edges of the tyre cover over the rim edge.

Force is entirely unnecessary, and may be dangerous, as it merely tends to damage the cover edges and serves no helpful purpose.

Fitting or removing will be quite easy if the wire edges are carefully adjusted into the rim base; if it is not found to be easy, the operation is not being performed correctly.

### To Remove the Tyre.

Remove all valve parts, and push both cover edges into the base of the rim at the part diametrically opposite to the valve, then lever the cover edges near the valve over the rim edge.

### To Fit Tyre.

Push one edge of the cover over the edge of the rim. It will go quite easily if the part first put on is pushed right down into the wheel base.

A coloured spot on the outer wall indicates its lightest part, and the cover should be fitted so that the coloured spot is at the valve position.

1. Dust evenly with french chalk both the inside of the cover and the outside of the inner tube.
2. Inflate the tube until it begins to round out, then insert into cover.
3. Mount tyre.
4. Before inflating, make sure that the tyre beads are clear of the well of the rim all the way round.
5. Inflate slowly until the beads are fully seated.
6. Remove valve and deflate the tube completely.
7. Refit valve and inflate the tyre to the correct working pressure.

N.B.—This procedure must be followed whenever the tube is refitted.

### Inflation of Tyres.

The pressures recommended for the 6.50" by 16" India tyres are:—

Front	...	...	...	25 lbs.	}	Cold.
Rear	...	...	...	30 lbs.		

Tyre pressures will increase slightly after continued running at high speeds or in hot weather. It is not considered advisable to reduce pressures under such conditions, as this would tend to cause further heating, due to excessive flexing when the tyre cools.

The pressures being comparatively low, it is important that they should be carefully maintained if maximum tyre life is to be secured. It is, therefore, recommended that the pressure be tested weekly by means of a gauge applied to the valve stem orifice.



### Balancing the Road Wheels.

It is most important, in view of the high speeds attainable, that the front road wheels should be properly balanced. Therefore, it is necessary to have all the wheels balanced, and to re-balance a wheel after changing its tyre.

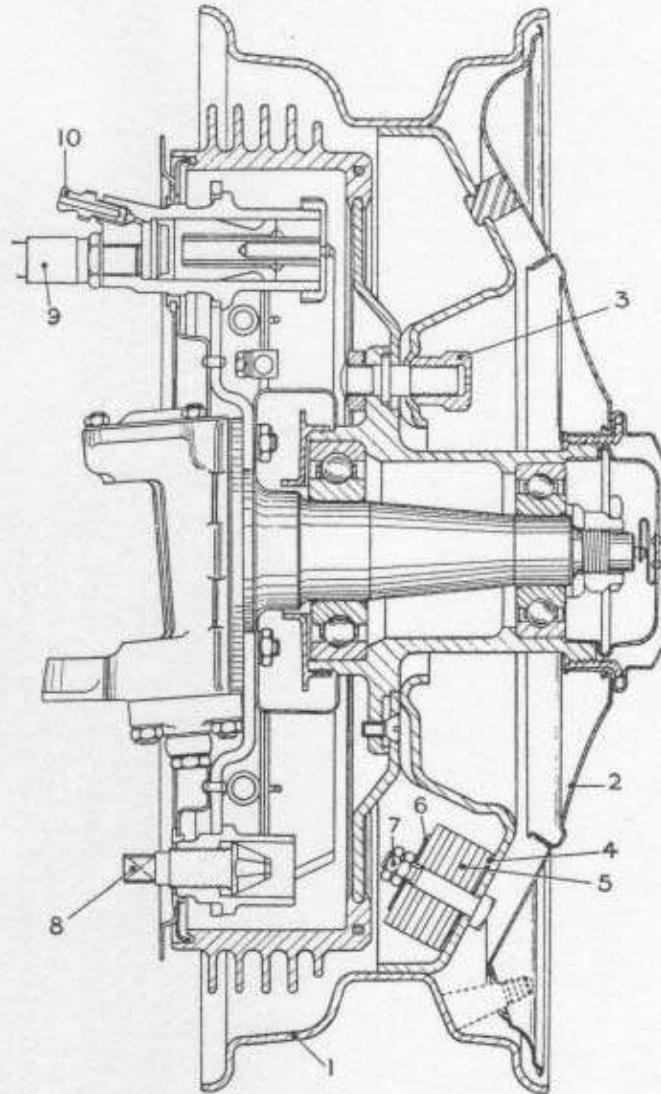

Fig. 30.—SECTION OF FRONT HUB AND WHEEL

- |                        |                          |
|------------------------|--------------------------|
| 1. Well base rim.      | 6. Steel washer          |
| 2. Wheel disc.         | 7. Locknuts.             |
| 3. Wheel securing nut. | 8. Brake adjuster screw. |
| 4. Fibre washer.       | 9. Hydraulic fluid pipe. |
| 5. Lead washer.        | 10. Bleeder nipple.      |

An out-of-balance effect is usually present in the complete wheel and tyre due to:—

- (a) The valve and its patch on the inner tube: and
- (b) unavoidable irregularities in the outer cover, due to movement of the material during vulcanizing.

A coloured spot on the outer wall indicates its lightest part, and the cover should be fitted so that this spot is at the valve position.

To correct such out-of-balance, three bolts are provided, spaced at equal intervals around the wheel centre, as shown in Figs. 30 and 31, and each carries a number of lead washers.

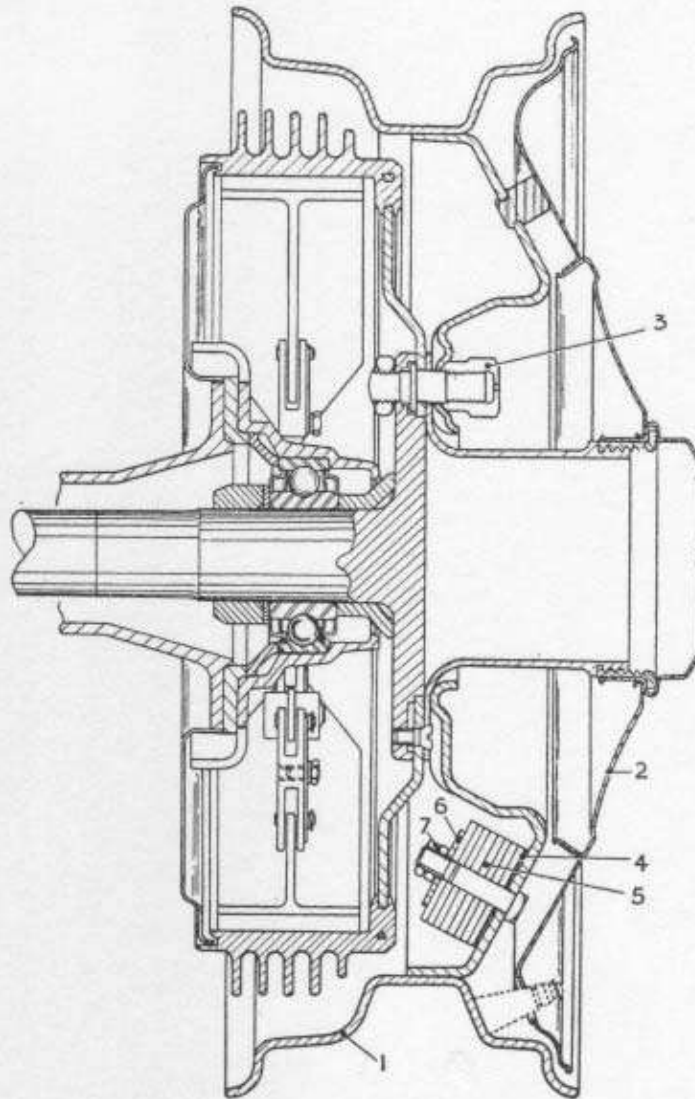

Fig. 31.—SECTION OF REAR HUB AND WHEEL.

- |                        |                  |
|------------------------|------------------|
| 1. Well base rim.      | 5. Lead washer.  |
| 2. Wheel disc.         | 6. Steel washer. |
| 3. Wheel securing nut. | 7. Locknuts.     |
| 4. Fibre washer.       |                  |

The parts are assembled on the bolt in the following order:—

1. Fibre washer (4).
2. Lead washers (5), up to eight in number on any one bolt.
3. Steel washer (6).
4. Locknuts (7), for retaining lead balancing washers.

To balance a wheel, proceed as follows:—

- 1.—Remove the wheel.
  - 2.—Remove all the washers from each bolt.
  - 3.—Reverse the bolts in the wheel, this will allow the operation of balancing to be performed more easily, as the balance washers may then be fitted externally, and re-fit the wheel.
  - 4.—Re-fit the fibre washers, steel washers and lock nuts.
  - 5.—The wheel should then be turned gently and allowed to come to rest. The lowest point of the tyre should then be marked.
  - 6.—The operation should then be repeated, and if the original mark returns to the bottom position, one or more lead washers should be added to the bolt on the opposite side of the wheel.
  - 7.—If the mark on the tyre is adjacent to the bolt, then one lead washer should be fitted on each of the other two bolts. On the other hand, if no bolt should lie on the vertical centre line through the marked point of the tyre, the washers of the two bolts furthest from the mark must be altered; for instance, if the distance of one bolt from the centre line is approximately twice that of the other, two lead washers should be fitted on the bolt nearest to the centre line, and one lead washer on the other bolt.
- This process should be continued until the wheel will remain in any position in which it may be brought to rest, the number of lead washers being kept down to a minimum consistent with good balance of the wheel.
- When all the lead washers are not required, fibre packing washers should be substituted, the lead washers being fitted last, so as to keep the greatest mass as near to the centre line of the tyre as possible.
- 8.—Remove the wheel and reverse the studs so as to return the balance weights to their correct position, on the inside of the wheel.
  - 9.—Re-fit the wheel and check that the balance is still correct, if any out of balance effect is still present, it will be necessary to correct this by the addition of washers as required.

---

## CHAPTER IX

---

### Engine Cooling System

*Coolant—Coolant Pump and Fan—Fan Belt Adjustment—Overheating—Radiator Thermostat—Radiator Mounting—Coolant Level—Frost and Anti-freeze Mixtures—Car Heater—Mascots.*

#### **Coolant.**

The cooling system is filled with a 25 per cent. mixture of inhibited ethylene glycol and water before the car leaves the factory, and it is strongly recommended that this, or a similar anti-freeze mixture, is used all the year round, both summer and winter.

The purpose of this is not only to provide protection against frost during the cold weather, but also to prevent any corrosion of the coolant passages and subsequent deterioration in the standard of cooling.

If there is any abnormal loss of coolant, the cause should be ascertained and rectified, and the system topped up with the correct anti-freeze mixture to maintain the level at approximately one inch below the bottom of the filling orifice.

If either of the recommended compounds (see page 80) are not available, plain, preferably soft, water may be used when there is no danger of frost.

*It is very important that a glycerine base compound should not be mixed with a glycol base compound.*

#### **Coolant Pump and Fan.**

The centrifugal coolant circulating pump is mounted in tandem with the fan, on the front part of the cylinder block, and is driven by a "V" belt, which also drives the dynamo, from the front end of the crankshaft.

It is improbable that any leakage or any other trouble will be experienced over long periods of running, and no attention should be necessary between general overhauls of the chassis.

If, for any cause, the engine has to be run with the fan removed, it is essential that the fan retaining set screws, with suitable distance-pieces to allow for the thickness of the fan, are refitted in position.

### Fan Belt Adjustment.

Normally the belt should not require adjustment. An adjustment is provided, however, and is effected by releasing the three nuts (3, 4 and 5, Fig. 32), and moving the dynamo outwards on the special slotted link.

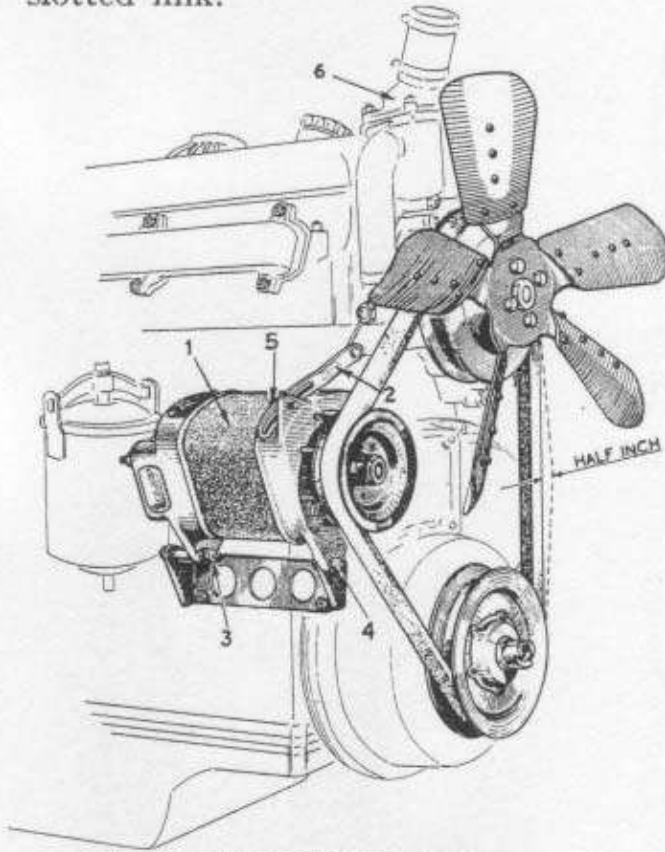

Fig. 32.—THE FAN BELT ADJUSTMENT.

- |                         |                  |
|-------------------------|------------------|
| 1. Dynamo.              | 2. Slotted link. |
| 3, 4, 5. Securing nuts. | 6. Thermostat.   |

The tension should be such that the fan belt can be moved transversely, with the fingers, at a point equidistant from the crankshaft pulley and the fan pulley through a total distance of one inch.

If it should be necessary to remove the belt for any reason, it must not be strained over the pulley. The three nuts (3, 4 and 5), should be released and the dynamo moved upwards to the full extent of the slot, when it will be found that the belt can be easily replaced without straining.

*The fan must not be forcibly turned by hand as this will cause bending of the blades and may result in a damaged radiator.*

### Overheating.

Overheating may be due to one or more of the following causes:—

- The thermostat may have failed. (See page 79.)
- The fan belt may need adjustment. (See above.)
- The continued ascent of a long steep gradient, under adverse circumstances at full throttle and too high a gear. There will be less tendency to overheating if the gear be changed to the next lower and the throttle opening reduced.
- There may be a shortage of coolant in the system.

### Radiator Thermostat.

The thermostat which controls the flow through the radiator to suit the engine cooling requirements, is contained within a casing (6, Fig. 32).

It is arranged to maintain a minimum coolant temperature of approximately 78°C.

Reference to the instrument-board thermometer will indicate that the thermostat is operating correctly and that there is no shortage of coolant.

An unusually and consistently low temperature, after the engine has been well warmed up, indicates failure of the thermostat.

A by-pass pipe acts to short circuit the radiator when the thermostat valve is closed or only partly open. This arrangement ensures a quick supply of heat to the induction pipes after starting from cold as well as a rapid warming up of the engine coolant jacket.

### **Radiator Mounting.**

The radiator comprises two main units, namely, the outer shell and the matrix itself, the complete assembly being mounted on a single central rubber support. The shell is diagonally braced and is bolted to the wings and valance plates. The radiator matrix is secured in the shell at three points, which are arranged to provide freedom for expansion under heat.

The object of this special construction is to avoid sideways movement of the radiator assembly due to road shocks, and to isolate the matrix from such shocks.

No lubrication or attention is necessary in connection with the mounting.

### **Coolant Level.**

The radiator filler is located under the left-hand side of the bonnet. A warning notice is embossed on the cap to the effect that it must not be removed when the engine is running. Hot coolant is likely to be forced out in such circumstances.

The correct level is approximately one inch below the bottom of the filling orifice, at which point it will stabilise itself. Filling above this level merely wastes coolant.

It is safe to run as long as the coolant is visible in the top tank when cold.

A drain tap is situated on the pipe connecting the pump with the bottom of the radiator. It is in the "off" position when the handle is pointing downwards.

*On no account must any strong alkaline compound be used to clean out the coolant system. Several such compounds are available, but their use must be carefully avoided, owing to the fact that they have a detrimental chemical action on aluminium.*

### Frost and Anti-Freeze Mixtures.

As long as the original coolant is maintained in the system, no precautions need be taken against frost.

If, for any reason, the original coolant has been replaced with water, then the system must be drained if the car is to be left exposed to temperatures below 32° F.

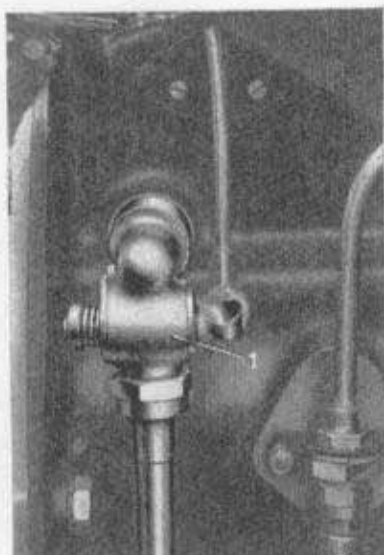

Fig. 33.—CYLINDER JACKET DRAIN TAP.

1. Drain tap.

Draining is accomplished by opening three drain taps, one situated on the pump inlet pipe, one on the right-hand side of the cylinder block, (1, Fig. 33), and one on the car heater return pipe. The filler cap must also be released a few turns.

Also, before attempting to turn the crankshaft for starting after exposure to frost, *hot water should be poured over the coolant pump* to thaw any particles of ice which may be present in the casing, and which would probably damage the impeller.

A suitable anti-freeze mixture is made by mixing soft water with either Inhibited Ethylene Glycol or "Bluecol", in proportions dependent on the degree of frost likely to be encountered.

The following table gives an approximate indication of the amount of frost protection ensured by different strengths of mixture.

Freezing point ... ..	22° F.	12° F.	2° F.	-3° F.
Degrees of frost ... ..	10° F.	20° F.	30° F.	35° F.
1. Inhibited Ethylene Glycol ...	4½ pts.	6¾ pts.	10 pts.	11 pts.
2. "Bluecol" ... ..	4½ pts.	6¾ pts.	10 pts.	11 pts.

When changing from water to anti-freeze, the radiator system must be drained. New anti-freeze of the required amount should be mixed with an equal quantity of soft water before being poured into the radiator, the radiator being finally topped up with soft water.

The engine should then be run until normal operating temperature is reached, to ensure uniform distribution of the anti-freeze throughout the system.

The rubber connections must be carefully examined and replaced if unsound, as any leakage will necessitate replenishment with anti-freeze mixture.

When using an anti-freeze mixture as described, a similar mixture should be used for topping-up purposes.

**Car Heater.**

A hot water heater is fitted under the front passenger's seat, warm air being circulated by an electric fan which is integral with the heater.

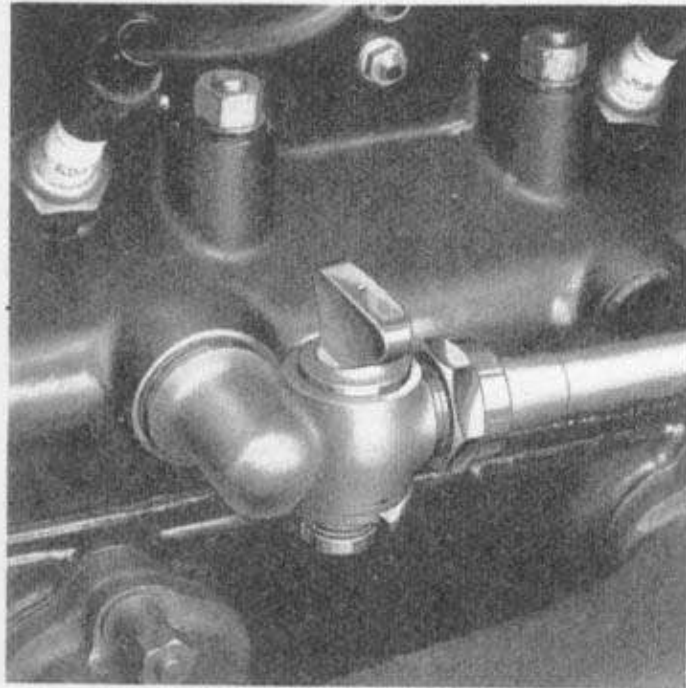

Fig. 34.—CAR HEATER CONNECTION AND ISOLATING TAP.

Hot coolant is circulated through the heater from the engine cooling system, the coolant being taken from the cylinder block through a tap (see Fig. 34), the latter being used to isolate the heater when not required.

The switch for the heater fan incorporates a rheostat, and is mounted on the instrument board, as shown in Fig. 1, thus giving a variable control of the interior temperature.

**Mascots.**

A heavy or cumbersome mascot should not be carried on the radiator cap, as it is liable to cause damage to the top of the radiator shell.

The mascot provided is of a distinctive type, and designed exclusively for use on Bentley cars.



**DIAGRAM**  
**ELECTRICAL WIRING**

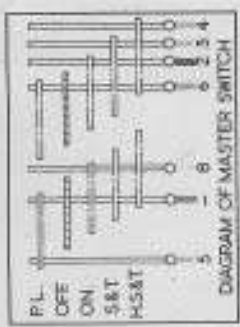
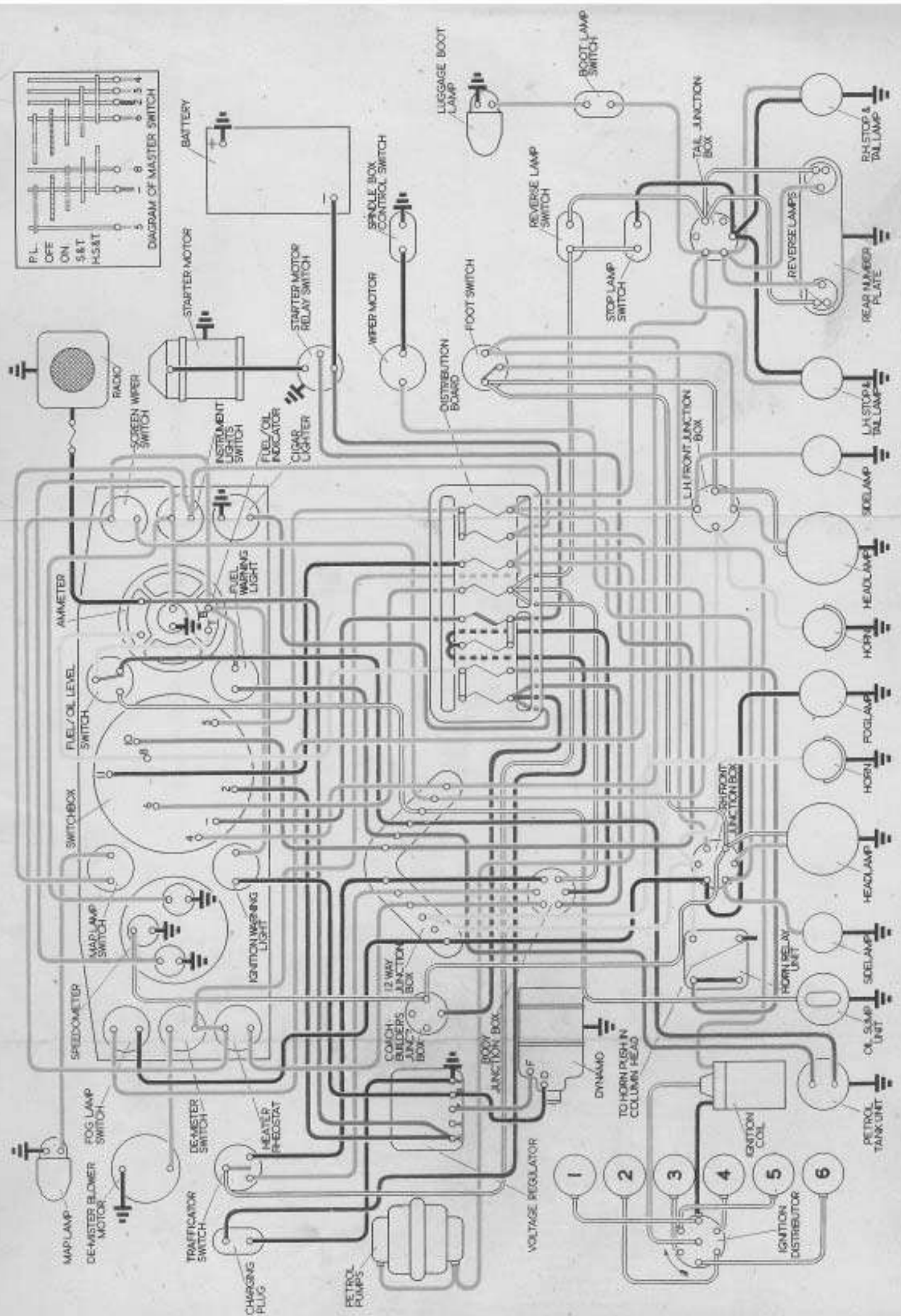

Fig. 35. ELECTRICAL WIRING DIAGRAM

## CHAPTER X

**The Electrical System**

*General—Dynamo—Fuse Box—Fuse Data—Output Regulator and Cut-out—Switchbox—Ammeter—Battery—Ignition—Ignition Coil—Ignition Timing—Firing Order of Cylinders—Sparking Plugs—Starter Motor—Starter Motor Switch—Use of Starter Motor—Electric Fuel Pumps and Gauge—Electric Horns—De-mister and De-froster—Electrical Fault Location—Recommended Lamp Bulbs—Headlamps—Replacing a Headlamp Bulb—Aligning the Headlamps—Side Lamps—Radio.*

**General.**

The equipment comprises a dynamo, fuse box, automatic output regulator and cut-out, switchbox, ammeter, a 12-volt, approximately 55-ampere-hour battery, a starter motor with relay-operated switch, two electric horns with push-button switch at head of steering column, head, side, rear and interior lights, windscreen wiper, trafficators, de-froster, de-mister, car heater, radio, electric fuel pumps and gauge, and battery ignition, consisting of coil with combined low-tension contact breaker and high-tension distributor, and the necessary wiring.

Incorporated in the distributor is a governor, which effects automatic control of the ignition timing.

The wiring diagram (Fig. 35), shows the units with their electrical connections, the various wires being indicated in colours to correspond with those of their actual coverings.

The electrical system is earthed on the positive side of the battery to the chassis frame, and all switching is done in the negative leads.

Before doing any work on a chassis which is likely to involve the electrical system, it is advisable to remove the chassis frame connection from the positive battery terminal, and so render the whole system dead, but do not disconnect whilst any charge or discharge current is passing.

**Dynamo.**

The dynamo, shown in Fig. 32, is driven by the same belt which also drives the water pump and fan. It is of the shunt-wound type, the excitation of the field being automatically regulated, in order to adjust the charge rate to suit the dynamo speed, the state of charge of the battery and the lighting load.

There are two external connections, the actual leads being coloured and the dynamo marked as follows:—

<i>Lead.</i>	<i>Colour.</i>	<i>Corresponding mark on dynamo.</i>
Armature    ...    ...	Blue    ...    ...	D.
Field    ...    ...	Grey    ...    ...	F.

The internal connections of the field coils are made one to the earthed brush, and the other to the terminal marked "F". The armature lead from terminal "D" is taken to the correspondingly marked terminal of the output regulator, and the field connection to the terminal marked "F" in the fuse box.

Every 10,000 miles, as directed on page 31, take out the securing screws and remove the cover. This will expose the commutator and brushes, which should be inspected. Deposits of brush dust, moisture and oil, should be removed, and note taken of any appreciable wear of the brushes.

Cleanliness of the commutator and freedom of the dynamo brushes in their holders are the most important points in the maintenance of the dynamo.

Premature failure or excessive wear, however, indicates some definite fault in the machine, which should be returned for correction. In normal circumstances the brushes should need replacing only after considerable running; in the event, however, of a new set of brushes being required, it is recommended that this work should be done by Messrs. Bentley Motors (1931) Ltd., or one of their "Special Retailers". Emphasis is laid on this point, as cases have arisen of faulty operation of the dynamo, due to inexperienced fitting of brushes.

When it is necessary to disconnect the wires to the dynamo, care must be taken to ensure their correct replacement, which is facilitated by the colouring and lettering adopted.

### **Fuse Box.**

The unit is shown in Fig. 36, with its cover removed.

There are two different types of fuses, easily distinguishable, as follows:—

- (a) The main fuse, this should be three strands of No. 32 S.W.G. tinned copper wire.
- (b) The circuit fuses are all of one strand of No. 32 S.W.G. tinned copper wire.

Spare wire of this gauge is provided on a special holder within the box.

Special care must be taken that all fuses are gripped firmly in their holders, and that the contacts are clean and tight.

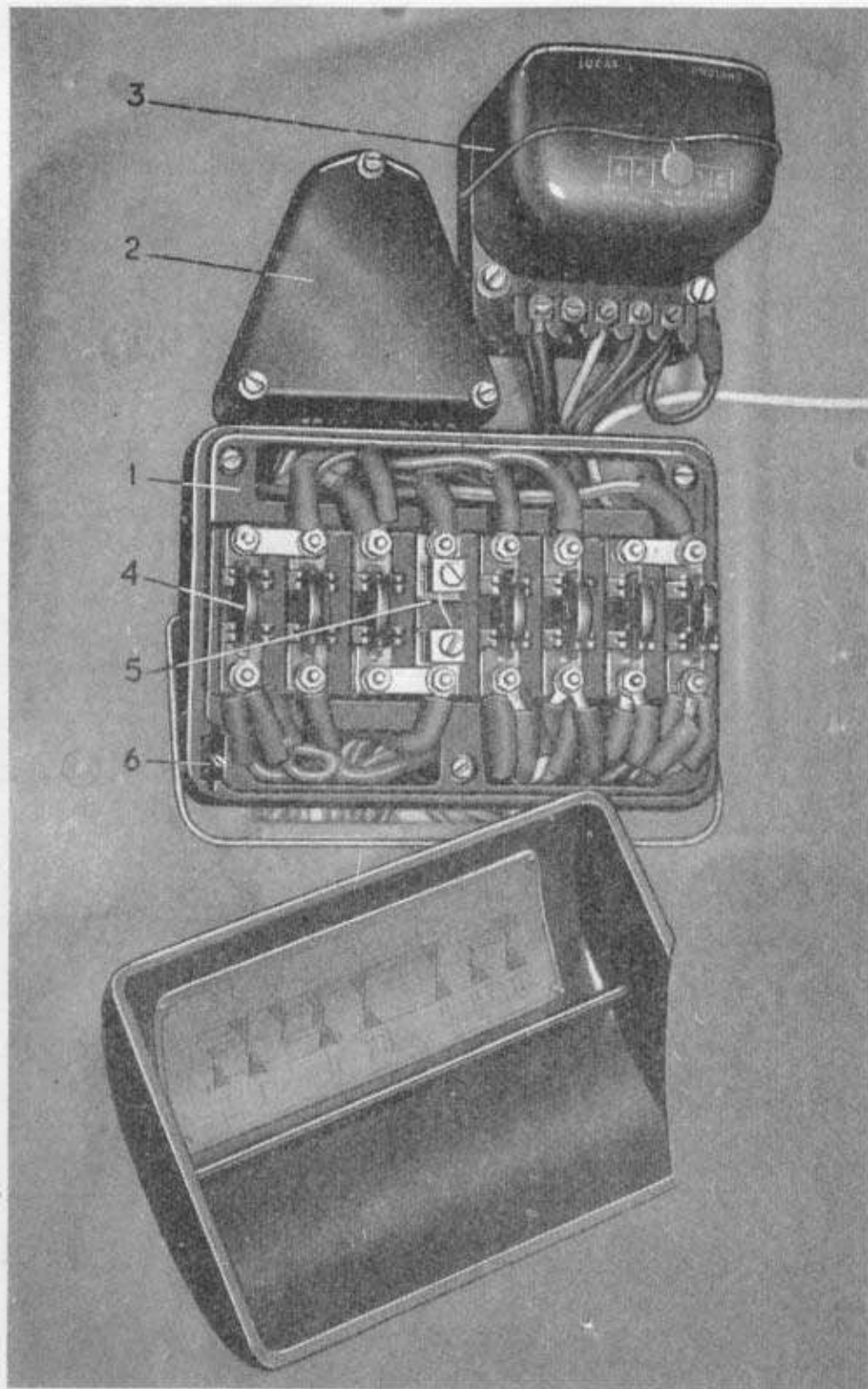

Fig. 36.—FUSE BOX, CONNECTING BOX, OUTPUT REGULATOR AND CUT-OUT.

- |                    |                                  |                     |
|--------------------|----------------------------------|---------------------|
| 1. Fuse box.       | 3. Output regulator and cut-out. | 5. Main fuse.       |
| 2. Connecting box. | 4. Circuit fuse.                 | 6. Spare fuse wire. |

#### FUSE DATA.

Circuit fuse No. 1—Coachbuilders' accessories.  
 Circuit fuse No. 2—Horn and cigar lighters.  
 Circuit fuse No. 3—Roof light.  
 Circuit fuse No. 4—Trafficators, reversing light,  
 stop light and companion lights.

Circuit fuse No. 5—De-mister and de-froster,  
 screen wiper, petrol pumps, ignition,  
 warning lamps and car heater.  
 Circuit fuse No. 6—Centre lamp  
 Circuit fuse No. 7—Instrument lamps, side  
 lamps, map lamp, tail lamp and rear  
 number plate.

### Output Regulator and Cut-Out.

The output regulator and cut-out are mounted on the front of the dashboard, and are shown (3, Fig. 36).

The output regulator operates to control the dynamo output by varying the field excitation in accordance with the load on the battery and its state of charge.

The operation of the regulator depends upon the fact that the voltage of a battery varies between certain fixed limits according to the state of charge of the battery, the voltage being, of course, a maximum when the battery is fully charged, and a minimum when the battery is fully discharged.

The regulator is combined structurally with the cut-out. The regulator and cut-out are, however, electrically separate, employing separate armatures, though they possess field systems which are common over a portion of the magnetic path.

The cut-out is operated when the dynamo speed rises high enough for the dynamo to charge the battery by means of its shunt coil connected across the main terminals of the dynamo. This closes the cut-out contacts and so connects the dynamo with the battery, via the regulator and ammeter, as shown in the wiring diagram (Fig. 35.)

The series coil is so connected that, when carrying the charging current, it assists the shunt coil in holding the contacts firmly together.

When the dynamo slows down, and its voltage falls below that of the battery, the current reverses through the series coil, and the effect of the shunt winding becomes neutralised, which results in the contacts falling apart.

The output regulator and cut-out requires no attention; it is a sealed unit, and no adjustment of any kind must be attempted. If any defects in operation should develop, as described under "Electrical Fault Location" (page 96), which are traceable to the regulator, it must be detached bodily and returned, *with the seal unbroken*, to Messrs. Bentley Motors (1931) Ltd., or one of their "Special Retailers", for correction.

### Switchbox.

Mounted on the instrument panel, this unit includes:—

- (a) Master switch and lamp switch combined.
- (b) Ignition switch.
- (c) Push-button switch for the starter motor.
- (d) A lock which can be locked and the key withdrawn either:—
  1. When the master switch is in the "Off" position; or,
  2. When the master switch is in the "P.L." (parking lights) position.

No attempt must be made to lock the switch in other positions.

With the master switch in the "**Off**" position, all accessories and lighting circuits, with the exception of the roof lamp, are rendered inoperative. Movement of this master switch to the "**On**" position renders these accessories available.

The various combinations controlled are clearly indicated, as follows:—

**Off.**—All circuits off except for roof lamp.

**On.**—Accessories available.

**S. and T.**—Side and tail lamps on and accessories available.

**H., S. and T.**—Head, side and tail lamps on and accessories available.

**P.L.**—"Parking Lights", side, tail and roof lamps on. (No reading is shown on the ammeter and all other accessories are "off".)

A separate switch is provided for the ignition, marked "**On**" and "**Off**". Normally, this switch can be left in the "**On**" position, and the switching to start the engine can be carried out on the master switch.

No independent charge position is provided owing to the presence of the output regulator. Whenever the master switch is on, connections are made which cause the dynamo to charge the battery through the regulator, as previously described.

Operation of the push-button switch for the starter motor completes a relay circuit, which in turn causes the main starter switch to close.

### **Ammeter.**

The ammeter is an instrument with a central zero and 20-ampere range, a needle deflection indicating Charge or Discharge.

As already explained under "Output Regulator", the charge rate varies in accordance with the state of the battery. Consequently, no alarm need be felt if the charge indicated on the ammeter is quite small, especially after a considerable period of running with no extra consuming apparatus, such as lamps, in use.

This will probably indicate that the battery is well charged. Under these circumstances, switching on the head lamps may cause a discharge reading to be shown, but this will only occur for a short time, as the dynamo will quickly respond to the slightest drop in battery voltage, due to the discharge, and re-adjust the output accordingly.

An unnoticed reversal of the ammeter connections causes the charge and discharge indications to be reversed.

**Battery.**

The battery recommended and specified for this car, is as follows:—

Battery Maker's Type Designation.		Voltage.	Normal Charging Current.
P. & R. Dagenite.	Exide.		
6 HZD <sub>9</sub> -S or 6 HZDP <sub>9</sub> -S	6 MXR <sub>9</sub> -L or 6 MXP <sub>9</sub> -L	12	5 amperes.

The full title should be given when ordering a replacement battery or spare parts.

**First Charge.**

If the battery is received in a dry condition, it will be necessary to fill the cells with acid solution of the correct specific gravity and charge the battery, before it is put into use.

In such cases, it is strongly recommended that the necessary charging should be undertaken by a properly equipped service station, as unless the initial charge is correct the battery will never give satisfactory service.

**Topping-Up.**

In the majority of cases, however, the battery will have already been charged and the cells filled with acid solution. Under normal operating conditions the level of the solution will gradually fall in each cell, mainly owing to evaporation losses. A regular inspection should be made, as directed on page 29, to see that the level of the acid solution has not fallen to such an extent that the tops of the separators and plates are exposed.

In this case, the battery should be "topped-up", by removing the vent plug in the centre of each cell lid and adding distilled water to each cell, until the level of the solution is approximately  $\frac{3}{8}$ " above the tops of the separators.

It is difficult to lay down a hard and fast rule as to how frequently "topping-up" will be required, because this varies so much, according to the use to which the car is put, and also the temperature in which it operates. It must be remembered that "topping-up" will be necessary more frequently in hot weather than in cold.

Normally it should never be necessary to add sulphuric acid to the cells, unless it is definitely known that some of the acid has been lost owing to slopping or spilling. The addition of acid to the battery should only be done by an experienced battery man, who at the same time will carry out any adjustments to the acid gravity.

**Specific Gravity of Electrolyte.**

Various acid specific gravity figures are given for reference in the following table, and they apply to both makes of batteries as given above.



Acid gravity figures are taken by means of an hydrometer.

Climate.	Specific Gravity of Sulphuric Acid Solution. (Corrected to 70° F.).		
	Filling in for First Charge.		Fully Charged.
	6 HZD <sub>9</sub> -S 6 MXR <sub>9</sub> -L	6 HZDP <sub>9</sub> -S 6 MXP <sub>9</sub> -L	
Temperate ... ..	1.340	1.260	1.280 (1.270-1.285)
Tropical (i.e. where the temperature is frequently 90° F. or over).	1.260	1.190	1.210 (1.200-1.215)

### Charging.

The output of the dynamo on the car is controlled so as to vary with the state of charge of the battery. Overcharging the battery is thus automatically avoided. The dynamo will, under ordinary running conditions, provide enough current to ensure re-charging of the battery, but in special cases, e.g., when the car is frequently standing with the lights on and daylight running is of short duration, it may be necessary to take the battery off the car from time to time for a bench re-charge. This re-charge can be done by any well-equipped service station.

### Charging Battery from an outside source.

It is possible to charge the battery in position on the car, making use of a flexible lead and the special two-pin plug supplied, which fits the charging plug socket on the facia board arranged just above the steering column.

Be certain that the direction of current is correct, the socket holes are marked + and — respectively, and, in addition, are made of different sizes in order to clearly distinguish them.

In the case of early models where this plug is not fitted, the charger should be connected as follows:—

1. Connect the NEGATIVE lead, by means of a clip, to the main fuse terminal in the fuse box (Fig. 36).
2. Connect the POSITIVE lead, by means of a clip, to any convenient clean part of the chassis, such as the windscreen wiper motor bracket, which is bolted to the dashboard.

### Maintenance.

The battery must be well secured in its box so that it cannot move.

The cable terminals should be well coated with lanolin or pure vaseline (not grease), before putting the battery into service.

The top of the battery should always be kept clean, and as far as possible, dry; attention should be given immediately to the least sign of corrosion occurring on the terminals.

Keep the terminals and connectors well covered with lanolin or pure vaseline, all contact surfaces clean and firmly screwed up, but do not use abrasives for cleaning. To remove corrosion, use a solution of ammonium carbonate, applying with a rag.

Do not inspect the battery with the aid of a naked light, and on no account disconnect any of the battery terminals or connections when a charge or discharge current is passing, for such a course incurs risk of explosion and involves personal risk.

The battery must never be allowed to remain in a discharged condition. A battery not in service should be kept in condition by fully charging it and then giving it a freshening charge at least once every two months. It should be given a thorough charge before being put back into service.

Care should be taken to avoid an inadvertent discharge of the

battery. Such a discharge may occur if there is an earth in the wiring system, instruments or fittings, or if the ignition switch be left on in error, and the engine happens to come to rest with the low-tension contacts in engagement. Provision is made for the latter contingency by the red warning lamp, which will remain illuminated until the ignition switch is turned off.

It should be made a practice, when leaving the car, always to observe that the warning lamp is not illuminated, and no switches are left on, and that no discharge is shown on the ammeter.

### Ignition.

The battery ignition contact breaker and distributor are shown in



Fig. 37.—CONTACT BREAKER AND DISTRIBUTOR.

- |                     |                |
|---------------------|----------------|
| 1. Contact breaker. | 3. Lubricator. |
| 2. Distributor.     | 4. Condenser.  |

Fig. 37, an internal view of the contact breaker being given in Fig. 38.

A condenser (4, Fig. 37) is connected across the contact points. In setting the points, the gap opening should be .019" (.483 m/m.) to .021" (.533 m/m.), adjustment being effected by loosening the locking

screws (3 and 4, Fig. 38) and turning the adjusting screws (5 and 6) to obtain the correct gaps, measured with a feeler gauge. Make sure that the locking screws are correctly tightened after adjustment.

The screws (7 and 8) *must not be disturbed*, as this would upset the synchronism of the two contact breaker arms.

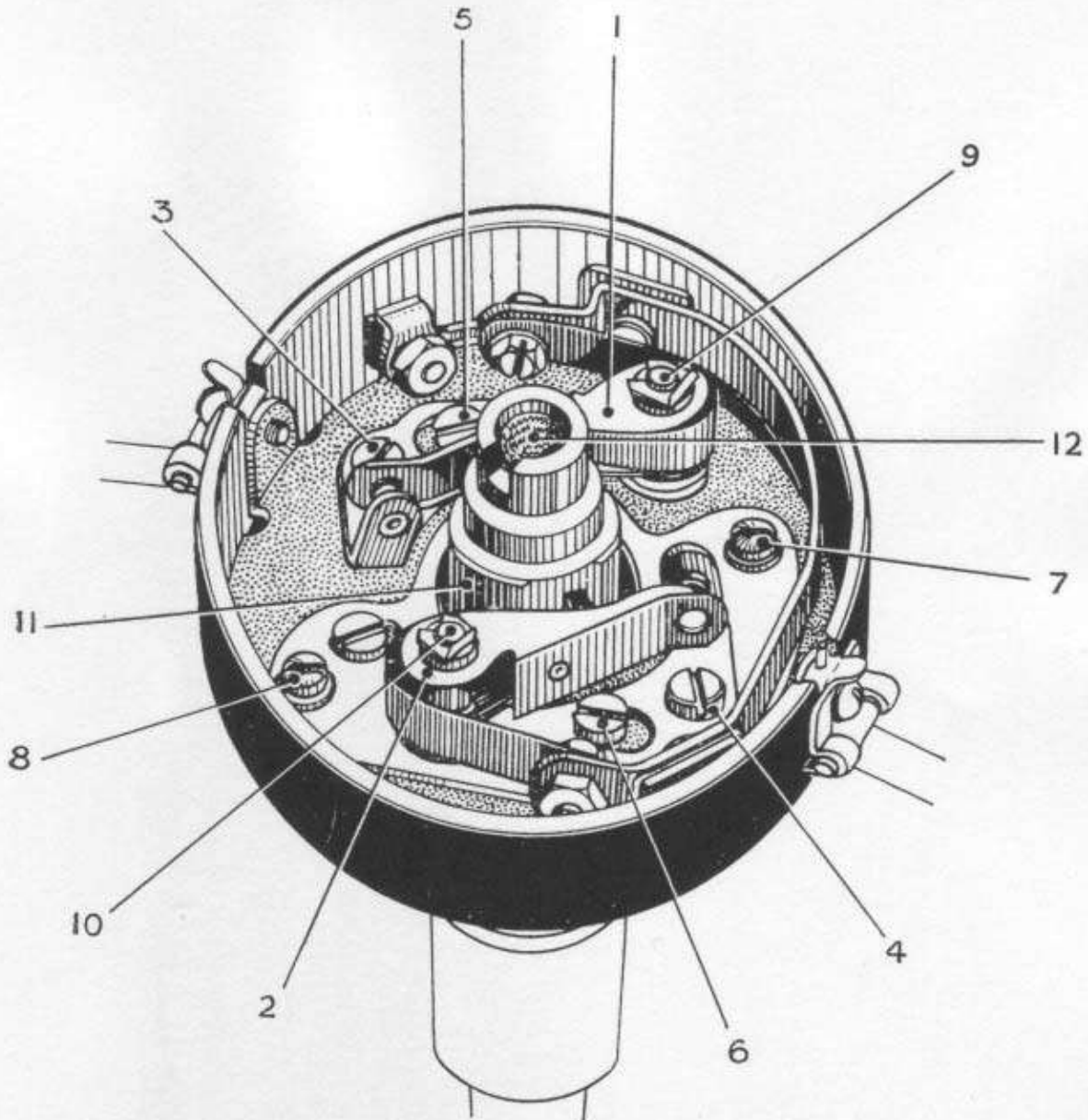

Fig. 38.—INTERIOR OF CONTACT BREAKER.

- |                         |                   |
|-------------------------|-------------------|
| 1. Contact breaker arm. | 7. Locking screw. |
| 2. Contact breaker arm. | 8. Locking screw. |
| 3. Locking screw.       | 9. Pivot pins.    |
| 4. Locking screw.       | 10. Pivot pins.   |
| 5. Adjusting screw.     | 11. Cam.          |
| 6. Adjusting screw.     | 12. Felt wick.    |

Every 5,000 miles, as directed on page 30, the rocker arm pivot pins (9 and 10) should be lubricated with one or two drops of oil "A"; at the same time a smear of Mobiloil Grease No. 2 should be applied to the cam (11). Also remove the rotor and apply a few drops of Oil "A" to the felt wick (12), to lubricate the automatic timing control.

The lubricator (3, Fig. 37) should be given a turn every 1,000 miles, and when empty, refilled with the correct grease, as specified on page 27.

The high-tension distributor requires no attention beyond an occasional wiping of the interior and exterior with a clean, dry rag.

### Ignition Coil.

Two H.T. coils are mounted on the dash-board as shown in Fig. 39. Only one is connected up, the other being carried as a spare. Connected to the terminal marked S.W. (Switch wire) is a 1 mfd. condenser to reduce electrical interference to the radio from the ignition system. Care must be taken that in the event of a change over to the spare coil, that the condenser is also changed over and correctly connected to the terminal marked S.W. and **not** to the output (C.B.) terminal of the coil.

The outside of the coil casing should be kept clean, misfiring is occasionally caused by an accumulation of dirt around the terminals.

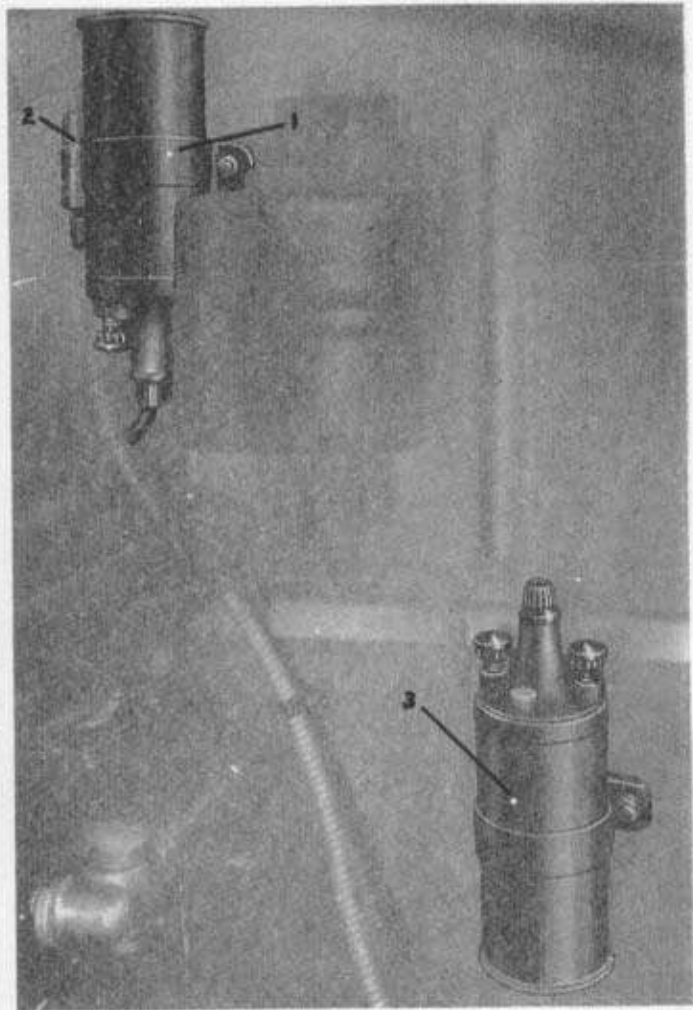

Fig. 39.—IGNITION COILS.

1. Ignition coil.
2. Condenser (suppressor).
3. Spare coil.

### Ignition Timing.

If the timing of the battery ignition should have become deranged, it can be reset by reference to the flywheel markings, which can be seen on removal of the small cover on the near-side of the clutch casing, adjacent to the starter motor.

To carry out this operation, the crankshaft should be rotated until the mark "**IGN.TDC.**" on the flywheel registers with the small pointer attached to the clutch casing, when No. 1 piston is at the top of its firing stroke.

Owing to the fact that a friction-damped spring drive is used for driving the valve gear and distributor, and that the starting handle

operates to turn the crankshaft through the medium of the spring drive, it is important that the crankshaft be rotated for timing purposes from the *flywheel end*, also, the starting handle should not have been used at all since the engine was last running.

The contact breaker should now be adjusted by rotating in an anti-clockwise direction, so that the cam is just on the point of causing the contact break when revolving in the normal direction, while at the same time the high-tension rotor is opposite No. 1 distributor contact. The rotor being in the fully retarded position.

A convenient method of determining precisely when the break takes place is by reference to the ammeter. With the ignition switched on, and someone watching the ammeter, the engine should be rotated until the required cam just breaks the contacts, as indicated by the reading of the ammeter.

The distributor head securing screw should then be securely tightened.

Ignition timing variation during running is entirely controlled by the centrifugal governor incorporated in the distributor, no hand control being provided.

### **Firing Order of Cylinders.**

The firing order of the engine is, 1, 4, 2, 6, 3, 5, No. 1 being the front cylinder.

### **Sparking Plugs.**

Alternative plugs are Champion Type N8, or Lodge Type CLN, 14 m/m. non-detachable. Every 5,000 miles, as directed on page 31, they should be removed and cleaned. The width of the gaps should be checked, and, if necessary, reset to .025" (.635 m/m.).

### **Starter Motor.**

The starter motor is shown in Fig. 40. A small planetary reduction gear is arranged in a casing behind the motor, the effect of which is to provide a total reduction gear ratio between motor and crankshaft of 16.0 : 1.

A plug (4), in the side of the gear casing, should be removed every 10,000 miles, as directed on page 31, and oil "B" injected until it reaches the mouth of the plug orifice. This oil also lubricates the driving end bearing of the armature shaft.

Ordinarily, the brushes will last a long time. In the event of replacements being necessary, application should be made to Messrs. Bentley Motors (1931) Ltd., or one of their "Special Retailers".

The fitting of new brushes requires expert knowledge and care, and emphasis is laid on this point, as cases have arisen of faulty operation of the motor, due to the inexpert fitting of brushes.

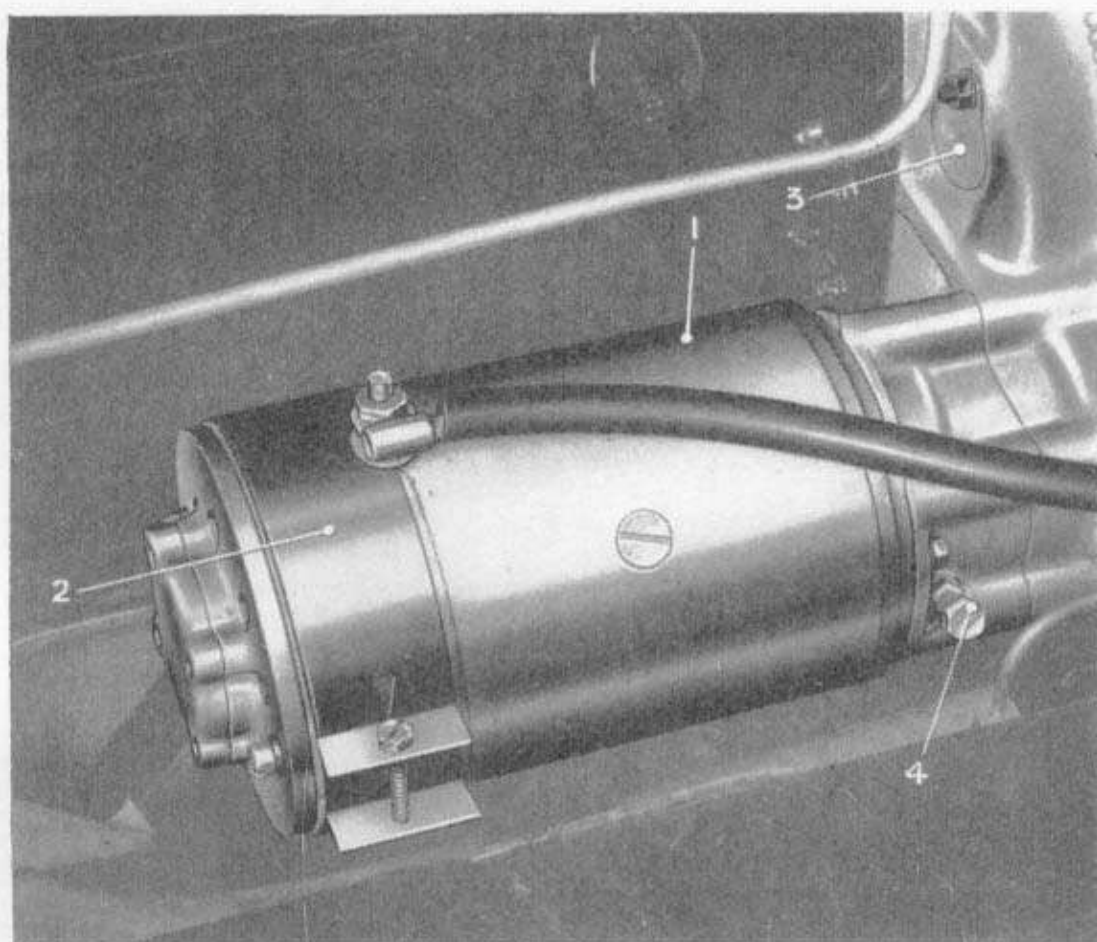

Fig. 40.—THE STARTER MOTOR.

- |                      |                    |
|----------------------|--------------------|
| 1. Starter motor.    | 3. Timing cover.   |
| 2. Brush gear cover. | 4. Oil level plug. |

When replacing the starter motor in the chassis, it is important to be sure that a clean and sound electrical connection of cable to motor is re-obtained, owing to the heavy current which this has to carry.

#### **Starter Motor Switch.**

The main starter switch is mounted on the front of the dashboard, and is relay-operated. Closing of the push-button switch on the instrument panel energises an electric magnet, which closes the main contacts.

No attention should be necessary to the switch between general overhauls of the chassis.

#### **Use of Starter Motor.**

Careless use of the starter will reduce the life of the battery, whereas careful use will make very little difference to that life. That is to say, the heavy motor current is not detrimental to a healthy, charged battery—it only becomes detrimental to a cell which for any reason is low in charge, density or voltage. Several dozen starts may be made on a fully-charged battery without detriment. On the contrary, it is very important, if the engine does not start reasonably quickly,

to look for the cause rather than to continue to use up the battery output, with the risk of damage to one or more cells, remembering that the battery may not always be fully charged at the time.

If the starter appears to be sluggish in its action, and such sluggishness is traceable to the battery, no further attempt should be made to use the starter until the battery has been duly inspected and fully charged from an external source.

### **Electric Fuel Pumps and Gauge.**

The electric fuel pumps should not need any attention over long periods of running, except, perhaps, the cleaning of the suction or delivery valves (see page 44); if an electrical fault is suspected, it is recommended that the necessary inspection and any work in connection with repairs should be carried out by Messrs. Bentley Motors (1931) Ltd., or one of their "Special Retailers".

Reference to the wiring diagram (Fig. 35), will show that they are supplied with current through the ignition switch, and, consequently, are only operative when the ignition switch is closed.

The fuel gauge is divided into two parts:—

- (a) An indicating instrument, mounted on the instrument panel, and marked "0,  $\frac{1}{4}$ ,  $\frac{1}{2}$ ,  $\frac{3}{4}$ , and F".
- (b) A petrol tank unit, with a float for measuring the amount of petrol in the tank.

The indicating instrument has two actuating coils:—

1. A control coil, which is connected across the battery and so provides a constant torque on the pointer, tending to swing it over to the "Full" side of the scale.
2. A deflecting coil, which is connected in series with the battery and the tank unit rheostat, and so arranged to act in opposition to the control coil.

The tank unit consists of a variable rheostat, the sliding arms of which are operated by the up-and-down movement of the float, thus varying the circuit resistance from a minimum in the empty position to a maximum in the full position. With the float in the "empty" position the current in the deflecting coil is at a maximum, and its turning effort is of sufficient strength to move the pointer, against the opposing force of the control coil, back to the "O" position on the indicating instrument. Thus as the resistance is varied by the position of the float, the pointer indicates the petrol level in the tank.

A warning light is provided on the instrument panel, which is automatically illuminated when there is approximately three gallons or less of petrol in the tank.

### **Electric Horns.**

Two tuned, wind-tone horns are provided, operated through a sealed relay mounted on the front of the dashboard.

No adjustments should be attempted. In the event of derangement, or deterioration of the tone, Messrs. Bentley Motors (1931) Ltd., or one of their "Special Retailers" should be consulted.

### De-Mister and De-Froster.

An electrically operated de-mister and de-froster is fitted under the scuttle, (See Fig. 41).

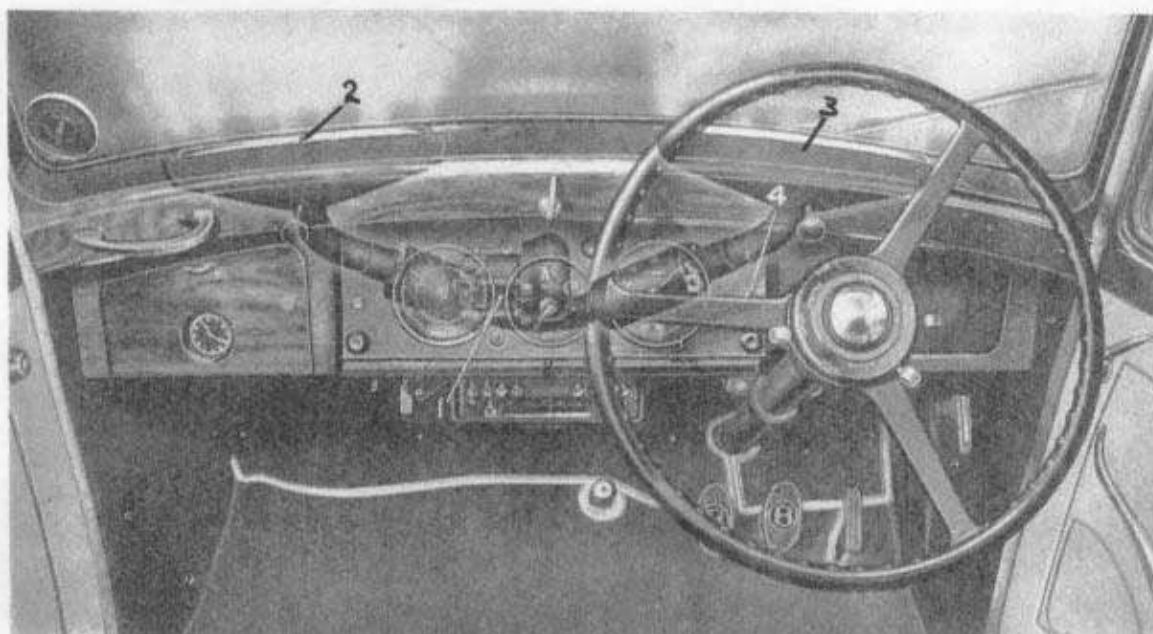

Fig. 41.—DE-MISTER AND DE-FROSTER.

- |                    |                    |
|--------------------|--------------------|
| 1. Blower motor.   | 3. Air vent cover. |
| 2. Air vent cover. | 4. Motor switch.   |

Warmed air, after passing through the radiator, is collected and taken via the large pipe (1, Fig. 42), to a blower motor mounted behind the dashboard.

Vents are so arranged in the top of the fascia board to allow streams of warmed air to be forced onto the wind-screen.

The vents are fitted with metal covers, these should normally remain open, but they may be closed if it is found that warmed air is being drawn into the car at unseasonable times.

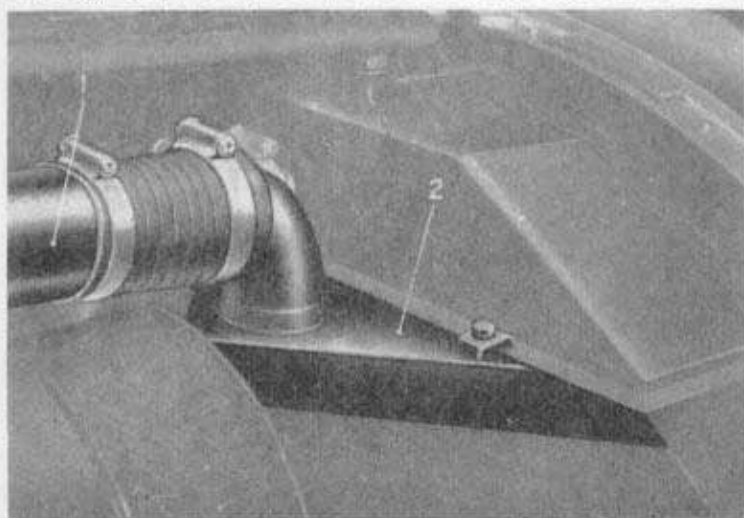

Fig. 42.—AIR COLLECTOR—DE-MISTER.

- |                          |                   |
|--------------------------|-------------------|
| 1. Pipe to blower motor. | 2. Air collector. |
|--------------------------|-------------------|

To operate, ensure vent covers are open by gently pulling same rearwards, and switch on motor (4, Fig. 41).



**Electrical Fault Location.**

In case of faulty operation, proceed to investigate as follows:—

1. Failure of any part of the system separately, may be due to a blown fuse in the fuse box (Fig. 36).
2. Failure or incorrect operation of the system, may be due to the fusing of the main fuse (Fig. 36), due to an earth.

If the dynamo does not charge:—

1. Check correctness of ammeter by switching on headlamps, this should show a "discharge" reading.

NOTE:—See that the main switch is in the "OFF" position, before making any change to the wiring connections.

2. Ascertain whether the dynamo or regulator unit is at fault by connecting together the regulator terminals F and D, this will short circuit the regulator. Start engine gently and increase speed slowly, engine speed should not exceed a fast idle. Observe ammeter, if dynamo is in order, the ammeter will show a "charge" reading and the defect will be in the regulator unit.
3. To test dynamo, disconnect the wiring from both main terminals and connect these terminals together. Connect a lamp between one terminal and earth, and gently speed up engine as before. If the dynamo is in order the lamp will light.
4. Dynamo brushes may be sticking, due probably to oiliness. Clean brushes and holders with rag moistened in petrol.
5. Cut-out contacts may be burnt out or sticking.

If dynamo output is low, this may be due to the battery being fully charged, but if low with lights on, i.e., ammeter indicates an abnormal discharge, the regulator may be sticking in such a manner as permanently to insert the field resistance. Low output may also be caused by a slack driving belt.

If dynamo gives an excessive charge when speeded up, this may be due to the regulator sticking or to a break in the regulator shunt coil circuit. Check regulator wiring conditions.

*In the case of defective operation which is traceable to the regulator, the unit must be removed and returned for rectification to Messrs. Bentley Motors (1931) Ltd., or one of their "Special Retailers".*

If, with the fuses intact, and the lights in order, the ignition:—

## (a) Misses.

1. First confirm right condition of sparking plugs.
2. Assure correct condition of contact breaker points, and adjust gap .019" to .021", if necessary.
3. Check condition of ignition coil casing. (See page 92.)

## (b) Fails.

1. With ignition switched on, see by ammeter, while engine is cranked, that coil is taking current intermittently. If no current, test availability of battery voltage at coil terminals.

(Insert in Bentley Mk. VI Handbook No. VII to face page 98.)

## HEADLAMPS.

The original installation in which the foot-switch, operated to extinguish the headlamps and switch on the pass-lamp, has been altered; the foot-switch now operates a "dipping" system for the headlamps, whilst the pass-lamp is controlled by a separate switch on the dashboard.

The foot-switch now operates to extinguish the right-hand light, and deflect the left-hand beam vertically downwards by switching over to the displaced filament of a twin-filament bulb in the left-hand headlamp.

Provision is made so that this system can be reversed for use in countries where the car is driven on the right-hand side of the road.

1. Change over the headlamp bulbs, i.e. fit the double filament bulb in the right-hand headlamp, and the single filament bulb in the left-hand headlamp.
2. Refer to sketch, and connect wire "A" to wire "E" in the right-hand wing valance junction box, as shown.
3. Disconnect the wire "B" in the left-hand wing valance junction box, and tape up the end.

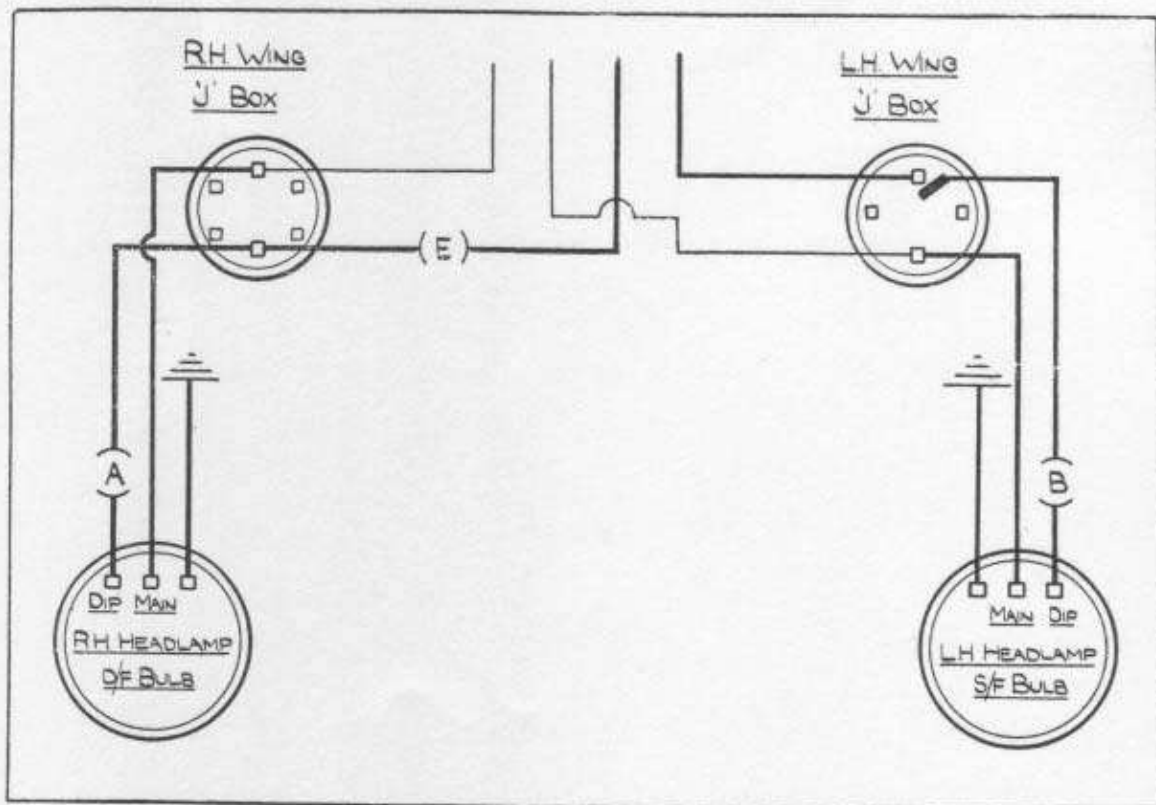

BENTLEY MOTORS (1931) LTD.,  
LONDON.

If, with battery in order, starter motor is sluggish or does not turn, examine commutator and brushes. Clean oily brushes and holders with a rag moistened with petrol. If motor turns without turning engine, check freedom of engine with starting handle. If found in order, the trouble lies in starter drive, and Messrs. Bentley Motors (1931) Ltd., or one of their "Special Retailers" should be consulted.

If battery will not retain charge:—

1. Ascertain that no circuit is left switched on.
2. See that no cell of the battery leaks acid.

### Recommended Lamp Bulbs.

R.H. Headlamp—12 volt, 48 watt—Single Centre Contact. (Lucas prefocus axial filament No. 185.)

L.H. Headlamp—12 volt, 48/48 watt—Double Contact. (Lucas prefocus transverse filaments No. 191.)

Centre Lamp—12 volt, 48 watt—Single Centre Contact. (Lucas prefocus axial filament No. 185.)

Front Wing Lamps—12 volt, 3 watt—Single Centre Contact, S.B.C. Cap.

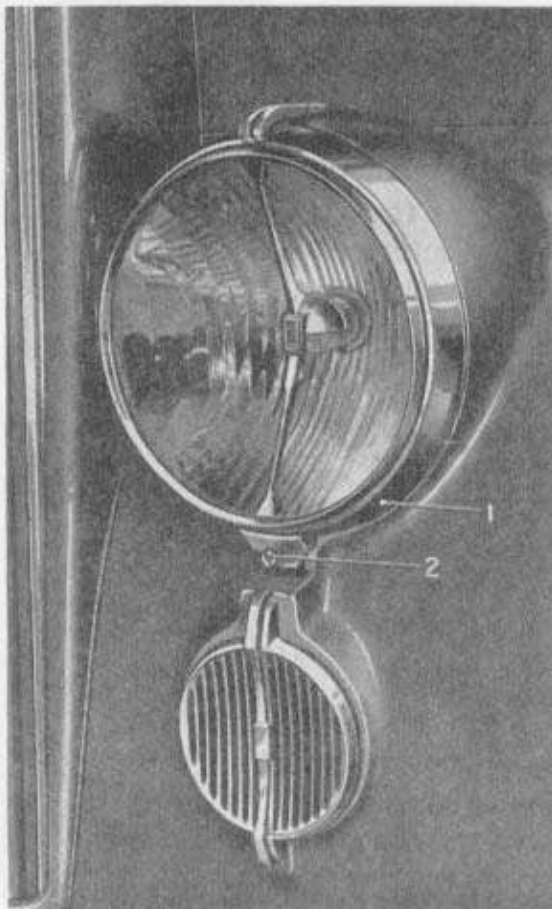

Fig. 43.—THE HEADLAMP.

1. Rim.
2. Rim securing screw.

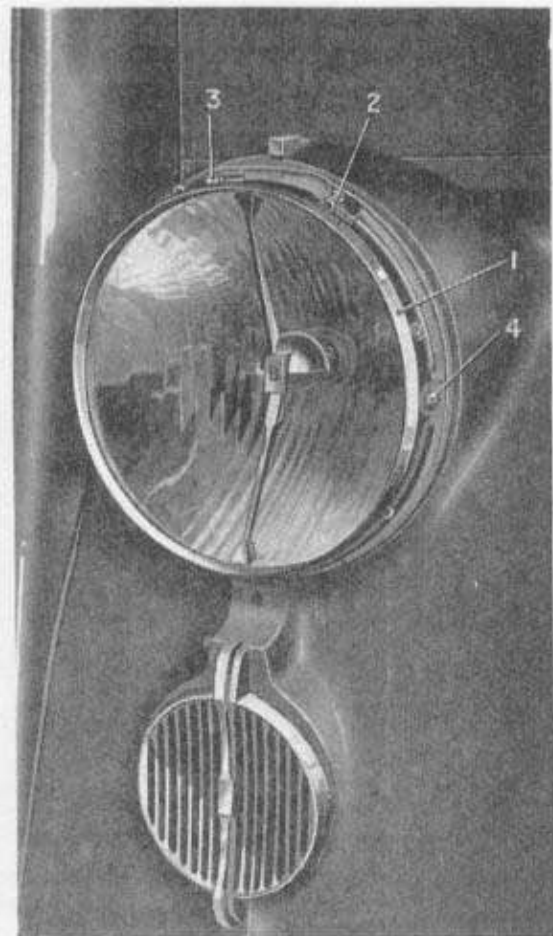

Fig. 44.—HEADLAMP—WITH RIM REMOVED.

1. Light unit.
2. Light unit securing screw.
3. Vertical trim adjustment screw.
4. Horizontal adjustment.

Stop/Tail Lamps—12 volt, 24/6 watt—Double Contact—S.B.C. Cap. (Lucas No. 189.)

Number Plate Illumination—12 volt, 3 watt—Single Centre Contact—S.B.C. Cap.

Reverse Lamps—12 volt, 6 watt—Single Centre Contact—S.B.C. Cap. (Lucas No. 207.)

Instrument Lights—12 volt, 2.4 watt—M.E.S. Cap.

Warning Lights, Map Lamp and Boot Lamp—16 volt, 3 watt,—M.E.S. Cap.—15 m/m bulb.

Interior Roof Light—12 volt, 6 watt—Single Centre Contact—S.B.C. Cap. (Lucas No. 207.)

Trafficators—12 volt, 3 watt—Festoon. (Lucas No. 256.)

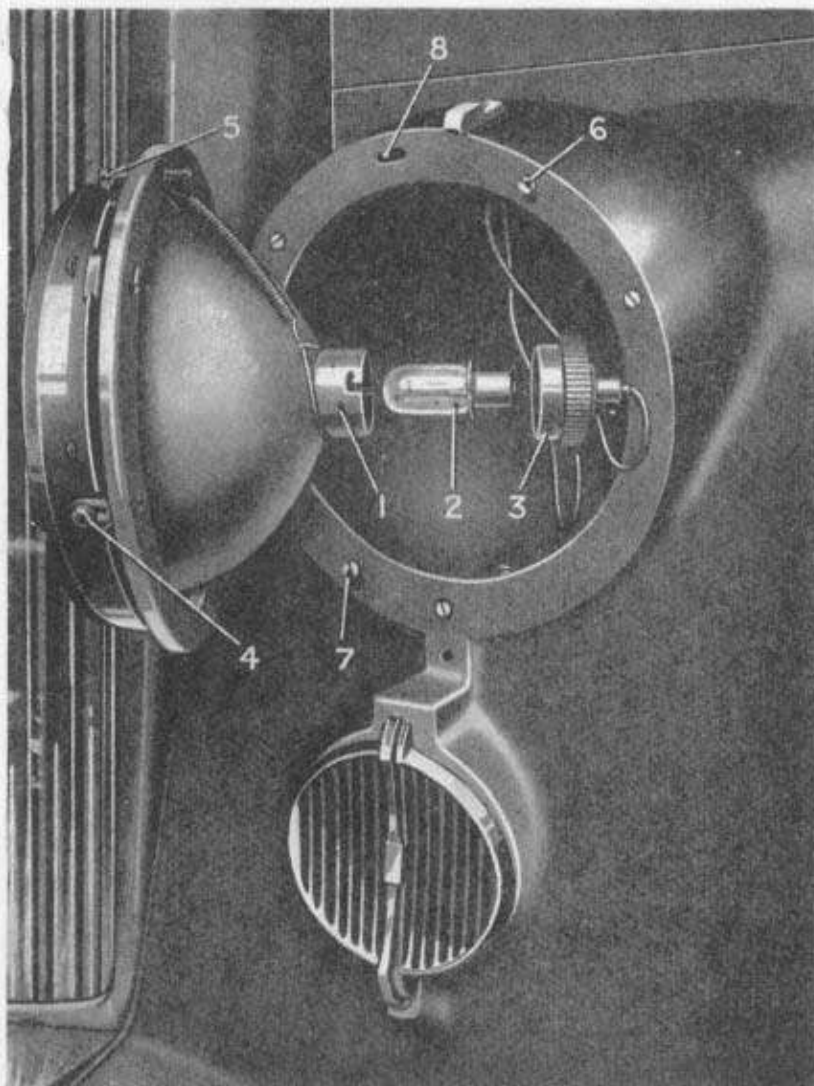

Fig. 45.—HEADLAMP—CHANGING THE BULB.

- |                           |   |
|---------------------------|---|
| 1. Bulb holder.           | 5. Vertical trim adjustment screw.          |
| 2. Bulb.                  | 6. Light unit securing screw.               |
| 3. Backshell.             | 7. Light unit.                              |
| 4. Horizontal adjustment. | 8. Slot for vertical trim adjustment screw. |

### Headlamps.

Each headlamp incorporates a Light Unit, which consists essentially of a reflector and front glass assembly provided with a mounting flange, by means of which it is secured in the body housing.

The bulb, which has a pre-focus cap, is located accurately in the reflector, and is secured by a bayonet-fixed backshell which also provides the contact to the bulb.

The design of the bulb and of its holder is such that the bulb is correctly positioned in

relation to the reflector, and no focusing is required when a replacement bulb is fitted.

### Replacing a Headlamp Bulb.

Remove the screw (2, Fig. 43), at the bottom of the lamp and lift off the rim. Slacken the two screws (6 and 7, Fig. 45), which secure the flange of the Light Unit, and turn it in an anti-clockwise direction to detach the flange from the securing screws. The Light Unit can then be lifted out of the lamp body.

Twist the backshell (3, Fig. 45) in an anti-clockwise direction and pull it off. The bulb can then be removed by inverting the Light Unit and holding one hand under the bulb holder so that the bulb slides into the hand.

Place the re-placement bulb in the bulb holder (1, Fig. 45), taking care to locate it correctly. Engage the projections on the inside of the backshell with the slots in the holder, press on and secure by twisting it to the right.

Position the Light Unit in the lamp body so that the vertical trim adjusting screw (5, Fig. 45), locates in the slot in the body rim, and the heads of the two fixing screws (6 and 7, Fig. 45), protrude through the holes in the flange of the Light Unit. Twist the Light Unit in a clockwise direction and secure by tightening the two screws.

Engage the tongue on the inside of the front rim in the slot at the top of the flange of the Light Unit, press it on fully at the bottom and secure with the fixing screw (2, Fig. 43).

### Aligning the Headlamps.

The headlamps should be aligned so that they direct their beams straight ahead, i.e. parallel with the road and with each other.

The simplest way of checking the adjustment of the lamps is to take the car on a straight level stretch of road at night and examine the direction of the beams. If one appears to be out of adjustment, adjust as follows:—

Remove the screw (2, Fig. 43) at the bottom of the lamp and lift off the rim.

Vertical adjustment is made by operating the screw (5, Fig. 45), screwing in raises the beam and screwing out lowers the beam.

Horizontal adjustment is made by slackening the nuts (4, Fig. 45) and sliding the reflector unit forward or backward in the slots provided.

Having obtained the correct adjustment, the nuts (4, Fig. 45) must be securely re-tightened, and the rim replaced.

### The Side Lamps.

The method of changing a lamp bulb is illustrated in Figs. 46 and 47.

The locking screw, (1) should be removed, and the lamp unit drawn bodily forward as in Fig. 46.



Fig. 46.—SIDE LAMP.  
1. Locking screw.



Fig. 47.—SIDE LAMP.  
2. Spring catch.

To obtain access to the bulb, detach the front portion by holding firmly, and rotating the rear portion a quarter of a turn to release the spring catch, (2).

The bulb is of the standard bayonet fitting type.

To replace, reverse the above instructions.

### Radio.

"His Master's Voice" automobile radio equipment is fitted as original equipment in the Bentley car. The receiver, known as "Radio-mobile" Model 100, has a six valve superheterodyne circuit designed for medium and long wave reception.

Fig. 48 illustrates the controls.

The combined Volume Control and "On/Off" switch, at the left of the control panel and below the push-buttons, switches the receiver off when turned fully anti-clockwise. Turning the knob clockwise switches the set on, indicated by the illumination of the tuning scale and controls the volume.

A period of about 40 seconds after switching on is required for the receiver valves to warm up.

The left-hand group of four push-buttons contains two buttons marked "MW" and "LW", and two marked "MU" and "SP".

The buttons marked "MW" and "LW", enable either the Medium or Long waveband to be selected, by pushing the appropriate button.

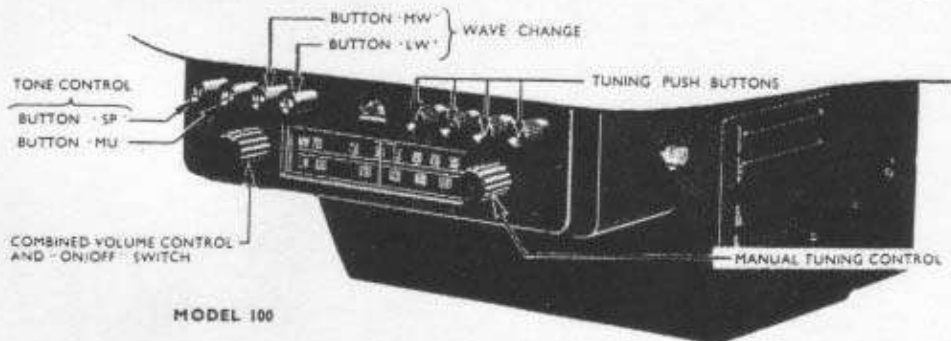

Fig. 48.—THE RADIOMOBILE CONTROLS.

The buttons marked "MU" and "SP" are for tonal control. Pushing the "MU" button the tonal balance is set to conditions favourable to musical reproduction, while the "SP" button provides accentuated high frequency response for good speech intelligibility.

The Manual Tuning Control, at the right of the control panel and below the push buttons, operates through a friction clutch, and in order to tune in a station it is necessary to press the tuning knob while turning it.

The four Tuning Push-buttons, at the right of the control panel, provide automatic tuning of four stations on the Medium or Long wavebands. These buttons can be rapidly adjusted to tune any four stations; the required station may then be selected simply by pushing the appropriate button.

The Tuning Scale is calibrated in wavelengths and is illuminated. The upper (yellow) scale covers the Medium waveband, the lower (red) the Long waveband.

#### TO SET UP THE TUNING PUSH-BUTTONS.

1. Switch on the receiver, leaving Volume Control set at roughly two-thirds of full rotation, and allow about 40 seconds to warm up.
2. If the station desired is on the Medium waveband, press the button marked "MW". If on the Long waveband, press the "LW" button.
3. Tune in the station, using Manual Control, in the same way as when tuning a domestic receiver. For example, if the London Home Service programme is required (wavelength 342.1 metres) turn the Tuning Control until the scale pointer reads approximately the correct wavelength on the Medium Wave scale. The station should then be heard, and a final adjustment should be made to tune it in accurately.

4. Release tuning knob.
5. Gripping the knurled portion of one of the Tuning Push-buttons between finger and thumb, unscrew it about half a turn (i.e. turn it anti-clockwise). Then push the button firmly as far as it will go. Allow it to spring back to normal position, and tighten firmly by turning it clockwise. The push-button is now set to tune the station required, and when pressed will "bring in" the station irrespective of the position to which the scale pointer may have been adjusted previously.

Proceed in the same manner for the other push-buttons, remembering that if the desired station is on the Long waveband the "LW" must first be pressed before the tuning button will bring in the station, similarly, the "MW" button must be pressed for Medium wave stations.

The aerial is normally mounted above the windscreen on the outside of the car, and is operated from the inside by a bakelite knob. An engraved arrow indicates the position of the aerial, vertical being for normal use and horizontal for when parked and not in use.

In some cases an under car aerial may be fitted, and with these there is no inside aerial control knob.

It is unlikely that either of these types of aerial will need attention, but to ensure the best reception they should be kept clean.

If any further advice or assistance in connection with the radio equipment is required, Messrs. Bentley (1931) Ltd., or one of their "Special Retailers", should be communicated with, or, if more convenient, any of the Radiomobile Service Depots.



**BLANK PAGE**

## CHAPTER XI

**The Body and Coachwork**

*General—Washing and Polishing—Doors—Seat Slides—Upholstery and Carpets—Sliding Roof—Luggage and Spare Wheel Compartments—Tools.*

**General.**

The following instructions apply only to the body as manufactured and fitted by Messrs. Bentley Motors (1931) Ltd., owners of cars fitted with special bodies should be guided by the coachbuilders' instructions.

The standardised saloon body on the Mark VI chassis is constructed entirely of pressed steel, and, possessing great strength and rigidity with minimum weight, ensures the greatest stability of body and chassis combined with maximum resistance to accidental damage.

Large doors permit quick and easy access to the driver's and passengers' compartments, the interior upholstery being of fine quality hide.

For the car to look well and retain its beauty and smart appearance, the coachwork must receive its share of attention and should never be neglected.

**Washing and Polishing.**

The cellulose finish of the car is easily cleaned and polished. It is inadvisable to polish the car without first washing down with a chamois leather and plenty of clean running water, as dry cleaning off, no matter how clean the cloth, will tend to produce surface scratches on the paintwork.

Tar should be removed with a grease solvent, while a light application of petrol will remove grease marks.

This petrol must be lead-free and dried off immediately.

Cleaning of movable windows by means of hosing should be avoided as this invites the collection of water inside the doors which may take some time to dry out.

After washing, chromium plated parts should be dried off with a damp chamois leather.

A recommended polish is "Belco No. 7", although other body polishes of known quality may be used in accordance with the instructions on the containers.

*Under no circumstances should any polishing compound containing ammonia be used.*

### Doors.

The door lock bolts and hinges should receive periodical attention with oil "A". Every 10,000 miles, as directed on page 33, the hinge plate (see Fig. 49) should be removed and the slides carefully oiled.

The window winding mechanism should need no attention for a very considerable period as this is amply provided with lubricant upon assembly.

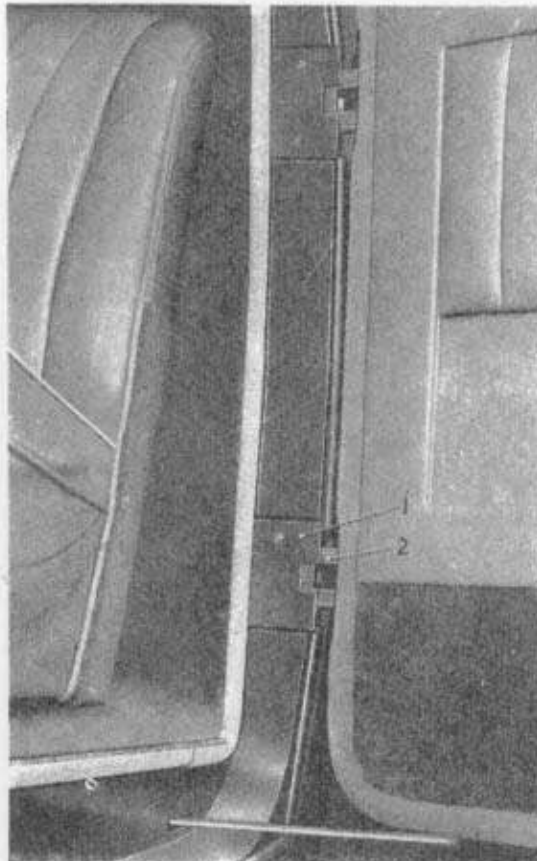

Fig. 49.—DOOR HINGES.

1. Hinge plate.                      2. Slide.

### Seat Slides.

Occasionally check the securing screws for tightness, and apply sparingly a little grease to the runners to ensure smooth operation.

### Upholstery and Carpets.

In general the leather upholstery has an impermeable surface, and to keep it clean and fresh looking, we recommend that the leather should occasionally be treated with a preparation known as "Connolly's Hide Food".

Floor carpets should be removed and cleaned with a vacuum cleaner, and any stains or grease marks removed with a clean cloth moistened in a solvent such as "Drik". This solvent can be used to advantage particularly on the head cloth, which should receive periodical attention similar to the carpets and the other upholstery.

**Sliding Roof.**

Occasionally inspect the side channels of the roof to make sure that the drain holes are clean.

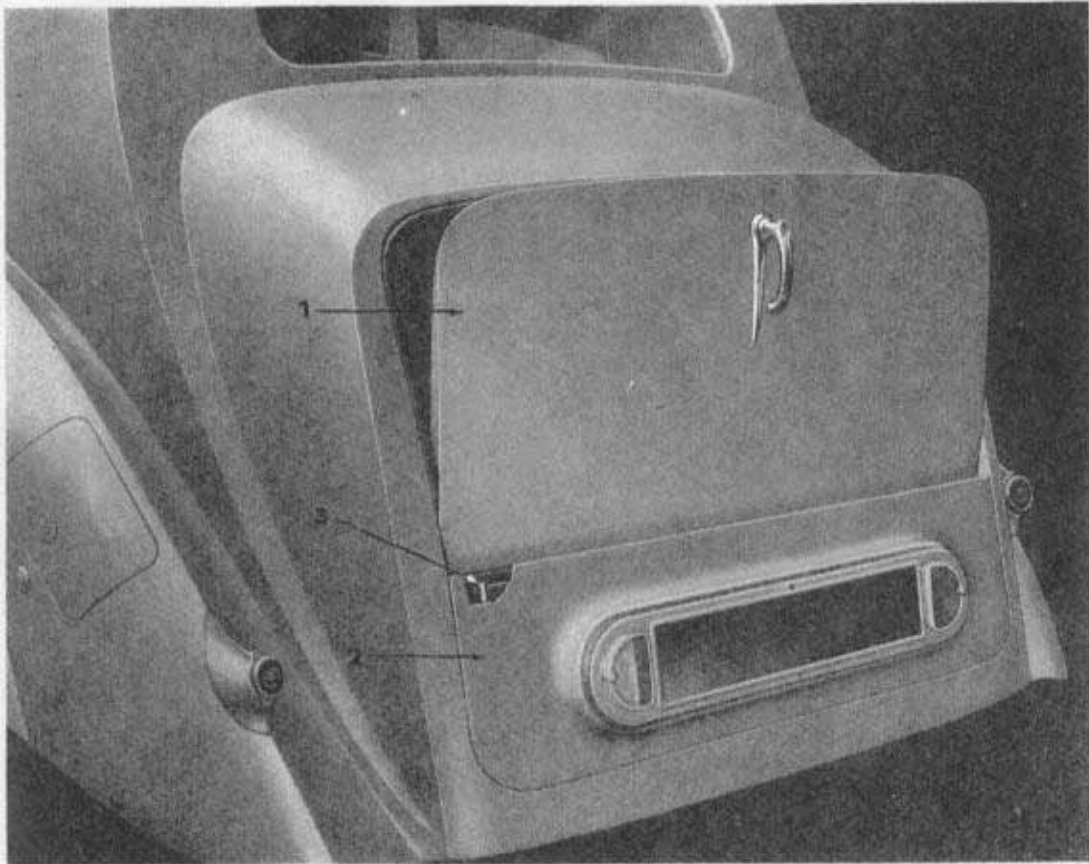

Fig. 50.—SPARE WHEEL COMPARTMENT.

1. Door to luggage boot.
2. Spare wheel and tool compartment.
3. Operating catch.

**Luggage and Spare Wheel Compartments.**

Ample luggage space is provided, and the spare wheel is carried in a separate compartment below, as illustrated in Fig. 50.

To gain access to the spare wheel compartment, firstly, open the luggage boot approximately corresponding to the position in Fig. 50. Secondly, insert the left hand into the slot below the door and operate the catch. Pull the lower door outwards, and then close the luggage boot. Thirdly, with both hands, lift and pull forward the spare wheel compartment door, which may then be lowered to rest on the hinges.

**Tools.**

An adequate set of tools is supplied with each car, the "small" tools being carried in a fitted tray in the tool drawer under the dash. (See Fig. 1.)

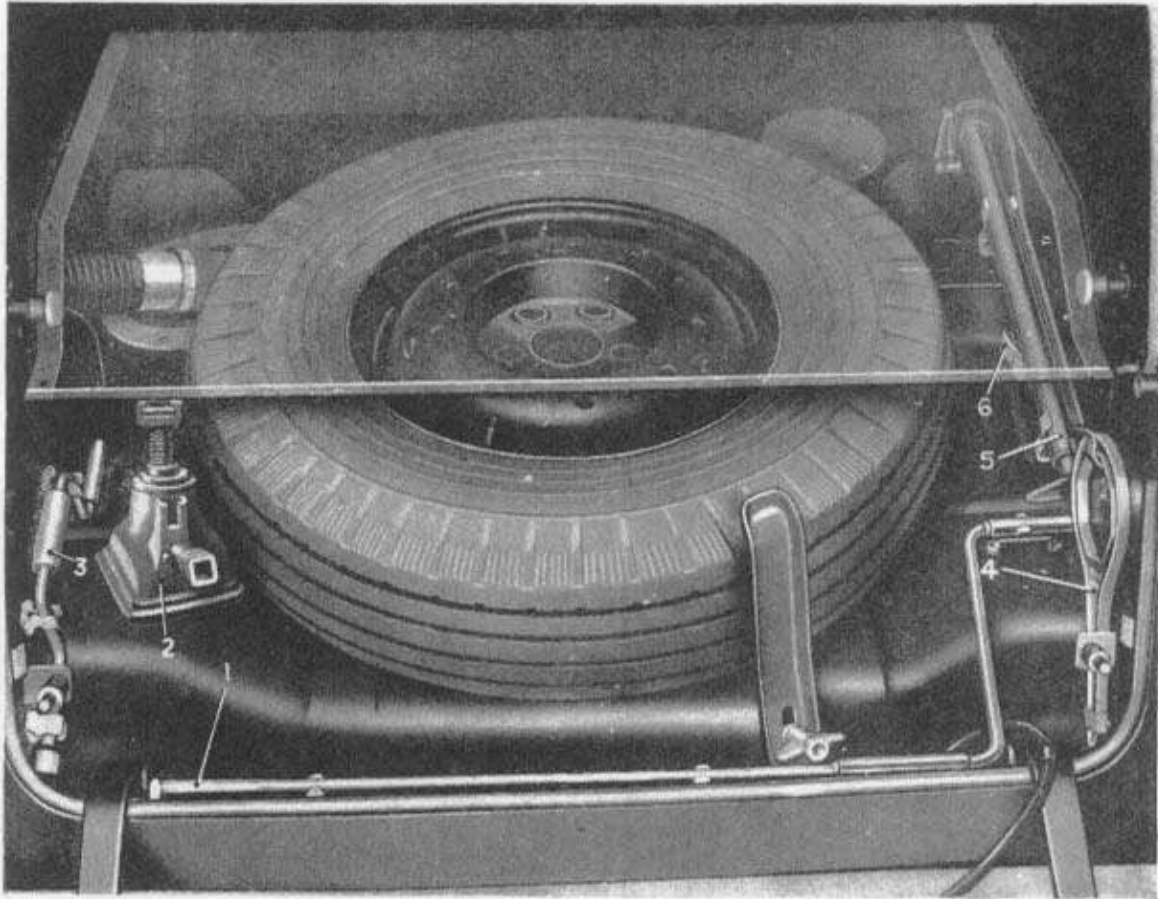

Fig. 51.—SPARE WHEEL AND TOOL COMPARTMENT.

- |                  |                        |
|------------------|------------------------|
| 1. Jack handle.  | 4. Wheel disc spanner. |
| 2. Lifting jack. | 5. Tyre pump.          |
| 3. Wheel brace.  | 6. Tyre levers.        |

The larger tools being carried in the spare wheel compartment, as illustrated in Fig. 51.

## CHAPTER XII

### Storage and Recommissioning of Cars

1.—After jacking up both rear wheels, as directed in (3), run engine gently for a few minutes with a gear engaged.

When engine is cold inject about two tablespoonfuls of engine oil through spark plug holes of each cylinder and turn crankshaft by hand a few times to distribute oil over cylinder walls.

2.—Crank engine over by hand once a week during storage. It must *not* be run under its own power.

3.—Jack up both axles to take all weight off tyres, using wood blocks or other suitable packing\*. Do not deflate tyres, but cover up to exclude light.

4.—If the cooling system contains anti-freeze, do not drain.

If the original coolant has been replaced by plain water, and there is any danger of freezing, drain the system. Otherwise leave water in.

5.—Drain all fuel from main tank, rear strainer and carburetter.

6.—Clean all bright parts and lightly smear with vaseline.

(*Note.*—In the case of parts having untarnishable finish, such vaselining is both unnecessary and undesirable.)

7.—Wash down and polish coachwork, extend hood in the case of an open touring car, and cover the whole with a light dust sheet.

8.—The storage place should be dry, well ventilated, and preferably heated.

9.—Remove battery and properly charge from an external source. Give a subsequent freshening charge from an external source every four or five weeks.

If the storage period is likely to exceed three months, the engine crankcase and also the gearbox and rear axle should be drained and filled up to the correct level with a *pure mineral* oil, e.g. Vacuum "BB" or Wakefield's Aero "C". One of these oils should also be used for injecting into the cylinders under such circumstances.

---

\* A jacking pad is provided on the centre of the front suspension "pan"

Before putting the car into service again the following operations should be performed:—

- 1.—Drain engine crankcase and refill to correct level with *fresh* engine oil.
- 2.—Prime cylinders with engine oil.
- 3.—If previously drained, refill coolant system to correct level.
- 4.—If gearbox and rear axle have been filled up with a pure mineral oil, as directed for long period storage, drain and refill with correct oils.
- 5.—Run engine gently for a time after starting up.
- 6.—Remove and clean spark plugs.

Tanks should be completely drained when it is known that the car will be laid up for an appreciable period.

Owing to the fact that motor spirits undergo deterioration with time, thereafter causing them adversely to affect inlet valves and the moving parts of the carburetter, it is undesirable to keep fuel tanks half filled with fuel in a warm atmosphere such as a showroom or garage.

## CHAPTER XIII

### School of Instruction

To enable the maximum satisfaction to be obtained from the ownership of a Bentley car, Instructional Courses of two weeks' duration are held on the maintenance of the Bentley chassis. During the Course, the mechanical features of the chassis are fully explained, particular emphasis being stressed on the points requiring lubrication or adjustment, at the same time instruction is given in the handling of the car on the road, where a high standard of driving is demanded. Suitable cars are maintained by the School for instructional purposes.

The Course is intended for chauffeurs who are undertaking the care of Bentley products for the first time, and also for drivers who have had previous Bentley experience on other models. In this latter case shorter periods can be arranged, although in most cases the full Course is desirable.

In the past owner-drivers and/or members of their families have frequently attended the Courses with beneficial results, and suitable arrangements may be made by application.

The School is located in part of the Service Department building at Willesden. Further particulars may be obtained from the Principal, School of Instruction, Bentley Motors (1931) Ltd., Hythe Road, Willesden Junction, London N.W.10. (Telephone No.: LADBROKE 2444.)



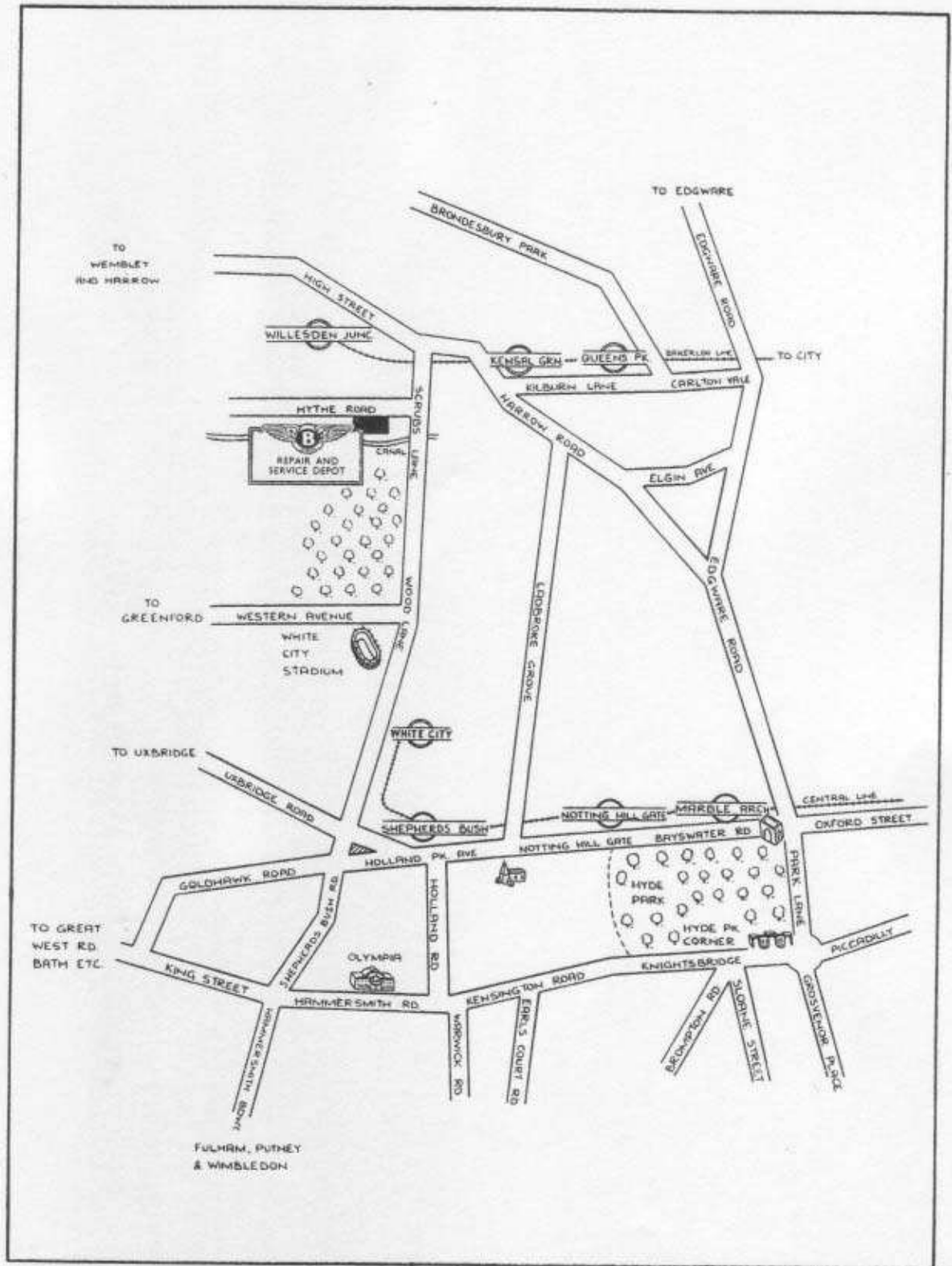

Fig. 52.—GUIDE TO LOCATION OF MAIN SERVICE STATION.

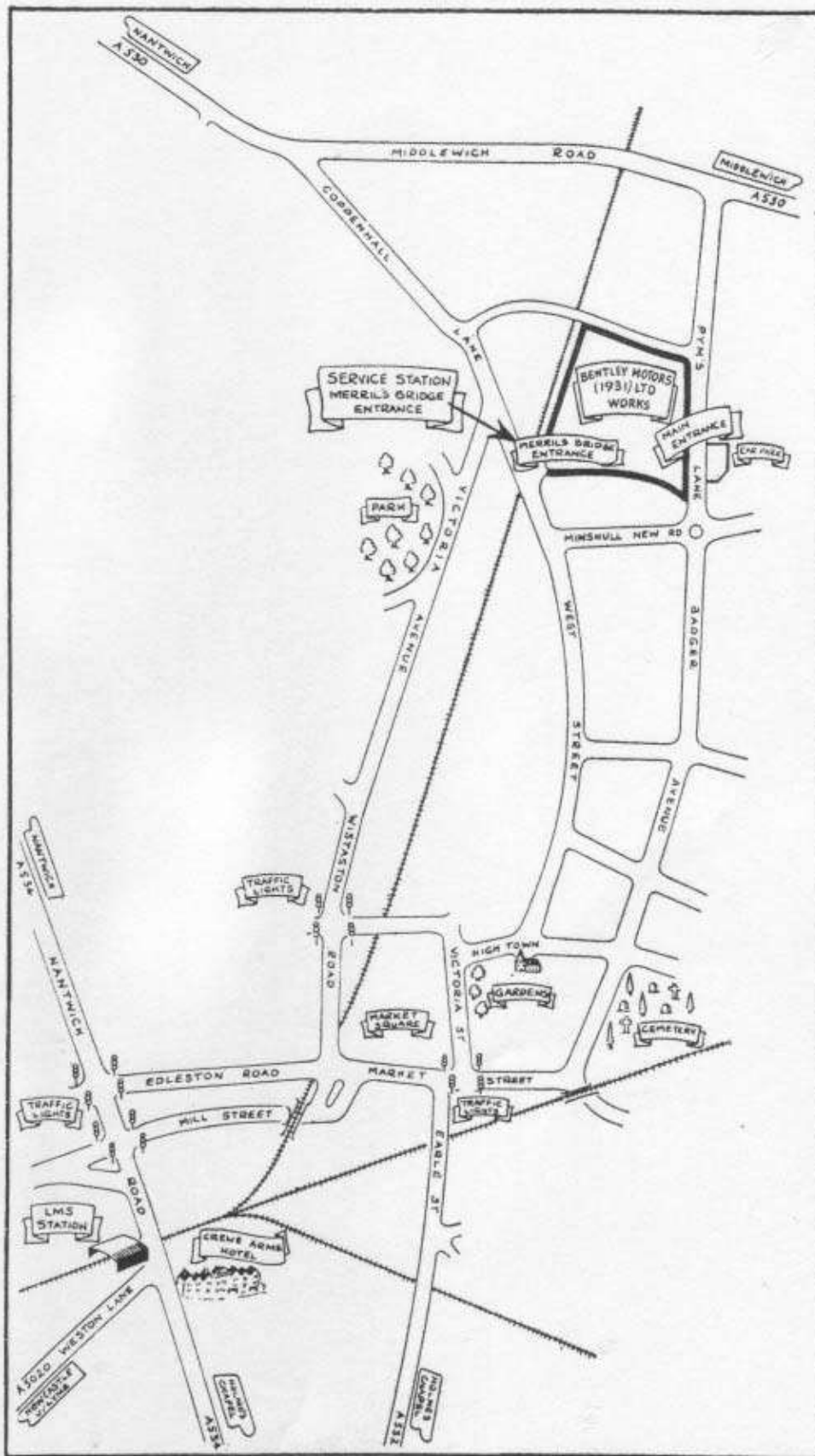

Fig. 53.—GUIDE TO LOCATION OF CREWE SERVICE STATION.

