



after sale service  
[www.saipayadak.org](http://www.saipayadak.org)  
[ceo@saipayadak.org](mailto:ceo@saipayadak.org)

[www.saipacorp.com](http://www.saipacorp.com)  
[www.parskhodro.ir](http://www.parskhodro.ir)



Owners manual **RICH**

CODE: PZPK99S003



## Foreword

Welcome to the growing family of new ParsKhodro owners. This vehicle has been delivered to you with confidence. Your vehicle has been produced using the latest techniques and strict quality control.

This manual has been prepared to help you understand the operation and maintenance of your vehicle so that you may enjoy many miles of driving pleasure. Please read through this manual before operating your vehicles.

Separate “Warranty information” explain details about the warranties covering your vehicles.

Remember that your ParsKhodro dealer knows your vehicle best. When you require any service or have any questions about your vehicle, he will be glad to assist you with the extensive resources available to him. This manual is applicable to ZN1033U2N4, ZN1033UBN4,

## INTRODUCTION

### REMINDESS FOR SAFETY

Follow these four important driving rules to help ensure a safe and complete trip for you and your passengers!

- **NEVER drive under the influence of alcohol of drugs.**
- **ALWAYS observe posted speed limits and never drive too fast for conditions.**
- **ALWAYS use your seat belts.**
- **ALWAYS provide information about the proper use of vehicle safety feature to all occupants of the vehicle.**
- **Read the manual provides important safety information.**

### WHEN READING THE MANUAL

This manual include information for all options available on this mode, therefore, you may find some information that does not apply to your vehicle.

### READ FIRST-THEN DRIVE SAFELY

Before driving your vehicle read your Owner’s Manual carefully. This will ensure familiarity with controls and maintenance requirements. Assisting you in the safe operation of your vehicle.

Throughout this manual we have used the symbol following by the word warning. This is used indicate the presence of hazard, which may cause the possibility of a personal injury or other damage and must be followed precisely.

CAUTION. This is also used throughout the manual to indicate the presence of a hazard that could cause possible minor injury to you or components and the procedures must be followed carefully.

### ALERTION OF THE VEHICLE

Please don’t alter the vehicle. Alteration may militate against the features, safety and durability, doubtless, it may also contravene the rules of the government. Furthermore (in addition), any damage and features problem that caused

by the altering,, ParsKhodro will not offer maintenance service.

All information, specifications and illustrations and illustrations in this manual are those in effect at the time of printing .ParsKhodro reserves the right to change specifications or design without notice and without obligation.

### **IMPORTANT INFORMATIONS IN THIS MANUAL**

In this manual you will see some different markings, their meaning is as follows.



This means that they can cause serious personal injury. In order to avoid or reduce the risk, you must comply with them.



This is used to point out some of the possible risk of minor damage to the vehicle or the person.

The manual only used to guide the driver use the vehicle. It cannot be used as the legal basis.

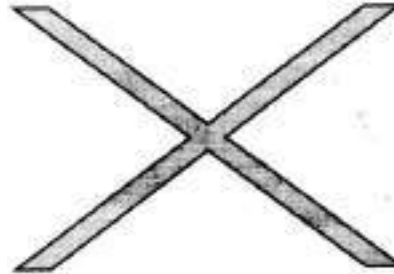

If you see this symbol appeared in the manual. That means please do not do it.

## PRECAUTIONS BE PAID ATTENTION IN USING DONGFENG BRAND VEHICLE



Thanks for purchasing our ParsKhodro vehicle.

Welcome to join the alignment that driving the vehicle of ParsKhodro brand.

We believe you must be satisfied with your chose.

This vehicle has been produced concentrating the latest techniques of Parskhodro. For helping the driver to drive and maintenance, each vehicle will be given a user manual.

Before operating the vehicle, you must read through this user manual to learn how to use this vehicle correctly.

Having anything you don't understand, please ask the Technique Service Center of ParsKhodro, they will be glad to serve you.

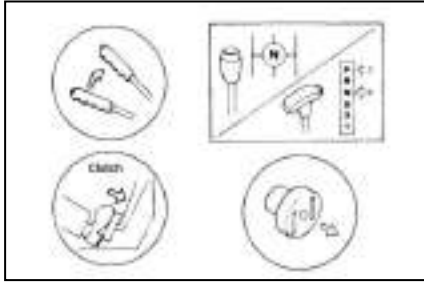

1. about starting engine

1) Be sure to pull the parking brake lever, move the gearshift lever to "N" (Neutral), and press the clutch pedal to the floor while cranking the engine. In order to start a cold engine easily, to keep the choke in closed position when you crank the engine.

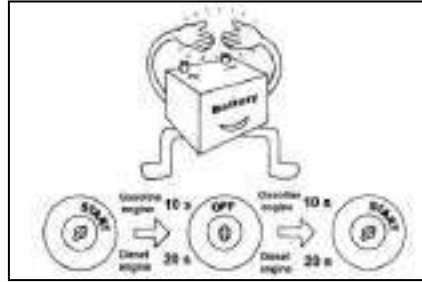

2) In order to prolong the lives of the starter and battery, do not crank the engine for more than 20 seconds at a time. If the engine does not start, wait 20 seconds before cranking again.

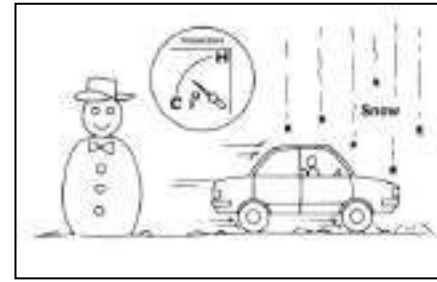

3) In cold winter, the engine must be pre-warmed until the water temperature indicator needle begins to move, only then can the vehicle be driven.

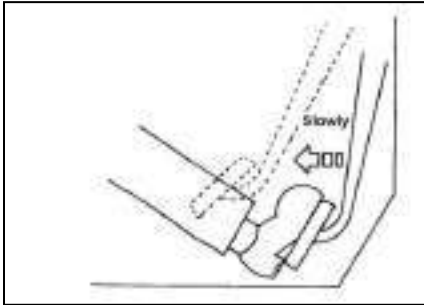

2 About driving economically

1) Connect the clutch slowly, and start the vehicle smoothly.

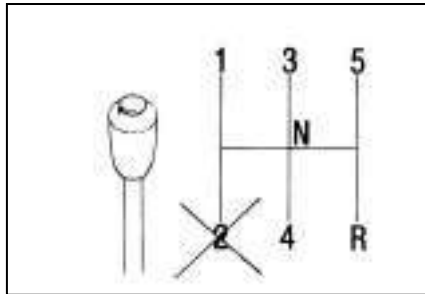

2) Forbid starting the vehicle in 2<sup>nd</sup> gear.

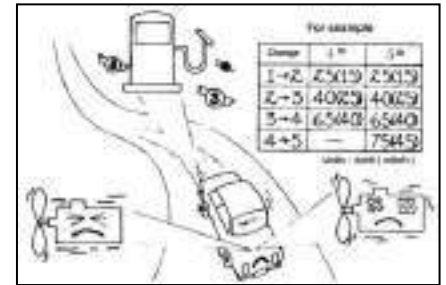

3) In order to save fuel and prolong the engine's using lives. When you start the vehicle in 1<sup>st</sup> gear, follow the speed recommended in this manual to change gear.

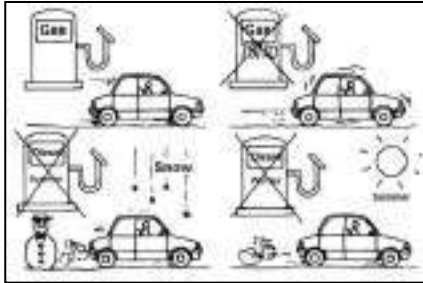

#### 4) About fuel

Seeing to the FUEL RECOMMENDATION for suitable fuel. Don't use other diesel oil, for it may apparently shorten the engine lives. All drivers should pay attention: Every abort that caused by using other fuel which is not recommended or incorrect operating, the ParsKhodro CO. will take no insurance.

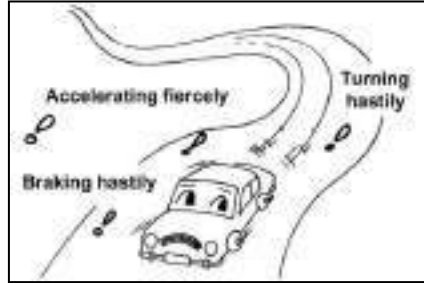

5) Accelerating smoothly, braking smoothly, and turning smoothly.

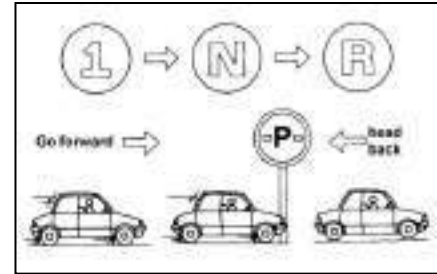

#### 6) Reversing

If you want shift the vehicle from forward to reverse, stop your vehicle completely for a point, and then shift into reverse.

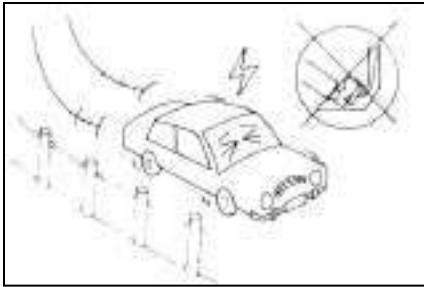

7) Do not rest your foot on the clutch pedal while driving. This may cause clutch damage.

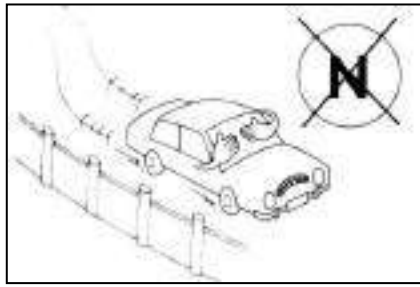

8) Do not coast with the engine stopped. While slipping the engine brake is out of function. Without the engine brake, in case of emergency condition, the braking distance will much longer, and it may cause danger.

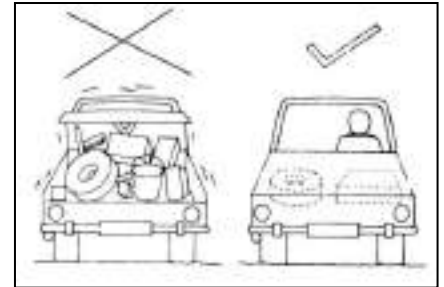

9) Do not take anything that not necessary in the cargo. It may add to the weight of vehicle and cause more fuel consumption.



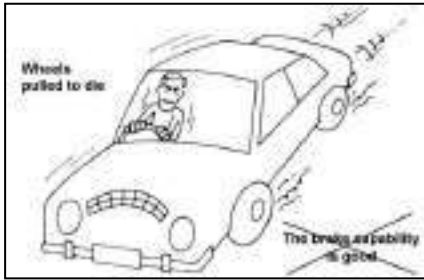

### 3 About braking

Some drivers corroborate brake capability base on whether the wheels can be pulled to die. If so, the brake capability is good, or is bad. But we know it is a completely wrong concept.

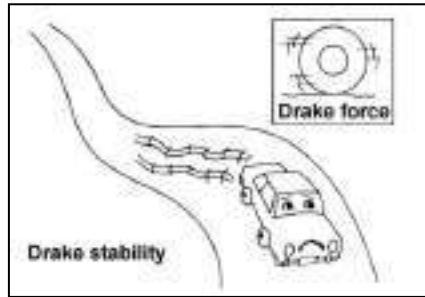

The brake capability is corroborated base on no other but brake force and stability.



During brake procedure, the vehicle's center of gravity will move forward, this change the weight balance of the vehicle, the rear wheel trend to flat, and be pulled die earlier than the front wheels.

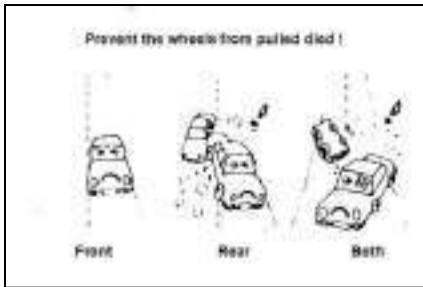

So all the vehicles have a control valve in their braking system, which prevent the rear wheels from pulled died earlier than the fronts.

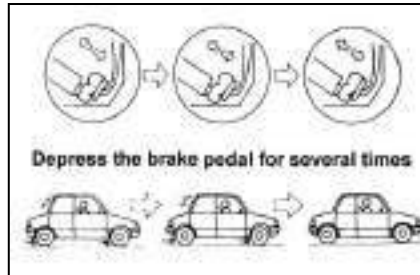

While braking, depress the brake pedal for several times may be economic, and the braking distance will be short too.

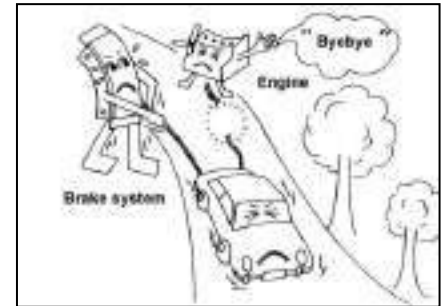

- 1) While going down a long slope, use both foot and engine brake.



2) The braking system should be maintained obey the manual.

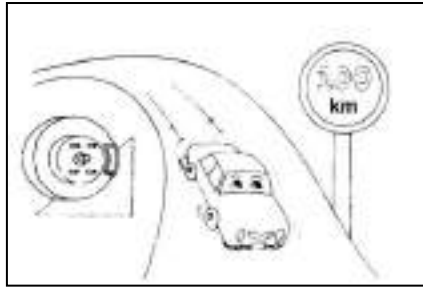

3) If you are the first time to drive vehicle with vacuum assisted brake, pay attention to the brake pedal operating force to get the best braking effect.

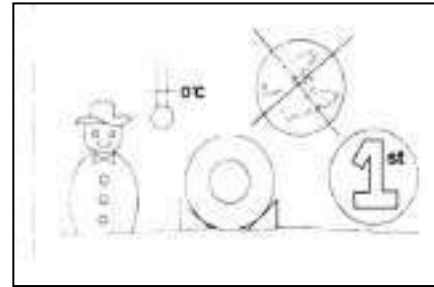

4) When parking vehicle out room in the areas which temperature below  $0^{\circ}C$  , place suitable blocks at both the front and back of each wheel; set the gearshift lever in the 1<sup>st</sup> position, do not pull the parking brake lever, or the parking brake may be frozen and be hard to start the vehicle.

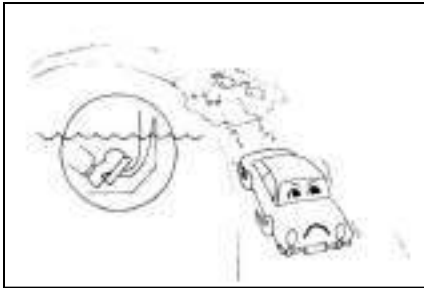

5) When the vehicle is washed or driven through deep water, the brakes may get wet. As a result, your braking effect may reduce. Lightly pressing the brake pedal to check up the brake function. To dry brakes, drive the vehicle at a safe speed while lightly pressing the brake pedal to heat-up the brakes. Do this until the brakes return to normal.

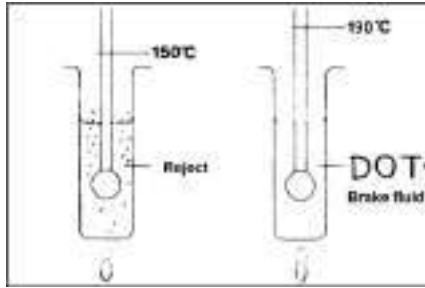

6) About brake fluid  
Fill the DOT4 high quality brake fluid whose boiling point is higher than 190 °C , the brake fluid should be changed periodically.

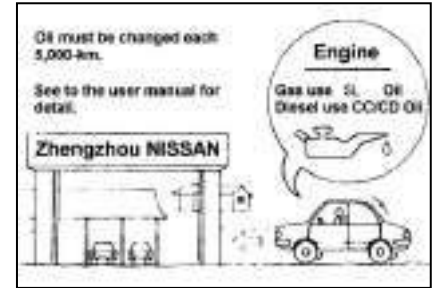

#### 4 about vehicle maintenance

1) Check the battery fluid, oil, clutch fluid, brake fluid, and coolant every day. If it is not enough add it in time. If there is abnormally reduce; come to have a check in the ParsKhodro Technique Service Center. Oil must be changed each 5,000-km, change the oil filters at the same time. Gasoline engine must fill the SL or more senior specification oil. See to the user manual for detail.

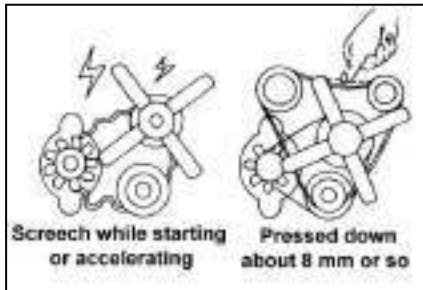

2) If the engine screech while starting or accelerating, please check the belt of the fan. If it is loose, adjust the belt to such degree, which is while a finger presses the center of the belt it can be pressed down about 8 mm or so.

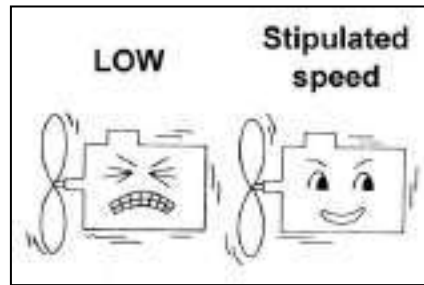

3) Adjust the idle to the stipulated speed, can the vehicle get economic driving and max tractive force.

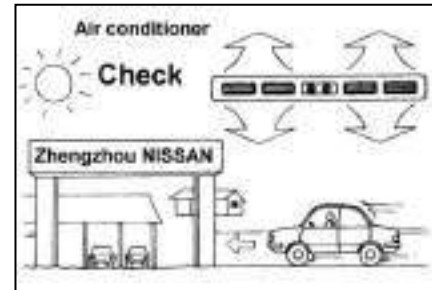

### 5 About air conditioner

1) When the season you may use air conditioner comes, go to check it in the ParsKhodro Technique Service Center, to keep it works as normal!

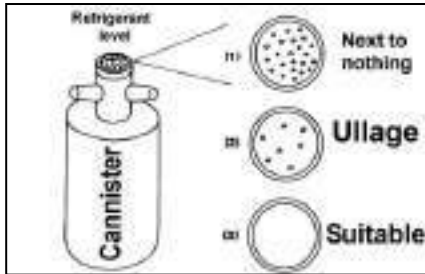

2) Check the refrigerant level if the air conditioner do not function cool. If it is not enough, you'd check whether the refrigerant has leaked, and refills it, but be careful not to overfill, or it may even worse cause losing cool function, compressor damage, system exploding and the engine may overheating, power reducing become of adding burden to it.

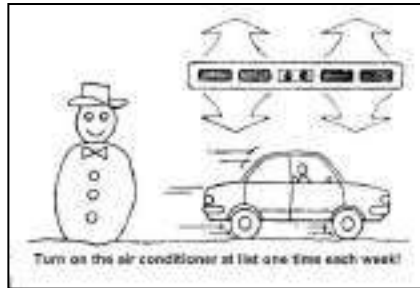

3) For the sake of preventing the interior of the air conditioner from corrodng and melting. In the season you do not use it even in winter; turn on the air conditioner at list one time each week to make the air conditioner system lubricants circulate. So do not pick off the belt of the air conditioner in the season you do not use it.

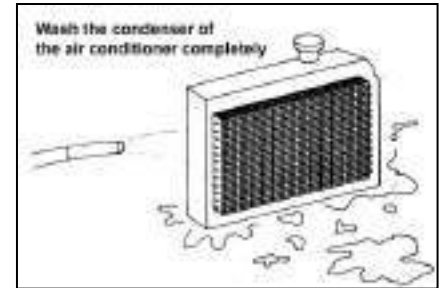

4) After driving in rainy weather or on mud road, wash the condenser of the air conditioner completely.

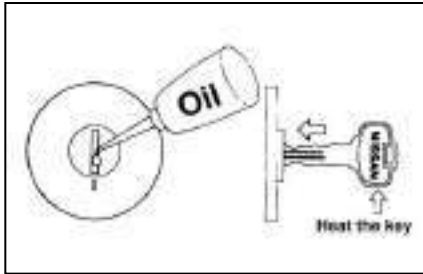

## 6 Other precautions

1) Parking the vehicle out room in winter, to prevent a door lock from freezing, apply deicer or glycerin to it through the key hole if the lock becomes frozen, heat the key before inserting it into the key hole.

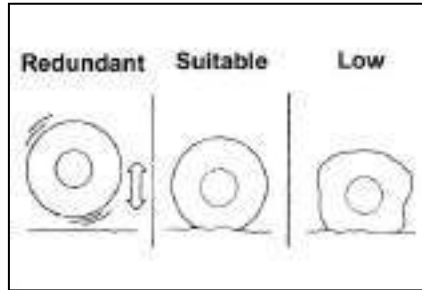

## 2) Tire inflation pressure

A bit high tire pressure can save fuel, but much higher tire pressure may reduce the comfort, cause driving unsteadily and the tire wear away early, shortening the live of the absorber, and the cab being lacerated. According to up all, to keep tier inflation pressure is very important.



## 3) Often waxing

The metal gloss paint surface of red, black and heavy blue colors are much lithe than the white, and are easy damaged. It is necessary to have your vehicle waxed at least one time a mouth to protect the paintwork and keep the fresher.

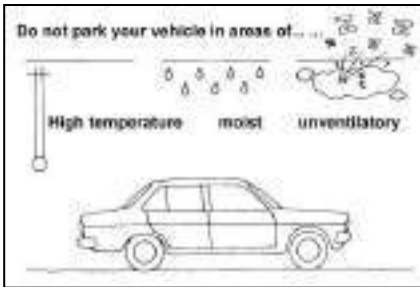

#### 4) Protecting against corrosion

Wash your vehicle often, especially after you back from seaside or the road use salt, wash the body and chassis immediately. Do not park your vehicle in areas of high temperature, moist and unventilatory.



5) When cleaning the under hood of the vehicle, be careful not to splash the water to the distributor, winding etc. electric system equipment. If you have splashed water to these parts, clean it use dry clothes or blow it use compressed air, especially do not forget to clean the water under distributor cover.

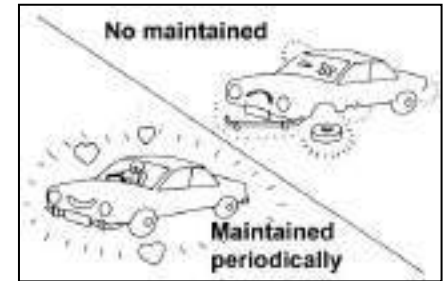

#### 7 For the sake of long period using

1) Obey the stipulation that the maintenance manual has pointed out to have your vehicle maintained periodically.





## 2) About original parts

The original parts have been proved to be measure up through the exacting verification of ParsKhodro Automobile Co. So ParsKhodro vehicle must use the original parts.



Best wish you driving safely.

# Contents

<b>Instruments and controls</b>
<b>Pre-driving checks and adjustments</b>
<b>Heater, air conditioner and audio system</b>
<b>Starting and driving</b>
<b>In case of emergency</b>
<b>Appearance and interior care</b>
<b>Maintenance and Do-it-yourself</b>

**1**

**2**

**3**

**4**

**5**

**6**

**7**

<b>Mainternance schedule</b>
<b>Technical information</b>
<b>Index</b>

**8**

**9**

**10**

# 1. INSTRUMENTS AND CONTROLS

INSTRUMENT PANEL .....	1-2
METERS AND GAUGES .....	1-3
SPEEDOMETER AND ODOMETER .....	1-4
TACHOMETER .....	1-4
ENGINE COOLANT TEMPERATURE GAUGE .....	1-5
FUEL GAUGE .....	1-5
WARNING/IDICATOR LIGHTS AND AUDIBLE REMINDERS.....	1-6
WINDSHIELD WIPER AND WASHER SWITCH .....	1-10

HEAD LIGHT, DIMMER AND TURN SIGNAL SWITCH.....	1-11
HAZARD WARNING FLASHER SWITCH	1-12
CIGARETTE LIGHTER AND ASH TRAYS	1-13
POWER WINDOW .....	1-13
INTERIOR LIGHT .....	1-14
INSPECTION LIGHT (IF SO EQUIPPED)	1-15
REAR FOG LIGHT SWITCH (IF SO EQUIPPED) ....	<b>Error! Bookmark not defined.</b>
OBD(IF SO EQUIPPED) .....	1-16

## INSTRUMENT PANEL

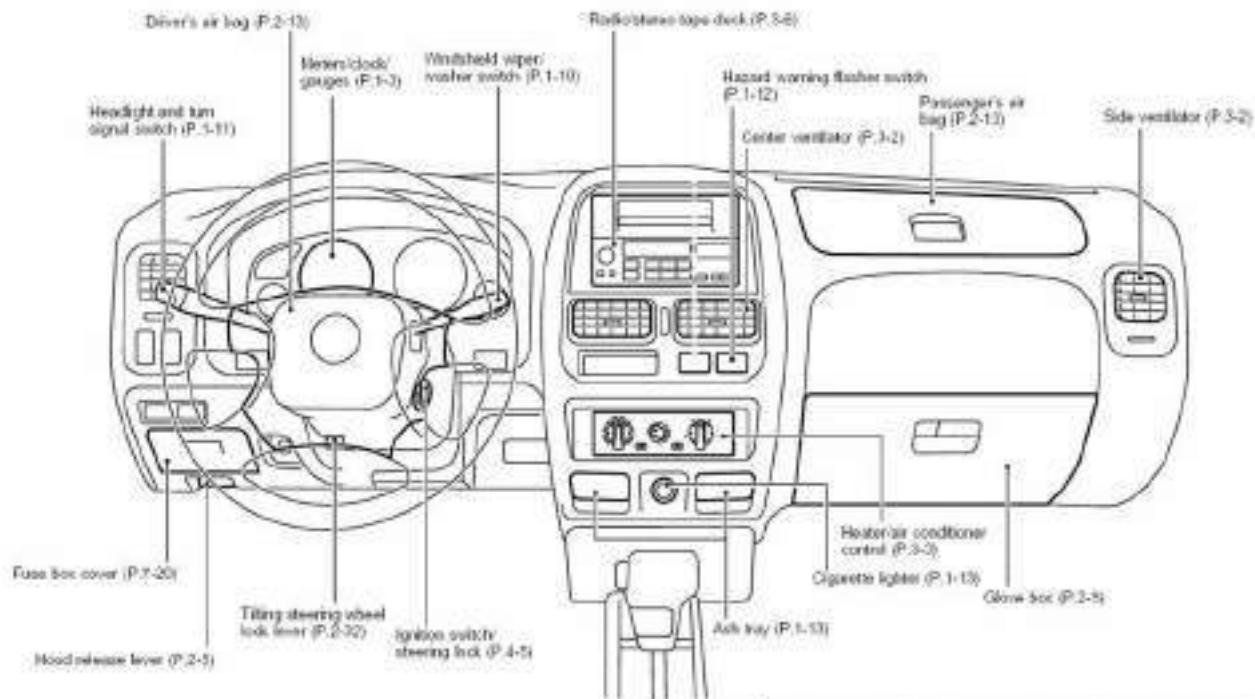

See the page indicated in parentheses for operating details.

8C2183

## METERS AND GAUGES

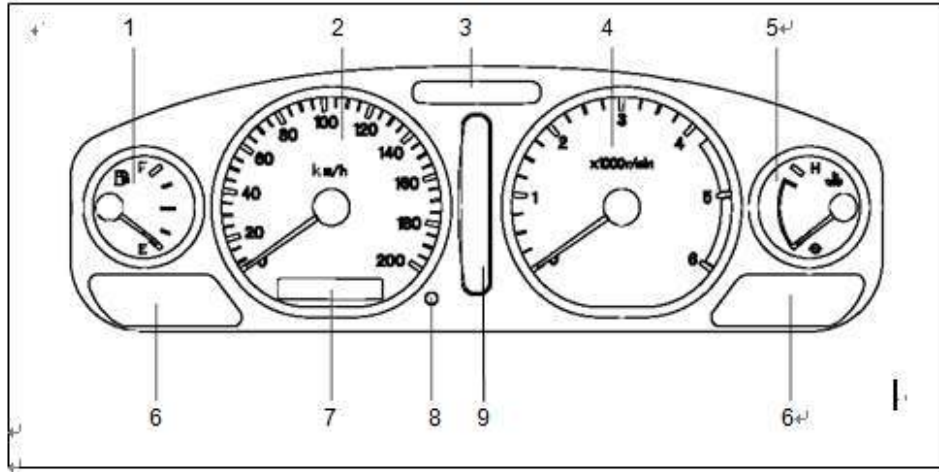

1. Fuel gauge
2. speedometer
3. turn signal/warning/indicator light
4. tachometer
5. engine coolant temperature gauge
6. warning/indicator light
7. odometer/meter odometer
8. reset knob
9. AT shift indicator ( automatic transmission models )

## SPEEDOMETER AND ODOMETER

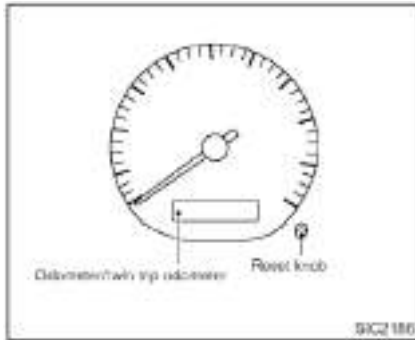

The speedometer indicates vehicle speed.

### **Odometer/twin trip odometer**

The odometer records the total distance the vehicle has been driven.

The trip odometer records the distance of individual trips.

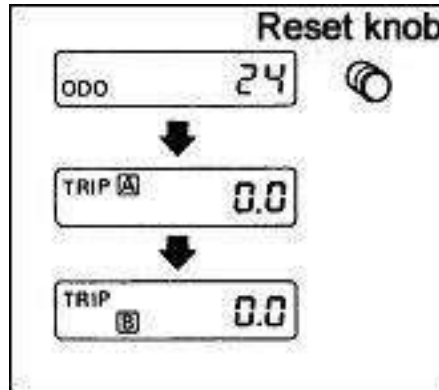

### **Changing the display**

Push the reset knob to change the display as follows:

ODO → TRIP A → TRIP B → ODO

Resetting the trip odometer

Push the reset knob for more than 1 second to reset the trip odometer to zero.

## TACHOMETER

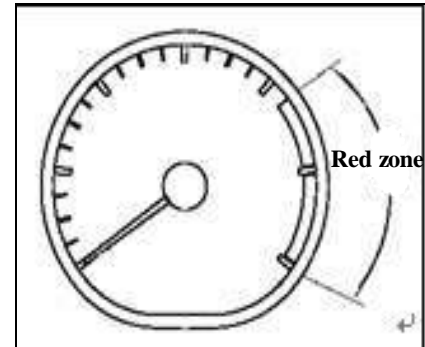

### **Don't run engine into red zone**

The tachometer indicates engine speed in revolutions per minute (r/min).

### **⚠ Caution**

**When engine speed approaches the red zone, shift to a higher gear. Operating the engine in the red zone may cause serious engine damage.**

## ENGINE COOLANT TEMPERATURE GAUGE

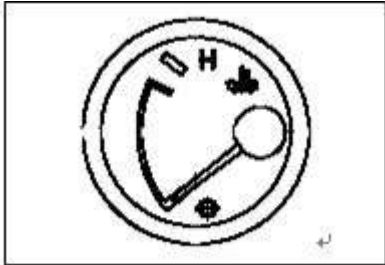

The gauge indicates the engine coolant temperature. The engine coolant temperature will vary with the outside air temperature and driving conditions.

### **△ Caution**

When towing a trailer or driving uphill, if the needle nears the hot end of the normal range, reduce the vehicle speed as soon as safely possible to decrease

the engine coolant temperature. It is recommended to use the 2nd gears under speeds of 15 km/h, use the 3rd gears under speeds of 30 km/h respectively.

- If the gauge indicates over the normal range, stop the vehicle as soon as safely possible.
- If the engine is overheated, continued operation of the vehicle may seriously damage the engine. See “In case of emergency” section for immediate action required.

### **⚠ Warning**

Allow the engine to cool before removing the radiator cap to avoid the danger of being scalded.

## FUEL GAUGE

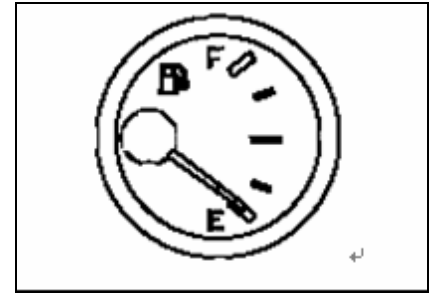

The gauge indicates the APPROXIMATE fuel level in the tank.

The gauge may move slightly during braking, turning, acceleration, or going up or down hill.















The gauge needle is designed to remain in approximately the same position, even when the ignition key is turned “OFF”.

### **△ Caution**

Refill the fuel tank before the gauge registers empty.



## WARNING/INDICATOR LIGHTS AND AUDIBLE REMINDERS

	Turn signal/hazard indicator lights		Rear fog light indicator light (If so equipped)		Charge warning light
	Brake warning light		Oil pressure warning light		Fault Indicator light
	Fuel warning light		High beam indicator light (blue)		Air bag warning light
	Anti-lock brake warning light ( if so equipped )		4-wheel drive indicator light (4x4model)		Seat belt warning lights
	Alarm lamp door open		Engine fault alarm lamp		Overspeed alarm lamp

### Checking the alarm lamp

Apply the parking brake and turn the ignition key to “ON” without starting the engine. The following lights will come on:



If any light fails to come on, it may indicate a burned-out or an open circuit in the electrical system. Have the system repaired promptly.



### Turn signal/hazard indicator lights

The light flashes when the turn signal switch lever or hazard switch is turned on.



### Brake warning light

This light functions for both the parking brake and the foot brake systems.

### Parking brake indicator

The light comes on when the parking brake is applied.

### The light warns of a low brake fluid level.

If the light comes on while the engine is running, stop the vehicle and perform the following:

Check the brake fluid level. Add brake fluid as necessary. See

“Brake and clutch fluid” in the “Do-it-yourself operations” section.

 **Warning**

If the level is below the MINIMUM mark on the brake fluid reservoir, do not drive until the brake system has been checked at a Zhengzhou NISSAN dealer.

If the brake fluid level is correct: Let Zhengzhou NISSAN dealer check the warning system.

 **Warning**

- Although you judge it to be safe, towed it, for driving it could be dangerous.
- Press the brake pedal with the engine stopped and / or low brake fluid level could increase your stopping distance and require greater pedal effort as well as pedal travel.



**Fuel warning light**

This light comes on when the fuel tank is almost empty. Refuel at the nearest gas station.



**Rear fog light indicator light (If so equipped)**

The light comes on when the rear fog light switch is turned on.



**Oil pressure warning light**

This light warns of low engine oil pressure. If the light flickers or comes on during normal driving, pull off the road in a safe area, stop the engine immediately and call a Zhengzhou NISSAN dealer or other authorized repair shop. Running the engine with the oil pressure warning light on could cause serious damage to the engine.

The oil pressure warning light is not designed to indicate a low oil level. Use the dipstick to check

the oil level. See “Engine oil” in the “Maintenance and do-it-yourself” section.



**Charge warning light**

If the light comes on while the engine is running, it may indicate the charging system is not functioning properly. Turn the engine off and check the alternator belt. If the belt is loose, broken, missing or if the light remains on, see your Zhengzhou NISSAN dealer immediately.

 **Caution**

**Do not continue driving if the belt is loose, broken or missing.**



**Air bag warning light (if so equipped)**

After turning the ignition key to the ON position, the air bag warning light will illuminate. The air bag warning light will turn off

after about 7 seconds if the system is operational.

If any of the following conditions occur, the air bag (and pre-tensioner seat belt, in the case of needs servicing and the vehicle must be taken to your nearest authorized Zhengzhou NISSAN dealer.

The air bag warning light remains on after approximately 7 seconds.

The air bag warning light flashes intermittently.

The air bag warning light does not come on at all.

Unless checked and repaired, the supplemental restraint system (and/or the pre-tensioner seat belt) may not function properly. For additional details on the Air Bag System, see the "Pre-driving checks and adjustments" section.



### **High beam indicator light (Blue)**

This light comes on when the

headlight high beam is on, and goes out when the low beams are selected.



### **Fault Indicator light**

This light functions for the engine control malfunction indicator.

Malfunction indicator light function for engine control:

If this light comes on while the engine is running, it may indicate a potential engine control malfunction. Although the vehicle is still driveable, see your Zhengzhou NISSAN dealer for service as soon as possible. You do not need to have your vehicle towed to the dealer. Continued operation without having the engine control system checked and repaired as necessary could lead to poor driveability, reduced fuel economy, and possible damage to the engine control system.

Incorrect setting of the engine control system may lead to non-compliance of local and

national emission laws and regulations.



### **Anti-lock brake warning light**

After turning the ignition key to the ON position, the light will illuminate. The anti-lock brake warning light will turn off after about 1.7 second if the system is operational.

If the light comes on while the engine is running, it may indicate the anti-lock brake system is not functioning properly. Have the system checked by your dealer. However if the light illuminates while starting the engine, it does not indicate a system malfunction.

If an abnormality occurs in the system, the anti-lock function will cease but the ordinary brakes will continue to operate normally.

• **If the light comes on while you are driving, contact your dealer for repair.**



### **4-wheel drive indicator light**

This light comes on when the transfer shift control switch is in the “4H” or “4L” position.

For the ELEC. Transfer vehicles, when the switch is in the “4H” position, green indicator light comes on; when the switch is in “4L” position, yellow indicator light comes on (For more details, see Character 4). If the light remains on when shifting from “4H” to “2H”, the 2-wheel drive is not selected.

Ensure safety and either accelerate, decelerate or back up the vehicle to change to 2-wheel drive.



### **Seat belt warning lights**

Warning light is used to remind you to fasten your seat belt. Whenever the ignition key is located in the "ON", the Light will be on until the driver wearing a seat belt.



### **Alarm lamp door open**

Warning light is used to remind you to close the door, when the vehicle starts, any door is not closed, the alarm lamp lights up.



### **Engine fault alarm lamp**

When the engine running, the light turns up saying there is potential problem of engine control. At this point, although cars can continue to drive, also please going to the zhengzhou nissan service network maintenance as soon as possible. Don't let your car was towed to the depot for failure. If not check and repair the engine control problem, continuing to drive will lead to bad

performance, reduce fuel economy, and cause damage to the engine control system.



### **Overspeed alarm lamp**

This lamp is used to remind users of not overspeeding more than the current system setting speed limit (120 km/h), when the speed is greater than this value, the alarm lamp lights up, when the speed is less than 118 km/h, alarm lights went out.

## WINDSHIELD WIPER AND WASHER SWITCH

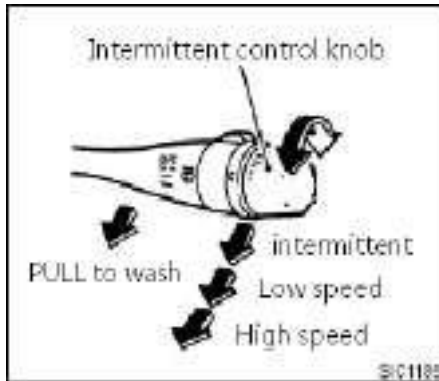

Turn the ignition switch to "ACC" or "ON" and push the lever down to operate the wiper. Pull the lever toward you to operate the washer.

### **△ Caution:**

- Do not operate the washer continuously for more than 30 seconds.
- Do not operate the washer if the reservoir tank is dry.

### **△ Warning**

In freezing temperatures the washer solution may freeze on the windshield and obscure your vision. Warm windshield with the defroster before you wash the windshield.

## HEAD LIGHT, DIMMER AND TURN SIGNAL SWITCH

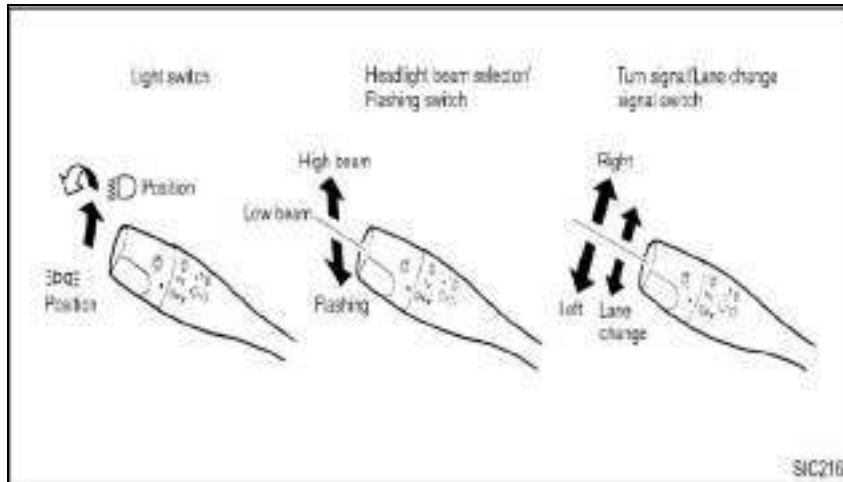

### Lighting

Turn the switch to the "Position" position:

The clearance, tall, license plate and instrument lights will come on.

Turn the switch to "Edge Position" position :  
Headlights will come on and all

the other lights remain on.

To select the high beam, push the lever forward. Pull it back to select the low beam.

The buzzer will alarm if you select the high beam and the driver's side door isn't locked well. Don't worry, please turn off the high beam or lock the driver's side door well to turn off the alarm.

### Passing signal

Pulling the lever forward you will turn on the passing signal even when the headlight switch is off.

### Turn signal light

Move the lever or down to signal to the turning direction. When the turn is completed, the turn signals conceal automatically.

### Lane change signal

To indicate a lane change, move the lever up or down to the point where lights begin flashing.

## FRONT/REAR FOG LIGHT SWITCH (IF SO EQUIPPED)

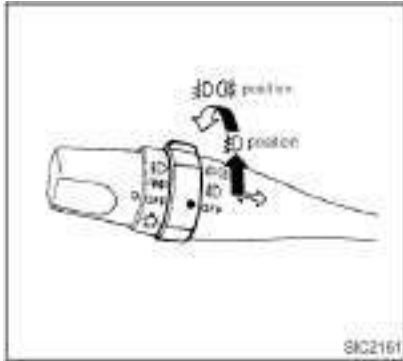

To turn the front fog lights on, turn the switch to the “ON” position.

To turn the front and rear fog lights on, turn the switch to the “ON” position.

To turn them off, turn the switch to the OFF position.

The low-beam headlight function must be on for the fog lights to operate. The fog lights automatically turn off whenever

the off headlight functions is selected.

The rear fog light should be used only when visibility is seriously reduced.

## HAZARD WARNING FLASHER SWITCH

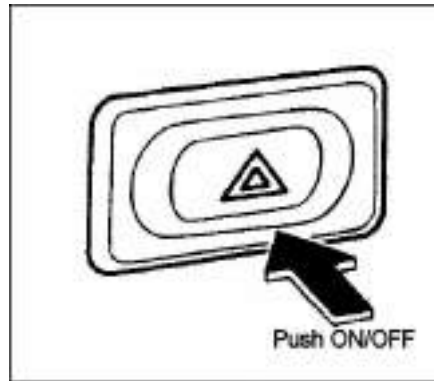

Push the switch on to warn other drivers when you must stop or park under emergency conditions. All turn signal lights will flash.

## Warning

- Be sure to park the vehicle down the road in case of emergency condition.

Do not use the switch while moving on the highway unless unusual circumstances force you to drive so slowly that your vehicle might become a hazard to other traffic.

- Some state laws may prohibit the use of the hazard warning flasher switch while driving.

- Turn signal does not work when the hazard warning flasher switch is operating. The flasher can be actuated with the ignition switch either off or on.

## CIGARETTE LIGHTER AND ASH TRAYS

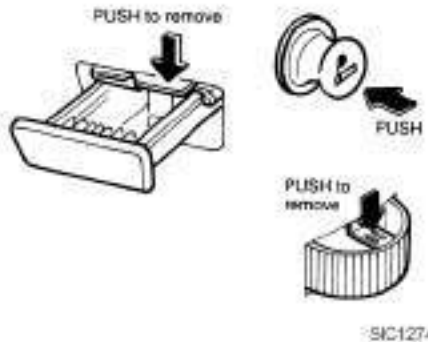

### Cigarette lighter

The cigarette lighter operates when the ignition switch is in "ACC" or "ON".

Push the lighter in all the way. When the lighter is heated, it will spring out.

Replace the lighter in its original position after use.

### **⚠ Caution**

The cigarette lighter should not be used while driving in order that full attention may be given to the driving operation.

## POWER WINDOW

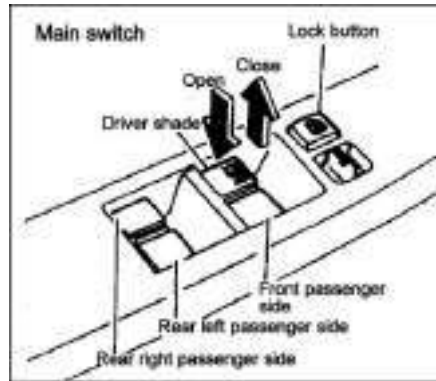

The power window operates when the ignition key is "ON".

To open or close the window, push down or pull up the switch and hold it. The main switch (driver side switches) will open or close all the window.

### Locking passenger's window

- When the lock switch is pushed in, the passenger side window (except the driver's window) can't be opened or closed. Push it again to cancel.

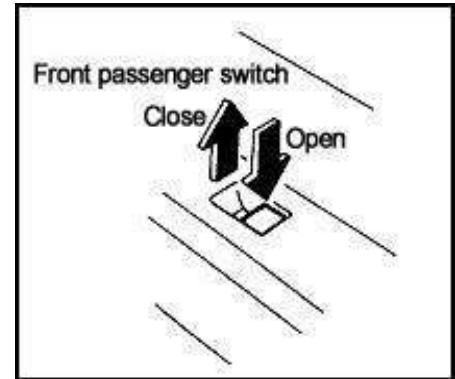

### **⚠ Warning**

- Make sure that the passenger has his/her hands, etc. inside the vehicle before closing the windows.

- Do not leave children unattended inside the vehicle. They could unknowingly activate switches.

The passenger side switch will open or close only the corresponding window. To open or close the window, push down



or pull up the switch and hold it.

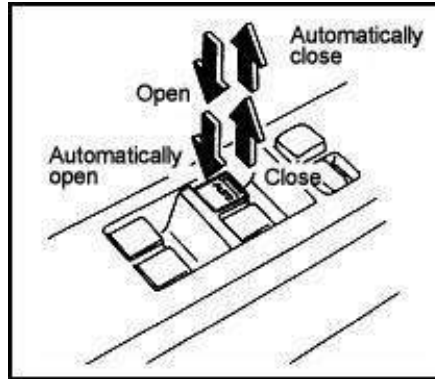
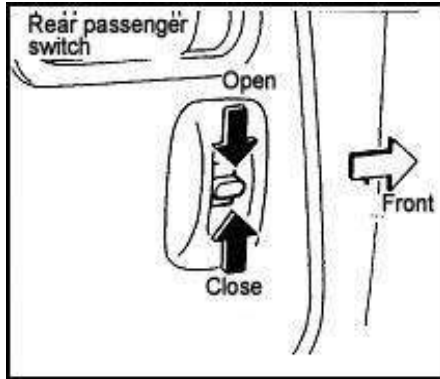

### Automatic operation

To fully open or close the driver's side window, completely push down or pull up the switch and release it; it need not be held. The window will automatically open or close all the way. To stop the window, just pull up or push down the switch on the opposite side.

## INTERIOR LIGHT

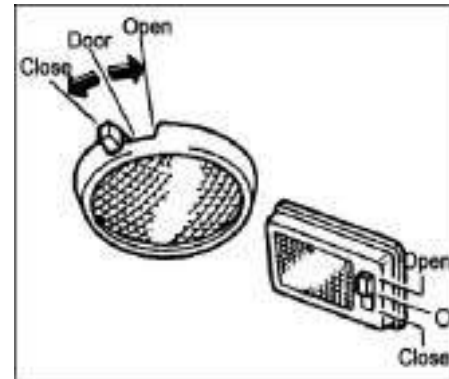

The interior light has a three-position switch.

- When the light is in the "O" or "DOOR" position, the interior light will illuminate by opening the doors.
- When the switch is in the "OFF" position, the interior light will not illuminate, regardless of door position..
- When the switch is in the "ON" position, the interior light will illuminate, whether any door is open or closed.

**△ Caution**

Do not use for extended periods of time with the engine stopped.

**INSPECTION LIGHT (IF SO EQUIPPED)**

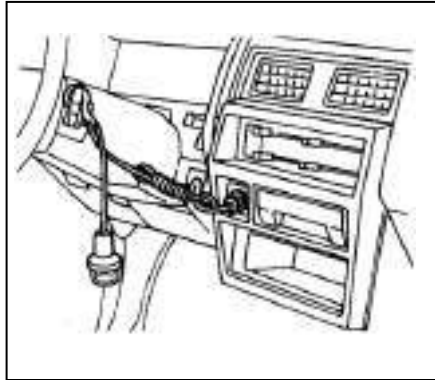

Insert the inspection light terminal into the cigarette lighter socket and turn the ignition switch to “ACC” or “ON”.

## OBD(IF SO EQUIPPED)

OBD is the abbreviation of On-Board Diagnostics。 When there is a failure of the control system or parts in relation to emission that cause the emission level overrun the restrict of law, the MI light will be lighting. When there is a failure of the circuit in relation to emission which is connected to the ECU, the MI light will be

lighting also. The icon is .

While the MI light is lighting continually or flashing, to reduce or avoid the damage to the engine ECU system:

- ①. avoid driving at a speed above 70km/h;
- ②. avoid accelerate or decelerate suddenly;
- ③. avoid driving ramp;
- ④. Avoid unnecessary load.

Go to the Zhengzhou NISSAN dealer for a check as soon as possible although the vehicle

can drive.

### Caution

**Must use unleaded gasoline of above 87 octants (RON) for you vehicle.**

## 2. PRE-DRIVING CHECKS AND ADJUSTMENTS

DOOR LOCKS.....	2-2	AIR BAG WARNING LABEL .....	2-13
HOOD RELEASE.....	2-3	AIR BAG WARNING LIGHT .....	2-13
GLOVE BOX .....	2-4	SEAT BELTS .....	2-15
FUEL FILLER LID AND CAP .....	2-4	PARKING BRAKE LEVER .....	2-18
TAILGATE LATCH .....	2-5	TILTING STEERING WHEEL.....	2-19
FASTEN HOOK.....	2-6	OUTSIDE MIRROR .....	2-19
REVERSING RADAR (IF SO EQUIPPED) .....	2-6	REARVIEW MIRROR.....	2-19
SEATS .....	2-8	REMOTE KEYLESS ENTRY SYSTEM ( IF SO EQUIPPED ) .....	2-20
SUPPLEMENTAL RESTRAINT SYSTEM ( MODELS EQUIPPED WITH DRIVER AND FRONT PASSENGER AIR BAGS ) .....	2-10		

## DOOR LOCKS

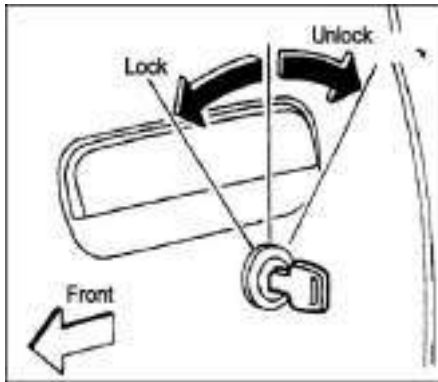

### Locking front doors with key

To lock the doors, turn the key towards the back of the vehicle. To unlock, turn it towards the front.

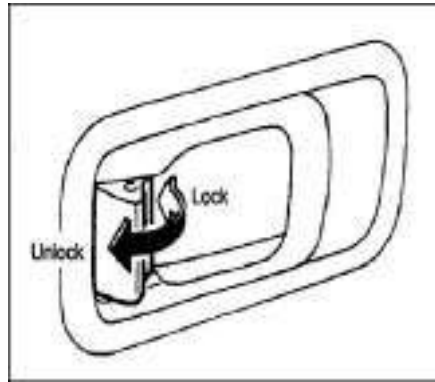

### Locking the door without key Driver's door and copilot's door

The door can't be locked from the outside without a key. This is to prevent the door lock from accidentally being locked with the key inside the vehicle. Using the remote keyless entry system can lock or unlock all doors at one time.

### Other doors

To lock from the outside without a key, move the inside lock knob to the "LOCK" position, then close the door.

### Warning

- When locking the door without a key, be sure not to leave the key inside the vehicle.
- Before opening the door, always look for and avoid oncoming traffic.
- Do not leave children unattended in a locked vehicle. If an emergency occurs, it will be difficult to help them.

## HOOD RELEASE

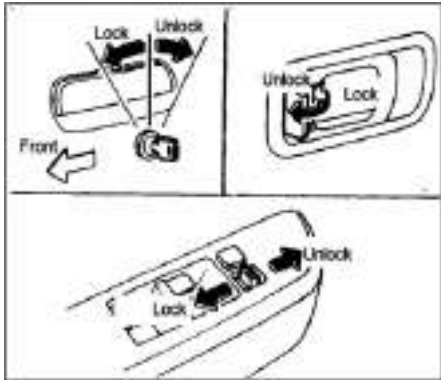

### Power door lock

The power door lock system allows you to lock or unlock all doors simultaneously.

Turning the driver side door key will lock or unlock all doors.

Pushing the driver's inside lock knob down will lock all doors. Pulling the lock knob up will unlock all doors.

Operating the lock-unlock switch will lock or unlock all doors except the drive side door.

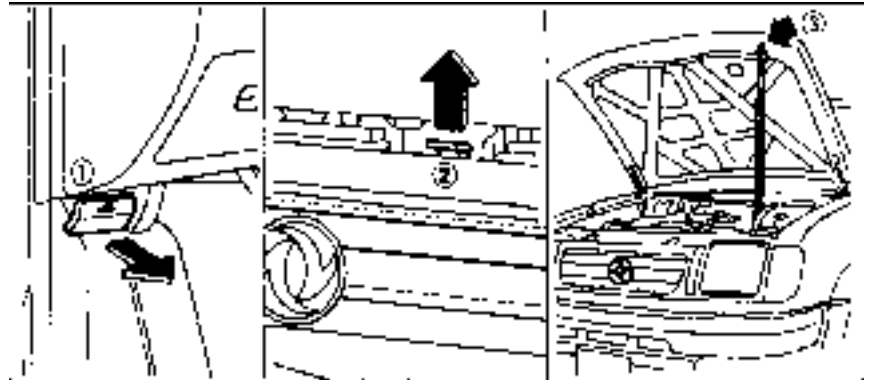

- 1 , Pull the hood lock release handle located below the instrument panel; the hood will then spring up slightly.
- 2 , Raise the lever at the front of the hood with your fingertips and raise the hood.
- 3 , Insert the assist bar into the slot i in the front edge of the hood.
- 4 , When closing the hood, reset the assist bar to its original position, then slowly close the hood and make sure it locks into place.

### Warning

**Always check that the hood is closed and locked securely to prevent it from opening while driving. The vehicle should only ever be operated with the hood securely closed.**

## GLOVE BOX

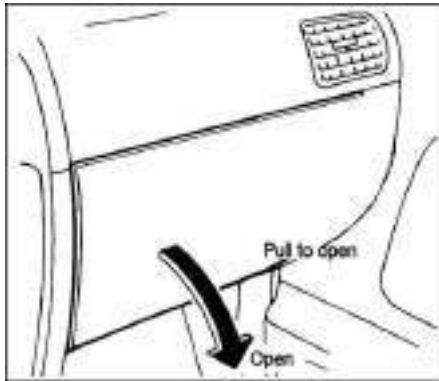

### **⚠ Warning**

Keep glove box lid closed while driving to prevent injury in an accident or sudden stop.

## FUEL FILLER LID AND CAP

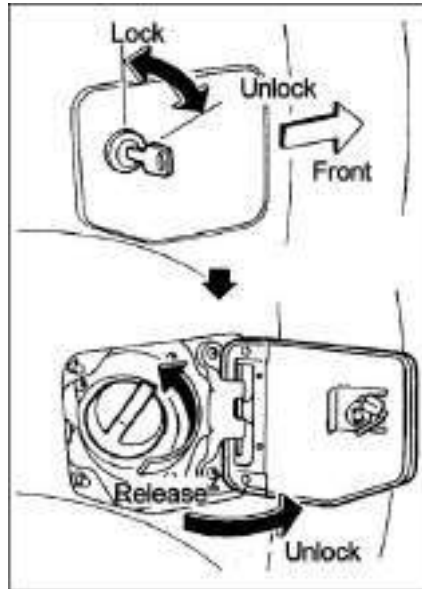

To open the fuel filler lid, turn the clockwise. To lock, close it and turn the keys counterclockwise.

The fuel filler cap is a screw-on ratcheting type. Tighten the cap clockwise until ratcheting clicks are heard. The cap will lock automatically.

### **⚠ Caution**

- Gasoline is extremely flammable and highly explosive under certain conditions. Always stop engine and do not smoke or allow open flames or sparks near the vehicle when refueling.

- Fuel may be under pressure. Turn the cap one-half turn and wait for any "hissing" sound to stop, to prevent fuel from spraying out and possible personal injury.

- Use only a genuine Zhengzhou NISSAN fuel filler cap as a replacement. It has a built-in safety valve needed for proper operation of the fuel system and emission control system. An incorrect cap can result in a serious malfunction and possible injury.

## TAILGATE LATCH

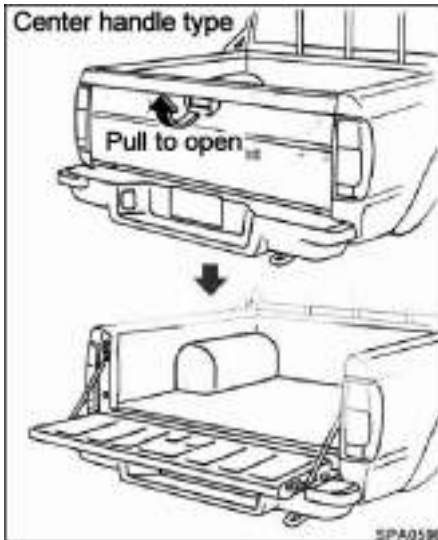

- The weight of the cargo load must be evenly distributed over both the front and the rear axles.
- All cargo should be securely fastened with ropes or straps to prevent it from shifting or sliding within the vehicle.

To open the tailgate, pull the tailgate handle and lower the tailgate.

The support stays/chains will hold the gate open.

- **When closing the tailgate, make sure that the latches are securely locked.**



## FASTEN HOOK

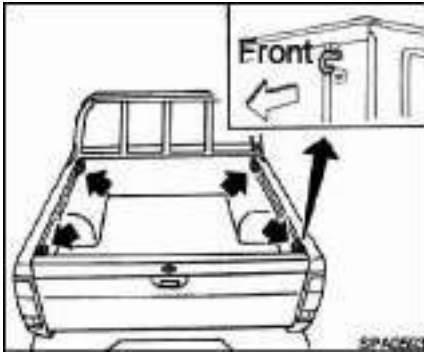

For expediently using, there's a hook at each corner of the cab.

- **The weight of the cargo load must be evenly distributed over both the front and the rear axles.**
- **All cargo should be securely fastened with ropes or straps to prevent it from shifting or sliding within the vehicle.**

## Warning

**All cargo should be securely fastened with ropes or straps to prevent it from shifting or sliding within the vehicle. Abrupt braking or stopping could lead to personal injury.**

## REVERSING RADAR (IF SO EQUIPPED)

Reversing radar system begins to check itself as you move the gearshift leave to the "R". If no problem, it works in normal. Two rings mean that one of the detectors is broken and three rings mean all.

If the distance is less than 90cm, it begins to ring slowly and if less than 50cm, briefly, but it rings all long under 30cm. You should stop the vehicle and check outside.

## Caution

- **The velocity should be under 5km/h when reversing the vehicle.**
- **It may result in some misguidance attributed to the position, background and so on.**
- **Especially, misguidance may occur under the condition of**

reversing on the ramp. Be careful.

- Please stop the vehicle when it rings all the time.

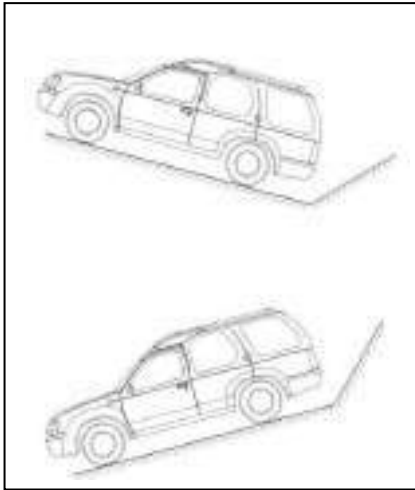

These condition as follows cause the misguider

- **Thin things like wire netting, rope and so on.**
- **Driving in the brushwood or mountain.**

- Things like snow, cotton and so on absorbing sound wave.
- Things hang on the detector.
- Some sounds have the same frequency as the detector, like metal, ultrasonic and so on.
- The obstruction is the things like cone.
- Some communication equipment may influence the detector .(except for mobile, the system of sound )

## SEATS

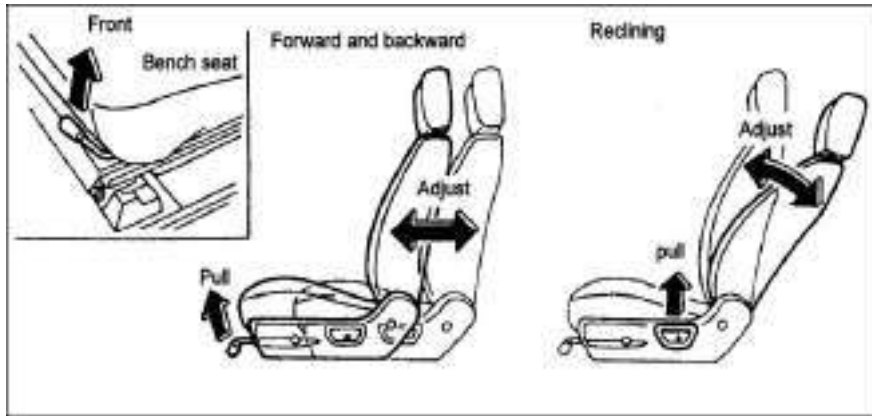

### Warning

- Do not adjust the driver's seat while driving. This seat moves suddenly and could cause loss of control of the vehicle.
- After adjustment, check to be sure that the seat is securely locked.

you slide the seat forward or backward to the desired position. Release the lever to lock the seat in position.

2 , Reclining ( Except for bench )

Pull the lever up and lean back until the desired angle is obtained. To bring the seat back forward again. Pull the lever and move your body forward. The seat back will move forward automatically.

### Warning

The seatback should not be reclined any more than needed for comfort. Seat belts are the most effective when the passenger sits well back and straight up in the seat. If the seat is reclined, the risk of sliding under the lap belt and being injured is increased.

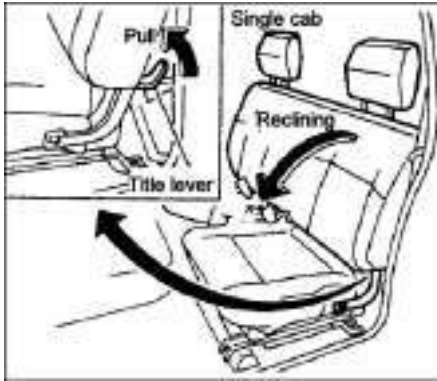

### Recline rear seat

The rear seat can be folded forward to get the lifting jack and so on easily.

Pull the strap up and push back forward to fold it down.

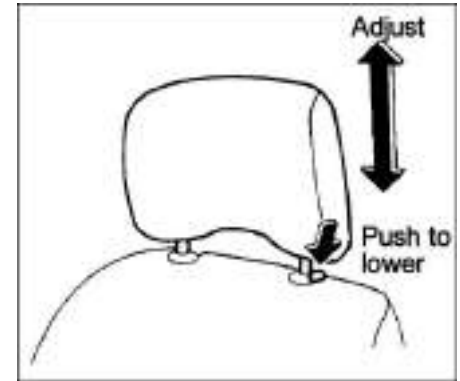
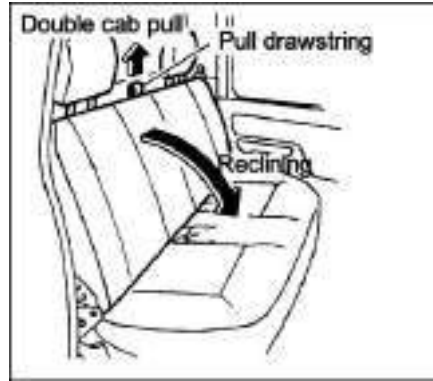

### Head restraints

Adjust the top of the head restraints even with the top of your ears.

To raise the restraint, just pull it up. To lower, push the lock knob and push the head restraint down. After adjustment, make sure that it is adjustment, make sure that it is securely locked.

### **⚠ Warning**

**Head restraints should as adjusted properly as they may provide significant protection against whiplash injury.**

## SUPPLEMENTAL RESTRAINT SYSTEM

### ( Models equipped with driver and front passenger air bags )

This Supplemental Restraint System section contains important information concerning the driver and passenger air bags. The Supplemental Restraint System Air Bag can help reduce impact force to the driver in certain frontal collisions. The air bag is designed to supplement the crash protection provided by the driver seat belt and is not a substitute for it. The seat belts should always be correctly worn and the driver seated a suitable distance from the steering wheel. (See "Seat belts" for instructions and precautions on seat belt usage.)

The air bag works when the ignition key is on the "on" or

"start" position .

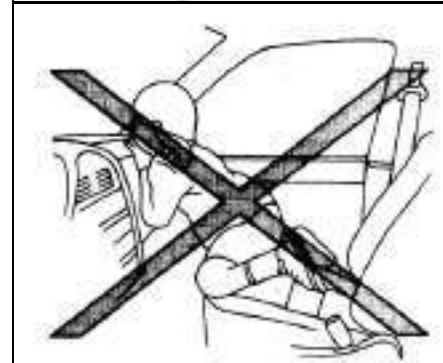
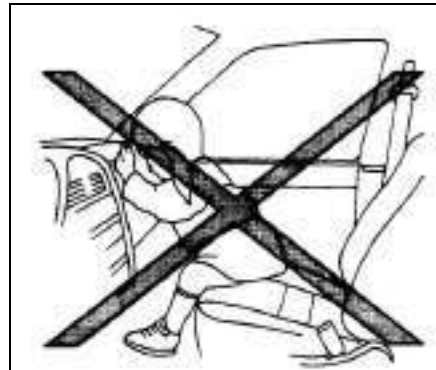

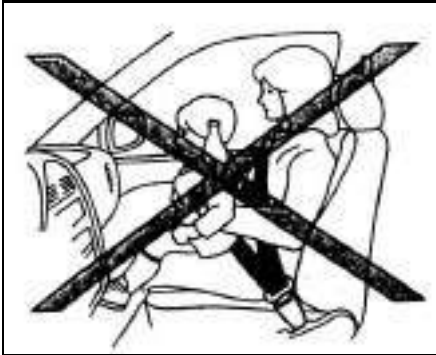
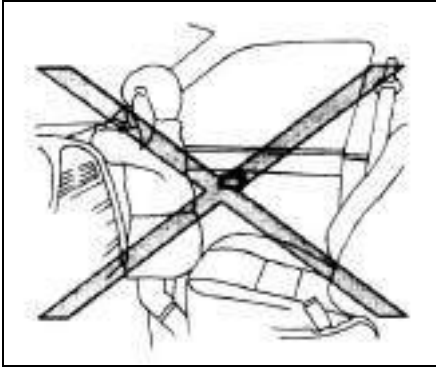

**forward, sitting sideways or out of position in any way, you are at greater risk of injury or death in a crash and may also receive serious or fatal injuries from the air bag if you are up against it when it inflates.**

### **Air Bag System**

The driver air bag is located in the center of the steering wheel. The air bag system is designed to inflate in higher severity frontal collisions, although it may inflate if the forces in another type of collision are similar to those of a higher severity frontal impact. When the air bag inflates, a fairly loud noise may be heard, followed by release of smoke. This smoke is not harmful and does not indicate a fire, but care should be taken not to intentionally inhale it, as it may cause irritation and choking. The air bag, along with the use of seat belts, helps to cushion the impact force on the face and chest of the

### **⚠ Warning**

- **The air bag ordinarily will not inflate in the event of a side impact, rear impact, roll over, or lower severity frontal collision; so always wear your seat belts to help reduce the risk or severity of injury in various kinds of accidents.**
- **The seat belts and the air bag are most effective when you are sitting back and upright in the seat. Air bag inflates with great force. If you are unrestrained, leaning**

occupant.

The seat belts should be correctly worn and the driver seated upright as far as practical away from the steering wheel. Since the air bag inflates quickly in order to help protect the occupant, the force of the air bag inflating can increase the risk of injury if the occupant is too close to or is against the air bag module during inflation. The air bag will deflate quickly after a collision.

**After turning the ignition key to the “ON” position, the air bag warning light illuminates. The air bag warning light will turn off after about 7 seconds if the system is operational.**

### **WARNING**

- **Right after inflation, several air bag system components will be hot. Do not touch them; you may severely burn yourself.**
- **No unauthorized changes should be made to any components or wiring of the air bag system. This is to prevent accidental inflation of the air bag or damage to the air bag system.**
- **Tampering with the air bag system may result in serious personal injury. Tampering includes changes to the steering wheel by placing material over the steering wheel pad or by installing additional trim material around the air bag system.**
- **Do not attach any objects to the steering wheel pad. Objects attached to the steering wheel pad may become dangerous projectiles**

**and cause injury if the air bag inflates.**

**Work around and on the air bag system should be done by an authorized Zhengzhou NISSAN dealer.**

## AIR BAG WARNING LABEL

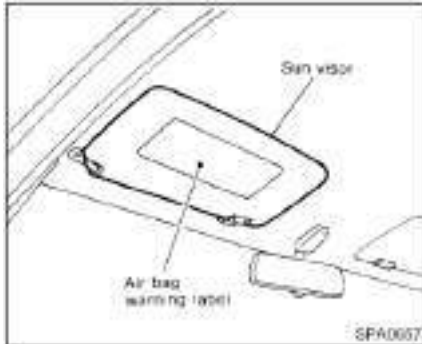

Warning labels about the air bag system are placed in the vehicle.

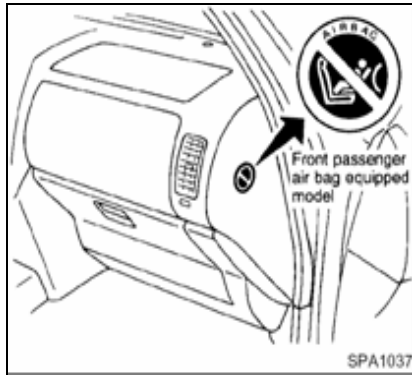

## AIR BAG WARNING LIGHT



The air bag warning light, displaying **AIR BAG** or  in the instrument panel, monitors the circuits of the front and side (if so equipped) air bag systems (and pre-tensioner seat belt — Type B). The circuits monitored by the air bag warning light are all sensors, air bag modules and all related wiring (and pre-tensioner seat belt — Type B).

After turning the ignition key to the ON position, the air bag warning light will illuminate. The air bag warning light will turn off after about 7 seconds if the

system is operational.



If any of the following conditions occurs, the air bag and side air bag systems (and pretensioner seat belt — Type B) needs servicing and should be taken to your nearest authorized Zhengzhou NISSAN dealer:

- **The air bag warning light remains on after approximately 7 seconds.**
- **The air bag warning light flashes intermittently.**
- **The air bag warning light does not come on at all.**
- **Under these conditions, the Supplemental Restraint**



**System Air Bag (and/or pre-tensioner seat belt — Type B) will not operate properly. It must be checked and repaired.**

### **Repair and replacement procedure**

The front air bags, side air bags and pretensioner seat belt are designed to inflate on a one-time-only basis. As a reminder, unless it is damaged, the air bag warning light will remain illuminated after inflation has occurred. Repair and replacement of the air bag system should be done only by authorized Zhengzhou NISSAN dealers.

When maintenance work is required on the vehicle, the air bag systems and related parts and pre-tensioner seat belt should be pointed out to the person conducting the maintenance. The ignition key should always be in the LOCK position when working under the hood or inside the

vehicle.



### **Warning**

- **Once the air bag has inflated, the air bag module will not function again and must be replaced. The air bag module should be replaced by an authorized Zhengzhou NISSAN dealer. The air bag module cannot be repaired.**
- **The air bag system should be inspected by an authorized Zhengzhou NISSAN dealer if there is any damage to the front end portion of the vehicle.**
- **When selling your vehicle, we request that you inform the buyer about the air bag system and guide the buyer to the appropriate sections in this Owner's Manual.**
- **If you need to dispose of an air bag or scrap the vehicle, contact an authorized Zhengzhou NISSAN dealer. Correct air bag disposal procedures are set forth in the**

**appropriate Zhengzhou NISSAN Service Manual. Incorrect disposal procedures could cause personal injury.**

## SEAT BELTS

**Precautions on seat belt usage**  
Zhengzhou NISSAN strongly encourages you and all of your passengers to buckle up every time you drive.

Your chances of being injured in an accident and the severity of injury may be greatly reduce if you are wearing your seat belt and it is properly adjusted.

### **Warning**

- **Seat belts are designed to bear upon the bony structure of the body, and should be worn low across the front of the pelvis, or the pelvis, chest and shoulders, as applicable; wearing the lap section of the belt across the abdominal area must be avoided. Serious injury can occur if seat belt is not worn properly.**
- **No modifications or additions should be made**

- **by the user which will either prevent the seat belt adjusting devices from operating to remove slack, or prevent the seat belt assembly from being adjust to remove slack.**

- **Seat belts should be adjusted as firmly as possible, consistent with comfort, to pro-vide the protection for which they have been designed. A slack belt will greatly reduce the protection afforded to the wearer. Care should be taken to avoid contamination of the webbing with polishes, oils and chemicals, and particularly battery acid. Cleaning may safely be carried out using mild soap and water. The belt should be replaced if webbing becomes frayed, contaminated or damaged.**

- **It is essential to replace the entire assembly after it has been worn in a severe impact**

**even if damage to the assembly is not obvious.**

- **Belts should not be worn with straps twisted.**
- **Each seat belt assembly must only be used by one occupant; it is dangerous to put a belt around a child being carried on the occupant's lap.**
- **All seat belt assemblies including retractors and attaching hardware should be inspected after any collision at your Zhengzhou NISSAN dealer. Zhengzhou NISSAN recommends that all seat belt assemblies in use during a collision be replaced unless the collision was minor and the belts show no damage and continue to operate properly. Seat belt assemblies not in use during a collision should also be inspected and replaced if either damage or improper operation is noted.**

## **Pregnant women**

Zhengzhou NISSAN recommends that pregnant women use seat belts. Contact your doctor for specific recommendations. The lap belt should be worn snug and positioned as low possible around the hips, not the waist.

## **Injured persons**

Zhengzhou NISSAN recommends that injured persons use seat belts, depending on the injury. Check with your doctor for specific recommendations.

## **SEAT BELT MAINTENANCE**

To clean the seat belt webbings, apply a mild soap solution or any solution recommended for cleaning upholstery or carpets. Then brush it, wipe with a cloth and allow it to dry in the shade. Do not allow the seat belts to retract until they are completely dry.

If dirt builds up in the shoulder belt guide of the seat belt anchors, the seat belts may retract slowly. Wipe the shoulder belt guide with

a clean, dry cloth.

Periodically check to see that the seat belt and the metal components such as buckles, tongues, retractors, flexible wires and anchors work properly. If loose parts, deterioration, cuts or other damage on the webbing is found, the entire belt assembly should be replaced.

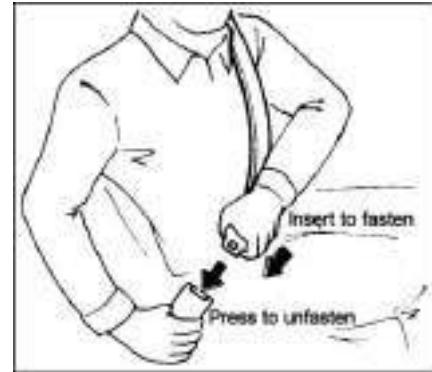

## **3-Point Type With Retractor Fastening The Belts**

1 , Adjust the seat

### **⚠ Warning**

- **The seatback should not be reclined any more than needed for comfort. Seat belts are most effective when the passenger sits well back and straight up in the seat.**
- **If the seatback is reclined, the risk of sliding under the lap belt and being injured is increased.**

2 , Slowly pull the seat belt out of the retractor and insert the tongue into the buckle until it snaps.

**The retractor is designed to lock during a sudden stop or on impact. A slow pulling motion will permit the belt to move, and allow you some freedom of movement in the seat.**

3 , Position the lap belt portion low on the hips as shown.

4 , Pull the shoulder belt portion toward the retractor to take up extra slack.

### **⚠ Warning**

- **The seat belt should rest on the middle of the shoulder. It must not rest against the neck.**
- **Make sure that the seat belt is not twisted in any way.**

### **Unfastening the belts**

To unfasten the belt, press the button on the buckle. The seat belt will automatically retract.

### **Checking seat belt operation**

Your seat belt retractors are designed to lock belt movement by two separate methods:

1 , When the belt is pulled quickly from the retractor.

2 , When the vehicle slows down rapidly.

**To increase your confidence in the belts, check the operation as follows: Grasp the shoulder belt and pull quickly forward. The retractor should lock and restrict further belt movement.**

If the retractor does not lock during these checks or if you have any question about belt operation see your Zhengzhou NISSAN dealer.

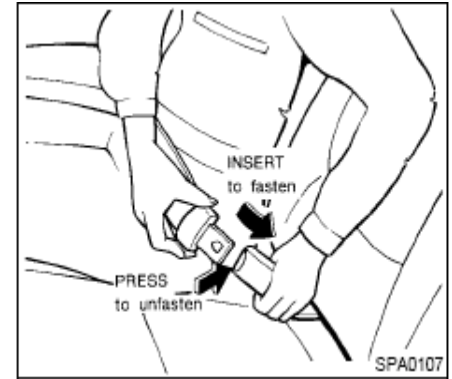

### **2-Point Type Without Retractor ( If So Equipped )**

#### **Fastening the belts**

1 , Insert the tongue into the buckle until it snaps.

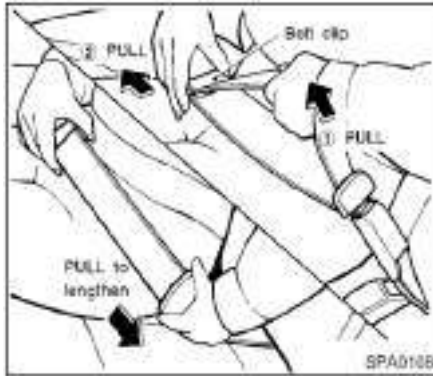

2 , To lengthen, hold the tongue at a right angle to the belt and pull on the belt. To shorten, pull the free end of the belt away from the tongue then pull the belt clip to take up the slack.



3 , Position the lap belt low on the hips as illustrated.

### **Unfastening the belts**

To unfasten the belt, press the button on the buckle. Fasten the seat belts when not in use to prevent them from being caught in the door.

## **PARKING BRAKE LEVER**

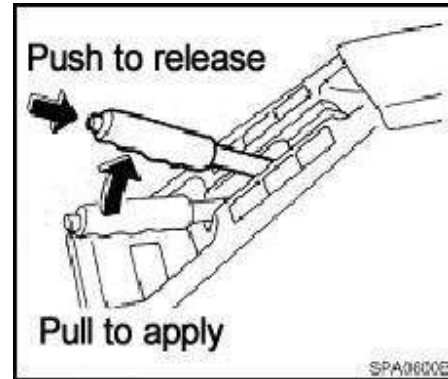

To apply : pull the lever up.

To release: pull the lever up slightly, push the button and lower completely. Before driving, be sure the parking brake warning light goes out.

## TILTING STEERING WHEEL

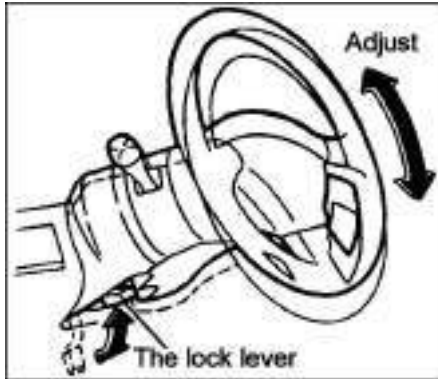

Push the lever down and adjust the steering wheel up or down to the desired position. Push the lock lever up securely to lock the steering wheel in place.

**⚠ Warning**  
Do not adjust the steering wheel while driving.

## OUTSIDE MIRROR

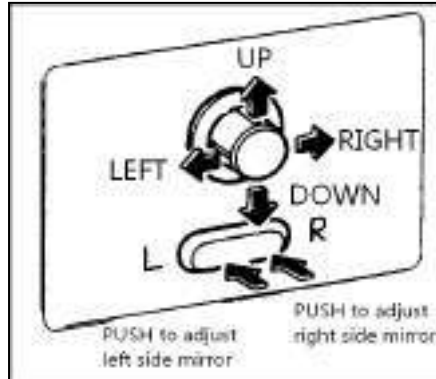

### Remote control type

Push the right or left end of the switch to adjust the right or left side mirror, then control the lever.

**⚠ Warning**  
Check the position of all mirrors before driving. Altering position while driving could distract your attention from the driving operation.

## REARVIEW MIRROR

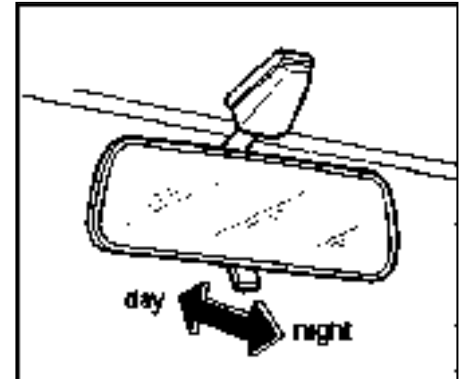

The night position will reduce glare from the headlights of vehicles behind you at night.

**⚠ Caution**  
Use the night position only when necessary, because it reduce rear view clarity.

## REMOTE KEYLESS ENTRY SYSTEM ( IF SO EQUIPPED )

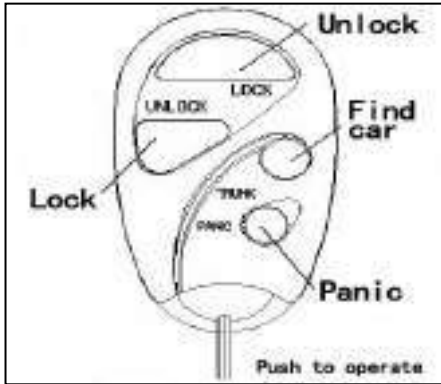

With the remote keyless entry system you could lock/unlock all doors, active the panic alarm and find the car from outside the car. Be sure to remove the key from the vehicle before locking the doors and leaving it.

As many as four key fobs can be used with one vehicle. For more information concerning the purchase and use of addition key fobs, contact your Zhengzhou NISSAN dealer.

### The key fob will not function when:

- The battery in the key fob is dead.
- The distance between the key fob and vehicle is more than 8m.

### **⚠ Caution**

- **Do not allow the key fob to be wet.**
- **Do not drop the key fob.**
- **Do not strike the key fob sharply to another object.**
- **Do not place the key fob for an extended period in an area where temperature exceed  $60^{\circ}C(140^{\circ}F)$ .**

If a key fob is stolen, Zhengzhou NISSAN recommends erasing the ID code of that key fob. This will prevent the key fob from

unauthorized use to unlock the vehicle. For information regarding the erasing procedure, please contact your Zhengzhou NISSAN dealer.

### Locking door

1. Remove the ignition key.
  2. Close all of the doors.
  3. Push the LOCK button on the key fob.
  4. The hazard indicators flash twice, all of doors will lock.
  5. If you lock the doors with any door unclosed well, the hazard indicators will flash three times, please close the door well and then lock it with the key fob.
- Although door locking with carob can be confirmed by looking at the hazard indicator, always check to be sure that the doors are properly before leaving your vehicle.

### Unlocking door

1. Push the UNLOCK button on the key fob.
2. The hazard indicators flash once and unlock all doors.

### **Finding car**

1. Push the TRUNK button on the key fob, the hazard indicators will flash for 15S to remind the vehicle owner.
2. Push the TRUNK button again to cancel reminding.

### **Panic**

In any case, push the PANIC button on the key fob, the horn will tweet loudly and the hazard indicators will flash at the same time, all these will be turned off by themselves after 25S, if you push the PANIC button in 25S again it will turn them off also.

### **Auto lock**

After locking doors well, it will be locked automatically if there is no operation of opening door or operating ignition key in 25S when the door is opened by pushing the "UNLOCK" button haphazard, then the hazard indicators flash once.

If you use the key to lock doors, it only can lock the driver's side

door, please use the remote keyless entry system to all doors.



### 3. HEATER, AIR CONDITIONER AND AUDIO SYSTEM

CENTER AND SIDE VENTS.....	3-2	AUDIO SYSTEM.....	3-7
HEATER AND AIR CONDITIONER.....	3-2		
AIR CONDITIONER OPERATION (IF SO EQUIPPED).....	3-5		

## CENTER AND SIDE VENTS

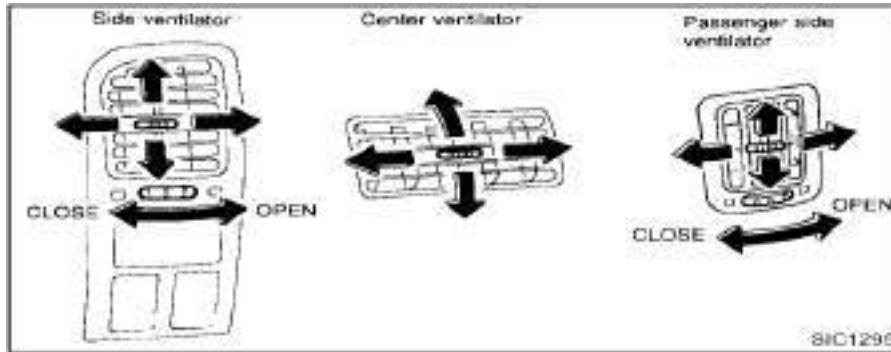

Open or close (if so equipped), and adjust the air flow direction of the ventilators.

## HEATER AND AIR CONDITIONER



### CONTROLS

#### Fan control lever/dial

This lever/dial turns the fan on and off, and controls fan speed.

#### Air flow control lever/dial

This lever/dial allows you to select the air flow outlets.

 — Air flows from center and side ventilators.

 — Air flows from center and side ventilators and foot outlets.

 — Air flows mainly from foot outlets.

 — Air flows from defroster outlets and foot outlets.



 — Air flows mainly from defroster outlets.

### **Temperature control lever/dial**

This lever/dial allows you to adjust the temperature of the outlet air.

(Except models without heater)



### **Air intake lever/Air recirculation button**

 position/  button off position (Indicator goes out)

Outside air is drawn into the passenger compartment.

Use this position for normal heater, or air conditioner operation.

If dust is not raised in front of the vehicle, this position is effective to prevent dust entry.

 position/  button on position (Indicator comes on)

Interior air is recirculated inside the vehicle.

Move the air intake lever to this position/push the”  ” button to

the on position when driving on a dust raised road or to avoid traffic fumes.

### **⚠ WARNING:**

Do not use in this position for long periods of time because it may cause the interior air to become stuffy and the windows to fog up.

### **Air conditioner button (If so equipped)**

This button is provided only for vehicles with an air conditioner.

Start the engine, move the fan control lever/dial to the desired (1 to 4) position and push the air conditioner button to turn on the air conditioner. The indicator light will come on when the air conditioner is on. To stop the air conditioner, push the switch again to return it to the original position.

### **The air conditioner cooling function operates only when the engine is running.**

### **⚠ WARNING:**



**Positioning of the heating or air**

**conditioning controls should not be done while driving, in order that full attention may be given to the driving operation.**

## **HEATER OPERATION**



### **Heating**

This mode is used to direct hot air from the floor outlets.

1. Move the air intake lever to the”  ” position, or push the”  ” button to the off position for normal heating.
2. Move the air control lever/dial to the  position.
3. Turn on the fan control lever/dial.
4. Move the temperature control lever/dial to the desired position between the middle and the “HOT” position.

### **Ventilation**



This mode directs outside air from the side and center vents.

1. Move the air intake lever to the”  ” position, or push the”  ” button to the off position.

2. Move the air control lever/dial to the "  "position.
3. Turn on the fan control lever/dial.
4. Move the temperature control lever/dial to the desired position.

### **Defrosting or defogging**



This mode is used to defrost/defog the windows.

1. Move the air intake lever to the "  " position, or push the "  " button to the off position.
2. Move the air control lever/dial to the "  " position.
3. Turn on the fan control lever/dial.
4. Move the temperature control lever/dial to the desired position between the middle and the "HOT" position.
5. Push on the air conditioner button. The indicator light will come on.

### **Bi-level heating**



This mode directs outside air from side and center vents and hot air

from the floor outlets.

1. Move the air intake lever to the "  " position, or push the "  " button to the off position.
2. Move the air control lever/dial to the "  "position.
3. Turn on the fan control lever/dial.
4. Normally move the temperature control lever/dial to the midpoint between "HOT" and "COLD".

### **Heating and defrosting**

This mode heats the interior and defogs the windshield.

1. Move the air intake lever to the "  " position, or push the "  " button to the off position.
2. Move the air control lever/dial to the "  "position.
3. Turn on the fan control lever/dial.
4. Move the temperature control lever/dial to the desired position between the middle and the "HOT" position.

### **Operating tips**

**Clear snow and ice from the wiper blade and air inlet in front of the windshield. This will improve heater and defroster operation.**



## **AIR CONDITIONER OPERATION (If so equipped)**

Start the engine, move the fan control lever/dial to the desired (1 to 4) position and push in the air conditioner button to activate the air conditioner. When the air conditioner is on, cooling and dehumidifying functions will be added to the heater operation.





**The air conditioner cooling function operates only when the engine is running.**

### **Cooling**

This mode is used to cool and dehumidify.



1. Move the air intake lever to the "  " position, or push the "  " button to the off position.
2. Move the air control lever/dial to the "  " position.
3. Turn on the fan control lever/dial.
4. Push on the air conditioner

button. The indicator light will come on.

5. Move the temperature control lever/dial to the desired position.
- For quick cooling, move the air intake lever to the "  " position, or push the "  " button to the on position. Be sure to return the air intake lever to the "  " position, or push the "  " button to the off position for normal cooling.

### **Dehumidified heating**



This mode is used to heat and dehumidify.

1. Move the air intake lever to the "  " position, or push the "  " button to the off position.
2. Move the air control lever/dial to the "  " position.
3. Turn on the fan control lever/dial.
4. Push on the air conditioner button. The indicator light will come on.

5. Move the temperature control lever/dial to the desired position.

### **Dehumidified defrosting**

This mode is used to defrost/defog the windows and dehumidify.

1. Move the air intake lever to the "  " position, or push the "  " button to the off position.
2. Move the air control lever/dial to the "  " position.
3. Turn on the fan control lever/dial.
4. Push on the air conditioner button. The indicator light will come on.
5. Move the temperature control lever/dial to the desired position.

### **Operating tips**

- Keep windows and sun roof closed while the air conditioner is in operation.
- After parking in the sun, drive for two or three minutes with the windows open to vent hot

air from the passenger compartment. Then, close the windows. This will allow the air conditioner to cool the interior more quickly.

- The air conditioning system should be operated for about ten minutes at least once a month, especially in winter. This helps prevent damage to the system due to lack of lubrication.
- If the coolant temperature gauge exceeds the "HOT" position, turn the air conditioner off. Have your

Vehicle inspected by PARSKHODRO service center. See "If your vehicle overheats" in the "In case of emergency" section for additional information.

### **Servicing air conditioner**

The air conditioning system in your NISSAN vehicle is charged with a new refrigerant designed with the environment in mind.

**This new refrigerant will not harm the earth's ozone layer.**

However it may contribute in a small part to global warming.

Special charging equipment and lubricant are required when servicing your NISSAN air conditioner. Using improper refrigerants or lubricants will cause severe damage to your air conditioning system. See "Air conditioning system refrigerant and lubricant recommendations" in the "Technical information" section of this manual.

PARSKHODRO service center will be able to service your environmentally "friendly" air conditioning system.

## **AUDIO SYSTEM**

Please read CD/USB FM player instruction part for operation and caution which followed vehicle's audio system.



### **AUDIO SYSTEM**

#### **CAUTION :**

- Please use authorized tape less than 60minutes .
- Use authorized disk.
- Don't start it in a bump road.

## 4. STARTING AND DRIVING

BREAK-IN SCHEDULE .....	4-2	.....	4-7
BEFORE STARTING THE ENGINE .....	4-2	4x4 TRANSFER CASE SHIFTING .....	4-10
PRECAUTIONS WHEN STARTING AND DRIVING .....	4-3	AUTO-LOCK FREE-RUNNING HUBS.....	4-11
EXHAUST GAS (CARBON MONOXIDE)...	4-3	DRIVING SAFETY PRECAUTIONS .....	4-15
PRECAUTIONS WHEN DRIVING ON-PAVEMENT AND OFF-ROAD .....	4-4	4x4 TIRES OF 4-WHEEL DRIVE .....	4-17
CARE WHEN DRIVING .....	4-5	PARKING .....	4-18
TRAILER TOWING .....	4-5	FOR YOUR VEHICLE SECURITY .....	4-19
IGNITION SWITCH .....	4-6	PRECAUTIONS WHEN DRIVING .....	4-19
STARTING THE ENGINE .....	4-7	ANTI-LOCK BRAKE SYSTEM ( ABS )( IF SO EQUIPPED ) .....	4-21
DRIVING WITH MANUAL TRANSMISSION		IN COLD WEATHER .....	4-22



## BREAK-IN SCHEDULE

During the first 1600km, follow the recommendations for the future reliability and economy of your new vehicle. Failure to follow these recommendations may result in vehicle damage or shortened engine life.

**Do not drive over the following speed limits:**

- **2-wheel drive models and 4x4 ( 2H position )**  
90km/h
- **4x4 ( 4H position ) :**  
80km/h
- **4x4 ( 4L position ) :**  
50km/h

**Engine speed :**

	DISTANCE ( km )	Weight	Speed ( rpm )
1	0~200	0	2000~3000
2	200~800	≤25%	2000~3500
3	800~1500	≤50%	2000~4000
4	1500~2000	≤75%	2000~4000

Avoid driving for long periods at constant speed, either fast or slow.

## BEFORE STARTING THE ENGINE



### WARNING:

The driving characteristics of your vehicle can be changed remarkably by any additional load and its distribution as well as by adding optional equipment (trailer coupling, roof rack, etc). Your driving style and speed have to be adjusted accordingly especially when carrying heavy loads, your speed must be reduced adequately.

- **Make sure the area around the vehicle is clear.**
- **Check fluid levels such as engine oil, coolant, brake and clutch fluid, window washer fluid as frequently as possible, at least whenever you refuel.**
- **Check to be sure that all windows and light lenses are clean.**

- Visually inspect tires for their appearance and condition. Also check tire pressure for proper inflation.
- Lock all doors.
- Position seats and adjust head restraints.
- Adjust rearview mirror and outside mirror.
- Adjust inside seat belts and ask all passengers to do likewise.
- Do not place hard or heavy objects on either the front or rear parcel shelf to prevent injury in the event of a sudden stop.
- Check the operation of warning lights when key is turned to the “ON(3)” position.
- Tune the radio to the desired broadcasting station.

## PRECAUTIONS WHEN STARTING AND DRIVING



### WARNING:

Do not leave children, unreliable adults, or pets alone in your vehicle. They could accidentally injure themselves or others through inadvertent operation of the vehicle. Also, on hot, sunny days, temperatures in a closed vehicle could quickly become high enough to cause severe or possibly fatal injuries to people and animals.

## EXHAUST GAS (CARBON MONOXIDE)



### WARNING:

- Do not breathe exhaust gases; they contain colorless and odorless carbon monoxide. Carbon monoxide is dangerous. It can cause unconsciousness or death.
- If you suspect that exhaust fumes are entering the vehicle, drive with all windows fully open, and have the vehicle inspected immediately.
- Do not run the engine in closed spaces such as a garage.
- Do not park the vehicle with the engine running for any extended length of time.
- It is not advisable to sit for any length of time in a parked vehicle with the engine running.
- When a vehicle has been stopped in an open area with its engine running for any

---

significant on to force outside air into the vehicle.

## **PRECAUTIONS WHEN DRIVING ON-PAVEMENT AND OFF-ROAD**

### **DRIVING PRECAUTIONS**

4x4 Utility vehicles have higher ground clearance and a narrower track to make them capable of performing in a wide variety of off-road applications. Specific design characteristics give them a higher center of gravity than ordinary cars. An advantage of higher ground clearance is a better view of the road, allowing you to anticipate problems. They are not designed for cornering at the same speeds as conventional 2-wheel drive vehicles any more than low-slung sports cars are designed to perform satisfactorily under off-road conditions. If at all possible, avoid sharp turns or abrupt maneuvers. As with other vehicles of this type, failure to operate this vehicle correctly may

### **SAFETY**

result in loss of control or vehicle rollover.

## **CARE WHEN DRIVING**

Driving your vehicle to fit the circumstances is essential for your safety and comfort. As a driver, you should be the one who knows best how to drive in the given circumstances.

### **ENGINE COLD START PERIOD**

Due to the higher engine speeds when the engine is cold, extra caution must be exercised when selecting gear (automatic and manual).

### **LOADING THE BAGGAGE**

Load and their distribution and the attachment of equipment (coupling devices, roof baggage carriers, etc.) will change the driving characteristics of the vehicle considerably. Driving style and speed must be changed according to the circumstances.

### **WHEN THE ROAD IS WET**

- **Avoid starting off, accelerating and stopping suddenly.**

- **Avoid sharp turns or lane changes.**
- **Extra distance should be kept from the vehicle in front.**
- **When water covers the road surface in puddles, small streams, etc., REDUCE SPEED to prevent aquaplaning which will cause skidding and loss of control.**
- **Worm tires increase this risk.**

### **UNDER WINTER CONDITIONS**

- Drive sensitively
- **Avoid sudden steering actions.**
- **Extra distance should be kept from the vehicle in front.**

## **TRAILER TOWING**

Your vehicle was designed to be used primarily for carrying passengers and luggage. Remember that towing a trailer will place additional loads on your vehicle's engine, drive train, steering, braking and other systems. Also, towing a trailer will exaggerate other conditions such as sway caused by crosswinds, rough road surfaces or passing trucks. Driving style and speed must be changed according to the circumstances.

- **Choose proper coupling devices (trailer hitch, safety chain, roof carrier, etc.) for your vehicle.**
- **Never allow the total trailer load (trailer weight plus its cargo weight) and coupling device to be exceeded.**
- **Before driving, make sure that the lighting system of the trailer works properly.**

- Observe the legal maximum speeds for trailer operation.
- Avoid abrupt starts, acceleration or stops.
- Avoid sharp turns or lane changes.
- Always drive your vehicle at a moderate speed.
- Always block the wheels on both vehicle and trailer when parking. Apply parking brake on trailer where fitted.
- Parking on a steep slope is not recommended.
- Take note of trailer manufacturer's instructions.
- Take care that tire pressure are at the pressure for full loading shown on the tire placard.
- The trailer must be loaded so that heavy goods are placed over the axle.

## IGNITION SWITCH

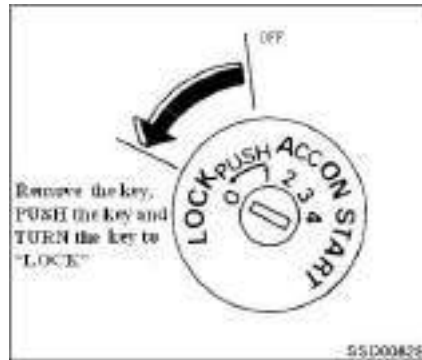

The switch includes the anti-theft steering lock device.

### “ LOCK ” Normal parking position ( 0 )

The ignition key can only be removed at this position. To lock the steering wheel, first turn the key to OFF and turn the key to LOCK while pushing the key in. It must be turned about 1/6 of a turn clockwise from the straight up position.

To unlock the steering wheel, insert the key and turn it gently

while rotating the steering wheel slightly right and left.

### **⚠ WARNING:**

- Never remove the key while driving. If the key is removed, the steering wheel will lock. This will cause the driver to lose control of the vehicle and could result in serious vehicle damage or personal injury.

### “OFF”(1)

The engine can be turned off without locking the steering wheel.

### “ACC”(Accessories) ( 2 )

This position activates electrical accessories such as the radio when the engine is not running.

### “ON” Normal operating position ( 3 )

This position turns on the ignition system and the electrical accessories.

### “START” ( 4 )

This position activates the starter motor, starting the engine. As soon as the engine has started, release the key immediately, it will

automatically return to the “ON” position.

## STARTING THE ENGINE

1. Apply the parking brake.
2. Move the gearshift lever to “N” (Neutral), and press the clutch pedal to the floor while cranking the engine.
3. Crank the engine with your foot off the accelerator pedal by turning the ignition key to “START”. Release the key when the engine starts. If the engine starts, but fails to run, repeat the above procedure.

— **If the engine is very hard to start in extremely cold or hot weather.** —

Use the accelerator pedal to help start the engine.

— **In the summer, when restarting the engine within 30 minutes after it has been stopped** —

Keep the accelerator pedal fully depressed while starting.



## WARNING:

**Do not crank the engine for more than 5 seconds at a time. If the engine does not start, wait 15 seconds before cranking again, otherwise the starter could be damaged.**

## 4. WARM ENGINE

Always allow the engine to idle for at least 30 seconds after starting. Drive at moderate speed for a short distance first, especially in cold weather.

## DRIVING WITH MANUAL TRANSMISSION

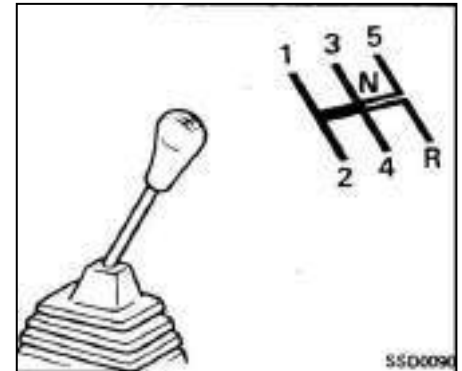

### Starting the vehicle

- Depress the clutch pedal to the floor and move the gearshift lever to the “1” or “R” position.
- Slowly depress the accelerator pedal, releasing the clutch pedal and parking brake lever at the same time.

If it is difficult to move the shift lever into Reverse or 1<sup>st</sup>, shift into Neutral, then release the clutch pedal and shift into Reverse or 1<sup>st</sup> again.

## Driving precautions

To change gears, fully depress the gearshift lever. After shifting, release the clutch slowly. On the 5-speed transmission model, you cannot shift directly from 5<sup>th</sup> gear into Reverse. First shift into Neutral, then into Reverse.

### **△ CAUTION:**

- **Do not rest your foot on the clutch pedal while driving.**
- **Stop your vehicle completely before shifting into reverse.**
- **Avoid abrupt starts and acceleration for your safety. When quick acceleration is required for some reason, shift to lower gear and accelerate until the vehicle reaches the maximum speed in each gear. Do not exceed the speed limit of any gear. Pay special attention into a lower gear on slippery surfaces. Sudden acceleration or down shifting could cause the wheels to skid and result in loss of control.**

## SUGGESTED SHIFT-UP SPEEDS

The following provides suggested speed ranges for shifting into a higher gear. These suggestions relate to fuel economy and vehicle performance. Actual shift ranges should be adjusted for specific road conditions, the weather and individual driving habits.

- **2-wheel drive models and 4 ×4 ( 2H and 4H position )**

Gear change	Speed (km/j)
1 <sup>st</sup> to 2 <sup>nd</sup>	15
2 <sup>nd</sup> to 3 <sup>rd</sup>	40
3 <sup>rd</sup> to 4 <sup>th</sup>	80
4 <sup>th</sup> to 5 <sup>th</sup>	100

- **4-wheel drive model**

Gear change	Speed(km/h)
1 <sup>st</sup> to 2 <sup>nd</sup>	13
2 <sup>nd</sup> to 3 <sup>rd</sup>	20
3 <sup>rd</sup> to 4 <sup>th</sup>	32
4 <sup>th</sup> to 5th	36

The figures listed in the chart refer to potential speed ranges for each gear. The speed at which you drive, however, should conform to all federal, state, province and territory laws, and to the condition which will permit safe operation.

### **Suggested maximum speed in each gear**

Downshift to a lower gear if the engine is not running smoothly, or if you need to accelerate.

Do not exceed the maximum suggested speed (shown below) in any gear. For level road driving, use the highest gear suggested for that speed. Always observe posted speed limits, and drive according to the road conditions which will ensure safe operation. Do not overrun the engine when shifting to a lower gear as it may cause engine damage or loss of vehicle control.

**Allowable maximum speed in each gear:**

2-wheel drive models

1 <sup>st</sup>	15
2 <sup>nd</sup>	30
3 <sup>rd</sup>	45
4 <sup>th</sup> and 5 <sup>th</sup>	50

4-wheel drive models

(2H position)

Speed ( km/h )

1 <sup>st</sup>	25
2 <sup>nd</sup>	50
3 <sup>rd</sup>	80
4 <sup>th</sup> and 5 <sup>th</sup>	120

4-wheel drive models

( 4H position )

Speed ( km/h )

1 <sup>st</sup>	35
2 <sup>nd</sup>	60
3 <sup>rd</sup>	80
4 <sup>th</sup> and 5 <sup>th</sup>	80

( 4L position )



## 4×4 TRANSFER CASE SHIFTING

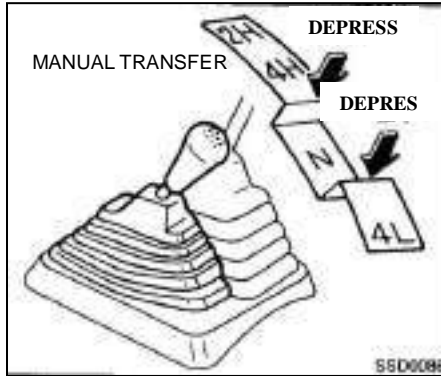

2H—( 2WD ,high range ) only the rear wheel are driven. Use when driving under the same conditions standard 2WD vehicle.

4H— ( 4WD, high range ) Four wheels are driven. Use when driving on roads where it is difficult to drive in the 2H position. (i.e., driving at normal speeds on snow covered, icy, wet, muddy or sandy roads)

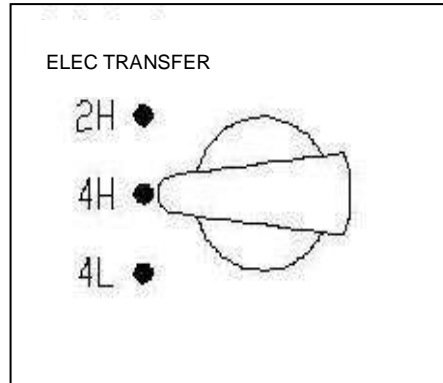

4H position supplies the max power and traction force. Avoid excessive speed, as it will cause loss of traction. Speed over 80 km/h in 4H is not recommended.

4L— ( 4WD, low range ) Four wheels are driven. Use when climbing or descending steep hills, or during hard driving in sand, mud or deep snow. The “4L” position provides maximum power and traction. Avoid raising vehicle speed excessively, as the

maximum speed in 5<sup>th</sup> gear approximately 50 km/h.

N—No wheels are driven. Always keep the transfer lever out of the “N” position. Shifting the lever quickly and smoothly when moving across the “N” position with the vehicle stopped.

### ⚠ CAUTION:

- Do not drive on dry hard surface roads in 4-wheel drive.
- Driving on dry hard surfaces in “4H” or “4L” may cause unnecessary noise and tire wear. We recommended driving in the “2H” position under these conditions.
- To lubricate the front wheel drive system, drive the vehicle in 4-wheel drive at least once a month.

### ⚠ WARNING:

- When parking the vehicle, apply the parking brake and shift the transfer control lever in the “2H”, “4H” or “4L” position.

- Do not leave in the “N” position. Otherwise the vehicle could roll unexpectedly even if the manual transmission is in any gear.

## AUTO-LOCK FREE-RUNNING HUBS

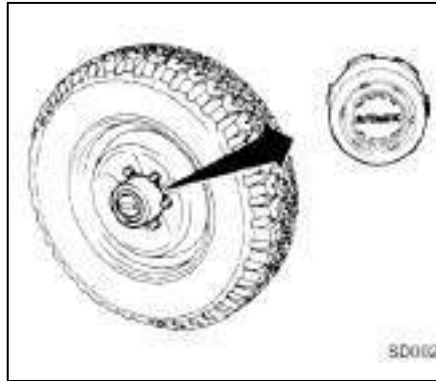

The auto-lock free-running hub is designed to allow for automatic 4-wheel drive engagement when the shift lever is moved to the “4H” or “4L” position. If your vehicle is equipped with this system, follow these operational cautions:



### **CAUTION:**

- When engaging and disengaging, the auto-lock hubs will make a clicking noise. This is normal.

- Accelerating the vehicle suddenly from a stop with the transfer lever in the “4H” or “4L” position may not engage the auto-lock free-running hub and may cause a clattering noise. Continued use of the vehicle with this noise may damage the hub lock. In such a case, release the accelerator pedal to reduce the engine speed.
- If the auto-lock hubs make a clattering noise while driving with the transfer lever in the “2H” position, stop and move the vehicle about 2 to 3 meters (7 to 10 ft) in the opposite direction of travel.
- Under extremely cold conditions [below  $-15^{\circ}\text{C}$  ( $5^{\circ}\text{F}$ )], when the vehicle is driven in 2-wheel drive at high speeds without first warming up the vehicle and gear oil, the axle shafts may rotate, causing the hub locks to make a clattering noise. To avoid this, first drive in 4-wheel drive, then shift to 2-wheel drive.

- 
- **When shifting from the “2H” to “4H” position while driving, do not stop shift lever movement midway. An incomplete shift from the “2H” to “4H” position or disengagement of only one hub lock may cause a clattering noise from the auto-lock hubs. Continued use of the vehicle with this noise may damage the hub lock. Shift to 4-wheel drive to stop the noise; unlock hubs as described.**
  - **Also, in cold weather, if difficulty is encountered in shifting from “2H” to “4H”, it may be necessary to reduce speed or stop the vehicle.**

## SHIFTING OF TRANSFER - MANUAL TRANSFER

TO SHIFT MANUAL TRANSFER CASE	SHIFT PROCEDURE FOR MODELS WITHOUT FREE-RUNNING HUBS
FROM "2H TO "4H"	Gear shifting from the 2H to 4H position must be performed at speeds below 40km/h and step on the clutch. Perform this operation when driving straight.
From "4H" to "2H"	<p>below 80 km/h, and it is not necessary to depress the clutch pedal. Perform this operation when driving straight.</p> <p><b>CAUTION:</b></p> <ol style="list-style-type: none"> <li>1) For the 2WD operation, auto-locked and idle operated wheel hub will be separated after the vehicle reverse 1 meter.</li> <li>2) Stop and reverse 1 meter before driving forward.</li> <li>3) When reversing, stop and drive straight 1 meter and reverse 1 meter. Separating of the auto-locked and idle operated wheel hub is good for save fuel, reduce noise and the abrasion.</li> <li>4) If the indicator light is still on after shifting from "4H" to "2H", you must change to 2WD states by accelerating, decelerating or reversing for safe insurance.</li> </ol>
From "4H" to "4L" or 4L" to "4H"	<ol style="list-style-type: none"> <li>5. Stop the vehicle.</li> <li>6. Depress the clutch pedal.</li> <li>7. Depress the transfer lever and move it "4L" or "4H" position.</li> </ol>
From "2H" to "4L"	<ol style="list-style-type: none"> <li>1. Stop the vehicle.</li> <li>2. Depress the clutch pedal.</li> <li>3. Depress the transfer lever and move it to "4L", change gears quickly and smoothly.</li> </ol>
From "4L" to "2H"	<ol style="list-style-type: none"> <li>1. Stop the vehicle.</li> <li>2. Depress the clutch pedal.</li> <li>3. Depress the transfer lever and move it to "2H" position.</li> </ol> <p><b>CAUTION:</b></p> <p>Move the transfer lever from "4H" to "2H", if the 4X4 indicator still comes on, it indicates the transfer shift control has not selected the "2H" lever. To be safe, accelerating, reducing or backward, increase the vehicle is in "2H" position.</p>

## SHIFTING OF TRANSFER - ELEC. TRANSFER

TO SHIFT ELEC. TRANSFER SWITCH	SHIFT PROCEDURE FOR MODELS WITHOUT FREE-RUNNING HUBS
FROM "2H TO "4H"	Shift the transfer switch to "4H" under the speed of 40km/h (25MPH).It is not necessary to depress the clutch pedal. Perform this operation when driving straight. Then the indicator light would be green.
From "4H" to "2H"	<ul style="list-style-type: none"> <li>● <b>Move the transfer lever to "2H". This can be done at any speed below 80 km/h, and it is not necessary to depress the clutch pedal. Perform this operation when driving straight.</b></li> <li>● <b>CAUTION:</b></li> <li>● <b>For the 2WD operation, auto-locked and idle operated wheel hub will be separated after the vehicle reverse 1 meter.</b></li> <li>● <b>Stop and reverse 1 meter before driving forward.</b></li> <li>● <b>When reversing, stop and drive straight 1 meter and reverse 1 meter. Separating of the auto-locked and idle operated wheel hub is good for save fuel, reduce noise and the abrasion.</b></li> <li>● <b>If the indicator light is still on after shifting from "4H" to "2H", you must change to 2WD states by accelerating, decelerating or reversing for safe insurance.</b></li> </ul>
From "4H" to "4L"	<ol style="list-style-type: none"> <li>8. Stop the vehicle and keep the engine running.</li> <li>9. Depress the clutch pedal.</li> <li>10. Shift the transfer switch from "4H" to "4L" smoothly and quickly.</li> <li>11. The 4WD indicator light should be yellow. Drive the vehicle after the light is steady.</li> </ol>
From 4L" to "4H"	<ol style="list-style-type: none"> <li>a) Stop the vehicle and keep the engine running.</li> <li>b) Depress the clutch pedal.</li> <li>c) Shift the transfer switch from "4L" to "4H" smoothly and quickly.</li> <li>d) The 4WD indicator light should be green Drive the vehicle after the light is steady.</li> </ol>
<p>For AUTO TRANSMISSION vehicle:</p> <p>Do not shift the transfer switch from "4H" to "4L" , "4L" to "4H" ,"2H" to "4L" or "4L" to "2H". Well it is very hard to change the transfer switch.</p>	

## **DRIVING SAFETY PRECAUTIONS**

Your vehicle is designed for both normal and off-road use. However, avoid driving in deep water or mud as your vehicle is mainly designed for leisure use, unlike a conventional off-road vehicle.

Remember that 2-wheel drive models are less capable than 4-wheel drive models for rough road driving and extrication when stuck in deep snow or mud, or the like.

Please observe the following precautions:

### **CAUTION:**

- **Drive carefully when off the road and avoid dangerous areas. Always wear your seat belts to help keep you and your passengers in position when driving over rough terrain.**

- **Do not drive across steep slopes. Instead drive either straight up or straight down the slopes. Off-road vehicles can tip over sideways much more easily than they can forward or backward.**

- **Many hills are too steep for any vehicle. If you drive up them, you may stall. If you drive down them, you may not be able to control your speed. If you drive across them, you may roll over.**

- **Stay alert when driving to the top of a hill. At the top there could be a drop-off or other hazard that could cause an accident.**

- **If your engine stalls or you cannot make it to the top of a steep hill, never attempt to turn around. Your vehicle could tip or roll over. Always back straight could tip or roll**

**over. Always back straight down in reverse gear. Never**

- **back down in neutral (N) or with the clutch depressed, using only the brake, as the could cause loss of control.**

- **Heavy braking going down a hill could cause your brakes to overheat and fade, resulting in loss of control and an accident. Apply brakes lightly and use a low gear to control your speed.**

- **Unsecured cargo can be thrown around when driving over rough terrain. Properly secure it so that it will not be thrown forward and cause injury to you or your passengers.**

- **Avoid raising the center of gravity by loading things on the roof or equipping the vehicle with tires larger than specified in this manual. This could cause your vehicle to rollover. Put heavy loads in the cargo**

---

area as far forward and as low as possible.

- Does not grip the inside or spokes of the steering wheel when driving off-road. The steering wheel could jerk and injure your hands. Instead drive with your fingers and thumbs on the outside of the rim.

- Before operating vehicle, ensure that the driver and all passengers have their seat belts fastened.

- Always drive with the floor mats in place as the floor may become very hot. Particular care should be taken if you are barefoot.

- Lower your speed when encountering strong crosswinds. With its higher center of gravity, your vehicle is more affected by gusty side winds. Slower speeds ensure better vehicle control.

- Do not drive beyond the performance of the tires even with 4WD.

- Sudden acceleration, sharp steering maneuvers or sudden braking may cause loss of control.

- Install the same size of winter tires on all four (4) wheels (such as stud less tires) or install tire chains to rear wheels when driving on slippery roads (e.g., after a snow and drive carefully using 4WD).

- Be sure to check the brakes immediately after driving in mud or water as specified in “WET BRAKES” under the heading “Precautions when driving”.

- Whenever you drive off-road through sand, mud or water as deep as the wheel hub, more frequent maintenance may be required. For details, refer to “Maintenance under severe driving conditions” in a separate maintenance booklet.

- Avoid parking your vehicle on steep hills. If you get out of the vehicle and it rolls forward,

backward or sideways, you could be injured.

## **4×4 TIRES OF 4-WHEEL DRIVE**

### **△ CAUTION:**

**Always use tires of the same size, brand, construction (bias, bias-belted or radial), and tread pattern on all four wheels. Failure to do so may result in a circumference difference between tires on the front and rear axles which will cause excessive tire wear and may damage the transmission transfer case and differential gears.**

If excessive tire wear is found, it is recommended that all four tires be replaced with tires of the same size, brand, construction and tread pattern. The tire pressure and wheel alignment should also be checked and corrected as necessary. Contact your PARSKHODRO dealer.

### **Snow tires**

If you install snow tires, they must also be the same size, brand, construction and tread pattern on all four wheels.

### **△ CAUTION:**

**Only use spare tires specified for each 4-wheel drive model.**

#### **Tire inflation pressure**

Check the pressure in all tires, including the spare, with a gauge periodically when at a service station. Adjust to the specified pressure if necessary. Tire pressures are shown on the tire placard affixed to the glove box.

#### **Tire rotation**

PARSKHODRO recommends that tires be rotated every 5,000 km . Do not include the temporary spare tire in the tire rotation.

#### **Tire chain**

Tire chains must be installed only on the rear wheels and not on the front wheels.

Do not drive with tire chains on paved roads which are clear of snow. Driving with chains in such conditions can cause damage to

the various mechanisms of the vehicle due to some overstress. When driving on clear paved roads, be sure to change to 2WD.



## PARKING

### ⚠ CAUTION:

- Do not park the vehicle over flammable materials such as dry grass, waste paper or rags, as they may burn easily.
  - Safe parking procedures require that the parking brake be set and the gearshift lever placed in the proper position.
1. Firmly apply the parking brake.
  2. Place the gearshift lever in the "REVERSE" position. When parking on an uphill grade, place the gearshift lever in the "1st" position.
  3. Turn the ignition key to the "LOCK" position and remove the key.

### ⚠ WARNING:

- Never leave the engine running while the vehicle is unattended.
- Never leave children unattended in the vehicle.

touches the curb. Then set the parking brake.

### • HEADED UPHILL : ②

Turn the wheels away from the curb and allow the vehicle to move back until the curb side

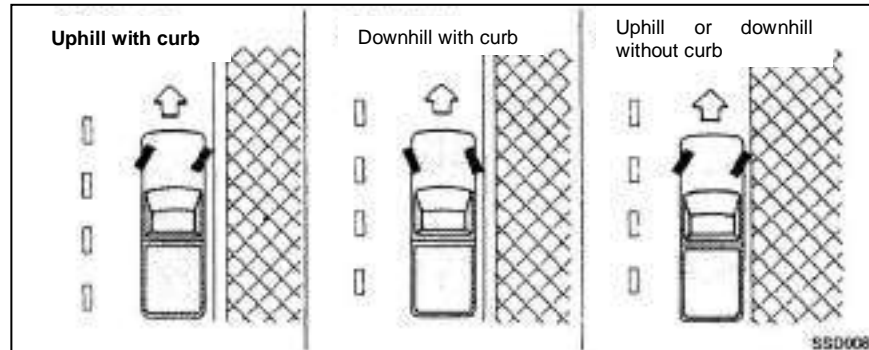

When parked on a sloping driveway, turn the wheels so the vehicle will not roll into the street in case it moves.

### • HEADED DOWNHILL: ①

Turn the wheels into the curb; allow the vehicle to move forward until the curb side wheel gently

Wheel gently touches the curb. Then set the parking brake.

### • HEADED UPHILL OR DOWNHILL, NO CURB : ③

Turn the wheels toward the side of the road so the vehicle will move away from the center of the road if it moves. Then set the parking brake.

## FOR YOUR VEHICLE SECURITY

When leaving your vehicle unoccupied :

- **Always remove the ignition key — even in your own garage.**
- **Close all windows completely and lock all doors.**
- **Always park your vehicle where it can be seen. At night, park in a well lit area.**
- **If you have an alarm or immobilization device, use it — even for short periods.**
- **Do not leave children and pets in the vehicle unattended.**
- **Do not leave valuables on view to tempt a thief. Always take your valuables with you. If you must leave something in your vehicle, lock it in the luggage compartment or hide it out of sight.**
- **Do not leave the vehicle documents in your vehicle. In the unfortunate event of your vehicle being stolen the**

documents will only help a thief to sell the vehicle.

- **Do not leave articles on a roof rack as they are particularly vulnerable. If possible, remove them from the rack and lock them in the luggage compartment or inside the vehicle.**
- **Do not leave the spare key in the vehicle — keep it in a safe place in your home.**
- **Do not leave a note of your vehicle key number in the vehicle. A thief may break into the vehicle, note the key number and return with a key to enter and drive the vehicle.**

## PRECAUTIONS WHEN DRIVING

### Driving with vacuum assisted brake:

The brake booster aids braking by using engine vacuum. If the engine stops, you can stop the vehicle by depressing the brake pedal. However, greater foot pressure on the brake pedal will be required to stop the vehicle and the stopping distance will be longer.



### **WARNING:**

**Do not coast with the engine stopped.**

### Driving with the power assisted steering:

The power assisted steering is designed to use a hydraulic pump, driven by the engine, to assist steering.

If the engine stops or drive belt breaks, you will still have control of the vehicle. However, much greater steering effort is

---

needed, especially in sharp turns or at low speeds.

**Wet brakes:**

When the vehicle is washed or driven through water, the brakes may get wet. As a result, your braking distance will be longer and the vehicle may pull to one side during braking.

To dry brakes, drive the vehicle at a safe speed while lightly pressing the brake pedal to heat-up the brakes. Do this until the brakes return to normal. Avoid driving the vehicle at high speeds until the brakes function correctly.

- **Avoid resting your foot on the brake pedal while driving. This will overheat the brakes, wear out the brake linings and pads faster and increase gas mileage.**

- **To help save the brakes and to prevent the brakes from overheating, before going down a slope or long grade, reduce speed and downshift to a lower gear.**

- **While driving on a slippery surface, be careful when braking, accelerating or downshifting. Abrupt braking actions or sudden acceleration could cause the wheels to skid.**

**DRIVING UPHILL**

When starting on a steep grade, it is sometimes difficult to operate both the brake and clutch. Use the parking brake to hold the vehicle. Do not slip the clutch. When ready to start, slowly release the parking brake while depressing accelerator pedal and releasing the clutch.

**DRIVING DOWNHILL**

The engine braking action is effective for controlling the vehicle while descending hills. The gearshift lever should be placed in the lower speed position prior to descending.

**SPARK PLUGS**

The factory-installed spark plugs on your vehicle are designed to meet normal driving conditions. If your vehicle is operated under either of the

following conditions, it is recommended that optional spark plugs of the proper heat range be installed.

When the vehicle is used primarily for short distance travel, so that the engine does not run long enough to reach its normal operating temperature, use hot-type spark plugs.

When the vehicle is frequently operated with throttle wide open for long periods of time, use cold-type spark plugs.

For spark plug types, please consult your PARSKHODRO dealer.

## **ANTI-LOCK BRAKE SYSTEM ( ABS ) ( IF SO EQUIPPED )**

### **Normal operation**

The ABS (anti-lock brake) system will not operate at speeds below 5 to 10 km/h to completely stop the vehicle. (The speeds will vary according to road conditions.)

When the anti-lock system senses that one or more wheels are close to locking up, the actuator (under the hood) rapidly applies and releases hydraulic pressure (like pumping the brakes very quickly). While the actuator is working, you may feel a pulsation in the brake pedal and hear a noise or vibration from the actuator under the hood. This is normal and indicates that the anti-lock system is working properly. However, the pulsation may indicate that road conditions are hazardous and extra care is required while driving.

### **Self-test feature**

The anti-lock brake system consists of electronic sensors, hydraulic pumps, and hydraulic solenoids controlled by a computer. The computer has a built-in diagnostic feature that tests the system each time you start the engine and move the vehicle at a low speed in forward or reverse. When the “self-test” occurs, you may hear a “clunk” noise and/or feel a “pulsation” in the brake pedal. This is normal and is not an indication of any malfunction. If the computer senses any malfunction, it switches the antilock brake system OFF and turns on the “ABS” warning light in the dashboard. The brake system will then behave normally, but without anti-lock assistance.

If the light comes on during the self check, or while you are driving, you should take your vehicle to your PARSKHODRO

dealer for repair at your earliest convenience.

### **USE THE ABS SYSTEM**

Tread down the brake pedal and keep it.



### **WARNING:**

**Do not tread down and release the brake pedal frequently, it will increase the brake distance.**

The anti-lock brake system is a sophisticated device, but is cannot prevent accidents resulting from careless or dangerous driving techniques. It can help maintain vehicle control during braking on slippery surfaces, but remember that the stopping distance on slippery surfaces will be longer than on normal surfaces, even with the anti-lock system. Ultimately, the responsibility for safety of self and others rests in the hands of the driver. Tire type and condition may also affect braking effectiveness.

---

- When replacing tires, install the specified tires on all 4 wheels.

- When installing a spare tire, make sure it is the proper size and type as specified on the tire placard. For tire placard location information, refer to “Tire placard” in the Owner’s Manual index.

## **IN COLD WEATHER**

### **Freeing a frozen door lock**

To prevent a door lock from freezing, apply de-icer or glycerin to it through the key hole. If the lock becomes frozen, heat the key before inserting it into the key hole.

### **Anti-freeze**

In the winter when it is anticipated that the temperature will drop below 0°C (32°F), check anti-freeze (ethylene glycol base) to assure proper winter protection. For details, see “Engine cooling system” in the “Maintenance and do-it-yourself” section.

### **Battery**

If the battery is not fully charged during extremely cold weather conditions, the battery fluid may freeze and damage the battery. To maintain maximum efficiency, the battery should be checked regularly. For details, see “Battery” in the “Maintenance and do-it-yourself” section.

### **Draining of coolant water**

If the vehicle is to be left outside without anti-freeze, drain the cooling system by opening the drain valve located under the radiator and on the engine block. Refill before operating the vehicle. For details, see “Changing engine coolant” in the “Maintenance and do-it-yourself” section.

### **Tire equipment**

1. If you have snow tires installed on the front/rear wheels of your vehicle, they should be of the same size, load range, construction and type (bias, bias-belted or radial) as the rear/front tires.
2. If the vehicle is to be operated in severe winter conditions, snow tires should be installed on all four wheels.
3. For additional traction on icy roads, studded tires may be used. However, some countries prohibit their use,

so, before installing studded tires, check the applicable laws in that country or area.

**Skid and traction capabilities of studded snow tires, on wet or dry surfaces, may be poorer than that of non-studded snow tires.**

4. Snow chains may be used if desired. Make sure they are of proper size for the tires on your vehicle and are installed according to the chain manufacturer's suggestions. Use chain tensioners when recommended by the tire chain manufacturer to ensure a tight fit. Loose end links of the tire chain must be secured or removed to prevent the possibility of whipping action damage to the fenders or undercarriage. In addition, drive at a reduced

speed, otherwise, your vehicle may be damaged and/or vehicle handling and performance may be adversely affected.

#### **SPECIAL WINTER EQUIPMENT**

It is recommended that the following items be carried in the vehicle during winter:

1. A scraper and stiff-bristled brush to remove ice and snow from the windows.
2. A sturdy, flat board to be placed under the jack to give it firm support.
3. A shovel to dig the vehicle out of snowdrifts.

#### **CORROSION PROTECTION**

Chemicals used for road surface de-icing are extremely corrosive and will accelerate corrosion and the deterioration of underbody components such as the exhaust system, fuel and brake lines,

brake cables, floor pan and fenders.

In winter, the underbody must be cleaned periodically. For more detailed information concerning cleaning the exterior to protect it from corrosion, please refer to the "Appearance and interior care" of this Manual.

For additional protection against rust and corrosion, which may be required in some areas, consult your local PARSKHODRO dealer.

## 5 . IN CASE OF EMERGENCY

FLAT TIRE .....	5-2
JUMP STARTING.....	5-6
PUSH STARTING .....	5-6
IF YOUR VEHICLE OVERHEATS .....	5-7

TOW TRUCK TOWING.....	5-7
FREEING VEHICLE FROM SAND, SNOW OR MUD .....	5-10

## FLAT TIRE

If you have a flat tire, follow the instructions below

### Stopping the vehicle

1. Safely move the vehicle off the road away from the traffic.
2. Turn on the hazard warning flasher.
3. Park on a level surface and apply the parking brake. Shift the manual transmission into reverse.
4. Turn the engine off.

### WARNING:

Never change tires when the vehicle is on a slope or soft uneven ground. This is dangerous.

Pickup

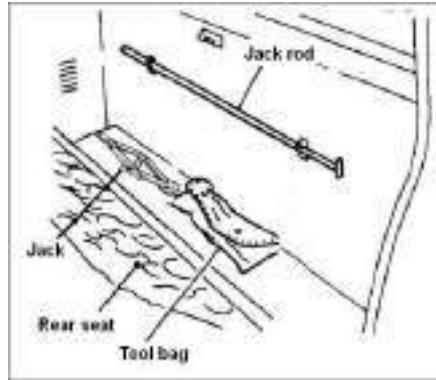

Van

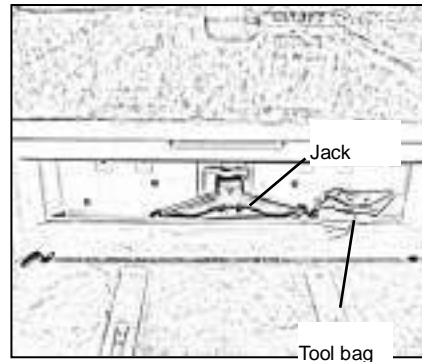

### Getting the spare tire and the tools

5. Remove jacking tools and spare tire from storage area.
6. Get the wheel nuts spanner from the tool bag. Fit the square end of the jack rod into the square hole of the wheel nut wrench to form a handle.
7. Find the oval shaped opening under the middle of the tailgate. Pass the T-shaped end of the jack rod through the opening and direct it towards the spare tire winch, located directly above the spare tire.
8. Seat the T-shaped end of the jack rod into the T-shaped opening of the spare tire winch, and turn the jack rod counterclockwise to lower the spare tire.
9. Once the spare tire is completely lowered, reach under the vehicle, remove the retainer chain, and



carefully slide the tire from under the rear of the vehicle.

**Tightening torque of nuts:**

66 to 89N.m

(6.7 to 9.1 kg-m)

Use a suitable padlock

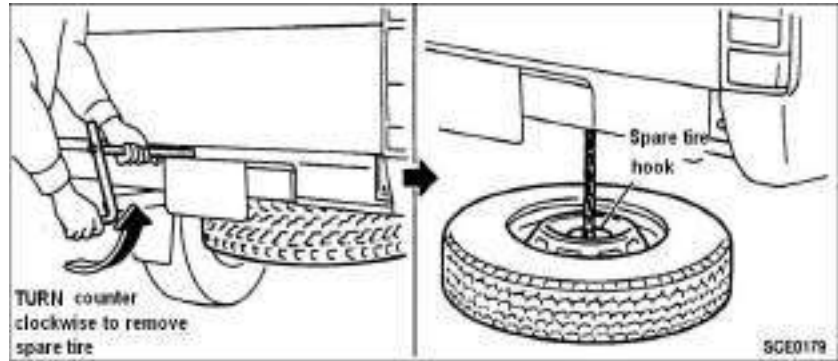

When installing the tire, tighten securely.

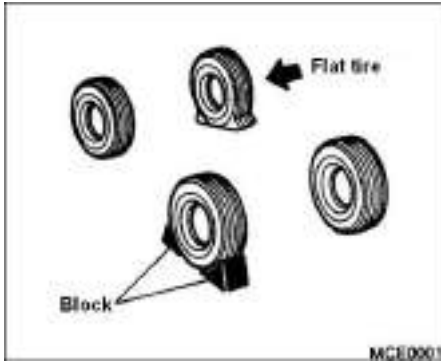

### Blocking wheel

Place suitable blocks at both the front and back of the wheel diagonally opposite the flat tire.

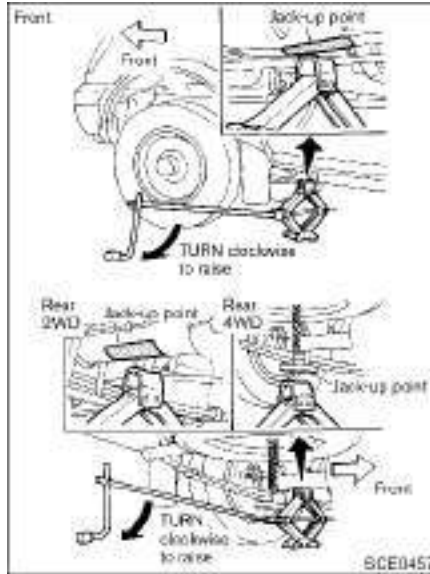

Jacking up and removing wheel  
Place the jack directly under the jack-up point.

### ⚠ CAUTION:

The jack should be used on level firm ground wherever possible.

### Remove the center cap.

Loosen each wheel nut one or two turns by turning counterclockwise with the wheel nut wrench (jack handle).

Do not remove the wheel nuts until the tire is off the ground.

Carefully raise the vehicle until the tire clears the ground.

Remove the wheel nuts, and then remove the wheel. Do not remove the brake drum with the wheel.



### WARNING:

- Never get under the vehicle while it is supported only by the jack; use vehicle support stands.
- Do not start or run engine while vehicle is on the jack.
- Do not allow passengers to stay in the vehicle while it is on the jack.

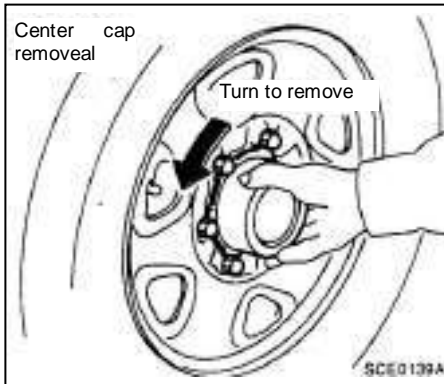

On models equipped with the limited slip differential carrier, never run the engine with one rear wheel off the ground. It may cause the vehicle to move.

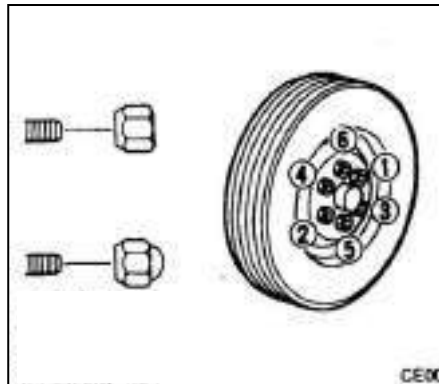

### Installing wheel

- 6 . Clean any mud or dirt from the surface between the wheel and hub.
- 7 . Carefully put the wheel on and tighten the wheel nuts finger tight.
- 8 . With the wheel nut wrench, tighten wheel nuts alternately and evenly until they are tight.
- 9 . Lower the vehicle slowly until the tire touches the ground. Then, with the wheel nut wrench, tighten the wheel nuts securely in the sequence as illustrated.

- As soon as possible tighten the wheel nuts to the specified torque with a torque wrench.

**Tightening torque of nuts:**  
**118 to 147N.m**  
**(12 to 15kg-m)**

- Adjust tire pressure to the **COLD** pressure.

**COLD pressure:**

**After vehicle has been parked for three hours or more or driven less than 1.6 km.**

**COLD** tire pressures are shown on the tire placard affixed to the glove box or driver's side center pillar.

- 10 . Install the center wheel cap securely.
- 11 . Securely store the spare tire and jacking equipment in the vehicle.

## JUMP STARTING

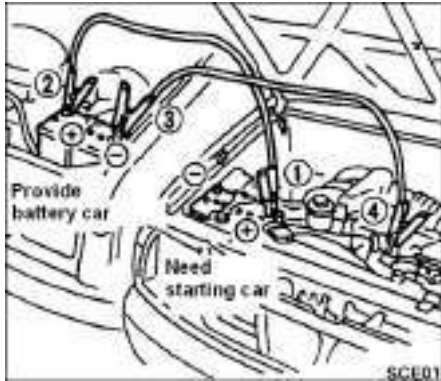

### ⚠ CAUTION:

**Use a battery rated at 12 volts for a booster.**

1. Remove vent caps on the battery (if so equipped). Cover the battery with an old cloth as shown.
2. Connect jumper cables in the sequence as illustrated.

### ⚠ CAUTION:

**An incorrect connection could result in damage to the charging system.**

3. Start the engine of the other vehicle and let it run for a few minutes. Keep the engine speed at about 2,000 rpm, and start your engine in the normal manner.
4. After starting your engine, carefully disconnect the negative cable and then the positive cable.
5. Replace the vent caps (if so equipped).

If your vehicle is equipped with dual batteries, it is not necessary to connect a booster battery to both batteries; one battery is enough. Jump starting procedure is the same as that for single battery models. Follow the instructions and precautions in the preceding page.

## PUSH STARTING

### ⚠ CAUTION:

- **Automatic transmission models cannot be started by pushing. This may cause transmission damage.**
- **Never try to start the vehicle by towing it; when the engine starts, the forward surge could cause the vehicle to collide with the tow vehicle.**

### Gasoline engine

1. Turn the ignition key to "ON".
2. Hold the clutch pedal fully depressed and shift into second or third. Place the transfer in "2H" and free-running hubs in the "FREE" position (models with manual-lock free-running hub).
3. Hold the accelerator pedal about halfway.
4. Start pushing, and when the vehicle reaches a speed of about 16 km/h, slowly releases the clutch pedal to start the engine.

## IF YOUR VEHICLE OVERHEATS

### **WARNING:**

**To avoid the danger of being burned, never remove the radiator cap while the engine is still hot.**

1. Move the vehicle safety off the road; apply the parking brake and move the gearshift lever to neutral.

### **Do not stop the engine.**

2. Turn off the air conditioner switch. Open all the windows, move the heater or air conditioner temperature control to “maximum hot” and fan control to “high speed”.
3. Open the engine hood. If steam or water is coming from the engine, stand clear to prevent getting burned.
4. If engine overheating is caused by climbing a long hill on a hot day, run the engine at a fast idle (approximately 1,500 rpm) until the

temperature gauge indication returns to normal.

5. Visually check drive belts for damage or looseness. Also check if the cooling fan is running. The radiator hoses and radiator should not leak water.



### **WARNING:**

**Be careful not to allow your hands, hair or clothing to come into contact with the running fan, belts, or motor fan. If coolant is leaking, the cooling fan belt is missing or loose, or the cooling fan does not run, stop the engine.**

6. After the engine cools down, check the coolant level in the reservoir tank with the engine running. Add coolant if necessary. Have your vehicle repaired at the nearest ZZNissan dealer.

## TOW TRUCK TOWING

When towing your vehicle, local regulations for towing must be followed. Incorrect towing equipment could damage your vehicle. To assure proper towing and to prevent accidental damage to your vehicle, NISSAN recommends that you have a service operator tow your vehicle. It is advisable to have the service operator carefully read the following precautions.

### **Towing precautions**

- **When towing, make sure that the transmission, axles, steering system and power train are in good order. If any unit is damaged, a dolly must be used.**

- **When towing with the rear wheels on the ground:**

**Turn the ignition key to the “OFF” position and secure the steering wheel in a straight ahead position with a rope or similar device. Never place the ignition key in the “LOCK”**

position. This will result in damage to the steering lock mechanism.

- For 4-wheel drive model:  
Set the free-running hubs to the free position (See 4X4“AUTO-LOCK FREERUNNING HUBS” or “MANUAL-LOCK FREE-RUNNING HUBS” as appropriate in the “Starting and driving” section). Move the transfer case shift lever into the “2H” position and the transmission shift lever into the neutral (“N”) position.

- Attach safety chains for all towing.

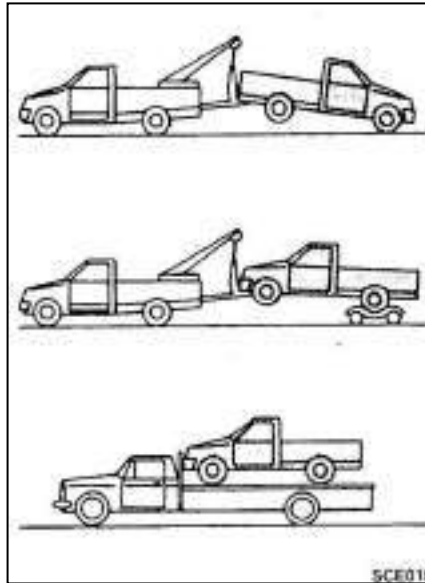

### 2-WHEEL DRIVE MODELS

We recommend that your vehicle be towed with driving (rear) wheels off the ground as illustrated.

**If you have to tow your vehicle with four wheels on the ground or rear wheels on the ground:**

1. Release the parking brake and move the gearshift lever to the neutral position (“N” position).
2. Observe the following restricted towing speeds and distances.

- **Speed: Below 95 km/h**

- **Distance: Less than 800 km**

If the speed or distance must necessarily be greater, remove the propeller shaft beforehand to prevent damage to the transmission.



### WARNING

**Never tow your vehicle from the rear (i.e., backward) with four wheels on the ground as this may cause serious and expensive damage to the transmission.**

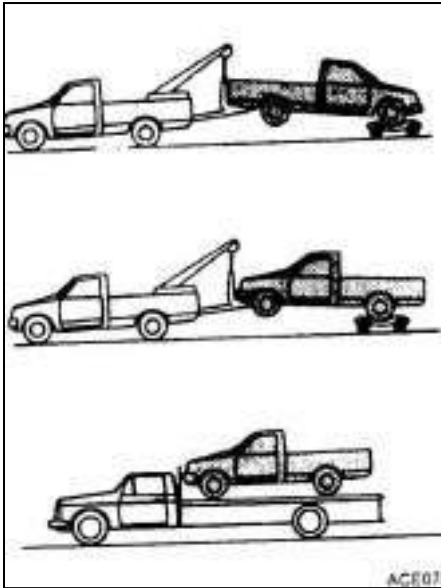

#### 4-WHEEL DRIVE MODELS

PARSKHODRO recommends that a dolly be used as illustrated when towing your vehicle.

If you have to tow your vehicle with four wheels on the ground or front or rear wheels on the ground.

1. Release the parking brake and move the gearshift lever to the neutral position ("N" position).
2. Observe the following restricted towing speeds and distance.

- **Speed: Below 95 km/h**
- **Distance: Less than 800 km**

If the speed or distance must necessarily be greater, remove the propeller shaft beforehand to prevent damage to the transmission.

#### **⚠ WARNING:**

- **Never tow your vehicle from the rear (i.e., backward) with four wheels on the ground as this may cause serious and expensive damage to the transmission.**

- **Be sure to place the transfer case shift lever into the "2H" position and the transmission shift lever into the neutral ("N") position if the vehicle is to be towed.**

## **FREEING VEHICLE FROM SAND, SNOW OR MUD**

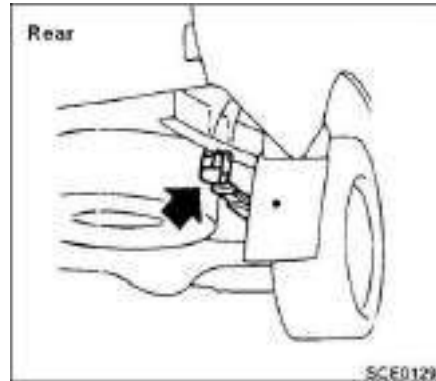
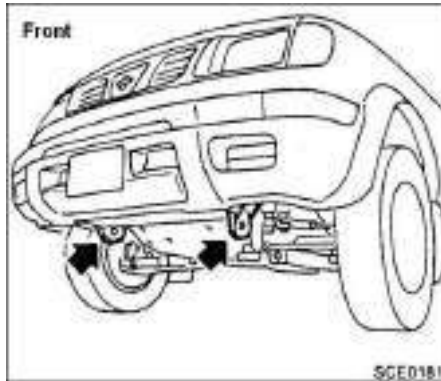

- Use the towing hooks only, not other parts of the vehicle. Otherwise, the vehicle body will be damaged.
- Use the towing hooks only to free a vehicle stuck in sand, snow, mud, etc. Never tow the vehicle for a long distance using only the towing hooks.
- The towing hook is under tremendous force when used to free a stuck vehicle.

- Always pull the cable straight out from the front or rear of the vehicle. Never pull on the hook at a sideways angle.



## **6. APPEARANCE AND INTERIOR CARE**

CLEANING EXTERIOR AND INTERIOR... 6-2

PROTECTING AGAINST CORROSION.... 6-4

## CLEANING EXTERIOR AND INTERIOR



In order to maintain the appearance of your vehicle, it is important to take proper care of it. In the following cases, please wash your vehicle as soon as possible to protect the paint surface.

- After a rainfall to prevent possible damage from acid rain
- After driving on coastal roads
- When things such as soot,

bird droppings, tree sap, metal particles or bugs get on the paint surface.

- When dust or mud builds up on the surface.

Whenever possible, store or park your vehicle inside a garage or in a covered area.

When it is necessary to park outside, park in a shady area or protect the vehicle with a body cover.

### ⚠ CAUTION

**Be careful not to scratch the paint surface when putting on or removing the body cover.**

### Washing

Wash dirt off with a wet sponge and plenty of water. Clean the vehicle thoroughly using a mild soap or detergent (a special vehicle soap or general purpose dish-washing liquid) mixed with clean, lukewarm (never hot) water.

### ⚠ WARNING

- Do not use strong

household soap, strong chemical detergents, gasoline or solvents.

- Do not wash the vehicle in direct sunlight or while the vehicle body is hot, as the surface may become water-spotted.

- Avoid using tight-napped or rough cloths, such as washing mitts. Care must be taken when removing caked-on dirt or other foreign substances so that the paint surface is not scratched or damaged.

Rinse the vehicle thoroughly with plenty of clean water.

Inside flanges, seams and folds on the doors, hatches and hood are particularly endangered by the effects of road salt. Therefore, these areas must be regularly cleaned. Take care that the drain holes in the lower edge of the door are open. Spray water under the body and in the wheel wells to loosen the dirt and wash away road salt.

A damp chamois can be used to dry the vehicle to avoid water spots.

### **Waxing**

Regular waxing protects the paintwork and keeps the finish. After waxing, polishing is recommended to remove built-up residue and avoid a “weathered” appearance.

The dealer can assist you in choosing the proper product.

- **Wax your vehicle only after a thorough washing. Follow the instructions supplied with the wax.**

- **Do not use a wax containing any abrasives, cutting compounds or cleaners that may damage the vehicle finish.**

- **If the surface does not polish easily, use a “road tar” remover and wax again.**

Machine compounding or aggressive polishing on a base coat/clear coat paint finish may dull the finish or leave swirl marks.

Only apply black wax or black shoe polish to the black urethane or polypropylene bumper.

### **Removing spots**

Remove tar and oil spots, industrial dust, insects and tree sap as quickly as possible from the surface of the paint to avoid lasting damage or staining. Special cleaning products are available at your PARSKHODRO dealer or any automotive accessories store.

### **Underbody**

In areas where road salt is used in winter, it is necessary to clean the underbody regularly in order to prevent dirt and salt from building up and causing corrosion on the underbody and suspension. Before the winter period and again in the spring, the under seal must be checked and, if necessary, re-treated.

### **Cleaning glass**

Use glass cleaner to remove smoke and dust film from the

glass surfaces. It is normal for glass to be coated with a film after the vehicle is parked in the hot sun. Glass cleaner and a soft cloth will easily remove this film.

When cleaning the inside of the window, do not use any sharp-edged tools or abrasive cleaners or chlorine-based disinfectant cleaners. These may damage the electrical conductors, radio antenna elements or rear window defogger elements.

### **Cleaning alloy wheels**

Wash regularly, especially during winter months in areas where road salt is used. Salt could discolor the wheel if not removed.

#### **Chrome parts**

Clean all chrome parts regularly with a nonabrasive chrome polish to maintain the finish.

### **Plastic parts**

Plastic parts can be cleaned with a mild soap solution. If the dirt cannot be easily removed, use a plastic cleaner. Do not use any solvents.

### **Cleaning interior**

Occasionally remove loose dust from the interior trim and seats using a vacuum cleaner or soft brush. Wipe the vinyl and leather surfaces with a clean, soft cloth dampened in mild soap solution, then wipe clean with a dry soft cloth. Before using any fabric protector, read the manufacturer's recommendations. Some fabric protectors contains chemicals that stain or bleach the seat material.

- **Never use benzine, thinner or any similar material.**
- **The leather seats should be regularly coated with a leather wax like saddle soap. Never use car wax.**
- **Never use fabric protectors unless recommended by the manufacturer.**

### **Seat belts**

The seat belts can be cleaned by wiping them with a sponge dampened in a mild soap solution. Allow the belts to dry completely before using them. Do not allow

wet belts to roll up in the retractor. NEVER use bleach, dye or chemical solvents since these may severely weaken the seat belt webbing.

## **PROTECTING AGAINST CORROSION**

Most common factors contributing to vehicle corrosion:

1. The accumulation of moisture-retaining dirt and debris in body panel sections, cavities, and other areas.
2. Damage to paint and other protective coatings caused by gravel and stone chips or minor traffic accidents.

Environmental factors influence the rate of corrosion:

### **Moisture**

The accumulation of sand, dirt and water on the underside of the body will accelerate corrosion. Floor sections which have snow and ice trapped under the floor matting will not dry.

### **Relative humidity**

Corrosion will be accelerated in areas of high relative humidity, especially those areas where the temperatures stay above freezing and where atmospheric pollution

exists and road salt is used.

### **Temperature**

A temperature increase will accelerate the rate of corrosion to those parts which are not well ventilated.

### **Air pollution**

Industrial pollution, the presence of salt in the air in coastal areas, or heavy road salt use will accelerate the corrosion process. Road salt will also accelerate the disintegration of paint Surfaces.

To protect your vehicle from corrosion:

- **Wash and wax your vehicle often to keep the vehicle clean.**
- **Always check for minor damage to the paint and repair it as soon as possible.**
- **Keep drain holes at the bottom of the doors and tailgate open to avoid water accumulation.**
- **Check the underbody and inside the pick box (Truck model). If any sand, dirt or salt has accumulated, wash it off**

**with water as soon as possible.**

- **NEVER remove dirt, sand or other debris from the passenger compartment by washing with a hose. Remove dirt with a vacuum cleaner or broom.**

- **Never allow water or other liquids to come in contact with electronic components inside the vehicle.**

Chemicals used for road surface de-icing are extremely corrosive. They accelerate corrosion and deterioration of underbody components such as the exhaust system, fuel and brake lines, brake cables, floor pan and fenders.

In winter, the underbody must be cleaned periodically.

For additional protection against rust and corrosion, which may be required in some areas, consult your local PARSKHODRO dealer.

# 7. MAINTENANCE AND DO-IT-YOURSELF

<b>PRECAUTIONS</b> .....	<b>7-2</b>
<b>ENGINE COOLING SYSTEM</b> .....	<b>7-5</b>
<b>ENGINE OIL</b> .....	<b>7-7</b>
<b>POWER STEERING FLUID</b> .....	<b>7-10</b>
<b>BRAKE AND CLUTCH FLUID</b> .....	<b>7-10</b>
<b>WINDOW WASHER FLUID</b> .....	<b>7-11</b>
<b>BATTERY</b> .....	<b>7-11</b>
<b>JUMP STARTING</b> .....	<b>7-13</b>
<b>DRIVE BELTS</b> .....	<b>7-13</b>
<b>SPARK PLUG REPLACEMENT</b> .....	<b>7-13</b>

<b>AIR CLEANER FILTER</b> .....	<b>7-14</b>
<b>WIPER BLADES REPLACEMENT</b> .....	<b>7-15</b>
<b>BRAKE CONDITIONS</b> .....	<b>7-16</b>
<b>BRAKE BOOSTER</b> .....	<b>7-17</b>
<b>FUSES</b> .....	<b>7-17</b>
<b>LIGHT BULBS</b> .....	<b>7-19</b>
<b>WHEELS AND TIRES</b> .....	<b>7-23</b>
<b>CLUTCH HOUSING</b> .....	<b>7-26</b>

## PRECAUTIONS

When performing any inspection or maintenance work on your vehicle, always take care to prevent serious accidental injury to yourself or damage to the vehicle. The following are general precautions which should be closely observed.

- Park the vehicle on a level surface, apply the parking brake securely and move the transmission control lever to neutral (“N”).
- When working under the engine hood, turn the engine off and wait until it cools down.
- Be sure to turn the ignition key to the “OFF” position when performing any replacement or repair.
- If you must work with the engine running, keep your hands, clothing, hair and tools away from moving fans and fan belts.

- It is advisable to remove necktie and any jewelry, such as rings, watch, etc. before working on your vehicle.
- If you must run the engine in an enclosed space such as a garage, be sure there is proper ventilation for exhaust gases.
- Never get under the vehicle while it is supported only by a jack. If it is necessary to work under the vehicle, support it with safety stands.
- Keep smoking materials, flame and sparks away from fuel and battery.
- Never connect or disconnect either the battery or any transistorized component connector while the ignition key is on.
- Always apply the parking brake and block the wheels to prevent the vehicle from moving.

- On gasoline engine models with the multiport fuel injection (MFI) system, the fuel filter or fuel lines should be serviced by a ParsKhodro dealer because the fuel lines are under high pressure even when the engine is off.
- Failure to follow these or other common sense guidelines may lead to serious injury or vehicle damage.
- Improperly disposed motor oil and/or other vehicle fluids can hurt the environment. Always conform to local regulations for disposal of vehicle fluid.

This “Maintenance and do-it-yourself” section gives instructions regarding only those items which are relatively easy for an owner to perform.

You should be aware that incomplete or improper servicing may result in operating difficulties or excessive emissions, and could affect your warranty coverage. If in doubt about any servicing, have it done by your Pars Khodro dealer.



ZG24 ENGINE

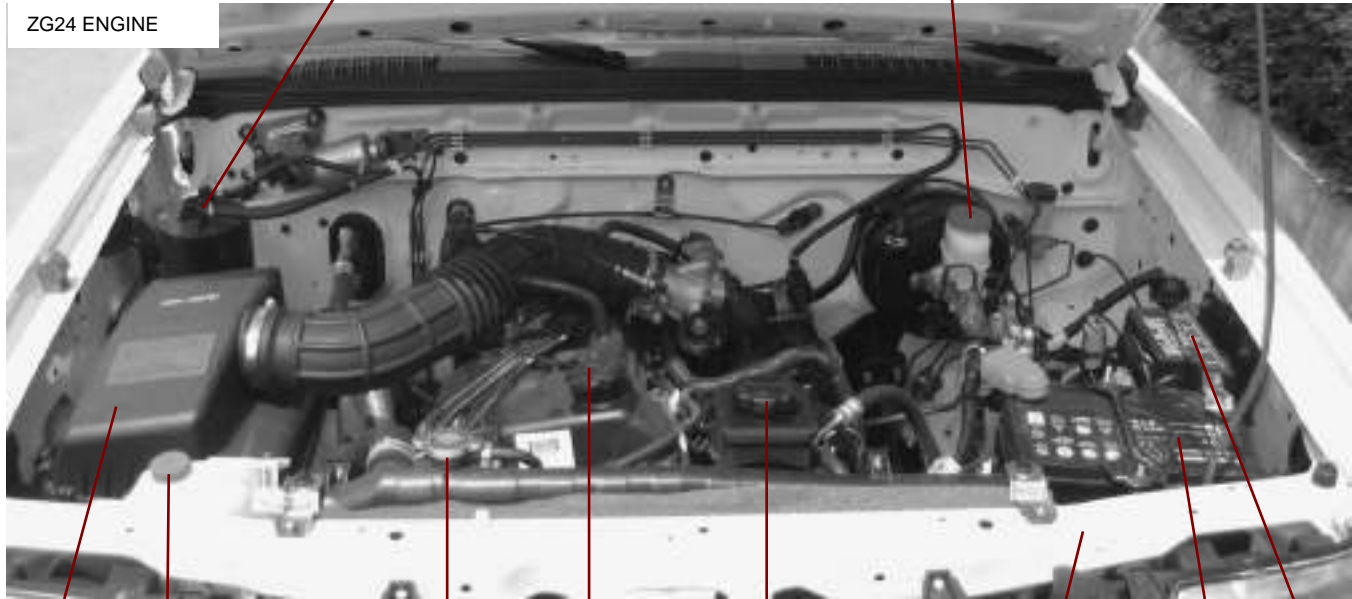

Canister

Brake fluid reservoir

Air cleaner

Coolant reservoir

Radiator cap

Engine oil filler  
cap

Power steering fluid  
reservoir

Windshield  
washer reservoir

Battery

Fuses

## 7-4 Maintenance and do-it-yourself

## ENGINE COOLING SYSTEM

When adding or replacing the coolant, be sure to use only a ParsKhodro Genuine Engine Coolant or equivalent in its quality with the proper mixture ratio. Examples are shown below:

Outside temperature	Engine Coolant	
°C	Antifreeze	Demineralized or distilled water
-35	50%	50%
-45	55%	45%

### WARNING

Never remove the radiator cap when the engine is hot. Serious burns could be caused by high pressure fluid escaping from the radiator. Wait until the engine and radiator cool down. See precautions in “If your vehicle overheats” found in the “In case of emergency” section.

Anti-freeze is poisonous and should be stored carefully in marked containers out of the

reach of children.

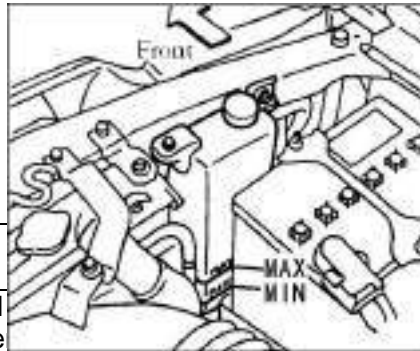

### CHECKING COOLANT LEVEL

Check the coolant level in the reservoir tank when the engine is cold. If the coolant level is below “MIN”, add coolant to the “MAX” level. If the reservoir tank is empty, check the coolant level in the radiator when the engine is cold. If there is insufficient coolant in the radiator, fill the radiator with coolant up to the filler opening and also add it to the reservoir tank up to the “MAX” level.

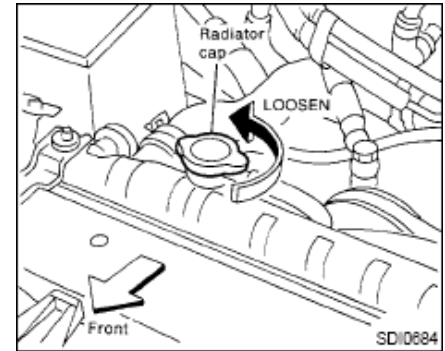

### CAUTION

If the cooling system frequently requires coolant, have it checked by your PARSKHODRO dealer.

### CHANGING ENGINE COOLANT

Major cooling system repairs should be performed by your ParsKhodro dealer. The service procedures can be found in the appropriate ParsKhodro Service Manual.

Improper servicing can result in reduced heater performance and engine overheating.

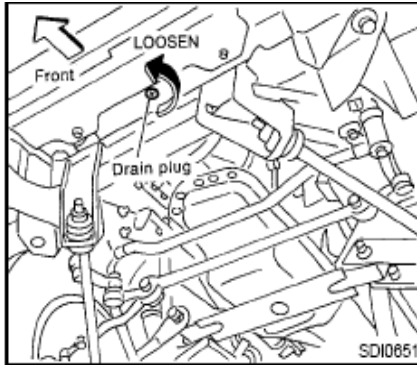

**⚠ WARNING**

- To avoid the danger of being scalded, never change the coolant when the engine is hot.
- Never remove the radiator cap when the engine is hot. Serious burns could be caused by high pressure fluid escaping from the radiator.

1. Open the drain plug at the bottom of the radiator and the radiator cap.



- Be careful not to allow coolant to contact drive belts.
  - Waste coolant must be disposed of properly. Check your local regulations.
2. Close the radiator drain plug securely.
  3. See the “Technical information” section for cooling system capacity. Fill the radiator with the proper mixture of ParsKhydro

genuine engine coolant and water. Fill the reservoir tank up to the “MAX” level. Then install the radiator cap.

4. Start the engine and warm it up until it reaches normal operating temperature. Then race the engine 2 or 3 times under no load. Watch the coolant temperature gauge for signs of overheating.
5. Stop the engine. After it completely cools down, refill the radiator up to the filler opening. Fill the reservoir tank up to the “MAX” level.
6. Check the drain plug for any sign of leakage.
7. Recheck the coolant level after the vehicle has been driving for a day.

## ENGINE OIL

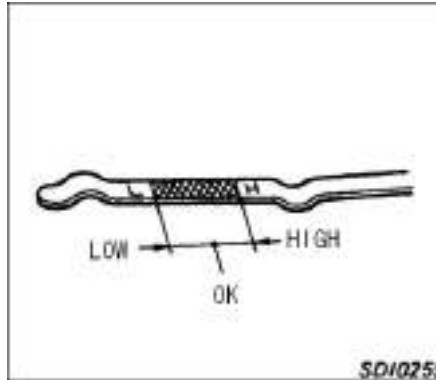

### **△ CAUTION**

- Oil level should be checked regularly. Operating with insufficient amount of oil can damage the engine, and such damage is not covered by warranty.
- It is normal to add some oil between oil changes or during the break-in period, depending on the severity of operating conditions.

### **CHECKING ENGINE OIL LEVEL**

1. Run the engine until it reaches operating temperature.
2. Turn off the engine. Wait a few minutes for the oil to drain back into the oil pan.
3. Remove the dipstick and wipe it clean. Reinsert it all the way.
4. Remove the dipstick again and check the oil level. It should be between the “H” and “L” marks. If the oil level is below the “L” mark, remove the oil filler cap and pour recommended oil through the opening.
5. Recheck oil level with dipstick.

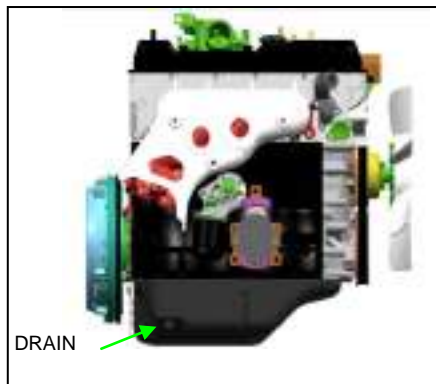
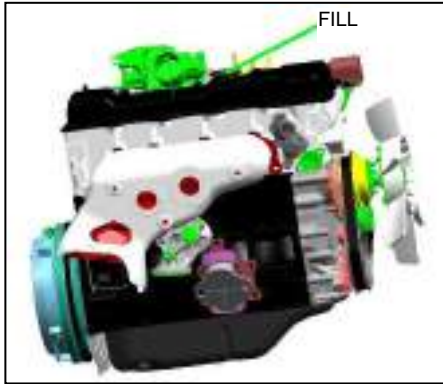

## CHANGING ENGINE OIL

1. Run the engine until it reaches operating temperature. Turn the engine off and wait more than 10 minutes.
2. Place a large drain pan under the drain plug.
3. Remove the oil filler cap. Remove the drain plug with a wrench and completely drain the oil.

If the oil filter is to be changed, remove and replace it at this time. See “Changing oil filter”.

### **⚠ WARNING**

**Be careful not to burn yourself, as the engine oil is hot.**

### **⚠ CAUTION**

**Waste oil must be disposed of properly. Check your local regulations.**

4. Clean and re-install the drain plug and a new washer. Securely tighten the drain plug with a wrench. Do not use excessive force.

Drain plug tightening torque:  
29 to 39 N·m (3.0 to 4.0 kg-m, 22 to 29 ft-lb)

5. Refill engine with recommended oil and install the cap securely.
6. See the “Technical information” section for refill capacity.
7. Start the engine. Check for leakage around the drain plug. Correct as required.
8. 10. Turn the engine off and wait several minutes. Check the oil level with the dipstick. Add engine oil if necessary.

### **⚠ Warning**

- **Prolonged and repeated contact with used engine oil may cause skin cancer.**
- **Try to avoid direct skin contact with used oil. If skin contact is made, wash thoroughly with soap or hand cleaner as soon as possible.**
- **Keep used engine oil out of reach of children.**

## Protect the environment

It is illegal to pollute drains, water courses and soil. Use authorized waste collection facilities, including civic amenity sites and garages providing facilities for disposal of used oil and used oil filters. If in doubt, contact your local authority for advice on disposal.

The regulations concerning the pollution of the environment will vary from country to country.

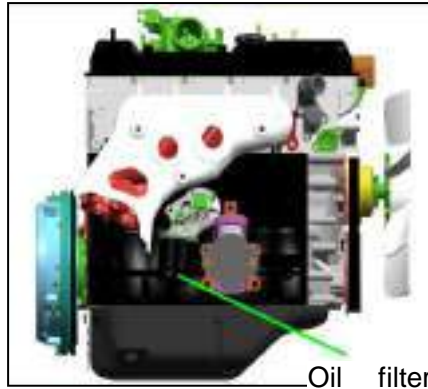

## CHANGING OIL FILTER

A used oil filter should be disposed of at a rubbish tip having proper facilities. We recommend having your oil filter changed by a ParsKhodro dealer.

1. Turn the engine off.
2. Loosen the oil filter with an oil filter wrench. Remove the oil filter by turning it by hand.

### **△ CAUTION**

**Be careful not to burn yourself, as the engine oil may be hot.**

3. Wipe the engine oil filter mounting surface with a clean rag.

Be sure to remove any old rubber gasket remaining on the mounting surface of the engine.

4. Coat the rubber gasket on the new filter with engine oil.
5. Screw in the oil filter until a slight resistance is felt, then tighten an additional 2/3 turn.
6. Start the engine and check for leakage around the oil filter. Correct as required.
7. Turn the engine off and wait several minutes. Check the oil level. Add engine oil if necessary.

## POWER STEERING FLUID

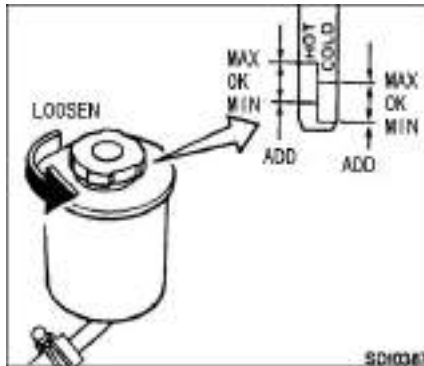

### Check the fluid level.

The fluid level should be checked using the “HOT” range at fluid temperatures of 50 to 80°C (122 to 176°F) or using the “COLD” range at fluid temperatures of 0 to 30°C (32 to 86°F).

### ⚠ CAUTION

- Do not overfill.
- Use Type DEXRONTMIII or equivalent.

## BRAKE AND CLUTCH FLUID

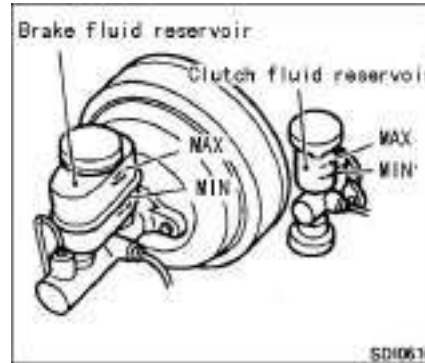

Check the fluid level in each reservoir. If the fluid level is below the MIN line or the brake warning light comes on, add DOT 4 fluid up to the MAX line.

If fluid must be added frequently, the system should be thoroughly checked by your ParsKhodro dealer.

### ⚠ CAUTION

- Refilling and checking the brake system should be left to a ParsKhodro dealer who will have the necessary brake fluid and technical knowledge.
- Use only new fluid. Old, inferior, or contaminated fluid may damage the brake and clutch systems. The use of improper fluids can damage the brake system and affect the vehicle's stopping ability.
- Do not spill the fluid on painted surfaces. This will damage the paint. If fluid is spilled, wash with water.

### ⚠ WARNING

Brake fluid is poisonous and should be stored carefully in marked containers out of the reach of children.

## WINDOW WASHER FLUID

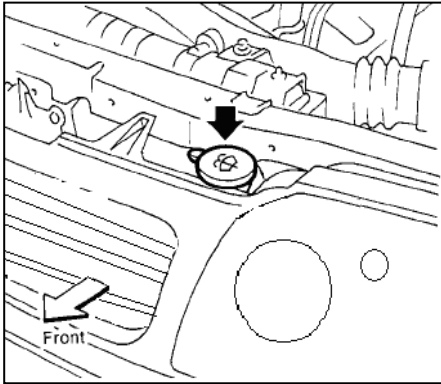

Check the fluid level in the reservoir tank and add fluid if necessary. Add a washer solvent to the water for better cleaning. In the winter season, add a windshield washer anti-freeze. Follow the manufacturer's instructions for the mixture ratio.

### **⚠ CAUTION**

**Do not substitute engine anti-freeze coolant for window washer solution. This may result in damage to the paint.**

### **⚠ WARNING**

**Washer solution is poisonous and should be stored carefully in marked containers out of the reach of children.**

## BATTERY

- Keep the battery surface clean and dry. Any corrosion should be washed off with a solution of baking soda and water.
- Make certain the terminal connections are clean and securely tightened.
- If the vehicle is not used for long, disconnect the “-” negative battery terminal cable to prevent discharge.

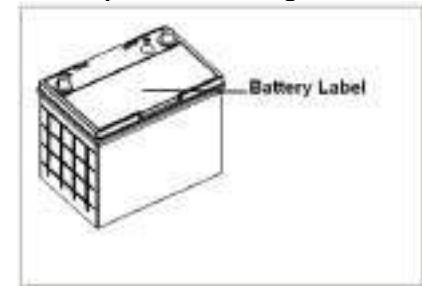

This car battery is maintenance-free battery. Do not dismantle or add liquid, to avoid damage to the battery or accident. If the battery not working, please Contact your ParsKhodro dealer. Please note the warning part in battery label.



## Warning

- Do not expose the battery to flames or electrical sparks. Hydrogen gas generated by battery action is explosive. Do not allow battery fluid to contact your skin, eyes, fabrics, or painted surfaces. After touching a battery or battery cap, do not touch or rub your eyes. Thoroughly wash your hands. If the acid contacts your eyes, skin or clothing, immediately flush with water for at least 15 minutes and seek medical attention.
- Keep the battery out of the reach of children.

## Battery caution label



## JUMP STARTING

If jump starting is necessary, see the “In case of emergency” section. If the engine does not start by jump starting, the battery may have to be replaced. Contact your ParsKhodro dealer.

## DRIVE BELTS

Be sure the ignition key is “OFF”.

1. Visually inspect each belt for signs of unusual wear, cuts, fraying or looseness. If the belt is in poor condition or loose, have it replaced or adjusted by your ParsKhodro dealer.
2. Have the belts checked regularly for condition and tension in accordance with the maintenance schedule in this manual.

## SPARK PLUG REPLACEMENT

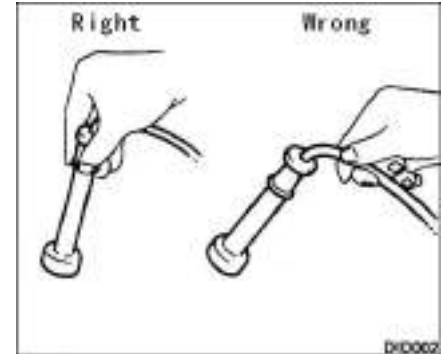

### **△ CAUTION**

**Be sure the engine and ignition switch are off and that the parking brake is engaged securely.**

1. Disconnect spark plug cables. Keep track of the original cable location.

When disconnecting, always hold the boots — not the cables. Mark all cables to identify.

2. Remove spark plugs with a spark plug wrench.

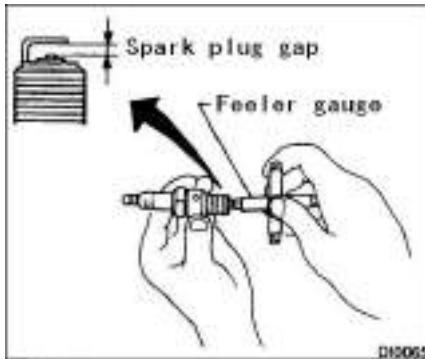

3. Check each new spark plug gap with a feeler gauge. (The spark plug gap is shown in the "Technical information" section.) Correct it as required.
4. Install spark plugs.

**⚠ CAUTION**

**When installing a plug, turn it in two or three turns by hand and then tighten with a spark plug wrench. Be careful not to over tighten it.**

Spark plug tightening torque:

20 to 29 N·m  
(2.0 to 3.0 kg-m, 14 to 22 ft-lb)

5. Reconnect the spark plug cables to their original positions.

## AIR CLEANER FILTER

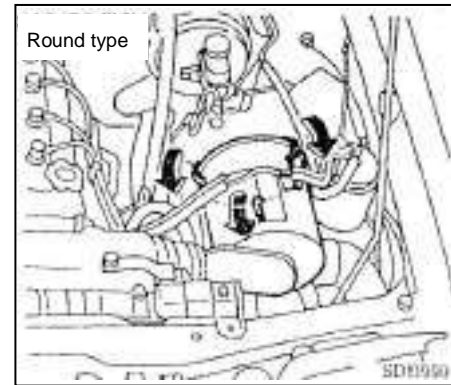

Check the filter element to see if it is dirty. If it is dirty, shake the element to remove dust. We recommend it be cleaned or replaced according to the maintenance intervals shown in a separate maintenance booklet. When cleaning or replacing the filter, wipe the inside of the air cleaner housing and the cover with a damp cloth. Clean the filter element after driving in dusty conditions.

## WIPER BLADES REPLACEMENT

Plain type

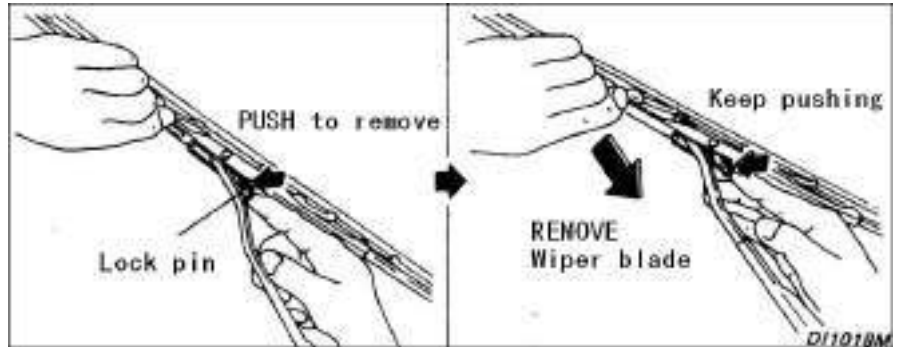
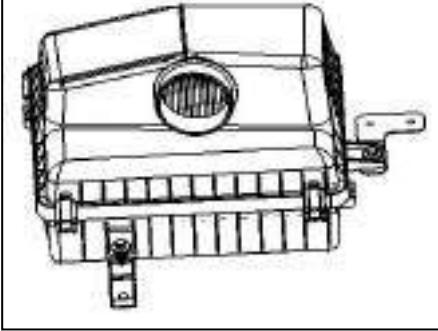

### **WARNING**

Operating the engine with the air cleaner off can cause you or others to be burned. The air cleaner not only cleans the air, it stops flame if the engine backfires. If it is not there, and the engine backfires, you could be burned. Don't drive with it off, and be careful working on the engine with the air cleaner off.

### **CLEANING**

If your windshield is not clear after using the windshield washer or if a wiper blade chatters when running, wax or other material may be on the blade or windshield.

Clean the outside of the windshield with a washer solution or a mild detergent. Your windshield is clean if beads do not form when rinsing with clear water.

Clean the blade by wiping it with a cloth soaked in a washer solution or a mild detergent. Then rinse the blade with clear water. If your windshield is still not clear after cleaning the blades and using the wiper, replace the blades.

### **REPLACEMENT**

Pull the wiper arm up. Push the lock pin, then remove the wiper blade. Insert the new wiper blade to the wiper arm until a click sounds.

## **△ CAUTION**

- After wiper blade replacement, return the wiper arm to its original position.
- Otherwise it may be damaged when the engine hood is opened.
- Make sure the wiper blade contacts the glass. Otherwise, the arm may be damaged from wind pressure.



## **BRAKE CONDITIONS**

### **Parking brake**

Periodically check the holding ability of the parking brake by parking on a steep hill and restraining the vehicle by using only the parking brake. If it does not hold satisfactorily, see your ParsKhodro dealer.

### **Brake pedal**

If the brake pedal suddenly goes down further than normal, the pedal feels “spongy” or the vehicle seems to take longer to stop, see your ParsKhodro dealer.

## BRAKE BOOSTER

Check the brake booster function with the following steps:

With the engine off, depress the brake pedal several times to make sure that the pedal travel distance does not change.

While depressing the brake pedal, start the engine. The pedal height should drop a little.

With the brake pedal depressed, stop the engine. Keeping the pedal depressed for about 30 seconds, the pedal height should not change.

Run the engine for one minute without depressing the brake pedal, then turn it off. Depress the brake pedal several times. The pedal travel distance will decrease gradually with each depression as the vacuum is released from the booster.

If the brakes do not operate properly, see your ParsKhodro dealer.

## FUSES

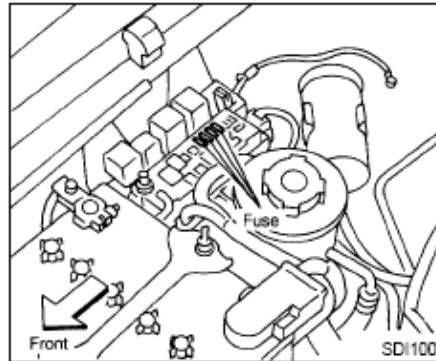

### Engine compartment

If any electrical equipment does not operate, check for an open fuse.

1. Be sure the ignition key and the headlight switch are "OFF".
2. Open the engine hood.
3. Remove the fusible link cover.
4. Remove the fuse with the fuse puller.
5. If the fuse is open, replace it with a new fuse.

Never use a fuse of higher amperage rating than that specified on the fuse box cover.

6. If a new fuse opens again, have the electrical system checked and repaired by your ParsKhodro dealer.

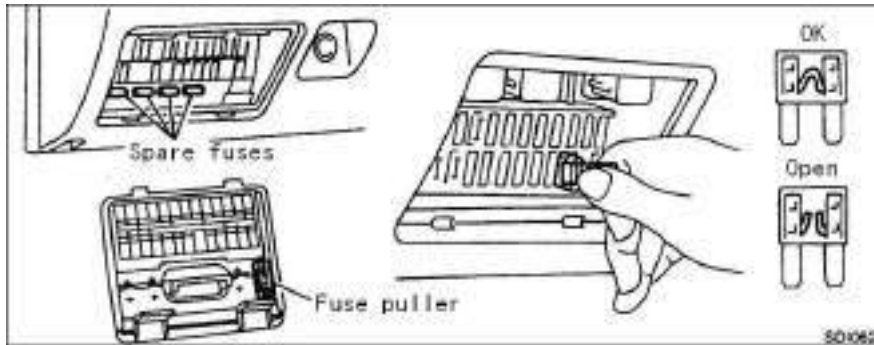

### Passenger compartment

If any electrical equipment does not operate, check for an open fuse.

1. Be sure the ignition key and the headlight switch are "OFF".
2. Remove the fuse box lid.
3. Remove the fuse with the fuse puller.
4. the fuse is open, replace it with a new fuse.

### **△ CAUTION**

**If never use a fuse of higher amperage rating than that specified on the fuse box cover.**

5. If a new fuse opens again, have the electrical system checked and repaired by your ParsKhodro dealer.

## LIGHT BULBS

### HEADLIGHTS

(Semi-sealed beam type)

The headlight is a semi-sealed beam type which uses a replaceable headlight bulb. A bulb can be replaced inside the engine compartment without removing the headlight assembly.

#### CAUTION:

High pressure halogen gas is sealed inside the halogen bulb. The bulb may break if the glass envelope is scratched or the bulb is dropped. Never touch the glass envelope.

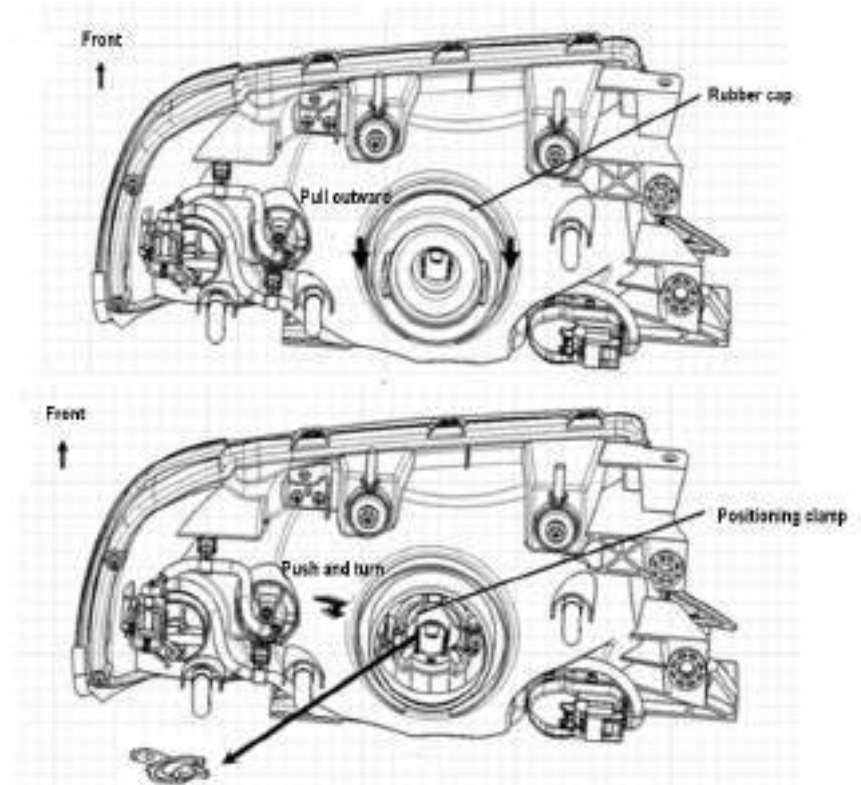



## Replacing the headlight bulb

1. Disconnect the negative battery cable.
2. Disconnect the electrical connector from the rear end of the bulb and remove the rubber cap.
3. Push and turn the retaining pin to loosen it.
4. Remove the headlight bulb. Do not shake or rotate the bulb when removing it.
5. Install the new bulb in the reverse order of removal. Press the rubber cap firmly so the lip comes into contact

with the headlight body.

### CAUTION:

- DO NOT TOUCH THE BULB.
- Use the same number and wattage as originally installed: Wattage 60/55.
- Aiming is usually not necessary after replacing the bulb. When aiming adjustment is necessary, contact your NISSAN dealer.
- Do not leave the bulb out of the headlight reflector for a long period of time as dust, moisture, smoke may enter the headlight body and affect

the performance of the headlight.

## OTHER LIGHTS

Item	Wattage(W)
Front turn signal light	21
Front position lamp	4.5 ( 0.5*9 )
Side turn signal light	5
Rear combination light	
Turn signal light	21

Stop/Tail light	21/5
Back-up light	21
Rear fog light	21
License plate light	5
Interior light	10
Personal light	8

# LIGHT LOCATION

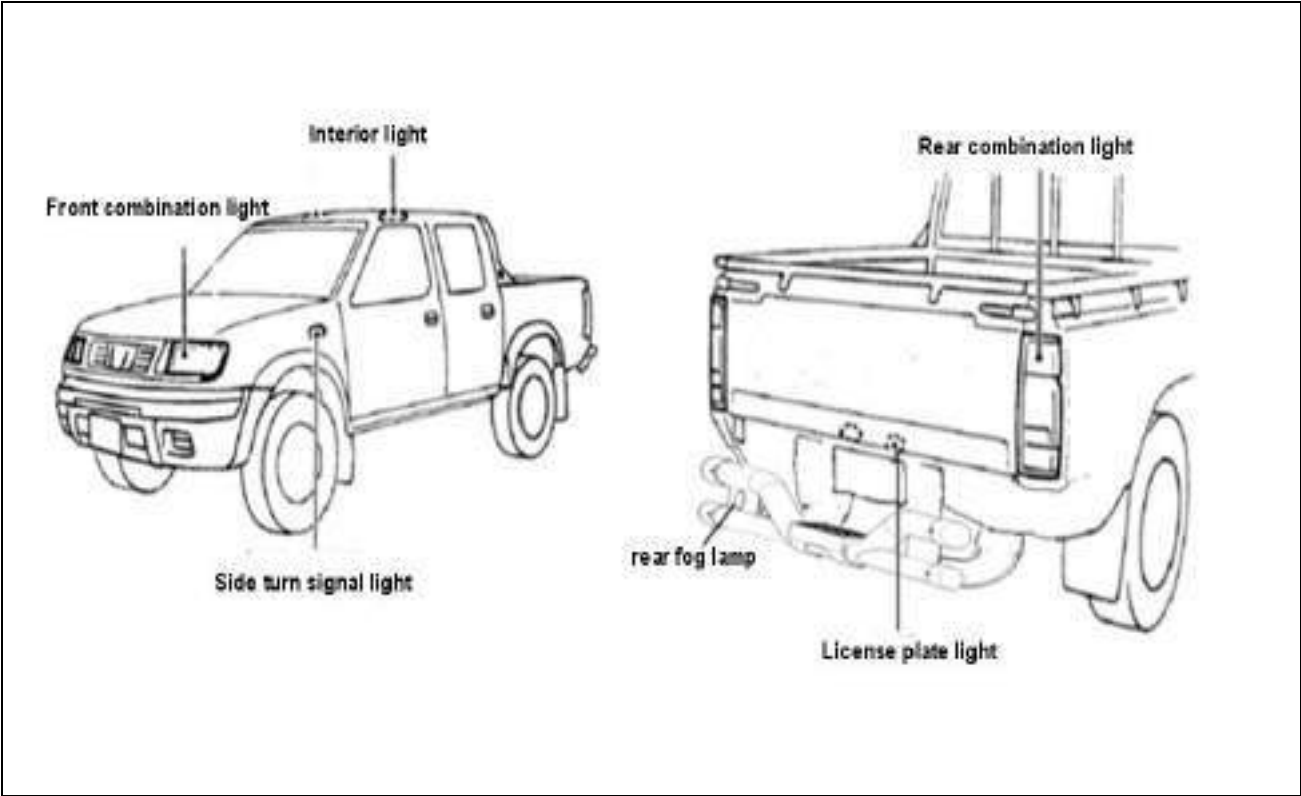

### Method for Replacement

These are all types of the light. Remove the shade first before you want to replace it.

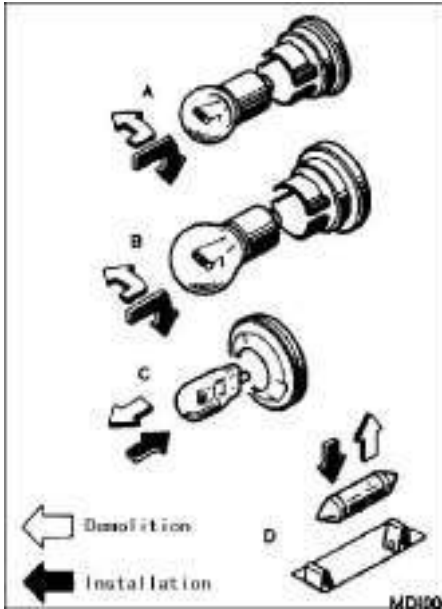

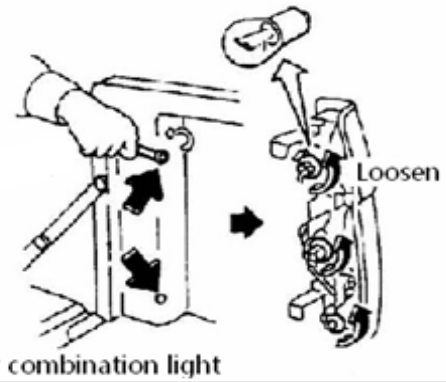
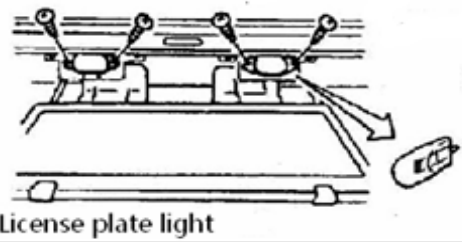
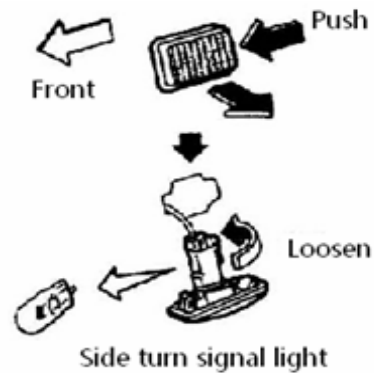
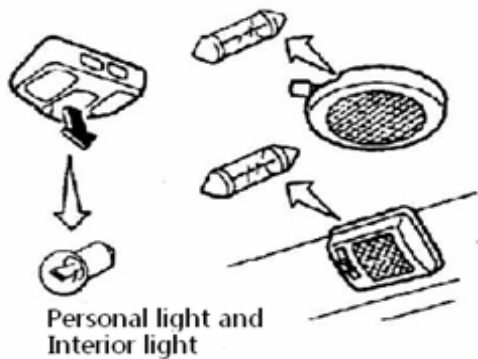

## COLD pressure

After vehicle has been parked for three hours or more or driven less than 1.6 km (1 mile).

Insufficient pressure can lead to an overheating of the tire and subsequent internal damage. At high speeds, this could result in tread separation and even bursting of the tire.

## Tire rotation

ParsKhodro recommends that tires be rotated every 10,000 km (6,000 miles) for 2WD vehicles and 5,000 km (3,000 miles) for 4WD vehicles.

See “Flat tire” in the “In case of emergency” section for tire replacing procedures.

- After rotating the tires, adjust the tire pressure.

### Warning

**Incorrect tire selection, fitting, care or maintenance can affect vehicle safety with risk of accident and injury. If in doubt, consult your ParsKhodro dealer or the tire manufacturer.**

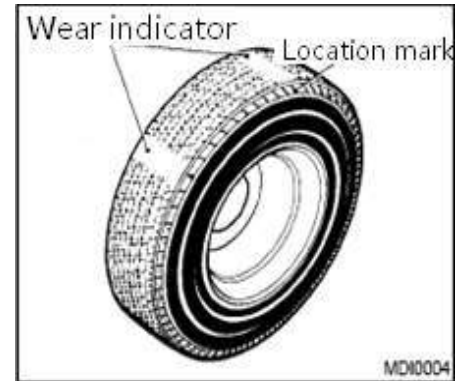

## Tire wear and damage

Tires should be periodically inspected for wear, cracking, bulging or objects caught in the tread. If excessive wear, cracks, bulging or deep cuts are found, the tire should be replaced.

The original tires have a built-in tread wear indicator. When the wear indicator is visible, the tire should be replaced.

## Tire age

Remember tire age. Never use a tire over six years old, regardless

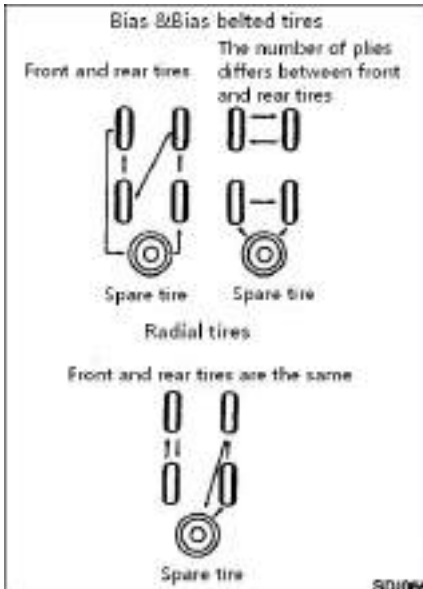

of whether it has been used or not.

Tires degrade with age as well as the use they are subjected to, have your tires checked and balanced frequently by a recognized tire agent. Report all accidents where the tire is knocked however minor.

### **Changing tires and wheels**

When replacing a tire, use the same size, speed rating and load carrying capacity as originally equipped. Recommended types and sizes are shown in “Wheels and tires” in the “Technical information” section. The use of tires other than those recommended or the mixed use of tires of different brands, construction (bias, bias-belted or radial), or tread patterns can adversely affect the ride, braking, handling, ground clearance, body-to-tire clearance, snow chain clearance, speedometer

calibration, headlight aim and

bumper height. Some of these effects may lead to accidents and could result in serious personal injury.

If the wheels are changed for any reason, always replace with wheels which have the same offset dimension. Wheels of a different offset could cause early tire wear, possibly degraded vehicle handling characteristics and/or interference with the brake discs/drums. Such interference can lead to decreased braking efficiency and/or early brake pad/shoe wear.

### **WARNING**

**Do not install a deformed wheel or tire even if it has been repaired. Such wheels or tires could have structural damage and could fail without warning.**

### **CAUTION**

- **Always use tires of the same size, brand, construction (bias, bias-belted or radial), and tread pattern on all four wheels. Failure to do so may result in a circumference difference between tires on the front and rear axles which will cause excessive tire wear and may damage the transmission, transfer case and differential gears.**
- **ONLY use spare tires specified for each 4-wheel drive model.**

### **Wheel balance**

Unbalanced wheels may affect vehicle handling and tire life. Even with regular use, wheels can get out of balance. Therefore, they should be balanced as required.

## Care of wheels

- Wash the wheels when washing the vehicle to maintain their appearance.
- Clean the inner side of the wheels when the wheel is changed or the underside of the vehicle is washed.
- Do not use abrasive cleaners when washing the wheels.
- Inspect wheel rims regularly for dents or corrosion. This may cause loss of pressure or damage the tire bead.
- ParsKhodro recommends that the road wheels be waxed to protect against road salt in areas where it is used during winter.

## Tire chains

Use of tire chains is prohibited according to location. Check the local laws before installing tire chains. When installing tire chains, make sure they are of proper size

for the tires on your vehicle and are installed according to the chain manufacturer's suggestions. Use chain tensioners when recommended by the tire chain manufacturer to ensure a tight fit. Loose end links of the tire chain must be secured or removed to prevent the possibility of whipping action damage to the fenders or undercarriage. In addition, drive at a reduced speed. Otherwise, your vehicle may be damaged and/or vehicle handling and performance may be adversely affected.

Never install tire chains on a small size spare tire.

Tire chains must be installed only on the rear wheels and not on the front wheels.

Do not drive with tire chains on paved roads which are clear of snow. Driving with chains in such conditions can cause damage to the various mechanisms of the vehicle due to some overstress. When driving on clear paved roads, be sure to change to 2WD.

## CLUTCH HOUSING

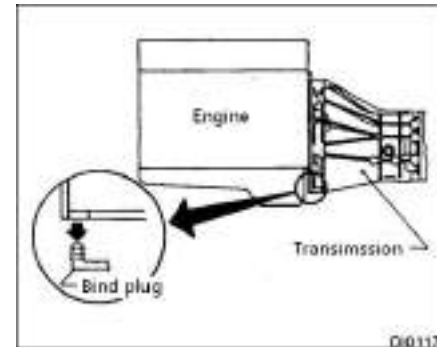

## Checking water entry

Whenever you drive in deep water or mud, check water entry in the clutch housing by removing the blind plug at the bottom of the transmission case. After checking, be sure to reinstall the plug.

## 8. MAINTENANCE SCHEDULE

MAINTENANCE REQUIREMENTS.....	8-2
GENERAL MAINTENANCE.....	8-3
OUTSIDE THE VEHICLE .....	8-3
INSIDE THE VEHICLE.....	8-4
UNDER THE HOOD AND VEHICLE .....	8-4
PERIODIC MAINTENANCE .....	8-5

ENGINE AND EMISSION CONTROL MAINTENANCE.....	8-6
CHASSIS BODY MAINTENANCE .....	8-7
MAINTENANCE UNDER SEVERE DRIVING CONDITIONS .....	8-8



## **MAINTENANCE REQUIREMENTS**

Your new vehicle has been designed to have minimum maintenance requirements with longer service intervals to save you both time and money. However, some day-to-day and regular maintenance is essential to maintain your vehicle's good mechanical condition, as well as its emission and engine performance.

It is the owner's responsibility to make sure that scheduled maintenance, as well as general maintenance, is performed.

As a vehicle owner, you are the only one who can ensure that your vehicle receives the proper maintenance care. You are a vital link in the maintenance chain.

### **Scheduled maintenance**

For your convenience, the required scheduled maintenance items are described and listed in a separate maintenance booklet. You must refer to that booklet to

ensure that necessary maintenance is performed on your vehicle at regular intervals.

### **General maintenance**

General maintenance includes those items which should be checked during normal day-to-day operation of the vehicle. They are essential if your vehicle is to continue to operate properly. It is your responsibility to perform these procedures regularly as prescribed.

Performing general maintenance checks require minimal mechanical skill and only a few general automotive tools.

These checks or inspections can be done by yourself, a qualified technician or, if you prefer, your ParsKhodro dealer.

### **Where to go for service**

If maintenance service is required or your vehicle appears to malfunction, have the systems checked and tuned by an authorized ParsKhodro dealer.

ParsKhodro technicians are

well-trained specialists and are kept up to date with the latest service information through technical bulletins, service tips, and in-dealership training programs. They are completely qualified to work on ParsKhodro's vehicles before they work on your vehicle, rather than after they have worked on it.

You can be confident that your ParsKhodro dealer's service department performs the best job to meet the maintenance requirements on our vehicle — in a reliable and economic way.

## GENERAL MAINTENANCE

During the normal day-to-day operation of the vehicle, general maintenance should be performed regularly as prescribed in this section. If you detect any unusual sounds, vibrations or smell, be sure to check for the cause or have your ParsKhodro dealer do it promptly. In addition, you should notify your ParsKhodro dealer if you think that repairs are required.

When performing any checks or maintenance work, closely observe “Maintenance precautions” later in this section.

## EXPLANATION OF GENERAL MAINTENANCE ITEMS

Additional information on the following items with “\*” is found later in this section.

## OUTSIDE THE VEHICLE

The maintenance items listed here should be performed from time to time, unless otherwise specified.

**Tires\*** Check the pressure with a gauge periodically when at a service station (including the spare) and adjust to the specified pressure if necessary. Check carefully for damage, cuts or excessive wear.

**Windshield wiper blades\*** Check for cracks or wear if they do not wipe properly.

**Doors and engine hood** Check that all doors and the engine hood operate properly. Also ensure that all latches lock securely. Lubricate hinges and latches if necessary. Make sure that the secondary latch keeps the hood from opening when the primary latch is released.

When driving in areas using road salt or other corrosive materials, check for lubrication frequently.

**Lights\*** Make sure that the

headlights, stop lights, tail lights, turn signal lights, and other lights are all operating properly and installed securely. Also check headlight aim.

**Tire rotation\*** Tires should be rotated every 10,000 km (6,000 miles) for 2WD vehicles and 5,000 km (3,000 miles) for 4WD vehicles. However, the timing for tire rotation may vary according to your driving habits and road surface conditions.

## INSIDE THE VEHICLE

The maintenance items listed here should be checked on a regular basis, such as when performing periodic maintenance, cleaning the vehicle, etc.

**Warning/indicator lights and buzzers/chimes** make sure that all warning/indicator lights and buzzers/chimes are operating properly.

**Steering wheel** Check for change in the steering conditions, such as excessive free play, hard steering or strange noises.

**Seat belts** check that all parts of the seat belt system (e.g. buckles, anchors, adjusters and retractors) operate properly and smoothly, and are installed securely. Check the belt webbing for cuts, fraying, wear or damage.

## UNDER THE HOOD AND VEHICLE

The maintenance items listed here should be checked periodically e.g. each time you check the engine oil or refuel.

**Windshield washer fluid\*** Check that there is adequate fluid in the tank.

**Engine coolant level\*** Check the coolant level when the engine is cold.

**Engine oil level\*** Check the level after parking the vehicle on a level spot and turning off the engine.

**Brake and clutch fluid level\*** Make sure that the brake and clutch fluid level is between the MAX and MIN lines on the reservoir.

### PRECAUTIONS

When performing any inspection or maintenance work on your vehicle, always take care to prevent serious accidental injury to yourself or damage to the vehicle. The following are general precautions which should be

closely observed.

- **Park the vehicle on a level surface, apply the parking brake securely and move the transmission control lever to neutral (“N”).**

- **When working under the engine hood, turn the engine off and wait until it cools down.**

- **Be sure to turn the ignition key to the “OFF” position when performing any replacement or repair.**

- **If you must work with the engine running, keep your hands, clothing, hair and tools away from moving fans and fan belts.**

- **It is advisable to remove necktie and any jewelry, such as rings, watch, etc. before working on your vehicle.**

- **If you must run the engine in an enclosed space such as a garage, be sure there is proper ventilation for exhaust gases.**

- **Never get under the vehicle while it is supported only by a jack. If it is necessary to work**

under the vehicle, support it with safety stands.

- **Keep smoking materials, flame and sparks away from fuel and battery.**
- **Never connect or disconnect either the battery or any transistorized component connector while the ignition key is on.**
- **Always apply the parking brake and block the wheels to prevent the vehicle from moving.**
- **On gasoline engine models with the multiport fuel injection (MFI) system, the fuel filter or fuel lines should be serviced by a ParsKhodro dealer because the fuel lines are under high pressure even when the engine is off.**
- **Failure to follow these or other common sense guidelines may lead to serious injury or vehicle damage.**
- **Improperly disposed motor oil and/or other vehicle fluids can hurt the environment.**

**Always conform to local regulations for disposal of vehicle fluid.**

This “Maintenance and do-it-yourself” section gives instructions regarding only those items which are relatively easy for an owner to perform.

You should be aware that incomplete or improper servicing may result in operating difficulties or excessive emissions, and could affect your warranty coverage. If in doubt about any servicing, have it done by your ParsKhodro dealer.

## **PERIODIC MAINTENANCE**

The following table's list the periodic maintenance servicing required ensuring good engine and emission control system performance and good mechanical condition of your new vehicle.

**The first 1000 km (600 miles) of cervical is one of the most important service periods and**

**is vital to ensure the optimum condition of your new vehicle.**

The following tables show the normal maintenance schedule. Depending on weather and atmospheric conditions varying road surfaces, individuate driving habits and vehicle usage, additional or more frequent maintenance may be required. See “Maintenance under severe driving conditions”.

Periodic maintenance beyond the last period shown on the labels requires similar maintenance.

## ENGINE AND EMISSION CONTROL MAINTENANCE

R=Replace; I=Check & replace; A=Adjust; C=Clean.

MAINTENANCE OPERATION	MAINTENANCE INTERVAL									
	kmx1000	1.5	5	10	15	20	25	30	35	40
Perform either at number of kilometers or months kmx1000 which ever comes first.	Months	—	3	6	9	12	15	18	21	24
Under hood and under vehicle										
Toque check manifolds & exhaust tube nuts & carburetor fixing nuts <sup>*1</sup>	I									
Adjust clearance of inspiration and exhaust valve				A		A		A		A
Check drive belts for cracks, fraying, wear & tension	I <sup>*1</sup>			I <sup>*1</sup>		I		I <sup>*1</sup>		I
Change engine anti-freeze coolant (ethylene glycol base, LLC)							R			R
Check cooling system				I		I		I		I
Check fuel lines										I
Clean & replace air cleaner filter (Dry type) ★			C	C	C	R	C	C	C	R
Engine oil (Adopt API SL oil) & oil filter			R	R	R	R	R	R	R	R
Replace fuel filter★							R			R
Check & replace spark plugs <sup>*2</sup>							R			R
Check ignition wires							I			I
Check PCV system								I		I
Check vacuum fitting hoses & connections <sup>*1</sup>				I		I		I		I
Check EVAP vapor lines							I			I
Check heated Oxygen sensor (exhaust sensor)							I			I

NOTE: Maintenance items with “★” should be performed more frequently according to “Maintenance under severe driving conditions”.

\*1 Vehicle without three-way catalytic converter.

\*2 Vehicle with three-way catalytic converter.

# CHASSIS BODY MAINTENANCE

R=Replace; I=Check & replace; A=Adjust; C=Clean.

MAINTENANCE OPERATION	MAINTENANCE INTERVAL									
	km×1000	1.5	5	10	15	20	25	30	35	40
Perform either at number of kilometers or months km×1000 which ever comes first.	Months	—	3	6	9	12	15	18	21	24
Under hood										
Check brake, clutch, steering gear fluid or oil level for leaks			I	I	I	I	I	I	I	I
Check brake fluid*						R				R
Check brake booster vacuum hoses, connection & check valve						I				I
Check power steering fluid & lines			I	I	I	I	I	I	I	I
Check brake, clutch exhaust system			I	I	I	I	I	I	I	I
Check oil level change oil in manual transmission※			I	I	I	I	I	I	I	I
Check oil level change oil in transfer differential gear			I	I	I	R	I	I	I	R
Antiskid differential mechanism gear oil				I		R		I		R
Check steering gear box linkage, axle, suspension parts drive shaft*		I	I	I	I	I	I	I	I	I
Check steering damper				I		I		I		I
Retighten body mounting		T		T		T		T		T
Outside and inside										
Check wheel alignment, if necessary, rotate & balance wheel				I		I		I		I
Check brake pads, disc & other brake components*			I	I	I	I	I	I	I	I
Check brake lings, drums & other components*				I		I		I		I
Check for wheel bearing grease ( 4×2 )						I				I
Check & repack front wheel latch ( 4×4 ) *				I*		R		I*		R
Lubricate lock, hinges hood latch*		L	L	L	L	L	L	L	L	L
Check seat belts, buckles, retractors & anchors adjuster			I			I		I		I
Check foot brake, parking brake & clutch for free play stroke & operation		I	I	I	I	I	I	I	I	I

NOTE : Maintenance items with “★” should be performed more frequently according to “Maintenance under severe driving conditions”

※ : Change oils every 100,000 km.

## MAINTENANCE UNDER SEVERE DRIVING CONDITIONS

The maintenance intervals shown on the preceding pages are for normal operating conditions. If the vehicle is mainly operated under severe driving conditions as shown below, more frequent maintenance must be performed on the following items as shown on the table.

### Severe driving conditions

A— Driving under dusty conditions

B— Driving repeatedly short distance

C— Towing a trailer

D— Extensive idling

E— Driving in extremely adverse weather condition or in areas where ambient temperatures are either extremely low or extremely high.

F— Driving in high humidity areas or in mountainous areas.

G— Driving in areas using salt or other corrosive materials. in the desert.

I— Frequent Brake or driving in mountainous areas

J— Frequent driving in water.

H— Driving on rough and /or muddy roads or										
Driving condition					maintenance		Maintenance operation	Maintenance interval		
A	.	.	.	.	.	Air cleaner filter			More frequently	
						Dry type		Clean		
						All type		Replace		
						Cyclone pre-air cleaner		Check		
						Positive crankcase ventilation filter & air induction valve filter		Replace		
A	B	C	D	.	.	Engine oil		Replace	Every 2,500km or 1.5 months.	
						Gasoline engine				
A	B	C	D	.	.	Engine oil		Replace	Every 2,500 km or 1.5 months.	
A	.	.	.	E	.	Fuel fluid			Every 10,000 km or 6 months.	
.	.	.	.	F	.	Brake fluid				
.	.	.	.	.	G	H	.	Steering gear & linkage, axle & suspension parts, propeller shafts & front drive shafts	Check	Every 2,500 km or 1.5 months.
A	C	.	.	.	G	H	I	Brake pad, disc & other brake components.	Check	
A	C	.	.	.	G	H	I	Brake linings, drums & other brake components	Check	Every 5,000 km or 3 months.
.	.	.	.	.	.	.	J	Front wheel bearing grease & free-running hub grease ( 4x4 )	Check	Every 2,500 km or 1.5 months.
.	.	.	.	.	G	.	.	Lock, hinges & hood latch	lubricate	

**Maintenance operation:** Check=Check. Correct or replace if necessary.

# 9. TECHNICAL INFORMATION

CAPACITIES AND RECOMMENDED FUEL/LUBRICANTS .....	9-2	TIGHTEN TORQUE OF BOLT AND NUT IN KEY POSITION OF MAINTENANCE AND REPAIR ..	9-9
RECOMMENDED FUEL .....	9-4	DRIVER'S TOOLS .....	9-9
RECOMMENDED SAE VISCOSITY NUMBER.....	9-5	THE VEHICLE TECHNICAL PERFORMANCE FIGURE .....	9-10
AIR CONDITIONING SYSTEM REFRIGERANT AND LUBRICANT RECOMMENDATIONS.....	9-5	WHEN TRAVELING OR REGISTERING IN ANOTHER COUNTRY .....	9-11
ENGINE .....	9-6	VEHICLE IDENTIFICATION .....	9-11
WHEELS AND TIRES .....	9-7		
TIRE PRESSURE.....	9-7		
WHEEL ALIGNMENT PARAMETER.....	9-8		



## CAPACITIES AND RECOMMENDED FUEL/LUBRICANTS

The following values are approximate capacities. The actual refill capacities may be a little different from them. When refilling, follow the procedure instructed in the “Maintenance and do-it-yourself” section to determine the proper refill capacity.

		Capacity(approximate)	Recommended fuel/lubricants
		Liter	
Fuel		60	
Engine oil ( Refill )			
ZG24	With oil filter	6	· API Certification Mark <sup>*2</sup> · API SL
Cooling system ( with reservoir tank )			PARSKHODRO Genuine Engine Coolant or equivalent in its quality.
ZG24	With air condition	9.5	

\*1. For further details, see the recommended fuel chart.

\*2. For further details, see the recommended SAE viscosity chart.

	Capacity ( approximate ) Liter	Recommended fuel/lubricants
Manual transmission oil	2.2	API GL-4 <sup>*1</sup> viscosity SAE75W-90 only
Main reducing gear oil	1.6	API GL-5 <sup>*1</sup>
Power steering fluid	Refill to the proper oil level according to the instructions in the "Maintenance and do-it yourself" section.	PARSKHODRO ATF DX or equivalent product <sup>*3</sup>
Brake and clutch fluid		PARSKHODRO brake fluid <sup>*4</sup> or equivalent product DOT 4
Transfer	Manual type	75W/90, API GL-4
	Electric type	SPEC40-00-244-001, ATF DEXRON III
Multi-purpose grease	--	NLGI NO.2 (Lithium soap base)
Air condition system refrigerant kg		HFC-134a ( R-134a ) <sup>5</sup>
Air condition system lubricants		PARSKHODRO air condition system R model oil or equivalent product. <sup>*5</sup>

\*1. For further details, see the recommended SAE viscosity chart.

\*2. Could be gotten from authorized dealer.

\*3. For further information , see the index tag of air condition.

## RECOMMENDED FUEL

Unleaded gasoline of above 87 octane (RON) ( or automotive ethanol gasoline ) .

### **△ CAUTION**

- **Doesn't use recommend fuel will heavily damage the emission control system , and influence the control circle.**
- **In any situation , Don't use leaded gasoline , it will damage the three way catalytic converter.**

Except for three way catalyst equipped models: Unleaded or leaded gasoline of above 87 octane (RON).

### **△ CAUTION:**

**Use unleaded gasoline if instructed on the fuel filler lid.**

## RON CAUTION TRANSACTION:

Use unleaded gasoline of above 93 octane ( RON ) ( or alcohol gasoline for car ) 。 But on the high altitude localities ( over 1219m ) , you could use unleaded gasoline of 88 octanes (or alcohol gasoline for car).

It will cause continued, oppressive knocking when using the unleaded gasoline of below 93 octane .Knocking is a kind of sound similarly as knocking metal. It could damage the engine when the situation is severe. If there is oppressive knocking or jar less knocking driving on the lever road with jar less speed when you use the previous fuel , please contact the authorized PARSKHODRO maintenance service center to adjust the working condition for you. Else , the car was inappropriate used , there is no duty of PARSKHODRO.

Incorrect timing ignition will cause knocking; then, it could increase the oil wear and damage engine by over heat. If you face any

previous situation, please contact authorized PARSKHODRO maintenance service center to check your car.

But, you will hear light knocking once in a while when accelerating or climbing. Don't worry, because the light knocking indicates that the engine got the highest oil efficiency in the situation of big load.

## RECOMMENDED SAE VISCOSITY NUMBER

Outside Temperature Range  
Anticipated Before Next Oil Change

Gasoline Engine Oil

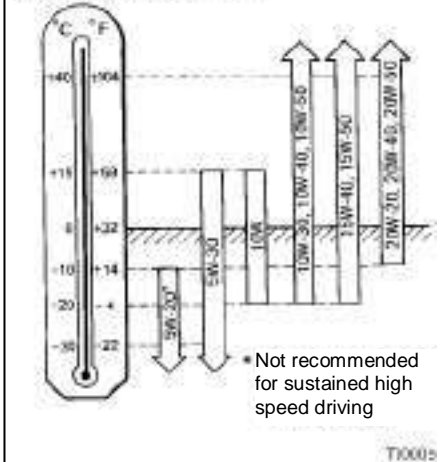

### Recommend SAE Viscosity number

- **For cold and warm areas :**  
10W-30 is preferable for ambient temperature above -20°C.
- **For hot areas :**  
15W-40 20W-20 and 20W-50 are suitable.

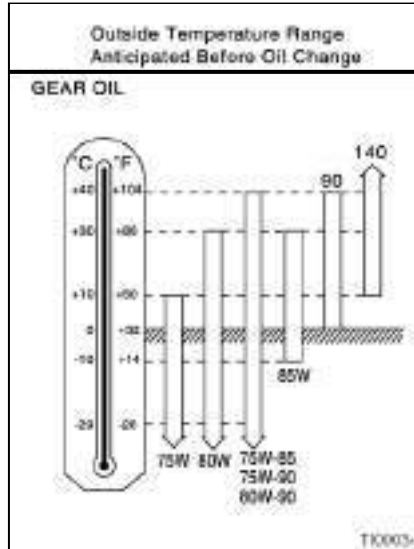

- **For cold and warm areas :**  
75W-90 is preferable for gasoline engine vehicle's transmission system and gearing system.  
80W-90 is preferable for differential gear.
- **For hot areas :**  
90 is suitable for ambient temperatures below 40°C.

## AIR CONDITIONING SYSTEM REFRIGERANT AND LUBRICANT RECOMMENDATIONS

The air conditioning system in this PARSKHODRO vehicle must be charged with the refrigerant HFC-134a (R-134a) and the lubricant, Nissan A/C System Oil Type R or the exact equivalents.

### ⚠ CAUTION:

**Use of any other refrigerants or lubricants will cause severe damage and you will need to replace your vehicle's entire air conditioning system.**

The release of refrigerant into the atmosphere is not recommended. The new refrigerant HFC-134a (R-134a) in your PARSKHODRO vehicle will not harm the earth's ozone layer. However it may contribute in a small part to global warming. PARSKHODRO recommends that the refrigerant be recovered and recycled.

## ENGINE

ZG24		
Cylinder arrangement		4-cylinder,in-line
Type		Gasoline,4-cylcle
Bore x stroke	(mm)	95x86
Displacement	(ml)	2438
Firing order		1—3—4—2
Max power and relevant speed	( kW/rpm )	102/4600 ~ 5000
Max torque and relevant speed	( N*m/rpm )	217/2600 ~ 3200
Idle speed	(rpm)	M/T: 750±50
Spark plug (Standard)Gap	(mm)	1.1±0.1
Camshaft operation		Timing chain
Emissions		Euro IV+OBD

\*: When the switching vacuum hoses cutting-off, ram it using plunger.

## WHEELS AND TIRES

Tire	Car model	Wheel	Pick-up	VAN
LT215/75R15,6PR		15x6JJ , 15x5½JK	○	
LT215/75R15,8PR		15x6JJ , 15x5½JK	○	
P215/75R15		15x6½JJ		○

○ : Equipment      ● : Available      × : Unavailable

## TIRE PRESSURE

	Tire pressure ( F/R ) Kpa	
	half load	Fully loaded
LT215/75R15,6PR	250/250	250/350
LT215/75R15,8PR	250/250	250/450
P215/75R15	180/200	200/250

## WHEEL ALIGNMENT PARAMETER

Item			4x2 model	4x4model
Kingpin inclination			9°13'±30'	10°48'±30'
Caster angle			0°32'±30'	2°10'±30'
Front-wheel camber			0°17'±30'	0°36'±30'
Convergences of front wheels(mm)			3 ~ 5	4 ~ 6
Max front wheel turning angle	Nearside wheel	LT215/75R15	36°12 <sup>0'</sup> <sub>.2°</sub>	35°18 <sup>0'</sup> <sub>.2°</sub>
	Off-side wheel	LT215/75R15	32°48 <sup>0'</sup> <sub>.2°</sub>	33°30 <sup>0'</sup> <sub>.2°</sub>

Note: The parameter upwards is in unladed state of the vehicle.

## TIGHTEN TORQUE OF BOLT AND NUT IN KEY POSITION OF MAINTENANCE AND REPAIR

(UNIT: N\*m)

- |  |   |
|--|---|
| <ol style="list-style-type: none"> <li>1. Engine crankcase drain plug: 29-39</li> <li>2. Engine adjustment lock nut: 16-21</li> <li>3. Fueling plug and drain plug of transmission \ power divider: 25-34</li> <li>4. Transaxle drain plug R: 59-98</li> <li>5. Bolt and nut of propeller shaft: 39-44</li> <li>6. Wheel nut: 118-147</li> <li>7. Steering wheel lock nut: 29-39</li> <li>8. Steering drive shaft universal joint tighten bolt: 24-29</li> <li>9. Coupling bolt between steering gear case and supporter: 84-96</li> <li>10. Steering rocker arm shaft lock nut</li> </ol> | <p>No power steering: 235-265<br/>Power steering: 137-177</p> <ol style="list-style-type: none"> <li>11. Steering link ball nut: 54-98</li> <li>12. Steering tie rod lock nut: 2WD: 14-20</li> <li>13. Front suspension top swing arm adjustment bolt: 98-118</li> <li>14. Front shock absorber bottom tighten bolt: 118-147</li> <li>15. Rear leaf spring pin and hanger pin lock nut: 78-98</li> <li>16. Rear leaf spring U-shape bolt and nut: 88-98</li> <li>17. Seat belt abutment anchor bolt: 43-55</li> </ol> |
|--|---|

### DRIVER'S TOOLS

No.	Name	Amount	note
1	Kit bag	1	
2	Wheel sleeve	1	

No.	Name	Amount	note
3	Jack assembly	1	
4	Jack bar	1	



## THE VEHICLE TECHNICAL PERFORMANCE FIGURE

Item	Drive Mode		4×2	4×4
	Vehicle Code		ZN1033U2N4	ZN1033UBN4
	Body Mode		Double cab	Double cab
Overall Length	mm		4885	4980
Overall Width	mm		1690	1820
Overall Height	mm		1650	1715
Wheelbase	mm		2950	2950
Platform Dimensions	L	mm	1395	1395
	W	mm	1390	1390
	H	mm	430	430
Complete Vehicle Design MAX Mass	kg		2570	2740
Complete Vehicle curb Mass	kg		1495	1665
Rated Load Mass	kg		750	750
Amount Of Occupant	P		5	5
Tire Tread	F	mm	1415	1545
	R	mm	1410	1525
MAX Speed	km/h		160	160
Approach Angle / Leave Angle	°		29/26	42/36
Ground Clearance	mm		210	215
MAX Climbing Capacity			≥30%	≥40%
			The overall length will be 4980mm if equipped with rear bumper, the Leave Angle of the 4×2 will be 20° and the 4×4 will be 32°.	

## **WHEN TRAVELING OR REGISTERING IN ANOTHER COUNTRY**

When planning to travel in another country, you should first find out if the fuel available is suitable for your vehicle's engine.

Using fuel with too low an octane rating may cause engine damage. Therefore, avoid taking your vehicle to areas where appropriate fuel is not available.

When traveling or registering in another country, state, province or district, check with the local authorities that the vehicle complies with the requirements.

The laws and regulations for motor vehicle emission control and safety standards vary according to the country, state, province or district; therefore, vehicle specifications may differ.

When any vehicle is to be taken into another country, state, province or district and registered, its modifications, transportation and registration are the responsibility of the user.

PARSKHODRO is not responsible

for any inconvenience that may result.

## **VEHICLE IDENTIFICATION**



Vehicle identification plate is affixed as shown.

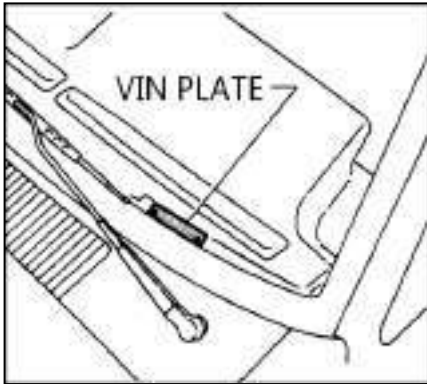

### **VEHICLE IDENTIFICATION NUMBER (VIN) PLATE**

VIN plate is affixed on the left side of instrument panel in the cab as shown. The VIN code is your vehicle's identification code which will be available while vehicle registering,

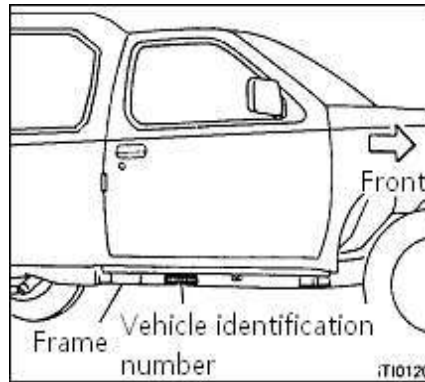

### **VEHICLE IDENTIFICATION NUMBER (VIN)**

The Vehicle identification number is stamped as shown.



### **ENGINE SERIAL NUMBER**

The number is stamped on the engine as shown.

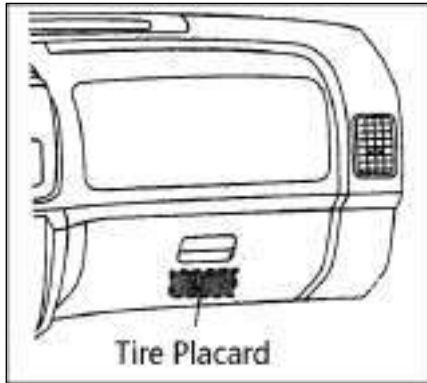

### **TIRE PLACARD**

The cold tire pressure is shown on the tire placard. The tire placard is stamped on the glove box as shown.

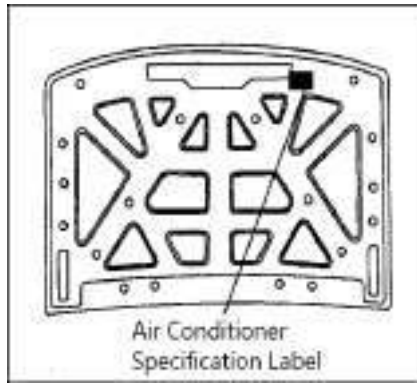

### **AIR CONDITIONER SPECIFICATION LABEL**

The label is stamped under the engine cover as shown.

# 10. INDEX

4x4 TIRES OF 4-WHEEL DRIVE	4-17	<b>C</b>	ENGINE COOLING SYSTEM	7-6
4x4 TRANSFER CASE		CAPACITIES	ENGINE OIL	7-8
SHIFTING	4-10	RECOMMENDED	EXHAUST GAS (CARBON MONOXIDE)	4-3
<b>A</b>		FUEL/LUBRICANTS		
AIR CLEANER FILTER	7-15	CARE WHEN DRIVING	<b>F</b>	
AIR CONDITIONING SYSTEM		CENTER AND SIDE VENT	FASTEN HOOK	2-6
REFRIGERANT AND LUBRICANT	9-5	CHASSIS BODY MAINTENANCE	FLATE TIRE	5-2
RECOMMENDATIONS		CIGARETTE LIGHTER AND ASH TRAYS	FOR YOUR VEHICLE SECURITY	4-19
ANTI-LOCK BRAKE SYSTEM ( ABS ) ( IF SO EQUIPPED )	4-21	CLEANING EXTERIOR AND INTERIOR	FREEING VEHICLE FROM SAND, SNOW OR MUD	5-10
AUTO-LOCK FREE-RUNNING HUBS	4-11	CLOCK	FUEL FILLER LID AND CAP	2-4
<b>B</b>		CLUTCH HOUSING	FUEL GAUGE	1-5
BACK DOOR	2-5	<b>D</b>	FUSES	7-18
BATTERY	7-12	DOOR LOCKS	<b>G/H</b>	
BEFORE STARTING THE ENGINE	4-2	DRIVE BELTS	GENERAL MAINTENANCE	8-3
BRAKE AND CLUTCH FLUID	7-11	DRIVER'S TOOLS	GLOVE BOX	2-3
BRAKE BOOSTER	7-17	DRIVING SAFETY PRECAUTIONS	HAZARD WARNING FLASHER SWITCH	1-12
BRAKE CONDITIONS	7-17	DRIVING WITH MANUAL TRANSMISSION	HEAD LIGHT, SIMMER AND TURN SIGNAL SWITCH	1-11
BREAK-IN SCHEDULE	4-2	<b>E</b>	HEATER AND CONDITIONER	3-2
		ENGINE	HOOD RELEASE	2-3
		ENGINE AND EMISSION CONTROL MAINTENANCE		
		ENGINE COOLANT TEMPERATURE GAUGE	<b>I</b>	
			IF YOUR VEHICLE OVERHEATS	5-7
			IGNITING SWITCH	4-6
			IN COLD WEATHER	4-22
			INSIDE THE VEHICLE	8-4

INSPECTION LIGHT ( IF SO EQUIPPED )	1-14	STARTING AND DRIVING PROTECTING AGAINST CORROSION	6-4	TIGHTEN TORQUE OF BOLT AND NUT IN KEY POSITION OF MAINTENANCE AND REPAIR	9-9
INSTRUMENT PANEL	1-2	PUSH STARTING	5-6	TILTING STEERING WHEEL	2-14
INTERIOR LIGHT	1-14			TIRE PRESSURE	9-7
<b>J/L/M/O</b>		<b>R</b>		TOW TRUCK TOWING	5-7
JUMP STARTING	5-6	RADIO	3-6	TRAILER TOWING	4-5
JUMP STARTING	7-13	REAR FOG LIGHT SWITCH	1-15	<b>V/W</b>	
LIGHT BULBS	7-19	REARVIEW MIRROR	2-15	VEHICLE IDENTIFICATION	9-12
MAINTENANCE REQUIREMENTS	8-2	RECOMMENDED FUEL	9-4	WARNING/IDICATOR LIGHTS AND AUDIBLE REMINDERS	1-7
MAINTENANCE UNDER SEVERE DRIVING CONDITIONS	8-8	RECOMMENDED SAE VISCOSI NUMBER	9-5	WHEEL ALIGNMENT	
METERS AND GAUGES	1-3	REMOTE KEYLESS ENTRY SYSTEM(IF SO EQUIPPED)	2-15	PARAMETER	9-8
OBD(IF SO EQUIPPED)	1-15	<b>S</b>		WHEELS AND TIRES	7-24
OUTSIDE MIRROR	2-15	SEAT BELTS	2-10	WHEELS AND TIRES	9-7
OUTSIDE THE VEHICLE	8-3	SEATS	2-7	WHEN TRAVELING OR REGISTERING IN ANOTHER COUNTRY	9-12
<b>P</b>		SPARK PLUG REPLACEMENT	7-14	WINDOW WASHER FLUID	7-12
PARKING	4-18	SPEEDOMETER AND		WINDSHIELD WIPER AND	
PARKING BRAKE LEVER	2-14	ODOMETER	1-4	WASHER SWITCH	1-10
PERIODIC MAINTENANCE	8-5	STARTING ENGINE	4-7	WIPER BLADES	
POWER STEERING FLUID	7-11	SUPPLEMENTAL RESTRAINT SYSTEM(IF SO EQUIPPED)	2-9	REPLACEMENT	7-16
POWER WINDOW	1-13	<b>T</b>			
PRECAUTIONS	7-2	TACHOMETER	1-4		
PRECAUTIONS WHEN DRIVING	4-19	TAILGATE LATCH	2-5		
PRECAUTIONS WHEN DRIVING ON-PAVEMENT AND OFF-ROAD PRECAUTIONS WHEN	4-4 4-3	THE VEHICLE TECHNICAL PERFORMANCE FIGURE	9-10		