

A/C SWITCH-DUAL PRESSURE(-)
A/C SWITCH-DUAL PRESSURE(+)
CAN-H
CAN-L
ODOMETER
TACHOMETER
SRS-ECU
A/C-ECU

crankshaft position sensor CT19

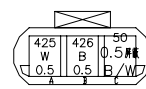

intake air temperature /pressure sensor CT20

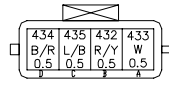

ignition coil CT5

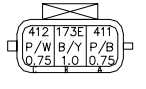

Froxygen sensor CT7

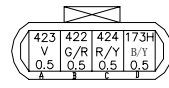

contact engine room CABLE2

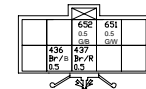

contact engine room CABLE1

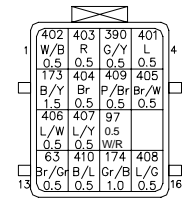

oil pressure sensor CD-Z037



contact engine CABLE1 CD-Z107

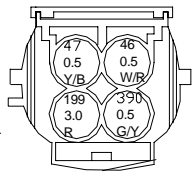

ignition switch CD-H005

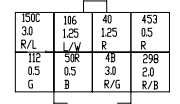

contact engine room CABLE-B



canister solenoid CT11

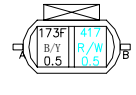

alternator CD-Z081

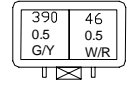

throttle position sensor CT18

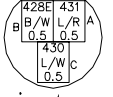

idle air stepper motor control valve CT16

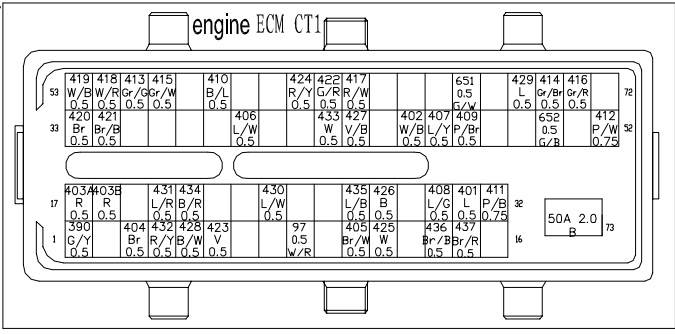
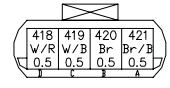

engine management system

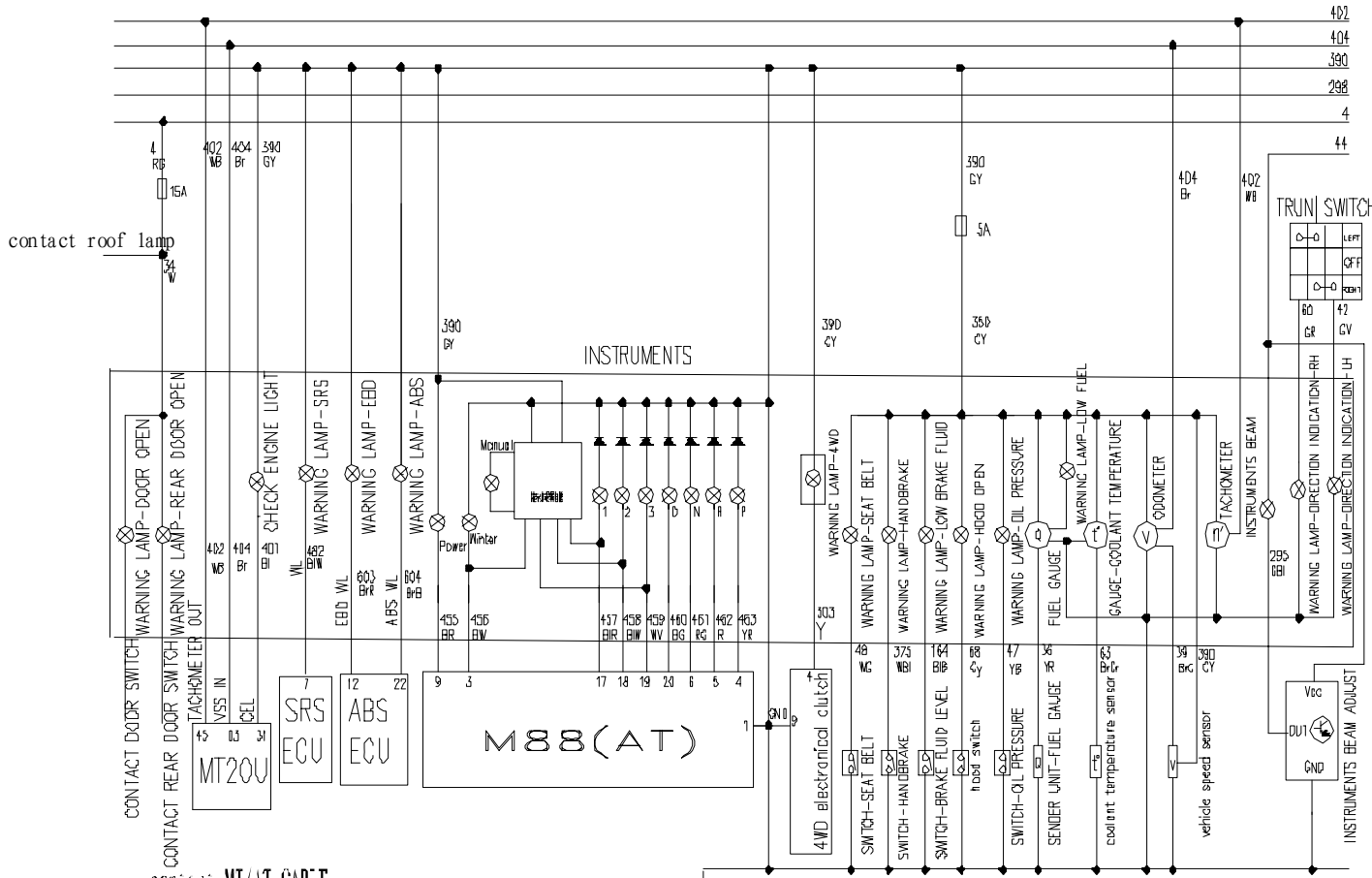

contact roof lamp
contact engine room CABLE 3
CD-H397
INSTRUMENTS-3
AVP 0316774

10857R	0.5	30	0.83	0.5	0.1	44
10857L	0.5	30	0.83	0.5	0.1	44
10857R	0.5	30	0.83	0.5	0.1	44
10857L	0.5	30	0.83	0.5	0.1	44
10857R	0.5	30	0.83	0.5	0.1	44
10857L	0.5	30	0.83	0.5	0.1	44

29	0.5	30	0.83	0.5	0.1	44
30	0.5	30	0.83	0.5	0.1	44
31	0.5	30	0.83	0.5	0.1	44
32	0.5	30	0.83	0.5	0.1	44
33	0.5	30	0.83	0.5	0.1	44
34	0.5	30	0.83	0.5	0.1	44

462 R	0.5	461 R/L	0.5	460 R/L	0.5	459 R/L	0.5	458 R/L	0.5	457 R/L	0.5
463 R	0.5	462 R/L	0.5	461 R/L	0.5	460 R/L	0.5	459 R/L	0.5	458 R/L	0.5

44	0.5	43	0.5	42	0.5	41	0.5	40	0.5	39	0.5	38	0.5	37	0.5	36	0.5	35	0.5	34	0.5	33	0.5	32	0.5	31	0.5	30	0.5	29	0.5	28	0.5	27	0.5	26	0.5	25	0.5	24	0.5	23	0.5	22	0.5	21	0.5	20	0.5	19	0.5	18	0.5	17	0.5	16	0.5	15	0.5	14	0.5	13	0.5	12	0.5	11	0.5	10	0.5	9	0.5	8	0.5	7	0.5	6	0.5	5	0.5	4	0.5	3	0.5	2	0.5	1	0.5
----	-----	----	-----	----	-----	----	-----	----	-----	----	-----	----	-----	----	-----	----	-----	----	-----	----	-----	----	-----	----	-----	----	-----	----	-----	----	-----	----	-----	----	-----	----	-----	----	-----	----	-----	----	-----	----	-----	----	-----	----	-----	----	-----	----	-----	----	-----	----	-----	----	-----	----	-----	----	-----	----	-----	----	-----	----	-----	---	-----	---	-----	---	-----	---	-----	---	-----	---	-----	---	-----	---	-----	---	-----

contact engine room CABLE 1
CD-E085

14L	0.5	14R	0.5	13L	0.5	13R	0.5	12L	0.5	12R	0.5	11L	0.5	11R	0.5	10L	0.5	10R	0.5	9L	0.5	9R	0.5	8L	0.5	8R	0.5	7L	0.5	7R	0.5	6L	0.5	6R	0.5	5L	0.5	5R	0.5	4L	0.5	4R	0.5	3L	0.5	3R	0.5	2L	0.5	2R	0.5	1L	0.5	1R	0.5
-----	-----	-----	-----	-----	-----	-----	-----	-----	-----	-----	-----	-----	-----	-----	-----	-----	-----	-----	-----	----	-----	----	-----	----	-----	----	-----	----	-----	----	-----	----	-----	----	-----	----	-----	----	-----	----	-----	----	-----	----	-----	----	-----	----	-----	----	-----	----	-----	----	-----

contact floor CABLE 2
CD-H374

14L	0.5	14R	0.5	13L	0.5	13R	0.5	12L	0.5	12R	0.5	11L	0.5	11R	0.5	10L	0.5	10R	0.5	9L	0.5	9R	0.5	8L	0.5	8R	0.5	7L	0.5	7R	0.5	6L	0.5	6R	0.5	5L	0.5	5R	0.5	4L	0.5	4R	0.5	3L	0.5	3R	0.5	2L	0.5	2R	0.5	1L	0.5	1R	0.5
-----	-----	-----	-----	-----	-----	-----	-----	-----	-----	-----	-----	-----	-----	-----	-----	-----	-----	-----	-----	----	-----	----	-----	----	-----	----	-----	----	-----	----	-----	----	-----	----	-----	----	-----	----	-----	----	-----	----	-----	----	-----	----	-----	----	-----	----	-----	----	-----	----	-----

contact floor CABLE 1
CD-H374

14L	0.5	14R	0.5	13L	0.5	13R	0.5	12L	0.5	12R	0.5	11L	0.5	11R	0.5	10L	0.5	10R	0.5	9L	0.5	9R	0.5	8L	0.5	8R	0.5	7L	0.5	7R	0.5	6L	0.5	6R	0.5	5L	0.5	5R	0.5	4L	0.5	4R	0.5	3L	0.5	3R	0.5	2L	0.5	2R	0.5	1L	0.5	1R	0.5
-----	-----	-----	-----	-----	-----	-----	-----	-----	-----	-----	-----	-----	-----	-----	-----	-----	-----	-----	-----	----	-----	----	-----	----	-----	----	-----	----	-----	----	-----	----	-----	----	-----	----	-----	----	-----	----	-----	----	-----	----	-----	----	-----	----	-----	----	-----	----	-----	----	-----

contact engine room CABLE 1
CD-E085

46	0.5	45	0.5	44	0.5	43	0.5	42	0.5	41	0.5	40	0.5	39	0.5	38	0.5	37	0.5	36	0.5	35	0.5	34	0.5	33	0.5	32	0.5	31	0.5	30	0.5	29	0.5	28	0.5	27	0.5	26	0.5	25	0.5	24	0.5	23	0.5	22	0.5	21	0.5	20	0.5	19	0.5	18	0.5	17	0.5	16	0.5	15	0.5	14	0.5	13	0.5	12	0.5	11	0.5	10	0.5	9	0.5	8	0.5	7	0.5	6	0.5	5	0.5	4	0.5	3	0.5	2	0.5	1	0.5
----	-----	----	-----	----	-----	----	-----	----	-----	----	-----	----	-----	----	-----	----	-----	----	-----	----	-----	----	-----	----	-----	----	-----	----	-----	----	-----	----	-----	----	-----	----	-----	----	-----	----	-----	----	-----	----	-----	----	-----	----	-----	----	-----	----	-----	----	-----	----	-----	----	-----	----	-----	----	-----	----	-----	----	-----	----	-----	----	-----	----	-----	---	-----	---	-----	---	-----	---	-----	---	-----	---	-----	---	-----	---	-----	---	-----

contact air-bag CABLE
contact engine room CABLE 2
CD-E075

462	0.5	461	0.5	460	0.5	459	0.5	458	0.5	457	0.5
-----	-----	-----	-----	-----	-----	-----	-----	-----	-----	-----	-----

29	0.5	28	0.5	27	0.5	26	0.5	25	0.5	24	0.5	23	0.5	22	0.5	21	0.5	20	0.5	19	0.5	18	0.5	17	0.5	16	0.5	15	0.5	14	0.5	13	0.5	12	0.5	11	0.5	10	0.5	9	0.5	8	0.5	7	0.5	6	0.5	5	0.5	4	0.5	3	0.5	2	0.5	1	0.5
----	-----	----	-----	----	-----	----	-----	----	-----	----	-----	----	-----	----	-----	----	-----	----	-----	----	-----	----	-----	----	-----	----	-----	----	-----	----	-----	----	-----	----	-----	----	-----	----	-----	---	-----	---	-----	---	-----	---	-----	---	-----	---	-----	---	-----	---	-----	---	-----

INSTRUMENTS

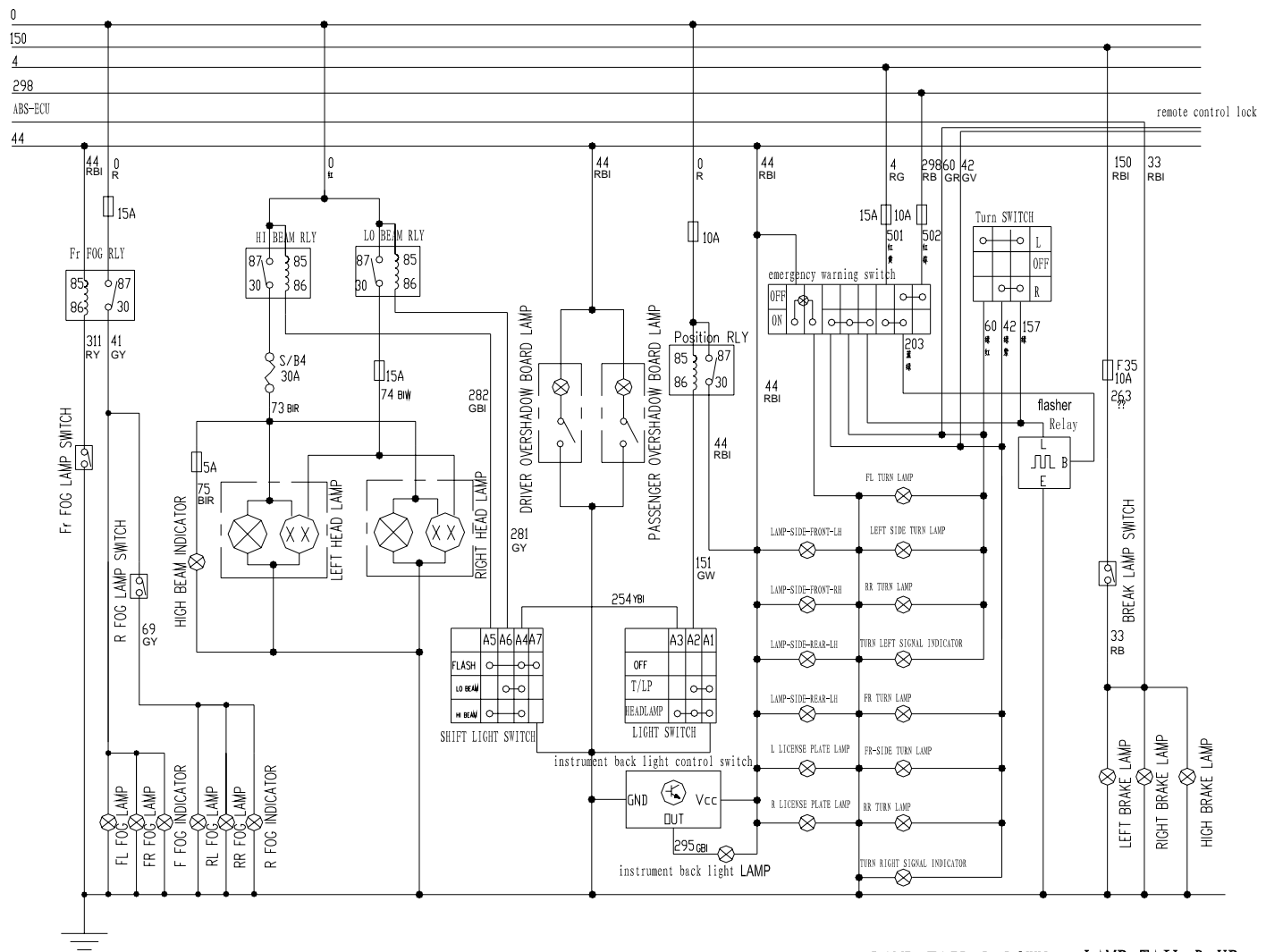

LEFT COMBINATION LAMP
CD-H012

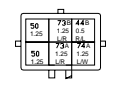

FL TURN SIGNAL INDICATOR
CD-H013

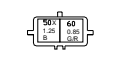

FR FOG LAMP
CD-H013

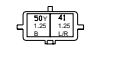

RIGHT COMBINATION LAMP
CD-H012

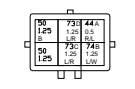

FR FOG LAMP
CD-H013

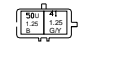

FR DIRECTION INDICATOR
CD-H013

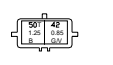

COMBINATION SWITCH 1 (GREEN)
CD-H068

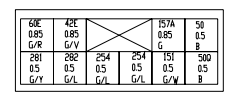

LAMP TAIL-L-UP
CD-H011

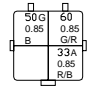

LAMP TAIL-L-DOWN
CD-H011

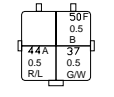

LICENSE PLATE LAMP
CD-H043

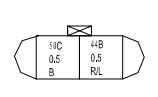

LAMP TAIL-R-DOWN
CD-H011

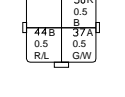

LAMP TAIL-R-UP
CD-H011

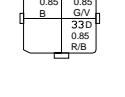

EXTERIOR LAMPS

WIPE AND ELECTRIC REAR VIEW MIRROR

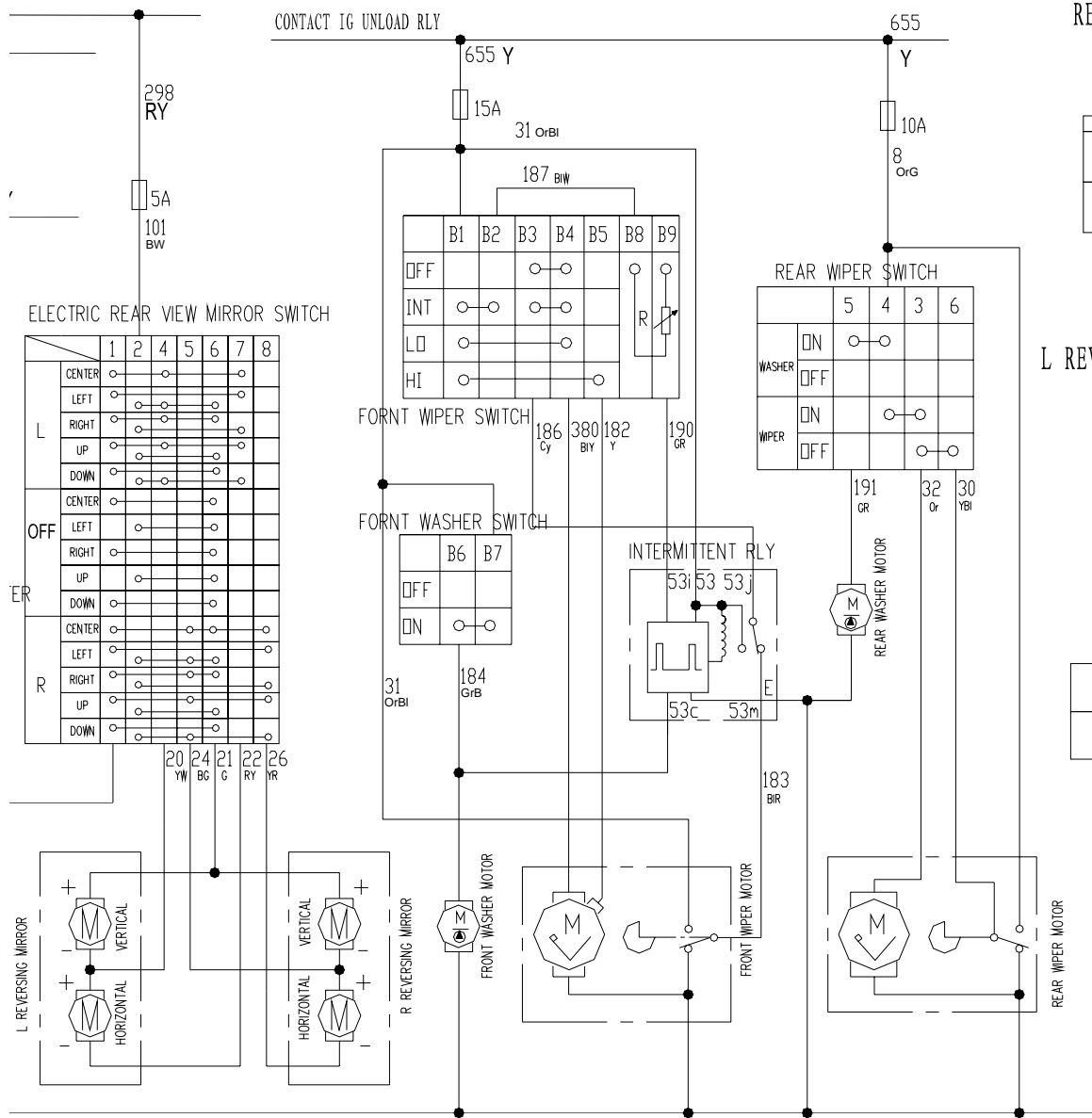

REAR WIPER SWITCH
CD-H055

8	30
0.85 O/G	0.85 Y/L
0.85 O	0.85 B

COMBINATION SWITCH2 (WHITE)
CD-H067

116	190		187	31B	
0.5 R/W	0.5 G/R		1.25 L/W	1.25 D/L	
184	182	380	186	187	31C
1.25 Gr/B	1.25 Y	1.25 L/Y	1.25 Lg	1.25 L/W	1.25 D/L

L REVERSING MIRROR
CD-H058

50D	29
0.85 B	0.85 L/Y
26	21
0.85 Y/R	0.85 G

FRONT WIPER
CD-H062

50AD	380	182
1.25 B	1.25 L/Y	1.25 Y
31	183	
1.25 O/L	1.25 L/W	

R REVERSING MIRROR
CD-H058

29	50E
0.85 L/Y	0.85 B
21	22
0.85 G	0.85 Y/W
	0.85 R/Y

REVERSING MIRROR SWITCH
CD-H078

26	22	21	24	20	101	50M
0.85 Y/R	0.85 R/Y	0.85 G	0.85 B/G	0.85 Y/W	0.85 B/Y	0.85 B

REAR WIPER SWITCH
CD-H026

44M		50N	
0.5 R/L		0.85 B	
30	32	8A	191
0.85 Y/L	0.85 O	0.85 D/G	0.85 G/R

AIR CONDITIONING AND AMUSEMENT SYSTEM

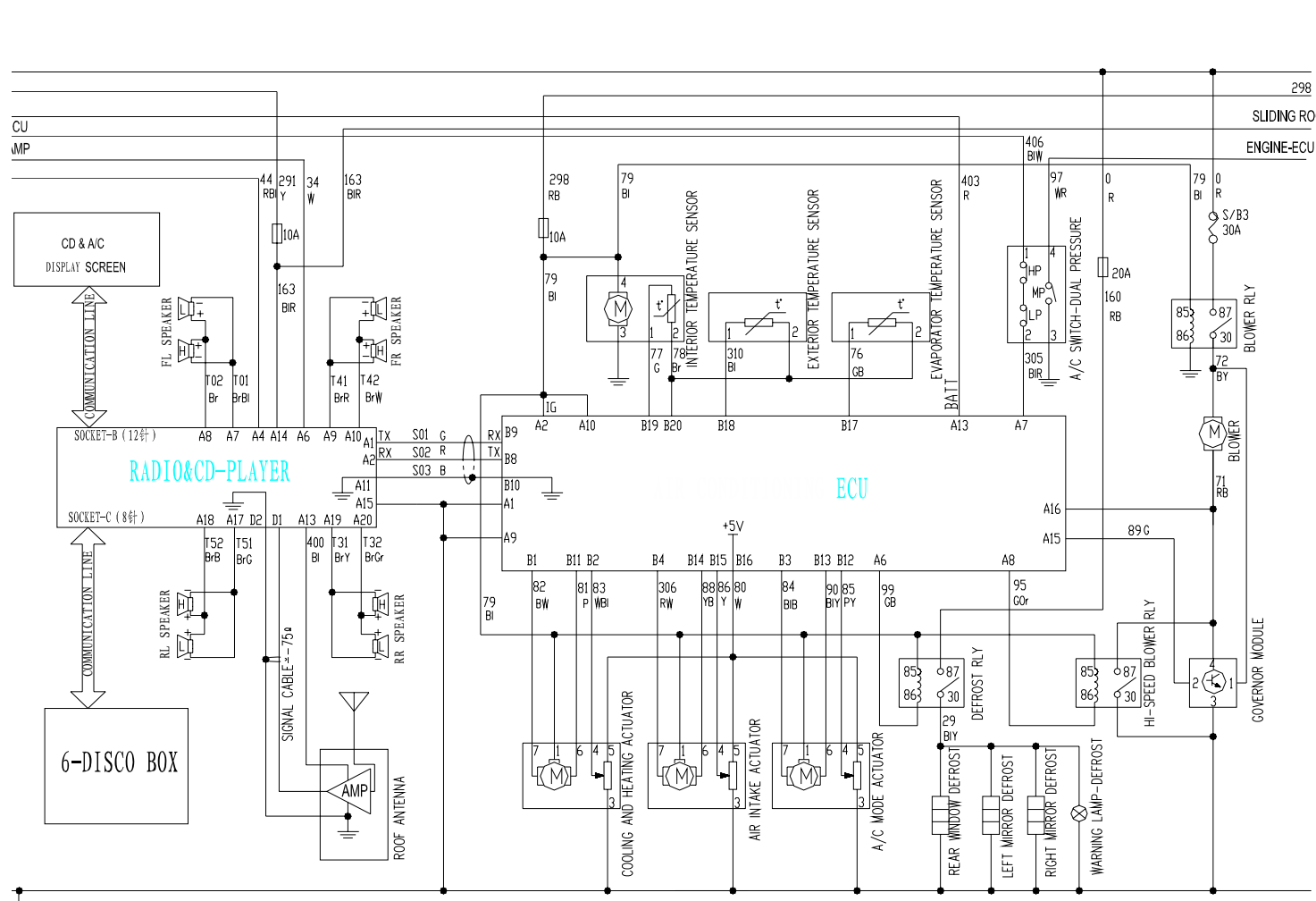

COOLING AND HEATING ACTUATOR
CD-H063

50AB 0.5 B	82 0.5 WB	81 0.5 P	80C 0.5 W	83 0.5 WL	79A 0.5 B
------------------	-----------------	----------------	-----------------	-----------------	-----------------

CD-H063
A/C MODE ACTUATOR

50AC 0.5 B	84 0.5 LB	90 0.5 LY	80A 0.5 W	85 0.5 PY	79B 0.5 B
------------------	-----------------	-----------------	-----------------	-----------------	-----------------

AIR INTAKE ACTUATOR
CD-H063

50M 0.5 B	306 0.5 R/W	88 0.5 Y/B	80B 0.5 W	86 0.5 Y	79C 0.5 L
-----------------	-------------------	------------------	-----------------	----------------	-----------------

EXTERIOR TEMPERATURE SENSOR
CD-H082

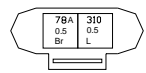

EVAPORATOR TEMPERATURE SENSOR
CD-H089



INTERIOR TEMPERATURE SENSOR
CD-H014

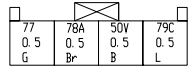

CD-H095
A/C PRESSURE SWITCH

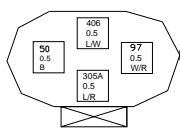

A/C ECU1
CD-H016

83 0.5 W/L	84 0.5 L/B	306 0.5 R/W			S02 0.5 R	S01 0.5 G	S03 0.5 B	
85 3.5 Y	90 0.5 L/Y	88 0.5 Y/B	86 0.5 Y	80 0.5 W	76 0.5 G/B	310 0.5 L	77 0.5 G	78 0.5 Br

A/C ECU2
CD-H015 C2A

50 0.5 B	79 0.5 L			99 0.5 G/R	305 0.5 L/R	95 0.5 L/D
A50 0.5 B	A79 0.5 L		403A 0.5 R	89 0.5 G	71 0.5 R/B	

CD-H080



CD PLAYER
CD-H083

S01 0.5 G	S02 0.5 R	A44 0.5 R/L				T01 0.5 Br/L	T02 0.5 Br	T41 0.5 Br/R	T42 0.5 Br/W
S03 0.5 B		400 0.5 L	163 0.85 L/R	B50 0.85 B	34C 1.25 W	T51 0.5 Br/G	T52 0.5 Br/B	T31 0.5 Br/Y	T32 0.5 Br/G

GOVERNOR MODULE
CD-H053



remote control module and interior lamp system

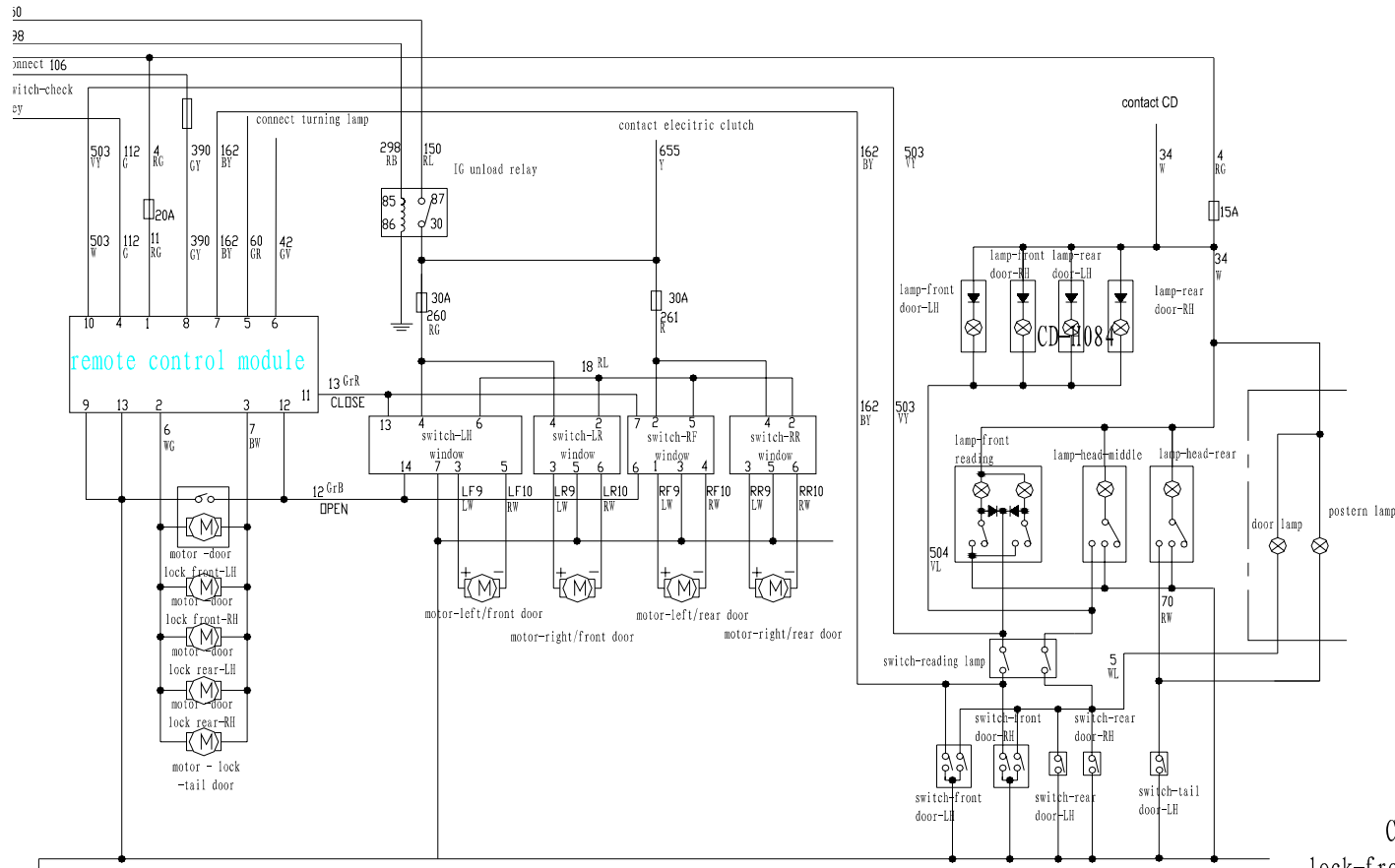

ROOF LIGHT-FRONT
CD-H051

50C	503	34D
0.5	0.5	0.5
B	V/Y	W

ROOF LIGHT-MIDDLE
CD-H048

504	34A
0.5	0.5
V/L	W

VISOR PLATE

44	50D
0.5	0.5
R/L	B

CD-H054
lock-tail door

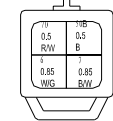

switch-window lifter
CD-H032

9	50B	261	10
2.0	2.0	2.0	2.0
L/W	B	R	R/W
50C	12	13	18
2.0	0.5	0.5	0.85
B	Gr/B	Gr/R	RA

CD-H054

CD-H054

lock-front door-LH

lock-front door-RH

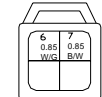
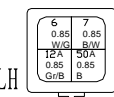

CD-H054

CD-H054

lock-rear door-LH

lock-front door-RH

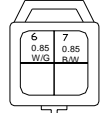
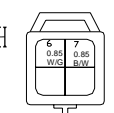

CD-H032
switch-window lifter-front-LH

8	9	260	10	50B
0.85	2.0	2.0	2.0	2.0
L/L	L/W	R/G	R/W	B
2B	13			50C
0.85	0.85			2.0
0.85	Gr/R			B

CD-H065
wiring harness-top connect floor

35	163	504
85	0.5	0.5
W	L/R	V/L
4	50	34
5	0.85	0.5
L	B	W
		503
		0.5
		V/Y

CD-H026
wiring harness front door-RH

12	T41	21
0.5	T41A	0.85
Gr/B	G	G
13	34	504
0.5	0.5	0.5
Gr/R	W	V/L
		T42
		T42A

CD-H026
wiring harness-rear door-LH connect floor-2

50	18	260
2.0	0.85	2.0
R/L	R/L	R/G
20	21	22
0.85	0.85	0.85
Y/W	G	R/Y
		13
		12
		0.85
		Gr/B

CD-H064
wiring harness-front door-RH connect floor

6	7	24
0.85	0.85	0.85
W/G	B/W	B/G
29	50	26
0.85	2.0	18
L/Y	B	Y/R
		0.85
		2.0
		R

CD-H064
wiring harness-front door-LH connect floor-1

T02	T01	7
T12	T11	0.85
		B/W
34	504	29
0.85	0.5	0.85
W	V/L	L/Y
		0.85
		W/G

CD-H058
wiring harness rear door-LH

18	261
0.85	0.85
R/L	R
6	50
0.85	2.0
W/G	B
	0.85
	B/W

CD-H026
wiring harness-rear door-LH connect floor

260	50	7	6
2.0	2.0	0.85	0.85
R/G	B	B/W	W/G
18	504	34	
0.85	0.5	0.5	
R/L	V/L	W	
		T52	T51
		T52A	T51A

CD-H060
wiring harness rear door-RH

504	T31
0.5	T31A
V/L	B/W
	34
	0.5
	W
	T32
	T32A

CD-H034
switch-window lifter-LH

18	50C	260	10
0.85	2.0	2.0	2.0
R/L	B	R/G	R/W
9	2.0		
L/W	B		

CD-H034
switch-window lifter-LH

6	7
0.85	0.85
W/G	B/W
12A	50A
0.85	0.85
Gr/B	B

CD-H034
switch-window lifter-RH

18	50	261	10
0.85	2.0	2.0	2.0
R/L	B	R	R/W
9	2.0		
L/W	B		

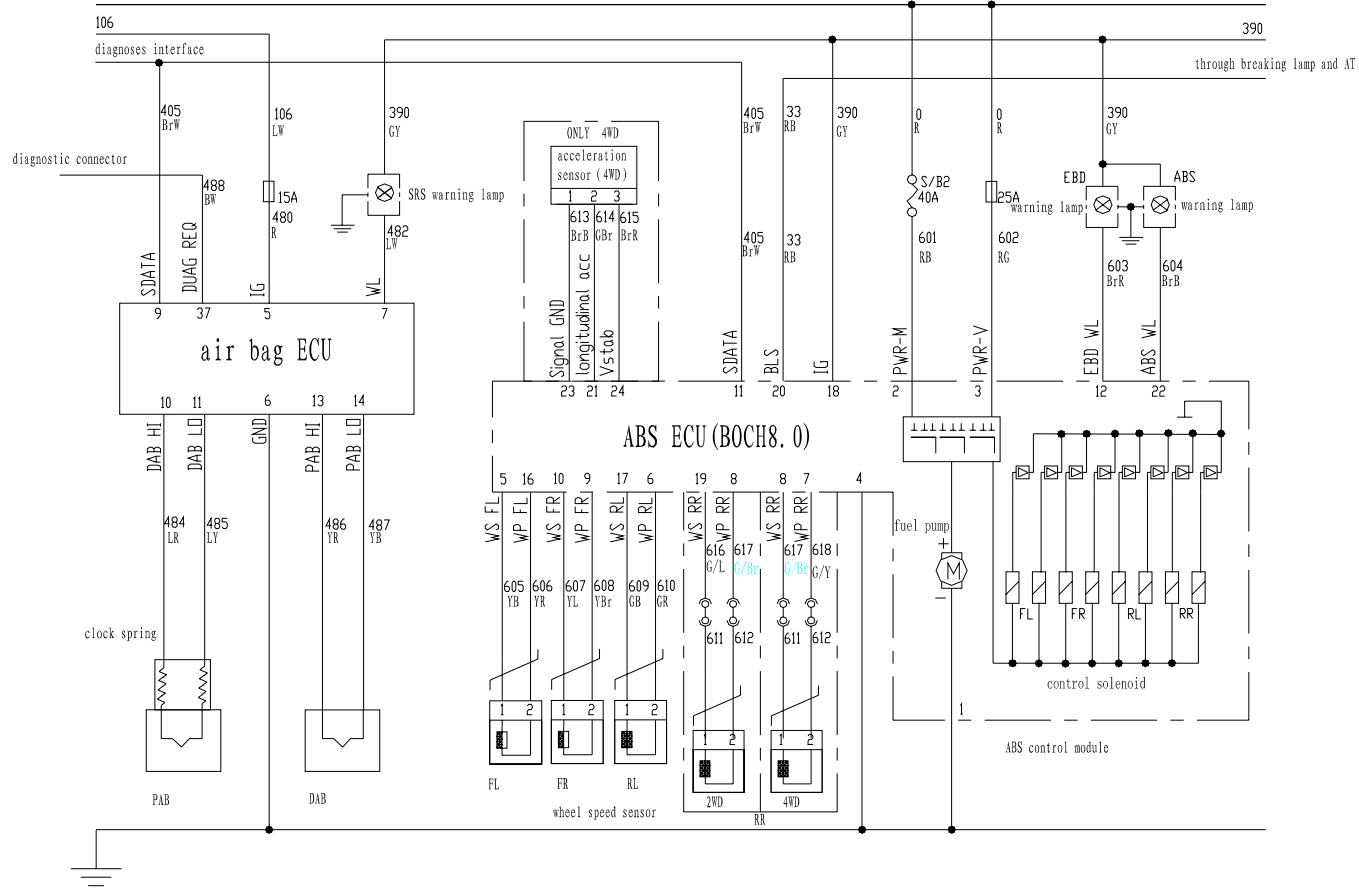

SRS and ABS system

ABS-ECU

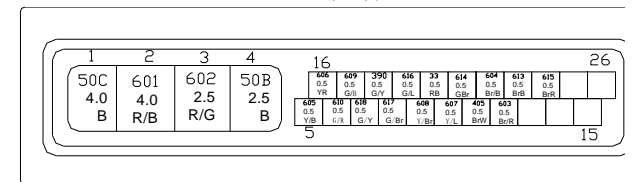

SRS-ECU (Y)

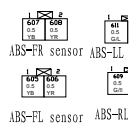
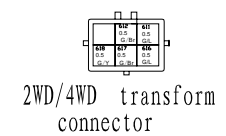
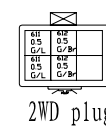
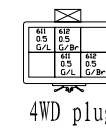
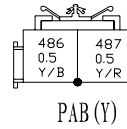
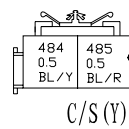
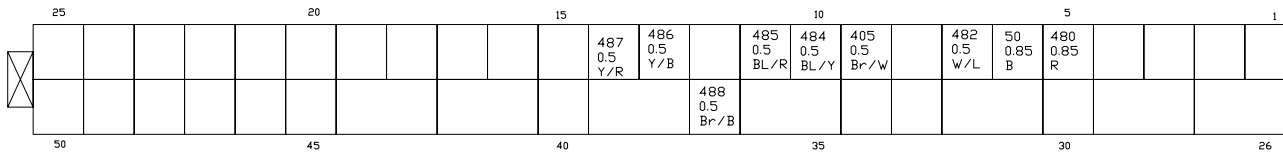

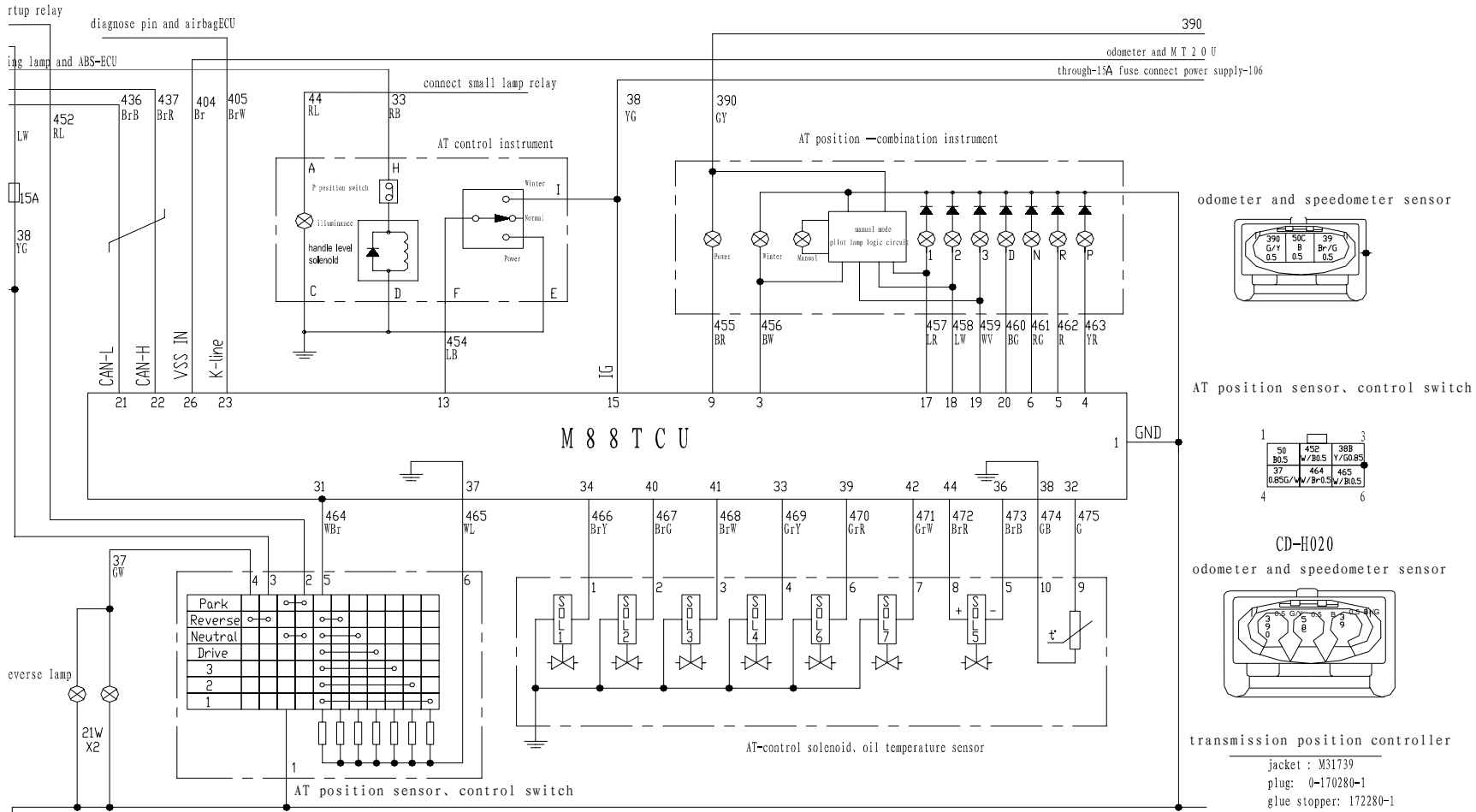

automatic transmission

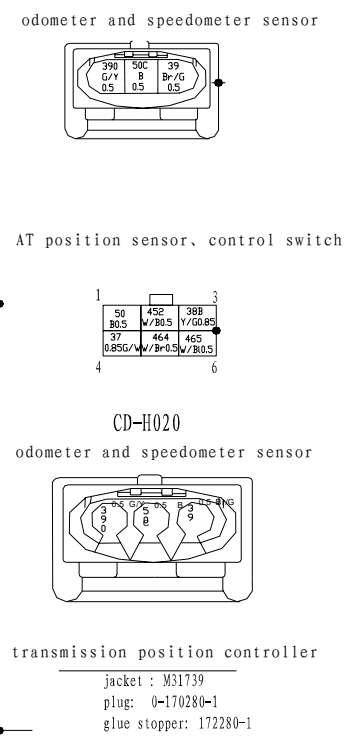
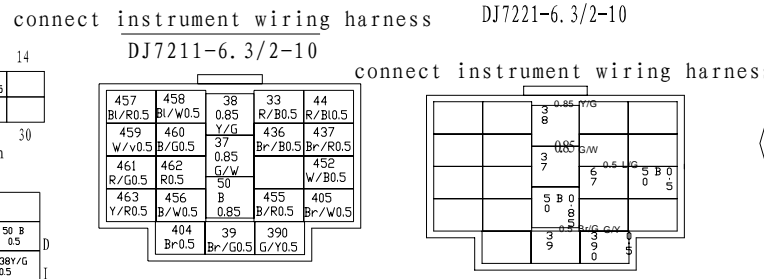
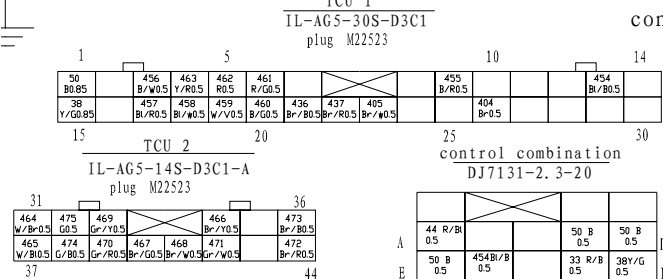

electric clutch and electric seat system

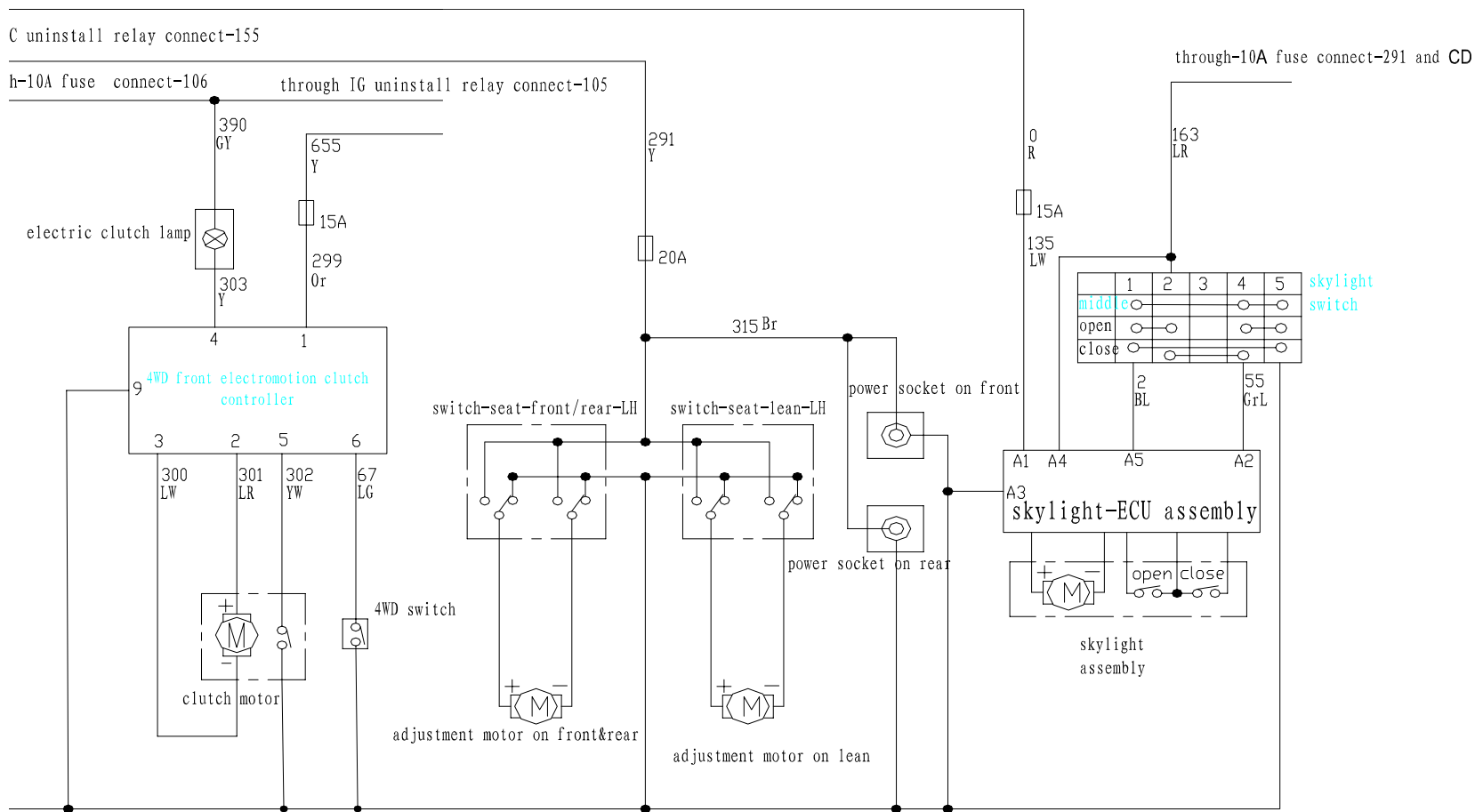

)-H066 clutch ECU

10	25	301	299
W		1.25	1.25
		L/R	0
		67	302
		0.85	0.5
		L/G	Y/W

CD-H056 electric clutch

50C	302
1.25	0.5
L/R	B/L
300	301
1.25	1.25
L/W	L/R

CD-H001 4WD-control

67	50Z
0.5	0.5
L/G	B

electric seat CD-H004

315B	50J
2.0	2.0
Br	B

skylight CD-H022

1	3	5
135	50B	2
0.85	0.85	0.5
L/W	B	B/L
	55	163
	0.5	0.5
	Gr/L	L/R
	2	4
		6

skylight switch CD-H079

50A	55	163	2
0.5	0.5	0.5	0.5
B	Gr/L	L/R	B/L
5			1