

Owners Handbook



T350



T350



Thank you for purchasing your T350, we trust that you will enjoy it. The car has been designed and built to be safe, rewarding to drive and have a long life.

Whilst many new customers of TVR may have previously owned high performance vehicles we feel that a few words of caution are necessary.

Your first impression of the T350, we hope, will be one of sophistication and comfort but please be aware of its very high performance. The power to weight ratio coupled with the progressive nature of the power curve can be deceptive. Consequently, it would be wise to gradually acquaint yourself with the abilities of your new car.

For all cars fitted with high performance tyres, there is a much greater difference between the amount of adhesion on dry roads than on a wet or slippery surface compared with normal cars. In addition it is essential you bed the tyres in for approx. 1000miles.

Please drive safely and have fun.

A handwritten signature in black ink, which appears to read 'Peter Wheeler'. The signature is fluid and cursive.

Chairman

Peter Wheeler

The Owners Handbook

This handbook is designed to help you understand and enjoy the TVR T350 by providing detailed information on controls, equipment and general car care.

If there are any queries, or if more information is required please contact your dealer.

TVR do not accept any responsibility for any inaccuracies, errors or omissions contained within this handbook, although every effort has been taken to make it as complete and accurate as possible.

TVR do not accept any liability for any consequential or other losses howsoever arising as a result of any of the recommendations contained within this handbook, save for any loss or damage arising as a result of the negligence of the company or its employees.

© TVR Engineering Limited- Issue 2 August 2003

TVR Engineering Limited,

Bristol Avenue, Blackpool, Lancashire, FY2 0JF

Tel•01253 509000 Fax•01253 356097

email•sales@tvr.co.uk web•www.tvr.co.uk

T350 in Brief

1

Dashboard	1	Tyres	5
Dash Pod Warning Lights	2	Brakes	5
Warning and Telltale Lights	2	Doors	5
LCD Display Brief	3	Refuelling	6
Starting the Engine	4	Fuel Tank Capacity	6
Horn	4	Fuel Type	6
Cigar Lighter	4	Tyre Pressures	6
Running in	5		

Instrumentation

9

Fog Lamp	9	Door Mirror Controller/Demist	21
Sidelight/Headlight	9	Heated Rear Screen	21
LCD Function Switches	9	Handbrake	22
LCD Display Information	10	Immobiliser Disarm Socket	22
Fuel Gauge	10 - 12	Interior Light	23
Water Temperature Gauge	10 - 12	Seat Adjust	23
LCD Setup Controller	14	Seat Belts	24
LCD Display Warning Screens	15	Demist/Temperature Controls	25
Horn	16	A/C Controls	25 - 26
Hazard Warning Lights	16	Window Position	27
Turn Indicator Stalk	17	Door Release	28
Wiper/Washer Stalk	17	Emergency Door Release	28
Intermittent Wipe Speed	18	Boot Release	29
Dashboard Buzzer	18	Luggage Cover	29
Steering Column Adjust	19	Tool Kit	30
Stereo Radio Cassette	19	Roof Panel (T350t)	31
Bonnet Release	20	Alarm	33 - 34
Internal Door Lock Switch	20	Radio Key	33 - 34
Gear Lever	21		

Routine Maintenance

36

Cooling System	36	Puncture Repair	46
Power Steering	38	Towing	46
Windscreen Washer Reservoir	38	Jump Starting	47
Engine Oil Dipstick	39	Brake Down Cover	47 - 48
Brake/Clutch Fluid Reservoir	40	Running in the Vehicle	48
Battery	41	Cleaning the Vehicle	49 - 50
Fuses	42	Checks and Servicing	51
Bulb Replacement	43 - 44	Resetting the Inertia Switch	54
Bulb Specification Chart	45		

Technical Specification**57**

Oils and Lubricants	57	Wheels and Tyres	58
Bodyshell	57	Transmission	59
Interior	57	Slip Differential	59
Chassis	58	Engine	60
Suspension	58	Fuel and Ignition Systems	60
Steering	58	Dimensions	60

Warranty**65**

General Warranty Coverage	65	Motor Racing	66
Body Warranty Coverage	65	Loss of Damage	67
Replacement Parts Coverage	65	Limitations of Warranties	67
Extent of Company Obligations	66	Obligations of the Owner	67
Exclusion from Warranty Cover	66	Disputes	67
Maintenance	66	Warranty Acknowledgement	67

Foreword**72****Index****75**

Dashboard	1
Dash Pod Warning Lights	2
Warning and Telltale Lights	2
LCD Display Brief	3
Starting the Engine	4
Horn	4
Cigar Lighter	4
Running in	5
Tyres	5
Brakes	5
Doors	5
Refuelling	6
Fuel Tank Capacity	6
Fuel Type	6
Tyre Pressures	6



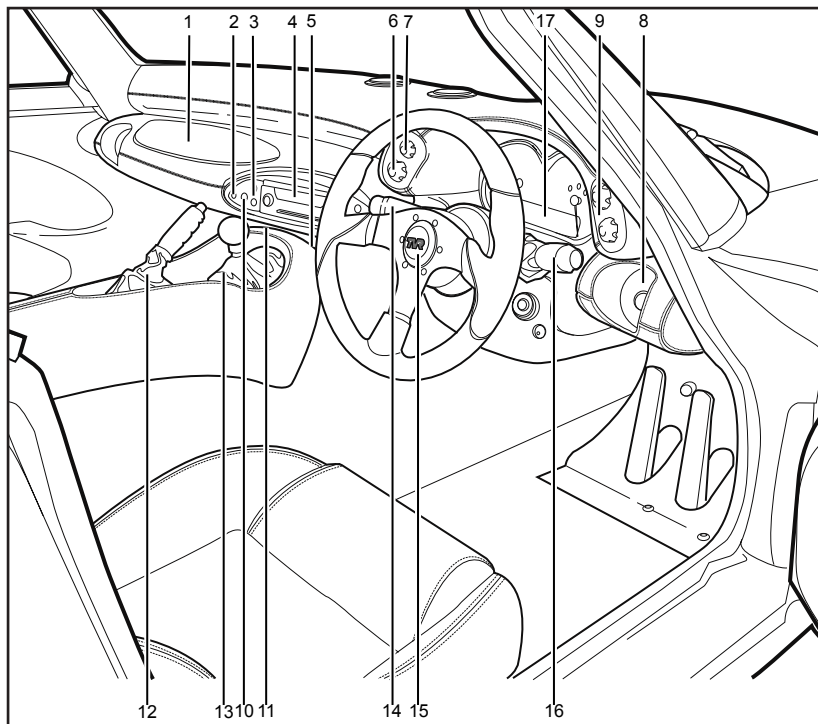

Dashboard

1	Glove box	
2	Internal Door Lock Switch	20
3	Window position controls	27
4	Audio head unit	19
5	Cigar lighter	4
6	Heating & ventilation fan control	25
7	Heating & ventilation temperature control	25
8	Door mirror controls	21
9	Headlamp/Foglight controls	9
10	Door Release	28
11	Ashtray	28
12	Handbrake lever	22
13	Gear lever	21
14	Directional Indicator/main beam & flash stalk	17
15	Horn	16
16	Windscreen wiper and washer stalk	17
17	LCD display	10

Dash Pod Warning Lights

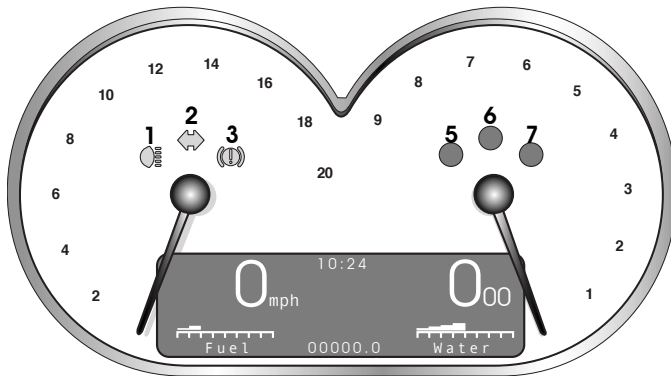

- 1 High beam warning light (blue)
- 2 Turn indicator (green)
- 3 Brake system warning light (red)
- 4 LCD panel
- 5 Shift light (amber) medium (green remains lit)
- 6 Shift light (red) high (green & amber remain lit)
- 7 Shift light (green) low

Warning and Telltale Lights



Turn indicator light

Flashes simultaneously with either the left or right hand indicator.



High beam headlights

Illuminates when the headlights are on high beam or when the headlight flash is operated.



Brake system warning light

Illuminates when the handbrake is applied or if the brake fluid level is too low.

LCD Display in Brief

The LCD screen in the middle of your dash pod has been designed to display selectable information screens.

The information can be accessed by pressing the function switches located on the steering wheel (see page 9).

For information on how to use the LCD screen display see pages 10-15

Note

The system has a memory function, so when the ignition is switched on, the setup of the last screen displayed, will be shown.

LCD Warning Screens in Brief

LCD Warning screens have been programmed to automatically override information screens.

Ignition and Steering Lock



The ignition key switch has four distinct clockwise positions:-

- | | |
|-------------------|---|
| Position 0 | The steering is set to lock upon removal of key. |
| Position 1 | The steering lock is released but the ignition remains off. |
| Position 2 | Ignition and all other electrical circuits are on. |
| Position 3 | Starter motor is engaged and engine will start. |

Starting the Engine

- 1 Apply the handbrake and insert the ignition key into the steering column ignition lock.
- 2 Depress the clutch pedal. Put the gear lever into neutral.
- 3 Turn the key to position 1 to release the steering lock.
(move the steering wheel slightly if necessary)
- 4 Turn the key to position 2 to activate electrical circuits.
(The fuel pump will be heard pressurising the fuel system.)
- 5 Turn the key to position 3 to engage the starter motor. The engine will start (minimal use of the throttle pedal may be needed during the engine start sequence.)
- 6 If the engine fails to start, **return the key to position 1** and repeat steps 4 and 5.

IMPORTANT: Where necessary only short repeated engine cranking periods should be used, as long cranking periods cause unnecessary wear to the starter motor and causes unburnt fuel to be deposited into the catalyst/exhaust system.

Horn

Press the centre of the steering wheel to sound the horn. The horn works independently of the ignition being switched on.

Cigar Lighter

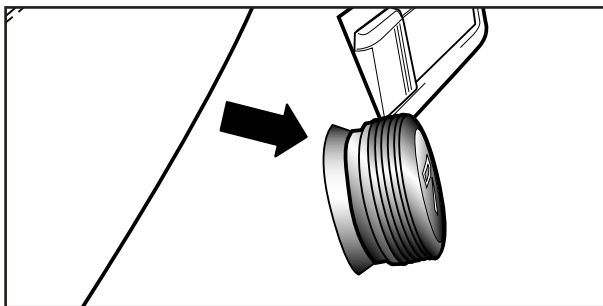

The cigar lighter is located on the transmission tunnel forward of the gear lever next to the ash tray. To operate, fully depress the button to heat the element. The button will eject back to its original position when ready for use (after approximately ten seconds). Withdraw the complete unit to reveal the element.

Running In

The purpose of running in is to allow the new engine components to bed in correctly. To gain maximum performance, service life and general reliability, the best policy to adopt during the run in period is to avoid high engine rpm and large throttle openings but most importantly, not allowing the engine to labour in a high gear.

Recommended rpm during the running in period

Starting the engine from cold. 0-1000 miles, rpm should not exceed 2500 rpm until the engine is warm.

1. 0-250 miles, max rpm should not exceed 3500 rpm even when the engine is warm.
2. 250-2000 miles, rpm should be gradually increased until full power and max rpm for the vehicle is achieved.
3. **Do not** use full throttle accelerations in low gear for at least 900 miles and avoid full throttle use in any gear for the first 250 miles
4. Avoid driving at a constant speed within the first 300 miles.

Tyres

To obtain the maximum performance from the tyres it is advisable to avoid excessive braking and cornering whenever possible during the 0-500 mile period.

Brakes

To bed the brake pads in correctly, avoid excessive braking during the first 500 miles, unless required to do so in an emergency.

Doors - Opening from the outside

As with other TVR models the door release button has been fitted to the underneath of the door mirror.

When unlocked to enter the vehicle press this release button, the door will pop open slightly.

Refuelling

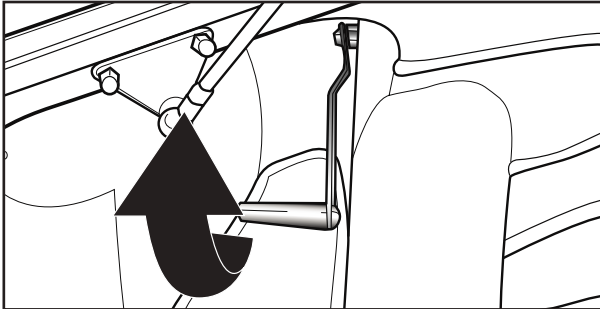

The fuel filler is located on the nearside rear wing. To open the filler neck - open the rear hatch and raise the handle located in the left corner just in front of the rear lights, through 90 degrees. The petrol nossle will now fit into the filler neck. To avoid the pump cutting out early do not fully insert.

Please note: Any petrol spilt onto the paint work should be washed off immediately to prevent staining.

Fuel Tank Capacity

56 Litres

Fuel Type

The TVR T350 is designed to run exclusively on unleaded fuel.

Please note: It is fitted with a narrow fuel filler neck, making it compatible for unleaded fuel pumps only.

For normal everyday use - Premium unleaded 95 Ron

For track use - Super unleaded 98 Ron

Tyre Pressures

Check the tyre pressures regularly.

Front 225/50 ZR 16 28 lbs sq/in

Rear 225/50 ZR 16 28 lbs sq/in

For high speed continental driving or when fully loaded with luggage or track use.

Front 30 lbs sq/in

Rear 32 lbs sq/in

Fog Lamp	9
Sidelight/Headlight	9
LCD Function Switches	9
LCD Display Information	10
Fuel Gauge	10 - 12
Water Temperature Gauge	10 - 12
LCD Setup Controller	14
LCD Display Warning Screens	15
Horn	16
Hazard Warning Lights	16
Turn Indicator Stalk	17
Wiper/Washer Stalk	17
Intermittent Wipe Speed	18
Dashboard Buzzer	18
Steering Column Adjust	19
Stereo Radio Cassette	19
Bonnet Release	20
Internal Door Lock Switch	20
Gear Lever	21
Door Mirror Controller/Demist	21
Heated Rear Screen	21
Handbrake	22
Immobiliser Disarm Socket	22
Interior Light	23
Seat Adjust	23
Seat Belts	24
Demist/Temperature Controls	25
A/C Controls	25 - 26
Window Position	27
Door Release	28
Emergency Door Release	28
Boot Release	29
Luggage Cover	29
Tool Kit	30
Roof Panel (T350t)	31
Alarm	33 - 34
Radio Key	33 - 34

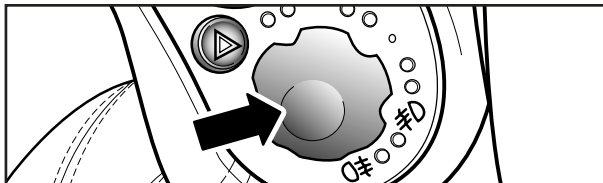

Dash Pod**Fog Lamp Switch**

Located on the right hand side of the dash pod. Rotate the switch clockwise to operate the lamps, position 1 (front only) position 2 (front and rear). The lamps will only work with the headlights and ignition switched on. Turning off the headlights or ignition will cancel the fog lamps. If cancellation occurs with the switch left on, reset by turning the switch off and then on again.

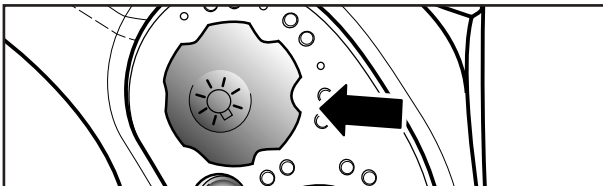
**Side Light/Headlight Switch**

Located on the right hand side of the dash pod. Rotate the switch clockwise to operate the lights, position 1 for sidelight illumination, and position 2 for headlight illumination. Surrounding LED's will light up as follows. Dipped headlights, 4 on, Highbeam, 6 on.

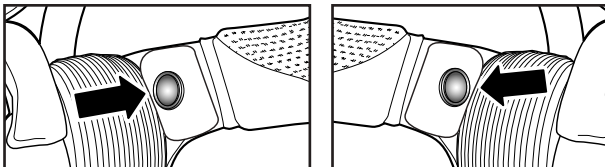
**LCD Function Switches**

Located on the back of the steering wheel spokes (inboard). These switches enable you to access, and alter the different information screens on the LCD display (left = down, right = up).

LCD Display Information

Screen 1

Due to the memory feature when the ignition is turned on the screen displayed will be the same one that was selected when the ignition was turned off (so the above screen may not be the one shown).

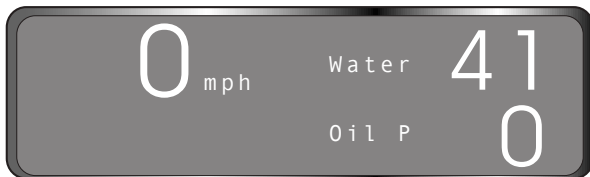
Screen 2

To cycle through the screens use the up and down LCD function switches (page 9).

Screen 3

From this screen the trip can be reset by pressing both function switches simultaneously.

LCD Display Information

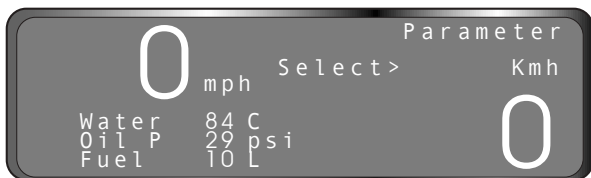

Screen 4

Changes the right side of the screen to show a selected parameter magnified.

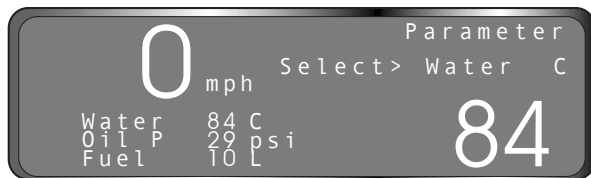

Screen 4 continued

To change the parameter shown on the right side of the screen press both function switches simultaneously, to enter the select mode. **Select>** will appear on the display.

Whilst **Select>** is shown in the display, use the up and down function switches to cycle through the various parameters.

KMH -> Oil Temperature -> Water Temperature -> Outside Air Temperature -> Fuel Quantity Remaining -> Oil Pressure -> Volts -> RPM.

To accept the required parameter (and leave the select mode), again press both function switches simultaneously

LCD Display Information

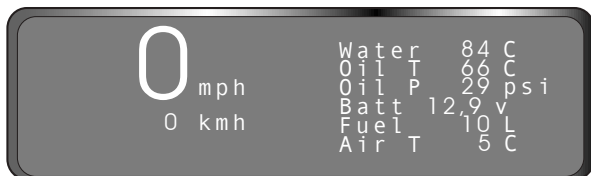

Screen 5

Shows MPH and temperatures

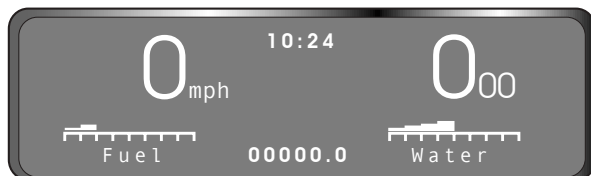

Screen 6

Shows MPH and Trip

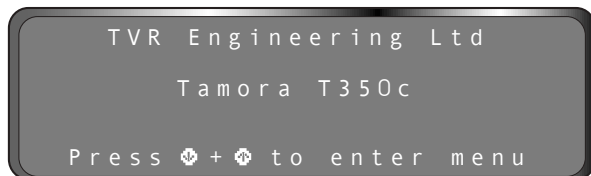

Screen 7

Main Menu Enter screen.

Press both function switches simultaneously to enter the Main Menu.

LCD Display Information

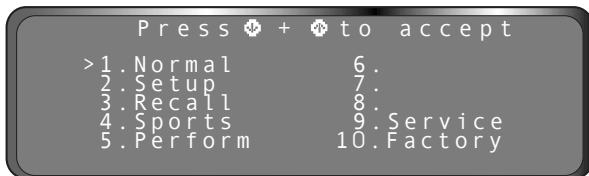
Main Menu Continued

1.	Normal	The 5 driving screens.
2.	Setup	To adjust display settings & set the clock.
3.	Recall	Optional track pack, not yet available.
4.	Sports	Optional track pack, not yet available.
5.	Perform	Optional track pack, not yet available.
6.		Not used.
7.		Not used.
8.		Not used.
9.	Service	Dealer functions.
10.	Factory	Factory use.

Use the up and down function switches to scroll the arrow (>) to the desired position, then press both switches simultaneously to select.

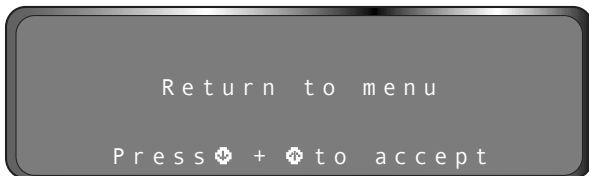

To return to the Main Menu press both function switches simultaneously.

LCD Display Information

Contrast	off	60%
	side	55% <
	head	50%
Bright	off	90%
	side	85%
	head	80%

Setup Screens

Use the up and down function switches to scroll the arrow (<) through the screens to the item to be adjusted. press both function switches simultaneously to select, < **Adjust** will appear in the display.

Dials	off	25%
	side	50%
	head	75%
Volume eng on		100%
Volume eng off		49% < Adjust

Use the up and down switches to alter the settings.

Contrast	off	Contrast of the LCD (lights off)
	side	Contrast of the LCD (side lights on)
	head	Contrast of the LCD (headlights on)
Brightness	off	Back Light of the LCD (lights off)
	side	Back Light of the LCD (side lights on)
	head	Back Light of the LCD (headlights on)
Dials	off	Dial Illumination (lights off)
	side	Dial Illumination (side lights on)
	head	Dial Illumination (headlights on)
Volume eng on		Volume of the Bleeper (engine on)
Volume eng off		Volume of the Bleeper (engine off)

When the desired levels are attained press both switches simultaneously to confirm and return to the setup screen.

LCD Display Information

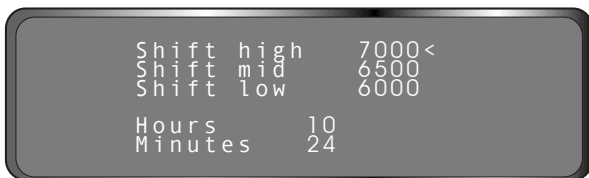

Carry on down to enter a third setup screen, here the shift lights can be set, and the clock adjusted.

Again use the up and down function switches to scroll the arrow (<) to the item to be adjusted.

Press both switches simultaneously, until <Adjust is shown in the display. Then use the up and down switches to alter the settings.

When the desired setting is attained press both switches simultaneously to confirm and return to the setup screen.

When all settings are complete, pressing both switches simultaneously again, will return the display to the main menu.

To return to the normal driving screen, select **1. Normal** from the Main Menu, and press both switches simultaneously.

LCD Warning Screens

Critical warning screens have been programmed to automatically override normal information screens. These will show warnings such as, Low Fuel, EFI Faults, Oil Pressure, Oil Temperature, Water Temperature, etc.

As well as the warning screen, the dash buzzer will sound.

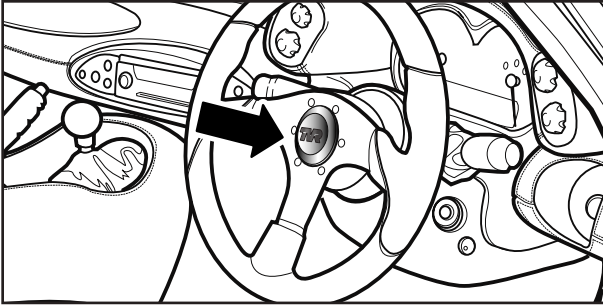
Horn

Press the centre of the steering wheel to sound the horn. The horn works independently of the Ignition being switched on.

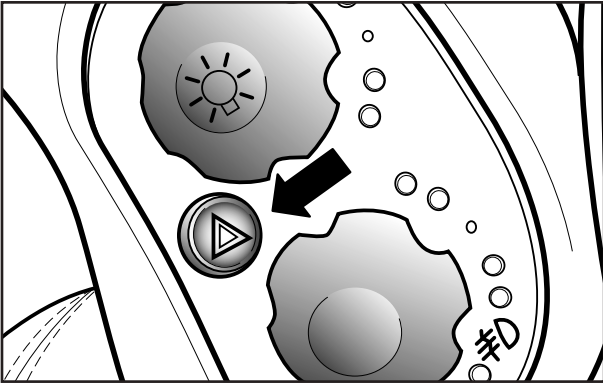
Hazard Warning Lights

Should the vehicle become immobile or present a hazard to other road users, indicators may be operated in unison as a hazard warning. Depress button (3) on the lights panel to activate the hazard warning lights. Depress the button once again to deactivate the hazard warning lights.

Turn indicator, Headlight Flash and Full Beam Stalk

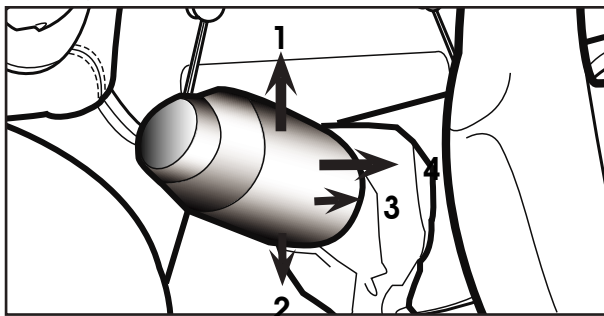

- Position 1.** Right hand turn indicator.
- Position 2.** Left hand turn indicator.
- Position 3.** Main beam flash. Operates only when the ignition is on.
- Position 4.** Main beam / Dip (Sequential). Operates only when the headlights are on.

If the indicator warning light flashes more frequently than normal, check to see if a bulb has burnt out.

Wiper and Washer Stalk

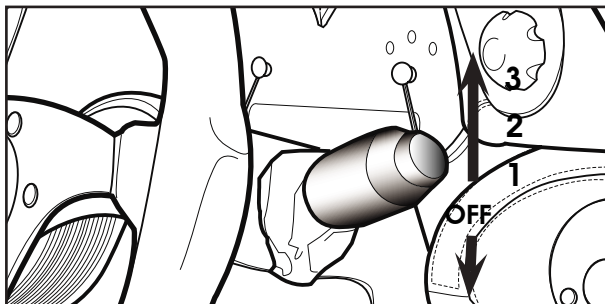

- Position 1.** Intermittent wipe.
- Position 2.** Normal wiper speed.
- Position 3.** Fast wiper speed.
- Position 4.** Flick wipe

The screen wash and wipe button is located on the end of the stalk. Press to activate, the wipers will operate, along with the washers, for several seconds and then stop automatically.

Intermittent Wipe Speed

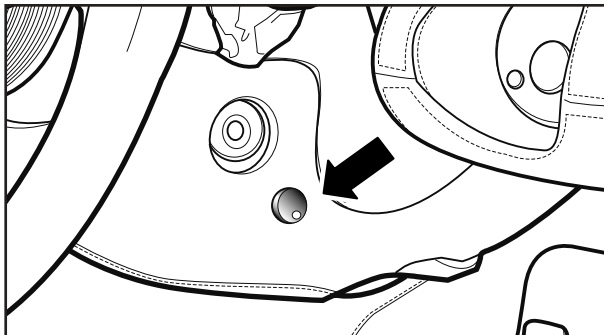

Your T350 has been fitted with a intermittent wipe controller, located forward of the ignition switch.

This controller allows you to alter the delay of the intermittent wipe, between 3 to 9 seconds (approx).

Dashboard Buzzer

A buzzer has been fitted to your T350, which will sound when any of the following warnings occur:-

- (1) Indicator Warning Lights
- (2) Low brake fluid
- (3) EFI fault
- (4) Oil Pressure
- (5) Water/Oil Temperature
- (6) Gear Shift
- (7) Door open
- (8) Ice warning

Please Note: The volume can be increased or decreased via the LCD information display (page 13).

Steering Column Adjustment Lever

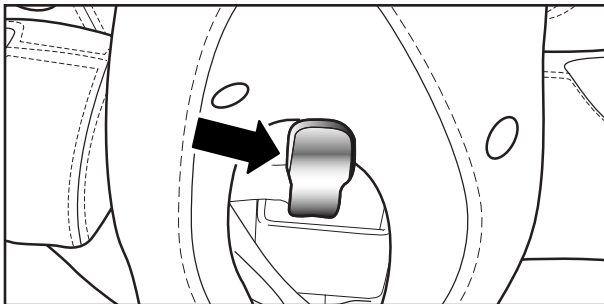

Located on the underside of the steering column the lever when released will allow adjustment to the height, and the fore and aft position of the steering wheel. Push the lever forwards to release the column and pull backwards to secure the column.

WARNING: Do not adjust the steering wheel position while you are driving.

Stereo
Cassette

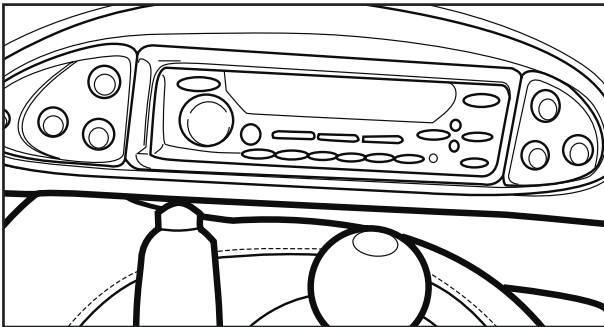

R a d i o

For detailed operating instructions please see the enclosed manufacturers instruction manual.

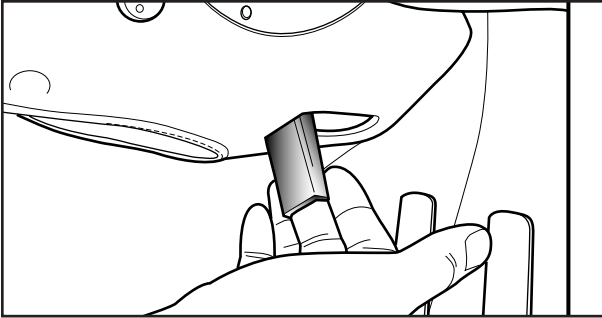
Bonnet Release

Pull the metal lever, located on the underside of the steering column towards the right hand side, to release the bonnet catch.

When closing the bonnet gently lower onto the catch putting pressure on the catch area

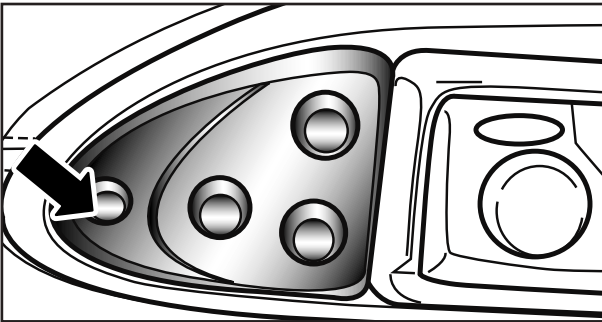
Internal Door Lock Switch

Located on the switch panel to the left of the radio. To lock the vehicles doors from within, depress the switch once. (page 1, item 2) The doors will automatically unlock when either interior door release button is pressed.

Please note: Arming or disarming the alarm will clear any internal lock command to both doors.

Gear Lever

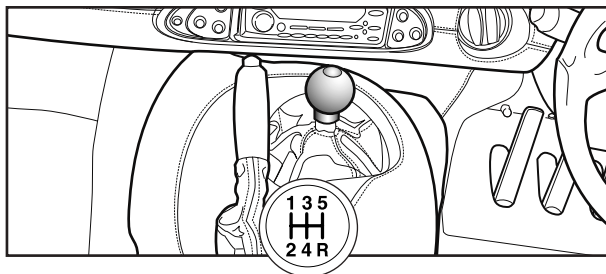

Always select neutral before starting the engine. To engage reverse gear smoothly, we recommend that you select fifth gear and then pull back into reverse.

WARNING: Only engage reverse whilst the car is stationary.

Door Mirror Adjustment/Demist

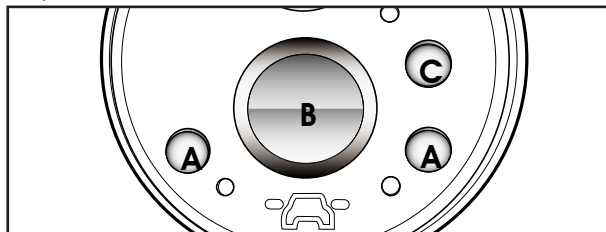

The Door Mirror Adjustment/Demist control panel is located on the right lower dash pod (8) page 7. This panel controls the movement of the door mirrors, as well as the demist function.

To adjust the position, first select the mirror to be adjusted by pushing one of the two small buttons (A). Swivel the central button (B) to move the mirror until the required position is achieved. To activate the demist function simply depress the button (C) once. A red LED will illuminate to indicate this function is active.

Please Note: The demist function will activate for 3 minutes.

To lock - press both left & right mirror select buttons.

To unlock - Press & hold the desired mirror button.

Please note: When the ignition is activated the mirrors lock.

Rear Window Demist

To activate press button (C). The rear window demist works with the mirror demist for 3 minutes. A red led will illuminate while active.

The demist will cancel when the ignition is switched off.

Handbrake

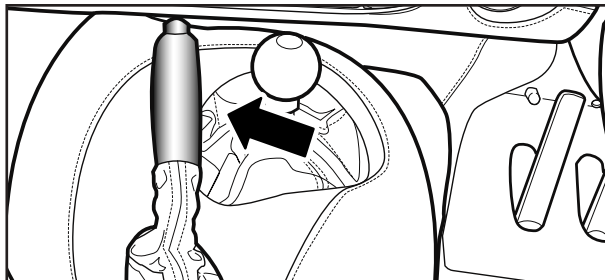

To apply the handbrake pull the handle upwards while depressing the button at the end of the lever. Release the button at the end of the lever's travel. When the lever is in this position the rear brakes are on. To release, press the button and lower the lever to its lowest position. A warning light on the dashpod will illuminate when the handbrake is on.

Please note: When parking on a hill ensure the wheels turn towards the kerb.

i.e. Facing Uphill - Trailing edge of n/s wheel to kerb.

Facing Downhill - Leading edge of n/s wheel to kerb.

Immobiliser Disarm Socket

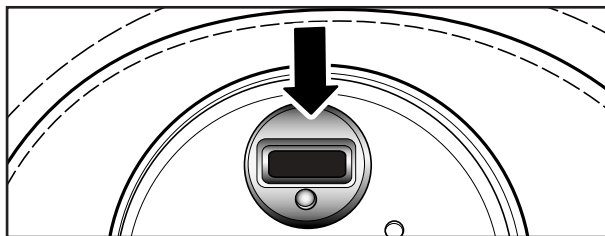

On entering the vehicle, the contact key should be inserted into the override key socket mounted on the door mirror adjustment panel. The small LED will be flashing to show the vehicle is immobilised. On insertion and removal of the contact key, the LED will be extinguished. The vehicle can now be started.

Note: The above is for use only when there is a fault with the key fob (if immobilised switch ignition on, and press the button on the key fob).

Interior light

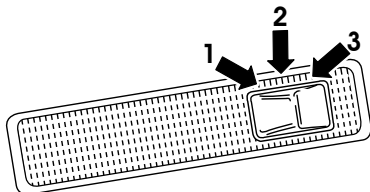

The interior light is located in the centre of the rear header rail.

- Position 1.** Light will remain permanently off.
- Position 2.** Light will come on when drivers or passenger door is open. After closing the doors the light will remain lit for approx. 15 seconds or until the windows have closed.
- Position 3.** Light will remain permanently on.

Please note: Activating the ignition will cancel the interior light. On disarming the alarm (with your key fob) the interior light will illuminate for 20 seconds. Switching on the ignition will cancel the light. The interior lights work independently from the ignition.

Seat Adjustments

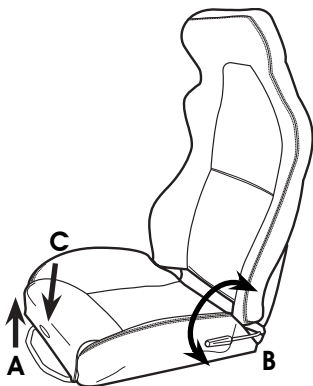

Seat Slide To adjust the fore/aft position of the seat, pull the lever located beneath the front of the seat (A) upwards, thus releasing the slider. Slide the seat to the required position. Release the lever and rock the seat to ensure the locking mechanism has engaged.

Seat Reclining To adjust the angle of the backrest, lift the lever located on the outer edge of the seat by the pivot point (B). Tilt the backrest to the required angle. Release the lever and ensure that the locking mechanism has engaged.

Lumbar Support Electric (if fitted)

To adjust the lumbar support in the backrest, use the rocker switch (C) located in the front of the seat, to inflate or deflate the support.

Seat Belts

When fastening your seat belt please ensure that it is not obstructed in any way before locating into the catch, and that it clicks in correctly.

When releasing the belt press the red button on the catch, the belt may need to be guided back to assist the reel, make sure the belt is fully retracted before leaving the vehicle. Clean the seat belt webbing using soapy water.

WARNING: Do not use solvents or abrasives to clean the webbing.

Demist & Temp Controls

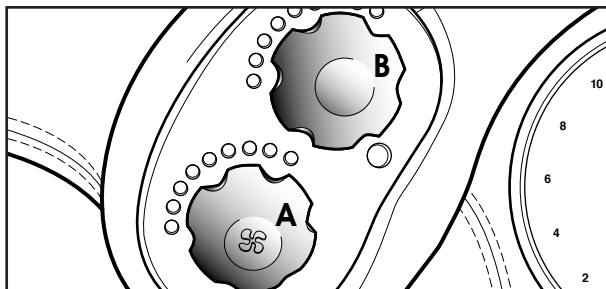

The demist and temperature switches are located on a small aluminium control panel, on the left hand side of the dash pod (page 1, item 6 & 7).

Fan Control (A)

To turn the fan "on" press switch (A) once. To turn "off" press once again. At least one of the LED's above the fan control switch will then illuminate to indicate the system has been activated. To boost the fan speed/air flow into the cabin, simply rotate the control switch clockwise, to reduce rotate anti-clockwise. The speed of the fan will be shown by the number of LED's lit.

Please note: As a guide, each LED represents a change in the fan speed of approx. 10%

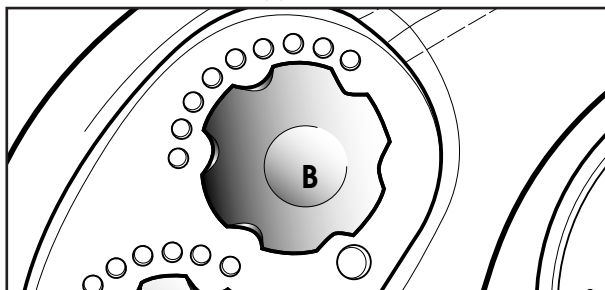
A/C Temperature Adjustment Switch (B)

Switch B located on the aluminium panel controls the Air-Con and cabin temperature adjustment.

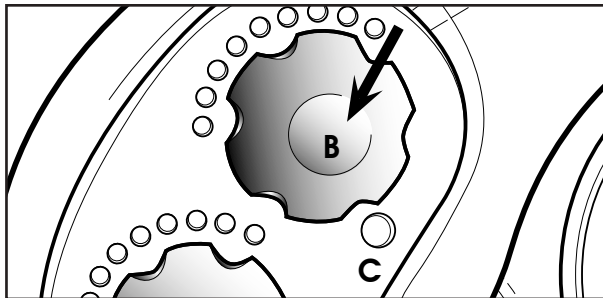
A/C Control (where fitted)

The first function of this second switch is to control the Air-Con System. To switch "on" depress switch (B) once. When the system has been activated the large blue LED (C) next to the switch will illuminate. To turn "off" depress switch again.

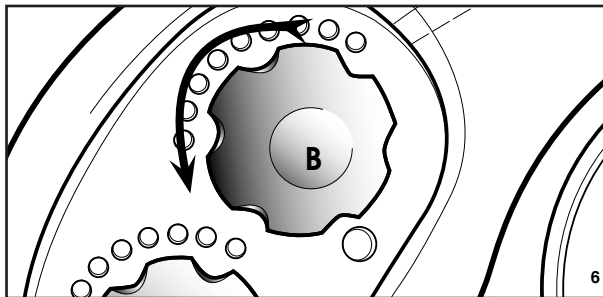
Air Temperature Blend

To adjust the air temperature into the cabin turn the switch (B), anti-clockwise for colder air and clockwise for warmer air.

Fully anti-clockwise (a lit blue LED) indicates 100% cold air. As the switch is rotated clockwise the system will slowly mix in more warmer air until fully clockwise (a lit red LED) which represents full 100% hot air.

A visual feedback of coloured LED's represents the amount of hot/cold air blend occurring between the full hot and full cold positions on the dial.

Please note: The fan motor will pause whilst the air temperature flap moves to its new position.

Window Position

The window position switches are located on both sides of the Radio and operate the relevant window.

To adjust the window position press the bottom switch to drop the level and top switch to raise the window level.

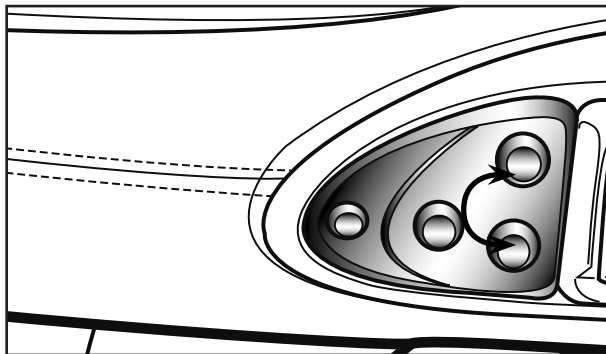

The window glass has been designed to drop a predetermined distance before the door opens. This movement is to ensure the window glass does not foul the 'A' post. The window will return to its original position on closing the door. On arming the alarm the windows will automatically close. To prevent your keys being locked in the vehicle, if the doors are open and the alarm is armed the windows will not raise and the door will not lock. The doors must be shut properly and the alarm disarmed and rearmed.

Door Release

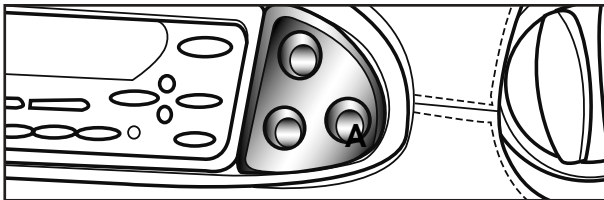

The door release switches are located on both sides of the radio. To open the respective door press the switch (A) once, you will hear the door mechanism release and the door will open. If the door switch is held, the release mechanism will repeatedly operate every second.

Please Note: For your safety these door switches become inoperable once the vehicle is in motion. This will be indicated by the LED pulsing every 10 seconds. When opening the door take care in high winds and when parked on a slope as the door will pop open slightly.

If the doors have previously been locked internally pressing the inner door release will unlock them.

Emergency Door Release

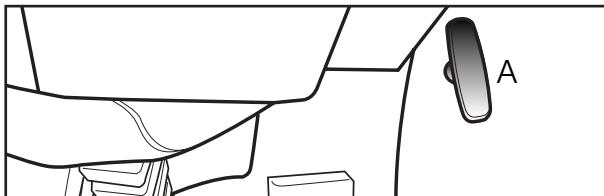

Should the door release switches become inoperable, there is a manual override facility that can be used in an emergency. These manual override release handles are located under the dash panel on the outer sides of the footwells and forward of the door apertures..(A) To open the door, pull the handle backwards.

Keys

There are no door keys with your T350, see page 31 about the alarm.

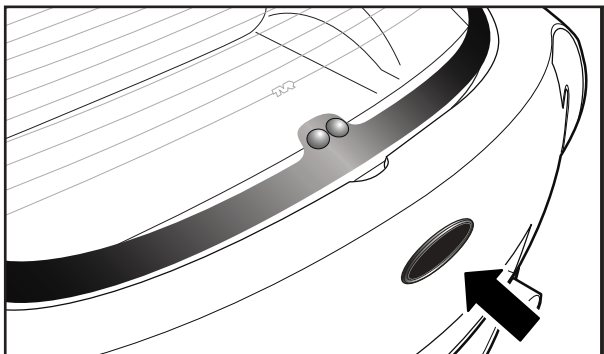
Boot**Boot Release**

The Boot lid is opened by pressing on the rear badge of the T350. A 'click' should be emitted, telling you that the lid has been released. By placing your hand into the gap allows you to raise the boot lid.

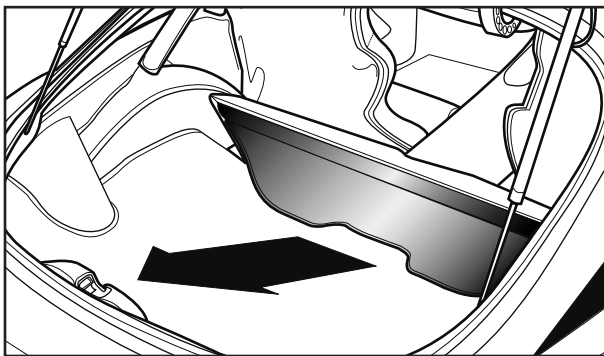
Luggage Cover

A cover can be placed over the boot to conceal its contents. The cover just pulls out from behind the seats and attaches around the boot lock. The cover clips with the use of clasps that you just push the blind onto.

Tool Kit

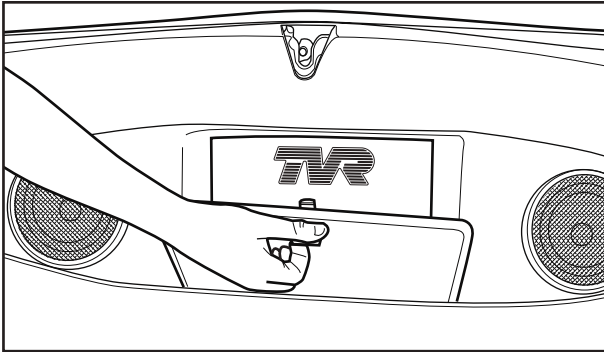

A tool kit is located in the compartment at the rear inside of the boot. The compartment can be opened by raising the handle.

Roof Panel (optional T350t)**Roof Panel Removal**

The targa roof panels can be removed on the T350t. Following the steps below, takes you through the procedure of removing the panels.

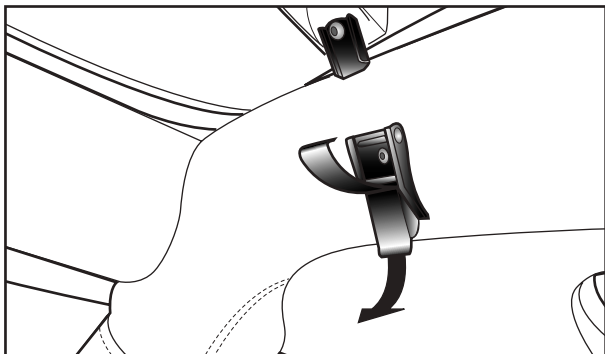

In the interior of the vehicle, on the sides and above the seats, two clips are located. These are released by raising the lower handle of the clip. Both clips have to be released for the panel to be free.

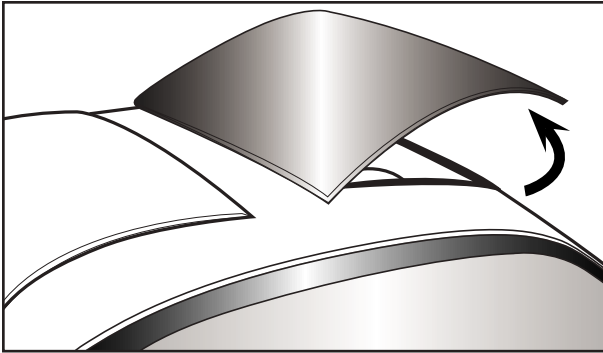

The targa roof panel can now be removed by raising the outer edge of the panel towards the center. Once the panel has cleared the center pegs, the targa panel can be removed fully and cleared from the roof. This is repeated for both panels.

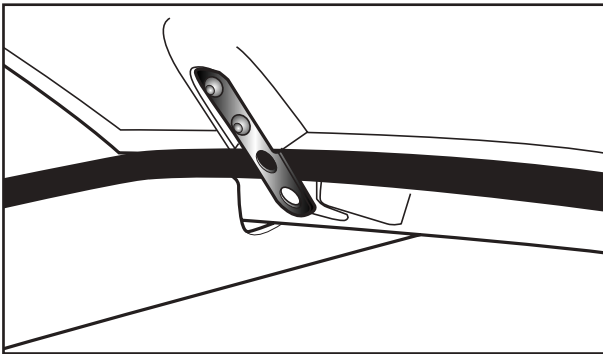

Once the panels are to be placed back onto the roof. The panels has to be re-aligned, by making sure the center pegs are inserted into their position first. Now the panel can be lowered back into place. In the interior the clips can be reattached and re-secure the targa panels.

Alarm System

Alarm & locking

The alarm System installed in your vehicle has been designed to provide optimum protection at all times. The system uses a contact key and a Rolling code radio key which never uses the same code twice and is therefore code grabber proof. The alarm and the immobiliser systems of the car are linked but run on different circuits to prevent total alarm/immobiliser failure.

Operation of the alarm system

On arming your alarm the immobiliser will instantly activate. 8 seconds after the ignition is switched off the immobiliser will always arm (even if you do not exit the vehicle) but the alarm will not arm. If you wish to drive the vehicle then simply press the button on the radiokey for less than two seconds or insert the contact key, to switch off the immobiliser.

Locking & using your radiokey

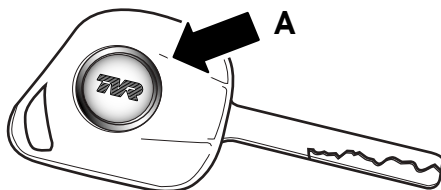

Exit the vehicle, press the button on the radiokey (A) once for two seconds, and release. Your car will acknowledge the signal by flashing its hazards lights twice and activating the immobiliser. Your alarm is now armed but, an additional 30 seconds is required for the motion detector to stabilise and become active. A red warning light mounted in the door mirror adjustment panel (no.8 page 7) will begin to flash to act as a visual deterrent.

Unlocking & Disarming the alarm

As you approach the vehicle, press the button on the radiokey. The vehicle will acknowledge the signal by flashing its hazard warning lights once and unlocking the doors. Once unlocked, to gain entry to the vehicle, press the exterior door release button located under the door mirror.

Please note: If you do not turn the ignition on within 9 seconds of disarming the alarm, the immobiliser will become active.

Electronic contact key operation

To show that the vehicle is immobilised a small LED on the immobiliser disarm socket will flash. Before turning the ignition insert the contact key into the socket, on removal the LED will be extinguished to show that the immobiliser has been turned off. The vehicle can then be started.

Please note: If the ignition is not switched on within 9 seconds the immobiliser will be reset.

System diagnostics

The alarm system is capable of indicating whether the alarm has been triggered in your absence. The LED mounted on the door mirror adjustment panel, will flash in one of the following sequences to indicate which circuit triggered the alarm:-

- | | |
|------------------------|---------------------------|
| 1. Internal sensor | 1 flash every 6 seconds |
| 2. Door trigger | 2 flashes every 6 seconds |
| 3. Bonnet/Boot trigger | 4 flashes every 6 seconds |
| 4. Ignition alarm | 8 flashes every 6 seconds |

When multiple alarms have been triggered for various reasons, the codes that identify them are indicated in sequence.

Cooling System	37
Power Steering	38
Windscreen Washer Reservoir	38
Engine Oil Dipstick	39
Brake/Clutch Fluid Reservoir	40
Battery	41
Fuses	42
Bulb Replacement	43 - 44
Bulb Specification Chart	45
Puncture Repair	46
Towing	46
Jump Starting	47
Brake Down Cover	47 - 48
Running in the Vehicle	48
Cleaning the Vehicle	49 - 50
Checks and Servicing	51
Resetting the Inertia Switch	54

Routine Maintenance



All fluid specifications and capacities are listed in the basic data and specifications section.

Cooling System

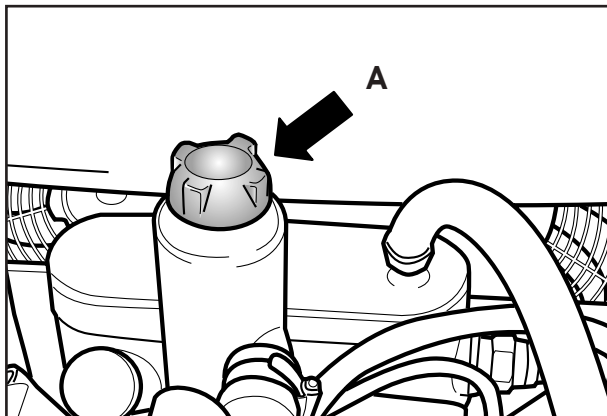

PLEASE NOTE: DO NOT REMOVE THE BLUE PRESSURE CAP ON THE EXPANSION TANK IF THE ENGINE IS HOT. ONLY CHECK THE COOLANT LEVEL WHEN THE ENGINE IS COLD.

To check the coolant level on your T350, remove the blue reservoir cap (A) and check whether the coolant fluid is visible in the filler neck. When the engine is cold, **there should be approx. 10mm of fluid visible within the filler neck.** If there is less than 10mm, top up with a coolant mix of 50% coolant to 50% water.

IMPORTANT: Check the coolant level every week.

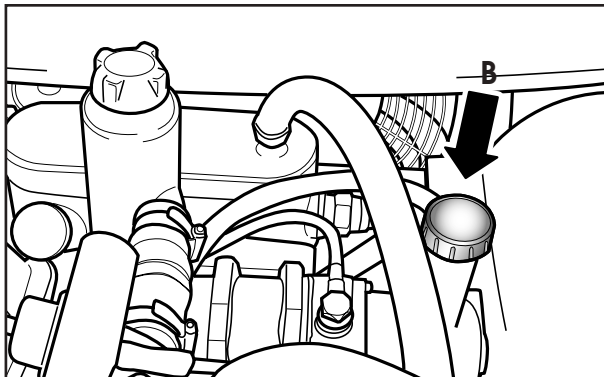
Power Steering Fluid

Check the fluid level is between the min and max mark on the filler neck of the reservoir (shown inset). Filler cap (B) is shown. Only top up with TVR recommended fluid (see page 57).

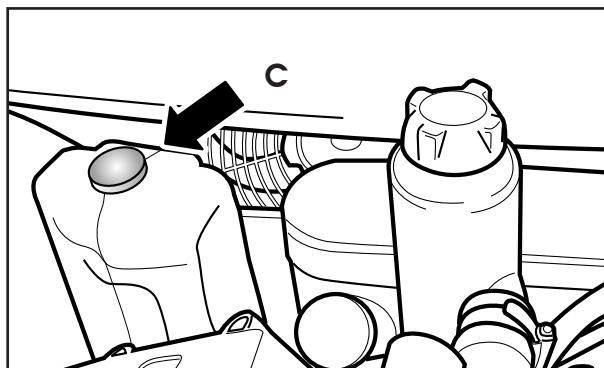
Windscreen Washer Reservoir

Located at the n/s front of the engine compartment. (C) Refill with a mixture of clean water and windscreen washer fluid.

Engine Oil Dipstick

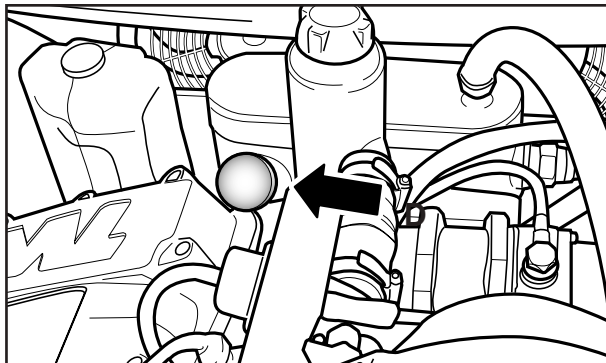

The dipstick on your TVR T350 is attached to the cap of the oil tank. (D). Due to the nature of the Speed Six's design, the engine will normally use a small amount of oil. We therefore recommend that the oil level is checked on a daily basis. The oil should always be checked on level ground with the engine switched off. To remove, unscrew the cap (D) in an anti clockwise direction. Pull the dipstick out and wipe clean to ensure a true reading. Re-insert the dipstick and remove once again. The level of oil should read between the min and max marks on the dipstick. Top up with TVR recommended oil (see page 57) if required.

Please note: The oil level should only be checked at operating temperature, immediately after stopping the vehicle. Over filling may cause oil wastage. Running the car with an oil level below the minimum mark could result in considerable damage to the engine. It is important that, once the oil has been checked, the dipstick is securely replaced to avoid oil leakage.

For track Days the oil level should be topped up to the Max mark on the dipstick and an eye should be kept on your oil pressure which should not fall below 35 psi @ 2000rpm.

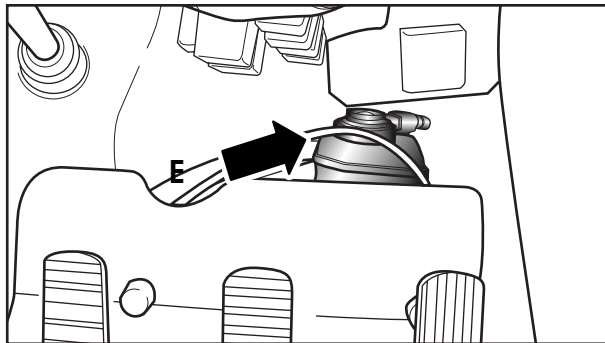
Brake/Clutch Fluid Reservoir

A universal Clutch/Brake fluid reservoir has been fitted to your T350. This combined reservoir feeds both the Brake and Clutch systems with fluid. The reservoir is situated in the drivers footwell behind the pedals.(E) The brake system warning light should illuminate if the fluid level falls below the minimum level but the reservoir can also be checked visually if desired. A loss of fluid will only occur due to a leak from either the clutch or brake system.

Please note: If the brake system warning light illuminates at any time other than when the handbrake is applied please consult your dealer. Check that the fluid level is up to the MAX line on the reservoir. Only top up with TVR recommended fluid (see page 59).

A fluid leak from the clutch system will be indicated by :-

- (A) A reduction of effort required to depress the clutch pedal.
- (B) Impossible gear selection- unable to disengage the clutch when the pedal is depressed.

Due to the reservoir design a clutch fluid leak will not result in brake system failure. TVR recommend that any work carried out on the brake system is completed by an authorised TVR dealer.

Battery

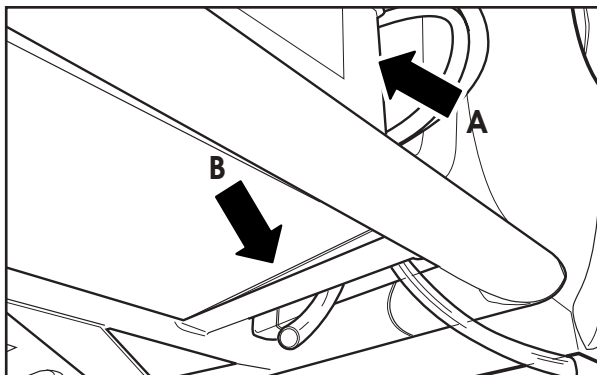

The position of the battery in your T350 is directly behind the front N/S wheel.(A) Your T350 has been fitted with a jump start/booster port which is located under the forward edge of the n/s sill (approx. 200mm back from the front wheel arch).(B) This port can be connected to a slave booster battery via a booster lead which is available from your local dealer. Simply connect the lead to the vehicle and the slave battery.

Please note: If charging the battery whilst it is still connected to the car, it is advisable to use a trickle charger giving out no more than 7 amps as a larger amp charger will cause damage to other components.

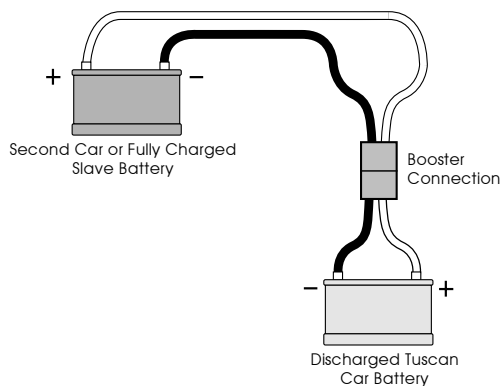

Fuse and Relay Panel

Located in the right hand footwell

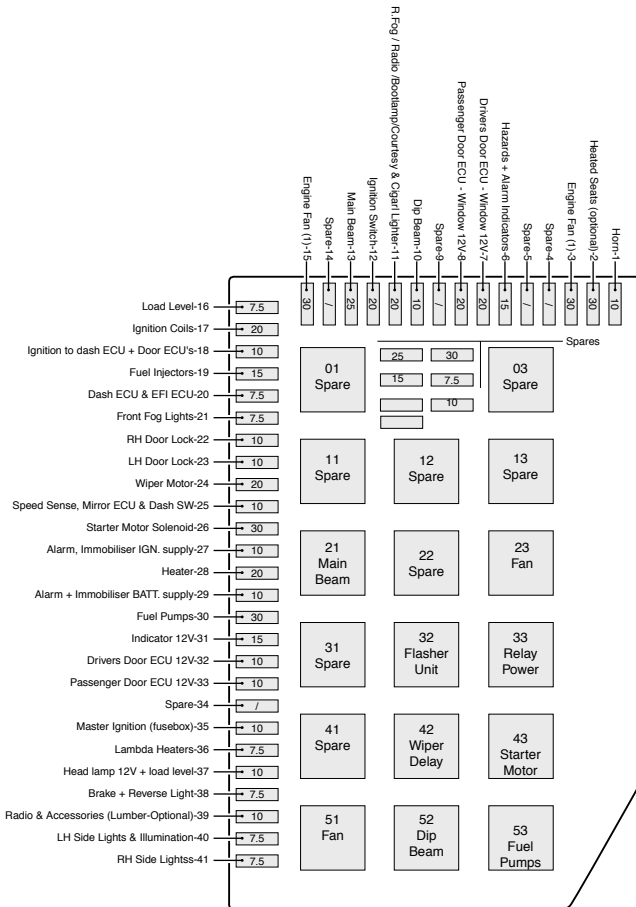

Bulb Replacement

Please Note: Before attempting to replace any faulty bulbs on the vehicle, the ignition should be switched off.

Interior Light Bulb Replacement

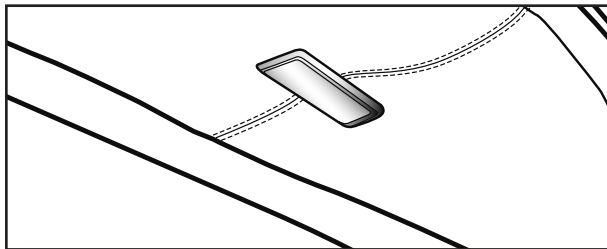

Insert a screwdriver behind the lens of the interior light and position a rag behind the screwdriver to safeguard against marking the trim surround. Lever the unit out to reveal the bulb. Replace the bulb (for the correct bulb see page 43). Place the assembly back into the aperture and push back into position.

Sidelight Bulb Replacement

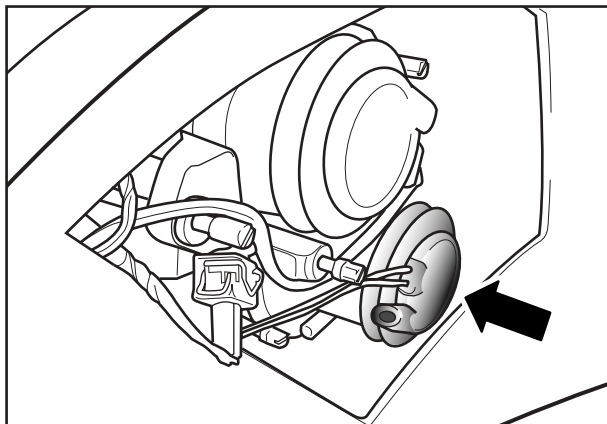

Access to all the front light clusters is gained by firstly removing the appropriate front wheel.

Sidelight Bulb Replacement cont.

Next remove the inner wing access panel which is secured by 4 screws. Then unclip the bulb from its mounting, disconnect and replace bulb (for the correct bulb see page 43) Refit the bulb and replace access panel.

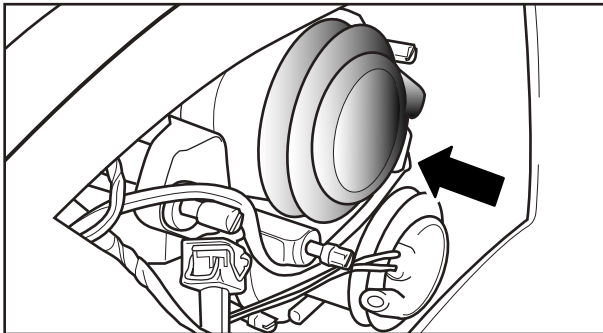
Headlamp/Main Beam Bulb Replacement

Access to the Headlamp bulb can be gained in the same way as with the sidelight bulbs. Once this has been done, locate the bulb, remove the rubber boot, disconnect the wires, unhook the spring retaining clip and remove the bulb. Replace the bulb, refit the spring clip and the access panel. (for the correct bulb see page 43)

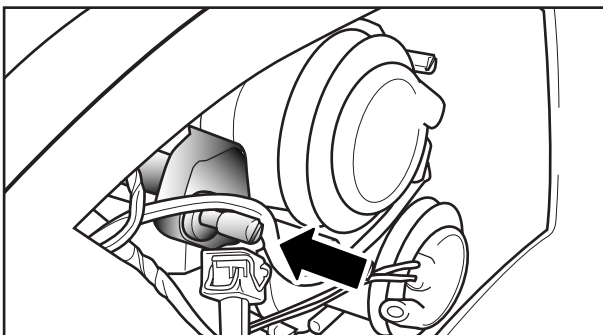
Indicator & Front Fog Light Bulb Replacement

Access to the Indicator bulb can be gained in the same way as for the side light bulb. Unscrew the indicator housing. Remove and replace the bulb (for the correct bulb see page 43), refit the housing.

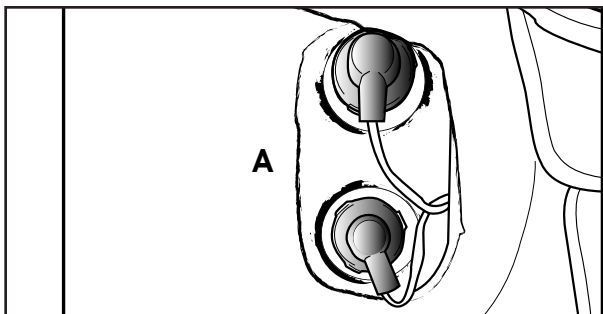
Rear Light Cluster

Access to the rear light cluster is gained by removing the cluster housing cover (A) (shown removed), located on the rear of the boot compartment. The covers are attached with velcro to the boot carpet. This cover can be easily removed simply by pulling the housing away from the boot carpet. To replace one of the bulbs unscrew the light unit housing by turning in an anti-clockwise direction. Replace the faulty bulb and replace the housing unit.

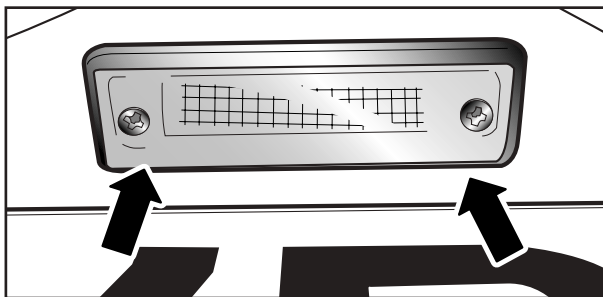
Rear Number Plate Light

There are 2 number plate lights located above the number plate. Undo the 2 screws and remove the light. Replace the faulty bulb.

Bulb Specification Table

Headlamps (dip & main beam)	H7 55W
Sidelights (front).....	5W
Indicators (Front).....	21W
Side Repeaters	5W Capless
Brake Lights.....	21W
Tail Lights	5W
Indicators (Rear).....	21W
Number Plate Lights.....	5W
Fog Light.....	21W
Reversing Light	21W
Interior Light	5W
Warning Lights	TVR LED's
Gauge Lights - Speedometer/Rev-Counter
.....	TVR Sealed LED unit
Initial Headlamp Beam Setting	
Vehicle Unladen.....	1.5%

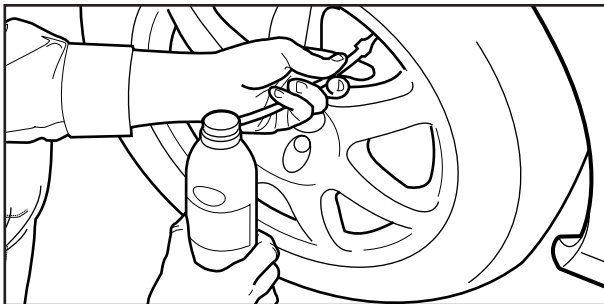
Puncture Repairs

Due to the impracticality of carrying a full sized wheel and tyre, the T350 is provided with a can of puncture repair foam which is intended as a temporary measure only to allow you travel home to have the puncture professionally repaired. Please follow the instructions printed on the can. However, should the puncture be more serious, due to a blowout or impact with a substantial object, this method of repair will not be effective. In this event, the vehicle will need to be recovered. AA Roadside Assistance is provided from new for 12 months.

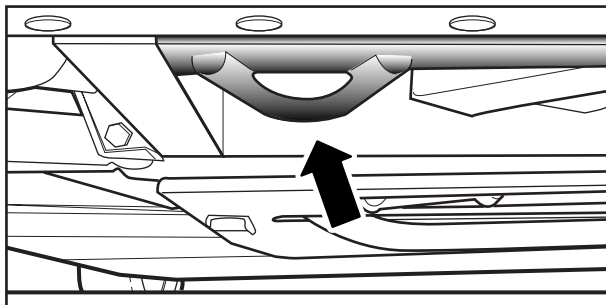
Towing the Vehicle

A towing eye is provided on the front of the vehicle for tow rope attachment. If the vehicle is being towed, the ignition switch should be switched on (ignition warning light illuminated). The indicators, horn and brake lights will now also be operational.

Towing the Vehicle cont.

Please Note: Assistance from the brake servo will be lost after the first two or three applications of the foot brake. This will increase the force required to depress the brake pedal.

Starting Using Jump Leads

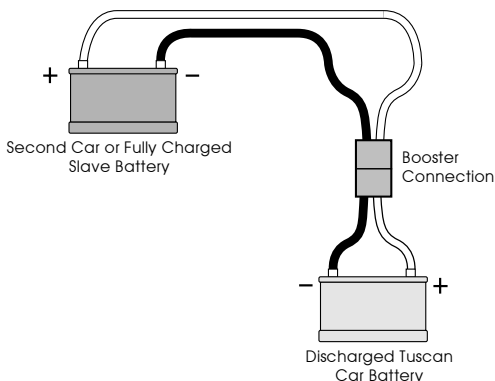

Your T350 has been fitted with a Jump Start/booster Port which is located under the forward edge of the front sill (approx. 200mm in from the front wheel arch). This port can be connected to a slave booster battery via a booster lead which is available from your local dealer.

To jump start the vehicle:-

1. Switch off all unnecessary electrical loads.
2. Connect the booster lead to vehicle.
3. Connect the end of the lead, with the crocodile clip, to the positive (+) terminal on the booster battery.
4. Connect the other lead to the negative (-) terminal on the booster battery.
5. Start the engine in the vehicle which has the booster battery, allow it to run for a few minutes.
6. Start the engine in the vehicle with the flat battery. If it starts and runs smoothly, carefully disconnect the jump leads in reverse order.

Please note: Ensure that one lead does not touch the clamp on the other lead when connecting to the terminals.

Breakdown Cover

In certain markets the vehicle, when bought from new, receives a 12 month Full Breakdown Cover policy. The policy is applied for by the factory on behalf of the customer, after being notified by the vending dealer of the customers details. Notification of the policy will be forthcoming, with registration card and full details enclosed. Should you require any further details regarding the cover, please contact your dealer.

Running In

During the first 2000miles, please follow the running in recommendations described on page 11/53 for the future reliability and economy of your new vehicle. Failure to follow these recommendations may result in vehicle damage or shortened engine life.

The benefit of this is a longer trouble free life for the mechanical components. The running-in procedure helps to hold down the lubricants' temperature and consequently the viscosity of the oil is maintained at a higher level than would be case if the component was put on full load and speed without running-in.

To gain maximum performance, service life and general reliability, the best policy to adopt during the running in period is to avoid high engine rpm, large throttle openings, and most importantly, not allowing the engine to labour in a high gear.

Recommended RPM during Running-in Period

Starting the engine from cold. 0-1000 miles, rpm should not exceed 2500 rpm until the engine is warm.

1. 0-250 miles, max rpm should not exceed 3500 rpm even when the engine is warm.
2. 250-2000 miles, rpm should be gradually increased until full power and max rpm for the vehicle is achieved.
3. **Do not** use full throttle accelerations in low gear for at least 900 miles and avoid full throttle use in any gear for the first 250 miles
4. Avoid driving at a constant speed within the first 300 miles.

Tyres

To obtain the maximum performance from the tyres it is advisable to avoid excessive braking and cornering whenever possible, during the 0-500 mile period.

Brakes

To bed the brake pads in correctly, avoid excessive braking during the first 500 miles, unless required to do so in an emergency.

Petrol Filling

The fuel filler cap is located in the boot, next to the left boot hinge. Press and twist the cap by turning anti-clockwise.

Please note: Any petrol spilled onto the paint work should be washed off immediately to prevent staining. The TVR T350 is designed to run exclusively on unleaded fuel and is fitted with a narrow fuel filler neck, making it compatible only for unleaded fuel pumps at petrol stations.

Cleaning the Vehicle

Exterior Cleaning By Hand

The body work can be washed using a mild detergent or specialist car shampoo. A low pressure hose pipe should be used to rinse the vehicle. Specialised cleaners should not be used when cleaning the road wheels.

Using a power wash

TVR Engineering do not recommend that you power wash any part of your T350. However if you do decide to do so, do not spray the high pressure jet directly at the paintwork, the mirrors, the door release switches, the boot release switches, under the rear wheel arches, directly into the nose or directly at the door/window seals. Do not, under any circumstances, power wash the engine bay, as this will cause serious electrical problems. Please avoid using any wheel cleaner sprays or traffic film remover "solvents".

Automatic car wash

The use of automatic car washes is not recommended as the door/window seals are not designed to withstand the direct force of high pressure water jets. Also, the detergents used and the cleaning action of the brushes may damage the paintwork.

Interior Cleaning

Vinyl/Leather

Vinyl and leather should be cleaned with a damp cloth. However, a little mild detergent or proprietary upholstery cleaner may be required to remove ingrained marks. Leather upholstery will benefit from a periodical application of Hide Food.

Carpets

Carpets panels should be cleaned regularly with a vacuum cleaner to remove dust and dirt. Mild detergents and warm water may be required to remove any difficult marks or stains.

Flocked panels

Flocked panels should be cleaned regularly with a vacuum cleaner to remove dust and dirt. A soft brush can be used with mild detergents and warm water to remove any difficult marks or stains.

Please note: Ensure to clean the whole flocked panel not just the marked area. Under no circumstances must wire or stiff brushes be used.

Checks and Servicing

Recommended Weekly Checks

1. All exterior lights
2. Coolant level
3. Brake fluid level
4. Clutch/Power steering fluid
5. Windscreen washer bottle
6. Tyre pressure
7. Visual check for any fluid leaks.

Recommended Daily Checks

1. Oil Level
2. Chassis

If for any reason the vehicle is grounded or an object strikes the chassis from below, it is advisable to visually inspect the chassis for signs of damage. If there is damage, the vehicle should be taken to your local dealer for a thorough inspection.

Service Intervals

The following are recommended service intervals for the vehicle.

- 1000 miles
- 6000 miles
- 12000 miles
- 18000 miles
- 24000 miles
- 30000 miles

and every 6000 miles thereafter or every twelve months, which ever is reached first.

Please Note: All service work should be carried out by a TVR factory approved service centre.

Catalytic Exhaust Systems

In conjunction with a highly efficient engine management system designed to work with exhaust catalysts and a fuel tank vapour recovery canister, the catalytic exhaust system is designed to reduce emissions of exhaust gas pollutants and fuel vapour to a level well below the strictest European and Scandinavian legal limits. To maintain the effectiveness of the emission control system the following points should be observed:

1) **NEVER USE LEADED PETROL**, even in an emergency. The emission system will only function correctly on unleaded fuel. Using 4 star or other grades of fuel containing lead will damage the vehicles catalytic converters and exhaust gas oxygen sensors. Replacement of these components is expensive. The TVR recommend the following fuel for its engine range:-

T350 Speed Six **95 (RON) octane unleaded.**

**Please note: For high performance driving i.e. Track days
98 (RON) octane (super green) fuel is recommended.**

2) Do not allow the car to run out of fuel. An irregular fuel supply, caused by a near empty tank, can cause engine misfires which may damage the catalytic converters.

3) Ensure that the car is regularly serviced by a TVR Dealer or approved service centre. All TVR Dealers have special diagnostic equipment necessary to check for the correct operation of the emission system.

4) Avoid all situations whereby unburnt or partially burnt fuel is allowed to enter the exhaust system. For instance, avoid unnecessarily long engine cranking periods, never run the engine with a sparking plug cap disconnected and do not allow the car to coast in gear with the ignition switched off.

5) It is not advisable to push or tow start the vehicle, especially if the catalysts are hot. If the engine will not start because the battery is flat, use a pair of jump leads and a slave battery. If the engine misfires or seems to lack normal performance it is recommended that you drive, at low engine speeds, to the nearest TVR dealer.

6) Take care when parking the vehicle. The catalytic converters and exhaust system can radiate a considerable amount of heat.

Please Note: The vehicle should not be parked over combustible materials, such as dry grass, leaves or paper.

7) Sealant or other materials should not be applied to the catalysts.

Seat Belts

Ensure that the seat belt is not obstructed in any way when fitting. The seat belts should be fully retracted before leaving the vehicle. Clean the seat belt webbing using soapy water. **Do not** use solvents or abrasives to clean the webbing.

Brake and Clutch

Certain brake and clutch components may contain asbestos based material. Precautions must be taken when servicing these components. Avoid any skin contact or inhalation of the dust. Servicing of these components should be carried out by qualified personnel only.

Used Engine Oil

Prolonged or repeated contact may cause serious skin disorders. Avoid excessive contact, and wash thoroughly after contact.

Environment Protection

It is illegal to pollute drains, water courses or soil. Use authorised waste disposal facilities to dispose of used engine oil. If in doubt, contact your local authority for advice.

Fuel Shut-off Inertia Switch

In the event of an accident the power to the engine management ECU is cut off, thereby stopping the supply of fuel to the engine. If the switch has been actuated the EFI warning screen will show on your LCD display.

Resetting the Inertia Switch

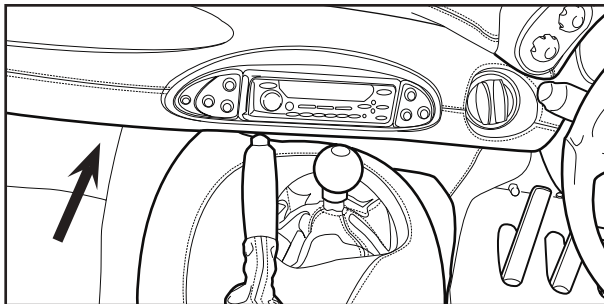

The inertia switch on your T350 is located underneath the dashboard in front of the glovebox, (attached to a welded bracket)

To reset the inertia please follow the procedure below:-

To gain access to the switch (best done by feel) from the lefthand footwell pass your hand upwards in front of the glovebox. The switch (A) is mounted in a vertical position.

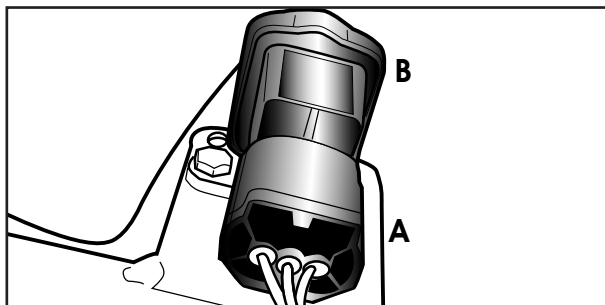

To reset simply press the rubber button (B) on the top of the switch.

Oils and Lubricants	59
Bodyshell	59
Interior	59
Chassis	60
Suspension	60
Steering	60
Wheels and Tyres	60
Transmission	61
Slip Differential	61
Engine	62
Fuel and Ignition Systems	62
Dimensions	62



Oils and Lubricants**Engine****Running in to 1000 miles**

Carlube Triple R 10W- 40 Semi-Synthetic	6 litres
---	----------

From 1000 miles - 6000 miles

Carlube Triple R 10W- 40 Semi-Synthetic	6 litres
---	----------

6000 miles on

Carlube Triple R 0W- 40 Fully Synthetic	6 litres
---	----------

Gearbox

Carlube ATF-Q3	1.4 litres
----------------	------------

Differential

Mobil SHC 80W 140 ID	1.6 litres
----------------------	------------

Cooling System

CarPlan Blue Star/ CarPlan Five Star Long-life	12 litres
--	-----------

Brakes and Clutch

Carlube DOT 4 Synthetic Brake Fluid	
-------------------------------------	--

C.V. Joints

Carlube Molybdenum Grease No.2	
--------------------------------	--

Power Steering

Carlube ATF-Q3	
----------------	--

Please note: TVR use and recommend Carlube products. Failure to use these products could effect vehicle performance and reliability and may also invalidate the warranty.

Bodyshell

Two seat two door coupe manufactured in glass reinforced polyester resin. Laminated sundym windscreen with frameless electrically operated door windows.

Interior

Half hide interior with individually reclining front seats trimmed in leather. Full Hide interior trim is available as an option, Aluminium dash pod with an LCD screen displaying comprehensive information including, tachometer, oil pressure, Clock, odometer, water/oil temp. as well as additional speedometer, and tachometer. Electrically operated boot release.

Chassis

Jig formed multi tubular steel frame chassis, phosphated and powder coated for corrosion resistance.

Suspension

Front - Independent comprising double wishbones and coil over gas dampers assisted by an anti-roll bar.

Rear - Independent comprising double wishbones and coil over gas dampers assisted by an anti-roll bar.

Limited - slip differential.

Braking

Front - 304 mm diameter ventilated front disc brakes with 4 piston alloy callipers.

Rear - 282 mm diameter ventilated rear discs with single piston sliding calliper

Servo assisted with front/rear split dual circuits. Cable operated handbrake operating on the rear.

Steering

Power assisted rack and pinion steering with adjustable rake steering column. 350 mm leather covered steering wheel.

Wheels & Tyres

Front - 7.5 x 16 aluminium alloy wheels fitted with 225/50 ZR16

Rear - 7.5 x 16 aluminium alloy wheels fitted with 225/50 ZR16

Recommended Tyre Pressures

Front - 28 psi (1.9 bar)
(sustained high speed or fully laden - 30 psi (2.04 bar))

Rear - 28 psi (1.9 bar)
(sustained high speed or fully laden - 32 psi (2.18 bar))

For track driving conditions we suggest pressures starting at 28-30 psi. all round in the dry; with a reduction of 5 psi. (.34 bar) if it is wet.

Note: Do not forget to return the tyres to their normal pressures.

Transmission

5 speed manual gearbox with hydraulically operated clutch.

Gear ratios:-

1st	2.95:1
2nd	1.95:1
3rd	1.34:1
4th	1.00:1
5th	0.80:1

Limited slip differential 3.73:1

Optional Close Ratio Gearbox

Gear ratios:-

1st	2.43:1
2nd	1.56:1
3rd	1.24:1
4th	1.00:1
5th	0.80:1

Optional Hydratrak™ Limited Slip Differential

The Hydratrak™ coupling unit which is a sealed for life, fluid filled cartridge, houses an inner rotating element which is also splined to the left hand shaft, thereby interconnecting both axle shafts via the coupling unit. Consequently, wherever there is any relative wheel speed difference between the left and right rear driving wheels, there will occur relative movement within the Hydratrak™ unit, which in turn creates hydraulic resistance. Greater torque is then transferred to the slower rotating wheel in order to provide the vehicle with enhanced stability as well as tractive ability. This hydraulic resistance also increases as the relative wheel speed increases, thereby providing a speed sensitive rather than torque sensitive type of limited slip differential ensuring smooth and progressive operation.

Please Note. In the event of the rear wheels being under difficult tractive conditions, continued excessive wheel spinning should be avoided to ensure excessive heat is not generated within the unit which may cause premature failure.

Engine - Speed Six

Straight 6 alloy engine, 4 valves per cylinder	
Capacity (cc)	3605 cc
Bore/stroke (mm)	96 x 83
Compression Ratio	11.8:1
Max power	350 bhp @ 7200 rpm
Max torque	290 ft.lbs @ 5500 rpm
0 to 60 mph	4.6 secs
0 to 100 mph	9.8 secs

Fuel & Ignition Systems

Fully mapped engine management with three way catalytic converters and closed loop fuel control strategy.

WARNING: This vehicle must not run on leaded fuel - see section on Catalytic Exhaust Systems page 51.

Dimensions

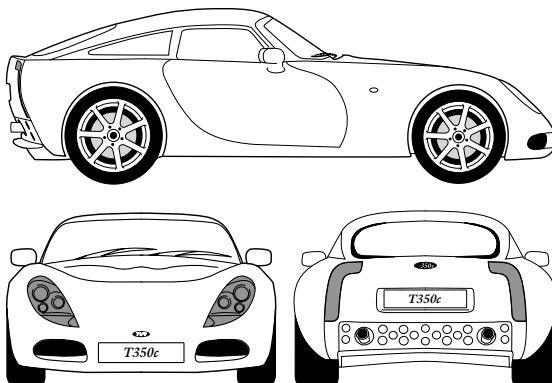

Length overall	3925 mm
Wheelbase	2361 mm
Width overall (inc. mirrors)	1715 mm
Height overall	1204 mm
Front track	1448 mm
Rear track	1492 mm
Ground clearance.....	102 mm
Weight	1060 kg

General Warranty Coverage	65
Body Warranty Coverage	65
Replacement Parts Coverage	65
Extent of Company Obligations	66
Exclusion from Warranty Cover	66
Maintenance	66
Motor Racing	66
Loss of Damage	67
Limitations of Warranties	67
Obligations of the Owner	67
Disputes	67
Warranty Acknowledgement	67



This TVR has been built by TVR Engineering Limited, to the best of their ability within the present scope of the art known to specialist car manufacturers. This warranty is given in addition to and shall not affect the purchaser's statutory rights as a consumer.

TVR Engineering Limited (hereafter known as the Company) warrants each motor car and each replacement part to be free from defects in material and workmanship, under normal use and service, and subject to the terms and conditions stated in this limited warranty, for the applicable Warranty Period set forth in paragraph 1(a)

1.(a) General Warranty Coverage.

The Company warrants each new motor car to be free of defects in material and workmanship for a period of 12 months after delivery of the motor vehicle to the original owner. If any part or parts of a TVR car should prove defective within this prescribed period, and if such part or parts are submitted within 14 days to an authorised TVR distributor or dealer, the Company will cause such part or parts to be examined within a reasonable time and in the event of a fault due to defective workmanship or material being found the defective part or parts will be repaired or replaced without charge for the parts or labour involved in their replacement.

1.(b) Body Warranty Coverage. One (1) year.

The Company warrants the body shell, paint, exterior and interior trim, seats and upholstery and battery of each new motor car to be free from defects in material and workmanship for a period of one (1) year after delivery of the motor car to the original owner.

1.(c) Replacement Parts Coverage.

Parts, assemblies and components which are replaced under the warranty are warranted to be free from defects in materials and workmanship for 180 days from the date of replacement, or until the expiration of the period in which the general or body warranty remains in effect, whichever occurs last.

2. Extent of Company Obligations.

The obligations of the Company under this warranty are limited to the repair or, at its option, the replacement of a new or remanufactured unit, without charge for labour or parts, of any part of assembly or component determined to be defective in material or workmanship during the applicable warranty period. All defective replacement parts become the property of the Company upon removal. All service under this warranty must be performed by an authorised TVR dealer importer or distributor at his place of business, unless prior authorisation is obtained from the Company. Persons dealing in the Company's vehicles or spare parts are not authorised to bind the company in any way or to assume any obligation whether expressed or implied on behalf of the Company nor to give any warranty or guarantee nor make any representation on behalf of the Company.

3. Exclusion from Warranty Cover.

(a) Proprietary Equipment. The only warranties given for radio receivers, tape players and tyres are written warranties which are issued by the suppliers of such equipment.

(b) Maintenance, Service, Wear & Tear.

The obligation of the Company does not extend to maintenance services such as tune ups, cleaning of coolant, fuel and hydraulic systems, wheel balancing and alignment, and other service adjustment, nor to the repair or replacement of service items such as lubricants, fluids, spark plugs, wiper blades, filters, belts, coolant hoses, clutches, brake pads, nor to the deterioration of the paintwork, upholstery or any damage occasioned as a result of an accident or as a result of the negligent use of the vehicle howsoever occasioned or any part, assembly or component as a consequence of normal wear and tear or exposure to the elements.

(c) Motor Racing, Alteration & Hire.

The obligation and warranties of the Company do not extend to vehicles used for motor racing or competition of any nature or to vehicles or parts which have been altered after leaving the Company's factory, or which have been let out on hire, or from which identification numbers or marks have been altered or removed.

(d) Consequential & Incidental Loss or Damage.

This warranty neither covers nor extends to any consequential damage or expense including, but not limited to, inconvenience hotel or restaurant expenses, towing or parking fees, car rentals, nor the loss of time or use of the motor car.

4. Limitations of Warranties.

This warranty limits the duration of all implied warranties, including the implied warranties of merchantability and fitness for a particular purpose, to the time periods set forth in sub paragraphs 1(a), 1(b) and 1(c). The warranty shall not be transferred to anyone unless the Company's consent in writing has first been obtained upon receipt of the change of ownership card located at the rear of this warranty.

5. Obligations of the Owner as to proper Care and Usage.

The Company has no obligations under this warranty in the following circumstances:-

(a) if the essential maintenance services identified in the service coupon booklet and the maintenance instructions described in the owners handbook are not performed and followed at the prescribed intervals.

(b) if failure or malfunction of the vehicle or any warranted part, component or assembly results from an accident.

(c) if failure or malfunction is caused by negligence in use of the vehicle.

(d) by performance of service, repair or modification other than in accordance with the recommended servicing and repair procedures of the Company

(e) if the vehicle is registered or used in the United States of America, Canada, Hawaii, Guam, and the United States Virgin Islands or Outside Continental Europe in countries where different legislation on vehicle safety and environmental emission standards apply so as to render the European specification illegal and invalid.

(f) if the vehicle is modified or added to in any way not previously agreed by the Company in writing.

(g) if the limits for chassis load, axle load, pay load, permissible gross weight or axial pressure are exceeded.

(H) if the vehicle is left running but unattended and any damage occurs.

6. Disputes.

The Company's decision shall be final and binding in respect of any claim or dispute arising out of a defect or alleged defect in any vehicle or part. After the expiration of fourteen days from dispatch of notification of the Company's decision the part or parts may be scrapped by the Company or returned to the purchaser ,in which event transport charges are payable by the purchaser.

7. Return of Warranty Acknowledgment Card.

The obligations of the Company under this warranty shall not arise unless and until the Company shall receive the warranty Acknowledgment appearing at the end of this warranty, within 28 days from the date of purchase, duly executed by the original owner.

For TVR Engineering Limited:
Peter Wheeler, Chairman

Please keep this booklet in your vehicle as to avoid unnecessary delay it must be shown to the authorised TVR distributor or dealer at the time the repair is requested.







This section should be completed by the vending dealer

Vehicle Registration No

Model

V. I. N.

Engine No.

Paint Colour

TVR Code

Trim Colour

TVR Code

Carpet Colour

TVR Code

Trim Material

Remote Key Fob No.

Ignition Key No.

The descriptions and codes listed above are relevant to all TVR dealers, and should be quoted in the event of paint or trim rectification.





A

A/C Control	25 - 26
A/C Temperature Adjustment Switch	25
Air Temperature Blend	26
Alarm and Locking	33
Alarm System	33

B

Battery	41
Bodyshell	59
Bonnet Release	29
Boot Release	29
Brake and Clutch	55
Brake System Warning Light	2
Brake and Clutch Fluid Reservoir	38
Brakes	5
Breakdown Cover	47 - 48
Bulb Replacement	43 - 44
Bulb Specification Table	45
Buzzer Volume	18

C

Carpets	51
Catalytic Exhaust Systems	53
Chassis	60
Checks and Servicing	51
Cigar Lighter	4
Cleaning the Vehicle	49 - 50
Clock	10 - 12
Cooling System	37

D

Dash Pod	2
Dashboard Buzzer	18
Demist and Temp Controls	25
Differential	61
Dimensions	62
Display Setup Screen	14
Door Mirror Adjustment/Demist	21
Door Release	28

E

Electric Contact Key Operation	33 - 34
Emergency Door Release	28
Engine	62
Engine Oil Dipstick	39
Engine Oil Filler Cap	39
Environment Protection	54
Exterior Cleaning	49

F

Fan Control	25
Flocked Panels	51
Fog Lamp Switch	9
Fuel and Ignition Systems	62
Fuel Gauge	10 - 12
Fuel Pump Shut-off Inertia Switch	54
Fuel Tank Capacity	6
Fuel Type	6
Fuse and Relay Panel	42

G

Gear Lever	21
Gearbox	61

H

Handbrake	22
Hazard Warning Lights	16
Headlamp/Main Beam Bulb Replacement	43
High Beam Headlights	9
Horn	16

I

Immobiliser Disarm Socket	22
Indicator Bulb Replacement	44
Inertia Switch	55
Interior Cleaning	49 - 50
Interior Light	23
Intermittent Wipe Speed	18

K

Keys	31
------	----

L

LCD Display in Brief	10
LCD Display Information	10
LCD Function Controller Switch	9
LCD Display Contrast	14
LCD Warning Screens	15
Left Turn Indicator Light	2
Locking and Using your Radiokey	33 - 34
Lumbar Support	24
Luggage Cover	29

O

Oils and Lubricants	59
Operation of the Alarm System	34
Optional Hydratrak	63

P

Power Steering	60
Power Steering Fluid	38
Puncture Repair	46

R

Rear Light Cluster	45
Rear Number Plate Light	45
Rear Window Demist	21
Recommended Daily Checks	52
Refuelling	6
Right Turn Indicator Light	2
Running In	5

S

Seat Adjustments	23
Seat Belts	24
Seat Reclining	23
Service Intervals	52
Sidelight/Headlight Switch	9
Sidelight Bulb Replacement	43
Starting Using Jump Leads	47
Steering	60
Steering Column Adjustment Lever	19
Stereo Radio Cassette	19
Suspension	60
System Diagnostics	13

T

Tool Kit	30
Towing the Vehicle	46
Transmission	61
Trip Meter	10
Turn Indicator, Headlight Flash and Full Beam Stalk	17
Tyre Pressures	60
Tyres	60

U

Unlocking and Disarming the Alarm	33 - 34
Used Engine Oil	39

V

Vinyl and Leather	51
-------------------	----

W

Warning and Telltale Lights	15
Warranty	65
Water Temperature Gauge	10 - 12
Wheels and Tyres	60
Window Position	27
Windscreen Washer Reservoir	38
Wiper and Washer Stalk	17