

ALCAZAR

Service Booklet

Operation
Maintenance

All information in this Owner's Manual is current at the time of publication. However, Hyundai Motor India Limited reserves the right to make changes at any time without prior notice and without obligation to incorporate such changes so that our policy of continual product improvement may be carried out. This manual applies to all variants of this vehicle and includes descriptions and explanations of optional as well as standard equipment. As a result, you may find material in this manual that does not apply to your specific vehicle. This booklet is not intended to be a substitute for the owner's manual given in QR code provided backside of the cover page.

CAUTION: MODIFICATIONS TO YOUR HYUNDAI

Your HYUNDAI vehicle should not be modified in any way. Such modifications may adversely affect the performance, safety or durability of your HYUNDAI vehicle and may, in addition, violate conditions of the limited warranties covering the vehicle. Certain modifications may also be in violation of regulations established by the Department of Transportation and other government agencies in your country.

TWO-WAY RADIO OR CELLULAR TELEPHONE INSTALLATION

Your vehicle is equipped with electronic fuel injection and other electronic components. It is possible for an improperly installed/adjusted two-way radio or cellular telephone to adversely affect electronic systems. For this reason, we recommend that you carefully follow the radio manufacturer's instructions or consult your HYUNDAI dealer for precautionary measures or special instructions if you choose to install one of these devices.

SAFETY AND VEHICLE DAMAGE WARNING

This manual includes information titled as DANGER, WARNING, CAUTION and NOTICE.

These titles indicate the following:



DANGER

DANGER indicates a hazardous situation which, if not avoided, will result in death or serious injury.



WARNING

WARNING indicates a hazardous situation which, if not avoided, could result in death or serious injury.



CAUTION

CAUTION indicates a hazardous situation which, if not avoided, could result in minor or moderate injury.

NOTICE

NOTICE indicates a situation which, if not avoided, could result in vehicle damage.

WONDER WARRANTY CUSTOMER COPY

(Not Applicable for Taxi/Commercial Vehicles)

This certificate depicts information about the vehicle basic warranty options and customer have to choose any one of them among three categories:

Model Name : _____

Customer Name : _____

VIN _____

Registration No. _____

Delivery Date _____ **Dealer code** _____

**WONDER
WARRANTY**

- 3 Years / Unlimited km***
 4 Years / 60 000 km*
 5 Years / 50 000 km*

*Whichever is earlier from the date of delivery to first purchaser.

In case No option is selected, Warranty on the car will be **3 Years/Unlimited km**, whichever is earlier from the date of delivery to the first purchaser. Option Once Chosen is Final & Binding and can't be altered/ changed once selected. Road Side Assistance services will be applicable for 3 Years from the date of sale.

I hereby declare that all the three warranty options have been explained to me and i have chosen the option selected above.

Customer Signature

Dealer Stamp

*T&C apply

Page no. - F1

Cut here

Cut here

Cut here

WONDER WARRANTY DEALER COPY

(Not Applicable for Taxi/Commercial Vehicles)

This certificate depicts information about the vehicle basic warranty options and customer have to choose any one of them among three categories:

Model Name : _____

Customer Name : _____

VIN _____

Registration No. _____

Delivery Date _____ **Dealer code** _____

**WONDER
WARRANTY**

- 3 Years / Unlimited km***
 4 Years / 60 000 km*
 5 Years / 50 000 km*

*Whichever is earlier from the date of delivery to first purchaser.

In case No option is selected, Warranty on the car will be **3 Years/Unlimited km**, whichever is earlier from the date of delivery to the first purchaser. Option Once Chosen is Final & Binding and can't be altered/ changed once selected. Road Side Assistance services will be applicable for 3 Years from the date of sale.

I hereby declare that all the three warranty options have been explained to me and i have chosen the option selected above.

Customer Signature

Dealer Stamp

*T&C apply

Page no. - F1

Table of Contents

Foreword	1
Hyundai Warranty Policy	2
Vehicle Information	3
Safety System	4
Instrument cluster	5
Convenient features	6
While driving	7
Emergency situations	8
Maintenance	9

2. Hyundai Warranty Policy

- Hyundai New Vehicle Warranty2-2
- Replacement Parts Warranty2-3
- Hyundai Extended Warranty 2-5
- Free Service Coupons..... 2-7

HYUNDAI NEW VEHICLE WARRANTY

Hyundai Motor India Limited hereinafter called "HMIL", warrants that each new Hyundai vehicle sold shall be free from any defects in material and workmanship, under normal use and maintenance, subject to the following terms and conditions.

1. Warranty Period

This warranty for Hyundai vehicle shall exist for a period as per option selected on the **Page F1** by the first purchaser from the date of delivery whichever is earlier. However the warranty for **ALCAZAR** being used for commercial purpose such as Taxi/Tourist operation is 36 months/100,000 kilometers from the date of delivery to the first purchaser which soever is earlier. This warranty is transferable to subsequent owner for the remaining warranty period. This warranty is applicable only in India and not transferable to any other country.

2. What is covered

Except as provided in paragraph 3 hereof, our Authorized Dealers shall either repair or replace, any Hyundai genuine part that is acknowledged by HMIL to be defective in material or workmanship within the warranty period stipulated above, at no cost to the owner of the Hyundai vehicle for parts or labour. Such defective parts which have been replaced will become the property of HMIL

3. What is not covered

This warranty shall not apply to:

- ▶ Normal maintenance services other than the three free services, including without limitation, cleaning and polishing, minor adjustments, engine tuning, oil/fluid changes, filters replenishment, fastener retightening, wheel balancing, wheel alignment and tyre rotation etc.
- ▶ Replacement of parts as a result of normal wear and tear such as spark plugs, belts, brake pads and linings, clutch disc/facing, filters, wiper blades, bulbs, fuses, etc.

Damage or failure resulting from :

- ▶ Negligence of proper maintenance as required in this Owner's Manual and Service Booklet.
- ▶ Misuse, abuse, accident, theft, flooding or fire.
- ▶ Use of improper or insufficient fuel, fluids or lubricants.
- ▶ Use of parts other than Hyundai Genuine Parts.
- ▶ Any device and/or accessories not supplied by HMIL.
- ▶ Modifications, alterations, tampering or improper repair.
- ▶ Parts used in applications of which they were not designed or not approved by HMIL.
- ▶ Slight irregularities not recognised as affecting quality or function of the vehicle or parts, such as slight noise or vibrations, or items considered characteristic of the vehicle.
- ▶ Airborne "fallout", Industrial fallout, acid rain, hail and windstorms, or other Acts of God.

- ▶ Paint scratches, dents or similar-paint or body damage.
- ▶ Action of road elements (sand, gravel, dust or road debris) which results in stone chipping of paint or glass.
- ▶ Incidental or consequential damages, including without limitation, loss of time, inconvenience, loss of use of vehicle or commercial loss.

Audio Video Navigation System, Wireless Charger, Air Purifier, Batteries, Tyres & Tubes, Audio Systems, or any external accessory originally equipped on Hyundai vehicles are warranted directly by the respective manufacturers and not by HMIL.

- ▶ This warranty is the entire warranty given by HMIL for Hyundai vehicles and no dealer or its or his agent or employee is authorized to extend or enlarge this warranty and no dealer or its or his agent or employee is authorized to make any oral warranty on HMIL's behalf.
- ▶ HMIL reserves the right to make any change in design or make any improvement on the vehicle at any time without any obligation to make the same change on vehicles previously sold.
- ▶ HMIL reserves the right for the final decision in all warranty matters.

Owner's Responsibilities

- ▶ Proper use, maintenance and care of vehicle in accordance with the instructions contained in this Owner's Manual and Service Booklet. If the vehicle is subject to severe usage conditions, su-

such as operation in extremely dusty, rough, more repeated short distance driving or heavy city traffic during hot weather, maintenance of vehicle should be done more frequently as mentioned in this Owner's Manual and Service Booklet

- ▶ Retention of maintenance service records. It may be necessary for the customer to show that the required maintenance has been performed, as specified in this Owner's Manual and Service Booklet.
- ▶ Delivery of the vehicle during regular service business hours to any authorized Hyundai Dealer to obtain warranty service.
- ▶ In order to maintain the validity of this Basic Warranty, the vehicle must be serviced by Hyundai Authorized workshop in accordance to the Owner's Manual and Service Booklet.

PARTS REPLACEMENT WARRANTY

Hyundai Motor India Limited hereinafter called "HMIL", warrants that each new Hyundai Genuine replacement part purchased from and installed by Hyundai Authorized Dealer shall be free from any defects in material or workmanship, under normal use and maintenance, subject to the following terms and conditions

1. Warranty period

This warranty shall exist for a period of 6 months or until the vehicle has

been driven for a distance of 10,000 Kilometers from the date of installation of replacement part by Hyundai Authorized Dealer, whichever occurs first.

2. What is covered

Our Authorized Dealers shall either repair or replace, any Hyundai genuine part listed in paragraph 3 hereof, that is acknowledged by HMIL to be defective in material or workmanship within the warranty period stipulated above, after examinations carried out to confirm that none of the original settings have been tampered with, at no cost to the owner of the Hyundai vehicle for parts or labour. Such defective parts which have been replaced will become the property of HMIL

3. What is not covered

This warranty shall not apply to:

- Normal maintenance services of parts such as cleaning, adjustment or replacement (i.e. spark plugs that are oil fouled, lead fouled, or which fail due to the use of low grade fuel).
- Parts that fail due to abuse, misuse, neglect, alteration or accident or which have been improperly lubricated or repaired
- Parts used in applications for which they were not designed or approved by HMIL.
- Failure due to normal wear of parts.
- Direct or indirect failures caused by misuse and improper maintenance of vehicle.

- Any vehicle on which the odometer reading has been altered so that mileage cannot be accurately determined.
- Incidental or consequential damages, including without limitation, loss of time, inconvenience, loss of use of vehicle or commercial loss.

This warranty is the entire warranty given by HMIL for Hyundai replacement parts and no dealer or its agent or employee is authorized to extend or enlarge this warranty and no dealer or its agent or employee is authorized to make any oral warranty on HMIL's behalf. HMIL reserves the right for the final decision in all warranty matters.

Owner's Responsibility :

- Proper use, maintenance and care of the vehicle in accordance with the instructions contained in the Owner's Manual and Service Booklet.
- Retention of maintenance service records. It may be necessary for the customer to show that the required maintenance has been performed, as specified in this Owner's Manual and Service Booklet.
- **Retention of the customer's copy of the original repair order and its invoice/bill against which the part was replaced.**
- Delivery of the vehicle during regular service business hours to the same Hyundai Authorized Dealer who had sold and installed the replacement part
- In order to maintain the validity

of this Parts replacement Warranty, the vehicle must be serviced by Hyundai Authorized workshop in accordance to the Owner's Manual and Service Booklet.

HYUNDAI EXTENDED WARRANTY*

HMIL offers optional paid extended warranty on selected models, in addition to the basic new vehicle warranty. For more details on Hyundai Extended Warranty please call the nearest dealer or our toll free number 1-800-11-4645.

**Conditions apply*

We are pleased to introduce you to our 24 X 7 Hyundai Road Side Assistance Programme

**Our Road Side Assistance number is : 1800 102 4645 (toll free),
(0124) 2564645 (call charges apply)**

Hyundai Roadside Assistance is a 24 X 7 emergency support provided in the event of any mechanical/electrical breakdown and/or road traffic accident of a vehicle.

Covered events & benefits *

Break Down/Accident	▶	Roadside repair or vehicle recovery in case of breakdown/road traffic accident.
Tire Related	▶	Tire Puncture-Replacement of punctured tire with the spare tire.
Battery related	▶	Dead Battery-Jump start.
Key Related	▶	Locked keys, lost keys or broken vehicle keys.

*Terms and conditions apply.

Terms & Conditions

- 1). The service is applicable for 3 years from the date of sale.
- 2). The 24 X 7 Road side assistance is available up to a nearest Hyundai authorized dealer workshop.
- 3). The service is applicable for a condition in which the vehicle has been immobilized.
- 4). Cost of parts replacement is not included, unless covered under Hyundai Warranty.
- 5). Cost of repairs made to your vehicle is not included, unless it is covered under Hyundai Warranty.
- 6). Download Hyundai India RSA Mobile App via URL : <https://goo.gl/0t8g9n>.
- 7). For Online refund RSA, kindly visit : <https://hyundai.com/assistance/in/>

1st FREE SERVICE COUPON

(1,200-1,500 km or within 2 months of delivery; whichever is earlier)

Customer Copy

Model Name _____

Customer's Name _____

VIN _____

Registration No. _____

Mileage _____

Delivery Date _____

Service Date _____

RO Number _____

Dealer/HASC code _____

Servicing Dealer's Stamp

Service Mgr's Signature _____

2nd FREE SERVICE COUPON

(9,000-10,000 km or within 12 months of delivery whichever is earlier)

Customer Copy

Model Name _____

Customer's Name _____

VIN _____

Registration No. _____

Mileage _____

Delivery Date _____

Service Date _____

RO Number _____

Dealer/HASC code _____

Servicing Dealer's Stamp

Service Mgr's Signature _____

3rd FREE SERVICE COUPON

(19,000-20,000 km or within 24 months of delivery whichever is earlier)

Customer Copy

Model Name _____

Customer's Name _____

VIN _____

Registration No. _____

Mileage _____

Delivery Date _____

Service Date _____

RO Number _____

Dealer/HASC code _____

Servicing Dealer's Stamp

Service Mgr's Signature _____

Free Service Coupons are valid at all Hyundai dealerships, dealer branches and Authorized service centres in India.

CHECK LIST FOR FREE SERVICE 1500 KM - 20,000 KM

A-ADD I-INSPECT C-CLEAN R-REPLACE L-LUBRICATE I(IR)-INSPECT IF REQUIRED

(AFTER INSPECTION, ADD, REPAIR OR REPLACE IF NECESSARY)

No.	Item Description	1st Service		2nd Service		3rd Service	
		Reqd.	Done	Reqd.	Done	Reqd.	Done
A. ENGINE BAY							
1	Engine oil & filter*	I		R		R	
2	Engine Timing Chain / belt						
3	Air cleaner filter (Petrol only)*		C		C		
4	Air cleaner Filter (Diesel only)*		C		R		
5	Battery condition & specific gravity	I		I			
6	Throttle body (Petrol only)						
7	Spark plugs (Petrol only)		C		C		
8	Valve clearance	I(IR)		I(IR)		I(IR)	
9	Hoses (Vacuum/ EGR/ VGT/ WGT)						
10	Crankcase ventilation hose	I		I		I	
11	Tensioner/idler/damper pulley	I(IR)		I(IR)		I(IR)	
12	Power steering fluid and leakages**						
13	Brake/Clutch fluid	I		I		I	
14	Engine coolant	I		I		I	
15	Manual transaxle fluid						
16	Automatic/CVTDCT transaxle fluid**						
B. VEHICLE ON FLOOR							
17	Wiper (wiper blade, washer fluid)	I		I		I	
18	Brake/Clutch (free play & leakages)	I		I		I	
19	Fuel filler cap						
20	Climate control air filter*	I	C		R		
21	Check AC system (refrigerant/compressor)	I		I		I	
22	Cooling system & leakage	I		I		I	

***NOTICE**
All consumables are chargeable to the customer(s).

1st Service - 1500 km/2 months
2nd Service - 10000 km/12 months
3rd Service - 20000 km/24 months

No.	Item Description	1st Service		2nd Service		3rd Service	
		Reqd.	Done	Reqd.	Done	Reqd.	Done
C. VEHICLE ON LIFT							
23	4WD Shaft differential Transfer case oil**						
24	Steering gear rack, linkage and boots	I		I		I	
27	Exhaust system	I		I		I	
28	Fuel filter (Petrol only)						
29	Fuel filter carriage (Diesel only)*						R
30	Charcoal Canister (Petrol only)						
31	Fuel tank air filter (Petrol only)**	I		I		I	
32	Front & rear suspension (linkages & ball joints)	I		I		I	
33	Fuel lines, hoses and connections	I		I		I	
34	Driveshafts & boots	I		I		I	
35	Fluid leakages	I		I		I	
36	Front and rear wheel bearing & bushes	I(IR)		I(IR)		I(IR)	
37	Front and rear disc/drum brakes & pads	I		I		I	
38	Parking brake (disc, shoe & operation)	I		I		I	
39	Wheel Alignment & Balancing*		I(IR)		I(IR)		I(IR)
40	Tyre pressure, condition & rotation*				TR		TR
D. FINAL CHECKS							
41	Bolt and nuts on chassis and body	I		I		I	
42	Lubricate locks & hinges	I		L		L	
43	All electrical systems (drive belts, alternator)						
44	Warning lights operation & GDS System Check	I		I		I	
45	Ext & int. lights, horn & gauges	I		I		I	
46	Power window /sunroof operation (if equipped)	I		C		C	
47	All seat belt operation	I		I		I	
48	Road test	I(IR)		I(IR)		I(IR)	

*Chargeable basis **if Applicable

3. Vehicle information

Exterior overview	3-2
Interior overview	3-4
Instrument panel overview	3-5
Engine compartment	3-7
Dimensions	3-9
Engine specification	3-9
Bulb wattage	3-10
Tires and wheels	3-11
Recommended lubricants and capacities	3-12
Recommended sae viscosity number	3-14
Vehicle identification number (VIN).....	3-15
Vehicle certification label.....	3-15
Tire specification and pressure label	3-16
Engine number	3-16
Air conditioner compressor label	3-16

EXTERIOR OVERVIEW

■ Front view



OSU2I011001L

1. Hood.....	6-39
2. Front windshield wiper blades.....	9-44
3. Outside rearview mirror.....	6-25
4. Front lamps.....	9-71
5. Panorama sunroof.....	6-33
6. Windows.....	6-28
7. Tires and wheels.....	9-50
8. Front fog light (if equipped).....	9-71

■ Rear view



1. Door.....	6-16
2. Fuel filler door	6-43
3. Antenna	6-102
4. Rear window wiper blades	9-45
5. High mounted stop lamp	9-78
6. Tailgate.....	6-41
7. Rear View Camera.....	6-57
8. Rear Ultrasonic sensors.....	6-61
9. Rear lamps	9-75

INTERIOR OVERVIEW

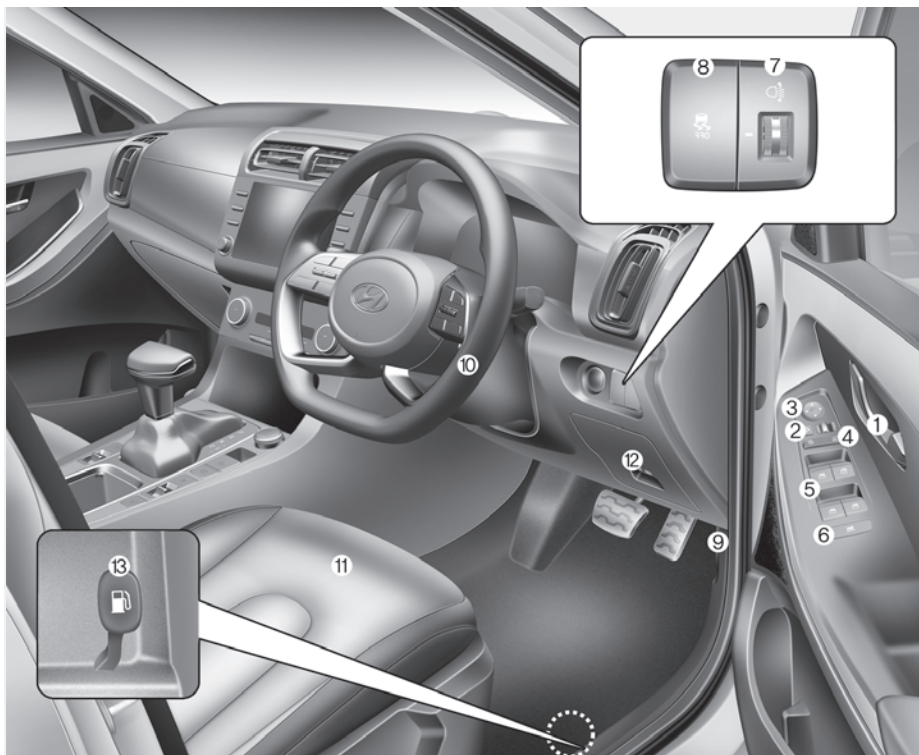

The actual shape may differ from the illustration.

OSU2I019003

1. Inside door handle.....	6-18
2. Outside rearview mirror folding*	6-27
3. Outside rearview mirror control*	6-26
4. Power window switch*	6-28
5. Power window lock button*	6-31
6. Central door lock/unlock button.....	6-19
7. Headlight leveling device	6-50
8. ESC OFF button*	6-46
9. Hood release lever	6-39
10. Steering wheel.....	6-22
11. Seat.....	4-4
12. Fuse box.....	9-65
13. Fuel filler door opener	6-43

* : if equipped

INSTRUMENT PANEL OVERVIEW



OSU2I010004

1. Instrument cluster.....	5-2
2. Horn.....	6-23
3. Driver's front air bag.....	4-48
4. Key ignition switch*	7-6
Engine Start/Stop button*	7-10
5. Light control/Turn signals	6-46
6. Wiper/Washer.....	6-54
7. Hazard warning flasher switch	8-2
8. Manual climate control system*	6-70
Automatic climate control system*	6-79
9. Passenger's front air bag	4-48
10. Glove box	6-91
11. USB charger*	6-96
12. Wireless cellular phone charging system*	6-97
13. Power outlet*	6-95

* : if equipped

Vehicle information

14. Manual Transmission*	7-18
Intelligent manual transmission	7-21
Automatic Transmission*	7-25
15. Drive mode button*	7-53
Drive/traction control mode button*	7-56
16. EPB (Electronic Parking Brake)*	7-35
17. Auto Hold*	7-41
18. Cruise button*	7-59
19. Air ventilation seat	4-18
20. Parking/View button	6-62

* : if equipped

ENGINE COMPARTMENT

■ Petrol Engine (Smartstream G2.0)

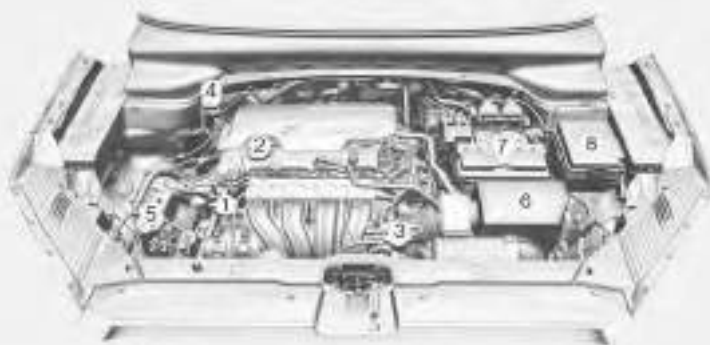

The actual engine room in the vehicle may differ from the illustration.

OSU21081002

1. Engine oil dipstick	9-27
2. Engine oil filler cap	9-27
3. Engine coolant reservoir	9-31
4. Radiator cap	9-32
5. Brake/clutch* fluid reservoir	9-34
6. Windshield washer fluid reservoir	9-37
7. Air cleaner	9-40
8. Battery	9-46
9. Engine room fuse block.....	9-63

■ Diesel Engine (1.5 WGT)

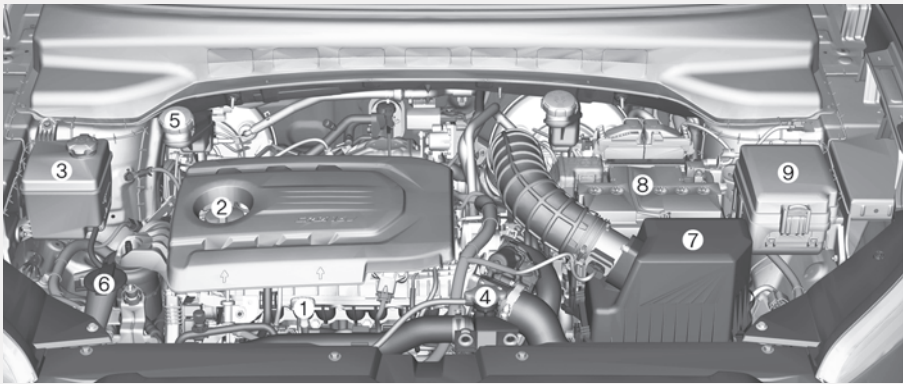

The actual engine room in the vehicle may differ from the illustration.

OSU21089003

1. Engine oil dipstick	9-27
2. Engine oil filler cap	9-27
3. Engine coolant reservoir	9-27
4. Radiator cap	9-31
5. Brake/clutch* fluid reservoir	9-34
6. Windshield washer fluid reservoir	9-37
7. Air cleaner	9-40
8. Battery	9-46
9. Engine room fuse block.....	9-63

DIMENSIONS

Items		mm
Overall length		4,500
Overall width		1790
Overall height	Without roof rack	1,670
	With roof rack	1635
Front tread	215/60 R17	1,595.5
	215/55 R18	
Rear tread	215/60 R17	1,564.3
	215/55 R18	
Wheelbase		2,760

ENGINE SPECIFICATION

Item	Petrol Engine	Diesel Engine
	Smartstream G2.0	1.5 VGT
Displacement cc (cu. in)	1,999 (121.99)	1,493 (91.1)
Bore x Stroke mm (in.)	81.0 X 97.0 (3.189 X 3.819)	75 X 84.5 (2.95 X 3.33)
Firing order	1-3-4-2	1-3-4-2
No. of cylinders	4, In-line	4, In-line

BULB WATTAGE

Light bulb		Bulb type	Wattage	
Front	Headlamp	High/Low (Type A)	HB3	60
		High/Low (Type B)	LED	LED
	Daytime running lamp (DRL)/ Position lamp	Type A/B	LED	LED
	Turn signal lamp	Type A/B	PY21W	21
	Front fog lamp		Bulb	H881 (27W)
Rear	Stop lamp	Type A	Bulb	P21/5W (21W)
		Type B	LED	LED
	Tail lamp		LED	LED
	Turn signal lamp	Type A/B	Bulb	P21W (21W)
	Back up Lamp		Bulb	P21W (21W)
	H.M.S.L		LED	LED
	License plate lamp		W5W	5
Interior	Map lamp	Type A	WEDGE	8
		Type B	LED	LED
	Personal lamp (if equipped)		LED	LED
	Room lamp (if equipped)		FESTOON	10
	Tailgate room lamp		FESTOON	10
	Luggage compartment lamp		FESTOON	10

TIRES AND WHEELS

Type	Tire size	Wheel size	Inflation pressure kPa (psi)				Wheel lug nut torque kgf-m (lbf-ft, N-m)
			Normal load *1		Maximum load		
			Front	Rear	Front	Rear	
Full size tire	215/60 R17	6.5J X 17	230 (33)	230 (33)	240 (35)	240 (35)	11~13 (79~94, 107~127)
	215/55 R18	6.5J X 18	230 (33)	230 (33)	240 (35)	240 (35)	
Spare tire	215/60 R17	6.5J X 17	230 (33)	230 (33)	240 (35)	240 (35)	

*1 : Normal load : Up to 3 persons

NOTICE

- It is permissible to add 20 kPa (3 psi) to the standard tire pressure specification if colder temperatures are expected soon. Tires typically lose 7 kPa (1 psi) for every 7°C (12°F) temperature drop. If extreme temperature variations are expected, recheck your tire pressure as necessary to keep them properly inflated.
- An air pressure generally decreases, as you drive up to a high-altitude area above sea level. Thus, if you plan to drive a high-altitude area, check the tire pressures in advance. If necessary, inflate them to a proper level (Air inflation per altitude: +10 kPa/1 km (+2.4 psi/1 mile).
- Spare tire are intended for Emergency purpose only.
- Spare tire can be from any manufacturer.
- Only steel wheel is provided as a Spare wheel in all Varients.



CAUTION

When replacing tires, use the same size originally supplied with the vehicle. Using tires of a different size can damage the related parts or make it work irregularly.

RECOMMENDED LUBRICANTS AND CAPACITIES

To help achieve proper engine and powertrain performance and durability, use only lubricants of the proper quality. The correct lubricants also help promote engine efficiency that results in improved fuel economy. These lubricants and fluids are recommended for use in your vehicle.

Lubricant		Volume	Classification
Engine oil *1 *2 (drain and refill)	Petrol Engine	4.3 l	Full synthetic SAE 0W-20, API SN PLUS/SP or ILSAC GF-6
	Diesel 1.5 WGT	With DPF *3	ACEA C5 or C3 or C2
Without DPF *3			
Manual transmission fluid	Petrol Engine (3rd Gen 2.0)	1.5 ~ 1.6 l	API Serviced GL-4, SAE 70W, TGO-9 (HYUNDAI genuine transmission fluid)
	1.5 WGT		
Intelligent Manual Transmission fluid	Petrol Engine (3rd Gen 2.0)	1.5 ~ 1.6 l	API Serviced GL-4, SAE 70W, TGO-9 (HYUNDAI genuine transmission fluid)
	1.5 WGT		
Automatic Transmission	Petrol Engine (3rd Gen 2.0)	6.7 l	ATF SP-IV, HYUNDAI genuine ATF SP-IV
	1.5 WGT	7.1 l	

Lubricant			Volume	Classification
Coolant	Petrol (3rd Gen 2.0)	M/T	6.81 l	MIXTURE, Antifreeze with water (Ethylene glycol base coolant for aluminum radiator)
		A/T	6.76 l	
	M/T	7.2 l		
	A/T	7.0 l		
Brake/Clutch fluid			0.7~0.8 l	SAE J1704 DOT-4LV, FMVSS 116 DOT-4, ISO4925 CLASS-6
Fuel			50 l	
iMT (Intelligent Manual Trans- mission)	Petrol Engine (3rd Gen 2.0)		0.082 l	SAE J1704 DOT-4 LV, ISO4925 CLASS-6, FMVSS116 DOT-4, FMVSS116 DOT-3
	Diesel Engine 1.5 WGT		0.086 l	
Urea (Diesel only, if equipped)			12 l	ISO22241, DIN70070

*1 : Refer to the recommended SAE viscosity numbers on the next page.

*2 : Engine oils labeled Energy Conserving Oil are now available. Along with other additional benefits, they contribute to fuel economy by reducing the amount of fuel necessary to overcome engine friction. Often, these improvements are difficult to measure in everyday driving, but in a year's time, they can offer significant cost and energy savings.

*3 : Diesel Particulate Filter

*4 : If the recommended engine oil is not available in your country, you are able to use engine oil above API CH-4 or above.

*5 : We recommend you to consult an Authorised

M/T : Manual Transmission

IMT : Intelligent Manual Transmission

A/T : Automatic Transmission

Recommended SAE viscosity number

CAUTION

Always be sure to clean the area around any filler plug, drain plug, or dipstick before checking or draining any lubricant. This is especially important in dusty or sandy areas and when the vehicle is used on unpaved roads. Cleaning the plug and dipstick areas will prevent dirt and grit from entering the engine and other mechanisms that could be damaged.

Engine oil viscosity (thickness) has an effect on fuel economy and cold weather operating (engine start and engine oil flowability). Lower viscosity engine oils can provide better fuel economy and cold weather performance, however, higher viscosity engine oils are required for satisfactory lubrication in hot weather.

Using oils of any viscosity other than those recommended could result in engine damage.

When choosing an oil, consider the range of temperature your vehicle will be operated in before the next oil change. Proceed to select the recommended oil viscosity from the chart.

Temperature Range for SAE Viscosity Numbers										
Temperature	°C	-30	-20	-10	0	10	20	30	40	50
	(°F)	-10	0	20	40	60	80	100	120	
(Petrol) 3rd Gen 2.0 *1		0W-20								
(Diesel) 1.5 WGT		5W-30								
		0W-20/30								

*1 : If mineral oil or semi-synthetic oil is used, it is a severe maintenance condition in terms of engine oil change.



An engine oil displaying this API Certification Mark conforms to the international Lubricant Specification Advisory Committee (ILSAC). It is recommended to only use engine oils that uphold this API Certification Mark.

VEHICLE IDENTIFICATION NUMBER (VIN)



The vehicle identification number (VIN) is the number used in registering your car and in all legal matters pertaining to its ownership, etc.

The number is punched on the floor under the front right seat. To check the number, pull out the slit part of carpet.

VEHICLE CERTIFICATION LABEL (IF EQUIPPED)



The vehicle certification label attached on the driver's (or front passenger's) side center pillar gives the vehicle identification number (VIN).

TIRE SPECIFICATION AND PRESSURE LABEL



The tires supplied on your new vehicle are chosen to provide the best performance for normal driving.

The tire label located on the driver's side center pillar gives the tire pressures recommended for your car.

ENGINE NUMBER

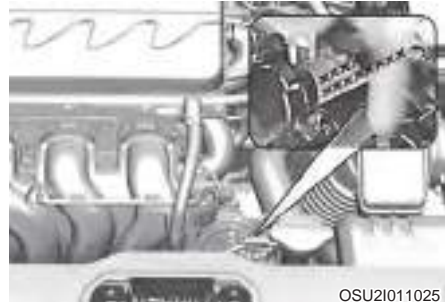

The engine number is stamped on the engine block as shown in the drawing.

AIR CONDITIONER COMPRESSOR LABEL

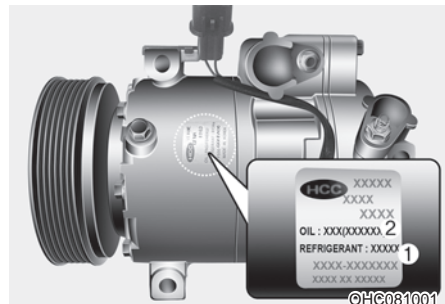

A compressor label informs you the type of compressor your vehicle is equipped with such as model, supplier part number, production number, refrigerant (1) and refrigerant oil (2).

4. Safety system

This chapter provides you with important information about how to protect yourself and your passengers. It explains how to properly use your seats and seat belts, and how your air bags work.

Additionally, this chapter explains how to properly restrain infants and children in your vehicle.

Important safety precautions	4-2
Always wear your seat belt	4-2
Restrain all children	4-2
Air bag hazards	4-2
Driver distraction	4-2
Control your speed	4-3
Keep your vehicle in safe condition	4-3
Seats	4-4
Front seats	4-7
Rear seats	4-12
Air ventilation seats	4-18
Seat belts.....	4-19
Pre-tensioner seat belt	4-24
Additional seat belt safety precautions	4-26
Care of seat belts.....	4-28
Child restraint system.....	4-29
Using a child restraint system	4-31
Installing a Child Restraint System (CRS)	4-32
Child restraint system Seating Postions.....	4-40
Air bag - supplemental restraint system (SRS)	4-41
How does the air bag system operate	4-42
Do not install a child restraint on the front passenger's seat.....	4-43
Air bag warning and indicator	4-45
SRS components and functions.....	4-46
Driver's and passenger's front air bag	4-49
Side impact air bag	4-51
Curtain air bag	4-53
SRS Care.....	4-59
Air bag warning label	4-62

IMPORTANT SAFETY PRECAUTIONS

You will find many safety precautions and recommendations throughout this section, and throughout this manual. The safety precautions in this section are among the most important.

Always wear your seat belt

A seat belt is your best protection in all types of accidents. Air bags are designed to supplement seat belts, not replace them. So even though your vehicle is equipped with air bags, ALWAYS make sure you and your passengers wear your seat belts, and wear them properly.

Restrain all children

All children under age 13 should ride in your vehicle properly restrained in a rear seat, not the front seat. Infants and small children should be restrained in an appropriate child restraint. Larger children should use a booster seat with the lap/shoulder belt until they can use the seat belt properly without a booster seat.

Air bag hazards

While air bags can save lives, they can also cause serious or fatal injuries to occupants who sit too close to them, or who are not properly restrained.

Infants, young children, and short adults are at the greatest risk of being injured by an inflating air bag. Follow all instructions and warnings in this manual.

Driver distraction

Driver distraction presents a serious and potentially deadly danger, especially for inexperienced drivers. Safety should be the first concern when behind the wheel and drivers need to be aware of the wide array of potential distractions, such as drowsiness, reaching for objects, eating, personal grooming, other passengers, and using cellular phones. Drivers can become distracted when they take their eyes and attention off the road or their hands off the wheel to focus on activities other than driving. To reduce your risk of distraction and an accident:

- ALWAYS set up your mobile devices (i.e., MP3 players, phones, navigation units, etc.) when your vehicle is parked or safely stopped.
- ONLY use your mobile device when allowed by laws and conditions permit safe use.
NEVER text or email while driving. Most countries have laws prohibiting drivers from texting. Some countries and cities also prohibit drivers from using handheld phones.
- NEVER let the use of a mobile device distract you from driving. You have a responsibility to your passengers and others on the road to always drive safely, with your hands on the wheel as well as your eyes and attention on the road.

Control your speed

Excessive speed is a major factor in crash injuries and deaths. Generally, the higher the speed, the greater the risk, but serious injuries can also occur at lower speeds. Never drive faster than is safe for current conditions, regardless of the maximum speed posted.

Keep your vehicle in safe condition

Having a tire blowout or a mechanical failure can be extremely hazardous. To reduce the possibility of such problems, check your tire pressures and condition frequently, and perform all regularly scheduled maintenance.

SEATS

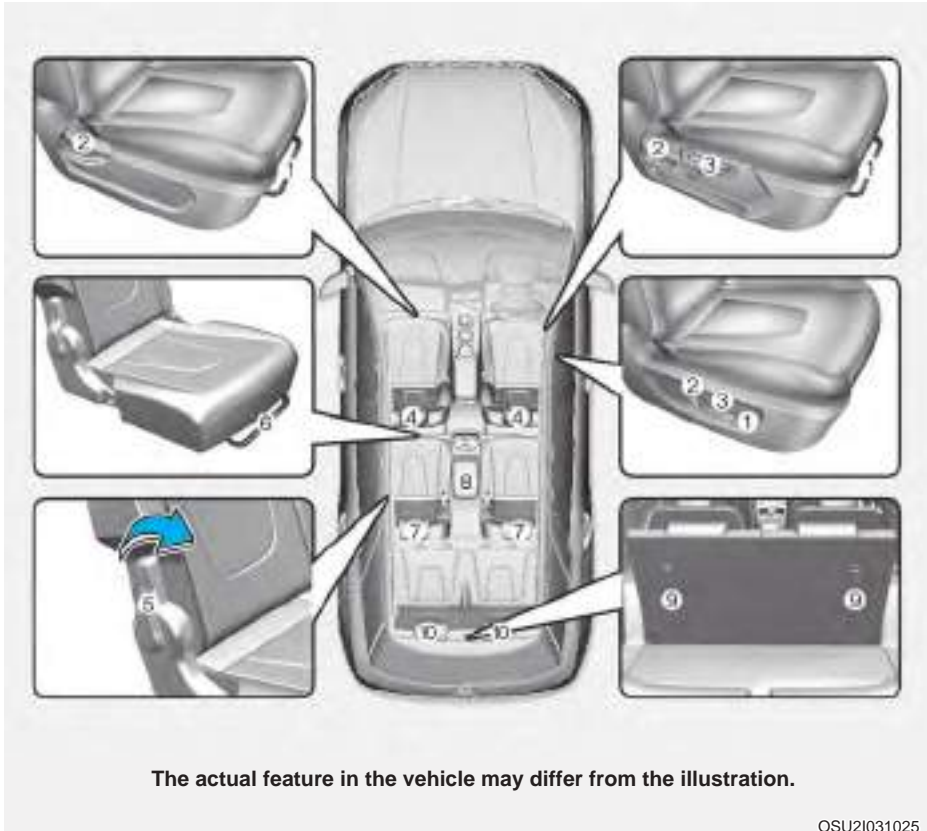

OSU21031025

Front seats

1. Seat adjustment, forward/backward
2. Seatback recliner
3. Seat cushion adjustment, height (for driver's seat)
4. Headrest adjustment

2nd row seat

5. Seatback folding, Double folding & Recliner
6. Forward & Backward Adjustment (Sliding)
7. Headrest
8. Armrest

3rd row seat

9. Seatback folding & Recliner
10. Headrest

 **WARNING**
Loose objects

Loose objects in the driver's foot area could interfere with the operation of the foot pedals, possibly causing an accident. Do not place anything under the front seats.

 **WARNING**
Uprighting seat

When you return the seatback to its upright position, hold the seatback and return it slowly and be sure there are no other occupants around the seat. If the seatback is returned without being held and controlled, the back of the seat could move forward or backward resulting in accidental injury to a person struck by the seatback.

 **WARNING**
Driver responsibility for passengers

Riding in a vehicle with seatback reclined could lead to serious or fatal injury in an accident. If a seat is reclined during an accident, the occupant's hips may slide under the lap portion of the seat belt applying great force to the unprotected abdomen. The protection of your restraint system (seat belt and air bags) is greatly reduced by reclining your seat. Serious or fatal internal injuries could result. The driver must advise the passenger to keep the seatback in an upright position whenever the vehicle is in motion.

 **WARNING**

Do not use a sitting cushion that reduces friction between the seat and passenger. The passenger's hips may slide under the lap portion of the seat belt during an accident or a sudden stop. Serious or fatal internal injuries could result because the seat belt can't operate normally.

 **WARNING**
Driver's seat

- Never attempt to adjust seat while the vehicle is moving. This could result in loss of control, and an accident causing death, serious injury, or property damage.
- Do not allow anything to interfere with the normal position of the seatback. Storing items against a seatback or in any other way interfering with proper locking of a seatback could result in serious or fatal injury in a sudden stop or collision.
- Always drive and ride with your seatback upright and the lap portion of the seat belt snug and low across the hips. This is the best position to protect you in case of an accident.
- In order to avoid unnecessary and perhaps severe air bag injuries, always sit as far back as possible from the steering wheel while maintaining comfortable control of the vehicle.

 **WARNING**

Rear seatbacks

- The rear seatback must be securely latched. If not, passengers and objects could be thrown forward resulting in serious injury or death in the event of a sudden stop or collision.
- Luggage and other cargo should be laid flat in the cargo area. If objects are large, heavy, or must be piled, they must be secured. Under no circumstances should cargo be piled higher than the seatbacks. Failure to follow these warnings could result in serious injury or death in the event of a sudden stop, collision or rollover.
- No passenger should ride in the cargo area or sit or lie on folded seatbacks while the vehicle is moving. All passengers must be properly seated in seats and restrained properly while riding.
- When resetting the seatback to the upright position, make sure it is securely latched by pushing it forward and backwards.
- To avoid the possibility of burns, do not remove the carpet in the cargo area. Emission control devices beneath this floor generate high temperatures.

 **WARNING**

After adjusting the seat, always check that it is securely locked into place by attempting to move the seat forward or backward without using the lock release lever. Sudden or unexpected movement of the driver's seat could cause you to lose control of the vehicle resulting in an accident.

 **WARNING**

- Do not adjust the seat while wearing seat belts. Moving the seat cushion forward may cause strong pressure on the abdomen.
- Use extreme caution so that hands or other objects are not caught in the seat mechanisms while the seat is moving.
- Do not put a cigarette lighter on the floor or seat. When you operate the seat, gas may gush out of the lighter and cause fire.
- If there are occupants in the rear seats, be careful while adjusting the front seat position.

Front seats

Manual adjustment

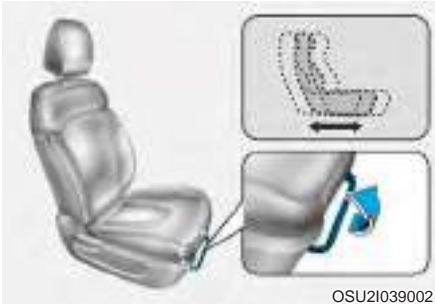

Forward and rearward

To move the seat forward or rearward:

1. Pull the seat slide adjustment lever up and hold it.
2. Slide the seat to the position you desire.
3. Release the lever and make sure the seat is locked in place.

Adjust the seat before driving, and make sure the seat is locked securely by trying to move forward and rearward without using the lever. If the seat moves, it is not locked properly.

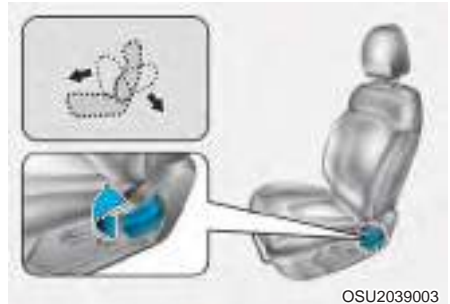

Seatback angle

To recline the seatback:

1. Lean forward slightly and lift up on the seatback recline lever.
2. Carefully lean back on the seat and adjust the seatback of the seat to the position you desire.
3. Release the lever and make sure the seatback is locked in place. (The lever **MUST** return to its original position for the seatback to lock.)

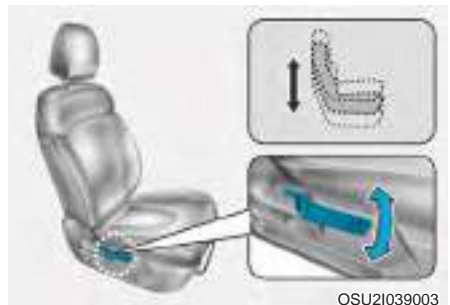

Seat cushion height (for driver's seat)

To change the height of the seat cushion, move the lever upwards or downwards.

- To lower the seat cushion, push the lever down several times.
- To raise the seat cushion, pull the lever up several times.

Power adjustment (if equipped)

WARNING

NEVER allow children in the vehicle unattended. Children might push the adjustment switch accidentally and get caught in the seat mechanisms while the seat is moving.

CAUTION

To prevent damage to the seats:

- Always stop adjusting the seats when the seat has been adjusted as far forward or rearward as possible.
- Do not adjust the seats longer than necessary when the engine is turned off. This may result in unnecessary battery drain.
- Do not operate two or more seats at the same time. This may result in an electrical malfunction.

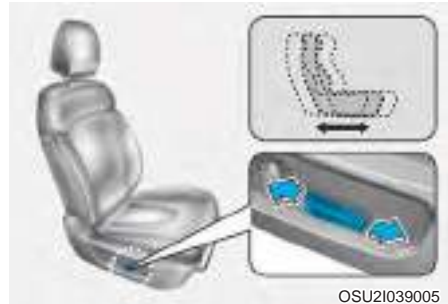

Forward and rearward

To move the seat forward or rearward: 1. Push the control switch forward or rearward. 2. Release the switch once the seat reaches the desired position.

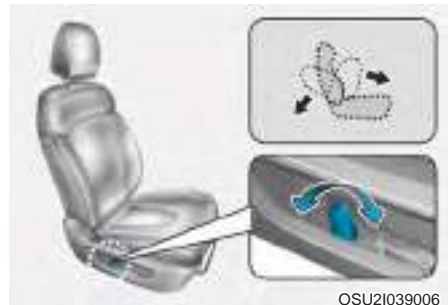

Seatback angle

To recline the seatback: 1. Push the control switch forward or rearward. 2. Release the switch once the seatback reaches the desired position.

Reclining seatback

Sitting in a reclined position when the vehicle is in motion can be dangerous. Even when buckled up, the protections of your restraint system (seat belts and air bags) is greatly reduced by reclining your seatback.



WARNING

NEVER ride with a reclined seatback when the vehicle is moving. Riding with a reclined seatback increases your chance of serious or fatal injuries in the event of a collision or sudden stop.

Driver and passengers should ALWAYS sit well back in their seats, properly belted, and with the seatbacks upright.

Seat belts must be snug against your hips and chest to work properly. When the seatback is reclined, the shoulder belt cannot do its job because it will not be snug against your chest. Instead, it will be in front of you. During an accident, you could be thrown into the seat belt, causing neck or other injuries. The more the seatback is reclined, the greater chance the passenger's hips will slide under the lap belt or the passenger's neck will strike the shoulder belt.

Headrest

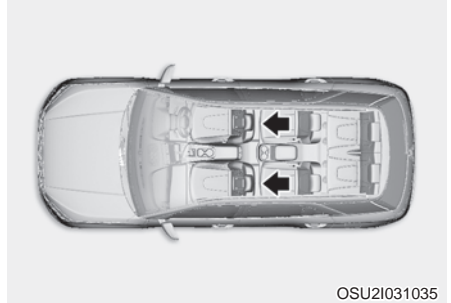

The driver's and front passenger's seats are equipped with a headrest for the occupant's safety and comfort. The headrest not only provides comfort for the driver and front passenger, but also helps to protect the head and neck in the event of a collision.



WARNING

To reduce the risk of serious injury or death in an accident, take the following precautions when adjusting your headrests:

- **Always properly adjust the headrests for all passengers BEFORE starting the vehicle.**
- **NEVER let anyone ride in a seat with the headrests removed or reversed.**



Adjust the headrests so the middle of the headrests is at the same height as the height of the top of the eyes.

- NEVER adjust the headrest position of the driver's seat when the vehicle is in motion.
- Adjust the headrest as close to the passenger's head as possible. Do not use a seat cushion that holds the body away from the seatback.
- Make sure the headrest locks into position after adjusting it.

NOTICE

To prevent damage, NEVER hit or pull on the headrests.



NOTICE

If you recline the seatback towards the front with the head restraint and seat cushion raised, the head restraint may come in contact with the sunvisor or other parts of the vehicle.

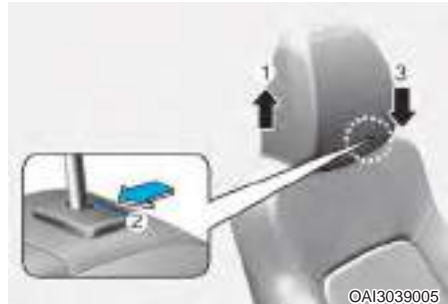

Adjusting the height up and down

To raise the headrest, pull it up to the desired position (1). To lower the headrest, push and hold the release button (2) on the headrest support and lower the headrest to the desired position (3).



Removal/Reinstall (if equipped)

To remove the headrest:

1. Recline the seatback (2) with the recline lever (1).
2. Raise headrest as far as it can go.
3. Press the headrest release button (3) while pulling the headrest up (4).

WARNING

NEVER allow anyone to ride in a seat with the headrest removed.

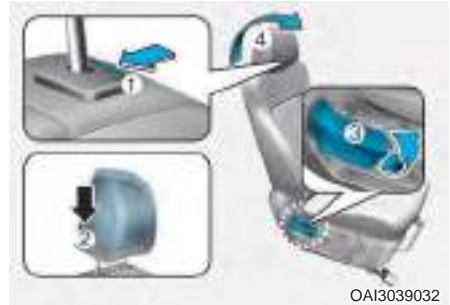

To reinstall the headrest :

1. Recline the seatback.
2. Put the headrest poles (2) into the holes while pressing the release button (1).
3. Adjust the headrest to the appropriate height.
4. Recline the seatback (4) with the seatback angle lever or switch (3).

WARNING

Always make sure the headrest locks into position after reinstalling and adjusting it properly.

Seatback pocket (if equipped)



The seatback pocket is provided on the back of the driver's and/or front passenger's seatback.

WARNING

Seatback pockets

Do not put heavy or sharp objects in the seatback pockets. In an accident they could come loose from the pocket and injure vehicle occupants.

Rear seats

Headrest (2nd, 3rd row rear seat)

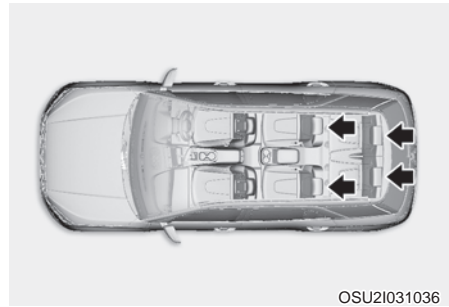

The rear seats are equipped with headrests in the outboard seating positions (and/or center seating position) for the occupant's safety and comfort.

The headrest not only provides comfort for passengers, but also helps to protect the head and neck in the event of a collision.

WARNING

To reduce the risk of serious injury or death in an accident, take the following precautions when adjusting your headrests:

- **Always properly adjust the headrests for all passengers BEFORE starting the vehicle.**
- **NEVER let anyone ride in a seat with the headrests removed.**



Adjust the headrests so the middle of the headrests is at the same height as the height of the top of the eyes.

- **NEVER** adjust the headrest position of the driver's seat when the vehicle is in motion.
- Adjust the headrest as close to the passenger's head as possible. Do not use a seat cushion that holds the body away from the seatback.
- Make sure the headrest locks into position after adjusting it.

NOTICE

To prevent damage, **NEVER** hit or pull on the headrests.



Adjusting the height up and down (if equipped)

To raise the headrest, pull it up (1). To lower the headrest, push and hold the release button (2) on the headrest support and lower the headrest (3).

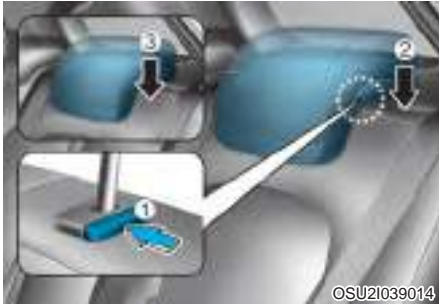

Removal and installation

To remove the headrest, raise it as far as it can go then press the release button (1) while pulling upward (2).

To reinstall the headrest, put the headrest poles (3) into the holes while pressing the release button (1). Then adjust it to the appropriate height.

WARNING

Make sure the headrest locks in position after adjusting it to properly protect the occupants.

Folding the rear seat

The rear seatbacks (or cushions) may be folded to facilitate carrying long items or to increase the luggage capacity of the vehicle.

WARNING

- **Never allow passengers to sit on top of the folded down seatback while the vehicle is moving as this is not a proper seating position and no seat belts are available for use. This could result in serious injury or death in case of an accident or sudden stop.**
- **Objects carried on the folded down seatback should not extend higher than the top of the front seats. This could allow cargo to slide forward and cause injury or damage during sudden stops.**

To fold down the rear seatback:

1. Set the front seatback to the upright position and if necessary
 - Slide the front seat forward
 - Fold the Seatback table
2. Lower the rear headrests to the lowest position (if equipped with adjustable headrests).



3. Routing the seat belt webbing through the rear seat belt guides will help keep the belts from being trapped behind or under the seats. After inserting the seatbelt, tighten the belt webbing by pulling it up.

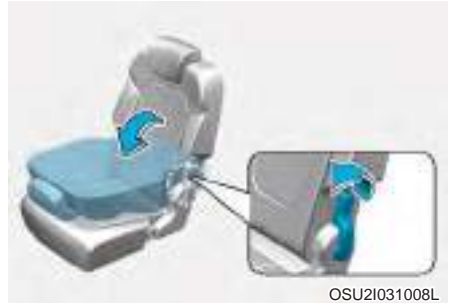

4. For 2nd row seats, Pull the seatback folding lever, then seatback folds automatically. If you keep pull the lever, the 2nd row seatback will slightly go up, then set 2nd row seat to upright position (vertical position). For 3rd row seats, push the seatback folding strap, then fold seatback towards the front of the vehicle.

i Information

If you are not able to pull out the seat belt from the retractor, firmly pull the belt out and release it. Then you will be able to pull the belt out smoothly.

■ 2nd row seat



■ 3rd row seat



5. To use the rear seat, lift and pull the seatback backward by pulling the folding lever or the strap. Pull the seatback firmly until it clicks into place. Make sure the seatback is locked in place.
6. Return the rear seat belt to the proper position.



WARNING

When the second row seat is folded vertically, the second row seat may cause injuries to the people seating on the third row seat. Please check the surroundings when folding the second row seats.

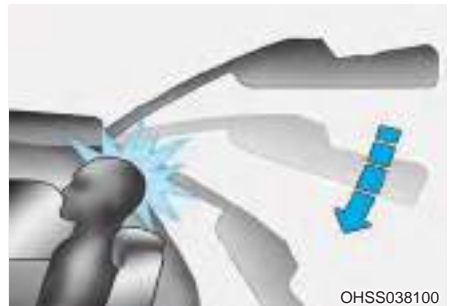

WARNING

If the tailgate is pushed down to close it when a passenger's head is not against a properly adjusted headrest or a tall person is seated, the tailgate may hit the occupant's head, which could cause injury.

 **WARNING**

When you return the rear seatback to its upright position after being folded down:

Prevent injury of 3rd row passenger foot during 2nd row folding & un-folding while entering or exiting the 3rd row seat.

Be careful not to damage the seat belt webbing or buckle. Do not allow the seat belt webbing or buckle to get caught or pinched in the rear seat. Ensure that the seatback is completely locked into its upright position by pushing on the top of the seatback. Otherwise, in an accident or sudden stop, the seat could fold down and allow cargo to enter the passenger compartment, which could result in serious injury or death.

NOTICE

- When returning the rear seatbacks to the upright position, remember to return the rear shoulder belts to their proper position.
- Routing the seat belt webbing through the rear seat belt guides will help keep the seat belts from being trapped behind or under the seats.

 **WARNING**
Cargo

Cargo should always be secured to prevent it from being thrown about the vehicle in a collision and causing injury to the vehicle occupants. Do not place objects in the rear seats, since they cannot be properly secured and may hit the front seat occupants in a collision.

 **WARNING**
Cargo loading

Make sure the engine is off, the automatic transmission is in P (Park) or the Manual transmission is in R (Reverse) or 1st, and the parking brake is securely applied whenever loading or unloading cargo. Failure to take these steps may allow the vehicle to move if the shift lever is inadvertently moved to another position.

 **CAUTION**

- Be careful when loading cargo through the rear passenger seats to prevent damage to the vehicle interior.
- When cargo is loaded through the rear passenger seats, ensure the cargo is properly secured to prevent it from moving while driving.

Air ventilation seats (if equipped)

Front air ventilation seat (if equipped)



The air ventilation seats are provided to cool the front seats by blowing air through small vent holes on the surface of the seat cushions and seat-backs.

When the operation of the air ventilation seat is not needed, keep the switches in the OFF position.

While the engine is running, push the switch to cool the driver's seat or the front passenger's seat (if equipped).

- Each time you push the switch, the airflow changes as follows:

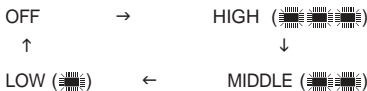

- When pressing the switch for more than 1.5 seconds with the air ventilation seat operating, the operation will turn OFF.
- The air ventilation seats defaults to the OFF position whenever the ignition switch is placed to the ON position.

NOTICE

To prevent damage to the air ventilation seat:

- Use the air ventilation seat **ONLY** when the climate control system is on. Using the air ventilation seat for prolonged periods of time with the climate control system off could cause the air ventilation seat to malfunction.
- Never use a solvent such as paint thinner, benzene, alcohol or gasoline to clean the seats.
- Avoid spilling liquids on the surface of the front seats and seat-backs; this may cause the air vent holes to become blocked and not work properly.
- Do not place materials such as plastic bags or newspapers under the seats. They may block the air intake causing the air vents to not work properly.
- Do not change the seat covers. It may damage the air ventilation seat.
- If the air vents do not operate, restart the vehicle. If there is no change, we recommend that you have your vehicle inspected by an authorized HYUNDAI dealer.

SEAT BELTS



WARNING

- For maximum restraint system protection, the seat belts must always be used whenever the car is moving.
- Seat belts are most effective when seatbacks are in the upright position.
- Children age 12 and under must always be properly restrained in the rear seat. Never allow children to ride in the front passenger seat. If a child over 12 must be seated in the front seat, he/she must be properly belted and the seat should be moved as far back as possible.
- Never wear the shoulder belt under your arm or behind your back. An improperly positioned shoulder belt can cause serious injuries in a crash. The shoulder belt should be positioned midway over your shoulder across your collarbone.
- Never wear a seat belt over fragile objects. If there is a sudden stop or impact, the seat belt can damage it.
- Avoid wearing twisted seat belts. A twisted belt can't do its job as well. In a collision, it could even cut into you. Be sure the belt webbing is straight and not twisted.
- Be careful not to damage the belt webbing or hardware. If the belt webbing or hardware is damaged, replace it.



WARNING

Seat belts are designed to bear upon the bony structure of the body, and should be worn low across the front of the pelvis or the pelvis, chest and shoulders, as applicable; wearing the lap section of the belt across the abdominal area must be avoided.

Seat belts should be adjusted as firmly as possible, consistent with comfort, to provide the protection for which they have been designed.

A slack belt will greatly reduce the protection afforded to the wearer.

Care should be taken to avoid contamination of the webbing with polishes, oils and chemicals, and particularly battery acid. Cleaning may safely be carried out using mild soap and water. The belt should be replaced if webbing becomes frayed, contaminated or damaged.

It is essential to replace the entire assembly after it has been worn in a severe impact even if damage to the assembly is not obvious. Belts should not be worn with straps twisted. Each belt assembly must only be used by one occupant; it is dangerous to put a belt around a child being carried on the occupant's lap.



WARNING

- No modifications or additions should be made by the user which will either prevent the seat belt adjusting devices from operating to remove slack, or prevent the seat belt assembly from being adjusted to remove slack.
- When you fasten the seat belt, be careful not to latch the seat belt in buckles of other seat. It's very dangerous and you may not be protected by the seat belt properly.
- Do not unfasten the seat belt and do not fasten and unfasten the seat belt repeatedly while driving. This could result in loss of control, and an accident causing death, serious injury, or property damage.
- When fastening the seat belt, make sure that the seat belt does not pass over objects that are hard or can break easily.
- Make sure there is nothing in the buckle. The seat belt may not be fastened securely.

Seat belt warning (if equipped)



As a reminder to the driver (or front passenger), the driver's (or front passenger's) seat belt warning lights will illuminate for approximately 6 seconds each time you turn the ignition switch ON regardless of belt fastening.

If the driver's (or front passenger's) seat belt is not fastened when the ignition switch is turned ON or if it is disconnected after the ignition switch is turned ON, the seat belt warning light will illuminate until the belt is fastened.

If you continue not to fasten the seat belt and you drive over 20 km/h, the illuminated warning light will start to blink until you drive under 6 km/h.

If you continue not to fasten the seat belt and you drive over 20 km/h (12 mph) the seat belt warning chime will sound for approximately 100 seconds and the corresponding warning light will blink.

i Information

- You can find the front passenger's seat belt warning light on the cluster.
- Although the front passenger seat is not occupied, the seat belt warning light will blink or illuminate for 6 seconds.
- The front passenger's seat belt warning may operate when luggage is placed on the front passenger seat.

Lap/shoulder belt



To fasten your seat belt:

To fasten your seat belt, pull it out of the retractor and insert the metal tab (1) into the buckle (2). There will be an audible “click” when the tab locks into the buckle.



You should place the lap belt (1) portion across your hips and the shoulder belt (2) portion across your chest.

The seat belt automatically adjusts to the proper length only after the lap belt portion is adjusted manually so that it fits snugly around your hips. If you lean forward in a slow, easy motion, the belt will extend and let you move around. If there is a sudden stop or impact, however, the belt will lock into position. It will also lock if you try to lean forward too quickly.

i Information

If you are not able to pull out the safety belt from the retractor, firmly pull the belt out and release it. After release, you will be able to pull the belt out smoothly.

 **WARNING**

Improperly positioned seat belts may increase the risk of serious injury in an accident. Take the following precautions when adjusting the seat belt:

- Position the lap portion of the seat belt as low as possible across your hips, not on your waist, so that it fits snugly. This allows your strong pelvic bones to absorb the force of the crash, reducing the chance of internal injuries.
- Position one arm under the shoulder belt and the other over the belt, as shown in the illustration.
- Always position the shoulder belt anchor into the locked position at the appropriate height.
- Never position the shoulder belt across your neck or face.



 **WARNING**

You should place the lap belt portion as low as possible and snugly across your hips, not on your waist. If the lap belt is located too high on your waist, it may increase the chance of injury in the event of a collision.

Both arms should not be under or over the belt. Rather, one should be over and the other under, as shown in the illustration.

Never wear the seat belt under the arm nearest the door.



©HSS038103

To release the seat belt:

The seat belt is released by pressing the release button (1) in the locking buckle. When it is released, the belt should automatically draw back into the retractor.

If this does not happen, check the belt to be sure it is not twisted, then try again.

2-point rear center seat belt (if equipped)



1

2

©HSS038003/H

To fasten your seat belt:

To fasten a 2-point static type belt, insert the metal tab into the locking buckle. There will be an audible “click” when the tab locks into the buckle. Check to make sure the belt is properly locked and that the belt is not twisted.



©HSS038004

With a 2-point static type seat belt, the length must be adjusted manually so it fits snugly around your body. Fasten the belt and pull on the loose end to tighten. The belt should be placed as low as possible on your hips, not on your waist. If the belt is too high, it could increase the possibility of your being injured in an accident.



When using the rear center seat belt, the buckle with the “CENTER” mark must be used.



To release the seat belt:

When you want to release the seat belt, press the button (1) in the locking buckle.

 **WARNING**

The center lap belt latching mechanism is different from those for the rear seat shoulder belts. When fastening the rear seat shoulder belts or the center lap belt, make sure they are inserted into the correct buckles to obtain maximum protection from the seat belt system and assure proper operation.

Pre-tensioner seat belt



Your vehicle is equipped with driver's and front passenger's pre-tensioner seat belts (retractor pre-tensioner). The purpose of the pre-tensioner is to make sure the seat belts fit tightly against the occupant's body in certain frontal or side collision(s). The pre-tensioner seat belts may be activated in crashes where the frontal or side collision(s) is severe enough, together with the air bags. When the vehicle stops suddenly, or if the occupant tries to lean forward too quickly, the seat belt retractor will lock into position. In certain frontal collisions, the pre-tensioner will activate and pull the seat belt into tighter contact against the occupant's body.

WARNING

- Always wear your seat belt and sit properly in your seat.
- Do not use the seat belt if it is loose or twisted. A loose or twisted seat belt will not protect you properly in an accident.
- Do not place anything near the buckle. This may adversely affect the buckle and cause it to function improperly.
- Always replace your pre-tensioners after activation or an accident.
- NEVER inspect, service, repair or replace the pre-tensioners yourself. This must be done by an authorized HYUNDAI dealer.
- Do not hit the seat belt assemblies.

WARNING

Do not touch the pre-tensioner seat belt assemblies for several minutes after they have been activated. When the pre-tensioner seat belt mechanism deploys during a collision, the pre-tensioner can become hot and can burn you.

CAUTION

Body work on the front area of the vehicle may damage the pre-tensioner seat belt system. Therefore, we recommend the system to be serviced by an authorized HYUNDAI dealer.

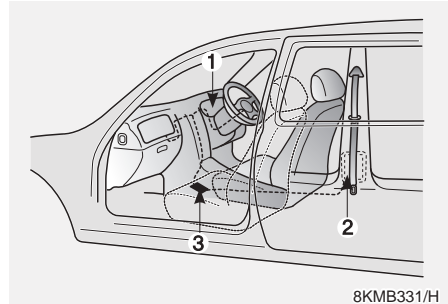

8KMB331/H

The seat belt pre-tensioner system consists mainly of the following components. Their locations are shown in the illustration:

- (1) SRS air bag warning light
- (2) Retractor pre-tensioner assembly
- (3) SRS control module

NOTICE

The sensor that activates the SRS control module is connected with the pre-tensioner seat belts. The SRS air bag warning light on the instrument cluster will illuminate for approximately 6 seconds after the ignition switch is placed in the ON position, and then it should turn off. If the pre-tensioner is not working properly, the warning light will illuminate even if the SRS air bag is not malfunctioning. If the warning light does not illuminate, stays illuminated or illuminates when the vehicle is being driven, we recommend the pre-tensioner seat belts and/or SRS control module be inspected by an authorized HYUNDAI dealer as soon as possible.

i Information

- Both the driver's and front passenger's pre-tensioner seat belts may be activated in certain frontal or side collisions.
- When the pre-tensioner seat belts are activated, a loud noise may be heard and fine dust, which may appear to be smoke, may be visible in the passenger compartment. These are normal operating conditions and are not hazardous.
- Although it is non-toxic, the fine dust may cause skin irritation and should not be inhaled for prolonged periods. Wash all exposed skin areas thoroughly after an accident in which the pre-tensioner seat belts were activated.

Additional seat belt safety precautions

Seat belt use during pregnancy

The seat belt should always be used during pregnancy. The best way to protect your unborn child is to protect yourself by always wearing the seat belt. Pregnant women should always wear a lap-shoulder seat belt. Place the shoulder belt across your chest, routed between your breasts and away from your neck. Place the lap belt below your belly so that it fits **SNUGLY** across your hips and pelvic bone, under the rounded part of the belly.



WARNING

To reduce the risk of serious injury or death to an unborn child during an accident, pregnant women should **NEVER** place the lap portion of the seat belt above or over the area of the abdomen where the unborn child is located.

Seat belt use and children

Infant and small children

Most countries have Child Restraint System laws which require children to travel in approved Child Restraint System devices, including booster seats. The age at which seat belts can be used instead of Child Restraint System differs among countries, so you should be aware of the specific requirements in your country, and where you are travelling. Infant and Child Restraint System must be properly placed and installed in a rear seat. For more details refer to the "Child Restraint Systems" in this chapter.

 **WARNING**

ALWAYS properly restrain infants and small children in a Child Restraint System appropriate for the child's height and weight. To reduce the risk of serious injury or death to a child and other passengers, NEVER hold a child in your lap or arms when the vehicle is moving. The violent forces created during an accident will tear the child from your arms and throw the child against the interior of the vehicle.

Small children are best protected from injury in an accident when properly restrained in the rear seat by a Child Restraint System that meets the requirements of the Safety Standards of your country. Before buying any Child Restraint System, make sure that it has a label certifying that it meets Safety Standard of your country. The Child Restraint System must be appropriate for your child's height and weight. Check the label on the Child Restraint System for this information. Refer to "Child Restraint Systems" in this chapter.

Larger children

Children under age 13 and who are too large for a booster seat should always occupy the rear seat and use the available lap/shoulder belts. A seat belt should lie across the upper thighs and be snug across the shoulder and chest to restrain the child safely. Check belt fit periodically. A child's squirming could put the belt out of position. In the event of an accident, children are afforded the best safety restrained by a proper Child Restraint System in the rear seats.

If a larger child over age 13 must be seated in the front seat, the child must be securely restrained by the available lap/shoulder belt and the seat should be placed in the rearmost position. If the shoulder belt portion slightly touches the child's neck or face, try placing the child closer to the center of the vehicle. If the shoulder belt still touches their face or neck, they need to be returned to an appropriate booster seat in the rear seat.

 **WARNING**

- **Always make sure larger children's seat belts are worn and properly adjusted.**
- **NEVER allow the shoulder belt to contact the child's neck or face.**
- **Do not allow more than one child to use a single seat belt.**

Seat belt use and injured people

A seat belt should be used when an injured person is being transported. Consult a physician for specific recommendations.

One person per belt

Two people (including children) should never attempt to use a single seat belt. This could increase the severity of injuries in case of an accident.

Do not lie down

Sitting in a reclined position when the vehicle is in motion can be dangerous. Even when buckled up, the protections of your restraint system (seat belts and/or air bags) is greatly reduced by reclining your seatback. Seat belts must be snug against your hips and chest to work properly. During an accident, you could be thrown into the seat belt, causing neck or other injuries.

The more the seat back is reclined, the greater the chance for the passenger's hips to slide under the lap belt or the passenger's neck to strike the shoulder belt.



WARNING

- **NEVER ride with a reclined seatback when the vehicle is moving.**
- **Riding with a reclined seatback increases your chance of serious or fatal injuries in the event of a collision or sudden stop.**
- **Driver and passengers should always sit well back in their seats, properly belted, and with the seatbacks upright.**

Care of seat belts

Seat belt systems should never be disassembled or modified. In addition, care should be taken to assure that seat belts and belt hardware are not damaged by seat hinges, doors or other abuse.

Periodic inspection

All seat belts should be inspected periodically for wear or damage of any kind. Any damaged parts should be replaced as soon as possible.

Keep belts clean and dry

Seat belts should be kept clean and dry. If belts become dirty, they can be cleaned by using a mild soap solution and warm water. Bleach, dye, strong detergents or abrasives should not be used because they may damage and weaken the fabric.

When to replace seat belts

The entire seat belt assembly or assemblies should be replaced if the vehicle has been involved in an accident. This should be done even if no damage is visible. We recommend that you consult an authorized HYUNDAI dealer.

CHILD RESTRAINT SYSTEM

Children riding in the car should sit in the rear seat and must always be properly restrained to minimize the risk of injury in an accident, sudden stop or sudden maneuver. According to accident statistics, children are safer when properly restrained in the rear seats than in the front seat. Larger children not in a child restraint should use one of the seat belts provided.

You should be aware of the specific requirements in your country. Child and/or infant safety seats must be properly placed and installed in the rear seat. You must use a commercially available child restraint system that meets the requirements of the Safety Standards of your country.

Child restraint systems are designed to be secured in vehicle seats by the lap belt portion of a lap/shoulder belt.

Children could be injured or killed in a crash if their restraints are not properly secured. For small children and babies, a child seat or infant seat must be used.

Before buying a particular child restraint system, make sure it fits your car seat and seat belts, and fits your child. Follow all the instructions provided by the manufacturer when installing the child restraint system.



WARNING

- **A child restraint system must be placed in the rear seat. Never install a child or infant seat on the front passenger's seat. Should an accident occur and cause the passenger-side air bag to deploy, it could severely injure or kill an infant or child seated in an infant or child seat. Thus only use a child restraint in the rear seat of your vehicle.**
- **A seat belt or child restraint system can become very hot if it is left in a closed vehicle on a sunny day, even if the outside temperature does not feel hot. Be sure to check the seat cover and buckles before placing a child there.**
- **When the child restraint system is not in use, store it in the luggage area or fasten it with a seat belt so that it will not be thrown forward in the case of a sudden stop or an accident.**
- **Children may be seriously injured or killed by an inflating air bag. All children, even those too large for child restraints, must ride in the rear seat.**



WARNING

To reduce the chance of serious or fatal injuries:

- Children of all ages are safer when restrained in the rear seat. A child riding in the front passenger seat can be forcefully struck by an inflating air bag resulting in serious or fatal injuries.
- Always follow the instructions for installation and use of the child restraint maker.
- Always make sure the child seat is secured properly in the car and your child is securely restrained in the child seat.
- Never hold a child in your arms or lap when riding in a vehicle. The violent forces created during a crash will tear the child from your arms and throw the child against the car's interior.
- Never put a seat belt over yourself and a child. During a crash, the belt could press deep into the child causing serious internal injuries.
- Never leave children unattended in a vehicle - not even for a short time. The car can heat up very quickly, resulting in serious injuries to children inside. Even very young children may inadvertently cause the vehicle to move, entangle themselves in the windows, or lock themselves or others inside the vehicle.
- Never allow two children, or any two persons, to use the same seat belt.
- Children often squirm and reposition themselves improperly. Never let a child ride with the shoulder belt under their arm or behind their back. Always properly position and secure children in rear seat.
- Never allow a child to stand-up or kneel on the seat or floorboard of a moving vehicle. During a collision or sudden stop, the child can be violently thrown against the vehicles interior, resulting in serious injury.
- Never use an infant carrier or a child safety seat that “hooks” over a seatback, it may not provide adequate security in an accident.
- Seat belts can become very hot, especially when the car is parked in direct sunlight. Always check seat belt buckles before fastening them over a child.
- After an accident, we recommend that the system be checked by an authorized HYUNDAI dealer.
- If there is not enough space to place the child restraint system because of the driver's seat, install the child restraint system in the rear right seat.

Using a child restraint system

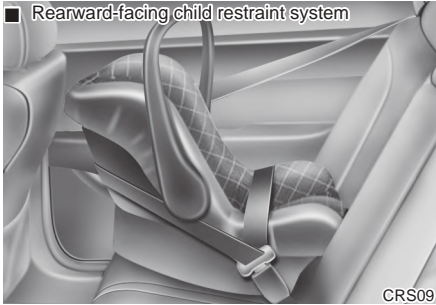

For small children and babies, the use of a child seat or infant seat is required. This child seat or infant seat should be of appropriate size for the child and should be installed in accordance with the manufacturer's instructions.

For safety reasons, we recommend that the child restraint system is used in the rear seats.

WARNING

Never place a rear-facing child restraint in the front passenger seat, because of the danger that an inflating passenger-side air bag could impact the rear-facing child restraint and kill the child.

WARNING

Child seat installation

- A child can be seriously injured or killed in a collision if the child restraint is not properly anchored to the car and the child is not properly restrained in the child restraint. Before installing the child restraint system, read the instructions supplied by the child restraint system manufacturer.
- If the seat belt does not operate as described in this section, we recommend that the system be checked by an authorized HYUNDAI dealer.
- Failure to observe this manual's instructions regarding child restraint system and the instructions provided with the child restraint system could increase the risk and/or severity of injury in an accident.

Installing a Child Restraint System (CRS)



WARNING

Before installing your Child Restraint System always:

- **Read and follow the instructions provided by the manufacturer of the Child Restraint System.**

Failure to follow all warnings and instructions could increase the risk of the SERIOUS INJURY or DEATH if an accident occurs.



WARNING

If the vehicle headrest prevents proper installation of a Child Restraint System (as described in the Child Restraint System manual), the headrest of the respective seating position shall be readjusted or entirely removed.

After selecting a proper Child Restraint System and checking that the Child Restraint System fits properly in the rear of this vehicle, you are ready to install the Child Restraint System according to the manufacturer's instruction. There are three general steps in installing the Child Restraint System properly:

- **Properly secure the Child Restraint System to the vehicle.** All Child Restraint Systems must be secured to the vehicle with the lap belt or lap part of a lap/shoulder belt or with the top-tether and/or ISOFIX anchorage.
- **Make sure the Child Restraint System is firmly secured.** After installing a Child Restraint System to the vehicle, push and pull the Child Restraint System forward and from side-to-side to verify that it is securely attached to the vehicle seat. A Child Restraint System secured with a seat belt should be installed as firmly as possible. However, some side-to-side movement can be expected.

When installing a Child Restraint System, adjust the vehicle seat (up and down, forward and rearward) so that your child fits in the Child Restraint System in a comfortable manner.

- **Secure the child in the Child Restraint System.** Make sure the child is properly strapped in the Child Restraint System according to the Child Restraint System manufacturer's instructions.



WARNING

A Child Restraint System in a closed vehicle can become very hot. To prevent burns, check the seating surface and buckles before placing your child in the Child Restraint System.

ISOFIX anchorage and top-tether anchorage (ISOFIX system) for children (if equipped)

The ISOFIX system holds a Child Restraint System during driving and in an accident. This system is designed to make installation of the Child Restraint System easier and reduce the possibility of improperly installing your Child Restraint System. The ISOFIX system uses anchors in the vehicle and attachments on the Child Restraint System. The ISOFIX system eliminates the need to use seat belts to secure the Child Restraint System to the rear seats.

ISOFIX anchors are metal bars built into the vehicle. There are two lower anchors for each ISOFIX seating position that will accommodate a Child Restraint System with lower attachments.

To use the ISOFIX system in your vehicle, you must have a Child Restraint System with ISOFIX attachments. (An ISOFIX-Child Restraint System may only be installed if it has vehicle-specific or universal approval in accordance with the requirements of ECE-R 44 or ECE-R 129.)

The Child Restraint System manufacturer will provide you with instructions on how to use the Child Restraint System with its attachments for the lower anchorages.

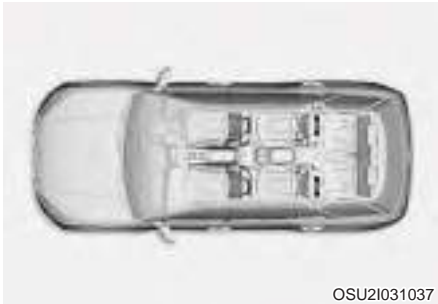

ISOFIX anchorages have been provided in the left and right outboard rear seating positions. Their locations are shown in the illustration. There are no ISOFIX anchorages provided for the center rear seating position.

 **WARNING**

Do not attempt to install a Child Restraint System using ISOFIX anchorages in the rear center seating position. There are no ISOFIX anchorages provided for this seat.

Using the outboard seat anchorages, for the CRS installation on the rear center seating position, can damage the anchorages which may break or fail in a collision resulting in serious injury or death.

[A] : ISOFIX Anchorage Position Indicator

[B] : ISOFIX Lower Anchorage

The ISOFIX anchorages symbols are located on the left and right rear seat cushions to identify the position of the ISOFIX anchorages in your vehicle (see arrows in illustration).

Both rear outboard seats are equipped with a pair of ISOFIX anchorages as well as a corresponding top-tether anchorage on the back side of the rear seats.

(Child Restraint Systems with universal approval according to ECE-R44 or ECE-R129 need to be fixed additionally with a top-tether connected to the corresponding top-tether anchorage point on the back side of the rear seats.)

ISOFIX anchorages are located between the seatback and the seat cushion of the rear seat left and right outboard seating positions.

Securing a Child Restraint System with the “ISOFIX system”

To install a ISOFIX-compatible Child Restraint System in either of the rear outboard seating positions:

1. Move the seat belt buckle away from the ISOFIX anchorages.
2. Move any other objects away from the anchors that could prevent a secure connection between the Child Restraint System and the ISOFIX anchorages.
3. Place the Child Restraint System on the vehicle seat, then attach the seat to the ISOFIX anchorages according to the instructions provided by the Child Restraint System manufacturer.
4. Follow the instructions of the Child Restraint System’s manufacturer for proper installation and connection of the ISOFIX attachments on the Child Restraint System to the ISOFIX anchorages.



WARNING

Take the following precautions when using the ISOFIX system:

- **Read and follow all installation instructions provided with your Child Restraint System.**
- **To prevent the child from reaching and taking hold of unretracted seat belts, buckle all unused rear seat belts and retract the seat belt webbing behind the child. Children can be strangled if a shoulder belt becomes wrapped around their neck and the seat belt tightens.**
- **NEVER attach more than one Child Restraint System to a single anchorage. This could cause the anchor or attachment to come loose or break.**
- **Always have the ISOFIX system inspected by your dealer after an accident. An accident can damage the ISOFIX system and may not properly secure the Child Restraint System.**

Securing a Child Restraint System with “Top-tether anchorage” system (if equipped)



Top-tether anchorages for Child Restraint Systems are located on the floor of the luggage room.



To install the top-tether :

1. Route the Child Restraint System top-tether over the Child Restraint System seatback. Route the top-tether under the headrest and between the headrest posts, or route the top-tether over the top of the vehicle seatback. Make sure the strap is not twisted.
2. Connect the top-tether to the top-tether anchorage, then tighten the top-tether according to the instructions of your Child Restraint System’s manufacturer to firmly attach the Child Restraint System to the seat.
3. Check that the Child Restraint System is securely attached to the seat by pushing and pulling the seat forward and from side-to-side.



WARNING

Take the following precautions when installing the top-tether:

- **Read and follow all installation instructions provided with your Child Restraint System.**
- **NEVER attach more than one Child Restraint System to a single top-tether anchorage. This could cause the anchorage or attachment to come loose or break.**
- **Do not attach the top-tether to anything other than the correct top-tether anchorage. It may not work properly if attached to something else.**
- **Child Restraint System anchorages are designed to withstand only those loads imposed by correctly fitted Child Restraint Systems. Under no circumstances are they to be used for adult seat belts or harnesses or for attaching other items or equipment to the vehicle.**

Suitability of each seating position for belted & ISOFIX Child Restraint Systems according to UN regulations (Information for vehicle users and CRS manufacturers)

- Yes : Suitable for fitment of the designated category of CRS
- No : Not suitable for fitment of the designated category of CRS
- "–" : Not applicable
- The table is based on LHD vehicle. Except for the front passenger seat, the table is valid for RHD vehicle. For RHD vehicle front passenger of number 1 , please use information for the seating position number 3.

CRS categories		Seating positions						Seating position
		1	2	3	4	5	6	
Universal belted CRS		-	-	Yes ⁽¹⁾ F, R	Yes F, R	Yes ⁽¹⁾ F, R	Yes F, R	
i-size CRS	ISOFIX CRF : F2, F2X, R1, R2	-	-	No	No	No	No	
ISOFIX infant CRS (i.e. CRS for a baby)	ISOFIX CRF : (R1)	-	-	No	Yes R	No	Yes R	
Carry cot (ISOFIX lateral facing CRS)	ISOFIX CRF : (L1,L2)	-	-	No	No	No	No	
ISOFIX toddler CRS - small	ISOFIX CRF : (F2, F2X, R2)	-	-	No	Yes F,R	No	Yes F, R	
ISOFIX toddler CRS – large* (*: not booster seats)	ISOFIX CRF : (F3, R3)	-	-	No	Yes F,R	No	Yes F, R	
Booster Seat – reduced Width	ISO CRF : B2	-	-	No	No	No	No	
Booster Seat – full Width	ISO CRF : B3	-	-	No	No	No	No	



OAH2038035L

Seat number	Position in the vehicle	Seat number	Position in the vehicle
1	Front left	4	2 nd row left
2	Front center	5	2 nd row center
3	Front right	6	2 nd row right

- F : FORWARD FACING
- R : REARWARD FACING

Note ¹⁾ : If seat belt is 2 point type, Universal belted CRS only applies to forward facing.

- * Never place a rearward facing Child Restraint System on the front passenger seat, unless the passenger air bag is deactivated.
- * If the vehicle headrest prevents proper installation of a CRS, the headrest of the seating position shall be readjusted or entirely removed.

Installing a child restraint system by lap/shoulder belt

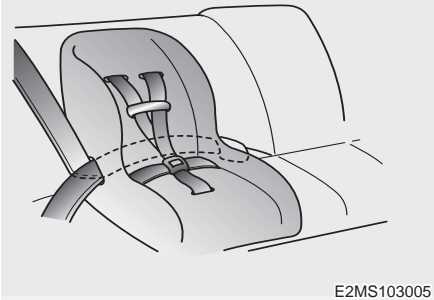

To install a child restraint system on the outboard or center rear seats, do the following:

1. Place the child restraint system in the seat and route the lap/shoulder belt around or through the restraint, following the restraint manufacturer's instructions. Be sure the seat belt webbing is not twisted.



2. Fasten the lap/shoulder belt latch into the buckle. Listen for the distinct "Click" sound.

Position the release button so that it is easy to access in case of an emergency.



3. Buckle the seat belt and allow the seat belt to take up any slack. After installation of the child restraint system, try to move it in all directions to be sure the child restraint system is securely installed.

If you need to tighten the belt, pull more webbing toward the retractor. When you unbuckle the seat belt and allow it to retract, the retractor will automatically revert back to its normal seated passenger emergency locking usage condition.

Child Seat Restraint for Vehicle ISOFIX Positions

Use child safety seats that have been officially approved and are appropriate for your children. When using the child safety seats, refer to the following table.

Mass Group	Seating Position (6 Seater & 7 Seater)					
	Front Passenger	Second Row			Third Row	
		Outboard	Center 6S	Centre 7S	Outboard	Centre
Group 0 (0-9months) up to 10kg	X	U	N/A	X	U	N/A
Group 0+ (0-2years) up to 13kg	X	U	N/A	X	U	N/A
Group I (9months-4years) 9 to 18kg	UF	U	N/A	X	U	N/A
Group II (15 to 25kg) 15 to 25kg	UF	U	N/A	X	U	N/A
Group III (22 to 36kg) 22 to 36kgD	UF	U	N/A	X	U	N/A

U = Suitable for “universal” category Child Restraints Systems approved for use in this mass group.
 UF = Suitable for forward facing “universal” category restraints for use in this mass group.
 X = Seat position not suitable for children in this mass group.
 N/A = Not Applicable

Remarks:- Co driver seat:
 Up right, Rearmost position & Seat belt shoulder anchorage to lowest position.

AIR BAG - SUPPLEMENTAL RESTRAINT SYSTEM (SRS)

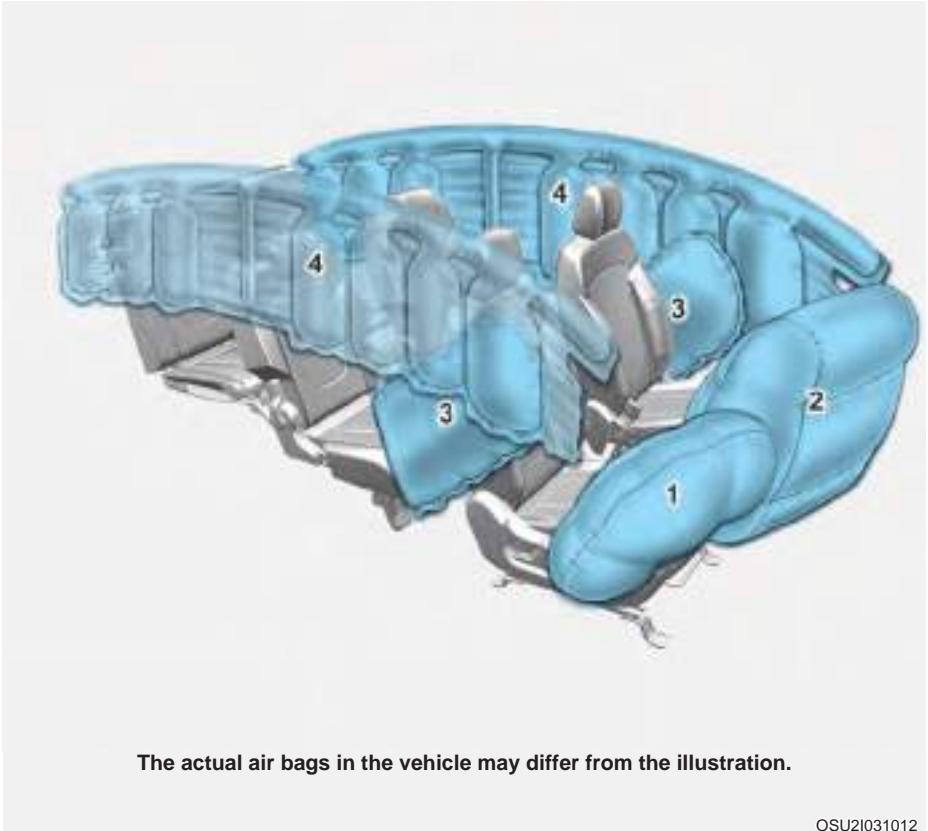

1. Driver's front air bag
2. Passenger's front air bag
3. Side air bag*
4. Curtain air bag*

* : if equipped



WARNING

- **Even in vehicles with air bags, you and your passengers must always wear the safety belts provided in order to minimize the risk and severity of injury in the event of a collision or roll-over.**
- **SRS and pretensioners contain explosive chemicals.**
If scraping a vehicle without removing SRS and pretensioners from a vehicle, it may cause fire. Before scraping a vehicle, we recommend that you contact an authorized Hyundai dealer.
- **Keep the SRS parts and wirings away from water or any liquid. If the SRS components are inoperative due to exposure to water or liquids, it may cause fire or severe injury.**

How does the air bag system operate

- Air bags are activated (able to inflate if necessary) only when the ignition switch is placed to the ON or START position.
- Air bags inflate instantly in the event of serious frontal or side collision in order to help protect the occupants from serious physical injury.
- There is no single speed at which the air bags will inflate.
Generally, air bags are designed to inflate based upon the severity of a collision and its direction. These two factors determine whether the sensors produce an electronic deployment/ inflation signal.
- Air bag deployment depends on a number of factors including vehicle speed, angles of impact and the density and stiffness of the vehicles or objects which your vehicle hits in the collision. The determining factors are not limited to those mentioned above.
- The front air bags will completely inflate and deflate in an instant.
It is virtually impossible for you to see the air bags inflate during an accident.
It is much more likely that you will simply see the deflated air bags hanging out of their storage compartments after the collision.

- In order to help provide protection in a severe collision, the air bags must inflate rapidly. The speed of air bag inflation is a consequence of extremely short time in which a collision occurs and the need to get the air bag between the occupant and the vehicle structures before the occupant impacts those structures. This speed of inflation reduces the risk of serious or life-threatening injuries in a severe collision and is thus a necessary part of air bag design.

However, air bag inflation can also cause injuries which can include facial abrasions, bruises and broken bones because the inflation speed also causes the air bags to expand with a great deal of force.

- There are even circumstances under which contact with the steering wheel air bag can cause fatal injuries, especially if the occupant is positioned excessively close to the steering wheel.



WARNING

- **To avoid severe personal injury or death caused by deploying air bags in a collision, the driver should sit as far back from the steering wheel air bag as possible. The front passenger should always move their seat as far back as possible and sit back in their seat.**
- **Air bag inflates instantly in an event of a collision, passengers may be injured by the air bag expansion force if they are not in a proper position.**
- **Air bag inflation may cause injuries including facial or bodily abrasions, injuries from broken glasses or burns.**

Noise and smoke

When the air bags inflate, they make a loud noise and they leave smoke and powder in the air inside of the vehicle. This is normal and is a result of the ignition of the air bag inflator. After the air bag inflates, you may feel substantial discomfort in breathing due to the contact of your chest with both the seat belt and the air bag, as well as from breathing the smoke and powder. **Open your doors and/or windows as soon as possible after impact in order to reduce discomfort and prevent prolonged exposure to the smoke and powder.**

Though smoke and powder are non-toxic, it may cause irritation to the skin (eyes, nose and throat, etc.). If this is the case, wash and rinse with cold water immediately and consult with the doctor if the symptom persists.

 **WARNING**

When the air bags deploy, the air bag related parts in the steering wheel are very hot. To prevent injury, do not touch the air bag storage areas internal components immediately after an air bag has inflated.

Do not install a child restraint on the front passenger's seat (if equipped)



OYDESA2042

Never place a rear-facing child restraint in the front passenger's seat. If the air bag deploys, it would impact the rear-facing child restraint, causing serious or fatal injury.

In addition, do not place front-facing child restraints in the front passenger's seat either. If the front passenger air bag inflates, it would cause serious or fatal injuries to the child.



WARNING

- **NEVER** use a rearward facing child restraint on a seat protected by an **ACTIVE AIR BAG** in front of it, **DEATH** or **SERIOUS INJURY** to the **CHILD** can occur.
- **Never** put a child restraint in the front **passenger** seat. If the front passenger air bag inflates, it would cause serious or fatal injuries.

Air bag warning and indicator

Air bag warning light



The purpose of the air bag warning light in your instrument panel is to alert you of a potential problem with your air bag - Supplemental Restraint System (SRS).

When the ignition switch is turned ON, the warning light should illuminate for approximately 6 seconds, then go off.

Have the system checked if:

- The light does not turn on briefly when you turn the ignition ON.
- The light stays on after illuminating for approximately 6 seconds.
- The light comes on while the vehicle is in motion.
- The light blinks when the ignition switch is in ON position.

SRS components and functions

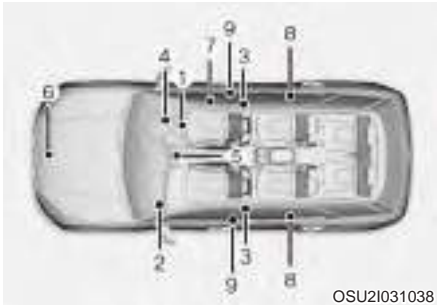

The SRS consists of the following components:

- (1) Driver's front air bag module
- (2) Passenger's front air bag module
- (3) Pre-tensioner seatbelt system
- (4) Air bag warning light
- (5) SRS control module (SRSCM)
- (6) Front impact Sensor
- (7) Side air bag modules*
- (8) Curtain air bag modules*
- (9) Side impact sensors*

* : if equipped

The SRSCM continuously monitors all SRS components while the ignition switch is ON to determine if a crash impact is severe enough to require air bag deployment or pre-tensioner seat belt deployment.

The SRS air bag warning light on the instrument panel will illuminate for about 6 seconds after the ignition switch is turned to the ON position, after which the air bag warning light should go out.

WARNING

If any of the following conditions occurs, this indicates a malfunction of the SRS. We recommend that the system be inspected by an authorized HYUNDAI dealer.

- **The light does not turn on briefly when you turn the ignition ON.**
- **The light stays on after illuminating for approximately 6 seconds.**
- **The light comes on while the vehicle is in motion.**
- **The light blinks when the ignition switch is in ON position.**

■ Driver's front air bag (1)

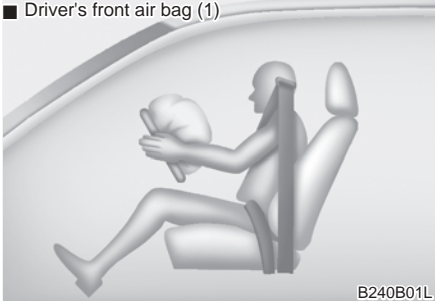

B240B01L

The air bag modules are located both in the center of the steering wheel and in the front passenger's panel above the glove box. When the SRSCM detects a sufficiently severe impact to the front of the vehicle, it will automatically deploy the front air bags.

■ Driver's front air bag (2)

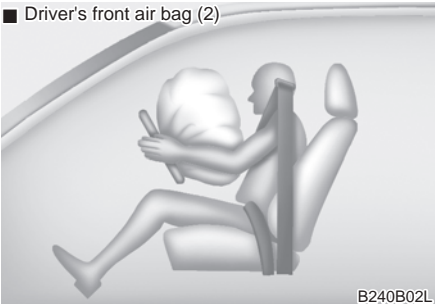

B240B02L

Upon deployment, tear seams molded directly into the pad covers will separate under pressure from the expansion of the air bags. Further opening of the covers then allows full inflation of the air bags.

■ Driver's front air bag (3)

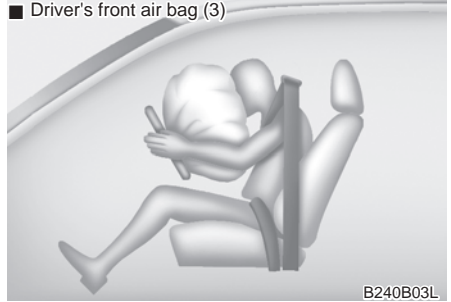

B240B03L

A fully inflated air bag, in combination with a properly worn seat belt, slows the driver's or the passenger's forward motion, reducing the risk of head and chest injury.

After complete inflation, the air bag immediately starts deflating, enabling the driver to maintain forward visibility and the ability to steer or operate other controls.

■ Passenger's front air bag



 **WARNING**

- If an air bag deploys, there may be a loud noise followed by a fine dust released in the vehicle. These conditions are normal and are not hazardous - the air bags are packed in this fine powder. The dust generated during air bag deployment may cause skin or eye irritation as well as aggravate asthma for some persons. Always wash all exposed skin areas thoroughly with cold water and a mild soap after an accident in which the air bags were deployed.
- The SRS can function only when the ignition switch is in the ON position.
- Before you replace a fuse or disconnect a battery terminal, turn the ignition switch to the LOCK position and remove the ignition key. Never remove or replace the air bag related fuse(s) when the ignition switch is in the ON position. Failure to heed this warning will cause the SRS air bag warning light to illuminate.

 **WARNING**

- Do not install or place any accessories (drink holder, cassette holder, sticker, etc.) on the front passenger's panel above the glove box in a vehicle with a passenger's air bag. Such objects may become dangerous projectiles and cause injury if the passenger's air bag inflates.
- When installing a container of liquid air freshener inside the vehicle, do not place it near the instrument cluster nor on the instrument panel surface.

It may become a dangerous projectile and cause injury if the passenger's air bag inflates.

Driver's and passenger's front air bag (if equipped)

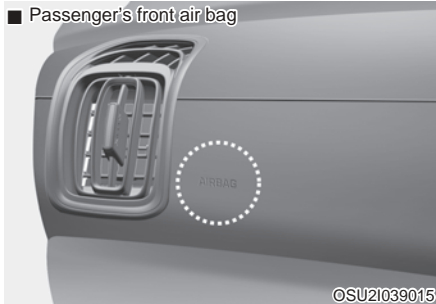

Your vehicle is equipped with a Supplemental Restraint (Air Bag) System and lap/shoulder belts at both the driver and passenger seating positions.

The indications of the system's presence are the letters "AIR BAG" engraved on the air bag pad cover in the steering wheel and the passenger's side front panel pad above the glove box.

The SRS consists of air bags installed under the pad covers in the center of the steering wheel and the passenger's side front panel above the glove box.

The purpose of the SRS is to provide the vehicle's driver and/or the front passenger with additional protection than that offered by the seat belt system alone in case of a frontal impact of sufficient severity.

WARNING

Always use seat belts and child restraints – every trip, every time, everyone! Air bags inflate with considerable force and in the blink of an eye. Seat belts help keep occupants in proper position to obtain maximum benefit from the air bag. Even with air bags, improperly and unbelted occupants can be severely injured when the air bag inflates. Always follow the precautions about seat belts, air bags and occupant safety contained in this manual.

To reduce the chance of serious or fatal injuries and receive the maximum safety benefit from your restraint system:

- **Never place a child in any child or booster seat in the front seat.**
- **ABC – Always Buckle Children in the back seat. It is the safest place for children of any age to ride.**
- **Air bags can injure occupants improperly positioned in the front seats.**
- **Move your seat as far back as practical from the front air bags, while still maintaining control of the vehicle.**

- You and your passengers should never sit or lean unnecessarily close to the air bags. Improperly positioned drivers and passengers can be severely injured by inflating air bags.
- Never lean against the door or center console – always sit in an upright position.
- No objects (such as crash pad cover, cellular phone holder, cup holder, perfume or stickers) should be placed over or near the air bag modules on the steering wheel, instrument panel, windshield glass, and the front passenger's panel above the glove box. Such objects could cause harm if the vehicle is in a crash severe enough to cause the air bags to deploy.
- Do not attach any objects on the front windshield and inside mirror.
- Do not tamper with or disconnect SRS wiring or other components of the SRS system. Doing so could result in injury, due to accidental deployment of the air bags or by rendering the SRS inoperative.
- If the SRS air bag warning light remains illuminated while the vehicle is being driven, we recommend that the system be inspected by an authorized HYUNDAI dealer.
- Air bags can only be used once – we recommend that the system be replaced by an authorized HYUNDAI dealer.
- The SRS is designed to deploy the front air bags only when an impact is sufficiently severe and when the impact angle is less than 30° from the forward longitudinal axis of the vehicle. Additionally, the air bags will only deploy once. Seat belts must be worn at all times.
- Front air bags are not intended to deploy in side-impact, rear-impact or rollover crashes. In addition, front air bags will not deploy in frontal crashes below the deployment threshold.
- A child restraint system must never be placed in the front seat. The infant or child could be severely injured or killed by an air bag deployment in case of an accident.
- Children age 12 and under must always be properly restrained in the rear seat. Never allow children to ride in the front passenger seat. If a child over 12 must be seated in the front seat, he or she must be properly belted and the seat should be moved as far back as possible.
- For maximum safety protection in all types of crashes, all occupants including the driver should always wear their seat belts whether or not an air bag is also provided at their seating position to minimize the risk of severe injury or death in the event of a crash. Do not sit or lean unnecessarily close to the air bag while the vehicle is in motion.

- **Sitting improperly or out of position can result in serious or fatal injury in a crash. All occupants should sit upright with the seat back in an upright position, centered on the seat cushion with their seat belt on, legs comfortably extended and their feet on the floor until the vehicle is parked and the ignition key is removed.**
- **The SRS air bag system must deploy very rapidly to provide protection in a crash. If an occupant is out of position because of not wearing a seat belt, the air bag may forcefully contact the occupant causing serious or fatal injuries.**

Side impact air bag (if equipped)

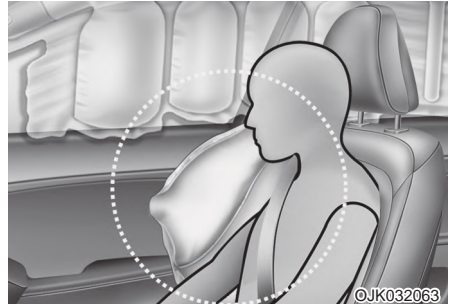
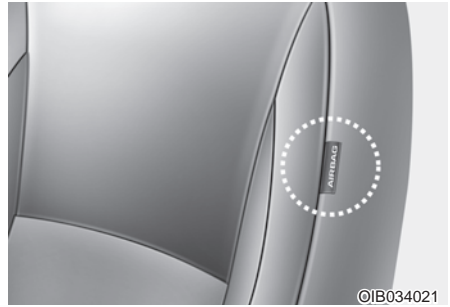

The actual air bags in the vehicle may differ from the illustration.

Your vehicle is equipped with a side impact air bag in each front seat.

The purpose of the air bag is to provide the vehicle's driver and/or the front passenger with additional protection than that offered by the seat belt alone.

The side impact air bags are designed to deploy only during certain side-impact collisions, depending on the crash severity, angle, speed and point of impact. The side impact air bags are not designed to deploy in all side impact situations.



WARNING

Do not allow the passengers to lean their heads or bodies onto doors, put their arms on the doors, stretch their arms out of the window, or place objects between the doors and passengers when they are seated on seats equipped with side and/or curtain air bags.



WARNING

- The side impact air bag is supplemental to the driver's and the passenger's seat belt systems and is not a substitute for them. Therefore your seat belts must be worn at all times while the vehicle is in motion. The air bags deploy only in certain side impact conditions severe enough to cause significant injury to the vehicle occupants.
 - For best protection from the side impact air bag system and to avoid being injured by the deploying side impact air bag, both front seat occupants should sit in an upright position with the seat belt properly fastened. The driver's hands should be placed on the steering wheel at the 9:00 and 3:00 positions. The passenger's arms and hands should be placed on their laps.
 - Do not use any accessory seat covers.
 - Use of seat covers could reduce or prevent the effectiveness of the system.
 - Do not install any accessories on the side or near the side impact air bag.
- Do not place any objects over the air bag or between the air bag and yourself. Also, do not attach any objects around the area the air bag inflates such as the door, side door glass, front and rear pillar.
 - Do not place any objects between the door and the seat. They may become dangerous projectiles if the side air bag inflates.
 - Do not put any objects between the side air bag label and seat cushion. It could cause harm if the vehicle is in a crash severe enough to cause the air bags to deploy.
 - To prevent unexpected deployment of the side impact air bag that may result in personal injury, avoid impact to the side impact sensor when the ignition switch is on.
 - If the seat or seat cover is damaged, we recommend that the system be serviced by an authorized HYUNDAI dealer.
 - Inform the dealer that your vehicle is equipped with side impact air bags.

Curtain air bag (if equipped)

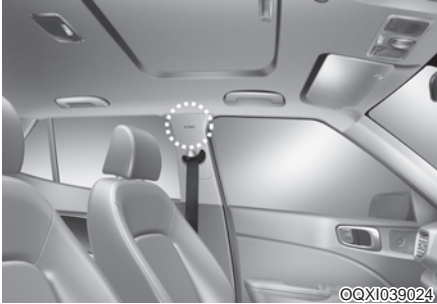

The actual air bags in the vehicle may differ from the illustration.

Curtain air bags are located along both sides of the roof rails above the front and rear doors.

They are designed to help protect the heads of the front seat occupants and the rear outboard seat occupants in certain side impact collisions.

The curtain air bags are designed to deploy only during certain side impact collisions, depending on the crash severity, angle, speed and impact. The curtain air bags are not designed to deploy in all side impact situations, collisions from the front or rear of the vehicle or in most rollover situations.

WARNING

- In order for side impact and curtain air bags to provide the best protection, both front seat occupants and both outboard rear occupants should sit in an upright position with the seat belts properly fastened. Importantly, children should sit in a proper child restraint system in the rear seat.
- When children are seated in the rear outboard seats, they must be seated in the proper child restraint system. Make sure to put the child restraint system as far away from the door side as possible, and secure the child restraint system in a locked position.
- Do not place any objects over the air bag. Also, do not attach any objects around the area the air bag inflates such as the door, side door glass, front and rear pillar, roof side rail.
- Do not hang other objects except clothes, especially hard or breakable objects. In an accident, it may cause vehicle damage or personal injury.

- Do not allow the passengers to lean their heads or bodies onto doors, put their arms on the doors, stretch their arms out of the window, or place objects between the doors and passengers when they are seated on seats equipped with side and/or curtain air bags.
- Do not open or repair the side curtain air bags.
- Never try to open or repair any components of the side curtain air bag system. We recommend that the system be serviced by an authorized HYUNDAI dealer.

Failure to follow the above mentioned instructions can result in injury or death to the vehicle occupants in an accident.

Why didn't my air bag go off in a collision? (Inflation and non-inflation conditions of the air bag)

There are many types of accidents in which the air bag would not be expected to provide additional protection.

These include rear impacts, second or third collisions in multiple impact accidents, as well as low speed impacts.

Air bag collision sensors



1. SRS control module
2. Front impact sensor
3. Side impact sensor (If equipped)



WARNING

- Do not hit or allow any objects to impact the locations where air bags or sensors are installed.

This may cause unexpected air bag deployment, which could result in serious personal injury or death.

- If the installation location or angle of the sensors is altered in any way, the air bags may deploy when they should not or they may not deploy when they should, causing severe injury or death.

Therefore, do not try to perform maintenance on or around the air bag sensors. We recommend that the system be serviced by an authorized HYUNDAI dealer.

- Problems may arise if the sensor installation angles are changed due to the deformation of the front bumper and body. We recommend that the system be serviced by an authorized HYUNDAI dealer.
- Your vehicle has been designed to absorb impact and deploy the air bag(s) in certain collisions. Installing aftermarket bumper guards or replacing a bumper with non-genuine parts may adversely affect your vehicles collision and air bag deployment performance.

Air bag inflation conditions



Front air bags

Front air bags are designed to inflate in certain frontal collision depending on the crash severity, speed or angles of impact of the front collision.

If the vehicle chassis is impacted by bumps or objects on unimproved roads or sidewalks, air bags may deploy. Drive carefully on unimproved roads or on surfaces not designed for vehicle traffic to prevent unintended air bag deployment.



Side and curtain air bags

Side and curtain air bags are designed to inflate when an impact is detected by side collision sensors depending on the severity from a side impact collision.

Although the driver's and front passenger's air bags are designed to inflate only in frontal collisions, they also may inflate in other types of collisions if the front impact sensors detect a sufficient impact. Side and curtain air bags are designed to inflate only in side impact collisions, but they may inflate in other collisions if the side impact sensors detect a sufficient impact.

If the vehicle chassis is impacted by bumps or objects on unimproved roads, the air bags may deploy. Drive carefully on unimproved roads or on surfaces not designed for vehicle traffic to prevent unintended air bag deployment.

Air bag non-inflation conditions



- In certain low-speed collisions the air bags may not deploy. The air bags are designed not to deploy in such cases because they may not provide benefits beyond the protection of the seat belts in such collisions.



- Front air bags are not designed to inflate in rear collisions, because occupants are moved backward by the force of the impact. In this case, inflated air bags would not be able to provide any additional benefit.



- Front air bags may not inflate in side impact collisions, because occupants move to the direction of the collision, and thus in side impacts, frontal air bag deployment would not provide additional occupant protection.



- Just before impact, drivers often brake heavily. Such heavy braking lowers the front portion of the vehicle causing it to “ride” under a vehicle with a higher ground clearance. Air bags may not inflate in this “under-ride” situation because deceleration forces that are detected by sensor may be significantly reduced by such “under-ride” collisions.



- In a slant or angled collision, the force of impact may direct the occupants in a direction where the air bags would not be able to provide any additional benefit, and thus the sensors may not deploy any air bags.

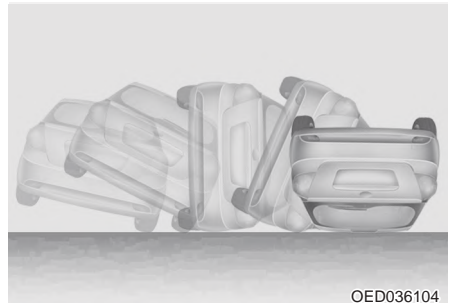

- Front air bags may not inflate in all rollover accidents when the SRS Control Module (SRSCM) indicates that the front air bag deployment would not provide additional occupant protection.

i Information

The side and/or curtain air bags may inflate when the vehicle is rolled over by a side impact collision, if the vehicle is equipped with side and/or curtain air bags.



- Air bags may not inflate if the vehicle collides with objects such as utility poles or trees, where the point of impact is concentrated and the collision energy is absorbed by the vehicle structure.

SRS Care

The SRS is virtually maintenance-free and so there are no parts you can safely service by yourself. If the SRS air bag warning light does not illuminate for 6 sec after IGN “ON” or continuously remains on, we recommend that the system be inspected by an authorized HYUNDAI dealer.

We recommend that the any work on the SRS system, such as removing, installing, repairing, or any work on the steering wheel, the front passenger’s panel, front seats and roof rails be performed by an authorized HYUNDAI dealer. Improper handling of the SRS system may result in serious personal injury.

⚠ WARNING

- **Modification to SRS components or wiring, including the addition of any kind of badges to the pad covers or modifications to the body structure, can adversely affect SRS performance and lead to possible injury.**
- **For cleaning the air bag pad covers, use only a soft, dry cloth or one which has been moistened with plain water. Solvents or cleaners could adversely affect the air bag covers and proper deployment of the system.**

- **No objects should be placed over or near the air bag modules on the steering wheel, instrument panel, and the front passenger's panel above the glove box, because any such object could cause harm if the vehicle is in a crash severe enough to cause the air bags to inflate.**
- **If the air bags inflate, we recommend that the system be replaced by an authorized HYUNDAI dealer.**
- **Do not tamper with or disconnect SRS wiring, or other components of the SRS system. Doing so could result in injury, due to accidental inflation of the air bags or by rendering the SRS inoperative.**
- **If components of the air bag system must be discarded, or if the vehicle must be scrapped, certain safety precautions must be observed. An authorized HYUNDAI dealer knows these precautions and can give you the necessary information. Failure to follow these precautions and procedures could increase the risk of personal injury.**
- **If your car was flooded and has soaked carpeting or water on the flooring, you shouldn't try to start the engine; we recommend that you contact an authorized HYUNDAI dealer.**

Additional safety precautions

- **Never let passengers ride in the cargo area or on top of a folded-down back seat.** All occupants should sit upright, fully back in their seats with their seat belts on and their feet on the floor.
- **Passengers should not move out of or change seats while the vehicle is moving.** A passenger who is not wearing a seat belt during a crash or emergency stop can be thrown against the inside of the vehicle, against other occupants, or out of the vehicle.
- **Each seat belt is designed to restrain one occupant.** If more than one person uses the same seat belt, they could be seriously injured or killed in a collision.
- **Do not use any accessories on seat belts.** Devices claiming to improve occupant comfort or reposition the seat belt can reduce the protection provided by the seat belt and increase the chance of serious injury in a crash.
- **Passengers should not place hard or sharp objects between themselves and the air bags.** Carrying hard or sharp objects on your lap or in your mouth can result in injuries if an air bag inflates.
- **Keep occupants away from the air bag covers.** All occupants should sit upright, fully back in their seats with their seat belts on and their feet on the floor. If occupants are too close to the air bag covers, they could be injured if the air bags inflate.

- **Do not attach or place objects on or near the air bag covers.** Any object attached to or placed on the front air bag covers could interfere with the proper operation of the air bags.
- **Do not modify the front seats.** Modification of the front seats could interfere with the operation of the supplemental restraint system sensing components air bags.
- **Do not place items under the front seats.** Placing items under the front seats could interfere with the operation of the supplemental restraint system sensing components and wiring harnesses.
- **Never hold an infant or child on your lap.** The infant or child could be seriously injured or killed in the event of a crash. All infants and children should be properly restrained in appropriate child safety seats or seat belts in the rear seat.



WARNING

- **Sitting improperly or out of position can cause occupants to be shifted too close to a deploying air bag, strike the interior structure or be thrown from the vehicle resulting in serious injury or death.**
- **Always sit upright with the seat-back in an upright position, centered on the seat cushion with your seat belt on, legs comfortably extended and your feet on the floor.**

Adding equipment to or modifying your air bag-equipped vehicle

If you modify your vehicle by changing your vehicle's frame, bumper system, front end or side sheet metal or ride height, this may affect the operation of your vehicle's air bag system.

Air bag warning label



Air bag warning labels are attached to alert the driver and passengers of potential risks of the air bag system. Be sure to read all of the information about the air bags that are installed on your vehicle in this Owner's Manual.

5. Instrument cluster

Instrument cluster	5-2
Instrument cluster control	5-4
Gauges	5-4
Icy road warning light	5-9
Transmission shift indicator	5-10
Warning and indicator lights	5-12
LCD display messages	5-24
LCD display.....	5-30
LCD display control	5-30
LCD display modes.....	5-31
User settings mode	5-34
Trip computer	5-40

INSTRUMENT CLUSTER

■ Type A

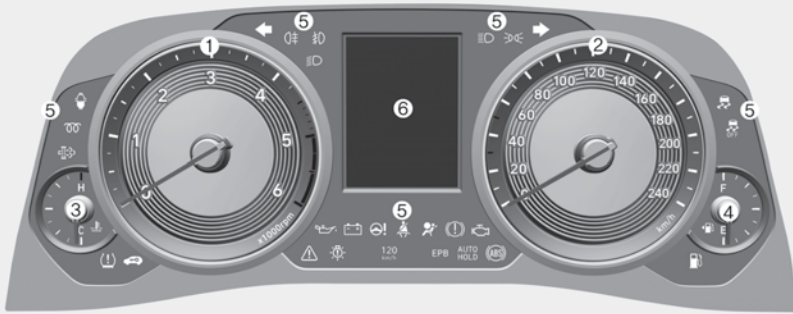

■ Type B



OSU21049001/OSU21049002

1. Tachometer
2. Speedometer
3. Engine coolant temperature gauge
4. Fuel gauge
5. Warning and indicator lights
6. LCD display (including Trip computer)

※ The actual cluster in the vehicle may differ from the illustration.
For more details, refer to the “Gauges” in this chapter.

■ Full LCD Cluster(Type C)

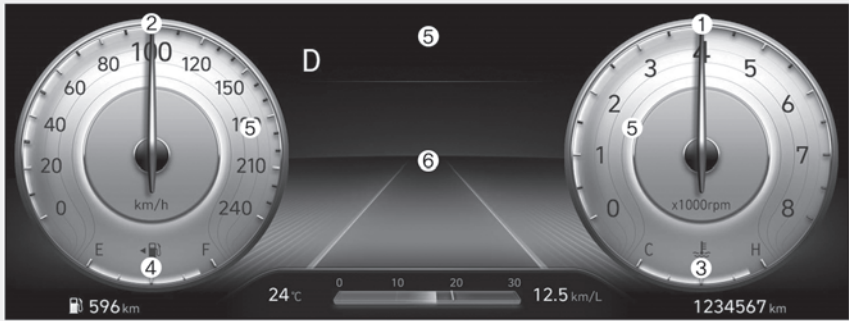

ONX4040002

1. Tachometer
2. Speedometer
3. Engine coolant temperature gauge
4. Fuel gauge
5. Warning and indicator lights
6. LCD display (including Trip computer)

Instrument cluster control

Instrument panel illumination

When the vehicle's position lights or headlamps are on, the brightness of the instrument panel illumination can be adjusted by:

- User Settings mode in the Cluster :
You can adjust the instrument panel illumination in the "Lights - Illumination".



WARNING

Never adjust the instrument cluster while driving. This could result in loss of control and lead to an accident that may cause death, serious injury, or vehicle damage.

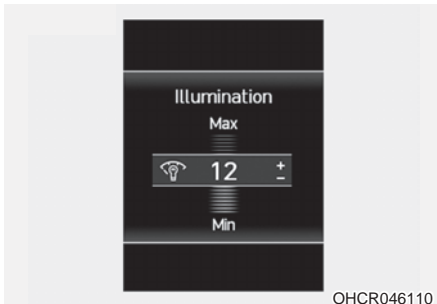

OHCR046110

- The brightness of the instrument panel illumination is displayed.
- If the brightness reaches the maximum or minimum level, an alarm will sound.

Gauges

Speedometer

■ Type A



OSU21049003

■ Type B



OSU21049014

■ Type C



OCN7040005

The speedometer indicates the speed of the vehicle and is calibrated in kilometers per hour (km/h).

Tachometer

- Type A
- Petrol



OSU21049005

- Diesel



OSU21049006

- Type B
- Petrol

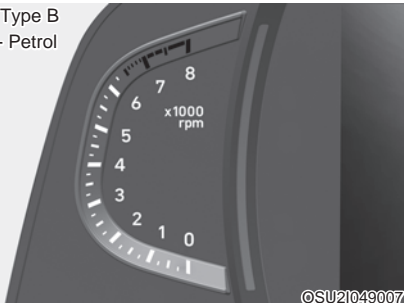

©SU21049007

- Diesel



©SU21049008

- Type C
- Petrol



OCN7040007

- Diesel



ONX4040006

The tachometer indicates the approximate number of engine revolutions per minute (rpm).

Use the tachometer to select the correct shift points and to prevent lugging and/or over-revving the engine.

NOTICE

Do not operate the engine within the tachometer's RED ZONE. This may cause severe engine damage.

Engine Coolant Temperature Gauge

■ Type A

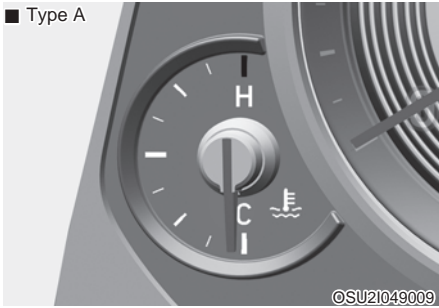

■ Type B

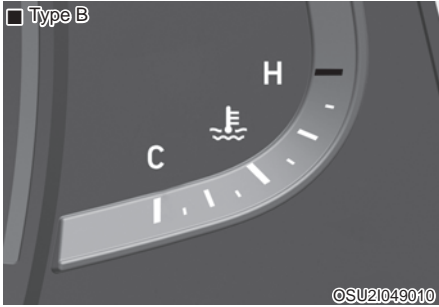

■ Type C

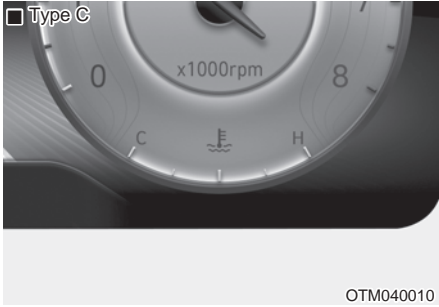

This gauge indicates the temperature of the engine coolant when the ignition switch is in the ON position.

NOTICE

If the gauge pointer moves beyond the normal range area toward the “H (Hot)” position, it indicates overheating that may damage the engine.

Do not continue driving with an overheated engine. If your vehicle overheats, refer to “If the Engine Overheats” in chapter 7.



WARNING

Never remove the radiator cap or reservoir cap when the engine is hot. The engine coolant is under pressure and could cause severe burns. Wait until the engine is cool before adding coolant to the reservoir.

Fuel Gauge

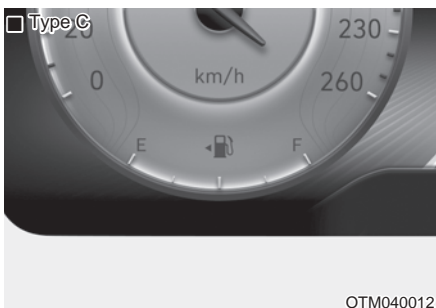
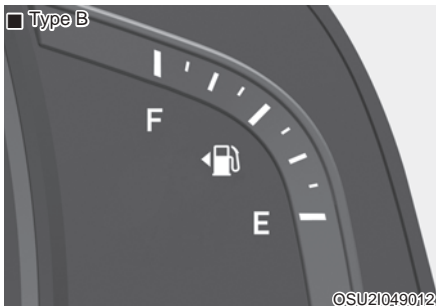
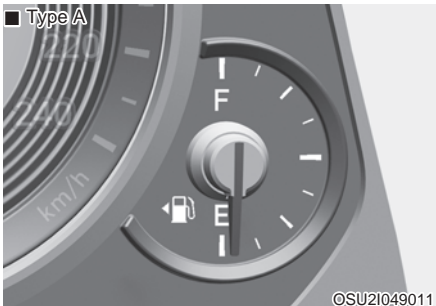

This gauge indicates the approximate amount of fuel remaining in the fuel tank.

i Information

- The fuel gauge is supplemented by a low fuel warning light, which will illuminate when the fuel tank is nearly empty.
- On inclines or curves, the fuel gauge pointer may fluctuate or the low fuel warning light may come on earlier than usual due to the movement of fuel in the tank.

! WARNING

Fuel Gauge

Running out of fuel can expose vehicle occupants to danger.

You must stop and obtain additional fuel as soon as possible after the warning light comes on or when the gauge indicator comes close to the “E (Empty)” level.

NOTICE

Avoid driving with a very low fuel level. Running out of fuel could cause the engine to misfire damaging the catalytic converter.

Odometer

■ Type A



OIG046114

■ Type B

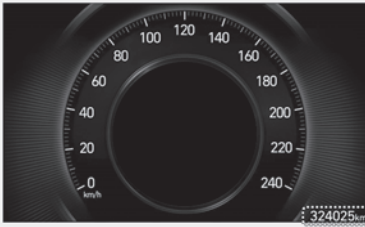

OSU2I049016

■ Type C



OTM040019

i Information

It is forbidden to alter the odometer of all vehicles with the intent to change the mileage registered on the odometer. The alteration may void your warranty coverage.

The odometer indicates the total distance that the vehicle has been driven and should be used to determine when periodic maintenance should be performed.

Outside Temperature Gauge (if equipped)

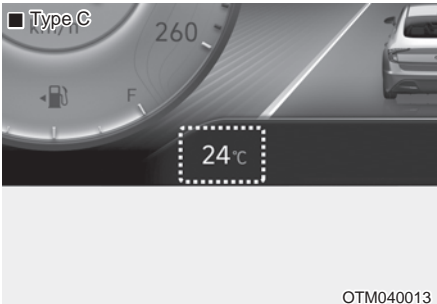
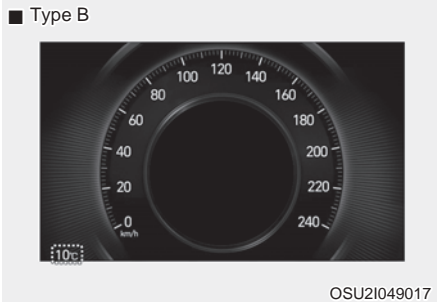
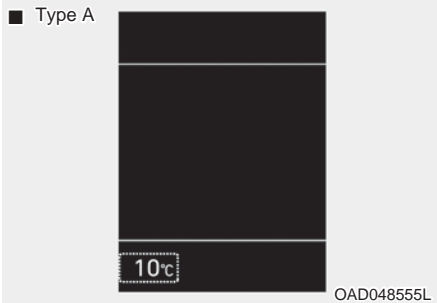

This gauge indicates the current outside air temperatures by 1°C (1°F).

- Temperature range : - 40°C ~ 85°C
(-40°F ~ 211°F)

The outside temperature on the display may not change immediately like a general thermometer to prevent the driver from being inattentive.

The temperature unit (from °C to °F or from °F to °C) can be changed as below procedures (if equipped).

- User Settings Mode in the Cluster :
You can change the temperature unit in the “Other Features - Temperature unit”.

Icy road warning light (if equipped)

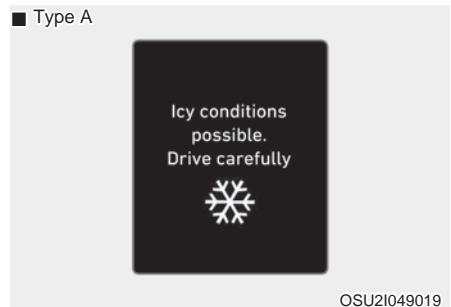

This warning light is to warn the driver the road may be icy.

When the temperature on the outside temperature gauge is approximately below 4°C (40°F), the Icy Road Warning Light and Outside Temperature Gauge blinks 10 times, and then illuminates. Also, the warning chime sounds 3 times.

i Information

If the icy road warning light appears while driving, you should drive more attentively and safely refraining from over-speeding, rapid acceleration, sudden braking or sharp turning, etc.

Transmission shift indicator

Manual transmission shift indicator/Intelligent transmission shift indicator (if equipped)

■ Type A



OAD04857N

■ Type B



OSU2I049020

■ Type C

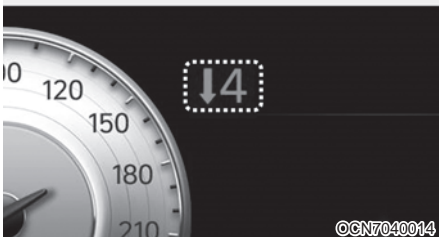

CCN7040014

This indicator informs which gear is desired while driving to save fuel.

- Shifting up : ▲2, ▲3, ▲4, ▲5, ▲6
- Shifting down : ▼1, ▼2, ▼3, ▼4, ▼5

For example

- ▲3 : Indicates that shifting up to the 3rd gear is desired (currently the shift lever is in the 2nd or 1st gear).
- ▼3 : Indicates that shifting down to the 3rd gear is desired (currently the shift lever is in the 4th, 5th, or 6th gear).

When the system is not working properly, the indicator is not displayed.

Automatic Transmission shift indicator

■ Type A

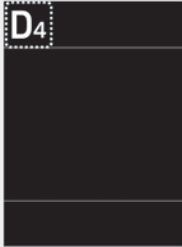

OSU21049024

■ Type B



OSU21049022

■ Type C



CGN7040013

This indicator displays which shift lever is selected.

- Park : P
- Reverse : R
- Neutral : N
- Drive : D
- Sports Mode : 1, 2, 3, 4, 5, 6

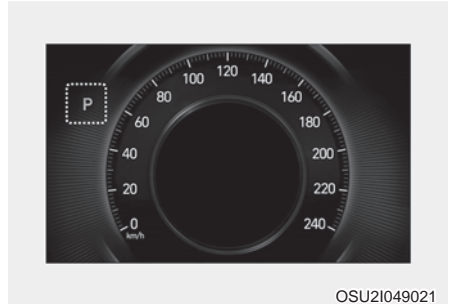

OSU21049021

Shift indicator pop-up (if equipped)

The pop-up displays the current gear position selected for 2 seconds (P/R/N/D).

The shift indicator pop-up function can be activated or deactivated from the User Settings mode in the cluster LCD display.

Warning and indicator lights

i Information - Warning light

Make sure that all warning lights are OFF after starting the engine. If any light is still ON, this indicates a situation that needs attention.

Air bag Warning Light



This warning light illuminates:

- Once you set the ignition switch or Engine Start/Stop button to the ON position.
 - It illuminates for approximately 6 seconds and then goes off.
- When there is a malfunction with the SRS.

In this case, we recommend that you have the vehicle inspected by an authorized HYUNDAI dealer.

Seat Belt Warning Light



This warning light informs the driver (or front passenger) that the seat belt is not fastened.

For more details, refer to the “Seat Belts” in chapter 3.

Parking Brake & Brake Fluid Warning Light



This warning light illuminates:

- Once you set the ignition switch or Engine Start/Stop button to the ON position.
 - It illuminates for approximately 3 seconds
 - It remains on if the parking brake is applied.
- When the parking brake is applied.
- When the brake fluid level in the reservoir is low.
 - If the warning light illuminates with the parking brake released, it indicates the brake fluid level is low.

If the brake fluid level in the reservoir is low:

1. Drive carefully to the nearest safe location and stop your vehicle.
2. With the engine stopped, check the brake fluid level immediately and add fluid as required (For more details, refer to “Brake Fluid” in chapter 8). Then check all brake components for fluid leaks. If any leak on brake system is still found, the warning light remains on, or the brakes do not operate properly, do not drive the vehicle.

In this case, we recommend that you have the vehicle towed to an authorized HYUNDAI dealer and inspected.

Dual-diagonal braking system

Your vehicle is equipped with dual-diagonal braking systems. This means you still have braking on two wheels even if one of the dual systems should fail.

With only one of the dual systems working, more than normal pedal travel and greater pedal pressure are required to stop the vehicle.

Also, the vehicle will not stop in as short a distance with only a portion of the brake system working.

If the brakes fail while you are driving, shift to a lower gear for additional engine braking and stop the vehicle as soon as it is safe to do so.



WARNING

Parking Brake & Brake Fluid Warning Light

Driving the vehicle with a warning light ON is dangerous. If the Parking Brake & Brake Fluid Warning Light illuminates with the parking brake released, it indicates that the brake fluid level is low.

In this case, we recommend that you have the vehicle inspected by an authorized HYUNDAI dealer.

Anti-lock Brake System (ABS) Warning Light



This warning light illuminates:

- Once you set the ignition switch or Engine Start/Stop button to the ON position.
 - It illuminates for approximately 3 seconds and then goes off.
- When there is a malfunction with the ABS (The normal braking system will still be operational without the assistance of the anti-lock brake system).

In this case, we recommend that you have the vehicle inspected by an authorized HYUNDAI dealer.

Electronic Brake Force Distribution (EBD) System Warning Light



These two warning lights illuminate at the same time while driving:

- When the ABS and regular brake system may not work normally.
 - In this case, we recommend that you have the vehicle inspected by an authorized HYUNDAI dealer.



WARNING

Electronic Brake Force Distribution (EBD) System Warning Light

When both ABS and Parking Brake & Brake Fluid Warning Lights are on, the brake system will not work normally and you may experience an unexpected and dangerous situation during sudden braking.

In this case, avoid high speed driving and abrupt braking.

We recommend you have the vehicle inspected by an authorized HYUNDAI dealer as soon as possible.



Information

- Electronic Brake Force Distribution (EBD) System Warning Light

When the ABS Warning Light is on or both ABS and Parking Brake & Brake Fluid Warning Lights are on, the speedometer, odometer, or tripmeter may not work. Also, the EPS Warning Light may illuminate and the steering effort may increase or decrease.

In this case, we recommend you have the vehicle inspected by an authorized HYUNDAI dealer as soon as possible.

Electronic Parking Brake (EPB) Warning Light (if equipped)

EPB

This warning light illuminates:

- When you set the ignition switch or the Engine Start/Stop button to the ON position.
 - It illuminates for approximately 3 seconds and then goes off.
- When there is a malfunction with the EPB.

In this case, we recommend that you have the vehicle inspected by an authorized HYUNDAI dealer.



Information

The Electronic Parking Brake (EPB) Warning Light may illuminate when the Electronic Stability control (ESC) Indicator Light comes on to indicate that the ESC is not working properly (This does not indicate malfunction of the EPB).

AUTO HOLD Indicator Light (if equipped)**AUTO HOLD****This indicator light illuminates:**

- [White] When you activate the auto hold system by pressing the AUTO HOLD button.
- [Green] When you stop the vehicle completely by depressing the brake pedal with the auto hold system activated.
- [Yellow] When there is a malfunction with the auto hold system.

In this case, we recommend that you have the vehicle inspected by an authorized HYUNDAI dealer.

For more details, refer to “Auto Hold” in chapter 6.

Electronic Stability Control (ESC) Indicator Light (if equipped)**This indicator light illuminates:**

- When you set the ignition switch to the ON position.
 - It illuminates for approximately 3 seconds and then goes off.
- When there is a malfunction with the ESC system.

In this case, we recommend that you have the vehicle inspected by an authorized HYUNDAI dealer.

This indicator light blinks:

- While the ESC is operating.

For more details, refer to “Electronic Stability Control (ESC)” in chapter 6.

Electronic Stability Control (ESC) OFF Indicator Light (if equipped)**This indicator light illuminates:**

- When you set the ignition switch to the ON position.
 - It illuminates for approximately 3 seconds and then goes off.
- When you deactivate the ESC system by pressing the ESC OFF button.

For more details, refer to “Electronic Stability Control (ESC)” in chapter 7.

Electric Power Steering (EPS) Warning Light



This warning light illuminates:

- Once you set the ignition switch or Engine Start/Stop button to the ON position.
 - It illuminates for approximately 3 seconds and then goes off.
- When there is a malfunction with the EPS.

In this case, we recommend that you have the vehicle inspected by an authorized HYUNDAI dealer.

Malfunction Indicator Lamp (MIL)



This warning light illuminates:

- Once you set the ignition switch or Engine Start/Stop button to the ON position.
 - It illuminates for approximately 3 seconds and then goes off.
- When there is a malfunction with the emission control system.

In this case, we recommend that you have the vehicle inspected by an authorized HYUNDAI dealer.

NOTICE

- Malfunction Indicator Lamp (MIL)

Driving with the Malfunction Indicator Lamp (MIL) on may cause damage to the emission control systems which could effect drivability and/or fuel economy.

NOTICE

- Gasoline Engine

If the Malfunction Indicator Lamp (MIL) illuminates, potential catalytic converter damage is possible which could result in loss of engine power.

In this case, we recommend that you have the vehicle inspected by an authorized HYUNDAI dealer as soon as possible.

NOTICE

- Diesel Engine

If the Malfunction Indicator Lamp (MIL) blinks, some error related to the injection quantity adjustment occurs which could result in loss of engine power, combustion noise and poor emission.

In this case, we recommend that you have the engine control system inspected by an authorized HYUNDAI dealer.

Charging System Warning Light



This warning light illuminates:

- Once you set the ignition switch or Engine Start/Stop button to the ON position.
 - It remains on until the engine is started.
- When there is a malfunction with either the alternator or electrical charging system.

If there is a malfunction with either the alternator or electrical charging system:

1. Drive carefully to the nearest safe location and stop your vehicle.
2. Turn the engine off and check the alternator drive belt for looseness or breakage.

If the belt is adjusted properly, there may be a problem in the electrical charging system.

In this case, we recommend that you have the vehicle inspected by an authorized HYUNDAI dealer as soon as possible.

Engine Oil Pressure Warning Light



This warning light illuminates:

- Once you set the ignition switch or Engine Start/Stop button to the ON position.
 - It remains on until the engine is started.
- When the engine oil pressure is low.

If the engine oil pressure is low:

1. Drive carefully to the nearest safe location and stop your vehicle.
2. Turn the engine off and check the engine oil level (For more details, refer to “Engine Oil” in chapter 8). If the level is low, add oil as required.

If the warning light remains on after adding oil or if oil is not available, we recommend that you have the vehicle inspected by an authorized HYUNDAI dealer as soon as possible.

NOTICE

- Engine Oil Pressure Warning Light

- If the engine does not stop immediately after the Engine Oil Pressure Warning Light is illuminated, severe damage could result.
- If the warning light stays on while the engine is running, it indicates that there may be serious engine damage or malfunction. In this case,
 1. Stop the vehicle as soon as it is safe to do so.
 2. Turn off the engine and check the oil level. If the oil level is low, fill the engine oil to the proper level.
 3. Start the engine again. If the warning light stays on after the engine is started, turn the engine off immediately. In this case, we recommend that you have the vehicle inspected by an authorized HYUNDAI dealer.

Low Fuel Level Warning Light



This warning light illuminates:

When the fuel tank is nearly empty.

If the fuel tank is nearly empty, add fuel as soon as possible.

NOTICE

- Low Fuel Level

Driving with the Low Fuel Level warning light on or with the fuel level below “E (Empty)” can cause the engine to misfire and damage the catalytic converter (if equipped).

Master Warning Light**This warning light illuminates:**

- When there is a malfunction in operation in any of the following systems:
 - Lamp malfunction (if equipped)
 - Tire Pressure Monitoring System (TPMS) malfunction (if equipped)

To identify the details of the warning, look at the LCD display.

Low Tire Pressure Warning Light (if equipped)**This warning light illuminates:**

- Once you turn the ignition switch or Engine Start/Stop button to the ON position.
 - It illuminates for approximately 3 seconds and then goes off.
- When one or more of your tires are significantly underinflated.

For more details, refer to “Tire Pressure Monitoring System (TPMS)” in chapter 7.

This warning light remains on after blinking for approximately 60 seconds or repeatedly blinks on and off at approximately 3 second intervals:

- When there is a malfunction with the TPMS.

In this case, we recommend that you have the vehicle inspected by an authorized HYUNDAI dealer as soon as possible.

For more details, refer to “Tire Pressure Monitoring System (TPMS)” in chapter 7.

**WARNING****Safe Stopping**

- The TPMS cannot alert you to severe and sudden tire damage caused by external factors.
- If you notice any vehicle instability, immediately take your foot off the accelerator pedal, apply the brakes gradually with light force, and slowly move to a safe position off the road.

Fuel Filter Warning Light (for diesel engine)



This warning light illuminates:

- When water has accumulated inside the fuel filter.

In this case, remove the water from the fuel filter.

For more details, refer to “Fuel Filter” in chapter 8.

NOTICE

- **When the Fuel Filter Warning Light illuminates, engine power (vehicle speed & idle speed) may decrease.**
- **If you keep driving with the warning light on, engine parts (injector, common rail, high pressure fuel pump) may be damaged. If this occurs, we recommend that you have the vehicle inspected by an authorized HYUNDAI dealer as soon as possible.**

Exhaust System (DPF or LNT) Warning Light (for diesel engine, if equipped)



This warning light illuminates:

- When there is a malfunction with the DPF or LNT system.

When this warning light illuminates, it may turn off after driving the vehicle:

- at more than 60 km/h (37 mph), or
- above 2nd gear with 1500 ~ 2500 engine rpm for a certain time (for about 25 minutes).

If this warning light illuminates in spite of the procedure, we recommend that you have the DPF system checked by an authorized HYUNDAI dealer.

- When the exhaust gas captures exhaust gases over certain amount or the LNT performance is degraded.
 - In this case, the warning light illuminates and the warning alarm sounds while displaying the warning message “Self Regeneration” on the LCD display.

For more details, refer to “Self Regeneration Mode” in chapter 8.

NOTICE

If you continue to drive with the DPF warning light blinking for a long time, the DPF system can be damaged and fuel consumption can worsen.

Glow Indicator Light (for diesel engine)



This indicator light illuminates:

- When the engine is being preheated with the ignition switch or Engine Start/Stop button in the ON position.
 - The engine can be started after the glow indicator light goes off.
 - The illumination time varies depending on the with the engine coolant temperature, air temperature, and battery condition.

If the indicator light remains on or blinks after the engine has warmed up or while driving, there may be a malfunction with the engine preheating system.

In this case, we recommend that you have the vehicle inspected by an authorized HYUNDAI dealer.

***i* Information**

If the engine does not start within 10 seconds after the preheating is completed, set the ignition switch or Engine Start/Stop Button to the LOCK or OFF position for 10 seconds and then to the ON position in order to preheat the engine again.

Immobilizer Indicator Light (without smart key)



This indicator light illuminates:

When the vehicle detects the immobilizer in your key properly while the ignition switch is ON.

- At this time, you can start the engine.
- The indicator light goes off after starting the engine.

This indicator light blinks:

When there is a malfunction with the immobilizer system.

In this case, we recommend that you have the vehicle inspected by an authorized HYUNDAI dealer.

Immobilizer Indicator Light (with smart key)



This indicator light illuminates for up to 30 seconds:

When the vehicle detects the smart key in the vehicle properly while the Engine Start/Stop button is ACC or ON.

- At this time, you can start the engine.
- The indicator light goes off after starting the engine.

This indicator light blinks for a few seconds:

When the smart key is not in the vehicle.

- At this time, you can not start the engine.

This indicator light illuminates for 2 seconds and goes off:

When the vehicle can not detect the smart key which is in the vehicle while the Engine Start/Stop button is ON.

In this case, we recommend that you have the vehicle inspected by an authorized HYUNDAI dealer.

This indicator light blinks:

- When the battery of the smart key is weak.
 - At this time, you can not start the engine. However, you can start the engine if you press the Engine Start/Stop button with the smart key. (For more details, refer to “Starting the Engine” in chapter 6).
- When there is a malfunction with the immobilizer system.

In this case, we recommend that you have the vehicle inspected by an authorized HYUNDAI dealer.

Turn Signal Indicator Light

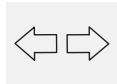

This indicator light blinks:

When you turn the turn signal light on.

If any of the following occurs, there may be a malfunction with the turn signal system. In this case, we recommend that you have the vehicle inspected by an authorized HYUNDAI dealer.

- The indicator light does not blink but illuminates.
- The indicator light blinks more rapidly.
- The indicator light does not illuminate at all.

LED Headlamp Warning Light (if equipped)



This warning light illuminates:

- When you set the ignition switch or the Engine Start/Stop button to the ON position.
- When there is a malfunction with the LED headlamp.

In this case, we recommend that you have the vehicle inspected by an authorized HYUNDAI dealer.

This warning light blinks:

- When there is a malfunction with a LED headlamp related part.

In this case, we recommend that you have the vehicle inspected by an authorized HYUNDAI dealer.

NOTICE

Continuous driving with the LED Headlamp Warning Light on or blinking can reduce LED headlamp life.

Low Beam Indicator Light



This indicator light illuminates:

- When the headlamps are on.

High Beam Indicator Light



This indicator light illuminates:

- When the headlights are on and in the high beam position
- When the turn signal lever is pulled into the Flash-to-Pass position.

Light ON Indicator Light



This indicator light illuminates:

- When the tail lights or headlamps are on.

Front Fog Indicator Light (if equipped)



This indicator light illuminates:

When the front fog lights are on.

Cruise Indicator Light (if equipped)



This indicator light illuminates:

- When the cruise control system is enabled.

For more details, refer to “Cruise Control System” in chapter 6.

COMFORT Mode Indicator Light



This indicator light illuminates:

- When you select “COMFORT” mode as drive mode.

For more details, refer to “Drive Mode Integrated Control System” in chapter 6.

ECO Mode Indicator Light



This indicator light illuminates:

- When you select “ECO” mode as drive mode.

For more details, refer to “Drive Mode Integrated Control System” in chapter 6.

SPORT Mode Indicator Light



This indicator light illuminates:

- When you select “SPORT” mode as drive mode.

For more details, refer to “Drive Mode Integrated Control System” in chapter 6.

LCD display messages

Key not in vehicle (for smart key system)

This warning message is displayed if the smart key is not in the vehicle when you open or close door in the ACC position or ON position. The warning sound is heard when you close door without a smart key in vehicle.

When attempting to start the vehicle always have the smart key with you.

Key not detected (for smart key system)

This warning message is displayed if the smart key is not detected when you press the Engine Start/Stop button.

Press START button with key (for smart key system)

This warning message is displayed if you press the Engine Start/Stop button while the warning message “Key not detected” is displayed.

At this time, the immobilizer indicator light blinks.

Low Key Battery (for smart key system)

This warning message is displayed if the battery of the smart key is discharged while changing the Engine Start/Stop button to the OFF position.

Press clutch pedal to start engine (for smart key system and Manual Transmission)

This warning message is displayed if the Engine Start/Stop button is in the ACC position twice by pressing the button repeatedly without depressing the clutch pedal.

Depress the clutch pedal to start the engine.

Press brake pedal to start engine (for smart key system and Automatic Transmission)

This warning message is displayed if the Engine Start/Stop button changes to the ACC position twice by pressing the button repeatedly without depressing the brake pedal.

You can start the vehicle by depressing the brake pedal.

Press START button again (for smart key system)

This message is displayed if you were unable to start the vehicle when the Engine Start/Stop button was pressed.

If this occurs, attempt to start the engine by pressing the Engine Start/Stop button again.

If the warning message appears each time you press the Engine Start/Stop button, we recommend that you have your vehicle inspected by an authorized HYUNDAI dealer.

Shift to P or N to start engine (for smart key system and Auto- matic Transmission)

This warning message is displayed if you try to start the engine with the shift lever not in the P (Park) or N (Neutral) position.

***i* Information**

You can start the engine with the shift lever in the N (Neutral) position. But, for your safety, we recommend that you start the engine with the shift lever in the P (Park) position.

Check BRAKE SWITCH fuse (for smart key system and Automatic Transmission)

This warning message is displayed if the brake switch fuse is disconnected.

You need to replace the fuse with a new one. If that is not possible, you can start the engine by pressing the Engine Start/Stop button for 10 seconds in the ACC position.

Door, Tailgate open indicator

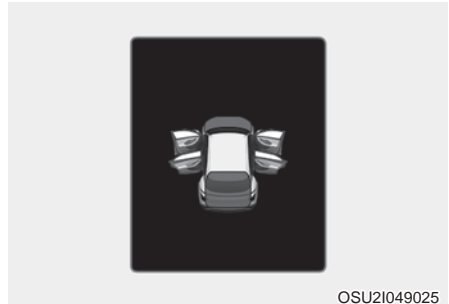

This warning is displayed indicating which door or tailgate is open.

***!* CAUTION**

Before driving the vehicle, you should confirm that the door/tailgate is fully closed. Also, check there is no door/tailgate open warning light or message displayed on the instrument cluster.

**Sunroof open indicator
(if equipped)**



This warning is displayed if you turn off the engine when the sunroof is open.

Close the sunroof securely when leaving your vehicle.

Turn on FUSE SWITCH

This warning message is displayed if the fuse switch located on the fuse box under the steering wheel is OFF.

You should turn the fuse switch on.

For more details, refer to “Fuses” in chapter 8.

Lights mode

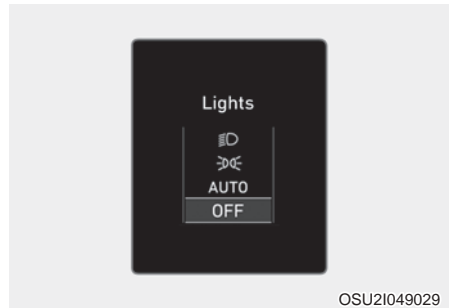

This indicator displays which exterior light is selected using the lighting control.

Wiper mode

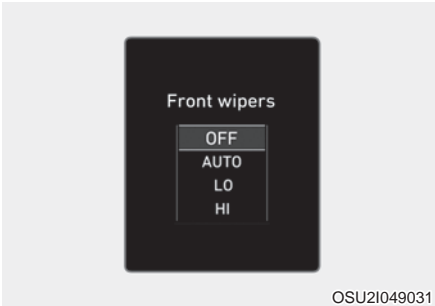

This indicator displays which wiper speed is selected using the wiper control.

Low pressure (if equipped)



This warning message is displayed if the tire pressure is low. The corresponding tire on the vehicle will be illuminated.

For more details, refer to “Tire Pressure Monitoring System (TPMS)” in chapter 7.

Low washer fluid

This warning message is displayed if the washer fluid level in the reservoir is nearly empty.

Have the washer fluid reservoir re-filled.

Low fuel

This warning message is displayed if the fuel tank is almost out of fuel.

When this message is displayed, the low fuel level warning light in the cluster will come on.

It is recommended to look for the nearest fueling station and refuel as soon as possible.

Engine has overheated (if equipped)

This warning message is displayed when the engine coolant temperature is above 120°C (248°F). This means that the engine is overheated and may be damaged.

If your vehicle is overheated, refer to “Overheating” in chapter 7.

Diesel filter regeneration required. See owner’s manual (if equipped)

- The DPF warning light illuminates if the exhaust gas captures exhaust gases over certain amount, sulfur in fuel or the engine oil is accumulated over certain amount in the LNT or the exhaust gas is accumulated over certain amount.
- In this case, the warning light illuminates and the warning alarm sounds while showing a warning message “Self Regeneration” on the LCD display.
- After the warning message appears for 10 seconds, it is stored in inspection message tap.

For more details, refer to “Self Regeneration Mode” in chapter 8.

Check headlight (if equipped)

This warning message is displayed if the headlamps are not operating properly.

In addition, if a specific lamp (turn signal lamp etc.) is not operating properly, the warning message according to a specific lamp (turn signal lamp etc.) is displayed. A corresponding bulb may need to be replaced.

Make sure to replace the burned out bulb with a new one of the same wattage rating.

***Check turn indicator
(if equipped)***

This warning message is displayed if the turn signal lamps are not operating properly. A lamp may need to be replaced.

Make sure to replace the burned out bulb with a new one of the same wattage rating.

Check brake light (if equipped)

This warning message is displayed if the stop lamps are not operating properly. A lamp may need to be replaced.

Make sure to replace the burned out bulb with a new one of the same wattage rating.

***Check daytime running light
(if equipped)***

This warning message is displayed if the daytime running lights are not operating properly. A lamp may need to be replaced.

Make sure to replace the burned out bulb with a new one of the same wattage rating.

***Check headlight LED
(if equipped)***

This warning message is displayed if there is a problem with the LED headlight. Have the vehicle inspected by an authorized HYUNDAI dealer.

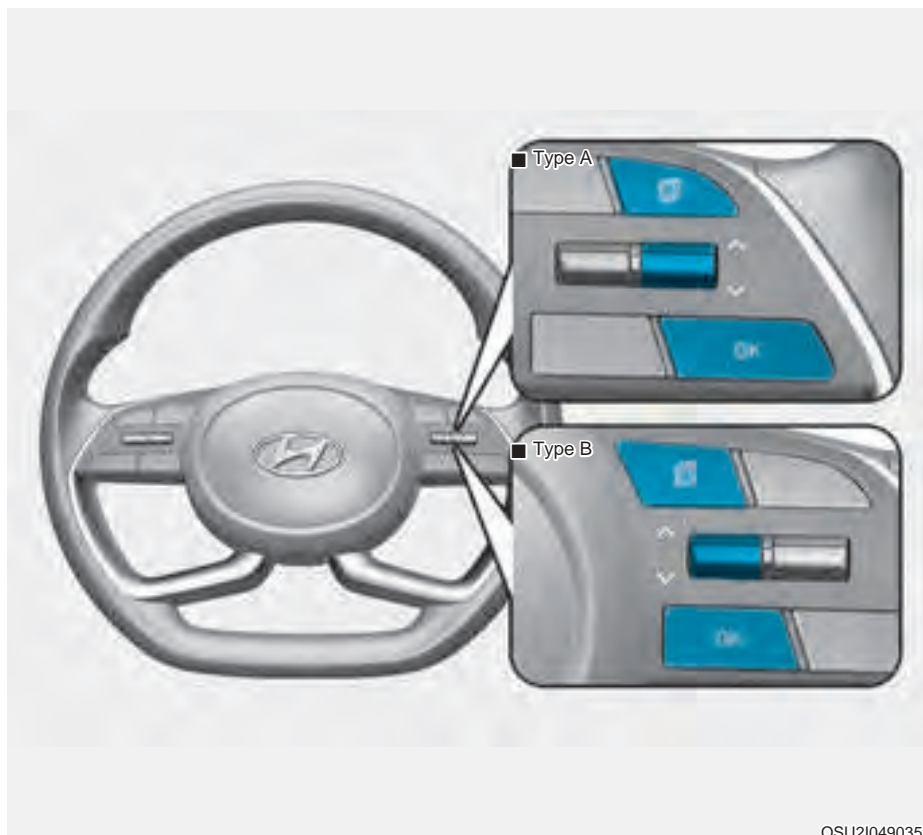

LCD DISPLAY

LCD display control









OSU21049035

The LCD display modes can be changed by using the control buttons.

- (1)  : MODE button for changing modes
- (2)  ,  : MOVE switch for changing items
- (3) OK : SELECT/RESET button for setting or resetting the selected item

LCD display modes

		Menu				
						
		Trip Computer	TBT	Driving Assist	User Settings	Master warning
  Up/Down	Fuel Economy	Route Guidance	Cruise Control	Lights	The Master Warning mode displays warning messages related to the vehicle when one or more systems is not operating normally.	
	Accumulated Info	Destination Info	TPMS	Door		
	Drive Info			Sound		
	Digital Speedometer			Convenience		
	Transmission Temperature			Service interval		
				Other features		
				Language		
				Reset		

The information provided may differ depending on which functions are applicable to your vehicle.

Trip computer mode

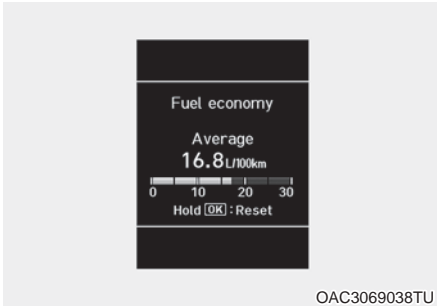

The trip computer mode displays information related to vehicle driving parameters including fuel economy, tripmeter information and vehicle speed.

For more details, refer to “Trip Computer” in this chapter.

Turn By Turn (TBT) mode



This mode displays the state of the navigation.

Driving Assist mode

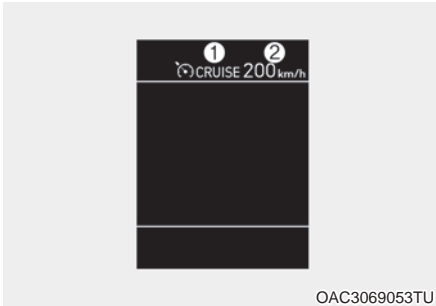

CC

This mode displays the state of Cruise Control (CC).

For more details, refer to “Cruise Control” in chapter 6.



Tire Pressure

This mode displays information related to Tire Pressure.

For more details, refer to “Tire Pressure Monitoring System (TPMS)” in chapter 7.



Master warning mode



This warning light informs the driver the following situations.

- Lamp malfunction (if equipped)
- Tire Pressure Monitoring System (TPMS) malfunction (if equipped)

The Master Warning Light illuminates if one or more of the above warning situations occur.

At this time, a Master Warning icon () will appear beside the User Settings icon (), on the LCD display.

If the warning situation is solved, the master warning light will be turned off and the Master Warning icon will disappear.

User settings mode

In this mode, you can change the settings of the instrument cluster, doors, lamps, etc.

1. Lights
2. Door
3. Sound
4. Convenience
5. Service interval
6. Other features
7. Language
8. Reset

The information provided may differ depending on which functions are applicable to your vehicle.

Shift to P to edit settings

This warning message illuminates if you try to select an item from the User Settings mode while driving.

For your safety, change the User Settings after parking the vehicle, applying the parking brake and pressing the P (Park) button.

Quick guide (Help)

This mode provides quick guides for the systems in the User Settings mode.

Select an item, press and hold the OK button.

For more details about each system, refer to this Owner's Manual.

**Information**

When the infotainment system is applied, only the User's Setting mode on the infotainment system is supported but the User's Setting mode on the instrument cluster is not supported.

1. Lights

Items	Explanation
Illumination	To adjust the brightness of the instrument panel illumination.
One Touch Turn Signal	<ul style="list-style-type: none"> • Off: The one touch turn signal function will be deactivated. • 3, 5, 7 Flashes: The turn signal indicator will blink 3, 5, or 7 times when the turn signal lever is moved slightly. For more details, refer to “Lighting” in chapter 5.
Ambient light brightness	<ul style="list-style-type: none"> • Off/Level 1/Level 2/Level 3/Level 4 To adjust the brightness of the Ambient Light (cabin mood light setting).
Ambient lighting	To activate or deactivate the Ambient Light (cabin mood light setting) function.
Headlight Delay	<ul style="list-style-type: none"> • To activate or deactivate the headlamp delay function. For more details, refer to “Lighting” in chapter 5.

2. Door

Items	Explanation
Auto lock	<ul style="list-style-type: none"> • Off : The auto door lock operation will be deactivated. • Enable on Speed: All doors will be automatically locked when the vehicle speed exceeds 15km/h (9.3mph). • Enable on Shift: All doors will be automatically locked if the Automatic Transmission/Intelligent Variable Transmission/Dual Clutch Transmission shift lever is pressed from the P (Park) position to the R (Reverse), N (Neutral), or D (Drive) position. (Only when the engine is running.)
Auto unlock	<ul style="list-style-type: none"> • Off : The auto door unlock operation will be canceled. • On key out/Vehicle Off : All doors will be automatically unlocked when the ignition key is removed from the ignition switch or the Engine Start/Stop button is set to the OFF position. • On Shift to P: All doors will be automatically unlocked if the Automatic Transmission/Intelligent Variable Transmission/Dual Clutch Transmission shift lever is pressed to P (Park) position. (Only when the engine is running.)
Lock/Unlock sound	To activate or deactivate the Lock/Unlock sound function.

3. Sound

Items	Explanation
Volume for PDW (Parking Distance Warning)	<ul style="list-style-type: none"> • Louder/Softer To adjust the Parking Distance Warning system volume.

4. Convenience

Items	Explanation
Welcome mirror/light	<ul style="list-style-type: none"> • On door unlock: The outside rearview mirrors are unfolded and the welcome light turns on automatically when the doors are unlocked. • On driver approach: The outside rearview mirrors are unfolded and the welcome light turns on automatically when the vehicle is approached with the smart key. For more details, refer to “Welcome System” in chapter 5.
Auto mirror folding	To activate or deactivate the Auto mirror folding mode.
Wireless charging system	To activate or deactivate the wireless charging system in the front seat. For more details, refer to “Wireless cellular phone charging system” in chapter 5.
Wiper/Lights display	To activate or deactivate the Wiper/ Light mode. When activated, the LCD display shows the selected Wiper/Light mode whenever you changed the mode.
Auto rear wiper (reverse)	To activate or deactivate the rear wiper while the vehicle is in reverse with the front wiper ON.
Gear position pop-up	To activate or deactivate the gear position pop-up. When activated, the gear position will be displayed on the LCD display.
Icy road warning	To activate or deactivate the Icy road warning.

5. Service interval

Items	Explanation
Enable service interval	To activate or deactivate the service interval function.
Adjust interval	If the service interval menu is activated, you may adjust the time and distance.

Information

To use the service interval menu, consult an authorized HYUNDAI dealer.

If the service interval is activated and the time and distance is adjusted, messages are displayed in the following situations each time the vehicle is turned on.

- Service in
: Displayed to inform the driver the remaining mileage and days to service.
- Service required
: Displayed when the mileage and days to service has been reached or passed.

Information

If any of the following conditions occur, the mileage and number of days to service may be incorrect.

- **The battery cable is disconnected.**
- **The fuse switch is turned off.**
- **The battery is discharged.**

6. Other features

Items	Explanation
Fuel economy auto reset	<ul style="list-style-type: none"> • Off: The average fuel economy will not reset automatically whenever refueling. • After vehicle On: When the engine has been OFF for 4 hours or longer the average fuel economy will reset automatically. • After refueling: The average fuel economy will reset automatically after adding 6 liters (1.6 gallons) of fuel or more and after driving speed exceeds 1 km/h (1 mph). <p>For more details, refer to “Trip Computer” in this chapter.</p>
Fuel economy unit	To select the fuel economy unit. (km/L, L/100km Or US gallon, UK gallon)
Temperature unit	To select the temperature unit. (°C, °F)
Tyre pressure unit	To select the tire pressure unit. (psi, kPa, bar)

7. Language (if equipped)

Items	Explanation
Language	Choose the language. You can choose the language in infotainment system.

8. Reset

Items	Explanation
Reset	You can reset the menus in the User Settings Mode. All menus in the User Settings Mode are reset to factory settings, except language and service interval.

Trip computer

The trip computer is a microcomputer-controlled driver information system that displays information related to driving.

i Information

Some driving information stored in the trip computer (for example Average Vehicle Speed) resets if the battery is disconnected.

Trip modes

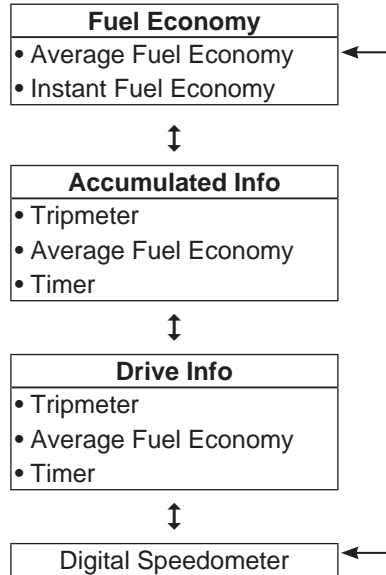

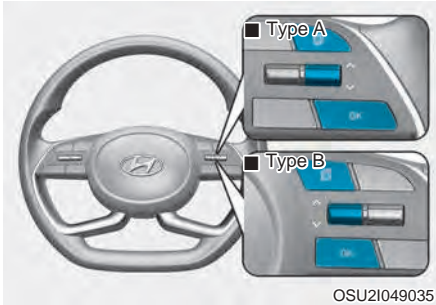

To change the trip mode, toggle the “^, v” switch on the steering wheel.

Fuel economy

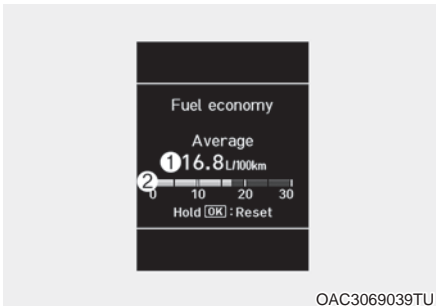

Average Fuel Economy (1)

- The average fuel economy is calculated by the total driving distance and fuel consumption since the last average fuel economy reset.
- The average fuel economy can be reset both manually and automatically.

Manual reset

To clear the average fuel economy manually, press the [OK] button on the steering wheel for more than 1 second when the average fuel economy is displayed.

Automatic reset

To automatically reset the average fuel economy after refueling, select the “Fuel Econ. Reset” mode in the User Settings menu on the LCD display.

- After ignition: The average fuel economy will reset automatically whenever it has passed 4 hours after turning OFF the engine.
- After refueling: The average fuel economy will reset automatically when driving speed exceeds 1 km/h, after adding 6 liters (1.6 gallons) of fuel or more.

i Information

The average fuel economy may be inaccurate, when the vehicle drives shorter than 300 meters (0.19 miles) after turning ON the Engine Start/Stop button.

Instant Fuel Economy (2)

- This mode displays the instant fuel economy during the last few seconds when the vehicle speed is more than 10 km/h (6.2 mph).

Accumulated Info display

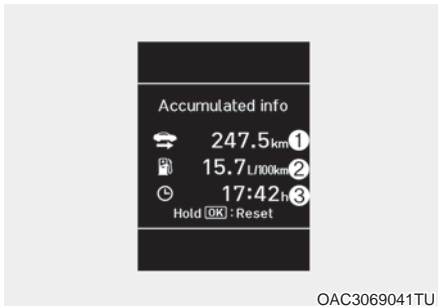

This display shows the accumulated trip distance (1), the average fuel economy (2), and the total driving time (3).

The information is accumulated starting from the last reset.

To manually reset the information, press and hold the OK button when viewing the Accumulated driving info. The trip distance, the average fuel economy, and total driving time will reset simultaneously.

The accumulated driving information will continue to be counted while the engine is still running (for example, when the vehicle is in traffic or stopped at a stop light).

i Information

The vehicle must be driven for a minimum of 300 meters (0.19 miles) since the last ignition key cycle before the average fuel economy will be recalculated.

Drive Info display

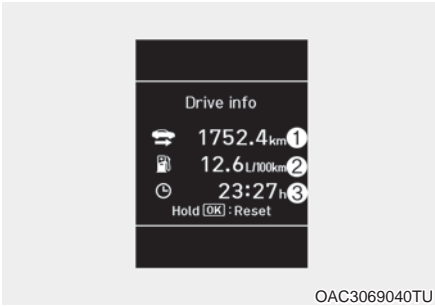

This display shows the trip distance (1), the average fuel economy (2), and the total driving time (3).

The information is combined for each ignition cycle. However, when the engine has been OFF for 4 hours or longer the Drive Info screen will reset.

To manually reset the information, press and hold the OK button when viewing the Drive Info. The trip distance, the average fuel economy, and total driving time will reset simultaneously.

The driving information will continue to be counted while the engine is still running (for example, when the vehicle is in traffic or stopped at a stop light.)

i Information

The vehicle must be driven for a minimum of 300 meters (0.19 miles) since the last ignition key cycle before the average fuel economy will be recalculated.

Digital speedometer



This message shows the speed of the vehicle (km/h, MPH).

6. Convenience features

Accessing your vehicle	6-4
Remote key	6-4
Remote key precautions	6-6
Smart key	6-7
Smart key precautions	6-11
Immobilizer system	6-13
MT(Manual Transmission) Remote start function.....	6-14
Door lock/unlock sound	6-15
Door locks	6-16
Operating door locks from outside the vehicle	6-16
Operating door locks from inside the vehicle	6-18
Auto door lock/unlock features.....	6-20
Child-protector rear door locks.....	6-20
Theft-alarm system.....	6-21
Steering Wheel.....	6-22
Electric power steering (EPS)	6-22
Tilt steering / Telescopic steering	6-23
Horn.....	6-23
Mirrors	6-24
Inside rearview mirror	6-24
Outside rearview mirror	6-25
Windows	6-28
Power windows	6-28
Panorama sunroof	6-33
Roller blind.....	6-34
Sliding the sunroof	6-34
Tilting the sunroof	6-35
Closing the sunroof	6-35
Resetting the sunroof.....	6-37
Sunroof open warning.....	6-38
Exterior features	6-39
Hood	6-39
Tailgate.....	6-41
Fuel filler door.....	6-43

Light.....	6-46
Exterior lights.....	6-46
Interior lights.....	6-51
Wipers and washers	6-54
Front windshield wipers	6-54
Front windshield washers.....	6-55
Rear window wiper and washer switch	6-56
Driver assistance system.....	6-57
Rear View Monitor (RVM)	6-57
Rear view while driving	6-58
Surround view monitor	6-58
Blind-Spot View Monitor (BVM)	6-60
Forward/Reverse Parking Distance Warning (PDW)	6-61
Operation of Forward/Reverse Parking Distance Warning	6-62
Non-operational conditions of Forward/Reverse Parking Distance Warning.....	6-64
Forward/Reverse Parking Distance Warning precautions	6-65
Reverse Parking Distance Warning (PDW)	6-66
Climate Control System	6-69
Defroster	6-69
Manual climate control system	6-70
Manual climate control system.....	6-70
Automatic climate control system.....	6-79
Windshield defrosting and defogging	6-89
Storage compartment	6-91
Center console storage.....	6-91
Glove box	6-91
Luggage tray	6-92
Cool box	6-92

6. Convenience features

- Interior features 6-93
 - Clock 6-93
 - Ashtray 6-93
 - Cup holder 6-93
 - Sunvisor..... 6-94
 - Power outlet..... 6-95
 - USB charger 6-96
 - Wireless cellular phone charging system 6-97
 - Floor mat anchor(s) 6-99
 - Shopping hook 6-100
 - Side curtain 6-100
- Exterior features 6-101
 - Roof rack 6-101
- Infotainment system 6-102
 - USB port 6-102
 - Antenna 6-102
 - Steering wheel audio control 6-103
 - Audio / Video (AV) 6-104
 - Bluetooth® Wireless Technology hands-free 6-105
 - How vehicle radio works..... 6-106

ACCESSING YOUR VEHICLE

Remote key (if equipped)



Your HYUNDAI uses a remote key, which you can use to lock or unlock a door (and tailgate) and even start the engine.

1. Door Lock
2. Door Unlock
3. Tailgate Unlock

Locking

To lock :

1. Close all doors, engine hood and tailgate.
2. Press the Door Lock button (1) on the remote key.
3. The doors will lock. The hazard warning lights will blink once.
4. Make sure the doors are locked by checking the position of the door lock button inside the vehicle.

WARNING

Do not leave the keys in your vehicle with unsupervised children. Unattended children could place the key in the ignition switch and may operate power windows or other controls, or even make the vehicle move, which could result in serious injury or death.

Unlocking

To unlock:

1. Press the Door Unlock button (2) on the remote key.
2. The doors will unlock. The hazard warning lights will blink two times.

Information

After unlocking the doors, the doors will lock automatically after 30 seconds unless a door is opened.

Tailgate unlocking

To unlock:

1. Press the Tailgate Unlock button (3) on the remote key for more than one second.
2. The hazard warning lights will blink two times. Once the tailgate is opened and then closed, the tailgate will lock automatically.

Information

- **After unlocking the tailgate, the tailgate will lock automatically.**
- **The word “HOLD” is written on the button to inform you that you must press and hold the button for more than one second.**

Start-up

For detailed information refer to “Key Ignition Switch” in chapter 6.

NOTICE

To prevent damaging the remote key:

- **Keep the remote key away from water or any liquid and fire. If the inside of the remote key gets damp (due to drinks or moisture), or is heated, internal circuit may malfunction, excluding the car from the warranty.**
- **Avoid dropping or throwing the remote key.**
- **Protect the remote key from extreme temperatures.**

Mechanical key



If the remote key does not operate normally, you can lock or unlock the door by using the mechanical key.

To unfold the key, press the release button then the key will unfold automatically.

To fold the key, fold the key manually while pressing the release button.

NOTICE

Do not fold the key without pressing the release button. This may damage the key.

Remote key precautions

The remote key will not work if any of the following occur:

- The key is in the ignition switch.
- You exceed the operating distance limit (about 10 m [30 feet]).
- The remote key battery is weak.
- Other vehicles or objects may be blocking the signal.
- The weather is extremely cold.
- The remote key is close to a radio transmitter such as a radio station or an airport which can interfere with normal operation of the remote key.

When the remote key does not work correctly, open and close the door with the mechanical key. If you have a problem with the remote key, it is recommended that you contact an authorized HYUNDAI dealer.

If the remote key is in close proximity to your mobile phone, the signal could be blocked by your mobile phones normal operational signals. This is especially important when the phone is active such as making and receiving calls, text messaging, and/or sending/receiving emails. Avoid placing the remote key and your mobile phone in the same pants or jacket pocket and always try to maintain an adequate distance between the two devices.

Information

Changes or modifications not expressly approved by the party responsible for compliance could void the user's authority to operate the equipment. If the keyless entry system is inoperative due to changes or modifications not expressly approved by the party responsible for compliance, it will not be covered by your manufacturer's vehicle warranty.

NOTICE

Keep the remote key away from electromagnetic materials that blocks electromagnetic waves to the key surface.

Battery replacement

If the remote key is not working properly, try replacing the battery with a new one.



OIB044180

Battery Type: CR2032

To replace the battery:

1. Insert a slim tool into the slot and gently pry open the cover.
2. Remove the old battery and insert the new battery. Make sure the battery position is correct.
3. Reinstall the rear cover of the remote key.

If you suspect your remote key might have sustained some damage, or you feel your remote key is not working correctly, it is recommended that you contact an authorized HYUNDAI dealer.

i Information



An inappropriately disposed battery can be harmful to the environment and human health. Dispose the battery according to your local law(s) and regulation.

Smart key (if equipped)

■ Type A



OIB044179

■ Type B



OTLE048900

Your HYUNDAI uses a Smart Key, which you can use to lock or unlock a door (and tailgate) and even start the engine.

1. Door Lock
2. Door Unlock
3. Tailgate Unlock
4. Remote start (if equipped)

Locking

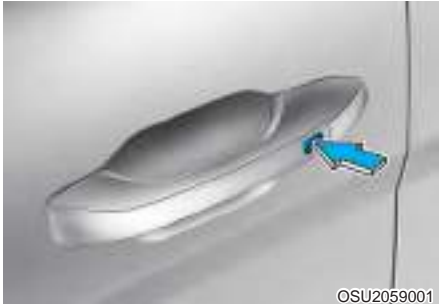

To lock :

1. Close all doors, engine hood and tailgate.
2. Either press the door handle button or press the Door Lock button (1) on the smart key.
3. The hazard warning lights will blink. Also, the outside rearview mirror will fold, if the outside rearview mirror folding switch is in the AUTO position (if equipped).
4. Make sure the doors are locked by checking the position of the door lock button inside the vehicle.

Information

The door handle button will only operate when the smart key is within 0.7~1 m (28~40 in.) from the outside door handle.

Even though you press the outside door handle button, the doors will not lock and the chime will sound for three seconds if any of the following occur:

- The Smart Key is in the vehicle.
- The Engine Start/Stop button is in ACC or ON position.
- Any door except the tailgate is open.

WARNING

Do not leave the Smart Key in your vehicle with unsupervised children. Unattended children could press the Engine Start/Stop button and may operate power windows or other controls, or even make the vehicle move, which could result in serious injury or death.

Unlocking



To unlock:

1. Carry the Smart Key.
2. Either press the door handle button or press the Door Unlock button (2) on the smart key.
3. The doors will unlock. The hazard warning lights will blink two times. Also, the outside rearview mirror will unfold, if the outside rearview mirror folding switch is in the AUTO position (if equipped).

i Information

- The door handle button will only operate when the smart key is within 1 m (40 in.) from the outside door handle. Other people can also open the doors without the smart key in possession.
- After unlocking the doors, the doors will lock automatically after 30 seconds unless a door is opened.

Tailgate unlocking

To unlock:

1. Carry the smart key.
2. Press the Tailgate Unlock button (3) on the smart key for more than one second.
3. The hazard warning lights will blink two times.

i Information

- The Tailgate Unlock button (3) will only unlock the tailgate. It will not release the latch and open the tailgate automatically. If the Tailgate Unlock button is used, someone must still press the tailgate handle button to open the tailgate.
- After unlocking the tailgate, the tailgate will lock automatically after 30 seconds unless the tailgate is opened.

Remote start (4) (if equipped)

You can start the engine and turn on the climate system by pressing the remote start button (3) outside the vehicle.

To start and stop engine remotely:

1. Press the door lock button (1), and then the hazard warning lights blink once to alert you.
2. Press the remote start button (4) for more than 2 seconds to start engine within 4 seconds after pressing the door lock button (1).
3. While remote starting, the hazard warning lights blink. If you want to stop the engine, press the remote start button (4) again.

Start-up

You can start the engine without inserting the key. For detailed information refer to the Engine Start/Stop button in chapter 6.

NOTICE

To prevent damaging the smart key:

- **Keep the smart key away from water or any liquid and fire. If the inside of the smart key gets damp (due to drinks or moisture), or is heated, internal circuit may malfunction, excluding the car from the warranty.**
- **Avoid dropping or throwing the smart key.**
- **Protect the smart key from extreme temperatures.**

NOTICE

Always have the smart key with you when leaving the vehicle. If the smart key is left near the vehicle, the vehicle battery may be discharged.

Mechanical key

If the Smart Key does not operate normally, you can lock or unlock the door by using the mechanical key.



OIB044175

Press and hold the release button (1) and remove the mechanical key (2). Insert the mechanical key into the key hole on the door.

To reinstall the mechanical key, put the key into the hole and push it until a click sound is heard.

Loss of a smart key

A maximum of two smart keys can be registered to a single vehicle. If you happen to lose your smart key, it is recommended that you should immediately take the vehicle and remaining key to your authorized HYUNDAI dealer or tow the vehicle, if necessary.

Smart key precautions

The smart key will not work if any of the following occur:

The smart key may not work if any of the following occur:

- The smart key is close to a radio transmitter such as a radio station, military area, police station, government offices, broadcasting stations, transmission towers, port or an airport which can interfere with normal operation of the transmitter.
- The smart key is near a mobile two way radio system or a mobile phone.
- The smart key is close to a metal product or coins.
- Another vehicle's smart key is being operated close to your vehicle.

In the following situations, the frequency band from the smart key may be mixed with a different frequency, which may cause smart key malfunction (engine operation, door lock function, etc.) or the working distance of smart key may change:

- The smart key is placed near the electronic systems (woofer, mobile phone, portable wired/wireless charger, electric heating device, electronic power bank, e-cigarettes, etc.).
- When you connect an external device to the multi-purpose socket or USB port and place it near the smart key, the smart key may not be recognized/work in some areas of the vehicle. In this case, try moving the smart key to another location to start the engine or press the start button directly with the smart key to start the engine.

When the smart key does not work correctly, open and close the door with the mechanical key. If you have a problem with the smart key, it is recommended that you contact an authorized HYUNDAI dealer.

If the smart key is in close proximity to your mobile phone, the signal could be blocked by your mobile phones normal operational signals. This is especially important when the phone is active such as making and receiving calls, text messaging, and/or sending/receiving emails. Avoid placing the smart key and your mobile phone in the same pants or jacket pocket and always try to maintain an adequate distance between the two devices.

i Information

Changes or modifications not expressly approved by the party responsible for compliance could void the user's authority to operate the equipment. If the keyless entry system is inoperative due to changes or modifications not expressly approved by the party responsible for compliance, it will not be covered by your manufacturer's vehicle warranty.

NOTICE

Keep the smart key away from electromagnetic materials that blocks electromagnetic waves to the key surface.

Battery replacement



If the Smart Key is not working properly, try replacing the battery with a new one.

Battery Type: CR2032

To replace the battery:

1. Pry open the rear cover of the smart key.
2. Remove the old battery and insert the new battery. Make sure the battery position is correct.
3. Reinstall the rear cover of the smart key.

If you suspect your smart key might have sustained some damage, or you feel your smart key is not working correctly, it is recommended that you contact an authorized HYUNDAI dealer.

i Information

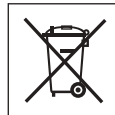

An inappropriately disposed battery can be harmful to the environment and human health. Dispose the battery according to your local law(s) and regulation.

Immobilizer system

The immobilizer system protects your vehicle from theft. If an improperly coded key (or other device) is used, the engine's fuel system is disabled.

When the ignition switch is placed in the ON position, the immobilizer system indicator should come on briefly, then go off. If the indicator starts to blink, the system does not recognize the coding of the key.

Place the ignition switch to the LOCK/OFF position, then place the ignition switch to the ON position again.

The system may not recognize your key's coding if another immobilizer key or other metal object (i.e., key chain) is near the key. The engine may not start because the metal may interrupt the transponder signal from transmitting normally.

Disclaimer :

The system is designed in such a way that it makes vehicle theft difficult if its circuit and battery connection is uninterrupted.

If the system repeatedly does not recognize the coding of the key, it is recommended that you contact your HYUNDAI dealer.

Do not attempt to alter this system or add other devices to it. Electrical problems could result that may make your vehicle inoperable.



WARNING

In order to prevent theft of your vehicle, do not leave spare keys anywhere in your vehicle. Your immobilizer password is a customer unique password and should be kept confidential.

NOTICE

The transponder in your key is an important part of the immobilizer system. It is designed to give years of trouble-free service, however you should avoid exposure to moisture, static electricity and rough handling. Immobilizer system malfunction could occur.

MT(Manual Transmission) Remote start function (if equipped)

Remote Engine Start allows you to start your vehicle engine remotely from your convenient place by Mobile (Blue Link Application).

The following conditions must be met for a vehicle to start remotely:



- All the vehicle doors including tailgate and hood must be closed and Locked; EPB should be in applied (ON) state.

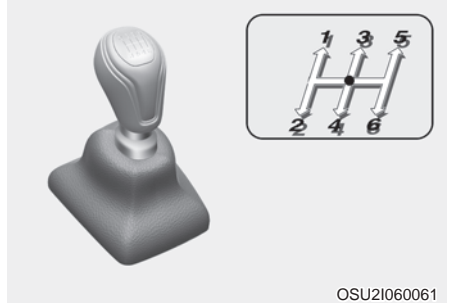

- Gear shift lever must be in 'N' position.



- Vehicle should be parked on a flat surface.
- Smart Key (FOB) should not be placed inside the vehicle.

Remote Engine Start will not operate:

1. If gear position is other than 'N'
2. If EPB state is in release(OFF) state
3. If vehicle is parked on a hill or an inclination road(not on flat area)
4. If vehicle battery is low.



CAUTION

For remote start operation in Manual Transmission, vehicle must be parked on a flat surface.

Door lock/unlock sound

When a user steps out of the car, all doors are closed and then the user tries to lock or unlock the car with the remote key or smart key, sound occurs along with flashing.

- Door Lock beep sound : 1time
- Door Unlock beep sound : 2times

Lock/Unlock Sound Function Disable / Enable:

The user can disable or enable the lock/unlock sound using the remote key or smart key.

- Default condition : Sound is Enabled (ON)
 - Sound Disable : User must press both lock and unlock buttons in the remote key or smart key together for at least 4seconds to deactivate the sound (from "ON → OFF").
 - Sound Enable : User must press both lock and unlock buttons in the remote key or smart key together for at least 4seconds to activate Sound (from " OFF → ON").
- For a successful Activation/Deactivation of Sound, Hazard warning lights will blink 4 times.

DOOR LOCKS

Operating door locks from outside the vehicle

Mechanical key

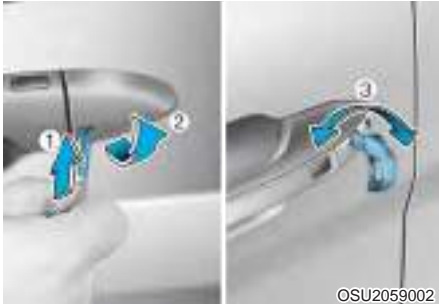

Turn the key toward the rear of the vehicle to unlock and toward the front of the vehicle to lock.

If you lock/unlock the driver's door with a key, all vehicle doors will lock/unlock automatically. (If equipped with the central door lock system)

Once the doors are unlocked, they may be opened by pulling the door handle.

When closing the door, push the door by hand. Make sure that doors are closed securely.

Remote key



To lock the doors, press the Door Lock button (1) on the remote key.

To unlock the doors, press the Door Unlock button (2) on the remote key.

Once the doors are unlocked, they may be opened by pulling the door handle.

When closing the door, push the door by hand. Make sure that doors are closed securely.

i Information

- **In cold and wet climates, door lock and door mechanisms may not work properly due to freezing conditions.**
- **If the door is locked/unlocked multiple times in rapid succession with either the vehicle key or door lock switch, the system may stop operating temporarily in order to protect the circuit and prevent damage to system components.**

Smart key

■ Type A



OSU21059001

■ Type B



OQXI049005

1. Door lock
2. Door unlock

To lock the doors, press the button on the outside door handle while carrying the smart key with you or press the door lock button on the smart key.

To unlock the doors, press the button on the outside door handle while carrying the smart key with you or press the door unlock button on the smart key.

Once the doors are unlocked, they may be opened by pulling the door handle.

When closing the door, push the door by hand. Make sure that doors are closed securely.

i Information

- In cold and wet climates, door lock and door mechanisms may not work properly due to freezing conditions.
- If the door is locked/unlocked multiple times in rapid succession with either the vehicle key or door lock switch, the system may stop operating temporarily in order to protect the circuit and prevent damage to system components.

Operating door locks from inside the vehicle

With the door lock button



- To unlock a door, push the door lock button (1) to the “Unlock” position.
- To lock a door, push the door lock button (1) to the “Lock” position.
- To open a door, pull the door handle (2) outward.
- If the inner door handle of the driver’s door is pulled when the door lock button is in the lock position, the button is unlocked and door opens.
- Front doors cannot be locked if the key is in the ignition switch and any front door is open.
- Doors cannot be locked if the smart key is in the vehicle and any door is open.

i Information

If a power door lock ever fails to function while you are in the vehicle try one or more of the following techniques to exit:

Operate the door unlock feature repeatedly (both electronic and manual) while simultaneously pulling on the door handle.

Operate the other door locks and handles, front and rear.

Lower a front window and use the mechanical key to unlock the door from outside.

With the central door lock/unlock switch



When pressing the (🔒) portion (1) of the switch, all vehicle doors will lock.

- If the key is in the ignition switch and any door is opened, the doors will not lock even though the lock button (1) of the central door lock switch is pressed.
- If the smart key is in the vehicle and any door is opened, the doors will not lock even though the lock button (1) of the central door lock switch is pressed.

When pressing the (🔓) portion (2) of the switch, all vehicle doors will unlock.

WARNING

- The doors should always be fully closed and locked while the vehicle is in motion. If the doors are unlocked, the risk of being thrown from the vehicle in a crash is increased.
- Do not pull the inner door handle of the driver's or passenger's door while the vehicle is moving.

WARNING

Do not leave children or animals unattended in your vehicle. An enclosed vehicle can become extremely hot, causing death or serious injury to unattended children or animals who cannot escape the vehicle. Children might operate features of the vehicle that could injure them, or they could encounter other harm, possibly from someone gaining entry to the vehicle.

WARNING

Always secure your vehicle

Leaving your vehicle unlocked increases the potential risk to you or others from someone hiding in your vehicle.

To secure your vehicle, while depressing the brake, move the shift lever to the P (Park, for Intelligent Variable Transmission/Dual Clutch Transmission/Automatic Transmission vehicle) position or first gear or R (Reverse, for manual transmission), engage the parking brake, and place the ignition switch in the LOCK/OFF position, close all windows, lock all doors, and always take the key with you.

 **WARNING**

Opening a door when something is approaching may cause damage or injury. Be careful when opening doors and watch for vehicles, motorcycles, bicycles or pedestrians approaching the vehicle in the path of the door.

 **WARNING**

If you stay in the vehicle for a long time while the weather is very hot or cold, there are risks of injuries or danger to life. Do not lock the vehicle from the outside when someone is in the vehicle.

Auto door lock/unlock features (if equipped)

Impact sensing door unlock system

All doors will be automatically unlocked when an impact causes the air bags to deploy.

Speed sensing door lock system

All doors will be automatically locked when vehicle speed exceeds 15 km/h (9 mph).

Child-protector rear door locks



The child safety lock is provided to help prevent children seated in the rear from accidentally opening the rear doors. The rear door safety locks should be used whenever children are in the vehicle.

The child safety lock is located on the edge of each rear door. When the child safety lock is in the lock position () , the rear door will not open if the inner door handle is pulled.

To lock the child safety lock, insert a key (or screwdriver) into the hole (1) and turn it to the lock () position.

To allow a rear door to be opened from inside the vehicle, unlock the child safety lock.

 **WARNING**

If children accidentally open the rear doors while the vehicle is in motion, they could fall out of the vehicle. The rear door safety locks should always be used whenever children are in the vehicle.

THEFT-ALARM SYSTEM (IF EQUIPPED)

This system helps to protect your vehicle and valuables. The horn will sound and the hazard warning lights will blink continuously if any of the following occurs:

- A door is opened without using the remote key or smart key.
- The tailgate is opened without using the remote key or smart key.
- The engine hood is opened.

The alarm continues for 30 seconds, then the system resets. To turn off the alarm, unlock the doors with the remote key or smart key.

The Theft Alarm System automatically sets 30 seconds after you lock the doors and the tailgate. For the system to activate, you must lock the doors and the tailgate from outside the vehicle with the remote key or smart key or by pressing the button on the outside of the door handles with the smart key in your possession.

The hazard warning lights will blink and the chime will sound once to indicate the system is armed.

Once the security system is set, opening any door, the tailgate, or the hood without using the remote key or smart key will cause the alarm to activate.

The Theft Alarm System will not set if the hood, the tailgate, or any door is not fully closed. If the system will not set, check the hood, the tailgate, or the doors are fully closed.

Do not attempt to alter this system or add other devices to it.

If the vehicle is locked by using a mechanical key, the security system doesn't operate.

Information

- **Do not lock the doors until all passengers have left the vehicle. If the remaining passenger leaves the vehicle when the system is armed, the alarm will be activated.**
- **If the vehicle is not disarmed with the remote key or smart key, open the doors by using the mechanical key and place the ignition switch in the ON position (for remote key) or start the engine (for smart key) and wait for 30 seconds.**
- **When the system is disarmed but a door or tailgate is not opened within 30 seconds, the system will be re-armed.**

Disclaimer :

The system is designed in such a way that it makes vehicle theft difficult if its circuit and battery connection is uninterrupted.

STEERING WHEEL

Electric power steering (EPS)

The system assists you with steering the vehicle. If the engine is off or if the power steering system becomes inoperative, the vehicle may still be steered, but it will require increased steering effort.

Also, the steering effort becomes lighter as the vehicle's speed increases and becomes heavier as the vehicle's speed decreases for better control of the steering wheel.

Should you notice any change in the effort required to steer during normal vehicle operation, we recommend that the system be checked by an authorized HYUNDAI dealer.

NOTICE

If the Electric Power Steering System does not operate normally, the warning light (⚠) will illuminate on the instrument cluster. The steering wheel may become difficult to control or operate. Take your vehicle to an authorized HYUNDAI dealer and have the system checked as soon as possible.

Information

The following symptoms may occur during normal vehicle operation:

- The steering effort may be high immediately after placing the ignition switch in the ON position.

This happens as the system performs the EPS system diagnostics. When the diagnostics is completed, the steering wheel will return to its normal condition.

- When the battery voltage is low, you might have to put more steering effort. However, it is a temporary condition so that it will return to normal condition after charging the battery.
- A click noise may be heard from the EPS relay after the ignition switch is placed to the ON or LOCK/OFF position.
- Motor noise may be heard when the vehicle is at stop or at a low driving speed.
- When you operate the steering wheel in low temperature, abnormal noise may occur. If temperature rises, the noise will disappear. This is a normal condition.

WARNING

Never adjust the steering wheel while driving. You may lose steering control and cause severe personal injury, death or accidents.

Tilt steering / Telescopic steering

WARNING

Never adjust the steering wheel while driving. You may lose steering control and cause severe personal injury, death or accidents.

Information

After adjustment, sometimes the lock-release lever may not lock the steering wheel.

It is not a malfunction. This occurs when two gears are not engaged correctly. In this case, adjust the steering wheel again and then lock the steering wheel.



To change the steering wheel angle and height:

1. Pull down the lock-release lever (1).
2. Adjust the steering wheel to the desired angle (2) and height (3, if equipped). Move the steering wheel, so it points toward your chest, not toward your face. Make sure you can see the instrument panel warning lights and gauges.

3. Pull up the lock-release lever to lock the steering wheel in place.

Push the steering wheel both up and down to be certain it is locked in position.

CAUTION

While adjusting the steering wheel height, please do not push or pull it hard since the fixture can be damaged.

Horn



To sound the horn, press the area indicated by the horn symbol on your steering wheel (see illustration). The horn will operate only when this area is pressed.

NOTICE

Do not strike the horn severely to operate it, or hit it with your fist. Do not press on the horn with a sharp-pointed object.

MIRRORS

Inside rearview mirror

Before you start driving, adjust the rearview mirror to the center on the view through the rear window.

WARNING

Make sure your line of sight is not obstructed. Do not place objects in the rear seat, cargo area, or behind the rear headrests which could interfere with your vision through the rear window.

WARNING

To prevent serious injury during an accident or deployment of the air bag, do not modify the rearview mirror and do not install a wide mirror.

WARNING

NEVER adjust the mirror while driving. This may cause loss of vehicle control resulting in an accident.

NOTICE

When cleaning the mirror, use a paper towel or similar material dampened with glass cleaner. Do not spray glass cleaner directly on the mirror as that may cause the liquid cleaner to enter the mirror housing.

Day/night rearview mirror (if equipped)



[A] : Day, [B] :Night

Make this adjustment before you start driving and while the day/night lever is in the day position.

Pull the day/night lever toward you to reduce glare from the headlights of the vehicles behind you during night driving.

Remember that you lose some rear-view clarity in the night position.

Electric Chromic Mirror (ECM) (if equipped)

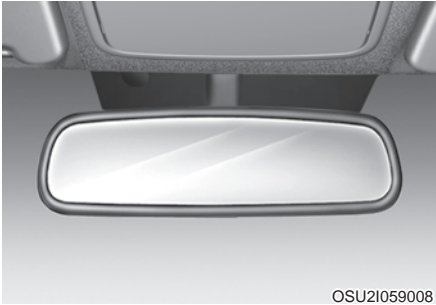

OSU21059008

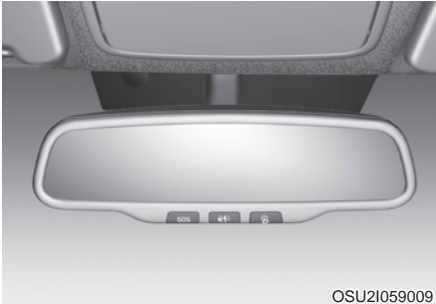

OSU21059009

The electric rearview mirror automatically controls the glare from the headlamp of the vehicle behind you in nighttime or low light driving conditions.

When the engine is running, the glare is automatically controlled by the sensor mounted in the rearview mirror. The sensor detects the light level around the vehicle, and automatically adjusts to control the headlamp glare from vehicles behind you.

Whenever the shift lever is placed in R (Reverse), the mirror will automatically go to the brightest setting in order to improve the drivers view behind the vehicle.

Outside rearview mirror



OSU21059010

Be sure to adjust mirror angles before driving.

Your vehicle is equipped with both left-hand and right-hand outside rearview mirrors. The mirrors can be adjusted remotely with the remote switch. The mirror heads can be folded to prevent damage during an automatic car wash or when passing through a narrow street.

The right outside rearview mirror is convex. Objects seen in the mirror are closer than they appear.

Use your interior rearview mirror or direct observation to determine the actual distance of following vehicles when changing lanes.



WARNING

Rearview mirrors

- **Both right and left outside rear view mirror are convex.**
Objects seen in the mirror are closer than they appear.
- **Use your interior rearview mirror or turn your head and look to determine the actual distance of following vehicles when changing lanes.**

 **WARNING**

Do not adjust or fold the outside rearview mirrors while the vehicle is moving. This could result in loss of control, and an accident which could cause death, serious injury or property damage.

NOTICE

- Do not scrape ice off the mirror face; this may damage the surface of the glass.
- If the mirror is jammed with ice, do not adjust the mirror by force. Use an approved spray de-icer (not radiator antifreeze) spray, or a sponge or soft cloth with very warm water, or move the vehicle to a warm place and allow the ice to melt.

Adjusting the outside rearview mirror



Manual type (if equipped)

To adjust an outside mirror, move the control lever.



Electric type (if equipped)

1. Move the lever (1) either to the L (left side) or R (right side) to select the rearview mirror you would like to adjust.
2. Use the mirror adjustment control (2) to position the selected mirror up, down, left or right.
3. After adjustment, move the lever (1) to the middle to prevent inadvertent adjustment.

NOTICE

- The mirrors stop moving when they reach the maximum adjusting angles, but the motor continues to operate while the switch is pressed. Do not press the switch longer than necessary, the motor may be damaged.
- Do not attempt to adjust the outside rearview mirror by hand or the motor may be damaged.

Folding the outside rearview mirror

OSU21059070

Manual type (if equipped)

To fold the outside rearview mirror, grasp the housing of the mirror and then fold it toward the rear of the vehicle.



OSU21059012

Electric type (if equipped)

To fold the outside rearview mirror, press the button.

To unfold outside rearview mirror, press the button again.

If the button is pressed, the mirror will fold or unfold automatically.

NOTICE

The electric type outside rearview mirror operates even though the ignition switch is in the ACC position. However, to prevent unnecessary battery discharge, do not adjust the mirrors longer than necessary while the engine is not running.

NOTICE

Do not fold the electric type outside rearview mirror by hand. It could cause motor failure.

WINDOWS

Power windows (if equipped)

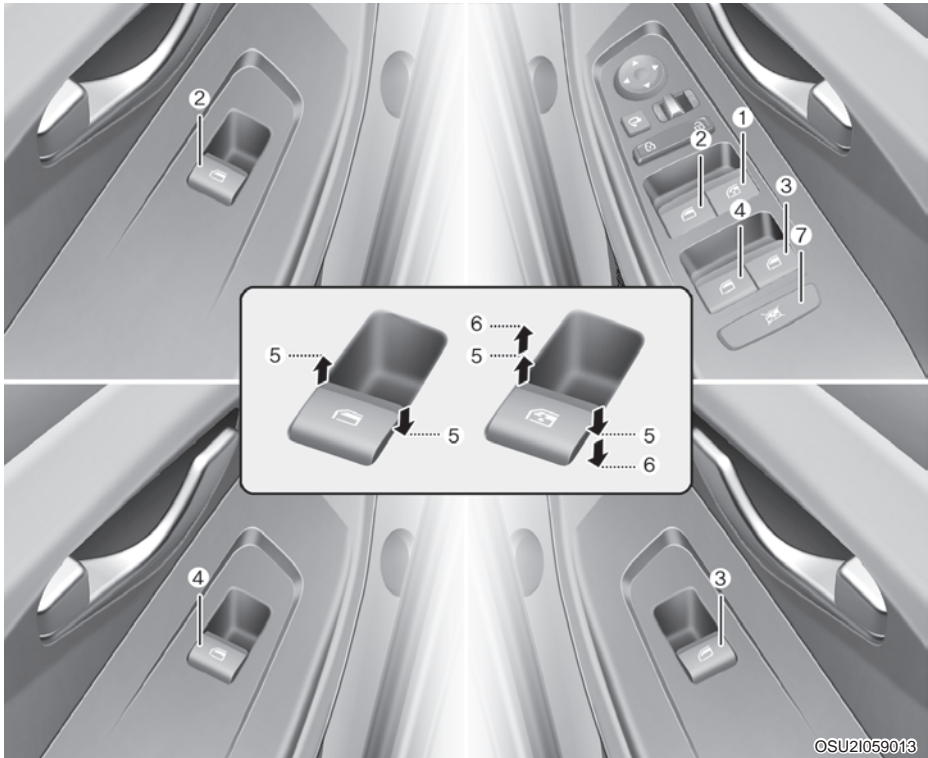

- (1) Driver's door power window switch*
- (2) Front passenger's door power window switch*
- (3) Rear door power window switch (Right)*
- (4) Rear door power window switch (Left)*
- (5) Window opening and closing
- (6) Automatic power window*
- (7) Power window lock switch*

* : if equipped

To reset the power windows

If the power windows do not operate normally, the automatic power window system must be reset as follows:

1. Place the ignition switch to the ON position.
2. Close the window and continue pulling up on the power window switch for at least 1 second.

If the power windows do not operate properly after resetting, it is recommended that the system be checked by an authorized HYUNDAI dealer.

WARNING

The automatic reverse feature doesn't activate while resetting power window system. Make sure body parts or other objects are safely out of the way before closing the windows to avoid injuries or vehicle damage.

Automatic reverse (if equipped)

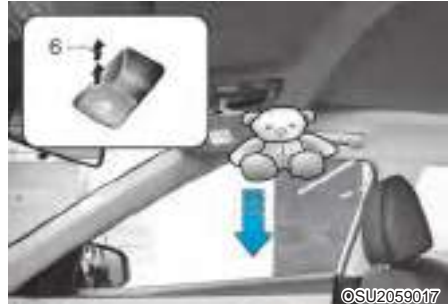

If a window senses any obstacle while it is closing automatically, it will stop and lower approximately 30 cm (12 inches) to allow the object to be cleared.

If the window detects the resistance while the power window switch is pulled up continuously, the window will stop upward movement then lower approximately 2.5 cm (1 inch).

If the power window switch is pulled up continuously again within 5 seconds after the window is lowered by the automatic window reverse feature, the automatic window reverse will not operate.

Information

The automatic reverse feature is only active when the “Auto Up” feature is used by fully pulling up the switch to the second detent.



WARNING

Make sure body parts or other objects are safely out of the way before closing the windows to avoid injuries or vehicle damage.

Objects less than 4 mm (0.16 inch) in diameter caught between the window glass and the upper window channel may not be detected by the automatic reverse window and the window will not stop and reverse direction.

NOTICE

Do not install any accessories on the windows. The automatic reverse feature may not operate.

Power window lock switch (if equipped)



The driver can disable the power window switches on the rear passengers' doors by pressing the power window lock switch.

When the power window lock switch is pressed:

- The driver's master control can operate all the power windows.
- The front passenger's control can operate the front passenger's power window.
- The rear passenger's control cannot operate the rear passengers' power window.

NOTICE

- To prevent possible damage to the power window system, do not open or close two windows or more at the same time. This will also ensure the longevity of the fuse.
- Never try to operate the main switch on the driver's door and the individual door window switch in opposite directions at the same time. If this is done, the window will stop and cannot be opened or closed.



WARNING

Windows

- **NEVER** leave the keys in your vehicle with unsupervised children, when the engine is running.
- **NEVER** leave any child unattended in the vehicle. Even very young children may inadvertently cause the vehicle to move, entangle themselves in the windows, or otherwise injure themselves or others.
- Always double check to make sure all arms, hands, head and other obstructions are safely out of the way before closing a window.
- Do not allow children to play with the power windows. Keep the driver's door power window lock switch in the LOCK position (pressed). Serious injury can result from unintentional window operation by the child.
- Do not extend your head, arms or body outside the win

PANORAMA SUNROOF (IF EQUIPPED)

If your vehicle is equipped with a sunroof, you can slide or tilt your sunroof with the sunroof switch located on the overhead console.



The sunroof can only be operated when the ignition switch is in the ON position.

The sunroof can be operated for approximately 10 minutes after the ignition switch is in the ACC or LOCK position. However, if the front door is open, the sunroof cannot be operated even within the 10 minute period.

WARNING

- **Never adjust the sunroof or sunshade while driving. This could result in loss of control and an accident that may cause injury, or property damage.**
- **Do not leave the engine running and the key in your vehicle with unsupervised children. Unattended children could operate the sunroof, which could result in serious injury.**
- **Do not sit on the top of the vehicle. It may cause injury or vehicle damage.**

NOTICE

Do not operate the sunroof when the roof bars are installed on the vehicle or when there is luggage on the roof.

Roller blind



- To open the roller blind, pull the sunroof control lever backward to the first detent position.
- To close the roller blind when the sunroof glass is closed, push the sunroof control lever forward.

To stop the sunroof movement at any point, push the sunroof control lever either forward or backward momentarily.

i Information

Activating the control lever to the first detent requires only a very light touch.

NOTICE

Do not pull the sunshade up or down, or apply excessive force as such action may damage the sunshade or cause it to malfunction.

Sliding the sunroof

When the roller blind is closed



If you push the sunroof control lever backward past the first detent, the roller blind will slide all the way open and then the sunroof glass will slide all the way open.

To stop the sunroof movement at any point, push the sunroof control lever either forward or backward momentarily.

When the roller blind is opened

If you pull the sunroof control lever backward, the sunroof glass will slide all the way open. To stop the sunroof movement at any point, pull or push the sunroof control lever momentarily.

i Information

Only the front glass of the panorama sunroof opens and closes.

The wrinkles that is occurred on blind while operating is a normal phenomenon that may occur due to the nature of the material

Tilting the sunroof



When the roller blind is closed

If you push the sunroof control lever upward, the roller blind will slide open then the sunroof glass will tilt open.

To stop the sunroof movement at any point, push the sunroof control lever either forward or backward momentarily.

When the roller blind is opened

If you push the sunroof control lever upward, the sunroof glass will tilt open.

To stop the sunroof movement at any point, push the sunroof control lever either forward or backward momentarily.

Closing the sunroof



To close the sunroof glass only

Push the sunroof control lever forward to the first detent position.

To close sunroof glass with roller blind

Push the sunroof control lever forward to the second detent position. The sunroof glass will close then the roller blind will close automatically.

To stop the sunroof movement at any point, push the sunroof control lever either forward or backward momentarily.

i Information

To reduce wind noise while driving, we recommend that you drive at the recommended position before the maximum slide open position.

Automatic reversal

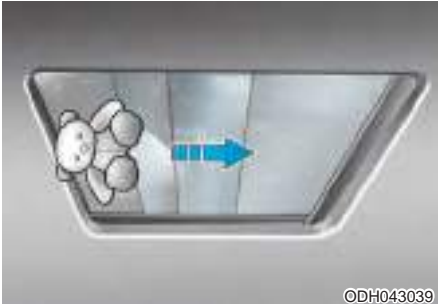

If the sunroof glass senses any obstacle while it is closing automatically, it will reverse direction then stop at a certain position.

The auto reverse function may not work if an object thin or soft is caught between the sliding sunroof glass and sunroof sash.



WARNING

- Make sure heads, hands, arms or any other body parts or objects are out of the way before operating the sunroof. Body parts or objects may get caught causing injuries or vehicle damage.
- Never deliberately use your body parts to test the automatic reversal function. The sunroof glass may reverse direction, but there is a risk of injury.

NOTICE

- Do not continue to push the sunroof switch after the sunroof is fully opened, closed, or tilted. Damage to the sunroof motor could occur.
- Continuous operations such as slide open/close, tilt open/close, etc. may cause the motor or sunroof system to malfunction.
- Regularly remove any accumulated dust on the sunroof rail.
- Using the sunroof for a long time can make noise caused by dust in accumulated between the sunroof and vehicle body. Open the sunroof and remove dust regularly using a clean cloth.
- Do not try to open the sunroof when the temperature is below freezing or when the sunroof is covered with snow or ice, otherwise the motor could be damaged. In cold and wet climates, the sunroof may not work properly.
- Do not open or drive with the sunroof glass open immediately after rain or washing the vehicle. Water may wet the interior of the vehicle.
- Do not extend any luggage outside the sunroof while driving. Vehicle damage may occur if the vehicle suddenly stops.



WARNING

Do not extend your head, arms, body parts or objects outside the sunroof while driving. Injuries may occur if the vehicle suddenly stops.

Resetting the sunroof



The sunroof may need to be reset if the following conditions occur:

- The battery is discharged or disconnected or the sunroof fuse has been replaced or disconnected
- The sunroof control lever is not operating correctly

To reset the sunroof, perform the following steps:

1. Turn the engine on and close the sunroof glass and roller blind completely.
2. Release the control lever.
3. Push and hold the sunroof control lever forward (to close the roller blind) for about 10 seconds until the sunroof moves slightly, then release the control lever.
4. Push and hold the sunroof control lever forward until the sunroof operates as follows:

Roller blind Open → Glass Tilt Open → Glass Slide Open → Glass Slide Close → Roller blind Close

Then, release the control lever.

When this is complete, the sunroof system is reset.

For more details, contact an authorized HYUNDAI dealer.

5. Once again push and hold the sunroof switch forward until the sunroof glass slides open and close. Do not release the switch until the operation is completed.

If you release the switch during operation, start the procedure again from step 2.

i Information

If the sunroof is not reset when the vehicle battery is disconnected or discharged, or the sunroof fuse is blown, the sunroof may not operate normally.

Sunroof open warning



If the driver turns off the engine when the sunroof is not fully closed, the warning chime will sound for several seconds and the sunroof open warning will appear on the cluster LCD display.

Close the sunroof securely when leaving your vehicle.



CAUTION

Make sure the sunroof is closed fully when leaving your vehicle.

If the sunroof is left open, rain or snow may wet the interior of the vehicle. Also, leaving the sunroof open when the vehicle is unattended may invite theft.

EXTERIOR FEATURES

Hood

Opening the hood



1. Park the vehicle and set the parking brake.
2. Pull the release lever to unlatch the hood. The hood should pop open slightly.



3. Go to the front of the vehicle, raise the hood slightly, push the secondary latch up (1) inside of the hood center and lift the hood (2).



4. Pull out the support rod.
5. Hold the hood opened with the support rod.

WARNING

The support rod must be inserted completely into the hole provided whenever you inspect the engine compartment. This will prevent the hood from falling and possibly injuring you.

Closing the hood

1. Before closing the hood, check the following:
 - All filler caps in engine compartment must be correctly installed.
 - Gloves, rags or any other combustible material must be removed from the engine compartment.
2. Return the support rod to its clip to prevent it from rattling.
3. Lower the hood halfway (lifted approximately 30 cm from the closed position) and push down to securely lock in place.
4. Then double check to be sure the hood is secure.
 - If the hood can be raised slightly, it is not properly locked.
 - Open it again and close it with a little more force.



WARNING

- **Before closing the hood, ensure that all obstructions are removed from the hood opening. Closing the hood with an obstruction present in the hood opening may result in property damage or severe personal injury.**
- **Do not leave gloves, rags or any other combustible material in the engine compartment. Doing so may cause a heat-induced fire.**
- **Do not move the vehicle with the hood raised. The view will be blocked and the hood could fall or be damaged.**



WARNING

Always double check to be sure that the hood is firmly latched before driving away. Check there is no hood open warning light or message displayed on the instrument cluster. Driving with the hood opened may cause a total loss of visibility, which might result in an accident.

Tailgate

Opening the tailgate



Make sure the vehicle is in P (Park) and set the parking brake.

Then do one of the following:

1. Unlock all doors with the Door Unlock button on your remote key or smart key. Press the tailgate handle switch and open the tailgate.
2. Press and hold the Tailgate Unlock switch on the remote key or smart key. Press the tailgate handle switch and open the tailgate.

Closing the tailgate



Lower the tailgate lid and press down until it locks. To be sure the tailgate lid is securely fastened, always check by trying to pull it up again without pressing the tailgate handle button.

WARNING

Always keep the tailgate lid completely closed while the vehicle is in motion. If it is left open or ajar, poisonous exhaust gases containing carbon monoxide (CO) may enter the vehicle and serious illness or death may result.

Information

To prevent damage to the tailgate lift cylinders and the attached hardware, always close the tailgate before driving.

NOTICE

In cold and wet climates, tailgate lock and tailgate mechanisms may not work properly due to freezing conditions.

 **WARNING**



Do not hold the part (gas lifter) that supports the tailgate. Be aware that the deformation of the part may cause vehicle damage and a risk of injury.

 **WARNING**

- **NEVER** allow anyone to occupy the luggage compartment of the vehicle at any time. If the tailgate is partially or totally latched and the person is unable to get out, serious injury or death could occur due to lack of ventilation, exhaust fumes and rapid heat build-up, or because of exposure to cold weather conditions. The luggage compartment is also a highly dangerous location in the event of a crash because it is not a protected occupant space but is a part of the vehicle's crush zone.
- Your vehicle should be kept locked and keys should be kept out of the reach of children. Parents should teach their children about the dangers of playing in luggage compartments.

Emergency tailgate safety release



Your vehicle is equipped with the emergency tailgate safety release lever located on the bottom of the tailgate. When someone is inadvertently locked in the luggage compartment. The tailgate can be opened by doing as follows:

1. Insert the key into the hole.
2. Push the release lever to the right by a key.
3. Push up the tailgate.

 **WARNING**

- For emergencies, be fully aware of the location of the emergency tailgate safety release lever in the vehicle and how to open the tailgate if you are accidentally locked in the luggage compartment.
- No one should be allowed to occupy the luggage compartment of the vehicle at any time. The luggage compartment is a very dangerous location in the event of a crash.
- Use the release lever for emergencies only. Use with extreme caution, especially while the vehicle is in motion.

Fuel filler door

Opening the fuel filler door



The fuel filler door must be opened from inside the vehicle by pulling up the fuel filler door opener.

1. Stop the engine.
2. Pull the fuel filler door opener up.



3. Pull the fuel filler door out (1) to fully open.
4. To remove the fuel tank cap (2), turn it counterclockwise. You may hear a hissing noise as the pressure inside the tank equalizes.
5. Place the cap on the fuel filler door (3).

WARNING

- Your diesel vehicle is equipped with the specially-designed breakaway valve inside the filler inlet to prevent accidental fuel blending with petrol. The fuel inlet of your diesel vehicle cannot be fitted with a standard petrol nozzle. Do not forcefully insert a standard petrol nozzle into the filler inlet of your diesel vehicle. It may damage your vehicle.
- Some gas stations may still use standard petrol nozzles for diesel refueling. If you find that a diesel nozzle is narrower than the fuel filler inlet diameter of your diesel vehicle, we recommend you to find/visit another gas station, which is equipped with standard diesel nozzles.
- Fully insert a standard diesel nozzle into the filler inlet to open the breakaway valve. If the nozzle is not fully inserted into the filler inlet, it causes diesel fuels to flow out of the fuel tank.

Information

If the fuel filler door does not open because ice has formed around it, tap lightly or push on the door to break the ice and release the door. Do not pry on the door. If necessary, spray around the door with an approved de-icer fluid (do not use radiator anti-freeze) or move the vehicle to a warm place and allow the ice to melt.

Closing the fuel filler door

1. To install the fuel tank cap (2), turn it clockwise until it “clicks” once. This indicates that the cap is securely tightened.
2. Close the fuel filler door (1) and push it lightly and make sure that it is securely closed.



WARNING

Petrol is highly flammable and explosive. Failure to follow these guidelines may result in SERIOUS INJURY or DEATH:

- Read and follow all warnings posted at the gas station.
- Before refueling, note the location of the Emergency Petrol Shut-Off, if available, at the gas station.
- Before touching the fuel nozzle, you should eliminate the potential build-up of static electricity by touching a metal part of the vehicle, a safe distance away from the fuel filler neck, nozzle, or other gas source, with your bare hand.
- Do not use cellular phones while refueling. Electric current and/or electronic interference from cellular phones can potentially ignite fuel vapors and cause a fire.
- Do not get back into a vehicle once you have begun refueling. You can generate a buildup of static electricity by touching, rubbing or sliding against any item or fabric capable of producing static electricity. Static electricity discharge can ignite fuel vapors causing a fire. If you must re-enter the vehicle, you should once again eliminate potentially dangerous static electricity discharge by touching a metal part of the vehicle, away from the fuel filler neck, nozzle or other petrol source, with your bare hand.
- When using an approved portable fuel container, be sure to place the container on the ground prior to refueling. Static electricity discharge from the container can ignite fuel vapors causing a fire. Once refueling has begun, contact between your bare hand and the vehicle should be maintained until the filling is complete.
- Use only approved portable plastic fuel containers designed to carry and store petrol.
- When refueling, always move the shift lever to the P (Park) position (for Automatic transmission) or first gear or R (Reverse, for manual transmission), set the parking brake, and place the ignition switch to the LOCK/OFF position. Sparks produced by electrical components related to the engine can ignite fuel vapors causing a fire.

- Do not use matches or a lighter and do not smoke or leave a lit cigarette in your vehicle while at a gas station, especially during refueling.
- Do not over-fill or top-off your vehicle tank, which can cause petrol spillage.
- If a fire breaks out during refueling, leave the vicinity of the vehicle, and immediately contact the manager of the gas station and then contact the local fire department. Follow any safety instructions they provide.
- If pressurized fuel sprays out, it can cover your clothes or skin and thus subject you to the risk of fire and burns. Always remove the fuel cap carefully and slowly. If the cap is venting fuel or if you hear a hissing sound, wait until the condition stops before completely removing the cap.
- Always check that the fuel cap is installed securely to prevent fuel spillage in the event of an accident.

i Information

- Make sure to refuel your vehicle according to the “Fuel Requirements” suggested in the 1 chapter.
- Do not spill fuel on the exterior surfaces of the vehicle. Any type of fuel spilled on painted surfaces may damage the paint.

NOTICE

If the fuel filler cap requires replacement, use only a genuine HYUNDAI cap or the equivalent specified for your vehicle. An incorrect fuel filler cap can result in a serious malfunction of the fuel system or emission control system.

LIGHT

Exterior lights

Lighting control

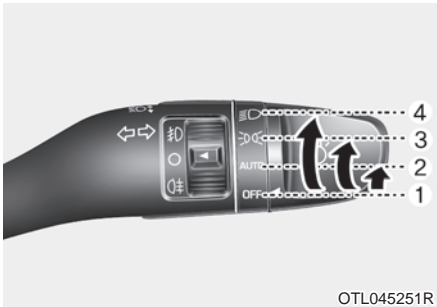

OTL045251R

To operate the lights, turn the knob at the end of the control lever to one of the following positions:

- (1) OFF position
- (2) AUTO light position (if equipped)
- (3) Position lamp position
- (4) Headlamp position



©SU2059049

AUTO light position (if equipped)

When the light switch is in the AUTO position, the position light and headlamps will be turned ON or OFF automatically depending on the amount of light outside the vehicle.

Even with the AUTO light feature in operation, it is recommended to manually turn ON the lights when driving at night or in fog, or when you enter dark areas, such as tunnels and parking facilities.

NOTICE

- Do not cover or spill anything on the sensor (1) located on the instrument panel.
- Do not clean the sensor using a window cleaner, the cleanser may leave a light film which could interfere with sensor operation.
- If your vehicle has window tint or other types of metallic coating on the front windshield, the AUTO light system may not work properly.



OTL045252R

Headlamp position (㊦)

The headlamp, position lamp, license plate lamp and instrument panel lamp are turned ON.

i Information

The ignition switch must be in the ON position to turn on the headlights.



OTL045253R

Position lamp position (㉞)

The position lamp, license plate lamp and instrument panel lamp are turned ON.

High beam operation



OTL045255R

To turn on the high beam headlight, push the lever away from you. The lever will return to its original position. The high beam indicator will light when the headlight high beams are switched on.

To turn off the high beam headlight, pull the lever towards you. The low beams will turn on.



WARNING

Do not use high beam when there are other vehicles approaching you. Using high beam could obstruct the other driver's vision.



OTL045254R

To flash the high beam headlights, pull the lever towards you, then release the lever. The high beams will remain ON as long as you hold the lever towards you.

Turn signals and lane change signals

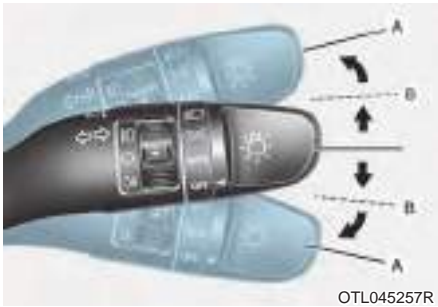

To signal a turn, push down on the lever for a right turn or up for a left turn in position (A). To signal a lane change, move the turn signal lever slightly and hold it in position (B). The lever will return to the OFF position when released or when the turn is completed.

If an indicator stays on and does not flash or if it flashes abnormally, one of the turn signal bulbs may be burned out and will require replacement.

One-touch turn signal function

To activate the One Touch Turn Signal function, push the turn signal lever up or down to position (B) and then release it. The lane change signals will blink 3, 5 or 7 times.

You can activate or deactivate the One Touch Turn Signal function or choose the number of blinks (3, 5, or 7) from the User Settings mode in the LCD display.

For more details, refer to the “LCD Display” section in chapter 4.

NOTICE

If the turn signal indicator stays on and does not flash, or if it flashes abnormally, a bulb may be burned out or have a poor electrical connection in the circuit. The bulb may require replacement.

Front fog light (if equipped)



Fog lamps are used to provide improved visibility when visibility is poor due to fog, rain or snow, etc. Use the switch next to the headlamp switch to turn the fog lamps ON and OFF.

1. Turn on the position lamp.
2. Turn the light switch (1) to the front fog lamp position.
3. To turn off the front fog lamp, turn the light switch to the front fog lamp position again or turn off the position lamp.

NOTICE

When in operation, the fog lights consume large amounts of vehicle electrical power. Only use the fog lights when visibility is poor.

**Battery saver function
(if equipped)**

The purpose of this feature is to prevent the battery from being discharged. The system automatically turns off the Parking (Position) lights when the driver removes the ignition key or turns the engine off (for smart key) and opens the driver-side door.

With this feature, the Parking (Position) lights will turn off automatically if the driver parks on the side of road at night.

If necessary, to keep the lights on when the ignition key is removed or the engine is turned off (for smart key), perform the following:

- 1) Open the driver-side door.
- 2) Turn the Parking (Position) lights OFF and ON again using the light switch on the steering column.

**Headlamp delay function
(if equipped)**

If you place the ignition switch to the ACC or LOCK/OFF position with the headlights ON, the headlamps (and/or position lamps) remain on for about 5 minutes. However, with the engine off if the driver's door is opened and closed, the headlamps (and/or position lamps) are turned off after 15 seconds.

The headlamps (and/or position lamps) can be turned off by pressing the lock button on the remote key (or smart key) twice or turning the light switch to the OFF or AUTO position. However, if you turn the light switch to the AUTO position when it is dark outside, the headlamps will not be turned off.

The headlights can be turned off by pressing the lock button on the transmitter twice or turning the light switch to the OFF position.

NOTICE

If the driver exits the vehicle through another door besides the driver door, the battery saver function does not operate and the headlamp delay function does not turn OFF automatically. This may cause the battery to discharge. To avoid battery discharge, turn OFF the headlamps manually from the headlamp switch before exiting the vehicle.

**Headlight leveling device
(if equipped)**



To adjust the headlight beam level according to the number of the passengers and loading weight in the luggage area, turn the beam leveling switch.

The higher the number of the switch position, the lower the headlight beam level. Always keep the headlight beam at the proper leveling position, or headlights may dazzle other road users.

Listed below are the examples of proper switch settings. For loading conditions other than those listed below, adjust the switch position so that the beam level may be the nearest as the condition obtained according to the list.

Loading condition	Switch position
Driver only	0
Driver + Front passenger	0
Full passengers (including driver)	1
Full passengers (including driver) + Maximum permissible loading	2
Driver + Maximum permissible loading	3

**Daytime running light (DRL)
(if equipped)**

The Daytime Running Lights (DRL) can make it easier for others to see the front of your vehicle during the day, especially after dawn and before sunset.

The DRL system will turn the dedicated lamp OFF when:

1. The headlights or front fog lights are in the ON position.
2. The engine is turned off.

Interior lights



WARNING

Do not use the interior lights when driving in the dark. The interior lights may obscure your view and cause an accident.

NOTICE

Do not use the interior lights for extended periods when the engine is turned off or the battery will discharge.

Front lamps

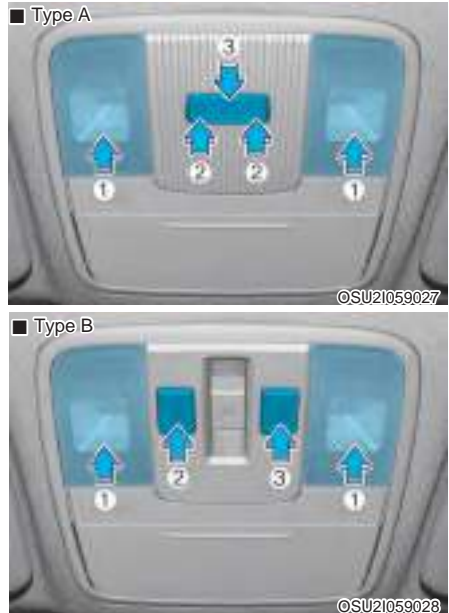



- (1) Front Map Lamp
- (2) Front Room Lamp
- (3) Front Door Lamp

Front map lamp

Press the map lamp lens (1) to turn ON the map lamp. Re-press the map lamp cover to turn OFF the map lamp.

Front room lamp

-  :
(Type A) Press the button to turn ON the room lamp for the front/rear seats.
(Type B) Press the button to turn ON the room lamp for the front/rear seats. Re-press the button to turn OFF the room lamp.
-  :
(Type A) Press the button to turn OFF the room lamp for the front/rear seats.

Front door lamp ()

The room lamp for the front/rear seats is automatically turned ON for approximately 30 seconds, when a door is opened.

The room lamp for the front/rear seats is automatically turned ON for approximately 15 seconds, when the remote key (smart key) unlocks the doors. The room lamp fades out, when the ignition switch is pressed to the ON position in 15 seconds. The room lamp remains ON up to 20 minutes, when a door is opened with the ignition switch in the either the ACC or OFF position.

Rear lamps

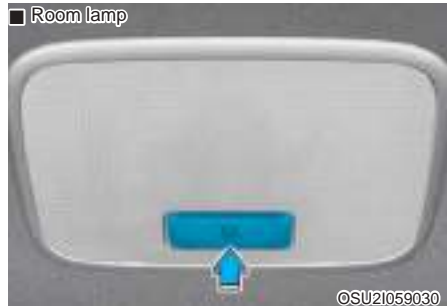

-  :
Press this button to turn the rear lamps on or off.

NOTICE

Do not leave the lamp switches on for an extended period of time when the engine is turned off.

Luggage room lamp (if equipped)



The luggage room lamp comes on when the tailgate is opened.

NOTICE

The luggage room lamp comes on as long as the tailgate is open. To prevent unnecessary charging system drain, close the tailgate securely after using the luggage room.

Mood lamp (if equipped)

The lamp turns on when 'Setup → Vehicle Settings → Lights → Ambient Light' is selected from the AVN screen.

Puddle lamp (if equipped)



Escort light

When the ignition switch is in the OFF position and the driver's door is opened, the puddle lamp will come on for 30 seconds. If the driver's door is closed within the 30 seconds, the puddle lamp will turn off after 15 seconds. If the driver's door is closed and locked, the puddle lamp will turn off immediately.

The Puddle Lamp Escort Light will turn on only the first time the driver's door is opened after the engine is turned off.

WIPERS AND WASHERS

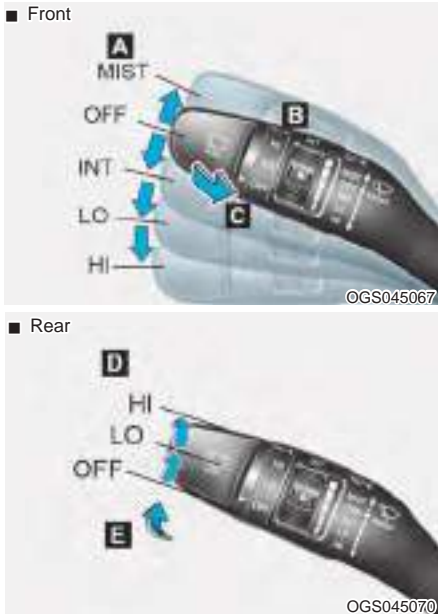

A : Wiper speed control

- MIST – Single wipe
- OFF – Off
- INT – Intermittent wipe
- LO – Low wiper speed
- HI – High wiper speed

B : Intermittent wipe time adjustment

C : Wash with brief wipes

D : Rear wiper/washer control (if equipped)

- HI – High wiper speed
- LO – Low wiper speed
- OFF – Off

E : Wash with brief wipes

Front windshield wipers

Operates as follows when the ignition switch is in the ON position.

MIST : For a single wiping cycle, move the lever upward and release. The wipers will operate continuously if the lever is held in this position.

OFF : Wiper is not in operation.

INT : Wiper operates intermittently at the same wiping intervals. To vary the speed setting, move the speed control knob (B). The top most setting will run the wipers most frequently (for more rain). The bottom setting will run the wipers the least frequently (for less rain).

LO : The wiper runs at a lower speed.

HI : The wiper runs at a higher speed.

i Information

If there is heavy accumulation of snow or ice on the windshield, defrost the windshield for about 10 minutes, or until the snow and/or ice is removed before using the windshield wipers to ensure proper operation.

If you do not remove the snow and/or ice before using the wiper and washer, it may damage the wiper and washer system.

Front windshield washers



OSU2I059032

In the OFF position, pull the lever gently toward you to spray washer fluid on the windshield and to run the wipers 1-3 cycles. The spray and wiper operation will continue until you release the lever.

If the washer does not work, you may need to add washer fluid to the washer reservoir.

WARNING

When the outside temperature is below freezing, **ALWAYS** warm the windshield using the defroster to prevent the washer fluid from freezing on the windshield and obscuring your vision which could result in an accident and serious injury or death.

NOTICE

- To prevent possible damage to the washer pump, do not operate the washer when the fluid reservoir is empty.
- To prevent possible damage to the wipers or windshield, do not operate the wipers when the windshield is dry.
- To prevent damage to the wiper arms and other components, do not attempt to move the wipers manually.
- To prevent possible damage to the wipers and washer system, use anti-freezing washer fluids in the winter season or cold weather.

Rear window wiper and washer switch (if equipped)

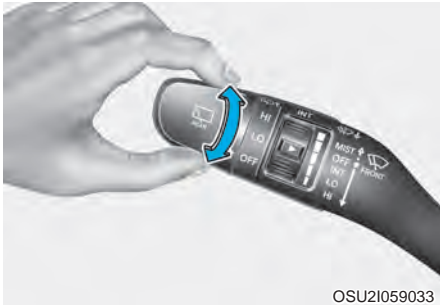

The rear window wiper and washer switch is located at the end of the wiper and washer switch lever. Turn the switch to the desired position to operate the rear wiper and washer.

HI - High wiper speed

LO - Low wiper speed

OFF - Wiper is not in operation



Push the lever away from you to spray rear washer fluid and to run the rear wipers 1~3 cycles. The spray and wiper operation will continue until you release the lever.

Auto rear wiper

The rear wiper will operate while the vehicle is in reverse with the front wipers ON by selecting the function on the LCD display.

Go to 'User Settings → Convenience → Auto rear wiper (reverse)

DRIVER ASSISTANCE SYSTEM

Rear View Monitor (RVM) (if equipped)



Rear View Monitor system will activate when the ignition switch is in the ON position and the shift lever is in the R (Reverse) position.

This is a supplemental system that shows behind the vehicle through the audio or infotainment system screen while backing-up.



WARNING

The Rear View Monitor is not a safety device. It only serves to assist the driver in identifying objects directly behind the middle of the vehicle. The camera does NOT cover the complete area behind the vehicle.



WARNING

- Never rely solely on the rear camera display when backing-up.
- ALWAYS look around your vehicle to make sure there are no objects or obstacles before moving the vehicle in any direction to prevent a collision.

- Always pay close attention when the vehicle is driven close to objects, particularly pedestrians, and especially children.
- During winter the camera image may be foggy due to the exhaust gas if the vehicle is stopped for a long time or parked in an indoor parking lot and when you park or stop your vehicle on hills.
- Due to the location of the camera, the license plate may be partially shown on the bottom of the rear view screen.

NOTICE

- Do not spray the camera or its surrounding area directly with a high pressure washer. Shock applied from high pressure water may cause the device to not operate normally.
- Do not use any cleanser containing acid or alkaline detergents when cleaning the lens. Use only a mild soap or neutral detergent, and rinse thoroughly with water.



Information

Always keep the camera lens clean. The camera may not work normally if the lens is covered with dirt, water or snow.

Rear view while driving (if equipped)

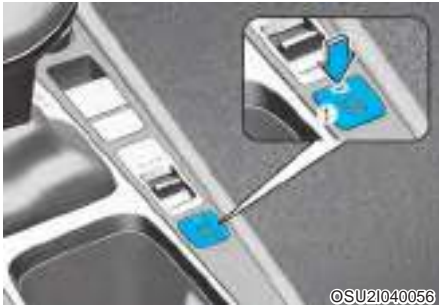

The driver is able to check the rear view on the screen while driving, it is to assist with safe driving.

Operating conditions

Press the Parking/View button while the gear is in D (Drive) or N (Neutral), the driving rear view will appear on the screen.

Off conditions

- Press the Parking/View button again, the driving rear view will turn off.
- Press one of the infotainment system button, the driving rear view will turn off.
- Shift the gear to P (Park), the driving rear view will turn off.

Surround view monitor (if equipped)

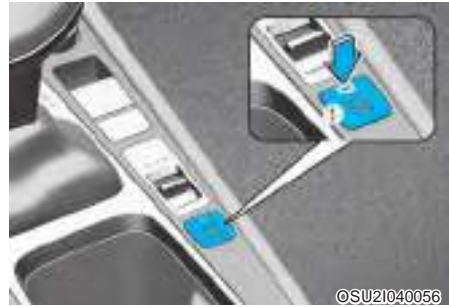

The Surround View Monitor system can assist in parking by allowing the driver to see around the vehicle.

Push the button to operate the system. To cancel the system, push the button again.

Operating conditions

- When the Engine Start/Stop button is in the ON position
- When the transmission is in D, N or R
- When vehicle speed is under 15km/h

i Information

- When vehicle speed is over 15km/h, the system will turn off. The system will not automatically turn on again, even though vehicle speed gets below 15 km/h. Push the button again, to turn on the system.
- When the vehicle is backing up, the system will turn ON regardless of vehicle speed or button status. However, if vehicle speed is over 15 km/h when driving forward, the SVM system will turn off.
- A warning appears on the system when:
 - The tailgate is opened
 - The driver's door is opened
 - The passenger's door is opened
 - The outside rearview mirror is folded
- If the system is not operating normally, we recommend that you take your vehicle to an authorized HYUNDAI dealer and have the system checked.

For more details, refer to the separately supplied manual with your vehicle.

! CAUTION

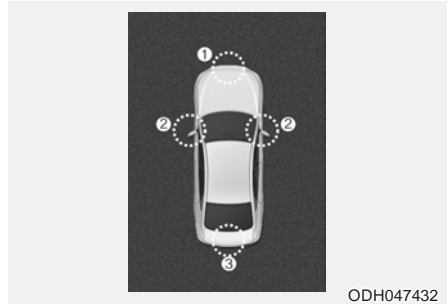

- (1) Front camera
- (2) Left/Right camera
- (3) Rear camera

Surround View Monitor system only serves to assist the driver in parking. **ALWAYS** look around your vehicle to make sure there are no objects or obstacles before moving the vehicle.

NOTICE

Always keep the camera lens clean. The camera may not work normally if the lens is covered with foreign material.

BLIND-SPOT VIEW MONITOR (BVM)



Blind-Spot View Monitor system displays the left or right side of the rear blind spot area of your vehicle in the AVN when the left or right turn signal is on. This function helps you drive safely when changing lanes.

WARNING

- Blind-Spot View Monitor system is a supplemental system only. It is the responsibility of the driver to always check the area around the vehicle before and while making turns or changing lanes.
- Always look around your vehicle to make sure there are no objects or obstacles before moving the vehicle in any direction to prevent a collision
- Objects are closer than they appear. Failure to visually confirm that is safe to change the lane before doing so may result in crash and serious injury or death.
- Always keep the camera lens clean. The camera may not work normally if the lens is covered with foreign substance.

- The system is activated when the following steps are performed.
 - The ignition switch is turned to the ON position
 - The gear is in D (Drive), N (Neutral) position
 - Vehicle speed is over 0 km/h
 - The turn signal is turned on
- The system is deactivated when the following steps are performed.
 - The turn signal is turned off

FORWARD/REVERSE PARKING DISTANCE WARNING (PDW) (IF EQUIPPED)



Forward/Reverse Parking Distance Warning assists the driver during movement of the vehicle by chiming if any object is sensed within the distance of 100 cm (39 in.) in front and 120 cm (47 in.) behind the vehicle.

This system is a supplemental system that senses objects within the range and location of the sensors, it cannot detect objects in other areas where sensors are not installed.



WARNING

- **ALWAYS** look around your vehicle to make sure there are no objects or obstacles before moving the vehicle in any direction to prevent a collision.
- Always pay close attention when the vehicle is driven close to objects, particularly pedestrians, and especially children.
- Be aware that some objects may not be visible on the screen or be detected by the sensors, due to the objects distance, size or material, all of which can limit the effectiveness of the sensor.
- Do not tamper with the location or size of the license plate discretionally.







Operation of Forward/Reverse Parking Distance Warning

Operating condition



- This system will activate when the Parking Safety button is pressed with the engine running.
- The Parking Safety button turns on automatically and activates Forward/Reverse Parking Distance Warning when you press the R(Reverse) button. However, if vehicle speed exceeds 10 km/h (6 mph), the system will not warn you even though objects are detected, and if vehicle speed exceeds 20 km/h (12 mph), the system will turn off automatically. To turn on the system, press the Parking Safety button.
- When more than two objects are sensed at the same time, the closest one will be recognized first.

Types of warning sound and indicator

Distance from object cm (in.)		Warning indicator		Warning sound
		When driving forward	When driving rearward	
60 ~ 100 (24 ~39)	Front		-	Buzzer beeps intermittently
60 ~ 120 (24 ~47)	Rear	-		Buzzer beeps intermittently
30 ~ 60 (12 ~24)	Front			Buzzer beeps frequently
	Rear	-		Buzzer beeps frequently
30 (12)	Front			Buzzer sounds continuously
	Rear	-		Buzzer sounds continuously

NOTICE

- The indicator may differ from the illustration depending on objects or sensors status. If the indicator blinks, we recommend that the system be checked by an authorized HYUNDAI dealer.
- If the audible warning does not sound or if the buzzer sounds intermittently when shifting into R (Reverse) position, this may indicate a malfunction with Forward/ Reverse Parking Distance Warning. If this occurs, we recommend that you have your vehicle checked by an authorized HYUNDAI dealer as soon as possible.

Non-operational conditions of Forward/Reverse Parking Distance Warning

Forward/Reverse Parking Distance Warning may not operate normally when:

- Moisture is frozen to the sensor.
- Sensor is covered with foreign matter, such as snow or water, or the sensor cover is blocked.

There is a possibility of Forward/Reverse Parking Distance Warning malfunction when:

- Driving on uneven road surfaces such as unpaved roads, gravel, bumps, or gradient.
- Objects generating excessive noise such as vehicle horns, loud motorcycle engines, or truck air brakes can interfere with the sensor.
- Heavy rain or water spray is present.
- Wireless transmitters or mobile phones are present near the sensor.
- The sensor is covered with snow.
- Any non-factory equipment or accessories have been installed, or if the vehicle bumper height or sensor installation has been modified.

Detecting range may decrease when:

- Outside air temperature is extremely hot or cold.
- Undetectable objects smaller than 1 m and narrower than 14 cm in diameter.

The following objects may not be recognized by the sensor:

- Sharp or slim objects such as ropes, chains or small poles.
- Objects, which tend to absorb sensor frequency such as clothes, spongy material or snow.



WARNING

Your new vehicle warranty does not cover any accidents or damage to the vehicle or injuries to its occupants related to Forward/Reverse Parking Distance Warning. Always drive safely and cautiously.

Forward/Reverse Parking Distance Warning precautions

- Forward/Reverse Parking Distance Warning may not sound consistently depending on the speed and shapes of the objects detected.
- Forward/Reverse Parking Distance Warning may malfunction if the vehicle bumper height or sensor installation has been modified or damaged. Any non-factory installed equipment or accessories may also interfere with the sensor performance.
- The sensor may not recognize objects less than 30 cm (12 in.) from the sensor, or it may sense an incorrect distance. Use caution.
- When the sensor is frozen or stained with snow, dirt, or water, the sensor may be inoperative until the stains are removed using a soft cloth.
- Do not push, scratch or strike the sensor. Sensor damage could occur.
- Do not spray the sensors or its surrounding area directly with a high pressure washer. Shock applied from high pressure water may cause the device to not operate normally.

REVERSE PARKING DISTANCE WARNING (PDW) (IF EQUIPPED)



[A] : Sensor

Reverse Parking Distance Warning system assists the driver during reverse movement of the vehicle by chiming if any object is sensed within the distance of 100 cm (39 inches) behind the vehicle.

This system is a supplemental system that senses objects within the range and location of the sensors, it cannot detect objects in other areas where sensors are not installed.

Operation of Reverse Parking Distance Warning system

Operating condition



- This system will activate when backing up with the ignition switch in the ON position. However, if vehicle speed exceeds 5 km/h (3 mph), the system may not detect objects.
- If vehicle speed exceeds 10 km/h (6 mph), the system will not warn you even though objects are detected.
- When more than two objects are sensed at the same time, the closest one will be recognized first.



WARNING

- **ALWAYS** look around your vehicle to make sure there are not any objects or obstacles before moving the vehicle in any direction to prevent a collision.
- Always pay close attention when the vehicle is driven close to objects, particularly pedestrians, and especially children.
- Be aware that some objects may not be visible on the screen or be detected by the sensors, due to the objects distance, size or material, all of which can limit the effectiveness of the sensor.

Types of warning indicator and sound

Distance from object	Warning indicator	Warning sound
100 cm ~ 61 cm (39 in. ~ 24 in.)		Buzzer beeps intermittently.
60 cm ~ 31 cm (24 in. ~ 12 in.)		Buzzer beeps more frequently.
Less than 30 cm (12 in.)		Buzzer beeps continuously.

NOTICE

- The indicator may differ from the illustration depending on objects or sensors status. If the indicator blinks, we recommend that you have your vehicle checked by an authorized HYUNDAI dealer.
- If the audible warning does not sound or if the buzzer sounds intermittently when shifting into R (Reverse) position, this may indicate a malfunction with Reverse Parking Distance Warning system. If this occurs, we recommend that you have your vehicle checked by an authorized HYUNDAI dealer as soon as possible.

Non-operational conditions of Reverse Parking Distance Warning system

Reverse Parking Distance Warning system may not operate normally when:

- Moisture is frozen to the sensor.
- The sensor is covered or stained with foreign material, such as snow or water, or the sensor cover is blocked.

There is a possibility of a Reverse Parking Distance Warning system malfunction when:

- Driving on uneven road surfaces such as unpaved roads, gravel, bumps, or gradient.
- Objects generating excessive noise such as vehicle horns, loud motorcycle engines, or truck air brakes can interfere with the sensor.
- Heavy rain or water spray is present.
- Wireless transmitters or mobile phones are present near the sensor.
- The sensor is covered with snow.
- Any non-factory equipment or accessories have been installed, or if the vehicle bumper height or sensor installation has been modified.

Detecting range may decrease when:

- Outside air temperature is extremely hot or cold.

The following objects may not be recognized by the sensor:

- Sharp or slim objects such as ropes, chains or small poles.
- Objects, which tend to absorb sensor frequency such as clothes, spongy material or snow.
- Undetectable objects smaller than about 1 m (40 in.) and narrower than about 14 cm (6 in.) in diameter.



Information

The system may not recognize objects less than 30 cm (12 in.) from the sensor, or it may sense an incorrect distance.

NOTICE

Do not push, scratch or strike the sensor with any hard objects that could damage the surface of the sensor. Sensor damage could occur.



WARNING

Your new vehicle warranty does not cover any accidents or damage to the vehicle or injuries to its occupants due to a Reverse Parking Distance Warning system malfunction. Always drive safely and cautiously.

Reverse Parking Distance Warning system precautions

- Reverse Parking Distance Warning system may not sound consistently depending on the speed and shapes of the objects detected.
- Reverse Parking Distance Warning system may malfunction if the vehicle bumper height or sensor installation has been modified or damaged. Any non-factory installed equipment or accessories may also interfere with the sensor performance.
- The sensor may not recognize objects less than 30 cm (12 in.) from the sensor, or it may sense an incorrect distance. Use caution.
- When the sensor is frozen or stained with snow, dirt, or water, the sensor may be inoperative until the stains are removed using a soft cloth.
- Do not push, scratch or strike the sensor with any hard objects that could damage the surface of the sensor. Sensor damage could occur.
- Do not spray the sensors or its surrounding area directly with a high pressure washer. Shock applied from high pressure water may cause the device to not operate normally.

CLIMATE CONTROL SYSTEM

Defroster

NOTICE

To prevent damage to the conductors bonded to the inside surface of the rear window, never use sharp instruments or window cleaners containing abrasives to clean the window.

If you want to defrost and defog the front windshield, refer to “Windshield defrosting and defogging” in this section.

Rear window defroster (if equipped)



OSU21059102



OSU21059103

The defroster heats the window to remove frost, fog and thin ice from the interior and exterior of the rear window, while engine is running.

To activate the rear window defroster, press the rear window defroster button located in the climate control system. The indicator on the rear window defroster button illuminates when the defroster is ON.

To turn off the defroster, press the rear window defroster button again.

i Information

- If there is heavy accumulation of snow on the rear window, brush it off before operating the rear defroster.
- The rear window defroster automatically turns off after approximately 20 minutes or when the ignition switch is turned off.

Manual climate control system (if equipped)





OSU21051100

1. Temperature control knob
2. Fan speed control knob
3. Mode selection knob
4. Air intake control button
(recirculated air position or outside (fresh) air position)
5. A/C (Air conditioning) button
6. Rear window defroster button (if equipped)

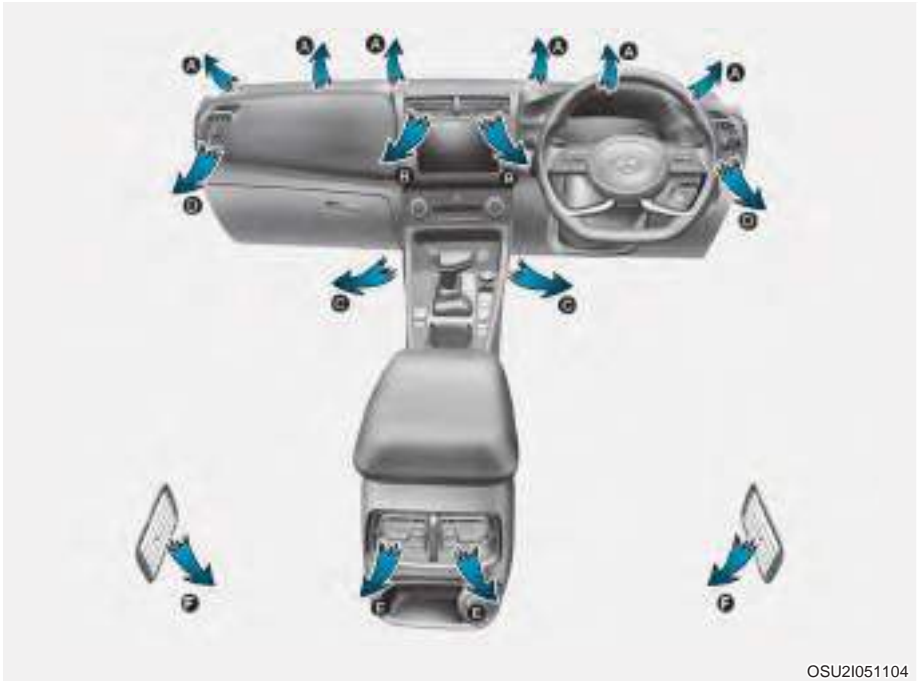
Heating and air conditioning



1. Start the engine.
2. Set the mode to the desired position.
To improve the effectiveness of heating and cooling :
 - Heating: 
 - Cooling: 
3. Set the temperature control to the desired position.
4. Set the air intake control to the outside (fresh) air or recirculated air position.
5. Set the fan speed control to the desired speed.
6. If air conditioning is desired, turn the air conditioning system (if equipped) on.

Mode selection



The mode selection knob controls the direction of the air flow through the ventilation system.

Air can be directed to the floor, dashboard outlets, or windshield. Five symbols are used to represent Face, Bi-Level, Floor, Floor-Defrost and Defrost air position.



Face-Level (B, D, E, H)

Air flow is directed toward the upper body and face. Additionally, each outlet can be controlled to direct the air discharged from the outlet.



Bi-Level (B, C, D, E)

Air flow is directed towards the face and the floor.



Floor-Level (A, C, D)

Most of the air flow is directed to the floor, with a small amount of the air being directed to the windshield, side window defrosters and side vents.



Floor/Defrost-Level (A, C, D)

Most of the air flow is directed to the floor and the windshield with a small amount directed to the side window defrosters and side vents.



Defrost-Level (A, D)

Most of the air flow is directed to the windshield with a small amount of air directed to the side vents.

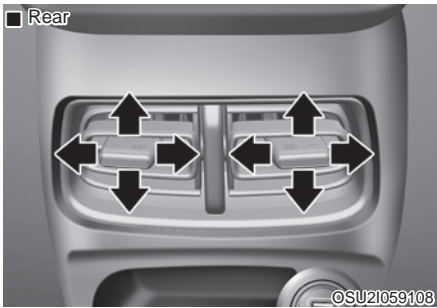
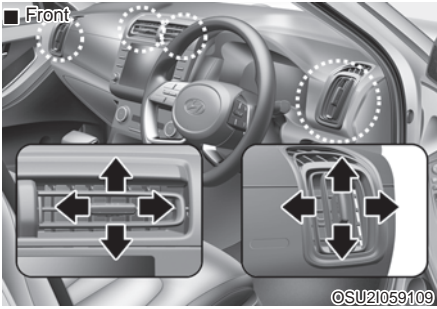

Instrument panel vents

You can adjust the direction of air delivered from these vents using the vent control lever as shown.

Temperature control



The temperature will increase by turning the knob to the right.

The temperature will decrease by turning the knob to the left.

Air intake control



This button is used to select the outside (fresh) air position or recirculated air position.

Recirculated air position



The indicator light on the button illuminates when the recirculated air position is selected.

With the recirculated air position selected, air from the passenger compartment will be drawn through the climate control system and heated or cooled according to the function selected.

Outside (fresh) air position



The indicator light on the button will turn off when the outside (fresh) air position is selected.

With the outside (fresh) air position selected, air enters the vehicle from outside and is heated or cooled according to the function selected.

i Information

Prolonged use of the air conditioning with the recirculated air position selected will result in excessively dry air in the passenger compartment.

! WARNING

- **Continued use of the climate control system operation in the recirculated air position can cause drowsiness or sleepiness, that may cause loss of vehicle control resulting in an accident. Set the air intake control to the outside (fresh) air position as much as possible while driving.**
- **Continued use of the climate control system operation in the recirculated air position (without the air conditioning selected) may allow humidity to increase inside the vehicle which may fog the glass and obscure visibility.**
- **Do not sleep in a vehicle with air conditioning or heating system on. It may cause serious harm or death due to a drop in the oxygen level and/or body temperature.**

Fan speed control



OSU2I059110

Turn the knob to the right to increase the fan speed and airflow. Turn the knob to the left to decrease fan speed and airflow.

Air conditioning (A/C) (if equipped)



OSU2I059111

Press the A/C button to turn the air conditioning system on (indicator light will illuminate). Press the button again to turn the air conditioning system off.

System operation

Ventilation

1. Select the Face Level  mode.
2. Set the air intake control to the outside (fresh) air position.
3. Set the temperature control to the desired position.
4. Set the fan speed control to the desired speed.

Heating

1. Select the Floor Level  mode.
2. Set the air intake control to the outside (fresh) air position.
3. Set the temperature control to the desired position.
4. Set the fan speed control to the desired speed.
5. If dehumidified heating is desired, turn the air conditioning system on.

If the windshield fogs up, select the Floor & Defrost  mode or select the Front Defroster  mode.

Operation Tips

- To keep dust or unpleasant fumes from entering the car through the ventilation system, temporarily set the air intake control to the recirculated air position. Return the control to the fresh air position when the irritation has passed. This will help keep the driver alert and comfortable.
- To prevent inside of the windshield from fogging, set the air intake control to the fresh air position and fan speed to the desired position, turn on the air conditioning system, and adjust the temperature control to desired temperature.

Air conditioning (if equipped)

HYUNDAI Air Conditioning Systems are filled with a R-134a refrigerant.

1. Start the engine.
2. Push the air conditioning button.
3. Set the mode to the Face Level  mode.
4. Set the air intake control to the recirculated air position. However, prolonged operation of the recirculated air position will excessively dry the air. In this case, change the air position.
5. Adjust the fan speed control and temperature control to maintain maximum comfort.

When maximum cooling is desired, set the temperature control to the extreme left position then set the fan speed control to the highest speed.

NOTICE

- **The refrigerant system should only be serviced by trained and certified technicians to insure proper and safe operation.**
- **The refrigerant system should be serviced in a well-ventilated place.**
- **The air conditioning evaporator (cooling coil) shall never be repaired or replaced with one removed from a used or salvaged vehicle and new replacement MAC evaporators shall be certified (and labeled) as meeting SAE Standard J2842.**

NOTICE

- **When using the air conditioning system, monitor the temperature gauge closely while driving up hills or in heavy traffic when outside temperatures are high. Air conditioning system operation may cause engine overheating. Continue to use the fan but turn the air conditioning system off if the temperature gauge indicates engine overheating.**
- **When opening the windows in humid weather air conditioning may create water droplets inside the vehicle. Since excessive water droplets may cause damage to electrical equipment, air conditioning should only be used with the windows closed.**

Air conditioning system operation tips

- If the vehicle has been parked in direct sunlight during hot weather, open the windows for a short time to let the hot air inside the vehicle escape.
- After sufficient cooling has been achieved, switch back from the recirculated air to the fresh outside air position.
- To help reduce moisture inside of the windows on rainy or humid days, decrease the humidity inside the vehicle by operating the air conditioning system with the windows closed.
- Use the air conditioning system every month only for a few minutes to ensure maximum system performance.
- If you operate air conditioner excessively, the difference between the temperature of the outside air and that of the windshield could cause the outer surface of the windshield to fog up, causing loss of visibility. In this case, set the mode selection knob or button to the  position and fan speed control to the lower speed.

System maintenance

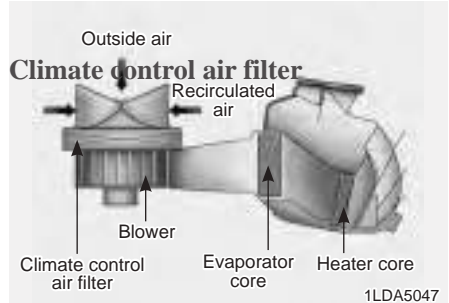

This filter is installed behind the glove box. It filters the dust or other pollutants that enter the vehicle through the heating and air conditioning system.

We recommend the climate control air filter be replaced by an authorized HYUNDAI dealer according to the maintenance schedule. If the car is being driven in severe conditions such as dusty or rough roads, more frequent air conditioner filter inspections and changes are required.

If the air flow rate suddenly decreases, we recommend the system be checked at an authorized HYUNDAI dealer.

Checking the amount of air conditioner refrigerant and compressor lubricant

When the amount of refrigerant is low, the performance of the air conditioning is reduced. Overfilling also has a bad influence on the air conditioning system.

Therefore, if abnormal operation is found, we recommend that the system be inspected by an authorized HYUNDAI dealer.

i Information

- **Replace the filter according to the Maintenance Schedule.**

If the car is being driven in severe conditions such as dusty, rough roads, more frequent climate control air filter inspections and changes are required.

- **When the air flow rate suddenly decreases, we recommend that the system be checked by an authorized HYUNDAI dealer.**

NOTICE

It is important that the correct type and amount of oil and refrigerant is used. Otherwise, damage to the compressor and abnormal system operation may occur. To prevent damage, the air conditioning system in your vehicle should only be serviced by trained and certified technicians.

⚠ WARNING

Vehicles equipped with R-134a



Since the refrigerant is operated at very high pressure, the air conditioning system should only be serviced by trained and certified technicians.

All refrigerants should be reclaimed with proper equipment.

Venting refrigerants directly to the atmosphere is harmful to individuals and environment. Failure to heed these warnings can lead to serious injuries.

Automatic climate control system (if equipped)



OSU2I051101

1. Fan speed control knob
2. A/C (Air conditioning) button
3. Recirculation mode/Fresh mode
4. Mode selection button
5. Rear window defroster button
6. Front windshield defroster button
7. OFF button
8. Temperature control knob
9. AUTO (automatic control) button
10. Climate control screen

Automatic heating and air conditioning

The Automatic Climate Control System is controlled by setting the desired temperature.



1. Press the AUTO button.

The modes, fan speeds, air intake and air-conditioning will be controlled automatically by the temperature setting you select.



2. Turn the temperature control knob to the desired temperature. If the temperature is set to the lowest setting (LO), the air conditioning system will operate continuously.

To turn the automatic operation off, select any button of the following:

- Mode selection button
- Front windshield defrost button (Press the button one more time to deselect the front windshield defroster function.
- Fan speed control button

The selected function will be controlled manually while other functions operate automatically.

For your convenience and to improve the effectiveness of the climate control, use the AUTO button and set the temperature to 23°C (73°F).

i Information



Never place anything near the sensor located to ensure better control of the heating and cooling system.

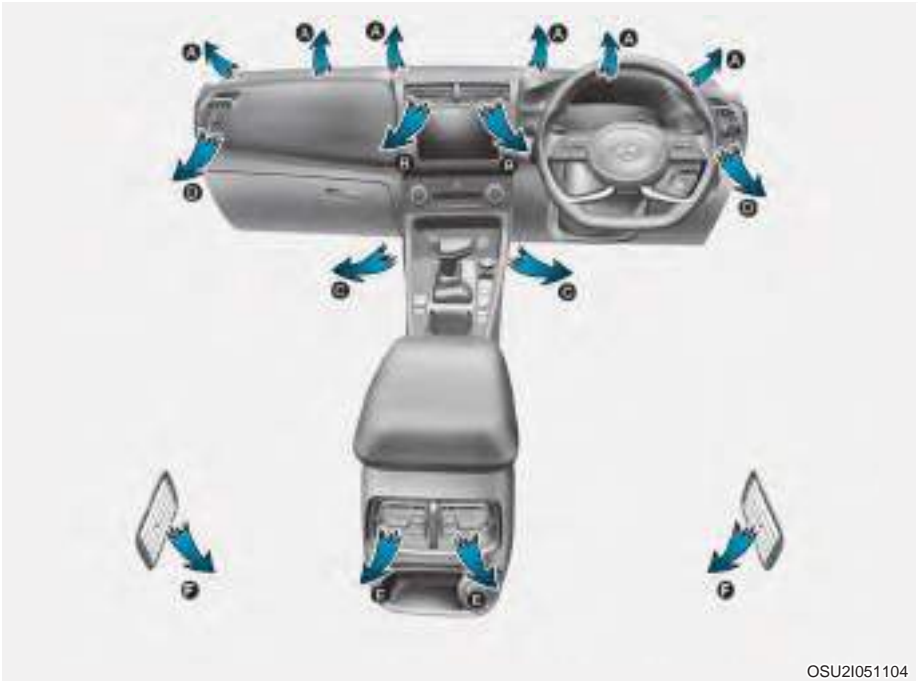

Heating and air conditioning



OSU21051104

The heating and cooling system can be controlled manually by pressing buttons other than the AUTO button. In this case, the system works sequentially according to the order of buttons selected.

When pressing any button (or turning any knob) except the AUTO button while using automatic operation, the functions not selected will be controlled automatically.

1. Start the engine.
2. Set the mode to the desired position.
To improve the effectiveness of heating and cooling:
 - Heating: 
 - Cooling: 
3. Set the temperature control to the desired position.
4. Press the fresh button.
5. Set the fan speed control to the desired speed.
6. If air conditioning is desired, turn the air conditioning system on.
7. Press the AUTO button in order to convert to full automatic control of the system.

Mode selection



The mode selection button controls the direction of the air flow through the ventilation system.

The air flow outlet port is converted as follows:



Air flow is directed toward the upper body and face. Additionally, each outlet can be controlled to direct the air discharged from the outlet.



Air flow is directed towards the face and the floor.



Most of the air flow is directed to the floor, with a small amount of the air being directed to the windshield, side window defrosters and side vents.



Most of the air flow is directed to the floor and the windshield with a small amount directed to the side window defrosters and side vents.



Defrost-Level (A, D)

Most of the air flow is directed to the windshield with a small amount of air directed to the side window defrosters.

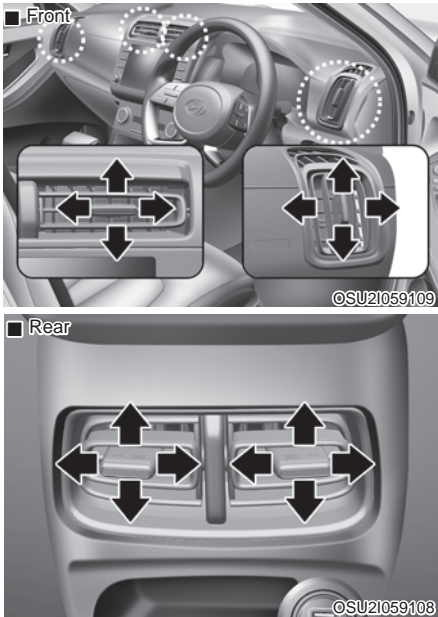

Instrument panel vents

The outlet vents located in the rear can be opened or closed separately using the thumbwheel.

Also, you can adjust the direction of air delivered from these vents using the vent control lever as shown.

Temperature control



The temperature will increase to the maximum (HI) by turning the knob to the right.

The temperature will decrease to the minimum (LO) by turning the knob to the left.

The temperature will increase or decrease by 0.5°C/1°F each time you turn the knob. When set to the lowest temperature setting, the air conditioning will operate continuously.

Air intake control



The air intake control button is used to select either Fresh mode (outside air) or Recirculation mode (cabin air).

Recirculated air position



The indicator light on the button illuminates when the recirculated air position is selected.

With the recirculated air position selected, air from the passenger compartment will be drawn through the climate control system and heated or cooled according to the function selected.

Outside (fresh) air position



The indicator light on the button will turn off when the outside (fresh) air position is selected.

With the outside (fresh) air position selected, air enters the vehicle from outside and is heated or cooled according to the function selected.

Information

Prolonged use of the air conditioning with the recirculated air position selected will result in excessively dry air in the passenger compartment.

WARNING

- Continued use of the climate control system operation in the recirculated air position can cause drowsiness or sleepiness, that may cause loss of vehicle control resulting in an accident. Set the air intake control to the outside (fresh) mode as much as possible while driving.
- Continued use of the climate control system operation in the recirculated air position (without the air conditioning selected) may allow humidity to increase inside the vehicle which may fog the glass and obscure visibility.
- Do not sleep in a vehicle with air conditioning or heating system on. It may cause serious harm or death due to a drop in the oxygen level and/or body temperature.

Fan speed control



Turn the knob to the right increase the fan speed and air flow. Turn the knob to the left to decrease fan speed and air flow.

Air conditioning



Push the A/C button to manually turn the system on (indicator light will illuminate) and off.

OFF mode





Push the OFF button to turn off the climate control system. You can still operate the mode and air intake buttons with the ignition switch in the ON position.

System operation

Ventilation

1. Select the Face Level  mode.
2. Set the air intake control to the outside (fresh) mode.
3. Set the temperature control to the desired position.
4. Set the fan speed control to the desired speed.

Heating

1. Select the Floor Level  mode.
 2. Set the air intake control to the outside (fresh) mode.
 3. Set the temperature control to the desired position.
 4. Set the fan speed control to the desired speed.
 5. If dehumidified heating is desired, turn the air conditioning system on.
- If the windshield fogs up, select the Front Defroster  mode.

Operation Tips

- To keep dust or unpleasant fumes from entering the car through the ventilation system, temporarily set the air intake control to the recirculated mode. Return the control to the fresh mode when the irritation has passed. This will help keep the driver alert and comfortable.
- To prevent inside of the windshield from fogging, set the air intake control to the fresh air position and fan speed to the desired position, turn on the air conditioning system, and adjust the temperature control to desired temperature.

Air conditioning

HYUNDAI Air Conditioning Systems are filled with a R-134a refrigerant.

1. Start the engine.
2. Push the air conditioning button.
3. Set the mode to the Face Level  mode.
4. Set the air intake control to the recirculated mode. However, prolonged operation of the recirculated mode will excessively dry the air. In this case, change the mode.
5. Adjust the fan speed control and temperature control to maintain maximum comfort.

When maximum cooling is desired, set the temperature control to the lowest setting (LO) then set the fan speed control to the highest speed.

NOTICE

- **The refrigerant system should only be serviced by trained and certified technicians to insure proper and safe operation.**
- **The refrigerant system should be serviced in a well-ventilated place.**
- **The air conditioning evaporator (cooling coil) shall never be repaired or replaced with one removed from a used or salvaged vehicle and new replacement MAC evaporators shall be certified (and labeled) as meeting SAE Standard J2842.**

NOTICE

- **When using the air conditioning system, monitor the temperature gauge closely while driving up hills or in heavy traffic when outside temperatures are high. Air conditioning system operation may cause engine overheating. Continue to use the fan but turn the air conditioning system off if the temperature gauge indicates engine overheating.**
- **When opening the windows in humid weather air conditioning may create water droplets inside the vehicle. Since excessive water droplets may cause damage to electrical equipment, air conditioning should only be used with the windows closed.**

Air conditioning system operation tips

- If the vehicle has been parked in direct sunlight during hot weather, open the windows for a short time to let the hot air inside the vehicle escape.
- After sufficient cooling has been achieved, switch back from the recirculated mode to the fresh mode.
- To help reduce moisture inside of the windows on rainy or humid days, decrease the humidity inside the vehicle by operating the air conditioning system with the windows closed.
- Use the air conditioning system every month only for a few minutes to ensure maximum system performance.
- If you operate air conditioner excessively, the difference between the temperature of the outside air and that of the windshield could cause the outer surface of the windshield to fog up, causing loss of visibility. In this case, set the mode selection knob or button to the  position and fan speed control to the lower speed.

System maintenance

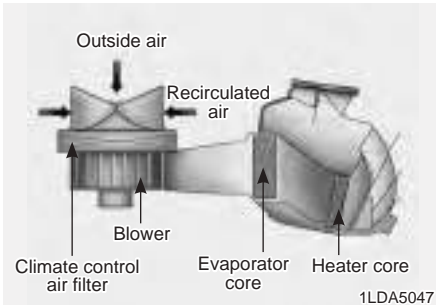

Climate control air filter

This filter is installed behind the glove box. It filters the dust or other pollutants that enter the vehicle through the heating and air conditioning system.

We recommend the climate control air filter be cleaned according to the maintenance schedule. If the car is being driven in severe conditions such as dusty or rough roads, more frequent air conditioner filter inspections and cleaning are required.

If the air flow rate suddenly decreases, we recommend the system be checked at an authorized HYUNDAI dealer.

Checking the amount of air conditioner refrigerant and compressor lubricant

When the amount of refrigerant is low, the performance of the air conditioning is reduced. Overfilling also has a bad influence on the air conditioning system.

Therefore, if abnormal operation is found, we recommend that the system be inspected by an authorized HYUNDAI dealer.

NOTICE

It is important that the correct type and amount of oil and refrigerant is used. Otherwise, damage to the compressor and abnormal system operation may occur. To prevent damage, the air conditioning system in your vehicle should only be serviced by trained and certified technicians.



WARNING



Vehicles equipped with R-134a



Since the refrigerant is operated at very high pressure, the air conditioning system should only be serviced by trained and certified technicians.

All refrigerants should be reclaimed with proper equipment.

Venting refrigerants directly to the atmosphere is harmful to individuals and environment. Failure to heed these warnings can lead to serious injuries.

Windshield defrosting and defogging

WARNING





Do not use the  or  position during cooling operation in extremely humid weather. The difference between the temperature of the outside air and that of the windshield could cause the outer surface of the windshield to fog up, causing loss of visibility. Set the mode selection to the  position and fan speed control to a lower speed.

- For maximum defrosting, set the temperature control to the extreme right/hot position and the fan speed control to the highest speed.
- If warm air to the floor is desired while defrosting or defogging, set the mode to the floor-defrost position.
- Before driving, clear all snow and ice from the windshield, rear window, outside rear view mirrors, and all side windows.
- Clear all snow and ice from the hood and air inlet at the bottom of the windshield.
- If the engine temperature is still cold after starting, then a brief engine warm up period may be required for the vented air flow to become warm or hot.

Manual climate control system



To defog inside windshield

1. Select desired fan speed.
2. Select desired temperature.
3. Select the  or  position.
4. The outside (fresh) air will be selected automatically. Additionally, the air conditioning will automatically operate if the mode is selected to the  or  position.

If the air conditioning and outside (fresh) mode are not selected automatically, press the corresponding button manually.



To defrost outside windshield

1. Set the fan speed to the highest (extreme right) position.
2. Set the temperature to the extreme hot position.
3. Select the  position.

4. The outside (fresh) mode and air conditioning will be selected automatically.

Automatic climate control system



To defog inside windshield

1. Select desired fan speed.
2. Select desired temperature.
3. Press the defroster button ().
4. The air-conditioning will turn on according to the detected ambient temperature, outside (fresh) and higher fan speed will be selected automatically.

If the air-conditioning, outside (fresh) air position and higher fan speed are not selected automatically, adjust the corresponding button or knob manually.

If the  position is selected, lower fan speed is adjusted to higher fan speed.



To defrost outside windshield

1. Set the fan speed to the highest position.
2. Set the temperature to the extreme hot (HI) position.
3. Press the defroster button ().
4. The air-conditioning will turn on according to the detected ambient temperature and outside (fresh) mode will be selected automatically.

If the  position is selected, lower fan speed is adjusted to higher fan speed

STORAGE COMPARTMENT

WARNING

Flammable materials

Do not store cigarette lighters, propane cylinders, or other flammable/explosive materials in the vehicle. These items may catch fire and/or explode if the vehicle is exposed to hot temperatures for extended periods.

WARNING

ALWAYS keep the storage compartment covers closed securely while driving. Items inside your vehicle are moving as fast as the vehicle. If you have to stop or turn quickly, or if there is a crash, the items may fly out of the compartment and may cause an injury if they strike the driver or a passenger.

NOTICE

To avoid possible theft, do not leave valuables in the storage compartment.

Center console storage



To open :
Pull up the storage cover.

Glove box



To open:
Pull the lever (1).

WARNING

ALWAYS close the glove box door after use.

An open glove box door can cause serious injury to the passenger in an accident, even if the passenger is wearing a seat belt.

Luggage tray



You can place a first aid kit, a reflector triangle (front tray), tools, etc. in the box for easy access.

- Grasp the strap on the top of the cover and lift it.

Cool box (if equipped)



You can keep beverage cans or other items cool in the glove box.

1. Turn on the air conditioning.
2. Turn the open/close switch (1) of the vent installed in the glove box to the open position.
3. When the cool box is not used, turn the switch (1) to the closed position.

WARNING

Do not put perishable food in the cool box because it may not maintain the necessary consistent temperature to keep the food fresh.

Information

- If the vent is blocked by items in the coolbox, cooling will be reduced.
- If the climate control system temperature control is in the warm or hot position, Cold air only will flow into the glove box.

INTERIOR FEATURES

Clock

WARNING

Do not adjust the clock while driving. You may lose your steering control and cause severe personal injury or accidents.

Ashtray (if equipped)

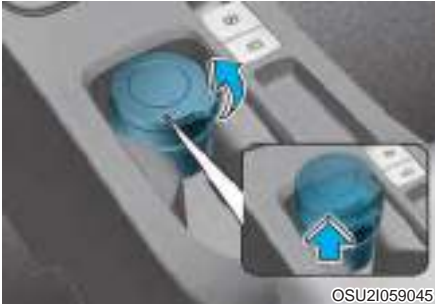

To use the ashtray, open the cover. To clean or empty the ashtray, pull the ashtray out.

Do not use the vehicle's ashtray as waste receptacles.

WARNING

Putting lit cigarettes or matches in an ashtray with other combustible materials may cause fire.

Cup holder

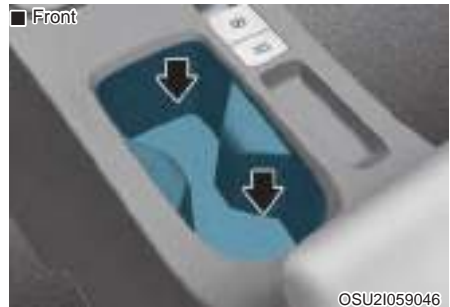

Cups or small beverage cans may be placed in the cup holders.

⚠ WARNING

- Avoid abrupt starting and braking when the cup holder is in use to prevent spilling your drink. If hot liquid spills, you could be burned. Such a burn to the driver could cause loss of vehicle control resulting in an accident.
- Do not place uncovered or unsecured cups, bottles, cans, etc., in the cup holder containing hot liquid while the vehicle is in motion. Injuries may result in the event of sudden stop or collision.
- Only use soft cups in the cup holders. Hard objects can injure you in an accident.

⚠ WARNING

Keep cans or bottles out of direct sun light and do not put them in a hot vehicle. It may explode.

NOTICE

- Keep your drinks sealed while driving to prevent spilling your drink. If liquid spills, it may get into the vehicle's electrical/electronic system and damage electrical/electronic parts.
- When cleaning spilled liquids, do not dry the cup holder at high temperature. This may damage the cup holder.

Sunvisor

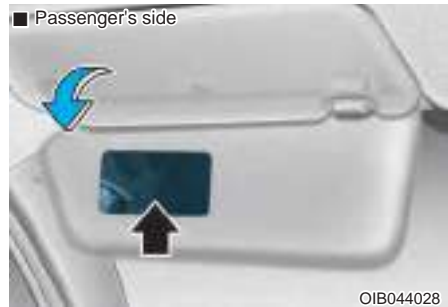
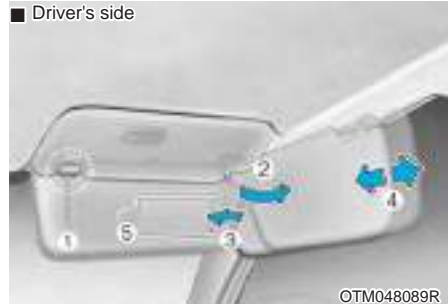

To use a sunvisor, pull it downward. To use a sunvisor for a side window, pull it downward, unsnap it from the bracket (1) and swing it to the side (2). To use the vanity mirror, pull down the sunvisor and slide the mirror cover (3). Adjust the sunvisor forward or backward(4) as needed. Use the ticket holder (5) to hold tickets.

⚠ WARNING

For your safety, do not block your view when using the sunvisor.

NOTICE

Do not put several tickets in the ticket holder at one time. This could cause damage to the ticket holder.

Power outlet (if equipped)



The power outlet is designed to provide power for mobile telephones or other devices designed to operate with vehicle electrical systems. The devices should draw less than 180W (Watt) with the engine running.

WARNING

Avoid electrical shocks. Do not place your fingers or foreign objects (pin, etc.) into a power outlet or touch the power outlet with a wet hand.

NOTICE

To prevent damage to the Power outlet:

- Use the power outlet only when the engine is running and remove the accessory plug after use. Using the accessory plug for prolonged periods of time with the engine off could cause the battery to discharge.
- Only use 12V electric accessories which are less than 180W (Watt) in electric capacity.
- Adjust the air-conditioner or heater to the lowest operating level when using the power outlet.
- Close the cover when not in use.
- Some electronic devices can cause electronic interference when plugged into a vehicle's power outlet. These devices may cause excessive audio static and malfunctions in other electronic systems or devices used in your vehicle.
- Push the plug in as far as it will go. If good contact is not made, the plug may overheat or the internal temperature fuse may open.
- Plug in battery equipped electrical/electronic devices with reverse current protection. The current from the battery may flow into the vehicle's electrical/electronic system and cause system malfunction.

USB charger (if equipped)



The USB charger is designed to recharge batteries of small size electrical devices using a USB cable.

The electrical devices can be recharged when the Engine Start/ Stop button is in the ACC, ON or START position.

The battery charging state may be monitored on the electrical device.

Disconnect the USB cable from the USB port after use.

- A smart phone or a tablet PC may get warmer during the re-charging process. It does not indicate any malfunction with the charging system.
- A smart phone or a tablet PC, which adopts a different re-charging method, may not be properly re-charged. In this case, use an exclusive charger of your device.
- The charging terminal is only to recharge a device. Do not use the charging terminal either to turn ON an audio or to play media on the infotainment system.

Wireless cellular phone charging system (if equipped)



On certain models, the vehicle comes equipped with a wireless cellular phone charger.

To start wireless charging, place the smart phone equipped with wireless charging function on the wireless charging pad. Firmly close all doors, and turn the ignition to IGN ON.

To charge a cellular phone

The wireless cellular phone charging system charges only the Qi-enabled cellular phones (Qi). Read the label on the cellular phone accessory cover or visit your cellular phone manufacturer's website to check whether your cellular phone supports the Qi technology.

The wireless charging process starts when you put a Qi-enabled cellular phone on the wireless charging unit.

1. Remove all items including smart key on wireless charging pad. If not, the wireless charging will be interrupted. Place the cellular phone on the center of the charging pad.
2. You can turn ON or OFF the wireless charging function in the user settings mode on the instrument cluster. For further information, refer to the "LCD Display Modes" in chapter 4.

If your cellular phone is not charging:

- Slightly change the position of the cellular phone on the charging pad.

In this case, temporarily stop the charging process, and re-attempt to charge your cellular phone again.

The system warns you with a message on the LCD display if the cellular phone is still on the wireless charging unit after the engine is turned OFF and the front door is opened.

Information

For some manufacturers' cellular phones, the system may not warn you even though the cellular phone is left on the wireless charging unit. This is due to the particular characteristic of the cellular phone and not a malfunction of the wireless charging.

WARNING

- The wireless cellular phone charging system may not support certain cellular phones, which are not verified for the Qi specification (Qi).
- When placing your cellular phone on the charging mat, position the phone in the middle of the mat for optimal charging performance. If your cell phone is off to the side, the charging rate may be less and in some cases the cell phone may experience higher heat conduction.
- In some cases, the wireless charging may stop temporarily when the Remote Key or Smart Key is used, either when starting the vehicle or locking/unlocking the doors, etc.
- The charging status will be appear on Head-up display (if equipped).
- The wireless charging process may temporarily stop, when temperature abnormally increases inside the wireless cellular phone charging system. Stop the charging cellular phone and wait until temperature falls to a certain level.
- The wireless charging process may temporarily stop when there is any metallic item, such as a coin, between the wireless cellular phone charging system and the cellular phone.
- When charging some cellular phones with a self-protection feature, the wireless charging speed may decrease and the wireless charging may stop.
- If the cellular phone has a thick cover, the wireless charging may not be possible.
- If the cell phone is not completely contacting the charging pad, wireless charging may not operate properly.
- Some magnetic items like credit cards, phone cards or rail tickets may be damaged if left with the cellular phone during the charging process.
- When any cellular phone without a wireless charging function or a metallic object is placed on the charging pad, a small noise may sound. This small sound is due to the vehicle discerning compatibility of the object placed on the charging pad. It does not affect your vehicle or the cellular phone in any way.
- Smaller handset users (ex. iPhone 8) may face intermittent charging issues due to its small size. (place the Smart Phone at Center of the PAD)
- To prevent liquid from damaging the wireless smart phone charging system in your vehicle, be sure not to spill liquid over the charging system when charging your phone

i Information

If the ignition switch is in the OFF position, the charging also stops.

Floor mat anchor(s) (if equipped)



ALWAYS use the Floor Mat Anchors to attach the front floor mats to the vehicle. The anchors on the front floor carpet keep the floor mats from sliding forward.

! WARNING

The following must be observed when installing ANY floor mat to the vehicle.

- Ensure that the floor mats are securely attached to the vehicle's floor mat anchor(s) before driving the vehicle.
- Do not use ANY floor mat that cannot be firmly attached to the vehicle's floor mat anchors.
- Do not stack floor mats on top of one another (e.g. all-weather rubber mat on top of a carpeted floor mat). Only a single floor mat should be installed in each position.

IMPORTANT - Your vehicle was manufactured with driver's side floor mat anchors that are designed to securely hold the floor mat in place. To avoid any interference with pedal operation, HYUNDAI recommends that the HYUNDAI floor mat designed for use in your vehicle be installed.

Shopping hook



It is convenient to keep small shopping carry bags in shopping hooks, which is located in the luggage compartment.

Side curtain (if equipped)



To use the side curtain:

1. Lift the curtain by the hook (1).
2. Hang the curtain on both sides of the hook.



CAUTION

- Always hang both sides of the curtain on the hook. This could cause damage to the side curtain if only one side of the curtain is hooked.
- Do not let any foreign material get in between the vehicle and side curtain. The side curtain may not be lifted up.
- Remove the curtain slowly from hooks. Sudden drop might result in damage to door trim

EXTERIOR FEATURES

Roof rack (if equipped)



Do not load cargo on the roof.

The roof rack is not for loading cargo but for aesthetic purpose.

INFOTAINMENT SYSTEM

NOTICE

- If you install an aftermarket HID head lamp, your vehicle's audio and electronic device may malfunction.
- Prevent chemicals such as perfume, cosmetic oil, sun cream, hand cleaner, and air freshener from contacting the interior parts because they may cause damage, button struck issues or discoloration.

USB port (if equipped)



You can use a USB port to plug in USB to play music.

NOTE : Please go through USB compatibility list in HYUNDAI India website.

i Information

When using a portable audio device connected to the power outlet, noise may occur during playback. If this happens, use the power source of the portable audio device.

Antenna

Pole antenna



The antenna will receive AM, FM broadcast signals, etc. and transmit data. This antenna pole is removable.

Rotate the antenna in a counterclockwise direction to remove it.

Rotate it in a clockwise direction to reinstall it.

Shark fin antenna



The shark fin antenna receives transmitted data. (for example: AM/FM)

NOTICE

- Before entering a place with a low height clearance, be sure that the antenna is removed.
- Be sure to remove the antenna before washing the vehicle in an automatic car wash or it may be damaged.
- When reinstalling your antenna, it is important that it is fully tightened and adjusted to the upright position to ensure proper reception. But it could be removed when parking the vehicle.

NOTICE

Installation of aftermarket antenna may result in water leakage, wind noise, rattling & improper radio operation. We recommend to use the antenna available with an authorized Hyundai dealer.

**Information**

Some models do not have audio (plastic blanking cover) system, and will not supply radio main cable. Thus if you want to insert Aftermarket audio or OEM audio to listen radio broadcasting service, we recommend to use the feeder cable available with an authorized HYUNDAI dealer.

Steering wheel audio control (if equipped)

■ Type A



■ Type B



The steering wheel audio control button is installed to promote safe driving.

NOTICE

Do not operate audio remote control buttons simultaneously.

VOLUME (+ / -) (1)

- Press the up button (+) to increase volume.
- Press the down button (-) to decrease volume.

SEEK/PRESET (/) (2)

If the SEEK/PRESET button is pressed for 0.8 second or more, it will work as follows in each mode.

RADIO mode

It will function as the AUTO SEEK select button. It will SEEK until next channel is reached.

MEDIA mode

It will function as the FF/REW button.

If the SEEK/PRESET button is pressed for less than 0.8 second, it will work as follows in each mode.

RADIO mode

It will function as the PRESET STATION select buttons.

MEDIA mode

It will function as the TRACK UP/DOWN button.

MODE (3)

- Press the MODE button to toggle through radio or media modes.
- Press and hold the button to turn the system ON/OFF.

MUTE (4)

- Press the button to mute the sound.
- Press the button again to activate the sound.

Detailed information for audio control buttons is included in the following pages in this chapter.

Audio / Video (AV) (if equipped)

Detailed information for the AVN system is described in a separately supplied manual.

Bluetooth® Wireless Technology hands-free (if equipped)



OSU21059059



OSU21059060



OSU21059061

(1) Call / Answer button : Press the button shortly.

Voice recognition mode (if equipped) : Press the button longer when you have an Android Auto or Carplay connection.

(2) Call end button

(3) Microphone

- Audio : For detailed information, refer to “AUDIO” in this chapter.
- Infotainment system : Detailed information for the *Bluetooth*® Wireless Technology hands-free is described in the manual supplied separately.

You can use the phone wirelessly by using the *Bluetooth*® Wireless Technology.

How vehicle radio works

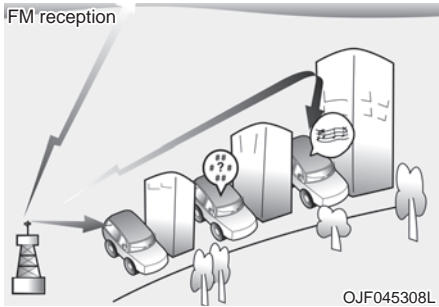

AM and FM radio signals are broadcast from transmitter towers located around your city. They are intercepted by the radio antenna on your vehicle. This signal is then processed by the radio and sent to your vehicle speakers.

When a strong radio signal has reached your vehicle, the precise engineering of your audio system ensures the best possible quality reproduction. However, in some cases the signal coming to your vehicle may not be strong and clear.

This can be due to factors, such as the distance from the radio station, closeness of other strong radio stations or the presence of buildings, bridges or other large obstructions in the area.

AM reception

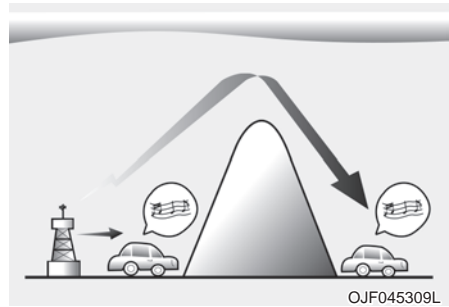

AM broadcasts can be received at greater distances than FM broadcasts. This is because AM radio waves are transmitted at low frequencies. These long, low frequency radio waves can follow the curvature of the earth rather than travelling straight out into the atmosphere. In addition, they curve around obstructions so that they can provide better signal coverage.

FM radio station

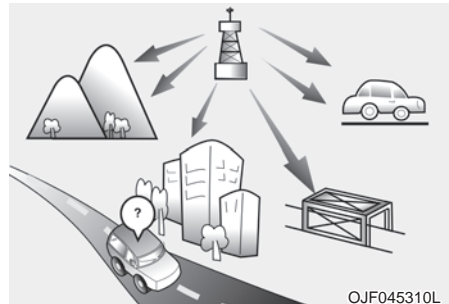

FM broadcasts are transmitted at high frequencies and do not bend to follow the earth's surface. Because of this, FM broadcasts generally begin to fade at short distances from the station. Also, FM signals are easily affected by buildings, mountains, or other obstructions.

These can result in certain listening conditions which might lead you to believe a problem exists with your radio. The following conditions are normal and do not indicate radio trouble :

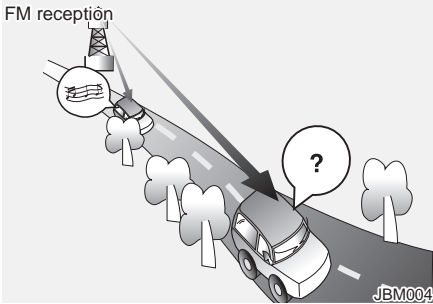

- **Fading** - As your vehicle moves away from the radio station, the signal will weaken and sound will begin to fade. When this occurs, we suggest that you select another stronger station.
- **Flutter/Static** - Weak FM signals or large obstructions between the transmitter and your radio can disturb the signal causing static or fluttering noises to occur. Reducing the treble level may lessen this effect until the disturbance clears.

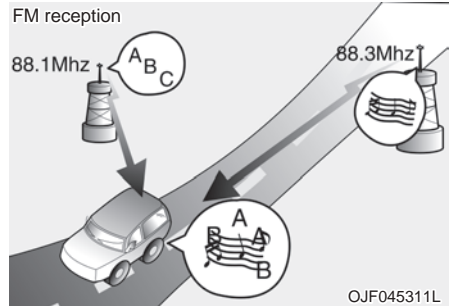

- **Station Swapping** - As a FM signal weakens, another more powerful signal near the same frequency may begin to play. This is because your radio is designed to lock onto the clearest signal. If this occurs, select another station with a stronger signal.
- **Multi-Path Cancellation** - Radio signals being received from several directions can cause distortion or fluttering. This can be caused by a direct and reflected signal from the same station, or by signals from two stations with close frequencies. If this occurs, select another station until the condition has passed.

Using a cellular phone or a two-way radio

When a cellular phone is used inside the vehicle, noise may be produced from the audio system. This does not mean that something is wrong with the audio equipment. In such a case, use the cellular phone at a place as far as possible from the audio equipment.

NOTICE

When using a communication system such as a cellular phone or a radio set inside the vehicle, a separate external antenna must be fitted. When a cellular phone or a radio set is used with an internal antenna alone, it may interfere with the vehicle's electrical system and adversely affect safe operation of the vehicle.



WARNING

Do not use a cellular phone while driving. Stop at a safe location to use a cellular phone.

iPod®

iPod® is a registered trademark of Apple Inc.

Bluetooth® Wireless Technology

The Bluetooth® word mark and logos are registered trademarks owned by Bluetooth SIG, Inc. and any use of such marks by HYUNDAI is under license.

Other trademarks and trade names are those of their respective owners.

A Bluetooth® Wireless Technology enabled cell phone is required to use Bluetooth® Wireless Technology.



7. While driving

Before driving	7-4
Before entering the vehicle	7-4
Before starting	7-4
Ignition switch	7-6
Key ignition switch	7-6
Engine Start/Stop button	7-10
Manual transmission	7-18
Manual transmission operation	7-18
Good driving practices	7-20
Intelligent Manual Transmission	7-21
Intelligent Manual Transmission operation	7-21
Automatic transmission	7-25
Automatic transmission operation.....	7-25
Parking	7-30
Good driving practices.....	7-30
Braking system	7-32
Power brakes	7-32
Disc brakes wear indicator	7-32
Rear drum brakes	7-33
Parking brake (hand type).....	7-33
Electronic Parking Brake (EPB).....	7-35
AUTO HOLD	7-41
Anti-lock Brake System (ABS).....	7-45
Electronic Stability Control (ESC).....	7-46
Vehicle Stability Management (VSM)	7-49
Hill-Start Assist Control (HAC)	7-50
Emergency Stop Signal (ESS).....	7-51
Good braking practices	7-51
Drive mode integrated control system	7-53
Drive mode	7-53
Traction control.....	7-56
Traction control mode.....	7-56
Traction mode operation	7-56
LCD display message.....	7-57

Cruise Control (CC)	7-58
Cruise Control operation	7-58
Special driving conditions.....	7-63
Hazardous driving conditions.....	7-63
Rocking the vehicle	7-63
Smooth cornering	7-64
Driving at night	7-64
Driving in the rain	7-64
Driving in flooded areas.....	7-65
Highway driving.....	7-65
Reducing the risk of a rollover.....	7-66
Winter driving	7-67
Snow or icy conditions.....	7-67
Winter precautions.....	7-69
Vehicle weight.....	7-71
Overloading	7-71



WARNING

Carbon monoxide (CO) gas is toxic. Breathing CO can cause unconsciousness and death.

Engine exhaust contains carbon monoxide which cannot be seen or smelled.

Do not inhale engine exhaust.

If at any time you smell engine exhaust inside the vehicle, open the windows immediately. Exposure to CO can cause unconsciousness and death by asphyxiation.

Be sure the exhaust system does not leak.

The exhaust system should be checked whenever the vehicle is raised to change the oil or for any other purpose. If you hear a change in the sound of the exhaust or if you drive over something that strikes the underneath side of the vehicle, we recommend that the exhaust system be checked as soon as possible by an authorized HYUNDAI dealer.

Do not run the engine in an enclosed area.

Letting the engine idle in your garage, even with the garage door open, is a hazardous practice. Run the engine only long enough to start the engine and to move the vehicle out of the garage.

Avoid idling the engine for prolonged periods with people inside the vehicle.

If it is necessary to idle the engine for a prolonged period with people inside the vehicle, be sure to do so only in an open area with the air intake set at "Fresh" and fan control set to high so fresh air is drawn into the interior.

Keep the air intakes clear.

To assure proper operation of the ventilation system, keep the ventilation air intakes located in front of the windshield clear of snow, ice, leaves, or other obstructions.

If you must drive with the tailgate/trunk open:

Close all windows.

Open instrument panel air vents.

Set the air intake control at "Fresh", the air flow control at "Floor" or "Face", and the fan control set to high.

BEFORE DRIVING

Before entering the vehicle

- Be sure all windows, outside mirror(s), and outside lights are clean and unobstructed.
- Remove frost, snow, or ice.
- Visually check the tires for uneven wear and damage.
- Check under the vehicle for any sign of leaks.
- Be sure there are no obstacles behind you if you intend to back up.

Before starting

- Make sure the hood, the tailgate, and the doors are securely closed and locked.
- Adjust the position of the seat and steering wheel.
- Adjust the inside and outside rear-view mirrors.
- Verify all the lights work.
- Fasten your seatbelt. Check that all passengers have fastened their seatbelts.
- Check the gauges and indicators in the instrument panel and the messages on the instrument display when the ignition switch is in the ON position.
- Check that any items you are carrying are stored properly or fastened down securely.



WARNING

To reduce the risk of **SERIOUS INJURY** or **DEATH**, take the following precautions:

- **ALWAYS wear your seat belt. All passengers must be properly belted whenever the vehicle is moving.**

For more information, refer to “Seat Belts” in chapter 3.

- **Always drive defensively. Assume other drivers or pedestrians may be careless and make mistakes.**
- **Stay focused on the task of driving. Driver distraction can cause accidents.**
- **Leave plenty of space between you and the vehicle in front of you.**

**WARNING**

NEVER drink or take drugs and drive.

Drinking or taking drugs and driving is dangerous and may result in an accident and **SERIOUS INJURY** or **DEATH**.

Drunk driving is the number one contributor to the highway death toll each year. Even a small amount of alcohol will affect your reflexes, perceptions and judgment. Just one drink can reduce your ability to respond to changing conditions and emergencies and your reaction time gets worse with each additional drink.

Driving while under the influence of drugs is as dangerous or more dangerous than driving under the influence of alcohol.

You are much more likely to have a serious accident if you drink or take drugs and drive. If you are drinking or taking drugs, don't drive. Do not ride with a driver who has been drinking or taking drugs. Choose a designated driver or call a taxi.

IGNITION SWITCH



WARNING

To reduce the risk of **SERIOUS INJURY** or **DEATH**, take the following precautions:

- **NEVER** allow children or any person who is unfamiliar with the vehicle to touch the ignition switch or related parts. Unexpected and sudden vehicle movement can occur.
- **NEVER** reach through the steering wheel for the ignition switch, or any other control, while the vehicle is in motion. The presence of your hand or arm in this area may cause a loss of vehicle control resulting in an accident.

Key ignition switch (if equipped)

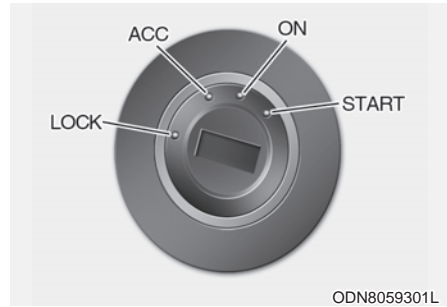

WARNING

- **NEVER** turn the ignition switch to the **LOCK** or **ACC** position while the vehicle is in motion except in an emergency. This will result in the engine turning off and loss of power assist for the steering and brake systems. This may lead to loss of directional control and braking function, which could cause an accident.
- Before leaving the driver's seat, always make sure the shift lever is in 1st gear (for Manual transmission vehicle) or P (Park, for Intelligent Variable Transmission/Dual Clutch Transmission/Automatic Transmission vehicle) position, apply the parking brake, and turn ignition switch to the **LOCK** position. Unexpected vehicle movement may occur if these precautions are not followed.

Key ignition switch positions

Switch Position	Action	Notice
LOCK	The ignition key can be removed in the LOCK position.	The steering wheel locks up (if equipped).
ACC	Electrical accessories are usable.	The steering wheel unlocks. If difficulty is experienced turning the ignition switch to the ACC position, turn the key while turning the steering wheel right and left to release tension.
ON	This is the normal key position when the engine has started. All features and accessories are usable. The warning lights can be checked when you turn the ignition switch from ACC to ON.	Do not leave the ignition switch in the ON position when the engine is not running to prevent the battery from discharging.
START	To start the engine, turn the ignition switch to the START position. The switch returns to the ON position when you let go of the key.	The engine will crank until you release the key.

Starting the engine



WARNING

- **Always wear appropriate shoes when operating your vehicle. Unsuitable shoes, such as high heels, ski boots, sandals, flip-flops, etc., may interfere with your ability to use the brake, accelerator and clutch pedals.**
- **Do not start the vehicle with the accelerator pedal depressed. The vehicle can move and lead to an accident.**
- **Wait until the engine rpm is normal. The vehicle may suddenly move if the brake pedal is released when the rpm is high.**

Starting the petrol engine

Vehicle with Manual transmission:

1. Make sure the parking brake is applied.
2. Make sure the shift lever is in neutral.
3. Depress the clutch and brake pedals.
4. Turn the ignition switch to the START position. Hold the key (maximum of 10 seconds) until the engine starts and release it.

The engine can not be started unless the shift lever is 'N' position.

Vehicle with intelligent manual transmission :

1. Make sure the parking brake is applied.
2. Depress the brake pedal fully and shift the transmission into Neutral.
3. Keep the brake pedal depressed while turning the ignition switch to the start position. If you turn the ignition switch to the start position without depressing the brake pedal, the engine will not start.

Vehicle with Automatic Transmission:

1. Make sure the parking brake is applied.
2. Make sure the shift lever is in P (Park).
3. Depress the brake pedal.
4. Turn the ignition switch to the START position. Hold the key (maximum of 10 seconds) until the engine starts and release it.



Information

- **Do not wait for the engine to warm up while the vehicle remains stationary.**

Start driving at moderate engine speeds. (Steep accelerating and decelerating should be avoided.)

- **Always start the vehicle with your foot on the brake pedal. Do not depress the accelerator while starting the vehicle. Do not race the engine while warming it up.**

Starting the diesel engine

To start the diesel engine when the engine is cold, it has to be pre-heated before starting the engine and then have to be warmed up before starting to drive.

Vehicle with Manual transmission:

1. Make sure the parking brake is applied.
2. Make sure the shift lever is in neutral.
3. Depress the clutch and brake pedals.
4. Turn the ignition switch to the ON position to pre-heat the engine. The glow indicator light (⌘) will illuminate.
5. When the glow indicator light (⌘) goes out, turn the key ignition switch to the START position. Hold the key (maximum of 10 seconds) until the engine starts and release it.

Vehicle with intelligent manual transmission :

1. Make sure the parking brake is applied.
2. Depress the brake pedal fully and shift the transmission into Neutral.
3. Keep the brake pedal depressed while turning the ignition switch to the start position. If you turn the ignition switch to the start position without depressing the brake pedal, the engine will not start.

Vehicle with automatic transmission:

1. Always carry the smart key with you.
2. Make sure the parking brake is applied.
3. Make sure the shift lever is in P (Park).
4. Depress the brake pedal.
5. Press the Engine Start/Stop button.
6. Continue depressing the brake pedal until the glow indicator light (⌘) goes out.
7. When the glow indicator light (⌘) goes out, the engine will start.

NOTICE

If the Engine Start/Stop button is pressed while the engine is pre-heating, the engine may start.

Starting and stopping the engine for turbocharger intercooler

1. Do not race or accelerate the engine immediately after starting the engine.

If the engine is cold, idle for several seconds before sufficient lubrication is ensured in the turbo charger unit.

2. After high speed or extended driving that requires heavy engine load, idle the engine about one minute before turning the engine off.

This idle time will allow the turbo-charger to cool prior to shutting the engine off.

NOTICE

Do not turn off the engine immediately after it has been subjected to a heavy load. Doing so may cause severe damage to the engine or turbo charger unit.

NOTICE

To prevent damage to the vehicle:

- Do not hold the ignition key in the **START** position for more than 10 seconds. Wait 5 to 10 seconds before trying again.
- Do not turn the ignition switch to the **START** position with the engine running. It may damage the starter.
- If traffic and road conditions permit, you may put the shift lever in the **N (Neutral)** position while the vehicle is still moving and turn the ignition switch to the **START** position in an attempt to restart the engine.
- Do not push or tow your vehicle to start the engine.

Engine Start/Stop button (if equipped)



With ignition switch off and all doors locked, when the driver unlock the car via smart key and open the door, Start/Stop button will illuminate for 30 seconds.

WARNING

To reduce risk of serious injury or death, NEVER allow children or any person who is unfamiliar with the vehicle to touch the Engine Start/Stop button or related parts. Unexpected and sudden vehicle movement can occur.

 **WARNING**

To turn the engine off in an emergency:

Press and hold the Engine Start/Stop button for more than two seconds OR Rapidly press and release the Engine Start/Stop button three times (within three seconds).

If the vehicle is still moving, you can restart the engine without depressing the brake pedal by pressing the Engine Start/Stop button with the shift lever in the N (Neutral) position.

 **WARNING**

- **NEVER** press the Engine Start/Stop button while the vehicle is in motion except in an emergency. This will result in the engine turning off and loss of power assist for the steering and brake systems.

This may lead to loss of directional control and braking function, which could cause an accident and severe damage to the Intelligent Variable Transmission.

- Before leaving the driver's seat, always make sure the shift lever is in the P (Park) position, set the parking brake, press the Engine Start/Stop button to the OFF position, and take the Smart Key with you. Unexpected vehicle movement may occur if these precautions are not followed.
- **NEVER** reach through the steering wheel for the Engine Start/Stop button or any other control while the vehicle is in motion. The presence of your hand or arm in this area may cause a loss of vehicle control resulting in an accident.

Engine Stop/Start button positions

- Vehicle with Manual transmission /Intelligent Manual Transmission (iMT)

Button Position	Action	Notice
OFF	<ul style="list-style-type: none"> To turn off the engine, stop the vehicle and then press the Engine Start/Stop button. The steering wheel locks up (if equipped). 	<p>If the steering wheel is not locked properly when you open the driver's door, the warning chime will sound.</p>
ACC	<ul style="list-style-type: none"> Press the Engine Start/Stop button when the button is in the OFF position without depressing the clutch pedal. Electrical accessories are usable. The steering wheel unlocks. 	<ul style="list-style-type: none"> If you leave the Engine Start/Stop button in the ACC position for more than one hour, the battery power will turn off automatically to prevent the battery from discharging. If the steering wheel doesn't unlock properly, the Engine Start/Stop button will not work. Press the Engine Start/Stop button while turning the steering wheel right and left to release tension.
ON	<ul style="list-style-type: none"> Press the Engine Start/Stop button while it is in the ACC position without depressing the clutch pedal. The warning lights can be checked before the engine is started. 	<p>Do not leave the Engine Start/Stop button in the ON position when the engine is not running to prevent the battery from discharging.</p>
START	<p>To start the engine, depress the clutch and brake pedals and press the Engine Start/ Stop button with the shift lever in neutral.</p>	<p>If you press the Engine Start/ Stop button without depressing the clutch pedal, the engine does not start and the Engine Start/Stop button changes as follows: OFF → ACC → ON → OFF</p>

Engine Stop/Start button positions - Vehicle with Automatic Transmission

Button Position	Action	Notice
OFF	To turn off the engine, press the Engine Start/Stop button with shift lever in P (Park). When you press the Engine Start/Stop button without the shift lever in P (Park), the Engine Start/Stop button does not turn to the OFF position, but turns to the ACC position. The steering wheel locks up (if equipped).	If the steering wheel is not locked properly when you open the driver's door, the warning chime will sound.
ACC	Press the Engine Start/Stop button when the button is in the OFF position without depressing the brake pedal. Electrical accessories are usable. The steering wheel unlocks.	<ul style="list-style-type: none"> • If you leave the Engine Start/Stop button in the ACC position for more than one hour, the battery power will turn off automatically to prevent the battery from discharging. • If the steering wheel doesn't unlock properly, the Engine Start/Stop button will not work. Press the Engine Start/Stop button while turning the steering wheel right and left to release tension.
ON	Press the Engine Start/Stop button while it is in the ACC position without depressing the brake pedal. The warning lights can be checked before the engine is started.	Do not leave the Engine Start/Stop button in the ON position when the engine is not running to prevent the battery from discharging.
START	To start the engine, depress the brake pedal and press the Engine Start/Stop button with the shift lever in the P (Park) or in the N (Neutral) position. For your safety, start the engine with the shift lever in the P (Park) position.	If you press the Engine Start/Stop button without depressing the brake pedal, the engine does not start and the Engine Start/Stop button changes as follows: OFF → ACC → ON → OFF or ACC

Starting the engine

WARNING

- Always wear appropriate shoes when operating your vehicle. Unsuitable shoes, such as high heels, ski boots, sandals, flip-flops, etc., may interfere with your ability to use the brake, accelerator and clutch pedals.
- Do not start the vehicle with the accelerator pedal depressed. The vehicle can move and lead to an accident.
- Wait until the engine rpm is normal. The vehicle may suddenly move if the brake pedal is released when the rpm is high.

Information

- The engine will start by pressing the Engine Start/Stop button, only when the smart key is in the vehicle.
- Even if the smart key is in the vehicle, if it is far away from the driver, the engine may not start.
- When the Engine Start/Stop button is in the ACC or ON position, if any door is open, the system checks for the smart key. If the smart key is not in the vehicle, the “” indicator will blink and the warning “Key not in vehicle” will come on, and if all doors are closed, the chime will also sound for about 5 seconds. The indicator will turn off while the vehicle is moving. Keep the smart key in the vehicle when using the ACC position or if the vehicle engine is ON.

Starting the petrol engine

Vehicle with Manual transmission:

1. Always carry the smart key with you.
2. Make sure the parking brake is applied.
3. Make sure the shift lever is in neutral.
4. Depress the clutch and brake pedals.
5. Press the Engine Start/Stop button.

Vehicle with Automatic Transmission:

1. Always carry the smart key with you.
2. Make sure the parking brake is applied.
3. Make sure the shift lever is in P (Park).
4. Depress the brake pedal.
5. Press the Engine Start/Stop button.

Vehicle with Intelligent Manual Transmission :

1. Make sure the parking brake is applied.
2. Depress the clutch pedal fully and shift the transmission into Neutral.
3. Keep the clutch pedal and brake pedal depressed while pressing the ENGINE START/STOP button to the START position.

If you press the ENGINE START/STOP button to the START position without depressing the brake pedal and clutch pedal, the engine will not start.

i Information

- **Do not wait for the engine to warm up while the vehicle remains stationary.**

Start driving at moderate engine speeds. (Steep accelerating and decelerating should be avoided.)

- **Always start the vehicle with your foot on the brake pedal. Do not depress the accelerator while starting the vehicle. Do not race the engine while warming it up.**
- **When you start to drive, move the shift lever after checking the RPM(revolutions per minute) is in the proper range (under 1000 rpm) by depressing the clutch pedal and brake pedal.**

After releasing the parking brake, take your foot off the clutch and depress the accelerator slowly while starting your vehicle.

Starting the diesel engine

To start the diesel engine when the engine is cold, it has to be pre-heated before starting the engine and then have to be warmed up before starting to drive.

Vehicle with Manual transmission:

1. Always carry the smart key with you.
2. Make sure the parking brake is applied.
3. Make sure the shift lever is in neutral.
4. Depress the clutch and brake pedals.
5. Press the Engine Start/Stop button.
6. Continue depressing the brake pedal until the glow indicator light (☾☾) goes out.
7. When the glow indicator light (☾☾) goes out, the engine will start.

When you start to drive, move the shift lever after checking the RPM(revolutions per minute) is in the proper range (under 1000 rpm) by depressing the clutch pedal and brake pedal.

After releasing the parking brake, take your foot off the clutch and depress the accelerator slowly while starting your vehicle.

Vehicle with Intelligent Manual Transmission :

1. Make sure the parking brake is applied.
2. Depress the clutch pedal fully and shift the transmission into Neutral.
3. Keep the clutch pedal and brake pedal depressed while pressing the ENGINE START/STOP button to the START position.

If you press the ENGINE START/STOP button to the START position without depressing the brake pedal and clutch pedal, the engine will not start.

Vehicle with Automatic Transmission:

1. Always carry the smart key with you.
2. Make sure the parking brake is applied.
3. Make sure the shift lever is in P (Park).
4. Depress the brake pedal.
5. Press the Engine Start/Stop button.
6. Continue depressing the brake pedal until the glow indicator light (⏻) goes out.
7. When the glow indicator light (⏻) goes out, the engine will start.

When you start to drive, move the shift lever after checking the RPM(revolutions per minute) is in the proper range (under 1000 rpm) by depressing the clutch pedal and brake pedal.

After releasing the parking brake, take your foot off the clutch and depress the accelerator slowly while starting your vehicle.

Information

If the Engine Start/Stop button is pressed while the engine is pre-heating, the engine may start.

Starting and stopping the engine for turbocharger intercooler

1. Do not race or accelerate the engine immediately after starting the engine.

If the engine is cold, idle for several seconds before sufficient lubrication is ensured in the turbo charger unit.

2. After high speed or extended driving that requires heavy engine load, idle the engine about one minute before turning the engine off. This idle time will allow the turbocharger to cool prior to shutting the engine off.

NOTICE

Do not turn off the engine immediately after it has been subjected to a heavy load. Doing so may cause severe damage to the engine or turbo charger unit.

NOTICE

To prevent damage to the vehicle:

- If the engine stalls while you are in motion, do not attempt to move the shift lever to the P (Park) position.

If traffic and road conditions permit, you may put the shift lever in the N (Neutral) position while the vehicle is still moving and press the Engine Start/Stop button in an attempt to restart the engine.

- Do not push or tow your vehicle to start the engine.

NOTICE

To prevent damage to the vehicle: When the stop lamp fuse is blown, you can't start the engine normally. Replace the fuse with a new one. If you are not able to replace the fuse, you can start the engine by pressing and holding the Engine Start/Stop button for 10 seconds with the Engine Start/Stop button in the ACC position.

Do not press the Engine Start/Stop button for more than 10 seconds except when the stop lamp fuse is blown.

For your safety always depress the brake and/or clutch pedal before starting the engine.





i Information

If the smart key battery is weak or the smart key does not work correctly, you can start the engine by pressing the Engine Start/Stop button with the smart key in the direction of the picture above.

MANUAL TRANSMISSION (IF EQUIPPED)



-  The shift lever can be moved without pressing the button (1).
-  The button (1) must be pressed while moving the shift lever to R (Reverse).

Manual transmission operation

The manual transmission has 6 forward gears. The transmission is fully synchronized in all forward gears so shifting to either a higher or a lower gear is easily accomplished

WARNING

Before leaving the driver's seat, always make sure the shift lever is in 1st gear when the vehicle is parked on a uphill and in R (Reverse) on a downhill, set the parking brake, and place the ignition switch in the LOCK/OFF position. Unexpected vehicle movement may occur if these precautions are not followed.

To shift to R (Reverse), make sure the vehicle has completely stopped, and then move the shift lever to neutral before moving into R (Reverse).

When you've come to a complete stop and it's hard to shift into 1st gear or R (Reverse):

1. Put the shift lever in neutral and release the clutch pedal.
2. Depress the clutch pedal, and then shift into first or R (Reverse) gear.

Information

During cold weather, shifting may be difficult until the transmission lubricant has warmed up.

Using the clutch (if equipped)

The clutch pedal should be depressed all the way to the floor before:

- Starting the engine
The engine will not start without depressing the clutch pedal.
- Shifting
To start your vehicle, slowly release the clutch pedal and depress the accelerator.

When releasing the clutch pedal, release it slowly. The clutch pedal should always be released while driving.

NOTICE

To prevent unnecessary wear or damage to the clutch:

- Do not rest your foot on the clutch pedal while driving.
- Do not hold the vehicle with the clutch on an incline, while waiting for the traffic light, etc.
- Always depress the clutch pedal down fully to prevent noise or damage.
- Do not start with the 2nd (second) gear engaged except when you start on a slippery road.
- Depress the clutch pedal all the way and be careful not to depress the pedal again before returning to the upright position after you release the pedal. If you depress the pedal before returning to the original position repeatedly, it may cause the clutch system failure.

Downshifting

Downshift when you must slow down in heavy traffic or drive up a steep hill to prevent engine load.

Also, downshifting reduces the chance of stalling and can accelerate when you need to increase your speed again.

When the vehicle is going downhill, downshifting helps maintain safe speed by providing brake power from the engine and enables less wear on the brakes.

NOTICE

To prevent damage to the engine, clutch and transmission:

- When downshifting from 5th gear to 4th gear, be careful not to inadvertently push the shift lever sideways engaging the 2nd gear. A drastic downshift may cause the engine speed to increase to the point the tachometer will enter the red-zone.
- Do not downshift more than two gear at a time or downshift the gear when the engine is running at high speed (5,000 RPM or higher). Such a downshifting may damage the engine, clutch and the transmission.

Good driving practices

- Never take the vehicle out of gear and coast down a hill. This is extremely dangerous.
- Don't "ride" the brakes. This can cause the brakes and related parts to overheat and malfunction.

When you are driving down a long hill, slow down and shift to a lower gear. Engine braking will help slow down the vehicle.

- Slow down before shifting to a lower gear. This will help avoid over-revving the engine, which can cause damage.
- Slow down when you encounter cross winds. This gives you much better control of your vehicle.
- Be sure the vehicle is completely stopped before you shift into R (Reverse) to prevent damage to the transmission.
- Exercise extreme caution when driving on a slippery surface. Be especially careful when braking, accelerating or shifting gears. On a slippery surface, an abrupt change in vehicle speed can cause the drive wheels to lose traction and may cause loss of vehicle control resulting in an accident.



WARNING

To reduce the risk of **SERIOUS INJURY or DEATH**:

- **ALWAYS wear your seatbelt. In a collision, an unbelted occupant is significantly more likely to be seriously injured or killed than a properly belted occupant.**
- **Avoid high speeds when cornering or turning.**
- **Do not make quick steering wheel movements, such as sharp lane changes or fast, sharp turns.**
- **The risk of rollover is greatly increased if you lose control of your vehicle at highway speeds.**
- **Loss of control often occurs if two or more wheels drop off the roadway and the driver over steers to reenter the roadway.**
- **In the event your vehicle leaves the roadway, do not steer sharply. Instead, slow down before pulling back into the travel lanes.**
- **HYUNDAI recommends you follow all posted speed limits.**



WARNING

Do not use the engine brake (shifting from a higher gear to lower gear) rapidly on slippery roads. The vehicle may slip causing an accident.

INTELLIGENT MANUAL TRANSMISSION (IF EQUIPPED)

Intelligent Manual Transmission (iMT) system use E-Clutch (Electronic Clutch) technology. Using the E-Clutch, the vehicle can cut engine drive off without pressing the clutch pedal by driver. The E-Clutch is controlled by an actuator that assists the driver in changing gear.

The shift lever must be returned to the neutral position before shifting into R (Reverse). Push the button located immediately below the shift knob and pull the gearshift lever to the left sufficiently, and then shift into reverse (R) gear position. Make sure the vehicle is completely stopped before shifting into R (Reverse). Never operate the engine with the tachometer (RPM) in the red zone.

Intelligent Manual Transmission operation

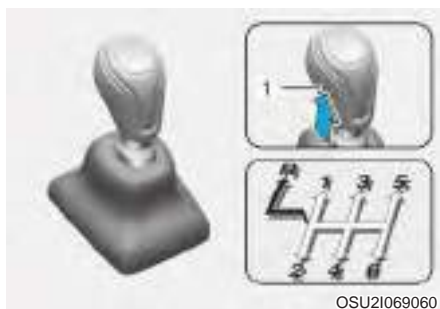

→ The shift lever can be moved without pressing the button (1).

→ The button (1) must be pressed while moving the shift lever.

The Intelligent manual transmission has 6 forward gears. This shift pattern is imprinted on the shift knob. The transmission is fully synchronized in all forward gears so shifting to either a higher or a lower gear is easily accomplished. Depress the clutch pedal down fully while shifting, then release it slowly. If your vehicle is equipped with an ignition lock switch, the engine will not start when starting the engine without depressing the brake pedal and clutch pedal. (if equipped)



CAUTION

- When downshifting from fifth gear to fourth gear, caution should be taken not to inadvertently press the shift lever sideways in such a manner that the second gear is engaged. Such a drastic downshift may cause the engine speed to increase to the point that the tachometer will enter the red-zone. Such over-revving of the engine and transmission may possibly cause engine damage.
- Do not downshift more than 2 gears or downshift the gear when the engine is running at high speed (5,000 RPM or higher). Such a downshifting may damage the engine, clutch and the transmission.
- During cold weather, shifting may be difficult until the transmission lubricant is warmed up. This is normal and not harmful to the transmission.
- If you've come to a complete stop and it's hard to shift into 1st or R(Reverse), leave the shift lever at N(Neutral) position and release the clutch. Press the clutch pedal back down, and then shift into 1st or R(Reverse) gear position.
- To avoid premature clutch wear and damage, do not drive with your foot resting on the clutch pedal. Also, don't use the clutch to hold the vehicle stopped on an uphill grade, while waiting for a traffic light, etc.
- Do not use the shift lever as a handrest during driving, as this can result in premature wear of the transmission shift forks.

- To prevent possible damage to the clutch system, do not start with the 2nd (second) gear engaged except when you start on a slippery road.



WARNING

- Before leaving the driver's seat, always set the parking brake fully and shut the engine off. Then make sure the transmission is shifted into 1st gear when the vehicle is parked on a level or uphill grade, and shifted into R (Reverse) on a downhill grade. Unexpected and sudden vehicle movement can occur if these precautions are not followed in the order identified.
- Do not use the engine brake (shifting from a high gear to lower gear) rapidly on slippery roads. The vehicle may slip causing an accident.

Using the clutch

The clutch should be pressed all the way to the floor before shifting, then released slowly. The clutch pedal should always be fully released while driving. Do not rest your foot on the clutch pedal while driving. This can cause unnecessary wear. Do not partially engage the clutch to hold the vehicle on an incline. This causes unnecessary wear. Use the foot brake or parking brake to hold the vehicle on an incline. Do not operate the clutch pedal rapidly and repeatedly.



CAUTION

When operating the clutch pedal, press the clutch pedal down fully. If you don't press the clutch pedal fully, the clutch may be damaged or noise may occur.

Downshifting

When you must slow down in heavy traffic or while driving up steep hills, downshift before the engine starts to labor. Downshifting reduces the chance of stalling and gives better acceleration when you again need to increase your speed. When the vehicle is traveling down steep hills, downshifting helps maintain safe speed and prolongs brake life.

Good driving practices

- Never take the vehicle out of gear and coast down a hill. This is extremely hazardous. Always leave the vehicle in gear.
- Don't "ride" the brakes. This can cause them to overheat and malfunction. Instead, when you are driving down a long hill, shift to a lower gear. When you do this, engine braking will help slow down the vehicle.
- Slow down before shifting to a lower gear. This will help avoid over-revving the engine, which can cause damage.
- Slow down when you encounter cross winds. This gives you much better control of your vehicle.
- Be sure the vehicle is completely stopped before you attempt to shift into reverse. The transmission can be damaged if you do not.
- Exercise extreme caution when driving on a slippery surface. Be especially careful when braking, accelerating or shifting gears. On a slippery surface, an abrupt change in vehicle speed can cause the drive wheels to lose traction and the vehicle to go out of control.



WARNING

- **Always buckle-up! In a collision, an unbelted occupant is significantly more likely to be seriously injured or killed than a properly belted occupant.**
- **Avoid high speeds when cornering or turning.**
- **Do not make quick steering wheel movements, such as sharp lane changes or fast, sharp turns.**
- **The risk of rollover is greatly increased if you lose control of your vehicle at highway speeds.**
- **Loss of control often occurs if two or more wheels drop off the roadway and the driver oversteers to reenter the roadway.**
- **In the event your vehicle leaves the roadway, do not steer sharply. Instead, slow down before pulling back into the travel lanes.**
- **Never exceed posted speed limits.**

AUTOMATIC TRANSMISSION (IF EQUIPPED)

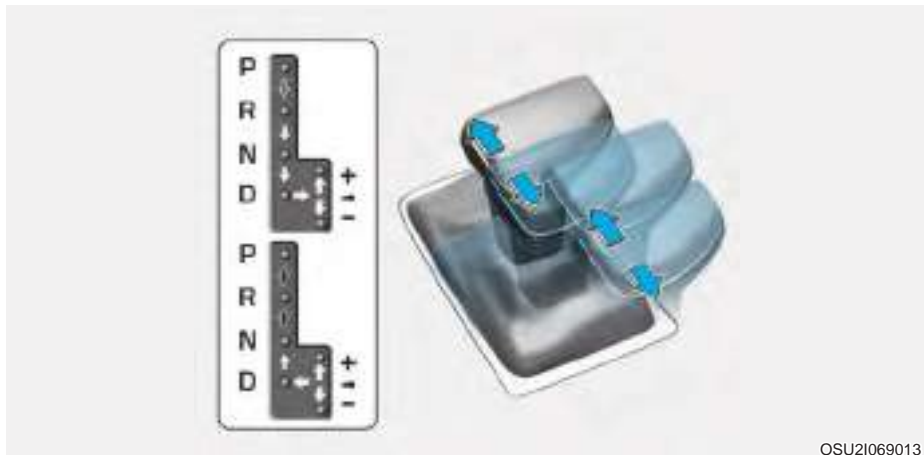

- ⚡ Depress the brake pedal, press the shift button, and then move shift lever.
- ➡ Press the shift button, then move shift lever.
- ⇨ Move shift lever.

Automatic transmission operation

The automatic transmission has six forward speeds and one reverse speed. The individual speeds are selected automatically in the D (Drive) position.

The indicator in the instrument cluster displays the shift lever position when the ignition switch is in the ON position.



WARNING

To reduce the risk of serious injury or death:

- **ALWAYS** check the surrounding areas near your vehicle for people, especially children, before shifting a vehicle into D (Drive) or R (Reverse).
- Before leaving the driver's seat, always make sure the shift lever is in the P (Park) position, then set the parking brake, and place the ignition switch in the LOCK/OFF position. Unexpected and sudden vehicle movement can occur if these precautions are not followed.
- Do not use the engine brake (shifting from a high gear to lower gear) rapidly on slippery roads. The vehicle may slip causing an accident.

Shift lever position

The indicator in the instrument cluster displays the shift lever position when the ignition switch is in the ON position.

P (Park)

Always come to a complete stop before shifting into P (Park).

To shift from P (Park), you must depress firmly on the brake pedal and make sure your foot is off the accelerator pedal.

The shift lever must be in P (Park) before turning the engine off.



WARNING

- Shifting into P (Park) while the vehicle is in motion may cause you to lose control of the vehicle.
- After the vehicle has stopped, always make sure the shift lever is in P (Park), apply the parking brake, and turn the engine off.
- When parking on an incline, place the shift lever in P (Park) and apply the parking brake to prevent the vehicle from rolling downhill.
- For safety, always engage the parking brake with the shift lever in the P (Park) position except for the case of emergency parking.

R (Reverse)

Use this position to drive the vehicle backward.

NOTICE

Always come to a complete stop before shifting into or out of R (Reverse); you may damage the transmission if you shift into R (Reverse) while the vehicle is in motion.

N (Neutral)

The wheels and transmission are not engaged.

Use N (Neutral) if you need to restart a stalled engine, or if it is necessary to stop with the engine ON. Shift into P (Park) if you need to leave your vehicle for any reason.

Always depress the brake pedal when you are shifting from N (Neutral) to another gear.

WARNING

Do not shift into gear unless your foot is firmly on the brake pedal. Shifting into gear when the engine is running at high speed can cause the vehicle to move very rapidly. You could lose control of the vehicle and hit people or objects.

D (Drive)

This is the normal driving position. The transmission will automatically shift through a 6-gear sequence, providing the best fuel economy and power.

For extra power when passing another vehicle or driving uphill, depress the accelerator fully. The transmission will automatically downshift to the next lower gear (or gears, as appropriate).

The DRIVE MODE switch, located on the shift lever console, allows the driver to switch from COMFORT mode to SPORT mode.

For more details, refer to “Drive Mode Integrated Control System” later in this chapter.

Manual shift mode



OSU2I069014

Whether the vehicle is stationary or in motion, manual shift mode is selected by pushing the shift lever from the D (Drive) position into the manual gate. To return to D (Drive) range operation, push the shift lever back into the main gate.

In manual shift mode, moving the shift lever backwards and forwards will allow you to select the desired range of gears for the current driving conditions.

+ (Up): Push the lever forward once to shift up one gear.

- (Down): Pull the lever backwards once to shift down one gear.

i Information

- Only the six forward gears can be selected. To reverse or park the vehicle, move the shift lever to the R (Reverse) or P (Park) position as required.
- Downshifts are made automatically when the vehicle slows down. When the vehicle stops, 1st gear is automatically selected.
- When the engine rpm approaches the red zone the transmission will upshift automatically.
- If the driver presses the lever to + (Up) or - (Down) position, the transmission may not make the requested gear change if the next gear is outside of the allowable engine rpm range. The driver must execute upshifts in accordance with road conditions, taking care to keep the engine rpms below the red zone.
- When driving on a slippery road, push the shift lever forward into the + (Up) position. This causes the transmission to shift into the 2nd gear which is better for smooth driving on a slippery road. Push the shift lever to the - (Down) side to shift back to the 1st gear.

Paddle shifter (if equipped)



The paddle shifter is available when the shift lever is in the D (Drive) position or the manual shift mode.

With the shift lever in the D position

The paddle shifter will operate when the vehicle speed is more than 10km/h.

Pull the [+] or [-] paddle shifter once to shift up or down one gear and the system changes from automatic mode to manual mode.

When the vehicle speed is lower than 10km/h, if you depress the accelerator pedal for more than 5 seconds or if you move the shift lever from D (Drive) to manual shift mode and move it from manual shift mode to D (Drive) again, the system changes from manual mode to automatic mode.

Automatic transmission warning messages



Transmission high temperature

- Under certain conditions, such as repeated stop-and go launches on steep grades, sudden take off or acceleration, or other harsh driving conditions, the transmission clutch temperatures will increase excessively. Finally the clutch in transmission could be overheated.
- When the clutch is overheated, the safe protection mode engages and the gear position indicator on the cluster blinks with a chime. At this time, "Transmission temp. is high! Stop safely" warning message will appear on the LCD display and driving may not be smooth.
- If this occurs, pull over to a safe location, stop the vehicle with the engine running, apply the brakes and shift the vehicle to P (Park), and allow the transmission to cool.
- If you ignore this warning, the driving condition may become worse. You may experience abrupt shifts, or Jerkiness. To return to the normal driving condition, stop the vehicle and apply the foot brake or shift into P (Park). Then allow the transmission to cool for a few minutes with engine on, before driving off.
- When possible, drive the vehicle smoothly.

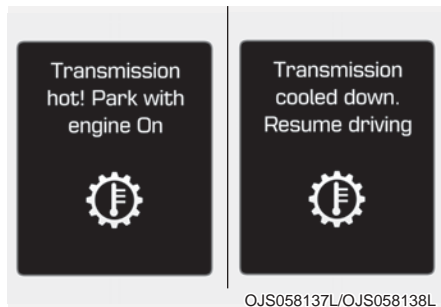

Transmission overheated

- If the vehicle continues to be driven and the clutch temperatures reach the maximum temperature limit, the "Transmission Hot! Park with engine on" warning will be displayed. When this occurs the clutch is disabled until the clutch cools to normal temperatures.
- The warning will display a time to wait for the transmission to cool.
- If this occurs, pull over to a safe location, stop the vehicle with the engine running, apply the brakes and shift the vehicle to P (Park), and allow the transmission to cool.
- When the message "Transmission cooled down. Resume driving (Trans cooled. Resume driving)" appears you can continue to drive your vehicle.
- When possible, drive the vehicle smoothly.
- If any of the warning messages in the LCD display continue to blink, for your safety, we recommend that you contact an authorized HYUNDAI dealer and have the system checked.

Shift-lock system

For your safety, the automatic transmission has a shift-lock system which prevents shifting the transmission from P (Park) into R (Reverse) unless the brake pedal is depressed.

To shift the transmission from P (Park) into R (Reverse):

1. Depress and hold the brake pedal.
2. Start the engine or place the ignition switch in the ON position.
3. Move the shift lever.

Parking

Always come to a complete stop and continue to depress the brake pedal. Move the shift lever into the P (Park) position, apply the parking brake, and place the ignition switch in the LOCK/OFF position. Take the Key with you when exiting the vehicle.



WARNING

When you stay in the vehicle with the engine running, be careful not to depress the accelerator pedal for a long period of time. The engine or exhaust system may overheat and start a fire.

The exhaust gas and the exhaust system are very hot. Keep away from the exhaust system components.

Do not stop or park over flammable materials, such as dry grass, paper or leaves. They may ignite and cause a fire.

Good driving practices

- Never move the shift lever from P (Park) or N (Neutral) to any other position with the accelerator pedal depressed.
- Never move the shift lever into P (Park) when the vehicle is in motion.

Be sure the vehicle is completely stopped before you attempt to shift into R (Reverse) or D (Drive).

- Do not move the shift lever to N (Neutral) when driving. Doing so may result in an accident because of a loss of engine braking and the transmission could be damaged.
- Do not drive with your foot resting on the brake pedal. Even light, but consistent pedal pressure can result in the brakes overheating, brake wear and possibly even brake failure.
- When driving in manual shift mode, slow down before shifting to a lower gear. Otherwise, the lower gear may not be engaged if the engine rpms are outside of the allowable range.
- Always apply the parking brake when leaving the vehicle. Do not depend on placing the transmission in P (Park) to keep the vehicle from moving.

- Exercise extreme caution when driving on a slippery surface. Be especially careful when braking, accelerating or shifting gears. On a slippery surface, an abrupt change in vehicle speed can cause the drive wheels to lose traction and may cause loss of vehicle control resulting in an accident
- Optimum vehicle performance and economy is obtained by smoothly depressing and releasing the accelerator.



WARNING

To reduce the risk of **SERIOUS INJURY or DEATH:**

- **ALWAYS** wear your seatbelt. In a collision, an unbelted occupant is significantly more likely to be seriously injured or killed than a properly belted occupant.
- Avoid high speeds when cornering or turning.
- Do not make quick steering wheel movements, such as sharp lane changes or fast, sharp turns.
- The risk of rollover is greatly increased if you lose control of your vehicle at highway speeds.
- Loss of control often occurs if two or more wheels drop off the roadway and the driver oversteers to reenter the roadway.
- In the event your vehicle leaves the roadway, do not steer sharply. Instead, slow down before pulling back into the travel lanes.
- HYUNDAI recommends you follow all posted speed limits.



Information

- Kickdown Mechanism (if equipped)

Use the kickdown mechanism for maximum acceleration. Depress the accelerator pedal beyond the pressure point. The automatic transmission will shift to a lower gear depending on the engine speed.

BRAKING SYSTEM

Power brakes

Your vehicle has power-assisted brakes that adjust automatically through normal usage.

If the engine is not running or is turned off while driving, the power assist for the brakes will not work. You can still stop your vehicle by applying greater force to the brake pedal than typical. The stopping distance, however, will be longer than with power brakes.

When the engine is not running, the reserve brake power is partially depleted each time the brake pedal is applied. Do not pump the brake pedal when the power assist has been interrupted.

Pump the brake pedal only when necessary to maintain steering control on slippery surfaces.



WARNING

Take the following precautions:

- **Do not drive with your foot resting on the brake pedal. This will create abnormally high brake temperatures, excessive brake lining and pad wear, and increased stopping distances.**
- **When descending a long or steep hill, shift to a lower gear and avoid continuous application of the brakes. Applying the brakes continuously will cause the brakes to overheat and could result in a temporary loss of braking performance.**

- **Wet brakes may impair the vehicle's ability to safely slow down; the vehicle may also pull to one side when the brakes are applied. Applying the brakes lightly will indicate whether they have been affected in this way. Always test your brakes in this fashion after driving through deep water. To dry the brakes, lightly tap the brake pedal to heat up the brakes while maintaining a safe forward speed until brake performance returns to normal. Avoid driving at high speeds until the brakes function correctly.**

Disc brakes wear indicator

When your brake pads are worn and new pads are required, you will hear a high pitched warning sound from your front or rear brakes. You may hear this sound come and go or it may occur whenever you depress the brake pedal.

Please remember some driving conditions or climates may cause a brake squeal when you first apply (or lightly apply) the brakes. This is normal and does not indicate a problem with your brakes.

NOTICE

To avoid costly brake repairs, do not continue to drive with worn brake pads.



Information

Always replace brake pads as complete front or rear axle sets.

Rear drum brakes

Your rear drum brakes do not have wear indicators. Therefore, have the rear brake linings inspected if you hear a rear brake rubbing noise. Also have your rear brakes inspected each time you change or rotate your tires and when you have the front brakes replaced.

Parking brake (hand type)



Always set the parking brake before leaving the vehicle, to apply:

Firmly depress the brake pedal.

Pull up the parking brake lever as far as possible.

WARNING

To reduce the risk of **SERIOUS INJURY** or **DEATH**, do not operate the parking brake while the vehicle is moving except in an emergency situation. It could damage the brake system and lead to an accident.



To release:

Firmly depress the brake pedal.

Slightly pull up the parking brake lever.

While pressing the release button (1), lower the parking brake (2).

If the parking brake does not release or does not release all the way, we recommend that the system be checked by an authorized HYUNDAI dealer.

WARNING

- **Whenever leaving the vehicle or parking, always come to a complete stop and continue to depress the brake pedal. Move the shift lever into the 1st gear (for Manual transmission vehicle) or P (Park, for Intelligent Variable Transmission/Dual Clutch Transmission/Automatic Transmission vehicle) position, then apply the parking brake, and place the ignition switch in the LOCK/OFF position.**

Vehicles with the parking brake not fully engaged are at risk for moving inadvertently and causing injury to yourself or others.

- **NEVER** allow anyone who is unfamiliar with the vehicle to touch the parking brake. If the parking brake is released unintentionally, serious injury may occur.
- **Only** release the parking brake when you are seated inside the vehicle with your foot firmly on the brake pedal.

NOTICE

- **Do not** apply the accelerator pedal while the parking brake is engaged. If you depress the accelerator pedal with the parking brake engaged, warning will sound. Damage to the parking brake may occur.
- **Driving with the parking brake on can overheat the braking system and cause premature wear or damage to brake parts. Make sure the parking brake is released and the Brake Warning Light is off before driving.**

Parking brake warning light



Check the Parking Brake Warning Light by placing the ignition switch to the ON position (do not start the engine).

This light will be illuminated when the parking brake is applied with the ignition switch in the START or ON position.

Before driving, be sure the parking brake is released and the Brake Warning Light is OFF.

If the Parking Brake Warning Light remains on after the parking brake is released while engine is running, there may be a malfunction in the brake system. Immediate attention is necessary.

If at all possible, cease driving the vehicle immediately. If that is not possible, use extreme caution while operating the vehicle and only continue to drive the vehicle until you can reach a safe location.

Electronic Parking Brake (EPB) (if equipped)

Applying the parking brake

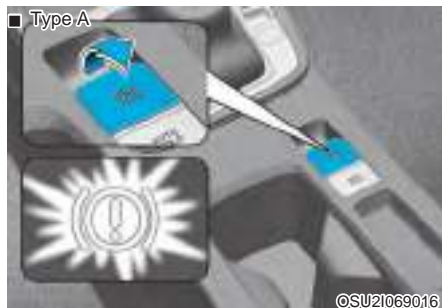

To apply the EPB (Electronic Parking Brake):

1. Depress the brake pedal.
2. Pull up the EPB switch.

Make sure the Parking Brake Warning Light comes on.

WARNING

To reduce the risk of **SERIOUS INJURY** or **DEATH**, do not operate the EPB while the vehicle is moving except in an emergency situation. It could damage the brake system and lead to an accident.

Releasing the parking brake



To release the EPB (Electronic Parking Brake), press the EPB switch in the following condition:

- Place the Engine Start/Stop button in the ON position.
- Depress the brake pedal.

Make sure the Parking Brake Warning Light goes off.

To release EPB (Electronic Parking Brake) automatically:

- Shift lever in P (Park)
With the engine running depress the brake pedal and shift out of P (Park) to R (Reverse) or D (Drive).
- Shift lever in N (Neutral)
With the engine running depress the brake pedal and shift out of N (Neutral) to R (Reverse) or D (Drive).
- Automatic transmission vehicle
 1. Start the engine.
 2. Fasten the driver's seat belt.
 3. Close the driver's door, engine hood and tailgate.
 4. Depress the accelerator pedal while the shift button is in R (Reverse) or D (Drive).
- Manual transmission vehicle/
Intelligent Manual Transmission
 1. Ensure seat belts are fastened and the doors, hood and tailgate are closed.
 2. With the engine running, depress the clutch pedal and move the shift lever to 1 (First) gear or R (Reverse).
 3. Depress the accelerator pedal while releasing the clutch pedal.

***i* Information**

- **For your safety, you can engage the EPB even though the Engine Stop/Start button is in the OFF position, but you cannot release it.**
- **For your safety, depress the brake pedal and release the parking brake manually with the EPB switch when you drive downhill or when backing up the vehicle.**

***i* Information**

- Manual transmission

A vehicle towing a trailer on a hill or on an incline may slightly roll backwards when starting the vehicle. To prevent the situation follow the below instructions.

- 1. Depress the clutch pedal and select a gear.**
- 2. Keep pulling up the EPB switch.**
- 3. Depress the accelerator pedal and slowly release the clutch pedal.**
- 4. If the vehicle starts off with enough driving power release the EPB switch.**

Do not follow the above procedure when driving on a flat level ground. The vehicle may suddenly move forward.

NOTICE

- If the parking brake warning light is still on even though the EPB has been released, we recommend that the system be checked by an authorized HYUNDAI dealer.
- Do not drive your vehicle with the EPB applied. It may cause excessive brake pad and brake rotor wear.

EPB (Electronic Parking Brake) may be automatically applied when:

- Requested by other systems
- If the driver turns the engine off while Auto Hold is operating, EPB will be automatically applied.

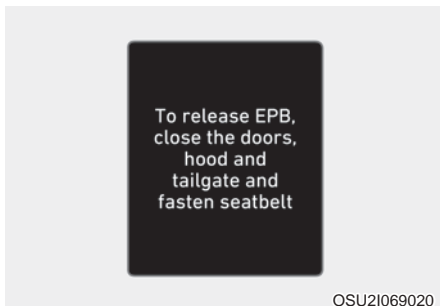
Warning messages

To release EPB, close the doors, hood and tailgate and fasten seatbelt

- If you try to drive with the EPB applied, a warning will sound and a message will appear.
- If the driver's seat belt is unfastened and the engine hood or tailgate is opened, a warning will sound and a message will appear.
- If there is a problem with the vehicle, a warning may sound and a message may appear.

If the situation occurs, depress the brake pedal and release EPB by pressing the EPB switch.

 **WARNING**

- Whenever leaving the vehicle or parking, always come to a complete stop and continue to depress the brake pedal.

Move the shift lever into the P (Park) position, press the EPB switch, and press the Engine Start/Stop button to the OFF position. Take the Smart Key with you when exiting the vehicle.

Vehicles not fully engaged in P (Park) with the parking brake set are at risk for moving inadvertently and causing injury to yourself or others.

- NEVER allow anyone who is unfamiliar with the vehicle to touch the EPB switch. If the EPB is released unintentionally, serious injury may occur.
- Only release the EPB when you are seated inside the vehicle with your foot firmly on the brake pedal.

NOTICE

- Do not apply the accelerator pedal while the parking brake is engaged. If you depress the accelerator pedal with the EPB engaged, a warning will sound and a message will appear. Damage to the parking brake may occur.
- Driving with the parking brake on can overheat the braking system and cause premature wear or damage to brake parts. Make sure the EPB is released and the Parking Brake Warning Light is off before driving.

 **Information**

- A clicking sound may be heard while operating or releasing the EPB. These conditions are normal and indicate that the EPB is functioning properly.
- When leaving your keys with a parking attendant or assistant, make sure to inform him/her how to operate the EPB.

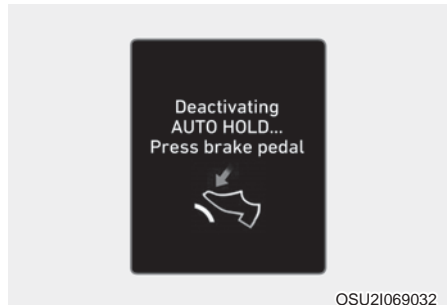

**Deactivating AUTO HOLD...
Press brake pedal**

When the conversion from Auto Hold to EPB is not working properly a warning will sound and a message will appear.

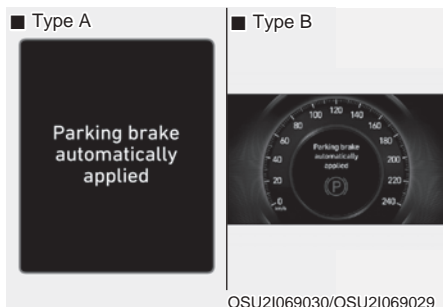

OSU21069030/OSU21069029



OJX1069066L

EPB malfunction indicator (if equipped)



OSU21069022/OSU21069023

This warning light illuminates if the Engine Start/Stop button is changed to the ON position and goes off in approximately 3 seconds if the system is operating normally.

If the EPB malfunction indicator remains on, comes on while driving, or does not come on when the Engine Start/Stop button is changed to the ON position, this indicates that the EPB may have malfunctioned.

If this occurs, we recommend that the system be checked by an authorized HYUNDAI dealer.

The EPB malfunction indicator may illuminate when the ESC indicator comes on to indicate that the ESC is not working properly, but it does not indicate a malfunction of the EPB.

Parking brake automatically applied

If the EPB is applied while Auto Hold is activated, a warning will sound and a message will appear.

NOTICE

- If the EPB warning light is still on, we recommend that the system be checked by an authorized HYUNDAI dealer.
- If the parking brake warning light does not illuminate or blinks even though the EPB switch was pulled up, the EPB may not be applied.
- If the parking brake warning light blinks when the EPB warning light is on, press the switch, and then pull it up. Repeat this one more time. If the EPB warning does not go off, we recommend that the system be checked by an authorized HYUNDAI dealer.

Emergency braking

If there is a problem with the brake pedal while driving, emergency braking is possible by pulling up and holding the EPB switch. Braking is possible only while you are holding the EPB switch. However, braking distance will be longer than normal.



WARNING

Do not operate the parking brake while the vehicle is moving except in an emergency situation. It could damage the brake system and lead to a severe accident.



Information

During emergency braking, the parking brake warning light will illuminate to indicate that the system is operating.

NOTICE

If you continuously notice a noise or burning smell when the EPB is used for emergency braking, we recommend that the system be checked by an authorized HYUNDAI dealer.

When the EPB (Electronic Parking Brake) does not release

If the EPB does not release normally, we recommend that you contact an authorized HYUNDAI dealer by loading the vehicle on a flatbed tow truck and have the system checked.

AUTO HOLD (if equipped)

The Auto Hold maintains the vehicle in a standstill even though the brake pedal is not depressed, after the driver brings the vehicle to a complete stop by depressing the brake pedal.

To apply :

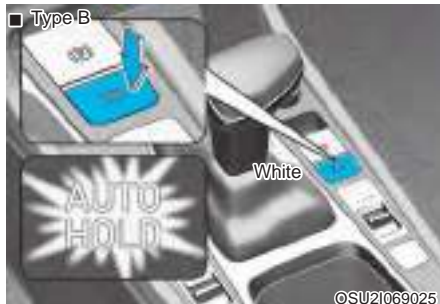

1. With the driver's door, engine hood closed, depress the brake pedal and then press the [AUTO HOLD] switch. The white AUTO HOLD indicator will come on and the system will be in the standby position.
2. When you stop the vehicle completely by depressing the brake pedal, the Auto Hold maintains the brake pressure to hold the vehicle stationary. The indicator changes from white to green.
3. The vehicle will remain stationary even if you release the brake pedal.
4. If EPB is applied, Auto Hold will be released.

To release :

- If you press the accelerator pedal with the shift lever in D (Drive), R (Reverse) or manual shift mode, the Auto Hold will be released automatically and the vehicle will start to move. The AUTO HOLD indicator changes from green to white.
- If the vehicle is restarted using the cruise control toggle switch (RES+ or SET-) while Auto Hold and cruise control is operating, the Auto Hold will be released regardless of accelerator pedal operation. The AUTO HOLD indicator changes from green to white. (if equipped with cruise control system)

⚠ WARNING

When the AUTO HOLD is automatically released by depressing the accelerator pedal, always take a look around your vehicle.

Slowly depress the accelerator pedal for a smooth start.

To cancel :



1. Depress the brake pedal.
 2. Press the [AUTO HOLD] switch.
- The AUTO HOLD indicator will turn off.

⚠ WARNING

To prevent, unexpected and sudden vehicle movement, ALWAYS press your foot on the brake pedal to cancel the Auto Hold before you:

- Drive downhill.
- Drive the vehicle in R (Reverse).
- Park the vehicle.

i Information

- Auto Hold does not operate when:
 - Driver's door is opened
 - The engine hood is opened
 - The shift lever is in P (Park) or R (Reverse)
 - The EPB is applied
- For your safety, Auto Hold automatically switches to EPB when:
 - Driver's door is opened
 - The engine hood is opened
 - The vehicle stops for more than 10 minutes
 - The vehicle stands on a steep slope
 - The vehicle moves several times

In these cases, the parking brake warning light comes on, the AUTO HOLD indicator changes from green to white, and a warning sound and a message will appear to inform you that EPB has been automatically engaged. Before driving off again, press the foot brake pedal, check the surrounding area near your vehicle and release the parking brake manually with the EPB switch.

- While Auto Hold is operating, you may hear mechanical noise. However, it is normal operating noise.

NOTICE

If the AUTO HOLD indicator changes to yellow, the Auto Hold is not working properly. We recommend that you contact an authorized HYUNDAI dealer.



WARNING

- Depress the accelerator pedal slowly when you start the vehicle.
- For your safety, cancel the Auto Hold when you drive downhill, back up the vehicle or park the vehicle.

NOTICE

If there is a malfunction with the driver's door or engine hood open detection system, the Auto Hold may not work properly.

We recommend that you contact an authorized HYUNDAI dealer.

Warning messages

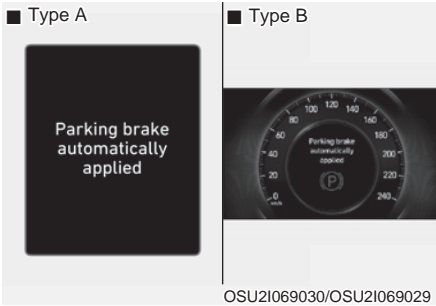

Parking brake automatically applied

When the EPB is applied from Auto Hold, a warning will sound and a message will appear.



Deactivating AUTO HOLD... Press brake pedal

When the conversion from Auto Hold to EPB is not working properly a warning will sound and a message will appear.

When this message is displayed, the Auto Hold and EPB may not operate. For your safety, depress the brake pedal.

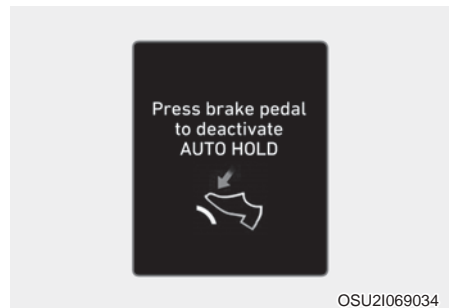

Press brake pedal to deactivate AUTO HOLD

If you did not apply the brake pedal when you released the Auto Hold by pressing the [AUTO HOLD] switch, a warning will sound and a message will appear.

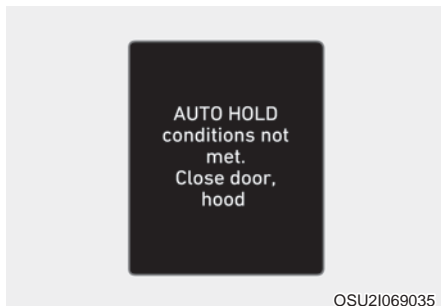

AUTO HOLD conditions not met. Close door, hood

When you press the [AUTO HOLD] switch, if the driver's door and engine hood are not closed, a warning will sound and a message will appear on the LCD display. At this moment, press the [AUTO HOLD] button after closing the driver's door and engine hood.

Anti-lock Brake System (ABS)

WARNING

An Anti-Lock Braking System (ABS) will not prevent accidents due to improper or dangerous driving maneuvers. Even though vehicle control is improved during emergency braking, always maintain a safe distance between you and objects ahead of you. Vehicle speeds should always be reduced during extreme road conditions. The braking distance for cars equipped with ABS may be longer than for those without these systems in the following road conditions.

Drive your vehicle at reduced speeds during the following conditions:

- Rough, gravel or snow-covered roads.
- On roads where the road surface is pitted or has different surface height.
- Tire chains are installed on your vehicle.

The safety features of an ABS equipped vehicle should not be tested by high speed driving or cornering. This could endanger the safety of yourself or others.

ABS is an electronic braking system that helps prevent a braking skid. ABS allows the driver to steer and brake at the same time.

Using ABS

To obtain the maximum benefit from your ABS in an emergency situation, do not attempt to modulate your brake pressure and do not try to pump your brakes. Depress your brake pedal as hard as possible.

When you apply your brakes under conditions which may lock the wheels, you may hear sounds from the brakes, or feel a corresponding sensation in the brake pedal. This is normal and it means your ABS is active.

ABS does not reduce the time or distance it takes to stop the vehicle.

Always maintain a safe distance from the vehicle in front of you.

ABS will not prevent a skid that results from sudden changes in direction, such as trying to take a corner too fast or making a sudden lane change. Always drive at a safe speed for the road and weather conditions.

ABS cannot prevent a loss of stability. Always steer moderately when braking hard. Severe or sharp steering wheel movement can still cause your vehicle to veer into oncoming traffic or off the road.

On loose or uneven road surfaces, operation of the anti-lock brake system may result in a longer stopping distance than for vehicles equipped with a conventional brake system.

The ABS warning light () will stay on for several seconds after the ignition switch is in the ON position. During that time, the ABS will go through self-diagnosis and the light will go off if everything is normal. If the light stays on, you may have a problem with your ABS. We recommend that you contact an authorized HYUNDAI dealer as soon as possible.

WARNING

If the ABS warning light () is on and stays on, you may have a problem with the ABS. Your power brakes will work normally. To reduce the risk of serious injury or death, we recommend that you contact your HYUNDAI dealer as soon as possible.

CAUTION

When you drive on a road having poor traction, such as an icy road, and apply your brakes continuously, the ABS will be active continuously and the ABS warning light () may illuminate. Pull your car over to a safe place and turn the engine off.

Restart the engine. If the ABS warning light is off, then your ABS system is normal. Otherwise, you may have a problem with your ABS system. We recommend that you contact an authorized HYUNDAI dealer as soon as possible.

Information

When you jump start your vehicle because of a drained battery, the ABS warning light () may turn on at the same time. This happens because of the low battery voltage. It does not mean your ABS is malfunctioning. Have the battery recharged before driving the vehicle.

Electronic Stability Control (ESC) (if equipped)



The Electronic Stability Control (ESC) system helps to stabilize the vehicle during cornering maneuvers.

ESC checks where you are steering and where the vehicle is actually going.

ESC applies braking pressure to any one of the vehicle's brakes and intervenes in the engine management system to assist the driver with keeping the vehicle on the intended path. It is not a substitute for safe driving practices. Always adjust your speed and driving to the road conditions.



WARNING

Never drive too fast for the road conditions or too quickly when cornering. The ESC system will not prevent accidents.

Excessive speed in turns, abrupt maneuvers, and hydroplaning on wet surfaces can result in severe accidents.

ESC operation

ESC ON condition

When the ignition switch is in the ON position, the ESC and the ESC OFF indicator lights illuminate for approximately three seconds and goes off, then the ESC is turned on.

When operating



When the ESC is in operation, the ESC indicator light blinks:

- When you apply your brakes under conditions which may lock the wheels, you may hear sounds from the brakes, or feel a corresponding sensation in the brake pedal. This is normal and it means your ESC is active.
- When the ESC activates, the engine may not respond to the accelerator as it does under routine conditions.
- If the Cruise Control was in use when the ESC activates, the Cruise Control automatically disengages. The Cruise Control can be reengaged when the road conditions allow. **See “Cruise Control System” later in this chapter** (if equipped).
- When moving out of the mud or driving on a slippery road, the engine rpm (revolutions per minute) may not increase even if you press the accelerator pedal deeply. This is to maintain the stability and traction of the vehicle and does not indicate a problem.

ESC OFF condition



To cancel ESC operation :

- State 1

Press the ESC OFF button briefly. The ESC OFF indicator light and/or message “Traction control disabled” will illuminate. In this state, the traction control function of ESC (engine management) is disabled, but the brake control function of ESC (braking management) still operates.

- State 2

Press and hold the ESC OFF button continuously for more than 3 seconds. The ESC OFF indicator light and/or message “Traction control and ESC disabled” illuminates and a warning chime sounds. In this state, both the traction control function of ESC (engine management) and the brake control function of ESC (braking management) are disabled.

If the ignition switch is placed in the LOCK/OFF position when ESC is off, ESC remains off. Upon restarting the vehicle, the ESC will automatically turn on again.

Indicator lights

- ESC indicator light (blinks)



OTD059012

- ESC OFF indicator light (comes on)



OTD059013

When the ignition switch is in the ON position, the ESC indicator light illuminates, then goes off if the ESC system is operating normally.

The ESC indicator light blinks whenever the ESC is operating.

If the ESC indicator light stays on, your vehicle may have a malfunction with the ESC system. When this warning light illuminates we recommend that the vehicle be checked by an authorized HYUNDAI dealer as soon as possible.

The ESC OFF indicator light comes on when the ESC is turned off with the button.

WARNING

When the ESC is blinking, this indicates the ESC is active:

Drive slowly and **NEVER** attempt to accelerate. **NEVER** turn the ESC off while the ESC indicator light is blinking or you may lose control of the vehicle resulting in an accident.

NOTICE

Driving with wheels and tires with different sizes may cause the ESC system to malfunction. Before replacing tires, make sure all four tires and wheels are the same size. **Never** drive the vehicle with different sized wheels and tires installed.

ESC OFF usage

When Driving

The ESC OFF mode should only be used briefly to help free the vehicle if stuck in snow or mud, by temporarily stopping operation of the ESC, to maintain wheel torque.

To turn ESC off while driving, press the ESC OFF button while driving on a flat road surface.

NOTICE

To prevent damage to the transmission:

- Do not allow wheel(s) of one axle to spin excessively while the ESC, ABS, and parking brake warning lights are displayed. The repairs would not be covered by the vehicle warranty. Reduce engine power and do not spin the wheel(s) excessively while these lights are displayed.
- When operating the vehicle on a dynamometer, make sure the ESC is turned off (ESC OFF light illuminated).

Information

Turning the ESC off does not affect ABS or standard brake system operation.

Vehicle Stability Management (VSM) (if equipped)

The Vehicle Stability Management (VSM) is a function of the Electronic Stability Control (ESC) system. It helps ensure the vehicle stays stable when accelerating or braking suddenly on wet, slippery and rough roads where traction over the four tires can suddenly become uneven.



WARNING

Take the following precautions when using the Vehicle Stability Management (VSM):

- **ALWAYS** check the speed and the distance to the vehicle ahead. The VSM is not a substitute for safe driving practices.
- **Never** drive too fast for the road conditions. The VSM system will not prevent accidents. Excessive speed in bad weather, slippery and uneven roads can result in severe accidents.

VSM operation

VSM ON condition

The VSM operates when:

- The Electronic Stability Control (ESC) is on.
- Vehicle speed is approximately above 15 km/h (9 mph) on curve roads.
- Vehicle speed is approximately above 20 km/h (12 mph) when the vehicle is braking on rough roads.

When operating

When you apply your brakes under conditions which may activate the ESC, you may hear sounds from the brakes, or feel a corresponding sensation in the brake pedal. This is normal and it means your VSM is active.





Information

The VSM does not operate when:

- Driving on a banked road such as gradient or incline
- Driving in reverse.
- The ESC OFF indicator light is on.
- The EPS (Electric Power Steering) warning light () is on or blinks.



WARNING

If the ESC indicator light () or EPS warning light () stays on or blinks, your vehicle may have a malfunction with the VSM system. When the warning light illuminates we recommend that the vehicle be checked by an authorized HYUNDAI dealer as soon as possible.

NOTICE

Driving with wheels and tires with different sizes may cause the ESC system to malfunction. Before replacing tires, make sure all four tires and wheels are the same size. Never drive the vehicle with different sized tires and wheels installed.

Hill-Start Assist Control (HAC) (if equipped)

The Hill-Start Assist Control (HAC) helps prevent the vehicle from rolling backwards when starting a vehicle from a stop on a hill. The system operates the brakes automatically for approximately 2 seconds and releases the brake after 2 seconds or when the accelerator pedal is depressed.



WARNING

Always be ready to depress the accelerator pedal when starting off on an incline. The HAC activates only for approximately 2 seconds.



Information

- The HAC does not operate when the shift lever is in P (Park) or N (Neutral).
- The HAC activates even when the ESC (Electronic Stability Control) is off. However, it does not activate, when the ESC does not operate normally.

Emergency Stop Signal (ESS)

The Emergency Stop Signal system alerts the driver behind by blinking the stop light when the vehicle is braked rapidly and severely.

The system is activated when:

- The vehicle suddenly stops (vehicle speed is over 55 km/h and the vehicle deceleration at greater than 7 m/s²)
- The ABS is activating

When the vehicle speed is under 40 km/h and the ABS deactivates or the sudden stop situation is over, the stop light blinking will stop. Instead, the hazard warning flasher will turn on automatically.

The hazard warning flasher will turn off when vehicle speed is over 10 km/h after the vehicle has stopped. Also, it will turn off when the vehicle is driven at low speed for some time. You can turn it off manually by pushing the hazard warning flasher switch.



CAUTION

The Emergency Stop Signal (ESS) system will not work if the hazard warning flasher is already on.

Good braking practices



WARNING

Whenever leaving the vehicle or parking, always come to a complete stop and continue to depress the brake pedal. Move the shift lever into the 1st gear (for manual transmission vehicle) or P (Park, for automatic transmission vehicle) position, then apply the parking brake, and place the ignition switch in the LOCK/OFF position.

Vehicles with the parking brake not fully engaged are at risk for moving inadvertently and causing injury to yourself or others.

Wet brakes can be dangerous! The brakes may get wet if the vehicle is driven through standing water or if it is washed. Your vehicle will not stop as quickly if the brakes are wet. Wet brakes may cause the vehicle to pull to one side.

To dry the brakes, apply the brakes lightly until the braking action returns to normal, taking care to keep the vehicle under control at all times. If the braking action does not return to normal, stop as soon as it is safe to do so and we recommend that you call an authorized HYUNDAI dealer for assistance.

DO NOT drive with your foot resting on the brake pedal. Even light, but constant pedal pressure can result in the brakes overheating, brake wear, and possibly even brake failure.

If a tire goes flat while you are driving, apply the brakes gently and keep the vehicle pointed straight ahead while you slow down. When you are moving slowly enough for it to be safe to do so, pull off the road and stop in a safe location.

Keep your foot firmly on the brake pedal when the vehicle is stopped to prevent the vehicle from rolling forward.

DRIVE MODE INTEGRATED CONTROL SYSTEM (IF EQUIPPED)



The DRIVE mode may be selected according to the driver's preference or road condition.

When the DRIVE MODE is activated by pressing the DRIVE/TRACTION MODE button, and turn the DRIVE MODE knob to desired mode.

* If you want to activate the TRACTION CONTROL mode, press the DRIVE/TRACTION mode button. The driving mode will be changed from Driving control to Traction control. You can select SNOW, MUD or SAND mode by rotating the knob to desired mode.

For more details, refer to “Traction control” later in this chapter.

Drive mode

The mode changes whenever the DRIVE MODE selection knob is rotated.

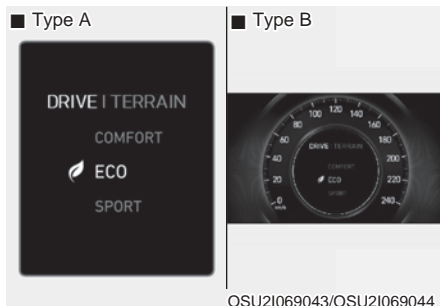
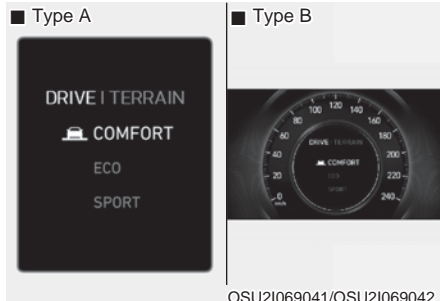

- COMFORT mode : COMFORT mode provides soft driving and comfortable riding.
- SPORT mode : SPORT mode provides sporty but firm riding.
- ECO mode : ECO mode improves fuel efficiency for eco-friendly driving.

The driving mode will be set to COMFORT or ECO mode when the engine is restarted. If it is in COMFORT/SPORT mode.

COMFORT mode will be set, when the engine is restarted.

If it is in Eco mode, Eco mode will be set when the engine is restarted.

SPORT mode

The image shows the SPORT indicator icon, which consists of the word "SPORT" in a bold, sans-serif font, enclosed within a rectangular border with rounded corners.

SPORT mode manages the driving dynamics by automatically adjusting the steering effort, and the engine and transmission control logic for enhanced driver performance.

- When SPORT mode is selected by rotating the DRIVE MODE button, the SPORT indicator (orange color) will illuminate.
- Whenever the engine is restarted, the Drive Mode will revert back to COMFORT mode. If SPORT mode is desired, re-select SPORT mode from the DRIVE/TRACTION MODE button.
- When SPORT mode is activated:
 - The engine rpm will tend to remain raised over a certain length of time even after releasing the accelerator
 - Upshifts are delayed when accelerating

***i* Information**

In SPORT mode, the fuel efficiency may decrease.

ECO mode

The image shows the ECO indicator icon, which consists of the word "ECO" in a bold, sans-serif font, enclosed within a rectangular border with rounded corners.

When the Drive Mode is set to ECO mode, the engine and transmission control logic are changed to maximize fuel efficiency.

- When ECO mode is selected by rotating the DRIVE/TRACTION MODE button, the ECO indicator (green color) will illuminate.
- If the vehicle is set to ECO mode, when the engine is turned OFF and restarted the Drive Mode setting will remain in ECO mode.

***i* Information**

Fuel efficiency depends on the driver's driving habit and road condition.

When ECO mode is activated:

- The acceleration response may be slightly reduced if the accelerator pedal is depressed moderately.
- The air conditioner performance may be limited.
- The shift pattern of the automatic transmission may change.
- The engine noise may get louder.

The above situations are normal conditions when ECO mode is activated to improve fuel efficiency.

Limitation of ECO mode operation:

If the following conditions occur while ECO mode is operating, the system operation is limited even though there is no change in the ECO indicator.

- When the coolant temperature is low:
The system will be limited until engine performance becomes normal.
- When driving up a hill:
The system will be limited to gain power when driving uphill because engine torque is restricted.
- When driving the vehicle with the paddle shifter in manual mode.
The system will be limited according to the shift location.

TRACTION CONTROL (IF EQUIPPED)

Traction Control is a system that achieve optimal driving performance by controlling engine and braking by road condition (snow, muddy, sandy).

Traction control mode



If you press the “DRIVE/TRACTION” mode button, the driving mode is changed from Driving control to Traction control. You can select SNOW, MUD or SAND mode by rotation the knob. If you press the “DRIVE/TRACTION” mode button again, the driving mode is changed from Traction Control to previous driving control.

The driving mode will be set to Driving control when the restarted, If it is in Traction Control.



WARNING

Traction mode is designed based on 2WD (2 Wheel Drive), Do not drive in condition that exceeds the vehicle’s intended design.

Invalid mode selection can lead to loss of traction and skidding, particularly on slippery roads, this can cause you to lose control of the vehicle, which can lead to accidents and serious injuries.

Traction mode operation

■ Type A

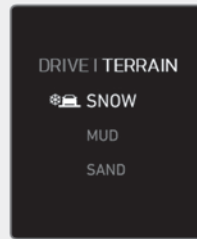

■ Type B



OSU2I069047/OSU2I069048

■ Type A

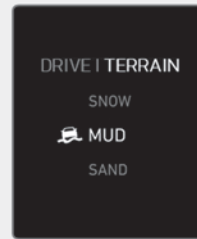

■ Type B



OSU2I069049/OSU2I069050

■ Type A

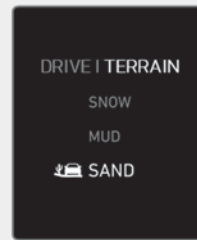

■ Type B



OSU2I069051/OSU2I069052

Traction mode offers special traction tuning for snow/mud/sand, optimizing available traction in adverse conditions. Traction mode adjusts left and right wheel slip control, engine torque and shift patterns according to available traction levels.

LCD display message

Transmission hot! Park with engine On



OAC3069035TU



OAC3069062TU

- Under certain conditions, such as harsh driving conditions (mud or sand road), the transmission temperatures will increase excessively. Finally the transmission could be overheated.
- If the vehicle continues to be driven and the transmission temperatures reach the maximum temperature limit, the “Transmission hot! Park with engine On” warning will be displayed. When this occurs the transmission is disabled until the transmission cools to normal temperatures.
- The warning will display a time to wait for the transmission to cool.
- If this occurs, pull over to a safe location, stop the vehicle with the engine running, apply the brakes and shift the vehicle to P (Park), and allow the transmission to cool.
- When the message “Transmission cooled down. Resume driving” appears you can continue to drive your vehicle.
- When possible, drive the vehicle smoothly.

CRUISE CONTROL (CC) (IF EQUIPPED)

Cruise Control operation

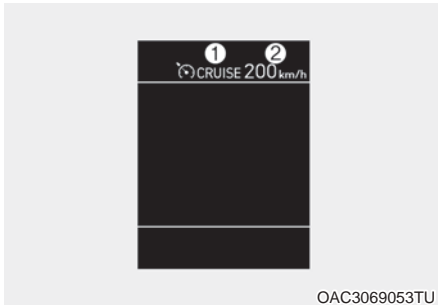

1. (Cruise) indicator
2. Set speed

Cruise Control system allows you to drive at speeds above 30 km/h (20 mph) without depressing the accelerator pedal.

WARNING

Take the following precautions:

- If Cruise Control system is left on, ((Cruise) indicator light in the instrument cluster illuminated) Cruise Control system can be activated unintentionally. Keep Cruise Control system off (the (Cruise) indicator light OFF) when Cruise Control system is not in use, to avoid inadvertently setting a speed.
- Use Cruise Control system only when traveling on open highways in good weather.
- Do not use Cruise Control system when it may not be safe to keep the vehicle at a constant speed:
 - Driving in heavy or varying speed traffic.
 - On slippery (rainy, icy or snow covered) roads.
 - Hilly or winding roads.
 - Very windy areas.
 - When driving with limited view (possibly due to bad weather such as fog, snow, rain and sandstorm)

NOTICE

During cruise-speed driving of a manual transmission vehicle, do not shift into neutral without depressing the clutch pedal, since the engine will be overrevved. If this happens, depress the clutch pedal or press the Cruise button.

i Information

- During normal cruise control operation, when the SET switch is activated or reactivated after applying the brakes, Cruise Control system will activate after approximately 3 seconds. This delay is normal.
- Before activating the cruise control function, the system will check to verify that the brake switch is operating normally. Depress the brake pedal at least once after turning ON the ignition or starting the vehicle.

Cruise control switch



 : Turns Cruise Control system on or off.

+ : Sets or increases Cruise Control speed.

- : Sets or decreases Cruise Control speed.

 : Pause and resume Cruise Control operation.

To set Cruise Control speed



1. Push the  (Cruise) button on the steering wheel to turn the system on. The cruise indicator on the LCD display will illuminate.
2. Accelerate to the desired speed, which must be more than 30 km/h (20 mph).

i Information

For manual transmission vehicles, you should depress the brake pedal at least once to set Cruise Control system after starting the engine.

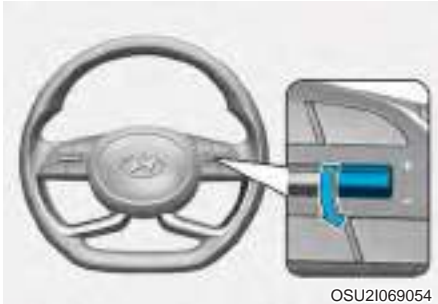

3. Push the switch down (-), and release it. The Set speed on the LCD display will illuminate.
4. Release the accelerator pedal.

i Information

The vehicle may slow down or speed up slightly while going uphill or downhill.

To increase Cruise Control speed

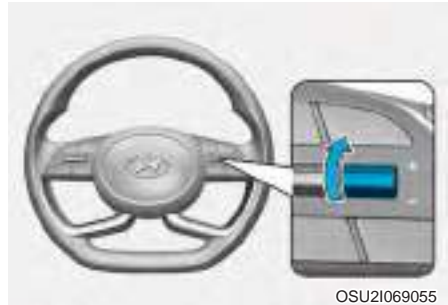

- Push the switch up (+) and hold it, while monitoring the SET speed on the instrument cluster. Release the switch when the desired speed is shown and the vehicle will accelerate to that speed.
- Push the switch up (+) and release it immediately. The cruising speed will increase 2.0 km/h (1.2 mph) each time the switch is operated in this manner.
- Depress the accelerator pedal. When the vehicle attains the desired speed, push the switch down (-).

To decrease Cruise Control speed

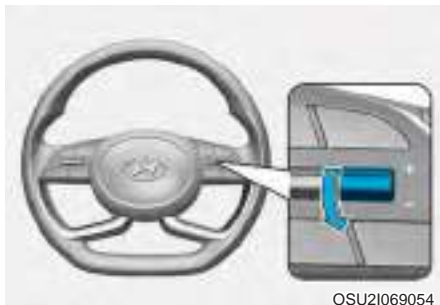

- Push the switch down (-) and hold it. Your vehicle will gradually slow down. Release the switch at the speed you want to maintain.
- Push the switch down (-) and release it immediately. The cruising speed will decrease 2.0 km/h (1.2 mph) each time the switch is operated in this manner.
- Lightly tap the brake pedal. When the vehicle attains the desired speed, push the switch down (-).



To temporarily accelerate with the Cruise Control ON

Depress the accelerator pedal. When you take your foot off the accelerator, the vehicle will return to the previously set speed.



If you push the switch Up (+) or down (-) at the increased speed, Cruise Control system will maintain the increased speed.

Cruise Control will be canceled when:



- Depressing the brake pedal.
- Depressing the clutch pedal. (for manual transmission vehicle)
- Pressing the  button located on the steering wheel. Both the  (Cruise) indicator and the set speed will turn off.
- Moving the shift lever into N (Neutral). (for Intelligent Variable Transmission/Dual Clutch Transmission/Automatic Transmission vehicle)
- Decreasing the vehicle speed lower than the memory speed by 20 km/h (12 mph).
- Decreasing the vehicle speed to less than approximately 30 km/h (20 mph).
- The ESC (Electronic Stability Control) is operating.
- Downshifting to the 2nd gear in Sports Mode.

i Information

Each of the above actions will cancel Cruise Control system operation (the SET indicator light in the instrument cluster will go off), but only pressing the  (Cruise) button will turn the system off. If you wish to resume Cruise Control system operation, push the switch up (+) located on your steering wheel. You will return to your previously preset speed, unless the system was turned off using the  (Cruise) button.

To resume preset Cruising speed

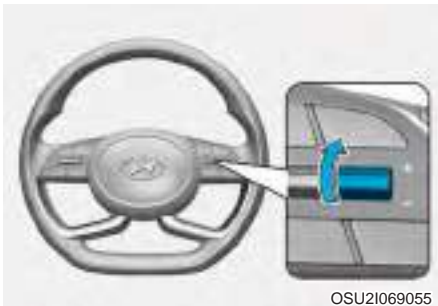

Push the switch Up (+) or down (-). If the vehicle speed is over 30 km/h (20 mph), the vehicle will resume the pre-set speed.

To turn Cruise Control off



- Pressing the  (CRUISE) button. The cruise indicator will go off.

SPECIAL DRIVING CONDITIONS

Hazardous driving conditions

When hazardous driving elements are encountered such as water, snow, ice, mud and sand, take the bellow suggestions:

- Drive cautiously and keep a longer braking distance.
- Avoid abrupt braking or steering.
- When your vehicle is stuck in snow, mud, or sand, use second gear. Accelerate slowly to avoid unnecessary wheel spin.
- Put sand, rock salt, tire chains or other non-slip materials under the wheels to provide additional traction while the vehicle becomes stuck in ice, snow, or mud.



WARNING

Downshifting with an automatic transmission, while driving on slippery surfaces can cause an accident. The sudden change in tire speed could cause the tires to skid. Be careful when downshifting on slippery surfaces.

Use sand, rock salt, or other non-slip material under the drive wheels to provide traction when stalled in ice, snow, or mud.

Rocking the vehicle

If it is necessary to rock the vehicle to free it from snow, sand, or mud, first turn the steering wheel right and left to clear the area around your front wheels. Then, shift back and forth between 1st and R (Reverse, for manual transmission vehicle) or R (Reverse) and a forward gear (for automatic transmission vehicle). Try to avoid spinning the wheels, and do not race the engine.

To prevent transmission wear, wait until the wheels stop spinning before shifting gears. Release the accelerator pedal while shifting, and press lightly on the accelerator pedal while the transmission is in gear. Slowly spinning the wheels in forward and reverse directions causes a rocking motion that may free the vehicle.

NOTICE

If the tires spin at high speed the tires can explode, and you or others may be injured. Do not attempt this procedure if people or objects are anywhere near the vehicle.

The vehicle can overheat causing an engine compartment fire or other damage. Spin the wheels as little as possible and avoid spinning the wheels at speeds over 56 km/h (35 mph) as indicated on the speedometer.

NOTICE

If you are still stuck after rocking the vehicle a few times, have the vehicle pulled out by a tow vehicle to avoid engine overheating, possible damage to the transmission, and tire damage. See “Towing” in chapter 7.

Smooth cornering

Avoid braking or gear changing in corners, especially when roads are wet. Ideally, corners should always be taken under gentle acceleration.

Driving at night

Night driving presents more hazards than driving in the daylight. Here are some important tips to remember:

- Slow down and keep more distance between you and other vehicles, as it may be more difficult to see at night, especially in areas where there may not be any street lights.
- Adjust your mirrors to reduce the glare from other driver's headlights.
- Keep your headlights clean and properly aimed. Dirty or improperly aimed headlights will make it much more difficult to see at night.
- Avoid staring directly at the headlights of oncoming vehicles. You could be temporarily blinded, and it will take several seconds for your eyes to readjust to the darkness.

Driving in the rain

Rain and wet roads can make driving dangerous. Here are a few things to consider when driving in the rain or on slick pavement:

- Slow down and allow extra following distance. A heavy rainfall makes it harder to see and increases the distance needed to stop your vehicle.
- Replace your windshield wiper blades when they show signs of streaking or missing areas on the windshield.
- Be sure your tires have enough tread. If your tires do not have enough tread, making a quick stop on wet pavement can cause a skid and possibly lead to an accident. See "Tire replacement" in chapter 8.
- Turn on your headlights to make it easier for others to see you.
- Driving too fast through large puddles can affect your brakes. If you must go through puddles, try to drive through them slowly.
- If you believe your brakes may be wet, apply them lightly while driving until normal braking operation returns.

Hydroplaning

If the road is wet enough and you are going fast enough, your vehicle may have little or no contact with the road surface and actually ride on the water. The best advice is **SLOW DOWN** when the road is wet. The risk of hydroplaning increases as the depth of tire tread decreases, refer to "Tire replacement" in chapter 8.

Driving in flooded areas

Avoid driving through flooded areas unless you are sure the water is no higher than the bottom of the wheel hub. Drive through any water slowly. Allow adequate stopping distance because brake performance may be reduced.

After driving through water, dry the brakes by gently applying them several times while the vehicle is moving slowly.

Highway driving

Tires

Adjust the tire inflation, as specified. Under-inflation may overheat or damage the tires.

Do not install worn-out or damaged tires, which may reduce traction or fail the braking operation.



Information

Never over-inflate your tires above the maximum inflation pressure, as specified on your tires.

Fuel, engine coolant and engine oil

Driving at higher speeds on the highway consumes more fuel and is less efficient than driving at a slower, more moderate speed. Maintain a moderate speed in order to conserve fuel when driving on the highway.

Be sure to check both the engine coolant level and the engine oil before driving.

Drive belt

A loose or damaged drive belt may overheat the engine.

Reducing the risk of a rollover

Your multi-purpose passenger vehicle is defined as a Sports Utility Vehicle (SUV). SUV's have higher ground clearance and a narrower track to make them capable of performing in a wide variety of off-road applications. The specific design characteristics give them a higher center of gravity than ordinary vehicles making them more likely to roll over if you make abrupt turns. Utility vehicles have a significantly higher rollover rate than other types of vehicles. Due to this risk, driver and passengers are strongly recommended to buckle their seat belts. In a rollover crash, an unbelted person is significantly more likely to die than a person wearing a seat belt.

There are steps that a driver can make to reduce the risk of a rollover. If at all possible, avoid sharp turns or abrupt maneuvers, do not load your vehicle with heavy cargo on the roof, and never modify your vehicle in any way.



WARNING

Utility vehicles have a significantly higher rollover rate than other types of vehicles. To prevent roll-overs or loss of control:

- **Take corners at slower speeds than you would with a passenger vehicle.**
- **Avoid sharp turns and abrupt maneuvers.**
- **Do not modify your vehicle in any way that you would raise the center of gravity.**
- **Keep tires properly inflated.**
- **Do not carry heavy cargo on the roof.**



WARNING

In a rollover crash, an unbelted person is significantly more likely to die than a person wearing a seat belt. Make sure all passengers are wearing their seat belts.

WINTER DRIVING

The severe weather conditions of winter quickly wear out tires and cause other problems. To minimize winter driving problems, you should take the following suggestions:

Snow or icy conditions

You need to keep sufficient distance between your vehicle and the vehicle in front of you.

Apply the brakes gently. Speeding, rapid acceleration, sudden brake applications, and sharp turns are potentially very hazardous practices. During deceleration, use engine braking to the fullest extent. Sudden brake applications on snowy or icy roads may cause skids to occur.

To drive your vehicle in deep snow, it may be necessary to use snow tires or to install tire chains on your tires.

Always carry emergency equipment. Some of the items you may want to carry include tire chains, tow straps or chains, a flashlight, emergency flares, sand, a shovel, jumper cables, a window scraper, gloves, ground cloth, coveralls, a blanket, etc.

Snow tires

WARNING

Snow tires should be equivalent in size and type to the vehicle's standard tires. Otherwise, the safety and handling of your vehicle may be adversely affected.

If you mount snow tires on your vehicle, make sure to use radial tires of the same size and load range as the original tires. Mount snow tires on all four wheels to balance your vehicle's handling in all weather conditions. The traction provided by snow tires on dry roads may not be as high as your vehicle's original equipment tires. Check with the tire dealer for maximum speed recommendations.

Information

Do not install studded tires without first checking local and municipal regulations for possible restrictions against their use.

Tire chains



Since the sidewalls of radial tires are thinner than other types of tires, they may be damaged by mounting some types of tire chains on them. Therefore, the use of snow tires is recommended instead of tire chains. Do not mount tire chains on vehicles equipped with aluminum wheels; if unavoidable use a wire type chain. If tire chains must be used, use genuine HYUNDAI parts and install the tire chain after reviewing the instructions provided with the tire chains. Damage to your vehicle caused by improper tire chain use is not covered by your vehicle manufacturer's warranty.

WARNING

The use of tire chains may adversely affect vehicle handling:

- Drive less than 30 km/h (20 mph) or the chain manufacturer's recommended speed limit, whichever is lower.
- Drive carefully and avoid bumps, holes, sharp turns, and other road hazards, which may cause the vehicle to bounce.
- Avoid sharp turns or locked wheel braking.

Information

- **Install tire chains on the front tires.** It should be noted that installing tire chains on the tires will provide a greater driving force, but will not prevent side skids.
- **Do not install tire chains without first checking local and municipal regulations for possible restrictions against their use.**

Chain Installation

When installing tire chains, follow the manufacturer's instructions and mount them as tightly possible. Drive slowly (less than 30 km/h (20 mph)) with chains installed. If you hear the chains contacting the body or chassis, stop and tighten them. If they still make contact, slow down until the noise stops. Remove the tire chains as soon as you begin driving on cleared roads.

When mounting snow chains, park the vehicle on level ground away from traffic. Turn on the vehicle Hazard Warning Flasher and place a triangular emergency warning device behind the vehicle (if available). Always place the vehicle in P (Park), apply the parking brake and turn off the engine before installing snow chains.

NOTICE

When using tire chains:

- **Wrong size chains or improperly installed chains can damage your vehicle's brake lines, suspension, body and wheels.**
- **Use SAE "S" class or wire chains.**
- **If you hear noise caused by chains contacting the body, retighten the chain to prevent contact with the vehicle body.**
- **To prevent body damage, retighten the chains after driving 0.5~1.0 km (0.3~0.6 miles).**
- **Do not use tire chains on vehicles equipped with aluminum wheels. If unavoidable, use a wire type chain.**
- **Use wire chains less than 15 mm (0.59 in) wide to prevent damage to the chain's connection.**

Winter precautions

Use high quality ethylene glycol coolant

Your vehicle is delivered with high quality ethylene glycol coolant in the cooling system. It is the only type of coolant that should be used because it helps prevent corrosion in the cooling system, lubricates the water pump and prevents freezing. Be sure to replace or replenish your coolant in accordance with the maintenance schedule in chapter 8. Before winter, have your coolant tested to assure that its freezing point is sufficient for the temperatures anticipated during the winter.

Check battery and cables

Winter puts additional burdens on the battery system. Visually inspect the battery and cables as described in chapter 8. The level of charge in your battery can be checked by an authorized HYUNDAI dealer or a service station.

Change to "winter weight" oil if necessary

In some climates it is recommended that a lower viscosity "winter weight" oil be used during cold weather. See chapter 2 for recommendations. If you aren't sure what weight oil you should use, we recommend that you consult with an authorized HYUNDAI dealer.

Check spark plugs and ignition system

Inspect your spark plugs as described in chapter 8 and replace them if necessary. Also check all ignition wiring and components to be sure they are not cracked, worn or damaged in any way.

To keep locks from freezing

To keep the locks from freezing, squirt an approved de-icer fluid or glycerine into the key opening. If a lock is covered with ice, squirt it with an approved de-icing fluid to remove the ice. If the lock is frozen internally, you may be able to thaw it out by using a heated key. Handle the heated key with care to avoid injury.

Use approved window washer anti-freeze in system

To keep the water in the window washer system from freezing, add an approved window washer anti-freeze solution in accordance with instructions on the container. Window washer anti-freeze is available from an authorized HYUNDAI dealer and most auto parts outlets. Do not use engine coolant or other types of anti-freeze as these may damage the paint finish.

Do not let your parking brake freeze

Under some conditions your parking brake can freeze in the engaged position. This is most likely to happen when there is an accumulation of snow or ice around or near the rear brakes or if the brakes are wet. If there is a risk the parking brake may freeze, apply it only temporarily while you put the shift lever in P (for automatic transmission) or in first or reverse gear (for manual transmission) and block the rear wheels so the vehicle cannot roll. Then release the parking brake.

Do not let ice and snow accumulate underneath

Under some conditions, snow and ice can build up under the fenders and interfere with the steering. When driving in severe winter conditions where this may happen, you should periodically check underneath the car to be sure the movement of the front wheels and the steering components is not obstructed.

Carry emergency equipment

Depending on the severity of the weather, you should carry appropriate emergency equipment. Some of the items you may want to carry include tire chains, tow straps or chains, flashlight, emergency flares, sand, shovel, jumper cables, window scraper, gloves, ground cloth, coveralls, blanket, etc.

Do not place foreign objects or materials in the engine compartment

Placement of foreign objects or materials which prevent cooling of the engine, in the engine compartment, may cause a failure or combustion. The manufacturer is not responsible for the damage caused by such placement.

VEHICLE WEIGHT

Two labels on your driver's door sill show how much weight your vehicle was designed to carry: the Tire and Loading Information Label and the Certification Label.

Before loading your vehicle, familiarize yourself with the following terms for determining your vehicle's weight ratings, from the vehicle's specifications and the Certification Label:

Base Curb Weight

This is the weight of the vehicle including a full tank of fuel and all standard equipment. It does not include passengers, cargo, or optional equipment.

Vehicle Curb Weight

This is the weight of your new vehicle when you picked it up from your dealer plus any aftermarket equipment.

Cargo Weight

This figure includes all weight added to the Base Curb Weight, including cargo and optional equipment.

GAW (Gross Axle Weight)

This is the total weight placed on each axle (front and rear) - including vehicle curb weight and all payload.

GAWR (Gross Axle Weight Rating)

This is the maximum allowable weight that can be carried by a single axle (front or rear). These numbers are shown on the Certification Label. The total load on each axle must never exceed its GAWR.

GVW (Gross Vehicle Weight)

This is the Base Curb Weight plus actual Cargo Weight plus passengers.

GVWR (Gross Vehicle Weight Rating)

This is the maximum allowable weight of the fully loaded vehicle (including all options, equipment, passengers and cargo). The GVWR is shown on the Certification Label located on the driver's door sill.

Overloading



WARNING

The Gross Axle Weight Rating (GAWR) and the Gross Vehicle Weight Rating (GVWR) for your vehicle are on the Certification Label attached to the driver's (or front passenger's) door. Exceeding these ratings can cause an accident or vehicle damage. You can calculate the weight of your load by weighing the items (and people) before putting them in the vehicle. Be careful not to overload your vehicle.

7. Emergency situations

Hazard warning flasher	7-2
In case of an emergency while driving	7-2
If the engine stalls while driving.....	7-2
If the engine stalls at a crossroad or crossing	7-2
If you have a flat tire while driving	7-3
If the engine will not start	7-3
If the engine doesn't turn over or turns over slowly	7-3
If the engine turns over normally but doesn't start	7-3
Jump starting	7-4
If the engine overheats	7-7
Tire Pressure Monitoring System (TPMS) - TYPE A	7-9
Low tire pressure telltale.....	7-10
TPMS (Tire Pressure Monitoring System) malfunction indicator.....	7-12
Changing a tire with TPMS	7-12
Tire Pressure Monitoring System (TPMS) - TYPE B	7-14
Check tire pressure	7-14
Tire pressure monitoring system.....	7-15
Low tire pressure telltale.....	7-16
Low tire pressure position telltale and tire pressure telltale	7-16
TPMS (Tire Pressure Monitoring System) malfunction indicator.....	7-17
Changing a tire with TPMS	7-18
If you have a flat tire (with spare tire).....	7-20
Jack and tools	7-20
Removing and storing the spare tire.....	7-20
Changing tires	7-21
Jack label	7-25
EC declaration of conformity for jack.....	7-26
Towing	7-27
Towing service.....	7-27
Removable towing hook	7-28
Emergency towing	7-29
Emergency commodity	7-31
First aid kit	7-31
Triangle reflector	7-31

HAZARD WARNING FLASHER



The hazard warning flasher serves as a warning to other drivers to exercise extreme caution when approaching, overtaking, or passing your vehicle.

It should be used whenever emergency repairs are being made or when the vehicle is stopped near the edge of a roadway.

To turn the hazard warning flasher on or off, press the hazard warning flasher button with the ignition switch in any position. The button is located in the heater control switch panel.

All turn signal lights will flash simultaneously.

- The hazard warning flasher operates whether your vehicle is running or not.
- The turn signals do not work when the hazard flasher is on.

IN CASE OF AN EMERGENCY WHILE DRIVING

If the engine stalls while driving

- Reduce your speed gradually, keeping a straight line. Move cautiously off the road to a safe place.
- Turn on your hazard warning flasher.
- Try to start the engine again. If your vehicle will not start, we recommend that you contact an authorized HYUNDAI dealer.

If the engine stalls at a crossroad or crossing

If the engine stalls at a crossroad or crossing, if safe to do so, move the shift lever to the N (Neutral) position and then push the vehicle to a safe location.

- If your vehicle has a manual transmission not equipped with a ignition lock switch, the vehicle can move forward by shifting to the 2(second) or 3(third) gear and then turning the starter without depressing the clutch pedal.

If you have a flat tire while driving

If a tire goes flat while you are driving:

- Take your foot off the accelerator pedal and let the vehicle slow down while driving straight ahead. Do not apply the brakes immediately or attempt to pull off the road as this may cause loss of vehicle control resulting in an accident. When the vehicle has slowed to such a speed that it is safe to do so, brake carefully and pull off the road. Drive off the road as far as possible and park on firm, level ground. If you are on a divided highway, do not park in the median area between the two traffic lanes.
- When the vehicle is stopped, press the hazard warning flasher button, move the shift lever into P (Park, for automatic transmission) or neutral (for manual transmission vehicle), apply the parking brake, and place the ignition switch in the LOCK/OFF position.
- Have all passengers get out of the vehicle. Be sure they all get out on the side of the vehicle that is away from traffic.
- When changing a flat tire, follow the instructions provided later in this chapter.

IF THE ENGINE WILL NOT START

If the engine doesn't turn over or turns over slowly

- Be sure the for automatic transmission or P (Park) if it is a vehicle. The engine starts only when the shift lever is in N (Neutral) or P (Park).
- Check the battery connections to be sure they are clean and tight.
- Turn on the interior light. If the light dims or goes out when you operate the starter, the battery is drained.

Do not push or pull the vehicle to start it. This could cause damage to your vehicle.

See instructions for “Jump Starting” provided in this chapter.



WARNING

Pushing or pulling to start the vehicle may cause the catalytic converter overload, which can lead to damage to the emission control system.

If the engine turns over normally but doesn't start

- Check the fuel level and add fuel if necessary.

If the engine still does not start, we recommend that you call an authorized HYUNDAI dealer for assistance.

JUMP STARTING

Jump starting can be dangerous if done incorrectly. Follow the jump starting procedure in this section to avoid serious injury or damage to your vehicle. If in doubt about how to properly jump start your vehicle, we strongly recommend that you have a service technician or towing service do it for you.



WARNING

To prevent **SERIOUS INJURY** or **DEATH** to you or bystanders, always follow these precautions when working near or handling the battery:



Always read and follow instructions carefully when handling a battery.



Wear eye protection designed to protect the eyes from acid splashes.



Keep all flames, sparks, or smoking materials away from the battery.



Hydrogen is always present in battery cells, is highly combustible, and may explode if ignited.



Keep batteries out of reach of children.



Batteries contain sulfuric acid which is highly corrosive. Do not allow acid to contact your eyes, skin or clothing.

If acid gets into your eyes, flush your eyes with clean water for at least 15 minutes and get immediate medical attention. If acid gets on your skin, thoroughly wash the area. If you feel pain or a burning sensation, get medical attention immediately.

- When lifting a plastic-cased battery, excessive pressure on the case may cause battery acid to leak. Lift with a battery carrier or with your hands on opposite corners.
- Do not attempt to jump start your vehicle if your battery is frozen.
- NEVER attempt to recharge the battery when the vehicle's battery cables are connected to the battery.
- The electrical ignition system works with high voltage. NEVER touch these components with the engine running or when the ignition switch is in the ON position.
- Do not allow the (+) and (-) jumper cables to touch. It may cause sparks.
- The battery may rupture or explode when you jump start with a low or frozen battery.
- Never attempt jump start if you observe cracks, leaks or other damage on Battery.

CAUTION

- Improper jump starting procedure can result in battery explosion and acid burn hazard.
- Loosely connected battery cables could damage the electronic control units.
- To disconnect battery terminals wait for at least 2 minutes to allow discharge of high voltage or it could lead to personal injury.
- While disconnecting, always disconnect the -VE terminal first and while connecting, always connect the -VE terminal last.

NOTICE

To prevent damage to your vehicle:

- Only use a 12-volt power supply (battery or jumper system) to jump start your vehicle.
- Do not attempt to jump start your vehicle by push-starting.

Information

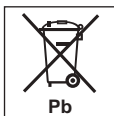

An inappropriately disposed battery can be harmful to the environment and human health. Dispose the battery according to your local law(s) or regulation.

Jump starting procedure

1. Position the vehicles close enough that the jumper cables will reach, but do not allow the vehicles to touch.
2. Avoid fans or any moving parts in the engine compartment at all times, even when the vehicles are turned off.
3. Turn off all electrical devices such as radios, lights, air conditioning, etc. Put the vehicles in P (Park, for automatic transmission vehicle) or neutral (for manual transmission vehicle), and set the parking brakes. Turn both vehicles OFF.

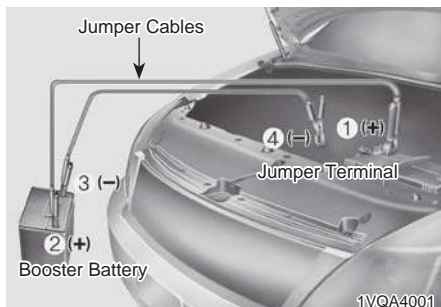

4. Connect the jumper cables in the exact sequence shown in the illustration. First connect one jumper cable to the red, positive (+) jumper terminal of your vehicle (1).
5. Connect the other end of the jumper cable to the red, positive (+) battery/jumper terminal of the assisting vehicle (2).
6. Connect the second jumper cable to the black, negative (-) battery/chassis ground of the assisting vehicle (3).

7. Connect the other end of the second jumper cable to the black, negative (-) chassis ground of your vehicle (4).

Do not allow the jumper cables to contact anything except the correct battery or jumper terminals or the correct ground. Do not lean over the battery when making connections.

8. Start the engine of the assisting vehicle and let it run at approximately 2,000 rpm for a few minutes. Then start your vehicle.

If your vehicle will not start after a few attempts, it probably requires servicing. In this event please seek qualified assistance. If the cause of your battery discharging is not apparent, we recommend that your vehicle be checked by an authorized HYUNDAI dealer.



WARNING

Never connect Jumper Cable directly to the negative (-) terminal of discharged Battery (Your Vehicle Battery), or an Explosion may occur.

Disconnect the jumper cables in the exact reverse order you connected them:

1. Disconnect the jumper cable from the black, negative (-) chassis ground of your vehicle (4).
2. Disconnect the other end of the jumper cable from the black, negative (-) battery/chassis ground of the assisting vehicle (3).
3. Disconnect the second jumper cable from the red, positive (+) battery/jumper terminal of the assisting vehicle (2).
4. Disconnect the other end of the jumper cable from the red, positive (+) jumper terminal of your vehicle (1).

IF THE ENGINE OVERHEATS

If your temperature gauge indicates overheating, you experience a loss of power, or hear loud pinging or knocking, the engine may be overheating. If this happens, you should:

1. Pull off the road and stop as soon as it is safe to do so.
2. Place the shift lever in P (Park, for automatic transmission vehicle) or neutral (for manual transmission vehicle) and set the parking brake. If the air conditioning is ON, turn it OFF.
3. If engine coolant is running out under the vehicle or steam is coming out from the hood, stop the engine. Do not open the hood until the coolant has stopped running or the steaming has stopped. If there is no visible loss of engine coolant and no steam, leave the engine running and check to be sure the engine cooling fan is operating. If the fan is not running, turn the engine off.
4. Check for coolant leaking from the radiator, hoses or under the vehicle. (If the air conditioning had been in use, it is normal for cold water to be draining from it when you stop.)
5. If engine coolant is leaking out, stop the engine immediately and we recommend that you call an authorized HYUNDAI dealer for assistance.

WARNING

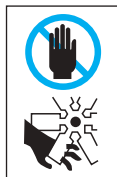

While the engine is running, keep hands, clothing and tools away from the moving parts such as the cooling fan and drive belt to prevent serious injury.

WARNING



NEVER remove the radiator cap or the drain plug while the engine and radiator are hot. Hot coolant and steam may

blow out under pressure, causing serious injury.

Turn the engine off and wait until the engine cools down. Use extreme care when removing the radiator cap. Wrap a thick towel around it, and turn it counterclockwise slowly to the first stop. Step back while the pressure is released from the cooling system. When you are sure all the pressure has been released, press down on the cap, using a thick towel, and continue turning counterclockwise to remove it.

6. If you cannot find the cause of the overheating, wait until the engine temperature has returned to normal. Then, if coolant has been lost, carefully add coolant to the reservoir to bring the fluid level in the reservoir up to the halfway mark.
7. Proceed with caution, keeping alert for further signs of overheating. If overheating happens again, we recommend that you call an authorized HYUNDAI dealer for assistance.

NOTICE

- **Serious loss of coolant indicates a leak in the cooling system and we recommend the system be checked by an authorized HYUNDAI dealer.**
- **When the engine overheats from low engine coolant, suddenly adding engine coolant may cause cracks in the engine. To prevent damage, add engine coolant slowly in small quantities.**

TIRE PRESSURE MONITORING SYSTEM (TPMS) (IF EQUIPPED) - TYPE A



Each tire, including the spare (if provided), should be checked monthly when cold and inflated to the inflation pressure recommended by the vehicle manufacturer on the vehicle placard or tire inflation pressure label. (If your vehicle has tires of a different size than the size indicated on the vehicle placard or tire inflation pressure label, you should determine the proper tire inflation pressure for those tires.)

As an added safety feature, your vehicle has been equipped with a tire pressure monitoring system (TPMS) that illuminates a low tire pressure telltale when one or more of your tires is significantly under-inflated.

Accordingly, when the low tire pressure telltale illuminates, you should stop and check your tires as soon as possible, and inflate them to the proper pressure. Driving on a significantly under-inflated tire causes the tire to overheat and can lead to tire failure. Under-inflation also reduces fuel efficiency and tire tread life, and may affect the vehicle's handling and stopping ability.

Please note that the TPMS is not a substitute for proper tire maintenance, and it is the driver's responsibility to maintain correct tire pressure, even if under-inflation has not reached the level to trigger illumination of the TPMS low tire pressure telltale.

Your vehicle has also been equipped with a TPMS malfunction indicator to indicate when the system is not operating properly. The TPMS malfunction indicator is combined with the low tire pressure telltale. When the system detects a malfunction, the telltale will flash for approximately one minute and then remain continuously illuminated. This sequence will continue upon subsequent vehicle start-ups as long as the malfunction exists. When the malfunction indicator is illuminated, the system may not be able to detect or signal low tire pressure as intended. TPMS malfunctions may occur for a variety of reasons, including the installation of replacement or alternate tires or wheels on the vehicle that prevent the TPMS from functioning properly. Always check the TPMS malfunction telltale after replacing one or more tires or wheels on your vehicle to ensure that the replacement or alternate tires and wheels allow the TPMS to continue to function properly.

i Information

If the TPMS indicator does not illuminate for 3 seconds when the ignition switch is turned to the ON position or engine is running, or if it comes on after blinking for approximately one minute, we recommend that you contact an authorized HYUNDAI dealer.



Low tire pressure telltale



When the tire pressure monitoring system warning indicators are illuminated, and warning message displayed on the cluster LCD display, one or more of your tires is significantly under-inflated. The low tire pressure position telltale warning message will indicate which tire is significantly under-inflated by illuminating the corresponding position light.

If either telltale or LCD warning message displays immediately reduce your speed, avoid hard cornering and anticipate increased stopping distances. You should stop and check your tires as soon as possible.

Inflate the tires to the proper pressure as indicated on the vehicle's placard or tire inflation pressure label located on the driver's side center pillar outer panel.

If you cannot reach a service station or if the tire cannot hold the newly added air, replace the low pressure tire with a spare tire.

After you replace the low pressure tire with the spare tire, one of the following will happen:

- The TPMS malfunction indicator may blink for approximately 1 minute and then remain continuously illuminated because the TPMS sensor is not mounted on the spare wheel. (changed tire equipped with a sensor not in the vehicle)
- The TPMS malfunction indicator will remain continuously illuminated while driving because the TPMS sensor is not mounted on the spare wheel. (changed tire equipped with a sensor in the vehicle)



CAUTION

In winter or cold weather, the low tire pressure telltale may be illuminated if the tire pressure was adjusted to the recommended tire inflation pressure in warm weather. It does not mean your TPMS is malfunctioning because the decreased temperature leads to a proportional lowering of tire pressure.

When you drive your vehicle from a warm area to a cold area or from a cold area to a warm area, or the outside temperature is greatly higher or lower, you should check the tire inflation pressure and adjust the tires to the recommended tire inflation pressure.



WARNING

Low pressure damage

Significantly low tire pressure makes the vehicle unstable and can contribute to loss of vehicle control and increased braking distances.

Continued driving on low pressure tires can cause the tires to overheat and fail.



TPMS (Tire Pressure Monitoring System) malfunction indicator

The TPMS malfunction indicator will illuminate after it blinks for approximately one minute when there is a problem with the Tire Pressure Monitoring System. If the system is able to correctly detect an under inflation warning at the same time as system failure then it will illuminate the TPMS malfunction indicator.

We recommend that the system be checked by an authorized HYUNDAI dealer.

NOTICE

- **The TPMS malfunction indicator may be illuminated if the vehicle is moving around electric power supply cables or radios transmitter such as at police stations, government and public offices, broadcasting stations, military installations, airports, or transmitting towers, etc. This can interfere with normal operation of the Tire Pressure Monitoring System (TPMS).**
- **The TPMS malfunction indicator may illuminate if snow chains or some separately purchased devices such as notebook computers, mobile charger, remote starter, navigation etc. are used in the vehicle. This can interfere with normal operation of the Tire Pressure Monitoring System (TPMS).**

Changing a tire with TPMS

If you have a flat tire, the Low Tire Pressure will come on. We recommend that the flat tire be checked by an authorized HYUNDAI dealer.

NOTICE

We recommend that you use a puncture-repairing agent approved by HYUNDAI.

The sealant on the tire pressure sensor and wheel shall be eliminated when you replace the tire with a new one.

Each wheel is equipped with a tire pressure sensor mounted inside the tire behind the valve stem. You must use TPMS specific wheels. It is recommended that you have your tires serviced by an authorized HYUNDAI dealer.

Even if you replace the low pressure tire with the spare tire, the Low Tire Pressure Telltale will blink or remain on until the low pressure tire is repaired and placed on the vehicle.

After you replace the low pressure tire with the spare tire, the Low Tire Pressure Telltale may blink or illuminate after a few minutes because the TPMS sensor mounted on the spare wheel is not initiated.

Once the low pressure tire is re-inflated to the recommended pressure and installed on the vehicle or the new TPMS sensor mounted on the wheel, the TPMS malfunction indicator and the low tire pressure and position telltales will turn off within a few minutes of driving.

If the indicator does not turn off after a few minutes of driving, we recommend that the system be checked by an authorized HYUNDAI dealer.

NOTICE

If original mounted tire is replaced with the spare tire, the TPMS sensor on the replaced spare wheel should be initiated and we recommend that the TPMS sensor on the original mounted wheel be deactivated by a HYUNDAI dealer. If the TPMS sensor on the original mounted wheel located in the spare tire carrier still activates, the tire pressure monitoring system may not operate properly. We recommend that the system be serviced by an authorized HYUNDAI dealer.

You may not be able to identify a low tire by simply looking at it. Always use a good quality tire pressure gauge to measure the tire's inflation pressure. Please note that a tire that is hot (from being driven) will have a higher pressure measurement than a tire that is cold.

A cold tire means the vehicle is in parked position for at least 3 hours or driven less than 1.6 km (1 mile) in that period.

Allow the tire to cool before measuring the inflation pressure. Always be sure the tire is cold before inflating to the recommended pressure.

NOTICE

We recommend that you use the tire sealant approved by HYUNDAI if your vehicle is equipped with a Tire Pressure Monitoring System. The liquid sealant can damage the tire pressure sensors.



WARNING

TPMS

- The TPMS cannot alert you to severe and sudden tire damage caused by external factors such as nails or road debris.
- If you feel any vehicle instability, immediately take your foot off the accelerator, apply the brakes gradually and with light force, and slowly move to a safe position off the road.



WARNING

Protecting TPMS

Tampering with, modifying, or disabling the Tire Pressure Monitoring System (TPMS) components may interfere with the system's ability to warn the driver of low tire pressure conditions and/or TPMS malfunctions. Tampering with, modifying, or disabling the Tire Pressure Monitoring System (TPMS) components may void the warranty for that portion of the vehicle.

TIRE PRESSURE MONITORING SYSTEM (TPMS) (IF EQUIPPED) - TYPE B



- (1) Low tire pressure telltale / TPMS malfunction indicator
- (2) Low tire pressure position telltale and tire pressure telltale (Shown on the LCD display)

Check tire pressure



- You can check the tire pressure in the Assist mode on the cluster.
- Refer to the “LCD Display Modes” in chapter 3.**
- Tire pressure is displayed after a few minutes of driving after initial engine start up.
 - If tire pressure is not displayed when the vehicle is stopped, “Drive to display” message will appear. After driving, check the tire pressure.
 - The displayed tire pressure values may differ from those measured with a tire pressure gauge.
 - You can change the tire pressure unit in the User Settings mode on the instrument cluster.
 - psi, kpa, bar (**Refer to “LCD Modes” in chapter 3.**)

Tire pressure monitoring system



WARNING

Over-inflation or under-inflation can reduce tire life, adversely affect vehicle handling, and lead to sudden tire failure that may cause loss of vehicle control resulting in an accident.

Each tire, including the spare (if provided), should be checked monthly when cold and inflated to the inflation pressure recommended by the vehicle manufacturer on the vehicle placard or tire inflation pressure label. (If your vehicle has tires of a different size than the size indicated on the vehicle placard or tire inflation pressure label, you should determine the proper tire inflation pressure for those tires.)

As an added safety feature, your vehicle has been equipped with a tire pressure monitoring system (TPMS) that illuminates a low tire pressure telltale when one or more of your tires is significantly under-inflated.

Accordingly, when the low tire pressure telltale illuminates, you should stop and check your tires as soon as possible, and inflate them to the proper pressure. Driving on a significantly under-inflated tire causes the tire to overheat and can lead to tire failure. Under-inflation also reduces fuel efficiency and tire tread life, and may affect the vehicle's handling and stopping ability.

Please note that the TPMS is not a substitute for proper tire maintenance, and it is the driver's responsibility to maintain correct tire pressure, even if under-inflation has not reached the level to trigger illumination of the TPMS low tire pressure telltale.

Your vehicle has also been equipped with a TPMS malfunction indicator to indicate when the system is not operating properly. The TPMS malfunction indicator is combined with the low tire pressure telltale. When the system detects a malfunction, the telltale will flash for approximately one minute and then remain continuously illuminated. This sequence will continue upon subsequent vehicle start-ups as long as the malfunction exists. When the malfunction indicator is illuminated, the system may not be able to detect or signal low tire pressure as intended. TPMS malfunctions may occur for a variety of reasons, including the installation of replacement or alternate tires or wheels on the vehicle that prevent the TPMS from functioning properly. Always check the TPMS malfunction telltale after replacing one or more tires or wheels on your vehicle to ensure that the replacement or alternate tires and wheels allow the TPMS to continue to function properly.



Information

If the TPMS indicator does not illuminate for 3 seconds when the ignition switch is turned to the ON position or engine is running, or if it comes on after blinking for approximately one minute, we recommend that you contact an authorized HYUNDAI dealer.



Low tire pressure telltale

Low tire pressure position telltale and tire pressure telltale



When the tire pressure monitoring system warning indicators are illuminated and a warning message displayed on the cluster LCD display, one or more of your tires is significantly under-inflated. The low tire pressure position telltale light will indicate which tire is significantly under-inflated by illuminating the corresponding position light.

If either telltale illuminates, immediately reduce your speed, avoid hard cornering and anticipate increased stopping distances. You should stop and check your tires as soon as possible. Inflate the tires to the proper pressure as indicated on the vehicle's placard or tire inflation pressure label located on the driver's side center pillar outer panel. If you cannot reach a service station or if the tire cannot hold the newly added air, replace the low pressure tire with a spare tire.

If you drive the vehicle for about 10 minutes at speeds above 25 km/h after replacing the low pressure tire with the spare tire, the following will happen:

- The TPMS malfunction indicator may blink for approximately 1 minute and then remain continuously illuminated because the TPMS sensor is not mounted on the spare wheel.

NOTICE

In winter or cold weather, the low tire pressure telltale may be illuminated if the tire pressure was adjusted to the recommended tire inflation pressure in warm weather. It does not mean your TPMS is malfunctioning because the decreased temperature leads to a proportional lowering of tire pressure.

When you drive your vehicle from a warm area to a cold area or from a cold area to a warm area, or the outside temperature is greatly higher or lower, you should check the tire inflation pressure and adjust the tires to the recommended tire inflation pressure.

**WARNING****Low pressure damage**

Significantly low tire pressure makes the vehicle unstable and can contribute to loss of vehicle control and increased braking distances.

Continued driving on low pressure tires can cause the tires to over-heat and fail.

**TPMS (Tire Pressure Monitoring System) malfunction indicator**

The TPMS malfunction indicator will illuminate after it blinks for approximately one minute when there is a problem with the Tire Pressure Monitoring System. If the system is able to correctly detect an under inflation warning at the same time as system failure then it will illuminate the TPMS malfunction indicator.

We recommend that the system be checked by an authorized HYUNDAI dealer.

NOTICE

If there is a malfunction with the TPMS, the low tire pressure position telltale will not be displayed even though the vehicle has an under-inflated tire.



CAUTION

- The TPMS malfunction indicator may be illuminated if the vehicle is moving around electric power supply cables or radios transmitter such as at police stations, government and public offices, broadcasting stations, military installations, airports, or transmitting towers, etc. This can interfere with normal operation of the Tire Pressure Monitoring System (TPMS).
- The TPMS malfunction indicator may illuminate if snow chains or some separately purchased devices such as notebook computers, mobile charger, remote starter, navigation etc. are used in the vehicle. This can interfere with normal operation of the Tire Pressure Monitoring System (TPMS).

Changing a tire with TPMS

If you have a flat tire, the low Tire Pressure and Position telltales will come on.

We recommend that you have the flat tire repaired by an authorized HYUNDAI dealer as soon as possible or replace the flat tire with the spare tire.



CAUTION

It is recommended that you do not use a puncture-repairing agent not approved by HYUNDAI dealer or the equivalent specified for your vehicle to repair and/or inflate a low pressure tire. Tire sealant not approved by HYUNDAI dealer or the equivalent specified for your vehicle may damage the tire pressure sensor.

Each wheel is equipped with a tire pressure sensor mounted inside the tire behind the valve stem. You must use TPMS specific wheels. It is recommended that you have your tires serviced by an authorized HYUNDAI dealer.

Even if you replace the low pressure tire with the spare tire, the Low Tire Pressure Telltale will blink or remain on until the low pressure tire is repaired and placed on the vehicle.

After you replace the low pressure tire with the spare tire, the Low Tire Pressure Telltale may blink or illuminate after a few minutes because the TPMS sensor mounted on the spare wheel is not initiated.

Once the low pressure tire is re-inflated to the recommended pressure and installed on the vehicle or the new TPMS sensor mounted on the wheel, the TPMS malfunction indicator and the low tire pressure and position telltales will turn off within a few minutes of driving.

If the indicator does not turn off after a few minutes of driving, we recommend that the system be checked by an authorized HYUNDAI dealer.

NOTICE

If original mounted tire is replaced with the spare tire, the TPMS sensor on the replaced spare wheel should be initiated and we recommend that the TPMS sensor on the original mounted wheel be deactivated by a HYUNDAI dealer. If the TPMS sensor on the original mounted wheel located in the spare tire carrier still activates, the tire pressure monitoring system may not operate properly. We recommend that the system be serviced by an authorized HYUNDAI dealer.

You may not be able to identify a low tire by simply looking at it. Always use a good quality tire pressure gauge to measure the tire's inflation pressure. Please note that a tire that is hot (from being driven) will have a higher pressure measurement than a tire that is cold.

A cold tire means the vehicle is in parked position for at least 3 hours or driven less than 1.6 km (1 mile) in that period.

Allow the tire to cool before measuring the inflation pressure. Always be sure the tire is cold before inflating to the recommended pressure.

NOTICE

We recommend that you use the tire sealant approved by HYUNDAI if your vehicle is equipped with a Tire Pressure Monitoring System. The liquid sealant can damage the tire pressure sensors.



WARNING

TPMS

- The TPMS cannot alert you to severe and sudden tire damage caused by external factors such as nails or road debris.
- If you feel any vehicle instability, immediately take your foot off the accelerator, apply the brakes gradually and with light force, and slowly move to a safe position off the road.



WARNING

Protecting TPMS

Tampering with, modifying, or disabling the Tire Pressure Monitoring System (TPMS) components may interfere with the system's ability to warn the driver of low tire pressure conditions and/or TPMS malfunctions. Tampering with, modifying, or disabling the Tire Pressure Monitoring System (TPMS) components may void the warranty for that portion of the vehicle.

IF YOU HAVE A FLAT TIRE (WITH SPARE TIRE, IF EQUIPPED)

WARNING

Changing a tire can be dangerous. Follow the instructions in this section when changing a tire to reduce the risk of serious injury or death.

CAUTION

Be careful as you use the jack handle to stay clear of the flat end. The flat end has sharp edges that could cause cuts.

WARNING

Be cautious as the minimum ground clearance gets lower when you store the original tire in the bottom of the vehicle after replacing it with a spare tire. In particular, drive below 30 km/h (18 mph) when driving over a speed bump and on uphill/downhill/uneven road.

Jack and tools



The jack, jack handle, wheel lug nut wrench and socket are stored in the luggage compartment.

Pull up the luggage box cover to reach this equipment.

(1) Jack handle

- (2) Jack
- (3) Wheel lug nut wrench
- (4) Socket

Jacking instructions

The jack is provided for emergency tire changing only.

To prevent the jack from "rattling" while the vehicle is in motion, store it properly.

Follow jacking instructions to reduce the possibility of personal injury.

Removing and storing the spare tire

Your spare tire is stored underneath your vehicle, directly below the cargo area.



To remove the spare tire:

1. Open the tailgate.
2. Find the plastic hex bolt cover and remove the cover with a coin or flat-blade screwdriver.



3. Connect the socket and wheel lug nut wrench.

4. Loosen the bolt enough to lower the spare tire. Turn the wrench counterclockwise until the spare tire reaches the ground.
5. After the spare tire reaches the ground, continue to turn the wrench counterclockwise, and draw the spare tire outside. Never rotate the wrench excessively, otherwise the spare tire carrier may be damaged.



6. Draw out the retainer guide (1) through the center hole of spare tire.

Changing tires



WARNING

A vehicle can slip or roll off of a jack causing serious injury or death to you or those nearby. Take the following safety precautions:

- Do not get under a vehicle that is supported by a jack.
- NEVER attempt to change a tire in the lane of traffic. ALWAYS move the vehicle completely off the road on level, firm ground away from traffic before trying to change a tire. If you cannot find a level, firm place off the road, call a towing service for assistance.
- Be sure to use the jack provided with the vehicle.
- ALWAYS place the jack on the des-

ignated jacking positions on the vehicle and NEVER on the bumpers or any other part of the vehicle for jacking support.

- Do not start or run the engine while the vehicle is on the jack.
- Do not allow anyone to remain in the vehicle while it is on the jack.
- Keep children away from the road and the vehicle.

Follow these steps to change your vehicle's tire:

1. Park on a level, firm surface.
2. Move the shift lever into P (Park, for automatic transmission vehicle) or neutral (for manual transmission vehicle), apply the parking brake, and place the ignition switch in the LOCK/OFF position.
3. Press the hazard warning flasher button.
4. Remove the wheel lug nut wrench, jack, jack handle, and spare tire from the vehicle.
5. Block both the front and rear of the tire diagonally opposite of the tire you are changing.



6. Loosen the wheel lug nuts counterclockwise one turn each in the order shown above, but do not remove any lug nuts until the tire has been raised off of the ground.

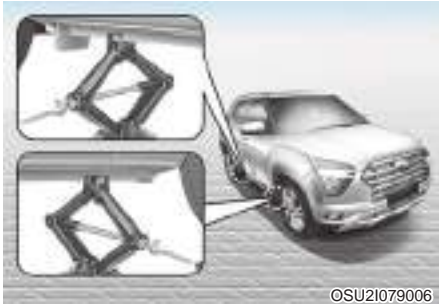

7. Place the jack at the designated jacking position under the frame closest to the tire you are changing. The jacking positions are plates welded to the frame with two tabs and a raised dot. Never jack any other position or part of the vehicle. Doing so may damage the side seal molding of other parts of the vehicle.

8. Insert the jack handle into the jack and turn it clockwise, raising the vehicle until the tire clears the ground. Make sure the vehicle is stable on the jack.
9. Loosen the lug nuts with the wheel lug nut wrench and remove them with your fingers. Remove the wheel from the studs and lay it flat on the ground out of the way. Remove any dirt or debris from the studs, mounting surfaces, and wheel.

WARNING

- Jack location

To reduce the possibility of injury, be sure to use only the jack provided with the vehicle and in the correct jack position; never use any other part of the vehicle for jack support.

10. Install the spare tire onto the studs of the hub.
11. Tighten the lug nuts with your fingers onto the studs with the smaller end of the lug nuts closest to the wheel.
12. Lower the vehicle to the ground by turning the jack handle counterclockwise.



13. Use the wheel lug nut wrench to tighten the lug nuts in the order shown. Double-check each lug nut until they are tight. After changing tires, we recommend that an authorized HYUNDAI dealer tighten the lug nuts to their proper torque as soon as possible. **The wheel lug nut should be tightened to 11~13 kgf.m (79~94 lbf.ft).**

If you have a tire gauge, check the tire pressure (see “Tires and Wheels” in chapter 2 for tire pressure instructions.). If the pressure is lower or higher than recommended, drive slowly to the nearest service station and adjust it to the recommended pressure. Always reinstall the valve cap after checking or adjusting tire pressure. If the cap is not replaced, air may leak from the tire. If you lose a valve cap, buy another and install it as soon as possible. After changing tires, secure the flat tire and return the jack and tools to their proper storage locations.

i Information

Check the tire pressure as soon as possible after installing a spare tire. Adjust it to the recommended pressure.

NOTICE

Your vehicle has metric threads on the studs and lug nuts. Make certain during tire changing that the same nuts that were removed are reinstalled. If you have to replace your lug nuts make sure they have metric threads to avoid damaging the studs and ensure the wheel is properly secured to the hub. We recommend that you consult an authorized HYUNDAI dealer for assistance.

If any of the equipment such as the jack, lug nuts, studs, or other equipment is damaged or in poor condition, do not attempt to change the tire and call for assistance.

Use of compact spare tires (if equipped)

Compact spare tires are designed for emergency use only. Drive carefully on the compact spare tire and always follow the safety precautions.



WARNING

To prevent compact spare tire failure and loss of control possibly resulting in an accident:

- **Use the compact spare tire only in an emergency.**
- **NEVER operate your vehicle over 80 km/h (50 mph).**
- **Do not exceed the vehicle's maximum load rating or the load carrying capacity shown on the sidewall of the compact spare tire.**
- **Do not use the compact spare tire continuously. Repair or replace the original tire as soon as possible to avoid failure of the compact spare tire.**

When driving with the compact spare tire mounted to your vehicle:

- Check the tire pressure after installing the compact spare tire. The compact spare tire should be inflated to 420 kPa (60 psi).
- Do not take this vehicle through an automatic car wash while the compact spare tire is installed.
- Do not use the compact spare tire on any other vehicle because this tire has been designed especially for your vehicle.

- The compact spare tire's tread life is shorter than a regular tire. Inspect your compact spare tire regularly and replace worn compact spare tires with the same size and design, mounted on the same wheel.
- Do not use more than one compact spare tire at a time.
- Do not tow a trailer while the compact spare tire is installed.



Information

When the original tire and wheel are repaired and reinstalled on the vehicle, the lug nut torque must be set correctly to prevent wheel vibration. The correct lug nut tightening torque is 11~13 kgf.m (79~94 lbf.ft).

NOTICE

To prevent damaging the compact spare tire and your vehicle:

- **Drive slowly enough for the road conditions to avoid all hazards, such as a potholes or debris.**
- **Avoid driving over obstacles. The compact spare tire diameter is smaller than the diameter of a conventional tire and reduces the ground clearance approximately 25 mm (1 inch).**
- **Do not use tire chains on the compact spare tire. Because of the smaller size, a tire chain will not fit properly.**
- **Do not use the compact spare tire on any other wheels, nor should standard tires, snow tires, wheel covers or trim rings be used with the compact spare wheel.**

TOWING

Towing service

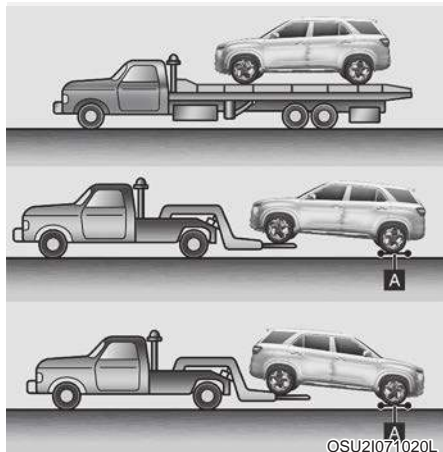

[A] : Dolly

If emergency towing is necessary, we recommend having it done by an authorized HYUNDAI dealer or a commercial tow-truck service. Proper lifting and towing procedures are necessary to prevent damage to the vehicle. The use of wheel dollies or flatbed is recommended.

On 2WD vehicles, if the transmission is operable in N (Neutral), it is only acceptable to tow the vehicle with the rear wheels on the ground (without dollies) and the front wheels off the ground. If the transmission is not shifted to N (Neutral), the vehicle should never be towed with the wheels on the ground. If any of the loaded wheels or suspension components are damaged or the vehicle is being towed with the front wheels on the ground, use a towing dolly under the front wheels.

When being towed by a commercial tow truck and wheel dollies are not used, the front of the vehicle should always be lifted, not the rear.



CAUTION

- Do not tow the vehicle with the front wheels on the ground as this may cause damage to the vehicle and transmission.
- Do not tow with sling-type equipment. Use a wheel lift or flatbed equipment.
- Do not tow the vehicle with four wheels in contact with the ground if it is the vehicle equipped with IVT, AT or DCT. Otherwise, the transmission will be seriously damaged. Also, make sure not to tow the vehicle connecting it with other vehicles including camper vans.

⚠ WARNING

If your vehicle is equipped with a rollover sensor, place the ignition switch in the OFF or ACC position when the vehicle is being towed. The side impact and curtain air bag may deploy if the sensor detects the situation as a rollover.

When towing your vehicle in an emergency without wheel dollies:

1. Place the ignition switch in the ACC position.
2. Place the shift lever in N (Neutral).
3. Release the parking brake.

NOTICE

Failure to place the shift lever in N (Neutral) when being towed with the front wheels on the ground can cause internal damage to the transmission.

Removable towing hook



1. Open the tailgate, and remove the towing hook from the tool case.
2. Remove the hole cover pressing the lower part of the cover on the front bumper.
3. Install the towing hook by turning it clockwise into the hole until it is fully secured.
4. Remove the towing hook and install the cover after use.

Emergency towing

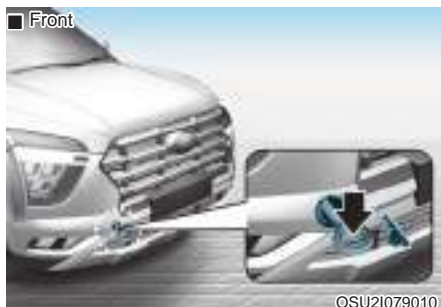

If towing is necessary, we recommend you have it done by an authorized HYUNDAI dealer or a commercial tow truck service.

If towing service is not available in an emergency, your vehicle may be temporarily towed using a cable or chain secured to the emergency towing hook at the front (or rear) of the vehicle.

Use extreme caution when towing the vehicle with a cable or chain. A driver must be in the vehicle to steer it and operate the brakes.

Towing in this manner may be done only on hard-surfaced roads for a short distance and at low speeds.

Also, the wheels, axles, power train, steering and brakes must all be in good condition.

CAUTION

The driver must be in the vehicle for steering and braking operations when the vehicle is being towed. Passengers other than the driver must not be in the vehicle.

Always follow these emergency towing precautions:

- Place the ignition switch in the ACC position so the steering wheel is not locked.
- Place the shift lever in N (Neutral).
- Release the parking brake.
- Depress the brake pedal with more force than normal since you will have reduced braking performance.
- More steering effort will be required because the power steering system will be disabled.
- Use a vehicle heavier than your own to tow your vehicle.
- The drivers of both vehicles should communicate with each other frequently.
- Before emergency towing, check that the hook is not broken or damaged.
- Fasten the towing cable or chain securely to the hook.
- Do not jerk the hook. Apply steady and even force.

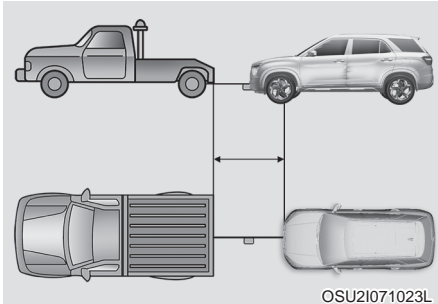

- Use a towing cable or chain less than 5 m (16 feet) long. Attach a white or red cloth (about 30 cm (12 inches) wide) in the middle of the cable or chain for easy visibility.
- Drive carefully so the towing cable or chain remains tight during towing.
- Before towing, check the automatic transmission for fluid leaks under your vehicle. If the automatic transmission fluid is leaking, flat-bed equipment or a towing dolly must be used.

NOTICE

Accelerate or decelerate the vehicle in a slow and gradual manner while maintaining tension on the tow rope or chain to start or drive the vehicle, otherwise tow hooks and the vehicle may be damaged.

NOTICE

To avoid damage to your vehicle and vehicle components when towing:

- **Always pull straight ahead when using the towing hooks. Do not pull from the side or at a vertical angle.**
- **Do not use the towing hooks to pull a vehicle out of mud, sand or other conditions from which the vehicle cannot be driven out under its own power.**
- **Limit the vehicle speed to 15 km/h (10 mph) and drive less than 1.5 km (1 mile) when towing to avoid serious damage to the transmission.**

EMERGENCY COMMODITY

Your vehicle is equipped with emergency commodities to help you respond to emergency situation.

First aid kit

Supplies for use in giving first aid such as bandage and adhesive tape, etc. are provided.

Triangle reflector

Place the triangle reflector on the road to warn oncoming vehicles during emergencies, such as when the vehicle is parked by the roadside due to problems.

⚠ WARNING

If your vehicle is equipped with a rollover sensor, place the ignition switch in the OFF or ACC position when the vehicle is being towed. The side impact and curtain air bag may deploy if the sensor detects the situation as a rollover.

When towing your vehicle in an emergency without wheel dollies:

1. Place the ignition switch in the ACC position.
2. Place the shift lever in N (Neutral).
3. Release the parking brake.

NOTICE

Failure to place the shift lever in N (Neutral) when being towed with the front wheels on the ground can cause internal damage to the transmission.

Removable towing hook



1. Open the tailgate, and remove the towing hook from the tool case.
2. Remove the hole cover pressing the lower part of the cover on the front bumper.
3. Install the towing hook by turning it clockwise into the hole until it is fully secured.
4. Remove the towing hook and install the cover after use.

Emergency towing

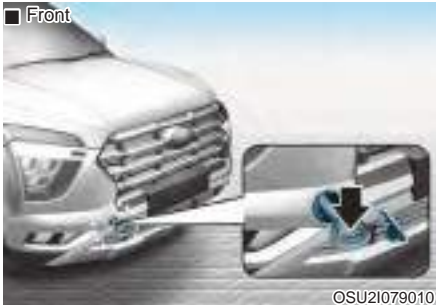

If towing is necessary, we recommend you have it done by an authorized HYUNDAI dealer or a commercial tow truck service.

If towing service is not available in an emergency, your vehicle may be temporarily towed using a cable or chain secured to the emergency towing hook at the front (or rear) of the vehicle.

Use extreme caution when towing the vehicle with a cable or chain. A driver must be in the vehicle to steer it and operate the brakes.

Towing in this manner may be done only on hard-surfaced roads for a short distance and at low speeds.

Also, the wheels, axles, power train, steering and brakes must all be in good condition.

CAUTION

The driver must be in the vehicle for steering and braking operations when the vehicle is being towed. Passengers other than the driver must not be in the vehicle.

Always follow these emergency towing precautions:

- Place the ignition switch in the ACC position so the steering wheel is not locked.
- Place the shift lever in N (Neutral).
- Release the parking brake.
- Depress the brake pedal with more force than normal since you will have reduced braking performance.
- More steering effort will be required because the power steering system will be disabled.
- Use a vehicle heavier than your own to tow your vehicle.
- The drivers of both vehicles should communicate with each other frequently.
- Before emergency towing, check that the hook is not broken or damaged.
- Fasten the towing cable or chain securely to the hook.
- Do not jerk the hook. Apply steady and even force.

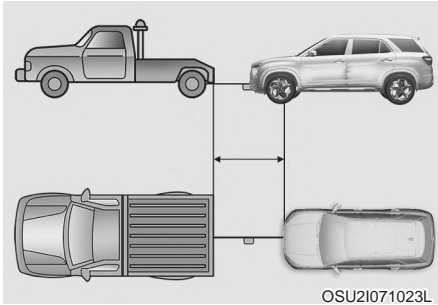

- Use a towing cable or chain less than 5 m (16 feet) long. Attach a white or red cloth (about 30 cm (12 inches) wide) in the middle of the cable or chain for easy visibility.
- Drive carefully so the towing cable or chain remains tight during towing.
- Before towing, check the automatic transmission for fluid leaks under your vehicle. If the automatic transmission fluid is leaking, flat-bed equipment or a towing dolly must be used.

NOTICE

Accelerate or decelerate the vehicle in a slow and gradual manner while maintaining tension on the tow rope or chain to start or drive the vehicle, otherwise tow hooks and the vehicle may be damaged.

NOTICE

To avoid damage to your vehicle and vehicle components when towing:

- **Always pull straight ahead when using the towing hooks. Do not pull from the side or at a vertical angle.**
- **Do not use the towing hooks to pull a vehicle out of mud, sand or other conditions from which the vehicle cannot be driven out under its own power.**
- **Limit the vehicle speed to 15 km/h (10 mph) and drive less than 1.5 km (1 mile) when towing to avoid serious damage to the transmission.**

EMERGENCY COMMODITY

Your vehicle is equipped with emergency commodities to help you respond to emergency situation.

First aid kit

Supplies for use in giving first aid such as bandage and adhesive tape, etc. are provided.

Triangle reflector

Place the triangle reflector on the road to warn oncoming vehicles during emergencies, such as when the vehicle is parked by the roadside due to problems.

9. Maintenance

Engine compartment	9-4
Maintenance services	9-6
Owner's responsibility.....	9-6
Owner maintenance precautions	9-7
Owner maintenance	9-8
Owner maintenance schedule	9-9
Scheduled maintenance services	9-11
Normal maintenance schedule - petrol engine	9-12
Maintenance under severe usage conditions- petrol engine	9-16
Normal maintenance schedule - diesel engine	9-18
Maintenance under severe usage conditions - diesel engine	9-21
Explanation of scheduled maintenance items.....	9-24
Engine oil.....	9-28
Checking the engine oil level (petrol engine).....	9-28
Checking the engine oil level (diesel engine).....	9-29
Changing the engine oil and filter.....	9-31
Engine coolant.....	9-32
Checking the coolant level	9-32
Recommended engine coolant.....	9-34
Changing the coolant.....	9-34
Brake/clutch fluid	9-35
Checking the brake/clutch fluid level.....	9-35
Automatic transmission fluid.....	9-37
Changing the automatic transmission fluid	9-37
Washer fluid	9-38
Checking the washer fluid level	9-38
Parking brake	9-39
Checking the parking brake.....	9-39

Fuel filter (for diesel).....	9-40
Draining water from fuel filter	9-40
Fuel filter cartridge replacement	9-40
Air cleaner	9-41
Filter replacement	9-41
Climate control air filter	9-43
Filter inspection.....	9-43
Filter replacement.....	9-43
Wiper blades	9-45
Blade inspection.....	9-45
Blade replacement	9-45
Battery	9-47
For best battery service	9-47
Battery capacity label	9-49
Battery recharging.....	9-49
Reset items	9-50
Battery replacement	9-50
Tires and wheels	9-51
Tire care	9-51
Recommended cold tire inflation pressures	9-51
Checking tire inflation pressure	9-53
Tire rotation	9-54
Wheel alignment and tire balance	9-55
Tire replacement	9-55
Wheel replacement	9-57
Tire traction.....	9-57
Tire maintenance	9-57
Tire sidewall labeling.....	9-57
Low aspect ratio tire	9-61

Fuses.....	9-62
Instrument panel fuse replacement	9-63
Engine compartment panel fuse replacement	9-64
Fuse/relay panel description	9-66
Light bulbs.....	9-71
Headlight, position lamp, turn signal lamp, fog light and daytime running light bulb replacement.....	9-72
Side repeater lamp bulb replacement	9-75
Rear combination light bulb replacement	9-76
Back up lamp replacement.....	9-78
High mounted stop lamp replacement.....	9-79
License plate lamp bulb replacement	9-79
Interior light bulb replacement	9-80
Appearance care.....	9-82
Exterior care.....	9-82
Interior care.....	9-88
Emission control system	9-92
Crankcase emission control system	9-92
Evaporative emission control system	9-92
Exhaust emission control system.....	9-93
Self regeneration mode	9-96

ENGINE COMPARTMENT

- Petrol Engine (Smartstream G2.0)

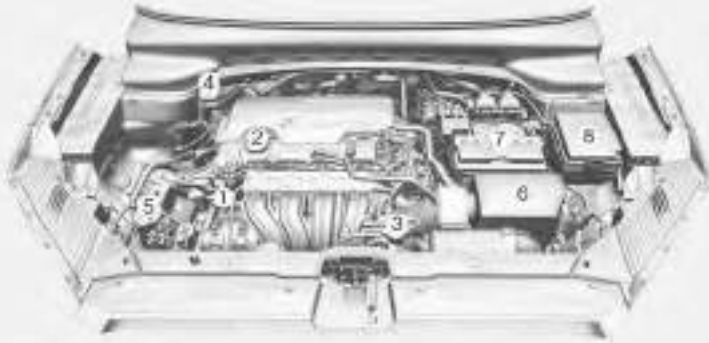

The actual engine room in the vehicle may differ from the illustration.

OSU21081002

- | | |
|---------------------------------|--------------------------------------|
| 1. Engine oil dipstick | 6. Windshield washer fluid reservoir |
| 2. Engine oil filler cap | 7. Air cleaner |
| 3. Engine coolant reservoir | 8. Battery |
| 4. Radiator cap | 9. Engine room junction block |
| 5. Brake/clutch fluid reservoir | |

■ Diesel Engine (1.5 WGT)

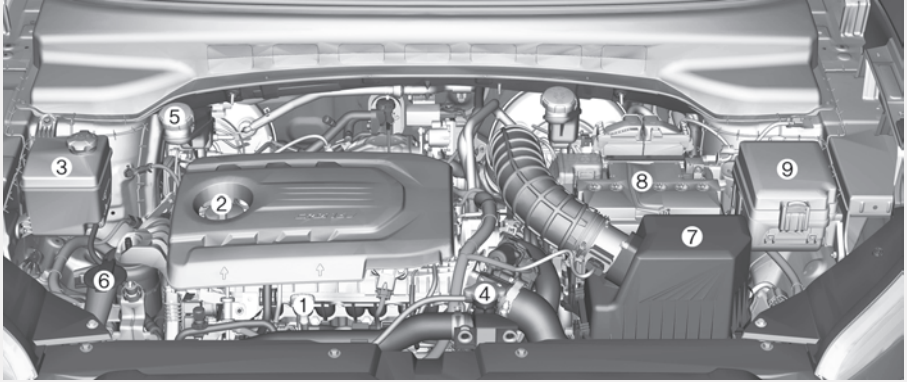

The actual engine room in the vehicle may differ from the illustration.

OSU21089003

1. Engine oil dipstick
2. Engine oil filler cap
3. Engine coolant reservoir
4. Radiator cap
5. Brake/clutch* fluid reservoir
6. Windshield washer fluid reservoir
7. Air cleaner
8. Battery
9. Engine room fuse block

MAINTENANCE SERVICES

You should exercise the utmost care to prevent damage to your vehicle and injury to yourself whenever performing any maintenance or inspection procedures.

We recommend you have your vehicle maintained and repaired by an authorized HYUNDAI dealer. An authorized HYUNDAI dealer meets HYUNDAI's high service quality standards and receives technical support from HYUNDAI in order to provide you with a high level of service satisfaction.

Owner's responsibility

Information

Maintenance Service and Record Retention are the owner's responsibility.

We recommend in general that you have your vehicle serviced by an authorized HYUNDAI dealer.

You should retain documents that show proper maintenance has been performed on your vehicle in accordance with the scheduled maintenance service charts shown on the following pages. You need this information to establish your compliance with the servicing and maintenance requirements of your vehicle warranties.

Detailed warranty information is provided in your Service Passport.

Repairs and adjustments required as a result of improper maintenance or a lack of required maintenance are not covered when your vehicle is covered by warranty.

Owner maintenance precautions

Inadequate, incomplete or insufficient servicing may result in operational problems with your vehicle that could lead to vehicle damage, an accident, or personal injury. This chapter provides instructions only for the maintenance items that are easy to perform. Several procedures can be done only by an authorized HYUNDAI dealer with special tools.

Your vehicle should not be modified in any way. Such modifications may adversely affect the performance, safety or durability of your vehicle and may, in addition, violate conditions of the limited warranties covering the vehicle.

Information

Improper owner maintenance during the warranty period may affect warranty coverage. For details, read the separate Service Passport provided with the vehicle. If you're unsure about any servicing or maintenance procedure, we recommend that the system be serviced by an authorized HYUNDAI dealer.

WARNING

Maintenance work

- **Performing maintenance work on a vehicle can be dangerous. You can be seriously injured while performing some maintenance procedures. If you lack sufficient knowledge and experience or the proper tools and equipment to do the work, we recommend that the system be serviced by an authorized HYUNDAI dealer.**
- **Working under the hood with the engine running is dangerous. It becomes even more dangerous when you wear jewelry or loose clothing. These can become entangled in moving parts and result in injury.**

OWNER MAINTENANCE



WARNING

Performing maintenance work on a vehicle can be dangerous. If you lack sufficient knowledge and experience or the proper tools and equipment to do the work, we recommend that the system be serviced by an authorized HYUNDAI dealer. **ALWAYS** follow these precautions for performing maintenance work:

- Park your vehicle on level ground, move the shift button into the P (Park) position, apply the parking brake, place the ignition switch in the LOCK/OFF position.
- Block the tires (front and back) to prevent the vehicle from moving.
Remove loose clothing or jewelry that can become entangled in moving parts.
- If you must run the engine during maintenance, do so out doors or in an area with plenty of ventilation.
- Keep flames, sparks, or smoking materials away from the battery and fuel-related parts.



WARNING

Touching metal parts

Do not touch metal parts (including strut bars) while the engine is operating or hot. Doing so could result in serious personal injury. Turn the engine off and wait until the metal parts cool down to perform maintenance work on the vehicle.

The following lists are vehicle checks and inspections that should be performed at the frequencies indicated to help ensure safe, dependable operation of your vehicle.

Any adverse conditions should be brought to the attention of your dealer as soon as possible.

These Owner Maintenance Checks are generally not covered by warranties and you may be charged for labor, parts and lubricants used.



WARNING

Diesel Engine

Never manipulate or modify the injection system while running the diesel engine or within 30 seconds after turning OFF the diesel engine. The high-pressure pump, high-pressure pipes, rail, and injectors are still subject to high pressure immediately after stopping the diesel engine.

When the fuel leakage vents out, it may cause serious body injury. Any people, who are implanted with the artificial cardiac pacemaker, should remain away from the ECU or the wiring harness by at least 30 cm, while running the diesel engine. The high currents of the electronic engine control system produce a considerable amount of magnetic fields.

Owner maintenance schedule

When you stop for fuel:

- Check the coolant level in coolant reservoir.
- Check the windshield washer fluid level.
- Look for low or under-inflated tires.
- Check the radiator and condenser. Check if the front of the radiator and condenser are clean and not blocked with leaves, dirt or insects etc.

If any of the above parts are extremely dirty or you are not sure of their condition, we recommend that you contact an authorized HYUNDAI dealer.



WARNING

Be careful when checking your engine coolant level when the engine is hot. Scalding hot coolant and steam may blow out under pressure. This could cause burns or other serious injuries.

While operating your vehicle:

- Note any changes in the sound of the exhaust or any smell of exhaust fumes in the vehicle.
- Check for vibrations in the steering wheel. Notice any increased steering effort or looseness in the steering wheel, or change in its straight-ahead position.
- Notice if your vehicle constantly turns slightly or “pulls” to one side when traveling on smooth, level road.
- When stopping, listen and check for unusual sounds, pulling to one side, increased brake pedal travel or “hard-to-push” brake pedal.
- If any slipping or changes in the operation of your transmission occurs, check the transmission fluid level.
- Check automatic transmission P (Park) function.
- Check the parking brake.
- Check for fluid leaks under your vehicle (water dripping from the air conditioning system during or after use is normal).

At least monthly:

- Check the coolant level in the engine coolant reservoir.
- Check the operation of all exterior lights, including the stoplights, turn signals and hazard warning flashers.
- Check the inflation pressures of all tires including the spare for tires that are worn, show uneven wear, or are damaged.
- Check for loose wheel lug nuts.

At least twice a year (i.e., every Spring and Fall):

- Check the radiator, heater and air conditioning hoses for leaks or damage.
- Check the windshield washer spray and wiper operation. Clean wiper blades with clean cloth dampened with washer fluid.
- Check the headlight alignment.
- Check the muffler, exhaust pipes, shields and clamps.
- Check the lap/shoulder belts for wear and function.

At least once a year:

- Clean the body and door drain holes.
- Lubricate the door hinges and checks, and hood hinges.
- Lubricate the door and hood locks and latches.
- Lubricate the door rubber weatherstrips.
- Check the air conditioning system.
- Inspect and lubricate automatic transmission linkage and controls.
- Clean the battery and terminals.
- Check the brake/clutch fluid level.

SCHEDULED MAINTENANCE SERVICES

Follow Normal Maintenance Schedule if the vehicle is usually operated where none of the following conditions apply. If any of the following conditions apply, you must follow the Maintenance Under Severe Usage Conditions.

- Repeated driving short distance of less than 8 km (5 miles) in normal temperature or less than 16 km (10miles) in freezing temperature
- Extensive engine idling or low speed driving for long distances
- Driving on rough, dusty, muddy, unpaved, graveled or salt-spread roads
- Driving in areas using salt or other corrosive materials or in very cold weather
- Driving in heavy dust conditions
- Driving in heavy traffic area
- Driving on uphill, downhill, or mountain road repeatedly
- Towing a trailer or using a camper
- Driving as a patrol car, taxi, other commercial use of vehicle towing
- Frequently driving under high speed or rapid acceleration/deceleration
- Frequently driving in stop-and-go condition
- Engine oil usage which is not recommended(Mineral type, Semi-synthetic, Lower grade spec, etc)

If your vehicle is operated under the above conditions, you should inspect, replace or refill more frequently than the following Normal Maintenance Schedule. After the periods or distance shown in the chart, continue to follow the prescribed maintenance intervals.



Information

- **As it is normal for engine oil to be consumed during driving, the amount of engine oil should be checked regularly.**
- **The replacement cycle of engine oil is set by the period which the performance of the recommended engine oil is maintained. So, if recommended engine oil is not used, replace the engine oil according to the maintenance schedule under severe usage conditions.**

NORMAL MAINTENANCE SCHEDULE - FOR PETROL & DIESEL ENGINE

- *1 : Check the engine oil level and leak every 500 km (350 miles) or before starting a long trip.
- *2 : Driving in ambient temperature over 40 °C (104 °F) or driving at constant highway speeds must conform the severe driving condition.
- *3 : The engine oil level should be checked regularly and maintained properly. Operating with an insufficient amount of oil can damage the engine, and such damage is not covered by warranty.
- *4 : Inspect for excessive valve noise and/or engine vibration and adjust if necessary. We recommend that an authorized HYUNDAI dealer should perform the operation.
- *5 : When adding coolant, use only deionised water or soft water for your vehicle and never mix hard water in the coolant filled at the factory. An improper coolant mixture can result in serious malfunction or engine damage.
- *6 : Manual/Auto./IVT/DCT transaxle fluid should be changed anytime the vehicle has been submerged in water.
- *7 : If good quality petrols that meet Europe Fuel standards (EN228) or equivalents including fuel additives is not available, one bottle of additive is recommended. Additives are available from your authorised HYUNDAI dealer along with information on how to use them. Do not mix other additives.
- *8 : Maintenance schedule depends on fuel quality. If there are some important matters like fuel flow restriction, surging, loss of power, difficulty in starting problems etc, we recommend replacing the fuel filter immediately regardless of the maintenance schedule and consulting with an authorised HYUNDAI dealer for details.
- *9 : Inspect drive belt tensioner, idler & alternator pulley, Starter and all chassis electrical items. Correct or replace, if necessary.
- *10 : For your convenience, it can be replaced prior to it's interval when you do maintenance of other items.
- *11 : Adjust alternator and power steering (and water pump drive belt) and air conditioner drive belt (if equipped). Inspect and if necessary correct or replace.

NORMAL MAINTENANCE SCHEDULE - PETROL ENGINE (CONT.)

MAINTENANCE INTERVALS		Number of months or driving distance, whichever comes first								
		1.5	10	20	30	40	50	60	70	80
MAINTENANCE ITEM		2	12	24	36	48	60	72	84	96
ENGINE BAY		Years	1	2	3	4	5	6	7	8
Engine oil & filter *1 *2 *3	I	R	R	R	R	R	R	R	R	R
Drive belt	-	-	I	-	-	-	-	-	-	I
Air Cleaner Filter	C	C	C	R	C	C	C	R	C	C
Battery condition & specific gravity	I	I	I	I	I	I	I	I	I	I
Spark Plugs *10	Replace at every 160,000 kms									
Valve clearance *4	Inspect at every 90,000 kms or 108 months									
Vacuum Hose	-	-	-	I	-	-	-	I	-	I
Idler / damper pulley/Adj. Bolt	Inspect when replacing the drive belt or timing belt/chain									
Brake/Clutch fluid	Replace @ every 40,000 Km or 3 years									
Engine Coolant (topup & specify gravity) *5	Inspect at every service; Replace first at 100,000 Km or 60 months ; then at every 40,000 Km or 24 months									
Manual transaxle fluid *6	-	-	-	-	-	-	-	I	-	-
Automatic /Intelligent Var. Transmission fluid (if equipped) *6	No check ; No Service Required									

I : Inspect and if necessary adjust,top-up, clean or replace C : Clean and Replace if necessary R : Replace

NORMAL MAINTENANCE SCHEDULE - PETROL ENGINE (CONT.)

MAINTENANCE INTERVALS	Number of months or driving distance, whichever comes first									
	Kmsx1,000	1.5	10	20	30	40	50	60	70	80
Months	2	12	24	36	48	60	72	84	96	
Years	-	1	2	3	4	5	6	7	8	
VEHICLE ON FLOOR										
Wiper (wiper blade , washer fluid)	I	I	I	I	I	I	I	I	I	I
Brake/Clutch (Pedal free play/Pipes/Hoses/Connectors)	I	I	I	I	I	I	I	I	I	I
Fuel filler cap	-	I	I	I	I	I	I	I	I	I
Climate control air filter	I	C	R	C	R	C	R	C	R	C
Check AC system (refrigerant/Compressor)	I	I	I	I	I	I	I	I	I	I
Cooling system (water pump,hoses) & leakage	I	I	I	I	I	I	I	I	I	I
VEHICLE ON LIFT										
Steering gear rack, linkage and boots	I	I	I	I	I	I	I	I	I	I
Exhaust system	I	I	I	I	I	I	I	I	I	I
Fuel filter*8	-	-	-	-	-	-	R	-	-	-
Fuel tank air filter	Not Applicable									
Front & rear suspension (linkages & ball joints)	-	-	-	-	-	-	-	-	-	-

I : Inspect and if necessary adjust,top-up, clean or replace C : Clean and Replace if necessary

R : Replace

NORMAL MAINTENANCE SCHEDULE - PETROL ENGINE (CONT.)

MAINTENANCE INTERVALS	Number of months or driving distance, whichever comes first									
	Kmsx1,000	1.5	10	20	30	40	50	60	70	80
MAINTENANCE ITEM	Months	2	12	24	36	48	60	72	84	96
	Years	-	1	2	3	4	5	6	7	8
Power window		I	I	I	I	I	I	I	I	I
Sunroof operation (if equipped)		I	C	C	C	C	C	C	C	C
All seat belt operation		I	I	I	I	I	I	I	I	I
Road test		-	-	-	I	-	-	-	-	I

I : Inspect and if necessary adjust, top-up, clean or replace

C : Clean and Replace if necessary

R : Replace

Maintenance Under Severe Usage Conditions- Petrol Engine

The following items must be serviced more frequently on cars mainly used under severe driving conditions. Refer to the chart below for the appropriate maintenance intervals.

I : Inspect and if necessary, adjust, correct, clean or replace R : Replace or change

Maintenance item	Maintenance operation	Maintenance intervals	Driving condition
Engine oil and engine oil filter	R	Every 5,000 km or 6 months	A, B, C, D, E, F, G, H, I, J, K, L
Air cleaner filter	R	Replace more frequently depending on the condition	C, E
Spark plugs	R	Replace more frequently depending on the condition	A, B, H, I, K
Manual transmission fluid/ Intelligent manual transmission fluid	R	Every 120,000 km	C, D, E, F, G
Automatic transmission fluid	R	Every 100,000 km	A, C, D, E, F, G, H, I, J, K

Maintenance item	Maintenance operation	Maintenance intervals	Driving condition
Steering gear rack, linkage and boots	I	Inspect more frequently depending on the condition	C, D, E, F, G
Front suspension ball joints	I	Inspect more frequently depending on the condition	C, D, E, F, G
Disc brakes and pads, calipers and rotors	I	Inspect more frequently depending on the condition	C, D, E, G, H
Drum brakes and linings (if equipped)	I	Inspect more frequently depending on the condition	C, D, E, G, H
Parking brake	I	Inspect more frequently depending on the condition	C, D, G, H
Driveshaft and boots	I	Inspect more frequently depending on the condition	C, D, E, F, G, H, I, J
Cabin air filter	R	Replace more frequently depending on the condition	C, E, G

Severe driving conditions

- A : Repeatedly driving short distance of less than 8 km (5 miles) in normal temperature or less than 16 km (10 miles) in freezing temperature
- B : Extensive engine idling or low speed driving for long distances
- C : Driving on rough, dusty, muddy, unpaved, graveled or salt-spread roads
- D : Driving in areas using salt or other corrosive materials or in very cold weather
- E : Driving in the heavy dust condition
- F : Driving in heavy traffic area
- G : Driving on uphill, downhill, or mountain roads repeatedly
- H : Towing a trailer, or using a camper
- I : Driving as patrol car, taxi, commercial car or vehicle towing
- J : Driving over 170km/h (106mile/h) or frequent rapid acceleration/deceleration
- K : Frequently driving in stop-and-go conditions and under 15,000 km per year.
- L : Engine oil usage which is not recommended (Mineral type, Semi-synthetic, Lower grade spec, etc.)

NORMAL MAINTENANCE SCHEDULE - DIESEL ENGINE

MAINTENANCE INTERVALS	Number of months or driving distance, whichever comes first									
	Kmsx1,000	1.5	10	20	30	40	50	60	70	80
Months	2	12	24	36	48	60	72	84	96	
Years	-	1	2	3	4	5	6	7	8	
ENGINE BAY										
Engine oil & filter *1 *2 *3	I	R	R	R	R	R	R	R	R	R
Drive belt	-	-	-	I	-	-	-	-	-	I
Air cleaner filter	-	C	R	C	R	C	R	C	R	C
Battery condition & specific gravity	I	I	I	I	I	I	I	I	I	I
Valve clearance*4	Inspect at every 90,000 kms or 108 months									
Hoses (Vaccum/ EGR / VGT/ WGT)	-	I	I	I	I	I	I	I	I	I
Idler / damper pulley/Adj. Bolt	Inspect when replacing the drive belt or timing belt/chain									
Brake/Clutch fluid	Replace @ every 40,000 Km or 36 months									
Engine Coolant (topup & specify gravity) *5	Inspect at every service; Replace first at 100,000 Km or 60 months ; then at every 40,000 Km or 24 months									
Manual transaxle fluid *6	-	-	-	-	-	-	-	-	-	-
Automatic Transmission fluid (if equipped) *6	No Check ; No Service reqd.									

I : Inspect and if necessary adjust,top-up, clean or replace C : Clean and Replace if necessary

R : Replace

NORMAL MAINTENANCE SCHEDULE - DIESEL ENGINE (CONT.)

MAINTENANCE INTERVALS	Number of months or driving distance, whichever comes first										
	Kmsx1,000	1.5	10	20	30	40	50	60	70	80	
MAINTENANCE ITEM	Months	2	12	24	36	48	60	72	84	96	
Years	-	1	2	3	4	5	6	7	8		
VEHICLE ON FLOOR											
Wiper (wiper blade, washer fluid)	I	I	I	I	I	I	I	I	I	I	
Brake/Clutch (Pedal free play/Pipes/Hoses/Connectors)	I	I	I	I	I	I	I	I	I	I	
Fuel filler cap	-	I	I	I	I	I	I	I	I	I	
Climate control air filter	I	C	R	C	R	C	R	C	R	C	
Check AC system (refrigerant/Compressor)	I	I	I	I	I	I	I	I	I	I	
Cooling system (water pump,hoses) & leakage	I	I	I	I	I	I	I	I	I	I	
VEHICLE ON LIFT											
Steering gear rack, linkage and boots	I	I	I	I	I	I	I	I	I	I	
Exhaust system (leakages & damages)	I	I	I	I	I	I	I	I	I	I	
Fuel filter*8	I	I	R	I	R	I	R	I	R	I	
Fuel tank air filter (If equipped)	-	-	R	-	R	-	R	-	R	-	
Front & rear suspension (linkages & ball joints)	I	I	I	I	I	I	I	I	I	I	

I : Inspect and if necessary adjust,top-up, clean or replace
R : Replace
C : Clean and Replace if necessary

NORMAL MAINTENANCE SCHEDULE - DIESEL ENGINE (CONT.)

MAINTENANCE INTERVALS	Number of months or driving distance, whichever comes first									
	Kmsx1,000	1.5	10	20	30	40	50	60	70	80
MAINTENANCE ITEM	Months	2	12	24	36	48	60	72	84	96
	Years	-	1	2	3	4	5	6	7	8
Tyre Pressure, condition & rotation	-	I,TR	I,TR	I,TR	I,TR	I,TR	I,TR	I,TR	I,TR	I,TR
Fuel lines, hoses and connections	I	I	I	I	I	I	I	I	I	I
Driveshafts & boots	I	I	I	I	I	I	I	I	I	I
Fluid leakages	I	I	I	I	I	I	I	I	I	I
Front and rear wheel bearings & bushes	Inspect if reqd.									
Parking brake (disc/drum ,pad/shoe & operation)	-	C	C	C	C	C	C	C	C	C
Wheel Alignment & Balancing	-	Inspect if reqd.								
FINAL CHECKS										
Bolt and nuts on chasis and body	I	I	I	I	I	I	I	I	I	I
Lubricate locks & hinges	I	L	L	L	L	L	L	L	L	L
Check all electrical systems (Drive belts ,alternator)*9	I	I	I	I	I	I	I	I	I	I
Warning lights operation & GDS system check	I	I	I	I	I	I	I	I	I	I
Ext & int. lights, horn & gauges	I	I	I	I	I	I	I	I	I	I

I : Inspect and if necessary adjust,top-up, clean or replace C : Clean and Replace if necessary
 R : Replace TR : Tyre Rotation L : Lubricate

NORMAL MAINTENANCE SCHEDULE - DIESEL ENGINE

MAINTENANCE INTERVALS	Number of months or driving distance, whichever comes first										
	Kmsx1,000	1.5	10	20	30	40	50	60	70	80	
MAINTENANCE ITEM	Months	2	12	24	36	48	60	72	84	96	
	Years	-	1	2	3	4	5	6	7	8	
Power window		I	I	I	I	I	I	I	I	I	
Sunroof operation (if equipped)		I	C	C	C	C	C	C	C	C	
All seat belt operation		I	I	I	I	I	I	I	I	I	

I : Inspect and if necessary adjust,top-up, clean or replace

C : Clean and Replace if necessary

Maintenance Under Severe Usage Conditions - Diesel Engine

The following items must be serviced more frequently on cars mainly used under severe driving conditions. Refer to the chart below for the appropriate maintenance intervals.

I : Inspect and if necessary, adjust, correct, clean or replace R : Replace or change

Maintenance item	Maintenance operation	Maintenance intervals	Driving condition
Engine oil and engine oil filter	R	Every 5,000 km or 6 months	A, B, C, D, E, F, G, H, I, K, L
Air cleaner filter	R	Replace more frequently depending on the condition	C, E
Manual transmission fluid	R	Every 120,000 km	C, D, E, F, G
Automatic transmission fluid	R	Every 100,000 km	A, C, D, E, F, G, H, I, J
Steering gear rack, linkage and boots	I	Inspect more frequently depending on the condition	C, D, E, F, G

Maintenance item	Maintenance operation	Maintenance intervals	Driving condition
Front suspension ball joints	I	Inspect more frequently depending on the condition	C, D, E, F, G
Disc brakes and pads, calipers and rotors	I	Inspect more frequently depending on the condition	C, D, E, G, H
Parking brake	I	Inspect more frequently depending on the condition	C, D, G, H
Driveshaft and boots	I	Inspect more frequently depending on the condition	C, D, E, F, G, H, I, K
Cabin air filter	R	Replace more frequently depending on the condition	C, E, G

Severe driving conditions

- A : Repeatedly driving short distance of less than 8 km (5 miles) in normal temperature or less than 16 km (10 miles) in freezing temperature
- B : Extensive engine idling or low speed driving for long distances
- C : Driving on rough, dusty, muddy, unpaved, graveled or salt-spread roads
- D : Driving in areas using salt or other corrosive materials or in very cold weather
- E : Driving in the heavy dust condition
- F : Driving in heavy traffic area

G : Driving on uphill, downhill, or mountain roads repeatedly

H : Towing a trailer, or using a camper

I : Driving as patrol car, taxi, commercial car or vehicle towing

J : Driving over 170km/h (106mile/h) or frequent rapid acceleration/deceleration

K : Frequently driving in stop-and-go conditions and under 15,000 km per year.

L : Engine oil usage which is not recommended (Mineral type, Semi-synthetic, Lower grade spec, etc.)

EXPLANATION OF SCHEDULED MAINTENANCE ITEMS

Engine oil and filter

The engine oil and filter should be changed at the intervals specified in the maintenance schedule. If the car is being driven in severe conditions, more frequent oil and filter changes are required.

Drive belts

Inspect all drive belts for evidence of cuts, cracks, excessive wear or oil saturation and replace if necessary. Drive belts should be checked periodically for proper tension and adjusted as necessary.

NOTICE

When you are inspecting the belt, place the ignition switch in the LOCK/OFF or ACC position.

Fuel filter

A clogged filter can limit the speed at which the vehicle may be driven, damage the emission system and cause multiple issues such as hard starting. If an excessive amount of foreign matter accumulates in the fuel tank, the filter may require replacement more frequently.

After installing a new filter, run the engine for several minutes, and check for leaks at the connections.

We recommend that the fuel filter be replaced by an authorized HYUNDAI dealer.

Fuel lines, fuel hoses and connections

Check the fuel lines, fuel hoses and connections for leakage and damage. We recommend that the fuel lines, fuel hoses and connections be replaced by an authorized HYUNDAI dealer.



WARNING

Diesel Engine

Never manipulate or modify the injection system while running the diesel engine or within 30 seconds after turning OFF the diesel engine. The high-pressure pump, high-pressure pipes, rail, and injectors are still subject to high pressure immediately after stopping the diesel engine.

When the fuel leakage vents out, it may cause serious body injury. Any people, who are implanted with the artificial cardiac pacemaker, should remain away from the ECU or the wiring harness by at least 30 cm, while running the diesel engine. The high currents of the electronic engine control system produce a considerable amount of magnetic fields.

Vapor hose and fuel filler cap

The vapor hose and fuel filler cap should be inspected at those intervals specified in the maintenance schedule. Make sure that a new vapor hose or fuel filler cap is correctly replaced.

Vacuum crankcase ventilation hoses (if equipped)

Inspect the surface of hoses for evidence of heat and/or mechanical damage. Hard and brittle rubber, cracking, tears, cuts, abrasions, and excessive swelling indicate deterioration. Particular attention should be paid to examine those hose surfaces nearest to high heat sources, such as the exhaust manifold.

Inspect the hose routing to assure that the hoses do not come in contact with any heat source, sharp edges or moving component which might cause heat damage or mechanical wear. Inspect all hose connections, such as clamps and couplings, to make sure they are secure, and that no leaks are present. Hoses should be replaced immediately if there is any evidence of deterioration or damage.

Air cleaner filter

We recommend that the air cleaner filter be replaced by an authorized HYUNDAI dealer.

Spark plugs

Make sure to install new spark plugs of the correct heat range.

When assembling parts, be sure to wipe out foreign substances inside and outside of the boot bottom of the ignition coil and the insulator of the spark plug with a soft cloth to prevent contamination of the spark plug insulator.



WARNING

Do not disconnect and inspect spark plugs when the engine is hot. You may burn yourself.

Valve clearance (if equipped)

Inspect for excessive valve noise and/or engine vibration and adjust if necessary. We recommend that the system be serviced by an authorized HYUNDAI dealer.

Cooling system

Check cooling system components, such as radiator, coolant reservoir, hoses and connections for leakage and damage. Replace any damaged parts.

Coolant

The coolant should be changed at the intervals specified in the maintenance schedule.

Manual transmission fluid (if equipped)

Inspect the manual transmission fluid according to the maintenance schedule.

Dual clutch transmission fluid (if equipped)

Inspect the dual clutch transmission fluid according to the maintenance schedule.

Automatic transmission fluid (if equipped)

Inspect the automatic transmission fluid according to the maintenance schedule.

NOTICE

The use of non-specified fluid (even marked as compatible with genuine) could result in shift quality deterioration and vibrations, eventually, the transmission failure.

Use only specified automatic transmission fluid. (Refer to “Recommended lubricants and capacities” in chapter 2.)

Intelligent Variable Transmission (IVT) fluid (if equipped)

Intelligent Variable Transmission (IVT) fluid should not be checked under normal usage conditions.

We recommend that the Intelligent Variable Transmission (IVT) fluid is changed by an authorized HYUNDAI dealer according to the maintenance schedule.

Information

Intelligent Variable Transmission (IVT) fluid color is light amber when new.

As the vehicle is driven, the Intelligent Variable Transmission (IVT) fluid will begin to look darker.

This is a normal condition. It does not need to be replaced based on the color change.

NOTICE

The use of a non-specified fluid could result in transmission malfunction and failure.

Use only specified Intelligent Variable Transmission (IVT) fluid. (Refer to “Recommended lubricants and capacities” in section 2.)

Brake hoses and lines

Visually check for proper installation, chafing, cracks, deterioration and any leakage. Replace any deteriorated or damaged parts immediately.

Brake/clutch fluid (if equipped)

Check brake/clutch fluid level in the brake fluid reservoir. The level should be between “MIN” (Minimum) and “MAX” (Maximum) marks on the side of the reservoir. Use only hydraulic brake/clutch fluid conforming to DOT 4 specification.

Parking brake

Inspect the parking brake system including the parking brake lever and cables.

Rear brake drums and linings (if equipped)

Check the rear brake drums and linings for scoring, burning, leaking fluid, broken parts, and excessive wear.

Brake pads, calipers and discs

Check the pads for excessive wear, discs for run out and wear, and calipers for fluid leakage.

Suspension mounting bolts

Check the suspension connections for looseness or damage. Retighten to the specified torque.

Steering gear box, linkage & boots/lower arm ball joint

With the vehicle stopped and engine off, check for excessive free-play in the steering wheel.

Check the linkage for bends or damage. Check the dust boots and ball joints for deterioration, cracks, or damage. Replace any damaged parts.

Drive shafts and boots

Check the drive shafts, boots and clamps for cracks, deterioration, or damage. Replace any damaged parts and, if necessary, repack the grease.

Air conditioning refrigerant

Check the air conditioning lines and connections for leakage and damage.

ENGINE OIL

Checking the engine oil level (Petrol engine)

Engine oil is used for lubricating, cooling, and operating various hydraulic components in the engine. Engine oil consumption while driving is normal, and it is necessary to check and refill the engine oil regularly. Also, check and refill the oil level within the recommended maintenance schedule to prevent deterioration of oil performance.

Check the engine oil following the below procedure.



1. Follow all of the oil manufacturer's precautions.
2. Be sure the vehicle is on the level ground in P (Park) with the parking brake set. If possible, block the wheels.
3. Turn the engine on and warm the engine up until the coolant temperature reaches a constant normal temperature.
4. Turn the engine off, remove the oil filler cap and pull the dipstick out. Wait for 15 minutes for the oil to return to the oil pan.
5. Wipe the dipstick clean and re-insert it fully.
6. Pull the dipstick out again and check the level.

7. If the oil level is below L, add enough oil to bring the level to F.

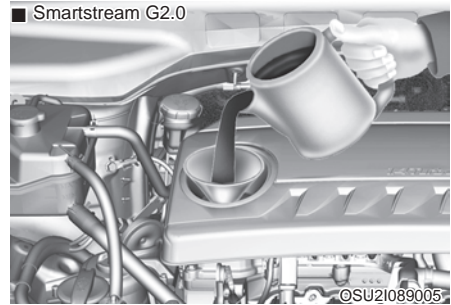

If it is near or at L (Low), add enough oil to bring the level to F (Full). **Do not overfill.**

Use a funnel to help prevent oil from being spilled on engine components.

Use only the specified engine oil. (Refer to "Recommended lubricants and capacities" in chapter 2.)

WARNING

Radiator hose

Be very careful not to touch the radiator hose when checking or adding the engine oil as it may be hot enough to burn you.

NOTICE

To prevent damage to your engine:

- Do not spill engine oil when adding or changing engine oil. Wipe off spilled oil immediately.
- The engine oil consumption may increase while you break in a new vehicle and it will be stabilized after driving 6,000 km (4,000 miles).
- The engine oil consumption can be affected by driving habits, climate conditions, traffic conditions, oil quality, etc. Therefore, it is recommended that you inspect the engine oil level regularly and refill it if necessary.

Checking the engine oil level (Diesel engine)

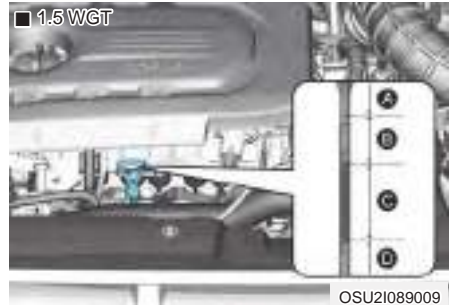

Range	Required action
A	Recommend to contact an authorized HYUNDAI dealer.
B	Do not refill engine oil.
C	Normal. You may add engine oil as long as the oil level does not go above the C range.
D	You must add oil and make sure that the oil level is in the C Range.

1. Be sure the vehicle is on level ground.
2. Start the engine and allow it to reach normal operating temperature.
3. Turn the engine off and wait for a few minutes (about 5 minutes) for the oil to return to the oil pan.
4. Turn the engine off, remove the oil filler cap and pull the dipstick out. Wait for 15 minutes for the oil to return to the oil pan.
5. Wipe the dipstick clean and re-insert it fully.

- Pull the dipstick out again and check the level. The level should be in the C range.
- If the level is in the D range, add enough engine oil to bring the level up the range.



WARNING

Radiator hose

Be very careful not to touch the radiator hose when checking or adding the engine oil as it may be hot enough to burn you.

NOTICE

To prevent damage to your engine:

- Do not spill engine oil when adding or changing engine oil. Wipe off spilled oil immediately.
- The engine oil consumption may increase while you break in a new vehicle and it will be stabilized after driving 6,000 km (4,000 miles).
- The engine oil consumption can be affected by driving habits, climate conditions, traffic conditions, oil quality, etc. Therefore, it is recommended that you inspect the engine oil level regularly and refill it if necessary.

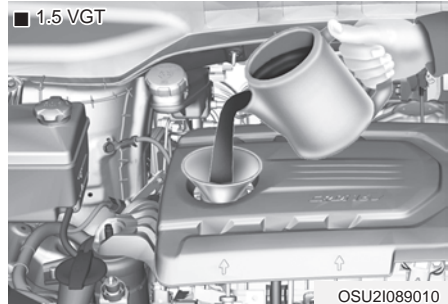

If it is near or at L, add enough oil to bring the level to F. Do not overfill.

Use only the specified engine oil.

(Refer to “Recommended lubricants and capacities” in chapter 8.)



Changing the engine oil and filter



We recommend that the engine oil and filter be replaced by an authorized HYUNDAI dealer.

- If the maintenance schedule to replace engine oil is exceeded, the engine oil performance may deteriorate, and the engine condition may be affected. Therefore, replace the engine oil according to the maintenance schedule.
- To keep the engine in optimal condition, use the recommended engine oil and filter. If the recommended engine oil and filter are not used, replace it according to the maintenance schedule under severe usage conditions.
- The purpose of the maintenance schedule for engine oil replacement is to prevent oil deterioration and it is irrelevant to oil consumption. Check and refill engine oil regularly.

Information

When the oil pressure is low due to insufficient engine oil, the Engine Oil Pressure () warning light will illuminate. In addition, the enhanced engine protection system, which limits the engine's power is activated and the Malfunction Indicator Lamp () will illuminate when the vehicle is driven in this state continuously. When oil pressure is restored, the Engine Oil Pressure warning light will turn off and the engine power will no longer be limited.

CAUTION

The engine oil is very hot immediately after the vehicle has been driven and can cause burns during replacement. Replace the engine oil after the engine oil has cooled down.

WARNING

Used engine oil may cause skin irritation or cancer if left in contact with the skin for prolonged periods of time. Used engine oil contains chemicals that have caused cancer in laboratory animals. Always protect your skin by washing your hands thoroughly with soap and warm water as soon as possible after handling used oil.

ENGINE COOLANT

The high-pressure cooling system has a reservoir filled with year-round antifreeze coolant. The reservoir is filled at the factory.

Check the antifreeze protection and coolant level at least once a year, at the beginning of the winter season, and before traveling to a colder climate.

NOTICE

- **Do not drive with no engine coolant. It may cause water pump failure and engine seizure, etc.**
- **When the engine overheats from low engine coolant, suddenly adding engine coolant may cause cracks in the engine. To prevent damage, add engine coolant slowly in small quantities.**

Checking the coolant level



Check the condition and connections of all cooling system hoses and heater hoses. Replace any swollen or deteriorated hoses.

The coolant level should be filled between F (Full) and L (Low) marked on the side of the coolant reservoir when the engine is cool.

If the coolant level is low, add enough distilled (deionized) water.

Bring the level to F (Full), but do not overfill. If frequent additions are required, we recommend that the system be inspected by an authorized HYUNDAI dealer.



OAI3089005

WARNING



Removing radiator cap

- Never attempt to remove the radiator cap while the engine is operating or hot. Doing so might lead to cooling system and engine damage and could result in serious personal injury from escaping hot coolant or steam.
- Turn the engine off and wait until it cools down. Use extreme care when removing the radiator cap. Wrap a thick towel around it, and turn it counterclockwise slowly to the first stop. Step back while the pressure is released from the cooling system. When you are sure all the pressure has been released, press down on the cap, using a thick towel, and continue turning counterclockwise to remove it.

- Even if the engine is not operating, do not remove the radiator cap or the drain plug while the engine and radiator are hot. Hot coolant and steam may still blow out under pressure, causing serious injury.

WARNING



The electric motor (cooling fan) is controlled by engine coolant temperature, refrigerant pressure and vehicle speed.

It may sometimes operate even when the engine is not running. Use extreme caution when working near the blades of the cooling fan so that you are not injured by a rotating fan blades. As the engine coolant temperature decreases, the electric motor will automatically shut off. This is a normal condition.

The electric motor (cooling fan) may operate until you disconnect the negative battery cable.

Recommended engine coolant

- When adding coolant, use only de-ionized water or soft water for your vehicle and never mix hard water in the coolant filled at the factory. An improper coolant mixture can result in serious malfunction or engine damage.
- The engine in your vehicle has aluminum engine parts and must be protected by an phosphate based ethylene-glycol coolant to prevent corrosion and freezing.
- DO NOT USE alcohol or methanol coolant or mix them with the specified coolant.
- Do not use a solution that contains more than 60% antifreeze or less than 35% antifreeze, which would reduce the effectiveness of the solution.

For mixture percentage, refer to the following table.

Ambient Temperature	Mixture Percentage (volume)	
	Antifreeze	Water
-15°C (5°F)	35	65
-25°C (-13°F)	40	60
-35°C (-31°F)	50	50
-45°C (-49°F)	60	40

i Information

If in doubt about the mix ratio, a 50% water and 50% antifreeze mix is the easiest to mix together as it will be the same quantity of each. It is suitable to use for most temperature ranges of -35°C (-31°F) and higher.

WARNING



Radiator cap

Do not remove the radiator cap when the engine and radiator are hot. Scalding hot coolant and steam may blow out under pressure causing serious injury.

Changing the coolant

We recommend that the coolant be replaced by an authorized HYUNDAI dealer.

NOTICE

Put a thick cloth or fabric around the radiator cap before refilling the coolant in order to prevent the coolant from overflowing into engine parts such as the alternator.

WARNING

- Do not use radiator coolant or antifreeze in the washer fluid reservoir.
- Engine coolant can severely obscure visibility when sprayed on the windshield and may cause loss of vehicle control or damage to paint and body trim.

BRAKE/CLUTCH (IF EQUIPPED) FLUID

Checking the brake/clutch fluid level



Check the fluid level in the reservoir periodically. The fluid level should be between MAX (Maximum) and MIN (Minimum) marks on the side of the reservoir.

Before removing the reservoir cap and adding brake/clutch fluid, clean the area around the reservoir cap thoroughly to prevent brake/clutch fluid contamination. If the level is low, add fluid to the MAX (Maximum) level. The level will fall with accumulated mileage. This is a normal condition associated with the wear of the brake linings and/or clutch disc (if equipped).

If the fluid level is excessively low, we recommend that the system be checked by an authorized HYUNDAI dealer.

Use only the specified brake/clutch fluid. (Refer to "Recommended lubricants or capacities" in chapter 2.)

Never mix different types of fluid.

WARNING

Loss of brake fluid

In the event the brake system requires frequent additions of fluid, we recommend that the system be inspected by an authorized HYUNDAI dealer.

Information

Before removing the brake/clutch filter cap, read the warning on the cap.

WARNING

Clean filler cap before removing. Use only DOT 4 brake/clutch fluid from a sealed container.



WARNING

Brake/clutch fluid

When changing and adding brake/clutch fluid, handle it carefully. Do not let it come in contact with your eyes. If brake/clutch fluid come in contact with your eyes, immediately flush them with a large quantity of fresh tap water. Have your eyes examined by a doctor as soon as possible.

NOTICE

Do not allow brake/clutch fluid to contact the vehicle's body paint, as paint damage will result.

Brake/clutch fluid, which has been exposed to open air for an extended time should never be used as its quality cannot be guaranteed. It should be properly disposed. Don't put in the wrong kind of fluid. A few drops of mineral-based oil, such as engine oil, in your brake/clutch system can damage brake/clutch system parts.

AUTOMATIC TRANSMISSION FLUID (IF EQUIPPED)

Information

A new automatic transmission fluid should be red. The red dye is added so the assembly plant can identify it as automatic transmission fluid and distinguish it from engine oil or anti-freeze. The red dye, which is not an indicator of fluid quality, is not permanent. As the vehicle is driven, the automatic transmission fluid will begin to look darker. The color may eventually appear light brown. Therefore, we recommend that the system be replaced by an authorized HYUNDAI dealer according to the Scheduled Maintenance at the beginning of this chapter.

Use only the specified automatic transmission fluid.

(Refer to “Recommended lubricants and capacities” in chapter 2.)

Changing the automatic transmission fluid

We recommend that the system be replaced by an authorized HYUNDAI dealer.

WASHER FLUID

Checking the washer fluid level



Check the fluid level in the washer fluid reservoir and add fluid if necessary. Plain water may be used if washer fluid is not available.

However, use washer solvent with antifreeze characteristics in cold climates to prevent freezing.

WARNING

Coolant

- Do not use radiator coolant or antifreeze in the washer fluid reservoir.
- Radiator coolant can severely obscure visibility when sprayed on the windshield and may cause loss of vehicle control or damage to the paint and body trim.
- Windshield washer fluid agents contain some amounts of alcohol and can be flammable under certain circumstances. Do not allow sparks or flame come in contact with the washer fluid or the washer fluid reservoir. Damage to the vehicle or occupants could occur.
- Windshield washer fluid is poisonous to humans and animals. Do not drink and avoid coming in contact with the windshield washer fluid. Serious injury or death could occur.

PARKING BRAKE

Checking the parking brake



Check the stroke of the parking brake by counting the number of “clicks” heard while fully applying it from the released position.

Also, the parking brake alone should securely hold the vehicle on a fairly steep grade. If the stroke is more or less than specified, we recommend that the system be inspected by an authorized HYUNDAI dealer.

Stroke : 5~7 “clicks” at a force of 20 kg (44 lbs, 196 N).

FUEL FILTER (FOR DIESEL)

Draining water from fuel filter

The fuel filter for diesel engine plays an important role of separating water from fuel and accumulating the water in its bottom.

If water accumulates in the fuel filter, the warning light comes on when the ignition switch is in the ON position.



If this warning light turned on, we recommend that the system be serviced by an authorized HYUNDAI dealer.

NOTICE

If the water accumulated in the fuel filter is not drained at proper times, damages to the major parts such as the fuel system can be caused by water permeation in the fuel filter.

Fuel filter cartridge replacement

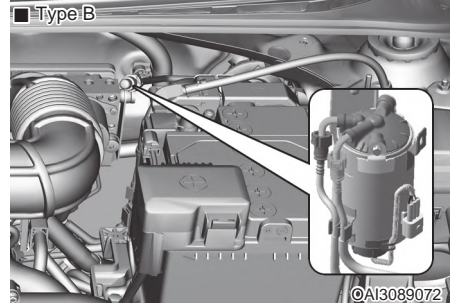
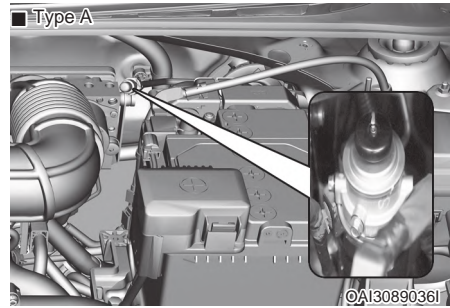

Information

When replacing the fuel filter cartridge, we recommend that you use parts for replacement from an authorized HYUNDAI dealer.

AIR CLEANER

Filter replacement



You can clean the filter when inspecting the air cleaner element.

1. Loosen the hose clamp and remove hose from cleaner.
2. Open the cleaner cover by opening the clips.



3. Remove the used filter and wipe the inside of the air cleaner housing carefully not to remain dusts in cover housing.
4. Place the new filter with clean hands and ensure the rubber gasket is not taken off.
5. Reassemble in the reverse order of removal.

Replace the filter according to the Maintenance Schedule.

If the vehicle is operated in extremely dusty or sandy areas, replace the element more often than the usual recommended intervals. (Refer to "Maintenance under severe usage conditions" in this chapter.)

NOTICE

- Do not drive with the filter removed; this will result in excessive engine wear.
- Clean the filter carefully. Do not wash or beat too strongly. Be careful for dust and other contaminations to come over upper side.
- Keep the new filter clean of any contamination while replacing.
- We recommend that you use parts for replacement from an authorized HYUNDAI dealer.



CAUTION

Don't clean the used filter. It can cause contaminations on the clean side of filter to result in engine wear or sensors' failure.

CLIMATE CONTROL AIR FILTER

Filter inspection

If the vehicle is operated in the severely air-polluted cities or on dusty rough roads for a long period, it should be inspected more frequently and replaced earlier. When you, the owner, replace the climate control air filter, replace it performing the following procedure, and be careful to avoid damaging other components.

Replace the filter according to the maintenance Schedule.

Filter replacement



1. Open the glove box.



2. Push in both sides of the glove box as shown. This will ensure that the glove box stopper pins will get released from its holding location allowing the glove box to hang.



3. Remove the climate control air filter cover.

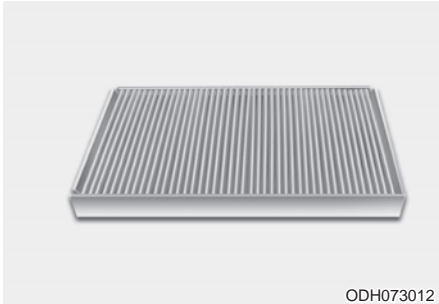

4. Clean the climate control air filter.
5. Reassemble in the reverse order of disassembly.

NOTICE

Install a new climate control air filter in the correct direction with the arrow symbol(↓) facing downwards.

Otherwise, the climate control effects may decrease, possibly with a noise.

WIPER BLADES

Blade inspection

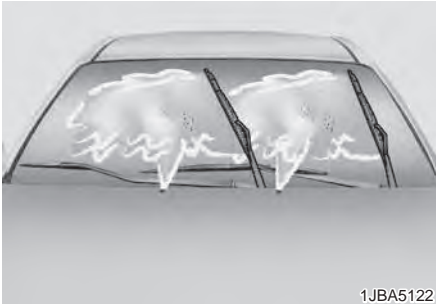

1JBA5122

i Information

Commercial hot waxes applied by automatic car washes have been known to make the windshield difficult to clean.

Contamination of either the windshield or the wiper blades with foreign matter can reduce the effectiveness of the windshield wipers. Common sources of contamination are insects, tree sap, and hot wax treatments used by some commercial car washes. If the blades are not wiping properly, clean both the window and the blades with a good cleaner or mild detergent, and rinse thoroughly with clean water.

NOTICE

To prevent damage to the wiper blades, do not use petrol, kerosene, paint thinner, or other solvents on or near them.

Blade replacement

When the wipers no longer clean adequately, the blades may be worn or cracked, and require replacement.

NOTICE

To prevent damage to the wiper arms or other components, do not attempt to move the wipers manually.

NOTICE

The use of a non-specified wiper blade could result in wiper malfunction and failure.

Front windshield wiper blade

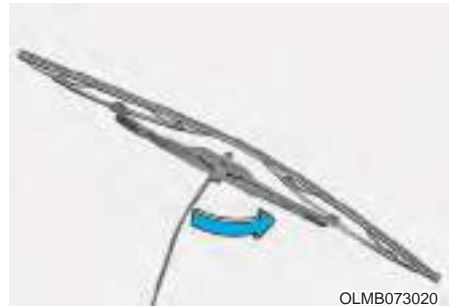

OLMB073020

Type A

1. Raise the wiper arm and turn the wiper blade assembly to expose the plastic locking clip.

NOTICE

Do not allow the wiper arm to fall against the windshield, since it may chip or crack the windshield.

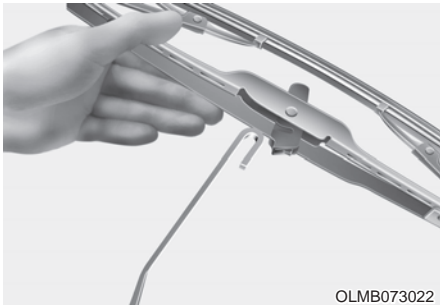
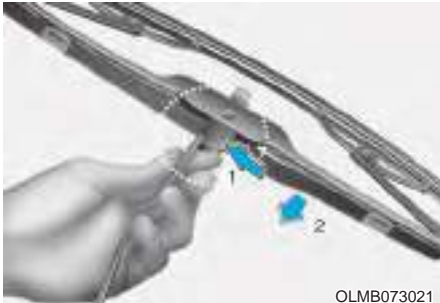

2. Compress the clip and slide the blade assembly downward.
3. Lift it off the arm.
4. Install the blade assembly in the reverse order of removal.

Rear window wiper blade (if equipped)



1. Raise the wiper arm and rotate the wiper blade assembly (1).
2. Pull out the wiper blade assembly.



3. Install the new blade assembly by inserting the center part into the slot in the wiper arm until it clicks into place.
4. Make sure the blade assembly is installed firmly by trying to pull it slightly.

To prevent damage to the wiper arms or other components, we recommend that the wiper blade be replaced by an authorized HYUNDAI dealer.

BATTERY

For best battery service



- Keep the battery securely mounted.
- Keep the battery top clean and dry.
- Keep the terminals and connections clean, tight, and coated with gasolineeum jelly or terminal grease.
- Rinse any spilled electrolyte from the battery immediately with a solution of water and baking soda.
- If the vehicle is not going to be used for an extended time, disconnect the negative terminal cable of the battery to prevent discharge.

i Information - For batteries marked with **UPPER** and **LOWER**

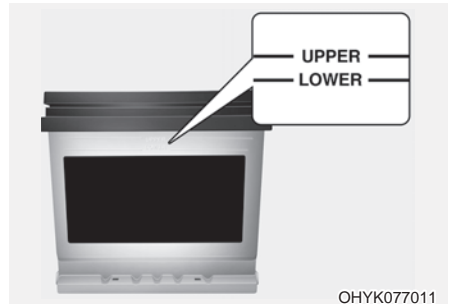

If your vehicle is equipped with a battery marked with LOWER (MIN) and UPPER (MAX) on the side, you should check the electrolyte level.

The electrolyte level should be between LOWER (MIN) and UPPER (MAX).

Be careful not to spill distilled (or de-mineralized) water over the battery surface or other adjacent components.

Also, do not overfill the battery cells.

If not, it may corrode the battery or other components. Finally, securely close the cell cap. However, we recommend you to contact an authorized HYUNDAI dealer for better battery service.

NOTICE

If the Electrolyte level is Low, add distilled (or demineralized) water. Never add sulfuric acid or other electrolyte.

 **WARNING**

Battery dangers



Always read the following instructions carefully when handling a battery.



Keep lighted cigarettes and all other flames or sparks away from the battery.



Hydrogen, a highly combustible gas, is always present in battery cells and may explode if ignited.



Keep batteries out of the reach of children because batteries contain highly corrosive SULFURIC ACID. Do not allow battery acid to contact your skin, eyes, clothing or paint finish.



If any electrolyte gets into your eyes, flush your eyes with clean water for at least 15 minutes and get immediate medical attention. If electrolyte gets on your skin, thoroughly wash the contacted area. If you feel a pain or a burning sensation, get medical attention immediately.



Wear eye protection when charging or working near a battery. Always provide ventilation when working in an enclosed space.



An inappropriately disposed battery can be harmful to the environment and human health. Dispose the battery according to your local law(s) or regulation.



The battery contains lead. Do not dispose of it after use. Please return the battery to an authorized HYUNDAI dealer to be recycled.

- When lifting a plastic-cased battery, excessive pressure on the case may cause battery acid to leak, resulting in personal injury. Lift with a battery carrier or with your hands on opposite corners.
- Never attempt to recharge the battery when the battery cables are connected.
- The electrical ignition system works with high voltage. Never touch these components with the engine running or the ignition switched on.

Failure to follow the above warnings can result in serious bodily injury or death.

NOTICE

If you connect unauthorized electronic devices to the battery, the battery may be discharged. Never use unauthorized devices.

Battery capacity label

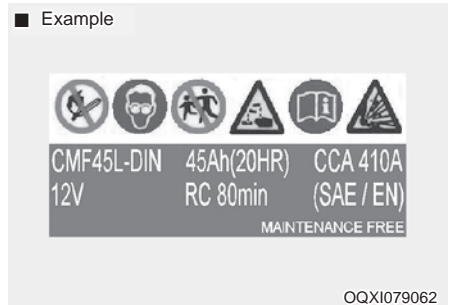

※ The actual battery label in the vehicle may differ from the illustration.

1. CMF45L-DIN : The HYUNDAI model name of battery
2. 12V : The nominal voltage
3. 45Ah(20HR) : The nominal capacity (in Ampere hours)
4. RC 80min : The nominal reserve capacity (in min.)
5. CCA410 : The cold-test current in amperes by SAE
6. 410A : The cold-test current in amperes by EN

Battery recharging

Your vehicle has a maintenance-free, calcium-based battery.

- If the battery becomes discharged in a short time (because, for example, the headlights or interior lights were left on while the vehicle was not in use), recharge it by slow charging (trickle) for 10 hours.
- If the battery gradually discharges because of high electric load while the vehicle is being used, recharge it at 20-30A for two hours.



WARNING

Recharging battery

When recharging the battery, observe the following precautions:

- The battery must be removed from the vehicle and placed in an area with good ventilation.
- Do not allow cigarettes, sparks, or flame near the battery.
- Watch the battery during charging, and stop or reduce the charging rate if the battery cells begin gassing (boiling) violently or if the temperature of the electrolyte of any cell exceeds 49°C (120°F).
- Wear eye protection when checking the battery during charging.
- Disconnect the battery charger in the following order.
 1. Turn off the battery charger main switch.
 2. Unhook the negative clamp from the negative battery terminal.
 3. Unhook the positive clamp from the positive battery terminal.



WARNING

- Before performing maintenance or recharging the battery, turn off all accessories and stop the engine.
- The negative battery cable must be removed first and installed last when the battery is disconnected.

Reset items

Items should be reset after the battery has been discharged or the battery has been disconnected.

- Auto up/down window (See chapter 5)
- Climate control system (See chapter 5)
- Audio (See chapter 5)

Battery replacement

Replacing a Battery required precautionary measures.

We recommend that you consult an authorized HYUNDAI dealer.

TIRES AND WHEELS

Tire care

For proper maintenance, safety, and maximum fuel economy, you must always maintain recommended tire inflation pressures and stay within the load limits and weight distribution recommended for your vehicle.

Recommended cold tire inflation pressures

All tire pressures (including the spare) should be checked when the tires are cold. “Cold Tires” means the vehicle has not been driven for at least three hours or driven less than 1.6 km (one mile).

Recommended pressures must be maintained for the best ride, top vehicle handling, and minimum tire wear.

For recommended inflation pressure, refer to “Tire and wheels” in chapter 2.



All specifications (sizes and pressures) can be found on a label attached to the vehicle.



WARNING

Tire underinflation

Severe underinflation (70 kPa (10 psi) or more) can lead to severe heat build-up, causing blowouts, tread separation and other tire failures that can result in the loss of vehicle control leading to severe injury or death. This risk is much higher on hot days and when driving for long periods at high speeds.

NOTICE

- Underinflation also results in excessive wear, poor handling and reduced fuel economy. Wheel deformation also is possible. Keep your tire pressures at the proper levels. If a tire frequently needs refilling, we recommend that the system be checked by an authorized HYUNDAI dealer.
- Overinflation produces a harsh ride, excessive wear at the center of the tire tread, and a greater possibility of damage from road hazards.

NOTICE

- Warm tires normally exceed recommended cold tire pressures by 28 to 41 kPa (4 to 6 psi). Do not release air from warm tires to adjust the pressure or the tires will be underinflated.
- Be sure to reinstall the tire inflation valve caps. Without the valve cap, dirt or moisture could get into the valve core and cause air leakage. If a valve cap is missing, install a new one as soon as possible.



WARNING

Tire Inflation

Overinflation or underinflation can reduce tire life, adversely affect vehicle handling, and lead to sudden tire failure. This could result in loss of vehicle control and potential injury.

NOTICE

Tire pressure

Always observe the following:

- Check tire pressure when the tires are cold. (After vehicle has been parked for at least three hours or hasn't been driven more than 1.6 km (one mile) since startup.)
- Check the pressure of your spare tire each time you check the pressure of other tires.
- Never overload your vehicle. Be careful not to overload a vehicle luggage rack if your vehicle is equipped with one.
- Worn, old tires can cause accidents. If your tread is badly worn, or if your tires have been damaged, replace them.

Checking tire inflation pressure

Check your tires once a month or more.

Also, check the tire pressure of the spare tire.

How to check

Use a good quality gage to check tire pressure. You can not tell if your tires are properly inflated simply by looking at them. Radial tires may look properly inflated even when they're underinflated.

Check the tire's inflation pressure when the tires are cold. - "Cold" means your vehicle has been sitting for at least three hours or driven no more than 1.6 km (1 mile).

Remove the valve cap from the tire valve stem. Press the tire gage firmly onto the valve to get a pressure measurement. If the cold tire inflation pressure matches the recommended pressure on the tire and loading information label, no further adjustment is necessary. If the pressure is low, add air until you reach the recommended amount.

If you overfill the tire, release air by pushing on the metal stem in the center of the tire valve. Recheck the tire pressure with the tire gage. Be sure to put the valve caps back on the valve stems. They help prevent leaks by keeping out dirt and moisture.



WARNING

- **Inspect your tires frequently for proper inflation as well as wear and damage. Always use a tire pressure gauge.**
- **Tires with too much or too little pressure wear unevenly causing poor handling, loss of vehicle control, and sudden tire failure leading to accidents, injuries, and even death. The recommended cold tire pressure for your vehicle can be found in this manual and on the tire label located on the driver's side center pillar.**
- **Worn tires can cause accidents. Replace tires that are worn, show uneven wear, or are damaged.**
- **Remember to check the pressure of your spare tire. HYUNDAI recommends that you check the spare every time you check the pressure of the other tires on your vehicle.**

Tire rotation

To equalize tread wear, HYUNDAI recommends that the tires be rotated according to the maintenance schedule or sooner if irregular wear develops.

During rotation, check the tires for correct balance.

When rotating tires, check for uneven wear and damage. Abnormal wear is usually caused by incorrect tire pressure, improper wheel alignment, out-of-balance wheels, severe braking or severe cornering. Look for bumps or bulges in the tread or side of tire. Replace the tire if you find either of these conditions. Replace the tire if fabric or cord is visible. After rotation, be sure to bring the front and rear tire pressures to specification and check lug nut tightness.

Refer to “Tire and wheels” in chapter 2.

■ With a full-size spare tire (if equipped)

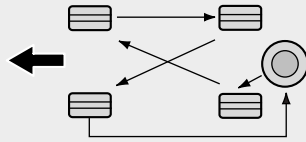

CBGQ0706

■ Without a spare tire

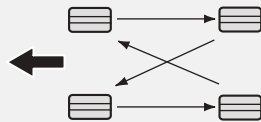

CBGQ0707

■ Directional tires (if equipped)

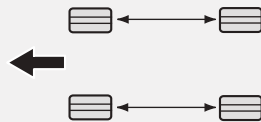

CBGQ0707A

Disc brake pads should be inspected for wear whenever tires are rotated.

i Information

Rotate radial tires that have an asymmetric tread pattern only from front to rear and not from right to left.

WARNING

- Do not use the compact spare tire for tire rotation.
- Do not mix bias ply and radial ply tires under any circumstances. This may cause unusual handling characteristics that could result in death, severe injury, or property damage.

Wheel alignment and tire balance

The wheels on your vehicle were aligned and balanced carefully at the factory to give you the longest tire life and best overall performance.

In most cases, you will not need to have your wheels aligned again. However, if you notice unusual tire wear or your vehicle pulling one way or the other, the alignment may need to be reset.

If you notice your vehicle vibrating when driving on a smooth road, your wheels may need to be rebalanced.

NOTICE

Improper wheel weights can damage your vehicle's aluminum wheels. Use only approved wheel weights.

Tire replacement



If the tire is worn evenly, a tread wear indicator will appear as a solid band across the tread. This shows there is less than 1.6 mm (1/16 inch) of tread left on the tire. Replace the tire when this happens.

Do not wait for the band to appear across the entire tread before replacing the tire.

NOTICE

When replacing the tires, recheck and tighten the wheel nuts after driving about 1,000 km (620 miles). If the steering wheel shakes or the vehicle vibrates while driving, the tire is out of balance. Align the tire balance. If the problem is not solved, we recommend that you contact an authorized HYUNDAI dealer.



WARNING

Replacing tires

To reduce the chance of serious or fatal injuries from an accident caused by tire failure or loss of vehicle control:

- Replace tires that are worn, show uneven wear, or are damaged. Worn tires can cause loss of braking effectiveness, steering control, and traction.
- Do not drive your vehicle with too little or too much pressure in your tires. This can lead to uneven wear and tire failure.
- When replacing tires, never mix radial and bias-ply tires on the same car. You must replace all tires (including the spare) if moving from radial to bias-ply tires.
- It is best to replace all four tires at the same time. If that is not possible, or necessary, then replace the two front or two rear tires as a pair. Replacing just one tire can seriously affect your vehicle's handling.
- Using tires and wheel other than the recommended sizes could cause unusual handling characteristics and poor vehicle control, resulting in a serious accident.
- Wheels that do not meet HYUNDAI's specifications may fit poorly and result in damage to the vehicle or unusual handling and poor vehicle control.

- The ABS works by comparing the speed of the wheels. Tire size can affect wheel speed. When replacing tires, all 4 tires must use the same size originally supplied with the vehicle. Using tires of a different size can cause the ABS (Anti-lock Brake System) and ESC (Electronic Stability Control) to work irregularly. (if equipped)

Compact spare tire replacement (if equipped)

A compact spare tire has a shorter tread life than a regular size tire. Replace it when you can see the tread wear indicator bars on the tire. The replaced compact spare tire should be the same size and design tire as the one provided with your new vehicle and should be mounted on the same compact spare tire wheel. The compact spare tire is not designed to be mounted on a regular size wheel, and the compact spare tire wheel is not designed to mount a regular size tire.

Wheel replacement

When replacing the metal wheels for any reason, make sure the new wheels are equivalent to the original factory units in diameter, rim width and offset.



WARNING

A wheel that is not the correct size may adversely affect wheel and bearing life, braking and stopping abilities, handling characteristics, ground clearance, body-to-tire clearance, snow chain clearance, speedometer and odometer calibration, headlight aim and bumper height.

Tire traction

Tire traction can be reduced if you drive on worn tires, tires that are improperly inflated or on slippery road surfaces. Tires should be replaced when tread wear indicators appear. Slow down whenever there is rain, snow or ice on the road, to reduce the possibility of losing control of the vehicle.

Tire maintenance

In addition to proper inflation, correct wheel alignment helps decrease tire wear. If you find a tire worn unevenly, have your dealer check the wheel alignment.

When you have new tires installed, make sure they are balanced. This will increase vehicle ride comfort and tire life. Additionally, a tire should always be rebalanced if it is removed from the wheel.

Tire sidewall labeling

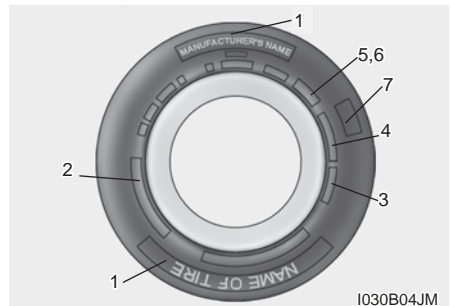

This information identifies and describes the fundamental characteristics of the tire and also provides the tire identification number (TIN) for safety standard certification. The TIN can be used to identify the tire in case of a recall.

1. Manufacturer or brand name

Manufacturer or Brand name is shown.

2. Tire size designation

A tire's sidewall is marked with a tire size designation. You will need this information when selecting replacement tires for your car. The following explains what the letters and numbers in the tire size designation mean.

Example tire size designation:

(These numbers are provided as an example only; your tire size designator could vary depending on your vehicle.)

215/60R17 96H

- 215 - Tire width in millimeters.
- 60 - Aspect ratio. The tire's section height as a percentage of its width.
- R - Tire construction code (Radial).
- 17 - Rim diameter in inches.
- 96 - Load Index, a numerical code associated with the maximum load the tire can carry.
- H - Speed Rating Symbol. See the speed rating chart in this chapter for additional information.

Wheel size designation

Wheels are also marked with important information that you need if you ever have to replace one. The following explains what the letters and numbers in the wheel size designation mean.

Example wheel size designation:

6.5J X 17

- 6.0 - Rim width in inches.
- J - Rim contour designation.
- 17 - Rim diameter in inches

Tire speed ratings

The chart below lists many of the different speed ratings currently being used for passenger car tires. The speed rating is part of the tire size designation on the sidewall of the tire. This symbol corresponds to that tire's designed maximum safe operating speed.

Speed Rating Symbol	Maximum Speed
S	180 km/h (112 mph)
T	190 km/h (118 mph)
H	210 km/h (130 mph)
V	240 km/h (149 mph)
W	270 km/h (168 mph)
Y	300 km/h (186 mph)

3. Checking tire life (TIN : Tire Identification Number)

Any tires that are over 6 years old, based on the manufacturing date, (including the spare tire) should be replaced by new ones. You can find the manufacturing date on the tire sidewall (possibly on the inside of the wheel), displaying the DOT Code. The DOT Code is a series of numbers on a tire consisting of numbers and English letters. The manufacturing date is designated by the last four digits (characters) of the DOT code.

DOT : XXXX XXXX OOOO

The front part of the DOT means a plant code number, tire size and tread pattern and the last four numbers indicate week and year manufactured.

For example:

DOT XXXX XXXX 2221 represents that the tire was produced in the 22th week of 2021.

WARNING

Tire age

Tires degrade over time, even when they are not being used.

Regardless of the remaining tread, it is recommended that tires generally be replaced after six (6) years of normal service. Heat caused by hot climates or frequent high loading conditions can accelerate the aging process. Failure to follow this warning could cause sudden tire failure, which could lead to a loss of control and an accident involving serious injury or death.

4. Tire ply composition and material

The number of layers or plies of rubber-coated fabric in the tire. Tire manufacturers also must indicate the materials in the tire, which include steel, nylon, polyester, and others. The letter "R" means radial ply construction; the letter "D" means diagonal or bias ply construction; and the letter "B" means belted-bias ply construction.

5. Maximum permissible inflation pressure

This number is the greatest amount of air pressure that should be put in the tire. Do not exceed the maximum permissible inflation pressure. Refer to the Tire and Loading Information label for recommended inflation pressure.

6. Maximum load rating

This number indicates the maximum load in kilograms and pounds that can be carried by the tire. When replacing the tires on the vehicle, always use a tire that has the same load rating as the factory installed tire.

7. Uniform tire quality grading

Quality grades can be found where applicable on the tire sidewall between tread shoulder and maximum chapter width.

For example:

TREAD wear 200

TRACTION AA

TEMPERATURE A

Tread wear

The tread wear grade is a comparative rating based on the wear rate of the tire when tested under controlled conditions on a specified government test course. For example, a tire graded 150 would wear one-and-a-half times (1½) as well on the government course as a tire graded 100.

The relative performance of tires depends upon the actual conditions of their use, however, and may depart significantly from the norm due to variations in driving habits, service practices and differences in road characteristics and climate.

These grades are molded on the side-walls of passenger vehicle tires. The tires available as standard or optional equipment on your vehicle may vary with respect to grade.

Traction - AA, A, B & C

The traction grades, from highest to lowest, are AA, A, B and C. Those grades represent the tire's ability to stop on wet pavement measured under controlled conditions on specified government test surfaces of asphalt and concrete. A tire marked C may have poor traction performance.



WARNING

The traction grade assigned to this tire is based on straight-ahead braking traction tests, and does not include acceleration, cornering, hydroplaning, or peak traction characteristics.

Temperature -A, B & C

The temperature grades are A (the highest), B, and C, representing the tire's resistance to the generation of heat and its ability to dissipate heat when tested under controlled conditions on a specified indoor laboratory test wheel.

Sustained high temperature can cause the material of the tire to degenerate and reduce tire life, and excessive temperature can lead to sudden tire failure. Grades B and A represent higher levels of performance on the laboratory test wheel than the minimum required by law.



WARNING

Tire temperature

The temperature grade for this tire is established for a tire that is properly inflated and not overloaded. Excessive speed, underinflation, or excessive loading, either separately or in combination, can cause heat build-up and sudden tire failure. This can cause loss of vehicle control and serious injury or death.

Low aspect ratio tire (if equipped)

Low aspect ratio tires, whose aspect ratio is lower than 50, are provided for sporty looks.

Because the low aspect ratio tires are optimized for handling and braking, it may be more uncomfortable to ride in and there is more noise compare with normal tires.

NOTICE

Because the sidewall of the low aspect ratio tire is shorter than the normal, the wheel and tire of the low aspect ratio tire is easier to be damaged. So, follow the instructions below.

- When driving on a rough road or off road, drive cautiously because tires and wheels may be damaged. And after driving, inspect tires and wheels.
- When passing over a pothole, speed bump, manhole, or curb stone, drive slowly so that the tires and wheels are not damaged.
- If the tire is impacted, we recommend that you inspect the tire condition or contact an authorized HYUNDAI dealer.
- To prevent damage to the tire, inspect the tire condition and pressure every 3,000km.

NOTICE

- It is not easy to recognize the tire damage with your own eyes. But if there is the slightest hint of tire damage, even though you cannot see the tire damage with your own eyes, have the tire checked or replaced because the tire damage may cause air leakage from the tire.
- If the tire is damaged by driving on a rough road, off road, pothole, manhole, or curb stone, it will not be covered by the warranty.
- You can find out the tire information on the tire sidewall.

FUSES

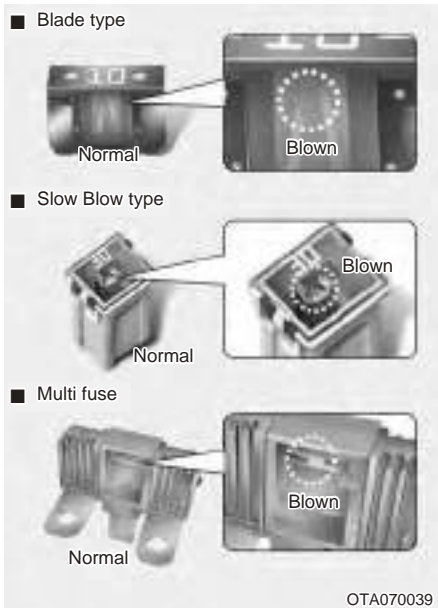

A vehicle's electrical system is protected from electrical overload damage by fuses.

This vehicle has 2 fuse panels, one located in the driver's side panel bolster, the other in the engine compartment near the battery.

If any of your vehicle's lights, accessories, or controls do not work, check the appropriate circuit fuse. If a fuse has blown, the element inside the fuse will be melted.

If the electrical system does not work, first check the driver's side fuse panel.

Before replacing a blown fuse, disconnect the negative battery cable.

Always replace a blown fuse with one of the same rating.

If the replacement fuse blows, this indicates an electrical problem. Avoid using the system involved and immediately consult an authorized HYUNDAI dealer.

i Information

Three kinds of fuses are used: blade type for lower amperage rating, cartridge type and multi fuse for higher amperage ratings.

! WARNING

Never replace a fuse with anything but another fuse of the same rating.

- A higher capacity fuse could cause damage and possibly a fire.
- Never install a wire or aluminum foil instead of the proper fuse - even as a temporary repair. It may cause extensive wiring damage and a possible fire.

NOTICE

Do not use a screwdriver or any other metal object to remove fuses because it may cause a short circuit and damage the system.

i Information

The actual fuse/relay panel label may differ from equipped items.

NOTICE

- When replacing a blown fuse or relay with a new one, make sure the new fuse or relay fits tightly into the clips. The incomplete fastening fuse or relay may cause the vehicle wiring and electric systems damage and a possible fire.
- Do not remove fuses, relays and terminals fastened with bolts or nuts. The fuses, relays and terminals may be fastened incompletely, and it may cause a possible fire. If fuses, relays and terminals fastened with bolts or nuts are blown, consult an authorized HYUNDAI dealer.
- Do not input any other objects except fuses or relays into fuse/relay terminals such as a driver or wiring. It may cause contact failure and system malfunction.
- Check the blown fuse with checking the fuse information on the fuse box cover.
- Replace the blown fuse on the safe place after turning off the ignition switch and all electric switches and disconnecting the negative battery cable.

Instrument panel fuse replacement

1. Turn the ignition switch and all other switches off.
2. Open the fuse panel cover.



3. Pull the suspected fuse straight out. Use the removal tool provided in the engine compartment fuse panel.
4. Check the removed fuse; replace it if it is blown.
5. Push in a new fuse of the same rating, and make sure it fits tightly in the clips.

If it fits loosely, we recommend that you consult an authorized HYUNDAI dealer.

If you do not have a spare, use a fuse of the same rating from a circuit you may not need for operating the vehicle, such as the cigarette lighter fuse.

If the electrical components do not work and the fuses are OK, check the fuse panel in the engine compartment. If a fuse is blown, it must be replaced.

Engine compartment panel fuse replacement



1. Turn the vehicle off.
2. Turn all other switches off.
3. Remove the fuse panel cover by pressing the tap and pulling up.
4. Check the removed fuse; replace it if it is blown. To remove or insert the fuse, use the fuse puller in the engine compartment fuse panel.
5. Push in a new fuse of the same rating, and make sure it fits tightly in the clips. If it fits loosely, we recommend that you consult an authorized HYUNDAI dealer.

NOTICE

After checking the fuse panel in the engine compartment, securely install the fuse panel cover. If not, electrical failures may occur from water leaking in.

**CAUTION**

If the main fuse is not assembled properly, it may cause fire.















If the main fuse is blown, we recommend that you consult an authorized HYUNDAI dealer.

Main fuse (Multi fuse)









If the main fuse is blown, it must be removed as follows:

1. Disconnect the negative battery cable.
2. Remove the nuts shown in the picture above.
3. Replace the fuse with a new one of the same rating.
4. Reinstall in the reverse order of removal.



Inner fuse panel

Type	Fuse Name	Symbol	Fuse rating	Circuit Protected
LP MINI FUSE	S/VENT FRT		10A	VENTILATION SEAT
	T/GATE		10A	TAILGATE ACTUATOR
	DOOR LOCK		20A	DOOR ACTUATOR
	A/BAG IND		7.5A	CLUSTER
	A/BAG		15A	ACU
	P/OUTLET 2		20A	POWER OUTLET
	MODULE 6		7.5A	IBU
	SAFETY P/ WINDOW LH		25A	SAFETY ECU
	SAFETY P/ WINDOW RH		25A	SAFETY ECU
	MODULE 1		7.5A	O/S MIRR SW
	A/C 2		10A	MTC, FATC, ECU
	MODULE 4		7.5A	CONSOLE SWITCH, ESC SWITCH
	MODULE 3		7.5A	STOP SWITCH, ATM LEVER
	USB CHARGE		10A	REAR USB CHARGER
RR WIPER		10A	REAR WIPER MOTOR	

Inner fuse panel

Type	Fuse Name	Symbol	Fuse rating	Circuit Protected
LP MINI FUSE	P/WINDOW RH	^{RH} 	25A	POWER WINDOW MOTOR
	AMP	AMP	25A	EXT. AMP
	WIPER FRT 1	¹ 	10A	FRONT WIPER MOTOR
	IBU 1	¹ IBU	15A	"IBU (INTEGRATED BODY CONTROL UNIT)"
	MULTIMEDIA	MULTI MEDIA	15A	AUDIO
	ABS		10A	"ABS (ANTI-LOCK BRAKE SYSTEM)"
	CLUSTER	CLUSTER	7.5A	CLUSTER
	MODULE 2	² MODULE	10A	O/S MIRR SW, AMP, IBU,AUDIO
	A/C 1	¹ A/C	7.5A	MTC,FATC
	SUNROOF		20A	SUNROOF MOTOR
	P/WINDOW LH	^{LH} 	25A	POWER WINDOW MOTOR
	P/SEAT(DRV)	^{DRV} 	20A	DRIVE POWER SEAT
	START		7.5A	INHIBITOR SWITCH, IGNITION LOCK SWITCH
	MODULE 5	⁵ MODULE	10A	FATC,C/PAD SWITCH,AUDIO, CONSOLE SWITCH
MDPS	 ¹	7.5A	MDPS	

Inner fuse panel

Type	Fuse Name	Symbol	Fuse rating	Circuit Protected
LP MINI FUSE	P/OUTLET 1	POWER OUTLET	20A	POWER OUTLET
	MODULE 7	⁷ MODULE	7.5A	IONIZER, SEAT ECU
	WASHER		15A	MULTI FUNCTION SWITCH
	HEATED		10A	"RR HEATED MIRROR, ECU"
	BRAKE SWITCH	BRAKE SWITCH	10A	STOP SWITCH
	MEMORY 2	² MEMORY	10A	CLUSTER, FATC, MTC
	IG 1	IG1	25A	ECU,PCU,SENSOR
	IBU 2	² IBU	7.5A	"IBU (INTEGRATED BODY CONTROL UNIT)"
	WIPER FRT 2	² 	25A	FRONT WIPER MOTOR

Engine compartment fuse panel



Inside the fuse/relay panel covers, you can find the fuse/relay label describing fuse/relay name and capacity.

i Information

Not all fuse panel descriptions in this manual may be applicable to your vehicle. It is accurate at the time of printing. When you inspect the fuse panel in your vehicle, refer to the fuse panel label.

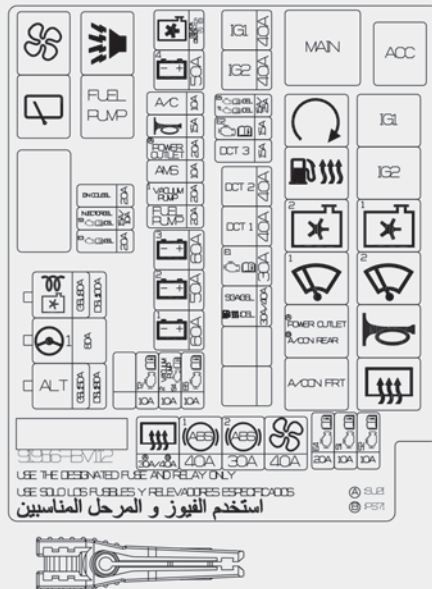

LIGHT BULBS

Consult an authorized HYUNDAI dealer to replace most vehicle light bulbs. It is difficult to replace vehicle light bulbs because other parts of the vehicle must be removed before you can get to the bulb. This is especially true for removing the headlight assembly to get to the bulb(s).

Removing/installing the headlight assembly can result in damage to the vehicle.

Information

The headlamp and tail lamp lenses could appear frosty if the vehicle is washed after driving or the vehicle is driven at night in wet weather. This condition is caused by temperature difference between the lamp inside and outside and, it does not indicate a problem with your vehicle. When moisture condenses in the lamp, it will be removed after driving with the headlamp on. The removable level may differ depending on lamp size, lamp position and environmental condition. However, if moisture is not removed, we recommend that your vehicle is inspected by an authorized HYUNDAI dealer.

WARNING

Prior to replacing a light, depress the foot brake, move the shift lever into the P (Park, for automatic transmission vehicle) or neutral (for manual transmission vehicle), apply the parking brake, place the ignition switch in the LOCK/OFF position, and take the key with you when leaving the vehicle to avoid sudden movement of the vehicle and to prevent possible electric shock.

Be aware the bulbs may be hot and may burn your fingers.

NOTICE

Be sure to replace the burned-out bulb with one of the same wattage rating. Otherwise, it may cause damage to the fuse or electric wiring system.

NOTICE

To prevent damage, do not clean the headlamp lens with chemical solvents or strong detergents.

i Information

- A normally functioning lamp may flicker momentarily to stabilize the vehicle's electrical control system. However, if the lamp goes out after flickering momentarily, or continues to flicker, we recommend the system be checked by an authorized HYUNDAI dealer.
- The position lamp may not turn on when the position lamp switch is turned on, but the position lamp and headlamp switch may turn on when the headlamp switch is turned on. This may be caused by network failure or vehicle electrical control system malfunction. If this occurs, we recommend the system be checked by an authorized HYUNDAI dealer.

i Information

The headlamp aiming should be adjusted after an accident or after the headlamp assembly is reinstalled.

i Information

Traffic Change (For Europe)

The low beam light distribution is asymmetric. If you go abroad to a country with opposite traffic direction, this asymmetric part will dazzle oncoming car driver. To prevent dazzle, ECE regulation demand several technical solutions (ex. automatic change system, adhesive sheet, down aiming). This headlamps are designed not to dazzle opposite drivers. So, you need not change your headlamps in a country with opposite traffic direction.

Headlight, position lamp, turn signal lamp, fog light and daytime running light bulb replacement

Type A



- (1) Headlamp (High/Low) *1
- (2) Position lamp
- (3) Turn signal lamp
- (4) Front fog lamp (if equipped)

*1 : Bi-Function Projection Headlight

Type B

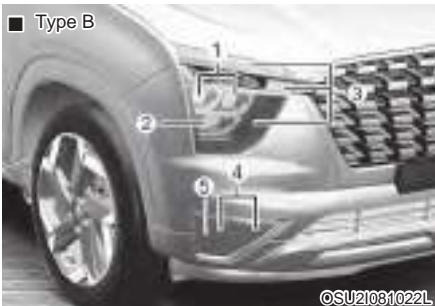

- (1) Headlamp (Low) *2
- (2) Headlamp (High) *2
- (3) Daytime running light (DRL)/
Position lamp
- (4) Turn signal lamp
- (5) Front fog lamp (if equipped)

*2 : MFR (Multi Focus Reflector)
Headlight



WARNING

Halogen bulbs

- Halogen bulbs contain pressurized gas that will produce flying pieces of glass if broken.
- Always handle them carefully, and avoid scratches and abrasions. If the bulbs are lit, avoid contact with liquids. Never touch the glass with bare hands. Residual oil may cause the bulb to overheat and burst when lit. A bulb should be operated only when installed in a headlight.
- If a bulb becomes damaged or cracked, replace it immediately and carefully dispose of it.
- Wear eye protection when changing a bulb. Allow the bulb to cool down before handling it.

Information

- If the headlight aiming adjustment is necessary after the headlight assembly is reinstalled, consult an authorized HYUNDAI dealer.
- The Fog Light aiming adjustment can be done by removing UNDER COVER. Consult an authorised HYUNDAI dealer.

Headlight (Low/High)

■ Headlamp (Low/High)



Headlamp (Low/High) - Type A

1. Open the hood.
2. Disconnect the negative battery cable.
3. Remove the headlamp bulb cover by turning it counterclockwise.
4. Disconnect the headlamp bulb socket-connector.
5. Remove the bulb from the headlamp assembly.
6. Install a new bulb.
7. Connect the bulb socket-connector.
8. Install the headlamp bulb cover by turning it clockwise.

i Information

- Bi-Function projection headlight

This headlight is bi-function type that switches the low beam to high or the high beam to low using solenoid system. So, the moving sound may be heard when the headlight switches the low beam to high or the high beam to low and it does not indicate malfunction of the headlight.

Headlamp (Low/High) –Type B

If the lamp (LED) does not operate, we recommend that the system be checked by an authorized HYUNDAI dealer.

The LED lamps cannot be replaced as a single unit because it is an integrated unit. The LED lamps has to be replaced with the unit.

A skilled technician should check or repair the LED lamp, for it may damage related parts of the vehicle.

i Information

The headlamp aiming should be adjusted after an accident or after the headlamp assembly is reinstalled at an authorized HYUNDAI dealer.

Daytime running light (DRL)/ Position lamp

If the lamp (LED) does not operate, we recommend that the system be checked by an authorized HYUNDAI dealer.

The LED lamps cannot be replaced as a single unit because it is an integrated unit. The LED lamps has to be replaced with the unit.

A skilled technician should check or repair the LED lamp, for it may damage related parts of the vehicle.



Turn signal lamp / Front fog lamp

1. Open the hood.
2. Disconnect the negative battery cable.
3. Loosen the pin-type retainers and screws of the front wheel guard and then detach it from the front bumper.
4. Reach your hand into the back of the front bumper.
5. Remove the socket from the assembly by turning the socket counterclockwise until the tabs on the socket align with the slots on the assembly.
6. Remove the bulb from the socket by pressing it in and rotating it counterclockwise until the tabs on the bulb align with the slots in the socket. Pull the bulb out of the socket.

7. Insert a new bulb by inserting it into the socket and rotating it until it locks into place.

Side repeater lamp bulb replacement (if equipped)



Type A

If the lamp (LED) does not operate, we recommend that the system be checked by an authorized HYUNDAI dealer.

The LED lamps cannot be replaced as a single unit because it is an integrated unit. The LED lamps has to be replaced with the unit.

A skilled technician should check or repair the LED lamp, for it may damage related parts of the vehicle.



Type B

1. Remove the lamp assembly from the vehicle by prying the lens and pulling the assembly out.
2. Disconnect the bulb electrical connector.
3. Separate the socket and the lens parts by turning the socket counterclockwise until the tabs on the socket align with the slots on the lens part.
4. Remove the bulb by pulling it straight out.
5. Insert a new bulb in the socket.
6. Reassemble the socket and the lens part.
7. Connect the bulb electrical connector.
8. Reinstall the lamp assembly to the body of the vehicle.

Rear combination light bulb replacement

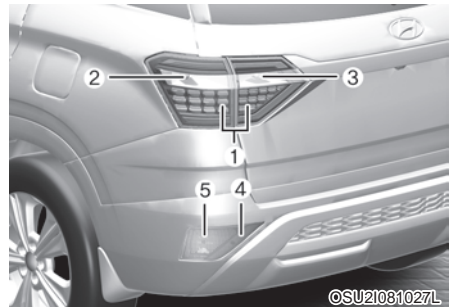

Type A

- (1) Tail lamp
- (2) Stop lamp
- (3) Turn signal lamp
- (4) Back up lamp
- (5) Reflex reflector

Stop lamp and turn signal lamp (Bulb Type)



1. Open the tailgate
2. Loosen the light assembly retaining screws with a cross-tip screwdriver.
3. Remove the rear combination light assembly from the body of the vehicle.

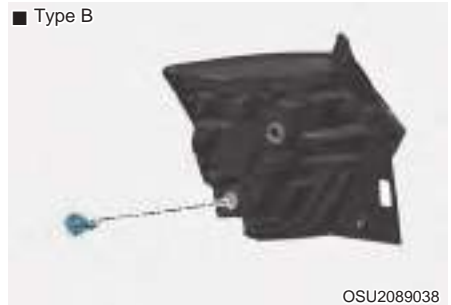
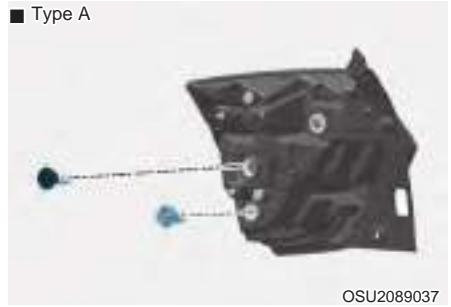

4. Remove the socket from the assembly by turning the socket counterclockwise until the tabs on the socket align with the slots on the assembly.
5. Remove the bulb from the socket by pressing it in and rotating it counterclockwise until the tabs on the bulb align with the slots in the socket. Pull the bulb out of the socket.
6. Insert a new bulb by inserting it into the socket and rotating it until it locks into place.
7. Install the socket in the assembly by aligning the tabs on the socket with the slots in the assembly. Push the socket into the assembly and turn the socket clockwise.
8. Reinstall the light assembly to the body of the vehicle.

Tail lamp / Stop lamp (LED Type)

If the lamp (LED) does not operate, we recommend that the system be checked by an authorized HYUNDAI dealer.

The LED lamps cannot be replaced as a single unit because it is an integrated unit. The LED lamps has to be replaced with the unit.

A skilled technician should check or repair the LED lamp, for it may damage related parts of the vehicle.

Back up lamp replacement



1. Loosen the pin-type retainers and screws of the rear wheel guard and then detach it from the rear bumper.
2. Reach your hand into the back of the rear bumper.
3. Remove the socket from the assembly by turning the socket counterclockwise until the tabs on the socket align with the slots on the assembly.
4. Remove the bulb from the socket by pressing it in and rotating it counterclockwise until the tabs on the bulb align with the slots in the socket. Pull the bulb out of the socket.
5. Insert a new bulb by inserting it into the socket and rotating it until it locks into place.
6. Install the socket in the assembly by aligning the tabs on the socket with the slots in the assembly. Push the socket into the assembly and turn the socket clockwise.

High mounted stop lamp replacement



If the light (LED) does not operate, we recommend that the system be checked by an authorized HYUNDAI dealer.

License plate lamp bulb replacement



1. Loosen the Lamp retaining screws with a Philips head screwdriver.
2. Pull the License Plate Lamp from the garnish
3. Remove the bulb holder from the lamp by rotating it Counter clockwise.
4. Remove the bulb by pulling it straight out.
5. Install a new bulb.
6. Reinstall the Bulb Holder in the Lamp
7. Reinstall the lamp securely in the Garnish with the retaining screws.

Interior light bulb replacement

Map lamp and personal lamp - LED



If the LED lamp (1) does not operate, we recommend that the system be checked by an authorized HYUNDAI dealer.

The LED lamps cannot be replaced as a single unit because it is an integrated unit. The LED lamps has to be replaced with the unit.

A skilled technician should check or repair the LED lamp, for it may damage related parts of the vehicle.

Map lamp, room lamp and luggage compartment lamp - Bulb

WARNING

Prior to working on the Interior Lights, ensure that the “OFF” button is depressed to avoid burning your fingers or receiving an electric shock.

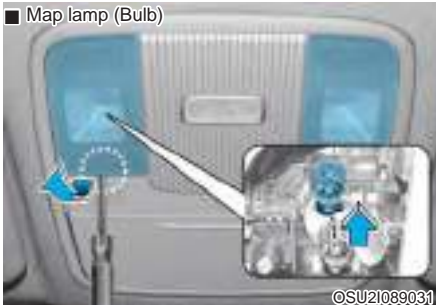

1. Open the Sunglass Holder & find 2 Screws on the Body surface.
2. Loose the lamp assembly retaining screws with a cross-tip screw-driver.
3. Remove the Over Head Console Lamp Assembly from the Headlining.
4. Remove the bulb from the bulb base by rotating it counterclockwise . Pull the bulb out of the socket.
5. Insert a new bulb by inserting it into the bulb base and rotating it until it locks into place
6. Remove the Blue Clips from the Roof Panel & Screw them to the Lamp Assembly using the Cross-tip screw Driver.
7. Assemble the Over Head Console Lamp assembly into the Headlining by pushing & making sure that the clips are locked in place.
8. Insert the outer cover into the housing.



1. Using a flat-head screwdriver, gently pry the lens from the interior light housing.
2. Remove the bulb by pulling it straight out.
3. Install a new bulb in the socket.
4. Align the lens tabs with the interior light housing notches and snap the lens into place.

If the lamps do not operating, have the vehicle checked by an authorized HYUNDAI dealer.

NOTICE

Use care not to dirty or damage lenses, lens tabs, and plastic housings.

APPEARANCE CARE

Exterior care

Exterior general caution

It is very important to follow the label directions when using any chemical cleaner or polish. Read all warning and caution statements that appear on the label.

High-pressure washing

- When using high-pressure washers, make sure to maintain sufficient distance from the vehicle. Insufficient clearance or excessive pressure can lead to component damage or water penetration.
- Do not spray the camera, sensors or its surrounding area directly with a high pressure washer. Shock applied from high pressure water may cause the device to not operate normally.
- Do not bring the nozzle tip close to boots (rubber or plastic covers) or connectors as they may be damaged if they come into contact with high pressure water.

Finish maintenance

Washing

To help protect your vehicle's finish from rust and deterioration, wash it thoroughly and frequently at least once a month with lukewarm or cold water.

If you use your vehicle for off-road driving, you should wash it after each off-road trip. Pay special attention to the removal of any accumulation of salt, dirt, mud, and other foreign materials. Make sure the drain holes in the lower edges of the doors and rocker panels are kept clear and clean.

Insects, tar, tree sap, bird droppings, industrial pollution and similar deposits can damage your vehicle's finish if not removed immediately.

Even prompt washing with plain water may not completely remove all these deposits. A mild soap, safe for use on painted surfaces, may be used.

After washing, rinse the vehicle thoroughly with lukewarm or cold water. Do not allow soap to dry on the finish.

NOTICE

- Do not use strong soap, chemical detergents or hot water, and do not wash the vehicle in direct sunlight or when the body of the vehicle is warm.
- Be careful when washing the side windows of your vehicle. Especially, with high-pressure water, water may leak through the windows and wet the interior.
- To prevent damage to the plastic parts and lamps, do not clean with chemical solvents or strong detergents.

**WARNING****Wet brakes**

After washing the vehicle, test the brakes while driving slowly to see if they have been affected by water. If braking performance is impaired, dry the brakes by applying them lightly while maintaining a slow forward speed.

**NOTICE**

- Water washing in the engine compartment including high pressure water washing may cause the failure of electrical circuits located in the engine compartment.
- Never allow water or other liquids to come in contact with electrical/electronic components inside the vehicle as this may damage them.

NOTICE

**Matte paint finish vehicle
(if equipped)**

Automatic car wash which uses rotating brushes should not be used as this can damage the surface of your vehicle. A steam cleaner which washes the vehicle surface at high temperature may result the oil to adhere and leave stains that is difficult to remove.

Use a soft cloth (e.g. microfiber towel or sponge) when washing your vehicle and dry with a microfiber towel. When you hand wash your vehicle, you should not use a cleaner that finishes with wax. If the vehicle surface is too dirty (sand, dirt, dust, contaminant, etc.), clean the surface with water before washing the car.

Waxing

Wax the vehicle when water will no longer bead on the paint.

Always wash and dry the vehicle before waxing. Use a good quality liquid or paste wax, and follow the manufacturer's instructions. Wax all metal trim to protect it and to maintain its luster.

Removing oil, tar, and similar materials with a spot remover will usually strip the wax from the finish. Be sure to re-wax these areas even if the rest of the vehicle does not yet need waxing.

NOTICE

- Wiping dust or dirt off the body with a dry cloth will scratch the finish.
- Do not use steel wool, abrasive cleaners, or strong detergents containing highly alkaline or caustic agents on chrome-plated or anodized aluminum parts. This may result in damage to the protective coating and cause discoloration or paint deterioration.

NOTICE

**Matte paint finish vehicle
(if equipped)**

Do not use any polish protector such as a detergent, an abrasive and a polish. In case wax is applied, remove the wax immediately using a silicon remover and if any tar or tar contaminant is on the surface use a tar remover to clean. However, be careful not to apply too much pressure on the painted area.

Finish damage repair

Deep scratches or stone chips in the painted surface must be repaired promptly. Exposed metal will quickly rust and may develop into a major repair expense.

***i* Information**

If your vehicle is damaged and requires any metal repair or replacement, be sure the body shop applies anti-corrosion materials to the parts repaired or replaced.

NOTICE

Matte paint finish vehicle (if equipped)

In case of matte paint finish vehicles, it is impossible to modify only the damaged area and repair of the whole part is necessary. If the vehicle is damaged and painting is required, we recommend that you have your vehicle maintained and repaired by an authorized HYUNDAI dealer. Take extreme care, as it is difficult to restore the quality after the repair.

Bright-metal maintenance

- To remove road tar and insects, use a tar remover, not a scraper or other sharp object.
- To protect the surfaces of bright-metal parts from corrosion, apply a coating of wax or chrome preservative and rub to a high luster.
- During winter weather or in coastal areas, cover the bright metal parts with a heavier coating of wax or preservative. If necessary, coat the parts with non-corrosive gasoline-jelly or other protective compound.

Underbody maintenance

Corrosive materials used for ice and snow removal and dust control may collect on the underbody. If these materials are not removed, accelerated rusting can occur on the underbody parts such as the fuel lines, frame, floor pan and exhaust system, even though they have been treated with rust protection.

Thoroughly flush the vehicle underbody and wheel openings with lukewarm or cold water once a month, after off-road driving and at the end of each winter. Pay special attention to these areas because it is difficult to see all the mud and dirt. It will do more harm than good to wet down the road grime without removing it. The lower edges of the doors, rocker panels, and frame members have drain holes that should not clog with dirt; trapped water in these areas can cause rusting.



WARNING

After washing the vehicle, test the brakes while driving slowly to see if they have been affected by water. If braking performance is impaired, dry the brakes by applying them lightly while maintaining a slow forward speed.

Aluminum wheel maintenance

The aluminum wheels are coated with a clear protective finish.

- Do not use any abrasive cleaner, polishing compound, solvent, or wire brushes on aluminum wheels. They may scratch or damage the finish.
- Clean the wheel when it has cooled.
- Use only a mild soap or neutral detergent, and rinse thoroughly with water. Also, be sure to clean the wheels after driving on salted roads. This helps prevent corrosion.
- Avoid washing the wheels with high-speed car wash brushes.
- Do not use any alkaline or acid detergent. It may damage and corrode the aluminum wheels coated with a clear protective finish.

Corrosion protection

Protecting your vehicle from corrosion

By using the most advanced design and construction practices to combat corrosion, we produce vehicles of the highest quality. However, this is only part of the job. To achieve the long-term corrosion resistance your vehicle can deliver, the owner's cooperation and assistance is also required.

Common causes of corrosion

The most common causes of corrosion on your vehicle are:

- Road salt, dirt and moisture that is allowed to accumulate underneath the vehicle.
- Removal of paint or protective coatings by stones, gravel, abrasion or minor scrapes and dents which leave unprotected metal exposed to corrosion.

High-corrosion areas

If you live in an area where your vehicle is regularly exposed to corrosive materials, corrosion protection is particularly important. Some of the common causes of accelerated corrosion are road salts, dust control chemicals, ocean air and industrial pollution.

Moisture breeds corrosion

Moisture creates the conditions in which corrosion is most likely to occur. For example, corrosion is accelerated by high humidity, particularly when temperatures are just above freezing. In such conditions, the corrosive material is kept in contact with the vehicle's surface by moisture that slowly evaporates.

Mud is particularly corrosive because it dries slowly and holds moisture in contact with the vehicle. Although the mud appears to be dry, it can still retain moisture and promote corrosion.

High temperatures can also accelerate corrosion of parts that are not properly ventilated so the moisture can be dispersed. For all these reasons, it is particularly important to keep your vehicle clean and free of mud or accumulations of other materials. This applies not only to the visible surfaces but particularly to the underside of the vehicle.

To help prevent corrosion

You can help prevent corrosion from getting started by observing the following:

Keep your vehicle clean

The best way to prevent corrosion is to keep your vehicle clean and free of corrosive materials. Attention to the underside of the vehicle is particularly important.

- If you live in a high-corrosion area — where road salts are used, near the ocean, areas with industrial pollution, acid rain, etc.—, you should take extra care to prevent corrosion. In winter, hose off the underside of your vehicle at least once a month and be sure to clean the underside thoroughly when winter is over.
- When cleaning underneath the vehicle, give particular attention to the components under the fenders and other areas that are hidden from view. Do a thorough job; just dampening the accumulated mud rather than washing it away will accelerate corrosion rather than prevent it. Water under high pressure and steam are particularly effective in removing accumulated mud and corrosive materials.
- When cleaning lower door panels, rocker panels and frame members, be sure that drain holes are kept open so that moisture can escape and not be trapped inside to accelerate corrosion.

Keep your garage dry

Don't park your vehicle in a damp, poorly ventilated garage. This creates a favorable environment for corrosion. This is particularly true if you wash your vehicle in the garage or drive it into the garage when it is still wet or covered with snow, ice or mud. Even a heated garage can contribute to corrosion unless it is well ventilated so moisture is dispersed.

Keep paint and trim in good condition

Scratches or chips in the finish should be covered with "touch-up" paint as soon as possible to reduce the possibility of corrosion. If bare metal is showing through, the attention of a qualified body and paint shop is recommended.

Bird droppings : Bird droppings are highly corrosive and may damage painted surfaces in just a few hours. Always remove bird droppings as soon as possible.

Don't neglect the interior

Moisture can collect under the floor mats and carpeting and cause corrosion. Check under the mats periodically to be sure the carpeting is dry. Use particular care if you carry fertilizers, cleaning materials or chemicals in the vehicle.

These should be carried only in proper containers and any spills or leaks should be cleaned up, flushed with clean water and thoroughly dried.

Interior care

Interior general precautions

Prevent chemicals such as perfume, cosmetic oil, sun cream, hand cleaner, and air freshener from contacting the interior parts because they may cause damage or discoloration. If they do contact the interior parts, wipe them off immediately. See the instructions that follow for the proper way to clean vinyl.

NOTICE

Never allow water or other liquids to come in contact with electrical/electronic components inside the vehicle as this may damage them.

NOTICE

When cleaning leather products (steering wheel, seats etc.), use neutral detergents or low alcohol content solutions. If you use high alcohol content solutions or acid/alkaline detergents, the color of the leather may fade or the surface may get stripped off.

Cleaning the upholstery and interior trim

Vinyl (if equipped)

Remove dust and loose dirt from vinyl with a whisk broom or vacuum cleaner. Clean vinyl surfaces with a vinyl cleaner.

Fabric (if equipped)

Remove dust and loose dirt from fabric with a whisk broom or vacuum cleaner. Clean with a mild soap solution recommended for upholstery or carpets. Remove fresh spots immediately with a fabric spot cleaner. If fresh spots do not receive immediate attention, the fabric can be stained and its color can be affected. Also, its fire-resistant properties can be reduced if the material is not properly maintained.

NOTICE

Using anything but recommended cleaners and procedures may affect the fabric's appearance and fire-resistant properties.

Leather (if equipped)

- Feature of Seat Leather
 - Leather is made from the outer skin of an animal, which goes through a special process to be available for use. Since it is a natural object, each part differs in thickness or density.
 - Wrinkles may appear as a natural result of stretching and shrinking depending on the temperature and humidity.
 - The seat is made of stretchable fabric to improve comfort.
 - The parts contacting the body are curved and the side supporting area is high which provides driving comfort and stability.
 - Wrinkles may appear naturally from usage. It is not a fault of the products.



CAUTION

- Wrinkles or abrasions which appear naturally from usage are not covered by warranty.
- Belts with metallic accessories, zippers or keys inside the back pocket may damage the seat fabric.
- Make sure not to wet the seat. It may change the nature of natural leather.
- Jeans or clothes which could bleach may contaminate the surface of the seat covering fabric.

- Caring for the leather seats
 - Vacuum the seat periodically to remove dust and sand on the seat. It will prevent abrasion or damage of the leather and maintain its quality.
 - Wipe the natural leather seat cover often with dry or soft cloth.
 - Use of proper leather protective may prevent abrasion of the cover and helps maintain the color. Be sure to read the instructions and consult a specialist when using leather coating or protective agent.
 - Light colored (beige, cream beige) leather is easily contaminated and the stain is noticeable. Clean the seats frequently.
 - Avoid wiping with wet cloth. It may cause the surface to crack.
- Cleaning the leather seats
 - Remove all contaminations instantly. Refer to instructions below for removal of each contaminant.
 - Cosmetic products (sunscreen, foundation, etc.)
Apply cleansing cream on a cloth and wipe the contaminate spot. Wipe off the cream with a wet cloth and remove water with a dry cloth.
 - Beverages (coffee, soft drink, etc.)
Apply a small amount of neutral detergent and wipe until contaminations do not smear.
 - Oil
Remove oil instantly with absorbable cloth and wipe with stain remover used only for natural leather.
 - Chewing gum
Harden the gum with ice and remove gradually.

Cleaning the lap/shoulder belt webbing

Clean the belt webbing with any mild soap solution recommended for cleaning upholstery or carpet. Follow the instructions provided with the soap. Do not bleach or re-dye the webbing because this may weaken it.

Cleaning the interior window glass

If the interior glass surfaces of the vehicle become fogged (that is, covered with an oily, greasy or waxy film), they should be cleaned with glass cleaner. Follow the directions on the glass cleaner container.

NOTICE

Do not scrape or scratch the inside of the rear window. This may result in damage to the rear window defroster grid.

EMISSION CONTROL SYSTEM

The emission control system of your vehicle is covered by a written limited warranty. Please see the warranty information contained in the Service Passport in your vehicle.

Your vehicle is equipped with an emission control system to meet all emission regulations.

There are three emission control systems which are as follows.

- (1) Crankcase emission control system
- (2) Evaporative emission control system
- (3) Exhaust emission control system

In order to assure the proper function of the emission control systems, it is recommended that you have your car inspected and maintained by an authorized HYUNDAI dealer in accordance with the maintenance schedule in this manual.

Caution for the Inspection and Maintenance Test (With Electronic Stability Control (ESC) system)

- **To prevent the vehicle from misfiring during dynamometer testing, turn the Electronic Stability Control (ESC) system off by pressing the ESC switch.**
- **After dynamometer testing is completed, turn the ESC system back on by pressing the ESC switch again.**

1. Crankcase emission control system

The positive crankcase ventilation system is employed to prevent air pollution caused by blow-by gases being emitted from the crankcase. This system supplies fresh filtered air to the crankcase through the air intake hose. Inside the crankcase, the fresh air mixes with blow-by gases, which then pass through the PCV valve into the induction system.

2. Evaporative emission control system

The Evaporative Emission Control System is designed to prevent fuel vapors from escaping into the atmosphere.

Canister

Fuel vapors generated inside the fuel tank are absorbed and stored in the onboard canister. When the engine is running, the fuel vapors absorbed in the canister are drawn into the surge tank through the purge control solenoid valve.

Purge Control Solenoid Valve (PCSV)

The purge control solenoid valve is controlled by the Engine Control Module (ECM); when the engine coolant temperature is low during idling, the PCSV closes so that evaporated fuel is not taken into the engine. After the engine warms up during ordinary driving, the PCSV opens to introduce evaporated fuel to the engine.

3. Exhaust emission control system

The Exhaust Emission Control System is a highly effective system which controls exhaust emissions while maintaining good vehicle performance.

When the engine starts or fails to start, excessive attempts to restart the engine may cause damage to the emission system.

Vehicle modifications

- This vehicle should not be modified. Modification of your vehicle could affect its performance, safety or durability and may even violate governmental safety and emissions regulations.

In addition, damage or performance problems resulting from any modification may not be covered under warranty.

- If you use unauthorized electronic devices, it may cause the vehicle to operate abnormally, wire damage, battery discharge and fire. For your safety, do not use unauthorized electronic devices.

Engine exhaust gas precautions (carbon monoxide)

- Carbon monoxide can be present with other exhaust fumes. Therefore, if you smell exhaust fumes of any kind inside your vehicle, have it inspected and repaired immediately. If you ever suspect exhaust fumes are coming into your vehicle, drive it only with all the windows fully open. Have your vehicle checked and repaired immediately.



WARNING

Exhaust

Engine exhaust gases contain carbon monoxide (CO). Though colorless and odorless, it is dangerous and could be lethal if inhaled. Follow the instructions on this page to avoid CO poisoning.

- Do not operate the engine in confined or closed areas (such as garages) any more than what is necessary to move the vehicle in or out of the area.
- When the vehicle is stopped in an open area for more than a short time with the engine running, adjust the ventilation system (as needed) to draw outside air into the vehicle.
- Never sit in a parked or stopped vehicle for any extended time with the engine running.
- When the engine stalls or fails to start, excessive attempts to restart the engine may cause damage to the emission control system.

Operating precautions for catalytic converters (if equipped)



WARNING

The exhaust system and catalytic converter are very hot during and immediately after the engine has been running. To avoid **SERIOUS INJURY** or **DEATH**:

- Do not park, idle, or drive the vehicle over or near flammable objects, such as grass, vegetation, paper, leaves, etc. A hot exhaust system can ignite flammable items under your vehicle.
- Keep away from the exhaust system and catalytic converter or you may get burned.

Also, do not remove the heat sink around the exhaust system, do not seal the bottom of the vehicle, and do not coat the vehicle for corrosion control. It may present a fire risk under certain conditions.

Your vehicle is equipped with a catalytic converter emission control device. To prevent damage to the catalytic converter and to your vehicle, take the following precautions:

- Use only UNLEADED FUEL for Petrol engine.
- Do not operate the vehicle when there are signs of engine malfunction, such as misfire or a noticeable loss of performance.
- Do not misuse or abuse the engine. Examples of misuse are coasting with the ignition off and descending steep grades in gear with the ignition off.
- Do not operate the engine at high idle speed for extended periods (5 minutes or more).
- Do not modify or tamper with any part of the engine or emission control system. All inspections and adjustments must be made by an authorized HYUNDAI dealer.
- Avoid driving with an extremely low fuel level. Running out of fuel could cause the engine to misfire, damaging the catalytic converter.

Failure to observe these precautions could result in damage to the catalytic converter and to your vehicle. Additionally, such actions could void your warranties.

Diesel particulate filter (DPF) (if equipped)

The Diesel Particulate Filter (DPF) system removes the soot in the exhaust gas. Unlike a disposable air filter, the DPF system automatically burns (oxidizes) and removes the accumulated soot according to the driving condition. In other words, the active burning by engine control system and high exhaust gas temperature caused by normal/high driving condition burns and removes the accumulated soot.

However, if the vehicle continues to be driven at repeated short distance or driven at low speed for a long time, the accumulated soot may not be automatically removed because of low exhaust gas temperature. More than a certain amount of soot deposited, the malfunction indicator light (MIL) illuminates.

When the malfunction indicator light illuminates, it may turn-off after driving the vehicle at more than 60km/h (37 mph) or at more than second gear with 1500~2500 engine rpm for a certain time (for about 25 minutes).

If the malfunction indicator light (MIL) is not turn-off or blinking continuously in spite of the procedure, visit a professional workshop and check the DPF system. HYUNDAI recommends to visit an authorized HYUNDAI dealer/service partner.

If you continue to drive with the malfunction indicator light blinking for a long time, the DPF system can be damaged and fuel consumption can be worsen and the engine durability can be worsen by oil dilution.



CAUTION

Diesel Fuel (if equipped with DPF)
We recommend you to use only the regulated diesel fuels, when your vehicle is equipped with the DPF system.

When you use other diesel fuels, which is high in sulfurs (above 50 ppm) or contains unspecified additives, it may damage the DPF system and cause the white smoke emission.

Lean NOx Trap (if equipped)

The Lean NOx Trap (LNT) system removes the nitrogen oxide in the exhaust gas. The smell can occur in the exhaust gas depending on the quality of the fuel and it can degrade NOx reduction performance, please use the regulated automotive diesel fuel.

- The LNT warning light blinks if the LNT performance is degraded. (MIL)

In this case, the warning light illuminates and the warning alarm sounds while showing a warning message "Self Regeneration" on the LCD display.

For more details, refer to "Self Regeneration Mode" in chapter 8.

Self Regeneration Mode

LCD Type

If the warning message “Self Regeneration” is stored in inspection message tap, it is operable in LCD warning message page.



WARNING

- **Make sure the vehicle parked on safety zone (to avoid the flammables like grass and traffic accident)**
- **Check remained fuel above 1/5 of full level fuel gauge to prevent fuel overheat**
- **Open the hood to prevent engine room overheat**
- **Self regeneration should be done only when DPF indicator illuminates**

■ Type A



OSU21089044

■ Type B

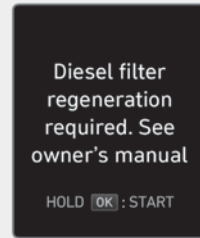

OSU21089042

- **If the warning message “Diesel filter regeneration required, See owner’s manual.” appears on the LCD display, Self Regeneration is required.**

To initiate Self Regeneration

1. Engage parking brake and shift lever at P state.
2. Turn on the engine
3. Warm up the engine and check engine temperature gauge at the middle position
4. Turn on the air conditioner and set the blower to the maximum.
5. Turn on the high beam.
6. Operate the rear defog function.
7. Hold the OK button on the LCD warning message page.

■ Type A

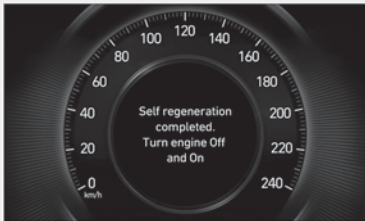

OSU2I089045

■ Type B

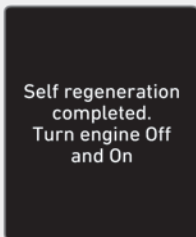

OSU2I089039

8. Turn off and turn on the engine again.

■ Type A



OSU2I089046

■ Type B

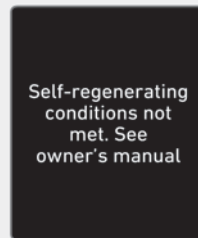

OSU2I089037

Not Operating Condition

Under below condition, Diesel Catalyst regeneration process may be interrupted. (Engine RPM drops to idle state)

- Engine overheat or insufficient warm-up
- Shift lever change to D or R state
- Acceleration pedal is pressed
- Movement of Vehicle (Vehicle speed over 0)

Service Check

If the DPF indicator change from illuminates to blink or Engine Check Lamp(MIL) illuminates with DPF indicator in spite of the procedure, please visit an authorized Hyundai dealer and then check the Diesel Catalyst and engine system including oil level inspection.

Please note that the vehicle acceleration is limited to protect engine system when DPF indicator blinks or Engine Check Lamp(MIL) illuminates.

■ Type A



OSU2I089047

■ Type B

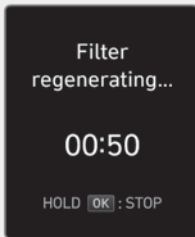

OSU2I089040

Operating Self Regeneration Mode

If the self regeneration mode starts, the message "Filter regeneration..." and the remaining time appears.

It takes around 30~60 minutes.

■ Type A



OSU2I089048

■ Type B

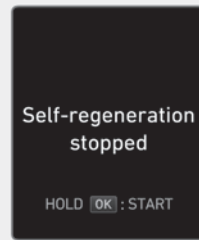

OSU2I089041

Self Regeneration Mode Fail

The regeneration operation could be canceled if the driver press the OK button firmly while operating the self regeneration process.

■ Type A



OSU2I089044

■ Type B

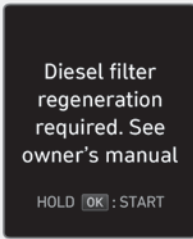

OSU2I089042

■ Type A



OSU2I089048

■ Type B

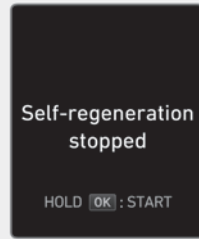

OSU2I089041

If the system still needs the self regeneration process after cancelling the operation, the warning message appears. (Diesel filter regeneration required.)

If the driver press the OK button firmly, it can restart the self regeneration mode again. (The Self regeneration conditions should be satisfied.)

The self regeneration process stops if any of the self regeneration conditions is cancelled. If the self regeneration process is cancelled automatically, the system maintains "Self-regeneration stopped" message.

If the driver press the OK button firmly, it can restart the self regeneration mode again. (Self regeneration conditions should be satisfied.)

Segment Type

Regeneration

The self regeneration procedure is conducted as follows.

- 1) Repeat key position at LOCK (or ACC) ↔ ON state 5 times (within 30 seconds)
- 2) Start engine
- 3) Monitor engine state
 - : Within 20 seconds, engine RPM rise to about 2000 and it continues for 30~60 minutes. After the end of regeneration, engine RPM drop to idle automatically.
- 4) Stop the engine (Key Off), wait for 20 seconds and restart the engine
- 5) Check malfunction indicator turn out

CAUTION

Under below condition, Diesel Catalyst regeneration process may be interrupted. (Engine RPM drops to idle state)

- Engine overheat or insufficient warm-up
- Shift lever change to D or R state
- Acceleration pedal is pressed
- Movement of Vehicle (Vehicle speed over 0)

WARNING

If vehicle doesn't enter regeneration mode or if regeneration mode is interrupted, stop the engine (Key Off), wait for 20 seconds and retry the self regeneration procedure.

WARNING

Self regeneration should be done only when DPF indicator illuminates. Frequent regeneration may cause engine oil dilution and shortening of Diesel Catalyst durability.

Service Check

If the DPF indicator change from illuminates to blink or Engine Check Lamp(MIL) illuminates with DPF indicator in spite of the procedure, please visit an authorized Hyundai dealer and then check the Diesel Catalyst and engine system including oil level inspection.

Please note that the vehicle acceleration is limited to protect engine system when DPF indicator blinks or Engine Check Lamp(MIL) illuminates.