

ELISE

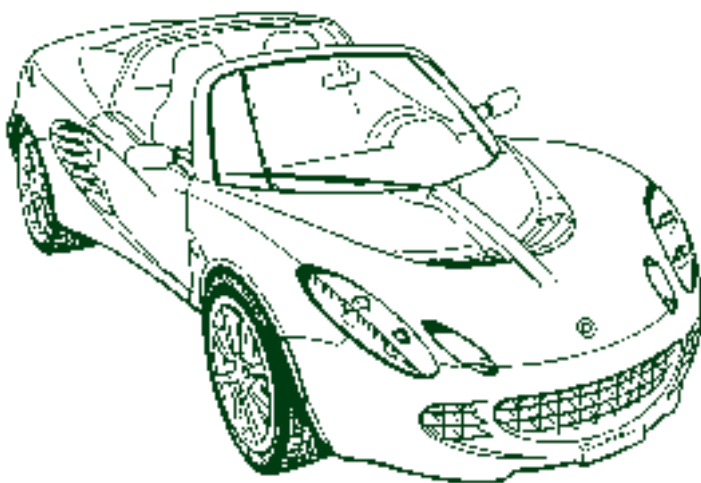

intro18f

Publication Part No.A121T0324
© Lotus Cars Limited 2004



ELISE

For North America



intro18e

OWNER'S HANDBOOK **2005 model year onwards**

Lotus Cars USA Inc.
2236 Northmont Parkway, Duluth, Georgia 30096.
Tel: 770 476 6540 Fax: 770 476 6541
www.LotusCars.com

CONTENTS

1. INTRODUCTION	6
2. SAFETY INFORMATION	7
3. REPORTING SAFETY DEFECTS	10
4. CAR IDENTIFICATION	15
5. SEATING & SAFETY RESTRAINTS	
Seats	17
Seat Belts	18
Seat Belt Precautions	19
Airbag Safety System	21
Airbag Tell Tale	23
Airbag Deployment	24
Child Restraints	26
6. KEYS & CAR SECURITY ALARM	
Keys	29
Car Security Alarm	30
Transmitter Fobs	30
Engine Immobiliser	31
Valet Mode	31
Arming the Alarm	32
Disarming the Alarm	33
Emergency Disarming/Mobilising	33
Intrusion Sensing	34
Manual Activation of Siren	34
Transmitter Fob Battery Replacement	35
Programming Additional Transmitter Fobs	36
Disconnecting Car Battery	36
7. ENTRY & COMFORT	
Central Door Locking	37
To Unlock From Outside	37
To Lock From Inside	37
To Unlock From Inside	38
To Lock From Outside	38
Lights On Buzzer	40
Interior Rear View Mirror	40
Door Mirrors	40
Interior Lamp	41
Sun Visors	41
Door Windows	42
Manual Windows	42
Electric Windows	42

8. INSTRUMENTS & SWITCHES

Ignition Switch/Steering Lock..... 44
 Engine Start Button..... 45
 Warning 'Tell Tale' Lamps 46
 Bulb Check..... 46
 Turn Tell Tale 46
 Seat Belt Tell Tale..... 47
 Brake Tell Tale..... 47
 Oil Pressure Tell Tale 47
 Low Fuel Level Tell Tale 48
 ABS Tell Tale 48
 High Beam Tell Tale 48
 Airbag Tell Tale..... 48
 Battery Charging Tell Tale 48
 Engine Malfunction Indicator Lamp..... 49
 Security/RPM Tell Tale 49
 Instruments 51
 Speedometer..... 51
 Tachometer 51
 LCD Display Panel 52
 Fuel Level Display 52
 Coolant Temperature Display 53
 Odometer 53
 Trip Recorder..... 53
 Dashboard Switches..... 54
 Parking Lamp Switch 54
 Headlamp Switch 54
 Lights-on Buzzer 55
 Hazard Warning Lamps Switch 55
 Instrument Illumination 56
 Auxiliary Power Socket 57
 Column Switches & Horn..... 58
 Headlamp High/Low Beam/Flasher/Turn Indicators 58
 Windscreen Wiper/Washer 59
 Horn 60
 Audio Equipment 60

9. HEATING, VENTILATION & AIR CONDITIONING

Air Conditioning 61
 Air Re-circulation 62
 Heater Temperature 62
 Fan Speed 62
 Air Distribution 63
 Engine Bay Ventilation..... 65

10. DRIVING CONTROLS	
Foot Pedals	66
Footwell Carpets.....	66
Clutch Pedal	66
Footbrake	67
Anti-Lock Brake System	67
Parking Brake	70
Gear Lever	71
11. STARTING PROCEDURE & ENGINE BREAK-IN	
Starting a Cold or Warm Engine	72
Idle Speed	73
Engine Break-In	73
Engine Special Features.....	74
12. EXTERNAL OPERATIONS	
Fuel Requirement	75
Fuel Filling	76
Front Service Access Panels	78
Engine Cover/Trunk Lid	79
Child Entrapment	80
Removable Roof Concept.....	81
Soft Top Roof Fitting.....	82
Soft Top Roof Removal	84
Hard Top Roof Fitting	85
Hard Top Roof Removal	90
13. SERVICING & MAINTENANCE	
Bodycare	93
Body Features.....	93
Paint Care	94
Ventilation	94
Paintwork Polishing.....	95
Washing	95
Soft Top Roof	96
Windscreen Cleaning	96
Alloy Road Wheels.....	96
Upholstery Cleaning.....	97
Seat Belts Cleaning.....	97
Footwell Cleaning.....	97
Owner Maintenance.....	98
Engine Oil Level Check.....	99
Engine Oil Change	100
Oil Filter	102
Used Engine Oil	103

Transmission Oil	103
Cooling System	106
Anti-Freeze/Corrosion Inhibitor	107
Coolant Drain/Refill Procedure	108
Washer Reservoir	109
Wiper Blade	109
Brake Fluid Reservoir	110
Brake Pads	111
Brake Pipes and Hoses	112
Air Cleaner Element	113
Auxiliary Drive Belt	114
Sparking Plugs	114
14. TIRES & WHEELS	
Tires	115
Glossary of Terms	115
Tire Safety	115
Tire Care	117
Replacement Tires	118
Tire Characteristics	119
Winter Tires	119
Tire Chains	120
Uniform Tire Quality Grading	120
Tire Placard/Label	121
Steps for Determining Correct Load Limit	122
Tire Markings	123
Tire Inflator Aerosol	124
Wheels	126
Wheel Bolts	126
Wheel Alignment & Tire Balance	126
Wheel Replacement	127
15. ELECTRICAL	
Battery	129
Battery Access	129
Disconnecting the Battery	129
Reconnecting the Battery	131
Battery Charging	131
'Jump' Starting	133
Electrical Accessories	134
Inertia Switch	135
Fuses	135

Engine Compartment Fuses	137
Footwell Sited Fuses	138
Headlamp Alignment.....	139
Bulb Replacement	142
Headlamp Bulb.....	142
Front Turn Indicator Lamp Bulb.....	143
Side Repeater Lamp Bulb	144
Rear Lamp Cluster Bulb.....	144
High Mounted Stoplamp Bulb	144
Licence Plate Lamp Bulb	144
Interior Lamp Bulb.....	145
Side Marker Lamp Bulb.....	145
16. LIFTING & TOWING	
Towing Eye	146
Towing a Trailer.....	147
Car Tie-Down	147
Lifting Your Car	148
Fuel Tank Undershield	149
17. ACCESSORIES	
Accessories & Modifications	150
Storing Your Elise	152
18. RECOMMENDED LUBRICANTS	
Engine	153
Transmission	154
Brakes & Clutch	154
Engine Coolant Additive.....	154
19. TECHNICAL DATA	155
20. WARRANTY INDEX	161
21. ALPHABETICAL INDEX	188

INTRODUCTION

Congratulations on your purchase of a Lotus Elise. Welcome to the Lotus family. The Elise has been designed for the discerning driver, and aims to provide fun motoring from a lightweight, distinctively styled and efficient package.

This handbook has been written for the owner/driver and should be read before using the car, and then stored in the car for ready reference, remaining with the car throughout any subsequent changes of ownership. **The content includes important safety information to protect you from injury**, explanations and instructions for operating the driving controls, owner maintenance requirements, technical specifications, and an explanation of the warranty. It is not intended to provide all the technical information required for servicing, and should any adjustment become necessary, owners are urged to contact their Lotus dealer. It is a requirement of the warranty, and the responsibility of the owner/driver, to ensure that servicing of the car is carried out at the correct intervals.

An alphabetical index is provided at the back of this book to help you find information about any particular feature or topic.

The information and specifications included in this publication were correct at the time of approval for printing. Lotus has a policy of continuous product improvement, and reserves the right to discontinue or change specification, design or equipment at any time without notice and without incurring any obligation whatsoever. You are urged to keep in regular contact with your Lotus dealer to ensure that you may be kept informed of any technical developments which may improve the specification, performance or safety of your car.

This handbook covers all Elise models for the North American market, and may include descriptions of equipment and features which are not fitted on your particular car.

Your Lotus is intended to be used safely, in a manner appropriate to the driving conditions and whilst obeying local laws. Any alteration or misuse of the car, or ignoring the instructions in this handbook could result in an accident causing severe or fatal injury.

Safety Information

To help you make informed decisions about safety, important safety information is provided in forms including:

- Safety labels on the car
- Safety messages in this handbook are shown as follows:

⚠ WARNING:

The hazard and instructions to avoid the hazard are given. If you do not take these instructions you and/or others can be KILLED OR SERIOUSLY INJURED.

Messages prefaced by **NOTICE** are intended to help you avoid damage to your car, other property or the environment.

Important Safety Precautions

You'll find many safety recommendations throughout this section, and throughout this manual. The recommendations on this page are the ones we consider to be the most important.

Always Wear Your Seat Belt

A seat belt is your best protection in accidents (including collisions). Airbags supplement seat belts, but airbags are designed to inflate only in a moderate to severe frontal collision. So even though your car is equipped with airbags, make sure you and your passenger always wear your seat belts, and wear them properly. (See page 18).

Your Car is Not Recommended for Child Passengers

Since all children are safest in the back seat of a car, and your car does not have a back seat, we strongly recommend that you do not carry a child passenger. Children should be carried in the Elise only if they are large enough to be able to use the standard seat belt (see page 26). You should never carry an infant in a rear-facing child seat in this car because the Elise has a passenger airbag which cannot be switched off or disabled (see page 26).

Be Aware of Airbag Hazards

While airbags can save lives, they can cause serious or fatal injuries to occupants who sit too close to them, or are not

properly restrained. Children, and short adults are at the greatest risk. Be sure to follow all instructions and warnings in the handbook (See page 21 to 27).

Don't Drink and Drive

Alcohol and driving don't mix. Even one drink can reduce your ability to respond to changing conditions, and your reaction time gets worse with every additional drink. So don't drink and drive, and don't let your friends drink and drive, either.

Control Your Speed

Excessive speed is a major factor in crash injuries and deaths. Generally, the higher the speed the greater the risk, but serious accidents can also occur at lower speeds. Never drive faster than is safe for current conditions, regardless of the maximum speed posted.

Keep Your Car in Safe Condition

Having a tire blowout or a mechanical failure can be extremely hazardous. To reduce the possibility of such problems, check your tire pressures and condition frequently, and perform all regularly scheduled maintenance (see separate Maintenance Record booklet).

Safety Features

Your car is equipped with many features that work together to protect you and your passenger during a crash. The Lotus Elise has been designed to comply with applicable safety regulations.

The Elise has passive safety features which include:

- A cockpit tub surrounded by substantial chassis side frames.
- Energy absorbing front composite 'crash structure'.
- Energy absorbing rear steel 'crash structure'.
- Side sill foam pads.
- A seat belt mounting frame incorporating a roof hoop
- Extruded aluminium door beams.
- A collapsible steering column.
- Airbags for both driver and passenger.

Active safety features include:

- Lap and diagonal inertia reel seat belts with impact sensing pre-tensioners.

- Powerful anti-lock four wheel disc brakes.
- High geared responsive steering requiring only small steering wheel movements to alter course
- Exceptional road holding with optimised handling characteristics

You and your passenger cannot take full advantage of these safety features unless you remain sitting in a proper position and always wear your seat belt properly. In fact, some safety features can contribute to injuries if they are not used properly. Drivers should be aware of their own limitations as well as those of the car, and ensure that all road driving is conducted well within both sets of capabilities, particularly on wet roads, or under adverse weather conditions.

Remember:

Driving a car requires:

- Care;
- Attention; and
- Sensible judgement.

Be aware that any motor car has the potential to cause death or injury both to its occupants and/or other persons, and must be used only in a responsible and cautious manner. **This entire handbook is filled with important safety information. Please read it carefully.**

Remember:

- ALWAYS WEAR YOUR SEAT BELT.
- Never drive while under the influence of alcohol or drugs.
- Never drive when excessively tired.
- Never use mobile phones, map read or attempt other distracting activities whilst driving.
- Always obey all speed and traffic laws and regulations and never drive faster than the posted speed limit or than conditions allow.
- Be particularly careful driving on slippery or wet surfaces.
- Familiarise yourself with the car and always drive prudently, being aware of your own limitations and the limitations of the car. Failure to operate the car properly can result in an accident and serious injury.

- Follow the Maintenance Schedule and keep the car in good condition.
- Never leave young children unattended in the car.
- Read and take account of all **⚠️ WARNINGS** in this handbook.

Owners should note that the only approved extras and modifications are those which are specified by Lotus and carried out by Lotus or by an authorised dealer. Lotus does not accept any liability whatsoever for defects which arise from extras or modifications which are not Lotus approved.

⚠️ WARNING:

Inexpert or unapproved modifications or additions to the car could adversely affect the handling of the car and the operation of its safety equipment. Ensure only modifications specified by Lotus are undertaken by authorised dealers. Failure to comply with this may result in a crash in which you and others may be killed or seriously injured.

REPORTING SAFETY DEFECTS

If you believe that your car has a fault which could cause a crash, injury or death, you should immediately inform the National Highway Traffic Safety Administration (NHTSA) in addition to notifying Lotus Cars USA, Inc. 2236 Northmont Parkway, Duluth, Georgia 30096. Tel: 770 476 6540.

If NHTSA receives similar complaints, it may open an investigation, and if it finds that a safety problem exists in a group of cars, it may order a recall and remedy campaign. However, NHTSA cannot become involved in individual problems between you and your dealer, or Lotus Cars USA, Inc.

To contact NHTSA, you may either call the Auto Safety Hotline toll-free at 1 (888)-327-4236 (or 366-0123 in Washington, D.C. area) or write to: NHTSA, U.S. Department of Transportation, Washington, D.C. 20590. You can also obtain other information about motor car safety from the Hotline.

Pre-delivery Inspection

Lotus strives at all times to provide the highest level of customer satisfaction, and to this end, quality assessments are made at several stages of the delivery process from factory to customer. If necessary, repairs and replacements will be made

to mechanical components or body finish either at the factory or dealer premises in order to ensure that the customer receives the car in optimum condition.

Engine Exhaust

California Proposition 65 Warning

⚠ WARNING:

Engine exhaust, some of its constituents, and certain car components contain or emit chemicals known to the State of California to cause cancer and birth defects or other reproductive harm.

In addition, certain fluids contained in cars and certain products of component wear contain or emit chemicals known to the State of California to cause cancer and birth defects or other reproductive harm.

⚠ WARNING:

If you ever suspect exhaust gas is entering the cockpit, do not drive the car until the fault has been repaired.

In particular, running the engine in an enclosed space can let exhaust gas into the car, even more quickly if the interior fan is switched on.

NEVER park in a garage with the engine running.

⚠ WARNING:

Engine exhaust can kill. It contains the gas carbon monoxide (CO), which you can't see or smell. It can cause unconsciousness and death.

You might have exhaust gas entering the cockpit if:

- Your exhaust system sounds strange or different.
 - Your car was damaged in a collision.
 - Your car was damaged when driving over high points in the road or over road debris.
 - Repairs weren't carried out correctly.
 - Your car or exhaust system had been modified improperly.
- Make sure your car is checked by an authorised dealer before driving it again.

NOTICE: The Elise is fitted with a 'three way' catalytic converter in the exhaust system in order to reduce the noxious content of the exhaust gases and comply with emission control regulations. It is essential that **ONLY UNLEADED FUEL** is used (see 'Fuel Requirement'). The use of leaded fuel, or lead replacement

petrol (LRP), will cause irreversible contamination of the precious metal catalysts and of the exhaust gas sensor used by the computer controlled engine management system.

It is important that the Maintenance Schedule (see separate booklet) is followed at the specified time and distance intervals (this is a requirement of the warranty), and that the car is kept in proper operating condition. Failure to do so may result not only in a loss of fuel economy and emission control, but may cause damage to the catalytic converter.

⚠ WARNING:

- If the engine malfunctions in any way (e.g by a change in sound) have the fault diagnosed and repaired promptly. Continuing to drive the car with an engine misfire could cause the catalytic converter to overheat, with possible heat damage to other car components, and an engine bay fire. Operation of the 'Malfunction Indicator Lamp' (MIL) is fully described later in this handbook on page 49.
- DO NOT park or drive the car in areas where combustible material, such as dry grass or leaves, could come into contact with the hot exhaust system. Under certain wind and weather conditions a grass fire could be initiated.
- DO NOT tamper with any electrical components with the battery connected. You could receive an electric shock from the spark plug coils or initiate a car fire.
- DO NOT check or adjust any engine bay equipment with the engine running. Failure to comply with this may result in you or your clothing becoming trapped.
- DO NOT use the car if a fuel leak is suspected, as may be indicated by a persistent smell of fuel. Have the fault diagnosed and rectified without delay. A fuel leak may result in a fire or explosion.
- DO NOT touch or approach, any part of a hot exhaust system. Failure to comply with this may result in you receiving severe burns.
- DO NOT allow servicing or repairs to be carried out by unskilled persons as this may adversely affect the handling and safety features on your car. Lotus dealers have trained staff who are best qualified to maintain your car to the correct specification.

NOTICE: DO NOT push or tow start the car; or turn off the ignition at engine speeds above idle; or run the fuel tank dry: Any of these actions may damage the catalytic converter.

Before driving the car:

- Check tires for damage, wear and proper inflation. Under-inflation causes increased rolling resistance and uses more fuel. (Please refer to the section in this handbook on tires, page 115).
- Check all windows, mirrors and lights are clear and unobstructed and all lights are correctly working.
- Check that the engine cover and front body access panels are correctly latched;
- Adjust the seat and mirrors, and familiarise yourself with the controls.
- Check all instruments and warning lamps ('tell tales') are reading correctly.
- Ensure that both driver and passenger are properly restrained by their seat belts.

Care of the Environment

By virtue of its light weight, simple content, constructional process and fuel efficiency, the Elise has a low environmental impact compared with many road cars. All drivers should, however, be aware of the effect of motor car exhaust emissions on the environment and drive in a way which minimises pollution by:

- Anticipating traffic flow to avoid needless acceleration and braking.
- Using the highest suitable gear.
- Switching off rather than idling for long periods.
- Driving off as soon as it is safe to do so; it is not necessary or beneficial to the engine to allow extended idling from cold.
- Having the car serviced regularly as a poorly maintained car will use more fuel; have any engine faults attended to immediately.
- Considering the need to use the car for very short journeys. The emissions produced by an engine are many times greater when cold than when warm.

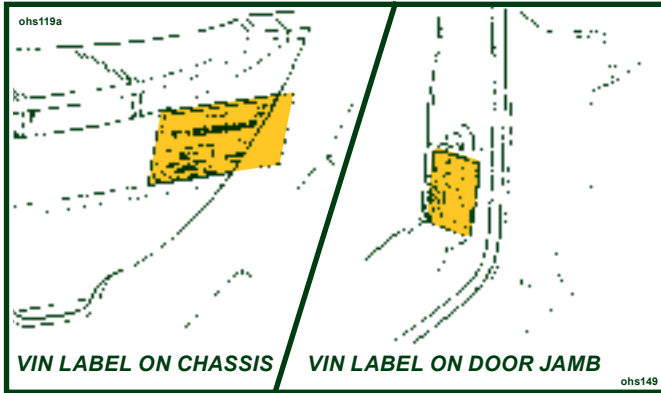

CAR IDENTIFICATION

The Vehicle Identification Number (V.I.N.) is a unique 17-digit number used to identify the car for warranty, spares ordering and administrative purposes. For reference, the number may be viewed from outside the car at the left hand bottom corner of the windscreen. The number is also printed on a label stuck to the inside of the chassis sideframe alongside the driver's seat. It is repeated on the certification label on the driver's door jamb. This label contains tire pressure information. The chassis frame is stamped with the V.I.N. in the right hand front wheelarch area, viewable with the front wheels turned to right full lock.

It is essential that the complete V.I.N. is quoted in any correspondence concerning the car, or when ordering spare parts.

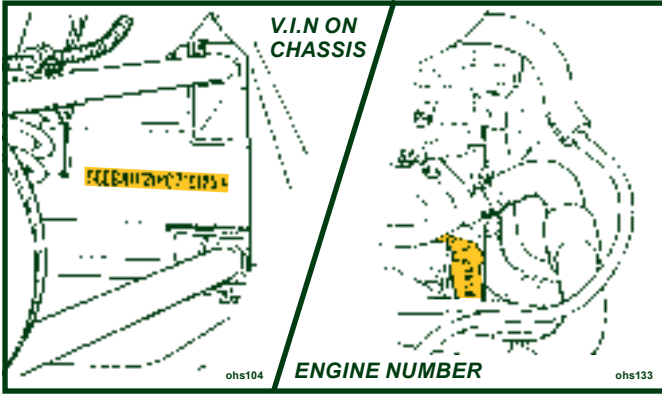

Engine Number

The engine number is stamped on the rear end of the cylinder block, exhaust side, and is followed by '2ZZ'.

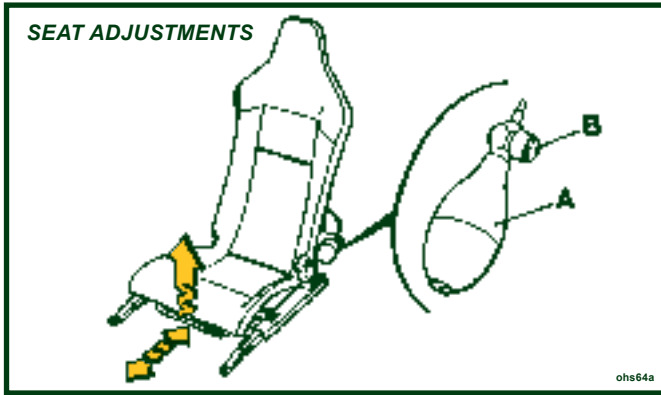

SEATING & SAFETY RESTRAINTS

Seats

On delivery of the car, first remove the protective plastic seat covers, if this has not already been done, and dispose of safely.

To adjust the fore/aft position of the driver's seat, raise the lift bar beneath the front of the seat, and slide to the position required. Ensure that the catch is fully engaged after adjustment by attempting to slide the seat without touching the lift bar. Note that the passenger seat position is fixed and cannot be adjusted, and that the backrest angle of both seats is fixed, and cannot be reclined.

⚠ WARNING:

- Sit as far back from the steering wheel as is comfortable, whilst ensuring that full control can be maintained. Sitting too close to an airbag can result in serious injury or death if the airbag inflates.
- Ensure that your chest is at least 10 inches (250mm) from the steering wheel.
- Do not attempt to adjust the seat position whilst driving as this could adversely affect your control of the car.
- Ensure that no persons or objects will be trapped when adjusting the seat.

Lumbar Support (if fitted): On seats equipped with adjustable lumbar support, an inflator 'bulb' (A) and air release button (B)



are located at the inboard rear of the seat. To increase lumbar support, squeeze the bulb repeatedly until sufficient support is obtained. To decrease support, press the small black button at the base of the inflator bulb.

Seat Belts

Seat belts provide important safety and comfort for both driver and passenger and have proven to be the single most effective safety device in reducing the risk of death or injury in a crash. The seat belts should be worn at all times, no matter how short the journey. This is required by law in most states and in all Canadian provinces. As a reminder, the seat belt tell tale in the instrument cluster will flash until the driver's seat belt is fastened, accompanied for the first eight seconds by an audible chime.

Inertia Reel Seat Belts

The standard fitment inertia reel seat belts allow the wearer freedom of movement under normal driving conditions. The belt reel will lock automatically whenever the car is subjected to braking, acceleration, or cornering forces, or on impact in a collision. Reel locking will also occur on steep hills or slopes, or if the car is tilted. In the event of a severe frontal impact sufficient to trigger the airbag system, a pre-tensioning device incorporated into each seat belt assembly will operate to tighten the belt for increased occupant protection.



To use the belt, sit erect and fully back in the seat before taking the buckle tongue in the outer hand, and drawing the belt through the top slide, pass the belt across the body and push the tongue into the buckle lock at the inboard side of the seat, until a positive 'click' is heard. Pull on the belt to check for correct latching and ensure that the belt fits snugly against the body with all the slack taken up by the reel. The belt should be worn low across the front of the pelvis, and across the chest and shoulder.

The belts are released by pressing the red button on the buckle lock, and will retract automatically for tidy storage and to permit easy access to the passenger compartment.

Seat Belt Precautions

WARNING:

- **Be sure you and your passenger always wear seat belts and wear them properly. Not wearing a seat belt correctly, increases the chance of serious injury or death in a crash, even with airbags.**
- **On fastening the seat belt, ensure that no part of the belt is twisted, or is entangled in the door or seat mechanism.**
- **Seat belts are designed to bear upon the bone structure of the body and should be worn low across the front of the pelvis, and across the chest and shoulder. Wearing the lap section of the belt across the abdominal area must be avoided.**
- **Improperly positioning the seat belts can cause serious injury or death in a crash. Ensure the seat belts are correctly positioned before driving.**
- **Pregnant women should always wear seat belts to protect both themselves and the unborn child. The lap belt portion of the belt should be kept as low as possible across the hips. Consult your doctor regularly to check if you should drive.**
- **The shoulder portion of the belt must never be worn beneath the arm, or behind the back.**
- **Each seat belt assembly is designed for use by one occupant of adult build, and should not be used by children unable to meet the requirements set forth herein.**



⚠ WARNING:

- Lotus strongly recommends that you do not carry children as passengers in your Elise.
- Because the Elise is fitted with a non-switchable passenger airbag, a rear facing child seat must never be used.
- Never use one belt around two people, or allow a child to be carried on a driver's or passenger's lap.
- Refer to Child Restraints section of handbook.

⚠ WARNING:

- No modifications or additions should be made to the inertia reel assemblies or seat belts. Do not attempt to adjust the seat belt tension by altering the mechanism.
- The seat belt should be replaced if webbing becomes frayed, contaminated, or damaged. Inspect regularly.
- It is essential to replace the entire seat belt assembly if it has been used in a severe impact, even if damage to the assembly is not obvious. In situations where the airbags have been deployed, the belt tensioner systems must also be replaced. Seat belt anchorage points must also be rigorously checked.
- Not checking or maintaining seat belts can result in serious injury or death if the seat belts do not work properly when needed. Check the belts regularly and have any problem corrected immediately.
- No one should sit in a seat with an in-operative seat belt.

Care should be taken to avoid contamination of the webbing with polishes, oils or chemicals and particularly battery acid. Use only a mild detergent to clean the webbing, never use bleach or dye, and allow the belt to dry fully before using the car. Ensure that the buckle mechanism is kept free of dirt contamination as disassembly for cleaning is not possible.

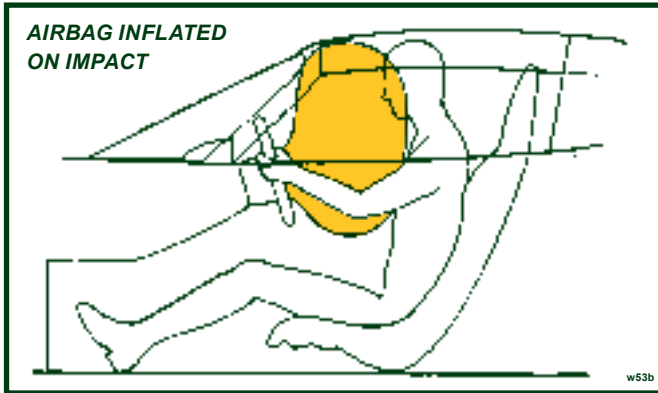

Airbag Safety System

Your car has airbags. One airbag for the driver, and another for the passenger.

The car is also equipped with shoulder and lap belts. Airbags are supplementary restraints to the seat belts.

In the event of a moderate to severe frontal collision, airbags provide occupant protection additional to that provided by the lap and diagonal seat belts. Both driver and passenger must wear the seat belts at all times, whether or not an air bag is provided, in order to minimise the risk of severe injury or death, no matter how short the journey. An occupant who is properly restrained by a seat belt, will be in the best position for full effectiveness of the airbag in the event of airbag deployment.

The airbag system is designed to inflate when the car is involved in a frontal, or near frontal collision, and the force of impact is sufficient to warrant additional occupant protection. The driver's airbag is housed in the centre of the steering wheel, and that for the passenger in the dashboard. When triggered by an electronic crash sensor, each air bag inflates in a fraction of a second to provide protection for the occupant's upper body, and then deflates very rapidly to minimise any obstruction to the driver.

Some parts of the system are designed to operate only once, and need replacing after air bag inflation with new components, before being ready for another deployment.

Remember that the seat belts, when correctly worn, provide

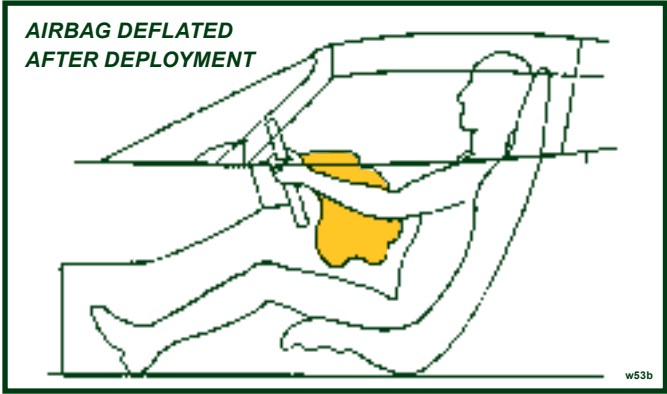

the primary crash protection to the occupants, especially in collisions below the actuation threshold of the airbag system, and during types of accident which do not cause airbag deployment. Therefore, both driver and passenger must always wear seat belts (in most states, and all Canadian provinces, the law requires the use of seat belts). See the earlier pages on 'Seat Belts'.

⚠ WARNING:

- You can be killed or seriously injured in a crash if you aren't wearing your seat belt - even with airbags. Wearing your seat belt during a crash helps reduce your chance of hitting things inside the car or being ejected from it. Airbags are designed to work with seat belts, but don't replace them. Airbags are designed to deploy only in moderate to severe frontal and near frontal crashes. They aren't designed to inflate at all in rollover, rear or low-speed frontal crashes, or in many types of side impacts. Both driver and passenger should wear a seat belt properly to minimise the risk of severe injury or death in the event of a crash.
- Airbags inflate with great force, in a fraction of a second. If you're too close to an inflating airbag, as you would be if you were leaning forward, you could be killed or seriously injured. Seat belts help keep you in the correct position before and during a crash. Always wear your seat

belt, even with airbags. Sit as far back from the steering wheel as is comfortable, whilst ensuring that full control can be maintained.

- Airbags plus lap-shoulder seat belts offer the best protection for adults, but not for young children and infants. Neither the car's seat belt system nor its airbag system is designed for them. Young children and infants need the protection that a child restraint system can provide. See later section on 'Child Restraints'.
- If an object is between a person and an airbag, the bag might not inflate properly or it might force the object into that person causing death or serious injury. The path of an inflating airbag must be kept clear. Don't put anything between an occupant and an airbag, and don't attach or put anything on the steering wheel hub or on or near any passenger dashboard air bag covering.
- Do not lean against the inside of the doors; always hold the steering wheel by the outer rim; never rest your hands on the airbag panel.
- Never transport heavy objects on or in front of the passenger seat.
- Give your passenger all of the information in this section.
- Do not attempt to de-activate the airbags, or make any other changes to the wiring or components of the airbag system. Do not undertake any wiring for electrical accessory equipment in the vicinity of the airbag wiring harnesses. Doing so may disable the airbag system, or cause its unintended deployment.
- Adjust the driver's seat to ensure that your chest is at least 10 inches (250mm) from the steering wheel.
- If the airbag trim cover on the passenger side of the dashboard is accidentally knocked off, the passenger airbag will not operate correctly. Improper protection could result in death or serious injury to a passenger in a crash. Do not attempt to refit or repair the trim cover, but have the fault rectified immediately by your dealer.

Airbag Tell Tale

There is an airbag warning light ('tell tale') on the instrument panel which shows the airbag symbol. The system checks the following airbag electrical circuits for malfunction:

- Drivers airbag circuit;
- Passenger airbag circuit;
- Seatbelts pre-tensioner circuit;
- Internal componentry of the sensor and diagnostic module.

As a bulb and circuit check, the tell tale will light briefly when the ignition is switched on, and then go out. If the lamp lights at any other time, a fault in the airbag system is indicated, which should be rectified without delay by your Lotus dealer.

⚠ WARNING:

If the airbag tell tale does not light up as the ignition is turned on, or remains lit for more than a few seconds, have the fault rectified immediately by your dealer. Ignoring the tell tale can result in serious injury or death if the airbags do not inflate when needed.

Airbag Deployment

If a crash or collision causes the airbags to inflate, you may see what looks like smoke, but is actually powder from the airbag surface used to aid smooth deployment. Although the powder is not harmful, people with respiratory problems may experience some temporary discomfort. If this occurs, get out of the car if possible as soon as it is safe to do so.

After airbag deployment, the airbags, seat belt tensioners and electronic control unit must be replaced by a Lotus dealer or other suitably qualified organisation.

Component parts of the airbag system are located in various sites around the car. Any technician working on the car should be advised that the car is fitted with airbags to allow suitable precautions to be taken.

⚠ WARNING:

- **For up to 20 seconds after the ignition has been turned off and the battery disconnected, an airbag can still inflate if improper servicing occurs. You can be injured if you are close to an airbag when it inflates.**
- **Airbag system components should be serviced only by an authorised Lotus dealer. Do not work on the airbag system yourself.**
- **The disposal of used airbag units is subject to stringent**

- regulations, and should be handled only by your dealer.
- If you sell your Lotus, notify the purchaser that the car is equipped with airbags, and refer them to 'Airbag Safety System' in this handbook (safety and disposal rules).
 - Further information on the airbag system can be found on stickers on the sun visors.
 - For important recommendations on the use of child restraints, please refer to 'Child Restraints' in this handbook. Never use a rear facing child seat in your Elise.
 - A crash can damage the restraint systems in your car. A damaged restraint system may not properly protect the person using it, resulting in serious injury or even death in a crash. To help make sure your restraint systems are working properly after a crash, have them inspected and any necessary replacements made as soon as possible.

Child Restraints

⚠ WARNING:

Lotus strongly recommends that children are **not** carried in the Elise due to the risk of death or serious injury if the child is too close to the dashboard when the airbag inflates.

Accident statistics show that children are safer when properly restrained in the back seats of cars, an option unavailable on this model. In addition, your car is equipped with a passenger's airbag which poses serious risks to children - particularly infants and small children. If, nevertheless, a child is to be carried in the car, the following notes are provided for guidance:

When a child is of a physical size whereby the standard fitment lap and diagonal seat belt will fit satisfactorily, with the belt positioned over the collar bone and against the centre of the chest, the standard seat and seat belt should be used. If the belt touches or crosses the child's neck, the child should **NOT** be carried in the Elise.

⚠ WARNING:

- Children should not be carried in the Elise unless they are large enough to be able properly to use the standard seat belt without any child seat or booster seat.
- Child restraint systems (other than belt positioning booster seats) are designed to be secured in the car seat by the lap belt portion of the lap/shoulder belt. **READ ALL INSTRUCTIONS THAT ACCOMPANY THE CHILD RESTRAINT OR BOOSTER SEAT.**
- Infants who are unable to sit up by themselves, unsupported, should **NOT** be carried in the Elise.
- Never put a rear-facing child seat in the passenger seat of the Elise. If the airbag inflates, it can hit the child or the back of the child seat with enough force to kill or very seriously injure an infant.
- There is no provision on the Elise to switch off or disable the passenger airbag.

⚠ WARNING:

Children who are not properly restrained can be killed or seriously injured in an accident.

Behaviour: It is essential that the behaviour of any child travelling in the car is such that they remain correctly seated and belted, and it is the responsibility of the driver to ensure that this occurs.

The following wording has been included to comply with National Highway Traffic Safety Authority requirements, however;

⚠ WARNING:

Lotus strongly recommends that you do not fit any type of child seat into the Elise due to the risk of death or serious injury if the child is too close to the dashboard when the airbag inflates.

Procedure for Proper Fitment of Forward-Facing Child Seat

Automatic Locking Retractor: The safety belt for the passenger's seat is equipped with an automatic locking retractor that must be used for securing a forward-facing child restraint system. When activated, this retractor allows you to securely fasten the child restraint system.

Activating the Automatic Retractor:

1. Pull the passenger seat safety belt **completely** out. At this point, the locking mechanism is activated.
2. Place the forward-facing child seat in the passenger seat, using the safety belt to secure the child seat, **following the instructions that come with the child seat.**
3. Insert the safety tongue into the buckle and make sure that it is properly latched.
4. Allow the safety belt to retract until it is tight on the child seat. You may further tighten the belt by pulling on it to allow more of it to retract. Check to make sure the child seat is secured, and that the belt is snug and will not pull out.

Releasing the safety belt and child seat:

1. Unbuckle the safety belt.
2. Remove the child seat.
3. Make sure that the belt has **fully** retracted. At this point the automatic locking feature is disengaged.

Seating & Safety Restraints

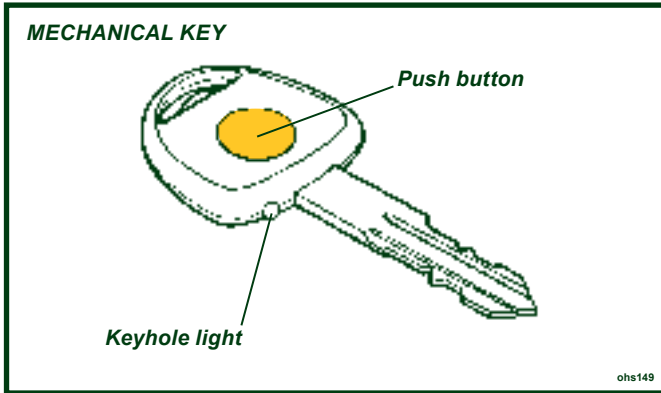

KEYS & CAR SECURITY ALARM

Keys

A single mechanical key operates the manual door locks (see also 'Doors' and 'Central Door Locking'), combined ignition switch/steering lock, and engine cover. The head of the key incorporates a push button activated key hole light to facilitate operation in the dark.

A duplicate key is supplied with the new car and, on receipt, should be separated and kept in a safe place for use in an emergency. The mechanical key code is printed on a plastic tab which should be removed from the key ring and the number recorded safely with the car documents. This number will be required when ordering a replacement, or any additional keys from your dealer. Ensure that a spare key is available at all times to guard against becoming stranded.

⚠ WARNING:

Never leave the car unattended with the key in the ignition switch, especially if unsupervised children and/or animals are in the car. Dangers can arise from window operation and other electric controls. If the engine is running, operation of the car's controls could cause an accident and result in death or serious injury.

COBRA TRANSMITTER FOB & CODE NUMBERS



S/N 99999999

PIN CODE =9999

oh102

Car Security Alarm

The Lotus Elise is fitted with a Cobra 8186 immobiliser/alarm which includes the following features:

- 'Dynamic coding' of the transmitter fobs; Each time the transmitters are used, the operating frequency is random changed to guard against unauthorised code copying.
- Automatic (passive) engine immobilisation to prevent the engine from being started without the transmitter fob.
- Sensing switches on doors, front body access panels and the engine cover, meaning the alarm sounds if someone tries to force entry.
- Personal protection by 'on demand' activation of the siren.
- Selectable cockpit intrusion sensing using a microwave sensor.
- Self powered siren to maintain protection if the car battery is disconnected.

Transmitter Fobs

Two transmitter fobs are provided with the car to operate the immobiliser/alarm system. The two transmitters should be kept separate, and a replacement obtained immediately after any loss to ensure that a spare is always available.

Each individual alarm system has a unique serial number and an owner's Personal Identification Number (PIN), both of which are printed on a code card supplied with the car. In order to allow replacement transmitters to be ordered, it is essential that these numbers are recorded and kept safely with the car documents. If the code card is not available on receipt of the

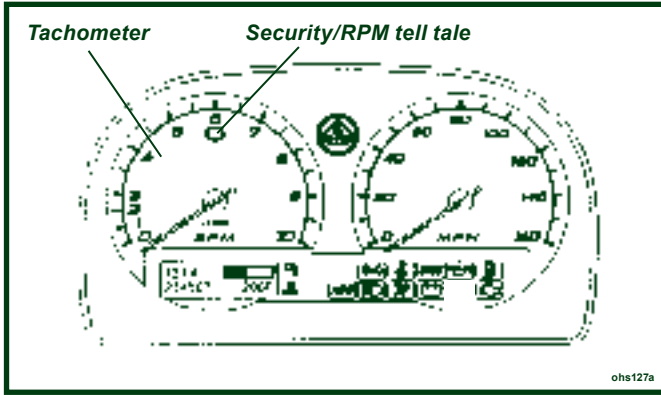

car, enquire with the dealer immediately.

Engine Immobiliser

In order to provide a measure of car security, independent of any driver action, the system will 'passively' immobilise the engine's cranking and running circuits after the first occurring of the following:

- i) Four minutes after switching off the ignition;
- ii) Two minutes after a mobilising command (see below); or
- iii) One minute after switching off the ignition and opening the driver's door.

The immobilised state is indicated by the security tell tale in the tachometer upper face flashing continuously.

To mobilise the engine, press once, and for a full second, the larger of the two buttons on the transmitter fob. The security tell tale will be extinguished.

Valet Mode

If leaving the car for servicing or parking, the passive immobilisation feature may be switched off by switching on the ignition and pressing the transmitter small button. Two beeps will confirm 'valet' activation, repeated as a reminder when the ignition is switched off. The security tell tale will remain off.

At the next arming command, the valet mode will be switched off, and normal immobilisation resume.

Arming the Alarm

Remove the ignition key, close (and lock) both doors, and check that the engine cover and front body access panels are secure. The roof may be either closed or open. Press once, and for a full second, the larger of the two buttons on the transmitter fob (on cars with central door locking, this action will automatically lock both doors - see later). This command will be acknowledged by:

- 2 flashes of the hazard warning lamps;
- Continuous flashing of the security tell tale.

Check that these indications occur. If not, press the button a second time, as the first press may have only switched off the passive immobilisation (see above).

Note that if the system is armed when a door or engine cover/ front access panel is not fully closed or if the interior lamp is in the 'off' position, a continuous buzz will be heard as warning.

If still open after expiry of the arming period, (see below) the alarm will be armed with that switch group (both doors, or front/rear access lids) excluded from the circuit.

After arming the system, the engine is immediately immobilised, but a period of approximately 45 seconds must elapse before all functions and sensors become fully active. After this time, the alarm will be triggered by any of the following actions:

- Interruption of the car battery power supply.
- Energising the ignition circuit ('hot wiring').
- Opening a door;
- Opening the engine cover or a front access panel.
- Movement detected within the cabin.

When the alarm is triggered, the hazard warning lamps will flash and the electronic wailing siren will sound for a period of approximately 30 seconds before closing down and resetting, ready for any further triggering input. If a trigger is continuously present, the alarm will repeat after a short delay, and continue in this sequence for about 10 cycles.

To silence the siren when triggered, press once, and for a full second, the larger button on the transmitter fob. This will not affect the status of the alarm which will remain armed.

Disarming the Alarm

To disarm the alarm, press once, and for a full second, the larger button on the transmitter fob. This command will be acknowledged by:

- 1 flash of the hazard warning lamps;
- Extinguishing of the security tell tale.

If the alarm had been triggered during the last armed period, the disarm command will be acknowledged by the hazard lamps flashing 4 times, and the buzzer sounding 4 times. The security tell tale will then flash a code to indicate the triggering source:

- 1 pulse flashing: door, engine cover/boot lid or body front access panel.
- 2 pulse flashing: movement detected in cabin by microwave sensor.
- 4 pulse flashing: tampering with ignition circuit.
- 6 pulse flashing: interruption of battery supply.

The coding will be deleted when the ignition is next turned on.

Emergency disarming/mobilising

If the transmitter fobs are lost or damaged, the alarm system owner's unique PIN may be used to disarm the alarm and/or mobilise the engine provided that access is available to the cabin. Follow the transmitter fob programming instructions (see page 18) from step 3.

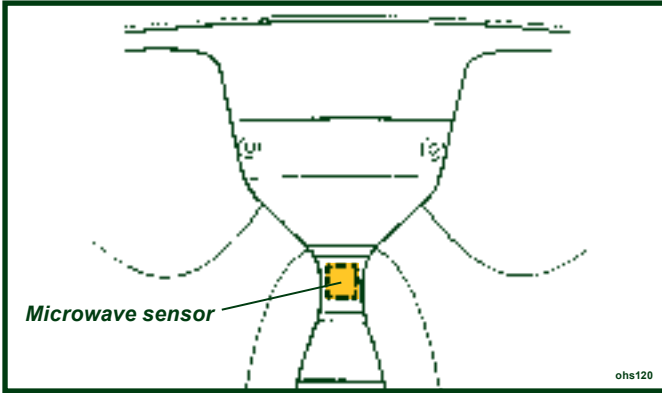

Intrusion Sensing

A microwave sensor is mounted behind the cabin rear bulkhead trim panel, and is able to detect substantial physical movement within the cockpit, and trigger the alarm. Microwave transmissions are blocked by metal objects, so it is important not to shield the signal by placing such items on the bulkhead ledge.

If desired, the alarm may be armed without the intrusion sensor or battery interruption circuits being active by arming the system in the usual way with the transmitter larger button, and within 20 seconds, pressing the smaller button twice.

Manual Activation of Siren

To enhance personal security, with the system in a fully armed state (after 45 second arming period), the siren may be manually triggered by pressing the transmitter smaller button. The siren will sound and the turn lamps flash for 15 seconds. To stop the siren, press either of the two transmitter buttons.

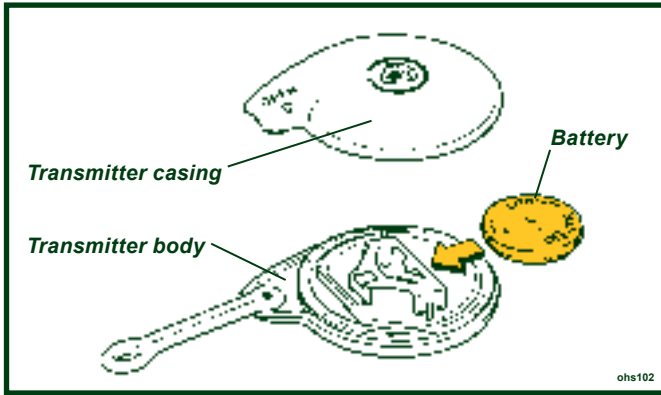

Transmitter Fob Battery Replacement

The transmitter fobs will normally operate within a range of 5 metres from the car, but this may be reduced by the presence of other radio signals in the vicinity. A small LED tell tale on the transmitter fob will flash whilst the button is held down to indicate correct operation, but if the lamp flashes irregularly or only once, transmitter battery replacement is required.

The transmitters are powered by a long life 3V Lithium battery, type CR2032, which with normal use should last for 3 years. To ensure continuity of operation, it is recommended to renew the batteries every 12 months:

- Using a small screwdriver, prise open the case in the areas marked 'open'.
- Remove the old battery and wait for 10 seconds before inserting the new battery with +ve sign uppermost, and holding the battery only by the periphery.
- Align the locating studs, and firmly press the case together.
- The transmitter should now operate normally, but may require re-synchronisation with the control unit.

Transmitter Re-synchronisation

If at any time the transmitter does not function, and the battery is known to be good, carry out the following re-synchronisation procedure:

- Stand close to the car and hold down both buttons on the transmitter until the LED on the fob is extinguished (approx. 10 seconds).

- Release both buttons; the fob tell tale should come on constantly.
- Press the larger button for one second (the fob tell tale will flash). Synchronisation is complete.

Programming Additional Transmitter Fobs

Two transmitter fobs are provided with the new car. If one transmitter is lost or damaged, a replacement should be obtained immediately from your dealer, and programmed to the car alarm controller using a functioning transmitter fob and the system owner's unique Personal Identification Number (PIN). Up to 4 transmitter fobs can be matched with the alarm system, but all fobs must collectively undergo the single programming operation:

1. Press, simultaneously, both buttons on a transmitter fob until the fob tell tale stops flashing (approx. 10 seconds). On release of the buttons, the fob tell tale will light.
2. Repeat operation (1) for ALL the transmitter fobs required to operate the system.
3. Turn the ignition on and off 3 times within 7 seconds; the security tell tale in the tachometer will light for 3 seconds.
4. Enter the PIN: Immediately the tell tale goes out, switch ON the ignition and count the number of security tell tale flashes until equal to the first number of the PIN, then turn the ignition OFF, then back ON again.
5. Repeat operation (4) for the remaining 3 digits of the PIN, remembering to turn the ignition OFF and back ON after each code number.

Note: If at any time a mistake is made when entering the PIN, turn the ignition OFF for 10 seconds and re-commence entering the PIN.

6. If the PIN is correct, the security tell tale will be lit. Test operation of each transmitter fob.

Disconnecting the Car Battery

If the battery is to be disconnected, refer to the 'Battery' section later in this handbook which includes the following precaution:

- Before disconnecting the battery, ensure that the alarm system is disarmed and mobilised.

ENTRY & COMFORT

⚠ WARNING:

- In very hot/cold territories, or under conditions of extreme solar heating, be aware of exposed metal surfaces in the cabin. Take suitable precautions to guard against burn injuries from hot or cold metal.
- Unlocked doors can be dangerous. Young children who get into unlocked cars may be unable to get out. Always lock your car whenever you leave it.

Central Door Locking (CDL)

The central door locking (CDL) operates on the driver's and passenger's doors in conjunction with the security alarm system. For full details of the alarm system, see page 30.

To unlock from outside:

To unlock the doors from outside, press once, for a full second, the larger button on the transmitter fob. The alarm will be disarmed and both doors unlocked. Press the exterior lock button and pull open the door using the finger grip below the button. If the door is swung fully open, a spring detent mechanism on the hinge will aid restraint of the door for convenience whilst entering or exiting the car, but the door should be manually held in windy conditions, or if the car is parked on a slope.

From inside the car, pull the door firmly shut using the recess provided at the top of the door trim panel.

⚠ WARNING:

Before closing a door take care to ensure that no persons or objects will be trapped to avoid injury or damage.

To lock from inside:

If it is desired to lock the doors from inside the car, for example to deter highjack attempts, press the right hand side of the CDL rocker switch on the front of the gear lever shroud to lock both doors with or without the ignition switched on. Alternatively, the doors can be locked individually by depressing the button at the rear end of each door sill.

⚠ WARNING:

Whether locked using the rocker switch or sill buttons,

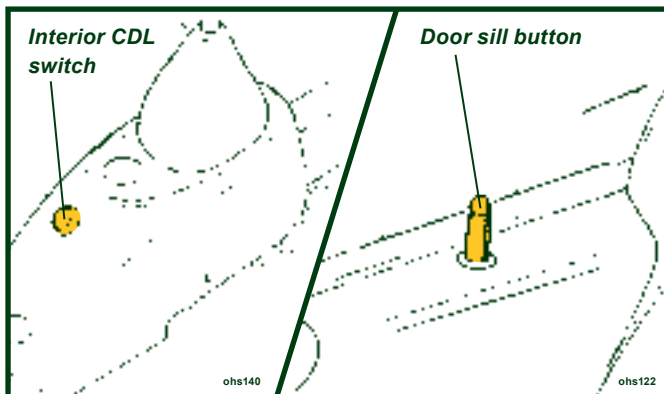

the doors will be 'deadlocked' meaning that the interior door release handles will not open the doors. In order to get out of the car in an emergency when the doors are locked see the section below 'to unlock from inside'.

To unlock from inside:

To unlock both doors from inside, press the left hand side of the rocker switch on the front of the gear lever shroud, or raise the sill button on each door. Note that in the event of a car collision which causes the safety inertia switch to be tripped, the doors will automatically be unlocked.

Pull the release handle at the front of the door and push open. Shut the door from outside by using firm hand pressure towards the rear of the door.

⚠ WARNING:

Before closing a door take care to ensure that no persons or objects will be trapped to avoid injury or damage.

To lock from outside:

To lock the car from outside, remove the ignition key, close both doors and check that the engine cover and front body access panels are secure. Arm the security alarm by pressing once, for a full second, the larger of the two buttons on the transmitter fob. This action will both arm the alarm and electrically lock the driver's and passenger's doors.

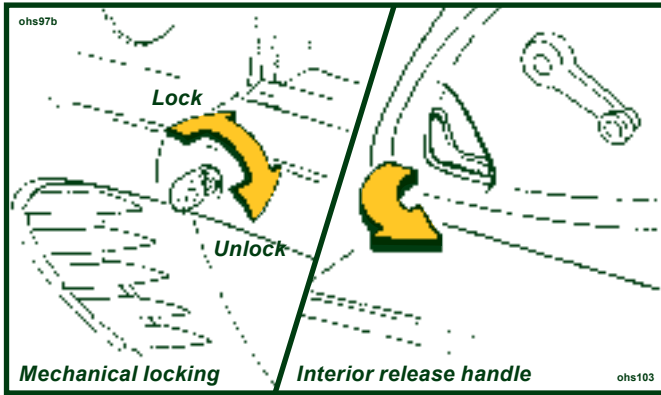

Notes:

- In the event of a flat car battery, the CDL will not operate. The doors can be unlocked from outside only after opening the engine cover and restoring power to the battery by substitution, re-charging or 'jumping' to a second battery. The doors cannot be unlocked using the mechanical key if the CDL was used to lock the car.
- To lock the car with a flat or disconnected car battery, or if the transmitter fob is disabled, use the mechanical key in each exterior door lock button and turn anticlockwise to the vertical position to disconnect each release button from the latch. This technique does not 'deadlock' the interior release handles, but does allow continued key access to the car until restoration of battery power.
Note that a door locked with the mechanical key cannot be unlocked using only the transmitter fob.
- To deadlock the car i.e. disable interior release handles, with a flat car battery, or without the use of the transmitter fob or mechanical key, close and lock one door using the sill button, and for the second door, hold the exterior release button pressed in and depress the sill button before closing the door. Access is now available only by using the transmitter fob after restoration of car electrical power.

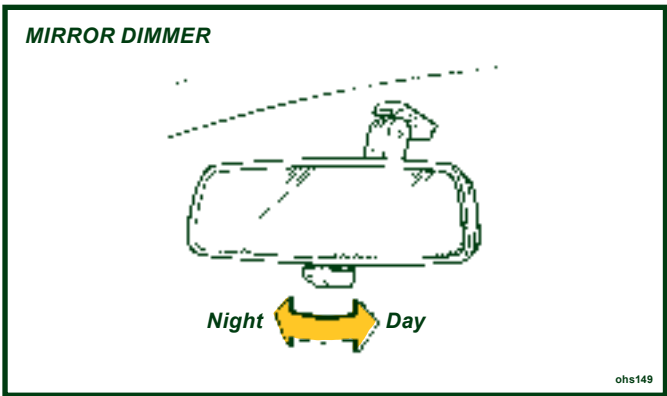

'Lights On' Buzzer

A 'lights on' reminder buzzer will sound if the lights are on, the ignition is switched off, and the driver's door is then opened.

Interior Rear View Mirror

The mirror can be dimmed to reduce headlamp glare from following cars by turning the lever on the underside of the mirror towards the left. Turn towards the right for daytime use.

Door Mirrors

Rear view mirrors are fitted on both driver's and passenger's doors, and may be adjusted manually by direct manipulation of the mirror housing. Note that the passenger side mirror glass is convex to provide a wider field of vision.

A spring detent mechanism allows the complete mirror to swing forwards or backwards on accidental contact to reduce possible damage.

⚠ WARNING:

The passenger side convex mirror makes objects seem smaller and farther away than when viewed through a flat mirror. Take care to judge distances and speeds correctly. If you move into a lane on your right when the car behind is too close, you could cause a collision and a crash. Check your interior mirror or glance over your shoulder before changing lanes.

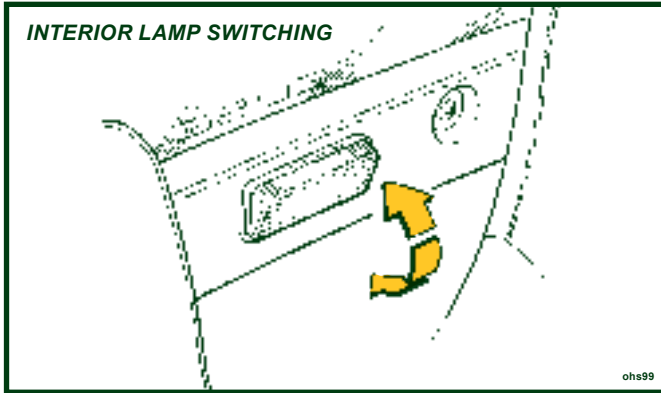

Interior Lamp

The interior lamp is located centrally in the rear bulkhead trim panel, and incorporates a three position rocking lens:

- Lens rocked upwards; lamp is switched off.
NOTICE: Use this position only temporarily as required. Arming the security alarm system with the lamp switched off may exclude the doors from activating the alarm.
- Lens central; lamp is switched on with or without ignition.
NOTICE: To guard against flattening the battery, take care not to leave the lamp on when parking the car, or to switch it on accidentally when using the storage space behind the seats.
- Lens rocked downwards; a courtesy mode applies, where the lamp is switched on whenever a door is opened, and goes out when both doors are closed. This is the normal position and should be used whenever leaving the car.

Sun Visors

To help reduce sun glare, pivoted visors are provided for both driver and passenger. Swing down the visor from the windscreen header rail as required.

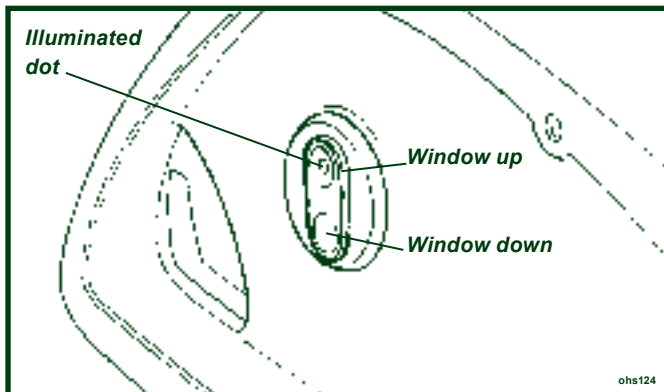

Door Windows

In frosty or icy weather conditions, the windows may become frozen to the weatherstrip seals. Use a windscreen de-icer spray to free the glass before operating the windows.

⚠ WARNING:

- **Before closing a window, always check that no persons or objects will be trapped; incautious window operation could be dangerous, especially to children. Ensure that any passenger is also made aware of this danger.**
- **To guard against incautious electric window operation, do not leave small children unattended in the car with the ignition key in position.**
- **Do not leave children or animals in a parked car with the roof and windows closed, in hot weather conditions as they may suffocate and/or experience heat exhaustion.**

Manual Winders:

Each door window may be raised or lowered by the winder handle near the front of the door.

Electric Windows:

On cars so equipped, switches for the electric window operation are mounted in the front of the door trim panels, and are operative only with the ignition switched on. To help locate the switches in the dark, an illuminated dot is provided in the 'up'

button which glows amber when the lights are switched on.

To lower a window, switch on the ignition and press the lower, domed end of the switch in the relevant door. Release the switch to stop window movement. To raise a window, press the upper, dished end of the switch.

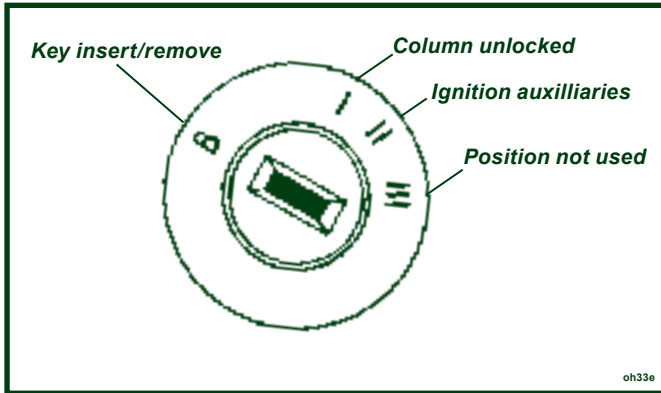

INSTRUMENTS & SWITCHES

Ignition Switch/Steering Lock

The switch/lock is located on the right hand side of the steering column.

- I Insert the key into the slot, and turn clockwise to position 'I' to unlock the steering column. If the key is reluctant to turn, wiggle the steering wheel to ease the load on the steering lock.
 - II Turn to position 'II' to switch on the ignition and operate auxiliary equipment.
 - III This spring loaded position is not used on the Elise. The engine start function is controlled by a 'Start' button at the left hand end of the dashboard (see below).
- B To remove the key, turn fully counterclockwise to 'B' and withdraw. The steering column lock will be activated when the key is withdrawn but may not engage until the steering is turned and the mechanism is aligned.

NOTICE: DO NOT leave the ignition switched on for long periods without the engine running. Although the engine ignition system itself draws no current when the engine is stopped, a battery drain will occur through other circuits even when auxiliary equipment is not being used.

For security reasons, and to guard against battery drain, always remove the key when leaving the car.

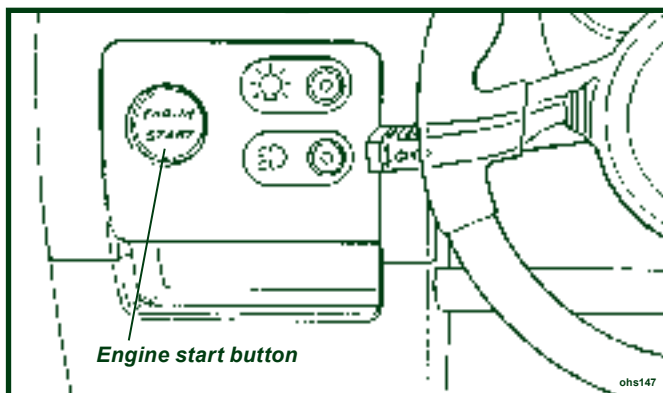

⚠ WARNING:

- Do not push or tow the car unless the key is first used to unlock the column and is then left in the lock. Withdrawing the key will cause the steering to lock.
- Never remove the key from the ignition switch or turn off the ignition while the car is moving. Withdrawing the key will cause the steering to lock and may cause an accident resulting in serious injury or death.
- To reduce the risk of theft, or danger to a child remaining in the car, always remove the key when leaving a parked car.

Engine Start Button

An engine start button is located at the left hand end of the dashboard, alongside the lighting switches, and is backlit when the ignition is turned on.

The button is operative only with the ignition on, and engages the engine starter motor for as long as the button is pressed. Release the button to stop engine cranking.

For the correct engine starting procedure, refer to later section 'Starting Procedure'.

NOTICE: Pressing the start button when the engine is running may damage the starter mecha

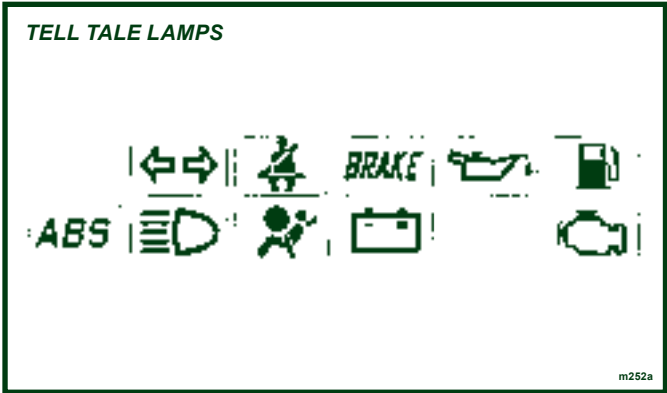

Passive Ilisation: The start button will operate only when the security tell tale in the tachometer face is out. If the tell tale is flashing, the engine is immobilised; Press once, and for a full second, the larger of the two buttons on the transmitter fob. The security tell tale will be extinguished. For further information see 'Car Security Alarm'.

WARNING 'TELL TALE' LAMPS

A block of tell tale lamps is incorporated into the instrument cluster to provide you with important information concerning the operation of your Elise.

Bulb Check

In order to check that the warning systems are operative, all the tell tale lamps (except the 'security' tell tale; see Car Security Alarm section) should light for about 6 seconds following ignition switch on. If any lamp should fail to light, it is possible that the bulb or warning circuit may be faulty; see your dealer without delay.

Turn Tell Tale

When the left hand or right hand turn indicators are operating, this green tell tale flashes in unison. A clicking sound may also be heard. If the tell tale fails to light, or flashes at an unusual or irregular rate, check the operation of the turn indicator lamps immediately.

Seat Belt Tell Tale

The red seat belt tell tale is provided as a reminder that both driver and passenger should always wear the seat belts, no matter how short the journey. The lamp will flash until the driver's seat belt is fastened, accompanied for the first 8 seconds by a buzzer.

Brake Tell Tale **BRAKE**

This tell tale will glow red with the ignition switched on whenever the parking brake is applied. Driving the car with the brake not fully released will cause overheat damage to the rear brakes. Each time the parking brake is released, check that the tell tale is extinguished.

With the parking brake released, if the tell tale should light at any time after the six second check period, stop the car immediately, as the circuit has detected a dangerously low level of brake fluid in the master cylinder reservoir, possibly caused by a hydraulic leak in one of the separate front or rear brake circuits. In the event of a leak there is a danger that air may enter the hydraulic system and cause spongy operation and extended pedal travel. The divided brake circuit should ensure that emergency braking remains, but the car should not be driven until the fault has been identified and rectified.

WARNING:

If the tell tale remains lit when the parking brake has been released, the footbrake may not be working properly. Stop the car immediately it is safe to do so, and do not continue until the fault has been rectified. Continuing to drive could cause a crash and result in death or serious injury.

Oil Pressure Tell Tale

This red tell tale warns of low engine oil pressure. The lamp will be lit whenever the ignition is on and the engine is stopped, but should go out as soon as the engine is started. If the lamp fails to go out after engine start up, or comes on when the engine is running, stop the engine immediately and do not restart until the cause has been investigated and rectified.

⚠ WARNING:

Continuing to run the engine with the oil tell tale lit could cause major engine damage or seizure, resulting in loss of car control and a crash. You or others could be killed or seriously injured.

Low Fuel Level Tell Tale

When only a single segment of the fuel gauge bar graph remains, representing approximately 1.3 U.S. gall. (5 litres), this amber tell tale will flash. Refuel at the next opportunity.

ABS Tell Tale

This amber tell tale should light for about four seconds following ignition switch on, and then go out. If the lamp remains lit, or comes on whilst driving, a fault in the anti-lock brake system is indicated. The base brake system will continue to operate normally, but without the anti-lock feature. The car can be driven but should be checked and repaired at the earliest opportunity.

High Beam Tell Tale

This lamp glows blue whenever the headlamp high beams are operating.

Airbag Tell Tale

The airbag safety system has a self-diagnostic feature which lights the red tell tale if a fault is detected. As a bulb and circuit check, the tell tale will light for about six seconds following ignition switch on, and then go out. If the lamp remains lit, or comes on at any other time, a fault in the airbag system is indicated, which should be rectified without delay.

⚠ WARNING:

If the airbag tell tale is lit, the airbags may not inflate correctly in a crash, or may inflate without warning. To help avoid injury to you or others, have the airbag system repaired as soon as possible.

Battery Charging Tell Tale

This red tell tale will light whenever the ignition is on and the engine is stopped. If it lights any time that the engine is running, the battery is not being charged, which may be due to a broken auxiliary drive belt, or an electrical fault. A broken drive belt

will also disable the engine coolant pump and result in rapid overheating; stop the engine as soon as it is safe to do so, and summon assistance. If the drive belt is intact and the cooling system unaffected, it may be possible in favourable daylight conditions, to drive a short distance to a repair facility, but do not, under any circumstances, allow the battery to become completely discharged by continuing to drive.

Engine Malfunction Indicator Lamp

The engine Malfunction Indicator Lamp (MIL) is provided to warn the driver that the engine management system has detected a fault which may result in increased noxious emissions from the exhaust. In order to minimise emissions and potential engine damage, various operational limitations may automatically be applied.

- i) If the MIL lights continuously whilst driving, immediately reduce speed and adopt a moderate driving style. Seek dealer advice without delay and avoid all unnecessary journeys.
- ii) If the MIL flashes, an engine misfire has been detected which is likely to cause overheat damage to the catalytic converter. Slow down immediately and be prepared to stop.
 - If the MIL then stops flashing, and is lit continuously, proceed with caution and seek dealer advice.
 - If the MIL continues to flash, stop the car as soon as it is safe to do so, and switch off the engine. Seek dealer advice.

NOTICE: Continuing to drive the car with a flashing MIL may cause overheat damage to the catalytic converter, possible engine damage, increased emissions, and impaired fuel economy and driveability.

In order to comply with emissions regulations, data regarding activation of the MIL is recorded in the engine electronic controller, and may be downloaded by Lotus dealers.

Security/RPM Tell Tale

The security tell tale is located at the top of the tachometer display, and indicates the status of the immobiliser and alarm.

- Tell tale out; engine is mobilised, and the alarm is off.
- Tell tale flashing; engine is immobilised, or alarm is armed and engine immobilised.

For full details of the car security system, refer to the earlier section 'Car Security'.

Note that the tell tale also functions as a high engine speed (rpm) warning - see 'Tachometer'.

NOTICE: The car is not fitted with a low pressure tell tale. You should check the tire condition and pressure regularly. See section in the handbook on tires which specifies tire care and pressures.

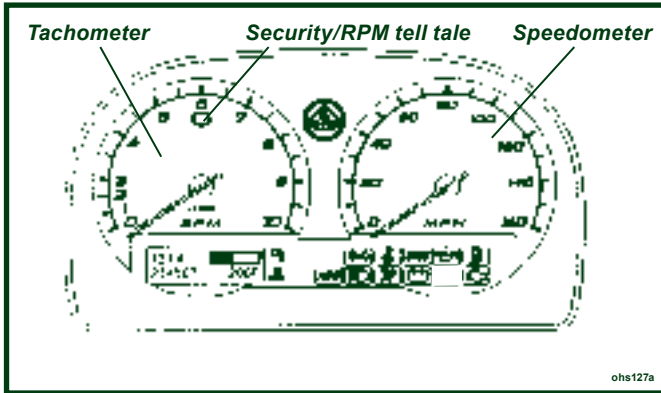

INSTRUMENTS

Speedometer

This instrument displays road speed in MPH, with a secondary scale in km/h.

Tachometer

The tachometer indicates engine speed in revolutions per minute. The engine management system limits the maximum continuous engine speed to 8000 rpm once normal running temperature has been reached. Very short bursts up to 8500 rpm are allowed during maximum acceleration through the lower gears.

A 6000 rpm limit is imposed on a cold engine in order to reduce possible damage from a harsh driving style.

NOTICE:

- The use of wide throttle openings and/or high rpm before normal running temperature has been reached will result in premature wear and should be avoided.
- Do not run the engine continuously at its maximum speed, or allow overspeeding to occur on the overrun by downshifting prematurely, as the high engine loads imposed could result in catastrophic failure.

A red tell tale lamp in the top of the tachometer face lights at high rpm (dependent on gear engaged) to warn that maximum

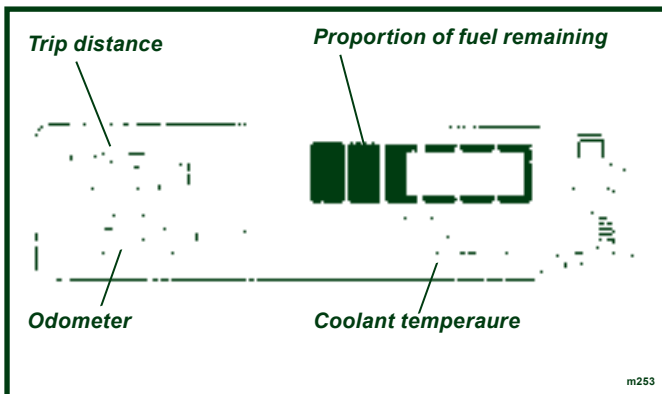

engine speed is being approached. When exploiting full acceleration, gearchange upshifts should be made immediately the tell tale comes on.

Note that this lamp also functions as a security system tell tale (see 'Car Security').

Recalibration of the speedo and tacho needle zero positions will occur during a 3 second period following ignition switch on, but if a needle becomes 'stranded' outside of the re-calibration range, the following procedure should be followed:

With the car stationary;

- Open driver's door;
- Press and hold trip reset button on steering column shroud;
- Turn on ignition.

LCD DISPLAY PANEL

A liquid crystal display (LCD) panel is provided below the instruments in order to display fuel level, coolant temperature, total mileage and trip functions. The panel is blank until the ignition is switched on.

Fuel Level Display

An indication of the level of fuel in the tank is displayed in the form of a bar graph at the right hand top of the LCD panel in the instrument cluster. When completely full (approximately 10.6 U.S. gall. {40 litres}), the display will show 6 black segments. As the fuel level falls, a white band will extend from the right to represent the empty proportion.

When only a single segment remains, representing approximately 1.3 U.S. gall. (5 litres), the amber low fuel tell tale will flash. Refuel at the next opportunity.

NOTICE: Do not allow the tank to run completely dry, as this may damage the catalytic converter and fuel pump. This may affect the terms of your warranty.

Coolant Temperature Display

The engine coolant temperature will be displayed at the bottom right hand corner of the panel as soon as the temperature reaches 162°F. The running temperature will fluctuate a certain amount as the operating conditions change, and during periods of idling or in heavy traffic, the temperature may rise to over 212°F, with the cooling fans switching on at half speed at approximately 208°F and at full speed at approximately 217°F. The temperature display will flash at temperatures over 226°F to prompt closer monitoring by the driver of high temperatures. The pressurised cooling system has a boiling point of over 248°F. If the temperature approaches this level then the driver should be concerned. If this should occur, allow the engine to idle for a few minutes whilst monitoring the temperature, and if it continues to rise, switch off and seek qualified assistance.

NOTICE: After a heavy snowfall, ensure that the radiator cooling outlet grilles in the front body are cleared of snow before driving the car, or overheating may occur.

Odometer

An odometer (total distance recorder) reading is displayed at the bottom left hand corner of the panel.

Trip Recorder

A trip distance recorder is provided at the top left hand corner of the panel.

In order to zero the trip display, switch on the ignition, and press for a moment (less than 1 second), the small button on the steering column shroud ahead of the ignition switch. This dual function button also controls the panel illumination - see 'Instrument & Switch Illumination'.

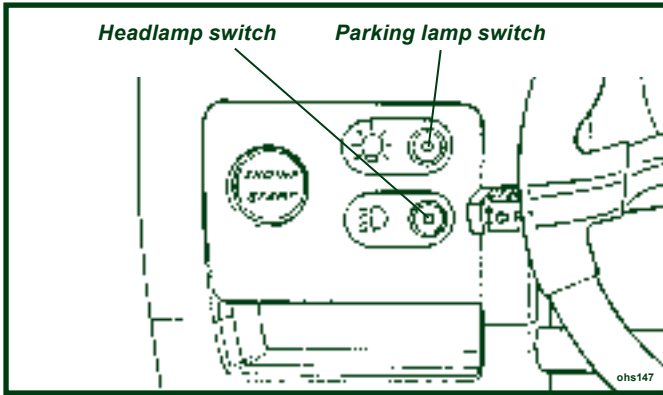

Dashboard Switches

Lighting functions are controlled by two push button switches mounted in the dashboard outboard of the steering column. Each switch is pressed once to switch on, and pressed a second time to switch off. A symbol is positioned alongside each switch to indicate its function, and is backlit orange when the lights are switched on.

Parking Lamps Switch

The upper switch functions with or without the ignition, and switches on the front and rear parking lamps, side marker lamps and instrument/switch illumination. A tell tale in the switch button lights up green to indicate when the circuit is active.

Note that the headlamps must be off before the parking lamps can be switched off.

Headlamp Switch

The lower switch functions with or without ignition, and switches on the headlamps together with the parking lamps, side marker lamps and instrument/switch illumination. A tell tale in the switch button lights up green to indicate when the circuit is active. The steering column lever switch (see later) is used to select high or low beam.

Pressing the switch a second time will switch off the headlamps, but leave on the parking lamps.

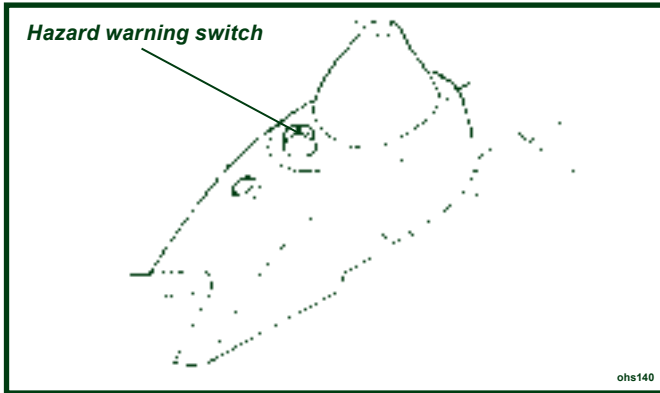

'Lights On' Buzzer

If the lights are on when the ignition is switched off, a 'lights on' reminder buzzer will sound when the driver's door is opened.

Hazard Warning Lamps Switch

The hazard warning switch is located in the trim shroud just ahead of the gear lever, and has an icon in the switch button which is back lit when the ignition is switched on. The switch is operative at all times, and when pressed, flashes in unison all the turn indicator lamps, the turn lamps tell tale and the hazard switch icon. Press a second time to switch off.

This switch should be used when the car has to be stopped on the highway in an emergency, or in other situations where a warning to other traffic needs to be relayed. Use of the hazard warning lamps may be subject to local traffic laws, with which drivers should familiarise themselves.

⚠ WARNING:

If stalled or stopped for emergency repairs, move the car well off the road, switch on the hazard warning lamps and mark the car with other warning devices as available to reduce the risk of a collision.

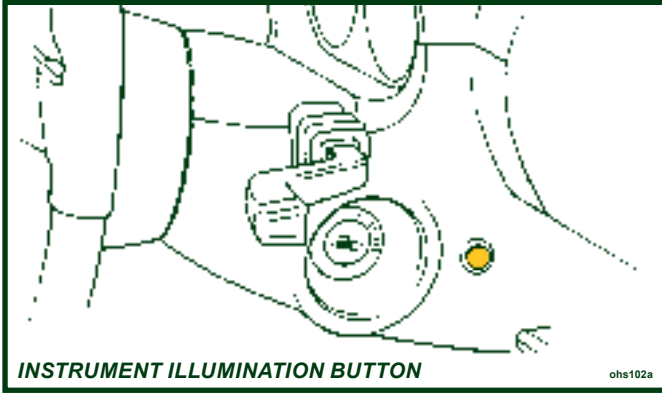

Instrument Illumination

A small button is provided on the steering column shroud ahead of the ignition switch, by which the brightness of the electroluminescent instrument illumination may be adjusted. To cycle through the range of brightness, press and hold the button, and release at the desired setting.

This dual function button also resets the trip distance recorder - see 'Trip Recorder'.

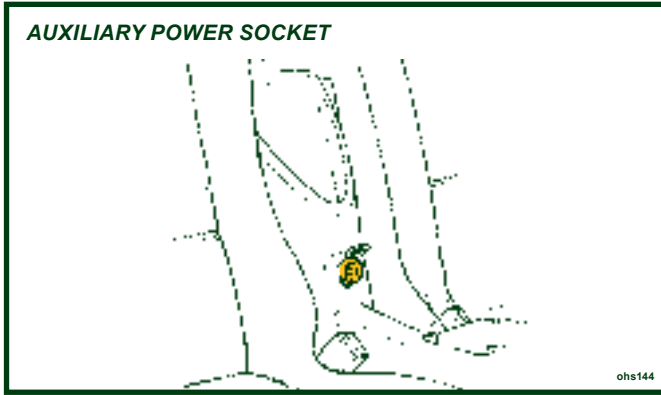

Auxiliary Power Socket

An auxiliary power socket is fitted in the centre trim shroud below the oddments pocket on the rear bulkhead. The socket is operative at all times, and is provided with a protective hinged flap.

The format of the socket allows a standard cigarette lighter element to be used, or other electrical accessories requiring this type of fitting. Maximum current draw should not exceed 15 amps.

⚠ WARNING:

Do not leave small children unattended in the car since careless interference with the power socket could be dangerous and result in burn injuries or the initiation of a car fire.

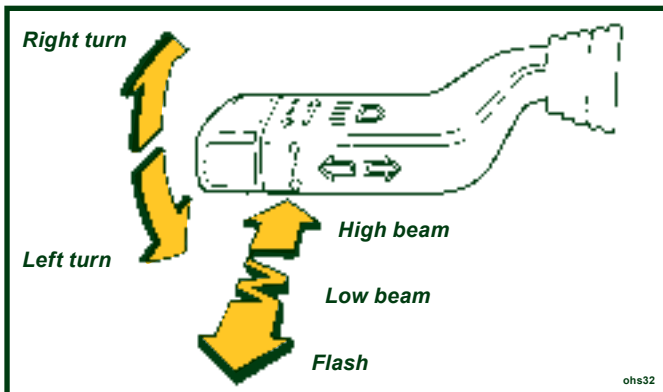

COLUMN SWITCHES & HORN

Headlamp High/Low Beam/Flasher/Turn Indicators

The steering column left hand lever switch controls the headlamps high and low beams, headlamp flasher and turn indicators.

Headlamp High/Low Beam: To switch on the headlamps, press the headlamp switch in the dashboard outboard of the steering column. The left hand lever switch is then used to select high or low beam. High beam is obtained with the lever furthest forward, away from the steering wheel, and low beam with the lever moved back towards the wheel. The high beam tell tale lamp in the instrument panel lights when high beam is operating.

Note that when high beam is selected, the low beam lamps remain lit.

NOTICE: The headlamps used on the Elise provide a beam pattern which differs from regular USA headlamps. Take a moment to familiarise yourself with the spread of light.

Headlamp Flasher: The headlamp flasher is operative at all times. The high beam lamps will light for as long as the lever switch is pulled towards the steering wheel against spring pressure.

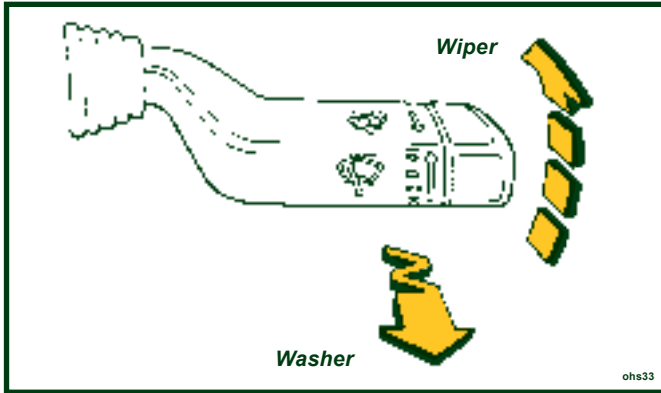

Turn Indicators: The turn indicators operate only with the ignition switched on. Move the lever down to indicate a left hand turn, and up for a right hand turn. The switch will be cancelled when the steering wheel is returned to the straight ahead position.

For convenience, when signalling a lane change, lightly pressing the switch up or down will allow its return under spring action.

Windscreen Wiper/Washer

The steering column right hand lever switch controls the windscreen wiper and washer, and is operative only with the ignition switched on.

NOTICE:

- Never use the wiper on a dry screen. This may overload the mechanism and/or scratch the screen.
- Ensure that snow is cleared from the windscreen before operating the wiper.

Windscreen Wiper: The wiper is controlled by the up/down position of the lever switch, which operates as follows:

- ⊙ Moved fully down, the wiper is switched off.
- ☐ Move up to the first position for intermittent wipe.
The wiper will make one sweep about every five seconds.
- ☐ Select the next position for normal wiper operation.
- ☐ Move fully upwards for quick wipe, to be used only in heavy rain.

HORN BUTTONS

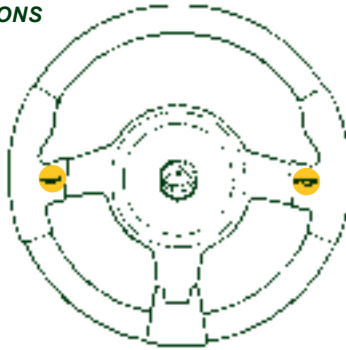

ohs150

Windscreen Washer: Two windscreen washer jets are provided, one each side of the wiper spindle. Pulling the control lever towards the steering wheel will operate both the washer pump and the wiper. When the switch is released, the wiper will continue for a further four sweeps.

Horn

The windtone horn, which functions at all times, is operated by a button, embossed with a bugle symbol, in each of the horizontal steering wheel spokes.

AUDIO EQUIPMENT

Operating instructions for the unit fitted are contained in a **separate booklet supplied by the equipment manufacturer**. The audio set will operate for convenience without the ignition key, so in order to avoid draining the battery, take care to switch off the set when leaving the car.

Aerial: An analogue di-pole type radio aerial is routed inside the front body for optimum performance, and to avoid the vandalism and accidental damage which may occur to external aerials.

Speakers: Two rear speakers, with 90W peak, 30W RMS, are mounted at each side of the cabin rear bulkhead trim panel. Front speakers, fitted beneath each side of the dashboard top panel are rated at 105W peak, 35W RMS.

Security: Some audio sets feature a removable front panel, and others a programmable security card. For details, refer to the manufacturer's literature.

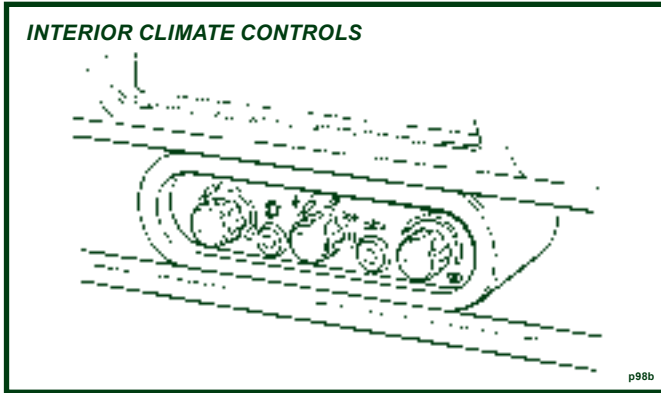

HEATING, VENTILATION & AIR CONDITIONING

The small size of the Elise together with the method of construction and emphasis on lightweight, have resulted in heating and a.c. systems which perform well under non-extreme climatic conditions. In extreme temperatures and humidity the operational limits of the systems may be reached before the desired temperature, or rate of temperature change inside the car is achieved.

The heating and ventilation controls comprise three rotary switches to regulate; heater temperature, fan speed and air distribution. Push button switches are provided for air conditioning and air re-circulation.

Air Conditioning

The left hand push button selects air conditioning, but the following conditions must first be met before the system will operate:

- The engine must be running;
- A fan speed must be selected;
- Ambient temperature must be above 3°C.

With a fully cold temperature setting, refrigerated air will be supplied. For dehumidified warm air, select air conditioning in conjunction with a warm temperature setting.

The tell tale in the switch button will light up blue when the circuit is active. Note that the a.c. will default to 'off' when the ignition is turned off.

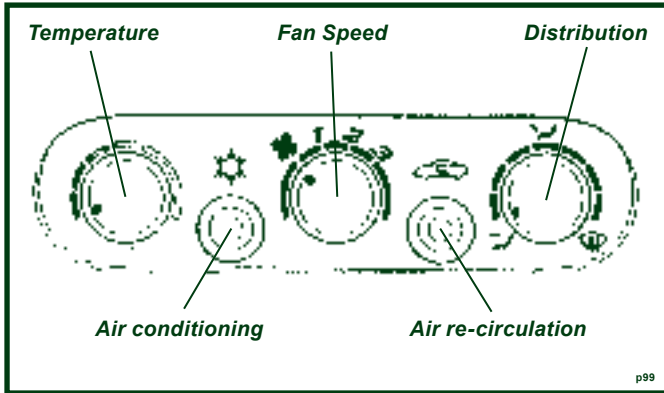

Air Re-circulation

The air supply for the interior climate system is normally drawn from both the car interior and from the fresh air intake duct ahead of the engine cooling radiator. When the re-circulation button is pressed, the fresh air intake port is closed down to provide 90% re-circulation air supply to the cabin interior. The re-circulation facility should be used when maximum refrigeration is desired.

The tell tale in the switch button will light up blue when the circuit is active.

Heater Temperature

With the left hand rotary control turned fully counterclockwise, no heating is provided. If cooled air is required, use this temperature position in conjunction with air conditioning.

Turning the control progressively clockwise provides increasing levels of heat until at the fully clockwise position, maximum heat is supplied.

Fan Speed

The centre rotary switch provides three fan speeds to boost air circulation. Turned fully counterclockwise, the fan is off; Turning the switch progressively clockwise operates the blower fan at increasing speed in three steps.

Note that the fan operates only with the ignition switched on.

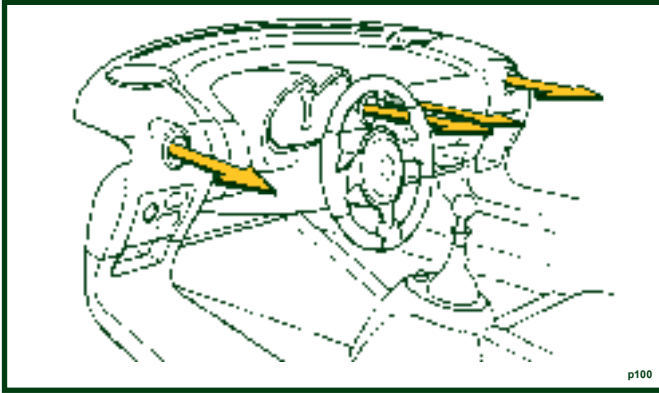

Air Distribution

The right hand rotary control determines the distribution of airflow to the various outlet vents. A few moments should be allowed for the flaps to operate following a new selection:

Face Level:

Turned fully counterclockwise, all airflow is directed to the four face level vents, each of which may be manipulated to adjust volume and direction.

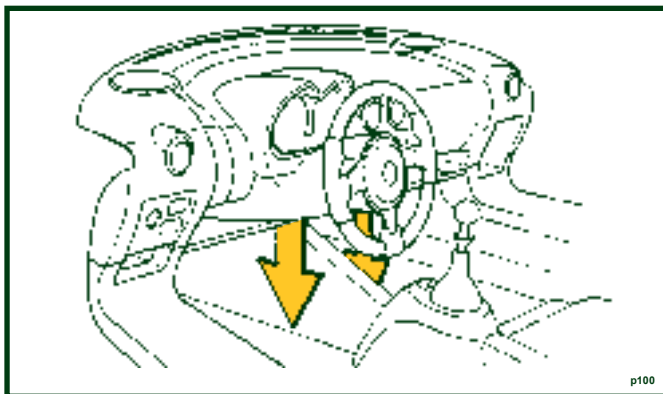

Footwell:

As the control is turned clockwise from the face level vents symbol towards the footwell symbol, an increasing proportion of airflow is directed towards the footwell vents.

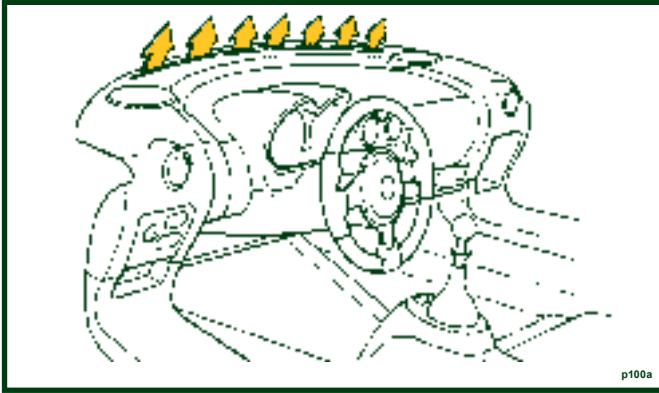

Demist:

As the control is turned clockwise from the footwell symbol to the windscreen symbol, more airflow is directed to the windscreen vents. Select a warm temperature setting and a suitable fan speed.

Full Defrost Performance

For maximum defrost performance, turn the distribution knob fully clockwise and select maximum temperature and fan speed. For optimum demisting in ambient temperatures above 38°F (+3°C), switching on the a.c. will help de-humidify the air directed to the screen.

Ventilation Shut-Off

To close off the ventilation, which you may want to do in heavy traffic to reduce fumes coming into the car, select re-circulation, turn off the fan, turn the distribution control fully counterclockwise to the face level vent position, and manually shut off each of the face level vents.

Engine Bay Ventilation

The engine bay is ventilated via intake ducts in the body sides and engine undertray, with outlet grilles provided in the engine cover and rear valance.

DRIVING CONTROLS

Foot Pedals

The clutch pedal, brake pedal and accelerator pedal are arranged in the usual positions, and are grouped closely together for ready access and refined driving technique.

⚠ WARNING:

Do not attempt to drive the car without suitable narrow soled, flat heeled footwear. Bare feet may inhibit the application of full pressure to the brake pedal, and adversely affect your control of the car. Bare feet could also suffer burns from sun heated metal surfaces in the car

Footwell Carpets

⚠ WARNING:

It is essential that any floor covering in the footwell is properly secured. Loose mats can interfere with the operation of the pedals causing possible loss of control and a crash in which you or others could be killed or seriously injured.

The carpets fitted in the footwells of the Elise are secured by two button screws at the rear, and Velcro strips beneath the front edge. Always ensure that the carpets are replaced and secured correctly, and never fit any loose mats on top.

Clutch Pedal

NOTICE:

- To avoid unnecessary clutch wear, do not, for more than a few moments, slip the clutch to 'hold' the car on a slope; apply the parking brake until ready to drive off.
- The clutch pedal must be fully depressed during each gear shift.
- Do not drive with the left foot resting on the clutch pedal, as rapid wear of the clutch components can result. A left foot rest is provided for comfort and convenience.

Footbrake

Ventilated disc brakes are fitted to all four wheels of the Elise. These are operated by separate front and rear hydraulic circuits, supplied from a tandem master cylinder with vacuum servo. Anti-lock control is provided by a microprocessor based electro-hydraulic unit, integrated into the base braking system.

The braking system is designed to provide good pedal feedback, with efficient disc cooling to inhibit brake fade. With a new car, or new brake system components, maximum braking efficiency will be achieved if, for the first few hundred miles, needless heavy braking is avoided. Allow the brake pads and discs to 'bed in' fully before using the brakes to their full potential. Pedal effort will reduce as the brakes are bedded in, and as they are warmed from cold to normal working temperature. Note that the hard grade pad material may give rise to a certain amount of brake noise under some conditions; such noise is not harmful and does not affect the life or efficiency of the brakes.

WARNING:

- **After driving through a ford, or a flooded road, some loss of braking response may be experienced until the brakes have dried out. As soon as it is safe to do so after such an encounter, apply the brakes until normal operation is restored. Failure to do so may result in an accident in which you or others may be killed or seriously injured.**
- **The brake assistance servo uses vacuum supplied from the engine intake plenum, such that assistance is available only when the engine is running. Never coast downhill with the engine stopped. If this situation accidentally arises, avoid repeated application of the brakes, or the stored vacuum supply will be rapidly used up. Greater pedal pressures will be required. This may adversely affect performance of the brakes which may result in an accident in which you or others may be killed or seriously injured.**

Anti-lock Brake System

The Anti-lock Brake System (ABS) is used to optimise brake performance in extreme conditions and reduce the potential for any wheel to lock up. Under most conditions, the maximum braking force is provided by a wheel which is rotating at about 90% of road speed. Apart from the likelihood of increasing the

stopping distance, a locked wheel provides little or no steering force, such that with both front wheels locked, movement of the steering wheel has no effect on car direction. With the anti-lock system, even panic braking results in controlled deceleration and the retention of steering response. ABS is especially advantageous when braking on slippery road surfaces and in bad driving conditions, but it is important to realise that the ABS cannot increase the friction level at the road surface, but can only make optimum use of the grip available.

⚠ WARNING:

When driving in adverse weather, or on poor road surfaces, always be alert to the possibility of slippery conditions and make the necessary allowance for increased stopping distances. Failure to do so may result in an accident in which you or others may be killed or seriously injured.

Normal braking, controlled by the pressure applied to the brake pedal, occurs when the road conditions allow for deceleration to be achieved without danger of wheel lock. The relative speeds of the four wheels are continuously monitored by the ABS when the brakes are applied, and if one or more wheels begin to lock, the brake pressure to that wheel(s) is modulated by the ABS to help keep the wheel rotating and provide the maximum controlled braking force. The wheels may appear to lock momentarily as the wheel speed rapidly changes, and some tire noise (intermittent screeching) may be heard which is normal and will vary with road and tire conditions. Note that the ABS does not function at speeds below 5 mph (7 km/h).

When the ABS is activated, the driver will feel a 'pulsing' sensation at the brake pedal as the fluid pressure is modulated, and also by audible clicking sounds. These signals indicate to the driver that maximum braking is occurring, and that driving style should be modified to suit the conditions.

The minimum stopping distance is achieved by applying the brakes firmly and steadily, and allowing the ABS to modulate hydraulic pressure. The driver should not attempt to emulate this process by 'pumping' the brake pedal, as modulation at the pedal will treat all four wheels similarly, rather than the individual wheel control allowed by the electronics.

An ABS tell tale lamp in the instrument panel is provided to warn of any problems in the system and to indicate that the

integral self diagnostics have switched out the anti-lock function. See 'ABS tell tale lamp'.

⚠ WARNING:

- The increased control that ABS provides should not induce you to take more risks with your safety. ABS will not prevent a skid caused by abrupt steering movements, or attempting to corner too quickly.
- Always maintain a safe following distance from other cars relative to the road surface and weather conditions. Obey all traffic laws.
- Risk of accidents due to inappropriate speed cannot be reduced even by ABS. The driver is responsible for the judgement of safe speed.
- The control unit of the ABS is set for standard tire size. If non-standard Tires are fitted, the control unit may misinterpret the speed of the car, because of the variant data it receives from the wheel speed sensors. Fitting non standard tires would seriously affect the performance of your ABS.
- The amber ABS tell tale in the instrument panel should light for about 4 seconds following ignition switch on, and then go out. If the lamp remains lit, or comes on whilst driving, a fault in the anti-lock brake system is indicated. The base brake system will continue to operate normally, but without ABS. The car can be driven but should be checked and repaired at the earliest opportunity.
- Activation of the ABS will vary according to the level of grip available at the Tires. On dry surfaces, activation will occur only with a high pedal pressure. On slippery surfaces, only a low pressure will be needed.
- On loose or uneven surfaces, such as gravel or snow, a car with ABS may need a longer stopping distance. Allow a greater distance between cars in these conditions.

PARKING BRAKE LEVER



ohs138

Parking Brake

The parking brake, which operates on only the rear wheels is applied by a hand lever mounted between the seats. A red tell tale icon in the instrument cluster warns of parking brake application (see 'Tell Tale Lamps').

The brake should be applied by pulling up the lever with high effort, and engaging the highest ratchet setting attainable. When parking the car on a slope take the additional precaution of leaving the transmission in first (facing downhill) or reverse (facing uphill) gear and steering the wheels towards the kerb.

⚠ WARNING:

If the parking brake is applied when the brakes are hot (e.g. after prolonged or frequent hard use), special care should be taken to ensure that the parking brake is securely engaged in order to allow for any potential brake force reduction as the discs cool. Failure to do so may result in the car rolling away and causing an accident in which you or others may be killed or seriously injured.

To release the brake, pull up the lever, press and hold the release button in the end of the handgrip, and lower the lever fully. Before driving off, always check that the parking brake has been fully released, as confirmed by the tell tale icon being turned off, or damage to the brake system may be caused.

Note that the parking brake uses a cable mechanism to apply the rear brake calipers, and is totally independent of the footbrake hydraulic circuit.

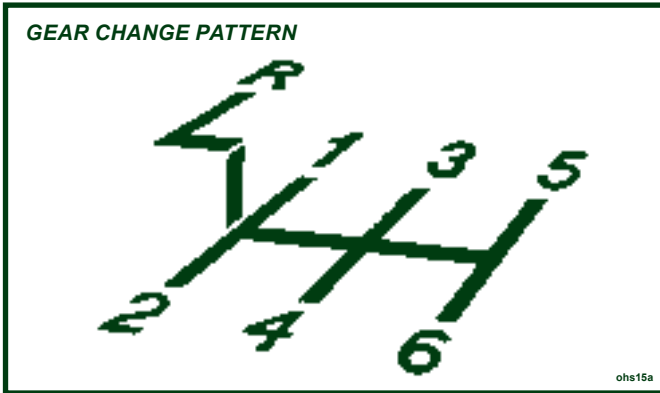

Gear Lever

The gear lever is spring biased towards the 3rd/4th gear plane, and must be moved against light spring pressure to the left before selecting first or second gear, or against similar pressure to the right before selecting 5th or 6th speed.

Engaging Reverse Gear: With the car at a complete standstill, pause for a moment with the clutch pedal fully depressed before moving the lever to the left, raising the lift collar beneath the knob, and then further to the left over a spring detent before finally pushing forwards to engage the gear.

When changing gear, it is essential that the transmission is not abused by 'power shifting'; the clutch pedal must be fully depressed during each gear shift, and the throttle pedal eased during upshifts.

NOTICE: Gearshifting without correct operation of the clutch and throttle controls can result in severe damage to the transmission and engine. Any damage caused by driving in this way will not be covered by the Limited Warranty.

STARTING PROCEDURE & ENGINE BREAK-IN

⚠ WARNING:

CARBON MONOXIDE - Be aware of the danger of carbon monoxide! Never run the engine in an enclosed space. The exhaust gases contain carbon monoxide, a deadly gas which is particularly dangerous, as being colourless odourless and tasteless, its presence is very difficult to detect.

Before starting the engine, always check that the parking brake is firmly applied, the transmission is in neutral, and as an extra precaution, depress the clutch pedal. Switch off any unnecessary electrical loads.

Starting a Cold or Warm Engine

The fuel injection and engine management system controls fuel delivery and engine settings under all normal operating conditions.

- i) Insert the key into the steering lock/ignition switch and turn to position 'I' to unlock the column. Before turning on the ignition; if the security tell tale in the tachometer face is flashing, mobilise the engine by pressing once, and for a full second, the larger of the two buttons on the transmitter fob.
- ii) Turn the key to position 'II' to switch on the ignition, and pause for a moment to allow the fuel system to prime.
- iii) Depress the clutch pedal as a precaution, and without moving the accelerator, press the 'Start' button at the left hand end of the dashboard to engage the starter motor. Release the button as soon as the engine starts. Allow a cold engine to idle for 10 seconds before driving off, but if ambient temperatures are below freezing, allow the engine and screen heating systems to warm up for a few minutes before driving.
- iv) If the engine fails to start within 15 seconds, stop cranking and pause for 10 seconds before a second attempt.
- v) If further efforts are unsuccessful, contact your dealer or seek other expert help.

⚠ WARNING:

An unattended car with a running engine is potentially hazardous. Turn off the engine before leaving the car.

NOTICE: The use of wide throttle openings and/or high rpm before the engine has reached normal running temperature will result in premature wear, and should be avoided.

Idle Speed

Engine idle speed is controlled electronically by the engine management computer, and is normally about 850 rpm. A raised idle speed is required under certain operating conditions including the engine warm up phase, when the increased speed helps the catalytic converter to reach operating temperature, as well as inhibiting engine stall. Idle speed will return to normal automatically when the engine has warmed sufficiently.

Engine Break-In

Although the Elise powertrain is built to close tolerances using modern technology, the progressive and sympathetic breaking-in (or bedding-in) of a new engine and transmission remains a major factor in attaining efficient operation with smooth, durable and economic performance to last throughout the life of the car.

NOTICE: Failure to comply with the following break-in provisions could invalidate the terms of the car warranty:

It is important during the car's early life to limit the workload on the engine and thus control the heat generated within it, which is primarily a function of throttle opening and rpm. However, being too sympathetic on the car will not allow the piston rings to bed in satisfactorily, so a balance of spirited and gentle use is required. For the first 600 miles (1,000 km), use no more than moderate throttle openings (about half of the available accelerator pedal travel) and do not run the engine continuously at engine speeds over 4,500 rpm. Occasional short bursts at wider throttle and higher rpm will be beneficial, as will a constantly changing cruising speed and making full use of the gearbox. Do not allow the engine to labour in too high a gear ratio, but change down and let the engine operate in its natural power band.

When changing gear, use only a light touch on the gear lever. Forcing the change will cause unnecessary wear on the system components and result in higher shift efforts being required. Allow the brakes to bed-in by avoiding needless heavy braking for the first 100 miles (160 km). Both gearchange and brake pedal

efforts are likely to reduce during the break-in process.

After 600 miles (1,000 km) have been covered, full throttle and/or maximum rpm may be used for short periods, but not until the first 'After Sales' service has been carried out should full car performance be exploited.

Note that various operating parameters are continuously monitored and recorded in the engine electronic controller. This data may be downloaded by Lotus dealers on demand to assist fault diagnosis and identify vehicle misuse.

Tires: New tires also require a short 'break-in' period before providing optimum grip.

Engine Special Features

The engine of the Elise is designated VVTL-i for 'Variable Valve Timing and Lift - intelligent'. Using microprocessor control, the inlet camshaft timing is advanced or retarded according to immediate operating conditions, and the lift of both inlet and exhaust valves is increased at high engine speed. This technology is used to provide high power output whilst retaining good low speed response.



EXTERNAL OPERATIONS

Fuel Requirement

USE UNLEADED PREMIUM GRADE GASOLINE.

Use only unleaded gasoline meeting ASTM specifications. Use of fuels not meeting ASTM specifications could cause poor performance and increase emissions.

For optimum car performance and fuel economy, the use of super or premium unleaded gasoline, with a minimum octane rating of 91 (RON+MON)/2 is recommended. Where super or premium fuel is not available, the Elise will operate satisfactorily on unleaded gasoline having a minimum rating of 87 (RON+MON)/2, but car performance and economy will be reduced.

Using fuel with a lower octane rating may cause knocking (pinking) which, if severe, can cause serious engine damage. Light knocking may occasionally be heard for short periods when accelerating or driving up hills, and this should cause no concern, although using a lower gear would be advised. If, however, you hear persistent heavy knocking when using the specified fuel, consult your dealer without delay.

The use of good quality fuels containing proper detergent additives is advised for good performance and emission control.

NOTICE: Do NOT use leaded fuel: damage caused by the use of leaded or other improper fuel is not covered by the New Car or Emission Control System Warranty. The effectiveness of the catalytic converter decreases after as little as one tankful of leaded fuel. Also, the car is fitted with a fuel injection system which includes an oxygen sensor. Leaded fuel will damage the sensor, and cause emission control to deteriorate.

Gasolines Containing Alcohol - Some gasolines sold at service stations contain alcohol although they may not be so identified. Use of fuels containing alcohol is not recommended, unless the nature of the blend can be determined as being satisfactory.

Gasohol - A mixture of 10% ethanol (grain alcohol) and 90% unleaded gasoline may be used in the Lotus Elise. If driveability problems are experienced as a result of using gasohol, it is recommended that the car is operated on gasoline.



Methanol - Do not use gasolines containing methanol (wood alcohol). Use of this type of alcohol can result in car performance deterioration and damage to critical parts in the fuel system. Fuel system damage and car performance problems, resulting from the use of gasolines containing methanol, may not be covered by your car warranty.

Fuels Containing MMT - Some North American fuels contain methylcyclopentadienyl manganese tricarbonyl (MMT), which is an octane enhancing additive. Such fuels may damage the emission control system and are NOT recommended.

Diesel - The Lotus Elise will not operate on diesel fuel.

Fuel Filling

WARNING:

- **Gasoline and its attendant fumes are highly explosive. You can be burned or seriously injured when handling fuel. Before stopping at a filling station, switch off mobile phones and other electronic equipment, ensure that all cigarettes are extinguished and that no naked flames or other potential ignition sources are present. Switch off the engine before refuelling.**
- **Remove the filler cap slowly to allow any pressure to bleed off gradually. Hasty removal may result in a small amount of fuel spray with a possible health or fire hazard.**

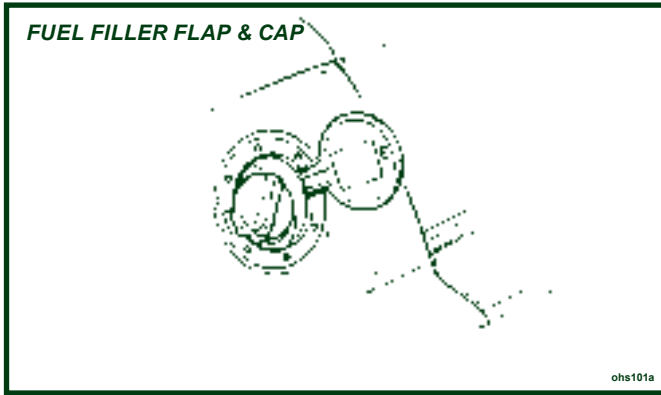

Filler Cap: The fuel filler cap is located in the right hand rear quarter panel, concealed beneath a spring loaded flap.

To remove, pull open the flap and turn the cap anticlockwise. As the cap is turned, any slight pressure differential between the tank and atmosphere will be released, and a brief hiss may be heard, which is completely normal. Note that the cap is tethered by a short strap to protect against loss.

To refit, place the cap into the filler neck and turn clockwise until the ratchet mechanism clicks several times. Push the flap closed.

Filling Procedure: Insert the pump nozzle fully into the neck, and fill until the auto-shut off mechanism is triggered. Do not attempt to 'brim' the tank to the top of the filler neck, as expansion of the fuel due to temperature change (cold underground fuel storage) may cause flooding of the fuel tank breather system charcoal canister, or spillage of fuel.

The useable fuel tank capacity is 10.6 U.S. gall. (40 litres).

REMOVING ACCESS PANEL



Front Service Access Panels

The front body has two removable access panels to allow servicing of the brake/clutch fluid reservoir and main fusebox.

To remove an access panel: Use the hexagonal key supplied in the car tool kit (in the battery cover rear pocket), to release the single threaded fastener securing the outboard corner of the panel, and withdraw the panel from the two locating holes in the front body spine.

Guard against the lightweight panel being blown away and damaged by a strong wind.

To refit a panel: Hook the extended lip on the front edge of the panel beneath the rear edge of the louvre panel before engaging the two locating pegs on the inboard side of the access panel with the holes in the front body spine. Fit the single screw at the outboard corner of the panel into the captive nut in the body, taking care not to cross-thread or overtighten the screw. Re-stow the hexagonal key in the tool kit.

⚠ WARNING:

Ensure the access panels are refitted and properly secured before driving.

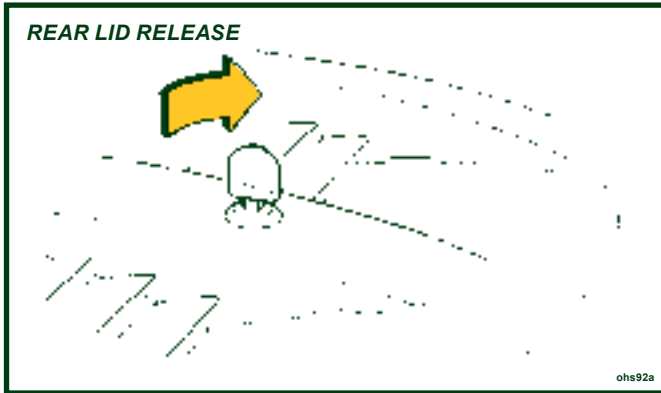

Engine Cover/Trunk Lid

The engine cover/trunk lid provides access to the engine and rear luggage compartment.

To open the lid: Insert the key into the lock and turn clockwise. When released, a spring plunger will lift the lid sufficiently to allow it to be raised fully by hand. Support the lid by engaging the prop provided on the trunk bulkhead, in the slotted plate adjacent to the latch mechanism.

⚠ WARNING:

- **When using the rear luggage compartment, beware of any hot surfaces exposed in the engine bay. Touching hot surfaces could cause serious burns.**
- **Before closing the lid, ensure that no persons or objects will be trapped.**
- **If necessary, protect and/or secure heavy objects as required.**

To close: Stow the support prop in its bulkhead clip, and, keeping fingers well clear of entrapment, and ensuring that no obstruction is present, lower the lid. Fully engage the latch mechanism by pressing down on the lid just forward of the key lock, NOT at the extreme rear end of the panel.

EMERGENCY RELEASE HANDLE(viewed from lid underside)



⚠ WARNING:

The maximum weight of goods which may be carried in the trunk is 110 lb (50 kg). Exceeding this limit can overload the Tires and affect the handling of the car, and result in a crash in which you or others could be killed or seriously injured. Refer also to the 'Tires' section in this handbook.

Child Entrapment

If a child should become trapped in the rear luggage compartment, an emergency internal release handle is provided to facilitate their escape.

To release the latch, pull the fluorescent handle on the underside of the lid.

Parents should decide if their children should be shown how to use this feature.

REMOVABLE ROOF CONCEPT

The Lotus Elise has been designed to exploit the pleasures of open top motoring, the better to enjoy exposure to the natural environment, without the restrictions and confinement of a cockpit roof.

In order to provide some weather protection to the occupants and car interior, and allow the continued enjoyment of the car in unfavourable weather conditions, a simple hard or soft top roof may be fitted. The constant changing of loads and strains to which a car is subject to when driving on roads, and the tolerances required to allow for repeated removal and refitting of the roof, means that minor wind noise, and seepage at joints between the roof, body and doors cannot be completely sealed in certain areas. Therefore small leaks are considered normal for this model.

NOTICE: Do not take the car through an automatic car wash. The soft top may suffer damage by the brushes or suffer leaks due to the high pressure water streams directed in areas which would not apply in normal driving conditions.

⚠ WARNING:

The soft or hard top roofs should be removed only whilst the car is safely parked. Do not attempt to remove the soft or hard top roof whilst the car is in motion.

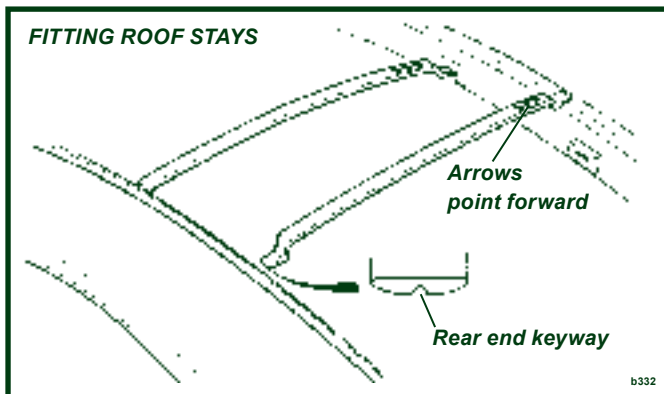

Soft Top Roof - Fitting

⚠ WARNING:

Do not attempt to fit the soft top roof whilst the car is in motion. This could cause a crash in which you or others could be killed or seriously injured.

1. From its stowage bag in the rear luggage compartment, withdraw the roof assembly and support stays. Lower both door windows, or open both doors.
2. Insert the two, identical, roof support stays, with the arrows pointing forwards, into the slots above the rear window, and in the windscreen header rail. Note that the slots are keyed to allow fitment of the stays in only the correct orientation.
3. Lay the soft top roof across the centre of the roof space with the arrows on the side rails pointing forwards.

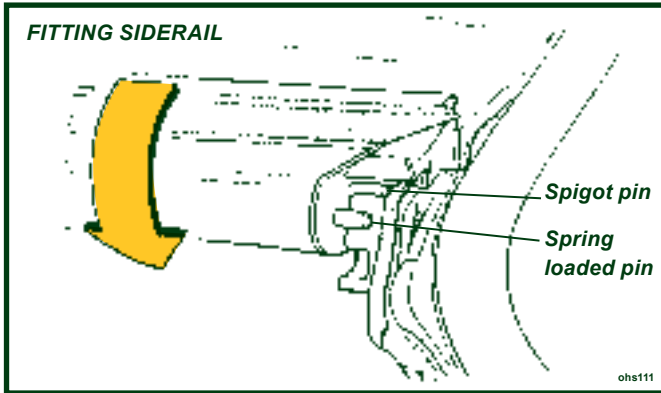

4. Roll out the left hand side of the roof, and engage the spigot pin on the front and rear end of the rail, into the uppermost slot in the latch blocks at the front and rear of the roof aperture.
5. Ensure that the tensioning cables at the front and rear edges of the roof canopy are correctly located in the channels between the seal and body before rotating the left hand side rail downwards. Ensure that both spring loaded pins 'click' into their ramped slots indicating that latching is complete. Pull up on the side rail to check security.
6. On the right hand side of the car, repeat steps (4) and (5) for the second side rail.

NOTICE: Engaging the left hand roof side rail first, will minimise the possibility of the canopy tensioning cable adjusters causing damage to the roof seals.

⚠ WARNING:

Before driving check that the roof is secure by pulling upwards on each end of both side rails. An improperly fitted or insecure roof could cause serious injury or death to car occupants or other road users.

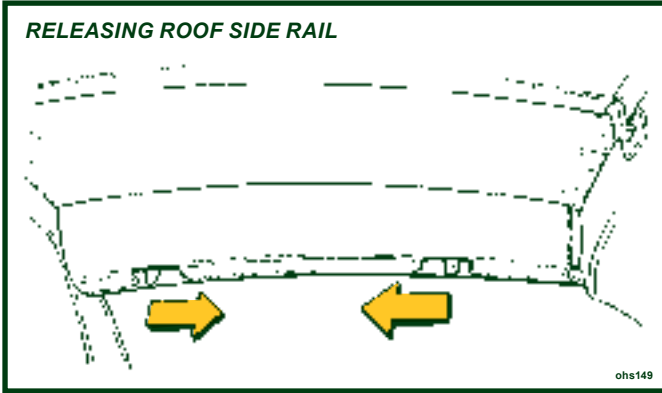

Soft Top - Removal

⚠ WARNING:

Do not attempt to remove the soft top roof whilst the car is in motion. This could cause a crash in which you or others could be killed or seriously injured.

1. With the car stationary, open both doors or lower both door windows.
2. On the inside face of the right hand roof side rail, locate the two latch release levers: Pull the two lever handles towards each other to release the side rail latches (press down on the side rail if necessary to relieve the load on the latch pins), and rotate the rail upwards to release the canopy tension.
3. Repeat step (2) for the left hand side rail.

NOTICE: Releasing the right hand roof side rail first, will minimise the possibility of the canopy tensioning cable adjusters causing damage to the roof seals.

4. Free the front and rear tensioning cables from the gutters before carefully rolling up each side of the roof canopy towards the centre. Lift the roof assembly off the car, and pack in the roof bag.

5. Unhook the two roof stays and pack in the roof bag. Stow the bag in the rear luggage compartment.

NOTICE: If the roof is not fully dry, it should be stowed for no longer than 1 or 2 days before unrolling or refitting and allowing to air dry completely. Prolonged stowage of a wet or damp roof will promote rotting of the fabric.

HARD TOP ROOF

NOTICE:

- The hard top roof has been designed to provide a seasonal, rather than single trip option. Some owners may prefer to entrust the fitting and removal of the hard top roof to their dealer.
- When stowing the roof off the car, care should be taken to avoid damage to the roof corners; e.g. use a suitable soft floor covering on which to stand the roof. Note that there is no provision for on-board hard top roof stowage.
- Fitment or removal of the hardtop is made considerably easier with the assistance of a second person.
- Use only the 'Torx' tool supplied in the car tool kit (in the battery cover rear pocket), to tighten or release the roof fixing screws.
- The hardtop roof fixings are tethered to the roof panel to guard against their loss.

⚠ WARNING:

Take care to avoid trapping hands or fingers when fitting or removing the hard top.

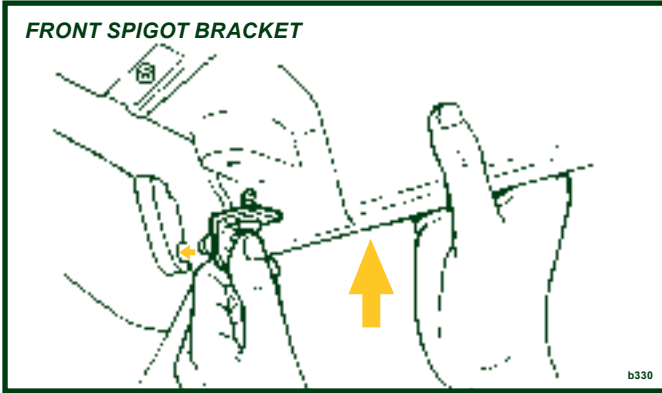

Hard Top - Fitting

1. Open both doors, and preferably with the aid of an assistant, lower the roof onto the car holding aside the loose tethered fixings to avoid their entrapment or their causing paint damage. Position the rear edge of the roof first before locating the front edge against the windscreen header rail.
2. Locate a front spigot bracket into its latch plate lower slot (lifting the roof slightly to allow this) and retain to the roof with the Torx bolt. Use only the special Torx tool supplied in the car tool kit (stowed in the battery cover pocket), and do not fully tighten at this stage.
3. Repeat step (2) for the opposite front spigot bracket.

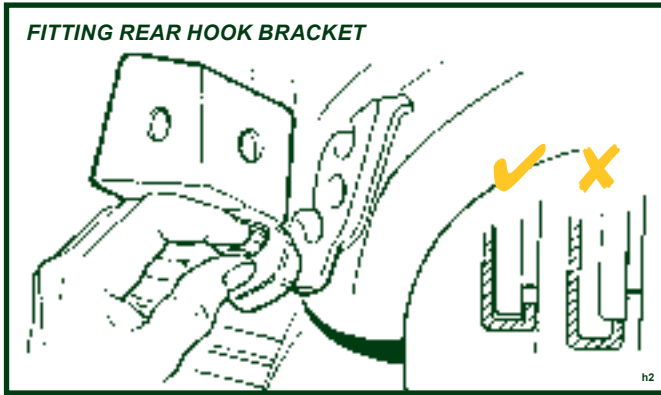

4. Engage a rear hook bracket with the lower tongue on its rear latch plate, and retain to the roof with the Torx bolt. Use only the special tool supplied, and do not fully tighten at this stage. Ensure that the hook is fully located onto the tongue.
5. Repeat step (4) for the opposite rear hook bracket.
6. Push the roof fully forwards before tightening the front spigot brackets using only the special Torx tool supplied. Hold each rear hook bracket in alignment whilst tightening the single fixing screw for each bracket. Do not overtighten.

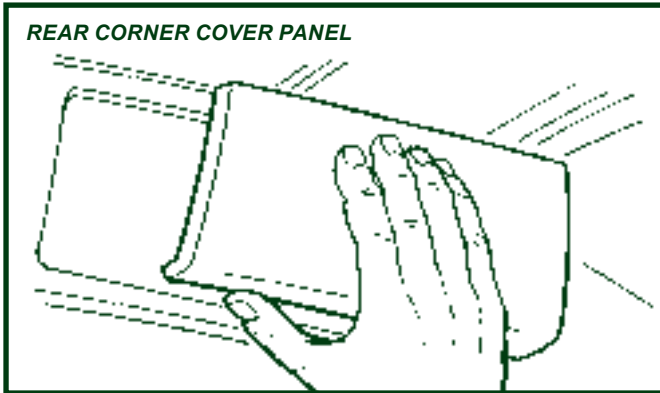

7. Fit the trimmed cover panels to each rear corner of the roof, noting that the panels are handed for left and right sides. Press the panels firmly into position fully to engage the 'Velcro' fixing patches.

⚠ WARNING:

Do not drive the car with the cover panels removed. Injury could result from contact with the roof brackets in a car collision.

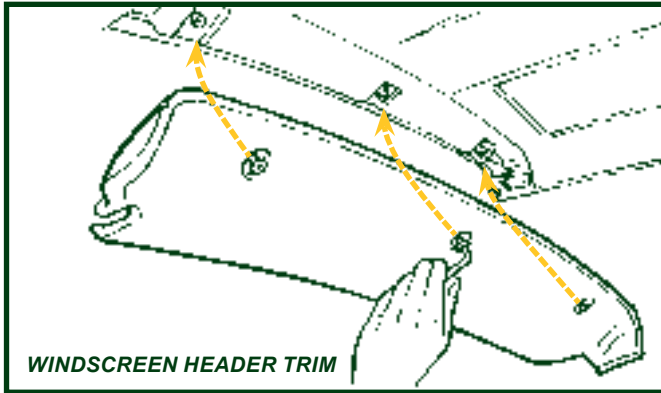

- Using the special tool provided, install the windscreen header cover panel by locating first with the central screw, and then by the outer screws before tightening in the same order.

⚠ WARNING:

- Do not drive the car with the trim cover panels removed. Injury could result from contact with the roof brackets in a car collision.
- Before driving check that the roof is secure by pulling upwards on each corner in turn. If any upward movement is evident, check the correct fitment of all mounting brackets. An insecure or incorrectly fitted roof could cause death or serious injury to other road users or a crash in which you or others could be killed or seriously injured.

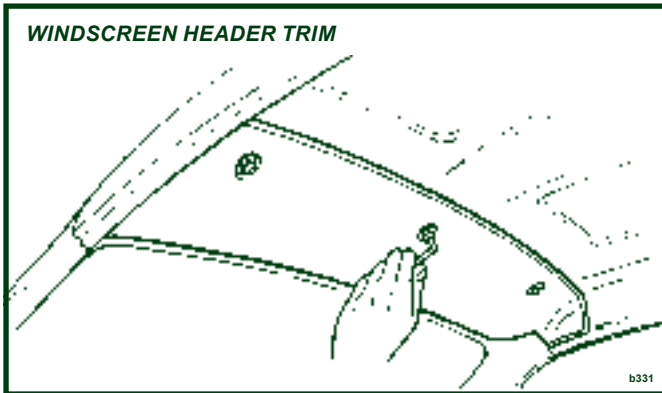

Hard Top - Removal

⚠ WARNING:

Do not attempt to remove the hard top roof whilst the car is moving. Serious injury or death could result from an unsecured roof panel.

1. Open both doors.
2. Using the special tool supplied, release the three Torx screws securing the windscreen header trim panel, and remove the panel.

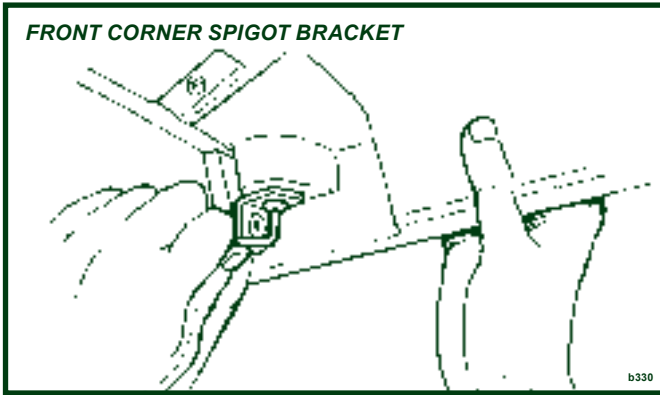

3. Using the special tool supplied, slacken the Torx screw securing each front corner spigot bracket to the roof, but do not yet remove the screws.

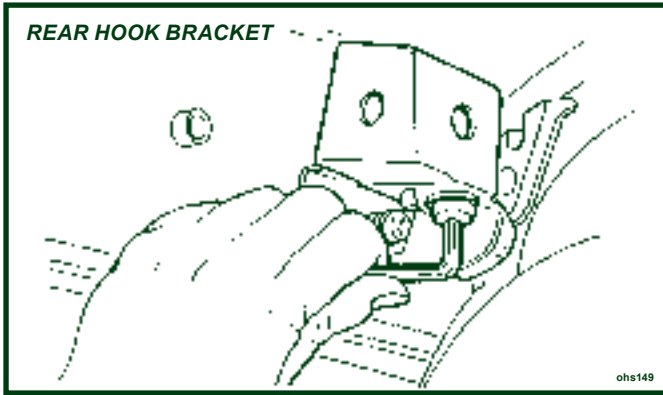

4. Pull off the trim cover from each rear corner of the roof panel and remove the screw securing the hook bracket to the latch plate at each rear corner.
5. Remove the two front corner bracket fixing screws and lift the front edge of the roof slightly to release the front brackets from their latch plate slots.
6. With the aid of an assistant, lift the roof from the car taking care to restrain the tethered brackets to avoid damaging the paintwork.
7. If storing the roof vertically, take care to avoid damaging the panel corners by using a protective floor covering.

SERVICING AND MAINTENANCE

BODYCARE

Body Features

Lotus are among the world leaders in the field of automotive composite moulding design and manufacturing techniques. Composite materials have major advantages for specialist car bodies, and these brief notes introduce some features of the construction and service properties of automotive composite bodies.

The manufacturing process enables the thickness of composite mouldings to be varied in order to provide efficient structures of high strength and low weight. Composites will not corrode, so the strength of composite components is retained regardless of age, unless physical damage is sustained. On the Elise, the body construction utilises several mouldings to form a single unit for the whole of the nose and front wings, and a second unit for the whole of the rear body aft of the doors. These two moulded assemblies are fixed using threaded fasteners to permit easy removal for access to chassis or powertrain components, or to allow simple and economic accident repair. Other composite mouldings include the door shells, sills, front access panels, windscreen frame and rear bulkhead, some panels being bonded to the aluminium alloy chassis with an elastomeric adhesive.

Several different processes are used to manufacture the various panels depending on the functional requirements, with the main outer panels using an injection compression moulding technique which eliminates the 'gelcoat' used on the outer surface of conventionally manufactured composite panels. This process provides considerably increased resistance to surface damage from minor knocks, where a conventional composite panel would suffer cracking of the gel coat, or a steel panel become dented. If severe damage is caused to a composite panel where the underlying structure is broken, repairs may take the form of panel replacement, or of panel repair using techniques where new composite material is integrated with the old to result in undiminished panel strength.

NOTICE: The Elise is not equipped with conventional separate shock absorbing bumpers, so extra care should be taken when parking to guard against body damage. The Lotus Elise does not offer the same kind and degree of impact resistance or energy absorption afforded by conventional U.S. bumper systems. Care is also required, due to the low ground clearance, to guard against car underside damage caused by ramps, kerbs and road humps.

Paint Care

The acrylic enamel finish of the Lotus Elise is extremely resistant to all normal forms of atmospheric attack. Following the simple maintenance procedure summarised below will help retain the gloss, colour and protective properties of the paint throughout the life of the car. However, car finishes are not immune to damage and amongst the more common causes of deterioration are:

- Atmospheric contaminants; dust, soot, ash, and acidic or alkaline aerosol mist can chemically attack paint.
- Abrasion; blowing sand and dust, or a dirty washing cloth.
- Tree sap and insect fluids; can form a water-insoluble polymer that adheres to the paint.
- Bird excrement; highly acidic or alkaline, they can chemically etch the paint. Wash off immediately.
- Leaves; contain tannic acid which can stain light finishes.
- Impact damage; granite chippings thrown up from poor or recently dressed road surfaces can subject the body to severe localised impact, and result in paint chips, especially around the vulnerable frontal panels. Do not follow other cars too closely in such circumstances. For optimum paintwork protection, Lotus recommends the use of a self adhesive film kit which your dealer will be pleased to supply and/or fit.
- Moisture entrapment; Long term use of a non-breathable car cover can trap moisture and/or induce condensation and promote water penetration of the paint film.

Ventilation

Water lying on the paint surface for a lengthy period will eventually penetrate the paint film. Although the effects will not be visible immediately, a deterioration in the protective properties of the paint film will ultimately result.

It is not recommended to store a wet car in a poorly ventilated garage. If good ventilation cannot be provided, storage outside on a hard standing or under a carport is to be preferred.

Paintwork Polishing

Eventually some loss of gloss, and an accumulation of traffic film, will occur. At this stage, after normal washing, the application of a good quality liquid polish will restore the original lustre of the paint film.

Higher gloss of the paint finish, and added protection against contamination, can be obtained by the use of a wax polish. However, this can only be used successfully on a clean surface, from which the previous application has been removed with white spirit or a liquid polish cleaner.

Washing

NOTICE: Lotus recommends hand washing of the painted bodywork. The car is a speciality sports vehicle not intended to go through an automatic car wash. Automatic car washing machines and jet wash facilities may have a detrimental effect on the paint film and the soft top. Use of automatic car washes will invalidate the terms of the Limited Warranty.

Many contaminants are water soluble and can be removed before any harm occurs by thorough washing with plenty of lukewarm water, together with a proprietary car wash additive (Household detergent and washing up liquid can contain corrosive salts, and will remove wax and accelerate oxidation). Frequent washing is the best safeguard against both seen and invisible contaminants.

Wash in the shade, and use a cotton chenille wash mitt or a sponge rinsed frequently to minimise the retention of dirt particles in the mitt or sponge. Use a straight back and forth washing motion to avoid swirled micro scratches, and rinse thoroughly.

In order to minimise degradation from road salt, the underside of the chassis should be rinsed with clean water as soon as possible after driving on treated roads. Many fuel filling stations offer pressure washing facilities ideal for this purpose, but do not use on the painted bodywork or soft top roof.

Soft Top Roof

1. Careful vacuuming of the soft top before washing may be helpful in removing excess dust and other foreign particles.
2. Wash in partial shade rather than strong sunlight.
3. Using only clean lukewarm water and a sponge (a chamois or cloth will leave lint, and a brush may abrade the threads), wash the entire soft top uniformly. Do NOT use a detergent, which may affect the waterproofing properties of the material.
4. Rinse the whole car to prevent streaking on the paintwork.
5. Remove surface water with a sponge and allow to air dry in direct sunlight. Ensure that the roof is fully dry before stowing, as prolonged stowage of a wet or damp roof will promote rotting of the fabric.

Keeping the soft top clean by regular washing will enhance the life and maintain the appearance of the roof, and facilitate subsequent cleaning. The use of stronger cleansers should be left to professionals experienced in handling this type of fabric as discoloration and degradation of the material may result. The application of wax finishes, dressings or preservatives may cause stains, and should be avoided. Your dealer will be able to advise on current Lotus approved soft top care products.

Windscreen Cleaning

When washing the windscreen, take care to lift the wiper blade only a small distance from the glass in order not to damage the wiper arm mechanism. Wash the wiper blade with clean water.

Alloy Road Wheels

It is recommended that the aluminium alloy road wheels are washed with the same preparation as is used to wash the bodywork. Use a brush having only nylon bristles. During the winter months, particularly when salt has been used on the roads for the dispersal of snow and ice, remove all the wheels, and wash thoroughly to remove all accumulated road filth from the wheels and Tires.

Be aware that on cars fitted with optional clear anodised forged alloy wheels (with 7 twin-spokes), the anodised surface finish may be attacked by some proprietary wheel cleaning products. Wash only using hot soapy water or car bodywork shampoo. Advise tire fitting companies accordingly.

Upholstery Cleaning

Cloth Trim: Normal cleaning consists of an occasional light wipe over with a cloth dampened in a mild soap and water solution; it is important that the cloth is only dampened, not soaked. Alternatively, a proprietary upholstery cleaner may be used.

Leather Trim: The leather should be wiped over occasionally with a cloth dampened in warm soapy water. Use a mild, non-caustic toilet soap or soap flakes. Repeat the operation using a fresh cloth and water only, but avoid flooding the leather. Finish by drying and polishing with a soft dry cloth. The manufacturers of the leather do not recommend the use of any hide 'food', and prohibit the use of petrol or detergents, furniture creams and polishes.

NOTICE: Lotus cars are upholstered with premium quality leather specifically tanned and dyed for automotive use. As a natural material, leather ages in various ways and may, over time, exhibit signs of cracking, scuffing, shrinking, etc. Such wear is not an indication of a defect, but rather the natural maturing of the leather.

Seat Belts Cleaning

The seat belts may be sponged with warm water and should be allowed to air dry naturally before use. Do not use chemical cleaners and never attempt to bleach or dye the webbing.

Footwell Cleaning

Each time the car is washed, the footwell carpet mats should be lifted and the floor surface cleaned and dried.

NOTICE: Use only correctly retained Lotus approved carpet mats in the footwells. Floor coverings made from plastic or other non-breathable materials may trap moisture and initiate surface corrosion of the footwell floors. Any damage caused by the use of incorrect mats will not be covered by your Limited Warranty.

OWNER MAINTENANCE

Remember that fuel consumption and wear and tear of the car are affected considerably by the way the car is driven and maintained. Be sure to carry out the simple maintenance checks detailed below, and to have your car serviced regularly by your Lotus dealer, in order to ensure maximum safety, reliability, longevity and pleasure of ownership.

NOTICE: Failure to follow and comply with the Maintenance Schedule may invalidate the terms of the warranty.

The Lotus Elise has been designed as a road going sports car. It is recognised that owners may wish to use the car occasionally on closed circuit tracks to experience the car's full range of dynamic capabilities. However, use of the car in a competitive manner, including timed runs or laps, is not endorsed by Lotus. Using the car on the track may cause a greater degree of wear and tear on parts and such wear and tear on parts and components will not be covered by your Limited Warranty.

⚠ WARNING:

Any type of timed, competitive car use will invalidate warranty and require appropriate levels of expert car preparation and servicing.

⚠ WARNING:

- **Attempts at car servicing with inadequate knowledge, tools or equipment, could result in car damage as well as endangering you, your passenger and other road users. Consult your Lotus dealer in all cases of doubt.**
- **Beware of hot surfaces in the engine bay. You could be seriously burned if you touch a hot engine part.**
- **Take great care not to drop flammable liquids or objects onto a hot engine and start a fire.**
- **Ensure that only Lotus dealers or suitably qualified technicians work on the airbag system.**
- **Beware of rotating engine components; to avoid injury, guard against entrapment of tools, body parts and loose clothing.**
- **The front mounted electric fans can start up and cause injury even when the engine is not running. Keep tools, hands and clothing well away.**

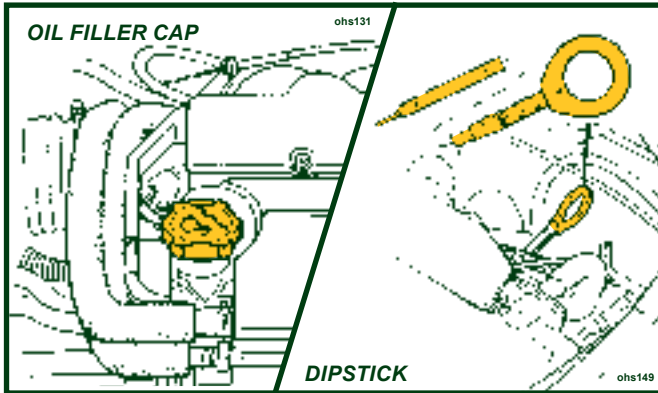

Engine Oil Level Check

⚠ WARNING:

- Engine oil is hazardous to your health and may be fatal if swallowed.
- Use protective gloves to avoid contact with skin as far as possible and wash thoroughly after any contact.

The engine oil level should be checked regularly, such as every two or three fuel stops, and the oil level maintained near the top mark on the dipstick. It is especially important to keep a check on the oil level during the car's first 1,000 miles (1,600 km), as both the fuel and oil consumption will be prone to some variance until the engine components have bedded in.

The best time to check the level is when the oil is warm, such as during a fuel stop. Ensure that the car is parked on a level surface and that a few minutes have elapsed since stopping the engine to allow oil to drain back into the sump. If the engine is stopped before reaching normal running temperature, the oil will not drain back so readily, and the dipstick will display an artificially low reading.

Dipstick: The dipstick is identifiable by its yellow loop handle, and is located at the right hand front of the engine. Withdraw the dipstick, and wipe with a paper towel. Replace the dipstick, if necessary feeding the blade into the tube with the towel, before

pressing firmly to ensure that the handle is fully seated. Withdraw the dipstick again to inspect the oil level, which should lie between the two dimples on the end of the stick. The oil level should be maintained at the upper of these two marks in order to provide optimum engine protection.

Topping Up: If topping up is necessary, unscrew the oil filler cap from the left hand end of the cam cover. Add a suitable quantity of the recommended engine oil (see 'Recommended Lubricants') taking care not to spill any oil onto engine or electrical components; use a funnel if necessary.

The difference between high and low dipstick marks is equivalent to 1.6 U.S. quarts (1.5 litre). Allow several minutes for the oil to drain through to the sump before re-checking the oil level. Do NOT overfill, or lubrication will be degraded and consumption increased as the oil becomes aerated. Refit the filler cap, turning clockwise until secure.

Engine Oil Change

The use of high quality oil, renewed at the specified intervals, is the key to engine longevity and sustained performance. Adhere strictly to the engine oil and filter change intervals specified in the Maintenance Schedule.

For access to the engine sump and filter, the engine bay undertray must first be removed. This is most easily achieved with the car raised on a garage hydraulic lift, or alternatively, parked over an inspection pit.

The drain plug is located at the rear of the sump, and should be removed to drain the sump immediately after a run when the oil is warm and the impurities are still held in suspension. On cars fitted with front mounted oil coolers, it is not necessary routinely to attempt to drain the cooler circuit.

⚠ WARNING:

- Engine oil is hazardous to your health and may be fatal if swallowed.
- Take all suitable precautions to guard against scalding from the hot oil.
- Prolonged and repeated contact with used engine oil may cause serious skin disorders, including dermatitis and cancer.
- Use protective gloves to avoid contact with skin as far as possible and wash thoroughly after any contact.
- Keep out of reach of children.

Allow the oil to drain completely before cleaning the drain plug, fitting a new sealing washer, and tightening securely. Refit the undertray.

Refill with the recommended lubricant (see page 153) via the oil filler on the camshaft cover, to the top mark on the dipstick, allowing several minutes for the oil to drain through to the sump before checking the level. Take care not to overfill. Refit the oil filler cap securely, and check the oil level again when the engine is fully warm (see above).

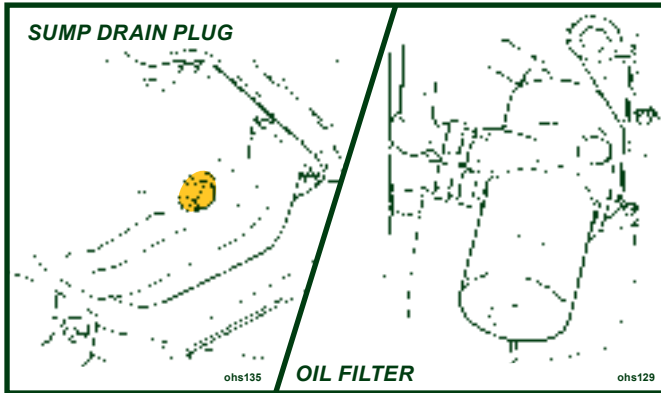

Oil Filter

The canister type oil filter is vertically mounted at the front of the engine, and is accessible from beneath after removal of the engine bay undertray. The filter should be renewed along with the engine oil, at intervals specified in the Maintenance Schedule.

⚠ WARNING:

- Engine oil is hazardous to your health and may be fatal if swallowed.
- Take all suitable precautions to guard against scalding from the hot oil.
- Prolonged and repeated contact with used engine oil may cause serious skin disorders, including dermatitis and cancer.
- Use protective gloves to avoid contact with skin as far as possible and wash thoroughly after any contact.
- Keep out of reach of children.

Remove the filter by turning in a counterclockwise direction, if necessary using an oil filter wrench, and dispose of safely (see 'Used Engine Oil').

Ensure that only a Lotus specified filter is fitted, as parts with identical outward appearance can contain different internal features. Before fitting a new filter, clean the mating face on the engine, and smear the new seal on the filter with clean oil. Add

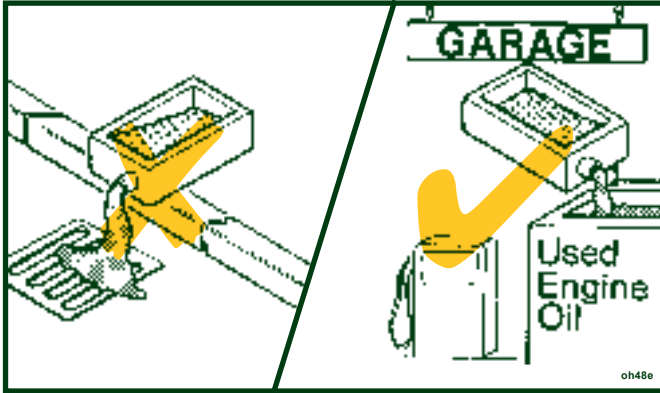

a small amount of clean engine oil into the filter, screw onto its spigot and tighten **BY HAND** sufficiently to make a secure seal, typically $2/3$ to $3/4$ of a turn after the sealing faces have made contact. Overtightening using a filter wrench may damage the canister and/or complicate subsequent removal.

Before refitting the undertray, start the engine and check for oil leaks. Re-check the security of the filter, further tightening by hand if necessary. Check the oil level (see above) when the engine is fully warm.

Used Engine Oil

NOTICE: PROTECT THE ENVIRONMENT: Do not pollute drains, water courses or land with oil. Use only authorised waste collection facilities, including civic amenity sites and garages providing facilities for disposal of used oil and used oil filters. If in doubt, contact your local authority for advice on disposal.

Transmission Oil

The transmission should be checked for oil leaks, for the correct oil level, and the oil renewed, at intervals specified in the Maintenance Schedule.

To check the oil level:

- A garage lift or inspection pit must be used.
- Remove the engine bay undertray.
- Wipe clean the area around the socket headed level plug on the front face of the transmission end casing.

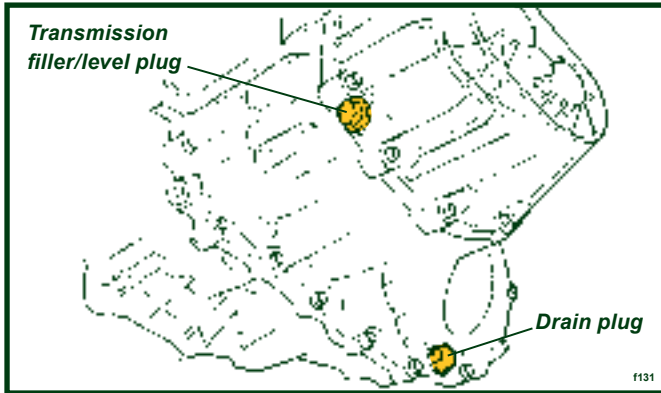

- Remove the plug, and check that the oil is level with the bottom of the hole. Note that the release of oil trapped by the plug, should not be confused with an indication of correct oil level.
- If necessary, add only the specified lubricant (see 'Recommended Lubricants') via the level plug hole until the oil level stabilises at the bottom of the plug hole.
- Refit the level plug with a new sealing washer, and tighten securely. Refit the undertray.

To renew transmission oil:

⚠ WARNING:

- Engine oil is hazardous to your health and may be fatal if swallowed.
- Take all suitable precautions to guard against scalding from the hot oil.
- Prolonged and repeated contact with used engine oil may cause serious skin disorders, including dermatitis and cancer.
- Use protective gloves to avoid contact with skin as far as possible and wash thoroughly after any contact.
- Keep out of reach of children.

- The hexagon headed drain plug located at the bottom of the final drive casing, should be removed immediately after a run when the oil is warm, taking suitable precautions against scalding.
- Clean the plug, fit a new sealing washer and refit securely.
- Refill to the level plug hole as detailed above.

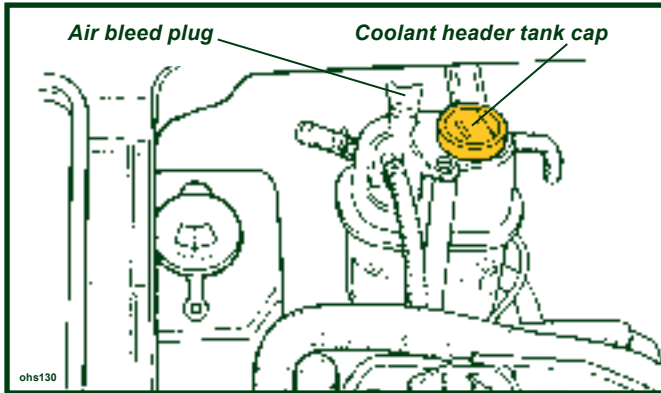

Cooling System

The engine cooling system uses a header tank to ensure that the system remains completely filled, and also to accommodate expansion of the coolant with increasing engine temperature. The tank is mounted at the left hand side of the engine bay, and is fitted with a 108 kPa (15 psi) pressure cap to raise the boiling point of the coolant to over 120°C (250°F).

⚠ WARNING:

- Do NOT attempt to remove the pressure cap or air bleed plug from the header tank when the engine is warm as serious scalding could result from boiling water and/or steam.
- Coolant is hazardous to your health and may be fatal if swallowed.
- Keep coolant out of reach of children.
- Coolant is hazardous to animals and may be fatal if swallowed. Clean up spilled coolant and do not leave in open containers.

The level of coolant in the translucent header tank will rise as the engine warms up, and fall as it cools down, and under normal circumstances it should not be necessary to add any coolant to the system between services. If overfilled, the excess coolant will be ejected when the engine is warm. If underfilled, overheating may result.

As a precaution, every week when the engine is completely COLD, and without disturbing the filler cap, check that the level of coolant in the translucent tank is between the 'FULL' and 'LOW' marks moulded on the front of the tank. If topping up is required, wait until the coolant has fully cooled before turning the cap a quarter turn counterclockwise and allowing any remaining pressure to escape. Only then may the cap be completely unscrewed.

In order to maintain protection from freezing damage and metal corrosion, use only an approved coolant mixture (see below) to top up the tank to the 'FULL' mark. Refit the cap, and turn clockwise until the leg on the cap locates in the slot at the front of the tank.

NOTICE: If the cap is removed when the engine is warm, the coolant may boil and a small coolant loss may occur. The completely cold header tank level should be checked at the first subsequent opportunity.

Cooling Fans: Two cooling fans are fitted below the radiator in the air intake duct. The fans are energised at high coolant temperatures, or when the air conditioning (if fitted) is selected. The fans will also run if certain types of engine fault are detected, and may operate during a 20 minute period following ignition switch off to prevent 'hot soak' boiling. An electric coolant circulation pump may also be heard running during this period.

⚠ WARNING:

Keep hands, tools and clothing away from the radiator cooling fan area, as personal injury could result from the fans starting up without warning.

At service intervals, the air duct and matrices of the engine cooling radiator, a.c. condenser and oil coolers, should be checked externally for clogging by insects, leaves or other debris, and if necessary, a water jet used to clear the finning. Take care not to damage or distort the delicate finning of the radiator or the cooling performance will be degraded.

Anti-Freeze/Corrosion Inhibitor

It is most important that the correct coolant specification is used in order to inhibit boiling and protect the engine and heat

exchangers from both frost damage, and metal corrosion. The Elise is factory filled with a 50% concentration of Havoline XLC Extended Life Coolant, which contains Organic Acid Technology (OAT) based corrosion inhibitors to provide long coolant change intervals combined with freedom from environmentally damaging phosphates, silicates and nitrites.

NOTICE: No other type of coolant should be mixed with this OAT coolant.

Havoline XLC may be identified by its orange colouration, and by a label around the header tank filler neck. The 50% concentration provides freezing protection down to -40°F (-40°C), and is recommended to be maintained throughout the life of the car. Stronger concentrations should not be used.

In an emergency, if an OAT coolant is not available, the cooling system should be topped up using water only, but the reduction in freezing protection should be recognised, and the concentration corrected promptly. In areas where the tap water is extremely hard (exceeding 250 parts per million), distilled, de-ionised or filtered rain water should be used for the water content of the coolant mix.

The effective level of ethylene glycol (anti-freeze) in the system may be measured by your dealer using a hydrometer, but in order to ensure that the required level of corrosion protection is maintained, the coolant should be renewed every 4 years.

For coolant capacity, refer to 'Recommended Lubricants' and 'Technical Data'.

NOTICE: Using an incorrect coolant mixture may result in expensive damage to your engine and/or other car parts caused by overheating, freezing or corrosion effects. This damage would not be covered by your new car warranty.

Coolant Drain/Refill Procedure

The cooling system of the Lotus Elise has been carefully optimised to allow the required cooling performance using the minimum volume of coolant. This provides for high cooling system efficiency, with quick engine warm up and interior heating.

When refilling the cooling system, it is vital to ensure that the correct bleeding procedure is followed, and that no air pockets remain. This operation should be entrusted to your Lotus dealer.

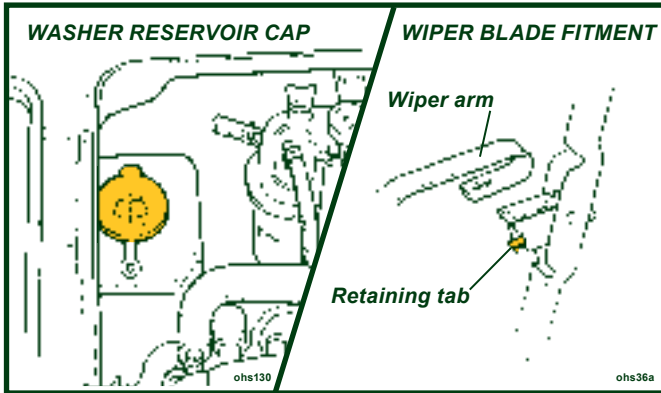

Washer Reservoir

The windscreen washer reservoir is situated at the left hand rear of the engine bay, and should be kept topped up with clean water and a suitable proprietary solvent.

NOTICE: Do NOT use radiator antifreeze in the reservoir as this could seriously damage the paintwork and/or some plastic components.

The washer jets are mounted each side of the wiper spindle, and may, if necessary, be cleared or adjusted using a suitable pin.

Wiper Blade

To replace the single wiper blade, lift the arm away from the screen, swing the blade through 90°, depress the retaining tab and slide the blade down the arm to unhook and release.

When refitting, ensure that the retaining clip is re-engaged in the wiper arm slot.

BRAKE FLUID RESERVOIR CAP

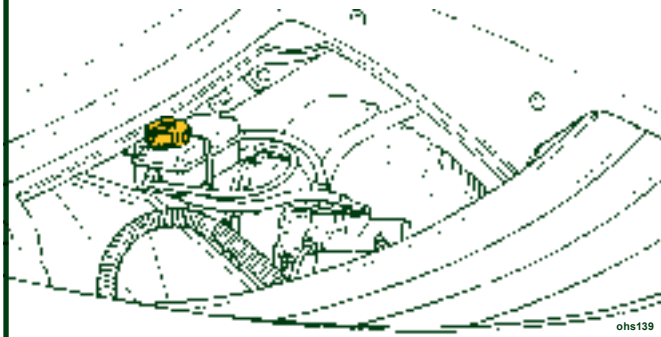

Brake Fluid Reservoir

Under normal circumstances, there is no requirement for routine 'topping up' of the brake master cylinder reservoir. A visual safety check is all that is required.

Every week, check the level of fluid in the brake fluid reservoir located in the driver's side of the front services compartment, beneath the access panel: Without disturbing the filler cap, check that the level lies between the 'MAX' and 'MIN' marks moulded on the translucent reservoir body. As the brake pads wear, the level will drop gradually from the 'MAX' mark towards the 'MIN', but if the level drops rapidly over a short period, have your Lotus dealer investigate without delay. If the level is found to be below the 'MIN' mark, it is likely there has been some fluid loss, and that air will have entered the hydraulic system. The car should not be driven until the fault has been investigated and rectified. Note that a single reservoir is used to supply both of the independent hydraulic circuits for the front and rear brakes, and also serves the hydraulic clutch release circuit.

If any fluid is to be added, first clean the surrounding area to guard against dirt ingress before unscrewing the reservoir cap.

NOTICE: Spilled brake fluid can seriously damage the car's paintwork and some plastic components, for example, the side marker lamps. Take suitable precautions to protect the paintwork from contamination, and in case of spillage, rinse the affected area with water immediately: **DO NOT WIPE.**

Use only a non-mineral type DOT 4 brake fluid from a sealed container marked with a yellow and black (non-mineral) symbol. Do not use DOT 5 silicone fluid, or any fluid which has been exposed to the atmosphere for more than a brief period, or any fluid suspected of being wet, dirty or contaminated. Do not overfill, and replace the cap securely.

Brake fluid, being hygroscopic, absorbs water from the atmosphere over a period of time, resulting in a lowering of the boiling point of the fluid, and corrosion of the hydraulic system. For optimum safety and brake performance, the brake fluid should be renewed every twelve months by your Lotus Dealer.

⚠ WARNING:

- **Brake fluid is hazardous to health and may be fatal if swallowed. Keep out of children's reach.**
- **Using the wrong type of brake fluid can damage brake system components and result in brake failure causing a crash in which you and others could be killed or seriously injured. See 'Recommended Lubricants'.**

Brake Pads

The thickness of the brake pad lining material should be checked at every service, and under no circumstances be allowed to fall below 0.1 inch (2.5 mm). If the brakes are in very frequent or arduous use, as when driving in mountainous terrain, or on race circuits, it is recommended that they be examined more frequently. The pads should be renewed if of insufficient thickness to ensure safe braking until the next scheduled service.

Note that in order to ensure that brake pads with the correct material specification are used, only genuine Lotus replacement parts should be fitted, and in the interests of safety, pad renewal should be entrusted to your Lotus dealer.

⚠ WARNING:

Using incorrect brake pads, or pads below 0.1 inch (2.5mm) thickness, may cause a crash in which you or others could be killed or seriously injured.

With a new car, or new brake system components, maximum braking efficiency will be achieved if, for the first few hundred miles, needless heavy braking is avoided, and the brake pads and discs are allowed to 'bed in' fully before being used to their full potential (see also 'Footbrake').

Brake Pipes & Hoses

At the recommended service intervals, the brake pipes and flexible hoses should be carefully examined for signs of damage, corrosion or perishing, especially in territories where salt is used on the road surface in the winter months.

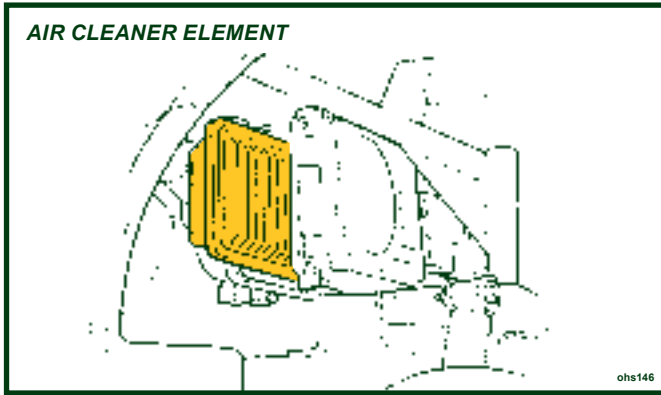

Air Cleaner Element

The air filter should be inspected at intervals dependent on the operating conditions. When the car is operated in a relatively clean environment, the element should be renewed at intervals specified in the Maintenance Schedule, but where a dusty or smog laden atmosphere prevails, or other factors contribute to filter contamination, more frequent replacement will be required dependent on the level of pollution.

A disposable folded paper type air cleaner element is fitted in a housing at the left hand front of the engine bay. For access to the element, the left hand rear wheel and wheelarch liner must first be removed so this operation is best entrusted to your dealer. Before opening the air cleaner housing, the wheelarch area should be cleaned to reduce the possibility of filter or housing contamination with road dirt.

To open the filter housing, release the two spring clips at the outboard end of the housing, and hinge open sufficiently to allow the element to be removed. If necessary, remove the air intake scroll for improved access.

Clean the inside of the housing, including the joint faces, taking care not to contaminate the 'clean' engine side of the assembly. Fit the new filter element into position with the shallow side towards the engine, and taking care to ensure that the two hinges of the filter housing are properly mated, and that the filter is seated correctly, close the housing and secure with the two spring clips. Refit the wheelarch liner and rear wheel.

Auxiliary Drive Belt

A single, multi-rib type auxiliary belt is used to transmit drive from the crankshaft to the alternator, water pump, and (if fitted) air conditioning compressor. The belt is automatically tensioned, and requires no periodic maintenance other than a visual check of its condition. If the belt exhibits any evidence of physical damage, cracking, fraying, perishing, abrasion or contamination, it should be renewed. In the case of contamination, the cause must be identified and rectified, and each of the pulleys must be thoroughly degreased before the new belt is fitted.

It is recommended that auxiliary belt replacement be entrusted to your Lotus dealer.

Sparking Plugs

The Elise uses a direct ignition system with an individual high tension coil mounted atop each of the four spark plugs and protected by a plastic cover, screw fixed to the engine.

⚠ WARNING:

The voltages produced with this ignition system can cause serious and potentially fatal injury. Never touch any ignition components when the engine is running or being cranked.

The spark plugs should be renewed in accordance with the Maintenance Schedule, with the gaps set to 0.043 in. (1.1 mm). This operation should be entrusted to your Lotus dealer.

TIRES AND WHEELS

Tires

Glossary of Terms:

Recommended inflation pressure: The cold tire inflation pressure which is recommended for this car and is specified in the 'Technical Data' section of this handbook.

Cold tire inflation pressure: All tires must be cold, meaning that the car has been stationary for a minimum of 3 hours, or has been driven less than 1 mile. Adjust pressures only in ambient conditions.

Maximum inflation pressure: The maximum inflation pressure to which the tire should be subjected. For the Elise, use only the recommended inflation pressure.

Lotus engineers have worked with tire manufacturers to produce tire specifications for the Elise which optimise performance on both road and track. To ensure that any replacement tires are to the correct Lotus specification, always refer to your Lotus dealer, who will have the latest recommendations.

⚠ WARNING:

In order to achieve the optimum handling characteristics, the wheel and tire sizes on the Elise are different front and rear. This means that interchanging of wheels and tires between axles is not permissible. Failure to adhere to this requirement will adversely affect the handling of the car and may result in an accident in which you or others could be killed or seriously injured,

The tires should be regularly inspected for signs of cuts, abrasions or other damage, and for any uneven tread wear patterns. Uneven treadwear may indicate that the suspension geometry or dampers require attention from your dealer.

NOTICE:

- On cars used on a race track or in a competitive manner, special vigilance is required due to the severity of tire operating conditions, with careful inspections carried out between sessions.
- Take care when parking to avoid tire contact with high or sharp edged kerbs. Such mistreatment can cause internal damage to the tire structure and this may not be readily apparent. The wheel rims may also be distorted or damaged by careless parking, and result in wheel imbalance or loss of tire pressure. Similar damage may also be caused by potholes, rocks or other highway debris.

⚠ WARNING:

- **Damage to wheels and tires may cause an accident in which you or others may be killed or seriously injured. If the wheels or tires have been damaged, have them replaced.**
- **Safety considerations should always be paramount when assessing tire condition and serviceability, and the tires replaced if any doubt exists, or if the legal tread depth limits are approached.**
- **Poorly maintained and improperly used tires are dangerous.**
- **Overloading your tires can cause overheating as a result of too much friction. You could have a blow out and a serious accident in which you could be killed or seriously injured. See 'Tire Placard Label'.**
- **Underinflated tires pose the same danger as over loaded tires. The resulting accident could cause serious injury, or death. Check all tires frequently and maintain at the recommended pressure. Tire pressures should be checked only when the tires are cold.**
- **Overinflated tires are more likely to be cut, punctured or broken by a sudden impact - such as hitting a pothole. Keep tires at the recommended pressure.**
- **Installing improper tires on your car can affect handling and stability. This can cause a crash in which you can be killed or seriously injured.**

Always use the size and type of tires recommended in this handbook.

- **Using incorrect tires or tires which are excessively worn or improperly inflated can cause a crash in which you can be killed or seriously injured.**
- **Please note your car is not fitted with a low tire pressure tell tale lamp so it is especially important that you regularly check the tire pressures.**

When driving on wet roads, surface water is squeezed out from between the tire and road. However excessive speed or water depth can overwhelm the water clearing capability of the tread and lead to a condition called 'aquaplaning' or 'hydroplaning', where the tire rides on a film of water and provides little or no grip on the road surface, leading to a loss of control. This condition is more likely to occur with worn tires having little depth of tread, or with incorrect tire pressures. Drivers should keep a vigilant check on tire wear and condition, and moderate their speed in adverse weather conditions.

Tire Care

Wear indicators are moulded into the bottom of the tread grooves at intervals around the tire, indicated by small pointers on the outer tread blocks. The tires should be replaced before being worn to this minimum legal tread depth.

The cold tire pressures should be checked every week, or every 1,000 miles (1,700 km), whichever is the sooner, and corrections made as necessary. See 'Technical Data' at the back of the handbook for tire pressures. For track use, tire condition and pressures should be checked before each run. Under-inflation will cause excessive wear, rapid deterioration of the tire sidewalls and heavy steering, whereas over-inflation results in a hard ride and increased susceptibility to tire damage. Both conditions will cause a degradation in the handling qualities.

It is important that the tire pressures are adjusted only when the Tires are cold (when the car has been standing for a minimum of 3 hours, or driven less than 1 mile), as the pressures may increase by 0.3 - 0.5 bar (4 - 8 lb/in²) when the Tires are warmed to normal running temperature.

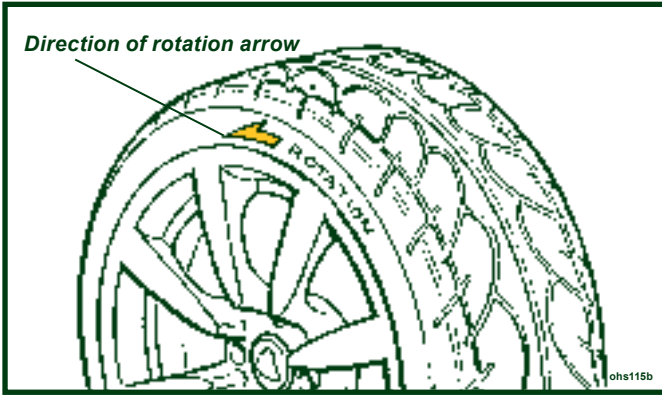

Use a good quality proprietary tire pressure gauge and always replace the tire valve dust cap to prevent the ingress of dirt and moisture into the valve, which could cause leakage.

Many fuel filling stations provide tire inflation facilities, which specific usage instructions should be carefully followed. For tire pressure information, refer to 'Technical Data' or the Certification Label on the driver's door jamb (see page 121).

Replacement Tires

When replacing tires, refer to the 'Technical Data' section in this handbook, or consult your dealer to check the current Lotus specification and recommendations. Do not use tires which differ from these specifications.

⚠ WARNING:

Note that some tread patterns are directional, so that the tire must be fitted onto the wheel with regard to which side of the car the wheel is to be used. In these cases, a direction of rotation arrow is included in the tire sidewall markings.

When balancing the wheel and tire assemblies, the wheels should be located by the centre spigot hole - NOT by the wheel bolt holes. In order to maintain the correct

handling feel and minimum steering wheel shake, it is very important that the radial and lateral run out of the Tires are to the high standard required by Lotus Cars. If any difficulty is experienced with replacement Tires, refer to the tire manufacturer.

Tire Characteristics

The Yokohama AD07 or A048 Tires fitted to the Elise are suitable for all normal weather conditions, but are optimised for dry road sports driving. The constructions of both tire types have been specially tailored for the Elise and are identified by the letters 'LTS' moulded on the tire sidewalls. Ensure that any replacement Tires are similarly marked. The tire characteristics include good feedback ('feel') from the road surface to the steering wheel, a high level of steering linearity and response, and little performance degradation with the high temperatures which may be reached in sports use.

However, tire performance will decrease at low ambient temperatures, resulting in reduced levels of grip and an increased susceptibility to damage from impacts. In these conditions, especially below 15°F (-10°C), it is recommended to fit a car set of the recommended winter Tires (see below).

Winter Tires

If the car is to be used in very cold territories, or driven on snow covered roads, it is recommended to fit a car set of winter Tires developed specifically for such conditions. Lotus approves the use of Pirelli 210 (front) and 240 (rear) Snowsport winter Tires in sizes specified in 'Technical Data'. These Tires should be fitted on regular Elise wheels.

⚠ WARNING:

- **Winter Tires are optimised for use on snow covered roads. When used on roads free of snow, winter Tires will produce different handling characteristics and less grip compared with regular Tires.**
- **When winter Tires are fitted, a maximum speed of 118 mph (190 km/h) must be observed.**
- **Pirelli Snowsport Tires are NOT suitable for stud-**

ding.

Tire Chains

In extreme weather conditions, Lotus approves the fitting of Pewag Neon X3 - NX373 snow chains, used only in conjunction with winter Tires (see above) and fitted only on the rear wheels. Close attention should be paid to the fitting and tensioning instructions supplied with the chains, and the chains should be removed as soon as road conditions allow.

Uniform Tire Quality Grading

Quality grades can be found where applicable on the tire sidewall between tread shoulder and maximum section width. For example:

Treadwear 200 Traction AA Temperature A

The following information relates to the system developed by the United States National Highway Traffic Safety Administration, which grades Tires by treadwear, traction and temperature performance (This applies only to cars sold in the United States).

The grades are moulded on the sidewalls of most passenger car Tires. The Uniform Tire Quality Grading system does not apply to deep tread, winter-type snow Tires, space-saver or temporary use spare Tires, Tires with nominal rim diameters of 10 to 12 inches (25 to 30 cm), or to some limited-production Tires.

While the Tires available on Lotus cars may vary with respect to these grades, they must also conform to federal safety requirements.

Treadwear

The treadwear grade is a comparative rating based on the wear rate of the tire when tested under controlled conditions on a specified government test course. For example, a tire graded 150 would wear one and a half (1.5) times as well on the government course as a tire graded 100. The relative performance of Tires depends upon the actual conditions of their use, however, and may depart significantly from the norm due to variations in driving habits, service practices, and differences in road

characteristics and climates.

Traction - AA, A, B, C: The traction grades, from highest to lowest are: AA, A, B, and C. They represent the tire's ability to stop on wet pavement as measured under controlled conditions on specified government test surfaces of asphalt and concrete. A tire marked 'C' may have poor traction performance.

⚠ WARNING:

The traction grade assigned to this tire is based on braking (straight ahead) traction tests and does not include acceleration, cornering, hydroplaning, or peak traction characteristics.

Temperature - A, B, C: The temperature grades are A (the highest), B, and C, representing the tire's resistance to the generation of heat and its ability to dissipate heat when tested under controlled conditions on a specified indoor laboratory test wheel. Sustained high temperature can cause the material of the tire to degenerate and reduce tire life, and excessive temperature can lead to sudden tire failure. The grade 'C' corresponds to a level of performance which all passenger car tires must meet under Federal Motor Car Safety Standard No. 109. Grades 'B' and 'A' represent higher levels of performance on the laboratory test wheel than the minimum required by law.

⚠ WARNING:

The temperature grade for this tire is established for a tire that is properly inflated and not overloaded. Excessive speed, underinflation, or excessive loading, either separately or in combination, can cause heat buildup and possible tire failure.

These grades are moulded onto the sidewalls of passenger car tires. All passenger car tires must conform to Federal safety requirements in addition to these grades.

Tire Placard/Label

The tire and loading Information label stuck on the driver's door jamb specifies the correct size and pres-

sure of tires to be used on the Elise. It also specifies the total weight the car can carry, called the car capacity weight. This includes the weight of driver, passenger and luggage.

Also to be found on the driver's door jamb is the Certification label ('Manufactured by Lotus Cars Ltd.')

which stipulates the Gross Car Weight Rating (GVWR). The GVWR includes the weight of the car, occupants, fuel and luggage. Never exceed the GVWR or the Gross Axle Weight Rating (GAWR) for either the front or rear axle. The maximum load which may be carried in the rear luggage compartment is 110 lb (50 kg). Note that the Elise is not designed to tow a trailer, and no such attempt should be made.

⚠ WARNING:

Do not exceed the GVWR, or front or rear GAWR. Exceeding these limits may cause unstable handling or car or tire damage which could cause a crash in which you or others could be seriously injured or killed. The Elise should never be used to tow a trailer.

Federal Motor Car Safety Standards require Lotus to include the following verbatim statement in this handbook:

Steps for Determining Correct Load Limit:

- 1) Locate the statement "The combined weight of occupants and cargo should never exceed XXX pounds" on your car's placard.
- 2) Determine the combined weight of the driver and passenger that will be riding in your car.
- 3) Subtract the combined weight of the driver and passenger from XXX kilograms, or XXX pounds.
- 4) The resulting figure equals the available amount of cargo and luggage load capacity. For example, if the "XXX" amount equals 1400 lbs. and there will be five 150 lb. passengers in your car, the amount of available cargo and luggage load capacity is 650 lbs. (1400 - 750 = 650 lbs.)

Note: Maximum load to be carried in the Elise rear luggage compartment is 110 lb (50 kg).

- 5) Determine the combined weight of luggage and cargo being loaded on the car. That weight may not safely exceed the available cargo and luggage load capacity calculated in Step 4.
- 6) Your Elise should never be used to tow a trailer

In the case of the Elise:

- The combined cargo and luggage load capacity is 551 lb (250 kg).
- The maximum load in the luggage compartment is 110 lb (50 kg).
- The maximum combined weight of the driver and passenger is 441 lb (200 kg).

⚠ WARNING:

Exceeding any of the above loadings may cause unstable handling or car or tire damage which could cause a crash in which you or others could be seriously injured or killed.

Tire Markings

Designation:

Example; Yokohama Advan A048 195/50 R16 84W
Yokohama = manufacturer. Advan A048 = tire model.
195 = nominal section width in mm. 50 = height of tire cross-section expressed as percentage of width. R = radial construction. 16 = rim diameter in inches. 84 = load capacity index, indicating the load in kg the tire can carry at the speed corresponding to the speed rating. W = speed rating indicating the speed (in this case 168 mph) at which the tire can carry the load corresponding to the load capacity index.

Tire Identification Number: On the left hand sidewall as fitted to the car. Commences with DOT (Department of Transportation) followed by a two digit manufacturing plant code, a two digit tire size code, a three digit tire construction code, and a four digit date code for the week and year of production.

'LTS' : Indicates Lotus specific construction.

Uniform Tire Quality Grading Standard: Example; Treadwear 60 Traction AA Temperature A. See page 120

Other tire markings are self explanatory.

Tire Inflator Aerosol (if fitted)

In order fully to exploit the benefits of light weight, and to maximise stowage space, the Elise has no provision for spare wheel carriage or lifting jack. A temporary puncture repair facility is provided in the form of a tire inflator aerosol which is mounted in spring clips at the extreme right hand front corner of the rear luggage compartment. If possible avoid driving on a deflated tire, or irreparable damage to the tire may be caused.

When the aerosol is connected to the tire valve, and the button pressed, a mixture of liquid latex and propellant is injected into the tire, such that the solidifying latex is forced into the puncture site at the same time as the tire is inflated, effecting a temporary repair and enabling the car to be driven at low speed to the nearest tire repair facility.

⚠ WARNING:

- **Use of the aerosol does not constitute a permanent repair, but is designed to allow the car to be driven to the nearest tire repair facility. At the earliest opportunity, the tire should be either professionally repaired or replaced dependent on the severity of the damage.**
- **Until the tire is repaired or replaced, the car should be driven in a moderate manner, not exceeding 30 mph (45 km/h).**
- **Do not use the aerosol for large holes or repairs, or when the tire sidewall has been damaged, or if the tire has been displaced from the rim.**
- **For safety reasons, the aerosol should at all times be carried only in the designated secure stowage position. Never carry loose in the passenger compartment.**

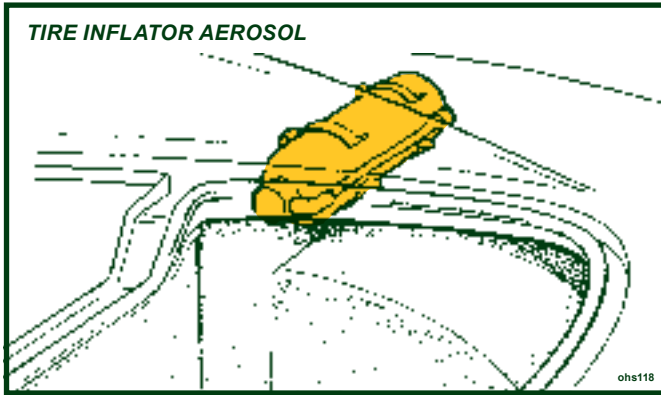

Directions for use of the aerosol: Before using, carefully read all the instructions on the canister, or on any literature accompanying the product. The following instructions apply to the use of Holts Tireweld:

1. Remove the object causing the puncture, and position the wheel with the puncture site lowermost. Deflate tire fully.
2. Shake the can vigorously. In cold conditions, warm the can using the car's heater outlets, or by body warmth.
3. Screw the aerosol tube onto the tire valve, remove the cap, hold the can upright and press the button until the tire is firmly inflated.
4. Immediately drive for 6 - 12 miles (10 - 20 km) (or to the tire repair facility if nearer) in a moderate manner and not exceeding 30 mph (45 km/h), to allow the sealant to spread. Then check and adjust the tire pressure as necessary.
5. Have the tire professionally repaired or replaced at the earliest opportunity, and until such time, limit speed to 30 mph (45 km/h) with a moderate driving manner. Note that some tire repairers may make an additional charge for cleaning the sealant off the tire before repair, and that any subsequent repairs may not be guaranteed.
6. Renew the puncture repair aerosol.

Wheels

Ensure that only original equipment, or Lotus approved wheel and tire combinations are fitted. After the car has been used on track, or in competition conditions, the wheels should be removed and thoroughly inspected for damage.

⚠ WARNING:

After striking a pothole or kerb, the wheels should be removed and the wheel and tire thoroughly inspected for damage. Renew the wheel and/or tire if necessary. Safety considerations should always be paramount and new parts fitted in any cases of doubt.

Wheel Bolts

The wheel bolts used on the Elise are of a special design to suit the small diameter fixing tunnels in the wheel centres. The bolts have a 10 spline socket head, for which a special extension tool is supplied with the car. A 17mm a/f deep socket and 1/2 inch square drive wrench should be applied to the extension tool, with a tightening torque of 77 lbf.ft (105 Nm) required.

To protect against wheel theft, one of the four bolts securing each wheel is key coded, and requires a corresponding coded socket wrench and 1/2 inch square drive extension. Rotate the coded socket until full engagement with the bolt head is ensured and take care to maintain the extension tool perpendicular to the wheel face before applying release torque.

NOTICE: It is not recommended to use hammer action air tools on the coded bolts - use only manual tools.

Both the standard extension and coded socket tools are stowed in the car tool kit, and should remain with the car at all times to ensure that servicing may be performed. The key code included in the tool kit should be recorded and kept safely with the car documents, in case a replacement socket tool needs to be ordered.

Wheel Alignment and Tire Balance

The wheels on your car were aligned and balanced carefully during the manufacture of your car to give you the longest tire life and best overall performance.

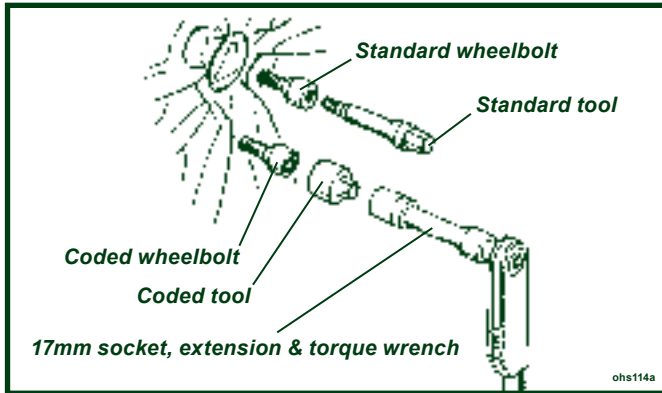

Scheduled wheel alignment and balancing are not required. However, if you notice unusual tire wear or the car pulling to one side or the other, the alignment may need to be reset. If you notice the car or steering wheel vibrating when driving on a smooth road, the wheels may need to be re-balanced.

Wheel Replacement

Replace any wheel that is bent, cracked, badly corroded or otherwise damaged. If the wheel bolts come loose after having been correctly fitted, the wheel and bolts should be replaced. If the wheel leaks air, have it replaced. See your Lotus dealer if any of these conditions should arise.

Ensure that only Lotus approved wheels and wheel bolts are used.

⚠ WARNING:

- **Using incorrect, or non-approved replacement wheels or wheel bolts could be dangerous. It could affect the braking and handling of your car, or cause tire deflation, and result in a crash in which you or others could be killed or seriously injured. Always use Lotus approved wheels and wheel bolts.**
- **Putting a used wheel on your car is dangerous. It may have been subjected to a heavy impact and suffered structural damage which cannot be seen. It could break and cause a crash in which you and others could be killed or seriously injured.**

NOTICE: Using incorrect wheel/tire equipment can also cause problems with wheel bearing life, brake cooling, speedo and odometer calibration, headlamp aim, ground clearance and tire clearance to the body.

⚠ WARNING:

Dirt or corrosion on a wheel or hub mounting flange or wheel bolts, can result in the wheel bolts coming loose. The wheel could come off and cause a crash in which you and others could be killed or seriously injured. Thoroughly clean these components or fit new Lotus approved replacements before fitting a wheel.

Never use oil or grease on the wheel bolts or hub threads. If you do, the bolts could come loose and the wheel could come off, causing a crash in which you and others could be killed or seriously injured.

Using incorrect wheel bolts, or the wrong tightening torque could cause the bolts to come loose and the wheel to come off, resulting in a crash in which you and others could be killed or seriously injured. Use only the correct Lotus approved wheel bolts tightened to 77 lbf.ft (105 Nm).

NOTICE: Improperly tightened wheel bolts, or dirt on the wheel to hub mounting face can cause brake pulsation and judder, and damage the brake discs. To avoid expensive brake repairs, ensure complete cleanliness on assembly and tighten the wheel bolts in a diagonal sequence to the correct torque.

For advice and information on lifting the Elise, refer to 'Lifting Points' on page 148

ELECTRICAL

BATTERY

⚠ WARNING:

POISON/DANGER - CAUSES SEVERE BURNS KEEP OUT OF REACH OF CHILDREN.

- Contains sulphuric acid - avoid contact with skin, eyes or clothing. If in contact with skin or eyes; flush with copious amounts of water. Remove contaminated clothing. Seek immediate medical attention. If ingested; seek immediate medical attention. Do not induce vomiting or give fluids to drink.
- Batteries produce explosive gases. Keep sparks, flames and cigarettes away. Ventilate when charging or using in enclosed space. Always shield eyes when working near batteries.

RISK OF SHORT CIRCUIT AND FIRE

- Observe all warning notes on the battery.
- Disconnect the battery during all work on the electrical system.
- Do not lay tools or other metal objects on the battery as they could cause a short circuit across the battery terminals.

Battery Access

The 'maintenance free' battery is located at the left hand front of the rear luggage compartment. No routine inspection or topping up of the electrolyte is required, but at intervals specified in the Maintenance Schedule, the battery terminals should be checked for security and condition, and protected with petroleum jelly.

For access to the terminals, first unclip the battery cover from the floor and ease the cover from around the left hand rear corner of the battery.

Disconnecting the Battery

⚠ WARNING:

Failure to follow the correct battery disconnection procedure detailed below could result in serious burns.

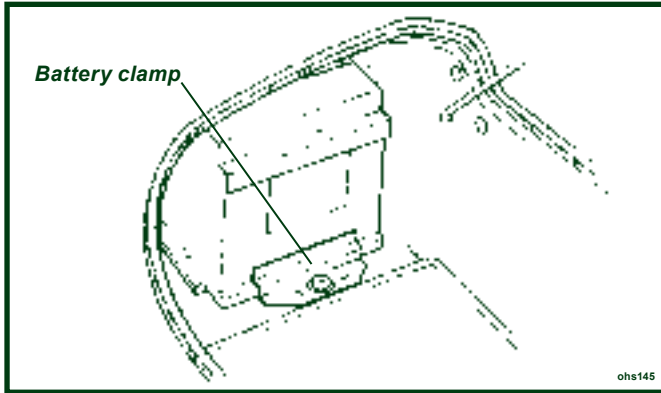

If the battery is to be disconnected, the following precautions should be taken:

- i) Ensure that all electrical loads (e.g. lights) are switched off. If the car is fitted with security coded audio equipment, check that the code is available for entering after battery reconnection.
- ii) Wait for at least ten seconds after switching off the ignition to allow the engine management system to adjust the setting of some components ready for re-starting.
- iii) Ensure the alarm is disarmed. If the battery is disconnected when armed, the alarm will be triggered.
- iv) Disconnect the negative (earth; black; '-') battery cable first, and re-connect last.

⚠ WARNING:

If the battery positive terminal is inadvertently earthed (e.g. when using a spanner) whilst the negative terminal is still connected, the resultant short circuit with heavy sparking and current flow could cause serious burns.

To remove the battery, pull off the breather pipe (if applicable), release the single screw securing the clamp bracket at the base of the battery, and manoeuvre the battery from the base retaining shoe.

⚠ WARNING:

When lifting the battery out of, or into the car, be aware of the considerable weight and take all appropriate precautions to safeguard personal health. Injury can result from improperly lifting the battery.

Keep the battery upright, and protect from sharp knocks and shocks.

Reconnecting the Battery**⚠ WARNING:**

Failure to follow the correct battery re-connection procedure detailed above could result in serious burns.

Refit the battery, with its terminals outboard, by reversing the above procedure. Remember to push on the breather pipe (if applicable), and reconnect the battery cables as detailed below. Refit the battery cover.

- i) Check again that all electrical loads are switched off.
- ii) Connect the positive battery cable first, followed by the negative (earth) cable.
- iii) After reconnection, a change in the engine performance characteristics may be noted for a period whilst the computer controlled engine management system 're-learns' some of its settings.
- iv) If necessary, enter the security code into audio equipment.

Battery Charging

Under conditions of normal daily use, it should not be necessary to use external battery charging equipment. In a low usage regime, however, it is important to maintain the charge state of the battery using a trickle charger, or an automatic battery management conditioner such as that available through Lotus Dealers. Starting difficulties may be encountered after an unattended period of 3 weeks. A battery conditioner is able to continuously monitor battery charge state and switch on and off automatically in order to maintain the battery in a fully charged state without danger of damage through overcharging.

If the battery becomes discharged to the extent that the car cannot be started, the recommended course of action is to fit a substitute battery whilst the original battery is trickle

charged. If, in an emergency, the car has to be 'jump' started, the subsequent conditions of car use may not allow for sufficient alternator charging of the battery to achieve a fully charged state. The battery should be trickle charged until 12.8 volts is recorded, which process may take 24 hours or longer. Putting the battery into service at a lower state of charge will reduce the time period for which the car can be parked. A battery left in a fully discharged state for a prolonged period, may not be recoverable to its original condition.

⚠ WARNING:

- **Hydrogen gas generated by the battery could cause an explosion, resulting in severe personal injuries.**
- **Charge battery in a well ventilated area.**
- **Never charge a frozen battery. It may explode because of gas trapped in the ice. Allow a frozen battery to thaw out first.**
- **If you get electrolyte, which is an acid, in your eyes or on your skin, immediately rinse with cold water for several minutes and call a doctor.**

Unless you are using an automatic battery management conditioner, the battery should be removed from the car for recharging, to a well ventilated area to avoid a build up of fumes in the luggage compartment and to prevent damage to the car's electrical system. Observe the safety precautions listed above when removing the battery and take care to avoid sharp knocks or shocks, keeping the battery as upright as possible. Beware of the considerable weight of a battery, and take necessary precautions against personal injury.

Check that the electrolyte level is between the upper and lower markers on the battery case, and if necessary add distilled water. The recommended bench charge rate is 4 amps. When the battery is fully charged (12.8 volts), allow the battery to stand for an hour before refitting to the car and reconnecting the leads - see above.

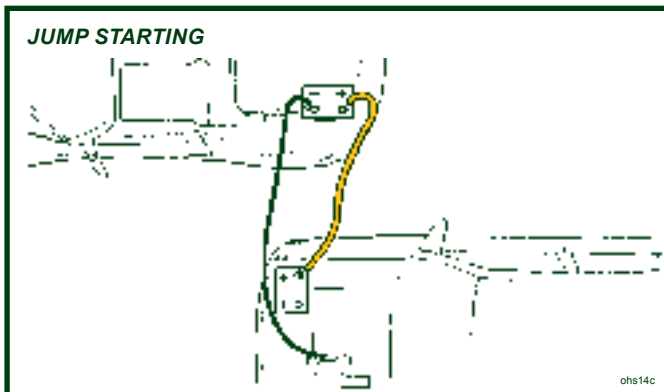

'Jump' Starting

If the battery becomes discharged to the extent that the engine cannot be started, proprietary good quality 'jumper cables' may be used to connect with the battery of a second car in order to provide the energy necessary for starting.

⚠ WARNING:

It is most important that the correct procedure is followed in order to avoid damage to either car's electrical system, and most importantly, to minimise the danger of a spark induced battery explosion. Check that the slave car also has a NEGATIVE EARTH electrical system.

- i) With the engine of the slave car running at a fast idle, use one jumper cable (red) to connect the positive (+) terminal of one battery to the positive terminal of the other battery. Take care during this process to avoid inadvertently earthing a free end of this cable to the metal body or chassis of either car.
- ii) Connect one end of the other jumper cable (black) to the negative (-) terminal of the discharged battery.
- iii) A spark will occur when the other end of this cable (the final connection) is connected to an earth on the slave car. This connection should therefore be made to a point away from the battery, and away from any fuel vapour area or moving parts. An engine hanger bracket is often ideal.
- iv) Start the car in the usual way, and run at a fast idle.

- v) A spark will occur at the first disconnection of a jumper cable, so it is essential that the first disconnection is made from the slave car earth. Both batteries (especially the discharged one) will be 'gassing' heavily at this time, and if the first disconnection is made at a battery terminal, there is a danger that the hydrogen gas may be ignited by the spark with a resultant explosion.
- vi) Have the cause of the flat battery investigated and rectified, and trickle charge the battery as detailed above.

⚠ WARNING:

- **Risk of damage and serious personal injury due to shortcircuit.**
- **Use only jumper cables of adequate cross-section, fitted with completely insulated alligator clamps. The cables must be long enough to allow that neither cars nor cables touch each other.**
- **Follow all warnings and instructions of the jumper cable manufacturer.**
- **When connecting the jumper cables, keep them away from engine moving parts.**
- **The two cars must not contact each other, or current could flow as soon as the positive terminals are connected.**
- **When the first clamp on each cable is connected, the other clamp on that cable must be held carefully to make sure it does not come into contact with either another cable clamp or either car.**
- **Ensure that tools or metal watches or jewellery do not contact the battery terminals or live car parts.**

NOTICE:

- Improper jumper cable connection can damage the alternator and other electrical components.
- Do not attempt to push or tow start the car, as damage to the catalytic converter or other parts could be caused.

Electrical Accessories

Owners should note that the only approved extras and modifications are those which are specified by Lotus and carried out by Lotus or by an authorised dealer. Neither Lotus Cars Ltd. or Lotus Cars Inc. accept any liability whatsoever for defects which arise from extras or modifications which are not approved by Lotus Cars Ltd.

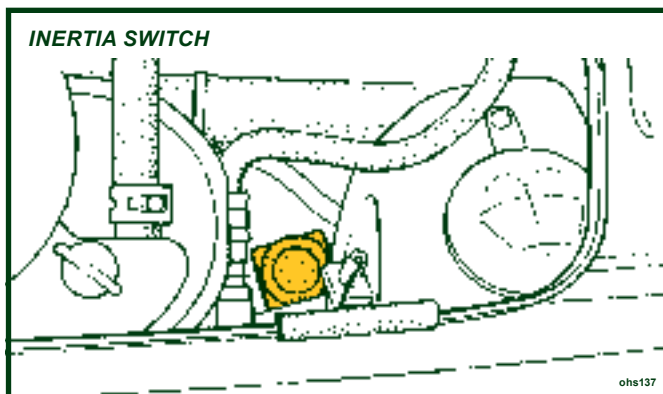

⚠ WARNING:

Inexpert modifications or additions to the electrical system could jeopardise safety.

Inertia Switch

The safety inertia switch is designed to operate on impact, typified by car collision, to switch off the fuel pump, and thus minimise any fire hazard. The central door locking will also be triggered to unlock the doors.

The inertia switch is mounted at the left hand bottom of the engine bay, on the inboard face of the rear subframe, and is accessible from between the coolant header tank and windscreen washer reservoir. The switch is reset by pressing the rubber diaphragm button on the top of the unit.

Fuses

The main fusebox is located in the front services compartment, on the passenger side, and is protected by a plastic cover. For access, remove the passenger side front body access panel, and unclip the fusebox lid.

Twenty two slots are provided for 'Littel' type fuses which are numbered, and coloured according to their amperage rating, and may be pulled out from their slots using the fuse extractor tool provided on the fusebox lid.

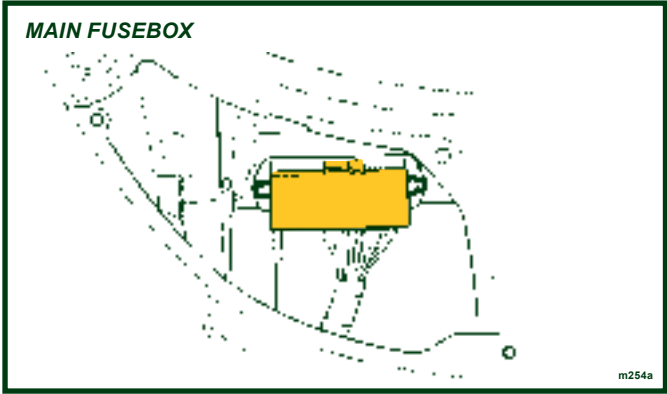

⚠ WARNING:

Replacing a fuse with one which has a higher rating may cause extensive damage to the electrical system and possibly cause a fire. If a fuse of the correct rating is not available, use one of a lower rating as a temporary measure.

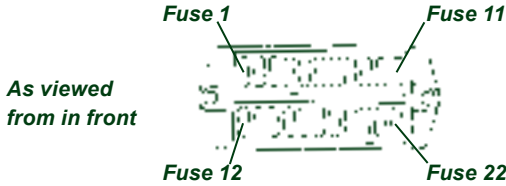

Slot	Rate	Circuit	Slot	Rate	Circuit
1	20A	Aux pwr socket	12	10A	ABS
2	5A	Reverse lamps	13	3A	ECU Ignition
3	20A	Driver's window	14	20A	Rad. fans; 1&2 slow, 1 fast
4	20A	Pass. window	15	7.5A	Radio, switch pack module
5	10A	Stoplamps	16	10A	Parking lamps
6	7.5A	Turn indicators	17	10A	Dip beam LH
7	10A	Ignition services	18	10A	Dip beam RH
8	7.5A	Battery services	19	20A	A.C. comp. relay, rad fan 2 fast
9	15A	Hazard lamps	20	15A	Main beam LH
10	7.5A	Horn	21	15A	Main beam RH
11	10A	Alarm pwr interior lamp	22	7.5A	CDL

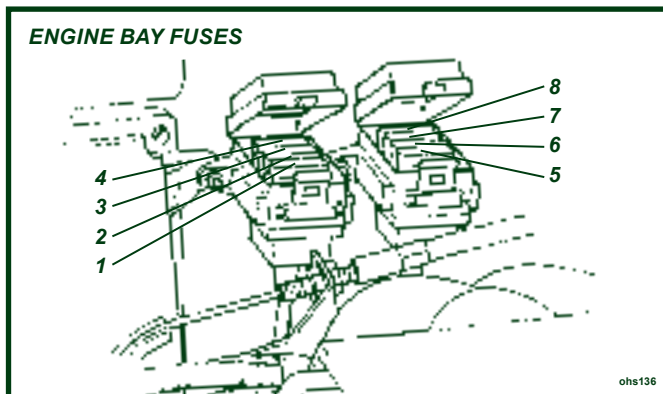

Engine Compartment Fuses

Fuses associated with the engine management system are contained in two 4-position fuse holders located at the front of the engine bay on the cabin bulkhead, adjacent to the engine ECM. To access the fuses, unclip rear edge of the cover.

Fuse	Rating	Circuit
R1	20A	Fuel pump
R2	3A	Immobiliser
R3	5A	Alternator sense
R4	5A	ECU battery feed
R5	5A	O2 heaters
R6	7.5A	VSV's VVT, VVL, IAC
R7	10A	Injectors, ignition coils
R8	5A	Re-circ. pump

⚠ WARNING:

- To avoid injury, beware of rotating engine components and guard against entrapment of body parts, tools and loose clothing.
- Stop engine before servicing fuses.
- Beware of hot surfaces in the engine bay. You could be seriously burned if you touch a hot engine part.
- Take great care not to drop flammable liquids or objects onto a hot engine and start a fire.

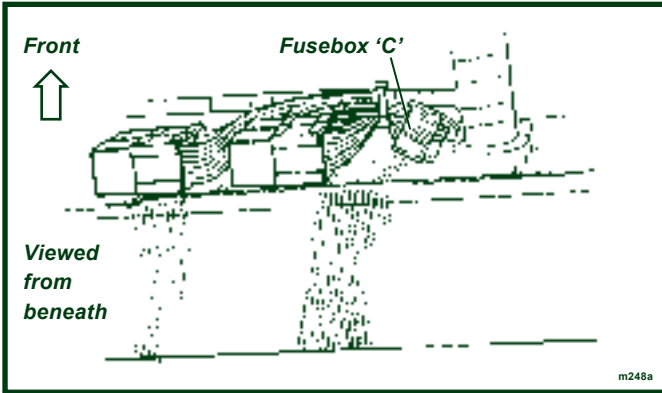

Footwell Sited Fuses

Four fuses are secured to the main wiring harness just ahead of the scuttle beam and accessible from the passenger footwell.

<i>Fuse</i>	<i>Rating</i>	<i>Circuit</i>
C1	20A	Interior fan
C2	15A	Wiper motor
C3	7.5A	Audio key-in
C4	7.5A	A.C. compressor

Headlamp Alignment

The headlamps of your Elise were correctly adjusted during the manufacture of the car, and should only require subsequent adjustment if the headlamp assembly or front body is disturbed. Simply replacing the bulb will not affect alignment. Incorrectly adjusted headlamps can cause poor lighting performance or dazzle to oncoming traffic. Special headlamp setting equipment is required to correctly set the headlamps, such that only qualified technicians using appropriate equipment should be entrusted with this procedure:

1. Using beam setting equipment compatible with local regulations, position the machine between 300 and 700mm in front of the LH headlamp, and parallel with the two headlamp units using the sight bar or similar device dependent on the machine design, to ensure cross car match. Use the guides provided on the machine to ensure the correct height and lateral setting.
2. Switch on the headlamp low beams (uppermost lamps) and check the lateral beam alignment. The 'knee point' of the beam cut off line must lie within a tolerance of 2% to the passenger side, and 0%. Check the vertical alignment of the low beam which must lie within a tolerance of -0.5% and -2%.

HEADLAMP COVER UNIT SOCKET BOLTS



3. If adjustment is required, the clear cover and mask must be removed from the body. From within the wheelarch, remove the access panel from the wheelarch liner to expose the headlamp cover retaining screws. Use the hexagonal key provided in the toolkit (in the rear pocket on the battery cover) to release the three socket head retaining screws and washers, and withdraw the cover assembly complete with rubber edge seal from the body. When refitting, do not overtighten the fixings.
4. To adjust the low beam laterally, adjust the dome headed screw at the upper inboard side of the low beam (uppermost) lamp, accessed from the front of the lamp. Turn clockwise to adjust the beam to the right. Optimum setting is 0%. To adjust the vertical aim of the low beam, adjust the dome headed screw at the lower outboard side of the lamp, accessed from the front of the lamp. Turn clockwise to raise the beam. Optimum setting is -1.5%.
5. Repeat for the RH lamp.
6. Centralise the machine on the LH high beam (lowermost) lamp, and switch on the high beams. Check the high beam alignment which should be centralised with the marker dot on the machine screen or slightly below the horizontal. Optimum setting is 0%.

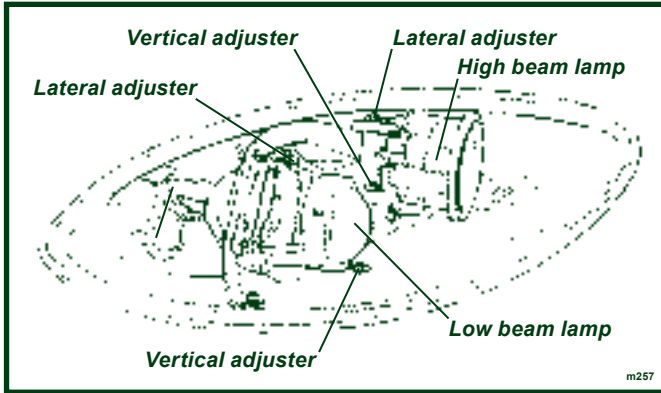

- To adjust the high beam laterally, adjust the dome headed screw at the upper inboard side of the lamp, accessed from behind the lamp. Turn clockwise to adjust the beam to the right.
 - To adjust the vertical aim of the high beam, adjust the dome headed screw at the lower outboard side of the lamp, accessed from behind the lamp. Turn clockwise to raise the beam.
7. Repeat for the RH lamp.
 8. Re-fit the cover/mask assemblies complete with edge seal to the body, and secure with the three socket head screws and washers. Refit the wheelarch access panel.

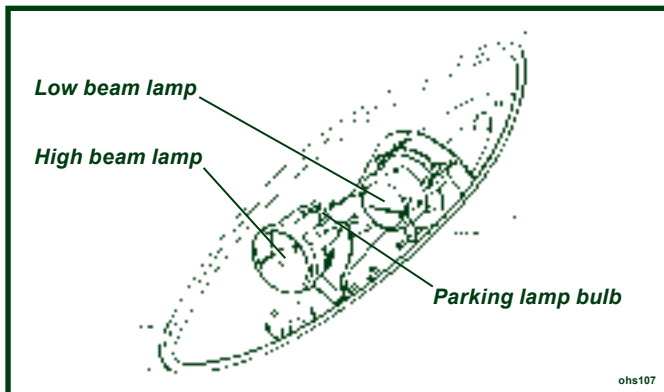

BULB REPLACEMENT

Headlamp Bulb

Mounted in the front body are the two headlamp units, each of which houses a halogen projector type low beam lamp (upper), and a halogen high beam lamp (lower) including the sidelamp bulb.

For access to the headlamp bulbs, first remove the clear cover and mask from the body (see previous pages).

⚠ WARNING:

- Allow bulbs to cool before attempting removal, or your fingers could be burnt.
- Halogen bulbs have pressurised gas inside and can burst if you drop or scratch the bulb. You or others could be injured.
- Be sure to read and follow instructions on the bulb packaging.

NOTICE: Do not touch a halogen bulb glass envelope with the fingers, as the greasy deposit left behind will greatly reduce bulb life. Use a paper tissue to handle the bulb.

Low beam bulb: Disconnect the single cable, release the spring wire clip, and withdraw the 55W H1 bulb. On refitting, note that the bulb is keyed to allow only one orientation.

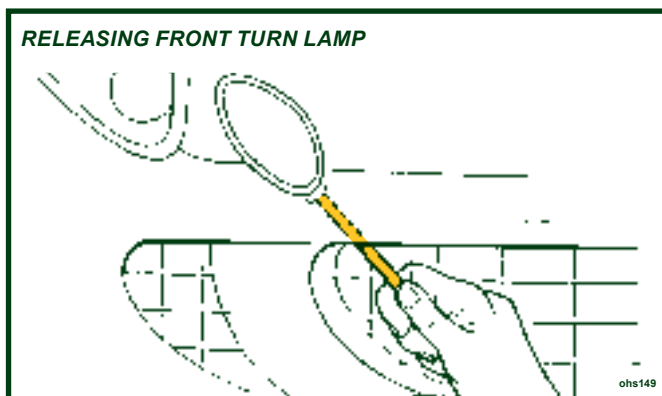

High beam bulb: Disconnect the two cables from the bulb, release the spring wire clip, and withdraw the 55W H7 bulb. On re-fitting, note that the bulb is keyed to allow only one orientation.

Parking lamp: Twist the bulb holder counterclockwise to release from the main beam lamp, and withdraw the bayonet fitting T4 W bulb.

Front Turn Indicator Lamp Bulbs

For access to the front turn indicator bulb, the lamp unit must be released from the body. Using a suitable stiff rod or screwdriver blade inserted through the access hole in the outer top corner of the air intake aperture, press back the lamp retaining clip at the front end of the lamp, and withdraw the lamp from the body. Twist the bulb holder counterclockwise to release from the lamp, and replace the bayonet fitting amber bulb.

After replacing the bulb and holder, ensure the rubber seal is correctly positioned around the lamp. Engage the tongue at the rear end of the lamp unit with the body flange, and press the front end of the lamp firmly down until a distinct 'click' is heard, indicating engagement of the retaining clip. Pull up on the front end of the lamp to check security.

Side Repeater Lamp Bulbs

The side marker lamps mounted on the front and rear wheelarch lips, each use four longlife LEDs which are not serviceable. In case of failure, the lamp unit should be replaced by your dealer.

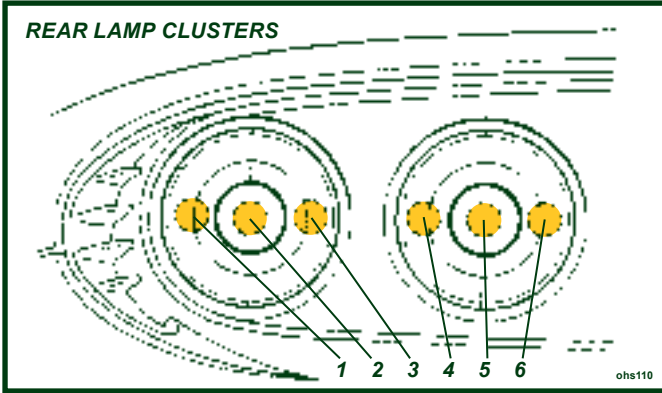

Rear Lamp Cluster Bulbs

Each pair of rear lamps is configured as follows:

Outboard Lamp:

- | | | |
|---|-------------------|--------------------|
| 1 | Outboard annulus; | Tail and turn lamp |
| 2 | Central unit; | Not used |
| 3 | Inboard annulus; | Turn lamp |

Inboard Lamp:

- | | | |
|---|-------------------|--------------------|
| 4 | Outboard annulus; | Stop lamp |
| 5 | Central unit; | Reverse lamp |
| 6 | Inboard annulus; | Stop and tail lamp |

The bulbs for the rear lamps are accessible from within the rear luggage compartment. Twist the bulbholder counterclockwise to remove, replace the bayonet fitting bulb, and refit the bulbholder.

High Mounted Stoplamp

The high mounted stoplamp, mounted beneath the rear window shroud uses light emitting diodes (LED) for optimum visibility. This is a self contained unit which may be replaced after releasing the two screws securing the housing to the body and unplugging the harness connector.

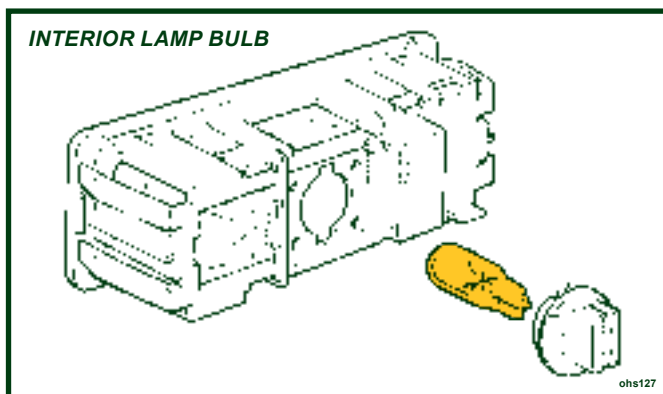

Licence Plate Lamps

To replace a bulb in a licence plate lamp, first remove the two screws securing the lamp, and withdraw. Replace the festoon bulb, and refit the lamp.

Interior Lamp

To withdraw the interior lamp from the rear bulkhead, first ease one end of the lamp from its aperture. Twist the bulbholder to release from the lamp body, and pull out the capless bulb.

Side Marker Lamps

The side marker lamps fitted to the front and rear wheelarch lips use light emitting diodes (LEDs) housed in a sealed lamp body. Replacement of a lamp assembly should be entrusted to your dealer.

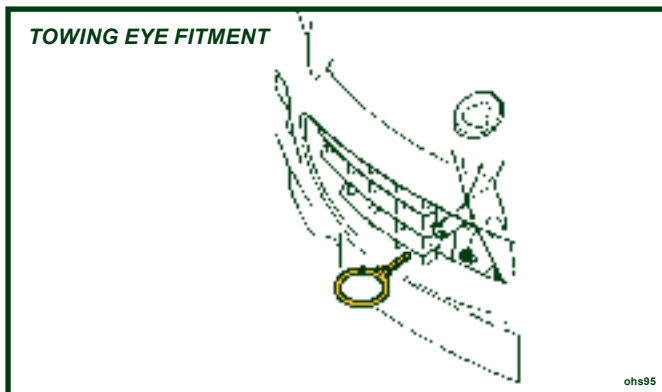

LIFTING AND TOWING

Towing Eye

A towing eye is stowed in the car tool kit, located in the battery cover rear pocket. When required, remove the protective bung (if fitted), and fit the towing eye to its anchorage point in the radiator air intake aperture, screwing fully into the tapped boss.

The eye is provided to aid car recovery, such as winching onto a flatbed car transporter, but only when the car is able to roll freely. Only in an emergency should the car be towed, and for the shortest distance necessary, during which time the following precautions must be taken:

⚠ WARNING:

- Use only towing equipment designed specifically for this purpose, or damage to the car may be caused, or you could be killed or seriously injured.
- Ensure that the key is used to unlock the steering column, and is then left in the lock. Never withdraw the key until the car is stationary. The steering column will lock when the key is withdrawn.
- Release the parking brake and ensure that the transmission is in neutral.
- Comply with all local legislation applicable to cars being towed.
- Under no circumstances is the car to be secured using the towing eye.

Towing a Trailer

⚠ WARNING:

The Elise is not suitable for towing a trailer.

Car Tie-Down

When moving a car by transporter or trailer, the car should be secured only by chocking and strapping around the road wheels. Attaching restraints around suspension linkages or chassis or body components may cause damage.

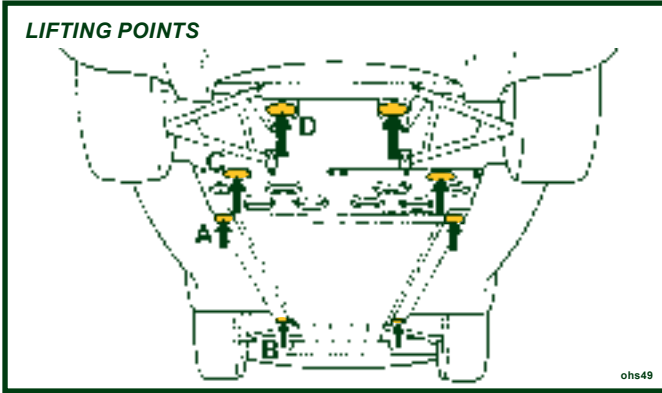

Lifting Your Car

⚠ WARNING:

- Using a lifting jack can be dangerous. If the car falls off the jack, you or others could be seriously injured or killed. NEVER get under a car when it is supported only by a jack.
- Before raising the car with a jack:
 - Turn off the engine;
 - Firmly apply the parking brake;
 - Engage first or reverse gear;
 - Securely chock all wheels not to be lifted.
- Use only those lifting points identified above. Jacking at any other point, or with a jack improperly positioned, may damage the chassis or body structure and/or jeopardise safety.

Care must be taken when using a lifting jack or hoist to position the device only in one of the areas shown in the illustration. Use a suitable rubber or timber pad to protect the chassis from surface damage:

A; Identified by a blue sticker. Beneath crossmember ahead of fuel tank bay. To be used one side at a time for wheel changing - lifts both wheels on one side.

B; **Garage use with 4-point lift.** Beneath the front end of the right or left hand main chassis rail, behind the front wheelarch.

C; **Garage use with 4-point lift.** Do not use if the diffuser panel is fitted. Beneath the outboard end of the chassis crossmember ahead of the rear wheelarches. Take care to position the jack between the fixing screws for the fuel tank bay perforated undershield. Avoid the fuel tank brackets.

D; Do not use if the diffuser panel is fitted. Beneath the rear subframe, close to the lower wishbone rearmost mountings.

NOTICE: In order fully to exploit the benefits of light weight, and to maximise stowage space, the Elise has no provision for spare wheel carriage or lifting jack. A temporary puncture repair facility is provided in the form of a tire inflator aerosol (see page 124).

Fuel Tank Undershield

⚠ WARNING:

The perforated panel enclosing the underside of the fuel tank bay, contributes to the structural rigidity of the chassis frame. Do not use the car with this panel removed.

ACCESSORIES

Accessories and Modifications

Modifying your car, or installing some non-Lotus accessories, can make your car unsafe. Before you make any modifications or add any accessories, be sure to read the following information and confer with your dealer:

Accessories:

Your dealer has genuine Lotus accessories that allow you to personalise your car. These accessories have been designed and approved for your car, and are covered by warranty.

Non-Lotus accessories may be designed for universal application, and although they may fit on your car, they may not meet factory specifications, and could adversely affect your car's handling and stability.

⚠ WARNING:

Improper accessories or modifications can affect your car's handling, stability and performance, and cause a crash in which you can be hurt or killed. Follow all instructions in this owner's manual regarding accessories and modifications.

When properly installed, cellular phones, alarms, two-way radios, and low powered audio systems should not interfere with your car's computer-controlled systems, such as the airbag and anti-lock brake system.

However, if such or similar electronic accessories are improperly installed, or exceed your car's electrical system capacity, they can interfere with the operation of your car, cause the airbags to deploy, or damage the car.

Before installing any accessory:

- Ensure the accessory does not obscure any lights, or interfere with proper car operation or performance.
- Ensure electronic accessories do not overload electrical circuits.
- Have the installer contact your Lotus dealer for assistance before installing any electronic accessory.
- If possible, have your Lotus dealer inspect the final installation.

Important Safety Information About Modifications

Do not remove any original equipment or modify your car in any way that would alter its design or operation. This could make your car unsafe or illegal to drive.

For example, do not install wheels and tires with a different overall diameter. Such modifications can adversely affect handling, and interfere with the operation of the car's anti-lock brakes and other systems.

In addition, any modifications that decrease ground clearance beyond Lotus approval, increase the chance of undercarriage parts striking a kerb, speed bump, or other raised object, which could cause your airbags to deploy as well as damaging the chassis and body underside.

Do not modify your steering wheel or any other part of your airbag system. Modifications could make the system ineffective.

⚠ WARNING:

Do not attach or place objects on the airbag covers. Any object attached to or placed on the covers marked 'AIRBAG', in the centre of the steering wheel and on top of the dashboard, could interfere with the proper operation of the airbags. Or, if the airbags inflate, the objects could be propelled inside the car and hurt someone.

Storing Your Elise

If you intend to store your Elise for a prolonged period, consult your Lotus dealer who will be pleased to advise you. We recommend that the car is stored inside a secure garage. The following guidelines are provided for your information:

- Ensure the engine oil and filter, coolant and brake fluid have recently been renewed. The a.c. system should be in good working order and fully charged.
- Thoroughly clean the inside and outside of the car, including the engine compartment. If necessary, use a 'jet' washer to remove dirt and salt deposits from the underside, but do not use around bearings, hydraulic components, painted surfaces or the soft top roof. Allow to dry completely.
- Chock the road wheels, leave off the parking brake, and engage reverse gear.
- Increase the tire pressures to 60 psi (4 bar). If possible, move the car slightly every month to help avoid flat spots on the Tires.
- Either leave the battery in the car and connect a battery management (conditioner) type of charger, or remove the battery and trickle charge every two months. Note that with the battery disconnected or removed, the alarm system is de-activated.
- Unless the garage is equipped with a de-humidifier, the use of drying agents (Silica-Gel) is recommended in cars with leather upholstery and in conditions of high humidity.
- The use of unapproved car covers may have a detrimental effect on the car's paint finish and such damage will not be covered by your car's warranty.

In general, the Elise will be kept in best operating condition by regular use.

RECOMMENDED LUBRICANTS

Engine

In order to enhance the longevity and reliability of the car, it is most important that only the specified lubricants are used. It is an entirely false economy to try to save money by using lower quality oils, which may break down before the next change interval and provide inadequate protection before the end of the term. High oil consumption may also result.

For topping up purposes during the running-in period prior to the First After Sales Service, a top quality mineral or semi-synthetic 5W/40 oil should be used. At the First After Sales Service and completion of the running-in period, a fully synthetic 5W/40 oil such as Texaco Havoline Synthetic should be used. This oil has been tested in all climatic conditions likely to be encountered, and offers advantages in ease of cranking, smooth cold running and fuel economy at low temperatures, in combination with good wear protection at elevated temperatures and at high engine speeds. If Texaco/Havoline products are not available, an oil meeting the following specification should be used.

NOTICE: Note that Lotus does not recommend the use of any oil additives and use of such additives may invalidate the terms of your car's warranty.

Viscosity:	5W/40
Quality Standard:	API SJEC; ILSAC; ACEA A3
Capacity - refill inc. filter	4.4 litre
(Cars fitted with front mounted oil coolers contain an additional 3.5 litres, but this oil is not drained during routine servicing)	
Difference between high & low dipstick marks	1.5 litre
Oil change interval	Refer to Maintenance Schedule

'Severe Service' Conditions

Certain operating conditions can cause rapid degradation of the oil quality, either by the accumulation of dirt particles, or by the absorption of water from condensation. If any of the 'severe service' conditions described below apply, it is recommended that the oil and filter be changed twice as frequently as is listed in the Maintenance Schedule.

- Driving in dusty areas (e.g. on unmetalled roads); Change the oil and filter as soon as possible after driving in a dust storm.
- Stop/start driving with frequent short trips where the engine rarely warms up thoroughly (especially in cold weather/climates); and/or frequent or prolonged idling.
- Track use, with repeated high rpm, wide throttle openings and high oil temperatures. For appropriate maintenance, discuss with your Lotus dealer. Note that use of the car off road or in a competitive manner, including timed runs or laps, will invalidate warranty and require appropriate levels of expert car preparation and servicing.

Transmission (gearbox & final drive)

Viscosity	SAE 75W/90
Quality Standard	API GL-4 or GL-5
Capacity	2.3 litre (2.4 US qt)
Oil change interval	Refer to Maintenance Schedule

Brake & Clutch System

Type	Non-mineral (non-petroleum) hydraulic fluid
Specification	DOT 4
Capacity - brake	1.5 litre
- clutch	0.5 litre
Fluid change interval	12 months

Engine Coolant Additive

Only approved product	Havoline XLC
Type	Ethylene glycol antifreeze with corrosion inhibitors
OAT	
Colour	Orange
Concentration	50%
Quantity reqd. @ 50%	6 litres

TECHNICAL DATA

Tires - Standard

Type	- std.	Yokohama Neova AD07
	- sport option	Yokohama A048
Size	- front - std.	175/55 R16
	- sport option	195/50 R16 84W
	- rear	225/45 R17 90W
Pressure (cold)	- front - std.	180kPa (26 psi)
	- sport option	180kPa (26 psi)
	- rear	200kPa (29psi)

Winter Tires

Type	- front	Pirelli 210 Snowsport
	- rear	Pirelli 240 Snowsport
Size	- front	195/50 R16
	- rear	215/45 R17
Pressure (cold)	- front	180kPa (26 psi)
	- rear	190kPa (27.5 psi)

Wheels

Type	- std.	Cast alloy, 8 spoke
	- sport option	Forged alloy, 7 twin-spoke
Size	- front - std.	5.5J x 16
	- sport option	6.5J x 16
	- rear	7.5J x 17
Wheel bolt torque		105 Nm (77 lbf.ft)

Dimensions

Overall length		3785 mm
Overall width	- excl. mirrors	1719 mm
	- incl. mirrors	1850 mm (approx.)
Overall height (at kerb weight)		1117 mm
Wheelbase		2300 mm
Track	- front	1457 mm
	- rear	1503 mm
Ground clearance (mid laden)	- std.	135 mm
	- sport	130 mm
Front overhang		783 mm
Rear overhang		702 mm
Approach angle (at kerb) (sport)		13.5°
Departure angle (at kerb) (sport)		23°

Unladen weight	- total	912 kg)	inc.
(heaviest)	- front	344 kg)	full fuel
	- rear	568 kg)	tank
Max. weight	- total	1162 kg	>	incl.
	- front	441 kg	>	occupants
	- rear	721 kg	>	& luggage
Trailer towing				Not permissible

Capacities

Engine oil (refill inc. filter)		4.7 U.S. qt. (4.4 litre)
(+3.7 U.S. qt (3.5) litre if front mounted oil coolers are drained)		
High/low dipstick mark difference		1.6 U.S. qt. (1.5 litre)
Transmission oil		2.4 U.S. qt. (2.3 litre)
Fuel tank		10.6 U.S. gall. (40 litre)
Cooling system		12.7 U.S. qt. (12 litre)
A.C. refrigerant (R134a)		1.2 lb (0.55 kg)

Front Suspension

Type		Independent. Upper and lower wishbone co-axial coil spring/telescopic damper unit; anti-roll bar
Steering axis inclination		12° nominal

Geometry specification - Standard:

Mid-laden ride height (reference height for geometry check)

	- front	135 mm below front end of chassis siderail
	- rear	135 mm below rear end of chassis siderail
Castor	- optimum	+ 3.8°
	- tolerance range	+ 3.5° to + 4.1°; max. side/side 0.35°
Camber	- optimum	- 0.1°
	- tolerance range	+ 0.1° to - 0.3° max. side/side 0.2°
Alignment	- optimum	Zero
	- tolerance range	0.5 mm toe-out, to 0.7mm toe-in overall

Geometry specification - Sport option:

Mid-laden ride height (reference height for geometry check)

	- front	130 mm below front end of chassis siderail
	- rear	130 mm below rear end of chassis siderail
Castor	- optimum	+ 3.8°
	- tolerance range	+ 3.5° to + 4.1°; max. side/side 0.35°
Camber	- optimum	- 0.3°
	- tolerance range	- 0.1° to - 0.5° max. side/side 0.2°
Alignment	- optimum	Zero
	- tolerance range	0.5 mm toe-out, to 0.5 mm toe-in overall

Rear Suspension

Type Independent. Upper and lower wishbone; co-axial coil spring/telescopic damper.

Geometry specification - Standard:

Mid-laden ride height (reference height for geometry check)

	- front	135 mm below front end of chassis siderail
	- rear	135 mm below rear end of chassis siderail
Camber	- optimum	- 1.8°
	- tolerance range	- 1.6° to - 2.0° max.side/side 0.2°
Alignment	- optimum	1.2 mm toe-in each side
	- tolerance range	1.2 to 1.8mm toe-in each side max.side/side 0.3 mm

Geometry specification - Sport option:

Mid-laden ride height (reference height for geometry check)

	- front	130 mm below front end of chassis siderail
	- rear	130 mm below rear end of chassis siderail

Camber	- optimum	- 1.8°
	- tolerance range	- 1.6° to - 2.0°
		max.side/side 0.2°
Alignment	- optimum	1.5 mm toe-in each side
	- tolerance range	1.2 to 1.8 mm toe-in each side
		max.side/side 0.3 mm

Electrical

<i>Light Bulbs</i>	<i>Watt.</i>	<i>Type</i>
Headlamps	55	H1 & H7
Front side/parking lamps	5	W5W
Front turn indicators	21	PY21w amber
Rear turn indicators	21	H21
Side repeater lamps	5	WY5W amber
Stop lamps	21	H21
Tail/stop lamps	4/21	P21/4w
Tail/turn lamps	4/21	P21/4w
High mounted stop lamp	2.5	16 x LED
Reversing lamp	21	H21
Licence plate lamps	5	C5W
Interior lamp	5	W5W

System voltage/polarity	12V negative earth
Alternator	85A
Battery (service replacement)	
- type	Delco 19001598
- BCI code	26R-6YR
- cranking power	550 amps @ -18°C
- reserve capacity	80 minutes

Engine

Type designation	2ZZ-GE
Cylinder configuration	in-line 4
Capacity	1796 cm ³
Bore	82.0 mm
Stroke	85.0 mm
Camshafts	Chain driven DOHC 4VPC
Valve actuation - inlet	Variable timing and lift
- exhaust	Variable lift
Compression ratio	11.5:1
Firing order	1,3,4,2

Spark plugs	NGK IFR6A11 DensoSK20R11
Spark plug gap	1.1 mm
Max. continuous engine speed	8000 rpm (8500 transient)
Fuel requirement	Unleaded
Minimum octane	91 (RON+MON)/2
Fuel system	Multi-point fully sequential fuel injection with Lotus T4 controller.
Peak power (SAE DIN 70020)	190 bhp (141.7 kW) @ 7,800 rpm
Peak torque (SAE DIN 70020)	138 lbf.ft (187 Nm) @ 6,800 rpm

Transmission

Type	6 speed manual transaxle. Bevel gear differential.		
Gear	Ratio	Final Drive	mph/1000 rpm
First	3.17:1)	5.1
Second	2.05:1)	7.7
Third	1.48:1) 4.53:1	10.7
Fourth	1.17:1)	13.6
Fifth	0.92:1)	17.3
Sixth	0.81:1)	19.4
Reverse	3.25:1)	

Brakes

Type	Front and rear discs with curved vane ventilation and cross drilling. AP Racing aluminium opposed piston front calipers. Single piston sliding rear calipers.
Disc Size - front and rear	288mm
Operation	Tandem master cylinder with vacuum servo and ABS
Parking Brake	Cable operation of rear calipers, self adjusting for pad wear.

Technical Data

WARRANTY INDEX

Limited Warranty	162
Warranty Periods	162
Limitations	163
Exclusive Remedies	163
Extent of Company Obligations	163
Exclusions From Warranty Coverage	164
Obligations of Owners	167
Exclusive Warranty	168
Customer Assistance	168
Lotus Federal Emission Control System Warranties	171
Emissions Defects Warranty	171
Emissions Performance Warranty	172
Required Maintenance	173
What is <i>Not</i> Covered	174
Improper Maintenance and Use	175
Warranty Claim Procedure	176
Further Information	178
Emissions Warranty Parts List	178
California Emission Control Warranty Statement	180
Lotus California Emission Control System Warranties	182
California Emission Control System Defects Warranty	182
California Emissions Performance Warranty	185
What Is Not Covered By The California Emission Warranty	186
Customer Assistance	187
7 Year/70,000 Mile Emissions Defects Warranty Parts List	187

LIMITED WARRANTY

Lotus Cars U.S.A. Inc.; 2236 Northmont Parkway, Duluth, Georgia 30096.

LOTUS CARS U.S.A. Inc., (the Company) warrants each new Lotus motor car sold by the Company or an authorised Lotus dealer* in the U.S.A., and each Lotus replacement part supplied by the Company or an authorised Lotus dealer* in the U.S.A., to be free from defects in material and workmanship under normal use and service, and subject to the terms and conditions in this Limited Warranty, for the applicable Warranty Period set forth in Paragraph 1. (*Authorised Lotus dealers are not owned by, or are agents of, the Company)

The paragraphs below are the only and exclusive remedies under the terms of the warranty.

The Limited Warranty excludes certain parts and sets of circumstances which are set out in section 4 below.

1. WARRANTY PERIODS

(a) LIMITED WARRANTY - Cars.

The Company warrants each new car to be free from defects in material and workmanship for a period of thirty six (36) months or 36,000 miles, whichever first occurs, after the first occurring of the following dates:

- i) date of delivery of the car to the retail original owner;
- ii) registration as a dealer demonstrator.

CONSULT YOUR SALES DOCUMENTS TO DETERMINE THE WARRANTY START DATE ON YOUR CAR; SPEAK TO YOUR DEALER OR LOTUS CARS USA IF YOU ARE IN DOUBT.

(b) LIMITED WARRANTY - Replacement Parts.

Genuine Lotus replacement parts are warranted to be free from defects in materials and workmanship for 12 months from the date of their installation or until the expiration of the car's limited warranty term, whichever occurs last.



(c) LIMITED WARRANTY - Corrosion Perforation.

The Company's Limited Corrosion Perforation Warranty (as set forth in Paragraph 4 (c)) runs for a period of 8 years from the commencement of the Car Limited Warranty as specified in paragraph 1(a).

2. LIMITATIONS

THE COMPANY DOES NOT AUTHORIZE ANY PERSON TO CREATE ANY OTHER OBLIGATION IN CONNECTION WITH ITS CARS. ANY IMPLIED WARRANTY OF MERCHANTABILITY OR FITNESS FOR A PARTICULAR PURPOSE, APPLICABLE TO A CAR OR PART IS LIMITED IN DURATION TO THE TIME PERIODS SET FORTH IN PARAGRAPH 1.

3. EXCLUSIVE REMEDIES

THE PERFORMANCE OF REPAIRS AND NEEDED ADJUSTMENTS ARE THE EXCLUSIVE REMEDIES UNDER THIS WRITTEN WARRANTY OR ANY IMPLIED WARRANTY. THE COMPANY SHALL NOT BE LIABLE FOR INCIDENTAL OR CONSEQUENTIAL DAMAGE RESULTING FROM THE BREACH OF ANY WARRANTY.

SOME STATES DO NOT ALLOW LIMITATIONS ON HOW LONG AN IMPLIED WARRANTY LASTS, OR THE EXCLUSION OR LIMITATION OF INCIDENTAL OR CONSEQUENTIAL DAMAGES, SO THE ABOVE LIMITATIONS OR EXCLUSIONS MAY NOT APPLY TO YOU.

4. EXTENT OF COMPANY OBLIGATIONS

(a) LIMITED WARRANTY - Car. This warranty extends to each original and subsequent owner of a Lotus motor car within the warranty period expressed in Paragraph 1(a). The obligations of the Company under this warranty are limited to the repair or, at its option, the replacement with a new or remanufactured unit without charge for labour or part, of any part or assembly or component determined to be defective in material or workmanship during the applicable warranty period. All items which are replaced become the property of the Company to the fullest extent allowed under applicable law. All Service under this warranty must be performed by a Lotus Dealer at its place of business.



(b) LIMITED WARRANTY - Replacement Parts.

The obligations of the Company during the warranty term are limited to the repair or, at its option, the replacement of any genuine Lotus part determined to be defective in material or workmanship during the warranty period expressed in paragraph 1(b). All replaced parts shall become the property of the Company.

(c) LIMITED WARRANTY - Corrosion Perforation.

The Company warrants to the original owner and each subsequent owner during the warranty period set forth in Paragraph 1(c), that if corrosion perforation occurs on the chassis or composite body structure of a Lotus motor car, within the warranty period expressed in Paragraph 1(c), the parts or components affected by such perforation shall be repaired or replaced, without charge for labour or parts. Provided, however, that:

- a) the Lotus car must be brought to an authorised Lotus dealer for inspection at least one time each year; and
- b) the Lotus car has been used and maintained in a normal and reasonable manner.

c) corrosion perforation is not due to any or all of the following: an accident; abuse; damage; installation of an accessory; chemical substance; an act of nature; fire; or salvaged car.

(d) OBTAINING REPAIRS.

All warranted repairs will be effected at Lotus Dealers upon presentation of suitable evidence of eligibility. A reasonable time must be allowed for the dealership to perform necessary repairs, and customers are requested to allow such a reasonable amount of time. It is not Lotus Cars USA's responsibility to provide the customer with a loan car during these repairs. The provision of a loan car should be discussed with the dealer.

5. EXCLUSIONS FROM WARRANTY COVERAGE (see also section 6)

(a) TIRES. The only provided warranty for tires is the written warranty issued by the tire supplier and included with the owner literature supplied with your car.

(b) CAR SPECIFICATION. The obligations of the Company under this Limited Warranty apply only to cars built by the manufacturer to USA specification for road use (i.e. not to

cars imported into the USA which are not manufactured to a USA specification.

(c) MAINTENANCE; SERVICE ITEMS; WEAR & TEAR.

Maintenance services are not covered, these include (although this list is not exhaustive):

- i) maintenance services such as tune-ups, cleaning, polishing, lubrication, wheel balancing and alignment, brake, clutch, belt and other normal adjustments,
- ii) recharging or replacement of the battery where the car is not used for prolonged periods and a battery charger is not used,
- iii) the repair or replacement of service items such as lubricants, fluids, spark plugs, wiper blades, filters, belts, hoses, brake pads and linings clutch components, light bulbs or glass, or,
- iv) after the first three months of service (unless as part of a warranty repair), the air conditioner refrigerant, or
- v) the deterioration of paintwork, upholstery (see para 5n) or any other part, assembly or component as a consequence of normal wear and tear or exposure to the elements, including airborne fallout (chemicals, tree sap etc.).
- vi) body panel, glass and trim adjustments may intermittently be required to prevent excessive water ingress, or noise and vibration and so should be considered as routine maintenance.

(d) INCIDENTAL AND CONSEQUENTIAL DAMAGES. UNLESS OTHERWISE EXPRESSLY PROVIDED BY LAW THIS WARRANTY NEITHER COVERS NOR EXTENDS TO ANY INCIDENTAL OR CONSEQUENTIAL DAMAGE OR EXPENSE. SUCH DAMAGE AND EXPENSE INCLUDES (ALTHOUGH IT IS NOT AN EXHAUSTIVE LIST) INCONVENIENCE, HOTEL OR RESTAURANT EXPENSES, TOWING OR PARKING FEES, CAR RENTALS OR THE LOSS OF TIME OR USE OF THE CAR.

SOME STATES DO NOT ALLOW THE EXCLUSION OR LIMITATION OF INCIDENTAL OR CONSEQUENTIAL DAMAGES, SO THE ABOVE LIMITATION OR EXCLUSIONS MAY NOT APPLY.

(e) ACCIDENTS AND SIMILAR EVENTS.

Car's malfunctions or damage resulting from accidents, col-

lision, fire, theft or climatic conditions are not covered under this warranty.

(f) ODOMETER ALTERATION.

Warranty coverages do not apply if the odometer has stopped, been altered or the car's correct mileage cannot accurately and easily be determined.

(g) This Limited Warranty excludes the **emission control system**, the Federal and California warranties for which are detailed on pages 171 through 187.

(h) Malfunctions, defects or damage caused by any non-Lotus part or accessory are not covered by this warranty. If a part which is covered by the Limited Warranty fails during the warranty period and in turn this failure causes a failure of a non-warranted part, then Lotus will consider replacing the non-warranted part.

(j) If any after-market sport parts are fitted to your car, such parts are not covered by the Limited Warranty. Such parts are covered by any warranty which accompanies the sale of that particular part. Defects arising from track use will not be covered by your Limited Warranty. Any original part affected or damaged by the fitment of any off road or track part may not be covered by your Limited Warranty.

k) Minor wind noise and minor water ingress from the hard or soft top roofs.

NOTICE: The car is a speciality sports car not intended to go through automatic car washes. If the car is taken through a car wash any damage **is not** covered by the warranty.

l) If it is determined that paint on the car must be repaired because of an item covered under warranty the paint colour matching of repaired or replaced body panels will be achieved within practicable limits as determined by the Company. Painting of the entire car solely for the purpose of paint colour matching will not be covered under the warranty.

m) Noise and vibration are a normal and necessary feature of a mechanical device such as a motor car. The nature and

extent of such noises, including brake squeal, engine and exhaust noise, gear whine, knocks, rattles and wind noise will differ from car to car, with the level of acceptability being determined by the Company.

n) Lotus cars are upholstered with premium quality leather specifically tanned and dyed for automotive use. As a natural material, leather ages in various ways and may, over time, exhibit signs of cracking, scuffing, shrinking, etc. Such wear is the natural maturing of the leather and is not covered under warranty.

o) Salvage title or total loss; the warranty does not cover any car which can no longer be used on the road because it only has salvage value or has been declared as an insurance write off due to an accident or damage.

6. OBLIGATIONS OF OWNERS. ALL WARRANTIES ARE VOID IF OWNERS FAIL TO PROPERLY USE AND MAINTAIN THE CAR.

The Company has no obligation under this warranty in the following circumstances:

- If the car has not been driven in accordance with the 'Break-in' instructions detailed in the Owner's Handbook;
- if the maintenance services and maintenance instructions specified in this Handbook are not performed and followed at the prescribed intervals. Car owners must keep up to date and accurate records of car service and maintenance in order for any warranty claim to be considered;
- if the motor car is used for commercial service, or for racing or reliability trials, or in a competitive manner, including timed runs or laps;
- if the motor car is registered or used outside the Continental United States, Canada, Hawaii, Puerto Rico, Alaska, Guam and the United States Virgin Islands;
- if failure or malfunction of the motor car or of any warranted part, component or assembly results from an accident; or,
- if failure or malfunction is caused by misuse, abuse or negligence in use of the motor car, including, but not limited to, where the car is not driven on road surfaces which have been maintained to a standard to allow regular vehicle traffic, or

- within legal speed limits, or by performance of service, repair, alteration or modification of the car other than in accordance with the recommended servicing and repair procedures of the Company, or;
- by fitting of a part, assembly, accessory or component not conforming to specifications of the manufacturer of the motor car.

7. EXCLUSIVE WARRANTY

This Limited Warranty and the Emission Control System Warranties are the only express warranties applicable to the car which are given by the Company or the manufacturer of the car. Subject to the provision of Paragraph 2 (Limitations of Warranties), this warranty and the emission control system warranties exclude all other obligations and liabilities of the Company and the manufacturer of the car, whether they arise in contract or tort, or otherwise to the fullest extent permitted by law. Any and all other express warranties, representations, promises or statements shall be of no force or effect as regards the Company, or the manufacturer of the car. If any provision of this warranty is declared or made ineffective or unenforceable by law, adjudication or otherwise, such ineffectiveness or unenforceability shall not affect any of the other terms and conditions of this warranty.

No person is authorised to change or modify this warranty, and under no circumstances may this warranty be changed or modified orally.

8. CUSTOMER ASSISTANCE

In order to obtain performance of any obligation under this Limited Warranty, bring the Lotus car to any authorised Lotus Dealer. Any such dealer is authorised to perform warranty obligations. If you are unhappy with work performed on your Lotus, speak first with the dealer's Service Manager, and then, if necessary, with the General Manager or owner. If you still cannot resolve a problem, contact:

Lotus Cars U.S.A. Inc.
2236 Northmont Parkway
Duluth, Georgia 30096.
Tel. 770 476 6540

When contacting Lotus Cars USA, please have the following information available:

- year and model of your Lotus;
- your car's vehicle identification number (viewable through bottom edge of windscreen, driver's side);
- date of purchase of your Lotus;
- name of dealer(s) from whom you purchased your Lotus and where you have it serviced.

State Repair - Replace-Refund Statutes

Each state has a law providing new car purchasers with certain rights for repair, replacement of the car, or refund of the purchase price, under certain circumstances (these laws are commonly called "lemon laws"). These laws vary from state to state. ***To the extent permitted by an applicable state law, Lotus Cars USA requires that, before you seek a remedy, you provide Lotus Cars USA (at the address set forth above) with written notification of the defect or nonconformity.*** In this way, Lotus Cars USA will be afforded an opportunity to perform any necessary repairs. Where appropriate, an additional lemon law information sheet is provided with this owner's manual.

Arbitration Programs

Some states have state-run arbitration programs that you can use to pursue lemon law remedies. These programs are operated by state agencies, and such agencies may be contacted for additional information.

In some states that do not have state-run programs, Lotus Cars USA may participate in private arbitration or mediation programs. In these states, additional information will be provided to you separately.

Where either a state-run or private arbitration program is in effect, to the extent allowed by law, Lotus Cars USA requires that your lemon law claim first be brought before such program before you pursue other remedies.

THIS WARRANTY GIVES YOU SPECIFIC LEGAL RIGHTS AND YOU MAY ALSO HAVE OTHER RIGHTS WHICH VARY FROM STATE TO STATE.

Limited Warranty

170

LOTUS FEDERAL EMISSION CONTROL SYSTEM WARRANTIES

The Lotus Emission Control System Warranties comprise an Emissions Defects Warranty and an Emissions Performance Warranty. In both cases, the warranty period shall begin on the date the car is delivered to its ultimate purchaser, or if the car is first placed in service as a 'demonstrator' or 'company' car prior to delivery, on the date it is first placed into service.

EMISSIONS DEFECTS WARRANTY

Lotus Cars Ltd. (Lotus), warrants to the owner of any new, USA specification, Lotus Elise that:-

- 1) the car was designed, built and equipped so as to conform at the time of sale, with applicable requirements of the U.S. Environmental Protection Agency; and
- 2) is free from defects in materials and workmanship in Emission Related Components which could cause the car to fail to conform with these requirements for a period of 2 years or 24,000 miles, whichever first occurs, provided however, that in the case of specified Major Emission Control Components, the warranty period shall be 8 years or 80,000 miles, whichever first occurs.

A list of the Emissions Related Components to which this Defects Warranty applies appears on page 178 to 179 (specified Major Emission Control Components are marked with an asterisk).

This warranty does not cover failures caused by abuse, neglect, collision accidents, improper maintenance, unauthorised modifications; nor does it cover loss of time inconvenience, loss of use of the car or incidental or consequential damages.

ANY IMPLIED WARRANTY OF MERCHANTABILITY OR FITNESS FOR A PARTICULAR PURPOSE, APPLICABLE TO A Car OR PART IS LIMITED IN DURATION TO THE TIME

PERIODS SET FORTH IN THIS WARRANTY. LOTUS SHALL NOT BE LIABLE FOR INCIDENTAL OR CONSEQUENTIAL DAMAGE RESULTING FROM THE BREACH OF ANY WARRANTY.

SOME STATES DO NOT ALLOW LIMITATIONS ON HOW LONG AN IMPLIED WARRANTY LASTS, OR THE EXCLUSION OR LIMITATION OF INCIDENTAL OR CONSEQUENTIAL DAMAGES, SO THE ABOVE LIMITATIONS OR EXCLUSIONS MAY NOT APPLY TO YOU.

EMISSIONS PERFORMANCE WARRANTY

Some state or local governments require periodic inspection and maintenance programs to ensure that your car's emissions control system functions properly. If an EPA approved program is in force where you are, you are eligible for Performance Warranty coverage.

Lotus warrants to the owner of any new, USA specification, Lotus Elise that if:-

- 1) the car is maintained and operated in accordance with the written instructions for proper maintenance and use;
- 2) the car fails to conform to the applicable emission standards as judged by an EPA approved emission test; and
- 3) such non-conformity results or will result in the car owner having to bear any penalty or other sanction (including denial or the right to use the car) under local, State or Federal law, then Lotus shall remedy the non conformity at no cost to the owner by adjusting, repairing or replacing emissions related components as is necessary in order for the car to conform to the applicable emission standard. This warranty is for a period of 2 years or 24,000 miles, whichever first occurs. However, specified Major Emission Control Components are covered for 8 years or 80,000 miles, whichever first occurs. Covered parts are listed on page 159 to 160 and specified Major Emission Control Components are followed by an asterisk.

Required Maintenance

The operations in the Maintenance Schedule (included in the Owner's Handbook package) must be undertaken at the mileages or time intervals specified to ensure the continued proper functioning of the emission control system, and to provide optimum car performance and reliability. More frequent maintenance may be needed for cars operating in dusty areas, on short trip driving, or in other severe conditions.

Inspection and service should also be performed any time a malfunction is suspected.

MAINTENANCE, REPLACEMENT OR REPAIR OF THE EMISSION CONTROL DEVICES AND SYSTEMS MAY BE PERFORMED BY ANY AUTOMOTIVE REPAIR ESTABLISHMENT OR INDIVIDUAL USING ANY CERTIFIED PART.

No emission performance warranty claim will be denied on the basis of the use of a properly certified part in the maintenance or repair of a car.

In no case will Lotus deny an emission performance warranty claim on the basis of:

- i) warranty work or pre-delivery service performed by any Lotus Dealer or
- ii) work performed in an emergency situation to rectify an unsafe condition, including an unsafe driveability condition attributable to Lotus provided the car owner has taken steps to put the car back in a conforming condition in a timely manner or
- iii) the use of any uncertified part or non compliance with the maintenance schedule or instruction for use (Owner's Handbook) which is not relevant to the reason that the car failed to comply with applicable emission standards or
- iv) any cause attributable to Lotus.

What Is *Not* Covered

Lotus may deny an emission performance warranty claim on the basis of an uncertified replacement part used in the maintenance or repair of a car if Lotus presents evidence that the uncertified replacement part is either defective in materials or workmanship, or not equivalent from an emission standpoint to the original equipment part, and the owner is unable to rebut the evidence.

A part not required to be replaced at a definite service interval (see Maintenance Schedule) shall be warranted for the applicable warranty period. Instructions to replace a component only if checked and found to be operating below specification shall have no bearing on warranty coverage unless the owner did not follow such an instruction prior to the short test failure and non compliance with that instruction caused the failure of another car component relevant to the non-conformity.

This warranty does not cover failures caused by abuse, neglect, collision, accidents, improper maintenance, unauthorised modification; nor does it cover loss of time, inconvenience, loss of use of the car or incidental or consequential damages.

ANY IMPLIED WARRANTY OF MERCHANTABILITY OR FITNESS FOR A PARTICULAR PURPOSE, APPLICABLE TO A Car OR PART IS LIMITED IN DURATION TO THE TIME PERIODS SET FORTH IN THIS WARRANTY. LOTUS SHALL NOT BE LIABLE FOR INCIDENTAL OR CONSEQUENTIAL DAMAGE RESULTING FROM THE BREACH OF ANY WARRANTY.

SOME STATES DO NOT ALLOW LIMITATIONS ON HOW LONG AN IMPLIED WARRANTY LASTS, OR THE EXCLUSION OR LIMITATION OF INCIDENTAL OR CONSEQUENTIAL DAMAGES, SO THE ABOVE LIMITATIONS OR EXCLUSIONS MAY NOT APPLY TO YOU.

Improper Maintenance and Use

- a) An emission performance warranty claim may be denied on the basis of non-compliance by a car owner with the Service Schedule or Owner's Handbook instructions for proper use.
- b) When determining whether an owner has complied with the written instructions for proper maintenance and use, Lotus may require an owner to submit evidence of compliance with those written maintenance instructions for which Lotus has an objective reason for believing:
 1. were not performed; and
 2. if not performed could be the cause of the particular car's exceeding applicable emission standards.
- c) Evidence of compliance with a maintenance instruction may consist of:
 1. a maintenance log book which has been validated at the appropriate time or mileage intervals specified for service by someone who regularly engages in the business of servicing automobiles for the relevant maintenance instruction(s); or
 2. a showing that the car has been submitted for scheduled maintenance servicing at the approximate time or mileage intervals specified for service to someone who regularly engages in the business of servicing automobiles for the purpose of performing the relevant maintenance; or
 3. a statement by the car owner that he or she performed the maintenance at the appropriate time or mileage interval specified, including a showing
 - i) that the owner purchased and used proper parts, and
 - ii) upon request by Lotus, that the owner is able to perform the maintenance properly.
- d) The time/mileage interval for scheduled maintenance services shall be the service interval specified for that part in the Maintenance Schedule or Owner's Handbook.
- e) For certified parts having a maintenance or replacement interval different from that specified in the written instructions for proper maintenance and use, the time/mileage interval shall be the service interval for which the part was certified.

- f) The owner may perform maintenance or have maintenance performed more frequently than required in the maintenance instructions.
- g) Lotus may deny an emission performance warranty claim on the basis of non-compliance with the written instructions for proper maintenance and use only if:
 - 1. an owner is not able to comply with a request by Lotus for evidence pursuant to paragraph (c) of this section; or
 - 2. notwithstanding the evidence presented pursuant to paragraph (c) of this section, Lotus is able to prove that the car failed an emission short test because
 - i) the car was abused; or
 - ii) an instruction for the proper maintenance and use was performed in a manner resulting in a component's being improperly installed or a component or related parameter's being adjusted substantially outside of the manufacturer's specifications; or
 - iii) unscheduled maintenance was performed on a vehicle which resulted in the removing or rendering inoperative of any component affecting the car's emissions.

Warranty Claim Procedure

- a) A claim under the emission performance warranty may be raised immediately upon the failure of an EPA approved emission short test, if as a result of that failure, an owner is required to take action of any kind in order to avoid imposition of a penalty or sanction. An owner need not suffer the loss of the right to use a car, be fined, incur repair expenses, or actually bear any penalty or sanction to satisfy the requirement (see 'Emissions Performance Warranty' paragraph (3)). That requirement shall be met if a test failure sets a procedure in motion under which the owner will bear a penalty or sanction if a car is not brought into conformity or repaired to some specified extent within some specified period of time.
- b) A warranty claim may be submitted by bringing a car and a copy of the EPA approved emission test report to
 - 1. any repair facility authorized by Lotus to service that model car, or
 - 2. any repair facility authorized by Lotus to perform emission performance warranty repairs for that model car.

- c) To the extent required by any Federal or State Law, whether statutory or common law: if an authorized repair facility is not reasonably available, Lotus will provide means for a suitably competent non-franchised repair facility to perform emission performance warranty repairs.
- d) 1. Lotus will make a final decision on an emission performance warranty claim within a maximum time limit of 30 days from the time at which the car is initially presented for repair or within the time during which an owner is required by local, state or federal law to have the car repaired without incurring further penalties or sanctions (whichever is shorter), unless a delay
- i) is requested by the car owner, or
 - ii) is caused by an event not attributable to Lotus or the warranty repair facility.
2. If the facility at which the car is initially presented for repair is unable for any reason to honour the particular claim, then, unless this requirement is waived in writing by the car owner, the repair facility shall forward the claim to; Lotus Cars U.S.A. Inc., 2236 Northmont Parkway, Duluth, Georgia 30096, in order for a decision to be made.
- e) Within the time period specified in paragraph (d) of this section, Lotus shall:
1. notify the owner that it will honour the claim; or
 2. provide the owner, in writing, with an explanation of the basis upon which the claim is being denied.
- f) Failure to notify an owner within the required time period (as determined under paragraph (d) of this section) for reasons that are not attributable to the car owner or events which are not beyond the control of Lotus or the repair facility, shall result in Lotus being responsible for repairing the car free of charge to the car owner.
- g) Lotus shall incur all costs associated with a determination that an emission performance warranty claim is valid.

FURTHER INFORMATION

Further information concerning the emission performance warranty is available from the Director Field Operation & Support Division (6406 J), Environmental Protection Agency, 401 'M' Street, SW, Washington DC 20460 (attention: Warranty Claim). Violations of the Emission Performance Warranty may also be reported to this office. Also contact Lotus Cars U.S.A. Inc., 2236 Northmont Parkway, Duluth, Georgia 30096.

EMISSIONS WARRANTY PARTS LIST

Air Induction System

- air inlet trunking
- intake manifold

Fuel Injection System

- fuel pressure regulator
- fuel injectors
- fuel delivery line
- throttle body

Ignition System

- spark plugs
- direct ignition coils

Positive Crankcase Ventilation System

- non return valve
- oil filler cap

Evaporative Emissions Control System (EECS)

- charcoal canister assembly
- fuel tank
- fuel level sender and seal
- fuel filler neck and hose
- fuel filler cap
- roll over valve assembly
- fuel lines
- fill level vent valve & pipe assy.
- canister close valve
- vapour management valve (VMV)

- fuel vapour pressure sensor

Exhaust System

- exhaust manifold
- catalytic converter, heat shields, gaskets and fasteners*

Engine Emission Control System Sensors

- electronic control module (ECM)*
- engine coolant temperature sensor (ECTS)
- air flow meter
- crankshaft sensor
- idle air control valve (IACV)
- wheel speed sensors
- throttle position sensor (TPS)
- knock sensor
- oxygen sensors
- oil control valves for VVTL-i
- oil pressure switch for VVTL-i
- camshaft position sensor
- coolant thermostat

On Board Diagnostics (OBD)

- malfunction indicator lamp (MIL)
- data link connector and harness

Miscellaneous Parts used in the Above Systems

- hoses
- switches, sensors and solenoids
- gaskets and seals
- wires, harnesses and connectors

* major emission control components - see page 171

CALIFORNIA EMISSION CONTROL WARRANTY STATEMENT

YOUR WARRANTY RIGHTS AND OBLIGATIONS

The California Air Resources Board and Lotus Cars Limited are pleased to explain the emission control system warranty on your new, USA specification, Lotus Elise. In California, new motor cars must be designed, built and equipped to meet the State's stringent anti-smog standards. Lotus must warrant the emission control system on your Elise for the periods of time listed below provided there has been no abuse, neglect or improper maintenance of your car. Your emission control system may include parts such as the carburettor or fuel injection system, the ignition system, catalytic convertor, and engine computer. Also included may be hoses, belts, connectors and other emission-related assemblies.

Where a warrantable condition exists, Lotus will repair your car at no cost to you including diagnosis, parts and labour.

MANUFACTURER'S WARRANTY COVERAGE

- For 3 years or 50,000 miles (whichever first occurs):
 - 1) If your car fails a Smog Check inspection, all necessary repairs and adjustments will be made by Lotus to ensure that your car passes the inspection. This is your emission control system PERFORMANCE WARRANTY.
 - 2) If any emission related part on your car is defective, the part will be repaired or replaced by Lotus. This is your short-term emission control system DEFECTS WARRANTY.
- For 7 years or 70,000 miles (whichever first occurs):
 - 1) If an emission related part listed in this warranty booklet specially noted with coverage for 7 years or 70,000 miles is defective, the part will be repaired or replaced by Lotus. This is your long term emission control system DEFECTS WARRANTY.

OWNER'S WARRANTY RESPONSIBILITIES:

- As the car owner, you are responsible for the performance of the required maintenance listed in your owner's manual. Lotus recommends that you retain all receipts covering maintenance on your car, but Lotus cannot deny warranty solely for the lack of receipts or for your failure to ensure the performance of all scheduled maintenance.
- You are responsible for presenting your car to a Lotus dealer as soon as a problem exists. The warranty repairs should be completed in a reasonable amount of time, not to exceed 30 days.
- As the car owner, you should also be aware that Lotus may deny you warranty coverage if your car or a part has failed due to abuse, neglect, improper maintenance or unapproved modifications.

If you have any questions regarding your warranty rights and responsibilities, you should contact: Lotus Cars U.S.A. Inc., at 2236 Northmont Parkway, Duluth, Georgia 30096, or the California Air Resources Board at 9528 Telstar Avenue, El Monte CA 91731.

LOTUS CALIFORNIA EMISSION CONTROL SYSTEM WARRANTIES

The Lotus California Emission Control System Warranties comprise the California Emissions Performance Warranty, and two levels of the California Emission Control System Defects Warranty.

Your car may also be eligible for additional warranty coverage under the Federal Emissions warranty (see previous section).

CALIFORNIA EMISSION CONTROL SYSTEM DEFECTS WARRANTY

Lotus Cars Ltd. (Lotus) warrants to the owner of any new, USA specification, Lotus Elise, that the car was designed, built and equipped so as to conform with requirements of the California Air Resources Board (CARB), and that if the car is maintained and operated in accordance with the written instructions for proper maintenance and use, then:

- i) if, during a period of 3 years or 50,000 miles, whichever first occurs, any part of the car which could affect emissions is broken or does not function as designed (including adjustments), provided the car does not qualify for an exclusion as described on page 186, Lotus shall be responsible for repair or replacement of any such part or parts, including diagnosis and labour charges.
- ii) if, during a period of 7 years or 70,000 miles, whichever first occurs, one or more of a certain group of emission related parts listed on page 187 is broken or does not function as designed (including adjustments), provided the car does not qualify for an exclusion as described on page 186, Lotus shall be responsible for repair or replacement of any such part or parts, including diagnosis and labour charges.

The warranty period shall begin on the date the car is delivered to the first retail purchaser, or, if the car is first placed in service as a demonstrator or company car prior to sale at retail, on the date the car is first placed in such service.

The emission control systems of your new, USA specification,

Lotus Elise, were designed, built and tested using genuine Lotus Service Parts and the car is certified as being in conformity with Federal and California emission control requirements. Accordingly, it is recommended that any replacement parts used for maintenance, repair or replacement of emission control systems be Lotus Service Parts or Lotus Authorized Remanufactured Parts. The owner may elect to have maintenance, replacement or repair of the emission control devices and systems performed by any automotive repair establishment or individual, and may elect to use parts other than Lotus Service or Authorized Remanufactured Parts for such maintenance, replacement or repair without invalidating this warranty; the cost of such service or parts, however, will not be covered under the warranty, except in emergency situations.

Use of replacement parts which are not of equivalent quality may impair the effectiveness of emission control systems. If other than Lotus Service Parts or Authorized Remanufactured Parts are used for maintenance, replacement or repair of components affecting emission control, the owner should obtain assurances that such parts are warranted by their manufacturer to be equivalent to genuine Lotus parts in performance and durability. Lotus however, assumes no liability under this warranty with respect to failure of such parts other than Lotus Service Parts or Authorized Remanufactured Parts. However, the use of non-Lotus replacement parts does not invalidate the warranty on other components. If a non-Lotus emission related part causes damage to other components, then the liability for the subsequent damage shall not be assumed by Lotus. If however, a Lotus Service Part or Authorized Remanufactured Part causes damage to a non-Lotus part, such non-Lotus part will be repaired.

Repairs and service covered by this warranty will be performed by any authorized Lotus Dealer at his place of business with no charge for parts or labour (including diagnosis), using Lotus Service or Authorized Remanufactured Parts for any part of the emission control system covered by this warranty. In the case of an emergency, where an authorized Lotus dealer is not available, or a Lotus part is not available within 30 days; repairs may be performed at any available service establishment or by any individual using any replacement part. Lotus will reimburse the owner for such repairs (including diagnosis) that are covered under this warranty, but such reimbursement will not exceed the

California Emission Warranty

Lotus suggested retail price for all warranted parts replaced, and labour charges based on Lotus's recommended warranty repair times, and the geographically appropriate hourly rate. A repair not being complete within 30 days constitutes an emergency. Replaced parts and paid invoices must be presented at a Lotus dealership as a condition of reimbursement for emergency repairs not performed at a Lotus dealer.

You are advised to perform all recommended maintenance or repairs on your new, USA specification, Lotus Elise. You are responsible for the performance of the required maintenance. Lotus will not deny a warranty claim solely because you have no record of maintenance; however, Lotus may deny a warranty claim if your failure to perform required maintenance resulted in the failure of a warranted part. Receipts and maintenance records covering the performance of regular maintenance should be retained in the event questions arise concerning maintenance. The receipts and maintenance records should be transferred to each subsequent owner of this car.

CALIFORNIA EMISSIONS PERFORMANCE WARRANTY

Lotus Cars Ltd. (Lotus) warrants to the owner of any new, USA specification, Lotus Elise, that if, during a period of 3 years or 50,000 miles, whichever first occurs, the car should fail to pass an Inspection/Maintenance test, for reasons other than those detailed on page 167 ('What is not covered by the Emission Warranty'), then the car will be repaired at no cost to the owner. The car is to be repaired so that it will pass the I/M test, and these repairs shall include diagnosis, replacement, repair, and adjustment of those defective parts affecting emissions.

The warranty period shall begin on the date the car is delivered to the first retail purchaser, or, if the car is first placed in service as a demonstrator or company car prior to sale at retail, on the date the car is first placed in such service.

If your car fails a Smog Check test or a Federal Emissions Short test, you may choose to have diagnosis of the failure and repairs made at a Lotus dealer or at another service facility. You may take your car to a Lotus dealer for warranty repairs and diagnosis without charge. You will have to pay for diagnostic costs and repairs if performed at another service facility except in the case of emergency repairs (see page 164). If your car fails a Smog Check test or a Federal Emissions Short test after the 3 year/50,000 mile performance warranty period has expired, but before 7 years/70,000 miles is reached, those parts listed on page 168 are still covered by the defects warranty.

If the warranty station demonstrates that the test failure was caused by one or more of the conditions excluded from warranty coverage (see below), the car owner shall be liable for all diagnostic and repair expenses. Such expenses shall not exceed the maximum repair costs permissible under the California Car Inspection Programme. Failure to notify the owner within 30 days that a performance warranty claim is invalid, shall render Lotus liable for the repair costs. If the warranty station identifies that the test failure was caused by one or more defects covered under warranty, and in combination with one or more of the conditions excluded from warranty coverage (see below), then the car owner shall be responsible only for that proportion of the diagnostic and repair costs that is not covered by warranty.

WHAT IS NOT COVERED BY THE CALIFORNIA EMISSION WARRANTIES

The warranty does not cover:

- Malfunctions in any part caused by any of the following: misuse, abuse, neglect, improper modification or alteration, tampering, disconnection, improper or inadequate maintenance, or use of leaded gasoline.
- Damage resulting from accident, acts of nature or other events beyond the control of Lotus.
- The repair or replacement of warranted parts which are scheduled for replacement prior to 50,000 miles (such as spark plugs, filters) once these parts have been replaced at the first recommended replacement interval as part of required maintenance services.
- Incidental and consequential damages, such as loss of time, inconvenience, loss of use of the car, or commercial loss.
- Any car on which odometer mileage has been changed so that mileage cannot be readily determined.

ANY IMPLIED WARRANTY OF MERCHANTABILITY OR FITNESS FOR A PARTICULAR PURPOSE APPLICABLE TO A Car OR PART IS LIMITED IN DURATION TO THE TIME PERIODS SET FORTH IN THIS WARRANTY. THE COMPANY SHALL NOT BE LIABLE FOR INCIDENTAL OR CONSEQUENTIAL DAMAGE RESULTING FROM THE BREACH OF ANY WARRANTY.

SOME STATES DO NOT ALLOW LIMITATIONS ON HOW LONG AN IMPLIED WARRANTY LASTS, OR THE EXCLUSION OR LIMITATION OF INCIDENTAL OR CONSEQUENTIAL DAMAGES, SO THE ABOVE LIMITATIONS OR EXCLUSIONS MAY NOT APPLY TO YOU.

CUSTOMER ASSISTANCE

Lotus Cars Ltd. wishes to help assure that the Emission Control Systems Warranty is properly administered. In the event that you do not receive the warranty service to which you believe you are entitled under the Emission Control Systems Warranty, or if you need additional assistance or information concerning this warranty, you should contact: Lotus Cars U.S.A. Inc., 2236 Northmont Parkway, Duluth, Georgia 30096.

If you cannot obtain satisfaction, you may contact: Air Resources Board, Mobile Source Division, 9528 Telstar Avenue, El Monte, CA. 91731.

7 YEAR/70,000 MILE EMISSIONS DEFECTS WARRANTY PARTS LIST

- Catalytic Converter
- Engine Management Electronic Control Module
- Throttle Body
- Exhaust Manifold
- Fuel Tank
- Fuel Level Sender and Seal
- IAC Valve
- Knock Sensor
- Intake Manifold and Gasket
- Fuel Pressure Regulator Valve
- Fuel Level Vent Valve
- Roll Over Valve
- Instrument Pack
- Main Harness

INDEX

Access Panels, front service 78

Accessories & Modifications, warnings 150

Air Cleaner Element 113

Air Conditioning 61

Airbag Safety System 21

Alarm, car security 30

Alternator Belt 114

Anti-freeze/Corrosion Inhibitor 107

Anti-Lock Brake System (ABS) 67

Audio Equipment 60

Auxiliary Power Socket 57

Battery 129

Bodycare 93

Brake Fluid Reservoir 110

Brake Pads 111

Break-In, running-in 73

Bulb Replacement 142

Central Door Locking 37

Child Restraints 26

Cleaning, bodycare 93

Coolant Temperature Display 53

Cooling System 106

Dipswitch 58

Doors, keys 37

Engine Cover/Trunk Lid 79

Environment, care of 14

Fuel Level Display 52

Fuel Filling 76

Fuel Requirement 75

Fuses 135

Gear Lever 71

Hazard Warning Lamps Switch 55

Headlamp Alignment 139

Headlamp Flasher	58
Heating & Ventilation	61
Horn	60
Idle Speed	73
Ignition Switch	44
Immobiliser, engine	31
Inertia Switch	135
Instrument Illumination	56
Interior Lamp	41
Jacking Points, lifting you car	148
'Jump' Starting	133
Keys	29
Lighting Switches	54
Lights On Buzzer	40,55
Lubrication	
- Dipstick, engine oil level check	99
- Engine Oil Change	100
- Oil Filter	102
- Recommended Lubricants	153
- Transmission Oil	103
Mirrors	40
Odometer	53
Parking Brake	70
Pedals	66
Queen's Award	191
Roof, Hard Top	85
Roof, Soft Top	82
Safety Information	7
Seat Belts	18
Seats	17
Servicing	see separate Maintenance Record booklet
Sparking Plugs	114
Speedometer	51
Start Button, engine	45
Starting Procedure	72

Steering Lock	44
Storing Your Elise	152
Sun Visors	41
Tachometer	51
Technical Data	155
Tell Tale Lamps	46
Tie Down, car securing	147
Towing Eye	146
Trip Recorder	53
Turn Indicators Switch	58
Tires	115
Tire Inflator Aerosol	124
Tire Chains	120
Identification, car	15
Warning 'Tell Tale' Lamps	46
Warranty	161
Washer Reservoir	109
Washing, bodycare	93
Wheelbolts	126
Wheels	126
Windows, door	42
Windscreen Wiper/Washer Control	59
Wiper Blade	109

The Queen's Award for Enterprise

The Queen's Award for Enterprise is the highest honour that can be bestowed upon a British company and is the UK's top award for business performance. The award is given annually by Her Majesty The Queen and the winning companies hold it for five years.

Group Lotus PLC and its staff were awarded The Queen's Award for Enterprise 2002 for the whole group's outstanding achievement in international trade. Lotus Cars has sold its prestigious sports car models into over 30 countries around the world and Lotus Engineering, which has been investing heavily in engine and chassis research, is regarded as one of the world's leading engineering consultancy groups.

The Lotus Elise now proudly displays The Queen's Award logo on the rear window. This logo symbolises the achievements of Group Lotus over the last few years culminating in the company being given the Award in 2002 – the year of The Queen's Golden Jubilee.

The Queen's Award scheme was introduced in 1966, originally as The Queen's Award to Industry before becoming known as The Queen's Award for Enterprise in 1999.

Her Majesty The Queen makes the Awards on the advice of the Prime Minister, who is assisted by an Advisory Committee that includes representatives of Government, industry and commerce, and the trade unions. They are announced on 21 April, The Queen's personal birthday.

For more information about The Queen's Awards, please see www.queensawards.org.uk

