

# 2000 Prelude Online Reference Owner's Manual

Use these links (and links throughout this manual) to navigate through this reference.  
For a printed owner's manual, click on authorized manuals or go to [www.helminc.com](http://www.helminc.com).

## Contents

---

### Owner's Identification Form

<b>Introduction</b> .....	<b>i</b>
<b>A Few Words About Safety</b> .....	<b>ii</b>
<b>Your Vehicle at a Glance</b> .....	<b>2</b>
<b>Driver and Passenger Safety</b> .....	<b>5</b>
Proper use and care of your vehicle's seat belts, and Supplemental Restraint System.	
<b>Instruments and Controls</b> .....	<b>51</b>
Instrument panel indicator and gauge, and how to use dashboard and steering column controls.	
<b>Comfort and Convenience Features</b> .....	<b>97</b>
How to operate the climate control system, the audio system, and other convenience features.	
<b>Before Driving</b> .....	<b>125</b>
What gasoline to use, how to break-in your new vehicle, and how to load luggage and other cargo.	
<b>Driving</b> .....	<b>139</b>
The proper way to start the engine, shift the transmission, and park, plus towing a trailer.	
<b>Maintenance</b> .....	<b>167</b>
The Maintenance Schedule shows you when you need to take your vehicle to the dealer.	
<b>Appearance Care</b> .....	<b>227</b>
Tips on cleaning and protecting your vehicle. Things to look for if your vehicle ever needs body repairs.	
<b>Taking Care of the Unexpected</b> .....	<b>235</b>
This section covers several problems motorists sometimes experience, and how to handle them.	
<b>Technical Information</b> .....	<b>261</b>
ID numbers, dimensions, capacities, and technical information.	
<b>Warranty and Customer Relations (U.S. and Canada)</b> .....	<b>273</b>
A summary of the warranties covering your new Acura, and how to contact us.	
<b>Authorized Manuals (U.S. only)</b> .....	<b>279</b>
How to order manuals and other technical literature.	
<b>Index</b> .....	<b>I</b>
<b>Service Information Summary</b>	
A summary of information you need when you pull up to the fuel pump.	

## Owner's Identification

---

OWNER \_\_\_\_\_  
\_\_\_\_\_

ADDRESS \_\_\_\_\_  
STREET

\_\_\_\_\_ CITY STATE/PROVINCE ZIP CODE /  
POSTAL CODE

V. I. N. \_\_\_\_\_

DELIVERY DATE \_\_\_\_\_  
(Date sold to original retail purchaser)

DEALER NAME \_\_\_\_\_ DEALER NO. \_\_\_\_\_

ADDRESS \_\_\_\_\_  
STREET

\_\_\_\_\_ CITY STATE/PROVINCE ZIP CODE /  
POSTAL CODE

OWNERS SIGNATURE \_\_\_\_\_

DEALER'S SIGNATURE \_\_\_\_\_

This Owner's Manual should be considered a permanent part of the car, and should remain with the car when it is sold.

The information and specifications included in this publication were in affect at the time of approval for printing. Honda Motor Co., Ltd. reserves the right, however, to discontinue or change specifications or design at any time without notice and with out incurring any obligation whatsoever.

Congratulations ! Your selection of a 2000 Honda Prelude was a wise investment. It will give you years of driving pleasure.

One of the best ways to enhance the enjoyment of your new Honda is to read this manual. In it, you will learn how to operate its driving controls and convenience items. Afterwards, keep this owner's manual in your car so you can refer to it at any time.

Several warranties protect your new Honda. Read the warranty booklet thoroughly so you understand the coverages and are aware of your rights and responsibilities.

Maintaining your car according to the schedules given in this manual helps to keep your driving trouble-free while it preserves your investment. When your car needs maintenance, keep in mind that your Honda dealer's staff is specially trained in servicing the many systems unique to your Honda. Your Honda dealer is dedicated to your satisfaction and will be pleased to answer any questions and concerns.

As you read this manual, you will find information that is preceded by a **NOTICE** symbol. This information is intended to help you avoid damage to your Honda, other property, or the environment.

## A Few Words About Safety

---

Your safety, and the safety of others, is very important. And operating this car safely is an important responsibility.

To help you make informed decisions about safety, we have provided operating procedures and other information on labels and in this manual. This information alerts you to potential hazards that could hurt you or others.

Of course, it is not practical or possible to warn you about all the hazards associated with operating or maintaining your car. You must use your own good judgement.

You will find this important safety information in a variety of forms, including:

- **Safety Labels** — on the car.
- **Safety Messages** — preceded by a safety alert symbol  and one of three signal words: **DANGER**, **WARNING**, or **CAUTION**.

These signal words mean:

 **DANGER**

You **WILL** be **KILLED** or **SERIOUSLY HURT** if you don't follow instructions.

 **WARNING**

You **CAN** be **KILLED** or **SERIOUSLY HURT** if you don't follow instructions.

 **CAUTION**

You **CAN** be **HURT** if you don't follow instructions.

- **Safety Headings** — such as Important Safety Reminders or Important Safety Precautions.
- **Safety Section** — such as Driver and Passenger Safety.
- **Instructions** — how to use this car correctly and safely.

This entire book is filled with important safety information — please read it carefully.

# Your Car at a Glance

---

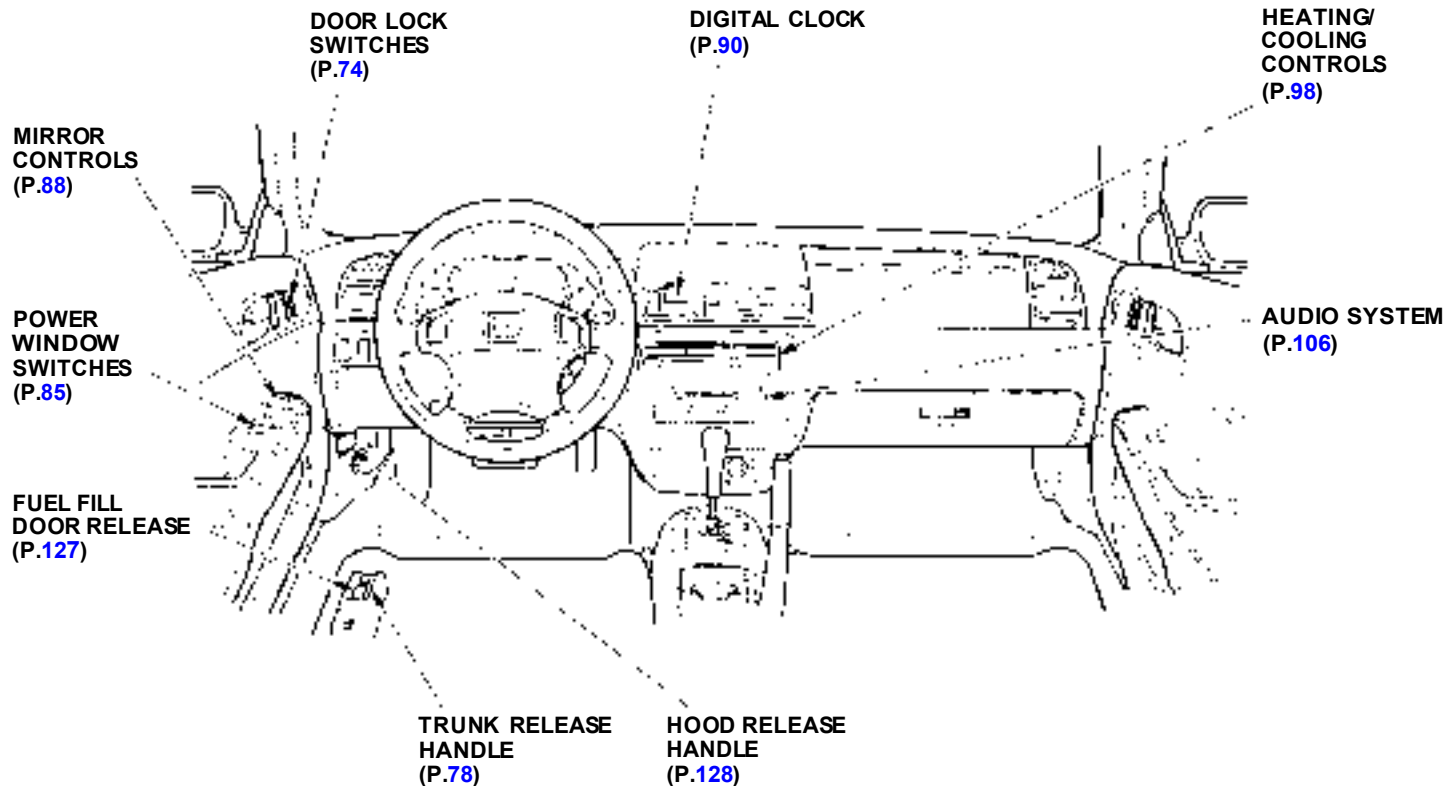

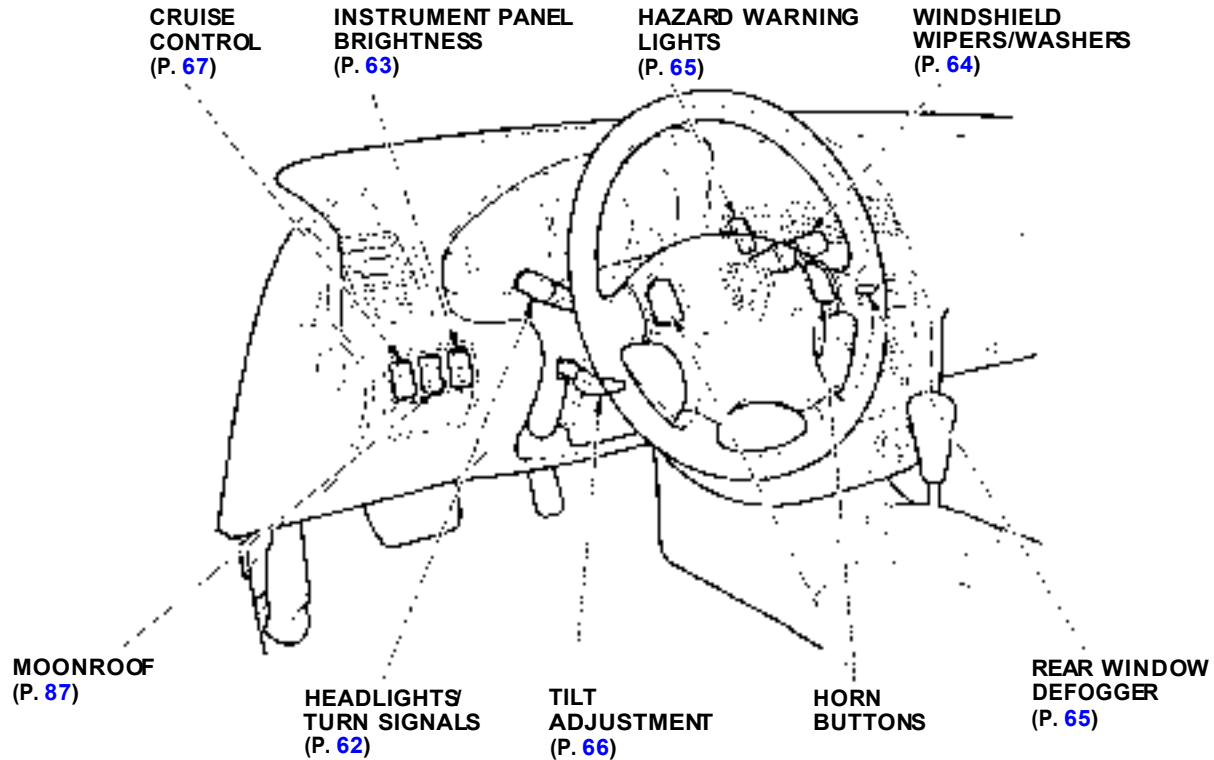



This section gives you important information about how to protect yourself and your passengers. It shows you how to use seat belts properly. It explains your Supplemental Restraint System. And it tells you how to properly restrain infants and children in your car.

Important Safety Precautions .....	6
Your Car's Safety Features .....	7
Seat Belts.....	8
Airbags.....	9
Seats & Seat-Backs.....	10
Head Restraints.....	10
Door Locks.....	11
Pre-Drive Safety Checklist.....	11
Protecting Adults.....	12
1. Close and Lock the Doors.....	12
2. Adjust the Front Seats.....	13
3. Adjust the Seat-Backs.....	14
4. Adjust the Head Restraints....	15
5. Fasten and Position the Seat Belts.....	16
6. Adjust the Steering Wheel.....	17
7. Maintain a Proper Sitting Position.....	18
Advice for Pregnant Women.....	19
Additional Safety Precautions....	19
Protecting Children.....	21
All Children Must Be Restrained.....	21
Children Should Sit in the Back Seat.....	22
The Passenger's Airbag Poses Serious Risks to Children.....	22
If You Must Drive with Several Children.....	24
If a Child Requires Close Attention.....	24
Additional Safety Precaution.....	24
General Guidelines for Using Child Seats.....	25
Protecting Infants.....	29
Protecting Small Children.....	33
Protecting Larger Children.....	36
Using Child Seats with Tethers.....	40
Additional Information About Your Seat Belts.....	42
Seat Belt System Components...	42
Lap/Shoulder Belt.....	42
Seat Belt Maintenance.....	44
Additional Information About Your SRS.....	45
SRS Components.....	45
How Your Airbags Work.....	45
How the SRS Indicator Light Works.....	47
SRS Service.....	47
Additional Safety Precautions....	48
Carbon Monoxide Hazard.....	49
Safety Labels.....	50



## Important Safety Precautions

---

You'll find many safety recommendations throughout this section, and throughout this manual. The recommendations on this page are the ones we consider to be the most important.

### **Always Wear Your Seat Belt**

A seat belt is your best protection in all types of collisions. Airbags supplement seat belts, but airbags are designed to inflate only in a moderate to severe frontal collision. So even though your car is equipped with airbags, make sure you and your passengers always wear your seat belts, and wear them properly. (See page [16](#).)

### **Restrain All Children**

Children are safest when they are properly restrained in the back seat, not the front seat. A child who is too small for a seat belt must be properly restrained in a child safety seat. (See page [21](#).)

### **Be Aware of Airbag Hazards**

While airbags can save lives, they can cause serious or fatal injuries to occupants who sit too close to them, or are not properly restrained. Infants, young children, and short adults are at the greatest risk. Be sure to follow all instructions and warnings in this manual. (See page [7](#).)

### **Don't Drink and Drive**

Alcohol and driving don't mix. Even one drink can reduce your ability to respond to changing conditions, and your reaction time gets worse with every additional drink. So don't drink and drive, and don't let your friends drink and drive, either.

### **Control Your Speed**

Excessive speed is a major factor in crash injuries and deaths. Generally, the higher the speed the greater the risk, but serious accidents can also occur at lower speeds. Never drive faster than is safe for current conditions, regardless of the maximum speed posted.

### **Keep Your Car in Safe Condition**

Having a tire blowout or a mechanical failure can be extremely hazardous. To reduce the possibility of such problems, check your tire pressures and condition frequently, and perform all regularly scheduled maintenance. (See page [170](#).)

## Your Car's Safety Features

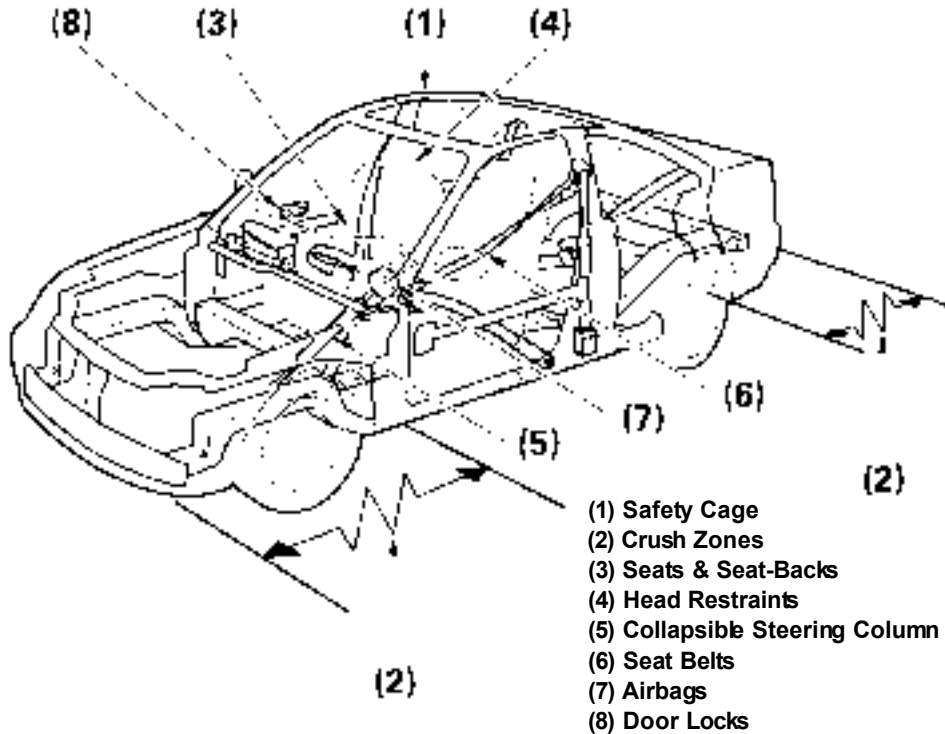

Your car is equipped with many features that work together to protect you and your passengers during a crash.

Some safety features do not require any action on your part. These include a strong steel framework that forms a safety cage around the passenger compartment; front and rear crush zones that are designed to crumple and absorb energy during a crash; and a collapsible steering column.

These safety features are designed to reduce the severity of injuries in a crash. However, you and your passengers can't take full advantage of these safety features unless you remain sitting in a proper position and ***always wear your seat belts properly***. In fact, some safety features can contribute to injuries if they are not used properly.

# Your Car's Safety Features

---

## Seat Belts

For your safety, and the safety of your passengers, your car is equipped with seat belts in all seating positions.



Your seat belt system also includes a light on the instrument panel to remind you and your passengers to fasten your seat belts.

### **Why Wear Seat Belts**

Seat belts are the single most effective safety device for adults and larger children. (Infants and smaller children must be properly restrained in child seats.)

Not wearing a seat belt properly increases the chance of serious injury or death in a crash, even though your car has airbags.

In addition, most states and all Canadian provinces require you to wear seat belts.

### **⚠ WARNING**

Not wearing a seat belt properly increases the chance of serious injury or death in a crash, even if you have airbags.

Be sure you and your passengers always wear seat belts and wear them properly.

When properly worn, seat belts:

- Keep you connected to the vehicle so you can take advantage of the car's built-in safety features.
- Help protect you in almost every type of crash, including side and rear impacts and rollovers. (Your airbag can only be helpful in a moderate to severe frontal

collision.)

- Help keep you from being thrown against the inside of the vehicle and against other occupants.
- Keep you from being thrown out of the vehicle.
- Help keep you in a good position should the airbags ever deploy. A good position reduces the risk of injury from an inflating airbag, and allows you to get the best advantage from the airbag.

Of course, seat belts cannot completely protect you in every crash. But in most cases, seat belts can reduce your risk of serious injury.

**What you should do:** Always wear your seat belt, and make sure you wear it properly.

## Airbags

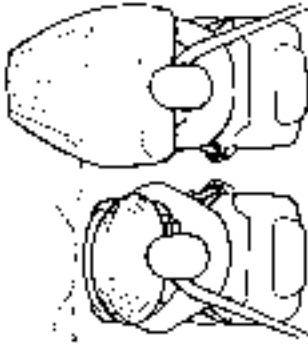

Your car has a Supplemental Restraint System (SRS) with frontal airbags to help protect the driver and a front seat passenger.

### SRS

This system also includes an indicator light on the instrument panel to alert you to a possible problem with the system.

The most important things you need to know about your airbags are:

- ***Airbags do not replace seat belts.*** The seat belts are the occupants' primary protection in all types of collisions. The airbags supplement the seat belts by providing extra protection for the head and chest of each front seat occupant in a moderate to severe frontal collision.
- ***Airbags offer no protection in side impacts, rear impacts, rollovers, or minor collisions.*** Airbags are designed to deploy only during a moderate to severe frontal collision.

- ***Airbags can pose serious hazards.*** To do their job, airbags must inflate with tremendous force and speed. So while airbags save lives, they can cause serious injuries to adults and larger children who are not wearing seat belts, are not wearing them properly, are sitting too close to the airbag, or are not sitting in a proper position. Infants and small children are at an even greater risk of injury or death.

***What you should do:*** Always wear your seat belt properly, and sit upright and as far back as possible from the steering wheel or dashboard.

# Your Car's Safety Features

---

## **Seats & Seat-Backs**

Your car's seats are designed to keep you in a comfortable, upright position so you can take full advantage of the protection offered by seat belts and the energy absorbing materials in the seats.

How you adjust your seats and seat-backs can also affect your safety. For example, sitting too close to the steering wheel or dashboard increases the risk of you or your passenger being injured by striking the inside of the car, or by an inflating airbag.

Reclining a seat-back too far reduces the seat belt's effectiveness and increases the chance that the seat's occupant will slide under the seat belt in a crash and be seriously injured.

***What you should do:*** Move the front seats as far back as possible, and keep adjustable seat-backs in an upright position whenever the car is moving.

## **Head Restraints**

Head restraints can help protect you from whiplash and other injuries. For maximum protection, the back of your head should rest against the center of the head restraint.

### Door Locks

Keeping your doors locked reduces the chance of being thrown out of the car during a crash. It also helps prevent occupants from accidentally opening a door and falling out, and outsiders from unexpectedly opening your doors.

### Pre-Drive Safety Checklist

To make sure you and your passengers get the maximum protection from your car's safety features, check the following each time before you drive away:

- All adults, and children who have outgrown child safety seats, are wearing their seat belts and wearing them properly (see page [16](#)).
- Any infant or small child is properly restrained in a child seat in the back seat (see page [21](#)).
- Front seat occupants are sitting upright and as far back as possible from the steering wheel and dashboard (see page [13](#)).
- Seat-backs are upright (see page [14](#)).
- Head restraints are properly adjusted (see page [15](#)).
- Both doors are closed and locked (see page [12](#) ).

All cargo is properly stored or secured (see page [135](#)).

The rest of this section gives more detailed information about how you can maximize your safety.

Remember, however, that no safety system can prevent all injuries or deaths that can occur in severe crashes, even when seat belts are properly worn and the airbags deploy.

# Protecting Adults

---

## Introduction

The following pages provide instructions on how to properly protect the driver and other adult occupants.

These instructions also apply to children who have outgrown child seats and are large enough to wear lap/shoulder belts. (See page 37 for important additional guidelines on how to properly protect larger children.)

## 1. Close and Lock the Doors

After everyone has entered the car, be sure the doors are closed and locked.



Your car has a door monitor light on the instrument panel to indicate when a specific door is not tightly closed.

For safety, locking the doors reduces the chance that a passenger, especially a child, will open a door while the car is moving and accidentally fall out. It also reduces the chance of someone being thrown out of the car during a crash.

For security, locked doors can prevent an outsider from unexpectedly opening a door when you come to a stop.

See page 74 for how to lock the doors.

### 2. Adjust the Front Seats

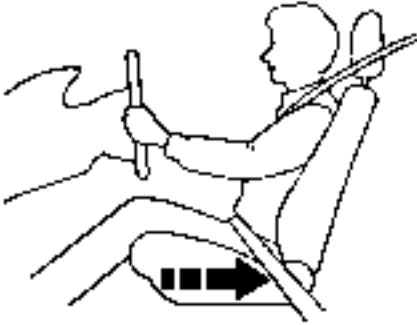

Any driver who sits too close to the steering wheel is at risk of being seriously injured or killed by striking the steering wheel, or from being struck by an inflating airbag during a crash.

To reduce the chance of injury, wear your seat belt properly, sit upright with your back against the seat, and move the seat as far back as possible from the steering wheel while still maintaining full control of the car. Also make sure your front seat passenger moves the seat as far to the rear as possible.

#### **WARNING**

Sitting too close to an airbag can result in serious injury or death if the airbags inflate.

Always sit as far back from the airbags as possible.

Most shorter drivers can get far enough away from the steering wheel and still reach the pedals. However, if you are concerned about sitting too close, we recommend that you investigate whether some type of adaptive equipment may help.

Once your seat is adjusted correctly, rock it back and forth to make sure the seat is locked in position.

See page [80](#) for how to adjust the front seats.



## Protecting Adults

### 3. Adjust the Seat-Backs

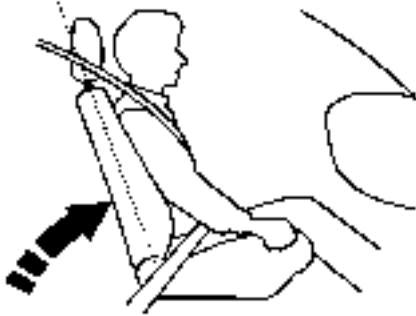

Adjust the driver's seat-back to a comfortable, upright position, leaving ample space between your chest and the airbag cover in the center of the steering wheel. If you sit too close to the steering wheel, you could be injured if the airbag inflates.

A front passenger should also adjust the seat-back to an upright position, but as far from the dashboard as possible. A passenger who sits too close to the dashboard could be injured if the airbag inflates.

Reclining a seat-back so that the shoulder part of the belt no longer rests against the occupant's chest reduces the protective capability of the belt. It also increases the chance of sliding under the belt in a crash and being seriously injured. The farther a seat-back is reclined, the greater the risk of injury.

#### **WARNING**

Reclining the seat-back too far can result in serious injury or death in a crash.

Adjust the seat-back to an upright position and sit well back in the seat.

See page [80](#) for how to adjust seat-backs.

### 4. Adjust the Head Restraints

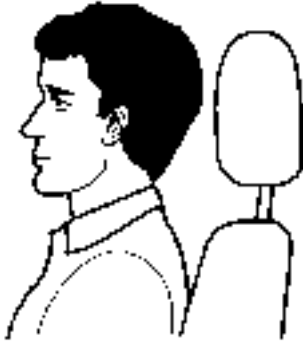

Before driving, make sure everyone with an adjustable head restraint has properly positioned the head restraint. The restraint should be positioned so the back of the occupant's head rests against the center of the restraint. A taller person should adjust the restraint as high as possible.

#### **WARNING**

Improperly positioning head restraints reduces their effectiveness and you can be seriously injured in a crash.

Make sure head restraints are in place and positioned properly before driving.

Properly adjusted head restraints will help protect occupants from whiplash and other crash injuries.

See page [82](#) for how to adjust the head restraints.

## Protecting Adults

---

### 5. Fasten and Position the Seat Belts

Insert the latch plate into the buckle, then tug on the belt to make sure the belt is securely latched. Also check that the belt is not twisted, because a twisted belt can cause serious injuries in a crash.

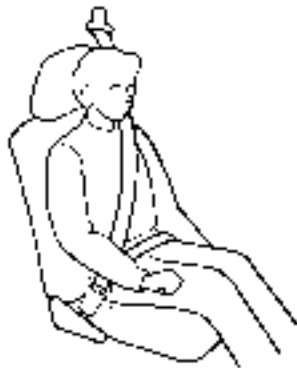

Position the lap part of the belt as low as possible across your hips, then pull up on the shoulder part of the belt so the lap part fits snugly. This lets your strong pelvic bones take the force of a crash and reduces the chance of internal injuries.

If necessary, pull up on the belt again to remove any slack from the shoulder part, then check that the belt rests across the center of your chest and over your shoulder. This spreads the forces of a crash over the strongest bones in your upper body.

#### **WARNING**

Improperly positioning the seat belts can cause serious injury or death in a crash.

Make sure all seat belts are properly positioned before driving.

***Never place the shoulder portion of a lap/shoulder belt under your arm or behind your back.*** This could cause very serious injuries in a crash.

If a seat belt does not seem to work as it should, it may not protect the occupant in a crash. **No one should sit in a seat with an inoperative seat belt.** Anyone using a seat belt that is not working properly can be seriously injured or killed. Have your Honda dealer check the belt as soon as possible.

See page [42](#) for additional information about your seat belt system and how to take care of your belts.

### 6. Adjust the Steering Wheel

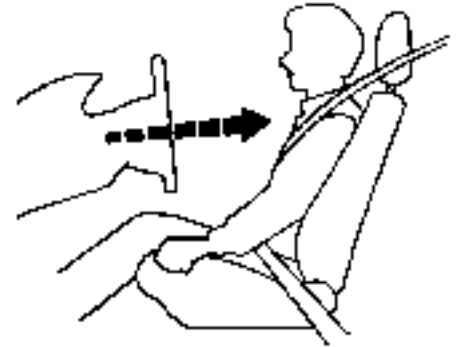

Adjust the steering wheel, if needed, so that the wheel points toward your chest, not toward your face.

Pointing the steering wheel toward your chest provides optimal protection from the airbag.

See page [66](#) for how to adjust the steering wheel.

## Protecting Adults

---

### 7. Maintain a Proper Sitting Position

After all occupants have adjusted their seats and put on seat belts, it is very important that they continue to sit upright, well back in their seats, with their feet on the floor, until the car is parked and the engine is off.

Sitting improperly can increase the chance of injury during a crash. For example, if an occupant slouches, lies down, turns sideways, sits forward, leans forward or sideways, or puts one or both feet up, the chance of injury during a crash is greatly increased.

In addition, an occupant who is out of position in the front seat can be seriously or fatally injured by striking interior parts of the car, or by being struck by an inflating airbag.

#### **WARNING**

Sitting improperly or out of position can result in serious injury or death in a crash.

Always sit upright, well back in the seat, with your feet on the floor.

Remember, to get the best protection from your car's airbags and other safety features, you must sit properly and wear your seat belt properly.

### Advice for Pregnant Women



Because protecting the mother is the best way to protect her unborn child, a pregnant woman should always wear a seat belt whenever she drives or rides in a vehicle.

Remember to keep the lap portion of the belt as low as possible across your hips.

Pregnant women should also sit upright and as far back as possible from the steering wheel or dashboard. This will reduce the risk of injuries to both the mother and her unborn child that can be caused by a crash or an inflating airbag.

Each time you have a check-up, ask your doctor if it's okay for you to drive.

### Additional Safety Precautions

- ***Two people should never use the same seat belt.*** If they do, they could be very seriously injured in a crash.
- ***Do not put any accessories on seat belts.*** Devices intended to improve occupant comfort or reposition the shoulder part of a seat belt can severely compromise the protective capability of the seat belt and increase the chance of serious injury in a crash.

CONTINUED

## Protecting Adults

---

- **Do not place hard or sharp objects between yourself and an airbag.**

Carrying hard or sharp objects on your lap, or driving with a pipe or other sharp object in your mouth, can result in injuries if your airbags inflate.

- **Do not attach or place objects on the front airbag covers.** Any object attached to or placed on the covers marked "SRS AIRBAG" in the center of the steering wheel and on top of the dashboard could interfere with the proper operation of the airbags. Or, if the airbags inflate, the objects could be propelled inside the car and hurt someone.

- **Keep your hands and arms away from the airbag covers.** If your hands or arms are close to the airbag covers in the center of the steering wheel and on top of the dashboard, they could be injured if

the airbags inflate.



Children depend on adults to protect them. However, despite their best intentions, many parents and other adults may not know how to *properly* protect young passengers.

So if you have children, or if you ever need to drive with a grandchild or other children in your car, be sure to read this section.

### **⚠ WARNING**

Children who are unrestrained or improperly restrained can be seriously injured or killed in a crash.

Any child too small for a seat belt should be properly restrained in a child seat. A larger child should be properly restrained with a seat belt.

### **All Children Must Be Restrained**

Each year, many children are injured or killed in vehicle crashes because they are either unrestrained or not properly restrained. In fact, vehicle accidents are the number one cause of death of children ages 12 and under.

To reduce the number of child deaths and injuries, every state and Canadian province requires that infants and children be restrained whenever they ride in a vehicle.

***Any child who is too small to wear a seat belt should be properly restrained in a child seat.*** (See page [25](#).)

***A larger child should always be restrained with a seat belt.*** (See page [37](#).)



# Protecting Children

---

## **Children Should Sit in the Back Seat**

According to accident statistics, children of all ages and sizes are safer when they are restrained in the back seat, not the front seat. The National Highway Traffic Safety Administration and Transport Canada recommend that all children ages 12 and under be properly restrained in the back seat.

In the back seat, children are less likely to be injured by striking hard interior parts during a collision or hard braking. Also, children cannot be injured by an inflating airbag when they ride in the back.

## **The Passenger's Airbag Poses Serious Risks to Children**

Airbags have been designed to help protect adults in a moderate to severe frontal collision. To do this, the passenger's airbag is quite large, and it inflates with tremendous speed.

### ***Infants***

***Never put a rear-facing child seat in the front seat of a vehicle equipped with a passenger's airbag.*** If the airbag inflates, it can hit the back of the child seat with enough force to kill or very seriously injure an infant.

### ***Small Children***

***Placing a forward-facing child seat in the front seat of a vehicle equipped with a passenger's airbag can be hazardous.*** If the vehicle seat is too far forward, or the child's head is thrown forward during a collision, an inflating airbag can strike the child with enough force to kill or very seriously injure a small child.

### ***Larger Children***

***Children who have outgrown child seats are also at risk of being injured or killed by an inflating passenger's airbag.*** Whenever possible, larger children should sit in the back seat, properly restrained with a seat belt. (See page 37 for important information about protecting larger children.)

## U.S. Models

To remind you of the passenger's airbag hazards, and that children must be properly restrained in the back seat, your car has warning labels on the dashboard and on the driver's and front passenger's visors. Please read and follow the instructions on these labels.

<b>WARNING</b>	
	<p>DEATH OR SERIOUS INJURY can occur if a child is seated in the front passenger seat with the passenger air bag deployed. Always use proper child restraint techniques. Always use proper seat belt techniques. Always use proper air bag techniques.</p>

<b>WARNING</b>	
<b>Children Can Be KILLED or INJURED by Passenger Air Bag</b>	
<p>The back seat is the safest place for children 12 and under. Make sure all children use seat belts or child seats.</p>	

## Canadian Models

To remind you of the airbag hazards, your car has warning labels on the driver's and front passenger's visors. Please read and follow the instructions on these labels.

<p><b>CAUTION</b> TO AVOID SERIOUS INJURY</p> <ul style="list-style-type: none"> <li>• FOR MAXIMUM SAFETY PROTECTION, ALWAYS WEAR YOUR SAFETY BELT.</li> <li>• DO NOT INSTALL REARWARD-FACING CHILD SEATS IN ANY FRONT PASSENGER SEAT POSITION.</li> <li>• DO NOT SIT OR STAND UNNECESSARILY CLOSE TO THE AIR BAG.</li> <li>• BEYOND THE AIR BAG OR BEYOND THE AIR BAG OR BEYOND THE AIR BAG.</li> <li>• SEE THE OWNER'S MANUAL FOR ADDITIONAL INFORMATION AND EXPLANATIONS.</li> </ul>	<p><b>PRÉCAUTIONS:</b> POUR ÉVITER DES BLESSURES GRAVES</p> <ul style="list-style-type: none"> <li>• POUR UNE PROTECTION MAXIMALE, PORTER TOUJOURS VOTRE CEINTURE DE SÉCURITÉ.</li> <li>• NE PAS INSTALLER D'ENFANTS EN SIÈGE EN FACE D'UN AIR BAG DANS UN SIÈGE AVANT.</li> <li>• NE PAS S'APPRIMER PASSENGER EN FACE D'UN AIR BAG.</li> <li>• NE PAS S'APPRIMER PASSENGER EN FACE D'UN AIR BAG.</li> <li>• VOIR LE MANUEL D'UTILISATION POUR PLUS D'INFORMATIONS ET D'EXPLICATIONS.</li> </ul>
---	--

## Protecting Children

---

### If You Must Drive with Several Children

Your car has two seating positions in the back seat where children can be properly restrained.

If you ever have to carry more than two children in your car:

- Place the largest child in the front seat, provided the child is large enough to wear a seat belt properly (see page 37).
- Move the vehicle seat as far to the rear as possible (see page 13).
- Have the child sit upright and well back in the seat (see page 19).
- Make sure the seat belt is properly positioned and secured (see page 17).

### If a Child Requires Close Attention

Many parents say they prefer to put an infant or small child in the front passenger seat so they can watch the child, or because the child requires attention.

Placing a child in the front seat exposes the child to hazards from the airbag, and paying close attention to a child distracts the driver from the important tasks of driving, placing both of you at risk.

If a child requires physical attention or frequent visual contact, we strongly recommend that another adult ride with the child in the back seat. The back seat is far safer for a child than the front.

### Additional Safety Precaution

***Do not leave children alone in your vehicle.*** Leaving children without adult supervision is illegal in most states and Canadian provinces, and can be very hazardous. For example, infants and small children left in a vehicle on a hot day can die from heatstroke. And children left alone with the key in the ignition can accidentally set the vehicle in motion, possibly injuring themselves or others.

### General Guidelines for Using Child Seats

The following pages give general guidelines for selecting and installing child seats for infants and small children.

#### **Selecting a Child Seat**

To provide proper protection, a child seat should meet three requirements:

1. **The child seat should meet safety standards.** The child seat should meet Federal Motor Vehicle Safety Standard 213 (FMVSS 213) or Canadian Motor Vehicle Safety Standard 213 (CMVSS 213). Look for the manufacturer's statement of compliance on the box and seat.
2. **The child seat should be of the proper type and size to fit the child.**



**Infants:** Children up to about one year old should be restrained in a rear-facing, reclining child seat. Only a rear-facing seat provides the proper support to protect an infant's head, neck, and back. See page [29](#) for additional information on protecting infants.



**Small Children:** A child who is too large for a rear-facing child seat, and who can sit up without support, should be restrained in a forward-facing child seat. See page [36](#) for additional information on protecting small children.

CONTINUED

## Protecting Children

---

**3. *The child seat should fit the vehicle seating position (or positions) where it will be used.***

Due to variations in the design of child seats, vehicle seats, and seat belts, all child seats will not fit all vehicle seating positions.

However, Honda is confident that one or more child seat models can fit and be properly installed in all recommended seating positions in your car.

Before purchasing a child seat, we recommend that parents test the child seat in the specific vehicle seating position (or positions) where they intend to use the seat. If a previously purchased child seat does not fit, you may need to buy a different one that will fit.

## **Placing a Child Seat**

This page briefly summarizes Honda's recommendations on where to place rear-facing and forward-facing child seats in your car.

### **Airbags Pose Serious Risks to Children**

The passenger's airbag inflates with enough force to kill or seriously injure an infant in a rear-facing child seat.

A small child in a forward-facing child seat is also at risk. If the vehicle seat is too far forward, or the child's head is thrown forward during a collision, an inflating airbag can kill or seriously injure the child.

If a small child must ride in the front, follow the instructions provided in this section.

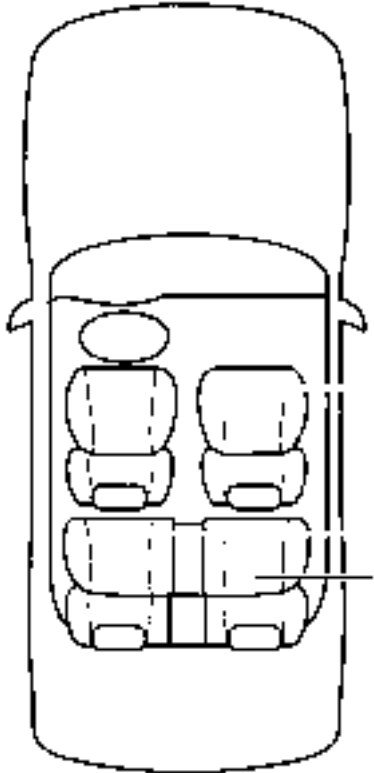

## **Front Passenger's Seat**

**Infants:** Never in the front seat, due to the passenger's airbag hazard.

**Small children:** Not recommended, due to the passenger's airbag hazard. If a small child must ride in front, move the vehicle seat to the rear-most position and secure a front-facing child seat with the seat belt (see page 34).

## **Back Seats**

**Infants:** Recommended positions. Secure a rear-facing child seat with the seat belt (see page 30).

**Small children:** Recommended positions. Secure a front-facing child seat with the seat belt (see page 34).

CONTINUED

# Protecting Children

---

## ***Installing a Child Seat***

After selecting a proper child seat, and a good position to install the seat, there are three main steps in installing the seat:

- 1. *Secure the child seat to the car with a seat belt.*** All child seats must be secured to the car with the lap part of a lap/shoulder belt. A child whose seat is not properly secured to the car can be endangered in a crash. See pages [30](#) and [34](#) for instructions on how to secure child seats in this car.
- 2. *Make sure the child seat is firmly secured.*** After installing a child seat, push and pull the seat forward and from side to side to verify that it is secure.

To provide security during normal driving maneuvers as well as during a collision, we recommend that parents secure a child seat as firmly as possible.

However, a child seat does not need to be "rock solid." In some vehicles or seating positions, it may be difficult to install a child seat so that it does not move at all. Some side-to-side or back-and-forth movement can be expected and should not reduce the child seat's effectiveness.

If the child seat is not secure, try installing it in a different seating position, or use a different style of child seat that can be firmly secured in the desired seating position.

- 3. *Secure the child in the child seat.***

Make sure the child is properly strapped in the child seat according to the child seat maker's instructions. A child who is not properly secured in a child seat can be thrown out of the seat in a crash and seriously injured.

## ***Storing a Child Seat***

When you are not using a child seat, either remove it and store it in a safe place, or make sure it is properly secured. An unsecured child seat can be thrown around the car during a crash or sudden stop and injure someone.

### Protecting Infants



#### **Child Seat Type**

Only a rear-facing child seat provides proper support for a baby's head, neck, and back. Infants up to about one year of age must be restrained in a rear-facing child seat.

Two types of seats may be used: a seat designed exclusively for infants, or a convertible seat used in the rear-facing, reclining mode.

#### **⚠ WARNING**

Placing a rear-facing child seat in the front seat can result in serious injury or death if the airbags inflate.

Always place a rear-facing child seat in the back seat, not the front.

We recommend that an infant be restrained in a rear-facing child seat until the infant reaches the seat maker's weight or height limit and is able to sit up without support.

#### **Rear-Facing Child Seat Placement**

In this car, a rear-facing child seat can be placed in any seating position in the back seat, but not in the front seat.

**Never put a rear-facing child seat in the front seat.** If the passenger's airbag inflates, it can hit the back of the child seat with enough force to kill or seriously injure an infant. If an infant must be closely watched, we recommend that another adult sit in the back seat with the baby.

**Do not put a rear-facing child seat in a forward-facing position.** If placed facing forward, an infant could be very seriously injured during a frontal collision.

CONTINUED



## Protecting Children

---

### ***Rear-Facing Child Seat Installation***

The lap/shoulder belts in the back seats have a locking mechanism that must be activated to secure a child seat.

The following pages provide instructions and tips on how to secure a rear-facing child seat with this type of seat belt.

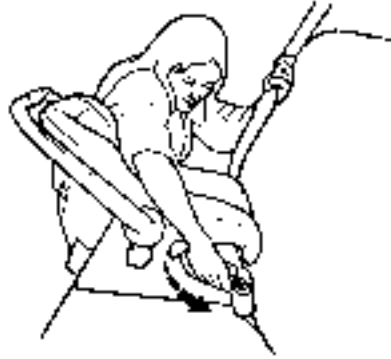

1. With the child seat in the desired back seating position, route the belt through the child seat according to the seat maker's instructions, then insert the latch plate into the buckle.

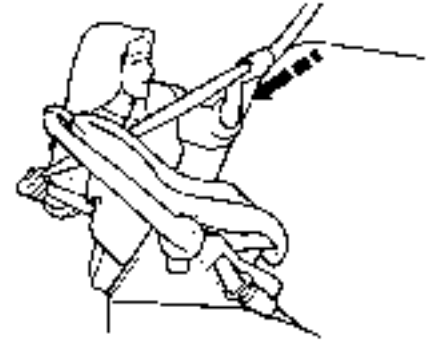

2. To activate the lockable retractor, slowly pull the shoulder part of the belt all the way out until it stops, then let the belt feed back into the retractor (you might hear a clicking noise as the belt retracts).

3. After the belt has retracted, tug on it. If the belt is locked, you will not be able to pull it out. If you can pull the belt out, it is not locked and you will need to repeat these steps.

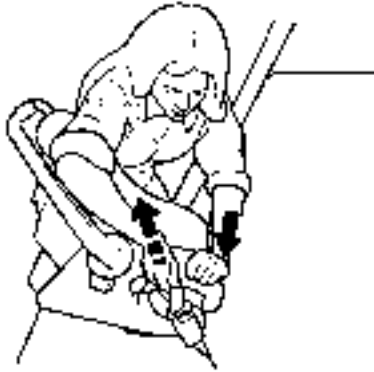

4. After confirming that the belt is locked, grab the shoulder part of the belt near the buckle and pull up to remove any slack from the lap part of the belt. Remember, if the lap part of the belt is not tight, the child seat will not be secure. To remove slack, it may help to put weight on the child seat, or push on the back of the seat, while pulling up on the belt.

5. Push and pull the child seat forward and from side to side to verify that it is secure enough to stay upright during normal driving maneuvers. If the child seat is not secure, unlatch the belt, allow it to retract fully, then repeat these steps.

To deactivate the locking mechanism and remove a child seat, unlatch the buckle, unrout the seat belt, and let the belt fully retract.

*CONTINUED*

## Protecting Children

---

### *Rear-Facing Child Seat Installation Tips*

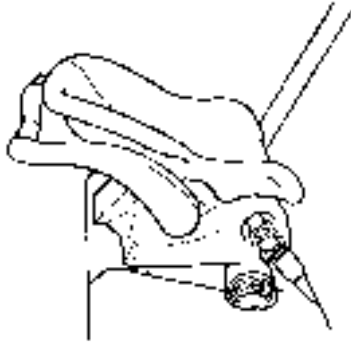

For proper protection, an infant must ride in a reclined, or semi-reclined position. To determine the proper reclining angle, check with the baby's doctor or follow the seat maker's recommendations.

To achieve the desired reclining angle, it may help to put a rolled up towel under the toe of the child seat, as shown.

When properly installed, a rear-facing child seat may prevent the driver or a front-seat passenger from moving the seat as far back as recommended (see page 13). Or it may prevent them from locking the seat-back in the desired upright position (see page 14).

In either case, we recommend that you place the child seat directly behind the front passenger seat, move the front seat as far forward as needed, and leave it unoccupied. Or you may wish to get a smaller child seat that allows you to safely carry a front passenger.

### *Additional Precautions for Infants*

- ***Never hold an infant on your lap.***

If you are not wearing a seat belt in a crash, you could be thrown forward into the dashboard and crush the infant.

If you are wearing a seat belt, the infant can be torn from your arms. For example, if your car crashes into a parked vehicle at 30 mph (48 km/h), a 20-lb (9 kg) infant will become a 600-lb (275 kg) force, and you will not be able to hold on.

- ***Never put a seat belt over yourself and an infant.*** During a crash, the belt could press deep into the infant and cause very serious injuries.

### Protecting Small Children



#### ***Child Seat Type***

A child who can sit up without support, and who fits within the child seat maker's weight and height limits, should be restrained in a forward-facing, upright child seat.

Of the different seats available, we recommend those that have a five-point harness system as shown.

We also recommend that a small child stay in the child seat as long as possible, until the child reaches the weight or height limit for the seat.

#### ***Child Seat Placement***

In this car, the best place to install a forward-facing child seat is in one of the seating positions in the back seat.

#### ***Placing a forward-facing child seat in the front seat of a vehicle equipped with a passenger airbag can be hazardous.***

If the car seat is too far forward, or the child's head is thrown forward during a collision, an inflating passenger's airbag can strike the child with enough force to cause very serious or fatal injuries. If a small child must be closely watched, we recommend that another adult sit in the back seat with the child.

CONTINUED

## Protecting Children

### **⚠ WARNING**

Improperly placing a forward-facing child seat in the front seat can result in serious injury or death if the airbags inflate.

If you must place a forward-facing child seat in front, move the vehicle seat as far back as possible and properly restrain the child.

If it is necessary to put a forward-facing child seat in the front, move the vehicle seat as far to the rear as possible, be sure the child seat is firmly secured to the car, and the child is properly strapped in the seat.

### ***Child Seat Installation***

The lap/shoulder belts in the back and front passenger seating positions have a locking mechanism that must be activated to secure a child seat.

The following pages provide instructions on how to secure a forward-facing child seat with this type of seat belt.



1. With the child seat in the desired back seating position, route the belt through the child seat according to the seat maker's instructions, then insert the latch plate into the buckle.

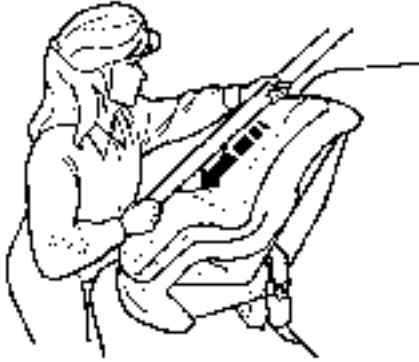

2. To activate the lockable retractor, slowly pull the shoulder part of the belt all the way out until it stops, then let the belt feed back into the retractor (you might hear a clicking noise as the belt retracts).
3. After the belt has retracted, tug on it. If the belt is locked, you will not be able to pull it out. If you can pull the belt out, it is not locked and you will need to repeat these steps.



4. After confirming that the belt is locked, grab the shoulder part of the belt near the buckle and pull up to remove any slack from the lap part of the belt. Remember, if the lap part of the belt is not tight, the child seat will not be secure. It may help to put weight on the child seat, or push on the back of the seat, while pulling up on the belt.

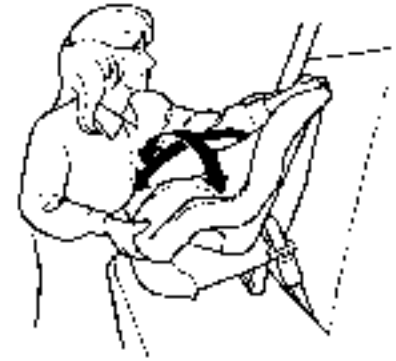

5. Push and pull the child seat forward and from side to side to verify that it is secure enough to stay upright during normal driving maneuvers. If the child seat is not secure, unlatch the belt, allow it to retract fully, then repeat these steps.

*CONTINUED*

# Protecting Children

---

To deactivate the locking mechanism in order to remove a child seat, unlatch the buckle, unrout the seat belt, and let the belt fully retract.

## ***Additional Precautions for Small Children***

- ***Never hold a small child on your lap.*** If you are not wearing a seat belt in a crash, you could be thrown forward into the dashboard and crush the child.

If you are wearing a seat belt, the child can be torn from your arms during a crash. For example, if your car crashes into a parked vehicle at 30 mph (48 km/h), a 30-lb (14 kg) child will become a 900-lb (410 kg) force, and you will not be able to hold on.

- ***Never put a seat belt over yourself and a child.*** During a crash, the belt could press deep into the child and cause very serious injuries.

## **Protecting Larger Children**

When a child reaches the recommended weight or height limit for a forward-facing child seat, the child should sit in one of the back seats and wear a lap/shoulder belt.

If a child is too short for the shoulder part of the belt to properly fit, we recommend that the child use a booster seat until they are tall enough to use the seat belt without a booster.

The following pages give instructions on how to check proper seat belt fit, what kind of booster seat to use if one is needed, and important precautions for children who must sit in the front seat.

### **WARNING**

Allowing a larger child to sit improperly in the front seat can result in injury or death if the airbags inflate.

If a larger child must sit in front, make sure the child moves the seat as far back as possible and wears the seat belt properly.

#### ***Checking Seat Belt Fit***

To determine if a lap/shoulder belt properly fits a child, have the child put on the seat belt. Follow the instructions on page 16 . Then check how the belt fits.



If the shoulder part of the belt rests over the child's collarbone and against the center of the chest, as shown, the child is large enough to wear the seat belt.

However, if the belt touches or crosses the child's neck, the child needs to use a booster seat.

***Do not let a child wear a seat belt across the neck.*** This could result in serious neck injuries during a crash.

***Do not let a child put the shoulder part of a seat belt behind the back or under the arm.*** This could cause very serious injuries during a crash. It also increases the chance that the child will slide under the belt in a crash and be injured.

CONTINUED



## Protecting Children

---

***Do not put any accessories on a seat belt.*** Devices intended to improve occupant comfort or reposition the shoulder part of a seat belt, severely compromise the protective capability of the seat belt and increase the chance of serious injury in a crash.

***Two children should never use the same seat belt.*** If they do, they could be very seriously injured in a crash.

### ***Using a Booster Seat***



If a child needs a booster seat, we recommend choosing a style that allows the child to use the lap/shoulder belt directly, without a shield, as shown.

Whichever style you select, follow the booster seat maker's instructions.

A child may continue using a booster seat until the tops of the ears are even with the top of the seat-back. A child of this height should be tall enough to use the lap/shoulder belt without a booster.

### ***When Can a Larger Child Sit in Front***

The National Highway Traffic Safety Administration and Transport Canada recommend that all children ages 12 and under be properly restrained in a back seat.

The back seat is the safest place for a child of any age or size.

In addition, the passenger's airbag poses serious risks to children. If the seat is too far forward, or the child's head is thrown forward during a collision, or the child is unrestrained or out of position, an inflating airbag can kill or seriously injure the child.

Of course, children vary widely. And while age may be one indicator of when a child can safely ride in the front, there are other important factors you should consider.

### ***Physical Size***

Physically, a child must be large enough for the lap/shoulder belt to properly fit over the hips, chest, and shoulder (see pages 16 and 37). If the seat belt does not fit properly, the child should not sit in the front.

### ***Maturity***

To safely ride in front, a child must be able to follow the rules, including sitting properly and wearing the seat belt properly throughout a ride.

If you decide that a child can safely ride up front, be sure to:

- Carefully read the owner's manual and make sure you understand all seat belt instructions and all safety information.
- Move the vehicle seat to the rear-most position.
- Have the child sit up straight, back against the seat, and feet on or near the floor.
- Check that the child's seat belt is properly positioned and secured.
- Supervise the child. Even mature children sometimes need to be reminded to fasten the seat belts or sit properly.

## Protecting Children

---

### Using Child Seats with Tethers *U.S. Models*

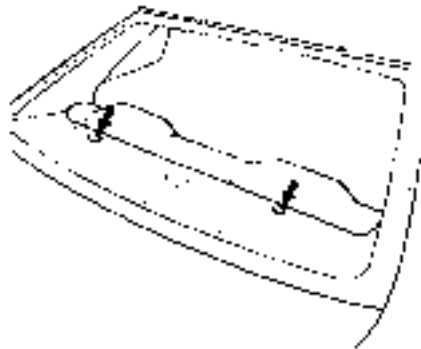

Your car has two places on the rear shelf where a tether anchor can be installed. A tether anchor is used to secure a tether-style child seat to the car.

Since a tether can provide additional security, we recommend using a tether whenever one is required or available.

To attach a tether to your car:

1. Using the illustration on page 40, locate the attachment point you want to use.
2. Remove the plug with a small flat-tipped screwdriver or a fingernail file.

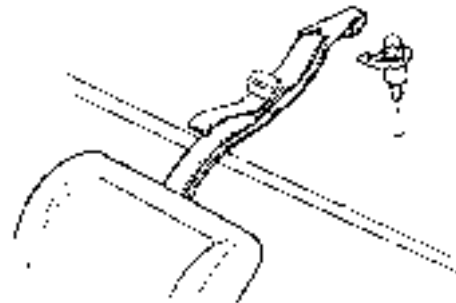

3. Install the anchor plate and mounting hardware. The hardware is available from your Honda dealer (part number 82410-SE3-C01).

When installing tether hardware, make sure the toothed washer is on the bottom of the bolt. Tighten the bolt to:  
16 lbf.ft (22 N.m, 2.2 kgf.m)

If a torque wrench was not used, see your Honda dealer as soon as possible to verify proper installation.

To attach the tether to the child seat, follow the child seat maker's instructions.

If you are not sure how to install the tether, or you need mounting hardware, contact your Honda dealer.

## Using Child Seats with Tethers *Canadian Models*



Your car has two tether anchorage points on the rear shelf for securing a tether-style child seat to the car.

Since a tether can provide additional security, we recommend using a tether whenever one is required or available.



Attach the tether strap hook to the tether anchorage point and tighten the strap according to the child seat maker's instructions.

## Additional Information About Your Seat Belts

---

### Seat Belt System Components

Your seat belt system includes lap/shoulder belts in all four seating positions.



The seat belt system also includes a light on the instrument panel to remind you and your passengers to fasten your belts. If the driver's seat belt is not fastened before the ignition is turned ON (II), the light will come on and a beeper will also sound. The beeper will stop after a few seconds, but the light will stay on until the driver's seat belt is fastened.

### Lap/Shoulder Belt

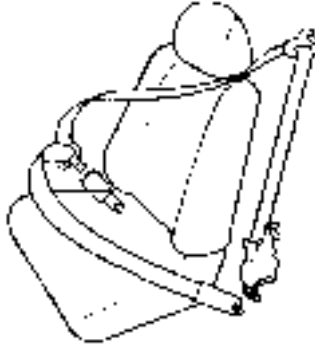

This seat belt has a single belt that goes over your shoulder, across your chest and across your hips.

To fasten the belt, insert the latch plate into the buckle, then tug on the belt to make sure the buckle is latched.

To unlock the belt, push the red PRESS button on the buckle. Guide the belt across your body to the door pillar. After exiting the car, be sure the belt is out of the way and will not get closed in the door.

## Additional Information About Your Seat Belts

---

All seat belts have an emergency locking retractor. In normal driving, the retractor lets you move freely in your seat while it keeps some tension on the belt. During a collision or sudden stop, the retractor automatically locks the belt to help restrain your body.

The seat belts in all seating positions except the driver's have an additional locking mechanism that must be activated to secure a child seat. (See pages 30 and 34 for instructions on how to secure child seats with this type of seat belt.)

If the shoulder part of the belt is pulled all the way out, the locking mechanism will activate. The belt will retract, but it will not allow the passenger to move freely.

To deactivate the locking mechanism, unlatch the buckle and let the seat belt fully retract. To refasten the belt, pull it out only as far as needed.

See page 16 for instructions on how to wear the lap/shoulder belt properly.

## Additional Information About Your Seat Belts

---

### Seat Belt Maintenance

For safety, you should check the condition of your seat belts regularly.

Pull each belt out fully and look for frays, cuts, burns, and wear. Check that the latches work smoothly and that the lap/shoulder belts retract easily. Any belt not in good condition or not working properly will not provide good protection and should be replaced as soon as possible.

### *U.S. Models*

Honda provides a lifetime warranty on seat belts. Honda will repair or replace any seat belt component that fails to function properly during normal use. Please see your *Honda Warranty Information* booklet for details.

### **WARNING**

Not checking or maintaining seat belts can result in serious injury or death if the seat belts do not work properly when needed.

Check your seat belts regularly and have any problem corrected as soon as possible.

If a seat belt is worn during a crash, you should have your dealer inspect the belt, and replace it if necessary. A belt that has been worn during a crash may not provide the same level of protection in a subsequent crash. The dealer should also inspect the anchors for damage and replace them if needed. For information on how to clean your seat belts, see page [231](#).

## Additional Information About Your SRS

### SRS Components

Your Supplemental Restraint System (SRS) includes:

- Two front airbags. The driver's airbag is stored in the center of the steering wheel; the front passenger's airbag is stored in the dashboard. Both are marked "SRS AIRBAG."
- Sensors that can detect a moderate to severe frontal collision.
- A sophisticated electronic system that continually monitors the sensors, control unit, the airbag activators, and all related wiring when the ignition is ON (II).

- An indicator light on the instrument panel that alerts you to a possible problem with the system (see page 47).
- Emergency backup power in case your car's electrical system is disconnected in a crash.

### How Your Airbags Work

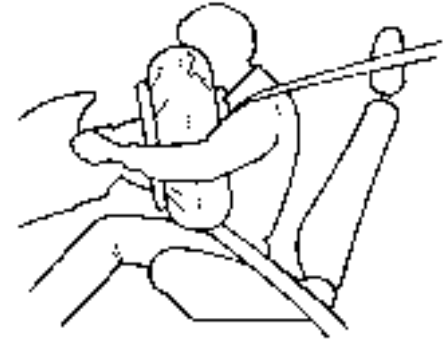

If you ever have a moderate to severe frontal collision, the sensors will detect rapid deceleration and signal the control unit to instantly inflate the airbags.

During a crash, your seat belt helps restrain your lower body and torso. Your airbag provides a cushion to help restrain and protect your head and chest.

*CONTINUED*



## Additional Information About Your SRS

---

Since both airbags use the same sensors, both airbags normally inflate at the same time. However, it is possible for only one airbag to inflate.

This can occur when the severity of a collision is at the margin, or threshold, that determines whether or not the airbags will deploy. In such cases, the seat belt will provide sufficient protection, and the supplemental protection offered by the airbag would be minimal.

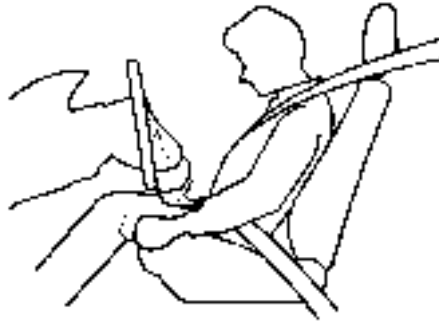

After inflating, the airbags immediately deflate, so they won't interfere with the driver's visibility, or the ability to steer or operate other controls.

The total time for inflation and deflation is approximately one-tenth of a second, so fast that most occupants are not aware that the airbags deployed until they see them lying in their laps.

After a crash, you may see what looks like smoke. This is actually powder from the airbag's surface. Although the powder is not harmful, people with respiratory problems may experience some temporary discomfort. If this occurs, get out of the car as soon as it is safe to do so.

### ***U.S. Owners***

For additional information on how your airbags work, see the booklet titled *SRS: What You Need to Know About Airbags* that came with your owner's manual.

### ***Canadian Owners***

For additional information on how your airbags work, ask your dealer for a copy of the booklet titled *SRS: What You Need to Know About Airbags*.

### How the SRS Indicator Light Works

**SRS** The purpose of the SRS light is to alert you to a potential problem with your Supplemental Restraint System.

When you turn the ignition ON (II), this indicator will light up briefly then go out. This tells you that the system is working properly.

However, if the light comes on at any other time, you should have the system checked by your dealer. For example:

- If the SRS indicator light does not come on after you turn the ignition ON (II).
- If the light stays on after the engine starts.

- If the light comes on or flashes on and off while you drive.

If you see any of these indications, your airbags may not deploy when you need them. See your Honda dealer as soon as possible.

### **WARNING**

Ignoring the SRS indicator light can result in serious injury or death if the airbags do not inflate when needed.

Have your vehicle checked by a dealer as soon as possible if the SRS light alerts you to a potential problem.

### SRS Service

Your Supplemental Restraint System is virtually maintenance-free, and there are no parts you can safely service. However, you must have your car serviced if:

- **Your airbags ever inflate.** The airbags and the control unit must be replaced. Do not try to remove or replace the airbags yourself. This must be done by a Honda dealer or a knowledgeable body shop.
- **The SRS indicator light alerts you to a problem.** Take your car to an authorized Honda dealer as soon as possible. If you ignore this indication, the airbags might not inflate when you need them (see page 45).

## Additional Information About Your SRS

---

### Additional Safety Precautions

- Do not attempt to deactivate your airbags. Together, airbags and seat belts provide the best protection in a moderate to severe frontal collision.
- Do not tamper with SRS components or wiring for any reason. Tampering could cause the airbags to deploy, possibly causing very serious injury.

See page [134](#) for further information and precautions relating to your SRS.

Your car's exhaust contains carbon monoxide gas. You should have no problem with carbon monoxide entering the car in normal driving if you maintain your car properly. Have the exhaust system inspected for leaks whenever:

- The car is raised for an oil change.
- You notice a change in the sound of the exhaust.
- The car was in an accident that may have damaged the underside.

### **WARNING**

Carbon monoxide gas is toxic. Breathing it can cause unconsciousness and even kill you.

Avoid any enclosed areas or activities that expose you to carbon monoxide.

High levels of carbon monoxide can collect rapidly in enclosed areas, such as a garage. Do not run the engine with the garage door closed. Even with the door open, run the engine only long enough to move the vehicle out of the garage.

With the trunk lid open, air flow can pull exhaust gas into your car's interior and create a hazardous condition. If you must drive with the trunk lid open, open all the windows and set the heating and cooling system as shown below.

If you must sit in your parked car, even in an unconfined area, with the engine running, adjust the heating and cooling system as follows:

1. Select the Fresh Air mode.
2. Select the  mode.
3. Turn the fan on high speed.
4. Set the temperature control to a comfortable setting.

## Safety Labels

These labels are in the locations shown. They warn you of potential hazards that could cause serious injury. Read these labels carefully.

If a label comes off or becomes hard to read, contact your Honda dealer for a replacement.

### HOOD

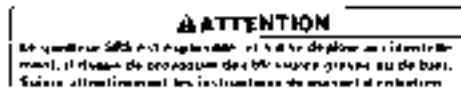

### RADIATOR CAP



### DASHBOARD

*U.S. models only*



### SUN VISOR

*U.S. models*



*Canadian models*

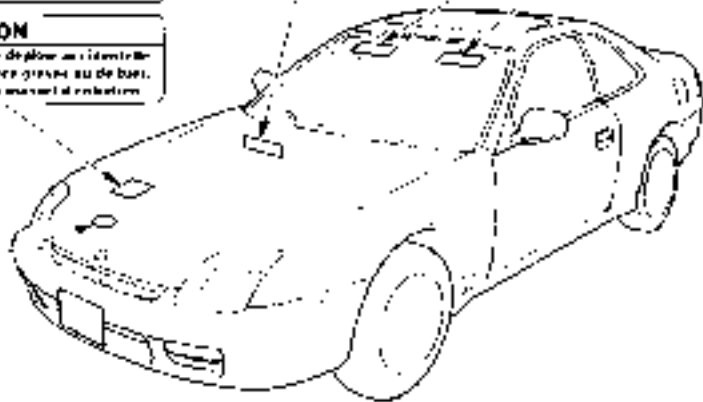
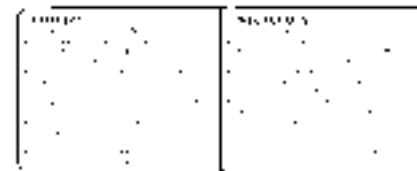

This section gives information about the controls and displays that contribute to the daily operation of your Honda. All the essential controls are within easy reach.

Control Locations.....	52	Tachometer.....	58	Lockout Prevention.....	75
Indicator Lights.....	53	Odometer.....	58	Remote Transmitter.....	75
Gauges.....	58	Trip Meter.....	58	Trunk.....	78
Speedometer.....	58	Fuel Gauge.....	59	Glove Box.....	79
		Temperature Gauge.....	59	Seat Adjustments.....	80
		Maintenance Required		Front Seat Adjustments.....	80
		Indicator.....	60	Driver's Seat Height	
		Controls Near the Steering		Adjustment.....	81
		Wheel.....	61	Rear Seat Access.....	81
		Headlights.....	62	Head Restraints.....	82
		Daytime Running Lights.....	62	Seat Heaters.....	83
		Instrument Panel Brightness.....	63	Folding Rear Seat.....	84
		Turn Signals.....	63	Power Windows.....	85
		Windshield Wipers.....	64	Moonroof.....	87
		Windshield Washers.....	65	Mirrors.....	88
		Hazard Warning.....	65	Adjusting the Power Mirrors.....	88
		Rear Window Defogger.....	65	Parking Brake.....	89
		Steering Wheel Adjustment.....	66	Digital Clock.....	90
		Steering Wheel Controls.....	67	Beverage Holder.....	91
		Cruise Control.....	67	Console Compartment.....	92
		Keys and Locks.....	70	Coin Box.....	93
		Keys.....	70	Accessory Power Socket.....	93
		Learning Key.....	71	Ashtrays.....	94
		Immobilizer System.....	71	Interior Lights.....	94
		Ignition Switch.....	73	Ceiling Lights.....	94
		Power Door Locks.....	74	Courtesy Lights.....	95

# Control Locations

---

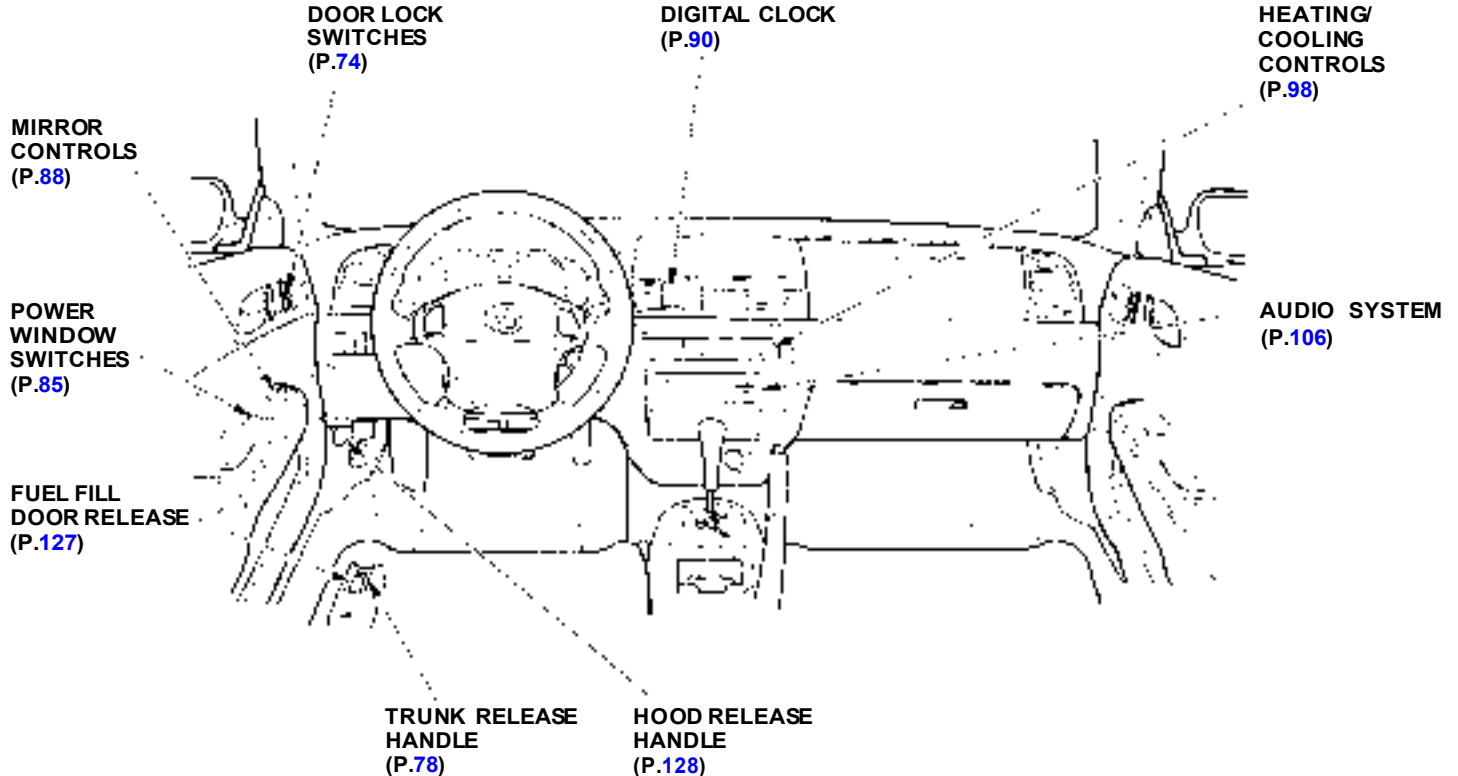

# Indicator Lights

The instrument panel has many indicators to give you important information about your car.

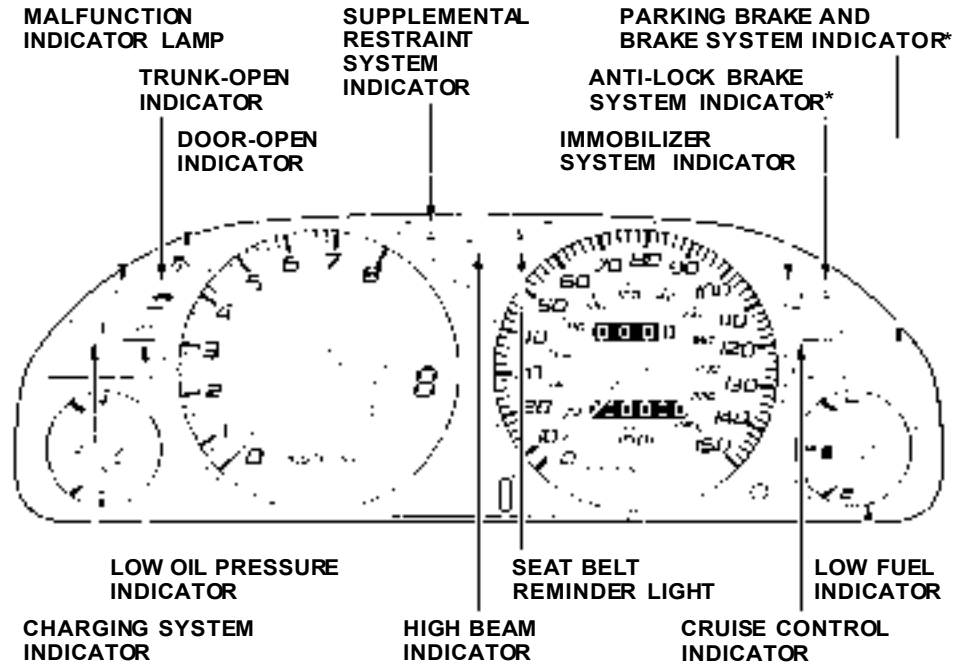

\* The U.S. instrument panel is shown. Differences for Canadian models are noted in the text.



# Indicator Lights



## Seat Belt Reminder Light

This indicator lights when you turn the ignition switch ON (II). It is a reminder to you and your passengers to protect yourselves by fastening the seat belts. A beeper also sounds if you have not fastened your seat belt.

If you do not fasten your seat belt, the beeper will stop after a few seconds but the light stays on until you do. Both the light and the beeper stay off if you fasten your seat belt before turning on the ignition.

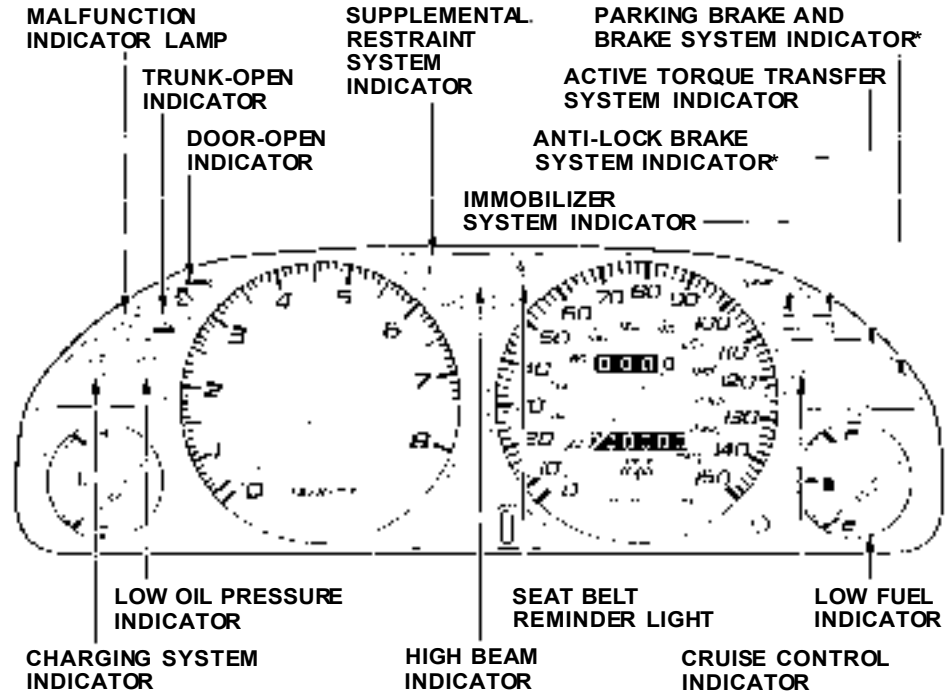

\* The U.S. Type SH instrument panel is shown. Differences for the Canadian model are noted in the text.

## Supplemental Restraint System Indicator

This indicator lights when you turn the ignition switch ON (II). If it comes on at any other time, it indicates a problem in the supplemental restraint system. For complete information, see page [47](#).

## Immobilizer System Indicator

This indicator comes on for a few seconds when you turn the ignition switch ON (II). It will then go off if you have inserted a properly-coded ignition key. If it is not a properly-coded key, the indicator will blink and the engine will not start (see page [71](#)).

This indicator also blinks several times when you turn the ignition switch from ON (II) to ACCESSORY (I) or LOCK (0).

## Charging System Indicator

If this light comes on when the engine is running, the battery is not being charged. For complete information, see page [249](#).

## Low Oil Pressure Indicator

The engine can be severely damaged if this light flashes or stays on when the engine is running. For complete information, see page [248](#).

## Malfunction Indicator Lamp

See page [250](#).

## Cruise Control Indicator

This lights when you set the cruise control. See page [67](#) for information on operating the cruise control.

## U.S. Canada **Parking Brake and Brake System Indicator**

This light has two functions:

1. It lights as a reminder that you have not released the parking brake. Driving with the parking brake applied can damage the brakes and tires.
2. If it remains lit after you release the parking brake while the engine is running, or comes on while driving, it can indicate a problem in the brake system. For complete information, see page [251](#).

## Indicator Lights

---



This light normally comes on for a few seconds when you turn the ignition switch ON (II), and when the ignition switch is turned to START (III). If this light comes on at any other time, there is a problem in the ABS. If this happens, take the car to your dealer to have it checked. With the light on, your car still has normal braking ability but no anti-lock. For complete information, see page [156](#).



*Type SH only*

This indicator normally comes on for a few seconds when you turn the ignition switch ON (II). If it comes on at any other time, there is a problem in the Active Torque Transfer System (ATTS). If this happens, take the car to your dealer to have it checked. With the indicator on, your car will corner normally, but you will not have active torque transfer.



The left or right turn signal light blinks when you signal a lane change or turn. If the light does not blink or blinks rapidly, it usually means one of the turn signal bulbs is burned out (see page [218](#)). Replace the bulb as soon as possible, since other drivers cannot see that you are signalling.

When you turn on the Hazard Warning switch, both turn signal lights blink. All turn signals on the outside of the car should flash.



### Trunk-open Indicator

This light comes on if the trunk lid is not closed tightly.



### Door-open Indicator

This light comes on if either door is not closed tightly.



### High Beam Indicator

This light comes on with the high beam headlights. See page 62 for information on the headlight controls.

On Canadian models, this indicator comes on with reduced brightness when the Daytime Running Lights (DRL) are on (see page 62).

### Low Fuel Indicator



**LOW FUEL INDICATOR**

This indicator is located in the fuel gauge. It comes on as a reminder that you must refuel soon.

**DRL**

### "Daytime Running Lights" Indicator

*Canadian models only*

This indicator lights when you turn the ignition switch to ON (II) with the headlight switch off and the parking brake set. It should go off if you turn on the headlights or release the parking brake. If it comes on at any other time, it means there is a problem with the DRL. There may also be a problem with the high beam headlights.

# Gauges

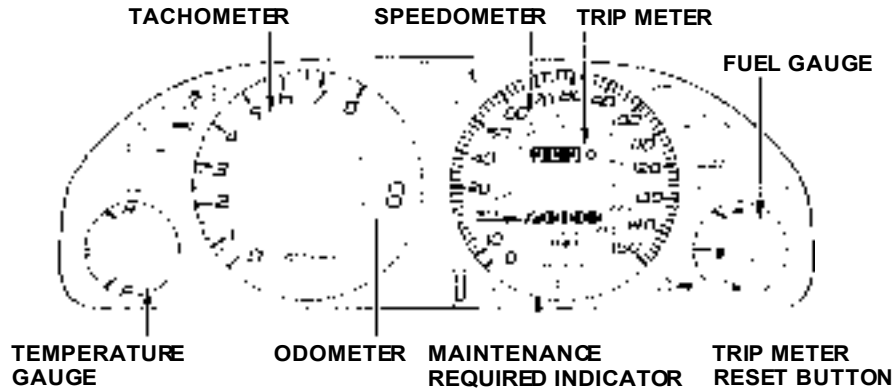

## Speedometer

### *U.S. Models*

This shows your speed in miles per hour (mph). The smaller inner numbers are the speed in kilometers per hour (km/h).

### *Canadian Models*

This shows your speed in kilometers per hour (km/h). The smaller inner numbers are the speed in miles per hour (mph).

## Tachometer

The tachometer shows the engine speed in revolutions per minute (rpm). To protect the engine from damage, never drive with the tachometer needle in the red zone.

## Odometer

The odometer shows the total distance your car has been driven. It measures miles in U.S. models and kilometers in Canadian models. It is illegal under U.S. federal law and Canadian provincial regulations to disconnect, reset, or alter the odometer with the intent to change the number of miles or kilometers indicated.

## Trip Meter

This meter shows the number of miles (U.S.) or kilometers (Canada) driven since you last reset it. To reset it, push the trip meter reset button.

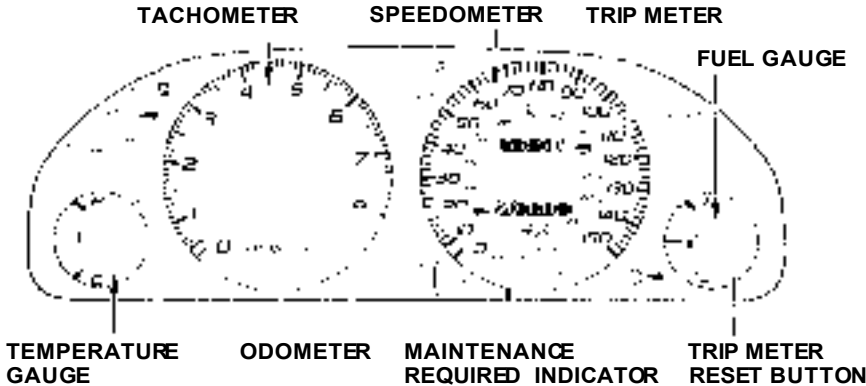

### Fuel Gauge

This shows how much fuel you have. It is most accurate when the car is on level ground. It may show slightly more or less than the actual amount when you are driving on curvy or hilly roads.

The gauge stays at the same fuel level reading after you turn off the ignition. When you add fuel, the gauge slowly changes to the new reading after you turn the ignition switch back ON (II).

### Temperature Gauge

This shows the temperature of the engine's coolant. During normal operation, the pointer should rise from the bottom white mark to about the middle of the gauge. In severe driving conditions, such as very hot weather or a long period of uphill driving, the pointer may rise to near the upper white mark. If it reaches the red (Hot) mark, pull safely to the side of the road. Turn to page [246](#) for instructions and precautions on checking the engine's cooling system.

# Gauges

---

## Maintenance Required Indicator

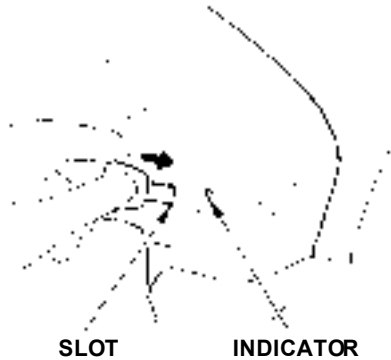

This indicator reminds you that it is nearing 7,500 miles (12,000 km) since the last scheduled maintenance. Refer to the Maintenance Schedules for Normal and Severe Driving Conditions on pages [172](#) — [176](#).

When the distance driven since the last scheduled maintenance nears 7,500 miles (12,000 km), the indicator will turn yellow. If you exceed 7,500 miles (12,000 km), the indicator will turn red.

Your dealer will reset the indicator when he performs the scheduled maintenance. If someone else performs the maintenance, reset the indicator by inserting your master or valet key in the slot beside the indicator.

## Controls Near the Steering Wheel

The two levers on the steering column contain controls for driving features you use most often. The left lever controls the turn signals, headlights, and high beams. The right lever controls the windshield washers and wipers.

The controls under the left air vent are for the moonroof, cruise control and instrument panel brightness. The switches for the hazard warning lights and rear window defogger are to the right of the steering column.

The tilt adjustment lever on the underside of the steering column allows you to tilt the steering wheel.

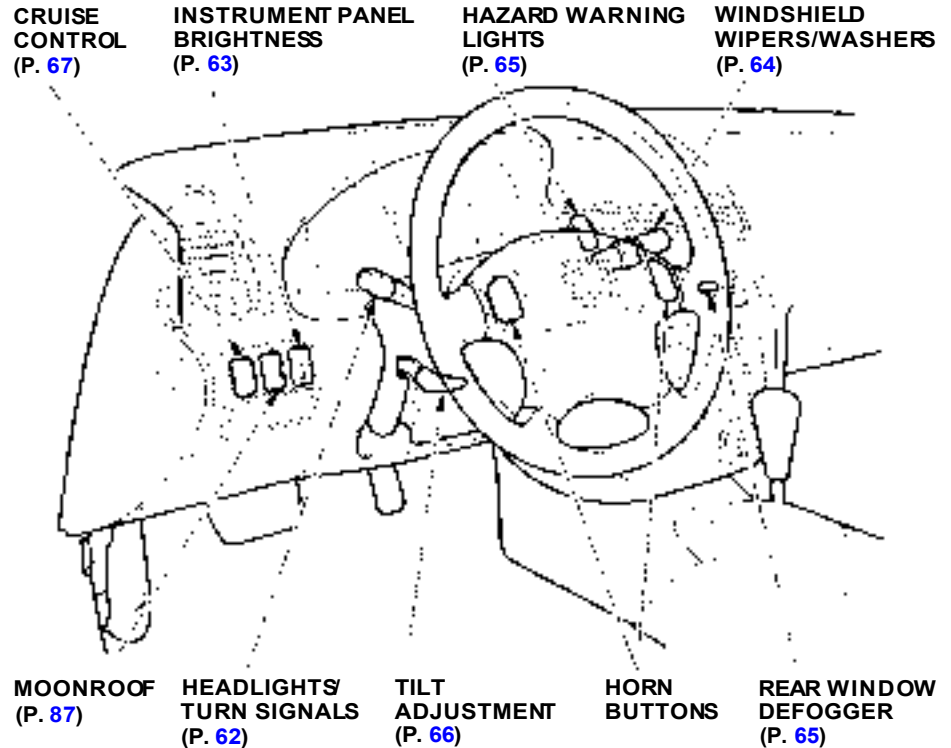





# Controls Near the Steering Wheel

## Headlights



The rotating switch on the left lever controls the lights. Turning this switch to the “” position turns on the parking lights, taillights, instrument panel lights, side-marker lights, and rear license plate lights. Turning the switch to the “” position turns on the headlights.

If you leave the lights on with the ignition switch in ACCESSORY (I) or LOCK (0), you will hear a reminder chime when you open the driver's door.



To change between low beams and high beams, pull the turn signal lever until you hear a click, then let go. The blue high beam indicator will light (see page [57](#)).

To flash the high beams, pull the turn signal lever back lightly, then release it. The high beams will come on and go off.

The high beams will stay on for as long as you hold the lever back, no matter what position the headlight switch is in.

## Daytime Running Lights (Canadian Models)

With the headlight switch off, the high beam headlights come on with reduced brightness when you turn the ignition switch to ON (II) and release the parking brake. They remain on until you turn the ignition off, even if you set the parking brake.

The headlights revert to normal operation when you turn them on with the switch.

## Controls Near the Steering Wheel

### *Instrument Panel Brightness*



The dial on the dashboard to the left of the instrument panel controls the brightness of the instrument panel lights. Turn the dial to adjust the brightness.

### Turn Signals



Signal a turn or lane change with this lever. Push down on the lever to signal a left turn, and up to signal a right turn. If you push it up or down all the way, the turn signal continues to blink even when you release the lever. It shuts off automatically as you complete the turn.

To signal a lane change, push lightly on the turn signal lever in the proper direction and hold it. The lever will return to the center position as soon as you release it.

# Controls Near the Steering Wheel

---

## Windshield Wipers



The right lever controls the windshield wipers and washers. The rotary switch at the end of the lever has three positions:

INT: intermittent

— : low speed

— — : high speed

In intermittent, the wipers operate every few seconds. You can vary how often the wipers sweep the windshield by turning the INT TIME ring next to the rotary switch. In low speed and high speed, the wipers run continuously.

To operate the wipers in mist mode, push the control lever down. The wipers run at high speed until you release the lever. This gives you a quick way to clear the windshield.

# Controls Near the Steering Wheel

## Windshield Washers



To clean the windshield, pull back on the wiper control lever. The washers spray until you release the lever.

The wipers run at low speed while you're pulling the lever, then complete one more sweep of the windshield after you release it.

## Hazard Warning

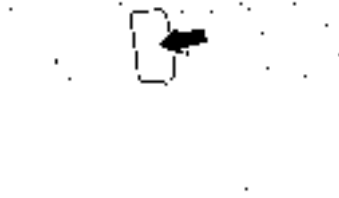

Push the red button to the left of the clock to turn on the hazard warning lights (four-way flashers). This causes all four outside turn signals and both indicators in the instrument panel to flash. Use the hazard warning lights if you need to park in a dangerous area near heavy traffic, or if your car is disabled.

## Rear Window Defogger



The rear window defogger will clear fog, frost, and thin ice from the window. Push the defogger button to turn it on and off. The light in the button lights to show the defogger is on. If you do not turn it off, the defogger will shut itself off after about 25 minutes. It also shuts off when you turn off the ignition. You have to turn it on again when you restart the car.

*CONTINUED*

## Controls Near the Steering Wheel

Make sure the rear window is clear and you have good visibility before starting to drive.

The defogger and antenna wires on the inside of the rear window can be accidentally damaged. When cleaning the glass, always wipe side to side.

### Steering Wheel Adjustment

See page 17 for important safety information about how to properly position the steering wheel.

Make any steering wheel adjustment before you start driving.

#### **WARNING**

Adjusting the steering wheel position while driving may cause you to lose control of the car and be seriously injured in a crash.

Adjust the steering wheel only when the car is stopped.

To adjust the steering wheel upward or downward:

1. Push the lever under the steering column all the way down.

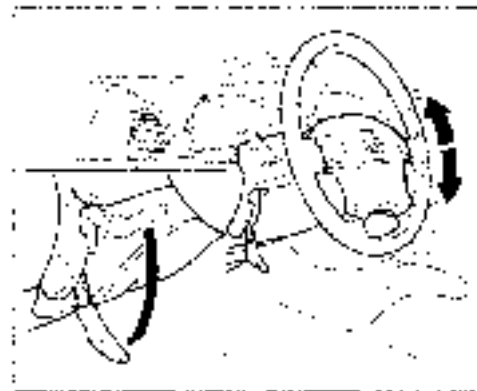

2. Move the steering wheel to the desired position, making sure the wheel points toward your chest, not toward your face. Make sure you can see the instrument panel gauges and the indicator lights.
3. Push the lever up to lock the steering wheel in that position.
4. Make sure you have securely locked the steering wheel in place by trying to move it up and down.

## Cruise Control

Cruise control allows you to maintain a set speed above 25 mph (40 km/h) without keeping your foot on the accelerator pedal. It should be used for cruising on straight, open highways. It is not recommended for conditions such as city driving, winding roads, slippery roads, heavy rain, or bad weather. You should have full control of the car under those conditions.

### **⚠ WARNING**

Improper use of the cruise control can lead to a crash.

Use the cruise control only when traveling on open highways in good weather.

### **NOTICE**

*The cruise control, as it operates, moves the accelerator pedal. You can damage your car's accelerator mechanism by resting your foot under the pedal and blocking the movement.*

## Using the Cruise Control



### **CRUISE CONTROL MASTER SWITCH**

1. Push in the Cruise Control Master Switch to the left of the steering column. The indicator in the switch will light.
2. Accelerate to the desired cruising speed above 25 mph (40 km/h).

CONTINUED

## Steering Wheel Controls

---

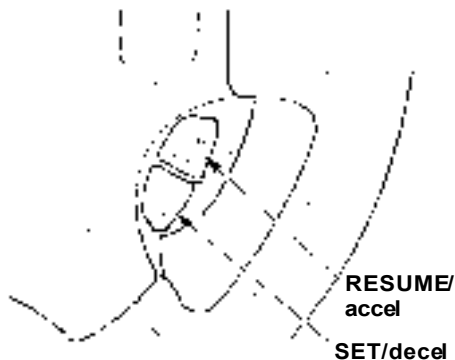

3. Press and release the SET/decel button on the steering wheel. The CRUISE CONTROL light on the instrument panel comes on to show the system is now activated.

The cruise control may not hold the set speed when you are going up and down hills. If your speed increases going down a hill, use the brakes to slow down to the desired speed. This will cancel the

cruise control. To resume the set speed, press the RESUME/accel button. The CRUISE CONTROL light on the instrument panel comes on.

When climbing a steep hill, the automatic transmission may downshift to hold the set speed.

### ***Changing the Set Speed***

You can increase the set cruising speed in any of these ways:

- Press and hold the RESUME/accel button. The car will accelerate. When you reach the desired cruising speed, release the button.
- Push on the accelerator pedal. Accelerate to the desired cruising speed and press the SET/decel button.
- To increase your speed in very small amounts, tap the RESUME/accel button repeatedly. Each time

you do this, your vehicle will speed up about 1 mph (1.6 km/h).

You can decrease the set cruising speed in any of these ways:

- Press and hold the SET/decel button. The car will decelerate. Release the button when you reach the desired speed.
- To slow down in very small amounts, tap the SET/decel button repeatedly. Each time you do this, your vehicle will slow down about 1 mph (1.6 km/h).
- Tap the brake or clutch pedal lightly with your foot. The CRUISE CONTROL light on the instrument panel will go out. When the car slows to the desired speed, press the SET/decel button. The car will then maintain the desired speed.

Even with the cruise control turned on, you can still use the accelerator pedal to speed up for passing. After completing the pass, take your foot off the accelerator pedal. The car will return to the set cruising speed.

Resting your foot on the brake or clutch pedal will cause the cruise control to cancel.

### ***Cancelling the Cruise Control***

You can cancel the cruise control in any of these ways:

- Tap the brake or clutch pedal.
- Press the SET/decel and RESUME/accel buttons at the same time.
- Press the Cruise Control Master Switch.

When you tap the brake or clutch pedal, or press the SET and RESUME buttons at the same time, the CRUISE CONTROL light on the instrument panel will go out and the car will begin to slow down. You can use the accelerator pedal in the normal way.

The system remembers the previously-set cruising speed. To return to that speed, accelerate to above 25 mph (40 km/h) and press

the RESUME/accel button until the CRUISE CONTROL light comes on. The car will accelerate to the same cruising speed as before.

Pressing the Cruise Control Master Switch turns the system completely off and erases the previous cruising speed from memory. To use the system again, refer to ***Using the Cruise Control.***



# Keys and Locks

## Keys

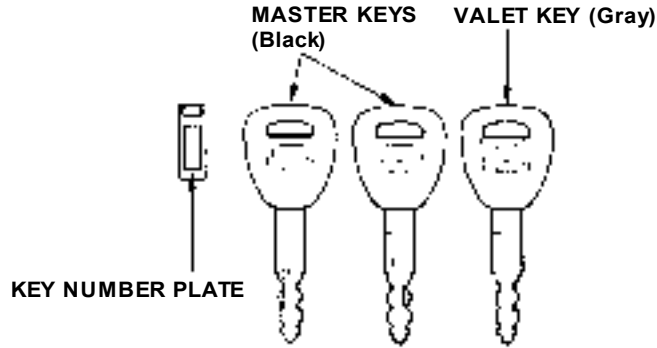

Your car comes with two master keys and a valet key. The master key fits all the locks on your vehicle:

- Ignition
- Doors
- Trunk
- Trunk release handle
- Rear seat trunk access
- Glove box

The valet key works only in the ignition and the door locks. You can keep the trunk, trunk release handle, rear seat trunk access and the glove box locked when you leave your car and the valet key at a parking facility.

You should have received a key number plate with your keys. You will need this key number if you ever have to get a lost key replaced. Keep the plate stored in a safe place. If you

need to replace a key, use only Honda-approved key blanks.

These keys contain electronic circuits that are activated by the Immobilizer System. They will not work to start the engine if the circuits are damaged.

- Protect the keys from direct sunlight, high temperature, and high humidity.
- Do not drop the keys or set heavy objects on them.
- Keep the keys away from liquids. If they get wet, dry them immediately with a soft cloth.

The keys do not contain batteries. Do not try to take them apart.

### **Learning Key**



You should also receive a small case containing a learning key. It is used by the Honda dealer to code replacement keys to your car's Immobilizer System. It must not be used in your car's ignition switch. Store the learning key with the key number plate in a safe place.

If you attempt to use the learning key to start your car's engine, it may cause a malfunction in the system that makes your master and valet keys unusable. If this happens, you should contact your Honda dealer.

If you need a new key made, take the key number plate, the learning key, and all other keys that came with your car to your Honda dealer.

### **Remote Transmitter**

Your car also comes with two remote transmitters; see page 75 for an explanation of the operation.

### **Immobilizer System**

The Immobilizer System protects your car from theft. A properly-coded ignition key must be used in the ignition switch for the engine to start. If an improperly-coded key (or other device) is used, the engine's fuel system is disabled.

When you turn the ignition switch to ON (II), the Immobilizer System indicator should come on for a few seconds, then go out. If the indicator starts to blink, it means the system does not recognize the coding of the key. Turn the ignition switch to LOCK (0), remove the key, reinsert it, and turn the switch to ON (II) again.

CONTINUED

## Keys and Locks

---

This indicator will also blink several times when you turn the ignition switch from ON (II) to ACCESSORY (I) or LOCK (0).

The system may not recognize your key's coding if another immobilizer key or other metal object is near the ignition switch when you insert the key. To make sure the system recognizes the key code:

- Do not keep other immobilizer keys on the same key ring.
- Use a plastic or leather key fob, not metal.
- Keep other keys away from your vehicle's key and the ignition switch while trying to start the engine.

If the system repeatedly does not recognize the coding of your key, contact your Honda dealer.

Do not attempt to alter this system or add other devices to it. Electrical problems could result that may make your car undriveable.

If you have lost your key and you cannot start the engine, contact your Honda dealer.

*As required by the FCC:*

*This device complies with Part 15 of the FCC rules. Operation is subject to the following two conditions: (1) This device way not cause harmful interference, and (2) this device must accept any interference received, including interference that may cause undesired operation.*

*Changes or modifications not expressly approved by the party responsible for compliance could void the user's authority to operate the equipment.*

*This device complies with Industry Canada Standard RSS-210. Operation is subject to the following two conditions: (1) this device may not cause interference, and (2) this device must accept any interference that may cause undesired operation of the device.*

### Ignition Switch

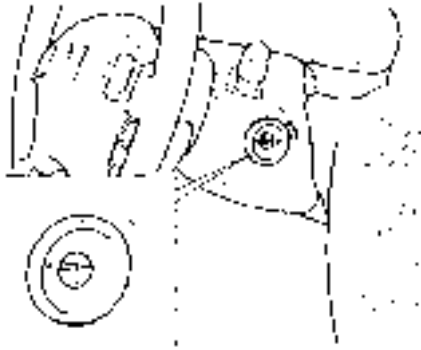

The ignition switch is on the right side of the steering column. It has four positions:

- LOCK (0)
- ACCESSORY (I)
- ON (II)
- START (III)

**LOCK (0)** — You can insert or remove the key only in this position. To switch from ACCESSORY to LOCK, you must push the key in slightly as you turn it. If your car has an automatic transmission, the shift lever must also be in Park. The anti-theft lock will lock the steering column when you remove the key. If the front wheels are turned, the anti-theft lock may sometimes make it difficult to turn the key from LOCK to ACCESSORY. Firmly turn the steering wheel to the left or to the right as you turn the key.

### **WARNING**

Removing the key from the ignition switch while driving locks the steering. This can cause you to lose control.

Remove the key from the ignition switch only when parked.

**ACCESSORY (I)** — In this position, you can operate the audio system and the accessory power socket.

**ON (II)** — This is the normal key position when driving. All features and accessories on the car are usable. Several of the lights on the instrument panel come on as a test when you turn the ignition switch from ACCESSORY to ON.

*CONTINUED*

## Keys and Locks

---

**START (III)** — Use this position only to start the engine. The switch returns to ON (II) when you let go of the key.

The engine will not start if the Immobilizer System does not recognize the key's coding (see page [71](#)).

You will hear a reminder beeper if you leave the key in the ignition switch in the LOCK (0) or ACCESSORY (I) position and open the driver's door. Remove the key to turn off the beeper.

### Power Door Locks



Each door has a master door lock switch. This switch locks and unlocks both doors. Push the switch down to lock both doors and up to unlock them.

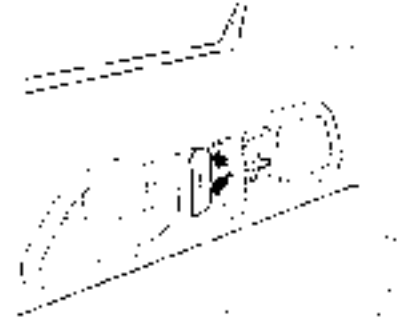

Each door has a lock tab next to the inside door handle. When you push in the lock tab on the driver's door, both doors lock. Pulling out the lock tab on the driver's door only unlocks that door. The lock tab on the passenger's door only locks and unlocks that door.

To lock the passenger's door when getting out of the car, push the lock tab in and close the door. To lock the driver's door, remove the key from the ignition switch and push the lock tab in or push the master switch down, then close the door.

Both doors can be locked from the outside by using the key in either door.

To unlock only the driver's door from the outside, insert the key in the driver's door lock, turn the key and release it. If you turn the key and hold it, both doors will unlock. Both doors will unlock when you unlock the passenger's door with the key.

### **Lockout Prevention**

If you forget and leave the key in the ignition switch, Lockout Prevention will not allow you to lock the driver's door. With the driver's door open and the key in the ignition, both master door lock switches are disabled. However, if the driver's door is not open, the master door lock switches are not disabled. Pushing the switch down on the open passenger's door will lock both doors. If you try to lock an open driver's door by pushing in the lock tab, the tabs on both doors pop out. Pushing in the lock tab on the passenger's door only locks that door.

### **Remote Transmitter**

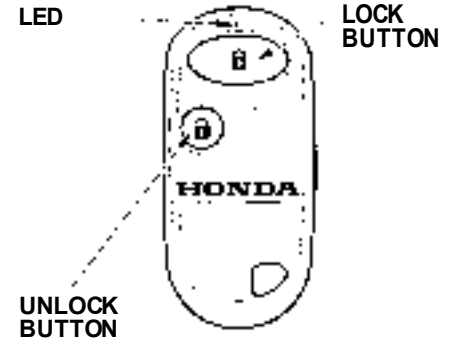

You can lock and unlock your car with the remote transmitter. When you push the LOCK button, both doors lock.

When you push the UNLOCK button once, only the driver's door unlocks. The passenger's door unlocks when you push the button a second time.

*CONTINUED*

## Keys and Locks

The ceiling light (if the ceiling light switch is in the center position) will come on when you press the UNLOCK button. If you do not open either door, the light will go out in about 10 seconds and the doors will automatically relock. If you relock the doors with the remote transmitter before 10 seconds have elapsed, the light will go off immediately.

You cannot lock or unlock the doors with the remote transmitter if either door is not fully closed or the key is in the ignition switch.

### *Replacing the Battery*

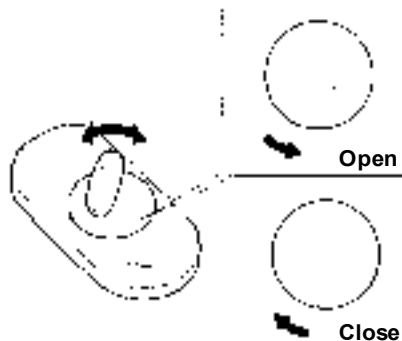

When the remote transmitter's battery begins to get weak, it may take several pushes on the button to lock or unlock the doors, and the LED will get dim. Replace the battery as soon as possible.

Battery type: CR2025

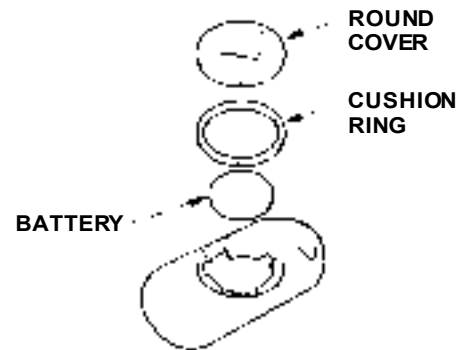

To replace the battery, remove the round cover on the back of the transmitter by turning it counterclockwise with a coin.

Remove the old battery and note the polarity. Make sure the polarity of the new battery is the same (+ side facing up), then insert it in the transmitter.

Reinstall the cushion ring. Align the  
▽ mark on the cover with the  
mark on the transmitter,  
then set the cover in place and turn it  
clockwise.

### **Transmitter Care**

Avoid severe shock to the trans-  
mitter, such as dropping or throwing  
it. Also, protect it from extreme hot  
or cold temperatures.

Clean the transmitter case with a  
soft cloth. Do not use strong  
cleaners or solvents that could harm  
the case. Immersing the transmitter  
in any liquid will harm the trans-  
mitter and cause it to not function  
properly.

If you lose a transmitter, you will  
need to have the replacement  
programmed to your car's system by  
your Honda dealer. Any other  
transmitters you have will also need  
to be reprogrammed.

*As required by the FCC:*

*This device complies with Part 15 of the  
FCC rules. Operation is subject to the  
following two conditions: (1) This device  
may not cause harmful interference, and  
(2) this device must accept any  
interference received, including  
interference that may cause undesired  
operation.*

*Changes or modifications not expressly  
approved by the party responsible for  
compliance could void the user's  
authority to operate the equipment.*

*This device complies with Industry  
Canada Standard RSS-210.  
Operation is subject to the following two  
conditions: (1) this device may not cause  
interference, and (2) this device must  
accept any interference that may cause  
undesired operation of the device.*



## Keys and Locks

---

### Trunk

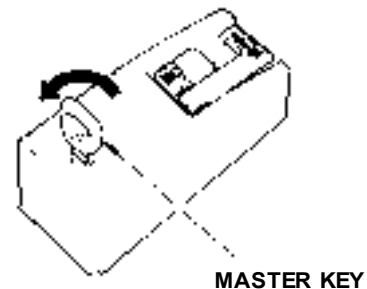
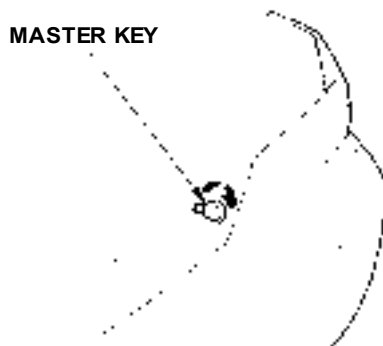

You can open the trunk in two ways:

- Pull the trunk release handle to the left of the driver's seat.
- Use the master key to open the trunk lock. The valet key does not work in this lock.

To close the trunk, press down on the trunk lid.

See page [136](#) for cargo loading and weight limit information. Keep the trunk lid closed at all times while driving to avoid damaging the lid, and to prevent exhaust gas from getting into the interior. See **Carbon Monoxide Hazard** on page [49](#).

To protect items in the trunk when you need to give the key to someone else, lock the trunk release handle with the master key and give the other person the valet key.

### Glove Box



Open the glove box by pulling the bottom of the handle. Close it with a firm push. Lock or unlock the glove box with the master key.

#### **⚠ WARNING**

An open glove box can cause serious injury to your passenger in a crash, even if the passenger is wearing the seat belt.

Always keep the glove box closed while driving.

# Seat Adjustments

---

## Front Seat Adjustments

See pages 13 — 14 for important safety information and warnings about how to properly position seats and seat-backs.

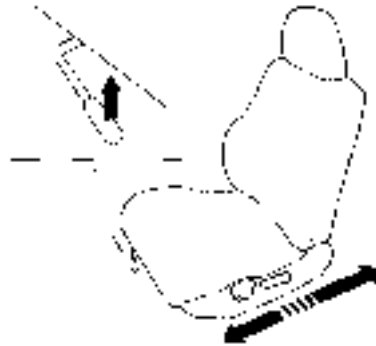

Adjust the seat before you start driving.

To adjust the seat forward and backward, pull up on the lever under the seat cushion's front edge. Move the seat to the desired position and release the lever. Try to move the seat to make sure it is locked in position.



To change the angle of the seat-back, pull up on the lever on the outside of the seat bottom. Move the seat-back to the desired position and release the lever. Let the seat-back latch in the new position.

## Driver's Seat Height Adjustment



See pages 13 — 14 for important safety information and warnings about how to properly position seats and seat-backs. To adjust the height of the driver's seat, turn the dial on the outside of the seat bottom.

## Rear Seat Access

To get into the back seat on the driver's side, pull up on the seat-back adjustment lever.

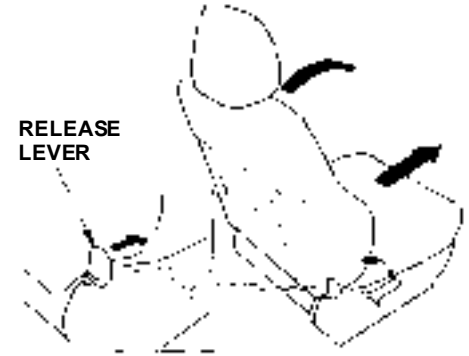

To get into the back seat on the passenger's side, push forward on the release lever at the base of the seat-back. The seat-back will tilt forward and the entire seat will move forward to allow easier entry to the back seat. After you return the seat-back to the upright position, push the whole seat backwards until it latches. Make sure the seat is fully latched before sitting in it.

# Seat Adjustments

---

## Head Restraints

See page 15 for important safety information and a warning about how to properly position the head restraints.

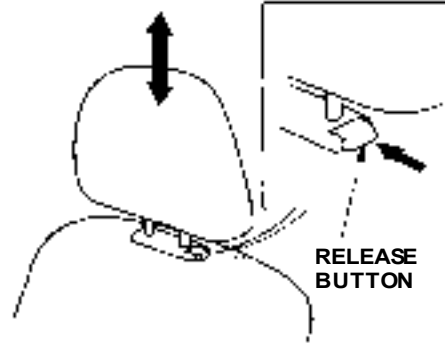

The front head restraints help protect you and your passenger from whiplash and other injuries. They are most effective when you adjust them so the back of the occupant's head rests against the center of the restraint. A taller person should adjust the restraint as high as possible.

The front head restraints adjust for height. You need both hands to adjust the restraint. Do not attempt to adjust it while driving. To raise it, pull upward. To lower the restraint, push the release button sideways and push the restraint down.

To remove a head restraint for cleaning or repair, pull it up as far as it will go. Push the release button and pull the restraint out of the seat-back.

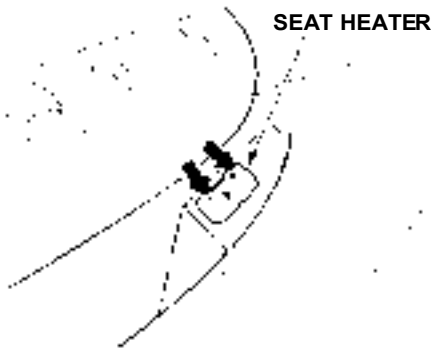

### *On Canadian models*

Both front seats are equipped with seat heaters. The ignition switch must be ON (II) to use them. Push the front of the switch, HI, to rapidly heat up the seat. After the seat reaches a comfortable temperature, select LO by pushing the back of the switch. This will keep the seat warm.

The HI or LO indicator lights and remains lit until you turn it off by pushing the opposite side of the switch lightly. The indicator will turn off.

In HI, the heater turns off when the seat gets warm, and turns back on after the seat's temperature drops. It continues to cycle as long as you leave it set on HI. The HI indicator remains lit as a reminder that you have the heater on.

In LO, the heater runs continuously. It does not cycle with temperature changes.

Follow these precautions whenever you use the seat heaters:

- Use the HI setting only to heat the seats quickly. Select the LO setting when the seats feel warm. The HI setting draws large amounts of current from the battery.
- Do not use the seat heaters, even on the LO setting, if the engine is left idling for an extended period. They can weaken the battery, causing hard starting.

## Folding Rear Seat

The back of the rear seat folds down, giving you direct access to the trunk. The seat-back can be released from inside the car or inside the trunk.

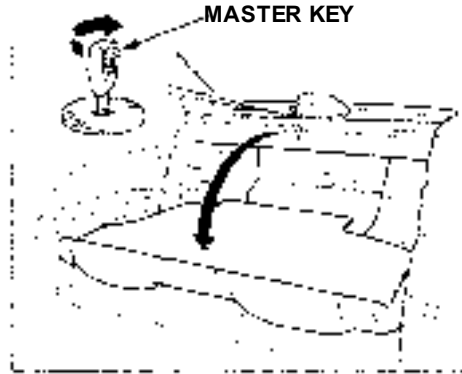

To fold down the seat-back from inside the car, insert the master key in the lock on the rear shelf. Turn the key clockwise, pull down the top of the seat-back, then release the key.

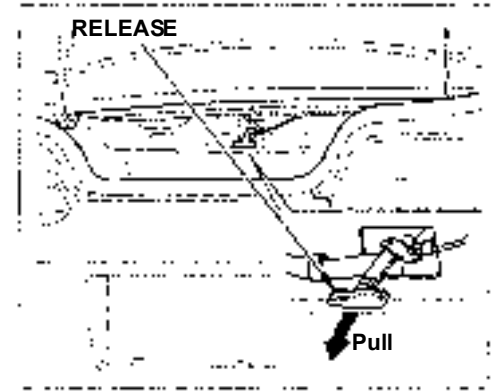

To release the seat-back from inside the trunk, pull the release under the rear shelf.

To lock the seat-back upright, push it firmly against the rear shelf. Make sure it is latched in place by pulling on the top of the seat.

## Folding Rear Seat, Power Windows

Make sure both rear shoulder belts are positioned in front of the rear seat-back whenever the seat-back is in its upright position.

Make sure all items in the trunk, or items extending through the opening into the back seat, are secured. Loose items can fly forward and cause injury if you have to brake hard. See **Carrying Cargo** on page [135](#).

Never drive with the seat-back folded down and the trunk lid open. See **Carbon Monoxide Hazard** on page [49](#).

### Power Windows

Your car's windows are electrically-powered. Turn the ignition switch to ON (II) to raise or lower any window.

Each door has a switch that controls its window. To open the window, push the switch down and hold it. Release the switch when you want the window to stop. Close the window by pulling back on the switch and holding it.

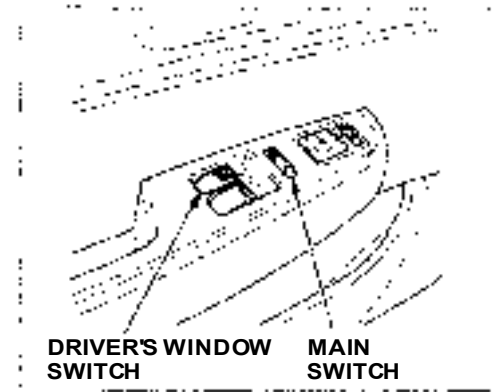

The driver's armrest has a master power window control panel. To open the passenger's window, push down on the switch and hold it down until the window reaches the desired position. To close the window, pull back on the window switch. Release the switch when the window gets to the position you want.

*CONTINUED*



## Power Windows

---

### **WARNING**

Closing a power window on someone's hands or fingers can cause serious injury.

Make sure your passengers are away from the windows before closing them.

The master control panel also contains these extra features:

**AUTO** — To open the driver's window fully, push the window switch firmly down and release it. The window automatically goes all the way down. To stop the window from going all the way down, pull back on the window switch briefly.

To open the driver's window only partially, push the window switch down lightly and hold it. The window will stop as soon as you release the switch.



The AUTO function only works to lower the driver's window. To raise the window, you must pull back on the window switch and hold it until the window reaches the desired position.

The MAIN switch controls power to the passenger's window. With this switch off, the passenger's window cannot be raised or lowered. The MAIN switch does not affect the driver's window. Keep the MAIN switch off when you have children in the car so they do not injure themselves by operating the window unintentionally.

The power window system has a key-off delay function. The windows will still operate for up to ten minutes after you turn off the ignition. Opening either door cancels the delay function. You must turn the ignition ON (II) again before you can raise or lower the windows.



**MOONROOF SWITCH**

Use the switch on the dashboard to open and close the moonroof. The ignition switch must be ON (II). Push and hold the  switch to open the moonroof. Release the switch when the moonroof reaches the desired position. To close the moonroof, press and hold the  switch.

The moonroof has a key-off delay. You can still open and close the moonroof for up to ten minutes after you turn off the ignition. The key-off delay cancels as soon as you open either door. You must then turn the ignition ON (II) for the moonroof to operate.

## NOTICE

*If you try to open the moonroof in below-freezing temperatures, or when it is covered with snow or ice, you can damage the moonroof panel or motor.*

## WARNING

Closing the moonroof on someone's hands or fingers can cause serious injury.

Make sure passengers are clear of the moonroof before closing it.

# Mirrors

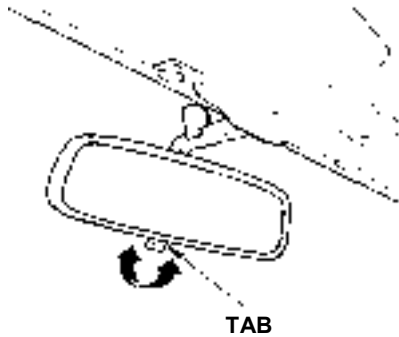

Keep the inside and outside mirrors clean and adjusted for best visibility. Be sure to adjust the mirrors before you start driving.

The inside mirror has day and night positions. The night position reduces glare from headlights behind you. Flip the tab on the bottom edge of the mirror to select the day or night position.

## Adjusting the Power Mirrors

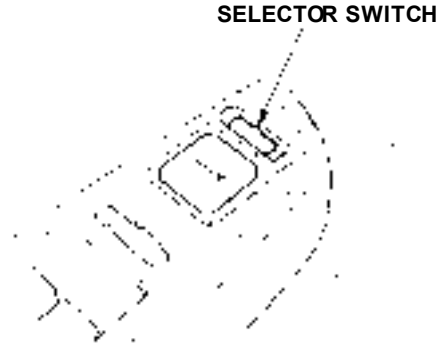

Adjust the outside mirrors with the adjustment switch on the driver's door armrest:

1. Turn the ignition switch ON (II).
2. Move the selector switch to L (driver's side) or R (passenger's side).



3. Push the appropriate edge of the adjustment switch to move the mirror right, left, up or down.
4. When you finish, move the selector switch to the center (off) position. This turns off the adjustment switch so you can't move a mirror out of position by accidentally bumping the switch.

**HEATED MIRROR  
BUTTON**



*Available on all Canadian models*  
The outside mirrors are heated to remove fog and frost. With the ignition switch ON (II), turn on the heaters by pressing the button. The light in the button comes on as a reminder. Press the button again to turn the heaters off.

**Parking Brake**

**PARKING BRAKE LEVER**



To apply the parking brake, pull the lever up fully. To release it, pull up slightly, push the button, and lower the lever. The parking brake light on the instrument panel should go out when the parking brake is fully released (see page [55](#)).

**NOTICE**

*Driving the car with the parking brake applied can damage the rear brakes and axles.*

# Digital Clock

---

HOUR MIN RESET



The digital clock displays the time with the ignition switch ON (II).

To set the clock:

1. Turn the ignition switch ON (II) to display the time.
2. Swing down the front cover of the wide button under the clock display. You will see HOUR, MIN, and RESET buttons.
3. Press and hold the HOUR button until the hour advances to the desired hour.
4. Press and hold the MIN (minute) button until the numbers advance to the desired minutes.

You can use the RESET button to quickly set the time to the nearest hour. If the displayed time is before the half hour, pressing RESET button sets the clock back to the previous hour. If the displayed time is after the half hour, pressing the RESET button sets the clock forward to the beginning of the next hour.

For example:

- 1:06 would RESET to 1:00.
- 1:52 would RESET to 2:00.

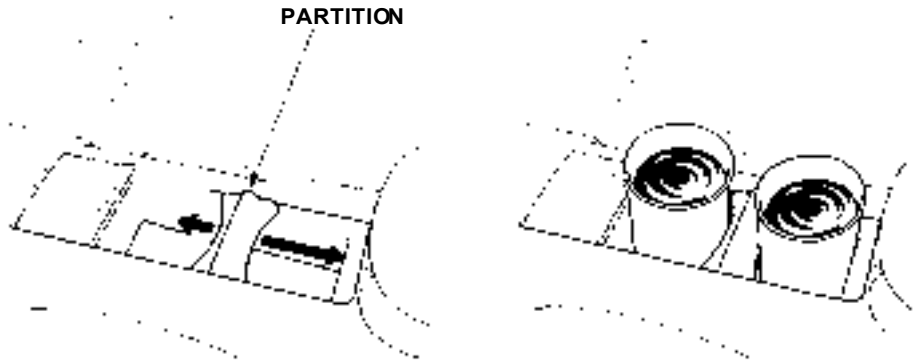

The front beverage holder is located on the center console. The partition in the beverage holder can be moved forward or backward. If you want to use the beverage holder, slide the partition forward until it clicks. To put small items in the beverage holder, slide the partition completely backward.

Be careful when you are using the beverage holder. A spilled liquid that is very hot can scald you or your passengers. Spilled liquids can also damage the upholstery, carpeting, and electrical components in the interior.

*CONTINUED*

## Beverage Holder, Console Compartment

---



The rear seat also has a beverage holder in the armrest on the driver's side.

### Console Compartment

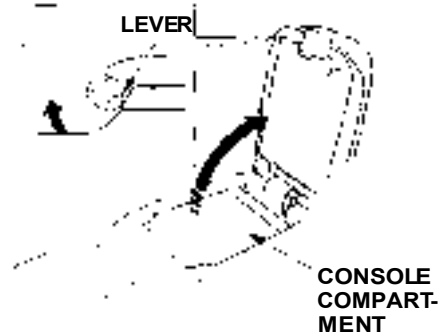

To open the console compartment, pull up on the lower lever and lift the lid.

To close, lower the lid and push it down until it latches.

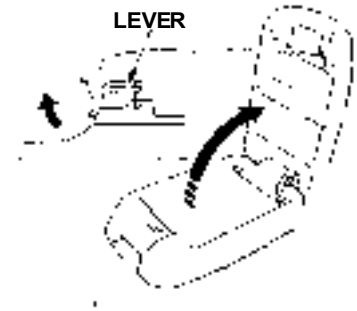

You can put small items in the tray located in the console compartment lid. To use the tray, pull up on the upper lever and lift up the armrest pad.

## Coin Box, Accessory Power Socket

### Coin Box



The coin box is located next to the beverage holder. Open the lid by lifting it up.



To remove the coin box for emptying, lift the coin box up by pushing up on the middle edge of the coin box on the console guide. Never use the coin box for smoking materials.

### Accessory Power Socket

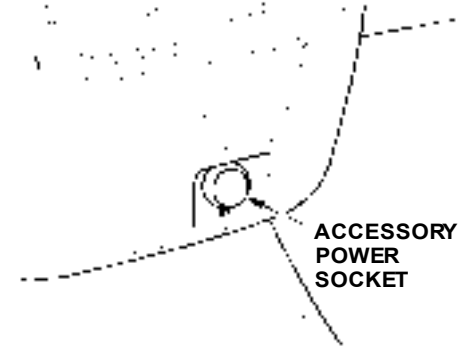

To use the accessory power socket, pull down the cover. The ignition switch must be in ACCESSORY (I) or ON (II).

This socket is intended to supply power for 12 volt DC accessories that are rated 120 watts or less (10 amps).

It will not power an automotive type cigarette lighter element.



## Ashtrays, Interior Lights

---

### Ashtrays (Optional)

A front ashtray, which is available as an option, can be used as a replacement for the coin box.

#### NOTICE

*Use the ashtray only for cigarettes, cigars, and other smoking materials. To prevent a possible fire and damage to your car, don't put paper or other things that can burn in the ashtray.*

### Ceiling Lights

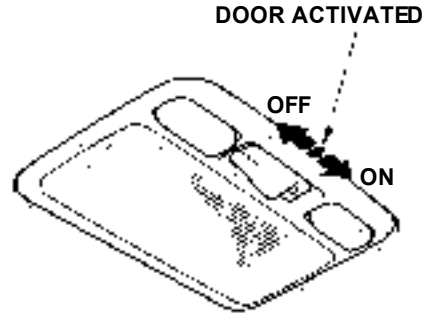

The ceiling light has a three-position switch. In the OFF position, the light does not come on. In the center position, the ceiling light comes on when you open either door. After both doors are closed tightly, the light dims slightly, then fades out in about 10 seconds. In the ON position, the ceiling light stays on continuously.

The ceiling light contains a main light as well as two spotlights.

## Courtesy Lights



Turn on the spotlight by pushing the button next to each light. Push the button again to turn it off. You can use the spotlights at all times.



Your car has a courtesy light in the ignition switch. The ignition switch light comes on whenever you open either door. It remains on, then fades out in about 10 seconds after both doors are closed tightly.

The ignition switch light and ceiling light (with the switch in the center position) also comes on when you unlock the door with the key, the lock tab on the driver's door, or the

master door lock switch. If you relock the driver's door or close the driver's door with the key in the ignition switch, the lights turns off immediately. Otherwise, the light remains on, then fades out in about 10 seconds.

If you keep the door open, the ceiling light (with the switch in the center position) will turn off after three minutes when the key is not in the ignition switch.

### *On Type SH*

Your car also has a courtesy light in each door. Each door light comes on when the door is opened, and goes out when the door is closed tightly.



## Comfort and Convenience Features

---

The heating and air conditioning systems in your Honda provide a comfortable driving environment in all weather conditions.

The standard audio system has many features. This section describes those features and how to use them. (If you selected an optional audio system, refer to the operating instructions that came with it.)

Your Honda has an anti-theft audio system that requires a code number to enable it.

Heating and Cooling.....	98
What Each Control Does.....	98
How to Use the System.....	100
To Turn Everything Off .....	105
Audio System.....	106
AM/FM/CD Audio System.....	106
Operating the Radio.....	106
Adjusting the Sound.....	109
Audio System Lighting.....	110
Radio Frequencies.....	110
Radio Reception.....	110
Operating the CD Player.....	112
Operating the CD Changer.....	114
Protecting Compact Discs.....	116
CD Player Error Indications.....	117
CD Changer Error Indications.....	118
Operating the Cassette Player.....	119
Tape Search Functions.....	120
Caring for the Cassette Player.....	122
Theft Protection .....	123

## Heating and Cooling

Proper use of the Heating and Cooling system can make the interior dry and comfortable, and keep the windows clear for best visibility.

### What Each Control Does

#### Fan Control Lever

Sliding this lever to the right increases the fan's speed, which increases air flow.

#### Temperature Control Lever

Sliding this lever to the right increases the temperature of the air flow.

#### Air Conditioning (A/C) Button

This button turns the air conditioning ON and OFF. The indicator in the button lights when the A/C is on.

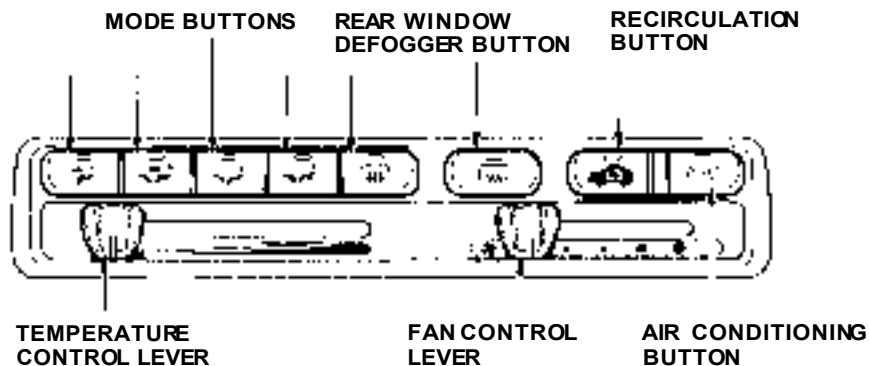

#### Rear Window Defogger Button

This button turns the rear window defogger on and off (see page 65).

#### Recirculation Button

This button controls the source of the air going into the system. When the indicator in this button is lit, air from the car's interior is sent through the system again (Recirculation mode). When the indicator is off, air is brought in from outside the car (Fresh Air mode).

## Mode Buttons

Use the MODE buttons to select the vents the air flows from. Some air will flow from the dashboard corner vents in all modes.

 Air flows from the center and corner vents in the dashboard.

 Air flow is divided between the vents in the dashboard and the floor vents.

 Air flows from the floor vents.

 Air flow is divided between the floor vents and the defroster vents at the base of the windshield.

 Air flows from the defroster vents at the base of the windshield.

When you select  , the system automatically switches to Fresh Air mode and turns on the A/C.

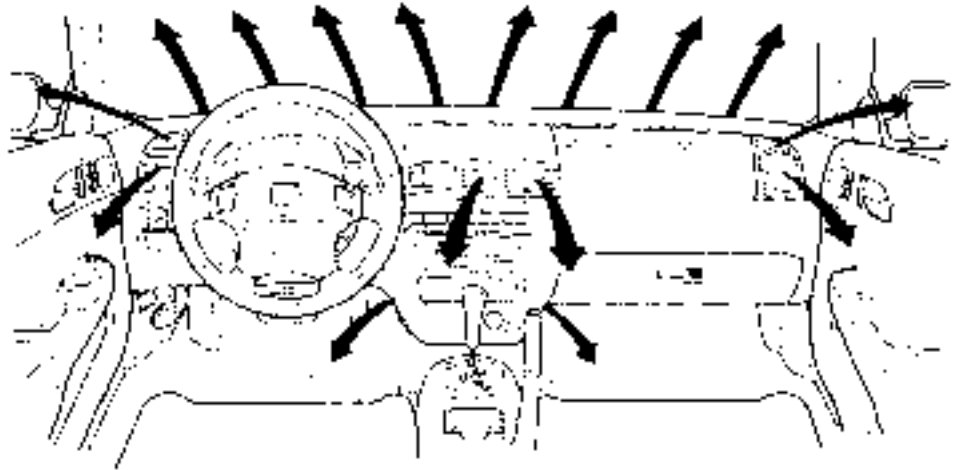

# Heating and Cooling

---

## Vent Controls

### CENTER VENT



You can adjust the direction of the air coming from the dashboard vents by moving the tab in the center of each vent up-and-down and side-to-side.

### SIDE VENT

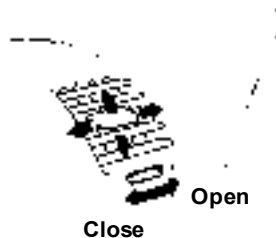

The vents in the corners of the dashboard can be opened and closed with the dials underneath them.

## How to Use the System

This section covers how to set up the system controls for ventilation, heating, cooling, dehumidifying, and defrosting.

The engine must be running for the heater and air conditioning to generate hot and cold air. The heater uses engine coolant to warm the air. If the engine is cold, it will be several minutes before you feel warm air coming from the system. The air conditioning does not rely on engine temperature.

It is best to leave the system in Fresh Air mode under almost all conditions. Keeping the system in Recirculation mode, particularly with the A/C off, can cause the windows to fog up. Switch to Recirculation mode when you are driving through smoky or dusty conditions, then switch back to Fresh Air mode when the condition clears.

The outside air intakes for the heating and cooling system are at the base of the windshield. Keep these clear of leaves and other debris.

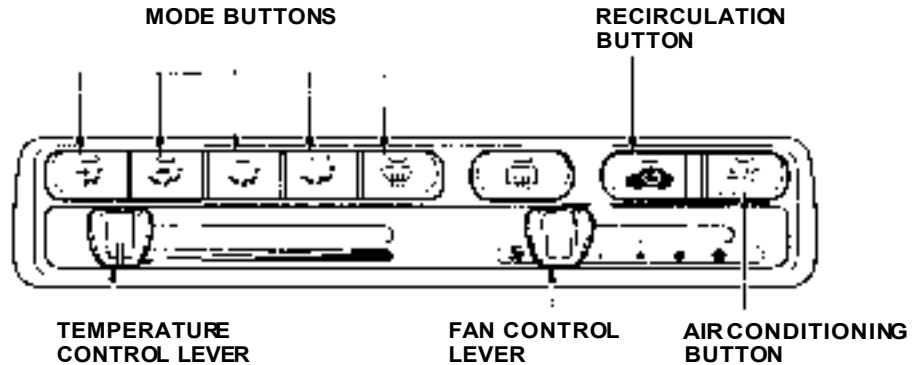

### ***Ventilation***

The flow-through ventilation system draws in outside air, circulates it through the interior, then exhausts it through vents near the rear window.

1. Slide the temperature control lever all the way to the left.  
Make sure the A/C is off.
2. Select  and Fresh Air mode.
3. Set the fan to the desired speed.

CONTINUED



## Heating and Cooling

---

### *To Cool with A/C*

1. Turn on the A/C by pressing the button. The light in the button should come on when a fan speed is selected.
2. Make sure the temperature control lever is set to maximum cool.
3. Select .
4. If the outside air is humid, select Recirculation mode. If the outside air is dry, select Fresh Air mode.
5. Set the fan to the desired speed.

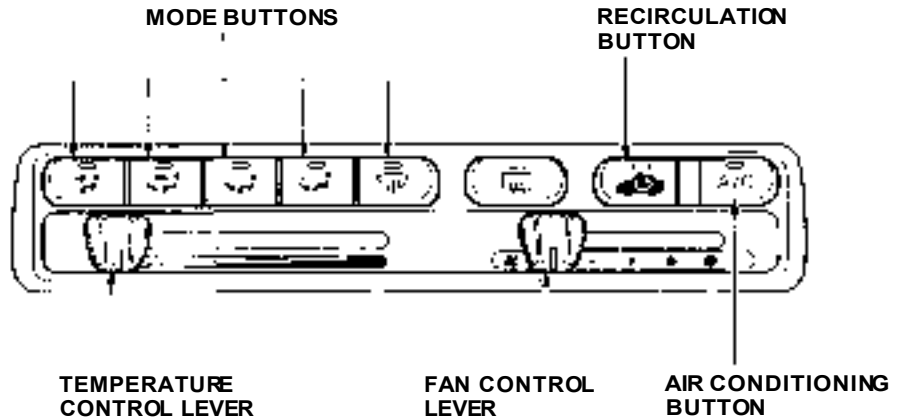

If the interior is very warm from being parked in the sun, you can cool it down more rapidly by setting up the controls this way:

1. Start the engine.
2. Turn on the A/C by pressing the button. Make sure the temperature control lever is all the way to the left.
3. Set the fan to maximum speed.
4. Open the windows partially. Select  and Fresh Air mode.

When the interior has cooled down to a more comfortable temperature, close the windows and set the controls as described for normal cooling.

Air conditioning places an extra load on the engine. Watch the engine coolant temperature gauge (see page 59) when driving in stop-and-go traffic or climbing a long, steep hill. If it moves near the red zone, turn off the A/C until the gauge reads normally.

### **To Heat**

To warm the interior:

1. Start the engine.
2. Select  and Fresh Air mode.
3. Set the fan to the desired speed.
4. Adjust the warmth of the air with the temperature control lever.

### **To Heat and Dehumidify with Air Conditioning**

Air conditioning, as it cools, removes moisture from the air. When used in combination with the heater, it makes the interior warm and dry.

1. Switch the fan on.
2. Turn on the air conditioning.
3. Select  and Fresh Air mode.
4. Adjust the temperature control lever so the mixture of heated and cooled air feels comfortable.



This setting is suitable for all driving conditions whenever the outside temperature is above 32°F (0°C).

CONTINUED

# Heating and Cooling

## To Defog and Defrost



To remove fog from the inside of the windows:

1. Switch the fan on.
2. Select  .  
When you select  , the system automatically switches to Fresh Air mode and turns on the A/C.
3. Adjust the temperature control lever so the air flow from the defroster vents feels warm.
4. Turn on the rear window defogger to help clear the rear window.

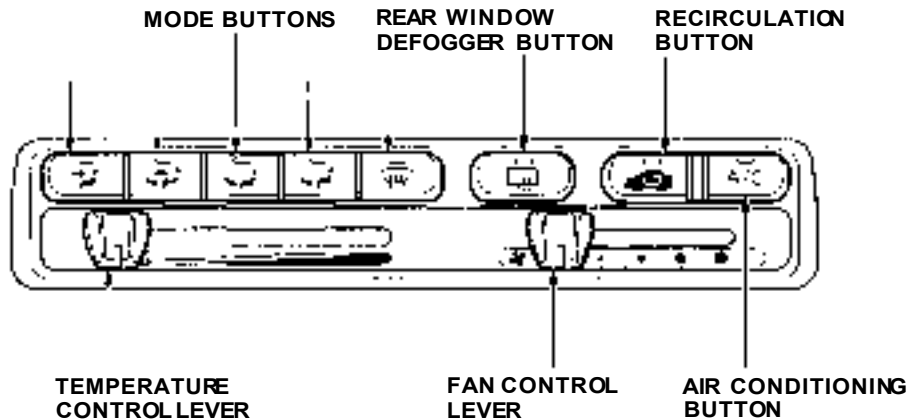
When you switch to another mode from  , the A/C stays on. Press the A/C button to turn it off.



To remove exterior frost or ice from the windshield and side windows after the car has been sitting out in cold weather:

1. Start the engine.
2. Select  .  
When you select  , the system automatically switches to Fresh Air mode and turns on the A/C.
3. Switch the fan and temperature controls to maximum.

To rapidly remove exterior frost or ice from the windshield (on very cold days), first select the Recirculation mode. Once the windshield is clear, select the Fresh Air mode to avoid fogging the windows.

These settings direct all the air flow to the defroster vents at the base of the windshield and the side window defroster vents. The air flow will get warmer and clear the windows faster as the engine warms up. You can close the side vents with the dial underneath each vent. This will send more warm air to the windshield defroster vents.

For safety, make sure you have a clear view through all the windows before driving away.

### **To Turn Everything Off**

To shut off the system temporarily, slide the fan speed and temperature control levers all the way to the left.

You should shut the system completely off only for the first few minutes of driving in cold weather, until the engine coolant warms up enough to operate the heater. Keep the fan on at all other times so stale air does not build up in the interior.

# Audio System

## AM/FM/CD Audio System

Your Honda's audio system provides clear reception on both AM and FM bands, while the preset buttons allow you to easily select your favorite stations.

The anti-theft feature will disable the system if it is disconnected from the vehicle's battery. To get the system working again, you must enter a code number (see page 123).

## Operating the Radio

The ignition switch must be in ACCESSORY (I) or ON (II) to operate the audio system. Turn the system on by pushing the PWR/VOL knob. Adjust the volume by turning the same knob.

The band and frequency that the radio was last tuned to is displayed. To change bands, press the AM/FM button. On the FM band, ST will be displayed if the station is broadcasting in stereo. Stereo reproduction on AM is not available.

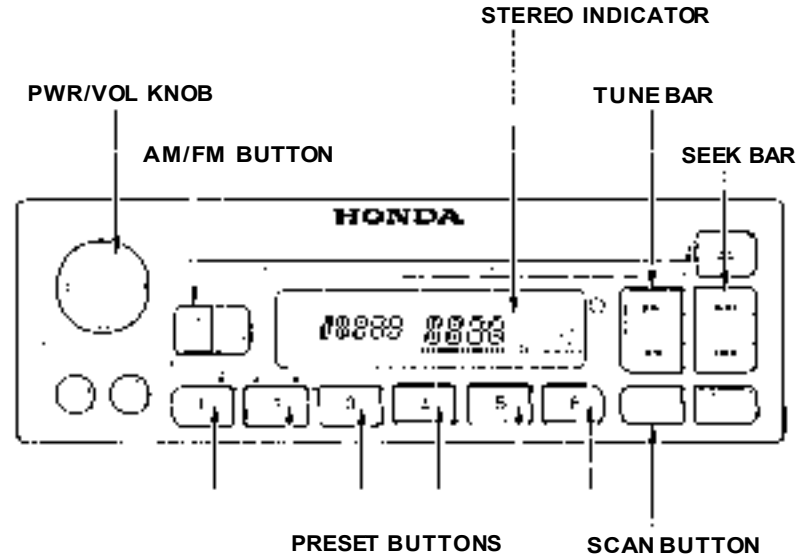

You can use any of four methods to find radio stations on the selected band: TUNE, SEEK, SCAN or the Preset buttons.

**TUNE** — Use the TUNE bar to tune the radio to a desired frequency. Press the ►► side of the bar to tune to a higher frequency, and the ◀◀ side to tune to a lower frequency. The frequency numbers will start to change rapidly. Release the bar when the display reaches the desired frequency. To change the frequency in small increments, press and release the TUNE bar quickly.

**SEEK** — The SEEK function searches the band for a station with a strong signal. To activate it, press the SEEK bar on either the ◀◀ or ►► side, then release it. Depending on which side you press, the system scans upward or downward from the current frequency. It stops when it finds a station with a

strong signal.

**SCAN** — The SCAN function samples all the stations with strong signals on the selected band. To activate it, press the SCAN button, then release it. When the system is in the SCAN mode, SCAN shows in the display. The system will scan up the band for a station with a strong signal. When it finds one, it will stop and play that station for approximately five seconds. If you do nothing, the system will then scan for the next strong station and play that for five seconds. When it plays a station that you want to continue listening to, press the SCAN button again.

**Preset** — You can store the frequencies of your favorite radio stations in the six preset buttons. Each button will store one frequency on the AM band, and two frequencies on the FM band.

To store a frequency:

1. Select the desired band, AM or FM. FM1 and FM2 let you store two frequencies with each Preset button.
2. Use the TUNE or SEEK function to tune the radio to a desired station.
3. Pick the Preset button you want for that station. Press the button and hold it until you hear a beep.
4. Repeat steps 1 to 3 to store a total of six stations on AM and twelve on FM.

Once a station's frequency is stored, simply press and release the proper preset button to tune to it.

The preset frequencies will be lost if your car's battery goes dead, is disconnected, or the radio fuse is removed.

*CONTINUED*

## Audio System

**AUTO SELECT** — If you are traveling far from home and can no longer receive the stations you preset, you can use the Auto Select feature to find stations in the local area.

To activate Auto Select, press the A. SEL button. A. SEL will flash in the display, and the system will go into scan mode for several seconds. It automatically scans both bands, looking for stations with strong signals; it stores the frequencies of six AM stations and twelve FM stations in the preset buttons. You can then use the preset buttons to select those stations.

If you are in a remote area, Auto Select may not find six strong AM stations or twelve strong FM stations. If this happens, you will see a "0" displayed when you press any preset button that does not have a station stored.

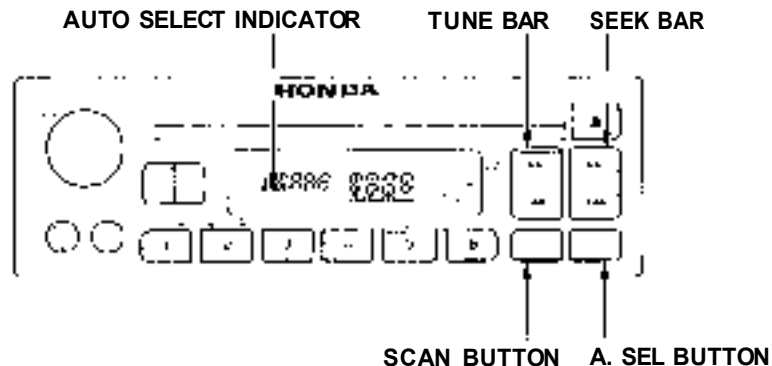

If you do not like the stations Auto Select has stored, you can store other frequencies in the preset buttons. Use the TUNE, SEEK, or SCAN function to find the desired frequencies, then store them in the selected preset buttons as described previously.

Auto Select does not erase the frequencies that you preset previously. When you return home, turn off Auto Select by pressing the A. SEL button. The preset buttons will then select the frequencies you originally set.

## Adjusting the Sound

**Balance/Fader** These two controls adjust the strength of the sound coming from each speaker. The Balance control adjusts the side-to-side strength, while the Fader control adjusts the front-to-back strength.

To adjust the fader, push on the BASS/FADER control knob to get it to pop out. Pull it out slightly farther, and adjust the front-to-back sound to your liking. Push the knob back in when you are done so you cannot change the setting by accidentally bumping it.

To adjust the balance, push on the TREBLE/BALANCE control knob to get it to pop out. Pull it out slightly farther, and adjust the side-to-side sound to your liking. Push the knob back in when you are done so you cannot change the setting by accidentally bumping it.

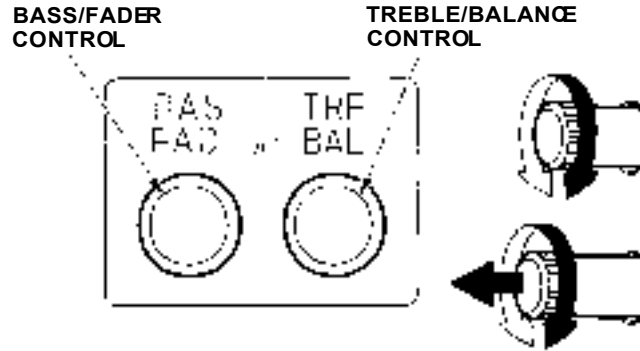

**Treble/Bass** — Use these controls to adjust the tone to your liking.

To adjust the Treble level, push on the TREBLE/BALANCE control knob to get it to pop out. Without pulling it out farther, turn the knob to adjust the treble level. Push the knob back in when you are done so you cannot change the setting by accidentally bumping it.

To adjust the Bass level, push on the BASS/FADER control knob to get it to pop out. Without pulling it out farther, turn the knob to adjust the bass level. Push the knob back in when you are done so you cannot change the setting by accidentally bumping it.



## Audio System

---

### Audio System Lighting

You can use the instrument panel brightness control dial to adjust the illumination of the audio system (see page 63). The audio system illuminates when the parking lights are on, even if the radio is turned off.

### Radio Frequencies

Your Honda's radio can receive the complete AM and FM bands. Those bands cover these frequencies:

AM band:

530 to 1,710 kilohertz

FM band:

87.7 to 107.9 megahertz

Radio stations on the AM band are assigned frequencies at least ten kilohertz apart (530, 540, 550).

Stations on the FM band are assigned frequencies at least 0.2 megahertz apart (87.9, 88.1, 88.3).

Stations must use these exact frequencies. It is fairly common for stations to round-off the frequency in their advertising, so your radio could display a frequency of 100.9 even though the announcer may identify the station as "FM101."

### Radio Reception

How well your Honda's radio receives stations is dependent on many factors, such as the distance from the station's transmitter, nearby large objects, and atmospheric conditions.

A radio station's signal gets weaker as you get farther away from its transmitter. If you are listening to an AM station, you will notice the sound volume becoming weaker, and the station drifting in and out. If you are listening to an FM station, you will see the stereo indicator flickering off and on as the signal weakens. Eventually, the stereo indicator will

go off and the sound will fade completely as you get out of range of the station's signal.



Driving very near the transmitter of a station that is broadcasting on a frequency close to the frequency of the station you are listening to can also affect your radio's reception. You may temporarily hear both stations, or hear only the station you are close to.

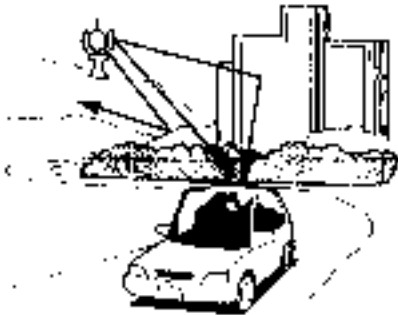

Radio signals, especially on the FM band, are deflected by large objects such as buildings and hills. Your radio then receives both the direct signal from the station's transmitter, and the deflected signal. This causes the sound to distort or flutter. This is a main cause of poor radio reception in city driving.



Radio reception can be affected by atmospheric conditions such as thunderstorms, high humidity, and even sunspots. You may be able to receive a distant radio station one day and not receive it the next day because of a change in conditions.

Electrical interference from passing vehicles and stationary sources can cause temporary reception problems.

*As required by the FCC:  
Changes or modifications not expressly  
approved by the party responsible for  
compliance could void the user's  
authority to operate the equipment.*

## Audio System

### Operating the CD Player

You operate the CD player with the same controls used for the radio.

With the ignition switch in ACCESSORY (I) or ON (II), insert the disc into the CD slot. Push the disc in halfway, the drive will pull it in the rest of the way and begin to play. The number of the track that is playing is shown in the display.

You can also play 3-inch (8-cm) discs without using an adapter ring. Play only standard round discs. Odd-shaped CDs may jam in drive or cause other problems.

When the system reaches the end of the disc, it will return to the beginning and play that disc again.

You can switch to the radio while a CD is playing by pressing the AM/FM button. Press the CD button to return to playing the CD. The CD will begin playing where it left off.

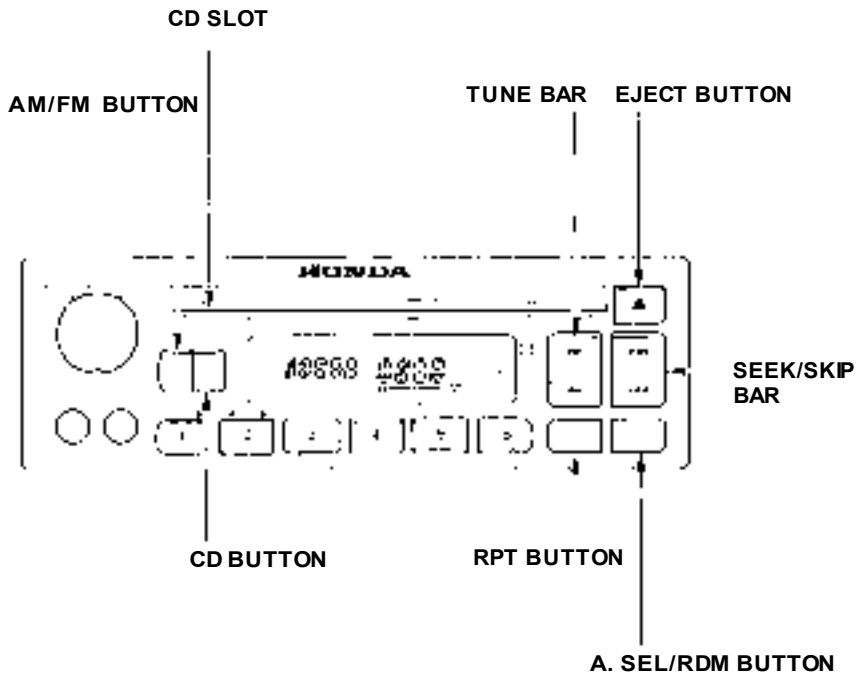





If you turn the system off while a CD is playing, either with the PWR/VOL knob or by turning off the ignition, the disc will stay in the drive. When you turn the system back on, the CD will begin playing where it left off.

Press the eject button to remove the disc from the drive.

If you eject the disc, but do not remove it from the slot, the system will automatically reload the disc after 15 seconds and put the CD player in pause mode. To begin playing the disc, press the CD button.

You can use the TUNE and SEEK/SKIP bars while a disc is playing to select passages and change tracks.

To move rapidly within a track, press and hold the TUNE bar. Press the  side to move forward. You will see CUE in the display. Press the  side to move backward. You will see REW displayed. Release the bar when the system reaches the point you want.

Each time you press the  side of the SEEK/SKIP bar, the system skips forward to the beginning of the next track. Press the  side to skip backward to the beginning of the current track. Press it again to skip to the beginning of the previous track.

**REPEAT** — To activate the Repeat feature, press and release the RPT button. You will see RPT in the display. The system continuously

replays the current track. Press the RPT button again to turn it off.

**RANDOM PLAY** — This feature, when activated, plays the tracks on the CD in random order, rather than in the order they are recorded on the CD. To activate Random Play, press and release the A. SEL/RDM button. You will see RDM in the display. The system will then select and play tracks randomly. This continues until you deactivate Random Play by pressing A. SEL/RDM again.

If the system is in Repeat mode, you must turn it off by pressing the RPT button before selecting Random Play.

## Audio System

### Operating the CD Changer (Optional)

A Compact Disc changer is available for your car. It holds up to six discs, providing several hours of continuous entertainment. You operate this CD changer with the same controls used for the in-dash CD player.

Load the desired CDs in the magazine and load the magazine in the changer according to the instructions that came with the unit. Play only standard round discs. Odd-shaped CDs may jam in the drive or cause other problems.

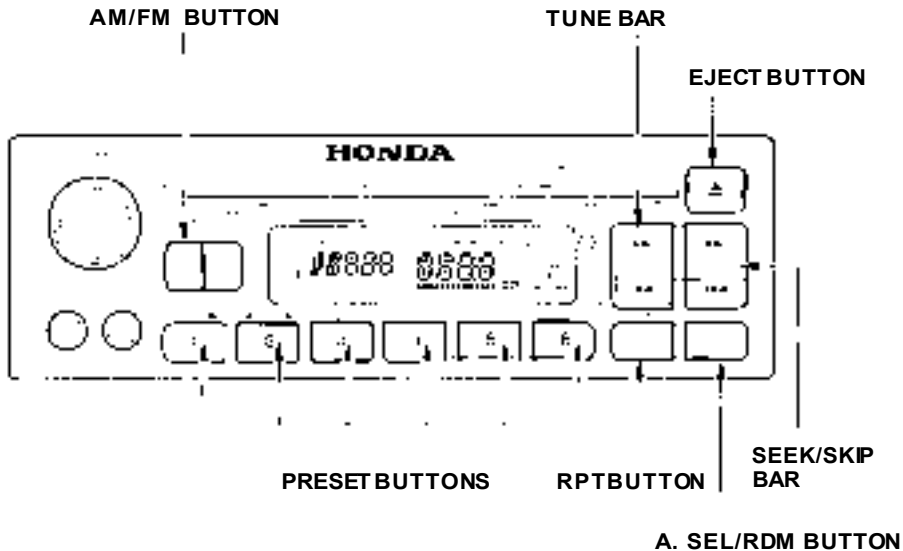

To select the CD changer, press the CD button. The disc and track numbers will be displayed.

To select a different disc, press the appropriate preset button (1 — 6). If you select an empty slot in the magazine, the changer will, after finding that slot empty, try to load the CD in the next slot. This continues until it finds a CD to load and play.

If you load a CD in the in-dash player while the changer is playing a CD, the system will stop the changer and begin playing the in-dash CD. To select the changer again, press the CD button. Play will begin where it left off. Use the CD button to switch between the player and the changer.

If you eject the in-dash CD while it is playing, the system will automatically switch to the CD changer and begin play where it left off. If there are no CDs in the changer, the display will flash. You will have to select another mode (AM or FM) with the button.

When you switch back to CD mode, the system selects the same unit (in-dash or changer) that was playing when you switched out of CD mode.

To use the SKIP, REPEAT, and RANDOM functions, refer to the in-dash player operating instructions.

# Audio System

---

## Protecting Compact Discs

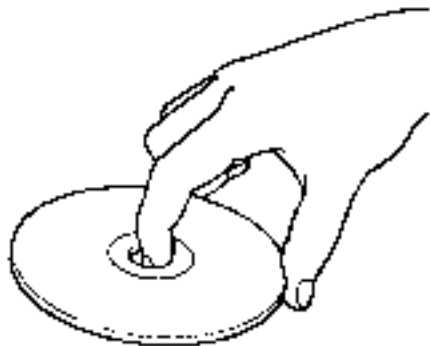

Handle a CD by its edges; never touch either surface. Contamination from fingerprints, liquids, felt-tip pens, and labels can cause the CD to not play properly, or possibly jam in the drive.



When a CD is not being played, store it in its case to protect it from dust and other contamination. To prevent warpage, keep CDs out of direct sunlight and extreme heat.

To clean a disc, use a clean soft cloth. Wipe across the disc from the center to the outside edge.

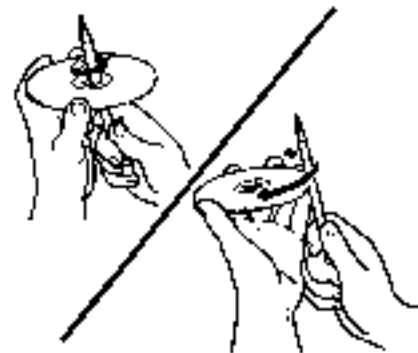

A new CD may be rough on the inner and outer edges. The small plastic pieces causing this roughness can flake off and fall on the recording surface of the disc, causing skipping or other problems. Remove these pieces by rubbing the inner and outer edges with the side of a pencil or pen.

Never try to insert foreign objects in the CD player or the magazine.

## CD Player Error Indications

If you see an error indication in the display while operating the CD player, find the cause in the chart to the right. If you cannot clear the error indication, take the car to your Honda dealer.

Indication	Cause	Solution
CD E-00	System Error (CD Error)	<p>press the EJECT button to pop out the disc. Check if the disc is inserted correctly in the player. Make sure the disc is not scratched or damaged. press the EJECT button to pop out the disc. Check the disc for damage or deformation. The disc cannot be pulled out for the entire minute after the stop button is pressed. It is a signal error of the unit itself.</p>
CD E-01	Mechanical Error	<p>press the EJECT button to pop out the disc. Consult your Honda dealer.</p>
CD E-02	Communication Error (S-Link Error)	<p>press the EJECT button to pop out the disc. Consult your Honda dealer.</p>



## Audio System

### CD Changer Error Indications

If you see an error indication in the display while operating the CD changer, find the cause in the chart to the right. If you cannot clear the error indication, take the car to your Honda dealer.

Indication	Cause	Solution
CD 0 (---)	System Error Disc Error	Press the <b>DISC</b> button and pull out the disc. Turn the ignition application. Insert the disc again. If the error does not disappear, the magazine cover has pulled out. Consult your Honda dealer.
CD 0 (E-01)	Abnormal Error	Press the <b>DISC</b> button and pull out the disc. Turn the ignition application. Insert the disc again. If the error does not disappear, the magazine cover has pulled out. Consult your Honda dealer.
CD 0 (E-02)	Communication Error	See your Honda dealer.
CD 0 (---)	High Temperature	Wait for the temperature to return to normal.
CD 0 (---)	No CD in magazine in the CD changer	Insert a CD in magazine.
CD 0 (---)	No CD in tray in the CD changer	Use the CD.

**Operating the Cassette Player (Optional)**

The cassette system features Dolby B\* noise reduction, automatic sensing of chromium-dioxide (CrO<sub>2</sub>) tape, and autoreverse for continuous play.

Make sure the tape opening on the cassette is facing to the right, then insert the cassette most of the way into the slot. The system will pull it in the rest of the way, and begin to play.

\* Dolby noise reduction manufactured under license from Dolby Laboratories Licensing Corporation. "DOLBY" and the double-D symbol  are trademarks of Dolby Laboratories Licensing Corporation.

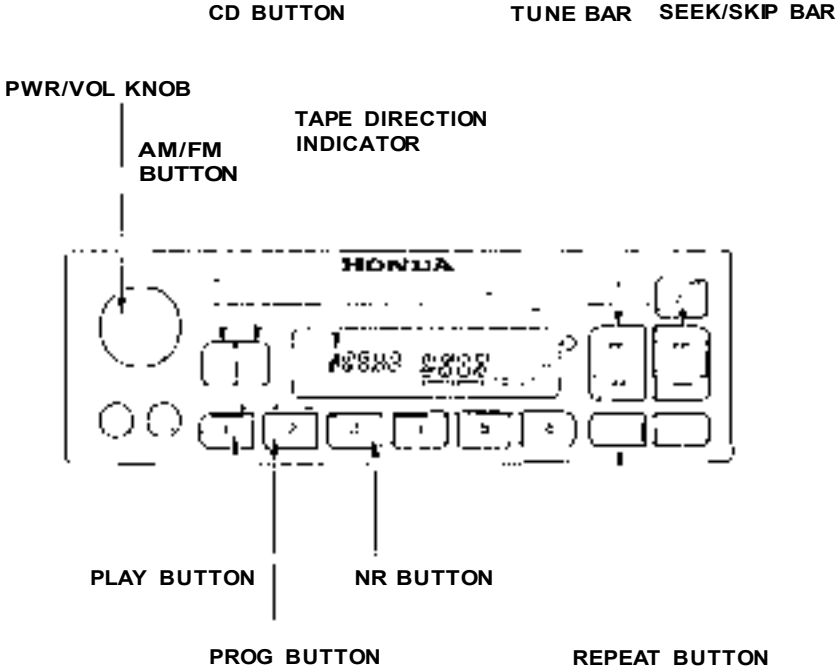

CONTINUED

## Audio System

---

The tape direction indicator will light to show you which side of the cassette is playing. The ▲ indicates the side you inserted facing upward is now playing. If you want to play the other side, press the PROG button.

Dolby B noise reduction turns on when you insert a cassette. If the tape was not recorded with Dolby B noise reduction, turn it off by pressing the NR button.

Dolby remains off until you turn it on by pressing the button again.

When the system reaches the end of the tape, it will automatically reverse direction and play the other side. If you want to remove the cassette *from* the drive, press the EJECT button on the cassette player.

If you turn the system off while a tape is playing, either with the PWR/VOL knob or by turning off the ignition, the cassette will remain in the drive. When you turn the system back on, the cassette player will be in pause mode. To begin playing, press the PLAY button.

To switch to the radio or CD player while a tape is playing, press the AM/FM, or CD button. To change back to the cassette player, push the CD button.

### Tape Search Functions

With a cassette playing, you can use the FF, REW, SKIP, or REPEAT function to find a desired program.

**FF/REW** — Fast Forward and Rewind move the tape rapidly. Press and release the ►► side of the TUNE bar to fast forward the tape, or the ◀◀ side to rewind. You will see FF or REW flashing in the display. To stop fast forward or rewind, press either side of the TUNE bar or the PLAY button. If the system reaches the end of the tape while in fast forward or rewind, it automatically stops that function, reverses direction, and begins to play.

**SKIP** — The skip function allows you to find the beginning of a song or passage. To activate SKIP, press the SEEK/SKIP bar. Press the ►| side to advance to the beginning of the next song or passage, or the |◀◀ side to return to the beginning of the current song or passage. FF or REW will flash in the display as the tape moves. When the system reaches the beginning of the next song or passage (FF), or the beginning of the current one (REW), it goes back to PLAY mode.

**REPEAT** — The Repeat function continuously replays the current song or passage. Press the REPEAT button to activate it; you will see RPT displayed as a reminder. When the system reaches the end of the song or passage currently playing, it will automatically go into rewind. When it senses the beginning of the same song or passage, the system returns to PLAY mode. It will continue to repeat this same program until you deactivate REPEAT by pressing the button again.

The SKIP and REPEAT functions use silent periods on the tape to find the end of a song or passage. These features may not work to your satisfaction if there is almost no gap between selections, a high noise level between selections, or a silent period in the middle of selection.

## Audio System

---

### Caring for the Cassette Player

The cassette player picks up dirt and oxides from the tape. This contamination builds up over time and causes the sound quality to degrade. To prevent this, you should clean the player after every 30 hours of use. Your dealer has a cleaning kit available.

If you do not clean the cassette player regularly, it may eventually become impossible to remove the contamination with a normal cleaning kit.

Use 100-minute or shorter cassettes. Cassettes longer than that use thinner tape that may break or jam the drive.

Look at the cassette before you insert it. If the tape is loose, tighten it by turning a hub with a pencil or your finger.

If the label is peeling off, remove it from the cassette or it could cause the cassette to jam in the player. Never try to insert a warped or damaged cassette in the player.

When they are not in use, store cassettes in their cases to protect them from dust and moisture. Never place cassettes where they will be exposed to direct sunlight, high heat, or high humidity. If a cassette is exposed to extreme heat or cold, let it reach a moderate temperature before inserting it in the player.

Never try to insert foreign objects into the cassette player.

If you see the error indication "TAPE EJECT" on the display, press the EJECT button and remove the cassette from the unit. Make sure the tape is not damaged. If the cassette will not eject or the error indication stays on after the cassette ejects, take the car to your Honda dealer.

## Theft Protection

Your car's audio system will disable itself if it is disconnected from electrical power for any reason. To make it work again, the user must enter a specific five-digit code in the Preset buttons. Because there are hundreds of number combinations possible from five digits, making the system work without knowing the exact code is nearly impossible.

You should have received a card that lists your audio system's code number and serial number. It is best to store this card in a safe place at home. In addition, you should write the audio system's serial number in this Owner's Manual. If you should happen to lose the card, you must obtain the code number from your Honda dealer. To do this, you will need the system's serial number.

If your car's battery is disconnected or goes dead, the audio system will disable itself. If this happens, you will see “ *LOCK* ” in the frequency display the next time you turn on the system. Use the Preset buttons to enter the five-digit code. If it is entered correctly, the radio will start playing.

If you make a mistake entering the code, do not start over or try to correct your mistake. Complete the five-digit sequence, then enter the correct code. You have ten tries to enter the correct code. If you are unsuccessful in ten attempts, you must then leave the system on for one hour before trying again.

You will have to store your favorite stations in the Preset buttons after the system begins working. Your original settings were lost when power was disconnected.



Before you begin driving your Honda, you should know what gasoline to use, and how to check the levels of important fluids. You also need to know how to properly store luggage or packages. The information in this section will help you. If you plan to add any accessories to your car, please read the information in this section first.

Break-in Period.....	126
Gasoline.....	126
Service Station Procedures .....	127
Filling the Fuel Tank.....	127
Opening the Hood.....	128
Oil Check.....	130
Engine Coolant Check.....	131
Fuel Economy.....	132
Vehicle Condition.....	132
Driving Habits.....	132
Accessories and Modifications....	133
Accessories.....	133
Modifications.....	134
Additional Safety Precaution....	134
Carrying Cargo.....	135
Load Limit.....	136
Carrying Items in the Passenger Compartment.....	136
Carrying Cargo in the Trunk or on a Roof Rack.....	137



## Break-in Period, Gasoline

---

### Break-in Period

Help assure your car's future reliability and performance by paying extra attention to how you drive during the first 600 miles (1,000 km). During this period:

- Avoid full-throttle starts and rapid acceleration.
- Avoid hard braking. New brakes need to be broken-in by moderate use for the first 200 miles (300 km).

You should follow these same recommendations with an overhauled or exchanged engine, or when the brakes are relined.

### Gasoline

Your Honda is designed to operate on premium unleaded gasoline with a pump octane number of 91 or higher.

If you are unable to find premium unleaded gasoline, you may substitute an unleaded regular gasoline. The engine will compensate for the lower octane, but you may notice a slight decrease in power as a result.

We recommend gasolines containing detergent additives that help prevent fuel system and engine deposits.

Using gasoline containing lead will damage your car's emissions

In Canada, some gasolines contain an octane-enhancing additive called MMT. If you use such gasolines, your emission control system performance may deteriorate and the Malfunction Indicator Lamp on your instrument panel may turn on. If this happens, contact your authorized Honda dealer for service.

### Filling the Fuel Tank

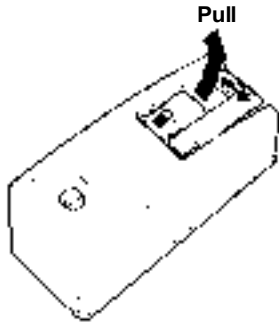

1. Because the fuel fill cap is on the driver's side of the car, park with that side closest to the service station pumps.
2. Open the fuel fill door by pulling on the handle to the left of the driver's seat.

### **WARNING**

Gasoline is highly flammable and explosive. You can be burned or seriously injured when handling fuel.

- Stop the engine and keep heat, sparks, and flame away
- Handle fuel only outdoors.
- Wipe up spills immediately.



3. Remove the fuel fill cap slowly. You may hear a hissing sound as pressure inside the tank escapes. Place the cap in the holder on the fuel fill door.
4. Stop filling the tank after the fuel nozzle automatically clicks off. Do not try to "top off" the tank, leave some room for the fuel to expand with temperature changes.

Your car has an on-board refueling vapor recovery system to help keep fuel vapors from going into the atmosphere. If the fuel pump keeps clicking off even though the tank is not full, there may be a problem with this system. Consult your dealer.

*CONTINUED*

## Service Station Procedures

---

5. Screw the fuel fill cap back on, tighten it until it clicks several times. If you do not properly tighten the cap, the Malfunction Indicator Lamp may come on (see page [250](#)).
6. Push the fuel fill door closed until it latches.

### Opening the Hood



HOODRELEASE HANDLE

1. Shift to Park or Neutral and set the parking brake. Pull the hood release handle located under the lower left corner of the dashboard. The hood will pop up slightly.



2. Standing in front of the car, put your fingers under the front edge of the hood to the right of center. Slide your hand to the left until you feel the hood latch handle. Push this handle up until it releases the hood. Lift the hood.

If you can open the hood without lifting the hood latch handle, or the hood latch handle moves stiffly or does not spring back as before, the mechanism should be cleaned and lubricated (see page 196).

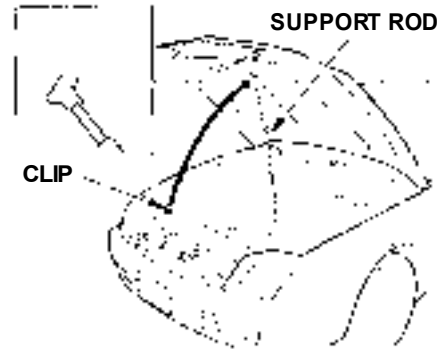

After closing the hood, make sure it is securely latched.

3. Pull the support rod out of its clip and insert the end into the hole on the left side of the hood.

To close the hood, lift it up slightly to remove the support rod from the hole. Put the support rod back into its holding clip. Lower the hood to about a foot (30 cm) above the fender, then let it drop.

CONTINUED

# Service Station Procedures

---

## *Oil Check*



DIPSTICK

Check the engine oil level every time you fill the car with fuel. Wait a few minutes after turning the engine off before you check the oil.

1. Remove the dipstick (orange handle).



2. Wipe the dipstick with a clean cloth or paper towel.



3. Insert it all the way back in its tube.

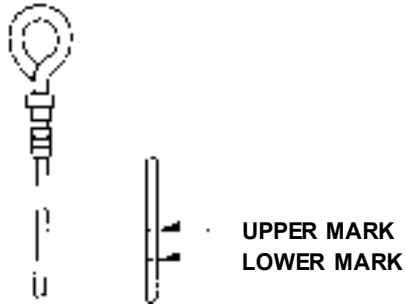

4. Remove the dipstick again and check the level. It should be between the upper and lower marks.

If it is near or below the lower mark, see **Adding Oil** on page [181](#).

### *Engine Coolant Check*

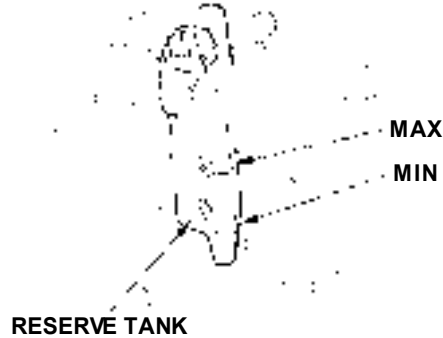

Look at the coolant level in the radiator reserve tank. Make sure it is between the MAX and MIN lines. If it is below the MIN line, see **Adding Engine Coolant** on page [185](#) for information on adding the proper coolant.

Refer to **Owner Maintenance Checks** on page [179](#) for information on checking other items in your Honda.

## Fuel Economy

---

The condition of your car and your driving habits are the two most important things that affect the fuel mileage you get.

### Vehicle Condition

Always maintain your car according to the maintenance schedule. This will keep it in top operating condition.

An important part of that maintenance is the **Owner Maintenance Checks** (see page 179). For example, an underinflated tire causes more "rolling resistance," which uses fuel. It also wears out faster, so check the tire pressure at least monthly.

In winter, the build-up of snow on your car's underside adds weight and rolling resistance. Frequent cleaning helps your fuel mileage and reduces the chance of corrosion.

### Driving Habits

You can improve fuel economy by driving moderately. Rapid acceleration, abrupt cornering, and hard braking use more fuel.

Always drive in the highest gear that allows the engine to run and accelerate smoothly.

Depending on traffic conditions, try to maintain a constant speed. Every time you slow down and speed up, your car uses extra fuel. Use the cruise control, when appropriate, to increase fuel economy.

A cold engine uses more fuel than a warm engine. It is not necessary to "warm-up" a cold engine by letting it idle for a long time. You can drive away in about a minute, no matter how cold it is outside. The engine will warm up faster, and you get better fuel economy. To cut down on the number of "cold starts," try to combine several short trips into one.

The air conditioning puts an extra load on the engine which makes it use more fuel. Turn off the A/C to cut down on air conditioning use. Use the flow-through ventilation when the outside air temperature is moderate.

Modifying your car, or installing some non-Honda accessories, can make your car unsafe. Before you make any modifications or add any accessories, be sure to read the following information.

### Accessories

Your dealer has Genuine Honda accessories that allow you to personalize your car. These accessories have been designed and approved for your car, and are covered by warranty.

Non-Honda accessories are usually designed for universal applications. Although aftermarket accessories may fit on your car, they may not meet factory specifications, and could adversely affect your car's handling and stability. (See "Modifications" on the page [134](#) for additional information.)

### WARNING

Improper accessories or modifications can affect your car's handling, stability and performance, and cause a crash in which you can be hurt or killed.

Follow all instructions in this owner's manual regarding accessories and modifications.

When properly installed, cellular phones, alarms, two-way radios, and low-powered audio systems should not interfere with your car's computer-controlled systems, such as the SRS and anti-lock brake system.

However, if electronic accessories are improperly installed, or exceed your car's electrical system capacity, they can interfere with the operation

of your car, or even cause the airbags to deploy.

Before installing any accessory:

- Make sure the accessory does not obscure any lights, or interfere with proper car operation or performance.
- Be sure electronic accessories do not overload electrical circuits (see page [256](#)).
- Have the installer contact your Honda dealer for assistance before installing any electronic accessory.

If possible, have your dealer inspect the final installation.



## Accessories and Modifications

---

### **Modifications**

Do not remove any original equipment or modify your car in any way that would alter its design or operation. This could make your car unsafe and illegal to drive.

For example, do not make any modifications that would change the ride height of your car, or install wheels and tires with a different overall diameter.

Such modifications can adversely affect handling, and interfere with the operation of the car's anti-lock brakes and other systems.

In addition, any modifications that decrease ground clearance increase the chance of undercarriage parts striking a curb, speed bump, or other raised object, which could cause your airbags to deploy.

Do not modify your steering wheel or any other part of your Supplemental Restraint System. Modifications could make the system ineffective.

### **Additional Safety Precaution**

Do not attach or place objects on the airbag covers. Any object attached to or placed on the covers marked "SRS AIRBAG," in the center of the steering wheel and on top of the dashboard, could interfere with the proper operation of the airbags. Or, if the airbags inflate, the objects could be propelled inside the car and hurt someone.

## Carrying Cargo

Your car has several convenient storage areas so you can stow cargo safely.

The glove box, and the pockets in the front doors and seat-back, are designed for small, lightweight items. The trunk is intended for larger, heavier items. In addition, the back seat can be folded down to allow you to carry more cargo or longer items.

However, carrying too much cargo, or improperly storing it, can affect your car's handling, stability and operation and make it unsafe. Before carrying any type of cargo, be sure to read the following pages.

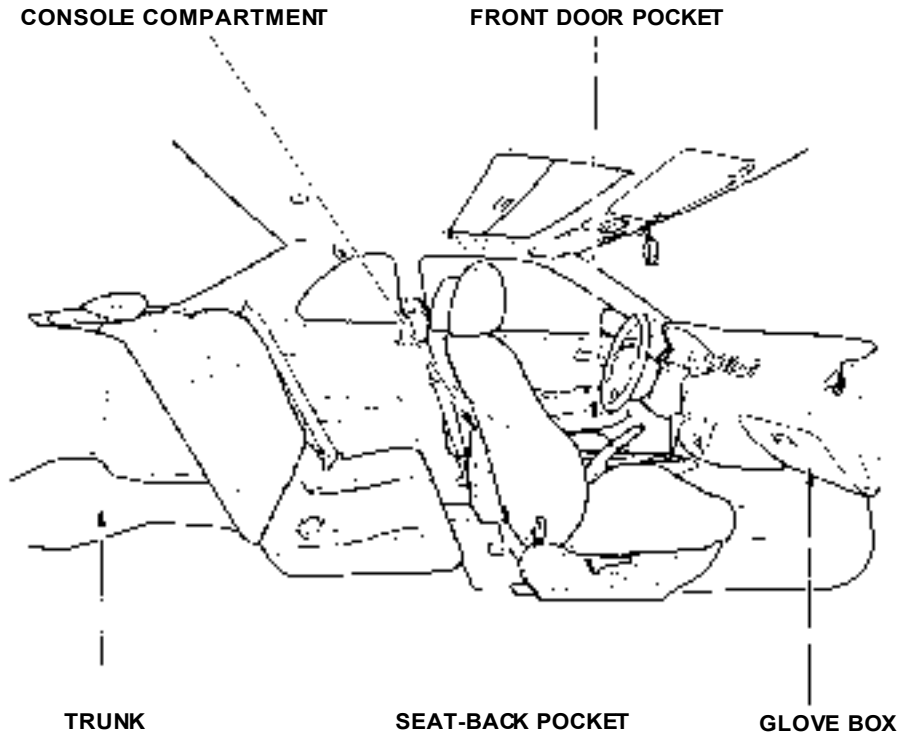

## Carrying Cargo

---

### Load Limit

The maximum load for your car is 700 lbs (325 kg).

This figure includes the total weight of all occupants, cargo, accessories, and the tongue weight if you are towing a trailer.

To figure out how much cargo you can carry:

- Add up the weight of all occupants.
- If you are towing a trailer, add the tongue weight to the number above.
- Subtract the total from 700 lb (325 kg).

The final number is the total weight of cargo you can carry.

### **WARNING**

Overloading or improper loading can affect handling and stability and cause a crash in which you can be hurt or killed.

Follow all load limits and other loading guidelines in this manual.

### Carrying Items in the Passenger Compartment

- Store or secure all items that could be thrown around and hurt someone during a crash.
- Do not put any items on top of the rear shelf. They can block your view and be thrown around the car during a crash.
- Be sure items placed on the floor behind the front seats cannot roll under the seats and interfere with the driver's ability to operate the pedals, or with the proper operation of the seats.
- Keep the glove box closed while driving. If the lid is open, a passenger could injure their knees during a crash or sudden stop.

### Carrying Cargo in the Trunk or on a Roof Rack

- Distribute cargo evenly on the floor of the trunk, placing the heaviest items on the bottom and as far forward as possible.
- If you fold down the back seat, tie down items that could be thrown about the car during a crash or sudden stop.
- If you carry large items that prevent you from closing the trunk lid, exhaust gas can enter the passenger area. To avoid the possibility of **carbon monoxide poisoning**, follow the instructions on page [49](#).
- If you can carry any items on a roof rack, be sure the total weight of the rack and the items does not exceed the maximum allowable weight. Please contact your Honda dealer for further information.



This section gives you tips on starting the engine under various conditions, and how to operate the 5-speed manual and automatic transmissions. It also includes important information on parking your car, the braking system, and facts you need if you are planning to tow a trailer.

- Preparing to Drive..... 140
- Starting the Engine..... 141
  - Starting in Cold Weather at High Altitude..... 141
- 5-speed Manual Transmission..... 142
  - Recommended Shift Points..... 143
  - Engine Speed Limiter ..... 143
- Automatic Transmission..... 144
  - Shift Lever Position Indicator.. 144
  - Shift Lever Positions..... 145
  - Engine Speed Limiter..... 150
  - Shift Lock Release..... 151
- Parking..... 152
- The Braking System..... 153
  - Brake Wear Indicators..... 153
  - Brake System Design..... 154
  - Anti-lock Brakes..... 154
    - Important Safety Reminders..... 155
    - ABS Indicator..... 156
- Active Torque Transfer System .. 157
- Driving in Bad Weather..... 158
- Towing a Trailer..... 160

## Preparing to Drive

---

You should do the following checks and adjustments every day before you drive your car.

1. Make sure all windows, mirrors, and outside lights are clean and unobstructed. Remove frost, snow, or ice.
2. Check that the hood and trunk are fully closed.
3. Visually check the tires. If a tire looks low, use a gauge to check its pressure.
4. Check that any items you may be carrying with you inside are stored properly or fastened down securely.
5. Check the adjustment of the seat (see page [80](#)).
6. Check the adjustment of the inside and outside mirrors (see page [88](#)).
7. Check the adjustment of the steering wheel (see page [66](#)).
8. Make sure the doors are securely closed and locked.
9. Fasten your seat belt. Check that your passengers have fastened their seat belts (see page [16](#)).
10. Turn the ignition switch ON (II). Check the indicator lights in the instrument panel.
11. Start the engine (see page [141](#)).
12. Check the gauges and indicator lights in the instrument panel (see page [53](#)).

1. Apply the parking brake.
2. In cold weather, turn off all electrical accessories to reduce the drain on the battery.
3. *Manual Transmission:*  
Push the clutch pedal down all the way. START (III) does not function unless the clutch pedal is depressed.  
  
*Automatic Transmission:*  
Make sure the shift lever is in Park. Press on the brake pedal.
4. Without touching the accelerator pedal, turn the ignition key to the START (III) position. If the engine does not start right away, do not hold the key in START (III) for more than 15 seconds at a time. Pause for at least 10 seconds before trying again.

5. If the engine does not start within 15 seconds, or starts but stalls right away, repeat step 4 with the accelerator pedal pressed half-way down. If the engine starts, release pressure on the accelerator pedal so the engine does not race.
6. If the engine still does not start, press the accelerator pedal all the way down and hold it there while starting in order to clear flooding. As before, keep the ignition key in the START (III) position for no more than 15 seconds. Return to step 5 if the engine does not start. If it starts, lift your foot off the accelerator pedal so the engine does not race.

### **Starting in Cold Weather at High Altitude (Above 8,000 feet/ 2,400 meters)**

An engine is harder to start in cold weather. The thinner air found at high altitude above 8,000 feet (2,400

meters) adds to the problem. Use the following procedure:

1. Turn off all electrical accessories to reduce the drain on the battery.
2. Push the accelerator pedal half-way to the floor and hold it there while starting the engine. Do not hold the ignition key in START (III) for more than 15 seconds. When the engine starts, release the accelerator pedal gradually as the engine speeds up and smooths out.
3. If the engine fails to start in step 2, push the accelerator pedal to the floor and hold it there while you try to start the engine for no more than 15 seconds. If the engine does not start, return to step 2.



## 5-speed Manual Transmission



The manual transmission is synchronized in all forward gears for smooth operation. It has a lockout so you cannot shift directly from Fifth to Reverse. When shifting up or down, make sure you push the clutch pedal down all the way, shift to the next gear, and let the pedal up gradually. When you are not shifting, do not rest your foot on the clutch pedal. This can cause your clutch to wear out faster.

Come to a full stop before you shift into Reverse. You can damage the transmission by trying to shift into Reverse with the car moving. Push down the clutch pedal, and pause for a few seconds before shifting into Reverse, or shift into one of the forward gears for a moment. This stops the gears so they won't "grind."

When slowing down, you can get extra braking from the engine by shifting to a lower gear. This extra braking can help you maintain a safe speed and prevent your brakes from overheating while going down a steep hill. Before downshifting, make sure engine speed will not go into the tachometer's red zone in the lower gear.

### **WARNING**

Rapid slowing or speeding-up can cause loss of control on slippery surfaces. If you crash, you can be injured.

Use extra care when driving on slippery surfaces.

### Recommended Shift Points

Drive in the highest gear that lets the engine run and accelerate smoothly. This will give you the best fuel economy and effective emissions control. The following shift points are recommended:

Shift up	Normal acceleration
1st to 2nd	15 mph (24 km/hr)
2nd to 3rd	28 mph (45 km/hr)
3rd to 4th	41 mph (66 km/hr)
4th to 5th	52 mph (83 km/hr)

Shift up	Cruise/road acceleration
1st to 2nd	7 mph (11 km/hr)
2nd to 3rd	22 mph (35 km/hr)
3rd to 4th	33 mph (53 km/hr)
4th to 5th	48 mph (77 km/hr)

### Engine Speed Limiter

If you exceed the maximum speed for the gear you are in, the engine speed will enter into the tachometer's red zone. If this occurs, you may feel the engine cut in and out. This is caused by a limiter in the engine's computer controls. The engine will run normally when you reduce the RPM below the red zone.

Before downshifting, make sure the engine will not go into the tachometer's red zone in the lower gear.

## Automatic Transmission

---

Your Honda's transmission has four forward speeds, and is electronically controlled for smoother shifting. It also has a "lock-up" torque converter for better fuel economy. You may feel what seems like another shift when the converter locks.

### Shift Lever Position Indicator

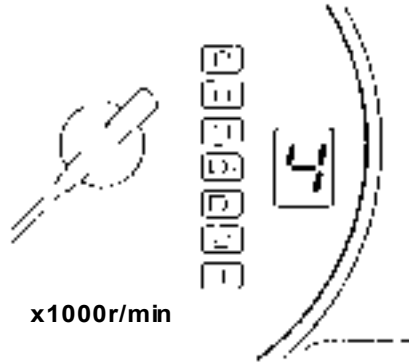

This indicator in the tachometer shows which position the shift lever is in. The illuminated number next to the "D4" indicator shows you the gear you have selected in the Sequential SportShift mode.

The "D4" indicator comes on for a few seconds when you turn the ignition switch ON (II). If it flashes while driving (in any shift position), it indicates a possible problem in the transmission. Avoid rapid acceleration and have the transmission checked by an authorized Honda dealer as soon as possible.

## Shift Lever Positions

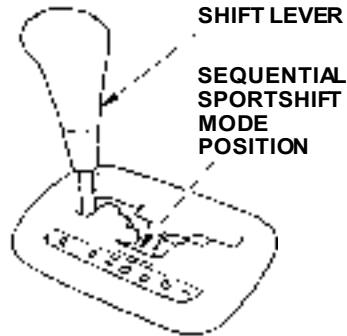

The shift lever has eight positions. It must be in Park or Neutral to start the engine. When you are stopped in D4, D3, 2, 1, N, R, or the Sequential SportShift mode, press firmly on the brake pedal and keep your foot off the accelerator pedal.

To select the Sequential SportShift mode, slide the shift lever toward the left from the "D4" position. In this mode the shift lever allows you to shift up and down manually.

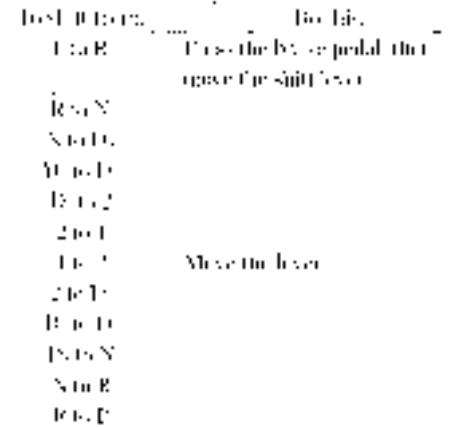

Whenever you move the shift lever, slide it along the guide on the console.

You cannot shift out of Park with the brake pedal depressed when the ignition switch is in LOCK (0) or ACCESSORY (I).

*CONTINUED*

## Automatic Transmission

---

**Park (P)** — This position mechanically locks the transmission. Use Park whenever you are turning off or starting the engine. To shift out of Park, you must press on the brake pedal and have your foot off the accelerator pedal. Move the shift lever to the right to shift out of the Park position.

If you have done all of the above and still cannot move the lever out of Park, see Shift Lock Release on page [151](#).



To avoid transmission damage, come to a complete stop before shifting into Park. The shift lever must be in Park before you can remove the key from the ignition switch.

**Reverse (R)** — To shift to Reverse from Park, see the explanation under Park. To shift to Reverse from Neutral, come to a complete stop and then shift.

Your car has a reverse lockout so you cannot accidentally shift to Reverse from Neutral or any other driving position when the car speed exceeds 7 — 9 mph (12 — 14 km/h).

If you cannot shift to Reverse when the car is stopped, press the brake pedal and slowly shift to Neutral then to Reverse.

If there is a problem in the reverse lockout system, or your car's battery is disconnected or goes dead, you cannot shift to Reverse. In this case, use the procedure of Shift Lock Release (see page [151](#)).

**Neutral (N)** — Use Neutral if you need to restart a stalled engine, or if it is necessary to stop briefly with the engine idling. Shift to Park position if you need to leave the car for any reason. Press on the brake pedal when you are moving the shift lever from Neutral to another gear.

**Drive (D4)** — Use this position for your normal driving. The transmission automatically selects a suitable gear for your speed and acceleration. You may notice the transmission shifting up at higher speeds when the engine is cold. This helps the engine warm up faster.

**Sequential SportShift Mode** — With the shift lever in "D4" position, you can select the Sequential SportShift mode to shift gears; much like a manual transmission, but without a clutch pedal.

To enter the Sequential SportShift mode, slide the shift lever further to the left. To return to "D4", slide the shift lever to the right.

In the Sequential SportShift mode, each time you push forward on the shift lever, the transmission shifts to a higher gear. Pull back on the lever to downshift. The number of the gear selected is displayed next to the "D4" indicator (see page [144](#)).

If you slide the shift lever from "D4" to the Sequential SportShift mode, the display shows the selected gear. If you selected "4", you will see / 4 / next to "D4" in the display. The Shift Lever Position Indicator will show

the gear you selected while in the sequential sportshift mode. If you select the Sequential SportShift while the car is stopped, the transmission automatically selects first gear and the display shows / 1 / .

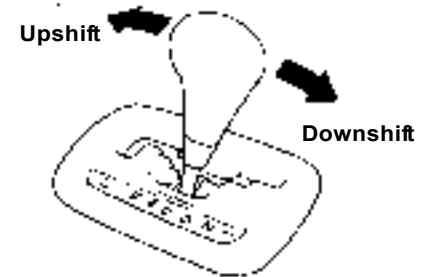

CONTINUED

## Automatic Transmission

---

When you accelerate away from a stop, the transmission will be in first gear. The transmission will not automatically upshift. Watch the tachometer and upshift manually before the engine reaches redline.

The transmission remains in the selected gear (4, 3, 2, or 1). There is no automatic downshift when you push the accelerator pedal to the floor.

The transmission may automatically downshift from fourth gear to third" gear under the following conditions:

- The car speeds drops below 20 mph (32 km/h).
- If you drive uphill between 20 — 31 mph (32 — 50 km/h).
- If you press the brake pedal as you drive downhill.

Downshifting gives you more power when climbing or provides engine braking when going down a steep hill.

The transmission will also shift automatically as the car comes to a complete stop. It will downshift to first gear when the car speed is under 6 mph (10 km/h).

If you try to manually downshift at a speed that would cause the engine to exceed the redline in a lower gear, the transmission will not downshift.

If you try to downshift from fourth gear to third gear, the gear indicator will flash /3/ several times, then return to /4/; if you try to downshift from third gear to second gear, the gear indicator will flash /2/ several times, then return to third gear.

If the car speed slows to below the redline of the selected lower gear position while the indicator is flashing, the transmission will downshift and the display will show the selected lower gear.

If the transmission temperature is below 14°F (—10°C), you may not be able to use the Sequential SportShift mode.

The table shows the speed ranges for upshifting and downshifting.

To shift from	Speed range
1 → 2	over 6 mph (10 km/h)
2 → 3	over 20 mph (32 km/h)

To shift from	Speed range
2 → 1	under 31 mph (50 km/h)
3 → 2	under 67 mph (108 km/h)
4 → 3	under 111 mph (162 km/h)

**Drive (D3)** — This position is similar to D4, except only the first three gears are selected. Use D3, when towing a trailer in hilly terrain, or to provide engine braking when going down a steep hill. D3 can also keep the transmission from cycling between third and fourth gears in stop-and-go driving.

For faster acceleration when in D3 or D4, you can get the transmission to automatically downshift by pushing the accelerator pedal to the floor. The transmission will shift down one or two gears, depending on your speed.

*CONTINUED*



## Automatic Transmission

---

**Second (2)** — This position locks the transmission in second gear. It does not downshift to first gear when you come to a stop. Second gives you more power when climbing, and increased engine braking when going down steep hills. Use second gear when starting out on a slippery surface or in deep snow. It will help reduce wheelspin.

**First (1)** — With the lever in this position, the transmission locks in First gear.

If you shift into First position when the car speed exceeds 31 mph (50 km/h), the transmission shifts into Second gear first to avoid the application of the sudden engine brake.

### **Engine Speed Limiter**

If you exceed the maximum speed for the gear you are in, the engine speed will enter into the tachometer's red zone. If this occurs, you may feel the engine cut in and out. This is caused by a limiter in the engine's computer controls. The engine will run normally when you reduce the RPM below the red zone.

## Shift Lock Release

This allows you to move the shift lever out of Park if the normal method of pushing on the brake pedal does not work. This procedure also releases the Reverse Lockout.

1. Set the Parking brake.
2. Make sure the key is in the ignition switch OFF (0) position.

To release the Reverse Lockout, make sure the key is in the ACCESSORY (I) position.

3. Put a cloth on the edge of the Shift Lock Release slot cover next to the shift lever.

Use a small flat-tipped screwdriver or small metal plate (neither are included in the tool kit) to remove the cover. Carefully pry off the edge of the cover.

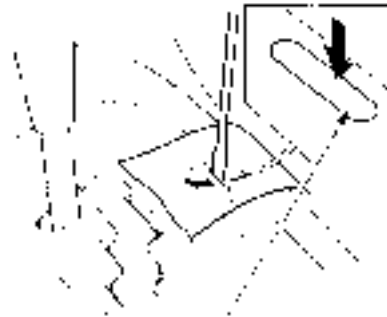

COVER

4. Insert a screwdriver in the shift lock release slot.
5. Push down on the screwdriver and move the shift lever out of Park to Neutral.

To release the Reverse Lockout, move the shift lever from Neutral to Reverse, then Park.

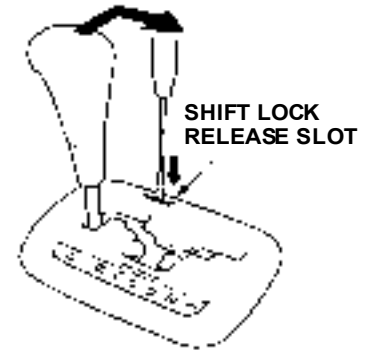

6. Remove the screwdriver from the shift lock release slot, then install a new cover. Depress the brake pedal and restart the engine.

If you need to use the Shift Lock Release, it means your car is developing a problem. Have the car checked by your Honda dealer.

## Parking

---

Always use the parking brake when you park your car. The indicator on the instrument panel shows that the parking brake is not fully released; it does not indicate that the parking brake is firmly set. Make sure the parking brake is set firmly or your car may roll if it is parked on an incline.

If your car has an automatic transmission, set the parking brake before you put the transmission in Park. This keeps the car from moving and putting pressure on the parking mechanism in the transmission — making it easier to move the shift lever out of Park when you want to drive away.

If the car is facing uphill, turn the front wheels away from the curb. If you have a manual transmission, put it in first gear.

If the car is facing downhill, turn the front wheels toward the curb. If you have a manual transmission, put it in reverse gear.

Make sure the parking brake is fully released before driving away. Driving with the parking brake partially set can overheat or damage the rear brakes.

### Parking Tips

- Make sure the moonroof and the windows are closed.

Turn off the lights.

- Place any packages, valuables, etc., in the trunk or take them with you.
- Lock the doors with the key or the remote transmitter.
- Never park over dry leaves, tall grass, or other flammable materials. The three way catalytic converter gets very hot, and could cause these materials to catch on fire.

Your Honda is equipped with disc brakes at all four wheels. A power assist helps reduce the effort needed on the brake pedal. The ABS helps you retain steering control when braking very hard.

Put your foot on the brake pedal only when you intend to brake. Resting your foot on the pedal keeps the brakes applied lightly, causing them to build up heat. Heat build-up can reduce how well your brakes work. It also keeps your brake lights on all the time, confusing drivers behind you.

Constant application of the brakes when going down a long hill builds up heat and reduces their effectiveness. Use the engine to assist the brakes by downshifting to a lower gear and taking your foot off the accelerator pedal.

Check your brakes after driving through deep water. Apply the brakes moderately to see if they feel normal. If not, apply them gently and frequently until they do. Since a longer distance is needed to stop with wet brakes, be extra cautious and alert in your driving.

### **Brake Wear Indicators**

All four brakes have audible brake wear indicators.

When the brake pads need replacing, you will hear a distinctive metallic "screeching" sound when you apply the brakes. If you do not have the brake pads replaced, they will begin screeching all the time.

Your brakes may sometimes squeal or squeak when you apply them lightly. Do not confuse this with the brake wear indicators. They make a very audible "screeching."

# The Braking System

---

## Brake System Design

The hydraulic system that operates the brakes has two separate circuits. Each circuit works diagonally across the vehicle (the left-front brake is connected with the right-rear brake, etc.). If one circuit should develop a problem, you will still have braking at two wheels.

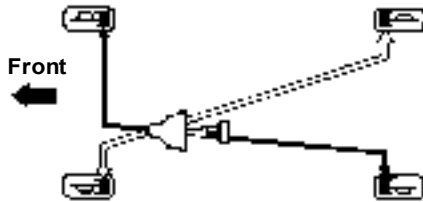

## Anti-lock Brakes

Your vehicle has an Anti-lock Brake System (ABS) as standard equipment. ABS helps to prevent the wheels from locking up and skidding during hard braking, allowing you to retain steering control.

When the front tires skid, you lose steering control; the car continues straight ahead even though you turn the steering wheel. The ABS helps to prevent lock-up and helps you retain steering control by pumping the brakes rapidly; much faster than a person can do it.

**You should never pump the brake pedal**, this defeats the purpose of the ABS. Let the ABS work for you by always keeping firm, steady pressure on the brake pedal as you steer away from the hazard. This is sometimes referred to as *"stomp and steer."*

You will feel a pulsation in the brake pedal when the ABS activates, and you may hear some noise. This is normal, it is the ABS rapidly pumping the brakes.

Activation varies with the amount of traction your tires have. On dry pavement, you will need to press on the brake pedal very hard before you activate the ABS. However, you may feel the ABS activate immediately if you are trying to stop on snow or ice.

### *Important Safety Reminders*

**ABS does not reduce the time or distance it takes to stop the car,** it only helps with steering control during braking. You should always maintain a safe following distance from other vehicles.

**ABS will not prevent a skid that results from changing direction abruptly,** such as trying to take a corner too fast or making a sudden lane change. Always drive at a safe, prudent speed for the road and weather conditions.

**ABS cannot prevent a loss of stability.** Always steer moderately when you are braking hard. Severe or sharp steering wheel movement can still cause your car to veer into oncoming traffic or off the road.

**A vehicle with ABS may require a longer distance to stop** on loose or uneven surfaces, such as gravel or snow, than a vehicle without anti-lock. Slow down and allow a greater distance between vehicles under those conditions.

*CONTINUED*

# The Braking System

---

## *ABS Indicator*

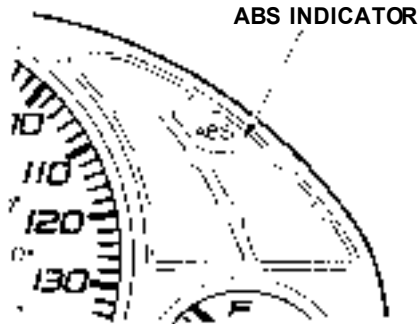

\* U.S. indicator shown

If anything goes wrong, the ABS indicator on the instrument panel comes on (see page 56). This means the anti-lock function of the braking system has shut down. The brakes still work like a conventional system without anti-lock, providing normal stopping ability. You should have the dealer inspect your car as soon as possible.

The ABS is self-checking. If anything goes wrong, the ABS indicator on the instrument panel comes on (see page 56). This means the anti-lock function of the braking system has shut down. The brakes still work like a conventional system without anti-lock, providing normal stopping ability. You should have the dealer inspect your car as soon as possible.

# Active Torque Transfer System

## *Type SH only*

Your Honda is equipped with an Active Torque Transfer System (ATTS). Under certain driving conditions, the ATTS enhances the car's cornering performance by transferring some torque between the inside and outside front wheels during a turn.

Based on steering wheel turn angle, lateral acceleration, and engine power, the ATTS regulates the driving force to each drive wheel through an electronically-controlled hydraulic system and two sets of clutches and gears.

## **Important Safety Information**

**The ATTS cannot prevent skidding if you enter a corner too fast.** It has almost no effect on braking and vehicle speed. It is still your responsibility to drive at reasonable speeds and to leave a sufficient margin of safety.

## **ATTS Indicator**

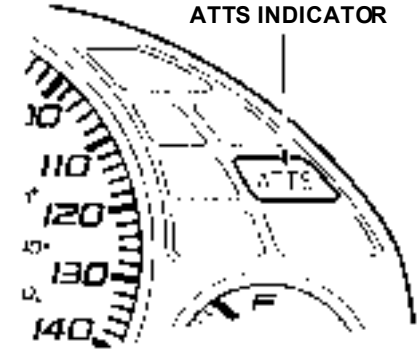

The Active Torque Transfer System (ATTS) is self-checking. If a problem is detected in the system, the ATTS indicator on the instrument panel comes on.

If this happens, take the car to your Honda dealer to have it checked. With the indicator on, your car will corner normally, but you will not have active torque transfer.



## Driving in Bad Weather

---



Rain, fog, and snow conditions require a different driving technique because of reduced traction and visibility. Keep your car well-maintained and exercise greater caution when you need to drive in bad weather. The cruise control should not be used in these conditions.

**Driving Technique** — Always drive slower than you would in dry weather. It takes your car longer to react, even in conditions that may seem just barely damp. Apply smooth, even pressure to all the controls. Abrupt steering wheel movements or sudden, hard application of the brakes can cause loss of control in wet weather. Be extra cautious for the first few miles (kilometers) of driving while you adjust to the change in driving conditions. This is especially true in snow. A person can forget some snow-driving techniques during the summer months. Practice is needed to relearn those skills.

Exercise extra caution when driving in rain after a long dry spell. After months of dry weather, the first rains bring oil to the surface of the roadway, making it slippery.

**Visibility** — Being able to see clearly in all directions and being visible to other drivers are important in all weather conditions. This is more difficult in bad weather. To be seen more clearly during daylight hours, turn on your headlights.

Inspect your windshield wipers and washers frequently. Keep the windshield washer reservoir full of the proper fluid. Have the windshield wiper blades replaced if they start to streak the windshield or leave parts unwiped. Use the defrosters and air conditioning to keep the windows from fogging up on the inside (see page [104](#)).

**Traction** — Check your tires frequently for wear and proper pressure. Both are important in preventing "hydroplaning" (loss of traction on a wet surface). In the winter, mount snow tires on all four wheels for the best handling.

Watch road conditions carefully, they can change from moment to moment. Wet leaves can be as slippery as ice. "Clear" roads can have patches of ice. Driving conditions can be very hazardous when the outside temperature is near freezing. The road surface can become covered with areas of water puddles mixed with areas of ice, so your traction can change without warning.

Be careful when downshifting. If traction is low, you can lock up the drive wheels for a moment and cause a skid.



Be very cautious when passing, or being passed by other vehicles. The spray from large vehicles reduces your visibility, and the wind buffeting can cause you to lose control.

## Towing a Trailer

---

Your Honda has been designed primarily to carry passengers and their cargo. You can use it to tow a trailer if you carefully observe the load limits, use the proper equipment, and follow the guidelines in this section.

### Load Limits

- **Total Trailer Weight:** The total weight of the trailer and everything loaded in it must not exceed 1,000 lbs (450 kg). Towing a load that is too heavy can seriously affect your vehicle's handling and performance. It can also damage the engine and drivetrain.

- **Tongue Load:** The weight that the tongue of a fully-loaded trailer puts on the hitch should be approximately 10 percent of the trailer weight. Too little tongue load can make the trailer unstable and cause it to sway. Too much tongue load reduces front-tire traction and steering control.

To achieve a proper tongue load, start by loading 60 percent of the load toward the front of the trailer and 40 percent toward the rear, then readjust the load as needed.

- **Gross Vehicle Weight Rating (GVWR):** The total weight of the vehicle, all occupants, all cargo, *and* the tongue load must not exceed: 3,835 lbs (1,740 kg)

- **Gross Axle Weight Rating (GAWR):**

The total weight of the vehicle, all occupants, all cargo, and the tongue load must not exceed:

2,160 lbs (980 kg)  
on the front axle

1,685 lbs (765 kg)  
on the rear axle

### **WARNING**

Exceeding load limits or improperly loading your vehicle and trailer can cause a crash in which you can be seriously injured or killed.

Check the loading of your vehicle and trailer carefully before starting to drive.

### **Checking Loads**

The best way to confirm that vehicle and trailer weights are within limits is to have them checked at a public scale.

Using a suitable scale or a special tongue load gauge, check the tongue load the first time you set up a towing combination (a fully-loaded vehicle and trailer), then recheck the tongue load whenever the conditions change.

### **Towing Equipment and Accessories**

Towing can require a variety of equipment, depending on the size of your trailer, how it will be used, and how much load you are towing.

Discuss your needs with your trailer sales or rental agency, and follow the guidelines in the rest of this section. Also make sure that all equipment is properly installed and that it meets federal, state, province, and local regulations.

### ***Hitches***

Any hitch used on your vehicle must be properly bolted to the underbody.

### ***Safety Chain***

Always use a safety chain. Make sure that it is secured to both the trailer and hitch, and that it crosses under the tongue so it can catch the trailer if it becomes unhitched. Leave enough slack to allow the trailer to turn corners easily, but do not let the chain drag on the ground.

*CONTINUED*

# Towing a Trailer

---

## **Trailer Brakes**

Honda recommends that any trailer having a total weight of 1,000 lbs (450 kg) or more be equipped with its own electric or surge-type brakes.

If you choose electric brakes, be sure they are electronically actuated. Do not attempt to tap into your vehicle's hydraulic system. No matter how successful it may seem, any attempt to attach trailer brakes to your vehicle's hydraulic system will lower braking effectiveness and create a potential hazard.

## **Trailer Lights**

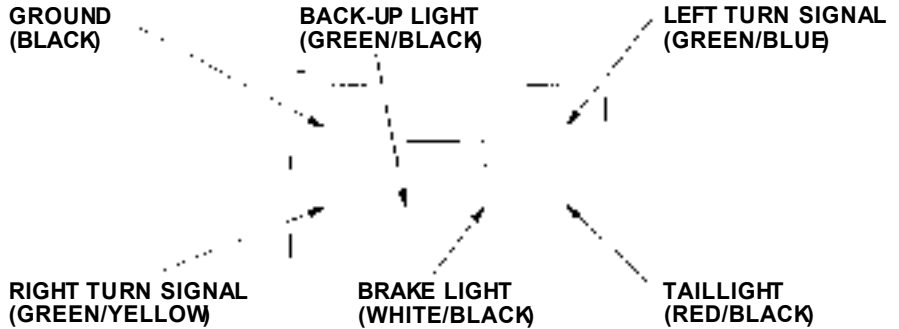

Your vehicle has a trailer lighting connector located behind the left side panel in the cargo area. Refer to the drawing above for the wiring color code and purpose of each pin.

Since lighting and wiring vary with trailer type and brand, you should also have a qualified technician install a suitable connector between the vehicle and the trailer.

If you use a converter, you can get the connector and pins that mate with the connector in your vehicle from your Honda dealer.

### ***Additional Trailer Equipment***

Many states and Canadian provinces require special outside mirrors when towing a trailer. Even if they don't, you should install special mirrors if you cannot clearly see behind you, or if the trailer creates a blind spot.

Ask your trailer sales or rental agency if any other items are recommended or required for your towing situation.

### **Pre-Tow Checklist**

When preparing to tow, and before driving away, be sure to check the following:

- The vehicle has been properly serviced, and the tires, brakes, suspension, and cooling system are in good operating condition.
  - All weights and loads are within limits (see pages [160](#) and [161](#)).
  - The hitch, safety chain, and any other attachments are secure.
  - All items on and in the trailer are properly secured and cannot shift while you drive.
  - The lights and brakes on your vehicle and the trailer are working properly.
- Your vehicle tires and spare are properly inflated (see page [206](#)), and the trailer tires and spare are inflated as recommended by the trailer maker.

# Towing a Trailer

---

## **Driving Safely With a Trailer**

The added weight, length, and height of a trailer will affect your vehicle's handling and performance, so driving with a trailer requires some special driving skills and techniques.

For your safety and the safety of others, take time to practice driving maneuvers before heading for the open road, and follow the guidelines discussed below.

### ***Towing Speeds and Gears***

Drive slower than normal in all driving situations, and obey posted speed limits for vehicles with trailers. If you have an automatic transmission, use D4 position when towing a trailer on level roads. D3 is the proper shift lever position to use when towing a trailer in hilly terrain. (See "***Driving on Hills***" in the next column for additional gear information.)

## ***Making Turns and Braking***

Make turns more slowly and wider than normal. The trailer tracks a smaller arc than your vehicle, and it can hit or run over something the vehicle misses. Allow more time and distance for braking. Do not brake or turn suddenly as this could cause the trailer to jackknife or turn over.

### ***Driving on Hills***

When climbing hills, closely watch your temperature gauge. If it nears the red mark, turn the air conditioning off, reduce speed and, if necessary, pull to the side of the road to let the engine cool.

If the automatic transmission shifts frequently between 3rd and 4th gears while going up a hill, shift to D3.

If you must stop when facing uphill, use the foot brake or parking brake. Do not try to hold the vehicle in place by pressing on the accelerator, as this can cause the automatic transmission to overheat.

When driving down hills, reduce your speed and shift down to 2nd gear. Do not "ride" the brakes, and remember it will take longer to slow down and stop when towing a trailer.

### ***Handling Crosswinds and Buffeting***

Crosswinds and air turbulence caused by passing trucks can disrupt your steering and cause trailer swaying. When being passed by a large vehicle, keep a constant speed and steer straight ahead. Do not try to make quick steering or braking corrections.

### ***Backing Up***

Always drive slowly and have someone guide you when backing up. Grip the *bottom* of the steering wheel; then turn the wheel to the left to get the trailer to move to the left, and turn the wheel right to move the trailer to the right.

### ***Parking***

Follow all normal precautions when parking, including firmly setting the parking brake and putting the transmission in Park (automatic) or in 1 st or Reverse (manual). Also, place wheel chocks at each of the trailer's tires.





This section explains why it is important to keep your car well maintained and to follow basic maintenance safety precautions.

This section also includes Maintenance Schedules for normal driving and severe driving conditions, a Maintenance Record, and instructions for simple maintenance tasks you may want to take care of yourself.

If you have the skills and tools to perform more complex maintenance tasks on your Honda, you may want to purchase the Service Manual. See page 279 for information on how to obtain a copy, or see your Honda dealer.

Maintenance Safety.....	168	Hood Latch.....	196
Important Safety Precautions ..	169	Spark Plugs.....	196
Maintenance Schedule.....	170	Replacement.....	196
Required Maintenance Record....	177	Specifications.....	198
Owner Maintenance Checks.....	179	Battery.....	198
Fluid Locations.....	180	Wiper Blades.....	200
Engine Oil.....	181	Air Conditioning System.....	202
Adding Oil.....	181	Air Conditioning Filter.....	203
Recommended Oil.....	181	Drive Belts.....	204
Synthetic Oil.....	182	Timing Belt.....	204
Additives.....	182	Tires.....	205
Changing the Oil and Filter.....	183	Inflation.....	205
Cooling System.....	185	Inspection.....	206
Adding Engine Coolant.....	185	Maintenance.....	207
Replacing Engine Coolant.....	187	Tire Rotation.....	208
Windshield Washers.....	190	Replacing Tires and Wheels ....	208
Transmission Fluid.....	191	Wheels and Tires.....	209
Automatic		Winter Driving.....	209
Transmission.....	191	Snow Tires.....	210
5-speed Manual		Tire Chains.....	210
Transmission.....	192	Lights.....	211
Brake and Clutch Fluid.....	193	Headlight Aimimg.....	213
Brake System.....	193	Replacing Bulbs.....	214
Clutch System.....	194	Storing Your Car.....	225
Power Steering.....	194		
Air Cleaner Element.....	195		

## Maintenance Safety

---

Regularly maintaining your car is the best way to protect your investment. Proper maintenance is essential to your safety and the safety of your passengers. It will also reward you with more economical, trouble-free driving and help reduce air pollution.

This section includes instructions for simple maintenance tasks, such as checking and adding oil. Any service items not detailed in this section should be performed by a Honda technician or other qualified mechanic.

Some of the most important safety precautions are given here. However, we cannot warn you of every conceivable hazard that can arise in performing maintenance. Only you can decide whether or not you should perform a given task.

### **WARNING**

Improperly maintaining this car or failing to correct a problem before driving can cause a crash in which you can be seriously hurt or killed.

Always follow the inspection and maintenance recommendations and schedules in this owner's manual.

### **WARNING**

Failure to properly follow maintenance instructions and precautions can cause you to be seriously hurt or killed.

Always follow the procedures and precautions in this owner's manual.

### **Important Safety Precautions**

Before you begin any maintenance, make sure your car is parked on level ground and that the parking brake is set. Also, be sure the engine is off. This will help to eliminate several potential hazards:

- **Carbon monoxide poisoning from engine exhaust.** Be sure there is adequate ventilation whenever you operate the engine.
- **Burns from hot parts.** Let the engine and exhaust system cool before touching any parts.
- **Injury from moving parts.** Do not run the engine unless instructed to do so.

Read the instructions before you begin, and make sure you have the tools and skills required.

To reduce the possibility of fire or explosion, be careful when working around gasoline or batteries. Use a commercially available degreaser or parts cleaner, not gasoline, to clean parts. Keep cigarettes, sparks, and flames away from the battery and all fuel-related parts.

You should wear eye protection and protective clothing when working near the battery or when using compressed air.

## Maintenance Schedule

---

The Maintenance Schedule specifies how often you should have your car serviced and what things need attention. It is essential that you have your car serviced as scheduled to retain its high level of safety, dependability, and emissions control performance.

The services and time or distance intervals shown in the maintenance schedule assume you will use your car as normal transportation for passengers and their possessions. You should also follow these recommendations:

Avoid exceeding your car's load limit. This puts excess stress on the engine, brakes, and many other parts of your car. The load limit is shown on the label on the driver's doorjamb.

- Operate your car on reasonable roads within the legal speed limit.
- Drive your car regularly over a distance of several miles (kilometers).
- Always use unleaded gasoline with the proper octane rating (see page [126](#)).

### **Which Schedule to Follow:**

Service your car according to the time and mileage periods on one of the Maintenance Schedules on the following pages. Select the schedule for "Severe Conditions" if most of your driving is done under one or more of the conditions listed on that page. Otherwise, follow the schedule for "Normal Conditions."

Your authorized Honda dealer knows your car best and can provide competent, efficient service. However, service at a dealer is not mandatory to keep your warranties in effect. Maintenance may be done by any qualified service facility or person who is skilled in this type of automotive service. Keep all the receipts as proof of completion, and have the person who does the work fill out the Maintenance Record. Check your warranty booklet for more information.

We recommend the use of Genuine Honda parts and fluids whenever you have maintenance done. These are manufactured to the same high-quality standards as the original components, so you can be confident of their performance and durability.

U.S. Vehicles:  
**Maintenance, replacement or repair of emissions control devices and systems may be done by any automotive repair establishment or individual using parts that are "certified" to EPA standards.**

According to state and federal regulations, failure to perform maintenance on the items marked with # will not void your emissions warranties. However, Honda recommends that all maintenance services be performed at the recommended time or mileage period to ensure long-term reliability.

Service or Inspection Item	Interval (Miles)	1	2	3	4	5	6	7	8	9	10
Check oil level - whenever you refuel	1000	•									
Replace engine oil	1000	•									
Check engine oil and replace	1000	•									
Replace air filter	1000	•									
Replace spark plugs	1000										
Replace timing belt and/or water pump	1000										
Inspect drive belts	1000										
Inspect all fluids	1000										
Replace engine coolant	1000										
Replace brake pads and fluid	1000										
Inspect brake system	1000										
Replace wheel and tire	1000										
Inspect and adjust brakes	1000										
Replace brake fluid	1000										
Check parking brake operation	1000										
Replace timing belt and water pump	1000										
Replace timing belt and water pump	1000										
Visually inspect the following items											
Check for any warning lights on dashboard											
Check for any leaks											
Check for any unusual noises											
Check for any unusual vibrations											
Check for any unusual odors											
Check for any unusual sounds											
Check for any unusual smells											
Check for any unusual tastes											
Check for any unusual textures											

### U.S. Owners

Follow the Normal Conditions Maintenance Schedule if the severe driving conditions specified in the Severe Conditions Maintenance Schedule do not apply.

NOTE: If you only *OCCASIONALLY* drive under a "severe" condition, you should follow the Normal Conditions Maintenance Schedule.

### Canadian Owners

Follow the Maintenance Schedule for Severe Conditions.

# : See information on maintenance and emissions warranty, last column, page 171 .

Service at the indicated distance or time, whichever comes first. Do the items in **A**, **B**, **C** as required for each distance/time interval. Follow this schedule if the severe driving conditions described in the Severe Conditions Schedule on the next page do not apply.

**Canadian owners:** Follow the schedule for Severe Conditions.

7,500 mi / 12,000 km	Do items in <b>A</b> .
15,000 mi / 24,000 km - 1 yr	Do items in <b>A</b> , <b>B</b> .
22,500 mi / 36,000 km	Do items in <b>A</b> .
30,000 mi / 48,000 km - 2 yrs	Do items in <b>A</b> , <b>B</b> , <b>C</b> .
37,500 mi / 60,000 km	Do items in <b>A</b> .
45,000 mi / 72,000 km - 3 yrs	Replace coolant. Replace brake fluid. Do items in <b>A</b> , <b>B</b> .
52,500 mi / 84,000 km	Do items in <b>A</b> .
60,000 mi / 96,000 km - 4 yrs	Do items in <b>A</b> , <b>B</b> , <b>C</b> .
67,500 mi / 108,000 km	Do items in <b>A</b> .
75,000 mi / 120,000 km - 5 yrs	Replace coolant. Do items in <b>A</b> , <b>B</b> .
82,500 mi / 132,000 km	Do items in <b>A</b> .
90,000 mi / 144,000 km - 6 yrs	Replace brake fluid. Replace transmission fluid. Replace ATF/ATF+D fluid. Do items in <b>A</b> , <b>B</b> , <b>C</b> .
97,500 mi / 156,000 km	Do items in <b>A</b> .
105,000 mi / 168,000 km - 7 yrs	Replace timing belt, balancer belt, and inspect water pump. Replace spark plugs. Replace coolant. Inspect idle speed. Inspect valve clearance. Do items in <b>A</b> , <b>B</b> .
112,500 mi / 180,000 km	Do items in <b>A</b> .
120,000 mi / 192,000 km - 8 yrs	Do items in <b>A</b> , <b>B</b> , <b>C</b> .

<b>A</b>	<input type="checkbox"/> Replace engine oil. <input type="checkbox"/> Rotate tires (follow pattern on page 208).
<b>B</b>	<input type="checkbox"/> Replace engine oil filter. <input type="checkbox"/> Inspect front and rear brakes. <input type="checkbox"/> Check parking brake adjustment. <input type="checkbox"/> Inspect tie rod ends, steering gearbox and boots. <input type="checkbox"/> Inspect suspension components. <input type="checkbox"/> Inspect driveshaft boots. <input type="checkbox"/> Inspect brake hoses and lines (including ABS). <input type="checkbox"/> Check all fluid levels and condition of fluids, and check for leaks. <input type="checkbox"/> Inspect cooling system hoses and connections. <input type="checkbox"/> Inspect exhaust system. <input type="checkbox"/> Inspect fuel lines and connections.
<b>C</b>	<input type="checkbox"/> Replace air cleaner element. <input type="checkbox"/> Inspect and adjust drive belts. <input type="checkbox"/> Replace air conditioning filter.

#: See information on maintenance and emissions warranty, last column, page 171.





Use this schedule if your vehicle is MAINLY driven in any of the following Severe Conditions, or normally driven in Canada; otherwise use the Normal Schedule. Service at the indicated distance or time, whichever comes first. Do the items in **A**, **B**, **C** as required for each distance/time.

**Severe Conditions:**

- Driving less than 5 miles (8 km) per trip or, in freezing temperatures, driving less than 10 miles (16 km) per trip.
- Driving in extremely hot (over 90°F/32°C) conditions.
- Extensive idling or long periods of stop-and-go driving.
- Trailer towing, driving with a roof top carrier, or driving in mountainous conditions.
- Driving on muddy, dusty, or de-iced roads.

3,150 mi / 5,000 km	Replace engine oil and filter
7,500 mi / 12,000 km or 6 mos	Do items in A.
11,750 mi / 18,900 km	Replace engine oil and filter
15,000 mi / 24,000 km 1 yr	Change or clean air element Do items in A, B
18,750 mi / 30,000 km	Replace engine oil and filter
22,500 mi / 36,000 km 1 1/2 yrs	Do items in A
26,250 mi / 42,000 km	Replace engine oil and filter
30,000 mi / 48,000 km 2 yrs	Replace air filter element Do items in A, B, C.
33,750 mi / 54,000 km	Replace engine oil and filter
37,500 mi / 60,000 km 2 1/2 yrs	Do items in A
41,250 mi / 66,000 km	Replace engine oil and filter
45,000 mi / 72,000 km 3 yrs	Change air cleaner element. Replace coolant. Replace brake fluid. Do items in A, B.
48,750 mi / 78,000 km	Replace engine oil and filter
52,500 mi / 84,000 km 3 1/2 yrs	Do items in A
56,250 mi / 90,000 km	Replace engine oil and filter

<b>A</b>	<input type="checkbox"/> Replace engine oil and filter.
	<input type="checkbox"/> Inspect front and rear brakes.
	<input type="checkbox"/> Rotate tires (follow pattern on page 208).
	<input type="checkbox"/> Inspect tie rod ends, steering gearbox and boots.
	<input type="checkbox"/> Inspect suspension components.
	<input type="checkbox"/> Inspect driveshaft boots.
<b>B</b>	<input type="checkbox"/> Check parking brake adjustment.
	<input type="checkbox"/> Lubricate all hinges, locks and latches.
	<input type="checkbox"/> Inspect brake hoses and lines (including ABS).
	<input type="checkbox"/> Check all fluid levels, condition of fluids, and check for leaks.
	<input type="checkbox"/> Inspect cooling system hoses and connections.
	<input type="checkbox"/> Inspect exhaust system.
	<input type="checkbox"/> Inspect fuel lines and connections.
	<input type="checkbox"/> Check all lights and controls.
	<input type="checkbox"/> Inspect the underbody.

#: See information on maintenance and emissions warranty, last column, page 171.

38 000 mi / 61 000 km 4 yrs	Replace timing belt, balance belt and inspect the water pump Deteriorate A, B, C
43 750 mi / 70 300 km	Replace engine oil and filter Deteriorate A
47 500 mi / 76 300 km 4 yrs	Replace engine oil and filter Clean air cleaner element Replace coolant (Deteriorate A, B)
52 000 mi / 83 700 km 5 yrs	Replace engine oil and filter Deteriorate A
56 750 mi / 91 300 km	Replace engine oil and filter
62,000 mi / 100,000 km 5 yrs	Deteriorate A
66,250 mi / 106,600 km	Replace engine oil and filter
70,500 mi / 113,000 km 6 yrs	Replace timing belt, Deteriorate A, B, C
74,750 mi / 120,000 km	Replace engine oil and filter
79,000 mi / 126,800 km 6 yrs	Deteriorate A
83,250 mi / 133,800 km	Replace engine oil and filter Clean air cleaner element Replace spark plugs
87,500 mi / 140,800 km 7 yrs	Replace timing belt, timing balance belt and inspect water pump Replace coolant - Inspect at 8 speed Inspect oil cleaner - Deteriorate A, B
91,750 mi / 147,800 km	Replace engine oil and filter
96,000 mi / 154,800 km 7 yrs	Deteriorate A
100,250 mi / 161,800 km	Replace engine oil and filter
104,500 mi / 168,800 km 8 yrs	Replace timing belt, timing balance belt and inspect the water pump Deteriorate A, B, C
108,750 mi / 174,000 km	Replace engine oil and filter
112,500 mi / 180,800 km 8 yrs	Deteriorate A
116,250 mi / 187,000 km	Replace engine oil and filter
120,000 mi / 193,000 km 8 yrs	Replace timing belt, balance belt and inspect the water pump Deteriorate A, B, C

**C** Replace air cleaner element  
Inspect and adjust drive belts  
Replace A/CTS oil fluid  
Replace air conditioning filter

- \* 1 : See Timing Belt on page 204 to determine need for replacement.
- \* 2 : See Air Conditioning Filter on page 203 for replacement information under special conditions.

## Required Maintenance Record (for Normal and Severe Schedules)

You or the servicing dealer can record all completed maintenance here, whether you follow the schedule for normal conditions (page 172 ) or severe conditions (page 174). Keep the receipts for all work done on your vehicle.

3,750 mi 6,000 km	Signature of dealer/tech rep	mi/km Date	33,750 mi 54,000 km	Signature of dealer/tech rep	mi/km Date
7,500 mi 12,000 km or 1 year		mi/km Date	37,500 mi 60,000 km or 2 years		mi/km Date
11,250 mi 18,000 km		mi/km Date	41,250 mi 66,000 km		mi/km Date
15,000 mi 24,000 km or 1 year		mi/km Date	45,000 mi 72,000 km or 2 years		mi/km Date
18,750 mi 30,000 km		mi/km Date	48,750 mi 78,000 km		mi/km Date
22,500 mi 36,000 km or 1 year		mi/km Date	62,500 mi 100,000 km or 2 years		mi/km Date
26,250 mi 42,000 km		mi/km Date	56,250 mi 90,000 km		mi/km Date
30,000 mi 48,000 km or 2 years		mi/km Date	60,000 mi 96,000 km or 2 years		mi/km Date

## Required Maintenance Record (for Normal and Severe Schedules)

---

83,750 mi  
132,300 km

Signature or dealer stamp

mi/km

Date

87,500 mi  
139,000 km  
or 1 year

mi/km

Date

91,250 mi  
145,000 km

mi/km

Date

95,000 mi  
150,000 km  
or 1 year

mi/km

Date

98,750 mi  
156,000 km

mi/km

Date

102,500 mi  
162,000 km  
or 1 year

mi/km

Date

106,250 mi  
167,000 km

mi/km

Date

110,000 mi  
172,000 km  
or 1 year

mi/km

Date

93,750 mi  
150,300 km

Signature or dealer stamp

mi/km

Date

97,500 mi  
155,000 km  
or 1 year

mi/km

Date

101,250 mi  
162,000 km

mi/km

Date

105,000 mi  
168,000 km  
or 1 year

mi/km

Date

108,750 mi  
174,000 km

mi/km

Date

112,500 mi  
180,000 km  
or 1 year

mi/km

Date

116,250 mi  
184,000 km

mi/km

Date

120,000 mi  
192,000 km  
or 1 year

mi/km

Date

You should check the following items at the specified intervals. If you are unsure of how to perform any check, turn to the page given.

- Engine oil level — Check every time you fill the fuel tank. See page [130](#).
- Engine coolant level — Check the radiator reserve tank every time you fill the fuel tank. See page [131](#).
- Windshield washer fluid — Check the level in the reservoir monthly. If weather conditions cause you to use the washers frequently, check the reservoir each time you stop for fuel. See page [190](#).
- Automatic transmission — Check the fluid level monthly. See page [191](#).
- Brakes — Check the fluid level monthly. See page [193](#).
- Tires — Check the tire pressure monthly. Examine the tread for wear and foreign objects. See page [205](#).
- Lights — Check the operation of the headlights, parking lights, taillights, high-mount brake light, turn signals, brake lights, and license plate lights monthly. See page [211](#).

# Fluid Locations

---

**ENGINE OIL  
FILL CAP**

**COOLANT  
RESERVOIR**

**AUTOMATIC  
TRANSMISSION  
FLUID DIPSTICK  
(Yellow loop)**

**BRAKE FLUID  
(Gray cap)**

**(5-speed Manual  
Transmission only)  
CLUTCH FLUID  
(Gray cap)**

**POWER STEERING  
FLUID (Red cap)**

**WASHER FLUID  
(Blue cap)**

**ENGINE OIL DIPSTICK  
(Orange loop)**

## Adding Oil

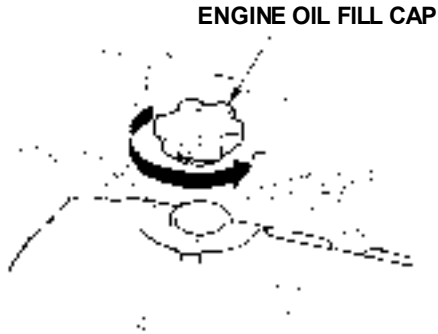

To add oil, unscrew and remove the engine oil fill cap on top of the valve cover. Pour in the oil, and replace the engine oil fill cap. Tighten it securely. Wait a few minutes and recheck the oil level. Do not fill above the upper mark; you could damage the engine.

## Recommended Oil

Oil is a major contributor to your engine's performance and longevity. Always use a premium-grade detergent oil. It is highly recommended that you use Genuine Honda Motor Oil in your vehicle for as long as you own it.

You can determine an oil's SAE viscosity and Service Classification from the API Service label on the oil container.

A fuel-efficient oil is recommended for your Honda. This is shown on the API Service label by the words "Energy Conserving." This oil is formulated to help your engine use less fuel.

The API Service label also tells you the service classification of the oil. Always use an oil that is labeled "API Service SJ." This service rating may include other classifications, such as CD. These additional classifications are not a problem, as long as the label also carries the SJ classification.



API SERVICE LABEL

CONTINUED



# Engine Oil

The oil container may also display the API Certification seal. Make sure it says "For Gasoline Engines."



API CERTIFICATION SEAL

The SAE numbers tell you the oil's viscosity or weight. Select the oil for your car according to this chart.

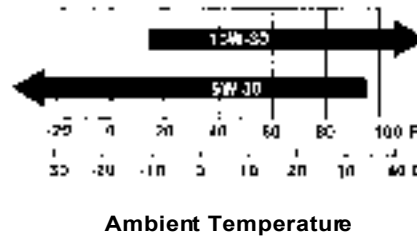

An oil with a viscosity of 5W-30 is preferred for improved fuel economy and year-round protection in your Honda. You may use a 10W-30 oil if the temperature in your area never goes below 20°F (−7°C).

## Synthetic Oil

You may use a synthetic motor oil if it meets the same requirements given for conventional motor oil: energy conserving, a service classification of SJ, and the proper weight as shown on the chart. When using synthetic oil, you must follow the oil and filter change intervals given in the maintenance schedule.

## Additives

Your Honda does not need any oil additives. Purchasing additives for the engine or transmission will not increase your car's performance or longevity. It only increases the cost of operating your car.

## Changing the Oil and Filter

Always change the oil and filter according to the time and distance (miles/kilometers) recommendations in the maintenance schedule. The oil and filter collect contaminants that can damage your engine if they are not removed regularly.

Changing the oil and filter requires special tools and access from underneath the car. The car should be raised on a service station-type hydraulic lift for this service. Unless you have the knowledge and proper equipment, you should have this maintenance done by a skilled mechanic.

1. Run the engine until it reaches normal operating temperature, then shut it off.

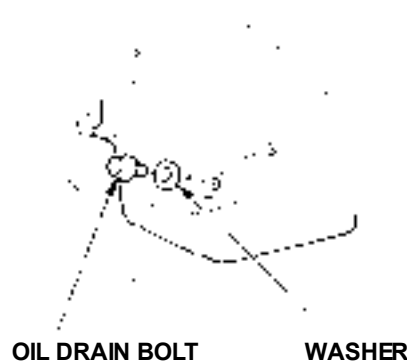

2. Open the hood and remove the engine oil fill cap. Remove the oil drain bolt and washer from the bottom of the engine. Drain the oil into an appropriate container.

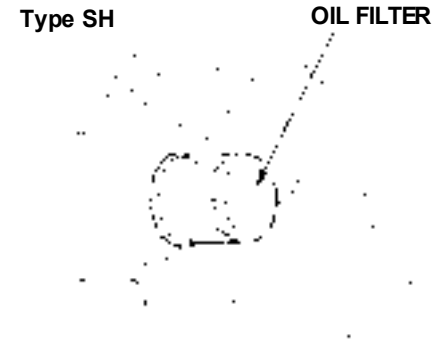

3. Remove the oil filter and let the remaining oil drain. A special wrench (available from your Honda dealer) is required to remove the filter.

CONTINUED

# Engine Oil

---

Except Type SH



OIL FILTER

4. Install a new oil filter according to instructions that come with it.

5. Put a new washer on the drain bolt, then reinstall the drain bolt.

Tighten it to:

**33 lbf·ft (44 N·m , 4.5 kgf·m)**

6. Refill the engine with the recommended oil.

Engine oil change capacity (including filter):

**5.1 US qt (4.8 l , 4.2 Imp qt)**

7. Replace the engine oil fill cap. Start the engine. The oil pressure indicator light should go out within five seconds. If it does not, turn off the engine and reinspect your work.

8. Let the engine run for several minutes and check the drain bolt and oil filter for leaks.

9. Turn off the engine, let it sit for several minutes, then check the oil level. If necessary, add oil to bring the level to the upper mark on the dipstick.

## NOTICE

*Improper disposal of engine oil can be harmful to the environment. If you change your own oil, please dispose of the used oil properly. Put it in a sealed container and take it to a recycling center. Do not discard it in a trash bin or dump it on the ground.*

## Adding Engine Coolant



**RESERVE TANK**

If the coolant level in the reserve tank is at or below the MIN line, add coolant to bring it up to the MAX line. Inspect the cooling system for leaks. This coolant should always be a mixture of 50 percent antifreeze and 50 percent water. Never add straight antifreeze or plain water.

Always use Genuine Honda Antifreeze/Coolant. If it is not available, you may use another major-brand non-silicate coolant as a temporary replacement. Make sure it is a high-quality coolant recommended for aluminum engines. However, continued use of any non-Honda coolant can result in corrosion, causing the cooling system to malfunction or fail. Have the cooling system flushed and refilled with Honda antifreeze/coolant as soon as possible.

If the reserve tank is completely empty, you should also check the coolant level in the radiator.

### **⚠ WARNING**

Removing the radiator cap while the engine is hot can cause the coolant to spray out, seriously scalding you.

Always let the engine and radiator cool down before removing the radiator cap.

*CONTINUED*

# Cooling System

---

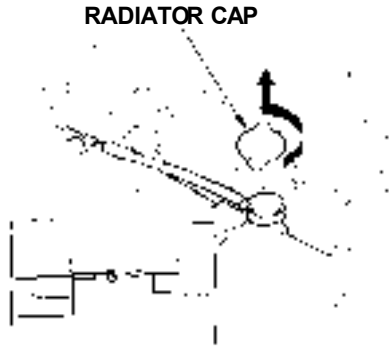

1. Make sure the engine and radiator are cool.
2. Turn the radiator cap counterclockwise, without pressing down on it, until it stops. This relieves any pressure remaining in the cooling system.

3. Remove the radiator cap by pushing down and turning counterclockwise.
4. The coolant level should be up to the base of the filler neck. Add coolant if it is low.
5. Put the radiator cap back on. Tighten it fully.



6. Pour coolant into the reserve tank. Fill it to halfway between the MAX and MIN marks. Put the cap back on the reserve tank.

Do not add any rust inhibitors or other additives to your car's cooling system. They may not be compatible with the coolant or engine components.

## Replacing Engine Coolant

The cooling system should be completely drained and refilled with new coolant according to the time and distance recommendations in the maintenance schedule. Only use Genuine Honda Antifreeze/Coolant.

Draining the coolant requires access to the underside of the car. Unless you have the tools and knowledge, you should have this maintenance done by a skilled mechanic.

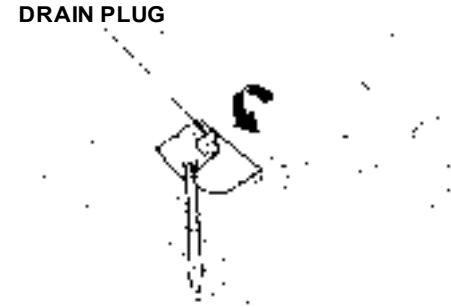
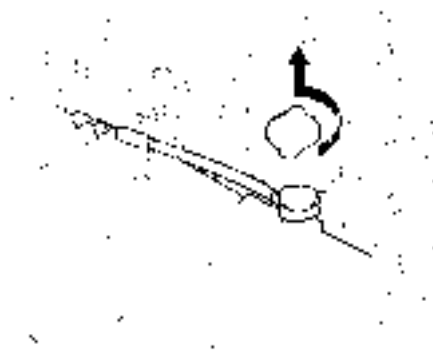

Type SH

1. Turn the ignition ON (II). Slide the heater temperature control lever to maximum heat. Turn off the ignition. Open the hood. Make sure the engine and radiator are cool to the touch.
2. Remove the radiator cap.
3. Loosen the drain plug on the bottom of the radiator. The coolant will come out through the hole in the splash cover.

*CONTINUED*

# Cooling System

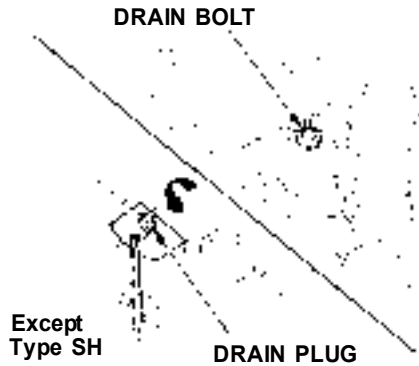

*Except Type SH only*  
Remove the drain bolt and washer from the engine block.

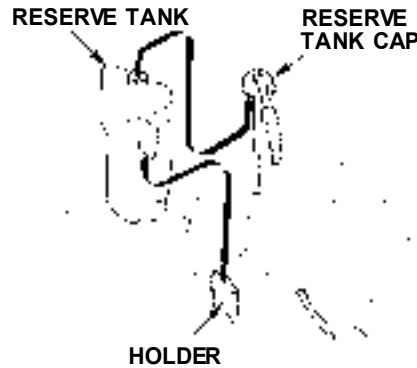

4. Remove the reserve tank from its holder by pulling it straight up. Drain the coolant, then put the tank back in its holder.
5. When the coolant stops draining, tighten the drain plug at the bottom of the radiator.

*Except Type SH only*

Apply non-hardening sealant to the drain bolt threads, put a new washer on the drain bolt, and reinstall the bolt in the engine block. Tighten it securely.

Tightening torque:

61 lbf.ft (83 N.m , 8.5 kgf.m)

6. Mix the recommended antifreeze with an equal amount of purified or distilled water in a clean container. The cooling system capacity is:

*With 5-speed manual transmission:*

(Except Type SH)

0.87 US gal (3.31, 0.73 Imp gal)

(Type SH)

0.85 US gal (3.21, 0.70 Imp gal)

*With automatic transmission:*

0.85 US gal (3.21, 0.70 Imp gal)

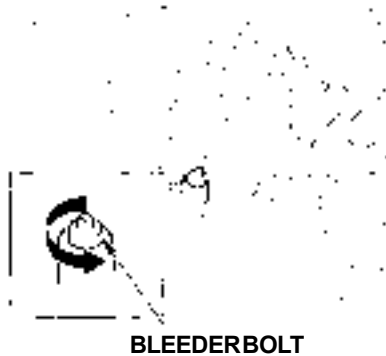
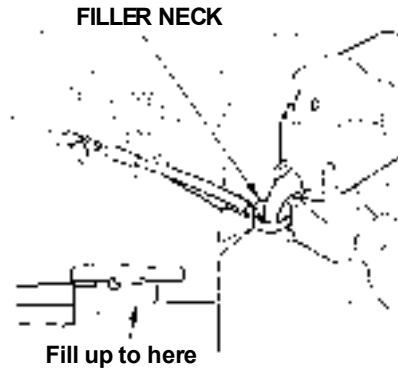

7. Loosen the bleeder bolt on top of the engine.

Pour coolant into the radiator up to the base of the filler neck. Tighten the bleeder bolt when coolant comes out in a steady stream with no bubbles.

8. Fill the reserve tank to the MAX mark. Install the reserve tank cap.

9. Check the level in the radiator, add coolant if needed.

10. Install the radiator cap, and tighten it to the first stop.

11. Start the engine and let it run until the radiator fan comes on two times. Then stop the engine.

12. Remove the radiator cap. Fill the radiator with coolant up to the filler neck and the reserve tank up to the MAX mark.

13. Start the engine and hold it at 1,500 rpm until the radiator fan comes on. Turn off the engine. Check the coolant level in the radiator and add coolant if needed.

14. Install the radiator cap, and tighten it fully.

15. If necessary, fill the reserve tank to the MAX mark. Install the reserve tank cap.



## Windshield Washers

---

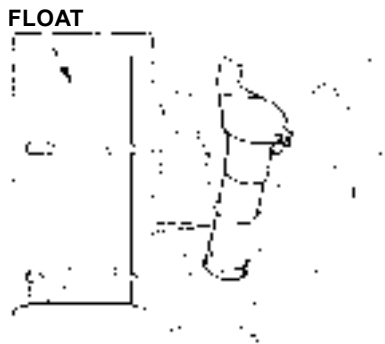

Check the level in the windshield washer reservoir at least monthly during normal usage. In bad weather, when you use the washers often, check the level every time you stop for fuel.

The windshield washer reservoir is located behind the driver's side headlight. Check the reservoir's fluid level by removing the cap and looking at the float. It should be up to the top of the neck. If the float is at the bottom of the neck, the reservoir is nearly empty.

Fill the reservoir with a good-quality windshield washer fluid. This increases the cleaning capability and prevents freezing in cold weather.

### NOTICE

*Do not use engine antifreeze or a vinegar/water solution in the windshield washer reservoir.*

*Antifreeze can damage your car's paint, while a vinegar/water solution can damage the windshield washer pump.*

*Use only commercially-available windshield washer fluid.*

## Automatic Transmission

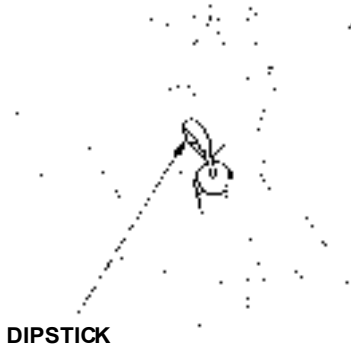

Check the fluid level with the engine at normal operating temperature.

1. Park the car on level ground. Shut off the engine.
2. Remove the dipstick (yellow loop) from the transmission and wipe it with a clean cloth.

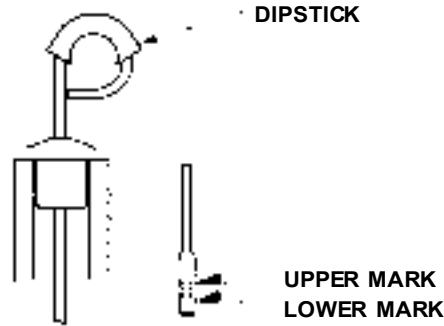

3. Insert the dipstick all the way into the transmission securely as shown in the illustration.
4. Remove the dipstick and check the fluid level. It should be between the upper and lower marks.

5. If the level is below the lower mark, add fluid into the filler hole to bring it to the upper mark. Always use Honda Premium Formula Automatic Transmission Fluid (ATF). If it is not available, you may use a DEXRON® III automatic transmission fluid as a temporary replacement. However, continued use can affect shift quality. Have the transmission drained and refilled with Honda ATF as soon as it is convenient.

6. Insert the dipstick all the way back into the transmission securely as shown in the illustration.

The transmission should be drained and refilled with new fluid according to the time and distance recommendations in the maintenance schedule.

# Transmission Fluid

---

## 5-speed Manual Transmission

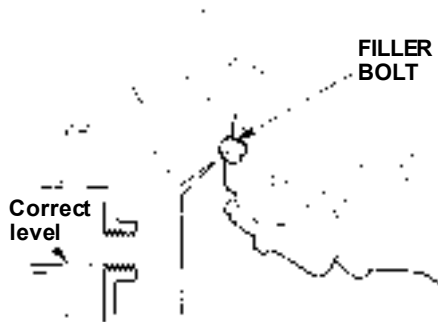

Check the fluid level with the transmission at normal operating temperature and the car sitting on level ground. Remove the transmission filler bolt and carefully feel inside the bolt hole with your finger. The fluid level should be up to the edge of the bolt hole. If it is not, add Genuine Honda Manual Transmission Fluid (MTF) until it starts to run out of the hole. Reinstall the filler bolt and tighten it securely.

If Honda MTF is not available, you may use an API service SG, SH or SJ grade motor oil with a viscosity of SAE 10W-30 or 10W-40 as a temporary replacement. An SG grade is preferred, but an SH or SJ grade may be used if SG is not available. However, motor oil does not contain the proper additives and continued use can cause stiffer shifting. Replace as soon as convenient.

The transmission should be drained and refilled with new fluid according to the time and distance recommendations in the maintenance schedule.

Check the fluid level in the reservoirs monthly. There are up to two reservoirs, depending on the model. They are:

- Brake fluid reservoir (all models)
- Clutch fluid reservoir (manual transmission only)

The brake fluid should be replaced according to the time and distance recommendations in the maintenance schedule.

Always use Genuine Honda DOT 3 brake fluid. If it is not available, you should use only DOT 3 or DOT 4 fluid, from a sealed container, as a temporary replacement. However, the use of any non-Honda brake fluid can cause corrosion and decrease the life of the system. Have the brake system flushed and refilled with Honda DOT 3 brake fluid as soon as possible.

Brake fluid marked DOT 5 is not compatible with your car's braking system and can cause extensive damage.

## Brake System

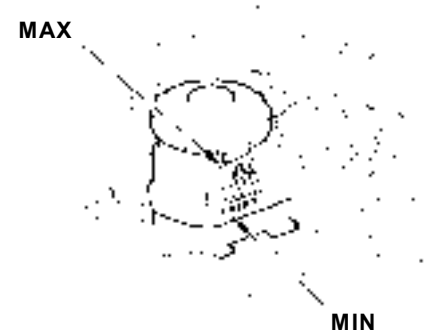

The fluid level should be between the MIN and MAX marks on the side of the reservoir. If the level is at or below the MIN mark, your brake system needs attention. Have the brake system inspected for leaks or worn brake pads.

# Brake and Clutch Fluid, Power Steering

## Clutch System

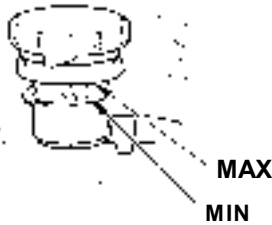

The fluid should be between the MIN and MAX marks on the side of the reservoir. If it is not, add brake fluid to bring it up to that level. Use the same fluid specified for the brake system.

Low fluid level can indicate a leak in the clutch system. Have this system inspected as soon as possible.

## Power Steering

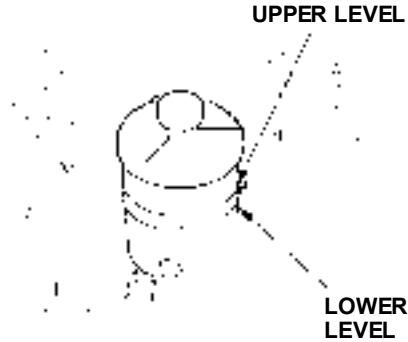

Check the level when the engine is cold. Look at the side of the reservoir. The fluid should be between the UPPER LEVEL and LOWER LEVEL. If it is below the LOWER LEVEL, add power steering fluid to the UPPER LEVEL.

Always use Genuine Honda Power Steering Fluid. If it is not available, you may use another power steering fluid as an emergency replacement. However, continued use can cause increased wear and poor steering in cold weather. Have the power steering system flushed and refilled with Honda PSF as soon as possible.

A low power steering fluid level can indicate a leak in the system. Check the fluid level frequently and have the system inspected as soon as possible.

### NOTICE

*Turning the steering wheel to full left or right lock and holding it there can damage the power steering pump.*

The air cleaner element should be cleaned or replaced according to the time and distance recommendations in the maintenance schedule.

## Cleaning (Severe Conditions)

Clean the air cleaner element by blowing compressed air through it in the opposite direction to normal air flow. If you do not have access to compressed air (such as a service station), ask your Honda dealer to do this service.

Follow the replacement procedure for removal and reinstallation.

## Replacement

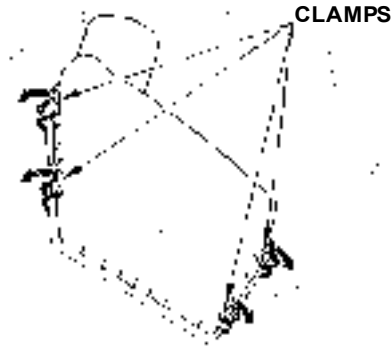

The air cleaner element is inside the air cleaner housing on the passenger's side of the engine compartment. To replace it:

1. Unsnap the four hold-down clamps and remove the air cleaner housing cover.
2. Remove the old air cleaner element.

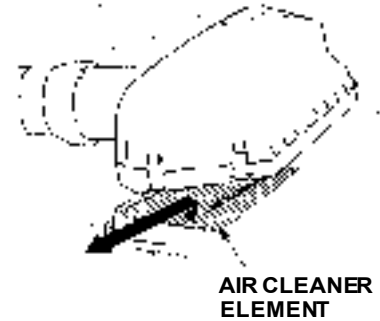

Carefully clean the inside of the air cleaner housing with a damp rag.

3. Place the new air cleaner element in the air cleaner housing.
4. Reinstall the air cleaner housing cover, snap the four hold-down clamps back into place.

## Hood Latch, Spark Plugs

---

### Hood Latch



Clean the hood latch assembly with a mild cleaner, then lubricate it with a multipurpose grease. Lubricate all the moving parts, including the pivot. Follow the time and distance recommendations in the Maintenance Schedule. If you are not sure how to clean and grease the latch, contact your Honda dealer.

### Spark Plugs

The spark plugs in your car should be replaced according to the time and distance recommendations in the maintenance schedule.

### Replacement

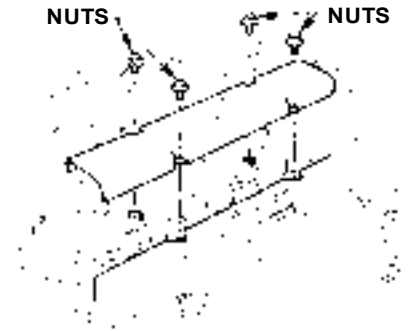

1. Remove the four nuts, then remove the plug wire cover.
2. Clean up any dirt and oil around the spark plug caps.

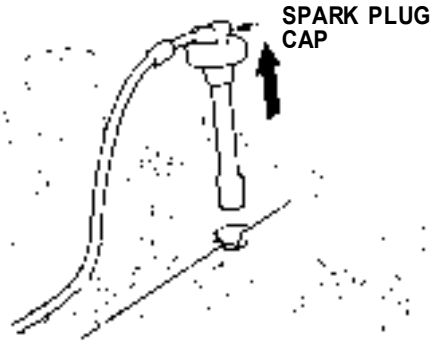

3. Remove the spark plug cap by pulling it straight out.
4. Remove the spark plug with a five-eighths inch (16 mm) spark plug socket.

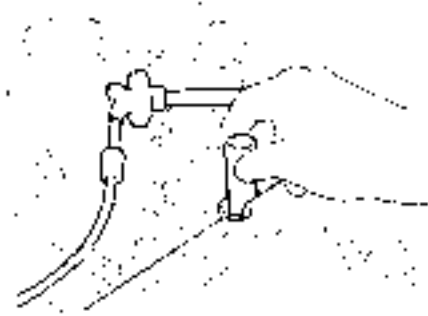

5. Put the new spark plug into the socket; then screw it into the hole. Screw it in by hand so you do not crossthead it.

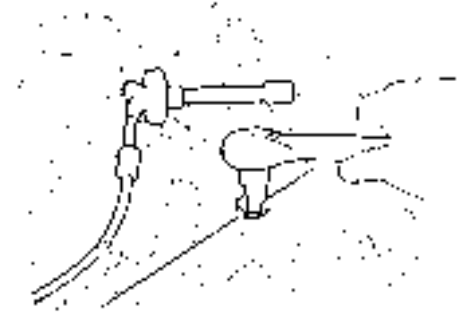

6. Torque the spark plug. (If you do not have a torque wrench, tighten the spark plug two-thirds of a turn after it contacts the cylinder head.)  
Tightening torque:  
13 lbf.ft (18N.m ,1.8kgf.m)

CONTINUED



## Spark Plugs, Battery

---

### NOTICE

*Tighten The spark plugs carefully. A spark plug That is too loose can overheat and damage The engine. Overtightening can cause damage to the Threads in the cylinder head.*

### Specifications

NGK: **PZFR6F-11**  
DENSO: **PKJ20CR-L11**

Spark Plug Gap:  
0.04 in (1.1 mm<sup>-0</sup><sub>-0.1 mm</sub>)

### Battery

Check the condition of your car's battery monthly. You should check the color of the test indicator window, and for corrosion on the terminals.

7. Install the spark plug cap.
8. Repeat this procedure for the other three spark plugs.

Reinstall the plug wire cover, and tighten the four nuts.



## TEST INDICATOR WINDOW

Check the battery condition by looking at the test indicator window on the battery. The label on the battery explains the test indicator's colors.

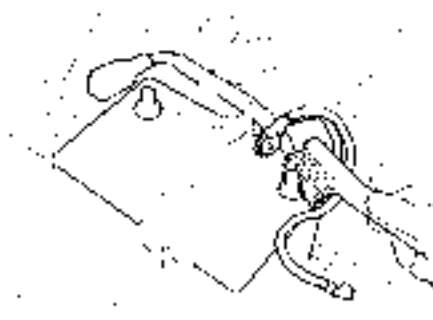

Check the battery terminals for corrosion (a white or yellowish powder). To remove it, cover the terminals with a solution of baking soda and water. It will bubble up and turn brown. When this stops, wash it off with plain water. Dry off the battery with a cloth or paper towel. Coat the terminals with grease to help prevent future corrosion.

If the terminals are severely corroded, clean them with baking soda and water. Then use a wrench to loosen and remove the cables from the terminals. Always disconnect the negative (—) cable first and reconnect it last. Clean the battery terminals with a terminal cleaning tool or wire brush. Reconnect and tighten the cables, then coat the terminals with grease.

If you need to connect the battery to a charger, disconnect both cables to prevent damage to the car's electrical system.

*CONTINUED*

## Battery, Wiper Blades

---

### **WARNING**

The battery gives off explosive hydrogen gas during normal operation.

A spark or flame can cause the battery to explode with enough force to kill or seriously hurt you.

Wear protective clothing and a face shield, or have a skilled mechanic do the battery maintenance.

If your car's battery is disconnected or goes dead, the audio system will disable itself. The next time you turn on the radio you will see “ **CODE** ” in the frequency display. Use the Preset buttons to enter the five-digit code (see page [123](#) ).

### **NOTICE**

*Charging the battery with the cables connected can seriously damage your car's electronic controls. Detach the battery cables before connecting the battery to a charger.*

### **Wiper Blades**

Check the condition of the wiper blades at least every six months. Look for signs of cracking in the rubber, or areas that are getting hard. Replace the blades if you find these signs, or they leave streaks and unwiped areas when used.

# Wiper Blades

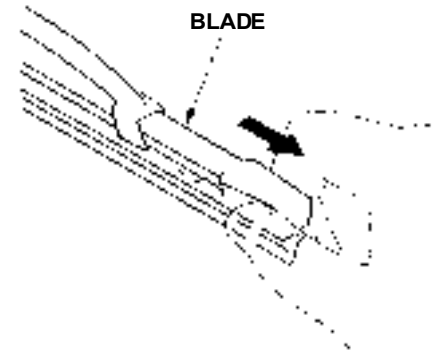
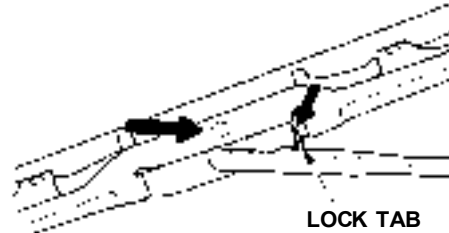
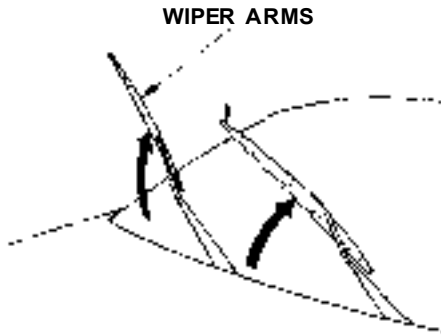

To replace the blade:

1. Raise the wiper arm off the windshield.  
Raise the driver's side first, then the passenger's side.
2. Disconnect the blade assembly from the wiper arm by pushing in the lock tab. Hold it in while you push the blade assembly toward the base of the arm.
3. Remove the blade from its holder by grasping the tabbed end of the blade. Pull firmly until the tabs come out of the holder.

*CONTINUED*

## Wiper Blades, Air Conditioning System

---

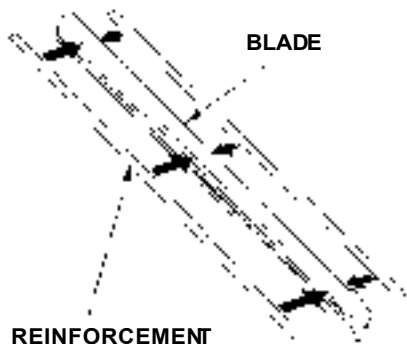

5. Slide the new wiper blade into the holder until the tabs lock.
6. Slide the wiper blade assembly onto the wiper arm. Make sure it locks in place.
7. Lower the wiper arm down against the windshield.  
Lower the passenger's side first, then the driver's side.

4. Examine the new wiper blades. If they have no plastic or metal reinforcement along the back edge, remove the metal reinforcement strips from the old wiper blade and install them in the slots along the edge of the new blade.

### Air Conditioning System

Your car's air conditioning is a sealed system. Any major maintenance, such as recharging, should be done by a qualified mechanic. You can do a couple of things to make sure the air conditioning works efficiently.

#### AIR CONDITIONING CONDENSER

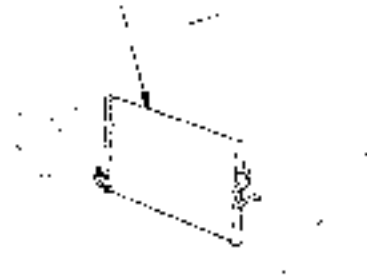

## Air Conditioning System, Air Conditioning Filter

---

Periodically check the engine's radiator and air conditioning condenser for leaves, insects, and dirt stuck to the front surface. These block the air flow and reduce cooling efficiency. Use a light spray from a hose or a soft brush to remove them.

### NOTICE

*The condenser and radiator fins bend easily. Only use a low-pressure spray or soft-bristle brush to clean them.*

Run the air conditioning at least once a week during the cold weather months. Run it for at least ten minutes while you are driving at a steady speed with the engine at normal operating temperature. This circulates the lubricating oil contained in the refrigerant.

If the air conditioning does not get as cold as before, have your dealer check the system. Recharge the system with Refrigerant HFC-134a (R-134a). (See Specifications on page [265](#).)

### NOTICE

*Whenever you have the air conditioning system serviced, make sure the service facility uses a refrigerant recycling system. This system captures the refrigerant for reuse. Releasing refrigerant into the atmosphere can damage the environment.*

### Air Conditioning Filter

The air conditioning filter removes pollen and dust from the outside air the climate control system brings into the interior.

This filter should be replaced every 30,000 miles (48,000 km) under normal conditions. It should be replaced every 15,000 miles (24,000 km) if you drive primarily in urban areas that have high concentrations of soot in the air from industry and diesel-powered vehicles. Replace it more often if air flow from the heating and cooling system becomes less than usual. Have the air conditioning filter replaced by your Honda dealer.

# Drive Belts, Timing Belt

---

## Drive Belts

POWER STEERING BELT



ALTERNATOR BELT

Check the condition of the two drive belts. Examine the edges of each belt for cracks or fraying. Check the tension of each belt by pushing on it with your thumb midway between the pulleys.

The belts should have the following "play" or deflection.

Alternator belt:

0.37 — 0.49 in (9.5 — 12.5 mm)

Power steering belt:

0.53 — 0.65 in (13.5 — 16.5 mm)

If you see signs of wear or looseness, have your dealer adjust or replace the belts.

## Timing Belt

The timing belt and balancer belt should normally be replaced at the intervals shown in the maintenance schedule.

Replace these belts at 60,000 miles (U.S.) or 100,000 km (Canada) if you regularly drive your car in one or more of these conditions:

- In very high temperatures (over 110°F, 43°C).
- In very low temperatures (under —20°F, —29°C).

To safely operate your car, your tires must be the proper type and size, in good condition with adequate tread, and correctly inflated. The following pages give more detailed information on how and when to check air pressure, how to inspect your tires for damage and wear, and what to do when your tires need to be replaced.

## **WARNING**

Using tires that are excessively worn or improperly inflated can cause a crash in which you can be seriously hurt or killed.

Follow all instructions in this owner's manual regarding tire inflation and maintenance.

## **Inflation**

Keeping the tires properly inflated provides the best combination of handling, tread life and riding comfort. Underinflated tires wear unevenly, adversely affect handling and fuel economy, and are more likely to fail from being overheated. Overinflated tires can make your car ride more harshly, are more prone to damage from road hazards, and wear unevenly.

We recommend that you visually check your tires every day. If you think a tire might be low, check it immediately with a tire gauge.

Use a gauge to measure the air pressure at least once a month. Even tires that are in good condition may lose one to two psi (10 to 20 kPa, 0.1 to 0.2 kgf/cm<sup>2</sup>) per month. Remember to check the spare tire at the same time you check all the other tires.

Check the pressure in the tires when they are cold. This means the car has been parked for at least three hours. If you have to drive the car before checking the tire pressure, the tires can still be considered "cold" if you drive less than 1 mile (1.6 km).

If you check the pressure when the tires are hot (the car has been driven several miles), you will see readings 4 to 6 psi (30 to 40 kPa, 0.3 to 0.4 kgf/cm<sup>2</sup>) higher than the cold reading. This is normal. Do not let air out to match the specified cold pressure. The tire will be underinflated.

You should get your own tire pressure gauge and use it whenever you check your tire pressures. This will make it easier for you to tell if a pressure loss is due to a tire problem and not due to a variation between gauges.

*CONTINUED*



# Tires

## **Recommended Tire Pressures for Normal Driving**

The following chart shows the recommended cold tire pressures for most normal driving conditions and speeds.

Tire Size	Cold Tire Pressure for Normal Driving (by location)
205 50R16 87V	32 psi (220 kPa), 2.2 kgf/cm <sup>2</sup>

The compact spare tire pressure is: 60 psi (420 kPa, 4.2 kgf/cm<sup>2</sup>)

These pressures are also given on the tire information label on the driver's doorjamb.

Tubeless tires have some ability to self-seal if they are punctured. However, because leakage is often very slow, you should look closely for punctures if a tire starts losing pressure.

## **Tire Pressure Adjustment For High Speed Driving**

Honda strongly recommends that you not drive faster than posted speed limits and conditions allow. If you decide it is safe to drive at high speeds, be sure to adjust the cold tire pressures as shown below. If you do not adjust the tire pressure, excessive heat can build up and cause sudden tire failure.

Tire Size	Cold Tire Pressure for Normal Driving (by location)
205 50R16 87V	40 psi (270 kPa), 2.8 kgf/cm <sup>2</sup>

Be sure to readjust the pressure for normal driving speeds. You should wait until the tires are cold before adjusting the tire pressure.

## **Inspection**

Every time you check inflation, you should also examine the tires for damage, foreign objects, and wear.

You should look for:

- Bumps or bulges in the tread or side of the tire. Replace the tire if you find either of these conditions.
- Cuts, splits, or cracks in the side of the tire. Replace the tire if you can see fabric or cord.
- Excessive tread wear.

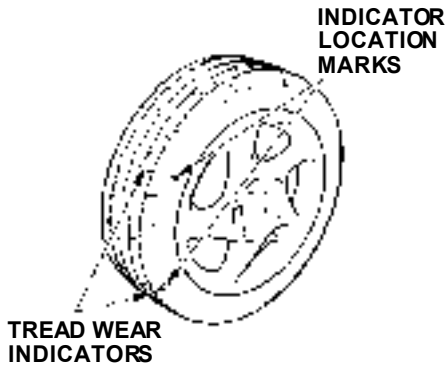

Your car's tires have wear indicators molded into the tread. When the tread wears down to that point, you will see a 1/2 inch (12.7 mm) wide band running across the tread. This shows there is less than 1/16 inch (1.6 mm) of tread left on the tire. A tire that is this worn gives very little traction on wet roads. You should replace the tire if you can see the tread wear indicator in three or more places around the tire.

## Maintenance

In addition to proper inflation, correct wheel alignment helps to decrease tire wear. If you find a tire is worn unevenly, have your dealer check the wheel alignment.

The tires were properly balanced by the factory. They may need to be rebalanced at some time before they are worn out. Have your dealer check the tires if you feel a consistent vibration while driving. A tire should always be rebalanced if it is removed from the wheel for repair.

Make sure the installer balances the wheels when you have new tires installed. This increases riding comfort and tire life. Your car's original tires were dynamic or "spin" balanced at the factory. For best results, have the installer perform a dynamic balance.

## NOTICE

*Improper wheel weights can damage your car's aluminum wheels. Use only Genuine Honda wheel weights for balancing.*

# Tires

## Tire Rotation

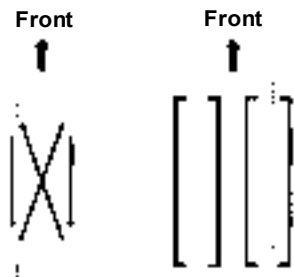

(For Non-directional Tires and Wheels) (For Directional Tires and Wheels)

To help increase tire life and distribute wear more evenly, you should have the tires rotated every 7,500 miles (12,000 km). Move the tires to the positions shown in the chart each time they are rotated.

When shopping for replacement tires, you may find that some tires are "directional." This means they are designed to rotate only in one direction. If you use directional tires, they should be rotated only front-to-back.

### Replacing Tires and Wheels

The tires that came with your car were selected to match the performance capabilities of the car while providing the best combination of handling, ride comfort, and long life. You should replace them with radial tires of the same size, load range, speed rating, and maximum cold tire pressure rating (as shown on the tire's sidewall). Mixing radial and bias-ply tires on your car can reduce its braking ability, traction, and steering accuracy.

### **WARNING**

Installing improper tires on your car can affect handling and stability. This can cause a crash in which you can be seriously hurt or killed.

Always use the size and type of tires recommended in this owner's manual.

It is best to replace all four tires at the same time. If that is not possible or necessary, then replace the two front tires or the two rear tires as a pair. Replacing just one tire can seriously affect your car's handling.

The ABS works by comparing the speed of the wheels. When replacing tires, use the same size originally supplied with the car. Tire size and construction can affect wheel speed and may cause the system to work inconsistently.

If you ever need to replace a wheel, make sure the wheel's specifications match those of the original wheel that came on your car. Replacement wheels are available at your Honda dealer.

## Wheels and Tires

Wheel:

16x6 1/2 JJ

Tire:

205/50R1687V

See page [266](#) for information about DOT Tire Quality Grading.

## Winter Driving

Tires that are marked "M + S" or "All Season" on the sidewall have an all-weather tread design. They should be suitable for most winter driving conditions. Tires without these markings are designed for optimum traction in dry conditions. They may not provide adequate performance in winter driving. For the best performance in snowy or icy conditions, you should install snow tires or tire chains. They may be required by local laws under certain conditions.

*CONTINUED*

# Tires

---

## ***Snow Tires***

If you mount snow tires on your Honda, make sure they are radial tires of the same size and load range as the original tires. Mount snow tires on all four wheels to balance your car's handling in all weather conditions. Keep in mind the traction provided by snow tires on dry roads may not be as high as your car's original equipment tires. You should drive cautiously even when the roads are clear. Check with the tire dealer for maximum speed recommendations.

## ***Tire Chains***

Mount traction devices (cable-type) only when required by driving conditions or local laws. Make sure they are the correct size for your tires. Install them only on the front tires.

When installing traction devices, follow the manufacturer's instructions and mount them as tightly as you can. Drive slowly with them installed. If you hear them coming in contact with the body or chassis, stop and investigate. Make sure the traction devices are installed tightly, and that they are not contacting the brakes or suspension.

Remove them as soon as you start driving on cleared roads.

## **NOTICE**

*Traction devices that are the wrong size or improperly installed can damage your car's brake lines, suspension, body, and wheels. Stop driving if they are hitting any part of the car.*

# Lights

PARKING LIGHT

HEADLIGHT LOW BEAM

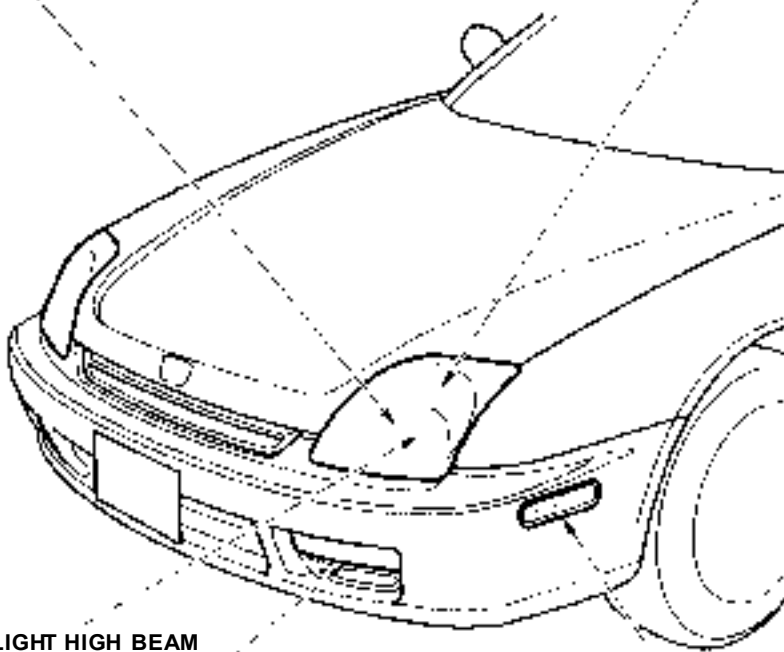

HEADLIGHT HIGH BEAM

TURN SIGNAL

SIDE MARKER LIGHT

Check the operation of your car's exterior lights at least once a month. A burned out bulb can create an unsafe condition by reducing your car's visibility and the ability to signal your intentions to other drivers.

*CONTINUED*

# Lights

---

Check the following:

- Headlights (low and high beam)
- Parking lights
- Taillights
- Brake lights
- High-mount brake light
- Turn signals
- Back-up lights
- Hazard light function
- License plate light
- Side marker lights
- Daytime running lights (Canadian models)

If you find any bulbs are burned out, replace them as soon as possible. Refer to the chart on page [265](#) to determine what type of replacement bulb is needed.

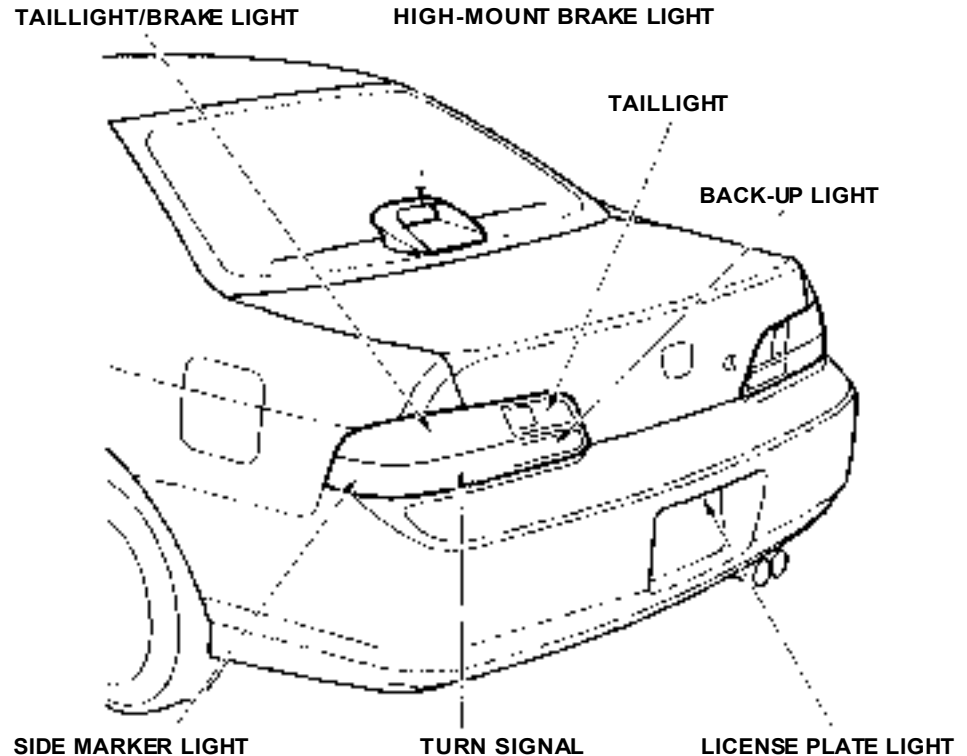

## Headlight Aiming

The headlights were properly aimed when your car was new. You should check their aim if you regularly carry heavy items in the trunk or pull a trailer. Each headlight assembly has horizontal and vertical adjustment indicators. These are set to their "0" positions after the headlights are aimed at the factory.

To check these settings:

1. Make sure the fuel tank is full.  
Park the vehicle on level ground.
2. The driver or someone who weighs the same should be sitting in the driver's seat for all checks and adjustments.  
Load the trunk with the items you normally carry.

HORIZONTAL ANGLE GAUGE

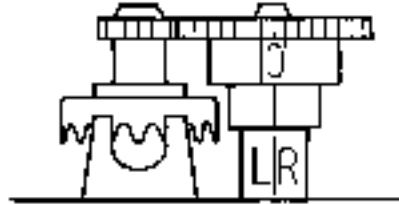

If you usually pull a trailer, load it as you would normally and attach it to the car. Push down on the front and rear bumpers several times to make sure the car is sitting normally.

3. Open the hood.
4. Check the horizontal angle gauge. The line on the adjustment screw indicator should line up with the "0" mark on the gauge.

VERTICAL ANGLE GAUGE



BUBBLE

5. Check the vertical angle gauge. The bubble should be centered underneath the longest scribe mark on the gauge.

CONTINUED



# Lights

---

## HORIZONTAL ADJUSTMENT

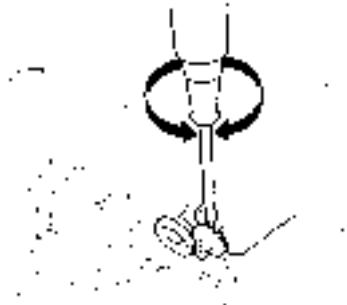

## VERTICAL ADJUSTMENT



6. If either indicator is not aligned with its "0" mark as described, an adjustment can be made using a Phillips-head screwdriver to realign it with the "0" mark. Please refer to the illustrations.

7. If you cannot get an indicator to align, have your Honda dealer inspect the vehicle for body damage or suspension problems.

## Replacing a Headlight Bulb

Your car has two bulbs on each side, four in total. Make sure you are replacing the bulb that is burned out. Your car uses halogen headlight bulbs. When replacing a bulb, handle it by its plastic case and protect the glass from contact with your skin or hard objects. If you touch the glass, clean it with denatured alcohol and a clean cloth.

The headlight bulbs in your car are H1 headlight bulbs for longer life. We recommend the use of Genuine Honda parts for replacing a headlight bulb.

### NOTICE

*Halogen headlight bulbs get very hot when lit. Oil, perspiration, or a scratch on the glass can cause the bulb to overheat and shatter.*

1. Open the hood.
2. Remove the electrical connector from the bulb by squeezing the connector on both sides to unlock the tab. Pull the connector straight off.

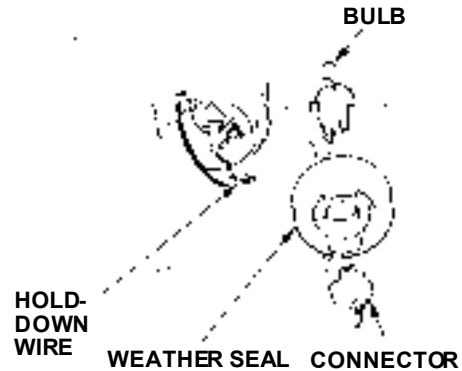

3. Remove the rubber weather seal by pulling on the tab.
4. Unclip the end of the hold-down wire from its slot. Pivot it out of the way and remove the bulb.
5. Insert the new bulb into the hole, making sure the tabs are in their slots. Pivot the hold-down wire back in place and clip the end into the slot.
6. Install the rubber seal over the back of the headlight assembly. Make sure it is right side up; it is marked "TOP."
7. Push the electrical connector onto the tabs of the new bulb. Make sure it locks in place. Turn on the headlights to test the new bulb.

# Lights

---

## Replacing a Parking Light Bulb

1. Open the hood. The front parking light is next to the headlight bulb.

If you need to change a bulb on the passenger's side, remove the radiator reserve tank by pulling it out of its holder.



2. Remove the socket from the headlight assembly by turning it one-quarter turn counterclockwise.

3. Pull the bulb straight out of its socket.

Push the new bulb straight into the socket until it bottoms.

4. Insert the socket back into the headlight assembly. Turn it clockwise to lock it in place.
5. Turn on the parking lights to make sure the new bulb works.
6. (Passenger's side)  
Reinstall the radiator reserve tank.

## Replacing a Front Side Marker Light Bulb

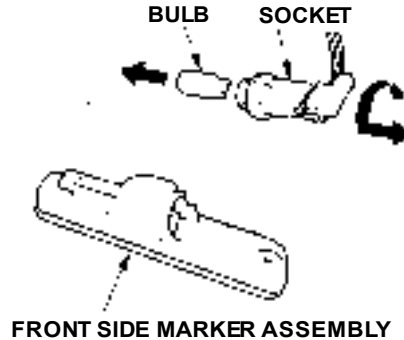
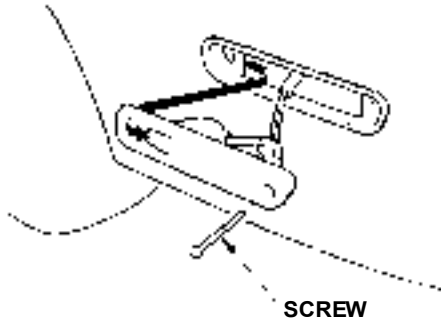

1. Use a Phillips-head screwdriver to remove the side marker assembly's mounting screw.
2. Remove the side marker assembly from the bumper.

3. Remove the socket from the side marker assembly by turning it one-quarter turn counterclockwise.
4. Pull the bulb straight out of its socket.

Push the new bulb straight into the socket until it bottoms.

5. Insert the socket back into the side marker assembly. Turn it clockwise to lock it in place.
6. Test the side marker to make sure the new bulb is working.
7. Put the side marker assembly into the bumper. Make sure the tab on the side marker assembly fits into the bumper slot. Tighten the mounting screw.

# Lights

---

## Replacing a Front Turn Signal Light Bulb

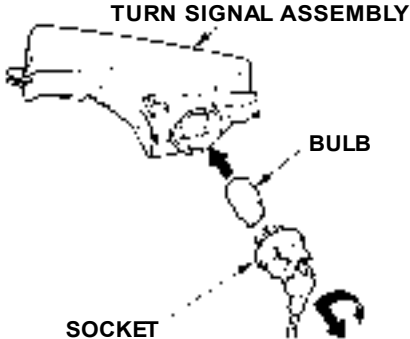
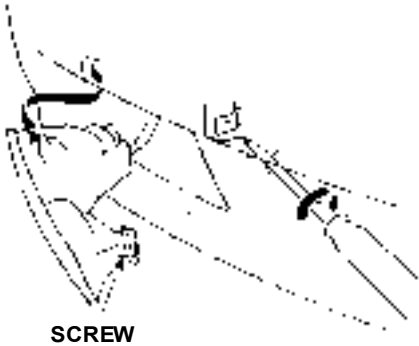

1. Use a Phillips-head screwdriver to loosen the turn signal assembly's mounting screw.
2. Remove the turn signal assembly from the bumper.

3. Remove the socket from the turn signal assembly by turning it one-quarter turn counterclockwise.
4. Pull the bulb straight out of its socket. Push the new bulb straight into the socket until it bottoms.

5. Insert the socket back into the turn signal assembly. Turn it clockwise to lock it in place.
6. Test the lights to make sure the new bulb is working.
7. Put the turn signal assembly into the bumper. Make sure the tab on the turn signal assembly fits into the bumper slot. Tighten the mounting screw.

## Replacing Rear Bulbs

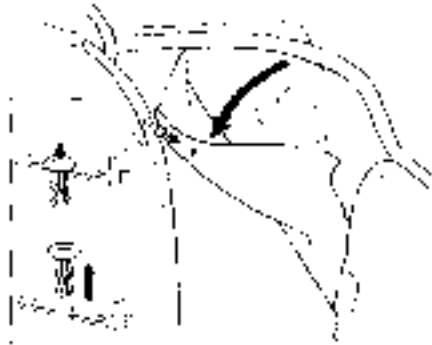

1. Open the trunk.
2. Undo the fastener on the side of the trunk lining by pushing on the center of the fastener's head until it pops in. Pull the lining back.
3. Determine which of the five bulbs is burned out: stop/taillight, turn signal light, side marker light, back-up light, or taillight.
4. Remove the socket by turning it one-quarter turn counterclockwise.
5. Pull the bulb straight out of its socket.  
Push the new bulb straight into the socket until it bottoms.

*CONTINUED*

## Lights

---

6. Reinstall the socket into the light assembly by turning it clockwise until it locks.
7. Test the lights to make sure the new bulb is working.
8. Reinstall the trunk lining.

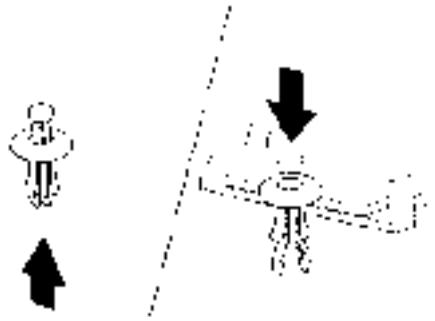

9. Reset the fastener by pushing on the pointed end until it pops back almost flush with the fingers on the housing.
10. Put the fastener in the hole in the side of the trunk lining and push on the center until it locks (the center is flush with the head).

## Replacing a High-mount Brake Light Bulb (Except Type SH model)

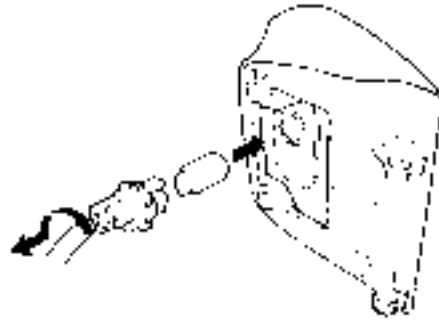
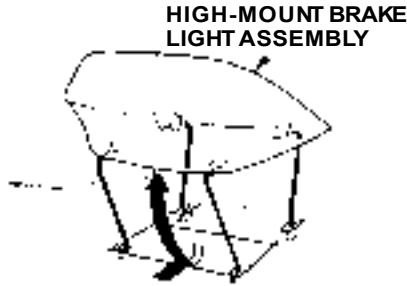

1. Remove the high-mount brake light assembly by pushing it slightly toward the rear windshield and sliding it out of the rear shelf.

2. Remove the socket from the light assembly by turning it one-quarter turn counterclockwise.

3. Pull the bulb straight out of its socket.  
Push the new bulb straight into the socket until it bottoms.

4. Reinstall the socket. Turn it clockwise until it locks.

5. Test the lights to make sure the new bulb is working.

6. Reinstall the high-mount brake light assembly on the rear shelf. Make sure the tabs on the high-mount brake light assembly fit into the slots.



# Lights

---

## Replacing a Rear License Bulb



1. Use a Phillips-head screwdriver to remove the two screws holding the license plate light assembly to the bracket. Pull the assembly away from the bracket.



2. Remove the socket from the light assembly by turning it one-quarter turn counterclockwise.

3. Pull the bulb straight out of its socket. Push the new bulb in until it bottoms in the socket.

4. Turn on the parking lights and check that the new bulb is working.

5. Put the license light assembly in place. Reinstall the two screws and tighten them securely.

## Replacing Bulbs in the Interior Courtesy Lights

The courtesy lights in the doors and roof come apart the same way. They do not all use the same bulb.

The spotlight bulbs are in the ceiling light housing.

1. Remove the lens by carefully prying on the edge of the lens with a fingernail file or a small flat-tip screwdriver. Do not pry on the edge of the housing around the lens.

Ceiling light:

Pry on the front edge of the lens in the middle.

*On Type SH*

Door light:

Pry on the top middle of the lens.

CEILING LIGHT



2. Remove the bulb by pulling it straight out of its metal tabs.
3. Push the new bulb into the metal tabs. Snap the lens back in place.

DOOR LIGHT

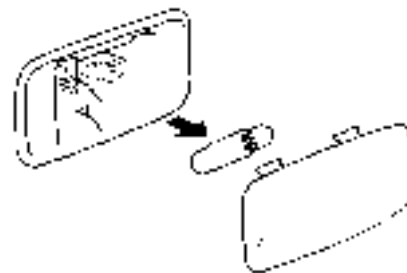

# Lights

---

## Replacing the Trunk Light Bulb

### TRUNK LIGHT

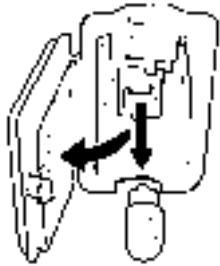

1. Open the trunk. Pull down the trunk light cover.
2. Remove the bulb by pulling it straight out of its metal tabs.
3. Push the new bulb into the metal tabs.
4. Push the cover back in place.

If you need to park your car for an extended period (more than one month), there are several things you should do to prepare it for storage. Proper preparation helps prevent deterioration and makes it easier to get your car back on the road. If possible, store your car indoors.

- Fill the fuel tank.
- Change the engine oil and filter (see page [183](#) ).
- Wash and dry the exterior completely.
- Clean the interior. Make sure the carpeting, floor mats, etc. are completely dry.
- Leave the parking brake off. Put the transmission in Reverse (5-speed manual) or Park (automatic).
- Block the rear wheels.
- If the car is to be stored for a longer period, it should be supported on jackstands so the tires are off the ground.
- Leave one window open slightly (if the car is being stored indoors).
- Disconnect the battery.
- Support the front wiper blade arms with a folded towel or rag so they do not touch the windshield.
- To minimize sticking, apply a silicone spray lubricant to all door and trunk seals. Also, apply a vehicle body wax to the painted surfaces that mate with the door and trunk seals.
- Cover the car with a "breathable" cover, one made from a porous material such as cotton. Nonporous materials, such as plastic sheeting, trap moisture, which can damage the paint.
- If possible, run the engine for a while periodically (preferably once a month).

If you store your car for 12 months or longer, have your Honda dealer perform the inspections called for in the 24 months/30,000 miles (48,000 km) maintenance schedule (Normal Conditions) as soon as you take it out of storage (see page [172](#)). The replacements called for in the maintenance schedule are not needed unless the car has actually reached that time or mileage.



Regular cleaning and polishing of your Honda helps to keep it "new" looking. This section gives you hints on how to clean your car and preserve its appearance: the paint, brightwork, wheels and interior. Also included are several things you can do to help prevent corrosion.

Exterior Care.....	228
Washing.....	228
Waxing.....	229
Aluminum Wheels.....	229
Paint Touch-up.....	229
Interior Care.....	230
Carpeting.....	230
Fabric.....	230
Vinyl.....	230
Seat Belts.....	231
Windows.....	231
Air Fresheners.....	232
Corrosion Protection.....	232
Body Repairs.....	233

## Exterior Care

---

### Washing

Frequent washing helps preserve your car's beauty. Dirt and grit can scratch the paint, while tree sap and bird droppings can permanently ruin the finish.

Wash your car in a shady area, not in direct sunlight. If the car is parked in the sun, move it into the shade and let the exterior cool down before you start.

Only use the solvents and cleaners recommended in this Owner's Manual.

#### NOTICE

*Chemical solvents and strong cleaners can damage the paint, metal, and plastic on your car.*

- Rinse the car thoroughly with cool water to remove loose dirt.
- Fill a bucket with cool water. Mix in a mild detergent, such as dishwashing liquid or a product made especially for car washing.
- Wash the car using the water and detergent solution and a soft-bristle brush, sponge, or soft cloth. Start at the top and work your way down. Rinse frequently.
- Check the body for road tar, tree sap, etc. Remove these stains with tar remover or turpentine. Rinse it off immediately so it does not harm the finish. Remember to re-wax these areas, even if the rest of the car does not need waxing.
- When you have washed and rinsed the whole exterior, dry it with a chamois or soft towel. Letting it air-dry will cause dulling and water spots.

As you dry the car, inspect it for chips and scratches that could allow corrosion to start. Repair them with touch-up paint (see page [229](#)).

### **Waxing**

Always wash and dry the whole car before waxing it. You should wax your car, including the metal trim, whenever water sits on the surface in large patches. It should form into beads or droplets after waxing.

You should use a quality liquid or paste wax. Apply it according to the instructions on the container. In general, there are two types of products:

**Waxes** — A wax coats the finish and protects it from damage by exposure to sunlight, air pollution, etc. You should use a wax on your Honda when it is new.

**Polishes** — Polishes and cleaner/waxes can restore the shine to paint that has oxidized and lost some of its shine. They normally contain mild abrasives and solvents that remove the top layer of the finish. You

should use a polish on your Honda if the finish does not have its original shine after using a wax.

Cleaning tar, insects, etc. with removers also takes off the wax. Remember to re-wax those areas, even if the rest of the car does not need waxing.

### **Aluminum Wheels**

Clean your Honda's aluminum alloy wheels as you do the rest of the exterior. Wash them with the same solution, and rinse them thoroughly.

The wheels have a protective clear-coat that keeps the aluminum from corroding and tarnishing. Using harsh chemicals, including some commercial wheel cleaners, or stiff brushes can damage this clear-coat. Only use a mild detergent and soft brush or sponge to clean the wheels.

### **Paint Touch-up**

Your dealer has touch-up paint to match your car's color. The color code is printed on a sticker on the driver's doorjamb. Take this code to your dealer so you are sure to get the correct color.

Inspect your car frequently for chips or scratches in the paint. Repair them right away to prevent corrosion of the metal underneath. Use the touch-up paint only on small chips and scratches. More extensive paint damage should be repaired by a professional.



## Interior Care

---

### **Carpeting**

Vacuum the carpeting frequently to remove dirt. Ground-in dirt will make the carpet wear out faster.

Periodically shampoo the carpet to keep it looking new. Use one of the foam-type carpet cleaners on the market. Follow the instructions that come with the cleaner, applying it with a sponge or soft brush. Keep the carpeting as dry as possible by not adding water to the foam.

### **Fabric**

Vacuum dirt and dust out of the material frequently. For general cleaning, use a solution of mild soap and lukewarm water, letting it air dry. To clean off stubborn spots, use a commercially-available fabric cleaner. Test it on a hidden area of the fabric first, to make sure it does not bleach or stain the fabric. Follow the instructions that come with the cleaner.

### **Vinyl**

Remove dirt and dust with a vacuum cleaner. Wipe the vinyl with a soft cloth dampened in a solution of mild soap and water. Use the same solution with a soft-bristle brush on more difficult spots. You can also use commercially-available spray or foam-type vinyl cleaners.

### Seat Belts

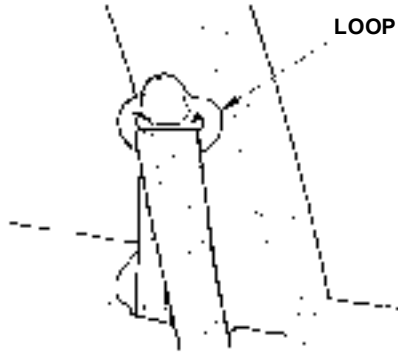

If your seat belts get dirty, you can use a soft brush with a mixture of mild soap and warm water to clean them. Do not use bleach, dye, or cleaning solvents. They can weaken the belt material. Let the belts air-dry before you use the car.

Dirt build-up in the loops of the seat belt anchors can cause the belts to retract slowly. Wipe the insides of the loops with a clean cloth dampened in mild soap and warm water or isopropyl alcohol.

### Windows

Clean the windows, inside and out, with a commercially-available glass cleaner. You can also use a mixture of one part white vinegar to ten parts water. This will remove the haze that builds up on the inside of the windows. Use a soft cloth or paper towels to clean all glass and clear plastic surfaces.

#### NOTICE

*The rear window defogger and antenna wires are bonded to the inside of the glass. Wiping vigorously up-and-down can dislodge and break these wires. When cleaning the rear window, use gentle pressure and wipe side-to-side.*

## Interior Care, Corrosion Protection

---

### Air Fresheners

If you want to use an air freshener/deodorizer in the interior of your car, it is best to use a solid type. Some liquid air fresheners contain chemicals that may cause parts of the interior trim and fabric to crack or discolor.

If you use a liquid air freshener, make sure you fasten it securely so it does not spill as you drive.

### Corrosion Protection

Two factors normally contribute to causing corrosion in your car:

1. Moisture trapped in body cavities. Dirt and road salt that collects in hollows on the underside of the car stays damp, promoting corrosion in that area.
2. Removal of paint and protective coatings from the exterior and underside of the car.

Many corrosion-preventive measures are built into your Honda. You can help keep your car from corroding by performing some simple periodic maintenance:

- Repair chips and scratches in the paint as soon as you discover them.

- Inspect and clean out the drain holes in the bottom of the doors and body.
- Check the floor coverings for dampness. Carpeting and floor mats may remain damp for a long-time, especially in winter. This dampness can eventually cause the floor panels to corrode.
- Use a high-pressure spray to clean the underside of your car. This is especially important in areas that use road salt in winter. It is also a good idea in humid climates and areas subject to salt air. Be careful of the ABS wheel sensors and wiring at each wheel.
- Have the corrosion-preventive coatings on the underside of your car inspected and repaired periodically.

Body repairs can affect your car's resistance to corrosion. If your car needs repairs after a collision, pay close attention to the parts used in the repair and the quality of the work.

Make sure the repair facility uses Genuine Honda replacement body parts. Some companies make sheet metal pieces that seem to duplicate the original Honda body parts, but are actually inferior in fit, finish, and corrosion resistance. Once installed, they do not give the same high-quality appearance.

When reporting your collision to the insurance company, tell them you want Genuine Honda parts used in the repair. Although most insurers recognize the quality of original parts, some may try to specify that the repairs be done with other available parts. You should investigate this before any repairs have begun.

Take your car to your authorized Honda dealer for inspection after the repairs are completed. Your dealer can make sure that quality materials were used, and that corrosion-preventive coatings were applied to all repaired and replaced parts.



This section covers the more-common problems that motorists experience with their vehicles. It gives you information about how to safely evaluate the problem and what to do to correct it. If the problem has stranded you on the side of the road, you may be able to get going again. If not, you will also find instructions on getting your car towed.

Compact Spare Tire.....	236
Changing a Flat Tire .....	237
If Your Engine Won't Start.....	242
Nothing Happens or the Starter Motor Operates Very Slowly.....	243
The Starter Operates Normally.....	244
Jump Starting.....	244
If Your Engine Overheats.....	246
Low Oil Pressure Indicator.....	248
Charging System Indicator.....	249
Malfunction Indicator Lamp .....	250
Brake System Indicator.....	251
Closing the Moonroof.....	252
Fuses.....	253
Checking and Replacing.....	254
Emergency Towing.....	258

## Compact Spare Tire

---

Your car has a compact spare tire that takes up less space. Use this spare tire as a temporary replacement only. Get your regular tire repaired or replaced and put back on your car as soon as you can.

Check the inflation pressure of the compact spare tire every time you check the other tires. It should be inflated to:  
60 psi (420 kPa , 4.2 kgf/cm<sup>2</sup>)

Follow these precautions whenever you are using the compact spare tire:

- Do not exceed 50 mph (80 km/h) under any circumstances.
- This tire gives a harsher ride and less traction on some road surfaces than the regular tire. Use greater caution while driving on this tire.
- Do not mount snow chains on the compact spare.
- The wheel of the compact spare tire is designed especially to fit your car. Do not use your spare tire on another vehicle unless it is the same make and model.

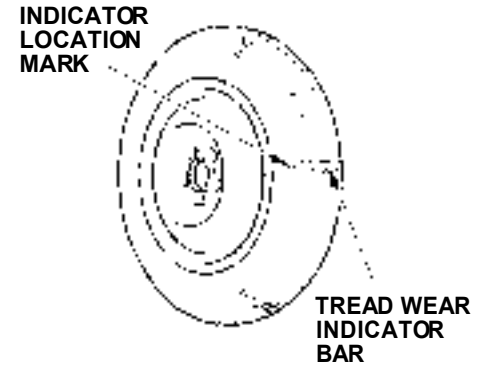

The compact spare tire has a shorter tread life than a regular tire. Replace it when you can see the tread wear indicator bars. The replacement should be the same size and design tire, mounted on the same wheel. The compact spare tire is not designed to be mounted on a regular wheel, and the compact wheel is not designed for mounting a regular tire.

## Changing a Flat Tire

If you have a flat tire while driving, stop in a safe place to change it. Stopping in traffic or on the shoulder of a busy road is dangerous. Drive slowly along the shoulder until you get to an exit or an area to stop that is far away from the traffic lanes.

### **WARNING**

The car can easily roll off the jack, seriously injuring anyone underneath.

Follow the directions for changing a tire exactly, and never get under the car when it is supported only by the jack.

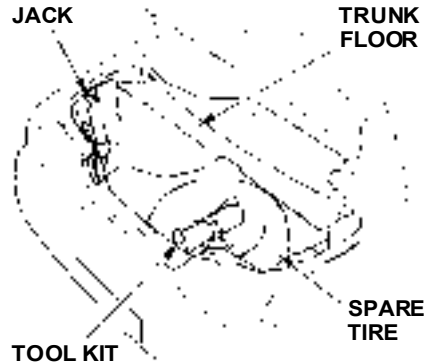

1. Park the car on firm, level and non-slippery ground away from traffic. Put the transmission in Park (automatic) or Reverse (manual). Apply the parking brake.
2. Turn on the hazard warning lights and turn the ignition switch to LOCK (0). Have all the passengers get out of the car while you change the tire.
3. Open the trunk. Raise the trunk floor by lifting up on the back edge.
4. Take the tool kit out of the trunk.
5. Unscrew the wing bolt and take the spare tire out of its well.

*CONTINUED*



## Changing a Flat Tire

---

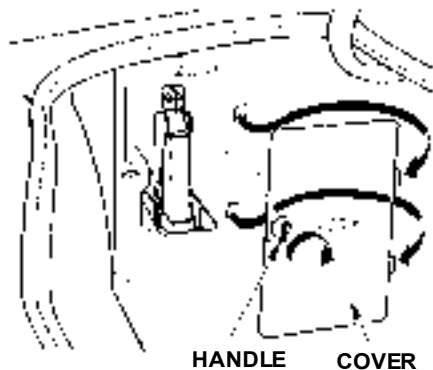

6. The jack is behind a cover in the left fender. Remove the cover by turning the handle clockwise, then pulling on the cover.

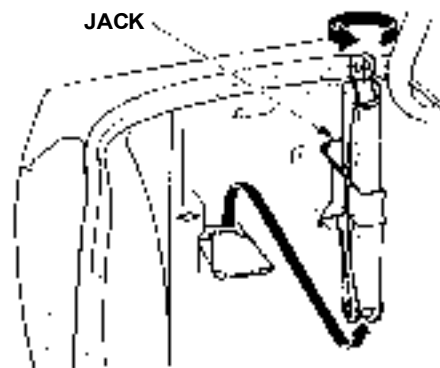

7. Turn the jack's end bracket counterclockwise to loosen it, then remove the jack.

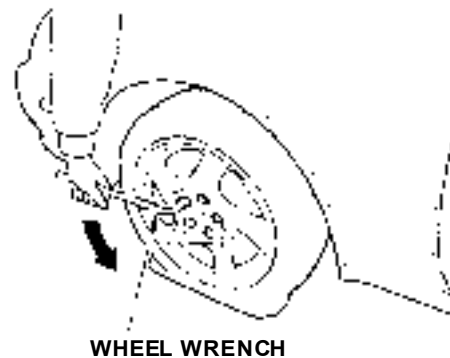

8. Loosen the five wheel nuts 1/2 turn with the wheel wrench.



9. Locate the jacking point nearest the tire you need to change. It is pointed to by a  $\triangle$  mark molded into the underside of the body. Place the jack under the jacking point. Turn the end bracket clockwise until the top of the jack contacts the jacking point. Make sure the jacking point tab is resting in the jack notch.

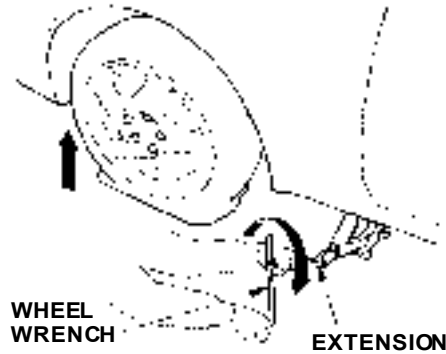

10. Use the extension and wheel wrench as shown to raise the vehicle until the flat tire is off the ground.

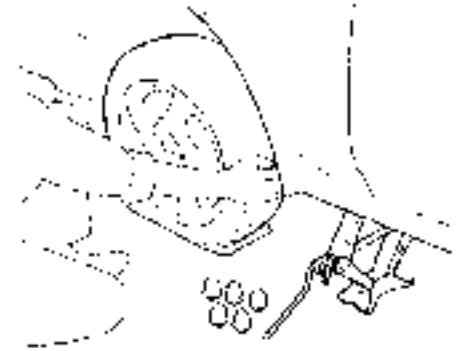

11. Remove the wheel nuts and flat tire. Temporarily place the flat tire on the ground with the outside surface of the wheel facing up. You could scratch the wheel if you put it face down.

*CONTINUED*

## Changing a Flat Tire

---

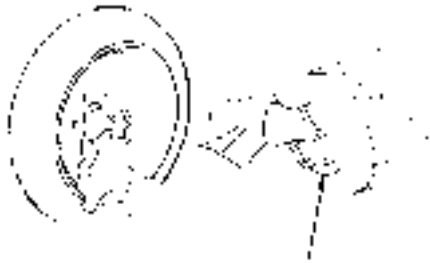

**BRAKE HUB**

12. Before mounting the spare tire, wipe any dirt off the mounting surface of the wheel and hub with a clean cloth. Wipe the hub carefully, it may be hot from driving.

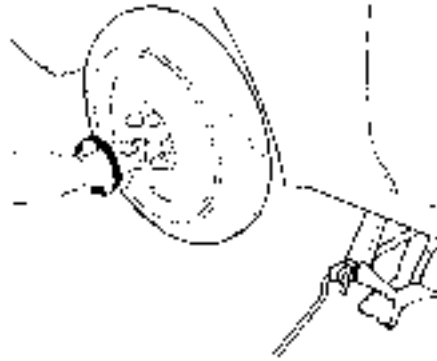

13. Put on the spare tire. Put the wheel nuts back on finger-tight, then tighten them in a crisscross pattern with the wheel wrench until the wheel is firmly against the hub. Do not try to tighten them fully.

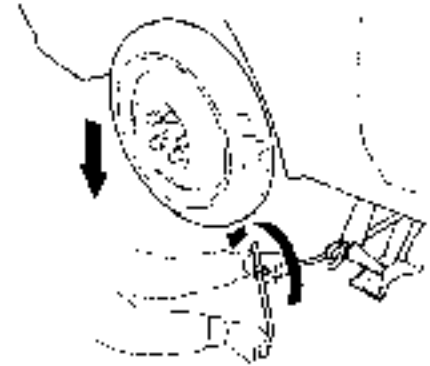

14. Lower the car to the ground and remove the jack.

## Changing a Flat Tire

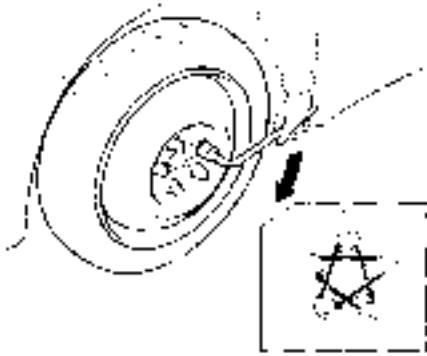

15. Tighten the wheel nuts securely in the same crisscross pattern. Have the wheel nut torque checked at the nearest automotive service facility.

Tighten the wheel nuts to:  
80 lbf.ft (108 N.m, 11 kgf.m)



16. Remove the center cap before storing the flat tire in the trunk well.

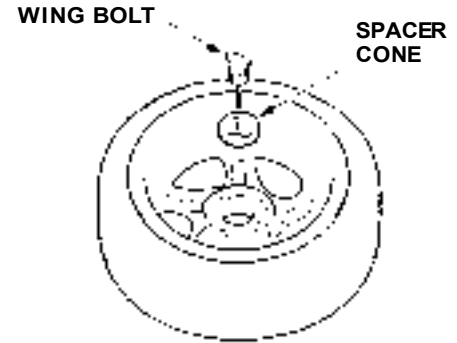

17. Place the flat tire face down in the spare tire well.
18. Remove the spacer cone from the wing bolt, turn it over, and put it back on the bolt.

*CONTINUED*

## Changing a Flat Tire, If Your Engine Won't Start

---

19. Secure the flat tire by screwing the wing bolt back into its hole.
20. Store the jack in its holder. Turn the jack's end bracket to lock it in place. Replace the cover. Store the tool kit.

### **WARNING**

Loose items can fly around the interior in a crash and could seriously injure the occupants.

Store the wheel, jack and tools securely before driving.

21. Store the center cap in the trunk. Make sure it does not get scratched or damaged.
22. Lower the trunk floor, then close the trunk lid.

#### *Type SH only*

If you mount the compact spare on either front or rear tire, it may cause the ATTS indicator light in the instrument panel to come on due to the difference in tire diameter. The light will go out when the proper tire is installed.

### **If Your Engine Won't Start**

Diagnosing why your engine won't start falls into two areas, depending on what you hear when you turn the key to START (III):

- You hear nothing, or almost nothing. The engine's starter motor does not operate at all, or operates very slowly.
- You can hear the starter motor operating normally, or the starter motor sounds like it is spinning faster than normal, but the engine does not start up and run.

### **Nothing Happens or the Starter Motor Operates Very Slowly**

When you turn the ignition switch to START (III), you do not hear the normal noise of the engine trying to start. You may hear a clicking sound or series of clicks, or nothing at all. Check these things:

- Your car has the Immobilizer System. You should use a properly-coded master or valet key to start the engine (see page 71). A key that is not properly coded will cause the immobilizer system indicator in the dash panel to blink rapidly.
- Check the transmission interlock. If you have a manual transmission, the clutch pedal must be pushed all the way to the floor or the starter will not operate. With an automatic transmission, it must be in Park or Neutral.
- Turn the ignition switch to ON (II). Turn on the headlights and check their brightness. If the headlights are very dim or don't light at all, the battery is discharged. See **Jump Starting** on page 244 .
- Turn the ignition switch to START (III). If the headlights do not dim, check the condition of the fuses. If the fuses are OK, there is probably something wrong with the electrical circuit for the ignition switch or starter motor. You will need a qualified technician to determine the problem. (See **Emergency Towing** on page 258.)

If the headlights dim noticeably or go out when you try to start the engine, either the battery is discharged or the connections are corroded. Check the condition of the battery and terminal connections (see page 198). You can then try jump starting the car from a booster battery (see page 244).

## If Your Engine Won't Start, Jump Starting

---

### The Starter Operates Normally

In this case, the starter motor's speed sounds normal, or even faster than normal, when you turn the ignition switch to START (III), but the engine does not run.

- Are you using the proper starting procedure? Refer to **Starting the Engine** on page 141.
- Do you have fuel? Turn the ignition switch to ON (II) for a minute and watch the fuel gauge. The low fuel level warning light may not be working, so you were not reminded to fill the tank.
- There may be an electrical problem, such as no power to the fuel pump. Check all the fuses (see page 254).

If you find nothing wrong, you will need a qualified technician to find the problem. See **Emergency Towing** on page 258 .

### Jump Starting

If your car's battery has run down, you may be able to start the engine by using a booster battery. Although this seems like a simple procedure, you should take several precautions.

#### **WARNING**

A battery can explode if you do not follow the correct procedure, seriously injuring anyone nearby.

Keep all sparks, open flames, and smoking materials away from the battery.

You cannot start a Honda with an automatic transmission by pushing or pulling it.

To jump start your car, follow these directions closely:

1. Open the hood and check the physical condition of the battery (see page 198). In very cold weather, check the condition of the electrolyte. If it seems slushy or like ice, do not try jump starting until it thaws.

#### **NOTICE**

*If a battery sits in extreme cold, the electrolyte inside can freeze. Attempting to jump start with a frozen battery can cause it to rupture.*

2. Turn off all the electrical accessories: heater, A/C, stereo system, lights, etc.

Put the transmission in Neutral or Park and set the parking brake.

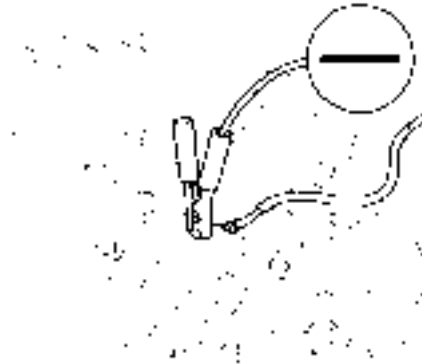
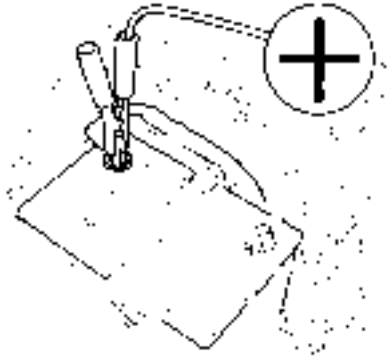

**BOOSTER BATTERY**

3. Connect one jumper cable to the positive (+) terminal on the booster battery. Connect the other end to the positive (+) terminal on your Honda's battery.
4. Connect the second jumper cable to the negative (—) terminal on the booster battery. Connect the other end to the grounding strap as shown. Do not connect this jumper cable to any other part of the engine.
5. If the booster battery is in another vehicle, have an assistant start that vehicle and run it at a fast idle.
6. Start your car. If the starter motor still operates slowly, check the jumper cable connections to make sure they have good metal-to-metal contact.
7. Once your car is running, disconnect the negative cable from your car, then from the booster battery. Disconnect the positive cable from your car, then the booster battery.



## If Your Engine Overheats

---

The pointer of your car's temperature gauge should stay in the mid-range under most conditions. It may go higher if you are driving up a long steep hill on a very hot day. If it climbs to the red mark, you should determine the reason.

### NOTICE

*Driving with the temperature gauge pointer at the red mark can cause serious damage to your engine.*

Your car can overheat for several reasons, such as lack of coolant or a mechanical problem. The only indication may be the temperature gauge climbing to or above the red mark. Or you may see steam or spray coming from under the hood. In either case, you should take immediate action.

### WARNING

Steam and spray from an overheated engine can seriously scald you.

Do not open the hood if steam is coming out.

1. Safely pull to the side of the road. Put the transmission in Neutral or Park and set the parking brake. Turn off the heating and cooling system and all other accessories. Turn on the hazard warning indicators.

2. If you see steam and/or spray coming from under the hood, turn off the engine.
3. If you do not see steam or spray, leave the engine running and watch the temperature gauge. If the high heat is due to overloading (climbing a long, steep hill on a hot day with the A/C running, for example), the engine should start to cool down almost immediately. If it does, wait until the temperature gauge comes down to the midpoint then continue driving.
4. If the temperature gauge stays at the red mark, turn off the engine.
5. Wait until you see no more signs of steam or spray, then open the hood.

6. Look for any obvious coolant leaks, such as a split radiator hose. Everything is still extremely hot, so use caution. If you find a leak, it must be repaired before you continue driving (see **Emergency Towing** on page 258).
7. If you don't find an obvious leak, check the coolant level in the radiator reserve tank (see page 131). If the level is below the MIN mark, add coolant to halfway between the MIN and MAX marks.
8. If there was no coolant in the reserve tank, you may also have to add coolant to the radiator. Let the engine cool down until the pointer reaches the middle of the temperature gauge, or lower, before checking the radiator.

### **WARNING**

Removing the radiator cap while the engine is hot can cause the coolant to spray out, seriously scalding you.

Always let the engine and radiator cool down before removing the radiator cap.

9. Using gloves or a large heavy cloth, turn the radiator cap counterclockwise, without pushing down, to the first stop. This releases any remaining pressure in the cooling system. After the pressure releases, push down on the cap and turn it until it comes off.
10. Start the engine and set the temperature control lever to maximum. Add coolant to the radiator up to the base of the filler neck. If you do not have the proper coolant mixture available, you can add plain water. Remember to have the cooling system drained and refilled with the proper mixture as soon as you can.
11. Put the radiator cap back on tightly. Run the engine and watch the temperature gauge. If it goes back to the red mark, the engine needs repair. (See **Emergency Towing** on page 258.)
12. If the temperature stays normal, check the coolant level in the radiator reserve tank. If it has gone down, add coolant to the MAX mark. Put the cap back on tightly.

## Low Oil Pressure Indicator

---

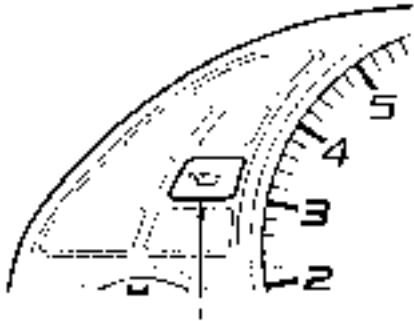

**LOW OIL PRESSURE INDICATOR**

This indicator should light when the ignition switch is ON (II), and go out after the engine starts. It should never come on when the engine is running. If it starts flashing, it indicates that the oil pressure dropped very low for a moment, then recovered. If the indicator stays on with the engine running, it shows that the engine has lost oil pressure and serious engine damage is possible. In either case, you should take immediate action.

### NOTICE

*Running the engine with low oil pressure can cause serious mechanical damage almost immediately. Turn off the engine as soon as you can safely get the car stopped.*

1. Safely pull off the road and shut off the engine. Turn on the hazard warning indicators.
2. Let the car sit for a minute. Open the hood and check the oil level (see page [130](#)). Although oil level and oil pressure are not directly connected, an engine that is very low on oil can lose pressure during cornering and other driving maneuvers.
3. If necessary, add oil to bring the level back to the full mark on the dipstick (see page [181](#)).
4. Start the engine and watch the oil pressure indicator. If the light does not go out within ten seconds, turn off the engine. There is a mechanical problem that needs to be repaired before you can continue driving. (See **Emergency Towing** on page [258](#).)

## Charging System Indicator

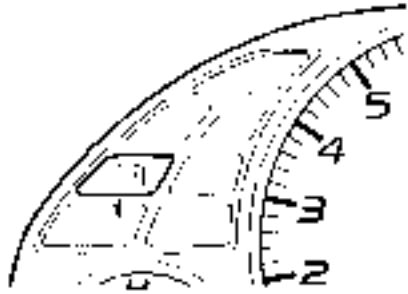

### CHARGING SYSTEM INDICATOR

This indicator should come on when the ignition switch is ON (II), and go out after the engine starts. If it comes on brightly when the engine is running, it indicates that the charging system has stopped charging the battery.

Immediately turn off all electrical accessories: radio, heater, A/C, rear defogger, cruise control, etc. Try not to use other electrically-operated controls such as the power windows. Keep the engine running and take extra care not to stall it. Starting the engine will discharge the battery rapidly.

By eliminating as much of the electrical load as possible, you can drive several miles (kilometers) before the battery is too discharged to keep the engine running. Drive to a service station or garage where you can get technical assistance.

# Malfunction Indicator Lamp

---

## MALFUNCTION INDICATOR LAMP

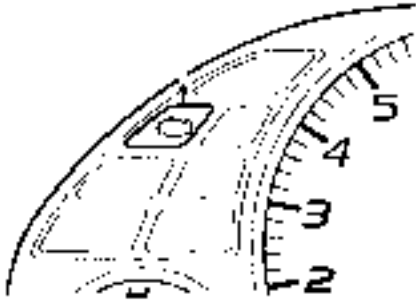

This indicator comes on for a few seconds when you turn the ignition switch ON (II). If it comes on at any other time, it indicates one of the engine's emissions control systems may have a problem. Even though you may feel no difference in your car's performance, it can reduce your fuel economy and cause your car to put out excessive emissions. Continued operation may cause serious damage.

If you have recently refueled your car, the cause of this indicator coming on could be a loose or missing fuel fill cap. Check the cap and tighten it until it clicks several times. Replace the fuel fill cap if it is missing. Tightening the cap will not make the indicator turn off immediately; it takes three driving trips.

If the indicator remains on past three driving trips, or the fuel cap was not loose or missing, have the car checked by the dealer as soon as possible. Drive moderately until the dealer has inspected the problem. Avoid full-throttle acceleration and driving at high speed.

You should also have the dealer inspect your car if this indicator comes on repeatedly, even though it may turn off as you continue driving.

## NOTICE

*If you keep driving with the malfunction indicator lamp on, you can damage your car's emissions controls and engine. Those repairs may not be covered by your car's warranties.*

## Brake System Indicator

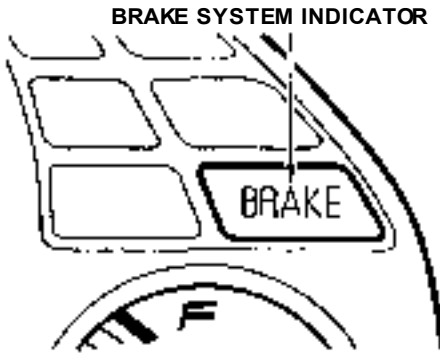

The Brake System indicator light comes on when you turn the ignition ON (II). If the parking brake is not set, it goes off after you start the engine. If the parking brake is set, it goes off when you fully release the parking brake with the engine running.

If it comes on at any other time, it indicates a problem with the car's brake system. In most cases, the problem is a low fluid level in the

brake fluid reservoir. Press lightly on the brake pedal to see if it feels normal. If it does, check the brake fluid level the next time you stop at a service station (see page 193 ). If the fluid level is low, take the car to your dealer and have the brake system inspected for leaks or worn brake pads.

However, if the brake pedal does not feel normal, you should take immediate action. Because of the brake system's dual-circuit design, a problem in one part of the system will still give you braking at two wheels. You will feel the brake pedal go down much farther before the car begins to slow down, and you will have to press harder on the pedal. The distance needed to stop will be much longer.

Slow down by shifting to a lower gear, and pull to the side of the road when it is safe. Because of the

longer distance needed to stop, it is hazardous to drive the car. You should have it towed, and repaired as soon as possible. (See **Emergency Towing** on page 258.)

If you must drive the car a short distance in this condition, drive slowly and cautiously.

## Closing the Moonroof

---

If the electric motor will not close the moonroof, do the following:

1. Check the fuse for the moonroof motor (see page [254](#)). If the fuse is blown, replace it with one of the same or lower rating.
2. Try closing the moonroof. If the new fuse blows immediately or the moonroof motor still does not operate, you can close the moonroof manually.
3. Get the sunroof wrench out of the tool kit in the trunk.

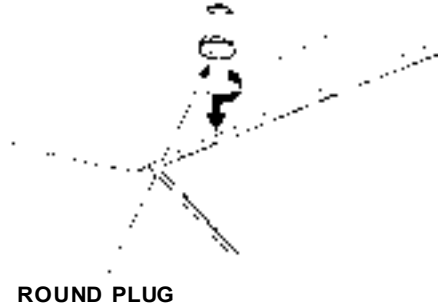

4. Use a screwdriver or coin to remove the round plug in the center of the headliner.

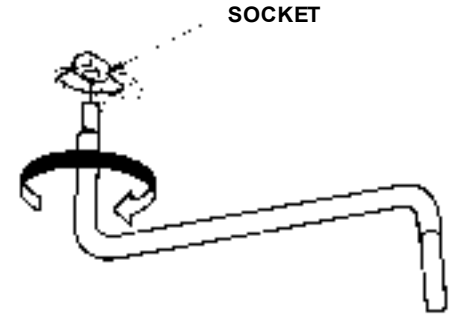

5. Insert the moonroof wrench into the socket behind this plug. Turn the wrench until the moonroof is fully closed.
6. Remove the wrench. Replace the round plug.

All the electrical circuits in your car have fuses to protect them from a short circuit or overload. These fuses are located in two fuse boxes.

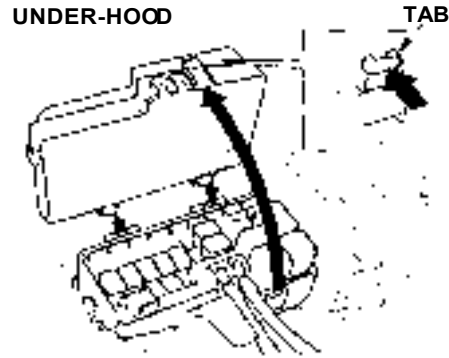

The under-hood fuse box is located in the back of the engine compartment on the passenger's side. To open it, push the tab as shown.

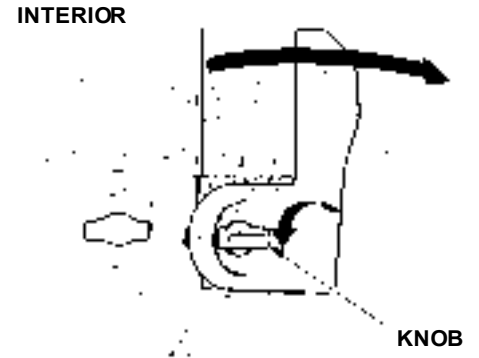

The interior fuse box is underneath the dashboard on the driver's side. To open it, turn the knob as shown.



# Fuses

## Checking and Replacing Fuses

If something electrical in your car stops working, the first thing you should check for is a blown fuse. Determine from the chart on pages [256](#) and [257](#), or the diagram on the fuse box lid, which fuse or fuses control that component. Check those fuses first, but check all the fuses before deciding that a blown fuse is not the cause. Replace any blown fuses and check the component's operation.

1. Turn the ignition switch to LOCK (0). Make sure the headlights and all other accessories are off.
2. Remove the cover from the fuse box.

FUSE

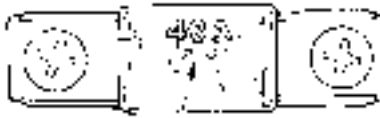

BLOWN

FUSE PULLER

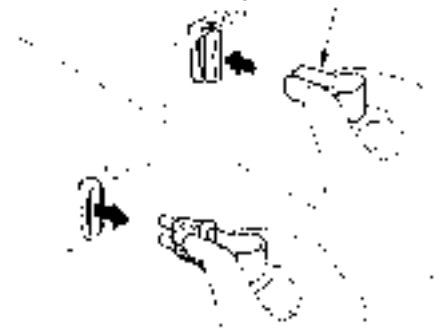

3. Check each of the large fuses in the under-hood fuse box by looking through the top at the wire inside. Removing these fuses requires a Phillips-head screwdriver.
4. Check the smaller fuses in the under-hood fuse box and all the fuses in the interior fuse box by pulling out each fuse with the fuse puller provided in the interior fuse box.

**BLOWN**

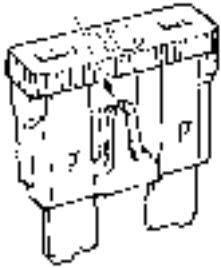

5. Look for a burned wire inside the fuse. If it is burned, replace it with one of the spare fuses of the same rating or lower.

If you cannot drive the car without fixing the problem, and you do not have a spare fuse, take a fuse of the same rating or a lower rating from one of the other circuits. Make sure you can do without that circuit temporarily (such as the accessory power socket or radio).

If you replace the blown fuse with a spare fuse that has a lower rating, it might blow out again. This does not indicate anything wrong. Replace the fuse with one of the correct rating as soon as you can.

## NOTICE

*Replacing a fuse with one that has a higher rating greatly increases the chances of damaging the electrical system. If you do not have a replacement fuse with the proper rating for the circuit, install one with a lower rating.*

6. If the replacement fuse of the same rating blows in a short time, there is probably a serious electrical problem in your car. Leave the blown fuse in that circuit and have your car checked by a qualified mechanic.

If the radio fuse is removed, the audio system will disable itself. The next time you turn on the radio you will see “CODE” in the frequency display. Use the Preset buttons to enter the five-digit code (see page [123](#)).

CONTINUED

# Fuses

## INTERIOR FUSE BOX

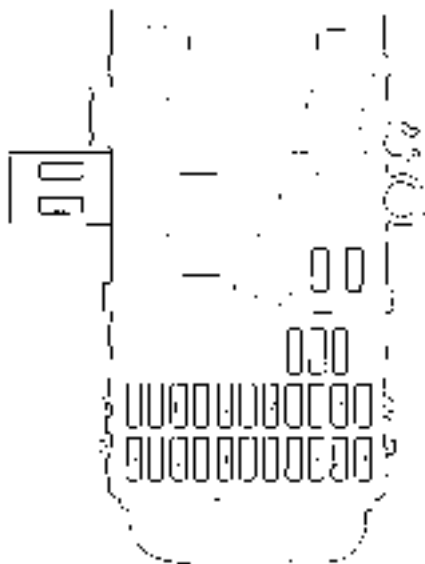

No.	Amps	Circuit's Protected	No.	Amps	Circuits Protected
1	10A	Advice Display, Power Windows, Anti-Lock Braking System, ABS	16	20A	Front Left Power Window
2	15A	Seat Belt System	17	20A	Front Right Power Window
3	15A	Seat Belt System	18	20A	Wiper
4	10A	Alarms	19	25A	AC
5	10A	CRS (air bag)	20	-	Not Used
6	15A	Brake System	21	10A	Not Used
7	20A	Motor (oil)	22	10A	Front Horn
8	10A	Electric Running Lights	23	10A	SRV
9	10A	Power Mirror (MISCELLANEOUS)	24	10A	Seat Belt
10	10A	Trunk Light	25	10A	Seat Belt
11	10A	Left Light	26	10A	Seat Belt
12	10A	Right Light	27	20A	Spay (use)
13	10A	Left Light (interior)	28	10A	Active Lamp (interior system)
14	10A	Left Light (interior)	29	-	Not Used
15	10A	Right Light (interior)			

\* 1 : On Type SH

\* 2 : On Canadian models

## UNDER-HOOD FUSE BOX

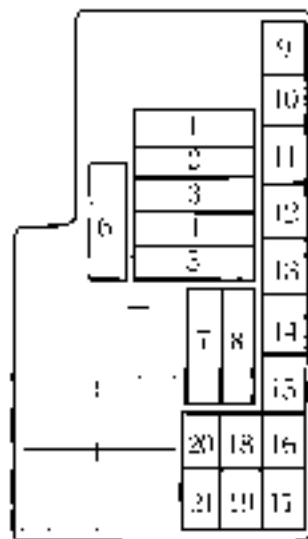

No.	Amps.	Circuits Protected	No.	Amps.	Circuits Protected
1	40-A	Main Fuse (Power Window)	10	15-A	Interior Lights
2	20-A	Main Fuse (Use Fuses)	11	30-A	Funk Fuse (Fan)
3	10-A	Main Fuse (Power Window)	12	10-A	Power Lock
4	10-A	Main Fuse (Door Locks)	13	15-A	Clock, Radio
5	20-A	Main Fuse (Ignition Switch)	14	20-A	Central Light
6		Not Used	15	10-A	Stop, Horn
7	100-A	Main Fuse (Battery)	16	20-A	ABS (R)
8	20-A	Main Fuse (ABS Motor)	17	10-A	Hazard
9	30-A	Cooling Fan	18	Not Used	Not Used
			19	10-A	ABS (L)
			20	20-A	Left Side Light
			21	10-A	Right Side Light

## Emergency Towing

---

If your car needs to be towed, call a professional towing service or, if you belong to one, an organization that provides roadside assistance. Never tow your car behind another vehicle with just a rope or chain. It is very dangerous.

There are three popular methods of towing a vehicle:

**Flat-bed Equipment** — The operator loads your car on the back of a truck. **This is the best way to transport your Honda.**

**Wheel-Lift Equipment** — The tow truck uses two pivoting arms that go under the tires (front or rear) and lift them off the ground. The other two tires remain on the ground. **This is an acceptable way to tow your Honda.**

**Sling-type Equipment** — The tow truck uses metal cables with hooks on the ends. These hooks go around parts of the frame or suspension and the cables lift that end of the car off the ground. Your car's suspension and body can be seriously damaged. **This method of towing is unacceptable**

If your Honda cannot be transported by flat-bed, it should be towed by wheel-lift equipment with the front wheels off the ground. If, due to damage, your car must be towed with the front wheels on the ground, do the following:

**5-speed Manual Transmission**

- Release the parking brake.
- Shift the transmission to Neutral.

**Automatic Transmission:**

- Release the parking brake.
- Start the engine.
- Shift to D4, then to N.
- Turn off the engine.

**NOTICE**

*Improper towing preparation will damage the transmission. Follow the above procedure exactly. If you cannot shift the transmission or start the engine (automatic transmission), your car must be transported with the front wheels off the ground.*

With the front wheels on the ground, it is best to tow the car no farther than 50 miles (80 km), and keep the speed below 35 mph (55 km/h).

### NOTICE

If you decide to tow your car with all four wheels on the ground, make sure you use a properly-designed and attached tow bar. Prepare the car for towing as described above, and leave the ignition switch in Accessory (I) so the steering wheel does not lock. Make sure the radio and any items plugged into the accessory power socket are turned off so they do not run down the battery.

*Trying to lift or tow your car by the bumpers will cause serious damage. The bumpers are not designed to support the car's weight.*

### NOTICE

*The steering system can be damaged if the steering wheel is locked. Leave the ignition switch in Accessory (I), and make sure the steering wheel turns freely before you begin towing.*



The diagrams in this section give you the dimensions and capacities of your Honda, and the locations of the identification numbers. The explanations of several electronic and mechanical systems on your Honda are for the more technically-oriented owner.

- Identification Numbers..... 262
- Specifications..... 264
- DOT Tire Quality Grading..... 266
  - Treadwear..... 266
  - Traction..... 266
  - Temperature..... 267
- Oxygenated Fuels..... 268
- Driving in Foreign Countries..... 269
- Emissions Controls..... 270
  - The Clean Air Act..... 270
  - Crankcase Emissions Control System..... 270
  - Evaporative Emissions Control System..... 270
  - Exhaust Emissions Controls... 271
    - PGM-FI System..... 271
    - Ignition Timing Control System..... 271
    - Exhaust Gas Recirculation (EGR) System..... 271
    - Three Way Catalytic Converter..... 271
  - Replacement Parts..... 271
  - Three Way Catalytic Converter... 272



## Identification Numbers

---

Your car has several identifying numbers located in various places.

The Vehicle Identification Number (VIN) is the 17-digit number your Honda dealer uses to register your car for warranty purposes. It is also necessary for licensing and insuring your car. The easiest place to find the VIN is on a plate fastened to the top of the dashboard. You can see it by looking through the windshield on the driver's side. It is also on the Certification label attached to the driver's doorjamb, and is stamped on the engine compartment bulkhead. The VIN is also provided in bar code on the Certification label.

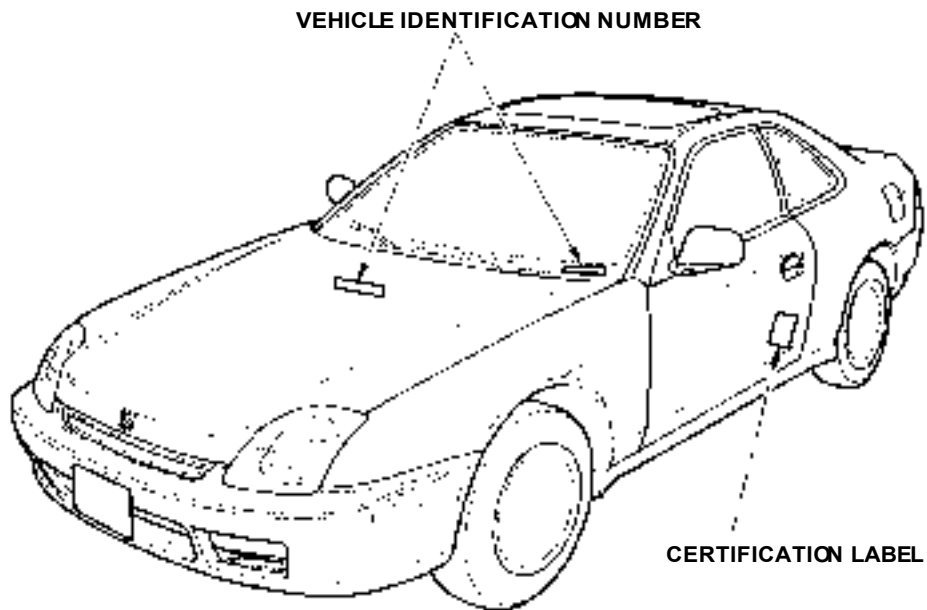

## Identification Numbers

The Engine Number is stamped into the engine block.

The Transmission Number is on a label on top of the transmission.

MANUAL TRANSMISSION NUMBER      AUTOMATIC TRANSMISSION NUMBER

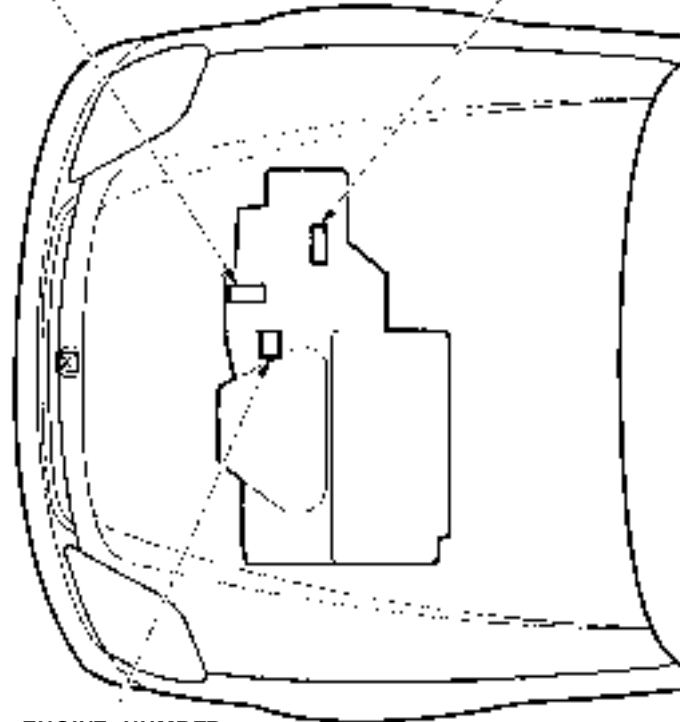

ENGINE NUMBER

# Specifications

## Dimensions

Length		1750 mm (4 500 mm)
Width		685 mm (1 050 mm)
Height		~135 mm (1 050 mm)
Wheel base		1018 mm (2 580 mm)
Track	Front	660 mm (1 625 mm)
	Rear	1810 mm (4 510 mm)

## Weights

Gross weight (weight category) See the certification label attached to the chassis for details.

## Engine

Type	Water-cooled 4-stroke DOHC-VTEC 4-cylinder speed sensitive
Bore x Stroke	3.45 x 2.97 in (87.0 x 90.7 mm)
Displacement	132 cc (8.1 x 1.97 liter)
Compression ratio	10.9 : 1
Spark plugs	See spark plug maintenance section on page 198.

## Capacities

Fuel tank		Approx.
		15.9 U.S. gal (60.2 L) 2 Imp gal
Engine coolant	Change	0.80 U.S. gal (3.0 L) 0.70 Imp gal
	Manual	0.47 U.S. gal (1.8 L) 0.70 Imp gal
	Automatic	0.95 U.S. gal (3.7 L) 0.70 Imp gal
	Total	1.00 U.S. gal (3.8 L) 1.50 Imp gal
	Manual	1.52 U.S. gal (5.8 L) 1.50 Imp gal
Automatic	1.00 U.S. gal (3.8 L) 1.50 Imp gal	
Engine oil	Change *	
	Including filter	5.1 U.S. qt (14.0 L) 4.2 Imp qt
	Without filter	4.0 U.S. qt (15.1 L) 3.0 Imp qt
	Total	6.2 U.S. qt (15.9 L) 5.2 Imp qt
Manual transmission fluid	Change	2.2 U.S. qt (2.1 L) 1.3 Imp qt
	Total	2.0 U.S. qt (1.9 L) 1.7 Imp qt
Automatic transmission fluid	Change	2.1 U.S. qt (2.2 L) 1.9 Imp qt
	Total	2.0 U.S. qt (2.0 L) 1.8 Imp qt
Windshield washer reservoir	U.S. cars	2.0 U.S. qt (2.5 L) 2.2 Imp qt
	Canadian cars	4.8 U.S. qt (15.4 L) 4.0 Imp qt

\* 1 : Including the coolant in the reserve tank and that remaining in the engine.

Reserve tank capacity:

0.16 US gal (0.6 l , 0.13 Imp gal)

\* 2 : Type SH

\* 3 : Except Type SH

\* 4 : Excluding the oil remaining in the engine.

## Lights

Headlights	High	12 V	55 W
	Low	12 V	55 W
Front turn signal lights		12 V	21 W
Front parking lights		12 V	3 CP
Rear turn signal lights		12 V	21 W
Stop/Tail lights		12 V	21.5 W
High-mount brake light		12 V	21 W
Side marker lights	Front	12 V	3 CP (SAE 158)
	Rear	12 V	3 CP (SAE)
Tail lights		12 V	3 CP (SAE)
Backup lights		12 V	21 W
License plate light		12 V	3 CP
Ceiling light		12 V	5 W (T10)
Spot lights		12 V	5 W (T10)
Trunk light		12 V	5 W
Door lights		12 V	5.4 W

## Battery

Capacity	12 V	55 Ah (5 HR)
	12 V	65 Ah (20 HR)

## Fuses

Location	See page 256 of the fuse label attached to the inside of the fuse box door under type distribution.
Under hood	See page 257 of the fuse box cover.

## Alignment

Toe-in	Front	0.00 to 0.0 mm
	Rear	0.08 to 0.2 mm
Camber	Front	0°
	Rear	0°±0.5°
Caster	Front	2°±0.5°
	Rear	4°±0.5°

- \* 1 : Except Type SH
- \* 2 : Type SH

## Tires

Size	Front/Rear Spare	205/50R16-87V
		175/60R16-89M
		175/70R16-85M
Pressure	Front/Rear Spare	32 psi (220 kPa) 32 psi (220 kPa)
		30 psi (207 kPa) 4.2 kgf/cm <sup>2</sup>

- \* 1 : Except Type SH
- \* 2 : Type SH

\* 1 : Except high-mount brake light installed in rear spoiler

\* 2 : Type SH

## Air Conditioning

Refrigerant type	HFC 134a (R-134a)
Charge quantity	0.47 (2000) (200) (50) g
Label type	SE-10

## DOT Tire Quality Grading (U.S. Cars)

---

The tires on your car meet all U.S. Federal Safety Requirements. All tires are also graded for treadwear, traction, and temperature performance according to Department of Transportation (DOT) standards. The following explains these gradings.

### **Uniform Tire Quality Grading**

Quality grades can be found where applicable on the tire sidewall between the tread shoulder and the maximum section width. For example:

**Treadwear 200**  
**Traction AA**  
**Temperature A**

### **Treadwear**

The treadwear grade is a comparative rating based on the wear rate of the tire when tested under controlled conditions on a specified government test course. For example, a tire graded 150 would wear one and one half (1-1/2) times as well on the government course as a tire graded 100. The relative performance of tires depends upon the actual conditions of their use, however, and may depart significantly from the norm due to variations in driving habits, service practices, and differences in road characteristics and climate.

### **Traction**

The traction grades, from highest to lowest, are AA, A, B, and C. Those grades represent the tire's ability to stop on wet pavement as measured under controlled conditions on specified government test surfaces of asphalt and concrete. A tire marked C may have poor traction performance.

**Warning:** The traction grade assigned to this tire is based on straight-ahead braking traction tests, and does not include acceleration, cornering, hydroplaning, or peak traction characteristics.

### **Temperature**

The temperature grades are A (the highest), B, and C, representing the tire's resistance to the generation of heat and its ability to dissipate heat when tested under controlled conditions on a specified indoor laboratory test wheel. Sustained high temperature can cause the material of the tire to degenerate and reduce tire life, and excessive temperature can lead to sudden tire failure. The grade C corresponds to a level of performance which all passenger car tires must meet under the Federal Motor Vehicle Safety Standard No. 109. Grades B and A represent higher levels of performance on the laboratory test wheel than the minimum required by law.

Warning: The temperature grade for this tire is established for a tire that is properly inflated and not overloaded. Excessive speed, underinflation, or excessive loading either separately or in combination, can cause heat build-up and possible tire failure.

## Oxygenated Fuels

---

Some conventional gasolines are being blended with alcohol or an ether compound. These gasolines are collectively referred to as oxygenated fuels. To meet clean air standards, some areas of the United States and Canada use oxygenated fuels to help reduce emissions.

If you use an oxygenated fuel, be sure it is unleaded and meets the minimum octane rating requirement.

Before using an oxygenated fuel, try to confirm the fuel's contents. Some states/provinces require this information to be posted on the pump.

The following are the U.S. EPA and Canadian CGSB approved percentages of oxygenates:

**ETHANOL** (ethyl or grain alcohol)  
You may use gasoline containing up to 10 percent ethanol by volume. Gasoline containing ethanol may be marketed under the name "Gasohol."

**MTBE** (Methyl Tertiary Butyl Ether)  
You may use gasoline containing up to 15 percent MTBE by volume.

**METHANOL** (methyl or wood alcohol)  
Your vehicle was not designed to use fuel that contains methanol. Methanol can corrode metal parts in the fuel system, and also damage plastic and rubber components. This damage would not be covered by your warranties.

If you notice any undesirable operating symptoms, try another service station or switch to another brand of gasoline.

Fuel system damage or performance problems resulting from the use of an oxygenated fuel containing more than the percentages of oxygenates given above are not covered under warranty.

If you are planning to take your Honda outside the U.S. or Canada, contact the tourist bureaus in the areas you will be traveling in to find out about the availability of unleaded gasoline with the proper octane rating.

If unleaded gasoline is not available, be aware that using leaded gasoline in your Honda will affect performance and fuel mileage, and damage its emissions controls. It will no longer comply with U.S. and Canadian emissions regulations, and will be illegal to operate in North America. To bring your car back into compliance will require the replacement of several components, such as the oxygen sensors and the three way catalytic converter. These replacements are not covered under warranty.



## Emissions Controls

---

The burning of gasoline in your car's engine produces several byproducts. Some of these are carbon monoxide (CO), oxides of nitrogen (NOx) and hydrocarbons (HC). Gasoline evaporating from the tank also produces hydrocarbons. Controlling the production of NOx, CO, and HC is important to the environment. Under certain conditions of sunlight and climate, NOx and HC react to form photochemical "smog." Carbon monoxide does not contribute to smog creation, but it is a poisonous gas.

### **The Clean Air Act**

The United States Clean Air Act\* sets standards for automobile emissions. It also requires that automobile manufacturers explain to owners how their emissions controls work and what to do to maintain them. This section summarizes how the emissions controls work. Scheduled maintenance is on page [172](#).

\* In Canada, Honda vehicles comply with the Canadian Motor Vehicle Safety Standards (CMVSS) for Emissions valid at the time they are manufactured.

### **Crankcase Emissions Control System**

Your car has a Positive Crankcase Ventilation System. This keeps gasses that build up in the engine's crankcase from going into the atmosphere. The Positive Crankcase Ventilation valve routes them from

the crankcase back to the intake manifold. They are then drawn into the engine and burned.

### **Evaporative Emissions Control System**

As gasoline evaporates in the fuel tank, an evaporative emissions control canister filled with charcoal adsorbs the vapor. It is stored in this canister while the engine is off. After the engine is started and warmed up, the vapor is drawn into the engine and burned during driving.

### **Onboard Refueling Vapor Recovery**

The Onboard Refueling Vapor Recovery (ORVR) system captures the fuel vapors during refueling. The vapors are adsorbed in a canister filled with activated carbon. While driving, the fuel vapors are drawn into the engine and burned off.

### **Exhaust Emissions Controls**

The exhaust emissions controls include four systems: PGM-FI, Ignition Timing Control, Exhaust Gas Recirculation and Three Way Catalytic Converter. These four systems work together to control the engine's combustion and minimize the amount of HC, CO, and NOx that comes out the tailpipe. The exhaust emissions control systems are separate from the crankcase and evaporative emissions control systems.

### ***PGM-FI System***

The PGM-FI System uses sequential multiport fuel injection.

It has three subsystems: Air Intake, Engine Control, and Fuel Control. The Engine Control Module (ECM) uses various sensors to determine how much air is going into the engine. It then controls how much fuel to inject under all operating conditions.

### ***Ignition Timing Control System***

This system constantly adjusts the ignition timing, reducing the amount of HC, CO and NOx produced.

### ***Exhaust Gas Recirculation (EGR) System***

The Exhaust Gas Recirculation (EGR) system takes some of the exhaust gas and routes it back into the intake manifold. Adding exhaust gas to the air/fuel mixture reduces the amount of NOx produced when the fuel is burned.

### ***Three Way Catalytic Converter***

The three way catalytic converter is in the exhaust system. Through chemical reactions, it converts HC, CO, and NOx in the engine's exhaust to carbon dioxide (CO<sub>2</sub>), dinitrogen (N<sub>2</sub>), and water vapor.

### **Replacement Parts**

The emissions control systems are designed and certified to work together in reducing emissions to levels that comply with the Clean Air Act. To make sure the emissions remain low, you should use only new Genuine Honda replacement parts or their equivalent for repairs. Using lower quality parts may increase the emissions from your car.

The emissions control systems are covered by warranties separate from the rest of your car. Read your warranty manual for more information.

## Three Way Catalytic Converter

---

The three way catalytic converter contains precious metals that serve as catalysts, promoting chemical reactions to convert the exhaust gasses without affecting the metals. The catalytic converter is referred to as a three-way catalyst, since it acts on HC, CO, and NOx. A replacement unit must be an original Honda part or its equivalent.

The three way catalytic converter must operate at a high temperature for the chemical reactions to take place. It can set on fire any combustible materials that come near it. Park your car away from high grass, dry leaves, or other flammables.



**THREE WAY CATALYTIC CONVERTER**

A defective three way catalytic converter contributes to air pollution, and can impair your engine's performance. Follow these guidelines to protect your car's three way catalytic converter.

- Always use unleaded gasoline. Even a small amount of leaded gasoline can contaminate the catalyst metals, making the three way catalytic converter ineffective.

- Keep the engine tuned-up.
- Have your car diagnosed and repaired if it is misfiring, back-firing, stalling, or otherwise not running properly.

## Warranty and Customer Relations

---

Customer Relations	
Information.....	274
U.S. Zone Office Map.....	275
Canada Zone Office Map.....	276
Warranty Coverages.....	277
Reporting Safety Defects (U.S. Vehicles).....	278
Authorized Manuals.....	279

## Customer Relations Information

---

Honda dealership personnel are trained professionals. They should be able to answer all your questions. If you encounter a problem that your dealership does not solve to your satisfaction, please discuss it with the dealership's management. The Service Manager or General Manager can help. Almost all problems are solved in this way.

If you are dissatisfied with the decision made by the dealership's management, contact your Honda Customer Relations Zone Office. Refer to the U.S. and Canadian Zone Office maps on the following pages.

When you call or write, please give us this information:

- Vehicle Identification Number (see page [262](#))
- Name and address of the dealer who services your car
- Date of purchase
- Mileage on your car
- Your name, address, and telephone number
- A detailed description of the problem
- Name of the dealer who sold the car to you

# U.S. Zone Office Map

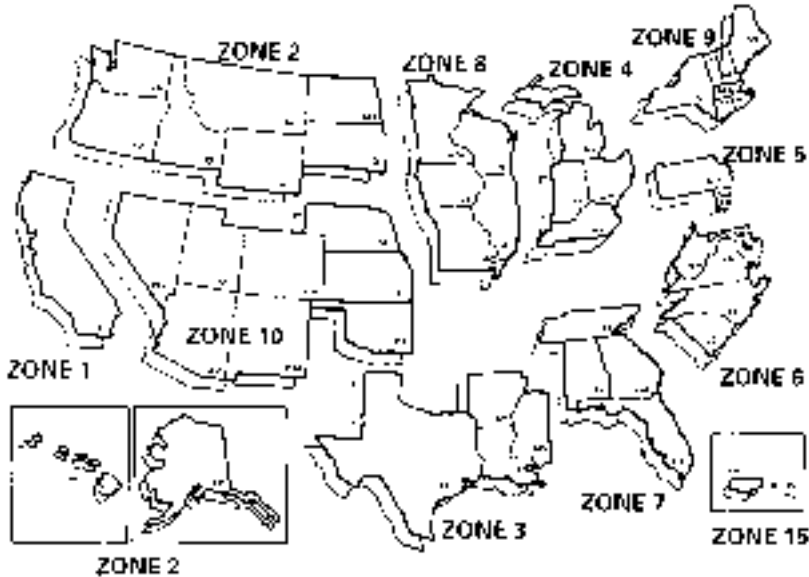

The addresses and telephone numbers are subject to change. If you cannot reach your Zone office, ask your Honda dealer for the current information.

**1** Western Zone  
P.O. Box 2260  
700 Van Ness Avenue  
Torrance, California  
90509-2260  
(310) 781-4565

**2** Northwestern Zone  
P.O. Box 20186  
12439 N.E. Airport Way  
Portland, Oregon 97230  
(503) 256-0943  
(also includes Alaska and Hawaii)

**3** South Central Zone  
4529 Royal Lane  
Irving, Texas 75063  
(972) 929-5481

**4** Central Zone  
101 South Stanfield Road  
Troy, Ohio 45373  
(937) 332-6250

**5** Northeastern Zone  
P.O. Box 337  
Eastgate Industrial Park  
115 Gaither Drive  
Moorestown, New Jersey 08057  
(609) 235-5533  
Includes: NYC Metro area and  
Fairfield County, CT area

**6** Mid-Atlantic Zone  
902 Wind River Ln., Suite 200  
Gaithersburg, Maryland 20878  
(301) 990-2020

**7** Southeastern Zone  
1500 Morrison Parkway  
Alpharetta, Georgia 30004  
(770) 442-2045

**8** North Central Zone  
601 Campus Drive, Suite A-9  
Arlington Heights, Illinois 60004  
(847) 870-5600

**9** New England Zone  
555 Old County Road  
Windsor Locks, Connecticut 06096  
(860) 623-3310  
See Zone 5 for:  
NYC Metro area and  
Fairfield County, CT area

**10** West Central Zone  
1600 South Abilene Street, Suite D  
Aurora, Colorado 80012  
(303) 696-3935

**15** Puerto Rico and U.S. V.I.  
Bella International  
P.O. Box 190816  
San Juan, PR 00919-0816  
(787) 250-4318

## Canada Zone Office Map

---



### **CUSTOMER RELATIONS RELATIONS AVEC LA CLIENTELE**

Honda Canada Inc.  
715 Milner Avenue  
Toronto, ON  
M1B 2K8

Tel: 1-888-9-HONDA-9

Fax: Toll-free 1-877-939-0909  
Toronto (416) 287-4776

### **U.S. Owners**

Your new Honda is covered by these warranties:

***New Car Limited Warranty*** — covers your new vehicle, except for the battery, emissions control systems and accessories, against defects in materials and workmanship.

### ***Emissions Control Systems Defects Warranty and Emissions***

***Performance Warranty*** — these two warranties cover your vehicle's emissions control systems. Time, mileage, and coverage are conditional. Please read the warranty manual for exact information.

***Original Equipment Battery Limited Warranty*** — this warranty gives up to 100 percent credit toward a replacement battery.

***Seat Belt Limited Warranty*** — a seat belt that fails to function properly is covered for the useful life of the vehicle.

***Rust Perforation Limited Warranty*** — all exterior body panels are covered for rust-through from the inside for the specified time period with no mileage limit.

***Accessory Limited Warranty*** — Genuine Honda Accessories are covered under this warranty. Time and mileage limits depend on the type of accessory and other factors. Please read your warranty manual for details.

***Replacement Parts Limited Warranty*** — covers all Genuine Honda replacement parts against defects in materials and workmanship.

***Replacement Battery Limited Warranty*** — provides prorated coverage for a replacement battery purchased from a Honda dealer.

***Replacement Muffler Lifetime Limited Warranty*** — provides coverage for as long as the purchaser of the muffler owns the car.

Restrictions and exclusions apply to all these warranties. Please read the 2000 Honda Warranty Information booklet that came with your car for precise information on warranty coverages. Your Honda's original tires are covered by their manufacturer. Tire warranty information is in a separate booklet.

### **Canadian Owners**

Please refer to the 2000 Warranty Manual that came with your car.



## Reporting Safety Defects (U.S. Vehicles)

---

If you believe that your vehicle has a defect which could cause a crash or could cause injury or death, you should immediately inform the National Highway Traffic Safety Administration (NHTSA) in addition to notifying American Honda Motor Co., Inc.

If NHTSA receives similar complaints, it may open an investigation, and if it finds that a safety defect exists in a group of vehicles, it may order a recall and remedy campaign. However, NHTSA cannot become involved in individual problems between you, your dealer, or American Honda Motor Co., Inc.

To contact NHTSA, you may either call the Auto Safety Hotline toll-free at 1-800-424-9393 (or 366-0123 in Washington D.C. area) or write to: NHTSA, U.S. Department of Transportation, Washington, D.C. 20590. You can also obtain other information about motor vehicle safety from the Hotline.

## Purchasing Factory Authorized Manuals (U.S. only)

The following publications covering the operation and servicing of your vehicle can be obtained from Helm Incorporated, either by filling out the attached form or, for credit card holders, calling the toll-free phone number on the form. For manuals prior to the year shown below, contact Helm Incorporated, P.O. Box 07280, Detroit, Michigan 48207, or call 1-800-782-4356.

Publication Form Number	Form Description	Price Each
61S3003	1997-2000 Prelude Service Manual	\$65.00
61S3003EL	1997-2000 Prelude Electrical Troubleshooting Manual	\$45.00
61S3030	1997-2000 Prelude Body Repair Manual	\$40.00
31S30630	2000 Prelude Owner's Manual	\$30.00
HON-R	Order Form for Previous Years- Indicate Year and Model Desired	FREE

Prices are subject to change without notice and without obligation.

Valid only for sales within the U.S. Canadian owners should contact their authorized Honda dealer.

**ORDER TOLL FREE: 1-800-782-4356**  
 (NOTE: For Credit Card Holder Orders Only)  
 (Monday-Friday 8:00 A.M. - 5:00 P.M. EST)  
**MINIMUM CREDIT CARD PURCHASE \$10.00**  
**OR**

By completing this form you can order the materials desired. You can pay by check or money order, or charge to your credit card. Mail to Helm Incorporated at the address shown on the back of the order form.

PUBLICATION NUMBER	VEHICLE MODEL		Qty	Price Each	Total Price
	Name	Year			
<p>Prices are subject to change without notice and without obligation.</p> <p>Orders are mailed within 10 days. Please allow adequate time for delivery.</p>					

# Authorized Manuals

---

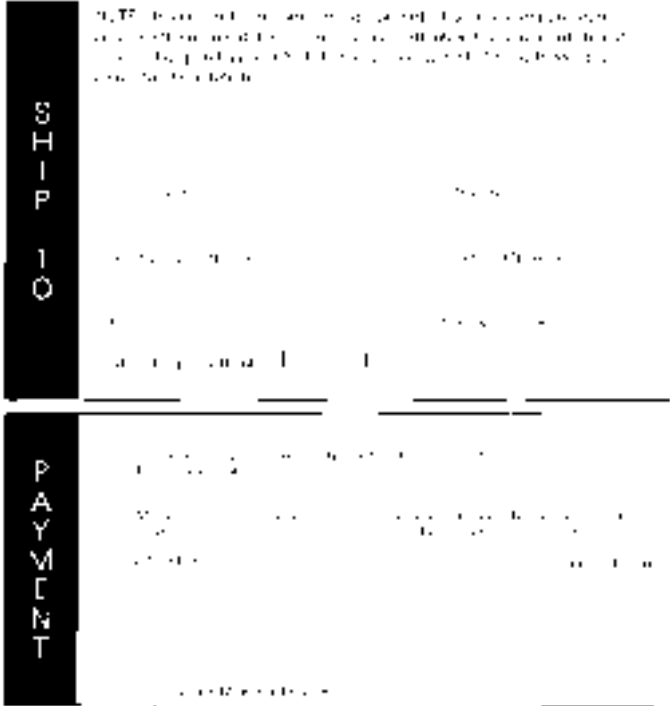

## **Service Manual:**

This manual covers maintenance and recommended procedures for repair to engine and chassis components. It is written for the Journeyman mechanic, but is simple enough for most mechanically-inclined owners to understand.

## **Electrical Troubleshooting Manual:**

This manual complements the Service Manual by providing in-depth troubleshooting information for each electrical circuit in your vehicle.

## **Body Repair Manual:**

This manual describes the procedures involved in the replacement of damaged body parts.

These Publications cannot be returned for credit without receiving advance authorization within 14 days of delivery. On returns, a restocking fee may be applied against the original order.

**HELM** P.O. BOX 07280·DETROIT, MICHIGAN 48207·1-800-782-4356

**A**

Accessories and Modifications.... 133  
  Accessories..... 133  
  Additional Safety Precautions.. 134  
  Modifications..... 134

ACCESSORY (Ignition Key  
  Position)..... 73

Accessory Power Socket..... 93

Active Torque Transfer System  
  (ATTS)  
  Indicator..... 56, 157  
  Operation..... 157

Adding  
  Automatic Transmission  
    Fluid..... 191  
  Brake Fluid..... 193  
  Clutch Fluid..... 194  
  Engine Coolant..... 185  
  Engine Oil..... 181  
  Manual Transmission Fluid .... 192  
  Power Steering Fluid..... 194  
  Windshield Washer Fluid..... 190

Additional Information About  
  Your Seat Belts..... 42  
  Lap/Shoulder Belt..... 42

  Seat Belt Maintenance..... 44  
  Seat Belt System Components... 42

Additional Information About  
  Your SRS..... 45

Additional Safety Precautions.... 48

How the SRS Indicator Light  
  Works..... 47

How Your Airbags Work..... 45

SRS Components..... 45

Additives, Engine Oil..... 182

Adjustments  
  Headlights..... 213  
  Head Restraints..... 82  
  Mirrors..... 88  
  Seats..... 80  
  Steering Wheel..... 66

Airbag (SRS)..... 45

Air Cleaner Element..... 195

Air Conditioning..... 98  
  Maintenance..... 202  
  Usage..... 98

Air Conditioning Filter..... 203

Air Outlets (Vents)..... 100

Air Pressure, Tires..... 205  
  High Speed Driving..... 206  
  Normal Driving..... 206

Alcohol in Gasoline..... 268

Antifreeze..... 185

Anti-lock Brakes (ABS)  
  Indicator Light..... 56, 156  
  Operation..... 154

Anti-theft Steering Column  
  Lock..... 73

Appearance Care..... 227

Ashtrays (Optional)..... 94

Audio System..... 106

Automatic Speed Control..... 67

Automatic Transmission..... 144  
  Capacity, Fluid..... 264  
  Checking Fluid Level..... 191  
  Sequential SportShift Mode.... 147  
  Shifting..... 145  
  Shift Lever Position Indicator.. 144  
  Shift Lever Positions..... 145  
  Shift Lock Release..... 151

CONTINUED

# Index

---

<b>B</b>		
Battery		
Charging System		
Indicator.....	55, 249	
Jump Starting.....	244	
Maintenance.....	198	
Specifications.....	265	
Before Driving.....	125	
Belts, Seat.....	8	
Beverage Holder.....	91	
Body Repair.....	233	
Brakes		
Anti-lock System (ABS).....	154	
Break-in, New Linings .....	126	
Fluid.....	193	
Light, Burned-out.....	219	
Parking.....	89	
System Indicator.....	55	
Wear Indicators.....	153	
Brakes, ABS		
Operation.....	154	
System Indicator.....	56, 156	
Braking System.....	153	
Break-in, New Car.....	126	
Brightness Control, Instruments...	63	
Brights, Headlights.....	62	
Bulb Replacement		
Back-up Lights.....	219	
Brake Lights.....	219	
Ceiling Lights.....	223	
Courtesy Lights.....	223	
Front Parking Lights.....	216	
Front Side Marker Lights.....	217	
Headlights.....	214	
High-mount Brake Light.....	221	
License Plate Light.....	222	
Rear Side Marker Lights.....	219	
Specifications.....	265	
Trunk Light.....	224	
Turn Signal Lights.....	218	
Bulbs, Halogen.....	214	
		
Cables, Jump Starting With.....	244	
Capacities Chart.....	264	
Carbon Monoxide Hazard.....	49	
Cargo, Loading.....	135	
Cassette Player		
Care.....	122	
Operation.....	119	
CAUTION, Explanation of .....	ii	
CD Changer.....	114	
CD Player.....	112	
Certification Label.....	262	
Chains.....	210	
Change Oil		
How to.....	183	
When to.....	172	
Changing a Flat Tire.....	237	
Changing Engine Coolant.....	187	
Charging System Indicator ...	55, 249	
Checking		
Automatic Transmission		
Fluid.....	191	
Battery Condition.....	198	
Brake Fluid.....	193	
Clutch Fluid.....	194	
Drive Belts.....	204	
Engine Coolant.....	131	
Engine Oil.....	130	
Fuses.....	254	
Manual Transmission Fluid .....	192	
Power Steering Fluid.....	194	
Checklist, Before Driving.....	140	
Child Safety.....	21	
Cleaner, Air.....	195	

Cleaning  
Aluminum Wheels..... 229  
Carpeting..... 230  
Exterior..... 228  
Fabric..... 230  
Interior..... 230  
Seat Belts..... 231  
Vinyl..... 230  
Windows..... 231  
Clock, Setting the ..... 90  
Clutch Fluid..... 194  
Coin Box..... 93  
CO in the Exhaust..... 270  
Cold Weather, Starting in..... 141  
Compact Spare..... 236  
Consumer Information\* ..... 274  
Controls, Instruments and..... 51  
Coolant  
Adding..... 185  
Checking.....131  
Proper Solution..... 185  
Replacing..... 187  
Temperature Gauge..... 59  
Corrosion Protection..... 232  
Courtesy Lights..... 95

Crankcase Emission Control  
System.....270  
Cruise Control Operation..... 67  
Customer Relations Office..... 274  
  
DANGER, Explanation of..... ii  
Dashboard..... 52  
Daytime Running Lights..... 62  
Dead Battery, What to Do..... 244  
Defects, Reporting Safety..... 278  
Defog and Defrost..... 104  
Defogger, Rear Window..... 65  
DEXRON® III Automatic  
Transmission Fluid..... 191  
Dimensions..... 264  
Dimming the Headlights..... 62  
Dipstick  
Automatic Transmission..... 191  
Engine Oil.....130  
Directional Signals..... 63  
Disabled, Towing Your Car If..... 258  
Disc Brake Wear Indicators..... 153  
Disposal of Used Oil..... 184

Doors  
Locking and Unlocking..... 74  
Power Door Locks..... 74  
DOT Tire Quality Grading..... 266  
Downshifting, 5-speed Manual  
Transmission..... 142  
Drive Belts..... 204  
Driving..... 139  
Economy..... 132  
In Bad Weather..... 158  
In Foreign Countries..... 269

E

Economy, Fuel..... 132  
Emergencies on the Road..... 235  
Battery, Jump Starting..... 244  
Brake System Indicator..... 251  
Changing a Flat Tire..... 237  
Charging System Indicator ..... 249  
Checking the Fuses..... 254  
Low Oil Pressure Indicator..... 248  
Malfunction Indicator Lamp .... 250  
Manually Closing Moonroof .... 252  
Overheated Engine..... 246

CONTINUED

# Index

---

Emergency Brake.....	89
Emergency Flashers.....	65
Emergency Towing.....	258
Emission Controls.....	270
Engine	
Coolant Temperature Gauge .....	59
Malfunction Indicator	
Lamp.....	55, 250
Oil Pressure Indicator.....	55, 248
Oil, What Kind to Use.....	181
Overheating.....	246
Specifications.....	264
Ethanol in Gasoline .....	268
Evaporative Emission Controls....	270
Exhaust Fumes.....	49
Expectant Mothers, Use of Seat	
Belts by.....	19
Exterior. Cleaning the.....	228

## F

Fabric, Cleaning.....	230
Fan, Interior.....	98
Features, Comfort and	
Convenience.....	97
Filling the Fuel Tank.....	127

Filters	
Air.....	195
Oil.....	183
First Gear, Shifting.....	150
5-speed Manual Transmission	
Checking Fluid Level.....	192
Shifting the.....	142
Flashers, Hazard Warning.....	65
Flat Tire, Changing a.....	237
Fluids	
Automatic Transmission.....	191
Brake.....	193
Clutch.....	194
Manual Transmission.....	192
Power Steering.....	194
Windshield Washer.....	190
FM Stereo Radio	
Reception.....	110
Folding Rear Seat.....	84
Foreign Countries, Driving in.....	269
Four-way Flashers.....	65
Front End, Towing by	
Emergency Wrecker.....	258
Fuel.....	126
Fill Door and Cap.....	127
Gauge.....	59

Octane Requirement.....	126
Oxygenated.....	268
Reserve Indicator.....	57
Tank, Filling the.....	127
Fuses, Checking the.....	254

## G

Gas Mileage. Improving.....	132
Gasohol.....	268
Gasoline.....	126
Fuel Reserve Indicator.....	57
Gauge.....	59
Octane Requirement.....	126
Tank, Filling the.....	127
Gas Station Procedures.....	127
Gauges	
Engine Coolant Temperature ....	59
Fuel.....	59
Gearshift Lever Positions	
Automatic Transmission.....	144
5-speed Manual	
Transmission.....	142
Glass Cleaning.....	231
Glove Box.....	79

**H**

Halogen Headlight Bulbs..... 214  
Hazard Warning Flashers..... 65  
Headlights  
  Aiming..... 213  
  Daytime Running Lights..... 62  
  High Beam Indicator..... 62  
  High Beams, Turning on..... 62  
  Low Beams, Turning on..... 62  
  Reminder Chime..... 62  
  Replacing Halogen Bulbs..... 214  
  Turning on..... 62  
Head Restraints..... 82  
Heating and Cooling..... 98  
High Altitude, Stalling at..... 141  
High-Low Beam Switch ..... 62  
High-mount Brake Light..... 221  
Hood Latch..... 196  
Hood, Opening the..... 128  
Horn..... 61  
Hot Coolant, Warning About..... 185  
Hydraulic Clutch..... 194  
Hydroplaning..... 159

**I**

Identification Number, Vehicle.... 262  
If Your Car Has to be Towed..... 258  
Ignition  
  Keys..... 70  
  Switch..... 72  
  Timing Control System..... 271  
Immobilizer System..... 71  
Indicator Lights. Instrument  
  Panel..... 53  
Infant Restraint..... 29  
Inflation, Proper Tire ..... 205  
  High Speed Driving..... 266  
  Normal Driving..... 206  
Inside Mirror..... 88  
Inspection, Tire..... 206  
Instrument Panel..... 52  
Instrument Panel Brightness..... 63  
Interior Cleaning..... 230  
Interior Lights..... 94  
Introduction..... i

Jacking up the Car..... 239

Jack, Tire..... 238  
Jump Starting..... 244

**K**

Keys..... 70

**L**

Label, Certification..... 262  
Lane Change, Signaling..... 63  
Lap/Shoulder Belts..... 42  
Leaking of Exhaust into Car..... 49  
Learning Key..... 71  
Lights  
  Bulb Replacement..... 214  
  Indicator..... 53  
  Parking..... 62  
  Turn Signal..... 63  
Loading Cargo..... 135  
LOCK (Ignition Key Position)..... 73

CONTINUED



# Index

---

Locks  
  Anti-theft Steering Column..... 73  
  Fuel Fill Door..... 127  
  Glove Box..... 79  
  Power Door..... 74  
  Trunk..... 78  
Low Coolant Level..... 131  
Lower Gear, Downshifting to a.... 142  
Low Fuel Indicator ..... 57  
Low Oil Pressure Indicator.... 55, 248  
Lubricant Specifications  
  Chart..... 264  
Luggage..... 135

**VI**

Maintenance..... 167  
  Owner Maintenance Checks.... 179  
  Record..... 177-178  
  Required Indicator..... 60  
  Schedule..... 170-176  
Malfunction Indicator Lamp .. 55, 250  
Manual Transmission..... 142  
Manual Transmission Fluid ..... 192  
Maximum Allowable  
  Speeds..... 143, 150

Meters, Gauges..... 58  
Methanol in Gasoline..... 268  
Mirrors, Adjusting..... 88  
Moonroof..... 87  
  Closing Manually..... 252  
  Operation..... 87



Neutral Gear Position..... 147  
New Vehicle Break-in ..... 126  
Normal Shift Speeds..... 143  
NOTICE, Explanation of..... i  
Numbers, Identification..... 262



Octane Requirement, Gasoline.... 126  
Odometer..... 58  
Odometer, Trip..... 58  
Oil  
  Change, How to ..... 183  
  Change, When to..... 172  
  Checking Engine..... 130  
  Pressure Indicator..... 55, 248

  Selecting Proper Viscosity  
    Chart..... 182  
ON (Ignition Key Position) ..... 73  
Opening the Hood ..... 128  
Opening the Trunk..... 78  
Operation in Foreign Countries... 269  
Outside Mirrors..... 88  
Overheating, Engine..... 246



Panel Brightness Control..... 63  
Park Gear Position..... 146  
Parking..... 152  
  Parking Brake..... 89  
  Parking Lights..... 62  
  Parking Over Things that Burn... 272  
PGM-FI System..... 271  
Polishing and Waxing..... 229  
Power  
  Door Locks..... 74  
  Mirrors..... 88  
  Steering..... 194  
  Windows..... 85  
Pregnancy, Using Seat Belts..... 19

Protecting Adults.....	12	Coolant.....	187	Safety Messages.....	ii
Additional Safety Precautions....	19	Engine Oil and Filter.....	183	Seat Belt, Additional Information..	42
Advice for Pregnant Women.....	19	Fuses.....	254	Lap/Shoulder Belt.....	42
Protecting Children.....	21	Light Bulbs.....	214	Seat Belt Maintenance.....	44
Protecting Infants.....	29	Schedule.....	170	Seat Belt System Components...	42
Protecting Larger Children.....	37	Spark Plugs.....	196	Seat Belts.....	8
Protecting Small Children.....	33	Timing Belt.....	204	Cleaning.....	231
Using Child Seats with		Tires.....	208	Maintenance.....	44
Tethers.....	40	Wiper Blades.....	200	Reminder Light and Beeper.....	54
<hr/>					
<b>H</b>					
Radiator Overheating.....	246	Replacing Seat Belts After a		System Components.....	42
Radio/CD Sound System.....	106	Crash.....	44	Tether Attachment Points.....	40
Rear End Towing.....	258	Reserve Tank, Engine Coolant...	131	Use During Pregnancy.....	19
Rear Lights, Bulb Replacement...	219	Restraint, Child.....	21	Seat Heaters.....	83
Rear Seat Access .....	81	Reverse Gear Position.....	146	Seats, Adjusting the.....	80
Rear Seat, Folding.....	84	Rotation, Tire.....	208	Sequential SportShift Mode .....	147
Rear View Mirror.....	88	<hr/>			
Rear Window Defogger.....	65	Safety Belts.....	8	Serial Number.....	262
Reclining the Seat Backs.....	80	Safety Features.....	7	Service Intervals.....	172
Recommended Shift Speeds .....	143	Airbags.....	9	Service Manual* .....	279
Reminder Lights.....	53	Door Locks.....	11	Service Station Procedures .....	127
Remote Transmitter.....	75	Head Restraints.....	10	Setting the Clock.....	90
Replacement Information		Seat Belts.....	8	Shifting	
Air Cleaner Element.....	195	Seats & Seat-Backs.....	10	The Automatic Transmission ..	144
		Safety Labels, Location of.....	50	The 5-speed Manual	
				Transmission.....	142
				Shift Lever Position Indicator.....	144

CONTINUED

# Index

---

Shift Lock Release..... 151  
Side Marker Lights, Bulb  
  Replacement in..... 217  
Signaling..... 63  
Snow Tires..... 210  
Solvent-type Cleaners..... 228  
Sound System..... 106  
Spare Tire  
  Inflating..... 236  
  Specifications..... 265  
Spark Plugs, Replacing..... 196  
Specifications Charts ..... 264, 265  
Speed Control..... 67  
Speedometer..... 58  
SRS, Additional Information..... 45  
  Additional Safety Precautions... 48  
  How the SRS Indicator Light  
  Works..... 47  
  How Your Airbags Work..... 45  
  SRS Components..... 45  
  SRS Service..... 47  
SRS Indicator..... 47, 55  
START (Ignition Key Position)..... 73  
Starting the Engine..... 141  
  In Cold Weather at High  
  Altitude..... 141

  With a Dead Battery..... 244  
Steam Coming from Engine..... 246  
Steering Wheel  
  Adjustment..... 66  
  Anti-theft Column Lock..... 73  
Stereo Sound System..... 106  
Storing Your Car..... 225  
Supplemental Restraint System.... 45  
  Servicing..... 47  
  SRS Indicator..... 47, 55  
Synthetic Oil..... 182

## T

Tachometer..... 58  
Taillights, Changing Bulbs in..... 219  
Taking Care of the  
  Unexpected..... 235  
Tape Player..... 119  
Technical Descriptions  
  Emission Control Systems..... 270  
  Three Way Catalytic  
  Converter..... 272  
Temperature Gauge..... 59  
Tether Attachment Points..... 40  
Three Way Catalytic Converter... 272

Time, Setting the..... 90  
Timing Belt..... 204  
Tire Chains..... 210  
Tire, How to Change a Flat..... 237  
Tires..... 205  
  Air Pressure..... 205  
  Checking Wear..... 206  
  Compact Spare..... 236  
  DOT Tire Quality Grading..... 266  
  Inflation..... 205  
  Inspection..... 206  
  Maintenance..... 207  
  Replacing..... 208  
  Rotating..... 208  
  Snow..... 210  
  Specifications..... 265  
  Tire Chains..... 210  
  Winter Driving..... 209  
Tools, Tire Changing..... 237  
Towing  
  A Trailer..... 160  
  Emergency..... 258

Transmission  
 Checking Fluid Level,  
 Automatic..... 191  
 Checking Fluid Level,  
 Manual..... 192  
 Fluid Selection..... 191  
 Identification Number..... 262  
 Shifting the Automatic..... 144  
 Shifting the Manual..... 142  
 Treadwear..... 266  
 Trip Meter..... 58  
 Trunk..... 78  
 Opening the..... 78  
 Open Monitor Light..... 57  
 Turn Signals..... 63

**U**

Underside, Cleaning..... 232  
 Unexpected, Taking Care  
 of the..... 235  
 Uniform Tire Quality Grading..... 266  
 Unleaded Gasoline..... 126  
 Upholstery Cleaning..... 230  
 Used Oil, How to Dispose of..... 184

**V**

Vehicle Capacity Load ..... 136  
 Vehicle Dimensions..... 264  
 Vehicle Identification Number..... 262  
 Vehicle Storage..... 225  
 Ventilation..... 100  
 VTN..... 262  
 Vinyl Cleaning..... 230  
 Viscosity, Oil..... 182

**W**

Warning Bleepers  
 Headlights on..... 62  
 Key in Ignition..... 73  
 Seat Belts..... 8  
 WARNING, Explanation of..... ii  
 Warning Labels, Location of..... 50  
 Warranty Coverages\*..... 277  
 Washer, Windshield  
 Checking the Fluid Level..... 190  
 Operation..... 65  
 Washing..... 228  
 Waxing and Polishing..... 229

Wheels  
 Adjusting the Steering..... 66  
 Alignment and Balance..... 207  
 Compact Spare..... 236  
 Wrench..... 238  
 Windows  
 Cleaning..... 231  
 Operating the Power..... 85  
 Rear, Defogger..... 65  
 Windshield  
 Cleaning..... 64  
 Defroster..... 104  
 Wipers, Windshield  
 Changing Blades..... 200  
 Operation..... 64  
 Worn Tires..... 206  
 Wrecker, Emergency Towing..... 258

\* U.S. and Canada only

## Service Information Summary

---

### **Gasoline:**

Premium unleaded gasoline, pump octane number of 91 or higher.

### **Fuel Tank Capacity:**

15.9 US gal (60 l, 13.2 Imp gal)

### **Recommended Engine Oil:**

API Service SJ "Energy Conserving" oil, SAE 5W-30 viscosity (see page [181](#)).

Oil change capacity (including filter):

5.1 US qt (4.8 l, 4.2 Imp qt)

### **Automatic Transmission Fluid:**

Honda Premium Formula Automatic Transmission Fluid preferred, or a DEXRON® III ATF as a temporary replacement (see page [191](#)).

### **5-speed Manual Transmission Fluid:**

Honda Manual Transmission Fluid preferred, or an API service SG, SH or SJ, SAE 10W-30 or 10W-40 motor oil as a temporary replacement (see page [192](#)).

Capacity (including differential):

*Type SH*

2.2 US qt (2.1 l, 1.8 Imp qt)

*Except Type SH*

2.0 US qt (1.9 l, 1.7 Imp qt)

### **Power Steering Fluid:**

Genuine Honda Power Steering Fluid preferred, or another brand of power steering fluid as a temporary replacement. Do not use ATF (see page [194](#)).

### **Brake Fluid:**

Genuine Honda DOTS Brake Fluid preferred, or a DOT 3 or DOT 4 brake fluid as a temporary replacement (see page [193](#)).

### **Tire Pressure (measured cold):**

Front/Rear:

32 psi (220 kPa, 2.2 kgf/cm<sup>2</sup>)

### **Spare Tire Pressure:**

60 psi (420 kPa, 4.2 kgf/cm<sup>2</sup>)