

ASSEMBLY GUIDE  
ALL CATERHAM SEVEN MODELS

*Version 02.2014*

## Contents

Contents .....	1
List of Tables .....	10
List of Figures .....	11
0.0) Preliminary information .....	17
0.1) General warnings & cautions .....	17
0.2) Specific warnings & cautions .....	17
1.0) Introduction .....	19
1.1) Contact information .....	19
1.1.1) Customer Liaison .....	19
1.1.2) Caterham Aftersales .....	19
1.1.3) Caterham Parts .....	19
1.1.4) Technical Assistance .....	19
1.2) Post build check .....	20
1.3) Individual Vehicle Approval .....	20
1.4) Disclaimer .....	21
1.5) Suggested Build Sequence .....	22
2.0) Kit contents .....	27
2.1) Packages .....	27
2.1.1) Exhaust, steering, large suspension items, bell-housing and front wing stays ...	27
2.1.2) Rear axle .....	31
2.1.3) Differential .....	32
2.1.4) Driveshafts .....	32
2.1.5) Suspension .....	33
2.1.6) Cooling .....	35
2.1.7) Lighting .....	36

2.1.8) Head light brackets.....	37
2.1.9) Uprights .....	38
2.1.10) Interior trim, cables and options .....	39
2.1.11) Gearbox .....	42
2.1.12) Chassis/body unit.....	43
2.1.13) Weather gear (optional).....	44
2.1.14) Engine .....	45
2.1.15) Heater assembly .....	45
2.1.16) Wheels .....	46
2.1.17) Seat.....	46
2.1.18) Wings .....	46
2.1.19) Nosecone .....	46
2.1.20) Roll over bar .....	46
3.0) Pre-assembly information.....	47
3.1) Package contents .....	47
3.2) Basic definitions .....	50
3.3) Tools and equipment .....	50
3.4) Nuts, bolts and washers.....	52
4.0) Steering.....	58
4.1) Steering rack (standard and wide rack) .....	58
4.2) Steering column .....	59
4.3.1) Motolita.....	62
4.3.2) Momo .....	62
4.3.3) Quick release column.....	62
4.4) Associated tasks .....	63
5.0) Front suspension .....	64
5.1) Preparation .....	64

5.2) Lower wishbones .....	64
5.3) Upper wishbones .....	65
5.4) Spring damper units.....	66
5.5) Upright attachment.....	66
5.5.1) Standard.....	67
5.5.2) Wide track .....	67
5.6) Front anti-roll bar.....	68
5.7) Front brake hoses .....	69
5.8) Final tightening.....	70
5.9) Cars fitted with adjustable damper platform.....	70
6.1) Assembly of gearbox kit – 5 and 6-speed.....	72
6.2) Fitting gearbox to engine .....	74
6.3) Starter motor.....	75
7.1) Sigma engine.....	76
7.1.1) Preparation.....	76
7.1.2) Installation of engine/gearbox into chassis.....	78
7.1.3) Electrical connections.....	80
7.1.4) Fuel system .....	82
7.1.5) Clutch hydraulic hose .....	82
7.1.6) Exhaust systems .....	83
7.1.7) Cooling system.....	86
7.1.8) Throttle cable fitment.....	92
7.1.9) Breather pipe fitment .....	93
7.1.10) Air filter fitment .....	94
7.1.11) Sigma 140 and Academy – air intake.....	94
7.2) Duratec - Roadsport 175/Superlight R300 engine .....	97
7.2.1) Preparation.....	97

7.2.2) Installation of engine/gearbox into chassis .....	99
7.2.3) Electrical connections.....	101
7.2.4) Fuel systems .....	102
7.2.5) Clutch hydraulic hose .....	103
7.2.7) Cooling system.....	106
7.2.8) Throttle cable fitment.....	112
7.2.9) Breather pipe fitment .....	113
7.3) Duratec – Superlight R400.....	116
7.3.1) Preparation.....	116
7.3.2) Installation of engine/gearbox into chassis .....	118
7.3.3) Electrical connections.....	120
7.3.4) Fuel system .....	121
7.3.5) Clutch hydraulic hose .....	122
7.3.6) Exhaust system .....	122
7.3.7) Cooling system and dry sump system.....	125
7.3.8) Throttle cable fitment.....	132
7.3.9) Breather pipe fitment .....	133
8.0) Preparation and installation of the differential.....	136
8.1) Procedure .....	136
9.0) Rear suspension .....	139
9.1) General.....	139
9.2) Preparation .....	139
9.3) Fitting of rear brake pipes .....	139
9.4) Rear brake hose .....	140
9.5) Assembly of the rear suspension.....	141
9.6) Rear spring damper assemblies .....	141
9.7) Radius arms.....	142

9.8) Watts link assembly (optional) .....	142
9.8.1) Construction of link arms .....	142
9.8.2) Link arms to bellcrank .....	142
9.8.3) Link arms to chassis .....	143
9.8.4) Bellcrank to Di Dion tube .....	143
9.9) Rear anti-roll bar (optional) .....	143
9.10) 'A' frame .....	144
9.11) Assembly of De Dion tube .....	145
9.12) Anti-roll bar connection and adjustment .....	148
9.13) Handbrake mechanism .....	149
9.14) Handbrake adjustment .....	151
9.15) Final adjustments .....	151
9.16) Filling of differential .....	151
10.0) Interior and trim .....	153
10.1) General .....	153
10.2) Seat back carpets .....	153
10.3) Transmission tunnel carpet .....	154
10.4) Transmission tunnel top .....	154
10.5) Rubber footwell mats .....	154
10.6) Boot carpet .....	155
10.7) Side and knee trim panels .....	155
10.8) Inertia reel seat belt .....	157
10.9) Four point harness .....	157
10.10) Six point harness .....	158
10.10.1) Standard floor .....	159
10.10.2) Lowered floor .....	159
10.11) Seats .....	159

10.11.1) Standard cloth or leather seats.....	159
10.11.2) Composite seats.....	160
10.12) Minor trim items .....	162
10.12.1) Scuttle edge trim .....	162
10.12.2) Nose badge.....	162
10.12) Rear view mirror.....	162
11.0) Fibreglass.....	164
11.1) Front cycle wings .....	164
11.2) Rear wing protectors (Stone guards).....	166
11.3) Rear wings.....	167
12.0) Lighting.....	169
12.1) Headlights and front indicators .....	169
12.2) Front indicator repeaters.....	170
12.3) Front wiring electrical connections .....	170
12.4) Rear lights.....	171
12.5) Reversing light and fog light.....	172
12.6) Rear number plate light.....	172
12.7) Testing.....	172
12.8) Headlight beam setting .....	173
13.0) Weather equipment .....	174
13.1) Fitting of hoodsticks and hoodstraps.....	174
13.2) Hood fitting.....	175
13.3) Sidescreen fitment .....	176
13.4) Arm rest bracket fitment (escutcheon bracket).....	178
13.5) Exterior mirrors .....	178
13.5.1) Fitment to screen stanchion .....	178
13.5.2) Fitment to side screens .....	179

13.6) Boot cover.....	180
13.7) Tonneau cover.....	181
13.8) Correct usage of fastener fixing tool .....	183
14.0) Wheel fitment .....	184
14.1) Spare wheel fitment .....	184
15.0) Start up procedure and final checks .....	186
15.1) Brake system – filling and bleeding.....	186
15.1.1) Standard brakes .....	186
15.1.2) Uprated front brakes.....	187
15.2) Clutch system – filling and bleeding.....	188
15.3) Coolant .....	189
15.4) Fuel.....	189
15.5) Engine/gearbox fasteners .....	189
15.6) Gearbox oil .....	189
15.7) Engine oil .....	190
15.8) Cranking for oil pressure.....	190
15.9) Start up .....	191
15.10) Front suspension and steering alignment .....	192
15.11) Final checks .....	193
16.0) Individual vehicle approval and registration.....	196
16.1) Requirements.....	196
16.2) How to apply for the inspection.....	197
16.3) Inspection refusal.....	197
16.4) Inspection data.....	198
16.4.1) Design weight.....	198
16.4.2) Towing.....	198
16.4.3) Speedometer.....	198



16.5) Checking and preparing the car prior to inspection.....	198
16.5.1) Wiper and washer system .....	198
16.5.2) Radio interference suppression.....	198
16.5.3) Lamps, reflectors and devices.....	198
16.5.4) Rear view mirrors .....	198
16.5.5) Noise .....	199
16.5.6) Emissions.....	199
16.5.7) General construction .....	199
16.5.8) Protective steering.....	199
16.5.9) Brakes .....	199
16.5.10) Interior and exterior projections.....	199
16.5.11) Race cars and IVA .....	202
16.6)Registration procedure after IVA inspection.....	202
16.7) Location of vehicle inspection test stations where the IVA test can be carried out .....	203
17.0) Options .....	205
17.1) Battery master switch.....	205
17.2) Standard roll over bar .....	205
17.3) Track day roll over bar .....	206
17.4) Roll cage.....	207
17.4.1) Preparation.....	207
17.4.2) Roll cage fitment.....	208
17.5) Head restraint (roll cage and roll over bar).....	210
17.6) Fire extinguisher pull handle .....	211
17.7) Aero fuel filler cap .....	212
17.8) High level brake light.....	215
17.8.1) Fitting the bracket.....	215

17.8.2) Light and wiring connections .....	216
17.8.3) Stack dash speed sensor fitment .....	218
17.8.4) Rear brake calliper sub assembly .....	219
17.8.5) IVA mirror fitting instructions.....	220
17.8.6) Front brake calliper sub assembly.....	221
18.0) Wiring diagrams.....	222

## List of Tables

TABLE 1: SUGGESTED BUILD SEQUENCE.....	22
TABLE 2: POLYTHENE BAG CONTENTS - EXHAUST, STEERING, SUSPENSION ITEMS, BELL-HOUSING AND FRONT WINGSTAYS.....	29
TABLE 3: POLYTHENE BAG CONTENTS - REAR AXLE.....	31
TABLE 4: POLYTHENE BAG CONTENTS - SUSPENSION.....	34
TABLE 5: POLYTHENE BAG CONTENTS - INTERIOR TRIM, CABLES AND OPTIONS.....	41
TABLE 6: PACKAGE CONTENTS.....	47
TABLE 7: TOOLS REQUIRED.....	50
TABLE 8: ADDITIONAL TOOLS AND EQUIPMENT.....	50
TABLE 9: CONSUMABLES.....	51
TABLE 10: RECOMMENDED LUBRICANTS.....	51
TABLE 11: GENERAL TORQUE FIGURES.....	52
TABLE 12: STEERING COMPONENT TORQUE FIGURES.....	63
TABLE 13: FRONT SUSPENSION TORQUE FIGURES.....	70
TABLE 14: GEARBOX TORQUE FIGURES.....	75
TABLE 15: SPECIAL TOOLS REQUIRED FOR SIGMA ENGINE.....	76
TABLE 16: GEARBOX INSTALLATION TORQUE FIGURES FOR SIGMA ENGINE.....	79
TABLE 17: SPECIAL TOOLS REQUIRED FOR DURATEC – ROADSPORT 175/ SUPERLIGHT R300 ENGINE.....	97
TABLE 18: GEARBOX TORQUE FIGURES FOR DURATECROADSPORT 175/ SUPERLIGHT R300 ENGINE.....	100
TABLE 19: SPECIAL TOOLS REQUIRED FOR SUPERLIGHT R400 ENGINE.....	116
TABLE 20: TORQUE FIGURES FOR DURATEC SUPERLIGHT R400 ENGINE.....	119
TABLE 21: SPECIAL TOOLS REQUIRED FOR REAR SUSPENSION.....	139
TABLE 22: TORQUE FIGURES FOR REAR SUSPENSION.....	152
TABLE 23: SPECIAL TOOLS REQUIRED FOR INTERIOR AND TRIM.....	153
TABLE 24: FRONT LIGHTING WIRING CONNECTIONS.....	170
TABLE 25: REAR LIGHTING WIRING CONNECTIONS.....	172
TABLE 26: ADDITIONAL TOOLS REQUIRED FOR WEATHER EQUIPMENT.....	174
TABLE 27: ENGINE OIL INITIAL FILL.....	190
TABLE 28: RECOMMENDED SUSPENSION ALIGNMENT - ROAD USE STANDARD AND WIDE TRACK.....	192
TABLE 29: TYRE PRESSURES.....	193
TABLE 30: TORQUE FIGURES FOR FINAL CHECKS AND START UP PROCEDURE.....	194
TABLE 31: TRACK DAY ROLL OVER BAR MOUNTING BOLT TORQUE FIGURES.....	207
TABLE 32: ROLL CAGE MOUNTING BOLT TORQUE FIGURES.....	210
TABLE 33: HEAD RESTRAINT FIXING TORQUE FIGURES.....	211

## List of Figures

FIGURE 1: EXHAUST.....	28
FIGURE 2: STEERING, LARGE SUSPENSION ITEMS, BELL-HOUSING AND FRONT WINGSTAYS.....	30
FIGURE 3: REAR AXLE ITEMS .....	31
FIGURE 4: DIFFERENTIAL.....	32
FIGURE 5: DRIVESHAFTS .....	32
FIGURE 6: SUSPENSION ITEMS.....	33
FIGURE 7: COOLING ITEMS .....	35
FIGURE 8: LIGHTING ITEMS .....	36
FIGURE 9: HEADLIGHT BRACKETS .....	37
FIGURE 10: UPRIGHTS .....	38
FIGURE 11: BOOT CARPET.....	39
FIGURE 12: BULKHEAD CARPET .....	39
FIGURE 13: RUBBER MATS .....	40
FIGURE 14: TRANSMISSION TUNNEL TOP .....	40
FIGURE 15: 5-SPEED GEARBOX.....	42
FIGURE 16: 6-SPEED GEARBOX (OPTIONAL).....	42
FIGURE 17: ITEMS LOOSE IN CHASSIS.....	43
FIGURE 18: WEATHER GEAR (OPTIONAL).....	44
FIGURE 19: 1.6 SIGMA ENGINE .....	45
FIGURE 20: HEATER ASSEMBLY .....	45
FIGURE 21: COMPLETE KIT (LESS ENGINE).....	49
FIGURE 22: CUT ALLEN KEY .....	51
FIGURE 23: FASTENER PACK .....	55
FIGURE 24: FRONT AXLE STANDS.....	56
FIGURE 25: REAR AXLE STANDS .....	57
FIGURE 26: STEERING RACK ASSEMBLY .....	58
FIGURE 27: PEDAL BOX.....	59
FIGURE 28: STEERING RACK TO STEERING COLUMN .....	60
FIGURE 29: UPPER STEERING COLUMN CLAMP.....	61
FIGURE 30: STEERING WHEEL - MOTOLITA.....	62
FIGURE 31: BODYWORK PROTECTION .....	64
FIGURE 32: WASHER USAGE - LOWER WISHBONE (LH SIDE) .....	65
FIGURE 33: UPPER WISHBONE SECURING.....	65
FIGURE 34: FRONT SUSPENSION.....	68
FIGURE 35: BRAKE PIPE UNION .....	69
FIGURE 36: STANDARD CALLIPER.....	69
FIGURE 37: UPRATED CALLIPER.....	70
FIGURE 38: CLUTCH ACTUATION MECHANISM.....	73

FIGURE 39: SPEEDO DRIVE PLUG .....	73
FIGURE 40: SPEEDO SHAFT PLUG .....	74
FIGURE 41: WATER RAIL AND 'U' HOSE.....	77
FIGURE 42: HORN LOCATION .....	78
FIGURE 43: ECU AND MAP UNIT .....	81
FIGURE 44: BRAKE LIGHT SWITCH HARNESS .....	81
FIGURE 45: FUEL PIPE CONNECTION .....	82
FIGURE 46: CLUTCH MASTER CYLINDER HOSE UNION .....	83
FIGURE 47: CLUTCH HYDRAULIC HOSE .....	83
FIGURE 48: EXHAUST MOUNTING .....	84
FIGURE 49: PRIMARY PIPES AND COLLECTOR/CATALYST .....	85
FIGURE 50: LAMBDA PROBE CONNECTION .....	85
FIGURE 51: EXHAUST ARRANGEMENT .....	86
FIGURE 52: COOLANT HOSES .....	86
FIGURE 53: BOTTOM HOSE ENGINE CONNECTION (VIEWED FROM BELLOW).....	87
FIGURE 54: RADIATOR/FAN PRIOR TO FITTING.....	87
FIGURE 55: STANDARD RADIATOR ARRANGEMENT .....	87
FIGURE 56: SV RADIATOR ARRANGEMENT .....	88
FIGURE 57: COOLANT EXPANSION BOTTLE MOUNTING BRACKET .....	88
FIGURE 58: HEATER INSTALLATION .....	89
FIGURE 59: HEATER VALVE ARRANGEMENT .....	91
FIGURE 60: HEATER CONTROL LOCATION .....	91
FIGURE 61: HEATER CONTROL CABLE .....	91
FIGURE 62: HEATER CONTROL CABLE ATTACHMENT.....	92
FIGURE 63: THROTTLE CABLE TO THROTTLE BODY .....	92
FIGURE 64: BREATHER PIPE .....	93
FIGURE 65: AIR INTAKE AND TRUNKING .....	94
FIGURE 66: SIGMA 125 ENGINE BAY OVERVIEW .....	95
FIGURE 67: SIGMA 125 ENGINE BAY OVERVIEW (REAR).....	96
FIGURE 68: WATER OUTLET AND 'L' SHAPE HOSE.....	98
FIGURE 69: HORN LOCATION .....	99
FIGURE 70: ECU .....	101
FIGURE 71: BRAKE LIGHT SWITCH HARNESS .....	102
FIGURE 72: FUEL PIPE CONNECTION .....	102
FIGURE 73: CLUTCH MASTER CYLINDER HOSE UNION .....	103
FIGURE 74: CLUTCH HYDRAULIC HOSE .....	103
FIGURE 75: EXHAUST MOUNTING .....	104
FIGURE 76: PRIMARY PIPES AND COLLECTOR/CATALYST .....	105
FIGURE 77: LAMBDA PROBE CONNECTION .....	106
FIGURE 78: EXHAUST ARRANGEMENT .....	106

FIGURE 79: LOCATION OF MODINE .....	107
FIGURE 80: BREATHER BOTTLE MOUNTING BRACKET .....	107
FIGURE 81: BOTTOM RADIATOR HOSE ENGINE CONNECTION (VIEW FROM TOP) .....	107
FIGURE 82: SV RADIATOR ARRANGEMENT .....	108
FIGURE 83: COOLANT EXPANSION BOTTLE MOUNTING BRACKET .....	108
FIGURE 84: HEATER INSTALLATION .....	109
FIGURE 85: COOLANT HOSES .....	110
FIGURE 86: HEATER VALVE.....	<b>ERROR! BOOKMARK NOT DEFINED.</b>
FIGURE 86 TEMP SENDER SUBMARINE .....	111
FIGURE 88: HEATER CONTROL LOCATION .....	111
FIGURE 89: HEATER CONTROL CABLE .....	112
FIGURE 90: HEATER CONTROL CABLE ATTACHMENT.....	112
FIGURE 91: THROTTLE CABLE LINKAGE .....	113
<b>FIGURE 92: BREATHER PIPE.....</b>	<b>114</b>
FIGURE 93: DURATEC ENGINE BAY OVERVIEW .....	115
FIGURE 94: WATER OUTLET AND 'L' SHAPE HOSE.....	117
FIGURE 95: HORN LOCATION .....	118
FIGURE 96: HORN LOCATION (TOP DOWN) .....	118
FIGURE 97: ECU .....	120
FIGURE 98: BRAKE LIGHT SWITCH HARNESS .....	121
FIGURE 99: FUEL PIPE CONNECTION .....	121
FIGURE 100: CLUTCH MASTER CYLINDER HOSE UNION .....	122
FIGURE 101: CLUTCH HYDRAULIC HOSE .....	122
FIGURE 102: EXHAUST MOUNTING .....	123
FIGURE 103: PRIMARY PIPES AND COLLECTOR/CATALYST .....	124
FIGURE 104: LAMBDA PROBE CONNECTION .....	124
FIGURE 105: EXHAUST ARRANGEMENT .....	125
FIGURE 106: FITMENT OF DRY SUMP OIL TANK.....	125
FIGURE 107: BOTTOM RADIATOR HOSE ENGINE CONNECTION (VIEWED FROM TOP) .....	126
FIGURE 108: RADIATOR COWL FLAPS.....	126
FIGURE 109: RADIATOR ARRANGEMENT .....	127
FIGURE 110: ROUTING OF THE OIL PIPES.....	127
FIGURE 111: SV RADIATOR ARRANGEMENT .....	128
FIGURE 112: HEATER INSTALLATION .....	129
FIGURE 113: COOLANT HOSES .....	130
FIGURE 114: WATER OUTLETS CYLINDER HEAD .....	131
FIGURE 115: HEATER VALVE ARRANGEMENT .....	131
FIGURE 116: HEATER CONTROL LOCATION .....	131
FIGURE 117: HEATER CONTROL CABLE .....	132
FIGURE 118: HEATER CONTROL CABLE ATTACHMENT.....	132

FIGURE 119: THROTTLE CABLE LINKAGE .....	133
FIGURE 120: BREATHER PIPE .....	134
FIGURE 121: DURATEC ENGINE BAY OVERVIEW .....	135
FIGURE 122: CATERHAM DIFFERENTIAL INSTALLATION (CAD IMAGE) .....	136
FIGURE 123: HANDBRAKE CABLE LOCATION .....	136
FIGURE 124: DIFFERENTIAL INSTALLATION AND LHS.....	137
FIGURE 125: DI DION TUBE RH BRAKE PIPE FITTING .....	140
FIGURE 126: LH BRAKE PIPE FITTING .....	141
FIGURE 127: WATTS LINK - RH SIDE .....	142
FIGURE 128: WATTS LINK - RH TOP VIEW.....	143
FIGURE 129: REAR ANTI-ROLL BAR MOUNTING.....	144
FIGURE 130: METALISTIC BRUSH - DE DION TUBE.....	144
FIGURE 131: FORWARD 'A' FRAME MOUNTING .....	145
FIGURE 132: DE DION TUBE END (LH) .....	146
FIGURE 133: ANTI-ROLL BAR BRACKET AND SPEED SENSOR.....	147
FIGURE 134: SPEED SENSOR.....	147
FIGURE 135: ANTI-ROLL BAR CONNECTIONS .....	148
FIGURE 136: HANDBRAKE ASSEMBLY.....	149
FIGURE 137: SV HANDBRAKE CABLE ARRANGEMENT .....	150
FIGURE 138: HANDBRAKE CABLE ROUTING S3 (NON-ADJUSTABLE SIDE).....	150
FIGURE 139: REAR SUSPENSION ARRANGEMENT .....	151
FIGURE 140: CARPETS.....	153
FIGURE 141: SIDE PANEL DETAIL .....	156
FIGURE 142: TRIM FIXINGS .....	157
FIGURE 143: MOUNTING HOLES FOUR-POINT HARNESS UPPER .....	157
FIGURE 144: SHOULDER STRAP WITH TRACK DAY ROLL OVER BAR .....	158
FIGURE 145: OUTBOARD LAP STRAP .....	158
FIGURE 146: LAP STRAPS.....	158
FIGURE 147: CRUTCH STRAP SPACER LOCATION .....	159
FIGURE 148: ADJUSTABLE SEAT .....	160
FIGURE 149: COMPOSITE SEAT AND SIX-POINT HARNESS .....	161
FIGURE 150: FIXED SEAT.....	161
FIGURE 151: COMPLETED INTERIOR.....	163
FIGURE 152: INDICATOR REPEATER WIRING.....	166
FIGURE 153: REAR WING PROTECTOR PIPING.....	166
FIGURE 154: REAR WING FITMENT .....	167
FIGURE 155: WING PIPING.....	168
FIGURE 156: REAR WING.....	168
FIGURE 157: HEADLIGHT AND INDICATOR LH.....	170
FIGURE 158: WEATHER EQUIPMENT.....	174

FIGURE 159: HOODSTICK SPACING .....	175
FIGURE 160: HOODSTRAP FIXING.....	175
FIGURE 161: HOOD SIDE FASTENERS.....	176
FIGURE 162: HINGE AND SIDE SCREEN FITTING.....	176
FIGURE 163: SIDESCREEN STRAPS .....	178
FIGURE 164: ARM REST BRACKET .....	178
FIGURE 165: IVA MIRROR STALK ADAPTOR.....	179
FIGURE 166: MIRROR FITTED TO SIDE SCREEN .....	179
FIGURE 167: BOOT COVER .....	180
FIGURE 168: FORWARD FASTENER BOOT COVER .....	181
FIGURE 169: TONNEAU COVER .....	181
FIGURE 170: TONNEAUCOVER POSITIONING .....	182
FIGURE 171: TONNEAU COVER FASTENERS (FRONT).....	182
FIGURE 172: DURABLE DOT FASTENER TOOL .....	183
FIGURE 173: SPARE WHEEL MOUNTING ITEMS .....	185
FIGURE 174: CLUTCH HYDRAULIC CONNECTIONS.....	188
FIGURE 175: IVA BAG CONTENTS .....	200
FIGURE 176: IVA SCUTTLE TRIM AND BATTERY MASTER SWITCH.....	200
FIGURE 177: BONNET CATCHES.....	201
FIGURE 178: FRONT SUSPENSION.....	201
FIGURE 179: EXHAUST MOUNTING .....	201
FIGURE 180: SIDE SCREEN HINGES.....	202
FIGURE 181: STANDARD ROLL OVER BAR .....	205
FIGURE 182: TRACK ROLL OVER BAR .....	206
FIGURE 183: FRONT FIXING BOSS LOCATION.....	208
FIGURE 184: REAR HOOP BUCKET BUSHES.....	209
FIGURE 185: HEAD RESTRAINT ASSEMBLY.....	211
FIGURE 186: FIRE EXTINGUISHER PULL HANDLE.....	211
FIGURE 187: FIRE EXTINGUISHER INNER CABLE LOCATION.....	212
FIGURE 188: FILLER COVER AND BOOT CARPET REMOVED.....	213
FIGURE 189: DRILL OUT THE SIX RIVETS.....	213
FIGURE 190: OLD FILLER BOSS REMOVED .....	213
FIGURE 191: GASKET POSITIONED ON BACK PANEL.....	213
FIGURE 192: CAREFULLY DRILL NEW HOLES .....	213
FIGURE 193: SPACER FITTED TO FILLER NECK .....	214
FIGURE 194: FIT FLANGE.....	214
FIGURE 195: JOB COMPLETE .....	214
FIGURE 196: KIT CONTENTS FOR HIGH LEVEL BRAKE LIGHT .....	215
FIGURE 197: DRILLING CENTRAL POPPER ON SV .....	215
FIGURE 198: ALIGNMENT OF BRACKET .....	216



FIGURE 199: WIRE ROUTING THROUGH LIGHT UNIT .....	216
FIGURE 200: DRILLED HOLE ABOVE SPARE WHEEL BOSS .....	216
FIGURE 201: VIEW FROM UNDER RHS REAR CORNER .....	217
FIGURE 202: EXPLODED VIEW OF ASSEMBLY .....	217
FIGURE 203: WIRES FROM SUPPORT TUBE ENTERING BOOT .....	217
FIGURE 204: COMPLETED ASSEMBLY .....	218
FIGURE 205: WHEEL SPEED SENSOR PLUG.....	218
FIGURE 206: WHEEL SPEED SENSOR BRACKET .....	218
FIGURE 207: WHEEL SPEED SENSOR .....	219
FIGURE 208: BRAKE CALLIPER ASSEMBLY .....	219
FIGURE 209: BRAKE PAD ASSEMBLY .....	219
FIGURE 210: KIT CONTENTS FOR MIRROR FITTING.....	220
FIGURE 211: DISMANTLED MIRROR .....	220
FIGURE 212: ASSEMBLED MIRROR .....	220
FIGURE 213: STUD LOCATED ON STANCHION .....	221
FIGURE 214: FINAL FITTED ASSEMBLY .....	221
FIGURE 215: FRONT BRAKE CALLIPER ASSEMBLY.....	221
FIGURE 216: FRONT BRAKE PADS ASSEMBLY .....	221
FIGURE 217: MAIN WIRING HARNESS FOR ALL STANDARD INSTRUMENTATION, FORD SIGMA VARIANTS .....	222
FIGURE 218: ENGINE HARNESS (SIGMA) .....	223
FIGURE 219: R400 ENGINE HARNESS.....	224
FIGURE 220: R400 MAIN CHASSIS HARNESS (STANDARD DASH) .....	225
FIGURE 221: R400 MAIN CHASSIS HARNESS (STACK DASH) .....	226

## **0.0) Preliminary information**

### **0.1) General warnings & cautions**

The following warnings and cautions indicate general and environmental hazards present during the building process:

#### **Warnings**

Due consideration should be given to the highly flammable nature of petroleum or alcohol based products and their vapours. Serious burns can result from incorrect use.

Oils – prolonged and repeated contact may cause serious skin disorders.

Avoid contact with the skin as far as possible and wash thoroughly after any contact.

Keep out of reach of children.

First aid treatment should be obtained for open cuts and wounds.

Use appropriate barrier creams.

Hydraulic fluid (brake fluid) is poisonous. Wash affected areas immediately in case of skin contact and seek medical assistance if swallowed.

Hydraulic fluid (brake fluid) is hygroscopic. Ensure only clean fresh fluid is used.

Hydraulic fluid (brake fluid) is corrosive to paintwork, powder coat and plastic components. Care should be taken to avoid spillage at any times.

#### **Cautions**

Protect the environment. It is illegal to pollute drains, water course and soil. Authorised waste collection facilities include civic amenity sites and garages which provide facilities for the disposal of oil and used oil filters. If in doubt ask the local authority for advice.

### **0.2) Specific warnings & cautions**

The following warnings and cautions indicate specific hazards relating to the Caterham build process:

#### **Warnings**

Never work underneath a car without supporting it on axle stands or equivalent. Do not rely on a jack alone.

Use appropriate eye protection whilst carrying out drilling operations.

Use appropriate eye protection whilst working under the car.

Cars fitted with electronic ignition systems have increased voltages compared with conventional systems. Ensure system is switched off prior to carrying out any work.

The electric radiator fan is controlled by a thermostatic switch which operates when the ignition is in the 'on' position. Whilst working on a hot engine ensure that the ignition is switched off.

Do not remove coolant expansion bottle cap whilst coolant is hot. Take precautions to prevent scalds.

Correct use of fixings is required in order to ensure full engagement of the nyloc nut.

Both imperial and metric threads are used on the de dion brake pipes. The threads on the three way union are imperial whilst those on the brake callipers are metric. To aid recognition a small notch is machined into the hexagon of the metric unions.

Retighten wheel nuts after 200 miles.

Ensure adhesive is applied in a well-ventilated area. Follow instructions on adhesive packaging. Care must be taken whilst working in a confined area, for instance the footwell.

Use a suitable face mask to prevent inhalation of dust when drilling fibreglass or carbon fibre.

## **Cautions**

All brake connections must be kept spotlessly clean and contamination with oil, water and petrol should be avoided.

When drilling fibreglass use tape on the surface over the drill holes to prevent damage to the gel coat or painted finish. Slow drill speeds must be used.

Do not over-tighten thermostatic fan switch.

## 1.0) Introduction

It is recommended that the entire assembly guide and IVA requirements are read before commencing building of the car. This will allow planning ahead for the procurement of tools, consumables and equipment required during the build process.

Whilst it is possible for many of the build processes to be undertaken simultaneously there are some areas where the correct build sequence is critical. A suggested build sequence is included at the end of this section.

### 1.1) Contact information

#### 1.1.1) Customer Liaison

For all enquiries between point of order and delivery please contact our sales departments at Caterham South on 01883 333700 or Caterham Midlands on 01455 841616

#### 1.1.2) Caterham Aftersales

To maximise the enjoyment of your Seven, the safety and integrity of the car must be maintained by careful adherence to the maintenance schedules. Further information on when servicing is required can be found in the Owners Handbook supplied with your car.

For all service, repairs, warranty and upgrade enquiries, contact the aftersales team located at all three of our sites:

#### Caterham Dartford (Kent)

T: +44 (0)1322 625804

E: [Aftersales@caterham.com](mailto:Aftersales@caterham.com)

#### Caterham Midlands (Leicester)

T: +44 (0)1455 841616

E: [MidlandService@caterham.com](mailto:MidlandService@caterham.com)

#### 1.1.3) Caterham Parts

For parts enquiries please contact Caterham Dartford +44 (0)1322 625801

#### 1.1.4) Technical Assistance

Caterham Cars will happily provide technical assistance when requires. When in doubt, ask. Our technical team can be contacted on +44 (0)1322 625800

Do ensure that you make a note of your sales order number (top of invoice) and your customer number as these are the references by which we know you and your kit and will ensure that, no matter how long you take to assemble your car, subsequent packages will be compatible.

The kit provided by Caterham Cars includes all the items required to build the

car. However, due to the sheer number of different components it is possible that some parts are omitted or duplicated. Kits should be checked to ensure all components (including contents of fastener packs) are present prior to starting construction. If there are any shortages or build enquiries contact Derek Howlett at Caterham Dartford on +44 (0)1322 625827.

### **1.2) Post build check**

When your Caterham Seven is finally completed and ready for the road it is strongly recommended that you make use of our Post Build Check facility. All customers are sent a free voucher covering the first three hours of the Post Build Check (this is ample time to check a completed kit, which can be carried out at Caterham Dartford, at Caterham Midlands or at one of our approved services agents). The Seven even in its lowest state of tune possesses acceleration and cornering abilities far in excess of most road going cars and it is therefore extremely important that it is assembled and set up correctly.

We are also keen to ensure that our customers do not suffer disappointment as a result of sub-standard performance or premature component failure resulting from incorrect assembly.

The Post Build Check therefore includes:

- Inspection of all safety related items.
- Inspection of all operating systems (Clutch, Gearbox, Axle etc.).
- A written report on any matters causing concern or requiring attention.
- Completion of any agreed warranty work.
- Post Build Inspection Certificate when the car has passed inspection.
- Check to ensure compliance to IVA requirements (if required).

The inspection will take approximately three hours and we suggest that you give at least two weeks' notice when booking your car in. If additional work is required please notify the Service Manager at the time of booking to ensure that sufficient time can be made available. Any additional work will be charged on an hourly basis.

### **1.3) Individual Vehicle Approval**

The requirements for Individual Vehicle Approval (IVA) are detailed in the IVA and registration section. To pass the IVA **YOU MUST TAKE PHOTOS OF YOURSELF BUILDING THE CAR.** For advice or assistance on IVA matters contact the Aftersales Department. IVA is a

requirement for UK markets only therefore the additional parts will not be supplied with overseas orders.

#### **1.4) Disclaimer**

The Caterham Seven is supplied in kit form and is supplied for amateur construction.

The builder must assume that all nuts, bolts and fasteners may be loose and takes the responsibility to ensure road worthiness.

Sound engineering principles must always be followed.

A free post build check is available from Caterham Dartford or from one of Caterham Cars agents.

#### **NOTE**

*In the UK, the assembled kit cannot legally be driven to the post build inspection (prior to successful completion of an IVA test).*

## 1.5) Suggested Build Sequence

**Table 1: Suggested Build Sequence**

Work Area	Detail	Comment
<b>Front</b>		
Steering		Initial fit
	Steering rack	
	IVA sleeves	
	Track rod ends	
Front suspension		
	Lower wishbones	
	Upper wishbones	
	Headlight brackets and headlight assembly	
	Damper units	
	Uprights	
	Wingstays	
	Anti-roll bar	On R400 back radiator cowling should be fitted before anti roll bar
	Front flexible brake hoses	
<b>Engine &amp; Gearbox</b>		
	Speedo drive plugs (large & small) 6 speed only	
	Gearbox rubber mounting	
	Gearbox to bell housing	
	Clutch release mechanism	

	Gearbox to engine	
Prep engine		
	Oil pressure sender	Normally fitted to the engine, if not please fit it before engine installation.
	Starter motor	
	Wiring loom (starter to alternator)	
	'J' hose	
	Intermediate top house ('U' hose)	
	Gearbox filler plug	Loosen
	Gearbox tail shaft plug	Remove
<b>Engine Bay</b>		
	Engine mount blocks	Fit to chassis
	Earth lead	
	Wiper reservoir	
	Alternate header tank mounting plate	Optional fitment
	Horns	
	Install engine/ gearbox	
	Engine mounts	Fit to engine
	Earth lead	
	Engine/ chassis loom connections	
	Starter/ battery leads	
	ECU	
	MAP unit	
	Reverse light switch	



	Gear stick	
	Fuel pipe	
	Primary exhaust pipes	
	Collector box/ cat	
	Lambda probe	
	Head tank mounting	
	Steering column	
	Steering wheel	
	Bottom hose	
	Top hose	
	Radiator bobbins	
	Fan and inner cowl	Cowling is only on R400
	Anti-roll bar	Front suspension section
	Fan switch	
	Radiator	
	Outer cowl	Cowling is only on R400
	Heater	Maybe fitted before engine
	Heater hoses	
	Heater valve	
	Heater control cable	
	Header tank	
	Expansion hoses	
	Cycle wings and indicator repeaters	
<b>Rear chassis</b>		
Prep and install diff		

	Handbrake and cables	Initial assembly
	Prop shaft	
	Differential	
Rear suspension		
	Brake pipes and flexi hose	
	De-Dion tube	
	Rear dampers	Only if standard roll over bar specified
	Radius arms	Or optional watts linkage
	'A' frame	
	Drive shafts	
	Rear anti –roll bar	Optional
	De-Dion ears	
	Hub carriers	
	Speed sensor	Including anti-roll bar spacer if specified
	Hubs/ discs	
	Callipers	
	Attach handbrake cables	Adjusted after brakes are bled
<b>Cockpit &amp; Boot</b>		
	Transmission tunnel trim	
	Gear knob	
	Scuttle edge trim	
	Sill protectors	Optional
	Knee trim panels and interior panel piping	Depends on roll over protection specified

	Four and six point harness lap and crutch straps	Optional
	Carpets	
	Seats	
	Roll over bar/ cage as specified	
	Head restraint	Roll cage option only
	Rear dampers	If track day roll over bar or roll cage specified
	Fuel filler shroud	
<b>Bodywork and Hood</b>		
	Front wings and indicator repeater lights	Maybe fitted immediately after fitting front anti-roll bar
	Rear wing protectors	
	Rear wings	
	Exhaust pipe bracket	
	Exhaust silencer	
	Heat shields	Silencer and collectors/ cat
	Hood sticks	
	Hood fasteners	
	Side screens	
	IVA	

## 2.0) Kit contents

The following pages include pictures and tables to assist with part recognition and location. Due to the multiple permutations that can be produced it is impossible to show the exact locations of every part. However the pictures have been laid out in such a way that each picture represents what you should expect to find in a particular box.

### 2.1) Packages

The complete kit is supplied as follows:

- Chassis/Body unit (CBU).
- Composite panels (nosecone, rear wings and front wings).
- Engine assembly.
- Gearbox assembly.
- Boxes of parts (approximately 10).
- Wheel/tyre assemblies.
- Seats.
- Exhaust silencer.
- Heater (in own box).

#### *IMPORTANT NOTE*

*The following pages are provided as a guide to aid recognition of parts. The packages shown will not be an exact representation of what you should expect to find in the packages supplied with your kit and should therefore not be used as a parts check list.*

#### *2.1.1) Exhaust, steering, large suspension items, bell-housing and front wing stays*

The exhaust, steering, large suspension items, bell-housing and front wingstay items are shown in Figure 1 and Figure 2. The contents of the polythene bags are shown in Table 2.

**Figure 1: Exhaust**



- 1. Exhaust silencer
- 2. Exhaust primary pipes
- 3. Cat/ collector
- 4. Cat guard
- 5. Polythene bag

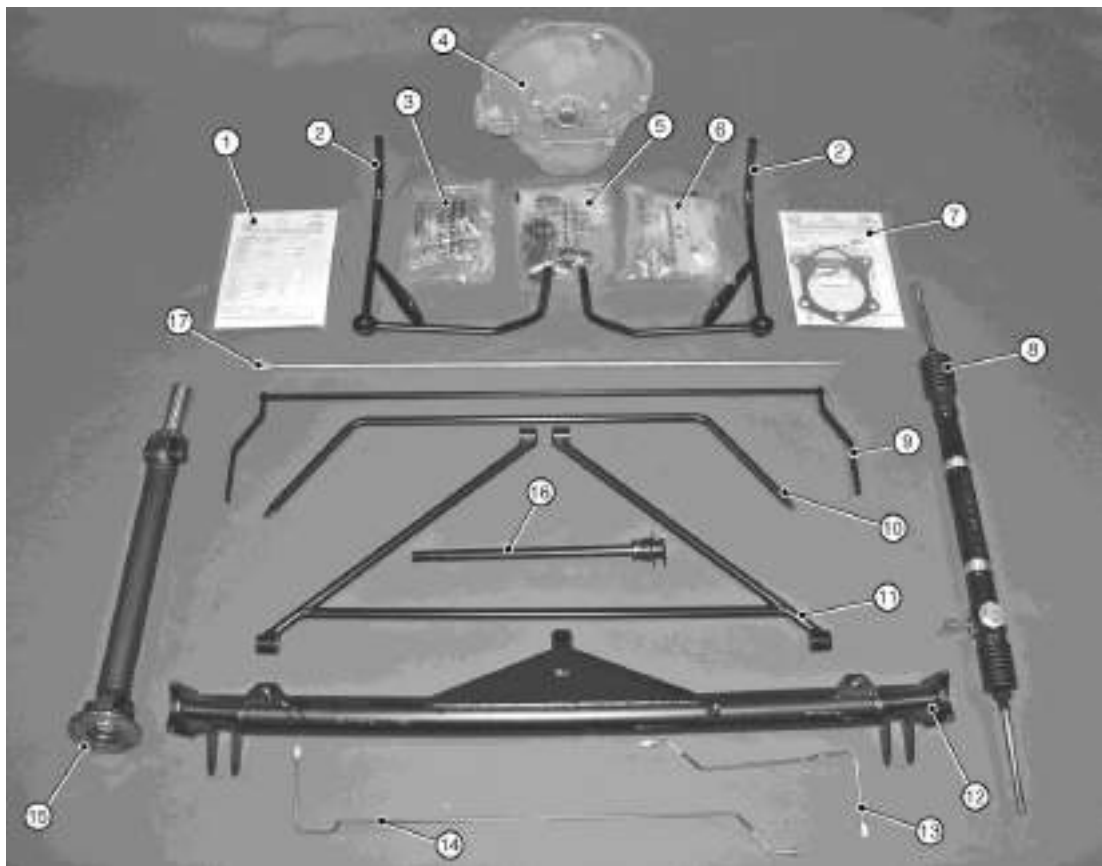
**NOTE**

*Items may differ from those illustrated*

**Table 2: Polythene bag contents - exhaust, steering, suspension items, bell-housing and front wingstays**

Identifier	Description	Qty
Gearbox	Gearbox mounting rubber	1
	Gear knob	1
	Speedo drive cover	1
	Reverse light switch	1
	Speedo blanking plug	1
Steering	Track rod ends	2
	Universal joint	1
	Aluminium steering rack clamps	2 pairs
	Steering column bush	1
	Grub screw	1
	Steering column clamp	1
	Steering column plate	1
Exhaust	Jubilee clips	5
	Exhaust clamp	1
	Exhaust mounting bracket	1
	Mounting bobbins	1
	Exhaust springs	2
	Lambda sensor	1
Wheels	Wheel nuts	16 or 18
	Wheel nut washers	16 or 18
	Centre caps	4 or 5
	Centre cap badges	4 or 5

**Figure 2: Steering, large suspension items, bell-housing and front wingstays**

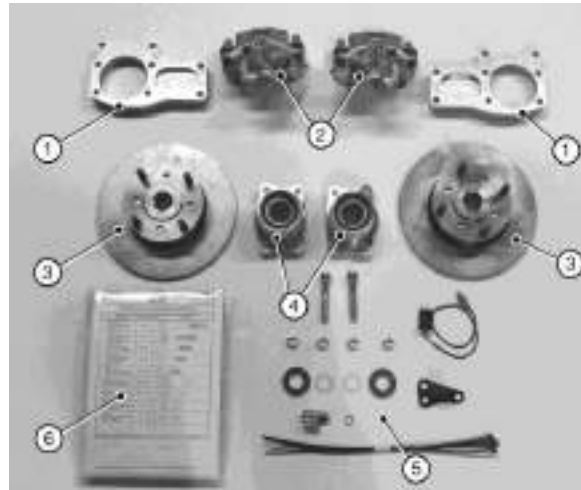


- |                             |  |
|-----------------------------|--|
| 1. Fastener pack 'steering' | 10. Front anti-roll bar                          |
| 2. Front wingstay           | 11. 'A' frame                                    |
| 3. Polythene bag 'steering' | 12. De Dion tube                                 |
| 4. Bell housing             | 13. Brake pipe (short)                           |
| 5. Polythene bag 'steering' | 14. Brake pipe (long)                            |
| 6. Polythene bag 'wheels'   | 15. Propshaft                                    |
| 7. Fastener pack 'gearbox'  | 16. Upper steering column and QR boss (optional) |
| 8. Steering rack            | 17. Lower steering column                        |
| 9. Rear anti-roll bar       |  |

### 2.1.2) Rear axle

The rear axle items are shown in Figure 3. The contents of the polythene bag are detailed in Table 2.

**Figure 3: Rear axle items**



1. De Dion ears
2. Brake calliper (2, LH and RH)
3. Brake disc
4. Hub/bearing assembly (2)
5. Polythene bag 'rear axle'
6. Fastener pack 30R011A

**Table 3: Polythene bag contents - rear axle**

Identifier	Description	Qty
Rear Axle	Cable ties	-
	Aluminium brake calliper spacers	4
	Drive shaft washer	2
	3-way brake union	1
	Race washers	2
	Rear brake pads	4



### 2.1.3) Differential

The differential is shown in Figure 4.

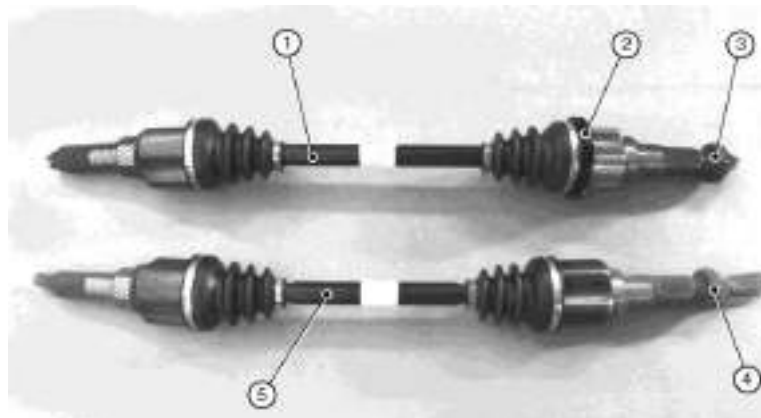
**Figure 4: Differential**



### 2.1.4) Driveshafts

The driveshafts are shown in Figure 5.

**Figure 5: Driveshafts**

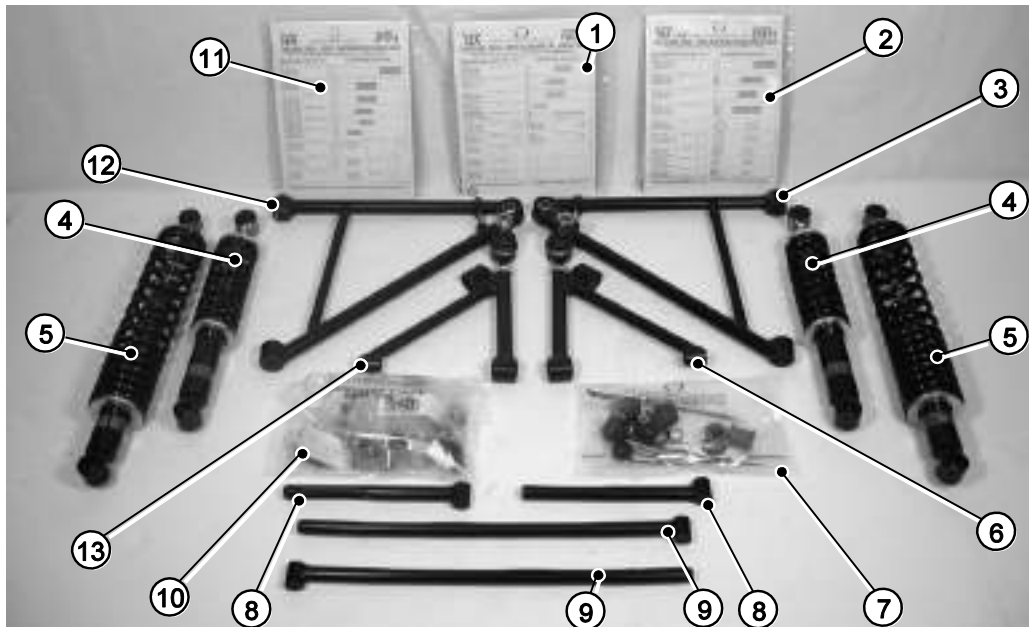


- |                             |                             |
|-----------------------------|-----------------------------|
| 1. RH driveshaft            | 4. Nyloc nut (white insert) |
| 2. Speed sensor ring        | 5. LH driveshaft assembly   |
| 3. Nyloc nut (green insert) |                             |

### 2.1.5) Suspension

The suspension items are shown in Figure 6. The contents of the polythene bags are detailed in Table 3.

**Figure 6: Suspension items**



- |                                    |                                    |
|------------------------------------|------------------------------------|
| 1 Fastener pack 30R012A            | 8 Watts link (rear) radius arm     |
| 2 Fastener pack 30R011A            | 9 Watts link (front) radius arm    |
| 3 Lower wishbone (RH)              | 10 Polythene bag 'rear suspension' |
| 4 Spring damper unit (front)       | 11 Fastener pack 30F015A           |
| 5 Spring damper unit (rear)        | 12 Lower wishbone (LH)             |
| 6 Upper wishbone (RH)              | 13 Upper wishbone (LH)             |
| 7 Polythene bag 'front suspension' |                                    |

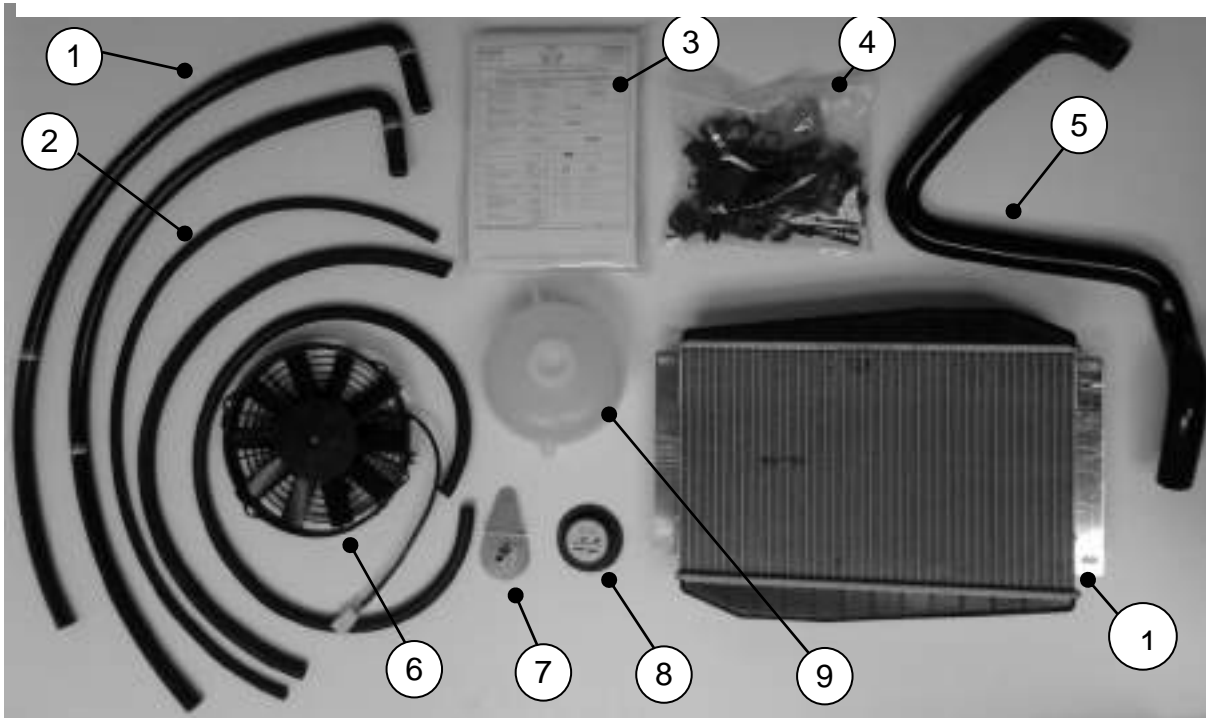
**Table 4: Polythene bag contents - suspension**

<b>Identifier</b>	<b>Description</b>	<b>Qty</b>
Front suspension	Rubber cotton reel bushes	2
	Damper sleeves	4
	Anti-roll bar rubber cover	2
	Anti-roll bar ball ends	2
	Cables ties	-
	Anti-roll bars mounting clamps	2
	Wishbone sleeves	2
	Special stepped nyloc nut (widetrack/SV)	2
Rear suspension (including rear anti-roll bar option)	Rubber cotton reel bushes	2
	Aluminium mounting blocks	2 pairs
	Bellcrank (Watts link)	2
	Bellcrank spacer	2
	Rod end (Watts link)	4
	ARB mounting boss	2
	Anti-roll bar extension	1
	Thrust washer	2

## 2.1.6) Cooling

The cooling items are shown in Figure 7.

**Figure 7: Cooling items**



- |                            |                             |
|----------------------------|-----------------------------|
| 1. Expansion bottle hose   | 6. Cooling fan              |
| 2. Hose                    | 7. Expansion bottle bracket |
| 3. Fastener pack 'cooling' | 8. Expansion bottle cap     |
| 4. Polythene bag 'cooling' | 9. Expansion bottle         |
| 5. Bottom radiator hose    | 10. Radiator                |

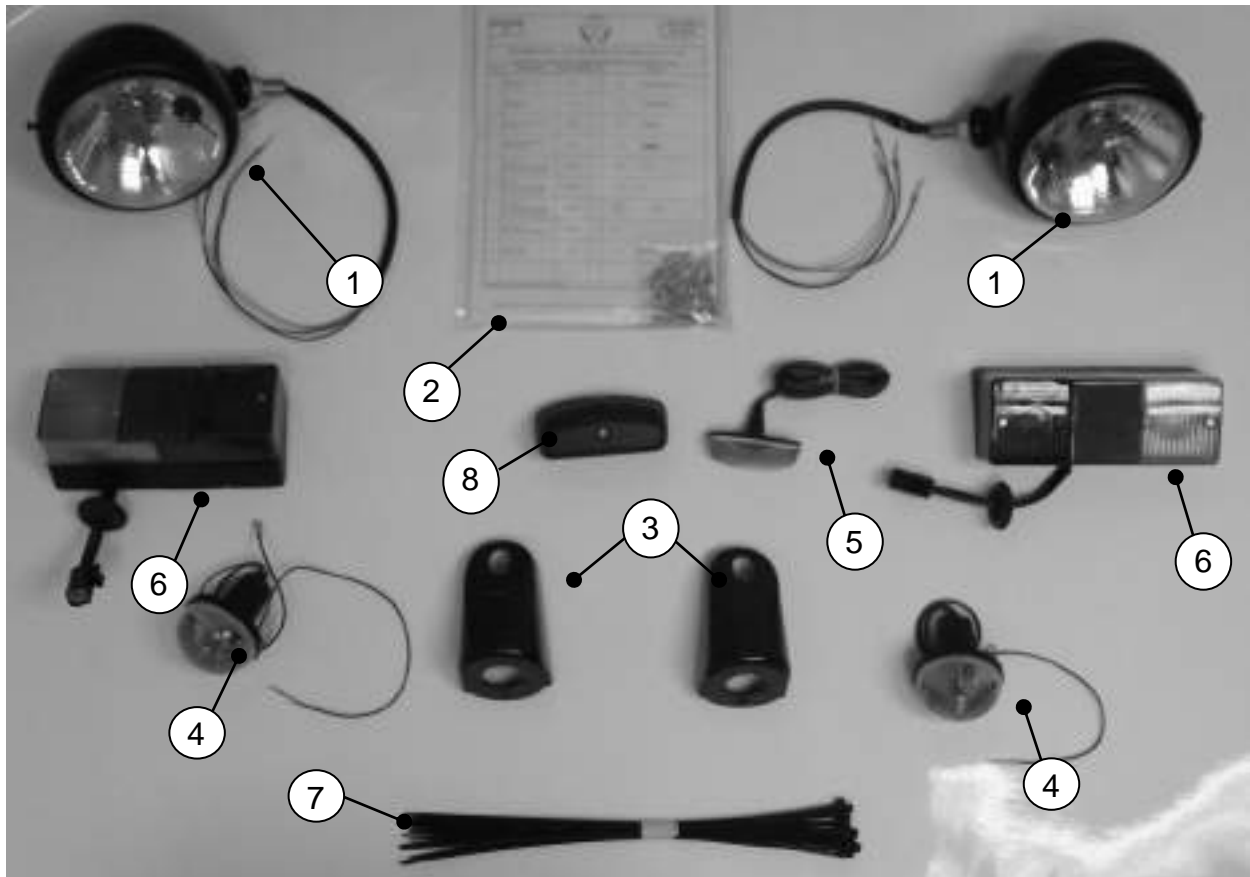
### NOTES

- (1) A thermostatic fan switch may be supplied in lieu of a blanking plug (if supplied, the switch **must not** be connected to the vehicle wiring harness).
- (2) If supplied, the water bleed pipe may be fitted to the engine.
- (3) Items may differ from those illustrated, dependant on kit specification.

### 2.1.7) Lighting

The lighting items are shown in Figure 8.

**Figure 8: Lighting items**

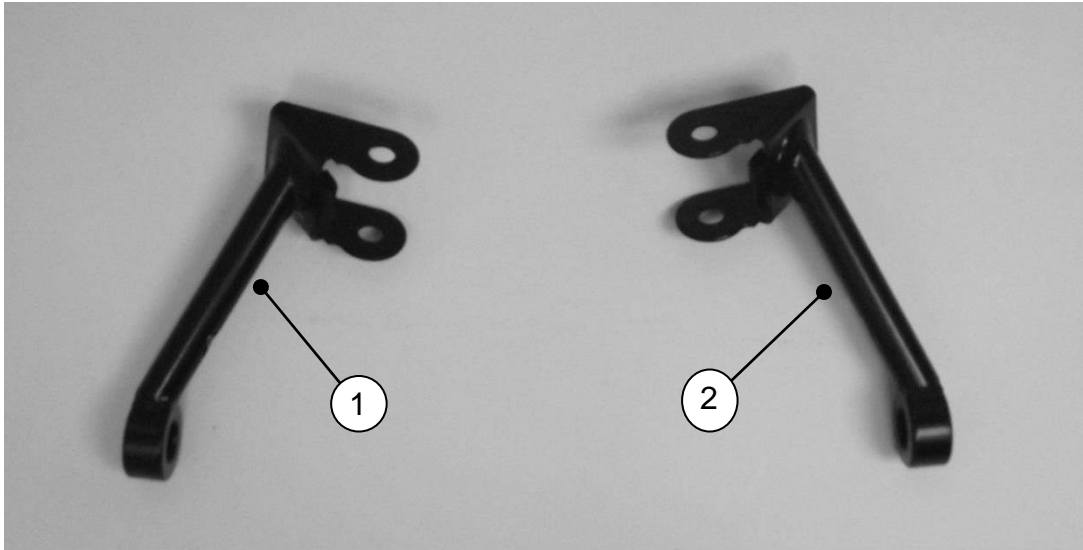


- |                                  |                          |
|----------------------------------|--------------------------|
| 1. Headlight                     | 5. Indicator repeater x2 |
| 2. Fastener pack 30L002A         | 6. Rear light cluster    |
| 3. Indicator cones (l/h and r/h) | 7. Cable ties            |
| 4. Indicator (front)             | 8. Number plate light    |

### 2.1.8) Head light brackets

The headlight brackets are shown in Figure 9.

**Figure 9: Headlight brackets**



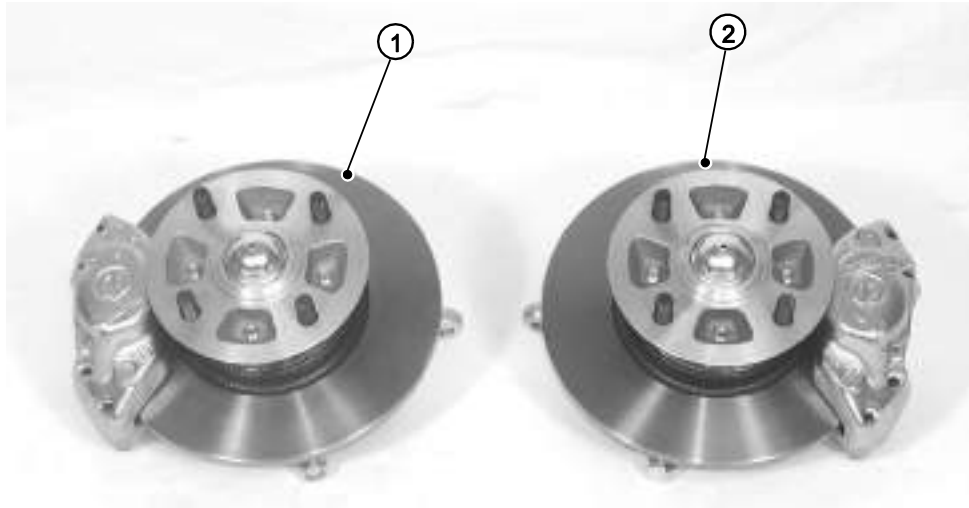
1. LH headlight bracket

2. RH headlight bracket

### 2.1.9) Uprights

The uprights are shown in Figure 10.

**Figure 10: Uprights**



1. Upright assembly (RH)

2. Upright assembly (LH)

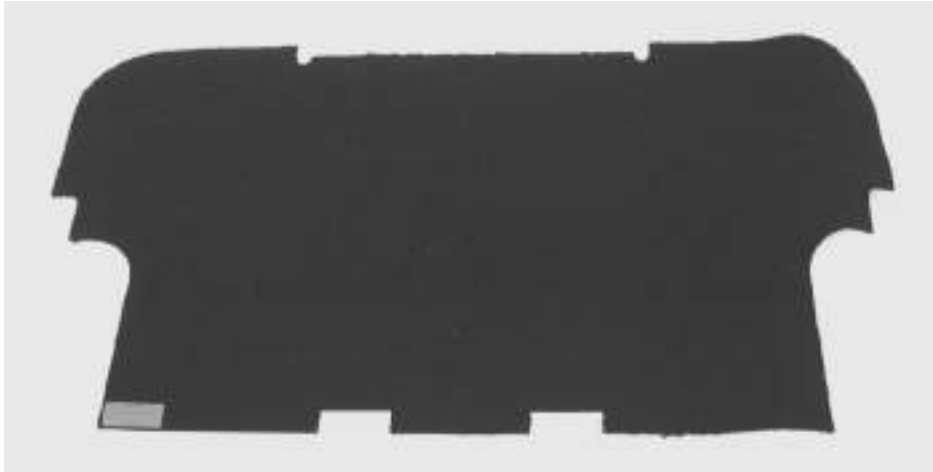
#### **NOTE**

*It is possible that the callipers may be supplied loose and not attached to the upright assembly. If this is the case, the callipers need to be attached with the two bolts and shim washers torqued to 58Nm.*

### 2.1.10) Interior trim, cables and options

The interior trim, cables and options items are shown in Figures 11, 12, 13 and 14. The contents of the polythene bags are detailed in Table 4.

**Figure 11: Boot carpet**



**Figure 12: Bulkhead carpet**





**Figure 13: Rubber mats**



**Figure 14: Transmission tunnel top**



**Table 5: Polythene bag contents - interior trim, cables and options**

<b>Identifier</b>	<b>Description</b>	<b>Qty</b>
SVA	Cable ties	-
	Track rod end sleeves	2
	Track rod end bottom cap	2
	Wing mirror pack	1
	Sticky back foam (roll)	1
	Edge trim (roll)	1
	Large flat bolt head covers	6
	Small domed caps	12
	Long bonnet catch rubbers	2
	Short bonnet catch rubbers	2
	Large domed caps	2
	Medium domed caps	4
Spare Wheel	Wheel nuts	2
	Spare wheel bolt	1
	Spacer	1
	Mounting wishbone	1

### 2.1.11) Gearbox

The standard 5-speed gearbox is shown in Figure15, the optional 6-speed gearbox is shown in Figure 16.

**Figure 15: 5-speed gearbox**



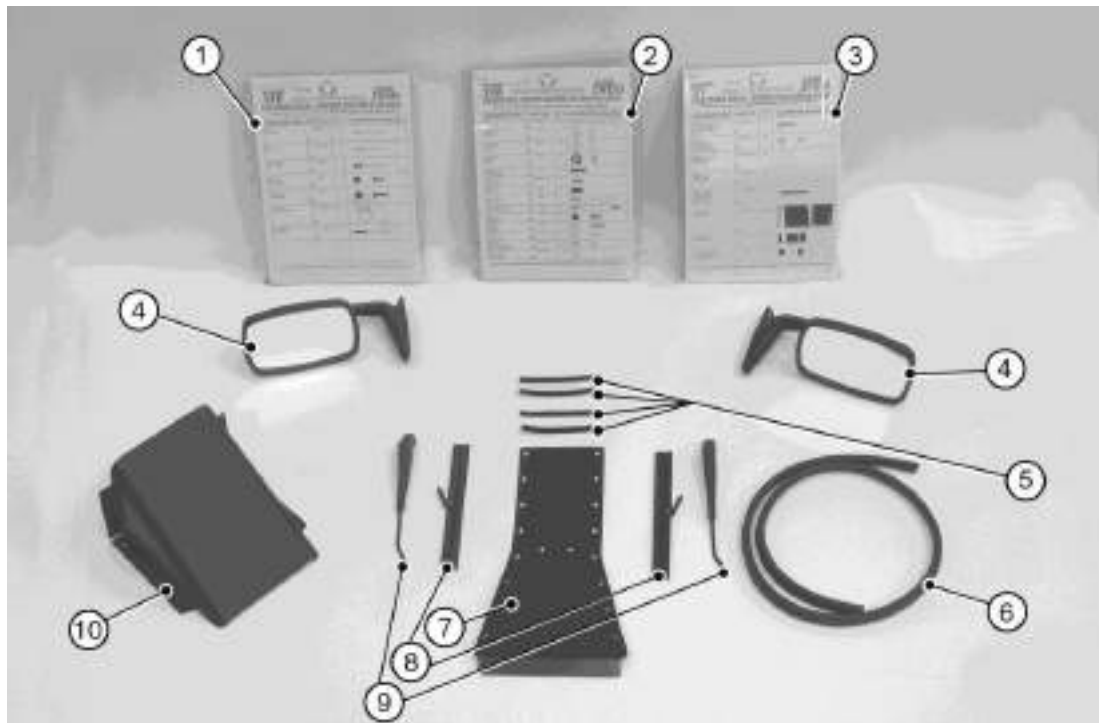
**Figure 16: 6-speed gearbox (optional)**



### 2.1.12) Chassis/body unit

The chassis body unit comprises; chassis, body panels, pedals, master cylinder, instruments, switches, wiring loom, windscreen, fuel tank, fuel pump, fuel lines, ECU. Additional items placed loose in the chassis are shown in Figure 17.

**Figure 17: Items loose in chassis**



- |                          |                              |
|--------------------------|------------------------------|
| 1. Fastener pack ZCH     | 6. IVA trim                  |
| 2. Fastener pack ZWE     | 7. Transmission tunnel cover |
| 3. Fastener pack 30P016A | 8. Wiper blades              |
| 4. Side screen mirrors   | 9. Wiper arms                |
| 5. Velcro strips         | 10. Fuel filler cover        |

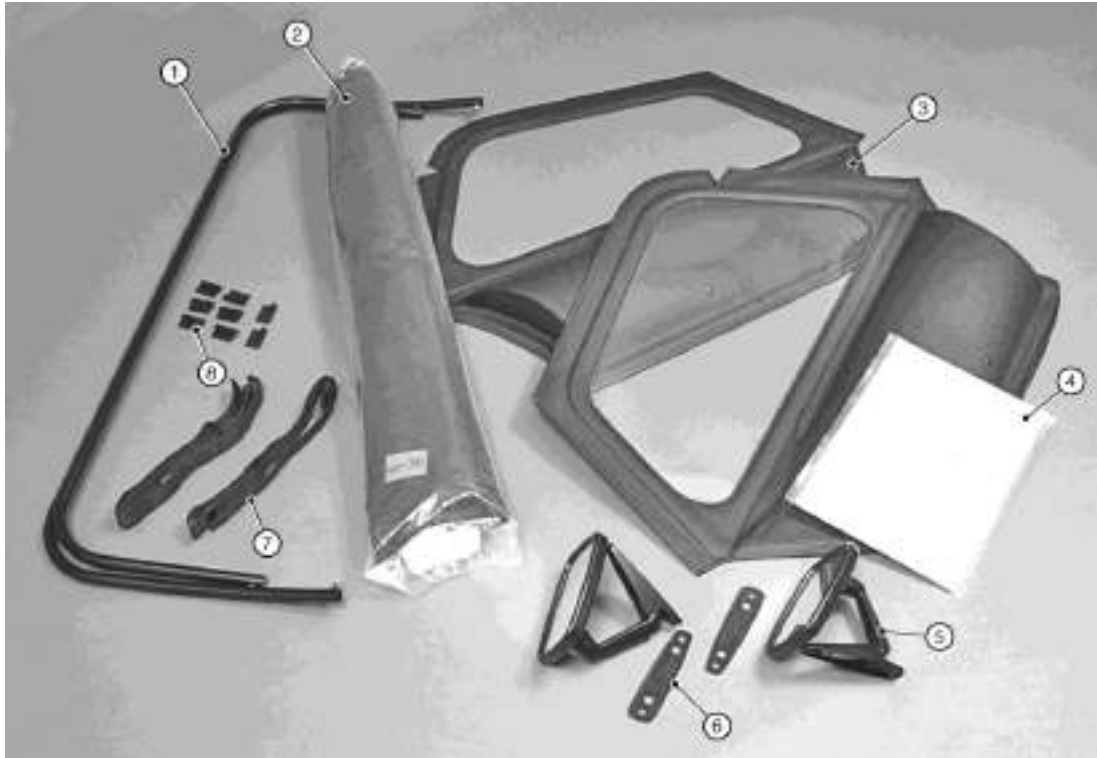
#### NOTE

*If the optional weather gear has been specified, the side screen mirrors will be supplied in the weather gear pack.*

### 2.1.13) Weather gear (optional)

The optional weather gear items are shown in Figure 18.

**Figure 18: Weather gear (optional)**



1. Hoodsticks

2. Hood

3. Side screens

4. Fastener pack 'weather'

5. Mirrors

6. Mirror plate (not required)

7. Hood straps

8. Hinges

#### 2.1.14) Engine

The engine, Fig 19, is supplied on a frame complete with engine mountings and lifting eyes. Once the engine is fitted the lifting eyes must be removed. The engine is supplied complete with wiring loom. The starter motor is not fitted as it is secured to the bell-housing.

**Figure 19: 1.6 sigma engine**



#### 2.1.15) Heater assembly

The heater assembly, Figure 20, is packed into an unmarked cardboard box.

**Figure 20: Heater assembly**



#### *2.1.16) Wheels*

The alloy wheels are supplied with tyres already fitted. It should be noted that the tyres may be handed, that is, have a direction of rotation arrow showing the direction of travel. Wheels must be fitted with the directional arrow in the correct direction.

#### *2.1.17) Seat*

The seats are supplied in protective covers. It is recommended that the covers are not removed until the seats are required for fitment.

#### *2.1.18) Wings*

The front and rear wings are supplied protected with bubble wrap. The two largest wings are for fitment to the rear of the car.

#### *2.1.19) Nosecone*

The nosecone is supplied in protective bubble wrap. It is recommended that it is left protected until required for fitment.

#### *2.1.20) Roll over bar*

The roll over bar is protected by bubble wrap and is supplied in its own box.

### 3.0) Pre-assembly information

This section has been included to aid recognition of parts and to give a basic idea as to where they might be found. Due to the complexity of the range of options available and subsequent variations on packages it is impossible to list every permutation; however Table 5 (below) and Annex A (at the end of this section) show the normal location of parts in a standard CKD kit.

#### 3.1) Package contents

Kits supplied from Caterham Cars arrive as shown in Fig 21. Due to packaging constraints some items may be located in different packages.

**Table 6: Package contents**

Box	Package	Contents
Box 1	Steering, exhaust, gearbox assembly, drive shafts	Steering rack, rack clamps, upper and lower steering columns, column bush, column clamp, track rod ends. Grub screws, silencer assembly (standard system). Primary pipes (4), collector or catalyst collector, silencer (competition system), catalyst heat guard, mounting brackets and bobbins, wheel nuts, centre caps, badges, bell-housing, clutch release mechanism, speed sensor and threaded adapter, reverse light switch, mounting rubber, gearknob, front and rear anti-roll bars and fixings, cycle wingstays, 'A' frame, differential driveshafts and nuts, De Dion Tube, brake pipes, propshaft
Box 2	Axle (De Dion)	Disc pads and callipers, drive flanges, De Dion ears, hub, bearings
Box 3	Differential	Differential assembly
Box 4	Front suspension, rear suspension	Spring damper units, upper and lower wishbones, spring damper units, radius arms/Watts linkage
Box 5	Cooling	Coolant hoses, water rail, cooling fan, heater (option on Superlight), bobbins, expansion bottle and cap, radiator cowling
Box 6	Lighting	Headlamp units, headlamp brackets, indicator pods, indicators, number plate light, reversing light, fog light, side repeaters, horns
Box 8	Interior trim	Covered tunnel top, tunnel side carpets, footwell mats, seat back carpets, hood, hood sticks, boot cover, pulley and cables, throttle



		cable, clutch cable, rear wing protectors, steering wheel, spare wheel wishbone, seat belts and fixings, tonneau cover, seat runners, seat spacers, assembly guide, arm restraint, hardware packs, IVA packs.
Box 9	Weather equipment	Hood straps, exterior mirrors, fuel filler cover, hinges (sidescreen), sill protectors, wiper arms, wiper blades, hardware pack, mirrors
Box 10	Airbox/air intake system	Airbox and fixings
Own box	Uprights	Front uprights assemblies inc brakes on uprated uprights
Pallet	Engine	Complete engine and clutch, engine loom, engine mounting brackets
Loose	Sidescreens	
Own box	Gear box	
Own box	Radiator	
Loose	Exhaust silencer	
Loose	Wheels and tyres	Alloy wheels and tyre assemblies
Loose	Seats	
Own box	Roll over bar	
On Chassis	Chassis/body unit	Chassis, battery, body panels, pedals, master cylinder, instruments, switches, wiring loom, fuel tank, fuel pump, fuel lines, ignition module/ECU. Rear wings, front wings, nosecone, battery, battery clamp/tray, knee trim panels, scuttle trim, econoseal plugs, steering column plate, grilles (Mesh 7), int panel trim, keys (ignition, fuel cap, battery master switch), aluminium tonneau cover, paint touch bottles

Figure 21: Complete kit (less engine)



### 3.2) Basic definitions

The text in the assembly guide refers to the Right Hand (RH) side or Left Hand (LH) side of the car. For all purposes the RH side of the car is taken to be the driver's side of a RH drive car.

Also mentioned in the assembly guide are the terms inboard (pointing towards the centre line of the car) and outboard (pointing away from the centre line of the car).

### 3.3) Tools and equipment

All kits supplied by Caterham Cars are specifically designed for the amateur car builder with basic facilities. Table 7 details the general purpose tools that will be required during the build process.

**Table 7: Tools required**

Item	Remarks
Socket set	Metric and imperial
Spanner set	Metric and imperial
Screwdriver	Flat point (various)
Screwdriver	Phillips/posidrive (various)
Soft faced hammer	Rubber/plastic/copper/hide
Circlip pliers	
Torque wrench	0-80 Nm
Allen Keys	Metric
Measuring tape	
Hacksaw	
Rivet gun	

Goggles	Eye protection
Twist drill bits	Metric and imperial
Crimp pliers	
Drill	Preferably rechargeable
Axle stand	Qty 4
Jug/small funnel	

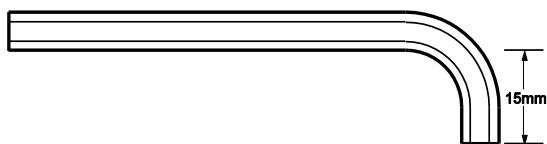
The tools detailed in Table 8 are not generally to hand in the amateur workshop. These will be required during the build process.

**Table 8: Additional tools and equipment**

Item	Remarks
Engine hoist	SWL of 150 kg
Socket 41mm	
Torque wrench	Up to 275 Nm
Cut down allen key 3/8" for 6 speed 10 mm for 5 speed	Gearbox oil filler plug
Durable Dot fastening tool	76068 – supplied with chassis kit

The engine hoist should only be required for a short time and can usually be sourced from a tool hire company. The 41 mm socket and torque wrench will be required to tighten the rear hubs to the drive shafts and the cut down Allen key is required to tighten the gearbox oil filler plug, due to the restricted access in the transmission tunnel. The key can be modified as shown in Fig 22.

**Figure 22: Cut Allen key**



The consumables detailed in Table 9 and recommended lubricants detailed in Table 10 are required during the build process.

**Table 9: Consumables**

Item	Type	Remarks
Rubber lubricant	Holts RL2R	To ease assembly and operation of rubber bushes and grommets
Copper grease	Comma Copper ease	Anti-seize compound where lubrication is not required to ensure ease of future

		disassembly
Threadlock	Loctite threadlock 242 or 243	Used where the application prevents the use of nyloc nuts or spring washers
Silicone sealant	Clear	To achieve a watertight seal. It should be applied sparingly
Masking tape	Duct tape	Protection of body
Adhesive	Contact	Carpet/trim

**Table 10: Recommended lubricants**

Item	Ford Sigma	Duratec	Rover
Engine oil	Ford engine oil formula E-5W-30		Caterham motorsport oil 5W-50
	Caterham motorsport oil 5W-50	Caterham motorsport oil 5W-50	
	Comma X-TEC 5W-30 semi synthetic	Comma X-TEC 5W-30 semi synthetic	
Gearbox oil (5 and 6 speed)	Caterham gearbox oil EP 80 grade	Caterham gearbox oil EP 80grade	Caterham gearbox oil EP 80 grade
Item	Ford Sigma	Duratec	Rover
Differential (All)	Caterham differential oil EP90	Caterham differential oil EP90	
LSD – additive	Lubeguard limited slip diff	Lubeguard limited slip	

	additive	diff additive	
Brake fluid	Comma DOT4	Comma DOT4	
Engine coolant	Comma Xstream red or ford super plus anti-freeze	Comma Xstream red or ford super plus anti-freeze	Comma Xstream red

It is recommended that a sturdy workbench and a good vice are made available for holding items stable.

The application of undue force should not be necessary if assembly is carried out in the correct sequence.

### 3.4) Nuts, bolts and washers

As a general rule the fasteners used are RH thread and of Metric dimensions. Some Imperial fasteners are still used, particularly within the brakes and suspension.

Always assume that bolts and fasteners are not properly tightened until they have been specifically checked.

All safety critical fastenings supplied by Caterham Cars are high tensile conforming to British Standards 1768 (Imperial) and 3692 (Metric). Customers supplying their own fasteners should only use fasteners with heads marked 10.9 and 12.9 particularly when attaching suspension, steering, upright and axle

kits. Any unmarked bolt should not be used.

Ensure that the correct tightening torque is applied. Where torque figures are not specified, use the figures detailed in Table 11. Particular care must be taken when using the torque wrench to tighten fastenings into aluminium.

**Table 11: General torque figures**

Thread	Socket size	Torque (Nm)
1/4" UNF/UNC	7/16" A/F	7
5/16" UNF/UNC	1/2" A/F	20
3/8" UNF/UNC	9/16" A/F	34
7/16" UNF	5/8" or 11/16" A/F	47
1/2" UNF	3/4" A/F	61
5mm	10mm	6
6mm	11mm	7
8mm	13mm	20
10mm	17mm	47
12mm	19mm	61

It is good practice to mark the bolt head or nut with a spot of paint once it has been finally tightened. This provides a good visual means of checking that all fixings have been set to the correct torque.

Over tightening can often cause more problems than under tightening, such as sheared bolts and studs and incorrect stresses.

The majority of fastenings have washers inserted between the nut and or bolt head and the item being secured. Spring washers or lock washers are usually placed next to the bolt head or nut then the plain washer. As a general rule the following washers are used as detailed:

#### Plain washer

- To protect the surface and spread a load when attaching to a soft material such as glass fibre or aluminium.
- To adjust the spacing of one component to another use plain washers of appropriate thickness and external diameter.
- To present a uniform surface on which to tighten a fastening onto a rough or irregular surface.

#### Spring washer

- To lock a thread where there is a possibility of the nut or bolt working loose. Not used with a nyloc nut.

#### Large diameter, thin plain washer

- To spread a load onto very thin material.

#### Large diameter plain washer

- To prevent migration (sideways movement) of rubber bushes.
- The large plain chamfered washers are often used in conjunction with the metalistic suspension bushes. Where this is the case the chamfered edge must be fitted towards the bush to prevent contact with the outer metal part of the bush.

Particular care should be taken to ensure that the correct fastening is being used, since it is possible to use an overlong bolt only to find that it is apparently missing when the only remaining bolts are too short.


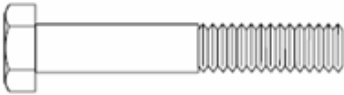
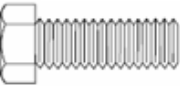





The majority of fasteners supplied by Caterham are in polythene bags with an A4 sheet on a card insert, refer to Fig 23. The A4 sheet can be used to confirm that the contents are correct. Each pack has a unique number, located at the top RH corner and each item within the pack can be identified by a number at the bottom LH corner of the part number box. Where fasteners are specified in the text, the unique pack number will be stated the first time it is required along with the description and the Item Identification number in brackets. The next time an item from that pack is required it will be identified by description and the Item Identification number only, for example:

- Bolt (fastener pack 30P017A Item 1) identifies the Bolt M8 x 50 mm from the fastener pack illustrated at Fig 23.
- At a later point in the same section of text 'nut (4)' identifies the M8 nut from the same fastener pack.

**NOTE**

*Imperial and metric fasteners are supplied together in some packs. Ensure that the correct threadform is identified before use.*

**Figure 23: Fastener pack**

<b>SERIAL NUMBER</b>				<b>PACK NUMBER</b>	
<b>51</b>				<b>30P017A</b>	
<b>FASTENER PACK - ROLL CAGE (SERIES 3 METRIC)</b>					
Please note : This pack may include extra fasteners to cover different options					
NO	DESCRIPTION	PART NUMBER	QTY	DRAWING	
1	Bolt M8 X 50 Grade 8.8 Bolt with plain section & Metric threaded section	BM8X50	2		
2	Set Screw M10 X 16 Grade 8.8 Hexagonal Head & Metric Full Threaded section	SM10X16	4		
3	Caphead Bolt M10 X 20 With Metric threaded section	BMCH10X20	2		
4	Nut M8 With Metric thread & Nyloc locking mechanism	NMYF 8	2	 	
5	Washer M10 Plain Washer Heavy-Duty	WPHM10	4		
6	Washer M8 Plain Washer Heavy-Duty	WPHM8	4		
* please note : Drawings are not to the scale					
Page 1 of 1					



### 3.5) General build information

Caterham Seven builders should take care to observe basic safety precautions whilst assembling the kit since tools, parts and materials handled incorrectly may result in injury.

Due to circumstances beyond the control of Caterham Cars, occasionally it is necessary to change suppliers and/or to make minor changes to the car or kit specification.

If it is intended to build the car over a short period (up to 4 weeks) it is recommended that an application for the IVA inspection is submitted as soon as possible. There is usually a wait of 2-3 weeks, minimum. In addition it will take up to a week for the Vehicle Inspectorate to process the application. Full details about applying for the IVA inspection can be found in the IVA section or at [www.directgov.co.uk](http://www.directgov.co.uk).

#### **Warning**

**Never work underneath a car without supporting it on axle stands or equivalent. Do not rely on a jack alone.**

**For IVA inspection you will need photographic evidence of the car build. Caterham recommends that you should take some photos of yourself**

### **working on the car at different build levels.**

It is recommended that the chassis is supported on 4 axle stands which will give stability for both safe working and ready access. Placing of the axle stands is made easier if assistance is available. Lift the front of the car and place the axle stands at the outer ends of the second chassis cross tube adjacent to the rear mounting of the lower front wishbone mounting, refer to Fig 24. If the car is raised using a jack, ensure that it is positioned under the front cruciform and that the powder coat finish is protected.

**Figure 24: Front axle stands**



The rear axle stands should be positioned at either end of the chassis tube that supports the front of the fuel tank, refer to Fig 25. If the car is raised using a jack, ensure that it is positioned centrally and the powder coat finish on the chassis tube is protected.

**Figure 25: rear axle stands**



## 4.0) Steering

The following section contains information on steering rack (standard and wide track), steering wheel fitments and other associated tasks.

### 4.1) Steering rack (standard and wide rack)

The steering rack should be fitted before the front suspension. Before fitting the steering rack it is advisable to protect the outside of the aluminium side panels around the circular cut-outs through which the rack protrudes. Masking tape is sufficient for this purpose.

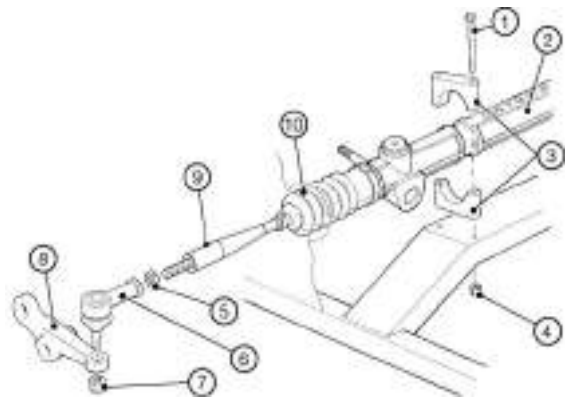
#### **Warning**

**Never work underneath a car without supporting it on axle stands or equivalent. Do not rely on a jack alone.**

Carefully pass the steering rack through the circular cut-outs in the side panels until the machined areas of the rack line up with the holes in the rack platform. Ensure that the rack pinion exits the rack on the driver's side of the vehicle.

The steering rack is held in place by two piece aluminium rack clamps (polythene bag marked 'steering'). The rack clamps are matched pairs and clamp the steering rack into position as they are bolted into place, refer to Figure 26.

**Figure 26: Steering rack assembly**



- |                  |                          |
|------------------|--------------------------|
| 1. Securing bolt | 6. Track rod end         |
| 2. Steering rack | 7. Securing nut          |
| 3. Rack clamps   | 8. Steering arm          |
| 4. Nyloc nut     | 9. IVA cover             |
| 5. Locknut       | 10. Steering rack gaiter |

Clamp the rack loosely into place using bolt (fastener pack 30S003A Item 1), nyloc nuts (8) and rack clamps (3).

Ensure a washer is placed between the rack clamp and the nyloc nut. The rack will be tightened later when the steering column is correctly positioned.

Fit the IVA cover (polythene bag marked 'IVA' to the end of the steering rack arm, ensure that the larger diameter is outboard. Screw the locknut (Figure 26 item 5) onto the steering rack arm then fit the track rod end. This should be screwed on 11 full turns (S3) or 13 (SV) to give an approximate track setting. Do not tighten the locknuts.

## NOTES

(1) The IVA covers will need to be trimmed on one end to fit over the tie rod ends

(2) The IVA covers are secured using cable ties. However this should not be done at this stage as final adjustment to the tracking will be required.

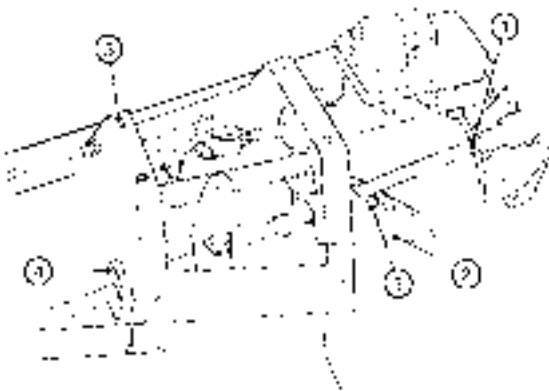
(3) Tracking is adjusted during final checks.

### 4.2) Steering column

The steering column should not be fitted until after the engine and gearbox have been installed.

Remove the lid of the pedal box, refer to Figure 27.

**Figure 27: Pedal box**



- |   |                       |   |                     |
|---|-----------------------|---|---------------------|
| 1 | Lower steering column | 3 | Grommet             |
| 2 | Cheese wedge          | 4 | Grommet sealing box |
|   | sealing box           | 5 | Pedal box           |

(Clutch master cylinder and brake pipes omitted for clarity)

The front of the pedal box is sealed using a grommet inserted into the hole through which the steering column passes, refer to Fig 27. The inside of the rubber grommet should be smeared with rubber lubricant to prevent wear.

Position the 'cheese wedge' (refer to Figure 27) on the pedal box, aligned with the hole for the steering column (it may be necessary to trim the top edge of the cheese wedge to avoid fouling the clutch master cylinder). Mark the three hole positions using the holes in the cheese wedge as a guide. Drill the holes using 1/8" drill bit (it may be necessary to remove the clutch master cylinder for access). Apply silicone sealant to the seating edges of the cheese wedge and secure the cheese wedge with rivets. Seal the edges with sealant. Fit the grommet to the large hole at the rear of the cheese wedge. Coat the grommet with rubber lubricant.

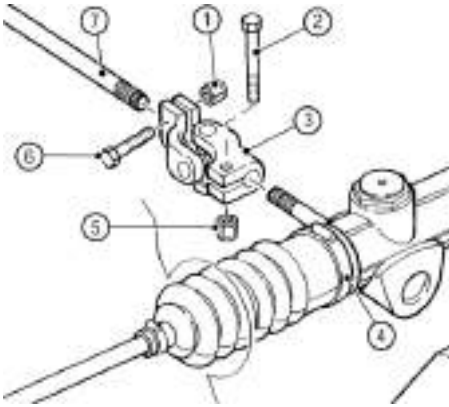
It is possible that the cheese wedge has already been fitted to the chassis.

The lower steering column is inserted, splined end first, through the dashboard under the brake master cylinder, through the rubber grommet in the 'cheese wedge', through the pedal box and finally through the rubber grommet in the pedal box sealing plate.

**NOTE**

*Engine installation will be easier before the lower steering column is fitted.*

**Figure 28: Steering rack to steering column**



- |                    |                          |
|--------------------|--------------------------|
| 1. Nyloc nut       | 5. Nyloc nut             |
| 2. Bolt            | 6. Bolt                  |
| 3. Universal joint | 7. Lower steering column |
| 4. Steering rack   |                          |

Position the front wheels (or uprights) in an approximate 'straight ahead' position and attach the universal joint (polythene bag marked 'steering') using bolt (3) and nyloc nut (7) noting how the bolt locates into the machined groove in the splined end of the lower steering column.

**NOTE**

*If insertion is difficult the universal joint can be opened up by inserting a flat blade screwdriver into the split and twisting. To ensure linearity of response it is recommended that the yoke of the universal joint is positioned with the cross*

*vertical/horizontal when the steering wheel is in the straight ahead position.*

Fit the lower end of the universal joint onto the rack, again clamping with the bolt and nyloc nut and tighten both bolts to 11 Nm. The universal joint should be run as straight as possible, continuing along the same angle as the column, the steering rack can be turned in its blocks to achieve this.

The upper steering column can now be fitted.

**NOTE**

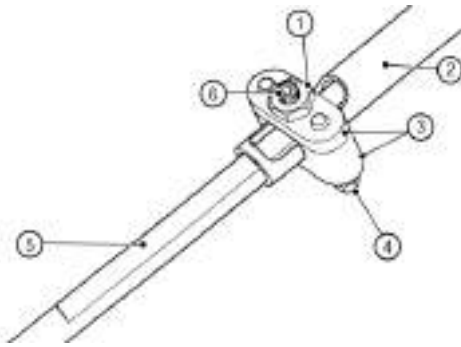
*When fitting an optional, quick release column the upper steering column bush can be fitted prior to inserting the upper steering column into the steering column lock tube.*

The lower column bush will have been fitted by Caterham, but care must be taken when sliding the upper steering column down through the dashboard. Ensure that the lowest portion of upper steering column is liberally coated with grease and minimum force is exerted. Telescope the upper steering column over the lower steering column.

Slide the upper steering bush onto the column and into the dash tube. Note how the raised rubber locators on the bush fit in the holes in the dash tube.

To ease fitment lightly coat the upper steering bush with rubber lubricant.

**Figure 29: Upper steering column clamp**



- |                          |                          |
|--------------------------|--------------------------|
| 1. Locknut               | 4. Securing bolts        |
| 2. Upper steering column | 5. Lower steering column |
| 3. Clamp                 | 6. Grub screw            |

The two parts of the steering column are clamped together using the locking clamp, make sure the cut out faces the column, refer to Fig 29. Insert the grub screw loosely into the clamp. Secure the two halves of the clamp using two bolts (2), plain washers (10) and spring washers (11). Torque to 14 Nm. Tighten the grub screw with an Allen key to eliminate any free play in the steering. Lock the grub screw into place using locknut (6).

**NOTE**

*Before tightening the clamp:*

*Fit the steering wheel boss onto its spline to ensure that the steering wheel boss does not foul the dashboard. Slide the steering column/steering wheel boss away from the dashboard to achieve clearance.*

*Check that the lower steering column does not foul the drive belt tension mechanism on the engine. If necessary rotate the steering rack in its clamps to provide clearance.*

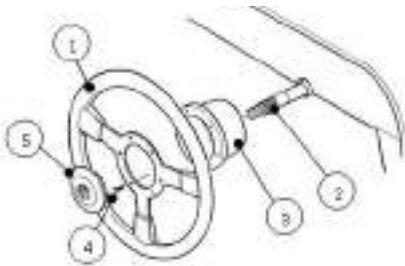
Tighten the steering rack clamps to 11 Nm. Ensure that the two bolts securing the steering column lock tube to the scuttle face are tight.

### 4.3) Steering wheel fitment

Two makes of steering wheel are available. Both the Motolita and the Momo wheel have a horn button mounted on the dashboard. Each steering wheel has a different type of mounting boss. It is recommended that the fitting of the steering wheel is left until the entire interior trim, including seats, has been completed.

#### 4.3.1) Motolita

**Figure 30: Steering Wheel - Motolita**



- |                    |                 |
|--------------------|-----------------|
| 1. Steering wheel  | 4. Fixing screw |
| 2. Steering column | 5. Wheel centre |
| 3. Mounting boss   |                 |

(IVA pad omitted for clarity)

Release steering lock and centre the road wheels to establish the straight ahead position. Fit the steering wheel over the steering column splines. Fit the washer (9) and secure the steering wheel to the steering column using nyloc nut (4) and tighten.

#### 4.3.2) Momo

Loosely fit the mounting boss to the steering wheel using the 6 mm x 16 mm countersunk Allen bolts. Centre the road wheels to establish the straight ahead position of the steering wheel. Place the steering wheel and boss over the splines in the straight ahead position. Remove the wheel and secure the boss to the column using nyloc nut (4) and washer (9). Finally re-secure the wheel to the boss using the fixing provided.

#### 4.3.3) Quick release column

The Quick Release (QR) column has a keyway in the QR boss and the steering wheel must be centred by removing the upper bolt on the lower steering column universal joint, withdrawing the column and then turning the steering wheel and column to the straight ahead position. Re-engage the column to the universal joint, re-insert the bolt and tighten the securing nyloc nut to 20 Nm.

Ensure that the steering wheel can be rotated smoothly with no tight spots. Tighten the steering rack clamp bolts and steering column universal joint bolts/nylocs to the torque figures specified in Table 12.

**Table 12: Steering component torque figures**

Location	Washers	Nut Torque
Steering rack clamps	Plain under bolt head	Nyloc 11 Nm
Universal joint	None	Nyloc 20 Nm
Column clamp	Spring and plain under bolt head	Bolt 14 Nm

#### **4.4) Associated tasks**

Whilst the pedal box lid is removed, fit the brake light switch harness and the throttle cable.

#### *NOTE*

*Before refitting the pedal box lid, check that the pedal positions are acceptable and that the brake switch operates correctly. Adjust as necessary.*

Refit the pedal box lid ensuring that the brake pipes are not trapped or kinked and that the 'P' clips are secured under the pedal box lid screws.



## 5.0) Front suspension

The following section covers the assembly and installation of all areas of the front suspension for your kit.

### 5.1) Preparation

It is recommended that the front wings are not fitted until the front suspension is assembled and the engine installed. This reduces the risk of damage to the wings and maintains easy access to the engine bay.

It is recommended that the steering rack is fitted before assembling the front suspension, refer to Section 3.

When assembling the front suspension, there is a risk that the aluminium body skin can be damaged, especially when fitting the top mounting bolts and the spring damper units. It is therefore advisable, particularly with painted cars, to protect the bodywork with 2 or 3 layers of masking tape in key areas. It is recommended that the bodywork under the front bonnet catches is protected using card and masking tape, refer to Figure 31.

Apply a thin coat of copper grease to all fixings prior to fitment (avoid contaminating any threads where Loctite is to be used).

Figure 31: Bodywork protection



### 5.2) Lower wishbones

#### Warning

**Never work underneath a car without supporting it on axle stands or equivalent. Do not rely on a jack alone.**

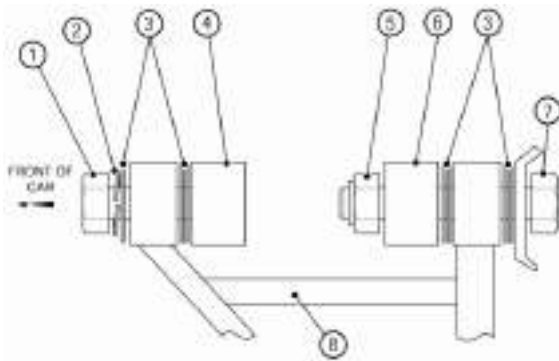
The lower wishbones are assembled with the longer leg forward and the bearing retaining circlip facing downward.

#### *NOTE*

*Ensure that the circlip is correctly located in the retaining groove prior to assembling the lower wishbone.*

Fit the rear leg of the lower wishbone through the slot in the bottom skin immediately behind the vertical chassis member. Secure using bolt (Fastener pack 30F015A Item 1) and nut (7) and inserting two plain washers (9) either side of the wishbone refer to Fig 32.

**Figure 32: Washer usage - lower wishbone (LH side)**



- |                  |                         |
|------------------|-------------------------|
| 1. Bolt          | 5. Nyloc nut            |
| 2. Spring washer | 6. Rear chassis mount   |
| 3. Plain washer  | 7. Bolt                 |
| 4. Front chassis | 8. Lower wishbone mount |

The front leg of the lower wishbone is secured to the front of the chassis using bolt (2), with washer (9) and spring washer (12) next to the bolt head. Two washers (9) are inserted between the wishbone and the chassis, refer to Figure 32.

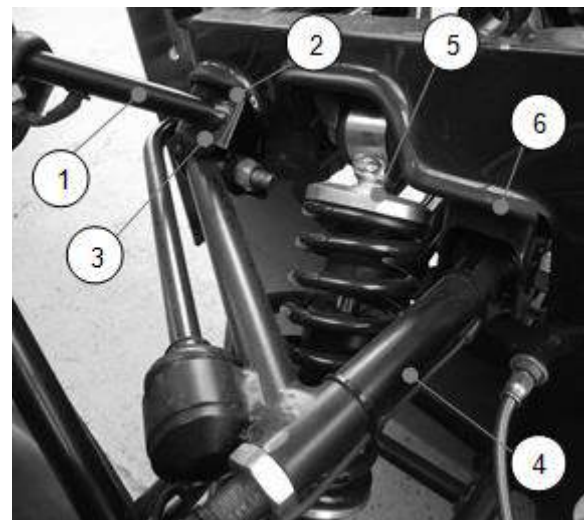
On wide track models there should be no washers between the front mount and the chassis and 4 washers between the chassis tube and the rear mount of the lower wishbone.

### 5.3) Upper wishbones

The upper wishbones are handed and are assembled with the longer leg facing the front of the car. Prior to locating the upper wishbone a spacer bush 10 mm ID x 1/2"

OD x 35 mm (polythene bag marked 'front suspension'), must be inserted into the rear bush. The rear leg of the upper wishbone, refer to Figure 33, is secured to the rear mount using bolts (3) inserted from the front of the mounting. The spacer bush must be coated with copper slip. The bolt is secured with a nut (8). Do not tighten fixings.

**Figure 33: Upper wishbone securing**



- |                               |                                |
|-------------------------------|--------------------------------|
| 1. Headlight bracket          | 4. Upper wishbone              |
| 2. Headlight bracket          | 5. Spring damper unit mounting |
| 3. Upper wishbone front mount | 6. Upper wishbone rear mount   |

The front leg of the upper wishbone is secured to the front mount using bolt (4). Prior to inserting the bolt the headlight bracket must be inserted over the chassis mount. Before fitting the headlight bracket assemble the headlight assembly to the bracket see page 164.

Ensure to fit a rubber grommet in the hole in the bracket before assembly.

Since access to the upper and lower wishbone mountings are restricted by other components installed later in the build process the mounting fasteners must be fully tightened at this point. Hold the wishbones horizontal and tighten the upper wishbone mounting bolts/nuts to 34 Nm and the bottom wishbone to 81 Nm.

#### *NOTE*

*Check that there is an equal amount of exposed threads between the locknut and ball joint, this should be adjusted to eight threads for normal road use*

#### **5.4) Spring damper units**

An aluminium spacer bush 8 mm id x 1/2" od x 32 mm (polythene bag marked 'front suspension') must be coated in copper slip and inserted into the top mounting bush of the front spring damper unit. The spring damper is secured to the top mounting by the M8 cap head bolt supplied in the chassis with a spring washer (13) under the bolt head. This bolt should be torqued to 20 Nm.

#### *NOTES*

*It is necessary to gently press the body panel inwards to allow sufficient clearance for the bolt to be located.*

An aluminium spacer 8 mm id x 1/2" od x 32 mm must be coated in copper slip and inserted into the lower mounting bush of the spring damper unit. The spring damper unit is secured using an M8 caphead bolt (supplied in wishbone) which passes through the rear leg of the lower wishbone through the aluminium spacer bush and into a captive thread on the front leg. This bolt should be torqued to 20 Nm.

#### *NOTE*

*Do not tighten any other fixings at this stage*

#### **5.5) Upright attachment**

##### **Warning**

**Correct use of fixtures is required to ensure full engagement of the nyloc nut.**

Remove and retain the upper wishbone ball-joint nyloc nut and the nyloc nut from the bottom of the upright assembly. The upright assembly must be mounted with the steering arm facing forward. Mount the upright assembly as follows:

#### *NOTE*

*The upright assemblies are marked RHS or LHS on the inside of the assembly.*

### 5.5.1) Standard

The upright is located into the spherical joint on the lower wishbone and secured using the retained 1/2" nyloc nut. Tighten the nyloc nut to 55 Nm.

### **Warning**

**Correct use of fixings is required in order to ensure full engagement of the nyloc nut.**

### 5.5.2) Wide track

The upright is located into the spherical joint on the lower wishbone. Prior to locating the upright, a spacer located in the polythene bag marked 'front suspension') must be inserted onto the bottom of the upright. The upright is secured using the special turned down nyloc nut supplied. Tighten the special nyloc nut to 55 Nm.

The cycle wingstay locates on the upright. Remove and discard the 1/2" UNF nyloc nut and plain washer fitted to the inner end of the stub axle. Place cycle wingstay over the stub axle and secure using the 1/2" UNF nyloc provided. Do not tighten.

### NOTE

*If uprated front brake callipers have been specified ensure that the brake pads are installed before fitting the cycle wingstays.*

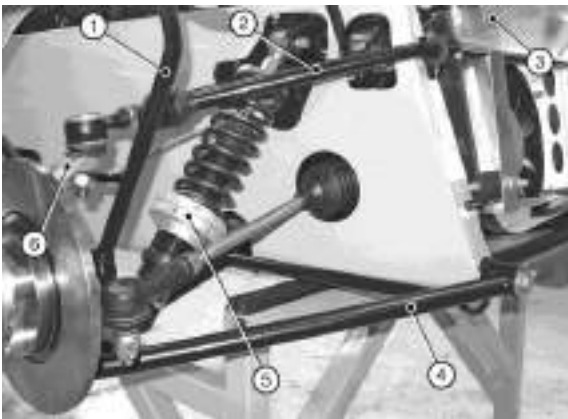
Pass the top wishbone ball-joint down through the top of the upright and through the wingstay. To fully engage the tapers of the wishbone and ball-joint, fit the M14 plain nut (6) from the fastener pack, apply pressure to the top of the ball-joint and tighten the plain nut. Once the ball-joint is locked in place remove the plain nut and replace it with the nyloc supplied on the ball-joint. Tighten the nyloc nut to 54 Nm.

Tighten the inner stub axle nut to 82 Nm and ensure that the upright turns freely on the wishbones.

Remove and retain the nyloc nut from the track rod end. Remove and discard the hard plastic boot protector from the track rod end taper and pass the tapered shaft down through the steering arm on the upright, secure with the nyloc nut. Tighten nyloc nut to 34 Nm.

Your front suspension should now resemble that shown in Figure 34. (IVA covers not shown)

**Figure 34: Front suspension**



- |                   |                          |
|-------------------|--------------------------|
| 1. Cycle wingstay | 4. Lower wishbone        |
| 2. Anti-roll bar  | 5. Spring damper unit    |
| 3. Inner radiator | 6. Upright assembly cowl |

### 5.6) Front anti-roll bar

#### Notes

(1) On R400 the inner radiator cowl is located inboard of the anti-roll bar and must be fitted first, refer to section 6. Sigma 125/140 does not have radiator cowl.

(2) Check that the colour of the bushes corresponds to the colour marked on the front anti-roll bar.

The anti-roll bar is attached to the front of the chassis using the special mounting brackets and cotton reel shaped bushes (supplied in the polythene bag marked 'front suspension'). Liberally coat the bushes with rubber lubricant and fit the bushes into the brackets. Slide the brackets over the ends of the anti-roll bar

and around so they will align with the holes drilled in the front face of the chassis tube.

The rubber boots should be slid over the anti-roll bar, ensuring that the larger diameter of the rubber boot is outboard. Apply Loctite to the threads at each end of the anti-roll bar and fit the plastic balls, tighten using protected grips.

Liberally coat the balls with bearing grease. Assemble the anti-roll bar onto the chassis by pushing the plastic balls, one at a time, into the mounting cups in the upper wishbones. Fit the spring washers (13) to the bolts (5) and pass forward through the vertical chassis tubes and into the captive nuts on the mounting brackets. Tighten to 20 Nm.

The rubber boots are slid over the mounting cups and secured to the top wishbone using cable ties which fit into the grooves provided. A further cable tie is used to hold the boot onto the anti-roll bar itself with the tails of the cable tie being cut off underneath for neatness.

#### NOTE

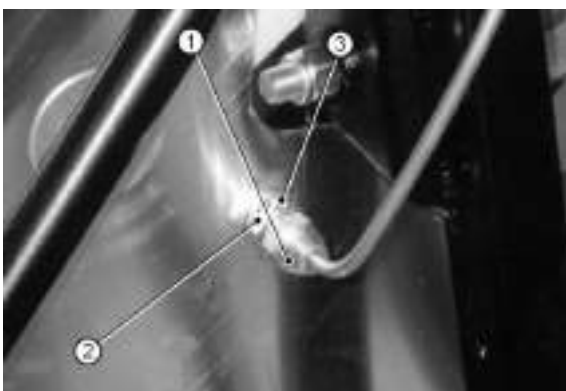
*All connections should initially be made finger tight*

## 5.7) Front brake hoses

Three stainless steel braided brake hoses are supplied, two of equal length for the front brakes and one of longer length for the rear brakes.

Attach the inner, threaded end of each brake hose through the hole in the aluminium body. A plain washer (fastener pack 30F015A item 11) should be fitted directly next to the aluminium body on the outside. Secure using the 3/8" nut and shake proof washer (14). The shake proof washer must be between the nut and the inside panel. Do not tighten.

**Figure 35: Brake pipe union**



- 1. Female pipe union
- 2. Plain washer
- 3. Shakeproof washer

The outer end should be attached to the brake calliper as follows:

### 5.6.1.1) Standard calliper

The outer end is attached to the brake calliper using the banjo bolt provided. The

large copper washer is placed next to the bolt head and smaller copper washer placed between the banjo union and the calliper, refer to Fig 36. Do not over tighten. Torque to 10 Nm.

**Figure 36: Standard calliper**

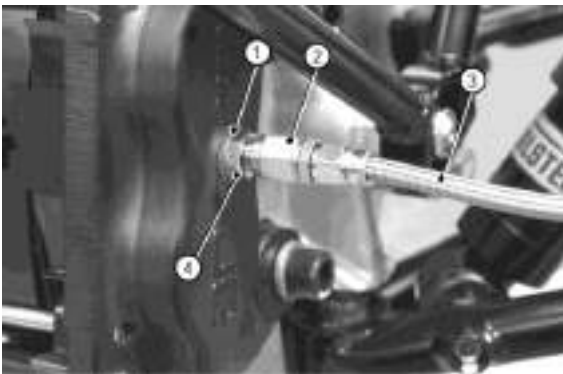


- 1. Banjo bolt
- 2. Large copper washer
- 3. Small copper washer
- 4. Banjo union
- 5. Braided brake hose

### 5.6.1.2) Up-rated calliper

On the up-rated brake calliper the braided brake hose has a female union at the calliper end, refer to Fig 37. The braided hoses are supplied with an adaptor that screws into a threaded drilling inboard of the calliper body. The adaptor must be fitted with the tapered end outward, this provides the seal between the adaptor and the braided brake hose female union, and a copper washer between the adaptor and the brake calliper. The female union on the braided hose screws directly to the adaptor. Do not over tighten. Torque to 10 Nm.

**Figure 37: Up-rated calliper**



- 1. Copper washer      3. Braided brake hose
- 2. Female union      4. Adaptor

Located on the inside of the body are the female unions, refer to Fig 35, on the end of the brake pipes from the brake master cylinder. Fix the female union to the braided brake hose connection and tighten to 10 Nm. Tighten the locknut to 10 Nm.

Turn the steering from lock to lock and ensure that the braided brake hoses do not foul on the suspension. If fouling is observed remove the braided brake hose from the calliper and twist the hose through 180°. Refit the braided brake hose to the calliper and tighten unions to 10 Nm.

**5.8) Final tightening**

All the remaining fixings should be tightened according to Table 13.

**Table 13: Front suspension torque Figures**

Location	Washer	Torque
Sub axle		81Nm
Damper to lower wishbone (lower fixing)	N/A	20Nm
Damper to chassis (top fixing)	N/A	20Nm
Front anti-roll bar fixing	Spring under head	20Nm
Upright top ball-joint	None	54Nm
Upright – bottom	Spacer – wide track only	54Nm
Location	Washer	Torque
Upper wishbone		34Nm
Lower wishbone front	Spring under head then plain as shown in Figure 2.	81Nm
Lower wishbone rear	Plain spacers as shown in Figure 2.	81Nm

**5.9) Cars fitted with adjustable damper platform**

Cars fitted with adjustable damper platforms need to be adjusted to achieve the optimum ride height. This is done by lowering or raising the height of the platforms on the threaded sleeve. It is essential that this task is carried out on level ground.

## NOTE

*Lowering the platforms will decrease ride height, and raising the platforms will increase ride height. For the best results the ride height should be set with the driver in the car and fuel in the tank.*

1. Start by adjusting the front dampers to achieve a minimum distance of 150 mm (this can be increased for road use to a maximum of 190 mm) between the ground and the bottom of the lower chassis rail, where the rear leg of the front lower wishbone exits the side of the car. This measurement should be the same on both sides with the car loaded.

2. Now adjust the rear dampers in the same manner to achieve a height 15 mm higher than the front, measured to the underside of the lower chassis rail immediately in front of the 'A' frame mounting point.

## NOTE

*Adjusting the rear may have an effect on the front therefore it is good practice to check between front and rear several times during adjustment*

3. Once the desired ride heights have been set ensure that the platforms are locked together to avoid movement.



## 6.0) Fitment of gearbox to engine

The following section details the assembly of the 5 and 6 speed gearbox.

### 6.1) Assembly of gearbox kit – 5 and 6-speed.

Both the 5 and 6-speed gearboxes are interchangeable and utilise all the same ancillaries. Assembly is identical for both 5 and 6-speed gearboxes with the exception of the sealing method for bell-housing to gearbox.

To assemble the gearbox to bell-housing, proceed as follows:

**5-Speed Sigma.** Smear the gasket on both sides with silicone sealant and position on the bell-housing. Using the four cap-head bolts (fastener pack 36G006A Item 9) and spring washers (12), bolt the bell-housing to the gearbox from the inside. Tighten the bolts to 47 Nm.

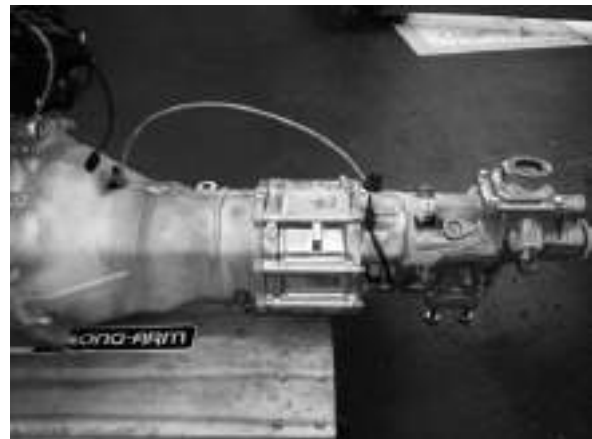
**Duratec:** Remove the bell-housing from the engine, smear the gasket with silicone and position on the bell-housing. Using 4 M12x70 bolts supplied and 4 spring washers from pack ZGB14 and bolt from the inside and torque to 47Nm

**6-Speed.** Apply a thin layer of silicone sealant to the front face of the gearbox and to the 'O' ring around the selector rod. Ensure sealant is applied to the entire 'O'

ring. Using the four cap-head bolts (fastener pack 36G006A Item 9) and spring washers (12), bolt the bell-housing to the gearbox from the inside. Tighten the bolts to 47 Nm.

**Duratec:** Do not remove bell-housing, smear silicone sealant over the O ring and place around the selector rod. Using 4 M10x35 bolts with spring and plain washers supplied in the gearbox pack bolt from the outside and torque to 35Nm.

### New 2014 5 speed Caterham gearbox.



Fit the clutch release bearing before the gearbox

There are no gaskets on this gearbox either between the gearbox and bell-housing or the bell-housing and engine.

Bolt the gearbox to the bell-housing using the 4M12x70 bolts with a plain washer from the inside. Tighten bolts to 47Nm

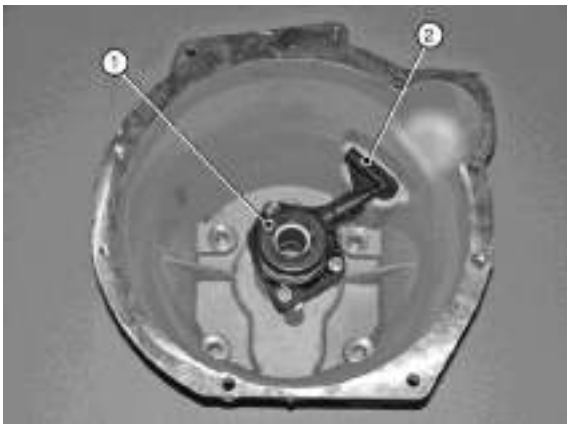
**NOTE**

*Loosen gearbox filler plug.*

*All Duratec models have the bellhousing pre-fitted to the engine, so fixing pack 36G006A is not required.*

Place the clutch release mechanism in position in the bell-housing and secure using the three cap-head bolts (7) and spring washers (13), refer to Figure 38.

**Figure 38: Clutch actuation mechanism**



1. Clutch release bearing
2. Hydraulic connection

Apply silicone sealant to the speedo drive opening on the LH side of the gearbox and insert the large plug supplied, refer to Figure 39.

Apply RTV silicone gasket sealant to the speedo output shaft opening on the RH side of the gearbox and insert the small plug supplied, refer to Figure 40.

**NOTE**

*The plugs are a drive fit and are installed closed end first the plugs only apply to 6 speed gearboxes.*

**New 2014 5 speed Caterham gearbox.**

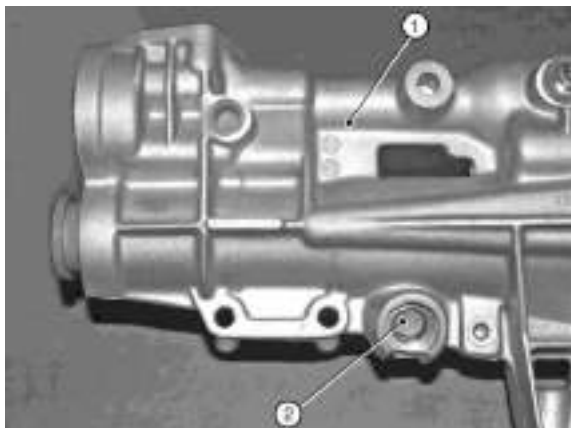
The clutch slave cylinder is bolted on using 3 M6x25 with spring and plain washers, tighten to 10Nm. Make sure the braided steel clutch hose is fitted before you bolt the bell-housing to engine.

**Figure 39: Speedo drive plug**



1. Gearbox
2. Plug
3. Gearbox mounting

**Figure 40: Speedo shaft plug**



- 1. Gearbox
- 2. Plug

Bolt the metal/rubber/metal gearbox mounting, chamfered edge forward, refer to Fig 39, to the underside of the tailshaft housing using one bolt (8) and spring washer (12). Tighten to 61 Nm.

**New 2014 5 speed Caterham gearbox.**



The gearbox mount can only be fitted once the engine and gearbox are in the car and before the engine mounts are fitted. Using 2 M14x40 bolts with a plain washer and thread lock bolt the mount to the gearbox, with the cut out facing the front, tighten to 40Nm,

Using 4 M8x40 caphead bolts with a plain washers and nyloc bolt the mount to the chassis, tighten to 20Nm, bolts can be found in pack 3EZ1105

**6.2) Fitting gearbox to engine**

Slide the gearbox into place on the rear of the engine. It may be necessary to rotate the gearbox assembly in order to line up the gearbox first motion shaft splines with the splines of the clutch plate.

Using the fixings supplied, connect the engine and gearbox; two bolts (2) and spring washers (10), pass forward from the top of the bell-housing into the cylinder block, two more bolts (2) and spring washers, pass forward from the bottom of the bell-housing into the sump. Two bolts (1) and spring washers pass rearward through the 'ears' on the engine assembly and into the bell-housing on the RH side, one further bolt (1) and spring washer passes forward from the LH side of the engine into the bell-housing.

**New 2014 5 speed Caterham gearbox.**

Slide the gearbox into place on the rear of the engine. It may be necessary to rotate the gearbox assembly in order to line up the gearbox first motion shaft splines with the splines of the clutch plate.

To bolt the bell-housing to engine from the front of the engine looking back from the top right going clockwise M10x40, M10x55, M10x55, M10x60, M10x45, M10x55 and M10x40 all with spring washers. Tighten to 35Nm

**6.3) Starter motor**

Install the starter motor into the front of the bell-housing and secure with 3 M10x55 cap head bolts and thin spring washers.

Tighten all starter motor and bell-housing the bolts to the torques specified in Table 14.

**New 2014 5 speed Caterham gearbox.**

Install the starter motor into the front of the bell-housing and secure with 3 M10x60 cap head bolts and spring washers.

Tighten all starter motor and bell-housing the bolts to the torques specified in Table 14.

**Table 14: Gearbox torque figures**

Fixing	Torque
Bell housing to gearbox	47Nm
Gearbox rubber mounting to tailshaft housing	61Nm
Engine to bell-housing	47Nm
Bell-housing to sump	20Nm
Starter motor	34Nm

## 7.0) Installation of engine and gearbox

The following section details the installation of the engine and gearbox for your kit. The [Sigma](#), [Duratec 175 \(R300\)](#) and [Duratec R400](#) engines are detailed separately. Please refer to the relevant section.

### 7.1) Sigma engine

#### 7.1.1) Preparation

The special tools detailed in Table 15 below will be required for this section.

**Table 15: Special tools required for sigma engine**

Item	Description
Engine hoist and sling	SWL of 150 Kg (min)

#### 7.1.1.1) Screen wash/wipe

##### NOTE

*The bracket for the washer bottle must be fixed to the front of the passenger side foot box before the engine is installed.*

Remove the securing nut from the base of the washer jet and pass the washer jet through the hole in the centre of the scuttle and secure with the plastic securing nut. Fit the clear plastic tubing to the washer jet. Dip the end of the clear

plastic tubing in hot water to soften in order to make fitting easier.

Route the clear washer tubing along the wiring loom behind the dashboard and attach using cable ties, to prevent it falling down into view. Pass it down through the large grommet in the top of the transmission tunnel and along the engine bay diagonal tube until in line with the washer bottle. Trim the tube to length and attach to the washer motor.

Connect the washer motor to the wiring loom via the two pin plug adjacent to the washer bottle mounting. To ease fitment of the two pin plug the washer motor can be removed from the washer bottle, the two pin plug fitted and the washer motor reinserted into the washer bottle.

**The windscreen wipers must not be fitted until the wiper motor has been run** and allowed to park in order to prevent damage to the paintwork. Fit the wiper arms so that they are horizontal when parked. The wiper arms must move smoothly through their range of travel.

##### NOTE

*A small amount of water splashed on the windscreen will prevent the wiper blades from juddering during test and adjustment*

### 7.1.1.2) Engine preparation

The large diameter pre-formed 'U' hose should be fitted onto the aluminium water outlet located on the rear of the cylinder head, and the rear aluminium water rail, you will need to cut this pipe to length, refer to Figure 41. Apply rubber lubricant to the ends of the hose and push over the outlets; Secure using a hose clip (Fastener pack 'cooling' 30C047A).

**Figure 41: Water rail and 'U' hose**



1. Engine connection
2. 'U' hose
3. Water rail

Remove and retain the gearbox filler plug. Removal of this plug is not essential; however access is restricted within the confines of the transmission tunnel. It is easier to fill the gearbox up before you put it into the car. Remove the plastic plug from the gearbox tailshaft housing once the engine and gearbox are in the chassis, the plug will hold the oil in the gearbox while you fit it.

### 7.1.1.3) Chassis preparation

Protect the appearance of the engine bay chassis tubes and pedal box sides and edges by covering with card and/or masking tape.

Ensure that all wires and connector plugs are secured and will not snag or catch the engine/gearbox as it is lowered.

#### NOTE

*Before fitting engine mounting rubber blocks ensure that the large threaded (1/2" UNF) boss in the centre is clear of rubber and that the bolt will thread in cleanly.*

Fit the engine mounting rubber block to the RH side of the engine bay. The two bolts (fastener pack 30P012A Item 3), plain washer (12) are passed downwards through the mounting, through the chassis and are secured with nyloc nuts (9) and plain washers (12). Do not tighten.

Fit the engine mounting rubber block to the LH side of the engine bay, locate the engine earth lead (a black earth lead approximately 300 mm long supplied loose in a box), pass bolt (2) and washer (12) downwards through the lead, through the front hole of the engine mounting block, through the chassis and secure with nyloc nut (9) and plain washer (12). Remove a little paint from the

chassis/mounting to ensure that a good electrical contact is made. Pass bolt (3), plain washer (12) downwards through the rear hole of the engine mounting block, through the chassis and secure with nyloc (9) and plain washer (12). Do not tighten. (Other end of the earth lead needs to be connected to engine through engine mount after engine installation).

Locate the twin electric horns on the two studs near the rear edge of the steering rack platform. Before fitting the horns, loosen the 13 mm nut in the centre of each horn, this will allow rotation of the horns so that the electrical connections are closer together.

Secure the horns with the nyloc nuts (fastener pack 30P012A item 10) and ensure that it is not possible for the horns to come into contact with each other, the steering rack or other components in the engine bay refer to Figure 42.

**Figure 42: Horn location**



Tighten the 13 mm nut in the centre of each horn and connect the horns to the electrical harness by the purple and yellow wires and connectors located above the horns on the front upper cross member.

### *7.1.2) Installation of engine/gearbox into chassis*

#### **Warnings**

- 1. Never work underneath a car without supporting it on axle stands or equivalent. Do not rely on a jack alone.**
- 2. Use appropriate eye protection whilst working under the car.**
- 3. Care should be taken while dropping the engine into the chassis to avoid any damage to engine component or wiring.**

Using the lifting hoist and sling detailed in Table 15, attach the engine/gearbox using the lifting eyes provided on the engine, lower the engine/gearbox assembly into the engine bay at an angle of between 30-40° (with the engine higher than the gearbox). Insert the gearbox assembly into the transmission tunnel.

Continue to slide the engine/gearbox rearward until the holes in the gearbox mounting line up with the holes in the chassis cross member. If the differential

and propshaft have already been fitted, ensure that the propshaft locates into the gearbox tailshaft housing.

Attach the LH engine mounting using the two M8 x 25 mm bolts (fastener pack 36G006A Item 4) and one M8 x 30 mm bolt (5), use spring washer item (11) for each bolts. Connect the other end of the earth lead through one of the engine mount fixings. Do not tighten the bolts.

Attach the RH engine mounting using the two M8 x 35 mm bolts (6) and two M10 x 40 mm bolt (2), use spring washer item (10 & 11 ) for each bolts, Do not fully tighten the engine mounting retaining bolts until advised later in this section.

Lower the engine onto the rubber engine mountings and pass the bolts (fastener pack 30P012A Item 1 (LHS) and 21 (RHS)) down through the tube on the outer end of the engine mounting brackets. Screw the bolts loosely into the threaded bush in the centre of the rubber engine mounting. It is recommended that the engine is not removed from the hoist until all the bolts have been tightened (detailed later in this section).

Adjust the gearbox on its slotted mountings to achieve equal clearance within the transmission tunnel. This must be checked carefully as clearances are tight and poor alignment can cause the

gearbox to contact the chassis under cornering.

Bolt the gearbox mounting rubber to the chassis using bolts (fastener pack 30P012A Item 4) passed down through the outer metal part of the rubber mounting and then through the elongated holes in the chassis. Secure with a plain washer (12) and nyloc nut (9) on each bolt and tighten to 20 Nm.

Finally tighten the fixings detailed in Table 16.

**Table 16: Gearbox installation torque figures for sigma engine**

Fixing	Torque
Engine mounting to block	25Nm
Engine mounting to mounting rubbers	41Nm
Engine mounting rubbers to chassis	20Nm
Gearbox mounting rubber to chassis	20Nm

#### NOTES

- 1. It is now safe to remove the engine hoist.*
- 2. Wiring – Every effort is made to clearly explain and identify all the electrical connections as you go through this section; however the loom fitted to your*



*car may have additional wires and connectors that are not required on your vehicle. To help clarify this, a wiring diagram can be found in the electrical section.*

Fit the gear lever to the top of gearbox tailshaft housing and secure with three setscrews (7). No washers are required; tighten to a torque of 20 Nm.

Fit the reverse light switch (polythene bag) into the side of the gearbox. This can be accessed via the hole in the RH side of the transmission tunnel. The switch should be inserted finger tight and then tightened a further quarter of a turn using a suitable sized spanner. Connect the wiring loom to the reverse light switch. From the cockpit, insert the large grommet (polythene bag) to cover the access hole in the transmission tunnel.

#### **New 2014 5 speed Caterham gearbox.**

The reverse light switch has already been fitted to the gearbox, just connect the two connectors to the connectors in the main wiring harness in the tunnel.



The gear lever can only be inserted one way, make sure the lower bush is seated correctly and bolt down with 3 M6x12 button head screws to 11NM, these can be found in 3EZ1105

#### *7.1.3) Electrical connections*

The engine wiring loom is already attached to the engine and some ancillaries, however it is necessary to link the engine wiring loom to the remaining ancillaries and the vehicle wiring loom. All the plastic connecting plugs are matched pairs so it is not possible to connect them incorrectly.

**Figure 43: ECU and MAP unit**



- |                         |               |
|-------------------------|---------------|
| 1. Fuel pipe connection | 4. ECU        |
| 2. MAP unit             | 5. Air filter |
| 3. Multi-pin plug       |               |

The ECU and MAP unit are already fitted.

Connect the green 3-pin plug on the engine loom to the connection on the MAP unit. Connect the short pipe on the MAP unit to the corresponding connection on the throttle body using the rubber vacuum hose provided (125 only).

Connect the black wire from the vehicle loom to pin 16 in the ECU plug (140 only)

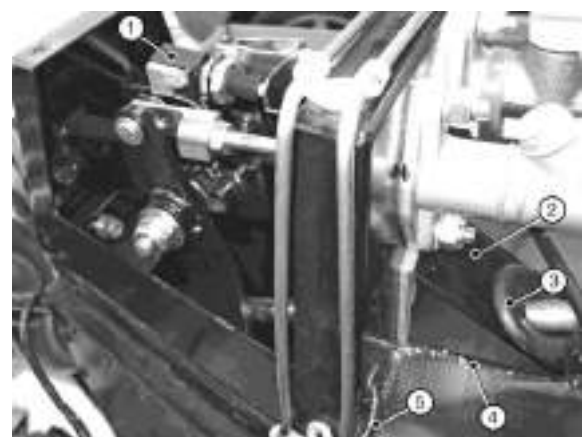
The ECU for the Academy is already fitted under the battery. The MAP unit is positioned on the passenger footbox.

Connect the oil pressure switch from the LH side of the engine block to the connector from the main loom which can be found clipped to the outside of the passenger foot box.

The two, paired, black/yellow wires with ring terminals in the engine loom are earth connections. Attach both pairs to a suitable earth point on the bulkhead.

The green, green/purple pair (with grommet) in the engine loom is for the brake light switch. The brake light switch is inside the drivers pedal box and the harness may be connected during installation of the steering column. Pass the brake light switch harness through the hole in the rear of the pedal box, refer to Fig 44 and push the two female connectors onto the male connectors of the brake light switch (orientation is not important). Fit the grommet into the hole and ensure that the harness will not foul the steering column or pedals.

**Figure 44: Brake light switch harness**



- |                       |                   |
|-----------------------|-------------------|
| 1. Brake light switch | 4. Sealant        |
| 2. Cheese wedge       | 5. Brake light    |
| 3. Grommet            | 6. Switch harness |

The longest wire from the engine loom (terminating in a 4-pin plug) is the connection for the exhaust mounted lambda probe. This cannot be connected until the exhaust primary pipes and collector/catalyst is fitted.

Remove the outermost Bell housing securing bolt and spring washer. Pass the Bell housing mounting bolt and attached spring washer through the black battery earth lead and secure to the bell-housing. Tighten to 34 Nm.

Connect the red lead from the starter motor to the battery. Also connect the black lead on the main vehicle loom to the starter motor on the same terminal.

#### **NOTE**

*If a battery master switch is fitted, there will be two red leads; one goes to the battery, the other to the starter. The brown lead is already connected.*

Connect the brown lead from the alternator to the starter.

Connect the brown/red wire (covered with black insulation) from the chassis loom to the starter solenoid.

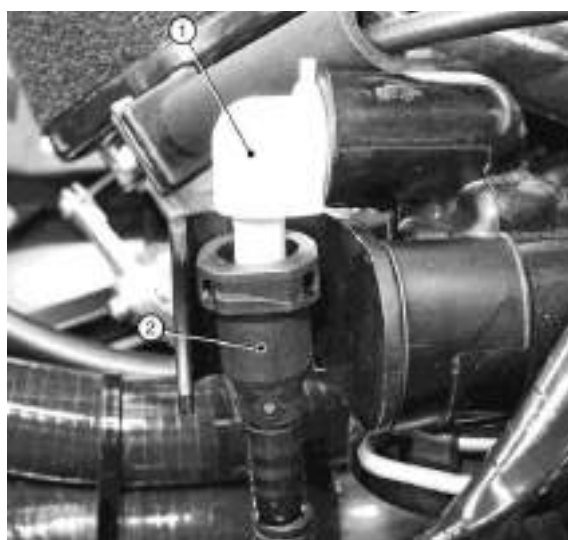
#### **NOTE**

*Make sure the leads are not touching to any surrounding metal component.*

#### **7.1.4) Fuel system**

The black, corrugated plastic, high pressure fuel pipe from the fuel pump emerges from the transmission tunnel and is a push-fit on the white elbow connection at the rear of the fuel rail, refer to Fig 45. Note that there is no fuel return pipe with this system

**Figure 45: Fuel pipe connection**



1. Fuel rail connection
2. Fuel pipe (from pump)

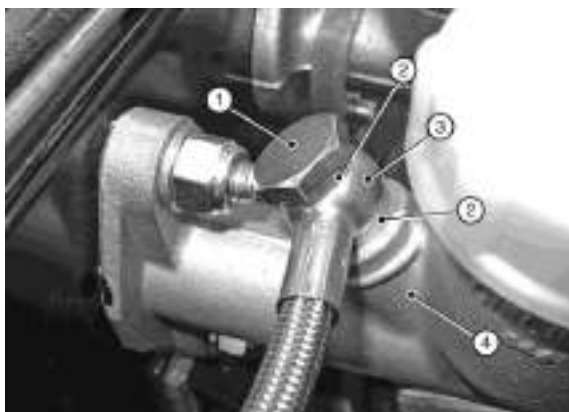
Once fitted the pipe cannot be removed without a special tool. Ensure that the pipe is kink free and routed away from possible snags or chafe points. Remove the red protective cover and push the connection on the pipe firmly onto the elbow and check that it is securely attached. Secure the pipe with cable ties if necessary.

#### **7.1.5) Clutch hydraulic hose**

Remove all packaging from the clutch hydraulic hose. Fit a copper washer to the

banjo bolt and pass the banjo bolt through the union at the end of the hose, refer to Fig 46. Fit the second copper washer to the banjo bolt and screw the banjo bolt into the clutch master cylinder outlet port (remove the port plug). Do not fully tighten the banjo bolt.

**Figure 46: Clutch master cylinder hose union**



- |                   |                           |
|-------------------|---------------------------|
| 1. Banjo bolt     | 3. Hose union             |
| 2. Copper washers | 4. Clutch master cylinder |

Route the hose down the side of the pedal box, over the wiring loom (under the heater hose if fitted) and across the top of the bell-housing, Refer to Figure 47. Push the end of the hose into the connector in the clutch release bearing assembly and ensure that the hose is firmly attached. Secure the hose with cable ties if necessary, to prevent chafing and tighten the banjo bolt (the clutch system is filled and bled during start-up/final checks.

**Figure 47: Clutch hydraulic hose**



#### 7.1.6) Exhaust systems

The standard exhaust system consists of four primary pipes, a collector assembly which also incorporates the catalytic converter and a one piece silencer and tail pipe.

Bolt the exhaust mounting bracket (polythene bag marked 'exhaust') to the RH side of the car forward of the rear wheel, using setscrew (fastener pack 30X020A Item 1) and spring washers (3), refer to Figure 48. Secure the bobbin to the angle bracket with a nut (2) and spring washer (3).

**Figure 48: Exhaust mounting**



- |                  |           |
|------------------|-----------|
| 1. Angle bracket | 4. Bobbin |
| 2. Spring washer | 5. Nut    |
| 3. Setscrew      |           |

Remove the exhaust gasket and associated fasteners from the RH side of the cylinder head, remove any masking tape protecting the exhaust ports and clean off any adhesive residue.

The S3 exhaust primary pipes are marked with their part numbers:

36X014A is for # 1 (front) cylinder

36X015A is for # 2 cylinder.

36X016A is for # 3 cylinder.

36X017A is for # 4 (rear) cylinder.

Protect the area around the square aperture in the side panel with masking tape and card, place the exhaust gasket over the remaining studs and fit the primary pipes in the following sequence:

1. Pass the flanged end of # 4 pipe inwards, attach the flange loosely to the cylinder head and ensure that the pipe sits in the bottom LH corner of the aperture (viewed from outside).

2. Pass the flanged end of # 1 pipe inwards, attach the flange loosely to the cylinder head and ensure that the pipe sits in the top RH corner of the aperture.

3. Pass the plain end of # 3 pipe outwards, attach the flange loosely to the cylinder head and ensure that the pipe sits in the bottom RH corner of the aperture.

4. Pass the plain end of # 2 pipe outwards, attach the flange loosely to the cylinder head and ensure that the pipe sits in the top LH corner of the aperture.

**NOTE**

*For SV use the same procedure to fit the primary, the sequence to fit the primary is 4,3,1,2.*

*56X005A is for #1(front) cylinder.*

*56X006A is for #2 cylinder.*

*56X007A is for #3 cylinder.*

*56X008A is for #4 (rear) cylinder.*

When the primary pipes are in place fit any remaining fasteners but do not tighten them.

Install the collector/catalyst over the assembled primary pipes with the threaded hole for the lambda probe faces towards the side panel. Secure the collector to the primary pipes with the two springs, refer to Figure 49. Support the weight of the collector such that the primary pipes are not in contact with the sides of the aperture and tighten the primary pipe/cylinder head fasteners to 34 Nm.

**Figure 49: Primary pipes and collector/catalyst**



1. Primary pipe
2. Collector/catalyst (guard fitted)

Fit the Lambda probe into the threaded hole in the collector/catalyst and connect the probe plug to the corresponding socket from the engine wiring loom. Secure the Lambda probe connection and wiring to the chassis ensuring that it cannot contact the hot exhaust or any moving part, refer to Figure 50.

#### NOTE

*The lambda probe wiring passes under the side of the car below the lower chassis tube, it must not be routed through the primary pipe aperture in the side panel.*

**Figure 50: Lambda probe connection**



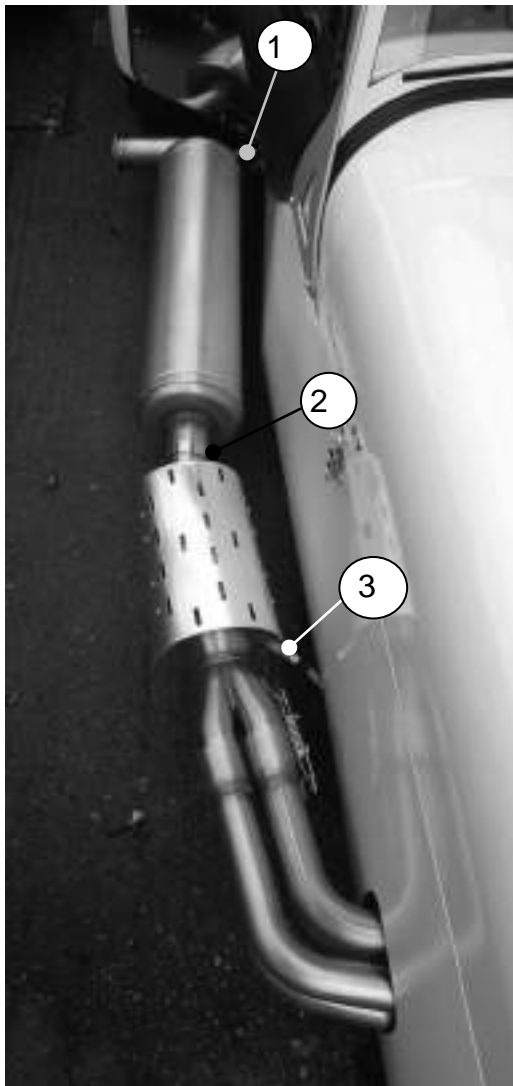
Undo the large worm drive clips and feed them through the channels on the inside of the collector/catalyst guard. Fit the silencer guard to the silencer body with the channels offset towards the rear of the silencer and tighten the clips, refer to Figure 51. Ensure that the clip drives are not at the bottom of the silencer where they could contact the road. Attach the collector/catalyst guard in the same manner.

#### NOTES

1. *For a neater appearance position the clips with the drive screw towards the ground so that the clip 'tail' is out of sight beneath the exhaust.*

2. To reduce the risk of damage it is advisable to fit the silencer after the RH rear wing has been attached.

**Figure 51: Exhaust arrangement**



- 1. Silencer bracket
- 2. Band clamp
- 3. Lambda probe

Loosely fit the single band clamp to the front of the silencer and position the front of the silencer over the collector/catalyst

outlet pipe. Locate the bracket at the rear of the silencer over the bobbin on the silencer mounting bracket and secure with a nut and spring washer. Tighten the nut and band clamp. It may be necessary to reposition the guards slightly.

*7.1.7) Cooling system*

Position a hose clip on the flexible top radiator hose, apply rubber lubricant and fit the hose to the end of the water rail pipe emerging from the curve of the inlet manifold, Refer to Fig 52. Do not tighten the clip.

**Figure 52: Coolant hoses**



- 1. Top radiator hose
- 2. Water rail
- 3. Hose to heater outlet
- 4. Hose to cylinder block
- 5. 'T' piece
- 6. Hose to expansion tank
- 7. Cable tie

Position a hose clip on the flexible bottom radiator hose, apply rubber lubricant and fit the hose to the larger of the two outlets on the LH side of the engine block, Refer

to Fig 53. The hose passes forwards along the LH side of the engine bay before turning to pass along the top of the steering rack and turns again to meet the radiator connection. Do not tighten the clip.

**Figure 53: Bottom hose engine connection (viewed from bellow)**



- 1. Hose to 'T' piece
- 2. Bottom radiator hose

Fit the four rubber radiator mountings to the front of the chassis and secure using nuts, plain washer and spring washers provided in the cooling pack.

Fit the four fan legs (polythene bag marked 'cooling') to the cooling fan. Secure the fan complete with legs to the brackets, ( using bolt 11 and nut 6 in pack 30C047A) the fan can then be mounted to the bobbins, ensuring that the fan electrical connector is located on the RH side, mount the radiator to the bobbins

using four nuts and washer provided in fastener pack (fastener pack 30C047A, Item 7,10 & 13).

**Figure 54: Radiator/fan prior to fitting**



- 1. Top hose connection
- 2. Fan
- 3. Fan legs
- 4. Fan power lead
- 5. Bottom hose connection

**Figure 55: Standard radiator arrangement**



The radiator mounting arrangement on SV models differs considerably from that shown. SV kits include LH and RH radiator mounting plates, refer to Figure 56; these plates must be fixed to the body



before attaching the rubber mountings and the radiator.

**Figure 56: SV radiator arrangement**



Position hose clips on the forward ends of the flexible top and bottom radiator hoses; apply rubber lubricant and fit the hoses over the connections on the radiator. Tighten the clips at both ends of both hoses.

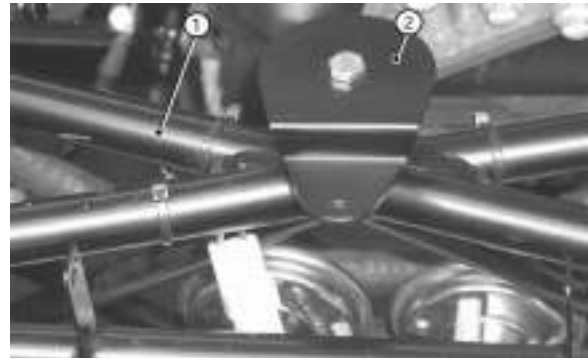
**NOTE**

*The flexible radiator hoses may need to be trimmed to length.*

Locate the two-pin plug containing the black/green and black wires situated on the upper front diagonal chassis member. Connect the two-pin plug to the cooling fan electrical connector. Secure the cable to the chassis members using cable ties.

Fit the expansion bottle mounting bracket on the top of the cruciform, immediately behind the radiator, refer to Fig 57, and secure using bolt, plain washer and spring washer. Tighten to 11 Nm.

**Figure 57: Coolant expansion bottle mounting bracket**



1. Cruciform
2. Expansion bottle mounting bracket

The round coolant expansion bottle sits on the mounting bracket and is secured using a setscrew, plain washer and nylocnut, refer to Figure 66 for correct orientation of the expansion tank hose connections.

**7.1.7.1) Water bleed hoses**

The smaller of the two inlets on the coolant expansion bottle connects to the rear RH side of the cylinder head, refer to Figure 66

Route the 5/16" bore hose, along the top radiator hose and fuel rail and around the

back of the cylinder head. Secure using hose clips (10).

#### 7.1.7.2) Heater and associated hoses

Remove and retain the four screws, nyloc nuts and washers and the two washer plates securing the diffuser panel to the heater. Position the diffuser panel on the inside surface of the scuttle with the air vents facing down and insert the four screws from the inside. Pass the heater harness through the large hole in the scuttle panel and locate the heater over the screws, secure with the washer plates, nyloc nuts, washers and two additional screws from the fastener pack, refer to Fig 58. Connect the heater harness connector heater to the matching plug, located under the dashboard.

#### NOTE

*Cars not fitted with a heater will be supplied with a blanking plate. Apply a small amount of silicon sealant around the edge of the plate to seal it.*

*Academy Cars.*

*From the T piece on the LH side of the block route the hose to the front of the Modine which is near the oil filter. From the rear of the Modine route the J hose up to the rear RH side of the engine. In this pipe under the coil pack you need to fit the*

*temp sender submarine and remember to bolt the earth tag on first.*

**Figure 58: Heater installation**



- |                       |                      |
|-----------------------|----------------------|
| 1. Washer plate       | 4. Heater inlet hose |
| 2. Heater             | 5. Heater control    |
| 3. Heater outlet hose | cable                |

Heater hose is supplied as three pre-formed pieces; a short 'L' shape, a long 'L' shape and a long 'J' shape:

The short 'L' connects the 'T' piece to the engine inlet next to the bottom radiator hose.

The long 'L' shape must be cut in two to provide a long straight hose (to connect the 'T' piece to the heater outlet) and a short 'L' shape (to connect the expansion tank to the 'T' piece). Measure the relevant distances carefully before cutting the hose.

Before fitting any hoses remove the bungs from the ends of the heater pipes.

The long 'J' hose connects the heater inlet to the water outlet at the rear of the cylinder head (next to the top hose 'U' bend). This hose must be trimmed to length. Cut a 240 mm length of hose from the straight leg and cut this into two 120 mm pieces. Use the 120 mm pieces to connect the heater inlet and outlet to the heater valve.

The larger of the two inlets on the coolant expansion bottle must connect to one end of the cross-bar of the large 'T' piece (near the alternator) that also connects to the heater valve (outlet side) and to the smaller of the two connections at the front LH side of the engine block, refer to Fig 52. Measure and cut the long, 5/8" bore, 'L' shaped hose as described previously. Apply rubber lubricant to the hose and fit to the coolant expansion bottle and 'T' piece securing with a hose clip at each end.

Apply rubber lubricant and connect the short 'L' shaped hose to the smaller of the two connections at the LH front of the engine block, connect this hose to the stem of the large 'T' piece. Secure using hose clips.

Use the cut length of 5/8" bore hose (from the long 'L' hose) to connect the remaining leg of the 'T' piece to the upper (outlet) connection on the heater valve,

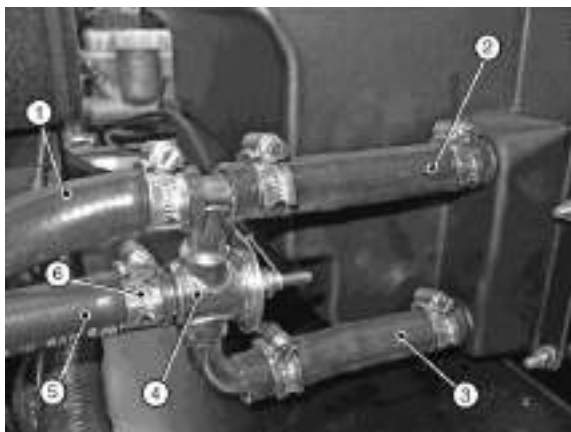
refer to Fig 59. Connect the other side of the heater valve upper (outlet) connection to the straight connector at the top of the heater. Apply rubber lubricant where necessary and secure using hose clips. Ensure that the hose is routed to avoid chafing, use cable ties as necessary.

Trim to length and connect the long 'J' hose between the lower (inlet) connection of the heater valve and the outlet at the back of the cylinder head (next to the top 'U' hose). Connect the curved pipe on the heater valve to the lower (inlet) connection on the heater using a short length of 5/8" bore hose, refer to Fig 59. Apply rubber lubricant where necessary and secure using hose clips. Ensure that the hose is routed to avoid chafing, use cable ties as necessary. Do not fully tighten the hose clips at the heater end at this point.

#### *NOTE*

*On cars where no heater is fitted the relevant connections at the rear of the cylinder head and on the front LH side of the engine block must be joined by a suitable length of hose.*

**Figure 59: Heater valve arrangement**



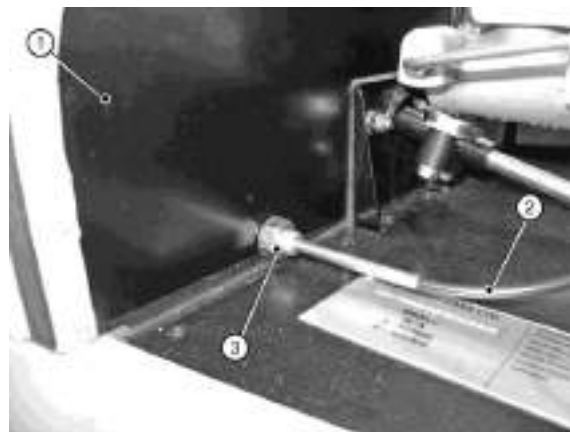
- 1. Hose to large 'T'
- 2. Heater outlet
- 3. Heater inlet
- 4. Heater valve
- 5. Hose to cylinder head
- 6. Hose clip(s)

Remove and retain the locknut and washer from the heater control cable and pass it from inside the cockpit, through the hole in the front face of the scuttle, refer to Figs 60 and 61. Secure the cable in place using the locknut and washer provided.

**Figure 60: Heater control location**



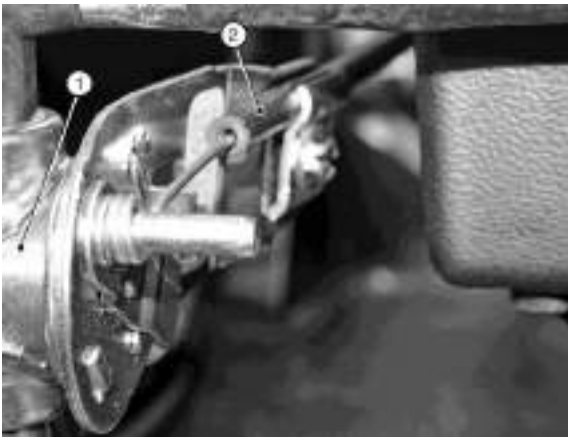
**Figure 61: Heater control cable**



- 1. Scuttle panel
- 2. Heater control cable
- 3. Locknut

Connect the other end to the heater control valve by sliding the eyelet on the inner cable over the peg on the heater valve operating arm then slide the outer cable under the adjacent clamp and tighten the screw to secure in place, refer to Figure 62. Ensure that the valve travels through its full range when operated from inside the car. This can be adjusted by slackening the clamp that locates the outer cable to the valve and sliding the cable one way or another.

**Figure 62: Heater control cable attachment**



1. Heater valve
2. Heater control cable

**Warning**

**Due consideration should be given to the highly flammable nature of petroleum or alcohol based products and their vapours. Serious burns can result from incorrect use.**

Fill the cooling system with a 50% antifreeze solution (refer to Owner's Handbook for Caterham recommended coolant). Add the coolant solution to the expansion bottle. Place paper or cloth on the scuttle in the area below the heater inlet/outlet hoses. Ensure that the heater valve is in the fully open position (control knob pulled towards the driver) and remove the heater inlet (top connector) hose which was previously left loose. Temporarily seal off the heater valve inlet and at the same time back fill the heater

inlet hose with coolant solution. When the hose is full refit it to the heater inlet and secure with the hose clip. This procedure should minimise the amount of bleeding required once the engine is running for the first time.

*7.1.8) Throttle cable fitment*

Attach the throttle cable to the linkage on the throttle body by engaging the nipple in the throttle operating lever and then clipping its square shaped black plastic adjuster onto the adjacent bracket. This adjuster can be threaded up and down the cable outer to adjust the throttle pedal position, refer to Figure 63.

**Figure 63: Throttle cable to throttle body**



1. Throttle cable
2. Throttle cable adjuster
3. Throttle body linkage

Route the other end of the cable around the front of the cam cover; refer to Fig 64 and through the 22 mm hole in the front of the pedal box and clip the plastic seat into place. The inner cable is fed into the slot on the top of the pedal with the portion of cable protruding past the cable termination located through the hole. The top of the pedal should be gently squeezed with a pair of pliers to capture the cable and prevent it escaping.

#### NOTE

*In order to obtain a preferred pedal height and achieve adequate cable tension it may be necessary to bend the top of the pedal prior to locating the cable. This is done by inserting a Phillips screwdriver into the top of the pedal, bracing the bottom of the pedal with a block of wood, and gently bending the top of the pedal so as to take up the slack in the cable. Use the adjusting mechanism at the throttle body end of the cable to remove any free play. **Once pedal has been manipulated to desired position; ensure that no part of the pedal is in contact with the head of the securing bolt.***

#### 7.1.9) Breather pipe fitment

Fit the breather pipe between the throttle body and engine cam cover, refer to Fig 64. Apply rubber lubricant where necessary and secure using hose clips.

Ensure that the pipe is routed to avoid chafing, use cable ties as necessary.

On Sigma 140 the throttle body is blocked off and the breather from the cam cover goes to a bottle located at the front LH side of the chassis above the steering rack, there is also another breather pipe that is already fitted just below the inlet manifold that also goes to the breather bottle.

The academy is similar to the 140 except the breather bottle is mounted on the front of the scuttle.

**Figure 64: Breather pipe**



1. Cam cover
2. Breather pipe
3. Throttle body



Check that the throttle operates smoothly without sticking.

#### 7.1.11) *Sigma 140 and Academy – air intake*

Fit the airbox and trunking as shown below. The airbox is mounted on three rubber bobbins secured to the heater tray panel.



#### 7.1.10) *Air filter fitment*

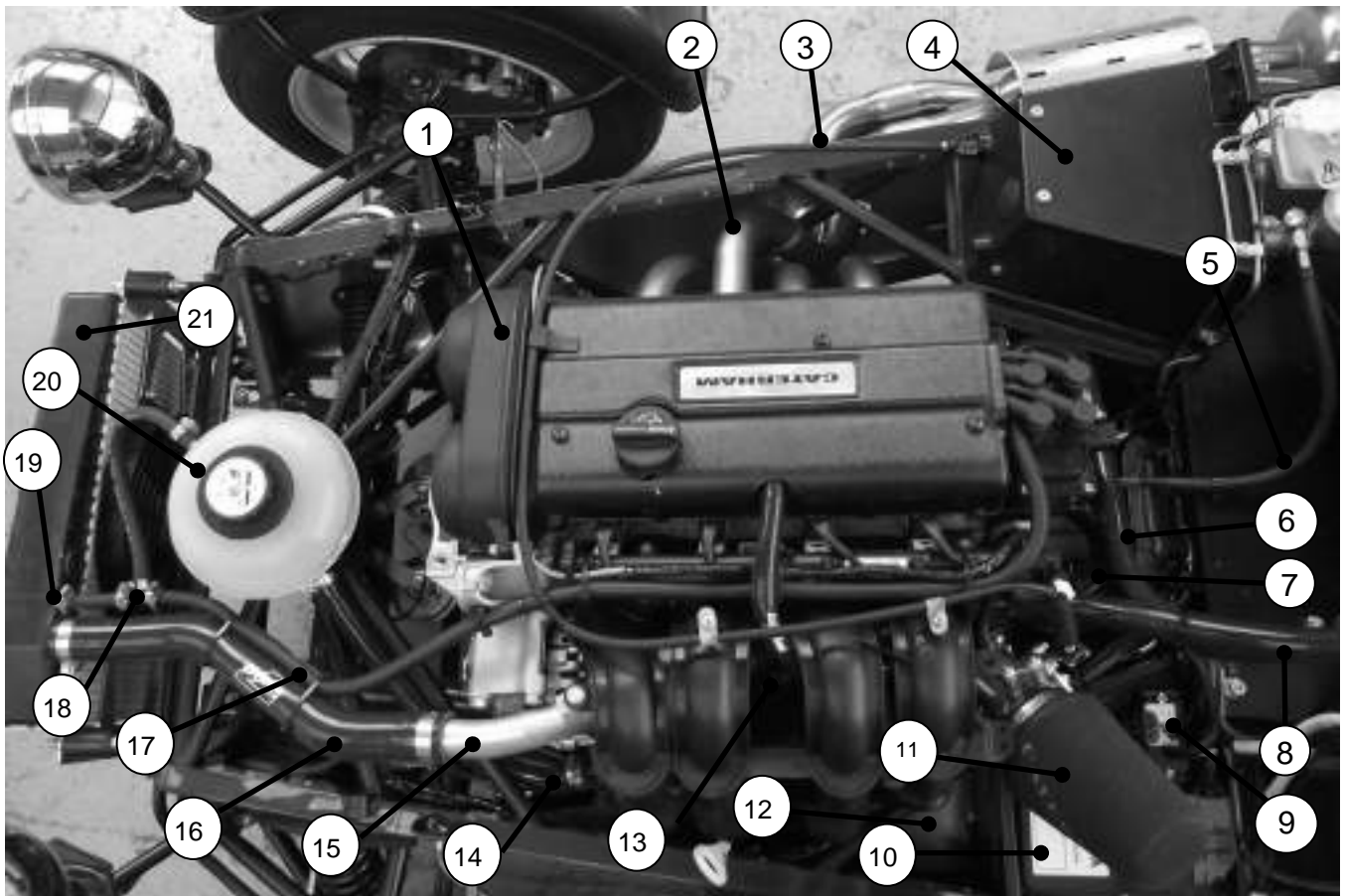
Fit the Caterham air filter element to the throttle body housing and secure using the hose clip provided. The hose clip should not be over tightened as it is possible to distort the throttle body and prevent smooth operation of the throttle.



**Figure 65: Air intake and trunking**

1. Air intake
2. Trunking

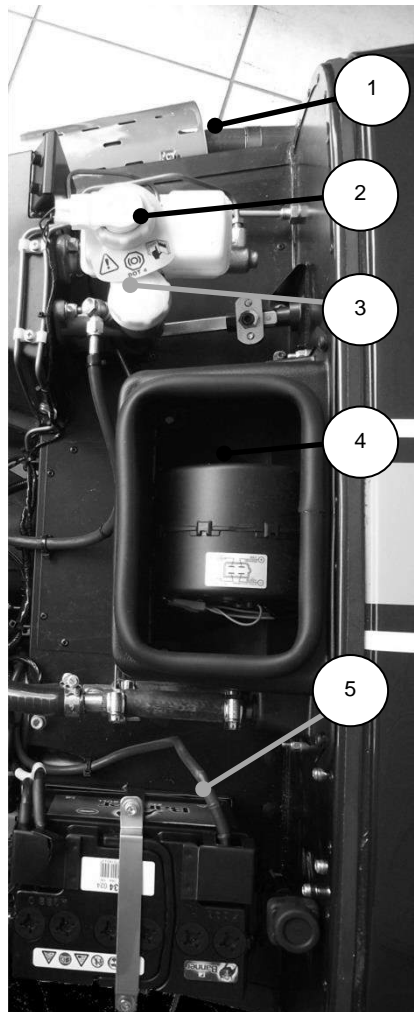
**Figure 66: Sigma 125 engine bay overview**



- |                      |                        |                       |
|----------------------|------------------------|-----------------------|
| 1. Engine            | 8. Heater outlet       | 15. Water rail        |
| 2. Exhaust           | 9. MAP unit            | 16. Top radiator hose |
| 3. Throttle cable    | 10. ECU                | 17. Water bleed hose  |
| 4. Pedal box         | 11. Air filter         | 18. Small 'T' piece   |
| 5. Clutch hose       | 12. Heater outlet      | 19. Blanking plug     |
| 6. Heater inlet hose | 13. Heater outlet hose | 20. Expansion bottle  |
| 7. 'U' hose          | 14. Large 'T' piece    | 21. Radiator          |



**Figure 67: Sigma 125 engine bay overview (rear)**



- |                           |                         |
|---------------------------|-------------------------|
| 1. Brake master cylinder  | 4. Heater control cable |
| 2. Clutch master cylinder | 5. Battery              |
| 3. Heater                 |                         |

## 7.2) Duratec - Roadsport 175/Superlight R300 engine

### 7.2.1) Preparation

The special tools detailed in Table 17 will be required.

**Table 17: Special tools required for Duratec – Roadsport 175/ Superlight R300 engine**

Item	Description
Engine hoist and sling	SWL if 150 Kg (min)

#### 7.2.1.1) Screen wash/wipe

##### NOTE

*The bracket for the washer bottle must be fixed to the front of the passenger side foot box before the engine is installed.*

Remove the securing nut from the base of the washer jet and pass the washer jet through the hole in the centre of the scuttle and secure with the plastic securing nut. Fit the clear plastic tubing to the washer jet. Dip the end of the clear plastic tubing in hot water to soften in order to make fitting easier.

Route the clear washer tubing along the wiring loom behind the dashboard and attach using cable ties, to prevent it falling down into view. Pass it down through the large grommet in the top of the transmission tunnel and along the engine bay diagonal tube until in line with the

washer bottle. Trim the tube to length and attach to the washer motor.

Connect the washer motor to the wiring loom via the two pin plug adjacent to the washer bottle mounting. To ease fitment of the two pin plug the washer motor can be removed from the washer bottle, the two pin plug fitted and the washer motor reinserted into the washer bottle.

**The windscreen wipers must not be fitted until the wiper motor has been run and allowed to park in order to prevent damage to the paintwork.** Fit the wiper arms so that they are horizontal when parked. The wiper arms must move smoothly through their range of travel.

##### NOTE

*A small amount of water splashed on the windscreen will prevent the wiper blades from juddering during test and adjustment.*

#### 7.2.1.2) Engine preparation

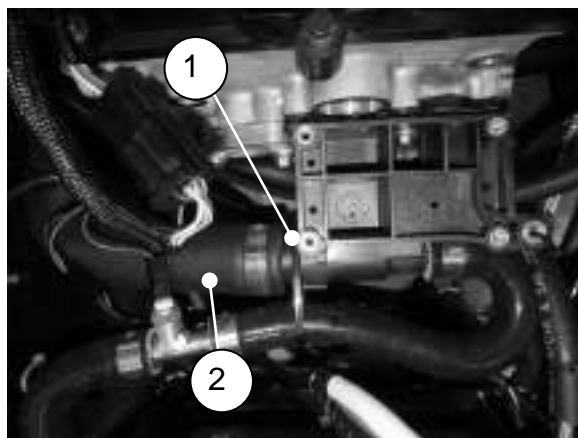
The large diameter short 'L' shape hose should be fitted onto the aluminium water outlet located on the rear of the cylinder head, refer to Fig 68. Apply rubber lubricant to the long end of the hose and push over the outlet; rotate the hose until the short end sits along the LH side of the engine refer fig 68. Secure using a hose clip.

Apply rubber lubricant to the end of the water rail; pass the rail from the front of the engine, over the alternator, and under the curve of the plenum chamber. Insert the pipe into the short end of the 'L' shape hose and secure using a hose clip. Align the water rail mountings with the lugs under the Plenum chamber and secure using screws, nuts and washers provided.

#### NOTE

*Water rail might have already been fitted to the engine.*

**Figure 68: Water outlet and 'L' shape hose**



1. Engine connection
2. Long 'L' hose

Remove and retain the gearbox filler plug. Remove the plastic plug from the gearbox tailshaft housing. Removal of these plugs is not essential; however access is restricted within the confines of the transmission tunnel.

#### 7.2.1.3) Chassis preparation

Protect the appearance of the engine bay chassis tubes and pedal box sides and edges by covering with card and/or masking tape.

Ensure that all wires and connector plugs are secured and will not snag or catch the engine/gearbox as it is lowered.

#### NOTE

*Before fitting engine mounting rubber blocks ensure that the large threaded (1/2" UNF) boss in the centre is clear of rubber and that the bolt will thread in cleanly.*

Fit the engine mounting rubber block to the RH side of the engine bay. The two bolts (fastener pack 30P012A Item 3), plain washer (12) are passed downwards through the mounting, through the chassis and are secured with nyloc nuts (9) and plain washers (12). Do not tighten.

Fit the engine mounting rubber block to the LH side of the engine bay, locate the engine earth lead (a black lead approximately 300 mm long), pass bolt (2) and washer (12) downwards through the lead, through the front hole of the engine mounting block, through the chassis and secure with nyloc nut (9) and plain washer (12). Remove a little paint from the chassis/mounting to ensure that a good

electrical contact is made. Pass bolt (3), plain washer (12) downwards through the rear hole of the engine mounting block, through the chassis and secure with nyloc (9) and plain washer (12). Do not tighten.

Locate the twin electric horns on the two studs near the rear edge of the steering rack platform. Before fitting the horns, loosen the 13 mm nut in the centre of each horn, this will allow rotation of the horns so that the electrical connections are closer together.

Secure the horns with the nyloc nuts provided and ensure that it is not possible for the horns to come into contact with each other, the steering rack or other components in the engine bay refer to Figure 69.

**Figure 69: Horn location**



Tighten the 13 mm nut in the centre of each horn and connect the horns to the electrical harness by the purple and yellow wires and connectors located

above the horns on the front upper cross member.

### *7.2.2) Installation of engine/gearbox into chassis*

#### **Warnings**

- 1. Never work underneath a car without supporting it on axle stands or equivalent. Do not rely on a jack alone.**
- 2. Use appropriate eye protection whilst working under the car.**
- 3. For Duratec engines, Alternator and starter motor must be removed before engine installation.**

Using the lifting hoist and sling detailed in Table 17, attach the engine/gearbox using the lifting eyes provided on the engine, lower the engine/gearbox assembly into the engine bay at an angle of between 30-40° (with the engine higher than the gearbox). Insert the gearbox assembly into the transmission tunnel.

Continue to slide the engine/gearbox rearward until the holes in the gearbox mounting line up with the holes in the chassis cross member. If the differential and Propshaft have already been fitted, ensure that the Propshaft locates into the gearbox tailshaft housing.

Attach the LH engine mounting using the two M8 x 25 mm bolts (fastener pack

36G006A Item 4) and one M8 x 30 mm bolt (5), do not fully tighten the bolts.

Attach the RH engine mounting using the two M8 x 35 mm bolts (6) and one M10 x 40 mm bolt (2). Do not finally tighten the engine mounting retaining bolts until advised later in this section.

Lower the engine onto the rubber engine mountings and pass the bolts (fastener pack 30P012A Item 1) down through the tube on the outer end of the engine mounting brackets. Screw the bolts loosely into the threaded bush in the centre of the rubber engine mounting. It is recommended that the engine is not removed from the hoist until all the bolts have been tightened (detailed later in this section).

Adjust the gearbox on its slotted mountings to achieve equal clearance within the transmission tunnel. This must be checked carefully as clearances are tight and poor alignment can cause the gearbox to contact the chassis under cornering.

Bolt the gearbox mounting rubber to the chassis using bolts (fastener pack 30P012A Item 4) passed down through the outer metal part of the rubber mounting and then through the elongated holes in the chassis. Secure with a plain

washer (12) and nyloc nut (9) on each bolt and tighten to 20 Nm.

Finally tighten the fixings detailed in Table 18.

**Table 18: Gearbox torque figures for DuratecRoadsport 175/ Superlight R300 engine**

Fixing	Torque
Engine mounting to block	34Nm
Engine mounting to mounting rubbers	41Nm
Engine mounting rubbers to chassis	20Nm
Gearbox mounting rubber to chassis	20Nm

#### NOTES

- 1. It is now safe to remove the engine hoist.*
- 2. Wiring – Every effort is made to clearly explain and identify all the electrical connections as you go through this section; however the loom fitted to your car may have additional wires and connectors that are not required on your vehicle. To help clarify this, a wiring diagram can be found in the electrical system.*

Fit the gear lever to the top of gearbox tailshaft housing and secure with three setscrews (7). No washers are required; tighten to a torque of 20 Nm.

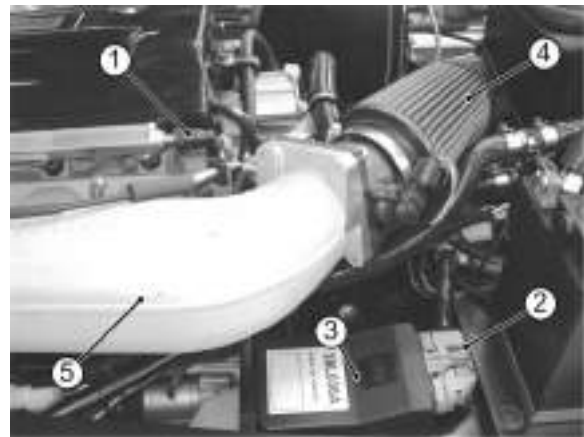
Fit the reverse light switch (polythene bag) into the side of the gearbox. This can be accessed via the hole in the RH side of the transmission tunnel. The switch should be inserted finger tight and then tightened a further quarter of a turn using a suitable sized spanner. Connect the wiring loom to the reverse light switch. From the cockpit, insert the large grommet (polythene bag) to cover the access hole in the transmission tunnel.

### 7.2.3) Electrical connections

The engine wiring loom is already attached to the engine and some ancillaries, however it is necessary to link the engine wiring loom to the remaining ancillaries and the vehicle wiring loom. All the plastic connecting plugs are matched pairs so it is not possible to connect them incorrectly.

Attach the grey, multi-pin plug to the respective socket on the Engine Control Unit (ECU), which is located on the passenger side heater tray, forward of the battery. Make the connection and ensure that the red retaining clip is pushed fully home, refer to Figure70.

**Figure 70: ECU**



- |                         |                   |
|-------------------------|-------------------|
| 1. Fuel pipe connection | 3. ECU            |
| 2. Multi-pin plug       | 4. Air filter     |
|                         | 5. Plenum chamber |

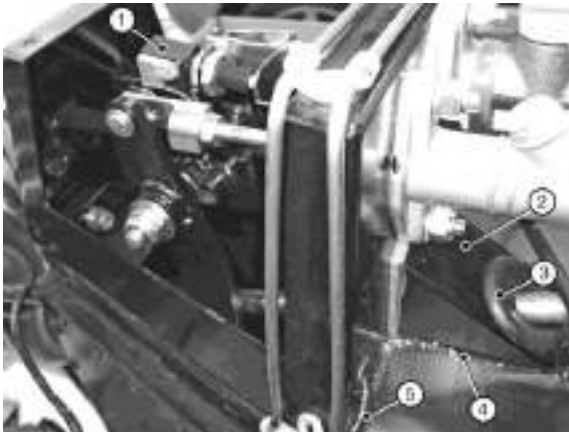
Connect the white/red/black wire plug from the oil pressure sender on the LH side of the engine block to the plug on the engine loom and route with cable ties (*Might have already been connected*).

The black wire with ring terminals in the engine loom is earth connections. Attach to a suitable earth point on the bulkhead.

The green, green/purple pair (with grommet) in the engine loom is for the brake light switch. The brake light switch is inside the drivers pedal box and the harness may be connected during installation of the steering column. Pass the brake light switch harness through the hole in the rear of the pedal box, refer to Fig 71 and push the two female connectors onto the male connectors of the brake light switch (orientation is not

important). Fit the grommet into the hole and ensure that the harness will not foul the steering column or pedals.

**Figure 71: Brake light switch harness**



- |                       |                               |
|-----------------------|-------------------------------|
| 1. Brake light switch | 4. Sealant                    |
| 2. Cheese wedge       | 5. Brake light switch harness |
| 3. Grommet            |                               |

The longest wire from the engine loom (terminating in a 4-pin plug) is the connection for the exhaust mounted lambda probe. This cannot be connected until the exhaust primary pipes and collector/catalyst is fitted, refer to cooling systems (section 7.1.7).

Remove the outermost Bell housing securing bolt and spring washer. Pass the Bell housing mounting bolt and attached spring washer through the black battery earth lead and secure to the Bell housing. Tighten to 34 Nm.

Connect the red lead from the starter motor to the battery.

#### NOTE

*In case of battery master switch, connect red leads from master switch to battery and starter motor as marked.*

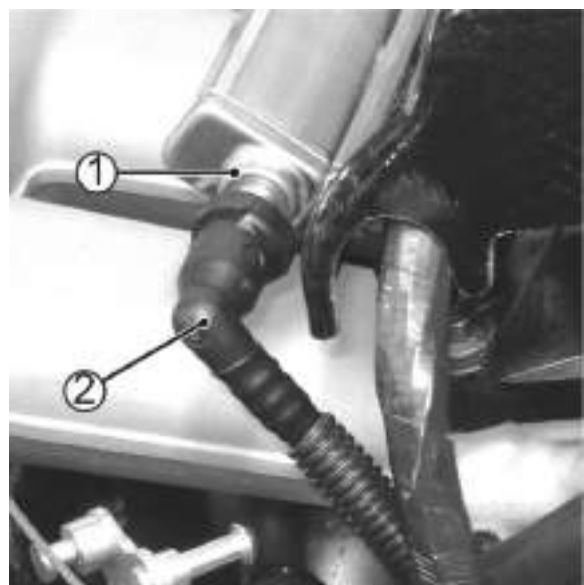
Connect the brown lead from the alternator to the starter.

Connect the brown/red wire from the chassis loom to the starter solenoid.

#### 7.2.4) Fuel systems

The black, corrugated plastic, high pressure fuel pipe from the fuel pump emerges from the transmission tunnel and is a push-fit on the connection at the rear of the fuel rail, refer to Fig 72. Note that there is no fuel return pipe with this system.

**Figure 72: Fuel pipe connection**



1. Fuel rail connection
2. Fuel pipe (from pump)

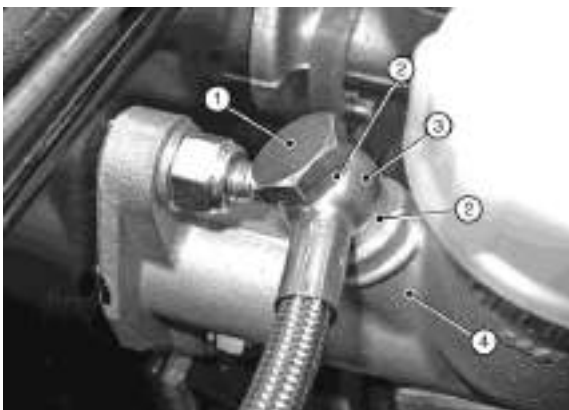
Once fitted the pipe cannot be removed without a special tool. Ensure that the pipe is kink free and routed away from possible snags or chafe points. Push the connection on the pipe firmly onto the elbow and check that it is securely attached. Secure the pipe with cable ties if necessary.

### 7.2.5) Clutch hydraulic hose

The clutch hydraulic hose is already connected to the clutch mechanism. Fit a copper washer to the banjo bolt and pass the banjo bolt through the union at the end of the hose, refer to Figure 73 (banjo bolt and the washers can be found in a bag attached to clutch hose) . Fit the second copper washer to the banjo bolt and screw the banjo bolt into the clutch master cylinder outlet port (remove the port plug).

Do not fully tighten the banjo bolt.

**Figure 73: Clutch master cylinder hose union**



- |                   |                           |
|-------------------|---------------------------|
| 1. Banjo bolt     | 3. Hose union             |
| 2. Copper washers | 4. Clutch master cylinder |

Route the hose down the side of the pedal box, over the wiring loom (under the heater hose if fitted) and across the top of the bell-housing, Refer to Figure 74.

Secure the hose with cable ties if necessary, to prevent chafing and tighten the banjo bolt (the clutch system is filled and bled during start-up/final checks).

**Figure 74: Clutch hydraulic hose**



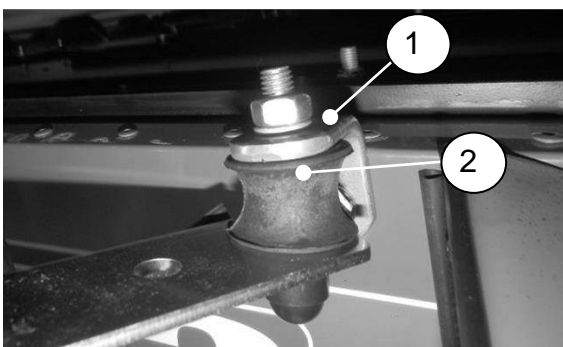


### 7.2.6) Exhaust system

The standard exhaust system consists of four primary pipes, a collector assembly which also incorporates the catalytic converter and a one piece silencer and tail pipe.

Bolt the exhaust mounting bracket (polythene bag marked 'exhaust') to the RH side of the car forward of the rear wheel, using setscrew (fastener pack 30X020A Item 1) and spring washers (3), refer to Fig 75. Secure the bobbin to the angle bracket with a nut (2) and spring washer (3).

**Figure 75: Exhaust mounting**



1. Angle bracket
2. Bobbin

Remove the exhaust gasket and associated fasteners from the RH side of the cylinder head, remove any masking tape protecting the exhaust ports and clean off any adhesive residue.

The exhaust primary pipes are marked with their part numbers.

Series 3.

CSP903 is for # 1 (front) cylinder

CSP904 is for # 2 cylinder.

CSP905 is for # 3 cylinder.

CSP906 is for # 4 (rear) cylinder.

Protect the area around the square aperture in the side panel with masking tape and card, place the exhaust gasket over the remaining studs and fit the primary pipes in the following sequence:

1. Pass the flanged end of # 4 pipe inwards, attach the flange loosely to the cylinder head and ensure that the pipe sits in the top LH corner of the aperture (viewed from outside).
2. Pass the flanged end of # 3 pipe inwards, attach the flange loosely to the cylinder head and ensure that the pipe sits in the bottom LH corner of the aperture.
3. Pass the plain end of # 2 pipe outwards, attach the flange loosely to the cylinder head and ensure that the pipe sits in the bottom RH corner of the aperture.
4. Pass the plain end of # 1 pipe outwards, attach the flange loosely to the cylinder head and ensure that the pipe sits in the top RH corner of the aperture.

*NOTE*

For SV use the same procedure to fit the primary, the sequence to fit the primary is 4,3,2,1.

58X0011A is for #1(front) cylinder.

58X0012A is for #2 cylinder.

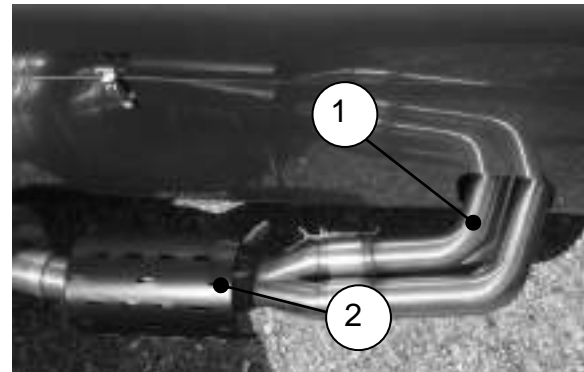
58X0013A is for #3 cylinder

58X0014A is for #4 (rear) cylinder

When the primary pipes are in place, fit the remaining fasteners but do not tighten them.

Install the collector/catalyst over the assembled primary pipes with the threaded hole for the lambda probe faces towards the side panel. Secure the collector to the primary pipes with the two springs, refer to Fig 76. Support the weight of the collector such that the primary pipes are not in contact with the sides of the aperture and tighten the primary pipe/cylinder head fasteners to 34 Nm.

**Figure 76: Primary pipes and collector/catalyst**



1.Primary pipe

2.Collector/catalyst

Fit the Lambda probe into the threaded hole in the collector/catalyst and connect the probe plug to the corresponding socket from the engine wiring loom. Secure the Lambda probe connection and wiring to the chassis ensuring that it cannot contact the hot exhaust or any moving part, refer to Figure 77.

#### NOTE

*The lambda probe wiring passes under the side of the car below the lower chassis tube, it must not be routed through the primary pipe aperture in the side panel.*

**Figure 77: Lambda probe connection**

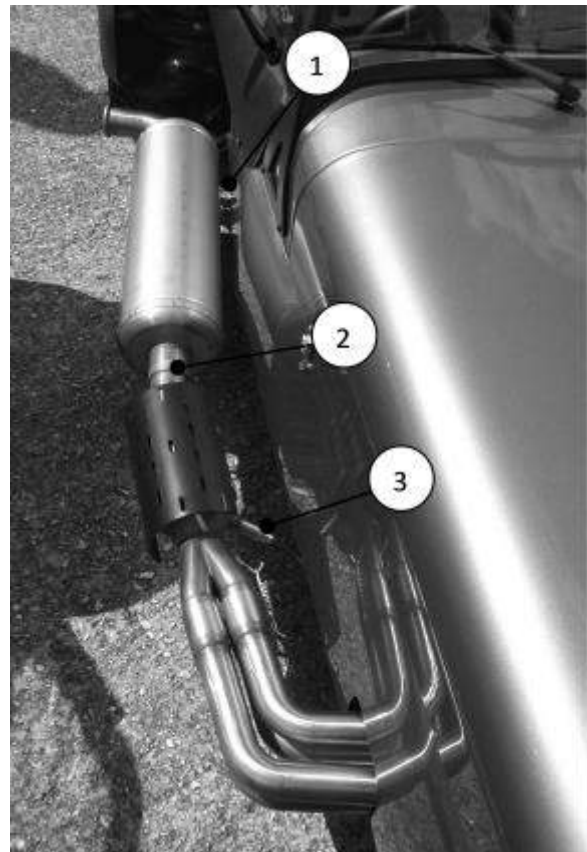


Undo the large worm drive clips and feed them through the channels on the inside of the collector/catalyst guard. Ensure that the clip drives are not at the bottom of the silencer where they could contact the road.

**NOTES**

- 1. For a neater appearance position the clips with the drive screw towards the ground so that the clip 'tail' is out of sight beneath the exhaust.*
- 2. To reduce the risk of damage it is advisable to fit the silencer after the RH rear wing has been attached.*

**Figure 78: Exhaust arrangement**



1. Silencer bracket
2. Band clamp
3. Lambda probe

Loosely fit the single band clamp to the front of the silencer and position the front of the silencer over the collector/catalyst outlet pipe. Locate the bracket at the rear of the silencer over the bobbin on the silencer mounting bracket and secure with a nut and spring washer. Tighten the nut and band clamp. It may be necessary to reposition the guards slightly.

**7.2.7) Cooling system**

All wet sump Duratec engines have an oil cooler modine fitted to the RHS of the

engine. It enables the engine oil to be cooled by circulating coolant around the oil-filled modine cooler.

**Figure 79: Location of modine**



Position the breather bottle mounting bracket on the chassis as shown in the picture. Align the RHS hole on the bracket with the RHS rivet on the chassis and mark both hole. Drill the marked hole with 5/32" drill and fit the bracket in place using 5/32 rivets refer to fig 80. Push fit the breather bottle on to the mounting bracket.

**Figure 80: Breather bottle mounting bracket**



Position a hose clip on the flexible bottom radiator hose, apply rubber lubricant and fit the hose to the larger of the two outlets on the LH side of the engine block, Refer to Fig 81. The hose passes forwards along the LH side of the engine bay before turning to pass along the top of the steering rack and turns again to meet the radiator connection. Do not tighten the clip.

**Figure 81: Bottom radiator hose engine connection (view from top)**



1. Small straight hose to 'T' piece
2. Bottom radiator hose

Fit the four rubber radiator mountings to the front of the chassis and secure using nuts, plain washer and spring washers provided in the cooling pack.

**Warning**

**Do not over tighten the blanking plug.**

The blanking plug is already fitted to the radiator, make sure it is tight. Fit the

radiator onto the rubber radiator mountings ensuring that the hose connections face towards the engine. Secure the upper mounting using nuts, plain washers and spring washers.

The radiator mounting arrangement on SV models differs considerably from that shown. SV kits include LH and RH radiator mounting plates, refer to Fig 82; these plates must be fixed to the body before attaching the rubber mountings and the radiator/inner cowl.

**Figure 82: SV radiator arrangement**



Position hose clips on the forward ends of the flexible top and bottom radiator hoses; apply rubber lubricant and fit the hoses over the connections on the radiator. Tighten the clips at both ends of both hoses.

#### **NOTE**

*The flexible radiator hoses may need to be trimmed to length.*

Locate the two-pin plug containing the black/green and black wires situated on the engine loom. Route the plug to the front and connect the two-pin plug to the cooling fan electrical connector. Secure the cable to the chassis members using cable ties.

Fit the expansion bottle mounting bracket on the top of the cruciform, immediately behind the radiator, refer to Fig 83, and secure using bolt, plain washer and spring washer. Tighten to 11 Nm.

**Figure 83: Coolant expansion bottle mounting bracket**



1. Cruciform
2. Expansion bottle mounting bracket

The round coolant expansion bottle sits on the mounting bracket and is secured using a setscrew, plain washer and nyloc nut; refer to Fig 93 for correct orientation of the expansion tank hose connections.

### 7.2.7.1) Water bleed hoses

The smaller of the two inlets on the coolant expansion bottle connects to the 5/16" bore hose that must connect to the small diameter connector at the rear RH side of the cylinder head, refer to Fig 19/26.

Route the 5/16" bore hose from the expansion bottle along the top radiator hose, water rail and under the plenum chamber around the back of the cylinder head. Cut piece of 5/16" hose to length, apply rubber lubricant to each open end and fit to the connections as described. Secure using hose clips. Secure the hose to the top radiator hose using cable ties refer to Fig 93.

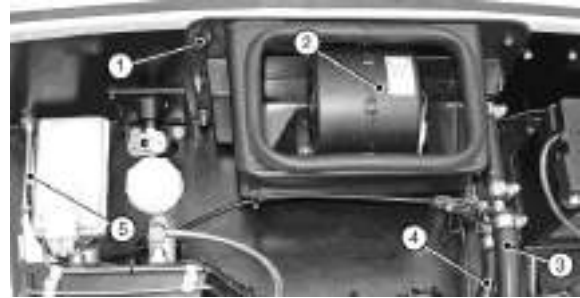
### 7.2.7.2) Heater and associated hoses

Remove and retain the four screws, nyloc nuts and washers and the two washer plates securing the diffuser panel to the heater. Position the diffuser panel on the inside surface of the scuttle with the legs pointing downwards and insert the four screws from the inside. Pass the heater harness through the large hole in the scuttle panel and locate the heater over the screws, secure with the washer plates, nyloc nuts, washers and two additional screws from the fastener pack, refer to Fig 84. Connect the heater harness connector heater to the matching plug, located under the dashboard.

### NOTE

*Cars not fitted with a heater are supplied with a blanking plate. Apply a small amount of silicon sealant around the edge of the plate to seal it.*

### Figure 84: Heater installation



- |                      |                         |
|----------------------|-------------------------|
| 1. Washer plate      | 4. Heater outlet hose   |
| 2. Heater            | 5. Heater control cable |
| 3. Heater inlet hose |                         |

### NOTE

*There are two long 'L' shape hose in the cooling kit. One with large right angle is heater hose and the other with smaller right angle is oil breather hose.*

Heater hose is supplied as three pre-formed pieces; one short straight, one long 'L' shape and one long 'J' shape

The short straight hose connects the 'T' piece to the engine inlet near to the bottom radiator hose.

The long 'L' shape hose must be cut in two to provide a short straight hose (to connect expansion bottle to 'T' piece) and

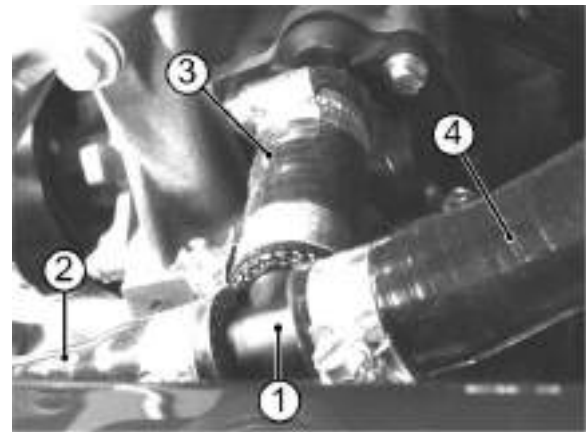
a long 'L' shape (to connect the 'T' piece to heater outlet). Measure the relevant distances carefully prior to cutting the hose.

The long 'J' hose connects the heater inlet to the water outlet at the rear of the cylinder head (near the large diameter 'L' shape hose connecting the water rail). This hose must be trimmed to length. Cut a 240 mm length of hose from the straight leg and cut this into two 120 mm pieces. Use the 120 mm pieces to connect the heater inlet and outlet to the heater valve, ref fig 87 and 93.

Before fitting any hoses remove the bungs from the ends of the heater pipes.

The larger of the two inlets on the coolant expansion bottle must connect to one end of the cross-bar of the large 'T' piece (near the alternator) that also connects to the smaller of the two connections at the front LH side of the engine block, refer to Fig 85. Measure and cut the long 'L' shaped hose as described previously. Apply rubber lubricant to the hose and fit to the coolant expansion bottle and 'T' piece securing with a hose clip at each end.

**Figure 85: Coolant hoses**



- |                             |   |
|-----------------------------|---|
| 1. 'T' piece                | 3. Small straight hose  |
| 2. Hose to expansion bottle | 4. Hose to heater outlet or rear of engine if heater isn't fitted |

Apply rubber lubricant and connect the short straight hose to the smaller of the two connections at the LH front of the engine block, connect this hose to the stem of the large 'T' piece. Secure using hose clips. Refer fig 85.

Use the cut length of hose (from the long 'L' hose) to connect the remaining leg of the 'T' piece to the heater valve inlet. Connect the other side of the heater valve upper/lower connection to the straight connectors on the heater using cut off hose of 120 mm length, trim the hose where necessary. Apply rubber lubricants where necessary and secure using hose clips. Ensure that the hose is routed to avoid chafing, use cable ties as necessary.

Trim to length and connect the long 'J' hose between the lower (inlet) connection of the heater valve and the outlet at the back of the cylinder head, insert the temp sender submarine into this pipe under the coil pack. Apply rubber lubricant where necessary and secure using hose clips. Ensure that the hose is routed to avoid chafing, use cable ties as necessary. Do not fully tighten the hose clips at the heater end at this point. Refer fig 86/87.

**Figure 86: Heater valve arrangement**



- |                      |                              |
|----------------------|------------------------------|
| 1. Hose to 'T' piece | 5. 'J' hose to cylinder head |
| 2. Heater outlet     | 6. Hose clip                 |
| 3. Heater inlet      |                              |
| 4. Heater valve      |                              |

**NOTE**

*On cars where no heater is fitted the relevant connections at the rear of the cylinder head and on the front LH side of the engine block must be joined by a suitable length of hose.*

**Figure 86: Temp sender submarine**



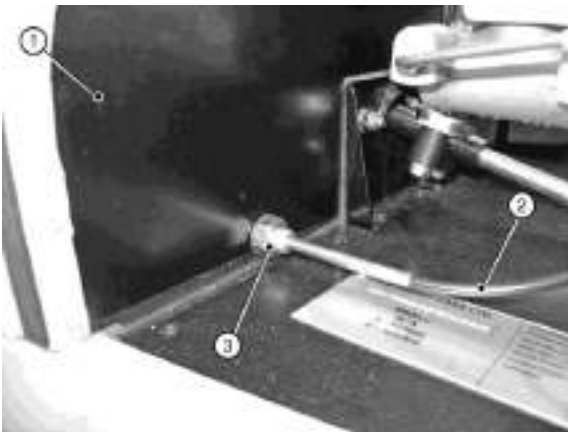
Remove and retain the locknut and washer from the heater control cable and pass it from inside the cockpit, through the hole in the front face of the scuttle, refer to Figures 88 and 89. Secure the cable in place using the locknut and washer provided.

**Figure 87: Heater control location**



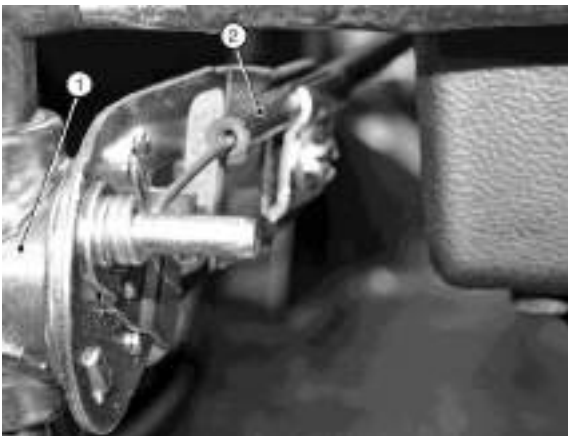


**Figure 88: Heater control cable**



1. Scuttle panel
2. Heater control cable
3. Locknut

**Figure 89: Heater control cable attachment**



1. Heater valve
2. Heater control cable

Connect the other end to the heater control valve by sliding the eyelet on the inner cable over the peg on the heater valve operating arm then slide the outer cable under the adjacent clamp and tighten the screw to secure in place, refer

to Figure 90. Ensure that the valve travels through its full range when operated from inside the car. This can be adjusted by slackening the clamp that locates the outer cable to the valve and sliding the cable one way or another.

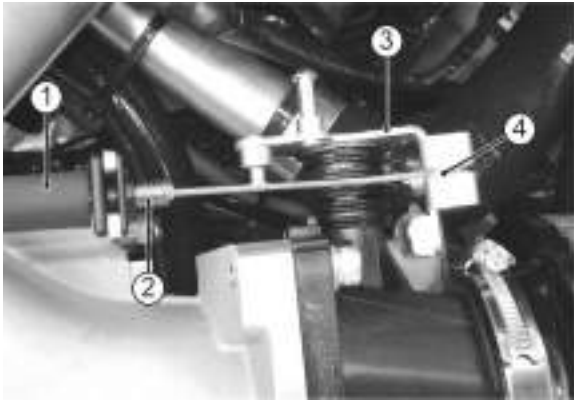
Fill the cooling system with a 50% antifreeze solution (refer to Owner's Handbook for Caterham recommended coolant). Add the coolant solution to the expansion bottle. Place paper or cloth on the scuttle in the area below the heater inlet/outlet hoses. Ensure that the heater valve is in the fully open position (control knob pulled towards the driver) and remove the heater inlet (top connector) hose which was previously left loose. Temporarily seal off the heater valve inlet and at the same time back fill the heater inlet hose with coolant solution. When the hose is full refit it to the heater inlet and secure with the hose clip. This procedure should minimise the amount of bleeding required once the engine is running for the first time.

#### *7.2.8) Throttle cable fitment*

Attach the throttle cable to the linkage on the throttle body by engaging the nipple in the throttle operating lever and then clipping its square shaped black plastic adjuster onto the adjacent bracket. This adjuster can be threaded up and down the

cable outer to adjust the throttle pedal position, refer to Figure 91.

**Figure 90: Throttle cable linkage**



1. Throttle cable
2. Throttle cable adjuster
3. Throttle body linkage
4. Throttle cable nipple

Route the other end of the cable around the front of the cam cover; refer to Fig 91 and through the 22 mm hole in the front of the pedal box and clip the plastic seat into place. The inner cable is fed into the slot on the top of the pedal with the portion of cable protruding past the cable termination located through the hole. The top of the pedal should be gently squeezed with a pair of pliers to capture the cable and prevent it escaping.

#### **NOTE**

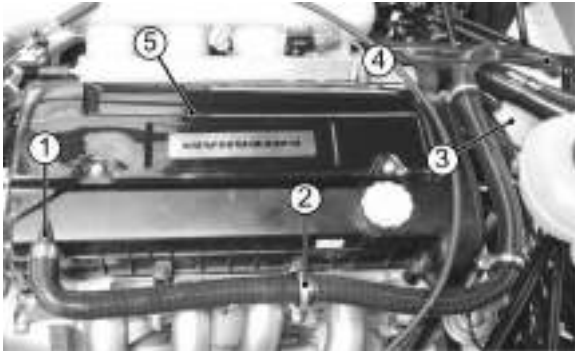
*In order to obtain a preferred pedal height and achieve adequate cable tension it may be necessary to bend the top of the pedal prior to locating the cable. This is*

*done by inserting a Phillips screwdriver into the top of the pedal, bracing the bottom of the pedal with a block of wood, and gently bending the top of the pedal so as to take up the slack in the cable. Finally use the adjusting mechanism at the throttle body end of the cable to remove any free play.*

#### **7.2.9) Breather pipe fitment**

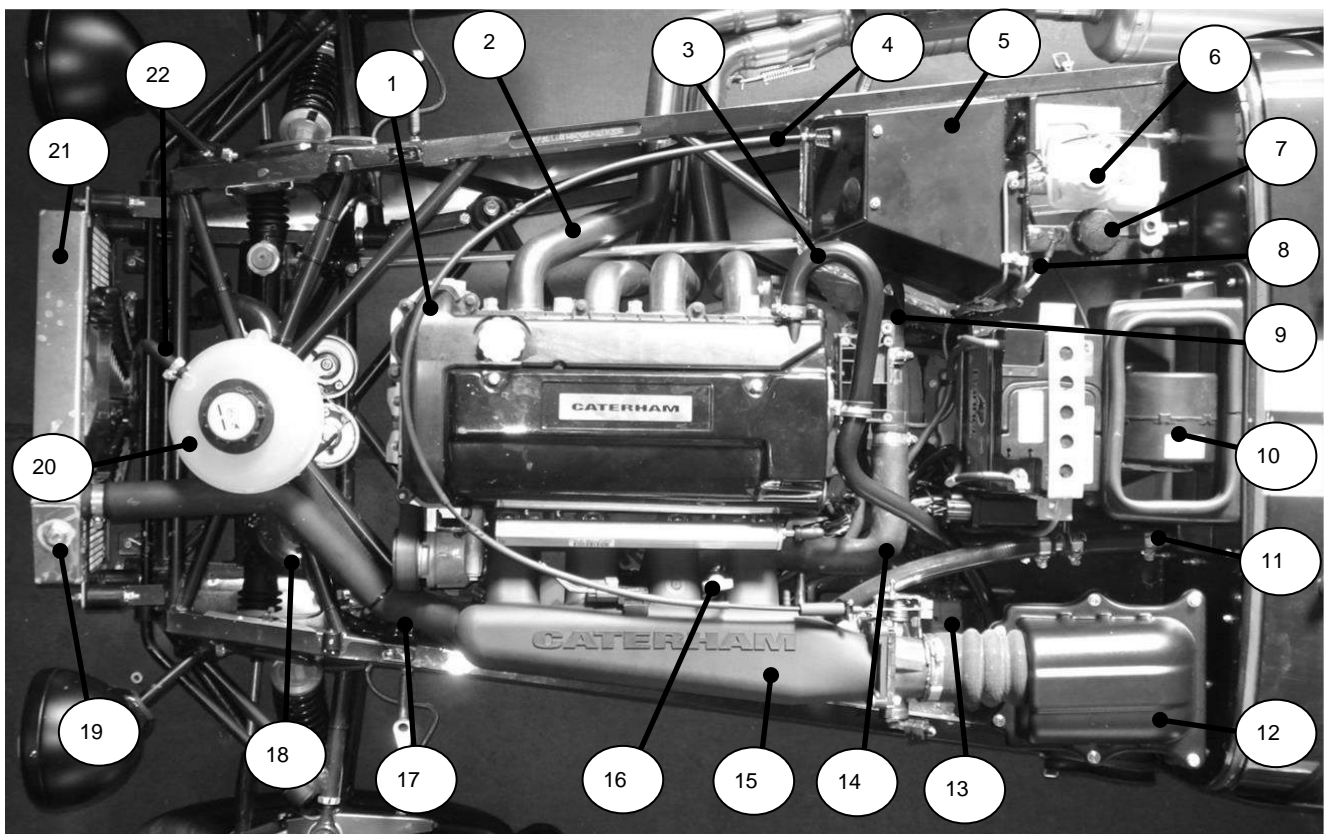
The long 'L' hose with smaller right angle is an oil Breather hose. Apply rubber lubricant and connect the right angle end of the hose to the top rear RH corner of the engine. Refer figure 92. Drill 20mm hole on the top of the breather bottle and fit the breather elbow refer to figure 93. Route the breather hose along the RH side of the engine to the front towards breather bottle using 'P' clips provided and fit to the breather elbow. Apply rubber lubricant where necessary. Ensure that the pipe is routed to avoid chafing, use cable ties as necessary.

**Figure 91: Breather pipe**



1. Oil breather hose
2. 'P' clip
3. Breather bottle
4. Breather elbow
5. Cam cover

**Figure 92: Duratec engine bay overview**



- |                           |                         |
|---------------------------|-------------------------|
| 1. Engine                 | 12. Air filter          |
| 2. Exhaust primary pipe   | 13. ECU                 |
| 3. Oil breather hose      | 14. 'L' water rail hose |
| 4. Throttle cable         | 15. Plenum chamber      |
| 5. Pedal box              | 16. Dip stick           |
| 6. Brake master cylinder  | 17. Top radiator hose   |
| 7. Clutch master cylinder | 18. Breather bottle     |
| 8. Clutch hose            | 19. Blanking plug       |
| 9. 'J' hose heater inlet  | 20. Expansion bottle    |
| 10. Heater                | 21. Radiator            |
| 11. Heater outlet         | 22. Water bleed hose    |

### 7.3) Duratec – Superlight R400

#### 7.3.1) Preparation

**Table 19: Special tools required for Superlight R400 engine**

Item	Description
Engine hoist and sling	SWL if 150 Kg (min)

##### 7.3.1.1) Screen wash/wipe

###### NOTE

*The bracket for the washer bottle must be fixed to the front of the passenger side foot box before the engine is installed.*

Remove the securing nut from the base of the washer jet (polythene bag marked 'miscellaneous') and pass the washer jet through the hole in the centre of the scuttle and secure with the plastic securing nut. Fit the clear plastic tubing to the washer jet. Dip the end of the clear plastic tubing in hot water to soften in order to make fitting easier.

Route the clear washer tubing along the wiring loom behind the dashboard and attach using cable ties, to prevent it falling down into view. Pass it down through the large grommet in the top of the transmission tunnel and along the engine bay diagonal tube until in line with the washer bottle. Trim the tube to length and attach to the washer motor.

Connect the washer motor to the wiring loom via the two pin plug adjacent to the washer bottle mounting. To ease fitment of the two pin plug the washer motor can be removed from the washer bottle, the two pin plug fitted and the washer motor reinserted into the washer bottle.

The windscreen wipers must not be fitted until the wiper motor has been run and allowed to park in order to prevent damage to the paintwork. Fit the wiper arms so that they are horizontal when parked. The wiper arms must move smoothly through their range of travel.

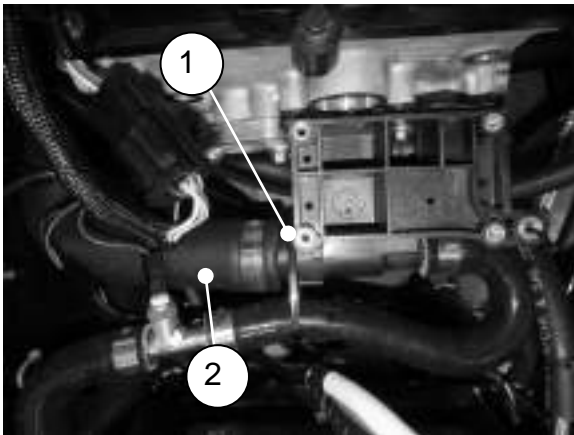
###### NOTE

*A small amount of water splashed on the windscreen will prevent the wiper blades from juddering during test and adjustment.*

##### 7.3.1.2) Engine preparation

The large diameter long shape 'L' hose should be fitted onto the plastic water outlet located on the rear of the cylinder head, refer to Figure94. Apply rubber lubricant to the long end of the hose and push over the outlet; rotate the hose until the short end sits along the LH side of the engine refer figure94. Secure using a hose clip.

**Figure 93: Water outlet and 'L' shape hose**



1. Engine connection
2. Long 'L' hose

Remove and retain the gearbox filler plug. Remove the plastic plug from the gearbox tailshaft housing. Removal of these plugs is not essential; however access is restricted within the confines of the transmission tunnel.

#### *7.3.1.3) Chassis preparation*

Protect the appearance of the engine bay chassis tubes and pedal box sides and edges by covering with card and/or masking tape.

Ensure that all wires and connector plugs are secured and will not snag or catch the engine/gearbox as it is lowered.

#### **NOTE**

*Before fitting engine mounting rubber blocks ensure that the large threaded (1/2" UNF) boss in the centre is clear of*

*rubber and that the bolt will thread in cleanly.*

Fit the engine mounting rubber block to the RH side of the engine bay. The two bolts (fastener pack 30P012A Item 3), plain washer (12) are passed downwards through the mounting, through the chassis and are secured with nyloc nuts (9) and plain washers (12). Do not tighten.

Fit the engine mounting rubber block to the LH side of the engine bay, locate the engine earth lead (a black lead approximately 300 mm long), pass bolt (2) and washer (12) downwards through the lead, through the front hole of the engine mounting block, through the chassis and secure with nyloc nut (9) and plain washer (12). Remove a little paint from the chassis/mounting to ensure that a good electrical contact is made. Pass bolt (3), plain washer (12) downwards through the rear hole of the engine mounting block, through the chassis and secure with nyloc (9) and plain washer (12). Do not tighten.

Locate the twin electric horns on the two studs near the rear edge of the steering rack platform. Before fitting the horns, loosen the 13 mm nut in the centre of each horn, this will allow rotation of the horns so that the electrical connections are closer together.

Drill an 8mm hole into the steering rack platform so that the horns can be bolted to the plate. The horns are fixed beneath the steering rack platform using a BMCH8x50 bolt dropped into the drilled hole with a spring washer under the head. A 32mm long aluminium spacer is then used to space the horns down, and the horns are attached to the bottom of the bolt with an M8 nyloc nut and a plain washer.

**Figure 94: Horn location**



**Figure 95: Horn location (top down)**



Tighten the 13 mm nut in the centre of each horn and connect the horns to the electrical harness by the purple and yellow wires and connectors located above the horns on the front upper cross member.

### 7.3.2) Installation of engine/gearbox into chassis

#### **Warnings**

- 1. Never work underneath a car without supporting it on axle stands or equivalent. Do not rely on a jack alone.**
- 2. Use appropriate eye protection whilst working under the car.**
- 3. For Duratec engines, Alternator and starter motor must be removed before engine installation.**

Using the lifting hoist and sling detailed in Table 19, attach the engine/gearbox using the lifting eyes provided on the engine, lower the engine/gearbox assembly into the engine bay at an angle of between 30-40° (with the engine higher than the gearbox). Insert the gearbox assembly into the transmission tunnel.

Continue to slide the engine/gearbox rearward until the holes in the gearbox mounting line up with the holes in the chassis cross member. If the differential and Propshaft have already been fitted, ensure that the Propshaft locates into the gearbox tailshaft housing.

Attach the LH engine mounting using the two M8 x 25 mm bolts (fastener pack 36G006A Item 4) and one M8 x 30 mm bolt (5), do not fully tighten the bolts.

Attach the RH engine mounting using the two M8 x 35 mm bolts (6) and one M10 x 40 mm bolt (2). Do not finally tighten the engine mounting retaining bolts until advised later in this section.

Lower the engine onto the rubber engine mountings and pass the bolts (fastener pack 30P012A Item 1) down through the tube on the outer end of the engine mounting brackets. Screw the bolts loosely into the threaded bush in the centre of the rubber engine mounting. It is recommended that the engine is not removed from the hoist until all the bolts have been tightened (detailed later in this section).

Adjust the gearbox on its slotted mountings to achieve equal clearance within the transmission tunnel. This must be checked carefully as clearances are tight and poor alignment can cause the gearbox to contact the chassis under cornering.

Bolt the gearbox mounting rubber to the chassis using bolts (fastener pack 30P012A Item 4) passed down through the outer metal part of the rubber mounting and then through the elongated holes in the chassis. Secure with a plain washer (12) and nyloc nut (9) on each bolt and tighten to 20 Nm.

Finally tighten the fixings detailed in Table 20.

**Table 20: Torque figures for Duratec Superlight R400 engine**

Fixing	Torque
Engine mounting to block	34Nm
Engine mounting to mounting rubbers	41Nm
Engine mounting rubbers to chassis	20Nm
Gearbox mounting rubber to chassis	20Nm

**NOTES**

- 1. It is now safe to remove the engine hoist.*
- 2. Wiring – Every effort is made to clearly explain and identify all the electrical connections as you go through this section; however the loom fitted to your car may have additional wires and connectors that are not required on your vehicle. To help clarify this, a wiring diagram can be found in the electrical system.*

Fit the gear lever to the top of gearbox tailshaft housing and secure with three setscrews (7). No washers are required; tighten to a torque of 20 Nm.



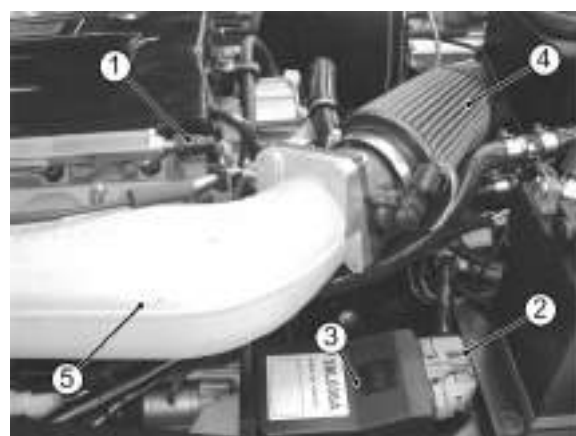
Fit the reverse light switch (polythene bag) into the side of the gearbox. This can be accessed via the hole in the RH side of the transmission tunnel. The switch should be inserted finger tight and then tightened a further quarter of a turn using a suitable sized spanner. Connect the wiring loom to the reverse light switch. From the cockpit, insert the large grommet (polythene bag) to cover the access hole in the transmission tunnel.

### 7.3.3) Electrical connections

The engine wiring loom is already attached to the engine and some ancillaries, however it is necessary to link the engine wiring loom to the remaining ancillaries and the vehicle wiring loom. All the plastic connecting plugs are matched pairs so it is not possible to connect them incorrectly.

Attach the grey, multi-pin plug to the respective socket on the Engine Control Unit (ECU), which is located on the passenger side heater tray, forward of the battery. Make the connection and ensure that the red retaining clip is pushed fully home, refer to Figure97.

**Figure 96: ECU**



- |                         |                   |
|-------------------------|-------------------|
| 1. Fuel pipe connection | 3. ECU            |
| 2. Multi-pin plug       | 4. Air filter     |
|                         | 5. Plenum chamber |

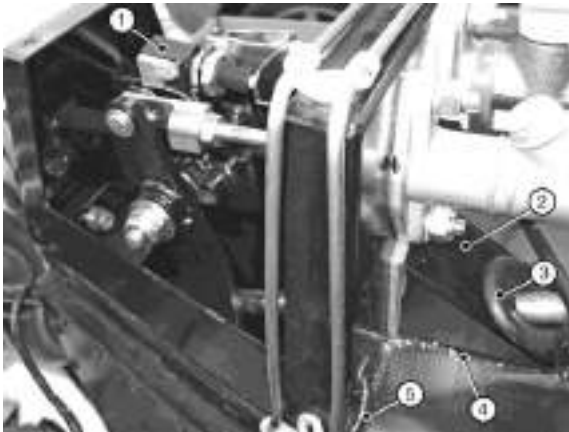
Connect the white/red/black wire plug from the oil pressure sender on the LH side of the engine block to the plug on the engine loom and route with cable ties. *(May have already been connected).*

The black wire with ring terminals in the engine loom is earth connections. Attach to a suitable earth point on the bulkhead.

The green, green/purple pair (with grommet) in the engine loom is for the brake light switch. The brake light switch is inside the drivers pedal box and the harness may be connected during installation of the steering column. Pass the brake light switch harness through the hole in the rear of the pedal box, refer to Figure 98 and push the two female connectors onto the male connectors of the brake light switch (orientation is not

important). Fit the grommet into the hole and ensure that the harness will not foul the steering column or pedals.

**Figure 97: Brake light switch harness**



- |                       |                               |
|-----------------------|-------------------------------|
| 1. Brake light switch | 4. Sealant                    |
| 2. Cheese wedge       | 5. Brake light switch harness |
| 3. Grommet            |                               |

The longest wire from the engine loom (terminating in a 4-pin plug) is the connection for the exhaust mounted lambda probe. This cannot be connected until the exhaust primary pipes and collector/catalyst is fitted.

Remove the outermost Bell housing securing bolt and spring washer. Pass the Bell housing mounting bolt and attached spring washer through the black battery earth lead and secure to the Bell-housing. Tighten to 34 Nm.

Connect the red lead from the starter motor to the battery.

**NOTE**

*In case of battery master switch, connect red leads from master switch to battery and starter motor as marked.*

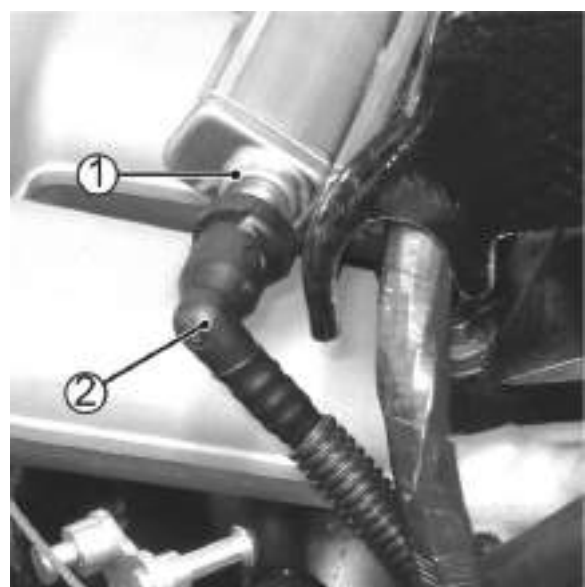
Connect the brown lead from the alternator to the starter.

Connect the brown/red wire from the chassis loom to the starter solenoid.

**7.3.4) Fuel system**

The black, corrugated plastic, high pressure fuel pipe from the fuel pump emerges from the transmission tunnel and is a push-fit on the connection at the rear of the fuel rail, refer to Figure 99. Note that there is no fuel return pipe with this system.

**Figure 98: Fuel pipe connection**



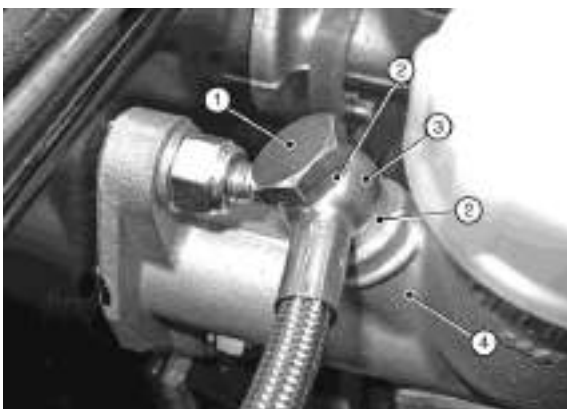
1. Fuel rail connection
2. Fuel pipe (from pump)

Once fitted the pipe cannot be removed without a special tool. Ensure that the pipe is kink free and routed away from possible snags or chafe points. Push the connection on the pipe firmly onto the elbow and check that it is securely attached. Secure the pipe with cable ties if necessary.

### 7.3.5) Clutch hydraulic hose

The clutch hydraulic hose is already connected to the clutch mechanism. Fit a copper washer to the banjo bolt and pass the banjo bolt through the union at the end of the hose, refer to Figure 100 (banjo bolt and the washers can be found in a bag attached to clutch hose) . Fit the second copper washer to the banjo bolt and screw the banjo bolt into the clutch master cylinder outlet port (remove the port plug). Do not fully tighten the banjo bolt.

**Figure 99: Clutch master cylinder hose union**



- |                   |                           |
|-------------------|---------------------------|
| 1. Banjo bolt     | 3. Hose union             |
| 2. Copper washers | 4. Clutch master cylinder |

Route the hose down the side of the pedal box, over the wiring loom (under the heater hose if fitted) and across the top of the bell-housing, Refer to Figure 101. Secure the hose with cable ties if necessary, to prevent chafing and tighten the banjo bolt (the clutch system is filled and bled during start-up/final checks).

**Figure 100: Clutch hydraulic hose**

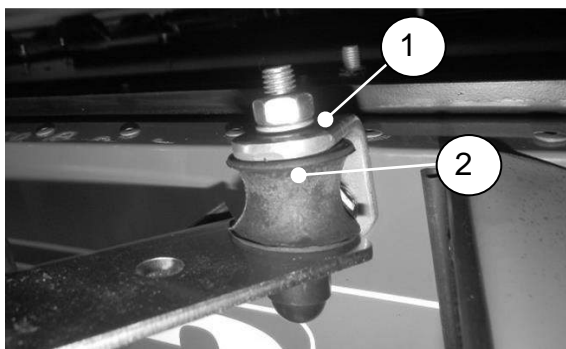


### 7.3.6) Exhaust system

The standard exhaust system consists of four primary pipes, a collector assembly which also incorporates the catalytic converter and a one piece silencer and tail pipe.

Bolt the exhaust mounting bracket (polythene bag marked 'exhaust') to the RH side of the car forward of the rear wheel, using setscrew (fastener pack 30X020A Item 1) and spring washers (3), refer to Fig 102. Secure the bobbin to the angle bracket with a nut (2) and spring washer (3).

**Figure 101: Exhaust mounting**



1. Angle bracket
2. Bobbin

Remove the exhaust gasket and associated fasteners from the RH side of the cylinder head, remove any masking tape protecting the exhaust ports and clean off any adhesive residue.

The exhaust primary pipes are marked with their part numbers:

Series 3.

CSP903 is for # 1 (front) cylinder

CSP904 is for # 2 cylinder.

CSP905 is for # 3 cylinder.

CSP906 is for # 4 (rear) cylinder

Protect the area around the square aperture in the side panel with masking tape and card, place the exhaust gasket over the remaining studs and fit the primary pipes in the following sequence:

1. Pass the flanged end of # 4 pipe inwards, attach the flange loosely to the cylinder head and ensure that the pipe sits in the top LH corner of the aperture (viewed from outside).
2. Pass the flanged end of # 3 pipe inwards, attach the flange loosely to the cylinder head and ensure that the pipe sits in the bottom LH corner of the aperture.
3. Pass the plain end of # 2 pipe outwards, attach the flange loosely to the cylinder head and ensure that the pipe sits in the bottom RH corner of the aperture.
4. Pass the plain end of # 1 pipe outwards, attach the flange loosely to the cylinder head and ensure that the pipe sits in the top RH corner of the aperture.

**NOTE**

*For SV use the same procedure to fit the primary, the sequence to fit the primary is 4,3,2,1.*

*58X0011A is for #1(front) cylinder.*

*58X0012A is for #2 cylinder.*

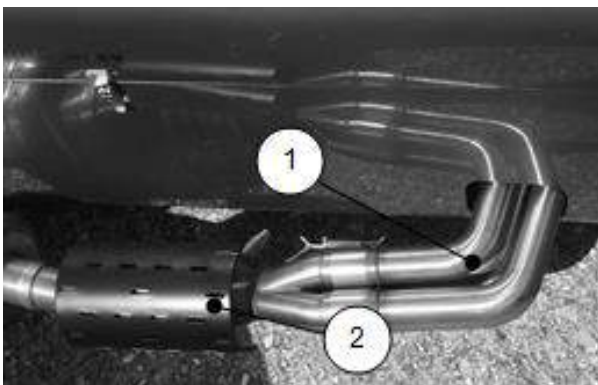
58X0013A is for #3 cylinder

58X0014A is for #4 (rear) cylinder

When the primary pipes are in place, fit the remaining fasteners but do not tighten them.

Install the collector/catalyst over the assembled primary pipes with the threaded hole for the lambda probe faces towards the side panel. Secure the collector to the primary pipes with the two springs, refer to Figure 103. Support the weight of the collector such that the primary pipes are not in contact with the sides of the aperture and tighten the primary pipe/cylinder head fasteners to 34 Nm.

**Figure 102: Primary pipes and collector/catalyst**



Fit the Lambda probe into the threaded hole in the collector/catalyst and connect the probe plug to the corresponding socket from the engine wiring loom. Secure the Lambda probe connection and wiring to the chassis ensuring that it

cannot contact the hot exhaust or any moving part, refer to Figure 104.

**NOTE**

*The lambda probe wiring passes under the side of the car below the lower chassis tube, it must not be routed through the primary pipe aperture in the side panel.*

**Figure 103: Lambda probe connection**



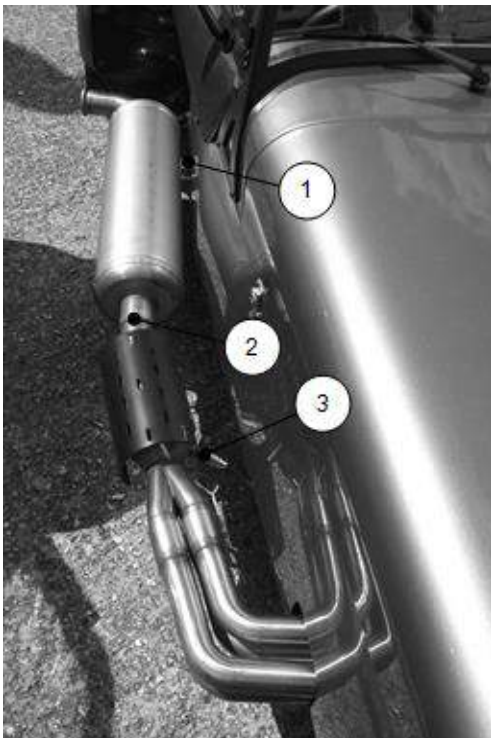
Undo the large worm drive clips and feed them through the channels on the inside of the silencer and collector/catalyst guard. Fit the silencer guard to the silencer body with the channels offset towards the rear of the silencer and tighten the clips, refer to Figure 105. Ensure that the clip drives are not at the bottom of the silencer where they could contact the road. Attach the collector/catalyst guard in the same manner.

## NOTES

1. For a neater appearance position the clips with the drive screw towards the ground so that the clip 'tail' is out of sight beneath the exhaust.

2. To reduce the risk of damage it is advisable to fit the silencer after the RH rear wing has been attached.

**Figure 104: Exhaust arrangement**



- 1. Silencer bracket
- 2. Band clamp
- 3. Lambda probe

Loosely fit the single band clamp to the front of the silencer and position the front of the silencer over the collector/catalyst outlet pipe. Locate the bracket at the rear of the silencer over the bobbin on the

silencer mounting bracket and secure with a nut and spring washer. Tighten the nut and band clamp. It may be necessary to reposition the guards slightly.

### 7.3.7) Cooling system and dry sump system

The oil tank should be fixed to the chassis rail intersection point with an M8x20 cap-head bolt using an M8 spring washer and an M8 plain washer. Position the breather bottle mounting bracket on the chassis as shown in the picture. Align the RHS hole on the bracket with the RHS rivet on the chassis and mark both hole. Drill the marked hole with 5/32" drill and fit the bracket in place using 5/32 rivets refer to Figure 106. Push fit the breather bottle on to the mounting bracket.

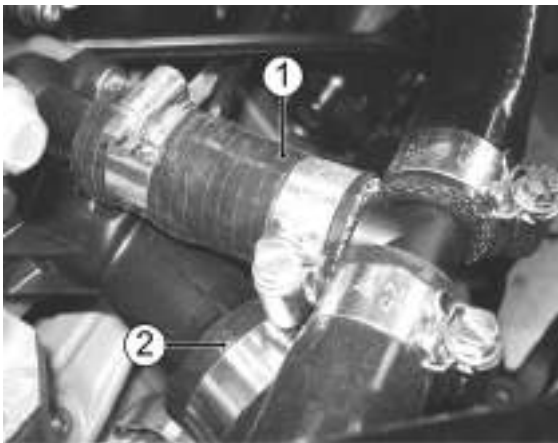
**Figure 105: Fitment of dry sump oil tank**



Two P-clips should then be placed around the bottom chassis rails and secured to the bottom of the oil tank with two M6x20 bolts and two M6 nyloc nuts using 1/4" plain washers under the bolt heads and

nuts. Position a hose clip on the flexible bottom radiator hose, apply rubber lubricant and fit the hose to the larger of the two outlets on the LH side of the engine block, Refer to Figure 107. The hose passes forwards along the LH side of the engine bay before turning to pass along the top of the steering rack and turns again to meet the radiator connection. Do not tighten the clip.

**Figure 106: Bottom radiator hose engine connection (viewed from top)**



1. Small straight hose to 'T' piece
2. Bottom radiator hose

Fit the four rubber radiator mountings to the front of the chassis and secure using nuts, plain washer and spring washers provided in the cooling pack.

Secure the fan to the inner cowl, ensuring that the fan electrical connector is located on the RH side, using four M6 screws and washers provided.

Secure the six rubber flaps (from polybag 'cooling') to the engine bay side of the inner cowl using the 5/32" rivets provided (two rivets per flap), refer to Figure 108. Fit the fan/cowl assembly to the rubber radiator mountings, ensuring that the cooling fan is closest to the engine bay, refer to Figure 108.

#### NOTES

1. The inner cowl must be fitted before the front anti-roll bar and the anti-roll bar must be fitted before the radiator.
2. The four screws in the integral radiator mounting brackets are not required; they should be removed and discarded.

**Figure 107: Radiator cowl flaps**



#### **Warning**

**Do not over tighten the blanking plug.**

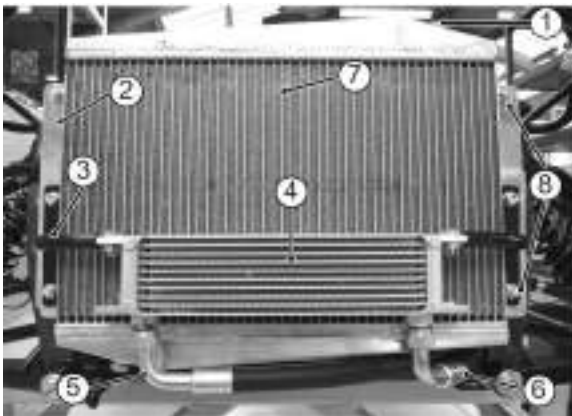
The blanking plug is already fitted to the radiator, make sure it is tight. Fit the radiator onto the rubber radiator mountings ensuring that the hose

connections face towards the engine.  
Secure the upper mounting using nuts, plain washers and spring washers.

Align the oil cooler bracket bottom mounting hole to the bottom rubber radiator mounting and the Secure using nuts, plain washers and spring washers (do not tighten) refer the Figure 109.

Align the oil cooler bracket against radiator bracket and mark the other hole on the oil cooler bracket. Drill the 8 mm hole, refer the Figure109. Fit the oil cooler bracket using fixings provided in z pack.

**Figure 108: Radiator arrangement**

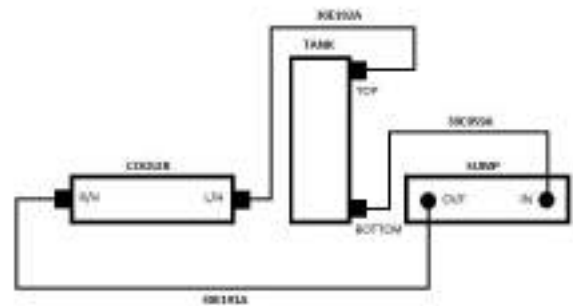


- |                       |                    |
|-----------------------|--------------------|
| 1. Blanking plug      | 5. Oil cooler hose |
| 2. Radiator bracket   | 6. Oil cooler hose |
| 3. Oil cooler bracket | 7. Radiator        |
| 4. Oil cooler         | 8. Radiator mount  |

Fit the oil cooler to the bracket using fixings provided in z pack refer figure. 110.

The oil cooler and dry sump hoses need to be fitted as shown in the schematic.

**Figure 109: Routing of the oil pipes**



- The bottom of the oil tank connects to the rear of the sump
- The RHS of the oil cooler connects to the front of the sump
- The LHS of the oil cooler connects to the top of the oil tank. The hose should run along the bottom of the radiator

The radiator mounting arrangement on SV models differs considerably from that shown. SV kits include LH and RH radiator mounting plates, refer to Figure 111; these plates must be fixed to the body before attaching the rubber mountings and the radiator/inner cowl.



**Figure 110: SV radiator arrangement**



Position hose clips on the forward ends of the flexible top and bottom radiator hoses; apply rubber lubricant and fit the hoses over the connections on the radiator. Tighten the clips at both ends of both hoses.

**NOTE**

*The flexible radiator hoses may need to be trimmed to length.*

Locate the two-pin plug containing the black/green and black wires situated on the engine loom. Route the plug to the front and connect the two-pin plug to the cooling fan electrical connector. Secure the cable to the chassis members using cable ties.

**7.3.7.1) Relocation of expansion bottle bracket**

A measurement of 135mm should be marked for the first riveting point, from the centre of the cross-member intersection to along the forward-most tube (RHS of the engine bay).

Use the position of this measurement to locate the other rivet positions for the expansion tank plate. The rivets used should be 5/32". The orientation of the expansion tank is dictated by the position of the expansion tank bracket. This will position the expansion tank so that the bottom outlet will face downward between the two chassis rails.

**7.3.7.2) Water bleed hoses**

The smaller of the two inlets on the coolant expansion bottle connects to the 5/16" bore hose that must connect to the small diameter connector at the rear RH side of the cylinder head, refer to Figure 86.

Route the 5/16" bore hose from the expansion bottle along the top radiator hose, water rail and under the plenum chamber around the back of the cylinder head. Cut piece of 5/16" hose to length, apply rubber lubricant to each open end and fit to the connections as described. Secure using hose clips. Secure the hose

to the top radiator hose using cable ties refer to Figure 121.

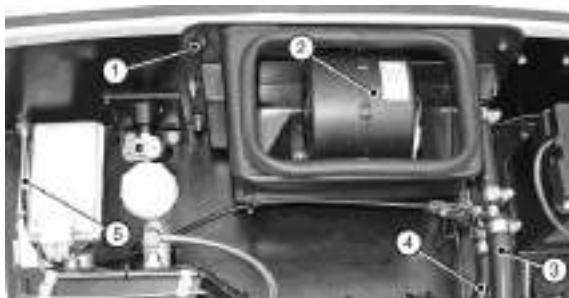
### 7.3.7.3) Heater and associated hoses

Remove and retain the four screws, nyloc nuts and washers and the two washer plates securing the diffuser panel to the heater. Position the diffuser panel on the inside surface of the scuttle and insert the four screws from the inside. Pass the heater harness through the large hole in the scuttle panel and locate the heater over the screws, secure with the washer plates, nyloc nuts, washers and two additional screws from the fastener pack, refer to Figure 112. Connect the heater harness connector heater to the matching plug, located under the dashboard.

#### NOTE

*Cars not fitted with a heater will be supplied with a blanking plate. Apply a small amount of silicon sealant around the edge of the plate to seal it.*

**Figure 111: Heater installation**



1. Washer plate
2. Heater
3. Heater inlet hose
4. Heater outlet hose
5. Heater control cable

#### NOTE

*There are two long 'L' shape hose in the cooling kit. One with large right angle is heater hose and the other with smaller right angle is oil breather hose.*

Heater hose is supplied as three pre-formed pieces; one short straight, one long 'L' shape and one long 'J' shape:

The short straight hose connects the 'T' piece to the engine inlet near to the bottom radiator hose.

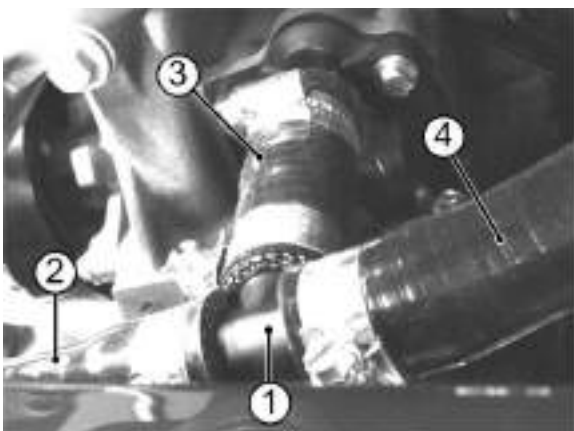
The long 'L' shape hose must be cut in two to provide a short straight hose (to connect expansion bottle to 'T' piece) and a long 'L' shape (to connect the 'T' piece to heater outlet). Measure the relevant distances carefully before cutting the hose.

The long 'J' hose connects the heater inlet to the water outlet at the rear of the cylinder head (near the large diameter 'L' shape hose connecting the water rail). This hose must be trimmed to length. Cut a 240 mm length of hose from the straight leg and cut this into two 120 mm pieces. Use the 120 mm pieces to connect the

heater inlet and outlet to the heater valve, refer to figure 115.

The larger of the two inlets on the coolant expansion bottle must connect to one end of the cross-bar of the large 'T' piece (near the alternator) that also connects to the smaller of the two connections at the front LH side of the engine block, refer to Figure 113. Measure and cut the long 'L' shaped hose as described previously. Apply rubber lubricant to the hose and fit to the coolant expansion bottle and 'T' piece securing with a hose clip at each end.

**Figure 112: Coolant hoses**



- |                             |   |
|-----------------------------|---|
| 1. 'T' piece                | 3. Small straight hose                    |
| 2. Hose to expansion bottle | 4. Hose to heater outlet expansion bottle |

Apply rubber lubricant and connect the short straight hose to the smaller of the two connections at the LH front of the engine block, connect this hose to the

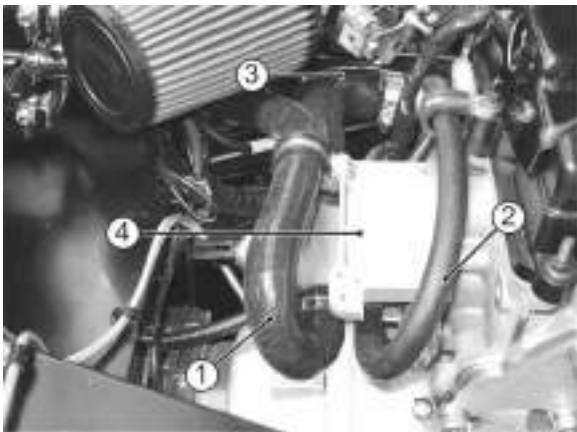
stem of the large 'T' piece. Secure using hose clips. Refer figure 114.

Use the cut length of hose (from the long 'L' hose) to connect the remaining leg of the 'T' piece to the heater valve inlet.

Connect the other side of the heater valve upper/lower connection to the straight connectors on the heater using cut off hose of 120 mm length as mentioned previously, trim the hose where necessary. Apply rubber lubricants where necessary and secure using hose clips. Ensure that the hose is routed to avoid chafing, use cable ties as necessary.

Trim to length and connect the long 'J' hose between the lower (inlet) connection of the heater valve and the outlet at the back of the cylinder head. Apply rubber lubricant where necessary and secure using hose clips. Ensure that the hose is routed to avoid chafing, use cable ties as necessary. Do not fully tighten the hose clips at the heater end at this point. Refer figure 114/115.

**Figure 113: Water outlets cylinder head**



1. 'J' hose
2. Hose to expansion tank
3. Large bore 'L' hose to water rail
4. Water outlets on engine cylinder head

**Figure 114: Heater valve arrangement**



- |                      |                              |
|----------------------|------------------------------|
| 1. Hose to 'T' piece | 5. 'J' hose to cylinder head |
| 2. Heater outlet     | 6. Hose clip                 |
| 3. Heater inlet      |                              |
| 4. Heater valve      |                              |

*On cars where no heater is fitted the relevant connections at the rear of the cylinder head and on the front LH side of the engine block must be joined by a suitable length of hose.*

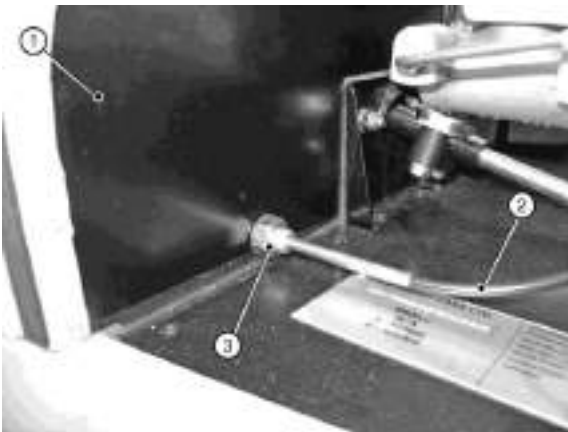
Remove and retain the locknut and washer from the heater control cable and pass it from inside the cockpit, through the hole in the front face of the scuttle, refer to Figures 116 and 117. Secure the cable in place using the locknut and washer provided.

**Figure 115: Heater control location**



**NOTE**

**Figure 116: Heater control cable**



1. Scuttle panel
2. Heater control cable
3. Locknut

**Figure 117: Heater control cable attachment**



1. Heater valve
2. Heater control cable

Connect the other end to the heater control valve by sliding the eyelet on the inner cable over the peg on the heater valve operating arm then slide the outer cable under the adjacent clamp and tighten the screw to secure in place, refer to Figure 118. Ensure that the valve

travels through its full range when operated from inside the car. This can be adjusted by slackening the clamp that locates the outer cable to the valve and sliding the cable one way or another.

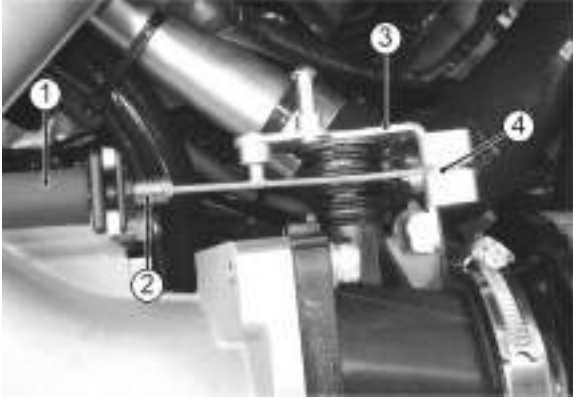
Fill the cooling system with a 50% antifreeze solution (refer to Owner's Handbook for Caterham recommended coolant). Add the coolant solution to the expansion bottle. Place paper or cloth on the scuttle in the area below the heater inlet/outlet hoses. Ensure that the heater valve is in the fully open position (control knob pulled towards the driver) and remove the heater inlet (top connector) hose which was previously left loose. Temporarily seal off the heater valve inlet and at the same time back fill the heater inlet hose with coolant solution. When the hose is full refit it to the heater inlet and secure with the hose clip. This procedure should minimise the amount of bleeding required once the engine is running for the first time.

#### *7.3.8) Throttle cable fitment*

Attach the throttle cable to the linkage on the throttle body by engaging the nipple in the throttle operating lever and then clipping its square shaped black plastic adjuster onto the adjacent bracket. This adjuster can be threaded up and down the

cable outer to adjust the throttle pedal position, refer to Figure 119.

**Figure 118: Throttle cable linkage**



1. Throttle cable
2. Throttle cable adjuster
3. Throttle body linkage
4. Throttle cable nipple

Route the other end of the cable around the front of the cam cover; refer to Figure 119 and through the 22 mm hole in the front of the pedal box and clip the plastic seat into place. The inner cable is fed into the slot on the top of the pedal with the portion of cable protruding past the cable termination located through the hole. The top of the pedal should be gently squeezed with a pair of pliers to capture the cable and prevent it escaping.

#### **NOTE**

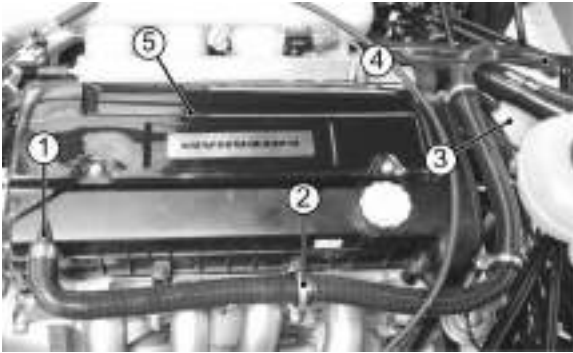
*In order to obtain a preferred pedal height and achieve adequate cable tension it may be necessary to bend the top of the pedal prior to locating the cable. This is*

*done by inserting a Phillips screwdriver into the top of the pedal, bracing the bottom of the pedal with a block of wood, and gently bending the top of the pedal so as to take up the slack in the cable. Finally use the adjusting mechanism at the throttle body end of the cable to remove any free play.*

#### **7.3.9) Breather pipe fitment**

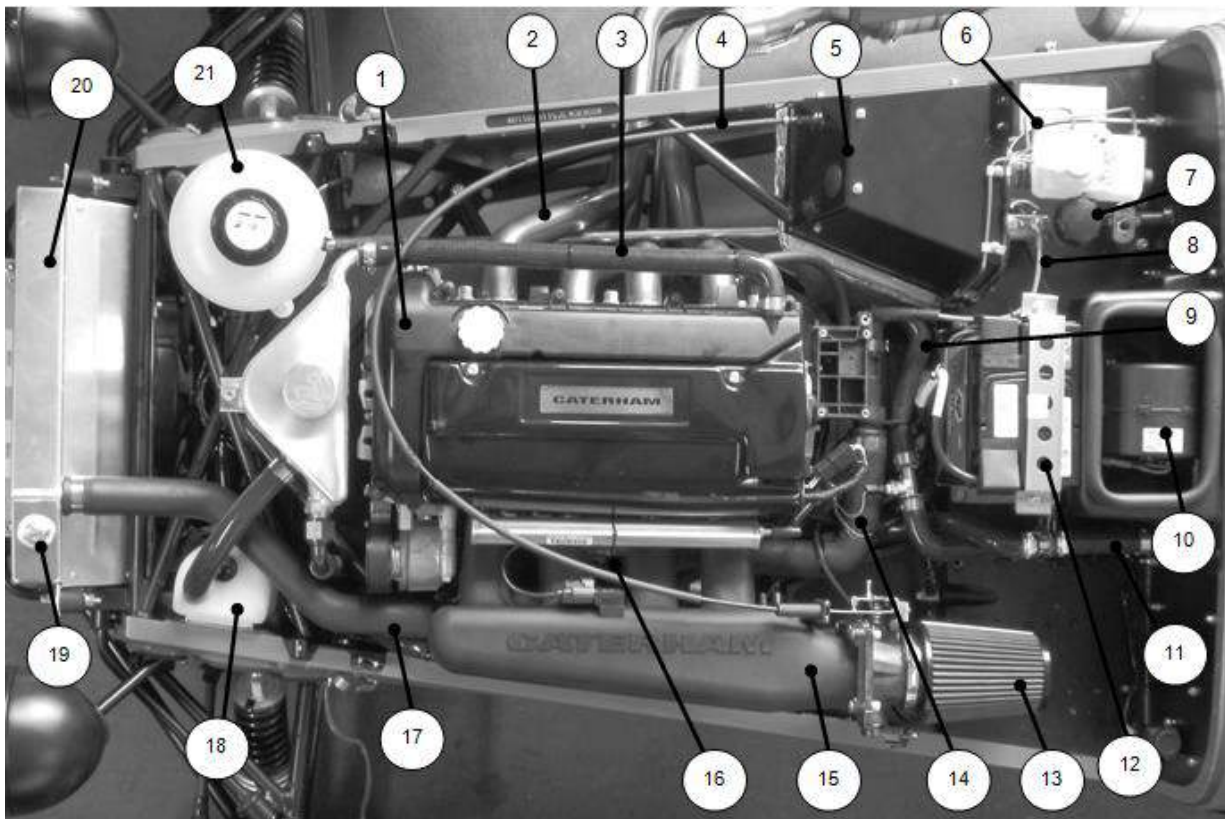
The long 'L' hose with smaller right angle is an oil Breather hose. Apply rubber lubricant and connect the right angle end of the hose to the top rear RH corner of the engine. Refer figure 120. Drill 20mm hole on the top of the breather bottle and fit the breather elbow refer to figure 121. Route the breather hose along the RH side of the engine to the front towards breather bottle using 'P' clips provided and fit to the breather elbow. Apply rubber lubricant where necessary. Ensure that the pipe is routed to avoid chafing, use cable ties as necessary.

**Figure 119: Breather pipe**



1. Oil breather hose
2. 'P' clip
3. Breather bottle
4. Breather elbow
5. Cam cover

**Figure 120: Duratec engine bay overview**



- |                          |                         |                      |
|--------------------------|-------------------------|----------------------|
| 1 Engine                 | 8 Clutch hose           | 15 Plenum chamber    |
| 2 Exhaust primary pipe   | 9 'J' hose heater inlet | 16 Dipstick          |
| 3 Oil breather pipe      | 10 Heater               | 17 Top radiator hose |
| 4 Throttle cable         | 11 Heater outlet        | 18 Breather bottle   |
| 5 Pedal box              | 12 Battery              | 19 Blanking plug     |
| 6 Brake master cylinder  | 13 Air filter           | 20 Radiator          |
| 7 Clutch master cylinder | 14 'L' water rail hose  | 21 Expansion bottle  |



## 8.0) Preparation and installation of the differential

The Caterham differential is attached to the chassis via a carrier that comes with the differential. The differential until is supplied with drive flanges – these can be discarded at a later stage in the installation process.

**Figure 121: Caterham differential installation (CAD image)**



### NOTE

*Install the handbrake mechanism and cables (see rear suspension section) before installing the differential and propshaft. The handbrake cables are connected to the rear brake callipers and are adjusted later.*

### 8.1) Procedure

1. Install the Propshaft into the chassis tunnel.

2. Check oil level inside the differential (14mm allen key) – if the unit is a non-LSD variant it will have oil in it.

### NOTE

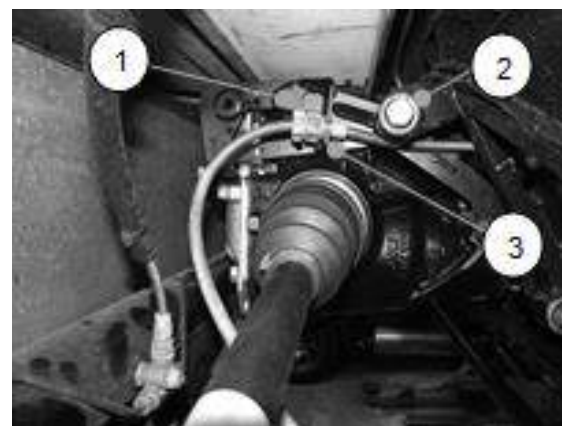
*The oil should still be checked and topped up if necessary with Caterham Differential Oil. If the unit is a LSD then please use the additive supplied.*

3. Install the handbrake cable down the tunnel (you may attach your clevis/clevis wheel to the handbrake at this stage). The white adjuster is located on the RHS, the chassis mounting for the yellow top hat on the cable is utilised on the LHS.

### NOTE

*If building an SV vehicle there is a longer clevis used on the handbrake (part number 50P014A).*

**Figure 122: Handbrake cable location**



1. Cable bracket
2. ½ x 11" bolt with schnorr washer (25)
3. Cable adjuster on RHS of vehicle

Use a jack to lift the differential up from under the vehicle. This may be easier with additional help. Hang the differential from the top mount with a thin/long screwdriver or tube/rod.

### **Warnings**

- 1. Never work underneath a car without supporting it on axle stands or equivalent. Do not rely on a jack alone.**
- 2. Use appropriate eye protection whilst working under the car.**

Attach the front end of the differential at the lower mounts; use the M12x55 capheads from the Z-Pack 30Z1067A (copper slip the shank). Take care to use M12 Schnorr washers underneath the head of the bolt. Attach the bolts loosely as you will need to centralise the differential in the next stage.

**Figure 123: Differential installation and LHS**



1. 1/2" nyloc nut with schnorr washer
2. Cable tie and handbrake cable
3. M12 x 55 with schnorr washer

Measure from either side of the differential carrier to the outboard side of the chassis (outboard of rear ARB mount – 1" BOX) to centralise. During this process there will be a need to pull the bottom bolts out and use shim washers (item 21 in pack 30Z1067A) inserted in between the metalastic bush and carrier as necessary.

You may now use the 1/2 x 11" top bolt (schnorr washer under the head). It is optional to grind a chamfer on the end of the bolt (threaded part 45 degrees x 1/2") as this makes it easier to slide and locate the top bolt. Ensure there is plenty of copper slip used on the bolt. You will also need to space the upper bolt between the carrier and the metalastic with shim washers. Use a 1/2" nyloc nut and schnorr washer to fasten the bolt.

Torque the top and bottom bolts to 60Nm.

The driveshaft flanges can now be removed into the differential. This is done by using a bar and levering them out of the main case.

The driveshafts can now be inserted into the differential and the suspension fitted.

Please ensure that the handbrake cable on the LHS does not sag down to the driveshaft. Utilise the holes on the side of the diff carrier and cable tie in place.

Attach the Propshaft to the differential pinion drive flange with 4 of M10x20 supplied in the Z-Pack and torque to 60Nm.

*NOTE*

*For checking purposes the torque settings of the carrier bracket to differential fasteners are as follows:*

*x2 M10 plain on rear – 47Nm*

*x2 M12 caphead on either side – 81Nm*

## 9.0) Rear suspension

The following section covers the rear suspension assembly of your Caterham.

### 9.1) General

The special tools identified in Table 10 will be required to tighten the rear hub nuts.

**Table 21: Special tools required for rear suspension**

Item	Description
Socket	41mm
Torque wrench	274Nm

Copper grease should be applied to all fixings prior to assembly (excluding brake pipe nuts and items secured with Loctite).

### 9.2) Preparation

It is recommended that the lower chassis tubes that will be under the De Dion tube are protected. Several layers of masking tape or a thin card taped to the tubes is sufficient.

### 9.3) Fitting of rear brake pipes

Place the De Dion tube on the work bench with the outer flange facing forward and the buttress facing downwards.

Fit the aluminium De Dion ears and brake calliper to the De Dion tube, refer to assembly of De Dion tube. Do not use lock washers or Loctite at this stage as the ears and brake callipers are

temporarily fitted to ensure correct alignment and routing of the brake pipe.

#### NOTE

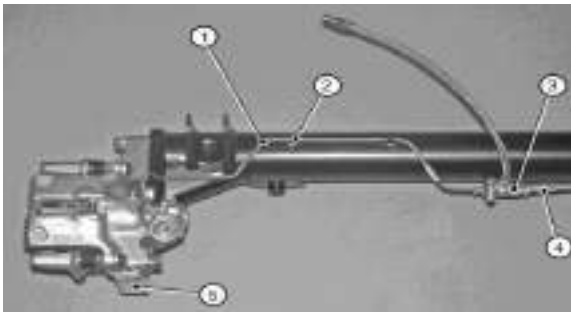
*Please check section options section for Brake calliper sub assembly.*

#### **Warning**

**Both imperial and metric threads are used on the de Dion brake pipes. The threads on the three way union are imperial whilst those on the brake callipers are metric. To aid recognition a small notch is machined into the hexagon of the metric unions on the pipes.**

With the fixing boss offset towards the RH side of the tube fit the three way union (polythene bag marked 'rear axle') to the threaded stud situated towards the RH end of the De Dion tube, refer to Figure 125, and secure using a nyloc nut (fastener pack 30R011A Item 11). Ensure that the three-way union is located with the input uppermost.

**Figure 124: Di Dion tube RH brake pipe fitting**



- |                    |                     |
|--------------------|---------------------|
| 1. Brake pipe (RH) | 4. Brake pipe (LH)  |
| 2. 'P' clip        | 5. Di Dion ear (RH) |
| 3. Three way union |                     |

Fit the RH short brake pipe loosely to the three way union and secure the brake pipe to the top of the De Dion tube using 'P' clips (fastener pack 30Z1067A Item 23) and rivet (22). The De Dion tube is predrilled with the correct spacing.

**NOTE**

*The existing holes may require cleaning with a 1/8" drill bit to remove paint but under no circumstances should additional holes be drilled.*

Fit the LH longer brake pipe loosely to the three way union as shown in Fig 126. Ensure that the brake pipe runs along the centre of the top of the De Dion tube. Secure the brake pipe using the 'P' clips (23) and rivets (22). Remove the brake callipers and De Dion ears.

**NOTE**

*The existing holes may require cleaning with a 1/8" drill bit to remove paint but under no circumstances should additional holes be drilled.*

**9.4) Rear brake hose**

**NOTE**

*All connections should initially be made finger tight.*

The rear braided hose can now be fitted. Thread the locknut onto the male union on one end of the hose then attach the braided hose to the three way union on the De Dion tube and tighten to 10 Nm. Lock into place using the locknut. The locknut supplied should not restrict the union from tightening fully.

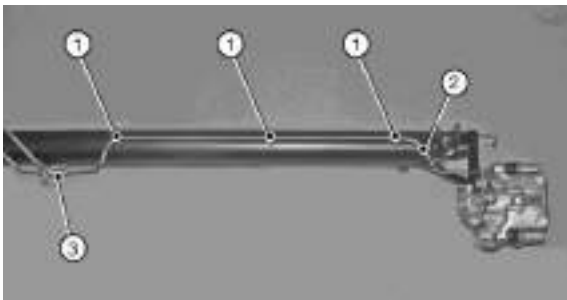
Place a plain washer over the male union on the other end of the braided hose then pass the union forwards through the vertical aluminium panel, apply a further plain washer then the shake proof washer and secure in place with the locknut provided. Finally, attach the rigid brake pipe from the transmission tunnel.

**NOTES**

*1. The rigid brake pipe may need slight realignment.*

*2. Sharp kinks must not be created.*

**Figure 125: LH brake pipe fitting**



1. P-clip
2. Brake pipe LH
3. Three way connector

## 9.5) Assembly of the rear suspension

### Warnings

**1. Never work underneath a car without supporting it on axle stands or equivalent. Do not rely on a jack alone.**

**2. Use appropriate eye protection whilst working under the car.**

Place the De Dion tube into the chassis from the RH side ensuring that the central buttress faces downwards and that the flanges face forward. Care must be taken to prevent damage to the brake pipes.

## 9.6) Rear spring damper assemblies

### NOTES

*1. The rear spring damper units are only fitted at this point if the standard roll over bar is to be installed.*

*2. If the track day roll over bar or roll cage is to be installed do not install the spring damper units yet.*

Insert a sleeve into the top bush of the damper unit (close coils of spring are at the top), align the top bush with the top mounting and insert the top mounting bolt (2) through the access holes provided in the seat back panel. Tighten to 54 Nm once the spring damper unit has been attached to the De Dion tube.

### NOTE

*Sometime it may be a tight interference while fitting sleeve into the damper and might need pressing using a bench vice.*

The lower spring damper mounting is secured to the threaded boss welded to the underside of the De Dion tube. Pass bolt (3) through spring washer (16), plain washer (13), the spring damper unit and plain washer and secure to the De Dion tube. Tighten to 54 Nm.

### NOTE

*Because the suspension is not under load, the bottom bush of the damper unit and the mounting on the De Dion tube will not be in alignment. Take great care not to cross-thread the bottom mounting bolt. If necessary remove the mounting bolt from the rear of the 'A' frame to allow more movement of the De Dion tube.*

## 9.7) Radius arms

If Watts link has been specified refer to next section (Watts link assembly).

Fit the radius arms to the lower chassis bush with the waisted section facing outboard, to provide maximum clearance to the brake calliper. The arms are fitted using M10 x 65 mm cap head bolts (fastener pack 30R011A Item 2) passed from the inside of the cockpit through the radius arm and secured with nyloc nut (8) and plain washer (14). The bolts should be tightened to 34 Nm with the arms parallel to the ground. This preloads the bushes in the correct position for when the suspension is properly loaded.

Fit the rear end of the radius arm between the brackets on the top of the De Dion tube using bolt (3) passed inboard and secure using a nyloc nut (6). Do not fully tighten.

## 9.8) Watts link assembly (optional)

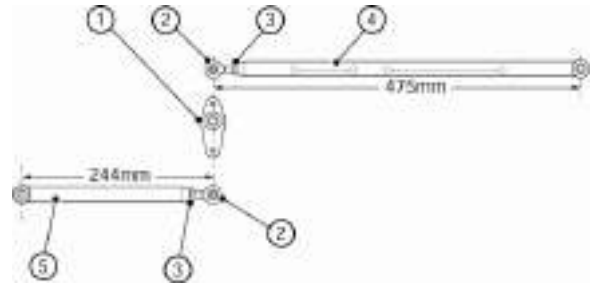
The Watts link replaces the conventional single radius arm location of the De Dion tube by employing two links, one facing forward and one facing rearward connected via a bellcrank.

### 9.8.1) Construction of link arms

Thread the rod ends (polythene bag marked 'rear suspension') with nut (fastener pack 30R012C Item 5) and fit

into the four linkage arms. Adjust the length of the link arms as shown in Figure 127. Tighten locknuts.

**Figure 126: Watts link - RH side**



1. Bell crank
2. Rod end
3. Locknut
4. Link arm (forward)
5. Link arm (rearward)

### 9.8.2) Link arms to bellcrank

Fit the short rearward link arm (waisted section inboard) to the larger offset mounting on the bellcrank using bolt (3) passing from inboard to outboard and secure with nyloc nut (6). Ensure that the larger offset of the bellcrank faces downwards and the links are inset towards the vehicle centre line.

Fit the long forward link arm to the upper mounting on the bellcrank using bolt (3) passing from inboard to outboard and secure with nyloc nut (6). Ensure that the waisted sections in the forward link arm are facing outboard.

### 9.8.3) Link arms to chassis

With the De Dion tube in place attach the forward link arm to the upper mounting bush on the chassis using caphead bolt (fastener pack 30R011A Item 2) pass from inside the cockpit, through the link arm. Secure using nyloc nut (8) and plain washer (14).

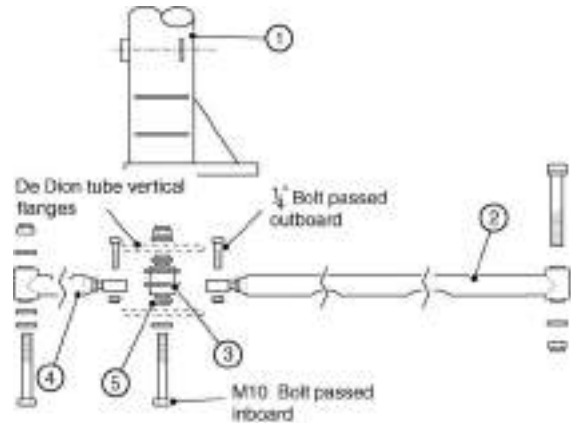
The rear link arm attaches to the rear of the wheel arch into a plain boss. Secure the rear link arm to the boss using bolt (fastener pack 30R012C Item 2) nyloc nut (4) and plain washer (7). Hold link arms horizontally and tighten to 34 Nm.

### 9.8.4) Bellcrank to Di Dion tube

Drop the bellcrank into the vertical flanges on top of the De Dion tube. It should be noted that the bellcrank is secured using an M10 bolt but the vertical flanges have a 1/2" hole for traditional radius arm fitment. Two bellcrank spacers are used on the inner sides of the flanges to centre the bolt in the hole, refer to Figure 128. Assemble the bellcrank into the vertical flanges ensuring that the two bellcrank spacers are correctly located; pass bolt (1) and plain washer (7) inboard through the vertical flanges. Secure with nyloc nut (4) and plain washer (7). Tighten to 34 Nm. It is essential that plain washers are used on the outside of both flanges in

order to pass the load to the flanges rather than the bellcrank spacers.

**Figure 127: Watts link - RH top view**



1. De Dion tube RH end
2. Link arm (forward)
3. Bellcrank
4. Link arm (rearward)
5. Bellcrank spacer

## 9.9) Rear anti-roll bar (optional)

### Warnings

- 1. Never work underneath a car without supporting it on axle stands or equivalent. Do not rely on a jack alone.**
- 2. Use appropriate eye protection whilst working under the car.**

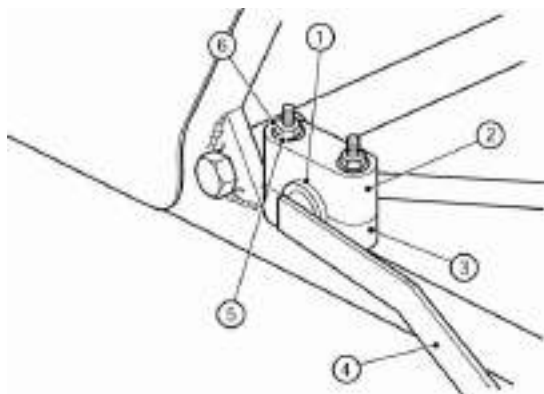
Ensure that the colour of the rubber 'cotton reel' bushes (polythene bag marked 'rear suspension') corresponds to the colour dot on the rear anti-roll bar. Apply rubber lubricant to the centre of the bushes and slide them down over the flat



blades and onto the round section of the rear anti-roll bar.

Feed the rear anti-roll bar across the top of the lower chassis tubes and below the differential. The rear anti-roll bar is clamped to the chassis by the aluminium anti-roll bar mounting block and secured using bolt (fastener pack 30R011A Item 4) and plain washer (15). The bolt is passed vertically up through the chassis tube, through the thin mounting block. Secure using plain washer (15) and nyloc nut (10), refer to Figure 129. Tighten to 14 Nm.

**Figure 128: Rear anti-roll bar mounting**



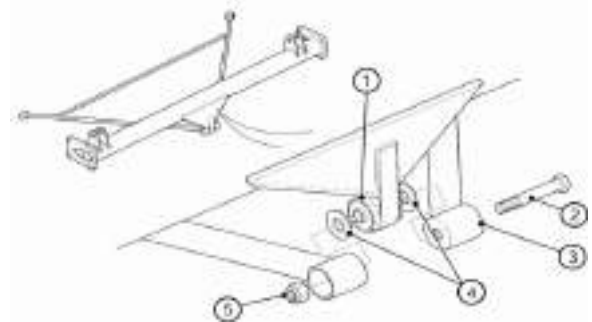
- |                        |                  |
|------------------------|------------------|
| 1. Cotton reel brush   | 4. Anti-roll bar |
| 2. Clamp (upper thick) | 5. Plain washer  |
| 3. Clamp (lower thin)  | 6. Nut           |

### 9.10) 'A' frame

The De Dion tube is located laterally using an 'A' frame which has bushes fitted to the forward ends. The De Dion tube has a metalistic bush fitted to the attachment

point for the 'A' frame, refer to Figure 130. Place the 'A' frame under the car with the forward mountings offset upwards.

**Figure 129: Metalistic brush - De Dion tube**



- |                     |                  |
|---------------------|------------------|
| 1. Metalistic brush | 4. Nylon washers |
| 2. Bolt             | 5. Nyloc nut     |
| 3. 'A' frame        |                  |

Attach the 'A' frame to the De Dion tube using bolt (18) passed through the 'A' frame, through the metalistic bush, make sure you put the nylon washers each side of the metalistic bush, and back through the 'A' frame. Secure using nyloc nut (6) but do not fully tighten unless the spring damper assemblies have been installed (spring damper installation depends on roll over bar/cage specified).

### NOTE

*Nylon 'Race' washers are provided in some applications and if supplied should be fitted over the centre part of the bush between the De Dion tube and the 'A' frame, refer to Figure 130.*

Attach the forward ends of the 'A' frame to the mounting provided on the chassis, refer to Fig 131, using bolts (fastener pack 30R011A Item 1), passed inboard, with large diameter plain washers (14), you need to space the A frame with the washers, there will be 4 one side and 3 on the other side between the A frame and the chassis, then put 1 washer (14) on the other side and then put on the nyloc nuts (7). Do not tighten the 'A' frame fixings.

Check that the De Dion tube is centralised in the chassis. Measure the gaps between the De Dion tube end plates and the outer edge of the chassis tube; these should be identical  $\pm 2$  mm. If adjustment is required move one of the washers (14) between the chassis and 'A' frame until the required position is achieved. You will normally have 3 washers one side and 4 the other.

**Figure 130: Forward 'A' frame mounting**



Insert the unthreaded end of the driveshaft into the differential taking care not to damage the seals in the differential. The longer driveshaft is fitted to the RH side. The shorter driveshaft is fitted to the LH side. To aid insertion, lightly grease the splines of the driveshaft and if necessary gently tap the outer end of the driveshaft with a soft faced hammer. Ensure that the driveshaft is held as straight as possible to prevent damage to the boot.

### 9.11) Assembly of De Dion tube

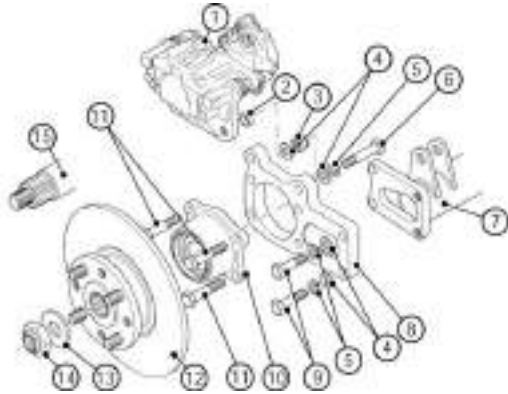
Position the aluminium ears over the driveshaft and attach to the De Dion tube, refer to Figure 132.

#### NOTES

1. The ears are not handed however the calliper fixing lugs protruding from the ear must be uppermost.

2. The holes in the ears are not symmetrical and therefore will ensure correct orientation.

**Figure 131: De Dion tube end (LH)**



- |                   |                               |
|-------------------|-------------------------------|
| 1. Brake calliper | 9. Bolt                       |
| 2. Spacer         | 10. Hub carrier               |
| 3. Nyloc nut      | 11. Bolt                      |
| 4. Plain washer   | 12. Rear disc/flange assembly |
| 5. Spring washer  | 13. Thrust washer             |
| 6. Bolt           | 14. Nyloc nut (41mm)          |
| 7. De Dion tube   | 15. Driveshaft                |
| 8. De Dion ear    |                               |

Apply Loctite to the threads of bolt (fastener pack 30Z1067A Item 6) and bolt the ears into place using spring washers (20) and plain washers (18) into the threaded holes at the rear of the De Dion tube.

Locate the rear hub carrier, with the rounded edge of the flange uppermost. Carefully slide the hub over the end of the driveshaft taking care not to damage bearings or seals. Bolt the hubs to the ear by passing the two bolts (3) through the

rear holes of the hub, the centre holes in the ear and the front holes in the De Dion tube and tighten into place with the nylocnuts (7). No washers are required on these bolts.

Secure the hub to the ear via the forward holes passing the two bolts (4) through the hub and ear then securing into place with plain washers (16) and nyloc nut (7).

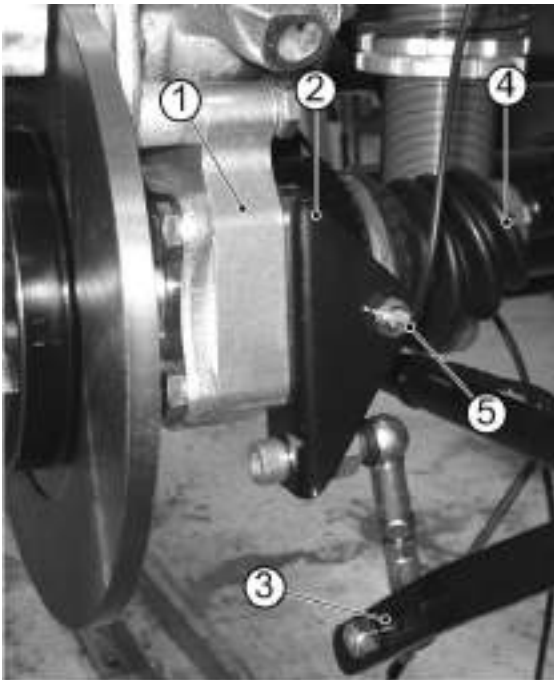
#### NOTES

*All cars come with 2 rear ARB brackets.*

*Academy cars only come with the right hand one for the speed sensor*

*The speed sensor also needs to be mounted on the ARB bracket Refer figure 133.*

**Figure 132: Anti-roll bar bracket and speed sensor**



1. De Dion ear
2. ARB bracket
3. Anti-roll bar
4. Drive shaft
5. Speed sensor

In the case of cars fitted with a rear anti-roll bar, coat the threads of bolt (fastener pack 30R011A Item 17) with Loctite and pass through the lower hole in the ARB bracket, through a plain washer (fastener pack 30Z1067A Item 16) and into the hexagonal, threaded, extension piece.

Tighten all fixings to a torque of 47 Nm.

Remove the outer locknut from the speed sensor. Pass the speed sensor through the bracket and replace the locknut ensuring that the serrated face is against

the bracket. Adjust the two locknuts until there is a 1 mm clearance between the sensor and the serrated disc on the driveshaft (this is only an approximate clearance you may have to move the sensor out to get a Speedo reading). Tighten the locknuts without disturbing this clearance. Refer figure 133 or 134 as appropriate.

Connect the sensor plug to the 3-pin connector on the chassis loom near the 'A' frame mounting boss. Secure the assembled connector to the lower chassis rail ensuring that there is sufficient free play in the sensor lead to accommodate suspension movement.

**Figure 133: Speed sensor**



Slide the rear disc/flange assembly over the splined end of the driveshaft and ease into position through the seal in the hub until it is tight against the bearing. (It may be necessary to use the driveshaft nut

and washer to pull the flange finally home). Place the thrust washer over the driveshaft and secure using the 41mmnyloc nut (LH plain insert, RH green insert) noting that the LH nyloc nut has a LH thread. These can initially be tightened to 81 Nm. These nuts must be finally torqued to 270 Nm. This is most easily achieved once the brakes have been bled and the foot brake is applied.

Check that there is clearance between the outboard rubber boot on the driveshaft and the lower damper mounting bolt.

Check that the outboard driveshaft CV joints do not foul the inner edges of the De Dion ears. If contact occurs, slacken the bolts holding the hub carrier to the ear and adjust until there is sufficient clearance. Re-tighten to the specified torque figures.

The brake callipers are handed and must be fitted with the handbrake cable abutments towards the front of the car. Fit the correct brake pads fully into the callipers ensuring that the range of movement of the pads is not hindered by the calliper body. Slide the calliper over the brake disc whilst separating the brake pads. Secure using bolt (fastener pack 30Z1067A Item 4) with spring washer (18) and plain washer (16). Pass through the De Dion ear, through the spacer (Fig 132 item 2) and into the calliper. Tighten fixing

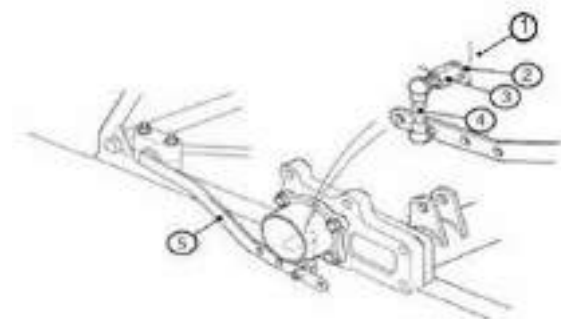
bolts to 47 Nm. Finally attach and tighten the brake pipes.

### 9.12) Anti-roll bar connection and adjustment

Shorten the droplinks as much as possible ensuring the threaded ends face in the same direction. Tighten locknuts.

Remove the nuts from the ends and discard, apply Loctite to the threaded arm of the droplink and screw into the extension piece using washer (15), refer to Fig 133. Pass the threaded portion of the lower droplink through the anti-roll bar and secure with nyloc nut (fastener pack 30R011A Item 9).

**Figure 134: Anti-roll bar connections**



- |                    |                  |
|--------------------|------------------|
| 1. Bolt            | 4. Drop link     |
| 2. Plain washer    | 5. Anti-roll bar |
| 3. Extension piece |                  |

#### NOTE

*Droplink assembly and connections, shown rotated through 180° for clarity.*

The position of the droplinks in the anti-roll bar determines the degree of the anti-roll given. Positioning the droplinks closer to the pivot (at the cotton reel bushes) will give more roll resistance. The same position must be set both LH and RH. The rearmost hole is the softest and forward most hole is the stiffest position.

### 9.13) Handbrake mechanism

#### Warnings

- 1. Never work underneath a car without supporting it on axle stands or equivalent. Do not rely on a jack alone.**
- 2. Use appropriate eye protection whilst working under the car.**

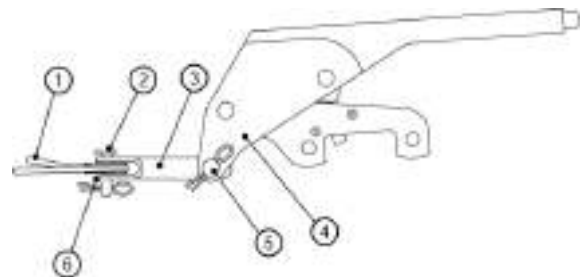
#### NOTES

- 1. Prior to installing the handbrake cable, ensure that the adjustable boss is slackened off to allow easier location.*
- 2. The grommet and short section of flexible tubing on each section of outer cable are not required in this application and may be removed.*

Install the handbrake mechanism and cables, before installing the differential and propshaft. The handbrake cables are connected to the rear brake callipers and adjusted later.

Pull the two sections of outer cable to the opposite ends of the inner cable with the nylon adjuster nuts to the right. Place the inner cable; refer to Figure 136, around the pulley (polythene bag). Install the pulley into the handbrake clevis and insert the thin clevis pin through the handbrake clevis through the pulley and back into the handbrake clevis. Secure the clevis pin in place with split pin (fastener pack 30P12A Item 14). On series 3 cars the inner cable should cross over before being inserted into the pulley.

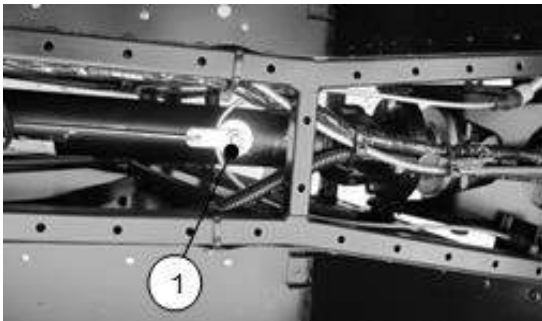
**Figure 135: Handbrake assembly**



1. Handbrake inner cable
2. Thin clevis pin and split pin
3. Handbrake clevis
4. Handbrake assembly
5. Thick clevis pin and split pin
6. Pulley

Insert the handbrake cables into the transmission tunnel with the nylon adjusting nuts to the RH side of the transmission tunnel; the cable routing is shown in Figure 137.

**Figure 136: SV Handbrake cable arrangement**



1. Pulley

### **S3 Handbrake cable arrangement**



Locate the fixed nylon boss on the outer cable into the LH bracket on the chassis above the differential and locate the adjuster on the outer cable into the RH bracket on the differential.

Secure the handbrake assembly to the chassis using the screws (fastener pack 30P012A Item 4) and nyloc nuts (9). There are two holes front hole in the handbrake mechanism to allow adjustment of the handbrake lever in the 'off' position.

Connect the electrical spade connector to the top switch on the handbrake.

The two ends of the handbrake cable emerge from the rear of the transmission tunnel rearwards. Each end of the handbrake cable should be routed over the respective driveshaft then turned through 180° under the driveshaft and secured to the chassis diagonals, using cable ties, just outboard of the 'A' frame. Finally the handbrake cable is turned back on itself and attached to the calliper through the abutments, refer to Figure 138.

#### *NOTE*

*Ensure that cable cannot foul flexible brake pipe during suspension movement.*

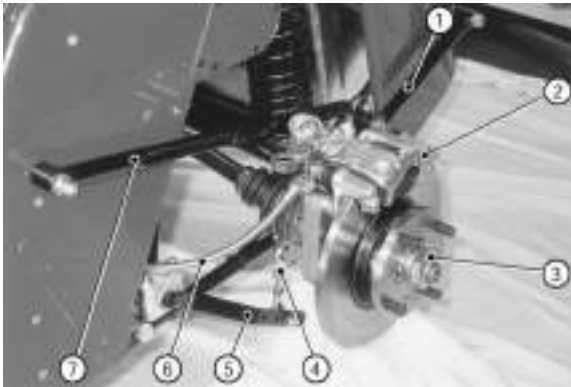
**Figure 137: Handbrake cable routing S3 (non-adjustable side)**



The handbrake cable should not be adjusted until the transmission tunnel

cover (interior trim) has been fitted as the handbrake lever is required to be in the vertical position during fitment of the trim.

**Figure 138: Rear suspension arrangement**



- |                        |                         |
|------------------------|-------------------------|
| 1. Watts link rear arm | 5. Anti-roll bar        |
| 2. Brake calliper      | 6. Handbrake cable      |
| 3. Hub assembly        | 7. Watts link front arm |
| 4. Drop link           |                         |

#### **9.14) Handbrake adjustment**

Adjust the handbrake by rotating the knurled nut that locates in the bracket above the differential. The handbrake should be set to lock the rear wheels on three clicks of the ratchet mechanism. Ensure that the pads are not binding and tighten the second knurled nut to lock the adjuster.

#### **9.15) Final adjustments**

##### **Warnings**

**1. Never work underneath a car without supporting it on axle stands or equivalent. Do not rely on a jack alone.**

**2. Use appropriate eye protection whilst working under the car.**

If the damper units have been fitted, place the axle stands under the De Dion tube so that the weight of the car is taken up through the spring damper units. Ensure that all the suspension securing bolts are tightened as detailed in Table 22.

#### **9.16) Filling of differential**

##### **Warnings**

**Oils - prolonged and repeated contact may cause serious skin disorders:**

**1. Avoid contact with the skin as far as possible and wash thoroughly after any contact.**

**2. Keep out of reach of children.**

**3. First aid treatment should be obtained for open cuts and wounds.**

**4. Use appropriate barrier creams.**

Once the driveshafts have been located the differential can be filled with oil if not already done. It is recommended that the differential is filled with EP90 gear oil (Including those fitted with a limited slip differential). Refer to your Owner's



Handbook for a complete list of recommended lubricants.

**NOTE**

*This operation is made easier if the boot floor has been removed to allow access.*

Ensure the filler plug is to hand. Fill the differential with approximately 1.1 litres of EP90 gear oil until the oil runs out of the filler hole. Screw the filler plug in and tighten.

Secure the boot floor to the chassis.

**Table 22: Torque figures for rear suspension**

<b>Location</b>	<b>Torque (Nm)</b>
Watts link locknut	20
Bellcrank to link	14
Watts link rear mount	34
Bellcrank to De Dion	34
Watts link front mount	34
Radius arm	34
'A' frame	81
Rear damper bolts (all)	54
Hub nuts	270
Hub mountings	47
Brake calliper	47
Rear anti-roll bar clamp	14
De Dion ears	47

## 10.0) Interior and trim

The following section details the interior trim of your Caterham including transmission tunnel top and carpeting, footwell and boot carpeting, seat belts/harnesses, seating and mirrors.

### 10.1) General

Superlight models are not supplied with any carpets unless otherwise specified.

Before fitting the carpets ensure that all operations that require access under the carpets have been completed.

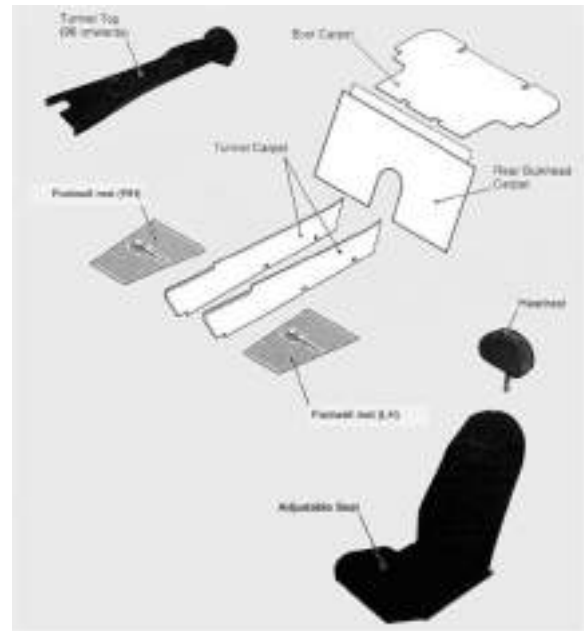
The items specified in Table 23 will be required during procedures detailed in this section.

**Table 23: Special tools required for interior and trim**

Item	Remarks
Adhesive	Contact adhesive
Durable dot fastening tool (Part No. 76068)	Supplied in chassis pack

It is recommended that a dry run is completed before cutting or gluing the carpets in the final position.

**Figure 139: Carpets**



### 10.2) Seat back carpets

#### **Warning**

**Ensure adhesive is applied in a well-ventilated area. Follow instructions on adhesive packaging. Care must be taken whilst working in a confined area e.g. The footwell.**

The carpet that covers the seat back area has a vinyl strip along the upper edge. Lay the carpet into place ensuring that the carpet covers the aluminium seat back right down to the floor. Apply adhesive to the vinyl strip and stick to the square tube at the top of the seat back panel.

The seatback carpet will need to be cut to allow the seat belt through it. Mark the carpet where the inertia reel seat belt exits the seat back and cut a slot.

The carpet must fit flat at the transmission tunnel. If necessary, small cuts should be made in the area of the corners to allow the tabs on the carpet to hinge out against the transmission tunnel.

Once the carpet has been fitted around the transmission tunnel apply adhesive to the carpet and press into position against the seat back. It is only necessary to apply adhesive as far down as the top of the transmission tunnel as the remainder of the carpet is behind the seats.

### **10.3) Transmission tunnel carpet**

Attach the small aluminium transmission tunnel cover on the rear of the transmission tunnel top using the 5/32" rivets provided.

Ensure that the reverse light switch and associated blanking grommet have been installed prior to fitting the transmission tunnel carpets. The transmission tunnel carpets are handed so ensure that the correct carpet is fitted to each side.

Coat the transmission tunnel with adhesive and stick the transmission tunnel carpets to the transmission tunnel.

Ensure that good adhesive coverage is maintained, particularly in the forward section of the transmission tunnel.

### **10.4) Transmission tunnel top**

#### *NOTE*

*Do not attempt to fit the tunnel top until the tunnel carpet adhesive is completely dry.*

The transmission tunnel top incorporates a padded armrest, the gear lever gaiter and the handbrake gaiter. On R300/R400 models the two electrical plugs on the underside of the tunnel top must be connected to the two plugs in the transmission tunnel.

Pull the handbrake near vertical. Fit the transmission tunnel top, ensuring that the handbrake and gear lever locate in the respective gaiter and press firmly into position over the sides of the transmission tunnel carpets.

Screw the gear knob into position and lock with a grubscrew.

### **10.5) Rubber footwell mats**

Place the mats in the respective footwell (mats are handed).

They are secured into the footwell using the three poppers fitted at the rear of the footwell.

Attach 3 popper bases (fastener pack ZIT03 Item 2) to the rear of the front footwell using rivets (1) through which need to be drilled in the floor panel.

Stick masking tape to the underside of the carpet in the approximate position of the floor mounted poppers and lay the carpet into position. Press down firmly on the carpet so that the bases make an impression on the masking tape. Make appropriate holes in the carpet and rivet together the popper (3) and fastener button (4), using the Durable Dot fastening tool, refer to Table 1. Ensure that the fastener button is uppermost on the carpet.

#### NOTE

*For correct use of the popper fastener tool refer to weather equipment section.*

Fit the footwell mats into place and secure using the poppers.

#### 10.6) Boot carpet

The boot carpet is laid into position and requires no adhesive. It will be necessary to cut the carpet to fit around the fuel filler pipe. Tuck the edges of boot carpet down the sides of the aluminium honeycomb bootboard at the rear and the sides taking care not to damage the aluminium body panel.

The boot carpet also covers the boot interior side and front panels. Apply adhesive and secure the carpet shape into the relevant space.

Fit the fuel filler cover plate into position and drill through the cover plate into the boot board using a 2 mm drill. Attach the cover plate using self-tapping screws (fastener pack ZCH01 Item 7). It may be necessary to relocate the fuel filler hose clips to fit the cover.

#### 10.7) Side and knee trim panels

##### NOTES

*1. If specified, the optional sill protectors and roll cage must be fitted before the installation of the knee trim panels, side panels and associated piping can be completed.*

*2. If specified, optional Arm rest bracket (escutcheon bracket) must be fitted with side panel/sill protectors (sill protectors are optional).*

Not all of the rivets used to secure the interior side panels into place will have been fitted. This is to allow fitting of sill protectors and to provide access to the front roll cage mountings, if required.

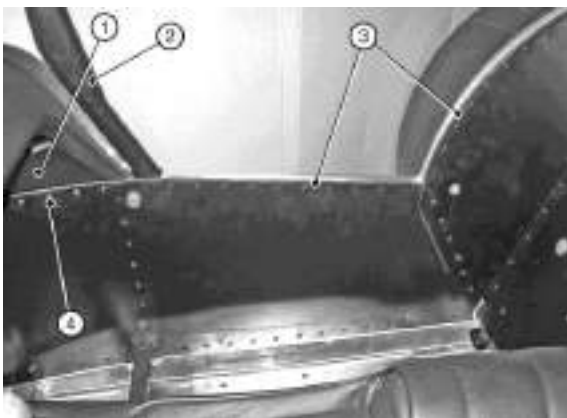
#### **Warning**

**When drilling the sill protectors take care not to drill through both sides of the chassis tube.**

If necessary, position the sill protector on the sill, with the long edge between the chassis tube and trim panel, press down

on the sill protector and drill (5/32") through the existing holes in the trim panel, through the sill protector and through the existing holes in the chassis tube. Position a length of trim piping with the flat portion between the interior side panel and the chassis tube and cut to length. The piping should reach from the front of the knee trim panel to just behind the point where the side panel meets the rear wheel arch panel, refer to Figure 141. Ensure that the rounded edge of the piping sits neatly along the top edge of the side panel.

**Figure 140: Side panel detail**



1. Knee trim panel
2. Roll cage (optional)
3. Piping
4. Self-tapping screws

Position the pre-bent and drilled knee trim panel between the piping and the chassis tube, secure the knee trim panel, piping and side panel to the chassis tube using

self-tapping screws (fastener pack ZCH01 Item 8).

**NOTE**

*If the optional roll cage is to be fitted leave the screws out of the rearmost two holes.*

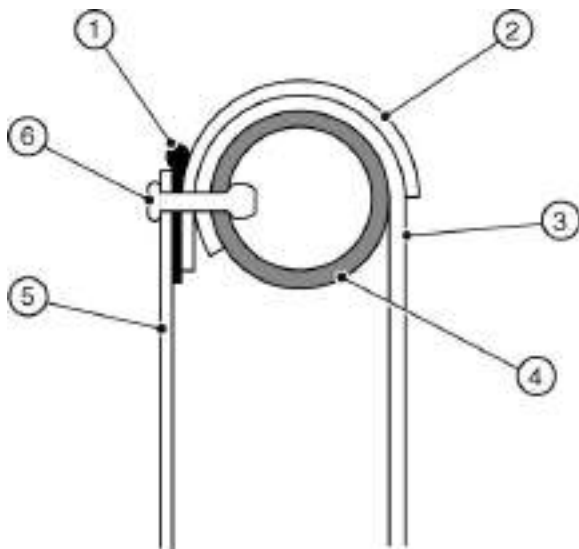
*For optional arm rest bracket fitment, do not fit rivets into 3-4 central rivet holes. (Please see arm rest bracket fitment section in the weather equipment section).*

Fit the sill protector between the piping and the chassis rail and align the holes drilled previously. Drill through the holes again to pierce the flat portion of the piping and secure the sill protector, piping and side panel using rivets (5), refer to Figure 142.

**NOTE**

*If the optional roll cage is to be fitted leave the rivets out of the forward three holes in the horizontal row and the top three holes in the vertical row.*

**Figure 141: Trim fixings**



- |                              |                 |
|------------------------------|-----------------|
| 1. Piping                    | 4. Chassis tube |
| 2. Sill protector (optional) | 5. Side panel   |
| 3. Body skin                 | 6. Rivet        |

Fit the piping and secure the curved section of side panel in a similar manner. Ensure that this section of piping overlays the horizontal section. Cut a series of 'V' shaped notches in the flat portion of the piping so that it follows the curve of the side panel neatly.

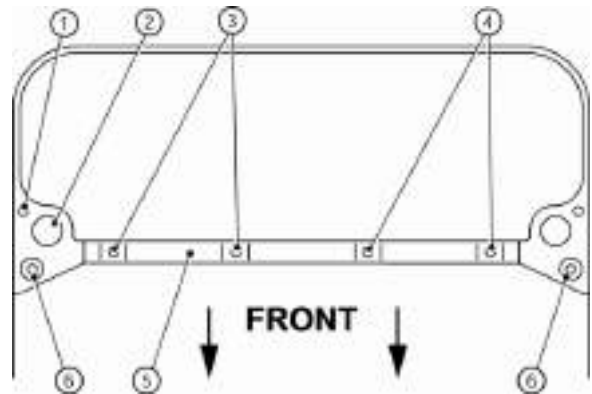
### 10.8) Inertia reel seat belt

If specified, the inertia reel seat belts will have been positioned by Caterham, however none of the visible chassis mountings will be tightened. The belts should be tightened at the same time as the interior trim is fitted. The top and bottom mountings should be tightened to 47 Nm.

### 10.9) Four point harness

The harness should be fitted after the seat back carpet, tunnel carpets and boot cover has been fitted (if specified). Locate the threaded mounting holes in the top of the chassis, (refer to Fig 143), and carefully cut away the material covering the holes.

**Figure 142: Mounting holes four-point harness upper**

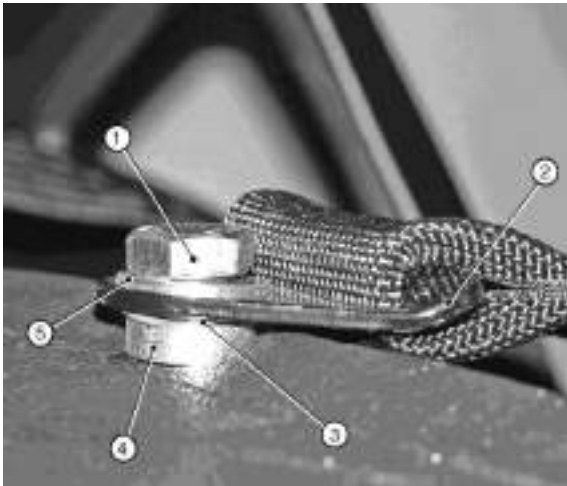


1. Roll over bar mounting
2. Roll over bar locating recess
3. Drivers harness mounting
4. Passenger harness mounting
5. Chassis member
6. Inertia reel mounting

From the mounting kit supplied with the harness, assemble a 7/16" UNF x 1 3/4" bolt, plain washer next to the bolt head, and pass through the broad shoulder strap, crinkle washer and through the bush. Ensure the smaller diameter of the bush is closest to the bolt head. Screw

the bolt into the harness mounting point, refer to Figure 144.

**Figure 143: Shoulder strap with track day roll over bar**



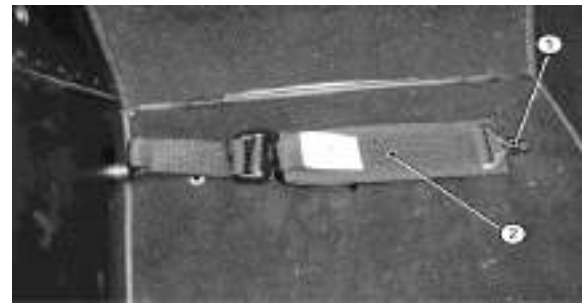
- 1. Bolt
- 2. Shoulder restraint
- 3. Crinkle washer
- 4. Bush
- 5. Plain washer

To fit the outboard lap strap, assemble a 7/16" UNF x 1" bolt, with a plain washer next to the bolt head, pass through the outboard lap strap crinkle washer, and through the bush. Ensure the smaller diameter of the bush is closest to the bolt head. Insert the bolt in the threaded boss and tighten to 48 Nm refer to Figure 145. Ensure lap strap buckle is uppermost.

**NOTE**

*Use of a longer bolt to secure the outer lap strap will result in damage to outer body side panel.*

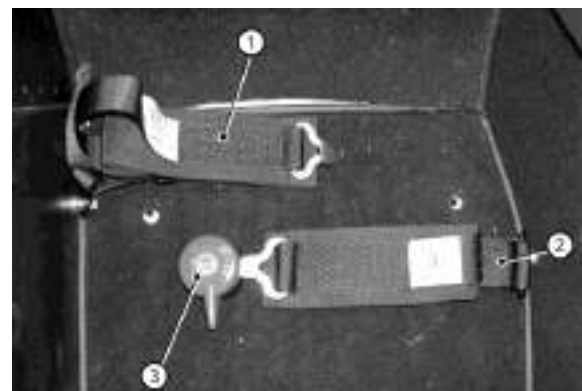
**Figure 144: Outboard lap strap**



- 1. Buckle
- 2. Outboard lap strap

To fit the inboard lap strap, assemble a 7/16" UNF x 1" bolt, with a plain washer next to the bolt head, pass through the inboard lap strap, crinkle washer, and through the bush. Ensure the smaller diameter of the bush is closest to the bolt head. Insert the bolt into the threaded boss and tighten to 47 Nm, refer to Figure 146. Ensure lap strap buckle is uppermost.

**Figure 145: Lap straps**



- 1. Outboard lap strap
- 2. Inboard lap strap
- 3. Buckle

**10.10) Six point harness**

The six-point harness is fitted in the same way as the four point, with the exception that the crutch straps are bolted to the chassis brackets protruding from the rear lower crossmember behind the seat.

#### 10.10.1) Standard floor

To fit the crutch strap drill an 11 mm hole through the two crutch strap mounting points located at the rear of the cockpit and through the floor of the cockpit. Assemble an M10 x 25 bolt with a plain washer next to the bolt head. Pass the bolt through the hole in the crutch strap, through the crinkle washer and top hat spacer, down through the chassis mounting ensuring the strap is offset downwards, and through the cockpit floor. Secure the bolt in place using a plain washer and nyloc nut. Tighten to 47 Nm. Ensure the crutch strap fixing plate has the bend facing the cockpit floor.

#### 10.10.2) Lowered floor

Drill a 7/16" hole through the crutch strap-fixing bracket then through the floor pan directly below it.

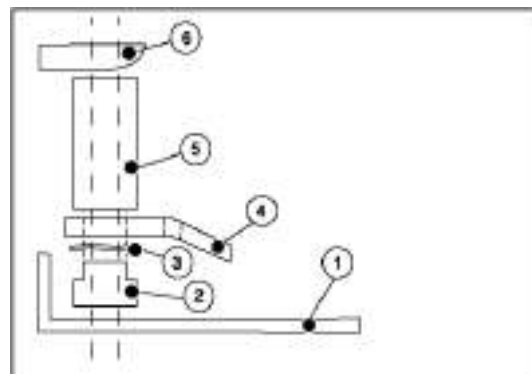
Lay out the crutch strap to assure the correct orientation and assemble the harness eyelets and spacers, refer to Fig 147.

Insert the long 7/16" x 3" bolt upwards through the floor pan and assembled

spacers detailed above. Secure in place using the plain washers and nyloc nuts supplied. Tighten all fixings to 61 Nm.

Fit the shoulder and lap straps as detailed previously.

**Figure 146: Crutch strap spacer location**



1. Lowered floor pan
2. Top hat spacer bush
3. Crinkle washer
4. Fixing eyelet
5. Aluminium Spacer
6. Crutch strap fixing bracket

### 10.11) Seats

#### 10.11.1) Standard cloth or leather seats

The adjustable seats are supplied attached to the seat runner. Place the seat into position over the underseat carpet (SV only) and secure the front mountings by passing setscrew (fastener pack ZSE03 Item 1) down through the mounting and securing using plain washer (3) and nyloc nut (2). Slide the seat fully forward and pass setscrew (1) down



through the rear mountings and secure using plain washer (3) and nyloc nut (2). Tighten the fastenings.

### 10.11.2) Composite seats

#### 10.11.2.1) Adjustable seats

Fit the runner with the adjusting handle to the RH side of the seat with the handle facing forwards and inboard of the runner. Secure the front mounting using reduced head cap head bolt (fastener pack ZSE06 Item 2) through the round hole then through two thick spacers (8) and into the threaded seat base. Secure the rear with cap head bolt (2) through the square hole, through 1 thick spacer (8) and 1 thin spacer (7) and into the threaded seat base, refer to Fig 148.

**Figure 147: Adjustable seat**



1. Spacers
2. Adjusting handle

Fit the LH runner in the same way ensuring that the outer part of the runner

is towards the seat base. Secure using bolt (2), one thick spacer (8) and one thin spacer (7) on each fixing ensuring they are between the runner and the seat.

Torque all fixings to 14 Nm.

Ensure that the harness option specified has been installed prior to fitting the seat. Place the seat into position feeding the lap and shoulder straps through the apertures in the seat body and the crutch strap (if specified) through the aperture in the seat base, refer to Fig 149. Ensure that the harness straps are not twisted.

On low-floor cars the seat adjusting handle must pass beneath the square chassis tube and through the aperture in the vertical section of aluminium panel.

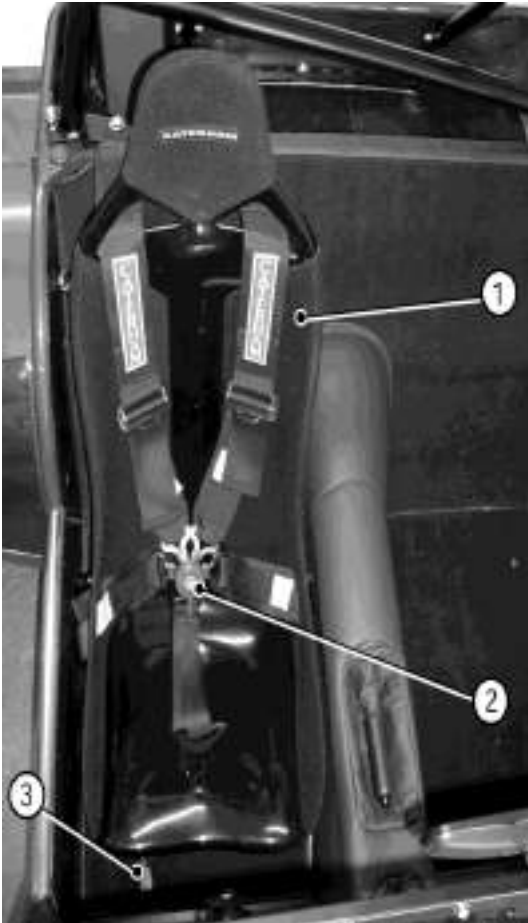
Secure the front mountings with bolt (2) passed down through the runner and secure under the floor using plain washer (5) and nyloc nut (4).

Slide the seat fully forwards and pass a bolt (2) down through the rear holes in the runner and secure under the floor using plain washer (5) and nyloc nut (4).

**NOTE**

If the car has a honeycomb floor, bolt (1) is passed through the runner, through spacer (6) and secured using plain washer (5) and nyloc nut (4).

**Figure 148: Composite seat and six-point harness**



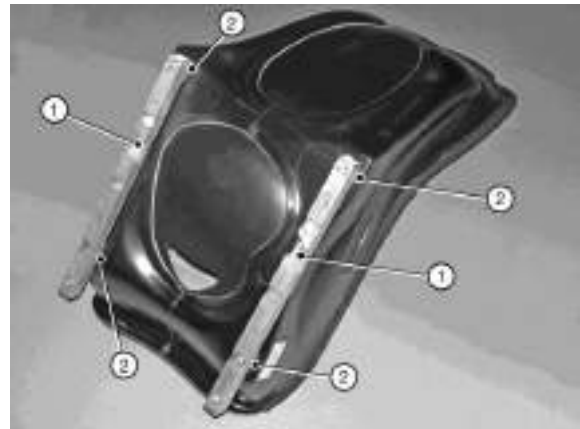
1. Composite seat
2. Six-point harness
3. Seat adjuster

#### 10.11.2.1) Fixed seat

The fixed seat is bolted to the floor via two 25 mm square section, aluminium tubes. This tube has a series of cut-outs on one side and plain holes in the opposite side. It is important that this tube

is fitted in the correct orientation. The cut-outs must face away from the seat base allowing flush fitment to the floor. The large cut-out must be biased towards the rear of the seat. Both tubes are identical and are fitted in the same orientation, refer to Fig 150.

**Figure 149: Fixed seat**



1. Large recess
2. Spacer

Position the square section aluminium tubes on the seat base and pass bolt (fastener pack ZSE05 Item 2) through the large hole in the underside of the spacer and into the small hole opposite, through one thick spacer (8) and into the threaded seat base. Torque all fixings to 14 Nm.

**NOTE**

*If a track day roll over bar and Petty strut is installed, the seat can reclined slightly by replacing the front fixing with bolt (1) and additional thick plastic spacers (8) on each side at the front, between the seat base and the aluminium tube.*

Ensure that the harness option specified has been installed prior to fitting the seat. Place the seat into position feeding the lap and shoulder straps through the apertures in the seat body and the crutch strap (if specified) through the aperture in the seat base, refer to Fig 143. Ensure that the harness straps are not twisted.

Secure the seat with bolts (2) and plain washers (5) passed upwards through the floor into the threaded bosses in the aluminium tubes.

## **10.12) Minor trim items**

### *10.12.1) Scuttle edge trim*

This strip (chassis kit) is designed both to finish off the scuttle around the dashboard tidily and to protect the occupants from the hard aluminium edge. Cut the trim to length and secure by firmly pushing the trim into place by hand. The scuttle edge trim is an IVA requirement.

### *10.12.2) Nose badge*

The circular nose badge (polythene bag marked 'miscellaneous') is mounted on the nose cone of the vehicle. It is self-

adhesive but has two locating dowels. Before removing the paper to reveal the adhesive on the underside of the badge, carry out a trial fit to ensure the badge will sit square. It may be necessary to remove the paint from the pre-drilled holes on the nose cone before fitting the badge.

## **10.12) Rear view mirror**

The centre mounted mirror is a legal requirement and must be fitted. The mirror has a self-adhesive pad and should be stuck as high as possible on the interior of the windscreen on the centre line of the car. Prior to removing the paper backing from the self-adhesive pad ensure the area where the mirror is to be placed has been thoroughly cleaned using an alcohol based degreaser. Note that the mirror can be inverted on its stalk to minimise windscreen obstruction.

On Superlight models without a windscreen, the mirror must be secured to the scuttle top on the centreline of the vehicle. Ensure that the area where the mirror is to be placed has been thoroughly cleaned using an alcohol based degreaser.

**Figure 150: Completed interior**



1. Rear bulkhead carpet
2. Footwell carpet
3. Tunnel carpet
4. Tunnel top

**NOTE**

*Items may differ from those shown,  
dependant on the chosen specification.*

## 11.0) Fibreglass

The following section details the fibreglass components of your kit including cycle wings, rear wing protectors and rear wings.

### 11.1) Front cycle wings

The front cycle wings are not handed, but they will be marked for the repeater position. The repeaters should be near the leading edge of the wing, on the outside.

Piping (polythene bag marked 'IVA') should be fitted around the edge of the cycle wing. This is an IVA requirement, refer to the IVA section.

It is easier to fit the front indicator repeaters to the cycle wings prior to fitting them to the cycle wingstay.

#### **Warnings**

- 1) Use appropriate eye protection whilst carrying out drilling operations.**
- 2) Use a suitable face mask to prevent inhalation of dust when drilling fibreglass or carbon fibre.**
- 3) When drilling fibreglass use tape on the surface over the drill holes to prevent damage to the gel coat or painted finish. Slow drill speeds must be used.**

Drill through the cycle wing at the pre-marked points using a 5 mm drill. Then enlarge the centre hole to approximately 15 mm.

Feed the repeater wire through the cycle wing from the outside then secure the base using the nuts supplied.

The cycle wing will have been marked with the positions for the front two mounting bolts for each wing. These should be drilled through using a 5 mm drill.

The front cycle wings bolt to the tubular wingstays which are rigidly mounted to the front uprights.

Fit the front wheels ensuring that the steering rack is centred. Place the cycle wing over the wingstay so that the bolt holes are over the centre line of the forward wingstay tube such that the wing overhangs evenly on either side of the tyre. The wing can be held in position using masking tape. It is possible that the wingstay will need to be bent to allow the cycle wing to fit centrally over the tyre. Mark the positions for the bolt holes onto the wingstay.

Remove the cycle wing and with the tyre protected centre punch the wingstay. Drill the holes through the wingstay using a 6

mm drill. Ensure that the drill cannot contact the tyre.

Drill an additional hole in the underside of the front wingstay near the open end using a 5/32" drill. Remove all sharp edges on the inside and outside of the wingstay tube.

Loosely fit the cycle wing to check the alignment of the cycle wing and wingstays relative to the tyre. The cycle wing should be checked to ensure that it is centrally located over the tyre. Remove the cycle wing. Place a strip of masking tape across the tyre underneath the drilled wingstay. Using a ruler held at 90° to the surface of the tyre, mark the lateral positions of the two holes. Rotate the wheel so that the masking tape is under the rear tube of the wingstay and transfer the bolt hole position to the wingstay tube. Centre punch and drill using a 6 mm drill as for the front holes.

Refit the cycle wing, loosely bolting it at the front and aligning it over the tyre and then carefully remove the wheel without disturbing the wing. Masking tape can be used to hold the wing in place. Carefully mark the underneath of the wing with the bolt hole positions and then remove the wing. Drill a small pilot hole from underneath the cycle wing, taking care not to damage the gel coat/painted surface.

Check alignment of the holes with the wingstays, adjusting if required, then drill through from the top of the cycle wing with a 5 mm drill.

Place a strip of self-adhesive foam (fastener pack ZFG12 Item 7) on the top of each cycle wingstay tube. Cut two rubber grommets in half to provide four rubber washers. Pass screw (5) through the manufactured washers and down through the cycle wing and wingstay. Secure using washers (4) and nyloc nuts (2). Tighten until the rubber washer is slightly larger than the screw head. The black wire from the indicator repeater is the earth lead and should be attached to the front wingstay using a pop-rivet in the 5/32" hole drilled at Para 10. Remove paint to ensure a good contact.

Route the green wire from the indicator repeater inside the wingstay until it emerges from the pre-drilled hole near the wingstay brace. From the wingstay the wire must be routed along the rear of the upper wishbone ball joint, and the upper wishbone. Secure using small cable ties at 50 mm intervals, refer to Fig 152.

**NOTE**

To comply with SVA requirements the green repeater wire must be covered with heat shrink sleeving.

**Figure 151: Indicator repeater wiring**



1. Upper wishbone
2. Front wingstay
3. Repeater wire
4. Wingstay brace

Once inside the aluminium body skin the green wire should be fitted into the 6 pin econoseal plug. It is recommended that this connection is made at the same time as the headlamp and indicator wiring.

**11.2) Rear wing protectors (Stone guards)**

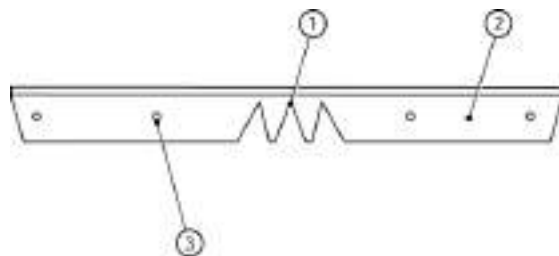
**NOTE**

It is advisable to fit the wing protectors to the wings before fitting the wings to the car. Once the wings are fitted there is very little clearance between bodywork and drill

chuck when drilling holes for the inner row of rivets.

The wing piping (fastener pack ZWS01 or ZWS02 (option) Item 2) fits between the rear wing protector and the rear wing. Cut the piping to length and fit around the top, outer and lower edges of the wing protector so the bead is against the edge of the protector. 'V' shaped notches (refer to Fig 153) should be cut to allow the piping to smoothly follow the shape of the protector. Position the piping under the protector, ensure correct orientation of the protector (refer to Fig 156) and drill through the existing holes into the piping with a 1/8" drill.

**Figure 152: Rear wing protector piping**



1. 'V' shaped notch
2. Wing piping
3. Holes

The wing protector should be placed on the lower front of the rear wings. The correct position can be obtained by placing the lower angled edge approximately 5 mm up from the lower edge of the wing and the inboard side of

the protector tight up against the inboard side of the wing (the side of the wing that bolts to the car).

#### NOTES

1. *The protectors are supplied flat so will need to be gently shaped to follow the contour of the wing.*

2. *The protective film on stainless steel wing protectors should be removed from around the rivet heads before fitting. The protected side faces outward.*

Position the protector on the rear wing and mark one of the corner holes. Ensure correct spacing and orientation. Drill the hole using a 1/8" drill. Fit the rear wing piping into position under the protector and rivet into position using rivet (1).

#### NOTE

*Carbon fibre wing protector uses black rivets and the stainless steel wing protector uses plain rivets.*

Attach the wing protector working outwards, one rivet at a time, from the corner ensuring that the wing piping is in the correct position. Drill 1/8" holes and attach using rivets (1).

### 11.3) Rear wings

The rear wings are provided pre-drilled with both the wing fixing holes and further

holes for the suspension arms. To enable the wing to be fitted to the car you will need to trim out the fibreglass from the larger holes to enable fitment over the radius arm or Watts link arms, refer to Fig 154). The wings are supplied in this way to maintain their strength prior to them being fitted to the car. An alternative fixing method would be to remove the suspension arms then refit them once the wing is secured in place.

**Figure 153: Rear wing fitment**



1. Rear wing fixings
2. Rear wings

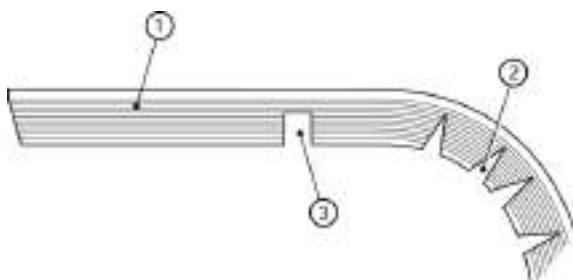
Offer the rear wing up to the side of the car and bolt in place using a setscrew (fastener pack ZFG12 Item 1) and plain washers (3) into rivnuts at the front of the rear wing and bolts (1), plain washers (3) through the rear of the wing and secured using plain washers (3) and nyloc nuts (2). The setscrews used to secure the rear upper section of the wing should be



passed through the body from inside the boot. Loosely fit all fasteners.

Wing piping (6) is provided to fit between the rear wing and the car body. The wing piping should be positioned against the rear wing and cut to length. The wing piping has six ribs running longitudinally. 'V' shaped notches, refer to Figure 155, should be cut to the sixth rib to allow the piping to smoothly follow the curve of the rear wing. Where the wing mounting bolts occur, rectangular shapes should be cut to the fifth rib to accommodate.

**Figure 154: Wing piping**



1. Wing piping
2. 'V' Shaped notches
3. Rectangular notches

Secure the rear wing ensuring that the bead of the wing piping is protruding. Do not over tighten fixings, refer to Figure 156.

**Figure 155: Rear wing**



1. Piping between wing and panel
2. Piping on three sides of wing protector

## 12.0) Lighting

The lighting kit includes all the parts needed to make the car comply with the lighting requirements of IVA. It is imperative that these instructions are adhered to in order to fulfil the legal requirements of the lighting.

If fitted, remove the lead from the battery negative terminal.

### 12.1) Headlights and front indicators

Fit a length of edge strip (polythene bag 'IVA') to the underside edge of the indicator cone. It is an IVA requirement that the edge strip covers the entire edge of the mounting cone, including the portion directly beneath the lens.

Remove the lens from the front indicator. Ensure that the drainage hole on the indicator seal is at the bottom, line up the holes in the indicator base with the holes in the indicator cone and secure using three setscrews (fastener pack 30L002A Item 3) and nyloc nuts (6). Do not over tighten. Replace the lens.

Tighten the two grub screws securing each headlight bracket into the chassis. Tighten to 7 Nm.

Remove the headlight rim by undoing the clamping screw located on top of the headlight bowl and unhooking the lens

from the headlight bowl. Remove the plug from the back of the headlight bulb and remove the sidelight housing from the reflector.

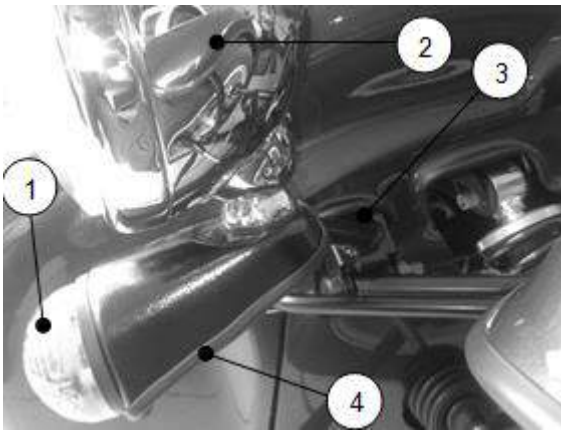
Remove the securing nut and lock washer from the headlight mounting stud and smear a thin layer of oil to the thread. Insert the headlight harness and headlight mounting stud through the indicator cone and into the headlight bracket.

Refit the headlight securing nut and lock washer and tighten until the headlight unit cannot move freely, this will aid assembly however these nuts will need to be slackened off to allow the headlights to be correctly adjusted, refer to Figure 157.

#### NOTE

*Ensure that the locating tag on the headlight shell engages with the recess in the mounting stud.*

**Figure 156: Headlight and indicator LH**



- 1. Indicator cone
- 2. Headlight unit
- 3. Headlight bracket
- 4. Indicator cone

Pass the black indicator earth wire (terminated in a ring terminal) through the hollow headlight unit mounting stud and secure to the earth screw at the base of the headlight unit. Pull excess wire into headlight unit.

Refit the sidelight housing into the reflector and refit the plug to the headlight bulb. Hook the bottom of the headlight rim into the lip on the headlight bowl and swing the headlight rim up into position. Secure using the clamping screw.

Feed the headlight wiring and the green indicator wire through the hollow headlight bracket so that it exits into the engine bay.

The headlamp wires can be “shortened” to equal lengths by gathering the excess wires into the headlamp bowl.

**12.2) Front indicator repeaters**

The front indicator repeaters are fitted at the same time as the front cycle wings, refer to cycle wing section within the fibreglass chapter.

**12.3) Front wiring electrical connections**

Locate the 2 loose econoseal plugs supplied in the chassis pack (2 part black plug and yellow insert). Take the six wires (the sixth wire is the indicator repeater wire which may not be fitted at this point) and push them into the back of the loose black plug ensuring that the connections click into place. If they do not locate correctly turn them through 180° and try again. Refer to Table 24 for the correct terminal position within the connector.

**Table 24: Front lighting wiring connections**

Function	Wiring loom colour	Light unit wire colour
Earth	Black	Black
Headlight (dipped beam)	Blue/red	Blue/red
Headlight (main beam)	Blue/white	Blue/white
Indicator	Green/white	Green
Repeater	Green/white	Green
Sidelight	Red	Red

Once the indicator repeaters have been fitted and all the connections have been located into the plug fit the yellow insert into the front of the plug. Connect the plug to the wiring loom and secure the cables to the chassis.

#### **12.4) Rear lights**

The kit includes two identical rear light assemblies which comprise of tail, brake and indicator lights. They are mounted on rubber blocks which ensure that the lights are vertical when fitted and are secured with four self-tapping screws. Turn one light unit around on the rubber block and ensure that the amber indicator lens is on the outside.

#### **Warnings**

- 1) Use appropriate eye protection whilst carrying out drilling operations.**
- 2) Use a suitable face mask to prevent inhalation of dust when drilling fibreglass or carbon fibre.**
- 3) When drilling fibreglass use tape on the surface over the drill holes to prevent damage to the gel coat or painted finish. Slow drill speeds must be used.**

The rear wings have been pre-drilled with two holes for the rear light assemblies. The outermost hole has been drilled to 30

mm and this takes the wiring and the econoseal plug. The innermost takes one of the retaining screws. Enlarge the innermost hole using a 4 mm drill.

Remove the lenses from the rear light assemblies along with the bulbs noting that the indicator uses a single filament bulb and the brake light uses a double filament bulb.

#### *NOTE*

*The rear light assemblies are not 'handed'. One of the metal baseplates must be inverted to create a LH/RH pair with the indicator fitting to the outside edge of each light.*

Using the metal baseplate as a guide, drill a 4 mm hole through the rubber block in each corner. Ensure that the drill is kept at 90° to the baseplate.

Feed the electrical wiring and the econoseal plug through the 30 mm hole ensuring that the grommet is passed through the hole. Attach the rear light unit at the lower inboard corner using screw (2). Do not over tighten. Ensure that the rear light unit is horizontal and drill through the rear light unit into the rear wing. Remove the light unit. Clear away the swarf and refit the light unit using screws (1) on the upper holes and screws (2) on the lower holes.

Do not over tighten. Replace the bulbs and lens cover ensuring correct orientation of the lens cover (indicator to the outside).

Connect the econoseal plug to the corresponding socket protruding from a hole inside the rear wing. Ensure that the plugs are correctly mated and push the plug inside the rear side panel. Fit the grommet to the hole in the body side panel.

For reference the rear electrical connections are detailed in Table 25.

**Table 25: Rear lighting wiring connections**

Function	Wiring loom colour	Light unit wire colour
Rear light	Red/white	Red
Brake	Green/mauve	Green
Left indicator	Green/red	Green
Right indicator	Green/white	Green
Earth	Black	Black

Secure the wiring inside the body using cable ties.

### 12.5) Reversing light and fog light

The reversing light and the fog light are fixed to the rear panel and the wiring connections have been made at the factory.

### 12.6) Rear number plate light

Remove and retain the cross-point screw retaining the light cover and lens; remove and retain the cover and lens. Remove and retain the two nuts and spring washers from the metal baseplate.

Pass the wire from the chassis loom through the RH upper hole of the light bracket on the chassis and through the back of baseplate. Fit the baseplate to the bracket and secure with the nuts and spring washers. Ensure that the baseplate studs earth to the bracket through the nuts (remove paint from the bracket as necessary).

#### NOTE

*Cars that are not supplied with a spare wheel bracket will be pre-fitted with a number plate light bracket located below the lower chassis tubes.*

Remove and discard the two brass bullet connectors supplied in the light. Shorten the wire to a convenient length, strip back sufficient insulation and attach (crimp) a male bullet connector. Insert the bullet connector into the central terminal on the light. Replace the lens, cover and cross-point screw.

### 12.7) Testing

Reconnect the battery negative lead. Check all the lights for correct operation.

In the event that there are problems check that the bulbs have not been damaged during transit and replace as necessary. If the problem persists check every earth point on the chassis both on the wiring loom and the battery earth lead. If the problem is related to a particular system or side, check the fuse box located under the dashboard in the passenger side of the cockpit further information on fuse identification can be found in your Owner's Handbook.

### **12.8) Headlight beam setting**

If possible the headlight beam setting should be carried out using professional equipment; if such equipment is not available, proceed as detailed below:

1. Position the car on a firm level surface, 2 m from a vertical surface (measured from the front edge of the lower lip of the nose cone). Slacken the headlight securing nuts and switch on the lights (dipped). Adjust the lights until the brightest spot of each light pool (at the apex of the dip-beam cut-off) is 650 mm above the ground.

2. Measure the distance between the centres of the headlights on the car and the distance between the centres of the bright spots on the wall. Adjust the headlights as necessary until the two measurements are approximately the

same. When alignment is satisfactory, re-check the vertical measurement and tighten the headlight securing nuts.

3. The alignment will be tested and adjusted during the post build check. If the car is not being submitted for a post build check, we strongly advise kit builders to get the headlights professionally adjusted.

### 13.0) Weather equipment

This section explains how to perform the initial fitment of the weather equipment, the tool identified in Table 26 will be required. However, if the specification for your car included hood fitment then instructions on how to refit, remove and fold for storage can be found in your Owner's Handbook.

**Table 26: Additional tools required for weather equipment**

Item	Description
Durable Dot fastening tool	Part No. 76068 (supplied in fastener pack ZBC02)

Correctly fitted weather equipment is shown in Figure 158.

**Figure 157: Weather equipment**



### 13.1) Fitting of hoodsticks and hoodstraps

#### NOTE

*Whichever option of roll over protection has been specified must be fitted before the hoodsticks.*

Remove the inner hoodstick from the hoodstick assembly and feed the end loop of hoodstraps over the front hoodstick and loop in the centre of the hoodstraps over the rear hoodstick ensuring that the adjusting buckle faces downwards when the hoodsticks are erect, refer to Figure 159.

Reassemble the hoodstick assembly and attach to the triangular brackets on the chassis using the fixings provided. Ensure that one plain washer is fitted under the head of the screw and the other between the fixing bracket and the hoodstick.

Before fitting the hood you must first secure the rearward part of the hoodstick in the correct position. Measure distance A from the top surface of the rear chassis tube to the centre of the rear hoodstick to obtain the correct positioning (standard chassis 395 mm or SV 420 mm), refer to Figure 159.

**Figure 158: Hoodstick spacing**

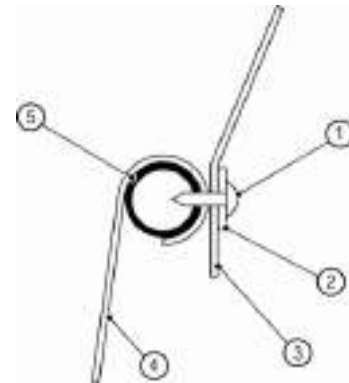


Drill two 7/64" holes into the upper chassis tube, one either side, on the inside rear edge of the boot, opposite the outermost popper base (145 mm from the roll cage mounting lug). Make a small hole in the loose end of each hoodstrap and using the two self-tapping screws (fastener pack ZWE05 Item 10) and washers, fix the straps to the rear panel on the inside of the top chassis rail, refer to Figure 160.

**NOTES**

- 1. With the hoodstraps taut, check the position of the rear hoodstick, as this will affect the tension of the hood when finally adjusted.*
- 2. For a neater appearance, popper bases may be used with the self-tapping screws used to secure the hoodstraps.*

**Figure 159: Hoodstrap fixing**



1. Screw
2. Washer (or popper base)
3. Hoodstrap
4. Rear body skin
5. Chassis tube

**13.2) Hood fitting**

With the hoodsticks in the upright position and the adjusting buckle fully slackened, drape the hood over the car and attach it to the windscreen with the pre-fitted fasteners. Start with the two outer most fasteners and ensure that the felt seal is correctly located along the top face of the windscreen frame.

Move to the rear of the car and attach the back of the hood again with the pre-fitted fasteners.

Tension the hood by adjusting the hoodstraps until the front hoodstick is in line with the stitched darts in the hood. Use the Velcro lined sleeve stitched to the inside of the hood to capture the front



hoodstick as this will ensure that it is correctly adjusted.

The front popper base for the side of the hood can now be fitted. To do this pull the side of the hood down and assess the approximate position for the popper base. Apply several layers of masking tape to this area.

Pull the side of the hood down again and press on the fastener to create an imprint in the masking tape. Drill a 3/32" hole through the centre of the impression, remove the tape and secure a popper base using a self-tapping screw.

#### NOTE

*Care should be taken while drilling hole on curve of the chassis tube.*

Repeat the above procedure for the remaining popper bases along the cockpit and boot sides, refer to Figure 161.

**Figure 160: Hood side fasteners**



1. Hoodstick
2. Popper base
3. Rear wing

### 13.3) Sidescreen fitment

Using the setscrews (5) and nyloc nuts (13) attach the sidescreen hinges to the outside of the windscreen stanchions with the eyelet towards the rear of the car, refer to Fig 162. Fit the brass hinge pins (8) into the 4 remaining hinges. Now slide the hinges with the pins fitted into the top of hinges attached to the car.

#### NOTE

*SV sidescreens hinges are now supplied with pre-fitted hinge pins.*

**Figure 161: Hinge and side screen fitting**



1. Windscreen stanchions
2. Sidescreen hinges

The sidescreen is constructed using a steel frame around the window section.

This is covered with the vinyl which continues away from the frame giving a soft flexible area of about 35 mm around the outside. The correct position for the sidescreen is with the soft part at the top tucked up between the two parts of the hood that make up the seal along the top of the door aperture and the soft area towards the front tucked inside the stanchion. The lower rear radius of the sidescreen should follow the lower edge of the hood and the metal frame at the top should be just below the top of the door aperture.

With the hood still fitted and correctly tensioned, offer up the sidescreen into position and mark the position of the four fixing holes. (For ease of marking it may help to run a strip of masking tape down the front edge of the sidescreen).

### **Warning**

**Use appropriate eye protection whilst carrying out drilling operations.**

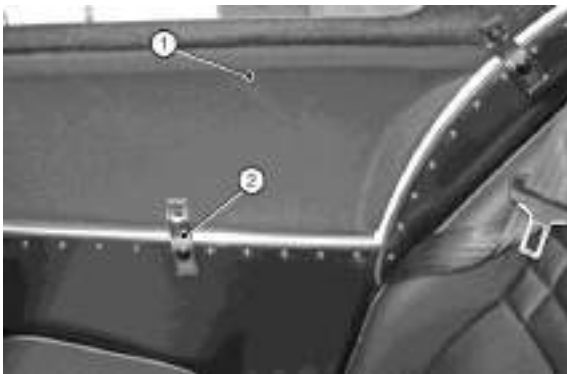
Next remove the sidescreen and place it on a solid surface and protect the window from damage caused by swarf before drilling the holes for the fixings. The metal frame inside the sidescreen is very hard so it is advisable to centre punch and drill through with a 3 mm pilot hole then finally with a 5 mm drill to enable fitment of the hinge.

Remove the top part of the hinges from the chassis and secure them to the outside of the sidescreen, using setscrew (5) and nyloc nut (13), with the pin towards the front and pointing downwards. Fit IVA covers to the nuts on the inside of the sidescreen and fit IVA protectors to the non-chamfered ends of the hinge halves, refer to Figure 164.

Refit the sidescreen by sliding the pins down into the hinges on the car. With the sidescreen closed, tuck the top in between the flap of the hood.

Each sidescreen is held shut by two vinyl straps and fasteners. From inside the car, pull the straps in over the top edge of the chassis and mark the place for the fastener base. Drill a 5/32" hole in line with the rivets holding the side panel in place. (You will be drilling into a round tube so care should be taken to avoid the drill wandering as it hits the tube).

**Figure 162: Sidescreen straps**



1. Sidescreen
2. Vinyl strap

**NOTE**

*Optional arm restraints are available. If these have been specified on your car then only the top strap is required to locate the sidescreen.*

Attach a popper base (2) using rivet (1). Next pull the strap down over the popper base and mark the centre to position the fastener. Whilst doing this ensure the sidescreen is pulled tight up against the body of the car to reduce draughts and water ingress. Fix a fastener to the marked position on the strap using the durable dot tool, refer to figure 172. Repeat this process for all fixing straps.

**13.4) Arm rest bracket fitment (escutcheon bracket)**

Optional arm rest bracket needs to be fitted at this stage. SV/CSR cars comes with arm rest attached to the side screen

(it's optional on S3). Stick the masking tape on the interior panel in the middle over the rivet holes. Hold the side screen tight against the car and press mark the arm rest popper position on the masking tape. Normally the popper line up with one of the rivet holes on the side panel. Push fit the escutcheon bracket and line up the marked position with the centre of the bracket (Bracket should fit over the inside panel and rubber trim). Drill the marked popper position through the bracket (5/32" drill size). Refer to figure160.

**Figure 163: Arm rest bracket**



**13.5) Exterior mirrors**

**NOTE**

*After the IVA inspection, the mirrors may be fitted to the side screens but in order to pass IVA inspection, the mirrors must be fitted to the windscreen stanchions.*

**13.5.1) Fitment to screen stanchion**

Remove and retain the central, slot-head screw, in the screen stanchion and screw in the IVA mirror stalk adaptor, refer to Fig

165. Fit a fibre washer and the mirror stalk over the adaptor and tighten the grub screw to secure the stalk (ensure that the large recess in the stalk faces rearwards).

**Figure 164: IVA mirror stalk adaptor**



- 1. IVA protector (1/2 grommet)
- 2. Mirror stalk adaptor
- 3. Hinge

Remove the mirror head from the original stalk noting the relationship of all parts. Assemble the mirror head to the IVA stalk and adjust as required (retain the remains of the original mirror for use post-IVA).

### 13.5.2) Fitment to side screens

Exterior mirrors are fitted to the sidescreens, towards the front, just below the clear window panel. Locate the holes pre-drilled in the metal frames (approximately 130 mm from front corner and 104 mm apart) then drill through the material with a sharp 5 mm drill. Attach the mirrors to the hidden metal frame of the sidescreen using the countersunk screws (6), washers (14) and secure with nyloc nuts (13).

**Figure 165: Mirror fitted to side screen**



- 1. Mirror
- 2. Hinges
- 3. Screen stanchion

Plastic M5 caps (polythene bag marked 'IVA') should be fitted to the nuts securing the mirror to the sidescreen. These can be secured in place using a little silicone sealant.

### 13.6) Boot cover

When correctly fitted, the boot cover should be as shown in Figure 167.

**Figure 166: Boot cover**



The boot cover is designed to attach permanently to the top of the bulkhead behind the seat and clip onto the same fasteners as those provided for the hood at the rear of the car. It is designed to fit over the hoodsticks when not in use therefore it is essential that these are fitted prior to fitting the boot cover. When the hood is erected, the boot cover is folded away and stored in the boot.

The boot cover is designed to fit around the roll bar, since these vary according to specification, ensure the correct boot cover has been supplied. There is a special boot cover designed for use with the roll cage.

#### **NOTE**

*For cars fitted with harness type seat belts go to 'Note' in Boot cover section.*

All boot covers have a metal insert along the forward edge, with pre-drilled holes to locate the fastener bases. The forward edge of the boot cover should align with the front edge of the seat bulkhead. Ensure that the boot cover is centrally located and mark the holes through the forward edge of the boot cover. Drill a 7/64" hole through each marked location and fit a popper base (fastener pack ZBC02 Item 5) secured with a self-tapping screw (6).

If harness type seat belts are being fitted the metal insert in the boot cover must be removed. Align the boot cover as previously described and mark the location of the four threaded bosses. Punch a hole in each of the marked locations and fit the harness shoulder strap securing bolts through the boot cover.

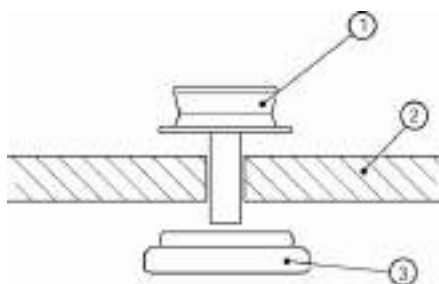
Additionally fit four fasteners (5) using screws (6) in the following locations; one fastener 1 1/4" either side of the car centreline and one fastener at the midpoint between each pair of shoulder restrains. If a tonneau cover is to be fitted, the position of the fasteners will have to be adjusted accordingly.

Stretch the boot cover over the luggage area. Secure around the rear stays of the roll over bar using the Velcro and

establish locations for the remaining fasteners (boot cover fastens to the hood fastenings on the body). Fit the popper bases (3) and buttons (4) starting from the rear centre working outwards and then forwards.

If a tonneau cover is to be fitted then the forward button on each side is substituted by a popper base (fastener pack ZTC01 Item 6), assembled as shown in Fig 167 and fitted to the fastener socket (4) using the punch provided (for correct usage of fastener fixing tool refer to figure 172).

**Figure 167: Forward fastener boot cover**



1. Popper base
2. Boot cover
3. Fastener socket

### 13.7) Tonneau cover

When correctly fitted the tonneau cover should be as shown in Figure 169.

**Figure 168: Tonneau cover**



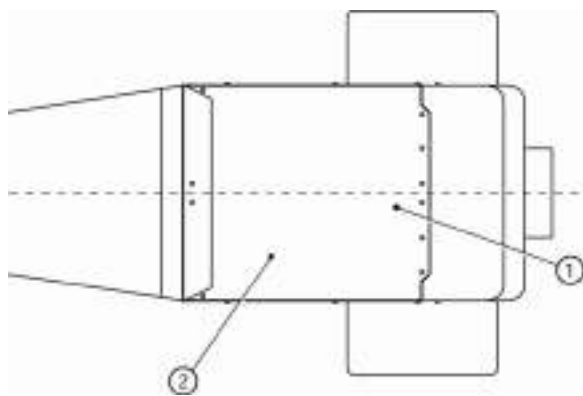
Before the tonneau cover can be fitted both the boot cover and seat belts must be installed and the detachable head restraints must be removed. The tonneau cover should be fitted with the steering wheel in place. However, if a Quick Release (QR) column has been specified to function as an anti-theft device and is intended to be removed when the car is unattended then this should also be removed prior to fitting the tonneau.

Carefully align the tonneau along the centre line of the car and stretch it so that there is about 25 mm of tonneau ahead of the fasteners fitted to the centre of the scuttle. Mark and fit two fasteners (4) and buttons (5) in the tonneau to correspond with these fasteners.

Carefully measure the positioning of the rear edge of the tonneau relative to the fastener bases securing the front of the boot cover ensuring that the rear edge of the tonneau is exactly parallel to the seat bulkhead and it is properly centred, refer

to Fig 170. Mark the position of the fastener bases and fit the six fasteners (4) and buttons (5) across the back. It is important that these fasteners are located correctly as these set the correct tension for the whole cover. It should not be stretched so tight that it puts tension on the fittings, bearing in mind it will not stretch so well in cold weather, nor so loose as to allow water to collect on it.

**Figure 169: Tonneaucover positioning**

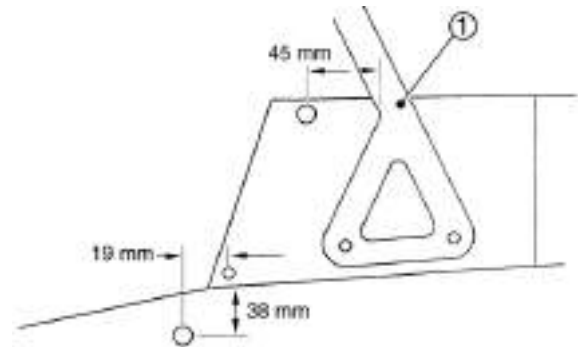


- 1. Tonneau cover
- 2. Boot cover

Starting with the passenger side, mark and drill a 5/32" hole and fit a further fastener (3) securing the rivet (1) on the scuttle 45 mm inward from the lower edge of the windscreen support where it joins the triangular base, refer to Fig 171. Stretch the tonneau carefully into position taking care to pull the tonneau far enough forward to achieve a little clearance in front of the rear wing, mark and drill a 5/32" hole and fit a further fastener (3)

securing with a rivet (1). Fit a fastener (4) and button (5) in the tonneau to correspond.

**Figure 170: Tonneau cover fasteners (front)**



- 1. Windscreen support

Mark and drill a 5/32" hole and fit a further fastener (3) securing with rivet (1) 38 mm below the rear lower edge of the scuttle, 19 mm rearward of the centreline of the large scuttle securing rivet. Stretch the tonneau and secure with a fastener (4) and button (5).

Mark, drill a 5/32" hole and fit a further fastener (3) securing with rivet (1) 50 mm down from the top rear of the sill and 45 mm forward of the wheel arch. Pull down the tonneau and secure with a fastener (4) and button (5).

Unzip the tonneau when fitting the fasteners to the driver's side, leaving the rear fasteners in place along the seat bulkhead. Repeat the fitting procedure as per the passenger's side taking care to

stretch the tonneau away from the vehicle centreline, towards the windscreen stanchion just sufficient to prevent bagginess in front of the steering wheel).

Fastening the zip will correctly tension the tonneau.

#### NOTE

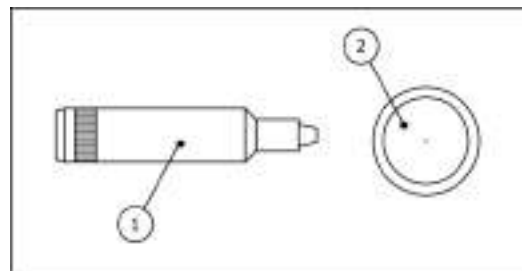
*If a roll cage is fitted, additional fasteners must be fitted to the body to match the tonneau cover fasteners on either side of the Velcro-fastened splits for the roll cage forward supports.*

### 13.8) Correct usage of fastener fixing tool

The fastener tool, Figure 172, consists of two parts; the dished base part and the punch.

- Place the base on a solid surface dished side upwards
- Put the fastener button through the material and rest it in the dished part of the base
- Then place the fastener socket over the tube part of the button so that the cupped section is facing upwards
- Place the punch on the end of the tube and hit it with a hammer until the tube has peened over gripping the two parts together

**Figure 171: Durable Dot fastener tool**



1. Punch
2. Dished base



## 14.0) Wheel fitment

### Warning

#### **Re-tighten wheel nuts after 200 mile.**

Some Caterham supplied alloy wheels are fitted with steel inserts enabling secure tightening of the wheel nuts. The wheel nuts can settle into the wheels over the first few hundred miles causing loss of torque so should be re-tightened to the correct torque after approximately 200 miles.

Many of the tyres supplied by Caterham are directional. Check that the tyre orientation is correct before fitting the wheel to the car.

Fit the wheel using the wheel nuts provided ensuring that the cone on each wheel nut is correctly located in the wheel. The wheel nuts should not be over tightened. It is recommended that they are tightened whilst the car wheels are on the ground. Tighten wheel nuts to 74 Nm.

Fit the wheel centre caps as follows:

**13", 14" and 15" wheels.** Placing wheel centre cap into wheel and pushing fully home ensuring correct seating.

#### **14.1) Spare wheel fitment**

*NOTE*

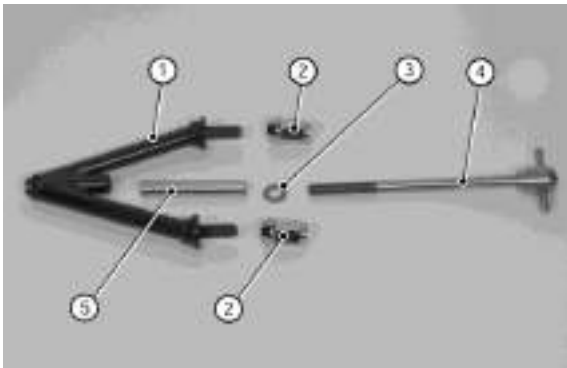
*If specified for your kit, the spare wheel carrier will have been fitted at the factory.*

Locate the mounting wishbone, Figure 173 (1) (polythene bag marked 'spare wheel') and secure to the spare wheel using two wheel nuts (2). The wishbone should be placed on the inboard side of the spare wheel.

Place the spare wheel in the spare wheel carrier with the point of the mounting wishbone inboard of the wheel. Care must be taken to avoid damage to the paintwork whilst locating the spare wheel.

Assemble the spare wheel bolt (4), fibre washer (3) (located in polythene bag marked 'miscellaneous') and spacer (polythene bag marked 'spare wheel') (5). Secure the spare wheel to the car using the assembled spare wheel bolt through the centre of the mounting wishbone. Ensure wheel nuts and spare wheel mounting bolt are tight.

**Figure 172: Spare wheel mounting items**



1. Mounting wishbone
2. Wheel nuts
3. Fibre washer
4. Spare wheel bolt
5. Spacer

**NOTE**

*13" wheels fitted with low profile tyres are secured to the spare wheel boss using a single bolt and spacer located through one of the wheel stud holes.*

## 15.0) Start up procedure and final checks

This section details the operations, adjustments and checks that should be carried out prior to starting the car for the first time. **Refer to your Owner's Handbook for recommended lubricants and capacities.**

### 15.1) Brake system – filling and bleeding

Prior to filling the brake master cylinder recheck all brake connections, including factory fitted connections, from the brake master cylinder to each calliper and ensure that they are properly tightened.

#### Warnings

- 1. Brake fluid is poisonous; wash affected areas immediately in case of skin contact and seek medical assistance if fluid is swallowed or enters the eyes.**
- 2. Brake fluid is hygroscopic. Ensure that fluid comes from freshly opened container.**
- 3. Brake fluid is corrosive to paintwork, powder coat and plastic components. Care should be taken to avoid spillage at all times.**

Remove the brake master cylinder cap and protect the surrounding scuttle

paintwork with clean cloths to prevent possible fluid leakage from causing damage to the paintwork.

Ensure all bleed nipples on the callipers are closed then fill the brake master cylinder with fresh brake fluid that complies with SA3J 1703F DOT 4 specification. Replace the master cylinder cap.

#### *15.1.1) Standard brakes*

Remove and retain the dust cap from the LH rear brake calliper bleed screw. Place a length of flexible hose over the bleed screw and place the other end of the tube into a clean glass container and pour in sufficient brake fluid to cover the end of the tube.

Depress the brake pedal several times to build up pressure and maintain pressure on the brake pedal.

With pressure maintained on the brake pedal unscrew the bleed screw and allow the compressed air and brake fluid to flow into the container. Tighten the bleed screw before the brake pedal is released repeat this process until no more air bubbles can be seen in the brake fluid.

#### *NOTE*

*Ensure brake fluid level remains above half full level in the brake master cylinder.*

Tighten bleed screw and remove flexible hose. Replace dust cap. Carry out the procedure in the following sequence. RH rear calliper, LH front calliper and finally RH front calliper.

As the rear callipers can be difficult to bleed, it may help to gently tap the calliper body during the bleed process to release trapped air pockets.

It may be necessary to repeat the brake bleed procedure several times before a firm high brake pedal is achieved.

#### *15.1.2) Uprated front brakes*

The uprated front callipers are usually supplied without the brake pads fitted. Before bleeding the system fit the brake pads into the calliper such that when viewed from the rear of the calliper the curve of the brake pad follows the shape of the disc.

#### *NOTE*

*The front wingstays obstruct access to the uprated callipers. Ensure that the brake pads are installed before fitting the wingstays.*

Fit the anti-rattle clips behind the retaining pin (between the pin and the pads/disc). Rotate the disc and ensure that the anti-rattle clip does not contact the disc at any time.

#### *NOTE*

*Ensure that the arrow on anti-rattle clip points in the direction of wheel rotation.*

Bleed the brake system observing the same order as for the standard brakes.

The uprated front brakes have two bleed screws on each calliper. Remove the dust cover from the inboard bleed screw on the front LH calliper. Connect the flexible tube to the bleed screw and operate the brake pedal several times. Whilst mounting pressure on the brake pedal open the bleed screw and allow compressed air and brake fluid to flow into the container. Tighten the bleed screw before the pedal is released. Repeat the procedure until no air bubbles are visible in the released brake fluid. Remove the flexible tube and replace the dust cap. Carry out the procedure for the outboard bleed screw.

As a final check on system integrity, apply pressure to the brake pedal and check all connections and bleed screws for any sign of leakage.

Initially brake pedal travel may seem excessive despite the system being fully bled. However, the system will improve as the pads bed to the discs during the first 500-1000 miles.

## 15.2) Clutch system – filling and bleeding

Prior to filling the clutch master cylinder, check all connections to ensure that they are properly tightened.

### Warnings

- 1. Brake fluid is poisonous; wash affected areas immediately in case of skin contact and seek medical assistance if fluid is swallowed or enters the eyes.**
- 2. Brake fluid is hygroscopic. Ensure that fluid comes from freshly opened container.**
- 3. Brake fluid is corrosive to paintwork, powder coat and plastic components. Care should be taken to avoid spillage at all times.**

Remove the clutch master cylinder cap and protect the surrounding scuttle paintwork with clean cloths to prevent possible fluid leakage from causing damage to the paintwork.

Locate the bleed nipple/key on the gearbox bell-housing (refer to Fig 174) and remove the bleed nipple cover.

Ensure that the bleed key is in the position shown in Fig 174 (rotated fully clockwise) and fill the clutch master cylinder reservoir with fresh brake fluid that complies with

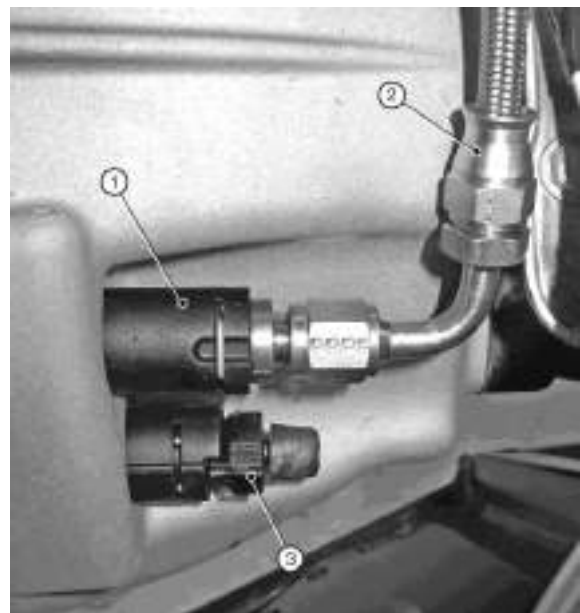
SA3J 1703F DOT 4 specification.

Replace the master cylinder cap.

Rotate the bleed key counter-clockwise until it stops and place a length of flexible hose over the bleed screw and place the other end of the tube into a clean glass container and pour in sufficient brake fluid to cover the end of the tube.

Pump the clutch pedal until good pressure is felt and clear fluid, free of air bubbles, flows from the bleed nipple. Rotate the bleed key fully clockwise, remove the pipe and replace the bleed nipple cover.

**Figure 173: Clutch hydraulic connections**



1. Pipe to master cylinder
2. Push-fit connector
3. Bleed key

Mop up any spilled fluid, check for clutch 'feel' and correct operation (repeat the bleeding procedure if necessary); finally, hold down the clutch pedal and check for leaks.

#### NOTE

*All sigma and Duratec cars are fitted with throttle and clutch pedal stop.*

*For Duratec cars the clutch bleed nipple is under the plate on top of the bellhousing.*

**1. Throttle stop:** *The adjustment of the stop is critical in order to obtain full throttle at the throttle body end. Reaching down into the footbox, press the throttle pedal until the butterfly is fully open then adjust the throttle stop up to the back of the pedal ball. This may take some time to get the correct adjustment. It is desired not to have any cable stretching at full throttle (when butterfly is fully open and pedal touches stop).*

**2. Clutch pedal stop:** *the adjustment of the Clutch stop is critical in order to obtain full clutch operation. The clutch pedal is adjusted to the require length but it might require fine tuning considering slight variation on different cars. This may take some time to get the correct adjustment.*

### 15.3) Coolant

Check all coolant hose securing clips are tight and that the coolant level is visible in the coolant expansion bottle.

### 15.4) Fuel

#### Warning

**Due consideration should be given to the highly flammable nature of petroleum or alcohol-based products and their vapours. Serious burns can result from incorrect use.**

Check the security of the push-fit fuel pipe connection at the fuel rail.

Remove the fuel filler cap and add 15 litres of unleaded petrol to the fuel tank.

### 15.5 Engine/gearbox fasteners

Check that all engine and gearbox mounts and fasteners are tight.

### 15.6) Gearbox oil

#### Warnings

**Oils - prolonged and repeated contact may cause serious skin disorders.**

**1. Avoid contact with the skin as far as possible and wash thoroughly after any contact.**

**2. Keep out of reach of children.**

**3. First aid treatment should be obtained for open cuts and wounds.**

#### 4. Use appropriate barrier creams.

Remove the gearbox oil filler plug (if not removed earlier) using the cut down 3/8" Allen key.

Add approximately 2 litres of gearbox oil to the gearbox until it dribbles out of the filler hole. Replace the filler plug.

Due to the restricted access it may help to make a filling tube using a small funnel and hose.

#### New 2014 5 speed Caterham gearbox.

You must use special oil for this gearbox GL-4 or GL-5 and is SAE 75W-90.

You need to put 1.6 litres of oil into the gearbox via the filler plug on the top. There is a level plug on the left hand side and 300ml into the gear lever hole.

#### 15.7) Engine oil

The capacity of the engine oil system will vary dependent upon the specification of the vehicle. Refer to Table 27 for an initial fill quantity which is sufficient to start and run the engine at idle before checking and topping up as detailed in your Owner's.

**Table 27: Engine oil initial fill**

Engine type	Initial fill Qty
Wet sump	4.5 litre
Dry sump	6 litre

With all variants the engine oil should be filled via the screw cap on the top of the engine. Remove the cap from the cam cover and slowly pour in the oil allowing time for the oil to run to the bottom of the engine. Replace the cap and tighten by hand only.

Check around the engine area both under the vehicle and within the engine compartment for any visible leaks (oil or coolant). Check all wiring and hoses to ensure that they are correctly located particularly near any moving parts, for example, alternator or cooling fan.

#### 15.8) Cranking for oil pressure

Before running the engine for the first time it is recommended that the following sequence is carried out. This will ensure that the oil system is capable of delivering lubricant throughout the engine.

- Apply handbrake and check that the gear lever is in the Neutral position
- Disconnect the wires from the inertia switch, located on the bulkhead above the ECU
- Operate the ignition switch to crank the engine over until oil pressure registers on the gauge (oil pressure will be low due to the speed of the engine when turned by the starter motor).

## NOTE

*It may be necessary to turn the engine over for 30-40 seconds to achieve oil pressure. Once oil pressure has been achieved, switch OFF ignition and reconnect the inertia switch. Press down on the rubber button on top of the inertia switch to ensure that it has been de-activated.*

### 15.9) Start up

Apply handbrake and check that the gear lever is in the Neutral position.

#### Warnings

**1. The electric radiator fan is controlled by a thermostatic switch which operates when the ignition is in the on position. whilst working on a hot engine ensure that the ignition is switched off.**

**2. Do not remove coolant expansion bottle cap whilst coolant is hot. Take precautions to prevent scalds.**

Check under the car to ensure that there are no visible leaks. De-activate the immobiliser.

Turn the ignition key to position II and listen for the fuel pump to prime. If no sound is heard, switch OFF the ignition and reset the inertia switch by pressing the rubber button on top until it clicks.

Turn ignition key to position II again and the pump should now prime.

Turn the ignition switch to position III so that the engine turns over until the engine starts. Some models are fitted with a pushbutton starter switch. If this is the case on your vehicle turn the ignition switch to position II (red ignition light ON) and depress the button to operate the starter motor.

Do not allow the engine to run for more than one minute without checking the oil level. Using the dipstick as a level, top up the oil system until oil is visible between the 'Min' and 'Max' marks. This will ensure enough oil is in the engine to perform the initial run and warm up. The final check for the engine oil level will be performed later in this Section. Check around and under the engine for any visible signs of leaks.

Once you have checked and topped up the oil level as required, restart the engine and leave running until it is warm. Ensure that the oil pressure gauge continues to indicate 2 bar (29 psi) or above at idle.

Allow the engine to run until the cooling fan cuts in (this should be at approximately 92°C). Switch off the engine.



**NOTE**

*Should the temperature exceed 92 °C without the cooling fan cutting in, switch OFF the engine immediately to avoid damage. Contact the Caterham technical helpline, as it is possible that there is an air lock in the cooling system.*

Check the car for visible leaks. Re-check the hose clips for tightness as the rubber hoses become softer when warm.

Finally check the engine oil as detailed in the Owner's Handbook ensuring the instructions for the correct engine specification are followed. If in any doubt please contact Caterham cars.

**15.10) Front suspension and steering alignment**

The front suspension is adjustable for both camber and castor angles. The top wishbones normally come from the factory pre-adjusted although you may wish to reset or change the basic settings. Factory recommended settings are shown in Table 28.

**Table 28: Recommended suspension alignment - road use standard and wide track**

	Front	Rear
Tracking	0° 20' ± 0° 10' Toe-In	N/A
Camber	1° 20' ± 0° 15' (Negative)	1° 30' ± 0° 15' (Negative)
Castor	4° 00' ± 1° 00' (0° 20' variation left to right, front)	

Increased negative camber will tend to improve the car's turn in characteristics in fast corners but at the expense of possible tramlining on uneven surfaces and uneven tyre wear under normal conditions. The factory settings should therefore be adhered to except where the car is being prepared for motor sport.

The adjustment of castor is achieved by moving the lower front wishbone backwards or forwards in the chassis using spacing washers, therefore altering the effective kingpin angle in side elevation. Increasing the angle away from vertical will produce more pronounced self-centring of the steering and hence a greater feeling of stability, but at the expense of heavier steering.

Initial toe-in settings (standard track) for driving to a service agent for post build checking can be set visually by ensuring the outside edge of the front tyres lines up

with a point on the rear tyres ~ 50 mm in from the outside edge, with the steering wheel centred. This approximate setting will not cause either dangerous handling or unnecessary tyre wear for limited initial mileage. Initial tracking of wide track cars can be set by visually aligning the outside edges of the front and rear wheels.

It is recommended that distinctly different settings are used for race, hill climb or sprint applications. Caterham can provide a range of anti-roll bars and a competition parts brochure is available from the Parts Department at the factory.

### 15.11) Final checks

#### Warning

#### **Re-tighten wheel nuts after 200 miles**

The wheel/tyre combinations supplied by Caterham, are pre-inflated to approximately 40 psi (2.8 bar) to ensure that the tyre is correctly seated on the wheel rim and must be reduced prior to driving. Tyre pressures should be checked in accordance with Table 29.

**Table 29: Tyre pressures**

Wheel type	Tyre type/size	Front (psi)	Rear (psi)
6J x 13	ACB10 6 x 20	18	18

	x 13		
6J x 13	CR500 175/55 x 13	18	18
6J x 14	AVON 185/60 x 14	20	20
6½J x 13	CR500 175/55 x 13	18	-
8½J x 13	CR500 205/55 x 13	-	20
6½J x 15	CR500 195/45 x 15	18	18

Some tyres supplied by Caterham are directional. As a result any spare tyre supplied will only be treaded in the correct direction for one side of the car. If the spare tyre needs to be fitted to the side where the rotation is incorrect this should be done only as a means to get you home and must be rectified before any further use of the vehicle. Ensure that the tyres are fitted with the correct orientation.

Ensure that no wires or brake hoses are in such a position to chafe or to contact moving or hot components. Particular care should be taken with wires close to the exhaust manifold.

Before the car is used, ensure that all bolts securing suspension, steering and brakes are properly tightened, refer to Table 30.

**Table 30: Torque figures for final checks and start up procedure**

Location	Washers	Torque Nm
Front lower wishbone front	Spring and plain	81
Front lower wishbone rear	Plain spacer	81
Front upper wishbone front	N/A	34
Front upper wishbone rear	N/A	34
Front spring damper top	Spring and plain	20
Front spring damper bottom	Loctite	20
Upright top ball joint	N/A	54
Upright bottom fixing	Spacer (widetrack only)	54
Front anti-roll bar clamps	N/A	20
Steering rack clamps	Plain under bolt head	11
Steering column universal joint	N/A	20
Steering column clamp plate	Spring and plain under bolt head	14
Track rod end to upright	N/A	34
Upper differential mounting	Plain under bolt head and nut	54
Lower differential mounting	Plain under bolt head	54
Propshaft	N/A	74
Rear spring damper top	N/A	54
Rear spring damper bottom		54
Watts link locknut		20
Bellcrank to link		14
Watts link rear mount		34
Watts link front mount		34
Bell crank to De Dion		34
Radius arms		34
'A' frame	N/A	81
Hub nuts	Thrust	270
Hub mounting	N/A	47
Brake calliper	Plain and spring	47
Rear anti-roll bar clamp	Plain under bolt head and spring under nut	14
De Dion ears	Plain and spring	47
Gearbox to bell housing	Spring under bolt head	47

Gearbox mount	Spring under bolt head	61
Engine to bell housing	Spring under bolt head	47
Bell housing to sump	N/A	20
Starter motor	Spring under bolt head	34
LH engine mounting bracket	Spring under bolt head	34
RH engine mounting bracket	Spring under bolt head	34
Engine mounting rubbers	Plain between chassis and nut	20
Engine mounting to rubbers	Spring under bolt head	41
Gearbox mount to chassis	Plain between chassis and nut	20
Exhaust manifold	N/A	34
Expansion tank bracket	Plain under bolt head and nut	10
Gear-lever to tail housing	N/A	20
Brake banjo bolt	Copper washer each side of banjo	10
Brake unions	N/A	10
Seat belt/harness bolts	See assembly instructions	47
All roll over bar fixings	See assembly instructions	20
Petty bar	See assembly instructions	47
Wheel nuts (2 part nut and tapered washer)	N/A	74

## **16.0) Individual vehicle approval and registration**

All Caterham cars will have to be inspected under the IVA regulations in order to be registered for road use.

The inspectors have all been trained to the same standard but may interpret certain regulations differently. Each test station will have received a detailed explanation of what a Caterham is and what European regulations it complies with. The inspectors therefore should have reasonable product knowledge and have a contact number at Caterham if required.

It is recommended that the car is presented in a clean condition as this will greatly improve the inspector's demeanour.

It is also advisable to take an emergency kit with you to the test station. This should consist of a basic toolkit, cable ties, push on trim and a length of rubber hose. In the event of components needing tightening for adjustment or a non-compliance, the emergency kit may save you taking the car away and having to re-present it at a later date.

You should remember that any modification made to the car subsequent

to passing the IVA inspection may prevent it from passing an MOT at a later date. For example if a competition exhaust is fitted the original catalyst equipped system would need to be retained in order to meet MOT emission standards. The MOT is an inspection of the vehicles condition and will be carried out in the same manner as for normal production cars. Items such as internal/external projections, noise and fields of visibility will not be inspected at an MOT.

### **16.1) Requirements**

The following items are checked under the IVA inspection:

- Anti-theft Devices
- Defrosting and Demister System
- Wiper and Washer System
- Seats and their Anchorages
- Seat Belts
- Seat Belt Anchorages
- Installation of Seat Belts
- Interior Projections
- Radio Interference Suppression
- Glass and Glazing
- Lamp, Reflectors and Devices
- Rear View Mirrors
- Tyres
- Exterior Projections
- Protective Steering
- Vehicle construction and design
- Brakes

- Noise
- Exhaust Emissions
- Speedometers

The examiner will conduct an engineering assessment rather than the more thorough test that full European Type Approval entails. In some cases (brakes, noise, emissions etc.) there will be a physical test either on a rolling road or within the grounds of the test centre.

The inspection will not require any part of the car to be dismantled and will be carried out at Vehicle Inspectorate test stations.

The inspection is anticipated to take approximately four hours and can be booked between 0800-1700 Monday to Thursday or 0800-1630 on Friday. There is a fee payable for this service. An additional fee will be charged if an inspection is required outside these hours.

### **16.2) How to apply for the inspection**

The inspection has to be formally booked in advance therefore you must:

- Obtain an application form from your local Vehicle Registration Office (VRO) or Vehicle Inspectorate Office (HGV Station).

- Complete the form and return it along with the test fee to:

IVA section  
The Vehicle and Operators  
Services Agency  
91/92 The Strand  
Swansea  
SA1 2DH

0870 6060 440  
<http://www.vosa.gov.uk>

You will then receive confirmation of the inspection which will give details of the time and location. Where possible the inspection will be carried out at the Vehicle Inspectorate test station you have selected.

### **16.3) Inspection refusal**

The test station may refuse to inspect your car for the following reasons:

- You arrive at the test station later than your appointment time
- You have not paid your fee
- There is insufficient fuel or oil for the test. You will be required to have a **full** tank of fuel
- The car is presented in a dangerous or such a dirty condition that the test is not feasible
- A device designed to be readily opened cannot be opened (e.g. bonnet padlocked)

- The vehicle presenter does not remain with the car to operate controls etc. as requested

## **16.4) Inspection data**

### *16.4.1) Design weight*

You will be asked to specify the maximum gross weights and maximum permitted axle weight during your application for a test date. This will then be checked by weighing the car without passengers and luggage (kerb weight) and then using a formula to calculate the theoretical gross weight. The following weights should be quoted for all models:

Maximum Gross Weight – 860Kgs

Maximum Permitted Front Axle Weight – 360Kgs

Maximum Permitted Rear Axle Weight – 500Kgs

### *16.4.2) Towing*

It is not recommended that the Seven is used for towing, therefore, when asked the question; the answer is 'Not Applicable'.

### *16.4.3) Speedometer*

The speedometer is compatible with this vehicle.

## **16.5) Checking and preparing the car prior to inspection**

It is recommended that the checks and operations detailed in the following paragraphs are completed prior to taking the car for the inspection.

### *16.5.1) Wiper and washer system*

Carry out a full system check prior to the inspection. Ensure the screen washer bottle is full, the wiper blades contact the windscreen and the washer jets are correctly adjusted. Ensure all hoses are secure as the system will be checked under pressure.

### *16.5.2) Radio interference suppression*

Caterham supplied ignition leads are suppressive. If you choose not to use the Caterham supplied ignition leads and have supplied your own leads, ensure they are clearly marked as suppressive.

### *16.5.3) Lamps, reflectors and devices*

If you have built your car using the components and information supplied, the car will comply with IVA lighting requirements. Ensure that repeater indicators are fitted to the front wings.

### *16.5.4) Rear view mirrors*

These should be set up for maximum visibility. Ensure that the windscreen mounted mirror and both screen stanchion mirrors are in place. It is also worth removing the hood, or arriving without it

altogether, as this improves both visibility and access.

#### *16.5.5) Noise*

Tailpipe noise will be tested. Though the silencer is brand new, the efficiency is increased when the internal packing has expanded against the inner wall. It is therefore recommended that you allow the car to idle as much as possible prior to taking the car to the test centre. This will also allow a layer of soot to settle which will help deaden the 'ring' of the new silencer.

#### *16.5.6) Emissions*

All Caterham cars are supplied with catalytic converters and will meet the test requirements.

#### *16.5.7) General construction*

This should be checked at the Post Build Check stage, however if you are not using that service ensure that chafing of brake pipes and the wiring looms is not possible. If you have followed the procedures detailed in the Assembly Guide then you should not have any problems at this stage of the inspection.

#### *16.5.8) Protective steering*

All standard Caterham steering wheel types have a removable pad fitted. This

pad must be in place during the inspection.

#### *16.5.9) Brakes*

The braking system will be subjected to a thorough test (on brake rollers) so it is imperative that you take the time to bleed the brakes correctly. The performance of the brakes often improves dramatically after a small amount of use. Frequent application of the brakes on the way to the test centre will help the brakes bed in.

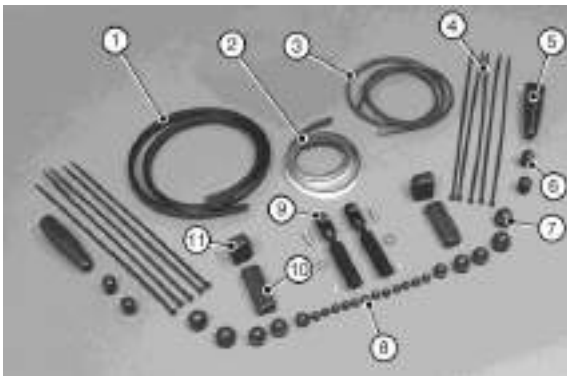
Ensure the handbrake is correctly adjusted and does actually lock the rear wheels.

#### *16.5.10) Interior and exterior projections*

Supplied with the kit is a polythene bag marked 'IVA', refer to Figure 175. It is essential that these items are fitted prior to presentation at the IVA Testing station.



**Figure 174: IVA bag contents**



- |                     |                                   |
|---------------------|-----------------------------------|
| 1. Scuttle trim     | 7. Bolt head covers               |
| 2. Foam tape        | 8. Nut covers                     |
| 3. Edge trim        | 9. IVA mirror stalks and fittings |
| 4. Cable ties       | 10. Rear bonnet catch cover       |
| 5. Track rod sleeve | 11. Front bonnet catch cover      |
| 6. Flexible covers  |                                   |

Ensure that the scuttle edge trim (Figure 176 Item 1) is fitted to the edges of the scuttle around the dashboard.

**Figure 175: IVA scuttle trim and battery master switch**



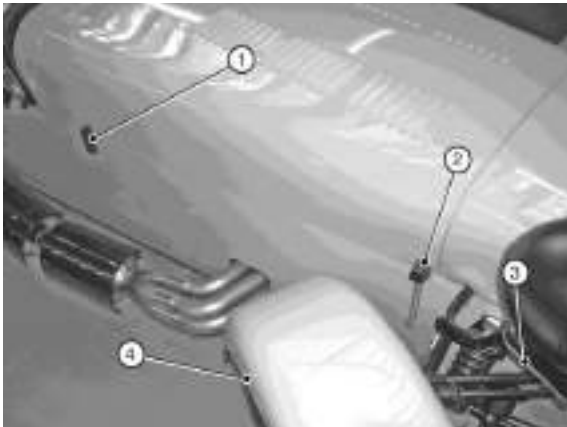
1. Scuttle edge trim
2. Eyebrow edge trim
3. IVA cover
4. Battery master switch sheath
5. IVA cover (optional roll cage)

Apply the self-adhesive Velcro strips around the sides and bottom of the fuse box cover. Attach the other half of the Velcro fastening to the Velcro already attached to the fuse box cover. Locate the cover over the fuse box sticking it in place. (R400 only).

The edge trim should also be secured to the edges of the front cycle wings (Fig 177 Item 4), the edge of the black plastic housing around the rear fog and reverse lights and the edges of the indicator cones. Cars fitted with the detachable wind deflector will also require edge trim along the top edge of the deflector and around the edges of the mirrors.

The caps (Figure 178 Item 3) should also be fitted to the nut and bolt head of the top wishbone front mounting.

Figure 176: Bonnet catches



1. Rear bonnet catch cover
2. Front bonnet catch cover
3. Edge trim (indicator cone)
4. Edge trim (cycle wing)

The bonnet catch covers (Figure 177 Items 1 and 2) should be pushed over the respective bonnet catch. The covers (Figure 175 Item 7) should be fitted to the shoulder strap mounting bolts (Only required if this 4 or 6-point harness option is specified). The sleeves (Figure 178 Item 1) should have been fitted over the track rodlocknuts during the front suspension build.

Figure 177: Front suspension



1. Track rod sleeve
2. Stub axle cover
3. Steering arm nut cover
4. Track rod end nut cover

Covers (Figure 178 Items 2, 3 and 4), should be fitted over the inner stub axle nuts, the steering arm nuts, the track rod end nuts and the two wheel nuts that hold the spare wheel to the spacer wishbone (if fitted). Covers (Figure 179 Item 1) should be fitted to the exposed nuts securing the exhaust bobbin and the exhaust bracket and an off-cut of scuttle edge trim should be fitted to the upper edge of the exhaust silencer bracket.

Figure 178: Exhaust mounting



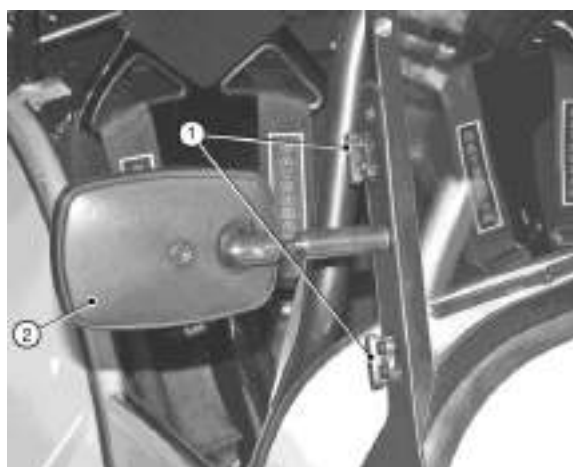
The sharp edge of each side screen hinges should be protected as shown in Fig 180. The protectors are made by cutting grommets in half and fixing them in place with superglue.

#### NOTE

*The hinge halves fitted to the side screens must be protected in a similar manner.*

Road wheels are exempt from external projections with the exception of the spare wheel. Ensure the wheel is positioned such that any balance weights are behind the spare wheel carrier.

**Figure 179: Side screen hinges**



1. Grommets
2. Rear view mirrors (IVA position)

#### 16.5.11) Race cars and IVA

There are several parts that are mandatory on race cars which are not IVA friendly. Ideally these parts should be fitted after the car has been submitted for its IVA test but if this is not possible then

these parts will need to comply with the IVA criteria.

**Fire Extinguisher.** The 'T' handle that operates the fire extinguisher will need to be removed and the boss in the dash covered.

**Track day roll over bar/roll cage.** All fixings will need to be covered. If the track day roll over bar petty strut is supplied this will need to be removed and the hole in the side panel must be covered.

**Battery Master Switch.** The edges of the master switch key will not pass IVA; a rubber sheath for the key is included in the IVA kit and this must be fitted for the test. The eyebrow must be fitted with edge trim and the fixing bolts will need protective caps, refer to Figure 176.

#### 16.6)Registration procedure after IVA inspection

If your vehicle fails the IVA inspection for any reason you will be allowed to take the car away to rectify it.

Upon successful completion of the IVA inspection you will be issued with a certificate to confirm that the car has passed to the standard required. This certificate is officially called a Minister's Approval Certificate (MAC) and must be retained. In order to register your car you must submit the MAC, a completed

application for registration form (currently V55/5), insurance certificate and your certificate of newness (with full CKD De Dion kits only) along with your Vehicle Excise Duty (VED) fee for either six months or twelve months to your local Vehicle Registration Office (VRO). In addition a registration fee will be levied by

DVLA to cover administration costs throughout the vehicle's life (sending out VED reminders etc.).

The car will be subjected to an MOT inspection three years after it was first registered.

## **16.7) Location of vehicle inspection test stations where the IVA test can be carried out**

### **Aberdeen**

Cloverhill  
Bridge of Don Industrial Estate  
Aberdeen AB23 8EE  
01224 702357

### **Beverley**

Oldbeck Road  
Off Grovehill Road  
Beverley  
East Yorkshire HU17 0JG  
01482 881522

### **Birmingham**

Garretts Green Industrial Estate  
Birmingham B33 0SS  
0121 783 6560

### **Bristol (Avonmouth)**

Unit 10, I.O. Centre  
Poplar Way West  
Avonmouth  
Bristol BS11 0QL  
01179 381157

### **Cardiff (Llantrisant)**

School Road  
Miskin  
Pontyclun  
Mid Glamorgan CF72 8YR  
01443 224701

### **Carlisle**

Brunthill Road  
Kingstown Industrial Estate  
Carlisle CA3 0EH  
01228 528106

### **Chelmsford**

Widford Industrial Estate  
Chelmsford  
Essex CM1 3DR  
01245 259341

### **Derby**

Curzon Lane  
Alvaston  
Derby DE21 7AY  
01332 571961

### **Exeter**

Grace Road  
March Barton Trading Estate  
Exeter  
Devon EX2 8PU  
01392 278267

### **Gillingham**

Ambley Road  
Gillingham  
Kent ME8 0SJ  
01634 232541

### **Glasgow (Bishopbriggs)**

Crosshill Road  
Bishopbriggs  
Glasgow G64 10A  
0141 772 6321

### **Leighton Buzzard:**

Stanbridge Road  
Leighton Buzzard  
Bedfordshire LU7 4QG  
01525 373074

### **Liverpool (Speke):**

C/O South Liverpool Commercials  
Woodend Avenue  
Speke  
Liverpool L24 9NB  
0151 4860050 or 0151 5474445

### **London–North (Edmonton)**

Anthony Wharf  
Lea Valley Trading Estate  
Edmonton N18 3JR  
020 8803 7733

### **London–South (Mitcham)**

Redhouse Road  
Croydon  
Surrey CR0 3AQ  
020 8684 1499

### **London–West (Yeading)**

Cygnets Way  
Willow Tree Lane  
Yeading  
Hayes  
Middlesex UB4 9BS  
020 8841 9205

### **Manchester–North (Chadderton)**

Broadgate  
Broadway Business Park  
Chadderton  
Oldham OL9 9XA  
0161 947 1000

### **Newcastle-upon-Tyne**

Sandy Lane  
Gosforth  
Newcastle-upon-Tyne NE3 5HB  
0191 236 5011

### **Norwich**

Jupiter Road  
Hellesden  
Norwich NR16 6SS  
01603 408128

### **Nottingham**

Main Road  
Watnall  
Nottingham NG16  
0115 938 2591

**Shrewsbury**

Unit 6 Levens Drive  
Harlescott  
Shrewsbury SY3 7EG  
01743 462621

**Southampton (Northam):**

Unit R, Centurian Industrial Estate  
Bitterne Road West  
Southampton SO18 1UB  
02380 837397

**Taunton**

Taunton Trading Estate  
Norton Fitzwarren  
Taunton  
Somerset TA2 6RX  
01823 282525

## 17.0) Options

These fitting instructions are supplied in addition to the normal assembly guide delivered with your kit. They are specific to the additional equipment required when using your car for competition purposes. This document is supplied with new kits and as instructions to customers purchasing upgrades for an older car. IVA notes have been included for customers needing to register a new vehicle.

It is important that these instructions are read in conjunction with your assembly guide in particular with regard to the preliminary information that can be found at the front of the guide.

### 17.1) Battery master switch

If specified the battery master switch will have been fitted at the factory.

Locate the two thick red leads exiting the transmission tunnel. Connect the lead marked 'starter' to the starter solenoid along with the large brown lead (with black sleeve) from the alternator. Route the lead marked 'battery' to the battery positive terminal. Do not connect.

Check that the lead to the battery is attached to the single connection of the master switch and the lead to the starter is

attached to the master switch connection along with a double brown wire.

### 17.2) Standard roll over bar

Insert the bosses; on the underside of the roll over bar main hoop into the bucket bushes located at each end of the seat belt header rail towards the rear of the cockpit, refer to Figure 181. Locate the rear diagonals of the roll over bar into the mounting brackets at the rear of the boot compartment. Secure the roll over bar to the chassis using set screws (fastener pack 30P010A Item 2), spring washers (6) and washer (5).

The rear diagonals are secured to the brackets by bolt (1) and nyloc nuts (4) with a plain washer (5) under the bolt head and nyloc nut. Tighten all fastenings to 20 Nm.

**Figure 180: Standard roll over bar**



- |                           |                  |
|---------------------------|------------------|
| 1. Standard roll over bar | 3. Spring washer |
| 2. Set screw              | 4. Plain washer  |

### 17.3) Track day roll over bar

Before fitting the Track day roll over bar it will be necessary to remove the rear spring damper units in order to gain access to the lower mounting points.

The Track day roll over bar is fitted in the same manner as the standard roll over bar with the exception of additional fixings located in the ends of the main hoop.

Having placed the roll over bar into position, but before finally tightening the fixings, pass from underneath bolt (3) supplied with the roll over bar z pack, into the threaded holes in the ends the main hoop of the Track day roll over bar. Leave these fasteners loose until all fixings are in place.

**Figure 181: Track roll over bar**



An additional, optional Petty strut can be added to the Track day bar for added strength.

*1. The Petty strut is not IVA compliant and therefore should be removed for normal road usage.*

The forward end of the Petty strut is secured to a mounting boss located within the chassis that is normally hidden behind the interior trim panel. It can be found in the passenger side of the cockpit approximately one inch below the point at which the dashboard tube is welded to the top of the chassis rail.

If a 7/16" hole is not visible, drill out the six 5/32" rivets holding the top edge of the trim panel surrounding this point and ease the trim panel away from the chassis until the exact location of the mounting boss is identified.

#### **Warning**

**Use appropriate eye protection whilst carrying out drilling operations.**

Drill a small pilot hole through the trim panel taking great care not to touch the outer side skin and enlarge such that a 7/16" bolt can be fitted through. Ensure that the inner thread in the mounting boss is not damaged during this process.

Loosely fit bolt (fastener pack ZPS01 Item 2) and secure the trim panel with rivets.

Remove bolt (2). Secure the Petty strut to the roll over bar, using bolts (1), with plain washers (4), under the head of the bolts.

Pass the bolts through the plate on the Petty bar then rearwards through the fixing holes in the centre of the main hoop, secure with plain washers (4) and nyloc nuts (3).

Attach the forward end of the Petty strut to the previously uncovered boss using bolt (2) passed through spring washer (6), plain washer (5) then the fixing plate at the forward end of the bar. It may be necessary to use the additional plain washer(s) (5) between the front fixing plate and the side of the chassis to achieve the best fit.

Tighten additional roll over bar mounting bolts in accordance with Table 31.

**Table 31: Track day roll over bar mounting bolt torque figures**

Location	Torque Nm
Base of the bucket bushes	20
Mounting flange 5/16" UNF	20
Rear diagonals 5/16" UNF	20
Petty bar (all fixings)	47

It is recommended that all parts of the roll over bar likely to be contacted by either the driver's or passenger's head to be protected with approved roll bar padding. Suitable FIA approved padding is available from the Caterham parts counter.

## 17.4) Roll cage

### Warning

**Never work underneath a car without supporting it on axle stands or equivalent. Do not rely on a jack alone.**

#### 17.4.1) Preparation

Before fitting the roll cage it will be necessary to remove the rear spring damper units in order to gain access to the roll cage lower mounting points.

#### NOTE

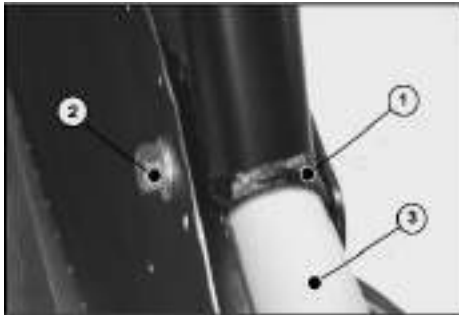
*This roll cage is IVA-compliant however protective covers will be required on the four bolt heads that attach the front hoop to the chassis.*

*You will also be required to have IVA compliant mirrors fitted to both the driver and passenger sides of the car to ensure rear visibility is maintained.*

The lower ends of the hoop that forms the front of the cage, attaches to two pre-fitted threaded bushes. These bushes are located, behind the side panels; one on each side of the car and approximately one inch below the point at which the dashboard tube is welded to the top of the chassis rail, refer to Figure 183 before attempting to fit the cage, these bushes will need to be uncovered.



**Figure 182: Front fixing boss location**



1. Front hoop saddle bracket
2. Fixing bolt – in threaded bush
3. Chassis top tube - sill

### **Warning**

**Use appropriate eye protection whilst carrying out drilling operations.**

If a 7/16" hole is not visible in the side panel, drill out the 5/32" rivets holding the top edge of the trim panel surrounding this point and ease the trim panel away from the chassis until the exact location of the mounting boss is identified. Drill a 4 mm pilot hole through the trim panel then enlarge to give clearance for a 7/16" bolt. Ensure that the inner thread in the mounting boss is not damaged during this process.

Take a 10 mm drill bit and pass it through the threaded boss until the pointed end of the drill touches the inside of the outer side panel. Gently tap the end of the drill bit until a small witness mark is visible on the outside of the side panel along the

centre line of the bush. Using a centre dot, dot the outside of the side panel on the witness mark and drill a 4 mm pilot hole, then enlarge such to give clearance for a 7/16" bolt. Ensure that the inner thread in the mounting boss is not damaged during this process.

Repeat this process on the other side of the car then run a 7/16" UNF bolt into both bosses to ensure the threads are clean and undamaged.

### **NOTES**

*1. Do not re-rivet the interior side panels at this stage.*

*2. If you intend to run sill protectors, you will need to remove these prior to fitting the cage. They will also require trimming at the forward end to enable them to be refitted around the cage.*

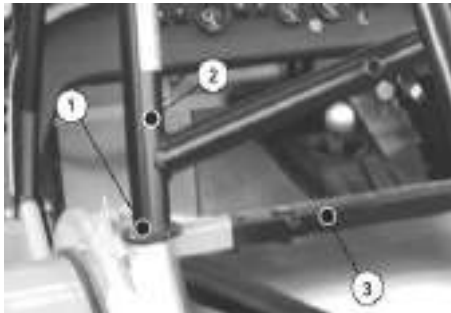
*3. You are now ready to attach the roll cage to the chassis however due to the size and weight of this part it is strongly recommended that you obtain further assistance as an extra pair of hands to help guide the cage into position could prevent damage.*

#### **17.4.2) Roll cage fitment**

Offer the cage up to the car and gently rest in place. Insert the bosses at the bottom of the rear hoop into the bucket

bushes located at each end of the seat back harness rail at the rear of the cockpit, refer to Figure 184.

**Figure 183: Rear hoop bucket bushes**



1. Bucket bush location
2. Roll cage rear hoop
3. Seat back harness rail

Carefully lower the front of the cage until the saddle brackets at the ends of the front hoop rest over the chassis top tube (sill). When fitted, the inner leg of the saddle should be between the fixing boss and the interior side panel, refer to Figure 183.

As the front of the cage is lowered into place the rear legs will rise and locate themselves between the mounting plates at the rear of the boot compartment. The bosses on the ends of the rear hoop will drop into the bucket bushes.

The cage can now be bolted into place using the fixings provided. Align the holes one by one and loosely fit all the fixings as

detailed below. Do not finally tighten any of the fixings until they are all in place.

Locate the underside of the bucket bushes and pass the reduced head bolts (fastener pack 30P017A Item 3) up through the bottom of the bush and into the threaded boss on the roll cage. No washers should be used on these bolts as this will restrict damper clearance. Do not tighten at this stage.

Loosely fit bolt (2) through the interior side panel, the roll cage and into the threaded chassis boss. This will hold the side panel in place whilst it is riveted back into place. If you intend to run sill protectors then these will need to be trimmed and re-fitted at this stage. Run the piping between the interior side panel and the chassis side rivet into place through the pre drilled holes using rivets (fastener pack ZCH 01 Item 5).

#### *NOTE*

*If you are building a new kit, refer to the assembly guide regarding fitment of knee trim panels as these are also best fitted at this time.*

Remove the loosely fitted bolt (fastener pack 30P017A Item 2) and adding a plain washer (5) pass through the interior side panel, roll cage saddle bracket and into

the threaded boss. Do not tighten at this stage.

Repeat the above using bolts (2) and plain washers (5) passed through the outer legs of the saddle bracket and into the threaded bush in the chassis. Ensure that this bolt does not 'bottom out' on the bolt inserted from inside the cockpit.

#### NOTES

*1. If you intend to fit a rear wheel protection bar then the outer fixing bolt on the driver's side of the car will need to be removed again to allow fitment of this part.*

*2. The rear wheel protection bar is not IVA-compliant and should not be fitted prior to the IVA test.*

The rear legs of the cage are secured to the mounting plates at the rear of the boot compartment using bolts (1) and nuts (4) passed through the plates and the holes in the end of the legs. Plain washers (6) must be fitted under both the head of the bolt and the nut (these bolts may appear to be undersize but they are intended to be only a loose fit in the respective holes).

With all the fixings in place they can be finally tightened in accordance with Table 32. See also note above.

**Table 32: Roll cage mounting bolt torque figures**

Location	Torque Nm
Base of the bucket bushes	34
Rear legs	20
Forward hoop saddle brackets	47

#### 17.5) Head restraint (roll cage and roll over bar)

##### NOTE

*The head restraint is not IVA-compliant and should not be fitted prior to the IVA test.*

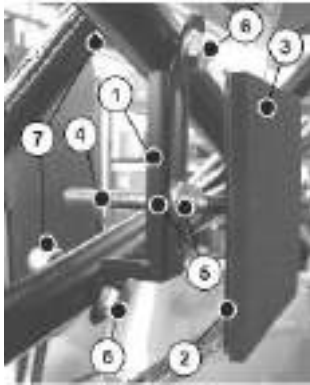
The head restraint is supplied as two parts, an adjusting bracket and a square head pad with a long adjusting stud.

Attach the self-adhesive foam pad (fastener pack 30P011A Item 5) to the front face of the square head pad.

Attach the bracket to the cross section of the roll cage/bar so that the adjusting slot is vertical to ground so that the longer fixing leg attaches to the lower cross tube, refer to Figure 185.

Bolt in place using bolts (1) and nyloc nuts (2) with plain washers (4) under both the head of the bolt and the nut.

**Figure 184: Head restraint assembly**



1. Adjusting bracket
2. Square head pad
3. Foam pad
4. Adjusting stud (head pad)
5. Plain nuts and washers (x2)
6. Bolts and washers (x2)
7. Nyloc nuts and washers (x2)

Screw one of the plain nuts (3) onto the head pad stud followed by one plain washer (4), pass the stud rearwards through the vertical slot in the adjusting bracket and fix into place with the remaining plain washer (4) and plain nut (3). Finally tighten all fixings in accordance with Table 33.

**Table 33: Head restraint fixing torque figures**

Location	Torque Nm
Bracket to roll cage/bar	34
Adjusting nuts (once adjusted)	34

When the car is complete and you have obtained a comfortable driving position this assembly can be adjusted up, down, forwards and backwards to give the optimum position in relation to your crash helmet. Once this position has been set, it is advisable to trim off any of the excess studding.

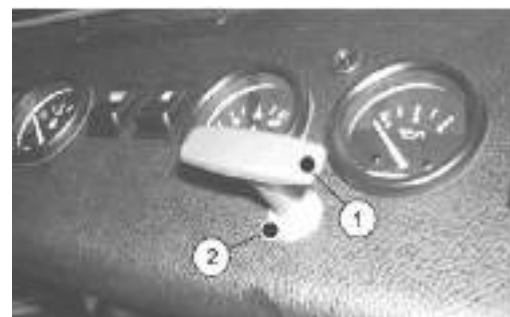
**17.6) Fire extinguisher pull handle**

*NOTE*

*The fire extinguisher handle is not IVA-compliant and therefore will not have been fitted at the factory, even though the rest of the extinguisher system may have been. Do not fit prior to IVA test.*

Insert the inner cable through the hole in the centre of the boss that has been pre fitted to your dashboard. Ensure that the handle is pushed fully home, refer to Figure 186.

**Figure 185: Fire extinguisher pull handle**



1. Pull handle
2. Dash mounting boss

Pass the inner cable through the hole in the cable locater fitted to the extinguisher lower handle, then through the opposing hole in the top handle.

Secure the inner cable in place using the solder-less nipple supplied, refer to Figure 187.

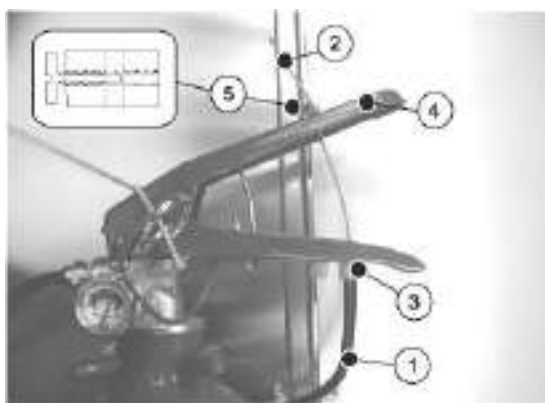
Trim off excess cable to approximately 30 mm.

Apply a small piece of tape or heat shrink to the trimmed inner cable to prevent fraying.

**NOTE**

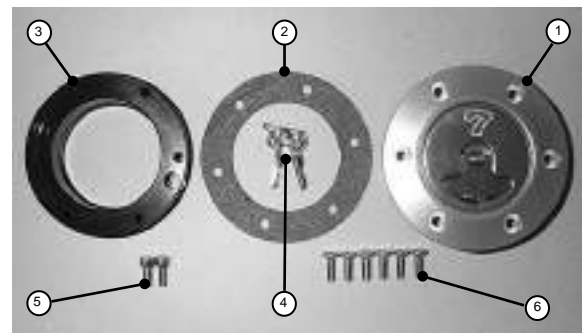
*It is advisable to allow approximately 5 mm of free play, as the scrutineer may want to ensure that the cable is free whilst scrutineering your car.*

**Figure 186: Fire extinguisher inner cable location**



- 1. Outer cable
- 2. Inner cable
- 3. Cable locater
- 4. Top handle
- 5. Solder-less nipple

**17.7) Aero fuel filler cap**



- 1. Filler cap
- 2. Gasket
- 3. Neck adapter
- 4. Keys
- 5. M5 x 12 cap head screws (x2)
- 6. M5 x 16 CSK head screws (x6)

**Warning**

**There is always a risk of fire or explosion when working on fuel tanks. Take the utmost care with preparations.**

If the Aero filler cap is to be retro fitted, the original cap must first be removed as follows. Undo the two self-tapping screws and remove the black filler neck cover inside the boot. Remove the boot carpet to prevent it getting dirty.

**Figure 187: Filler cover and boot carpet removed**



**Warning**

**Wear appropriate eye protection whilst carrying out drilling operations.**

Remove the old cap with the the key and block the filler hole with tape or cloth.

Remove the two self-tapping screws that retain the top of the filler neck to the filler boss, the rubber hoses will then allow the filler neck to be pulled out of the way.

Drill out the six rivets that retain the old filler boss. This must be done very carefully to avoid damage to the back panel. It is recommended this is done with a hand or air drill to eliminate the sparks caused by an electric drill.

**Figure 188: Drill out the six rivets**



The old filler boss can then be carefully pulled away from the back panel.

**Figure 189: Old filler boss removed**



Take the gasket supplied with the kit and carefully align the hole in the gasket with the hole in the back panel. Ensure two of the fixing holes are positioned at 3 o'clock and 9 o'clock.

**Figure 190: Gasket positioned on back panel**



Mark the new hole positions and carefully centre punch the marks. Taking great care, drill the holes (6 mm diameter).

**Figure 191: Carefully drill new holes**



Fit the black spacer to the filler neck using the two M5 cap head screws supplied in the kit. The spacer will be a tight fit on the

neck due to the O-ring and it must be pulled up evenly. The holes for the spacer are slotted to allow for correct alignment with the holes in the back panel. Tighten the screws fully after the alignment has been checked.

**Figure 192: Spacer fitted to filler neck**



Re-position the filler neck and gasket up against the back panel. Push the filler flange through the hole in the panel. Care must be taken to ensure correct orientation of the flange (One of the four 'scallops' has been enlarged to enable a petrol pump nozzle to pass further into the neck. It is important that this larger scallop is orientated towards the top), refer to Fig 195. Retain with the six M5 x 16 CSK head screws and pull these up evenly to ensure the flange locates correctly on the O-ring.

**Figure 193: Fit flange**



Remove all drillings from the inside of the boot and re-fit the boot carpet. Reposition the filler neck cover and retain it using the two self-tapping screws.

**Figure 194: Job complete**



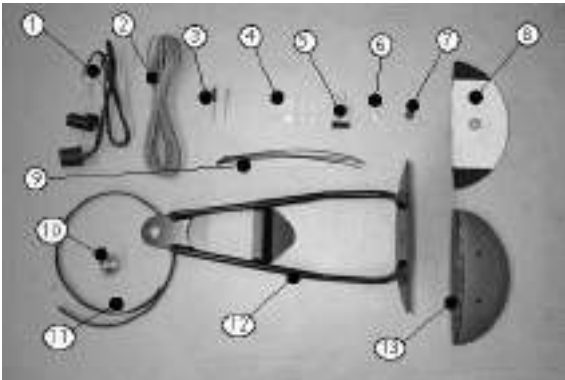
All that remains is to remove the tape or cloth from the neck and fit the new cap.

**NOTE**

*Remember to fit the key to the new cap to your key ring.*

## 17.8) High level brake light

**Figure 195: Kit contents for high level brake light**



1. Wiring sub loom
2. Wiring to high level brake light
3. Rivets (x2)
4. Male Lucar terminals and shrouds
5. Nut and plastic bolt from light kit
6. Replacement popper
7. Rubber grommet
8. Sticky pad
9. Cable ties
10. Larger spare wheel boss
11. Cable insulation
12. Light support bracket
13. High level brake light

### 17.8.1) Fitting the bracket

If retro-fitting, the spare wheel must first be removed from the car.

Working from inside the boot, unscrew the 5/8" nut which holds the spare wheel boss to the back panel, and remove the boss, taking care not to drop the large washers.

## Warning

**Wear eye protection when carrying out drilling operations.**

Centre mark a point 25 mm below the top of the back panel, on the vehicle centre line. Centre punch this, and drill a 5/32" hole, taking care not to damage the back panel. In the case of the SV, simply remove the central hood/boot cover popper using a 5/32" drill, as shown in Figure 198.

**Figure 196: Drilling central popper on SV**



Using masking tape to protect the paintwork from damage, position the bracket as shown in Fig 199, passing the new, larger spare wheel boss through the bracket and back panel, ensuring only one large washer is used in between the back panel and spare wheel support channel. Secure the boss using the 5/32" nut, finger tight only.



**Figure 197: Alignment of bracket**



Using a spirit level, refer to Figure 199, adjust the bracket until the light platform is exactly parallel to the top of the back panel, and mark from inside the boot through the previously drilled hole, onto the bracket.

Remove the bracket, centre punch and drill the hole using a 5/32" drill. Re-fit the bracket, and secure the upper mounting using the large black rivet, or for an SV the smaller countersunk rivet passed through the replacement popper. Apply threadlock, and tighten the 5/8" nut to 34 Nm.

#### *17.8.2) Light and wiring connections*

If painting of the light casing is required, follow the instructions supplied with the light.

Split the light and feed the terminated end of the supplied wires through both the hole in the base of the light unit, and the nut supplied with the light unit. Insert the

plastic bolt from the underside, and tighten nut to secure in place as shown in Fig 200. Connect the terminals to the male connectors on the metal strips on the bulb holder.

**Figure 198: Wire routing through light unit**



Centre mark a point on the vehicle centre line, 35 mm above the edge of the spare wheel mounting boss. Centre punch, and carefully drill a 1/4" hole, as shown in Figure 200. Masking tape can be used to protect the paintwork. Push the supplied rubber grommet into the hole.

**Figure 199: Drilled hole above spare wheel boss**



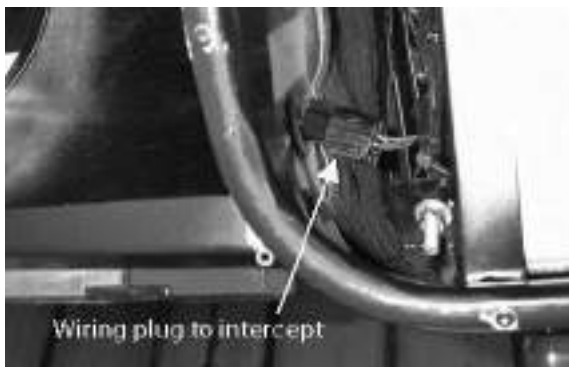
### **Warning**

**Disconnect the negative (-) terminal from the battery before carrying out electrical work.**

Working from inside the boot, unscrew the four retaining screws that secure the fuel

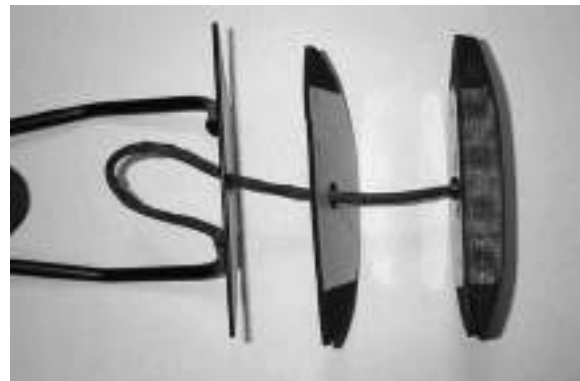
filler neck cover, and remove it. From under the right and rear corner of the car, feed the terminated end of the supplied sub-loom up into the boot area, through the hole exposed by removing the filler neck cover. Disconnect the wiring plugs leading to the rear light cluster, and connect the plugs from the sub loom in between, as shown in Fig 201.

**Figure 200: View from under RHS rear corner**



Re-assemble the light unit, and feed the cable insulation over the wires. Push them through the hole in the sticky pad and the hole in the platform on the bracket, then use the sticky pad to fix the light in place, shown in Fig 202. Feed the wires down through the RH support tube of the bracket, then through the rubber grommet into the boot area, shown in Fig 203.

**Figure 201: Exploded view of assembly**



Cut the wires from the light unit to length so the connections can be concealed behind the filler neck cover, and terminate with the male Lucar terminals and shrouds. Connect these to the sub-loom; grey/red to the green/purple, and grey to the black wire. Use the cable ties provided to tidy and secure the wiring, and re-fit the filler neck cover.

**Figure 202: Wires from support tube entering boot**



Reconnect the battery, and with the aid of an assistant, check to ensure that the high-level brake light operates in conjunction with the brake lights in the rear clusters, and re-fit the spare wheel. The completed assembly is shown in Fig 204.

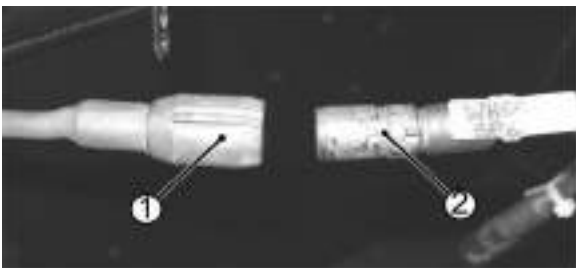
**Figure 203: Completed assembly**



*17.8.3) Stack dash speed sensor fitment*

Route the speed sensor loom through the hole on the tunnel top along with main wiring loom to the front of the chassis near LHS wheel. Use cable ties to route the loom where necessary. Connect the speed sensor plug to the plug on main wiring marked as wheel sensor refer figure 205.

**Figure 204: Wheel speed sensor plug**

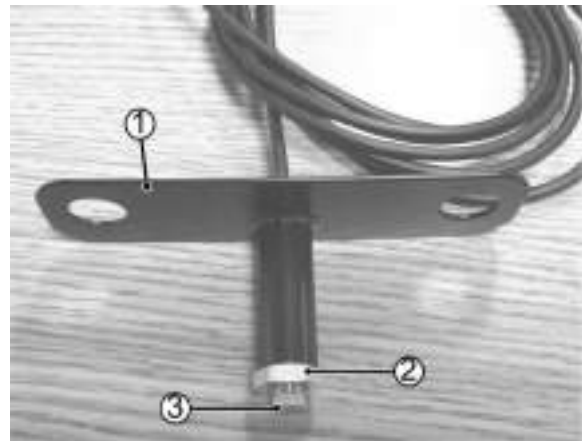


1. Plug on the wheel speed sensor loom
2. Plug on the main wiring loom

Insert the speed sensor in to the bracket and secure with locknut (do not tighten). Refer figure 206. Remove 2 caphead bolts on the LHS brake calliper and fit the bracket with speed sensor to the calliper

(do not tighten). There are four bolts on the brake disc, speed sensor should be adjusted by aligning with one of the four bolts. Select any of those bolt by rotating the disc and Adjust the speed sensor front edge so that the gap between the sensor and the bolt on the disk is 2-3 mm. tighten the lock nut on the sensor. Tighten the bolt on the calliper (50NM) and secured the bracket in place. Refer figure 207.

**Figure 205: Wheel speed sensor bracket**



1. Speed sensor bracket
2. Lock nut
3. Speed sensor

**Figure 206: Wheel speed sensor**



1. Calliper caphead bolts
2. Speed sensor
3. Speed sensor bracket

**17.8.4) Rear brake calliper sub assembly**

Insert the shim into the slot on the calliper assembly. Make sure the shim has seated properly. Please refer the fig. 208.

**Figure 207: Brake calliper assembly**



1. Brake calliper
2. Calliper bracket
3. Shim

Assemble calliper bracket and calliper together using two bolts provided in the brake pads box. Do not tighten the bolt at this stage. Refer fig 208.

**Figure 208: Brake pad assembly**

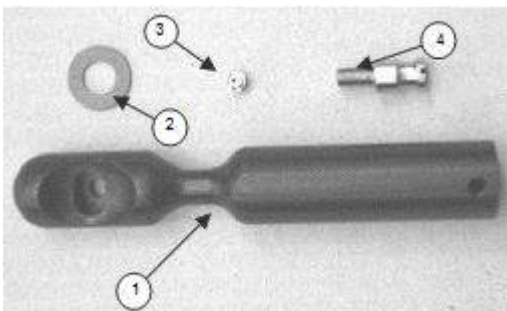


1. Brake calliper
2. Calliper bracket
3. Brake pads

Insert the brake pads into the Brake calliper assembly. Check for the correct alignment of the brake pads. Refer figure209. Now tighten the Calliper bracket bolt to 20NM.

17.8.5) IVA mirror fitting instructions

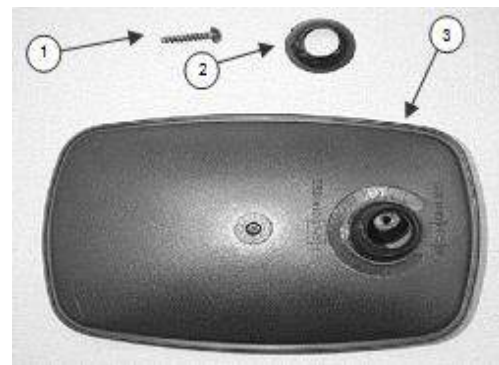
**Figure 209: Kit contents for mirror fitting**



- 1. Mirror stalk
- 2. Fibre washer
- 3. M5 grub screw
- 4. Fixing stud

Side screen mirror (part number 291 0074 01) must first be dismantled from its mounting arm using a T20 Torx bit. Retaining the mirror section, Torx screw, plastic cup and setting aside the arm (see fig 211).

**Figure 210: Dismantled mirror**



- 1. Torx screw
- 2. Plastic cup
- 3. Mirror

Parts taken from the mirror (figure 211.) now need to be assembled with the mirror mount. Place the plastic cup against hole cut in mirror casing. Inside the mirror section there is a small swivelling arm this is placed into the machined slot of the mirror mount. The flat on the swivelling arm faces towards the right (looking at figure 210). The Torx screw should then be inserted from the rear of the mount to secure the stalk and mirror together (see figure 212).

**Figure 211: Assembled mirror**



Insert M5 grub screw into threaded hole (right hand side of mount looking at Figure 210) until top of screw is just flush with surface of mount.

**Figure 212: Stud located on stanchion**



If fitted remove the centre of three windscreen-securing screws and replace with supplied stud (shown in Fig 211) using flat blade screwdriver. See Fig 213.

Place fibre washer over stud now located in side screen. The previously assembled mirror will now slide over the stud located on the side screen. See Fig 214.

**Figure 213: Final fitted assembly**



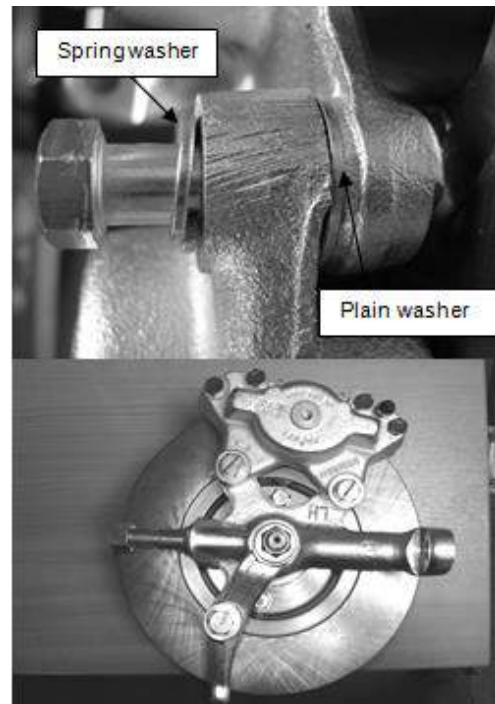
Adjust the mirror position to allow for optimum vision and lock in place by tightening M5 grub screw.

#### 17.8.6) Front brake calliper sub assembly

Remove the bolts and washer from the vertical link on upright. Slide the calliper

on to the brake disc (callipers and uprights are handed make sure for correct hand). Fit the bolt and washers in correct orientation. Torque the bolts to 58NM.

**Figure 214: Front brake calliper assembly**



Pull out the locking clips ('R' clip) on calliper and remove the brake pad Pins. Slide the brake pads into the calliper and fit the brake pad pins. Fit the locking clips ('R' clips).

**Figure 215: Front brake pads assembly**









Figure 218: R400 engine harness

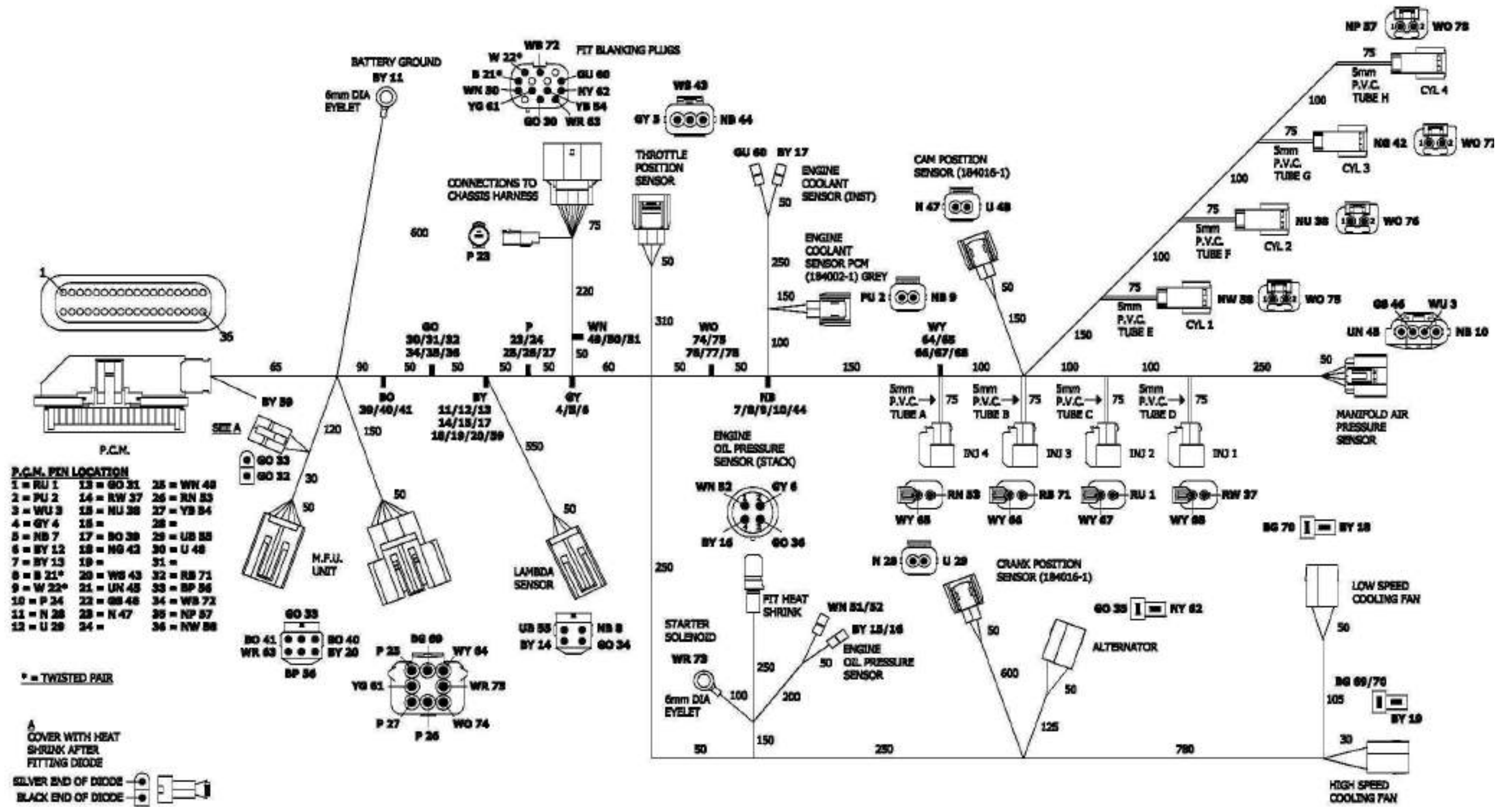


Figure 219: R400 main chassis harness (standard dash)

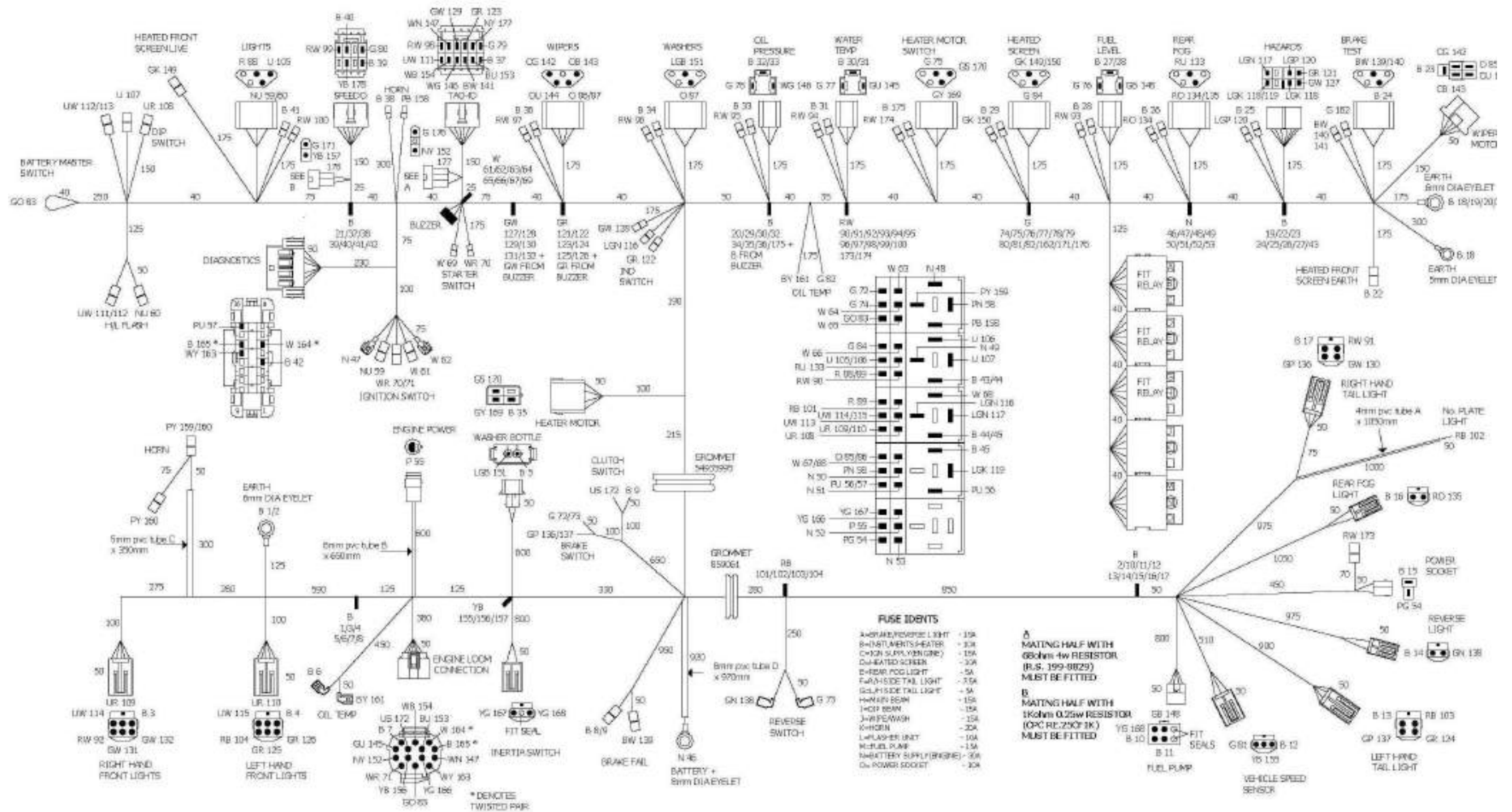


Figure 220: R400 main chassis harness (stack dash)

