



**MASERATI AUTOMOBILI  
MODENA**

**MASERATI  
« MEXICO »**

**DRIVING AND  
SERVICING MANUAL**



## FOREWORD

The purpose of this manual is to supply a brief description of car's specifications together with general information on its assemblies for normal driving and servicing operations. If you wish to obtain the best from your car in running costs, length of life and in reliability of performance, you should follow our instructions. For operations which cannot be easily carried out at the owner's garage without special tools and equipment, we advise our Customers to refer to our dealers' workshops where any overhaul and repair services will be promptly and properly carried out. In order to ensure the best performance of your car, original spare parts must be fitted.

## CAR IDENTIFICATION

Each car is marked with its own identification number of this type:

AM 112            ☆.....☆            (4200 cc.)

AM 112            ☆.....☆            (4700 cc.)

which is stamped on the left side of the cross member,            between two stars as Manufacturer's mark.

The engine's serial number is stamped on the clutch bell housing near the starter motor. These Identification numbers are also stamped on the name plate, which is readily visible in the bonnet, and are the only numbers legally recognised when the car is sold. They are copied on the certificate of origin and on the car's log-book.

## MAIN SPECIFICATIONS AND DATA

### MOTOR

	4200 cc.	4700 cc.
Number of cylinders	8 90° V	8 90° V
Bore and stroke	88 x 85 mm	94 x 85 mm
Capacity per cylinder	517 cc.	588 cc.
Total capacity	4136 cc.	4719 cc.
Maximum power at 5200 r.p.m.	260 HP	290 HP
Compression ratio	8,5	8,5
Combustion chamber volume	68,933 cc.	78,75 cc.



Cylinder block in light alloy with special cast iron liners.  
Cylinder heads in light alloy with overhead valves and inserted valve seats.  
Hemispherical combustion chambers.  
Crankshaft dynamically and statically balanced, with five main bearings and lead-lithium bearing shells.  
H-pressed steel connecting rods; big end bearings with lead- lithium shells; small end bearings with bronze bushes.  
Light alloy pistons with two compression rings and two scraper rings.  
Light alloy intake manifold with water circulation to heat the fuel mixture.

### TIMING

By inclined overhead valves controlled by four overhead camshafts which are driven through two double chains with automatic tensioner.  
The camshafts control directly the valves via cast iron cups.  
Adjustment is made possible by means of autotempering steel plaque.  
With a normal cold clearance between cups and cam lobes of 0,15 mm. for the inlet valves, and of 0.35 mm. for the exhaust valves, the following data are obtained:

Inlet valve lift at T.D.C.  
Exhaust valve lift at T.D.C.

Right	Left	Right	Left
1.7	1.8 mm.	.067	.071 "
1.8	1.4 mm	.071	.055 "

### LUBRIFICATION

Lubrification is of the forced-oil type on all engine components. It is supplied by means of one concentric gear-type pump directly driven by the crankshaft. The pump sucks oil from the oil sump and, after a full flow through a filter, forces it to the components to be lubricated. The two filter cartridge are contained in a heat exchanger in which the cooled water from the radiator and the oil to be filtered circulate inside flat copper ducts.

The heat exchanger has two purposes:

1° It helps to Warm up the oil in cold climates when water diverted by the thermostat does not pass through the radiator.

2° It lowers the oil temperature in hot climates by means of the cooled water from the radiator.



The oil filter is located at the front end of the crankcase and can be readily dismantled.  
The normal oil pressure varies between 43 and 72 psi depending on engine speed.  
This pressure can be adjusted by means of the relief valve which is built into the filter.  
The oil is supplied through the tank filler, and its level can be checked with a dipstick which is fitted on the left side of the oil sump.  
The oil capacity is approx. 16 pints.

### COOLING SYSTEM

The engine is water-cooled and the cooling system is provided with a centrifugal circulation pump and two electric fans which are controlled by two thermocouples fitted on the radiator ; the fans are switched on at a temperature of 168° F – 188° F. Water flow through the radiator is automatically controlled by two thermostats fitted on the cylinder heads. This device ensure the warming up of the engine, especially when it is started from cold.

The water temperature can be checked by means of an indicator fitted on the dashboard and connected to a thermocouple fitted on the cylinder head.

The water temperature must not be higher than 212° F.

A water drain tap is provided at the bottom header of the radiator.

Total quantity of cooling water: 24.6 pints.

### IGNITION SYSTEM

The ignition is controlled by a distributor fitted at the front right-hand side of the engine.

The BOSCH distributor is of the automatic timing type, and its shaft rotates counter-clockwise when Viewed from the top.

The static advance is 8° which is equal to a piston stroke of 0,528 mm.

Automatic advance: 30° (on crankshaft).

Total maximum ignition advance: 38° (on crankshaft).

Cylinder firing order: 1 - 8 - 4 - 2 - 7 - 3 - 6 - 5.

Clearance between points of contact breaker: 0.4 mm.

Clearance between points of spark plugs: 0.5 mm.

Diameter and pitch of the long thread: 14 mm x.1.25 mm

Coil: MARELLI heavy-duty.



## CLUTCH

The clutch is of the dry-type with two plates (4700 cc. engine) or single plate (4200 cc. engine) and a spring diaphragm. It is hydraulically actuated by two cylinders: one 3/4" master cylinder is fitted to the pedal control rod and the other, 7/8", is connected with the clutch.

The clutch pedal travel can be adjusted by means of a nut on the receiving slave cylinder; it must be adjusted with 0.4" free travel.

## GEARBOX

The gearbox is of the constant mesh type; there are five forward synchromesh gears plus reverse gear. The gear shift lever is fitted directly on the centre of the gearbox. The oil level in the gearbox can be checked by a dipstick which is found at the left side of the bonnet. This dipstick has the sole function of indicating the presence of oil and therefore there are no level mark on it.

S5 20 gearbox	GEAR BOX RATIOS		S5 325/27
1 <sup>st</sup> gear	0,347	1 <sup>st</sup> gear	0,336
2 <sup>nd</sup> gear	0,586	2 <sup>nd</sup> gear	0,520
3 <sup>rd</sup> gear	0,806	3 <sup>rd</sup> gear	0,746
4 <sup>th</sup> gear	1	4 <sup>th</sup> gear	1
5 <sup>th</sup> gear	1,18	5 <sup>th</sup> gear	1,11
R gear	0,85	R gear	0,302

## POSITION OF GEARS IN BOX

S5 20 gearbox

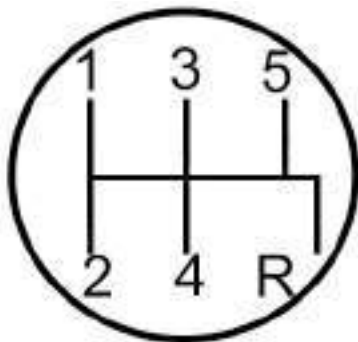

S5 325/27 gearbox

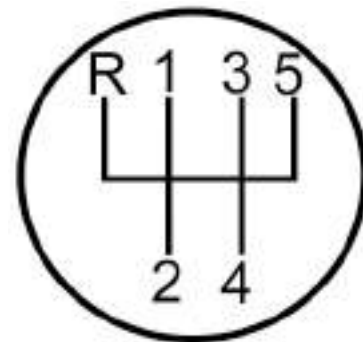



## REAR AXLE

The differential casing is fitted with hypoid bevel crown wheel and pinion, and the rear axle casing is attached to the chassis by means of rubber mountings.

### S5 20 GEARBOX (4200 cc. engine)

Normal final drive ratio	:	$13/46 = 3,54 = 0,28$
Special alternative ratios	:	$13/49 = 3,77 = 0,265$ $13/43 = 3,31 = 0,302$ $11/45 = 4,09 = 0,244$

### S5 325/27 GEARBOX (4700 cc. engine)

Normal final drive ratio	:	$13/43 = 3,31 = 0,302$
Special alternative ratios	:	$13/49 = 3,77 = 0,265$ $13/46 = 3,54 = 0,28$ $11/45 = 4,09 = 0,244$

## CHASSIS

Front track (measured at the ground)	=	1 3 9 0 mm.
Rear track (measured at the ground)	=	1 3 6 0 mm.
Wheelbase	=	2 6 4 0 mm.

The chassis is made of steel tubular sections and pressed, box type steel sheet.



CAR PERFORMANCES

Final drive ratio  $13/46 = 0.2825 = 3.54$  (4200 cc. engine)

Tyres: 205 VR x 15" - Roll radius - 2,10 m

ROAD SPEED DATA KPH - S5 20 GEARBOX

Engine r.p.m.	1 <sup>st</sup> gear 3,0	2 <sup>nd</sup> gear 1,705	3 <sup>rd</sup> gear 1,24	4 <sup>th</sup> gear 1	5 <sup>th</sup> gear 0,85
1000	11,7	20,87	28,7	35,6	42,5
1500	17,5	31,5	43	54	64
2000	23,5	42	57,5	72	85
2500	29,5	52	72	89	106
3000	35	63	86	107,5	127,5
3500	41	73	100,5	125,5	149
4000	48	83,5	115	143,5	170
4500	53	94	129	161	191
5000	58,5	104,5	143,5	179	212,5
5500	64,5	115	168	197	233,5
6000	70,2	125,22	172,2	213,6	255

Final drive ratio  $13/43 = 0.302 = 3.31$  (4700 cc. engine)

Tyres: 205 VR x 15" - Roll radius - 2,10 m

ROAD SPEED DATA KPH - S5 325/27 GEARBOX

Engine r.p.m.	1 <sup>st</sup> gear 2,97	2 <sup>nd</sup> gear 1,92	3 <sup>rd</sup> gear 1,34	4 <sup>th</sup> gear 1	5 <sup>th</sup> gear 0,9
1000	12,8	19,8	28,4	38,1	42,3
1500	19	30	43	57	63,5
2000	25,6	39,5	57	76	84,5
2500	32	50,5	71	95	106
3000	38,5	59,5	85,2	114	126
3500	48	69,5	99,5	133	148
4000	54	78	113,5	152,5	179
4500	57,5	90	128	171,5	190,5
5000	64	101	142	190,5	211,5
5500	70,5	110	156	209	232
6000	77	118,8	170,4	228	252

At higher road speed, the data of the above table should be multiplied by a coefficient for the increase of tyre volume caused by centrifugal force.

WEIGHTS

Maximum weight allowed on each axle

with 205 x 15" tyres

1250 Kg.

Unladen car weight

1500 Kg.

Car kerb weight

1600 Kg.



### AUTOMATIC TRANSMISSION

This car can be fitted with the BORG WARNER type 8 automatic transmission. The shift lever is centrally fitted and has the following control position :

- P Parking position with locking action on wheels.
- R Reverse gear position, in which the rear lamps are switched on.  
Transmission ratio 1 : 2 .
- N Neutral position - the car can be pushed or towed.
- D2 Driving position with one automatic change in direct drive  
Transmission ratio 1 : 1,47.
- D1 Driving position with two automatic changes in direct drive  
Transmission ratios 1 : 2,40 and 1 : 1,47.
- L Slow driving position to be used for town or mountain driving; there is no automatic charge in this position and transmission ratio is 1 : 2,40. It is advisable to use this position only when required in order to avoid prolonged running of the engine at high speed.

The engine can be started in P or N position only.

The fluid used in the automatic transmission is AGIP ROTRA ATF.

The fluid dipstick is fitted at the right side of the engine and the transmission sump capacity is approx. 15,8 pints.

It is advisable to change the oil after each 12.000 miles.

It is also recommended not to keep the engine running at over 5000 r.p.m. for long time.





PERFORMANCE OF THE CAR EQUIPPED WITH  
AUTOMATIC TRANSMISSION  
(ON ORDER)

Normal axle ratio  $13/43 = 3,31 = 0,302$   
Tyres – 205 x 15 " average circumference 84 inches.

ROAD SPEED DATA KPH

Engine r.p.m.	POSITION L	POSITION D1			POSITION D2	
	RATIO 2,40	RATIO 2,40	RATIO 1,47	RATIO 1	RATIO 1,47	RATIO 1
1000	15,8	15,8	25,8	38	25,8	38
1500	24	24	39	57	39	57
2000	32	32	52	76	52	76
2500	40	40	65	95	65	95
3000	47	47	77	114	77	114
3500	55	55	90	133	90	133
4000	63	63	103	152	103	152
4500	71	71	116	171	116	171
5000	79	79	129	190	129	190
5500	87	87	142	209	142	209
6000	95	95	155	228	155	228

At high speed the above specifications are to be multiplied by the expansion coefficient which is caused by centrifugal force.



### FRONT SUSPENSION

Unequal length wishbone suspension, with coil springs, RIV telescopic shock absorbers and stabilizer.

### REAR SUSPENSION

Longitudinal leaf springs with two double acting telescopic shock absorbers. A transverse stabilizer is also provided to avoid roll on cornering.

### STEERING GEAR

The steering box is of the recirculatory ball type, with adjustable play: it is controlled by a steering column, with a flexible joint which absorbs vibrations.

The steering rods are of a symmetrical type, with idler box.

The steering wheel drive position can be adjusted by means of a slide which is locked by a knob.

The normal driving position is on the left-hand side, but it can be provided also on the right-hand side.

### HYDRAULIC STEERING SERVO-CONTROL (OPTIONAL)

The Z.F. Steering Gear with hydraulic Servo-Control is of the recirculatory ball type, actuated by an engine driven hydraulic pump.

This system provides the following advantages: Play-free steering action: immediate hydraulic servo-control; possibility of adjustment; road sensitivity; possibility of driving without servo-control when this is damaged.

The horsepower absorbed by the pump is proportional to the engine speed and to the steering fluid pressure in relation to the steering effort; in normal working conditions the pump absorbs 1.5 HP approximately, whereas on uneven roads or sharp turns it may require 5-6 HP.

### BRAKES

The braking system, with two master cylinders, has two independent fluid circuits; one for the front wheels and the other for the rear wheels. The braking action is assisted by two Girling vacuum boosters with vacuum bottle..

The front disk brakes are fitted with 294 mm diameter disks and provide a braking surface of 2000 sq. cms; they are actuated by a Girling 3 C master cylinder and 3 wheel cylinders on each brake, which provide a total working surface of 57.5 sq. cms.

The rear disk brakes are fitted with 272 mm dia. disks and provide a braking surface of 1500 sq. cms.; they are actuated by a Girling 12/14/3 master cylinder and 3 wheel cylinders on each brake, which provide a total working surface of 36.3 sq. cms.

The brake pads are automatically compensated for their wear play. The rear brakes are mechanically connected with the hand brake lever which can be used for parking purposes only.



## STEERING GEOMETRY

The toe-in measured on rims, at hub centre height, is between 0 and 2 mm.

The camber angle is 1°.

The castor angle is 2°.

The king pin angle is 7° 30'.

## TYRES

Pirelli Cinturato HS, 205 VR x 15 ''.

Tyre pressures, from cold condition for a max. speed of 150 Km/h	front	1,9 Kg/sq. cm.
	rear	1,9 Kg/sq. cm.

Tyre pressures, from cold condition for non constant speed higher than 150 Km/h	front	2,5 Kg/sq. cm.
	rear	2,5 Kg/sq. cm.

Tyre pressures, from cold condition, for constant speed, on motorway, of 200 Km/h	front	2,8 Kg/sq. cm.
	rear	2,8 Kg/sq. cm.

WARNING: THE ABOVE PRESSURE DATA ARE SPECIFIED AS MINIMUM AND AS SUCH MUST BE ABSOLUTELY MAINTAINED.

## ELECTRICAL EQUIPMENT

Battery: It is located in the luggage boot, beside the spare wheel  
Capacity 72 amp/h. voltage 13,5 volts.

Alternator: Bosch with Mechanical voltage control. It is fitted on the left side of the engine  
and driven by the crankshaft through an adjustable V belt. Output 400 watts.

Starter motor: 1.8 HP BOSCH type.

Horns: Two Fiamm air horns with electromagnetic compressor: with push button  
control on steering wheel. A normal horn is also fitted, and this can be  
switched on/off by the same change-over lever which controls lights and  
direction indicators.

Fuse Box: It is fitted with 12 fuses and located at the right-hand side of the bonnet.

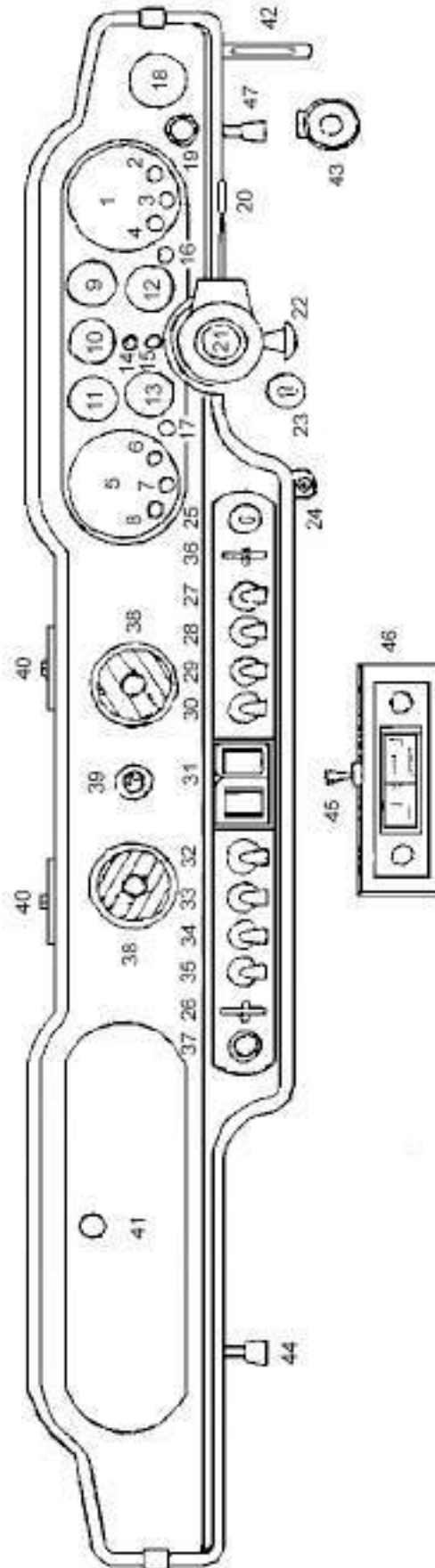

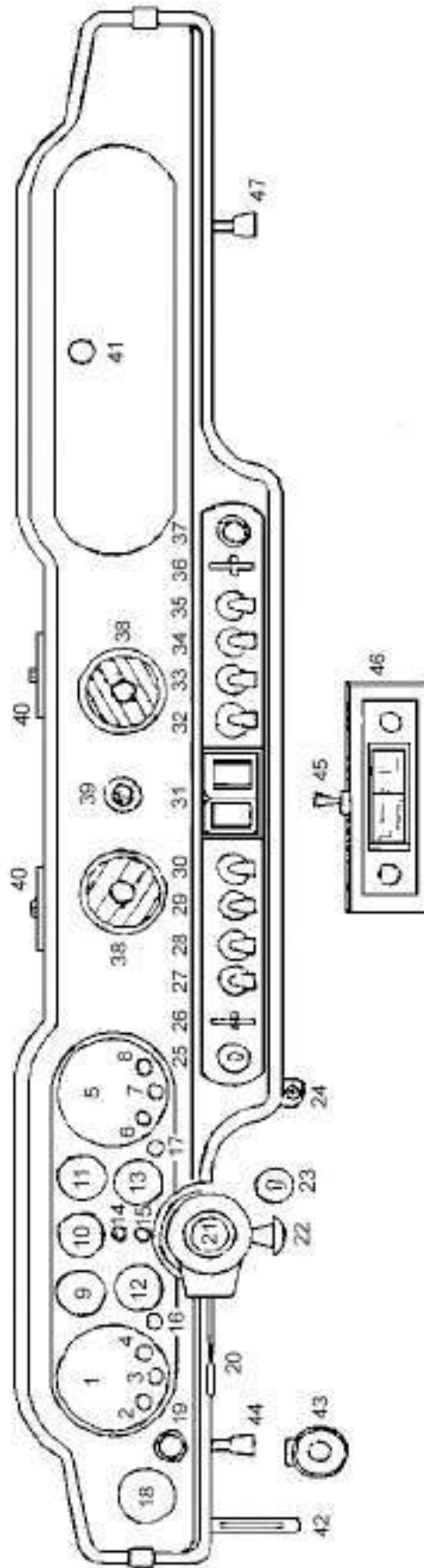



DASTHBOARD INSTRUMENTS

- 1 Tachometer
- 2 Headlamp main beam warning light - blue
- 3 Direction indicator warning light - red
- 4 Side lamp warning light - green
- 5 Speedometer and odometer
- 6 Heater blower warning light - amber
- 7 Ignition warning light - green
- 8 Alternator charge warning light - red
- 9 Water temperature indicator
- 10 Oil pressure gauge
- 11 Oil temperature indicator
- 12 Fuel level indicator
- 13 Ammeter
- 14 Hand brake warning light - red
- 15 Rear window defroster warning light - amber
- 16 Left side fuel tank reserve warning light - red
- 17 Right side fuel tank reserve warning light - red
- 18 Electric clock
- 19 Choke control knob
- 20 Change over lever for outer lights
- 21 Air horns push button
- 22 Driving position adjustment locking knob
- 23 Steering wheel locking device
- 24 Kilometer counter zero-setting knob
- 25 Ignition starter switch
- 26 Heater water flow control lever
- 27 Outer lights control switch
- 28 Low and fog light switch
- 29 Windscreen wiper switch
- 30 Instrument lighting switch
- 31 Window glass winder dual switch
- 32 Fuel feed pump switch
- 33 Heater blower two-speed control switch
- 34 Rear window defroster switch
- 33 Ceiling light switch
- 36 Ventilation control lever
- 37 Cigarette lighter
- 38 Ventilation outlets
- 39 Air conditioner thermostat
- 40 Windscreen defroster outlets
- 41 Glove box
- 42 Bonnet release lever
- 43 Windscreen washer pump
- 44 Driver's side ventilation outlet control knob (up to car n° 313)
- 45 Aereal switch control
- 46 Radio
- 47 Passenger's side ventilation outlet control knob



VENTILATION – HEATING – AIR CONDITIONING  
Description see illustration at pages 16-17

The air supplied through the right-hand duct (2) flows into the car through the shutter (3), the casing with blower (4), the transverse duct (6) and the radiators (8). Suitable flap deflectors (9 – 10 - 11) deliver the air to the windscreen, to the front seats and to the driver's and passenger's feet. A Torrington centrifugal blower (4), driven by a powerful two speed motor (5), controlled by switch (32), provides a high flow of air through the radiators. This air can be drawn either from the exterior, when the shutter flap (3) is moved rearwards, or from inside the car, through the shutter (7) controlled by the lever below the dashboard, when the shutter flap (3) is moved forwards. The air coming from manifold (6) goes through the radiators (8) flows warm or cold into the car according to whether the heating system or the air conditioning is operated.

HEATING SYSTEM

The system consists of: a hot water off take tap (22) fitted on the cylinder head and actuated by the dashboard control lever (25); two tiers of the radiators (8) ; a return tube (23) which delivers the hot water to the intake of the engine water pump as a tap (26) which is connected to the hot water line and prevents water from returning into the radiator during hot weather. This tap should therefore be actuated by hand at the beginning of summer and winter.

AIR CONDITIONING SYSTEM

This system consists of the following assemblies:

1. Evaporator assembly, which includes the first 4 tiers of the radiators (8); an adjustable injector which expands the compressed Freon 12 thus producing refrigeration ; a thermostat (24) which automatically controls and stabilizes the interior car temperature as required in the region of 14°C; the flap deflectors which direct the conditioned air as required.
2. Compressor assembly (15): of the open type, which can work at variable speed, between 500 and 6000 r.p.m. It absorbs a variable horsepower, between 1/3 and 3 HP, to produce a variable rate of refrigeration.  
The compressor is driven by two V belts which are driven by the crankshaft.
3. Isobaric valve(13) It replaces the pressure regulator, fitting on all conventional systems ; its main function is to avoid that pressure grows to a dangerous point as a result of particular heat exchanging conditions .  
While the function of the pressure regulator was to disengage the compressor via an electromagnetic coupling , should the system pressure exceed the value of 18 Atm. , the isobaric valve reduces progressively the efficiency of the compressor.  
This isobaric valve is installed right on the compressor replacing a cock and connected to the line that leads to the evaporator, its shutter being directly controlled by the compressor's delivery pressure. Therefore, higher the temperature, lower will be the quantity of circulating Freon. This means that even in the worst various heat exchanging conditions, the compressor will continue to work and the conditioning system will flow out a quantity of cold air proportionately to the warm air eliminated by the compressor. The valve is equipped with a pressure switch disengages the compressor, should the pressure drop because of a leak whatsoever.



4. Electromagnetic coupling: the engagement and disengagement of the compressor is automatically controlled by the thermostat which operates via an electromagnetic coupling. The coupling absorbs a current of 2,5 Amp.
5. Condenser (16): it consists of a copper coil with aluminium fins and is fitted at the front of the engine radiator.
6. Receiver-Filter (17): it contains some dehydrating material which eliminates any moisture from the Freon.
7. Tubes: the compressor (15), the condenser (16) and the evaporator (8) are interconnected by special tubes (19-20-21) which are suitable for the Freon circulation, high pressure and temperatures between  $-25^{\circ}\text{C}$  and  $+120^{\circ}\text{C}$ .

### VENTILATION – HEATING – AIR CONDITIONING Operation

The system can be easily actuated through a few controls which provide a quick adjustment of the internal car conditions at any external temperatures.

With the car motion, or by actuating a powerful two-speed blower through the switch (32), a high flow of air is supplied into the car. The air flow can be either warm or cold according to whether the control lever (25) is moved along its travel or the knob (38) is rotated.

The air flow from the exterior can be adjusted in volume by the control lever (35) and completely excluded when the lever is moved fully downward.

In the latter condition, the blower draws air from inside the car through a flap shutter actuated by the control lever (7), which is provided at the right side underneath the dashboard. By this operation the air is recirculated and can be increasingly heated or cooled (fig. A).

During the cold season, in order to dehumidify the air inside the car and to have the windows constantly demisted, it is advisable to operate the cooling system partially and the heating system fully, with the control lever (35) fully moved upward.

In order to obtain good and quick results all the windows should be kept fully closed, especially when air conditioning with recirculation flow is operated.

NOTE: In damp atmospheric conditions it is advisable to use the recirculation flow (Fig. A) ventilation in order to avoid moisture and condensation inside the car.



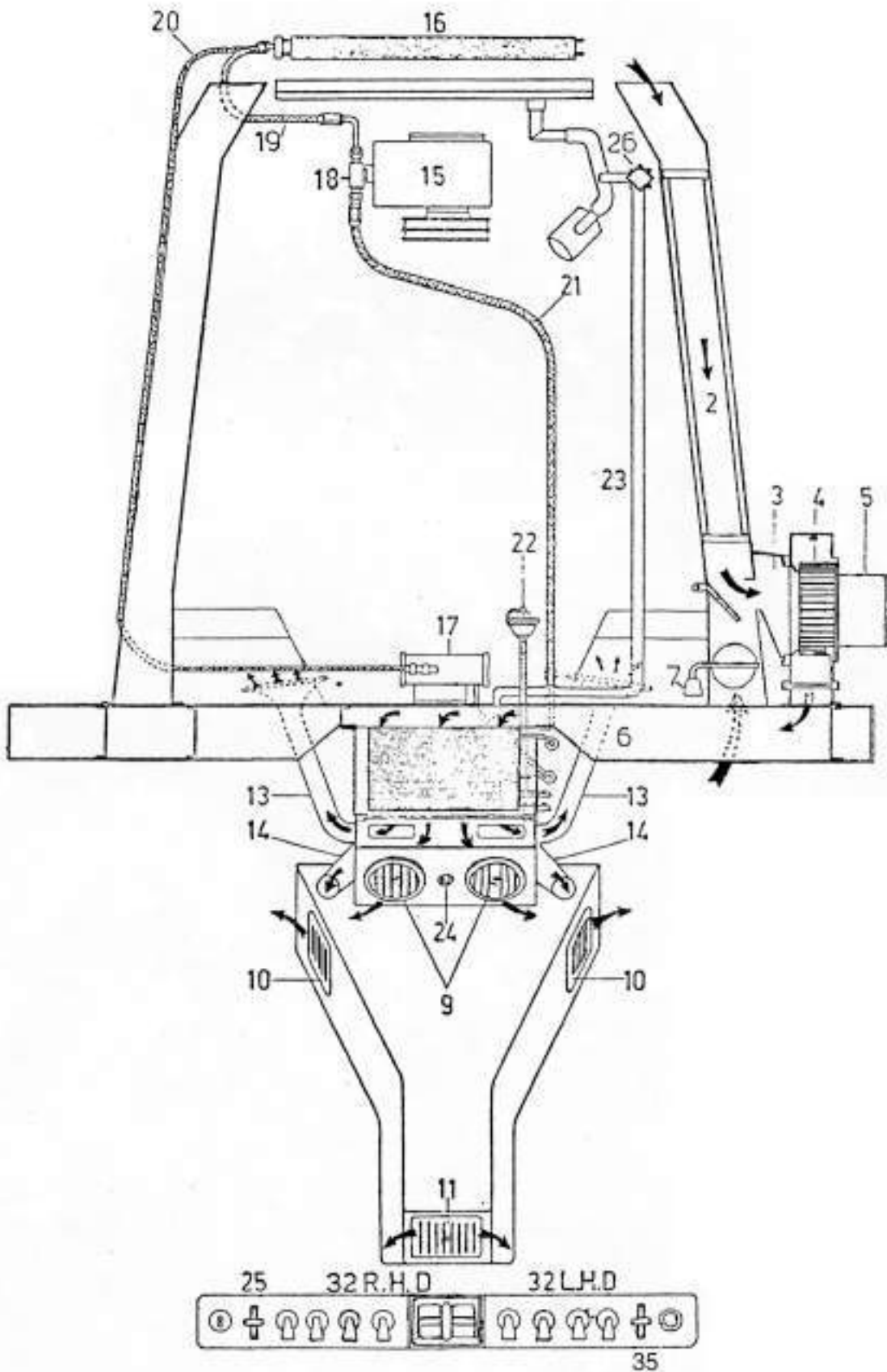

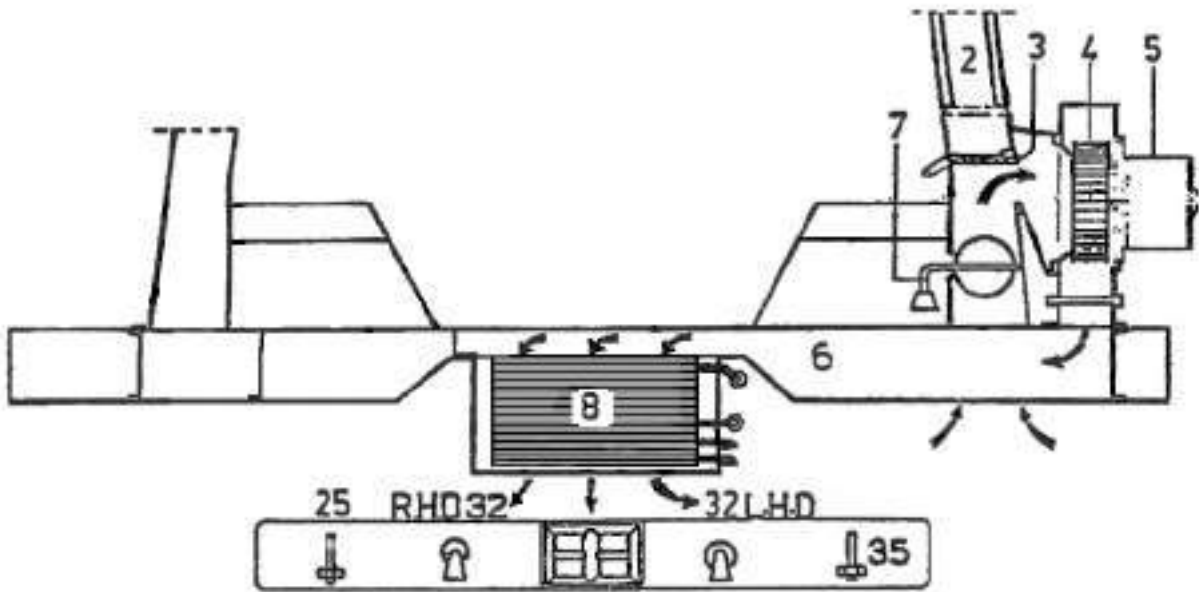

FIG. A - AIR FLOW WITH RECIRCULATION

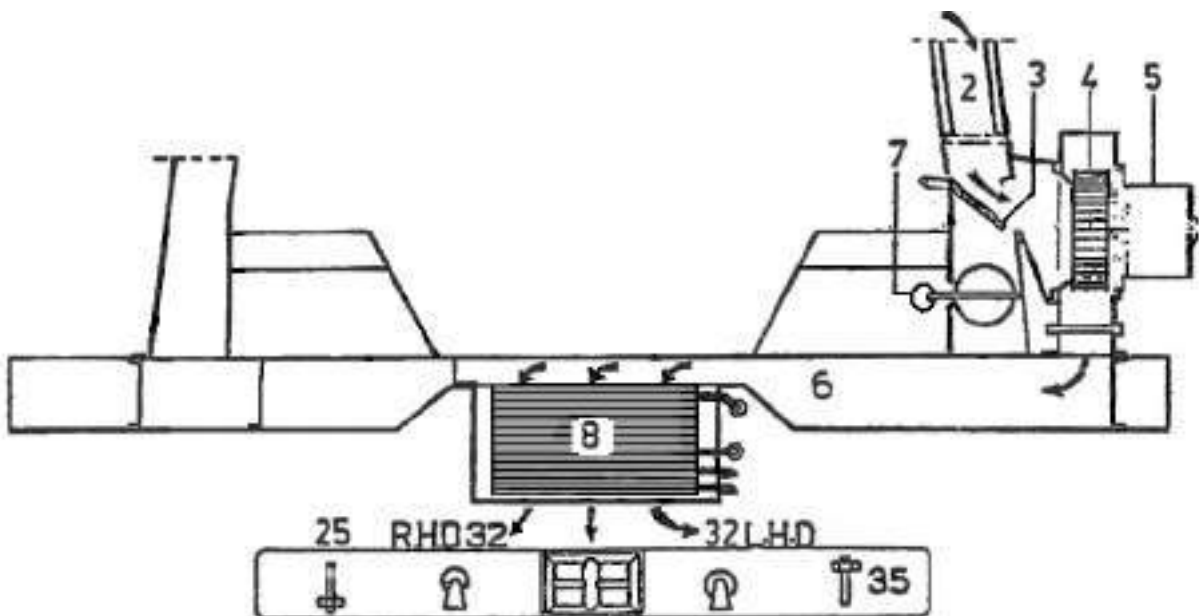

FIG. 8- AIR FLOW FROM EXTERIOR



### SERVICING INSTRUCTION

Normal service operation are to be carried out in accordance, to the following schedule:

#### EVERY 1,000 KILOMETERS

1. Engine: check oil level and refill as required.
2. Radiator: check level and refill possibly with distilled Water.
3. Tyres: check pressure.

#### EVERY 5,000 KILOMETERS

4. Engine : renew oil and filter elements.
5. Water pump : lubricate with a suitable hand-operated grease gun. Do not exceed the pressure of 0.2-0.3 atm.
6. Front Suspension Pins: lubricate grease nipples.
7. Propeller Shaft Universal Joints: lubricate grease nipples.
8. Steering Box and Joints: clean joints and check oil level in the steering box. If the hydraulic servo-steering is fitted with the engine stationary, the fluid level must be 1 – 2 cms. above the top mark on dipstick. Run then the engine at idling speed and recheck level as above refill as required.
9. Rear Wheel Hubs: lubricate grease nipples.
10. Clutch : Check fluid level in reservoir and refill as required.
11. Battery : Check level and refill, if necessary with distilled water.
12. Brake Fluid Tank: Check level and refill as required.
13. Spark Plugs: Clean and adjust gap at 0.5-0.6.
14. Contact Breaker : Clean and adjust clearance between points at 35 mm.
15. Driving Belts : Check tensioning.
16. Timing gear chains: Check tensioning.
17. Water pump seal : Check for leakage and renew seal if necessary.
18. Clutch pedal free travel : Check and adjust at 10 mm. free travel.
19. Brakes : the pad adjustment is automatically controlled.
20. Steering box : adjust play by means of its own bolt, ensuring a maximum torque of 7 Kgm.



EVERY 10,000 KILOMETERS :

21. Clutch Thrust Shaft :lubricate with a suitable grease gun.
22. Ignition Distributor :dismantle and lubricate bearings and bushes.
23. Gear Box:check oil level and refill as required.
24. Differential Unit:check oil level and refill as required.
25. Valves: check and adjust clearances.
26. Brakes:check braking pad thickness. New pads minimum thickness 7 mm. (back plate included).
27. Fuel Filter:check their condition and, if necessary, renew the filtering element inside the pressure regulating valve.
28. Water Pump : lubricate shaft bearings.
29. Throttle Control Cable: lubricate.
30. Front Wheel Hubs: check grease packing and bearing end play.

EVERY 20,000 KILOMETERS :

31. Fuel Filter: renew the filtering element inside the pressure regulating valve.
32. Gear Box: renew oil completely.
33. Differential Box: renew oil completely.
34. Steering Box : renew oil completely.
35. Front wheel Hubs: repack with grease.
36. Bendix Fuel Pumps: remove the bottom cover and clean accurately the filter; if necessary, renew filter.
37. Brakes: renew fluid.

EVERY 50,000 KILOMETERS :

38. Brakes: renew rubber plungers on wheel cylinders.

DETAILED INSTRUCTIONS IN RELATION TO SERVICE OPERATIONS 8 - 15 - 16 - 18 - 19.

8. Steering System: when normal overhauls are carried out,it is necessary to check all tyhe steering components in order to clean the joints on rods and steering box.
15. Alternator Driving Belt: In order to adjust the belt tension, loosen the nut on the fixing bracket end set the belt tension by moving the alternator as required.
16. Timing Gear Chains: When it is necessary to set the chain tension, unscrew the centre nut on tensioner ; remove the back washer and the dowel by means of a suitable extractor; rotate the cam up to a 0.1 Kgm. and lock it in this position by refitting the dowel, the back washer and the nut.



18. Clutch Assembly: The clearance between the clutch plate and the pressure plate is set at 2.5 mm., but it will be gradually reduced because of the clutch lining wear, and it may fall to a zero value and cause the clutch slippage. The clutch clearance can be adjusted to specification by rotating the adjustable screw which is provided on the slave cylinder. A clutch clearance of 2.5 mm. is equivalent to a pedal free travel of 14 mm.
19. Disk Brakes: When reassembling disk brakes, it is necessary to check parallelism between disk faces and brake caliper up to a tolerance of few hundredths of a millimetre. Brake pads should be renewed every 20.000 Kms. if brakes are used normally. They must be replaced when their thickness is reduced to a few millimetres.

**IMPORTANT:** When overhauling brake and clutch assemblies, take care in avoiding contamination of functional Components by mineral oil, petrol nad petroleum derivatives in order to prevent a possible failure of rubber seal plungers in master and wheel cylinders. These components must be cleaned in soda solution, alcohol or CLEAN GIRLING BRAKE FLUID.



**SUPPLIES – CONSUMPTION SPECIFICATIONS**

Supply	Capacity (in litre)	SPECIFICATIONS
Fuel tank	90	SUPERCORTEMAGGIORE N.O. 98/100 R.M.
Engine Radiator	14 4 5	Distilled Water AGIP F1 ANTIFREEZE Freezing point – 12°C Freezing point – 20°C Freezing point – 40°C
Engine oil sump	9	Winter : AGIP F1 RACING SAE 40 Summer/ AGIP F1 RACING SAE 50 For ambient temperature lower than –5°C use : AGIP F1 RACING SAE 30
Gearbox S5/20 S5/325/27	1,1 1,8	AGIP F1 RACING HYPOID 90
Differential box	1,4	AGIP F1 ROTRA MP SAE 90
Slip differential	1,4	AGIP F1 ROTRA MP/S SAE 90
Steering box	0,2	AGIP F1 ROTRA SAE 250
Brake tanks	0,8 0,8	1. CASTROL WAKEFIELD GIRLING BRAKE FLUID AMBER (EXTRA HIGH DUTY H 204/57) 2. AGIP F1 BRAKE FLUID
Clutch tank	0,2	AGIP F1 BRAKE FLUID
Hydraulic Seryosteering	0,85	AGIP F1 ROTRA ATF
Automatic transmission	9	AGIP F1 ROTRA ATF
Pivots, pins joints	-	AGIP F1 GREASE 15
Wheel hubs, bearings bushes	-	AGIP F1 GREASE 33 F.D.
Air conditioning compressor	0,35	AGIP F1 TER 34

Normal Fuel Consumption 18-24 litres/100 Kms. (CUNA Standards).

The average consumption may vary according to speed, road condition, and frequency of slowing-down and acceleration.

It is advisable not to exceed an engine speed of 5500 r.p.m.

Driving range: 420 Kms. approx. with full fuel tanks.



# MASERATI « MEXICO » DRIVING AND SERVICING MANUAL

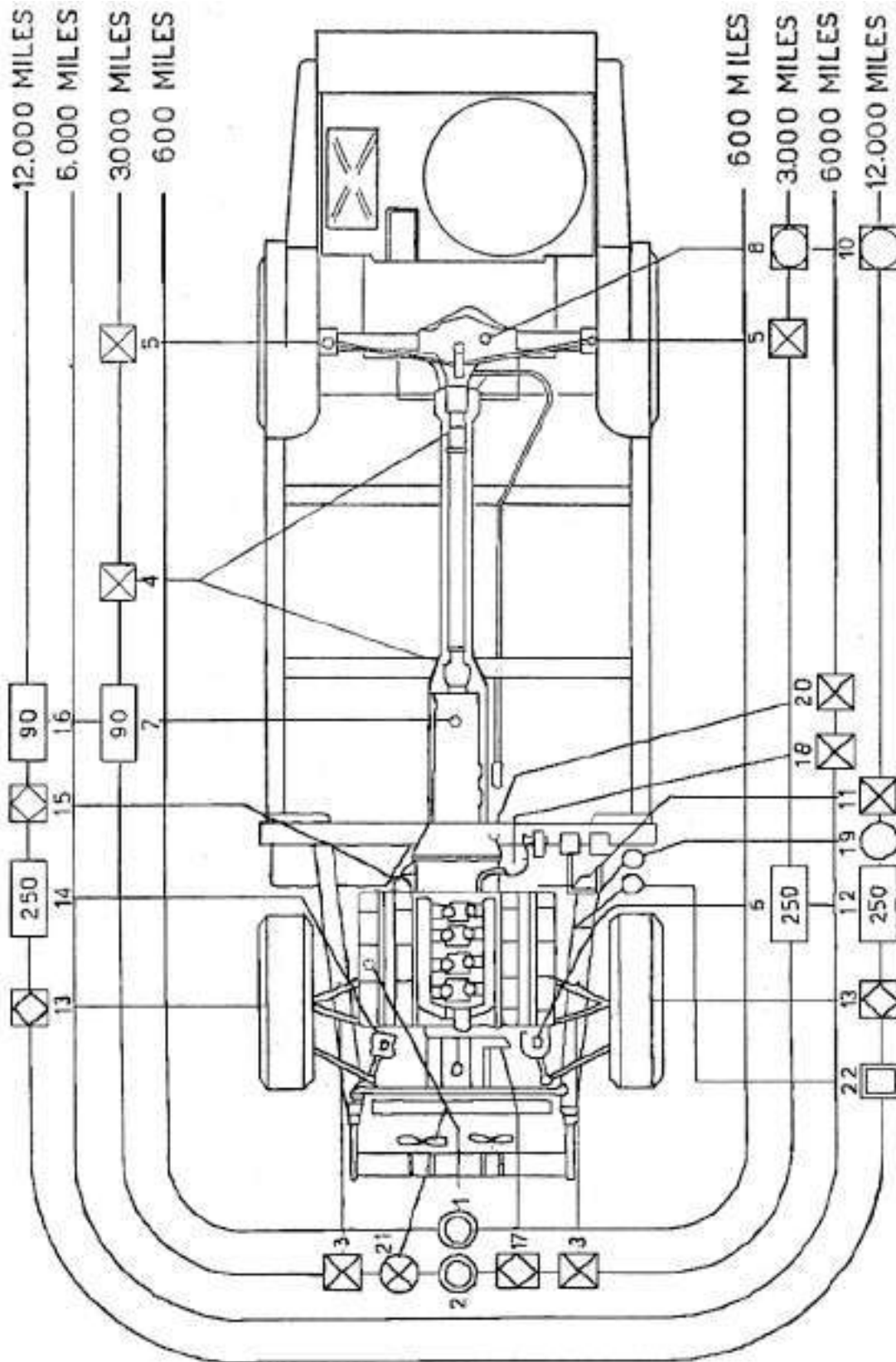



LUBRICATION DIAGRAM CODE NUMBERS

1. Engine.
2. Engine.
3. Front suspension.
4. Propeller shaft Universal joints.
5. Rear axle drive shaft.
6. Steering box.
7. Gearbox.
8. Differential unit.
10. Differential unit.
11. Pedal links.
12. Steering box.
13. Front wheel hubs.
14. Steering idler box.
15. Starter motor.
16. Gearbox.
17. Water pump.
18. Accelerator cable.
19. Brake fluid reservoir.
20. Clutch withdrawal shaft.
21. Air conditioning compressor.
22. Clutch fluid reservoir.

LUBRICATION DIAGRAM CODE SYMBOL



AGIP F1 RACING SAE 30-40 : Winter  
AGIP F1 RACING SAE 50 : Summer



1) CASTROL WAKEFIELD GIRLING BRAKE FLUID AMBER  
2) AGIP F1 BRAKE FLUID

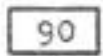

AGIP F 1 ROTRA HYPOID 90

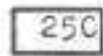

AGIP F1 ROTRA SAE 250



AGIP F1 GREASE 15



AGIP F1 GREASE 33 F.D.



AGIP F1 TER 34



AGIP F1 BRAXE FLUID



AGIP F1 ROTRA MP SAE 90





Electrical Equipment Components

1. Dipped light headlamp - left outside.
2. Main beam headlamp - left inside.
3. Left side fog lamp (on order).
4. Side lamp and direction indicator - left front.
5. Side direction indicator - left.
6. Dipped light headlamp - right outside.
7. Main beam headlamp - right inside.
8. Right side fog lamp (on order).
9. Side lamp and direction indicator - right front.
10. Side direction indicator - right.
11. Motor relay - condenser fans.
12. Horn
13. Thermal cut-out switches - engine radiator fans.
14. Radiator fan motor - left.
15. Air conditioning compressor electromagnetic drive.
16. Radiator fan motor - right.
17. Ignition distributor.
18. Ignition coil.
19. Air horn compressor.
20. Stop light hydraulic switch.
21. Bonnet light.
22. Bonnet light switch.
23. Windscreen wiper motor.
24. Alternator.
25. Choke control-on warning light switch.
26. Sparking plugs cable.
27. Oil temperature sender unit.
28. Oil pressure sender unit.
29. Starter motor.
30. Water temperature sender unit.
31. Alternator voltage regulator.
32. Harness connection.
33. Radio aerial control motor.
34. Heating / ventilation blower motor.
35. Voltage regulators - instruments.
36. Water temperature indicator.
37. Oil pressure indicator.
38. Oil temperature indicator.
39. Fuel tank level indicator.
40. Ammeter.
41. Tachometer with warning lights:
  - a) main beams - blue
  - b) direction indicators - red
  - c) side lamps - green



42. Speedometer/Kilometer counter with warning lights.
  - a) heating/ventilation blower - amber.
  - b) choke control-on - Green.
  - c) alternator charge - red.
43. Air horn wiping contact.
44. Hand brake-on warning light - red.
45. Rear window defroster warning light – amber.
46. Fuel reserve level warning light - red for left tank.
47. Fuel reserve level warning light - red for right tank.
48. Lamp control unit on steering wheel.
49. Ignition switch.
50. Control switch – external lights and headlamp dipped lights.
51. Fog lamps and low beams control switch.
52. Windscreen wiper two-speed control switch.
53. Lighting dimmer switch - instruments.
54. Two way switch - left door window winder.
55. Two - way switch - right door window winder.
56. Change-over - petrol pumps and level indicators.
57. Two-speed control switch - heating/ventilation blower.
58. Rear window defroster switch.
59. Ceiling light switch.
60. Main beam cancelling relay - headlamp flashing unit.
61. Radio set.
62. Radio aerial control switch.
63. Air conditioning compressor thermal switch.
64. Electric clock.
65. Cigar lighter on dashboard.
66. Air horn relay.
67. Direction indicators flashing unit.
68. Map-box lamp on dashboard.
69. Engine fans fuse valves.
70. Fuse box.
71. Hand brake-on warning light switch.
72. Reverse driving lights switch.
73. Cigarette lighter on transnission cover.
74. Rear view mirror with lamp.
75. Left side lamp for internal illumination.
76. Right side lamp for internal illumination.
77. Wiscreen washer pump.
78. Earth switch for left hand courtesy light.
79. Window winder motor - left door.
80. Signalling light for left door open.
81. Earth switch for right hand courtesy light.
82. Window winder motor - right door.
83. Signalling light for right door open.
84. Terminal block.



85. Trunk illumination switch.
86. Petrol tank float sender unit - left tank level and reserve.
87. Rear window resistance defroster.
88. Fuel feed pump - left tank.
89. Trunk lamp illumination.
90. Fuel feed pump - right tank.
91. Radio loudspeaker.
92. Battery.
93. Petrol tank float sender unit - right tank level and reserve.
94. Triple lamp unit - left hand rear.
  - a) direction indicator light.
  - b) Rear/ stop light.
  - c) Reverse driving light.
95. Number plate rear lights.
96. Triple lamp unit - right hand rear.
  - a) direction indicator light.
  - b) Rear/ stop light
  - c) Reverse driving light.

#### TOOL KIT

- 1 car lifting jack.
- 1 set of spanners, 6-22 mm.
- 1 socket wrench - spark plugs.
- 1 adjustable spanner.
- 1 wrench - carburettor.
- 1 spanner - wheels.
- 1 steel hammer.
- 1 universal pliers.
- 1 screw driver.
- 1 spanner for the heat exchanger.



MAIN FUSEBOX







### MAIN FUSEBOX

- 1** - Left headlamp main beam warning light.
- 2** - Right headlamp main beam.
- 3** - Front/rear side lamps - warning light.
- 4** - Dipped light headlamps, fog lamps.
- 5** - Left window winder motor.
- 6** - Right window winder motor, air horns.
- 7** - Windscreen wiper, headlamp flashing lights.
- 8** - Inside lights, door lights, glove box and clock lights.
- 9** - Radio and cigar lighter.
- 10** - Fan, horn, Rear window defroster.
- 11** - Fuel pumps.
- 12** - Reverse driving lamps, stop lights, direction indicator, flashing lights.

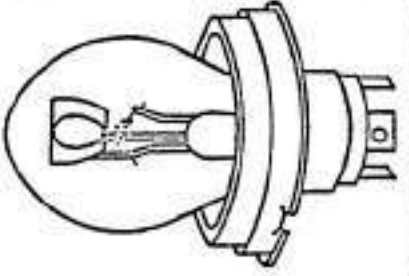
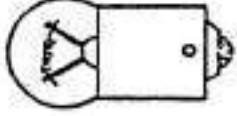
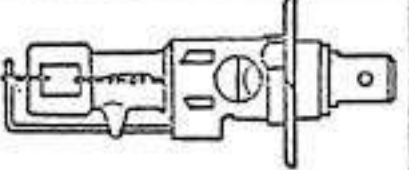
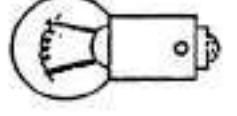
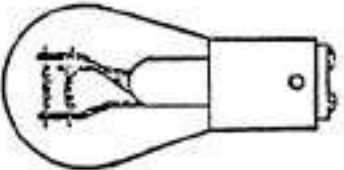

CAR BULBS

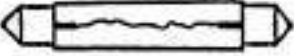
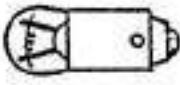
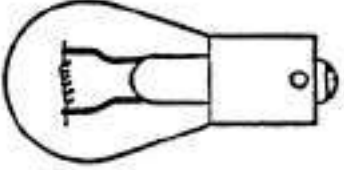
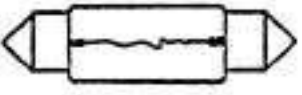
	1		6
	2		7
	3		8
	4		9
	5		10



### CAR BULBS

1. - Headlamps (amber) - used by the France Country only.  
Headlamps (white) - up to the first 25 cars. (P 45 T - 12V 55W)
2. - Headlamps - Jodine (Philips - 12V 55W)
3. - Rear side lamps and rear stop lights (BAY 150 – 12V 5+20W)
4. - Dashboard lighting (S 6 - 12V 3W)
5. - Front/rear direction indicators & reverse driving lights (BA 15S - 12V 20W)
6. - Front side lamps & number plate lights (BA 15S - 12V 5W)
7. - Lights on door (BA 9S -12V 6W)
8. - Instrument & warning lights (E 10/13 - 12V 3W)
9. - Light on cigar lighter (BA 9S - 12V 3W)
- 10.- Bonnet, Boot &: car roof lights (S 8.5 - 12V 5W)



**IMPORTANT**

Your car is fitted with an exhaust silencing assembly which has been approved by the « Ispettorato Generale della Motorizzazione » (the Italian Government Body for Automotives); the approval reference has been stamped on silencers.

---

CONFORMITY OF SILENCERS TO THE ITALIAN GOVERNMENT STANDARDS DOES NOT EXCLUDE THAT IN CERTAIN CONDITIONS, ESPECIALLY WHEN THE CAR HAS BEEN USED FOR A LONG TIME, THE NOISE LIMIT MIGHT BE EXCEEDED.

---

The Officine Alfieri Maserati S.p.A., Via Ciro Menotti 322, Modena, Italy are at your complete disposal for any further information on eus and maintenance of your car, and will be very glad to assist you so that you may obtain the best performance and most satisfaction from your car.





**MASERATI « MEXICO »  
DRIVING AND SERVICING MANUAL**

32

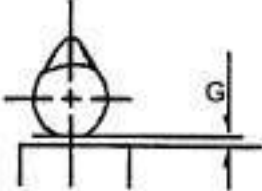
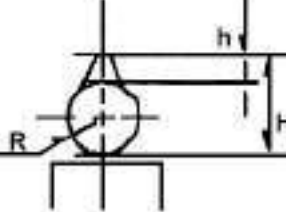
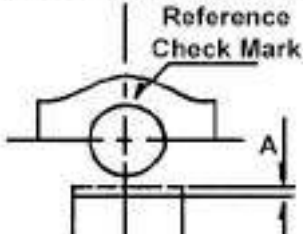
Profile	Maserati Spare Part Numbers	Valve Clearance 	Lobe Dimensions 	Valve Opening at T.D.C. Reference Check Mark 
67000	115-MD-67275 R.H. 115-MD-67273 L.H. Intake	G=0.25 to 0.30	H = 37.0 h = 11.0 R = 13.0	A = 1.7
67500	115-MD-67182 R.H. 115-MD-67273 L.H. Exhaust	G = 0.45 to 0.50	H = 36.2 h = 10.2 R = 13.0	A = 1.7
48377	103/3002-50766 R.H. 103-3003-50767 L.H. Intake	G = 0.12 to 0.15	H = 35.5 h = 9.52 R = 13.0	A = 1.3
64400	107/3-MD-67201 L.H. 107/3-MD-67203 R.H. Exhaust	G = 0.48 to 0.50	H= 35.11 h = 9.11 R = 13.0	A = 1.7
48377	103-3002-50766 R.H. 103-3003-50767 L.H. Exhaust	G = 0.30 to 0.35	H = 35.5 h = 9.52 R = 13	A = 1.1

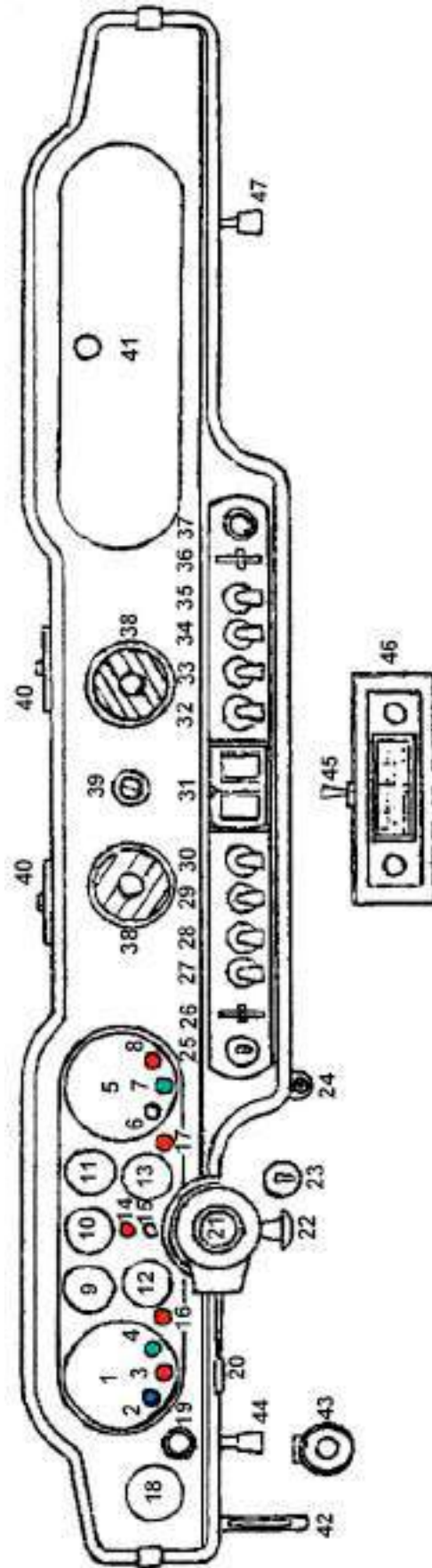



## DASHBOARD INSTRUMENTS

1. Tachometer.
2. Headlamp main beam warning light - blue.
3. Direction indicator warning light - red.
4. Side lamp warning light - green.
5. Speedometer and odometer.
6. Heater blower warning light - amber.
7. Ignition warning light - green.
8. Alternator charge warning light – green.
9. Water temperature indicator.
10. Oil pressure gauge.
11. Oil temperature indicator.
12. Fuel level indicator.
13. Ammeter.
14. Hand Brake warning light - red.
15. Rear Window defroster warning light - amber.
16. Left side fuel tank reserve warning light - red
17. Right side fuel tank reserve warning light – red.
18. Electric clock.
19. Choke control knob.
20. Change over lever for outer lights.
21. Air horns push button
22. Driving position adjustment locking knob.
23. Steering wheel locking device.
24. Kilometer counter zero-setting knob.
25. Ignition starter switch.
26. Heater water flow control lever.
27. Outer lights control switch.
28. Low and fog light switch.
29. Windscreen wiper switch.
30. Instrument lighting switch.
31. Window glass winder dual switch.
32. Fuel feed pump switch.
33. Heater blower two-speed control switch.
34. Rear window defroster switch.
35. Ceiling light switch.
36. Ventilation control lever.
37. Cigarette lighter.
38. Ventilation outlets.
39. Air conditioner thermostat.
40. Windscreen defroster outlets.
41. Glove box.
42. Bonnet release lever.
43. Windscreen washer pump.
44. Driver's side ventilation outlet control knob (up to car n° 31).
45. Aerial switch control.
46. Radio.
47. Passenger's side ventilation outlet control knob.

# 1: Dipped light headlamp

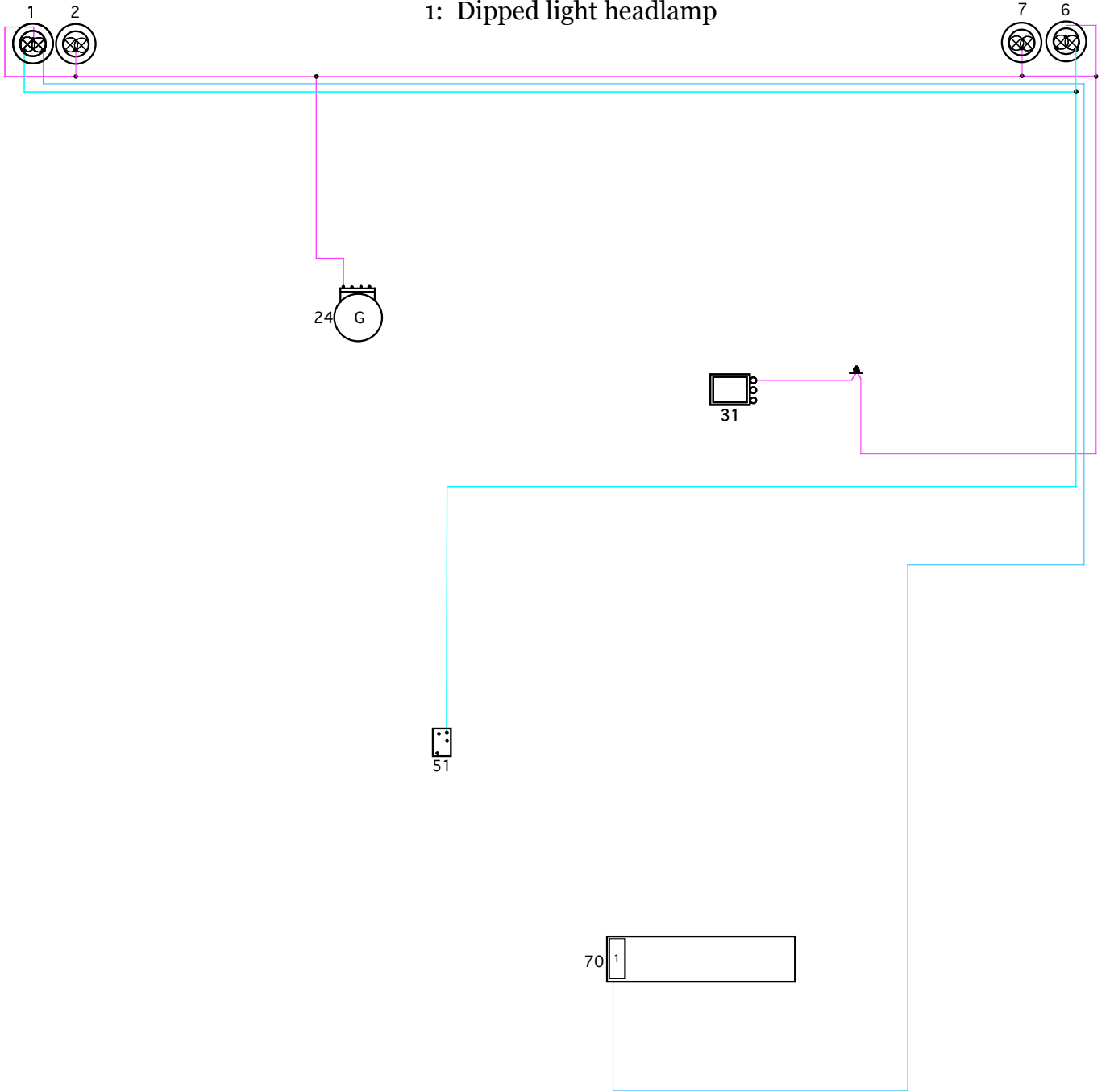

2 : Main beam headlamp

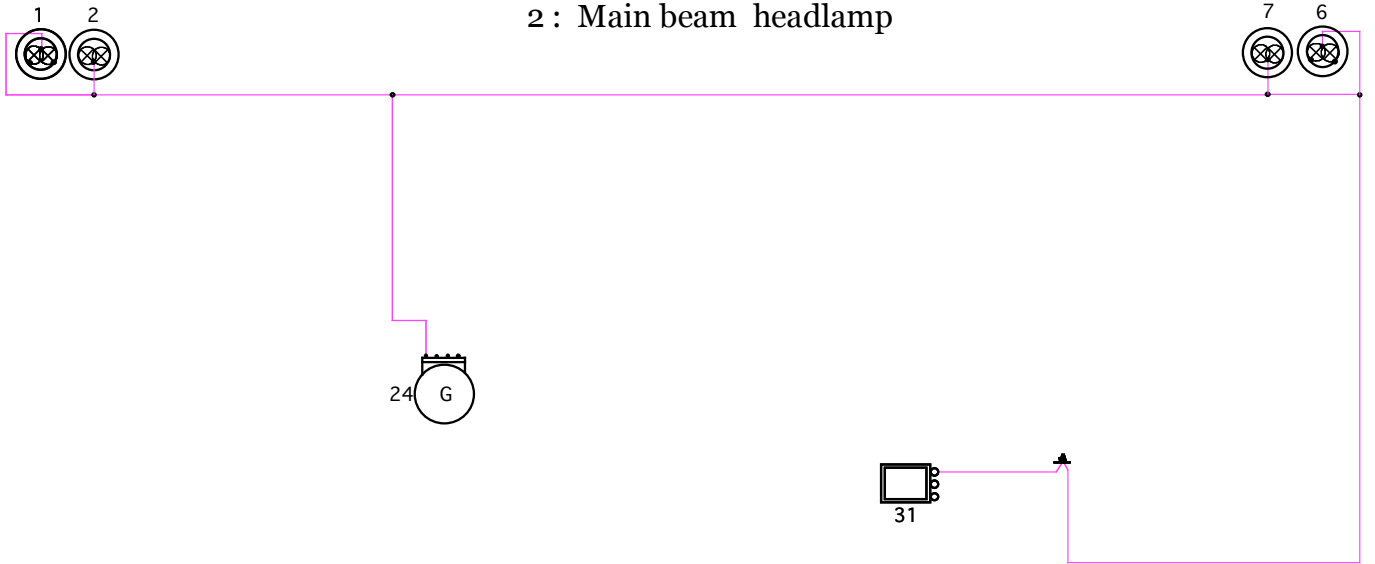

### 3 : Left side fog lamp

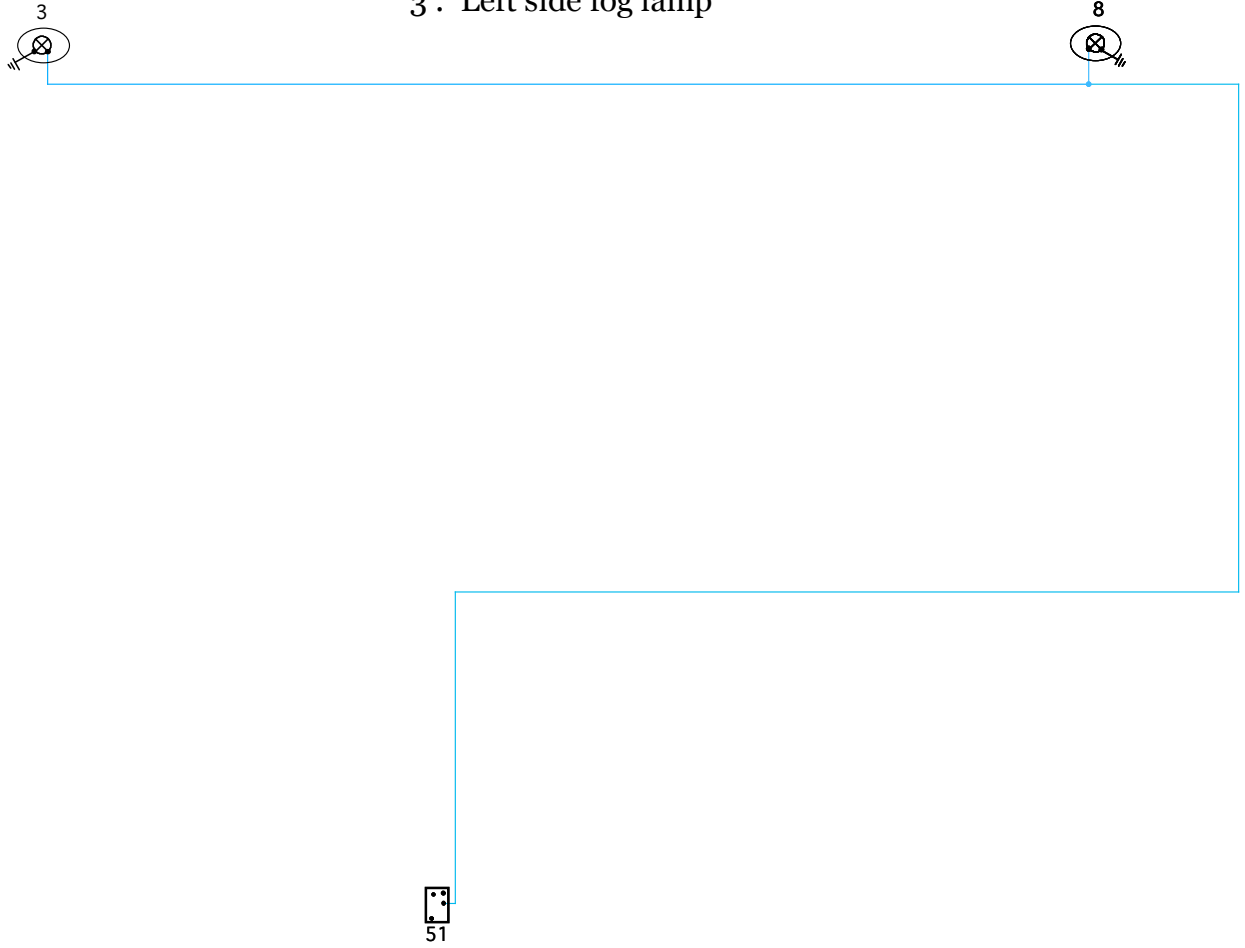

#### 4 : Side lamp and direction indicator

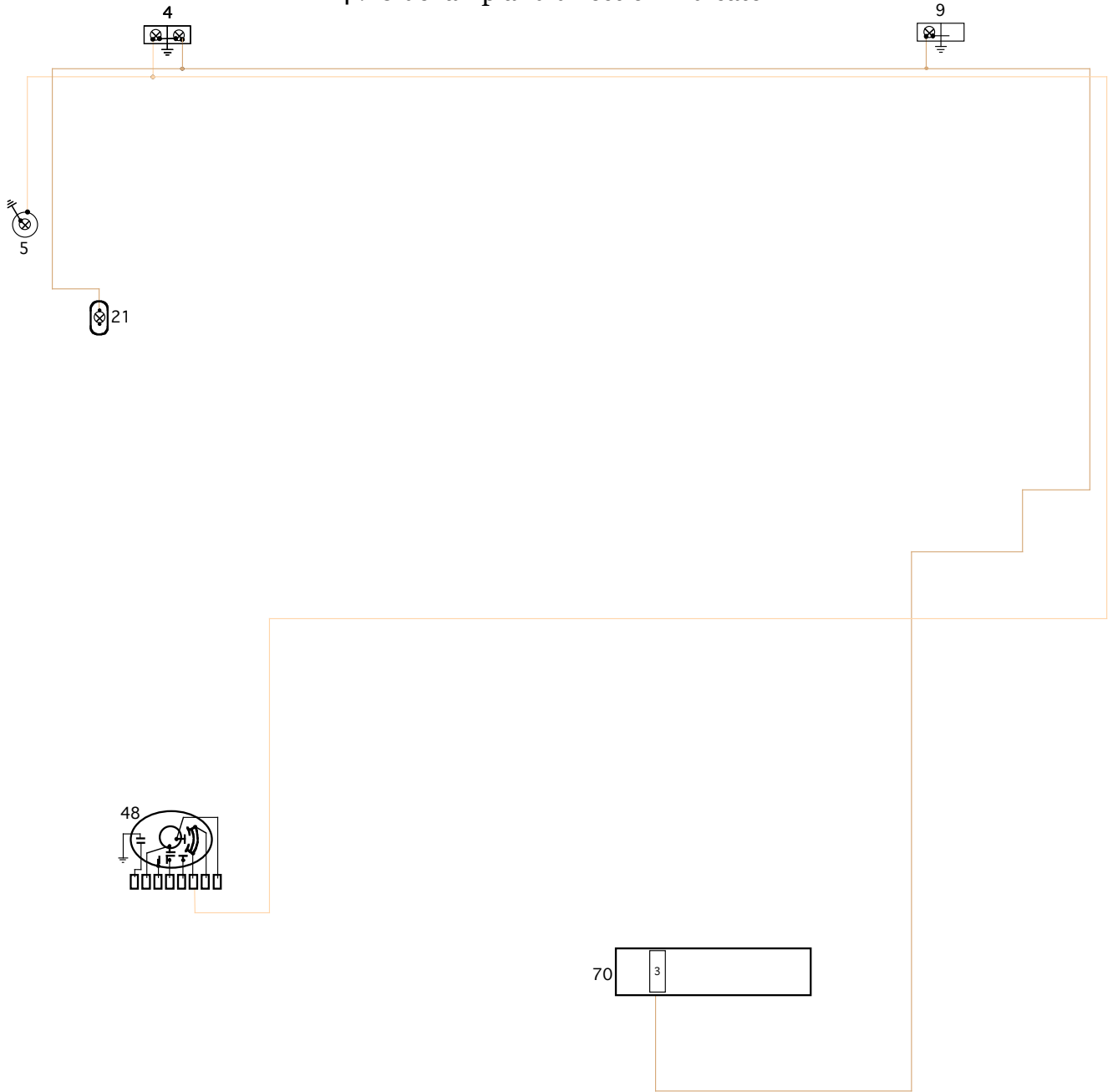

# 5 : Side direction indicator

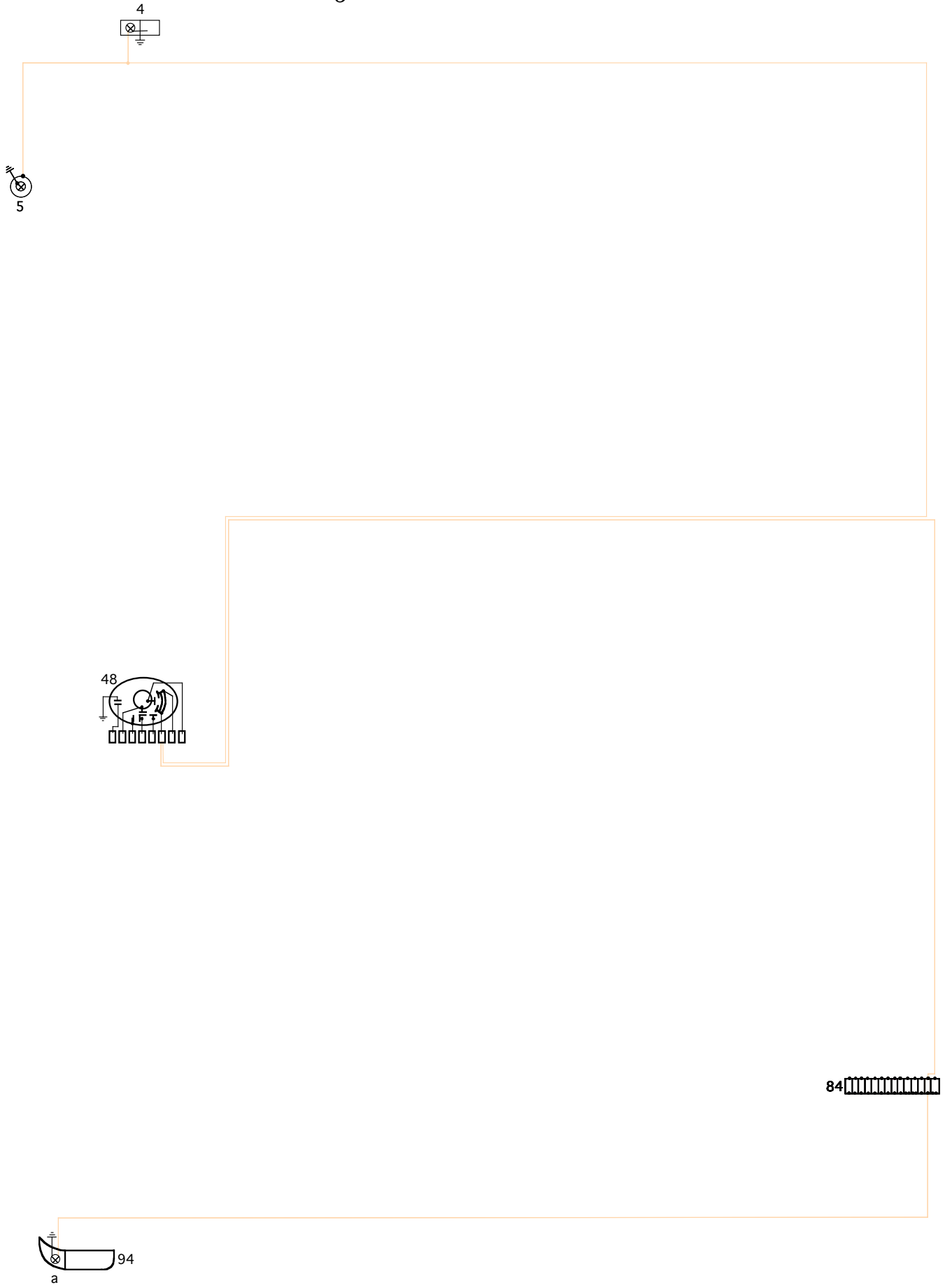



# 6 : Dipped light headlamp

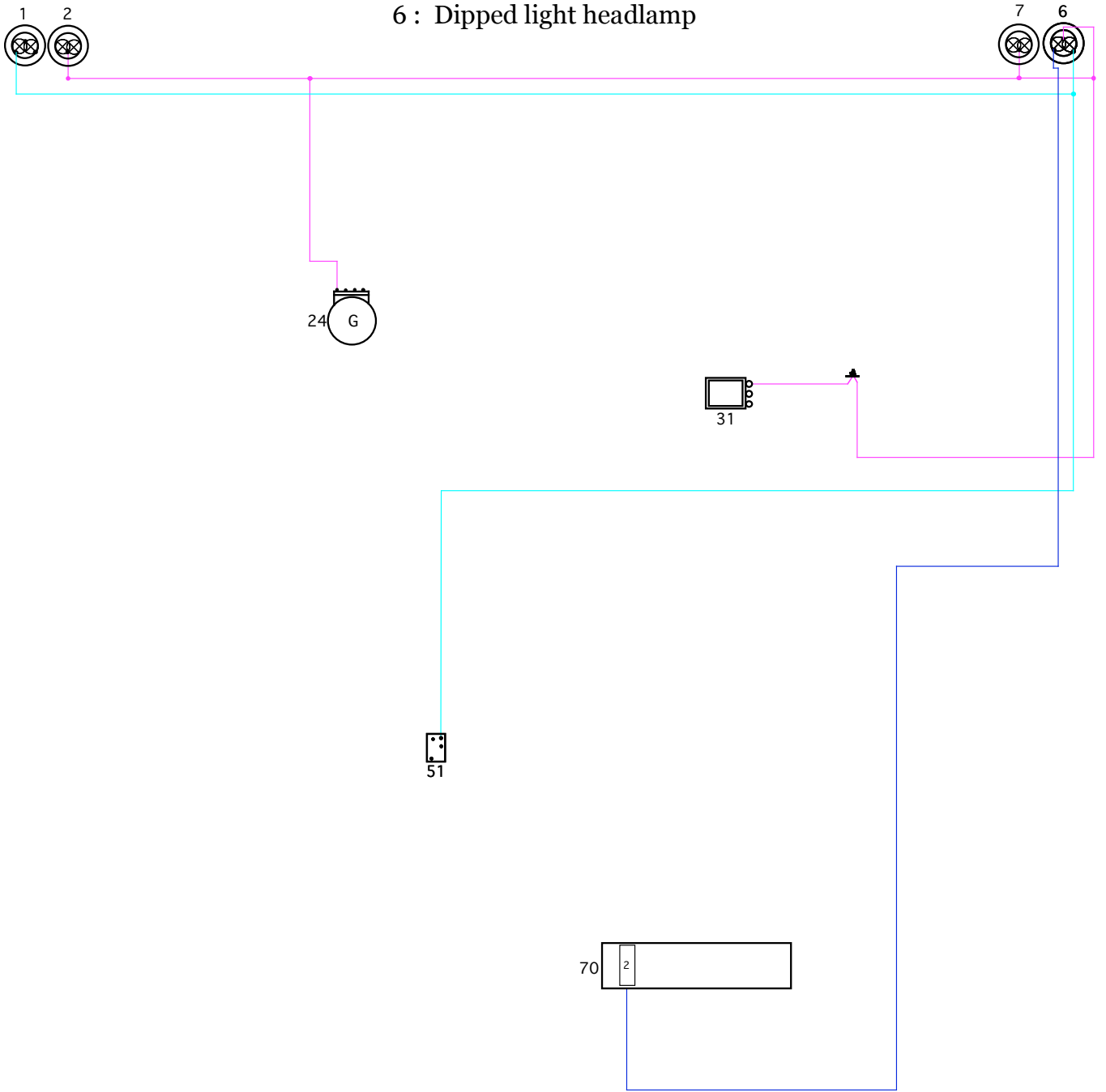

# 7: Main beam headlamp

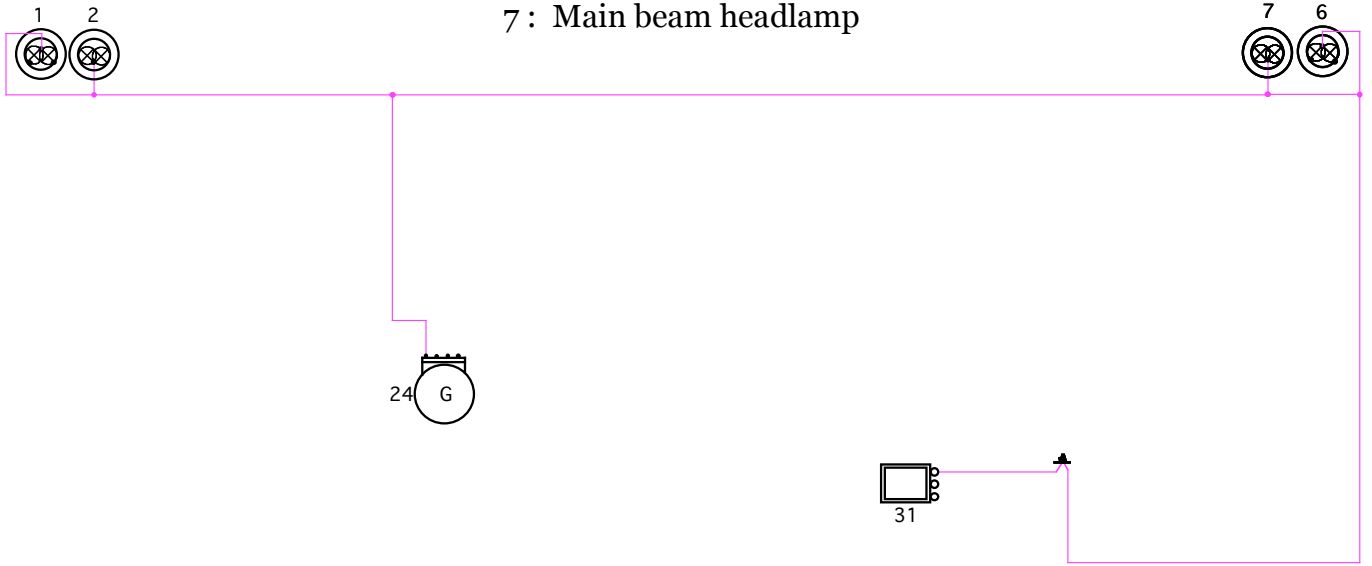

# 8 : Right side fog lamp

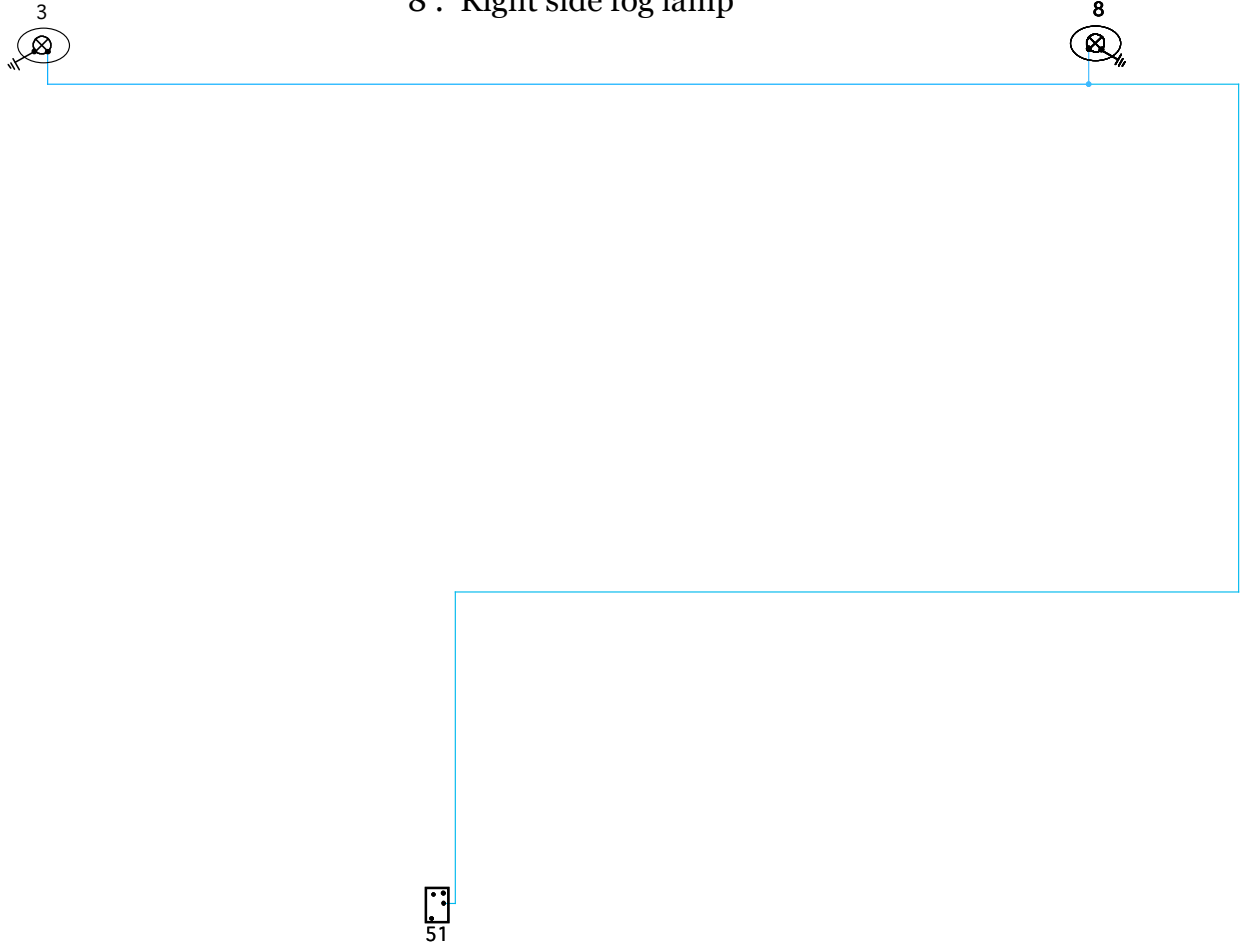

9 : Side lamp and direction indicator

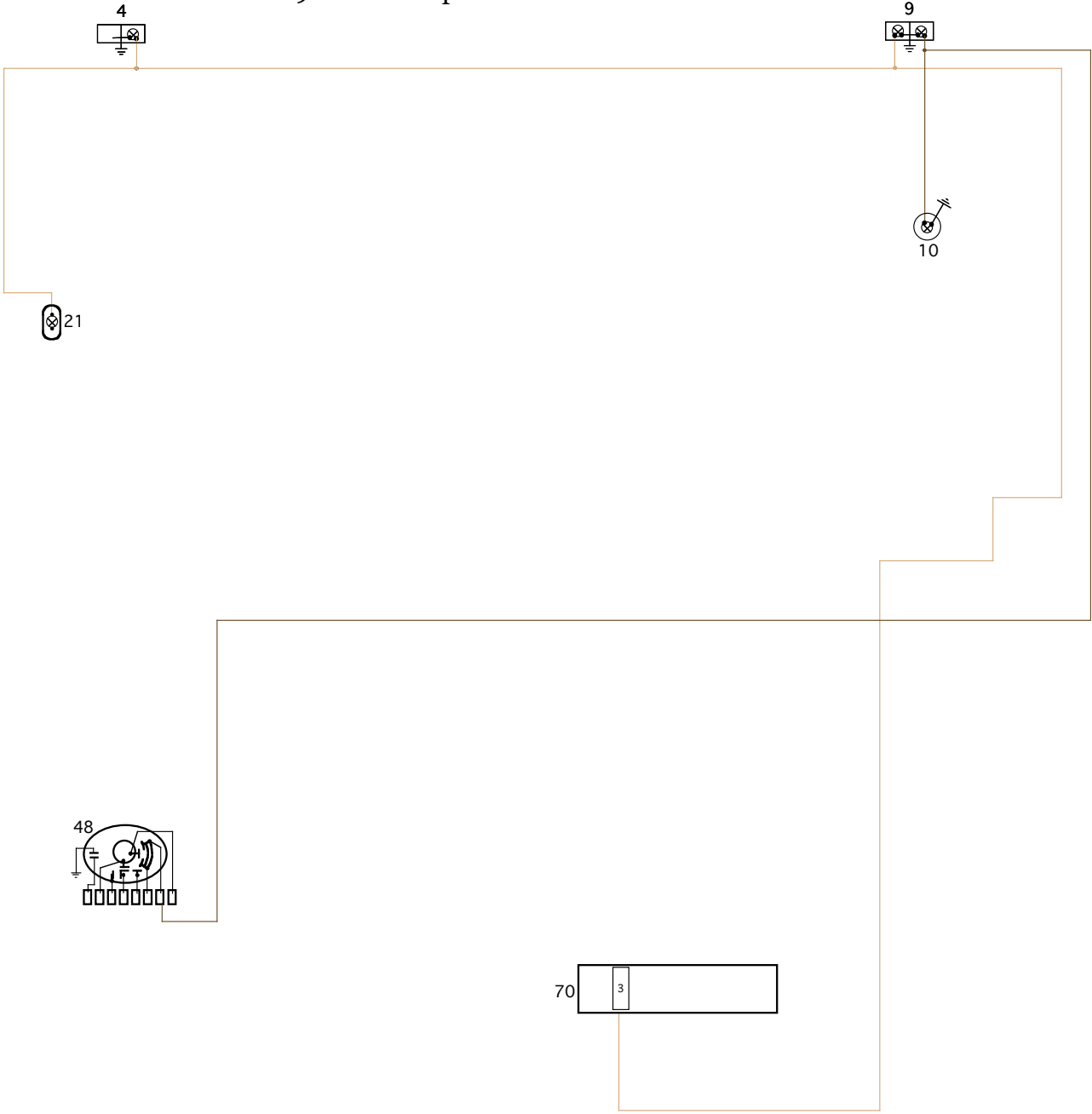

10 : Side direction indicator

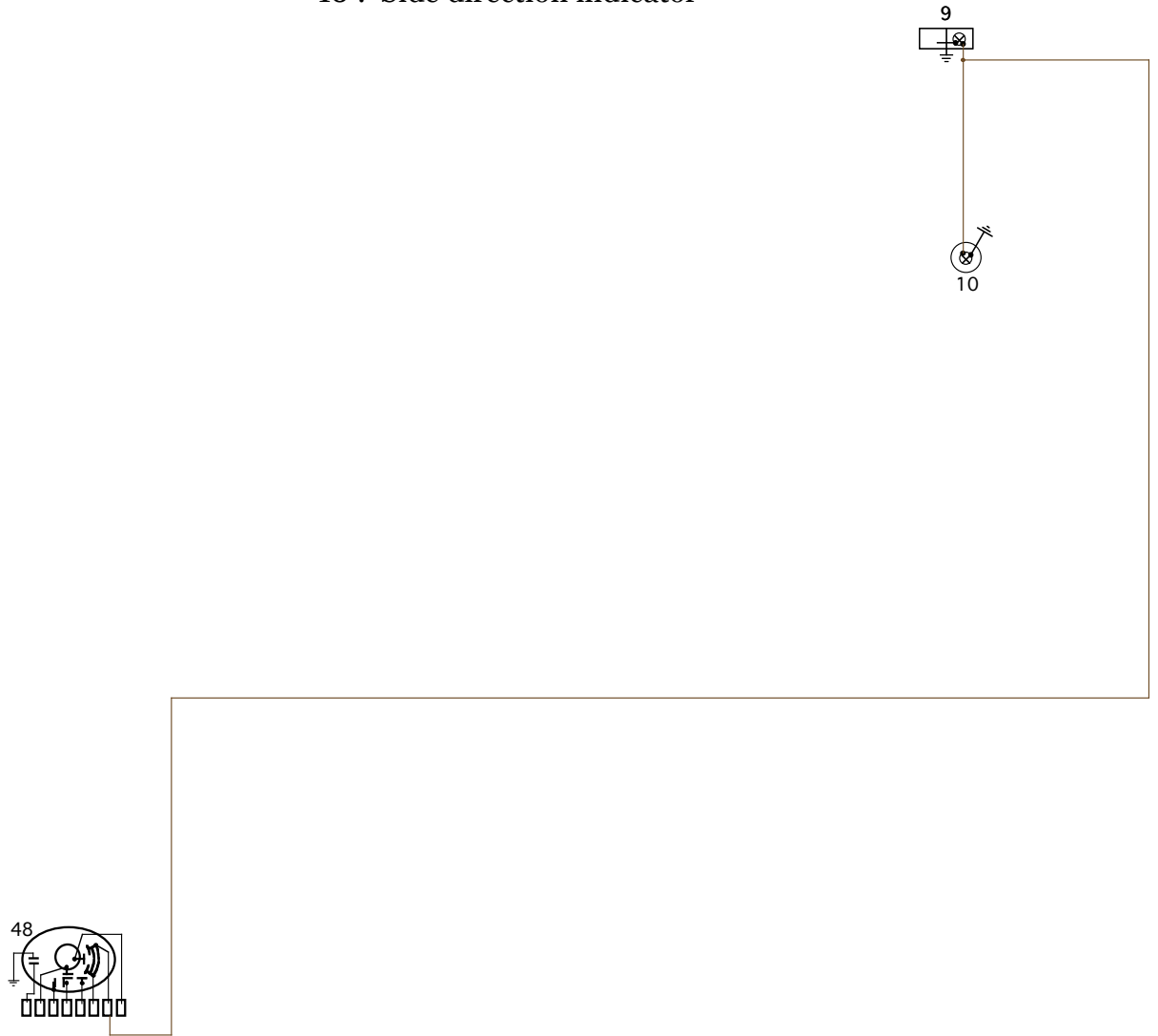

# 11 : Motor relay - Condenser fans

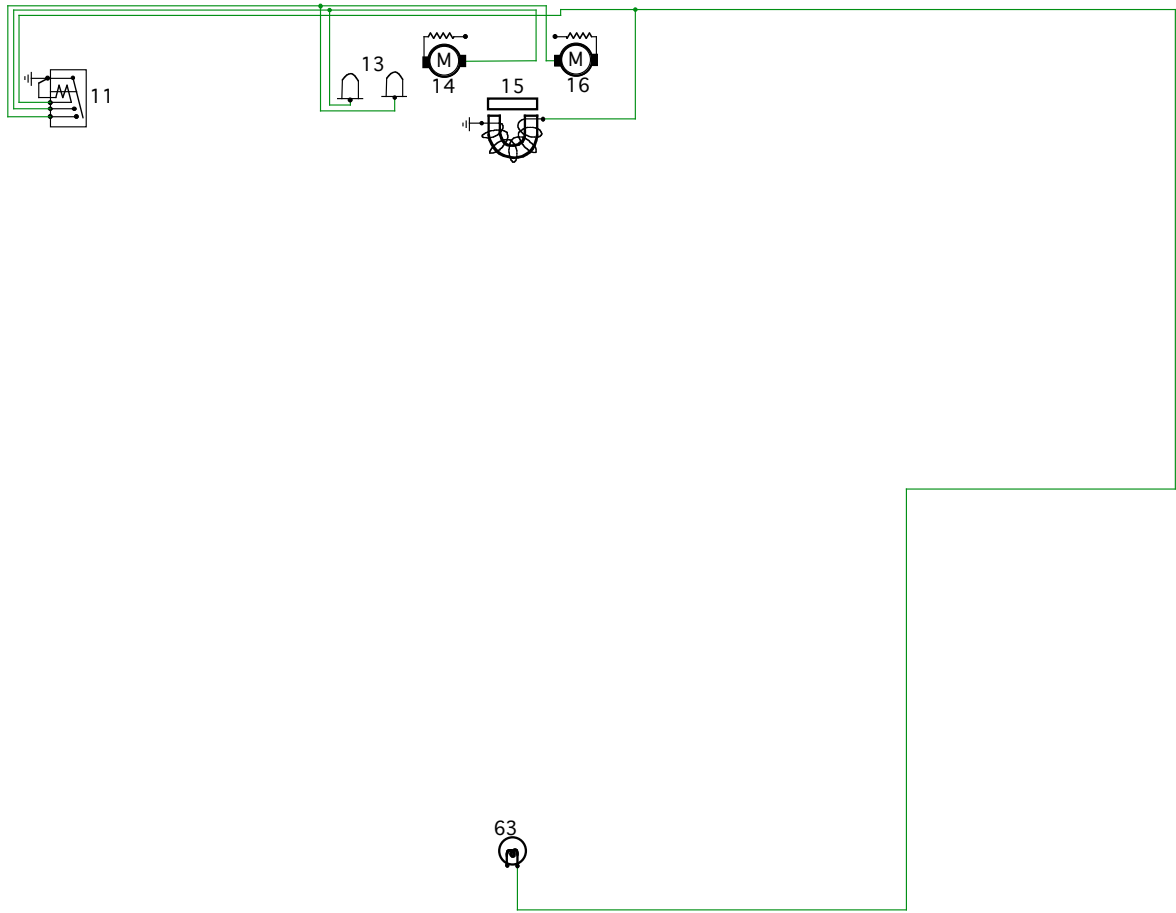

12 : Horn

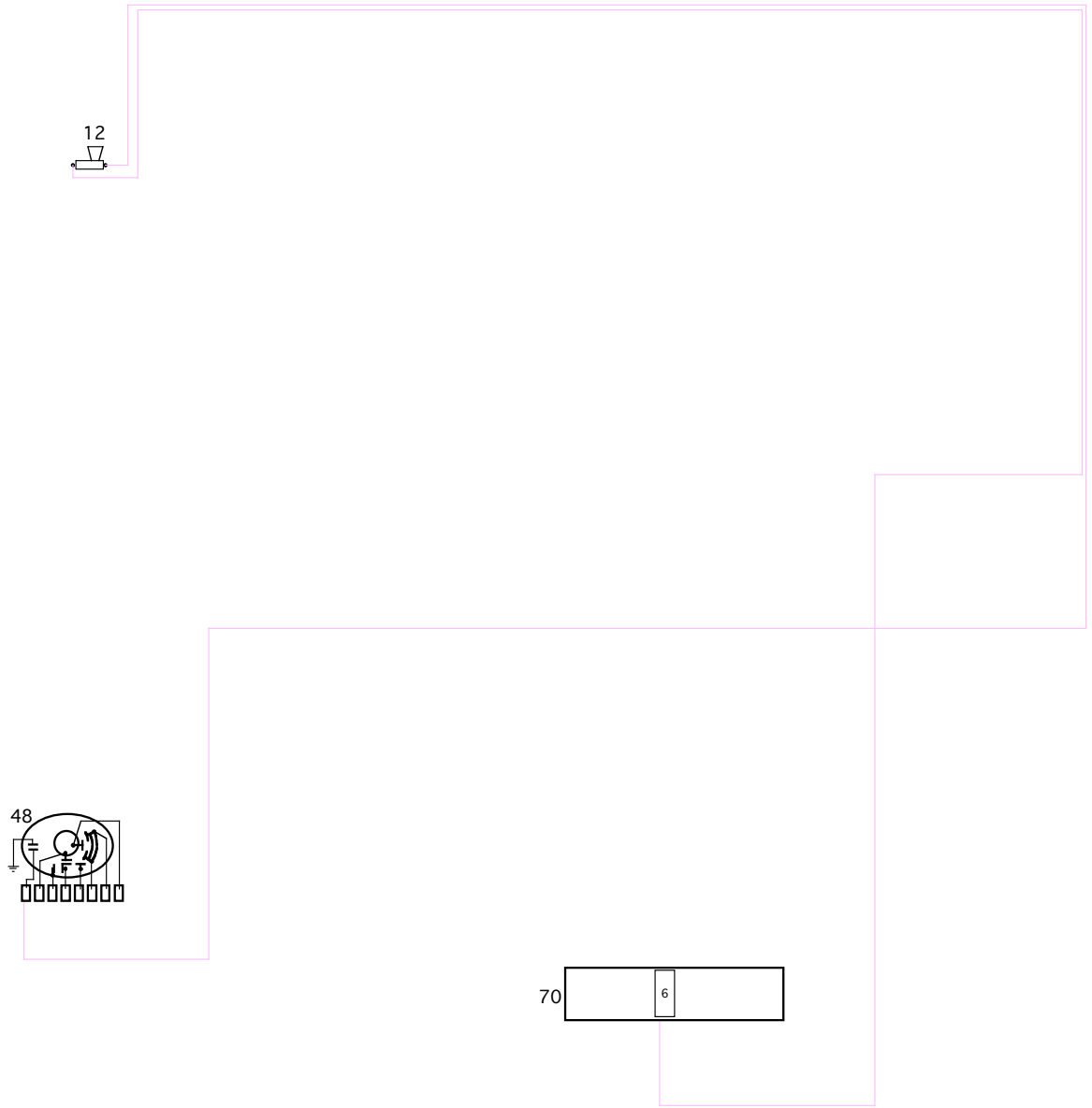

### 13 : Thermal cut-out switches - engine radiator fans

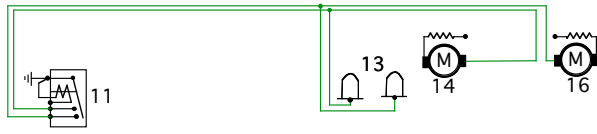



14 : Radiator fan motor - left

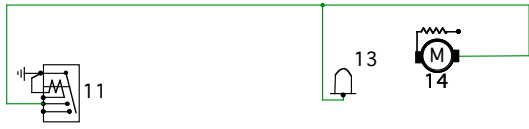

15 : Air conditioning compressor electromagnetic drive

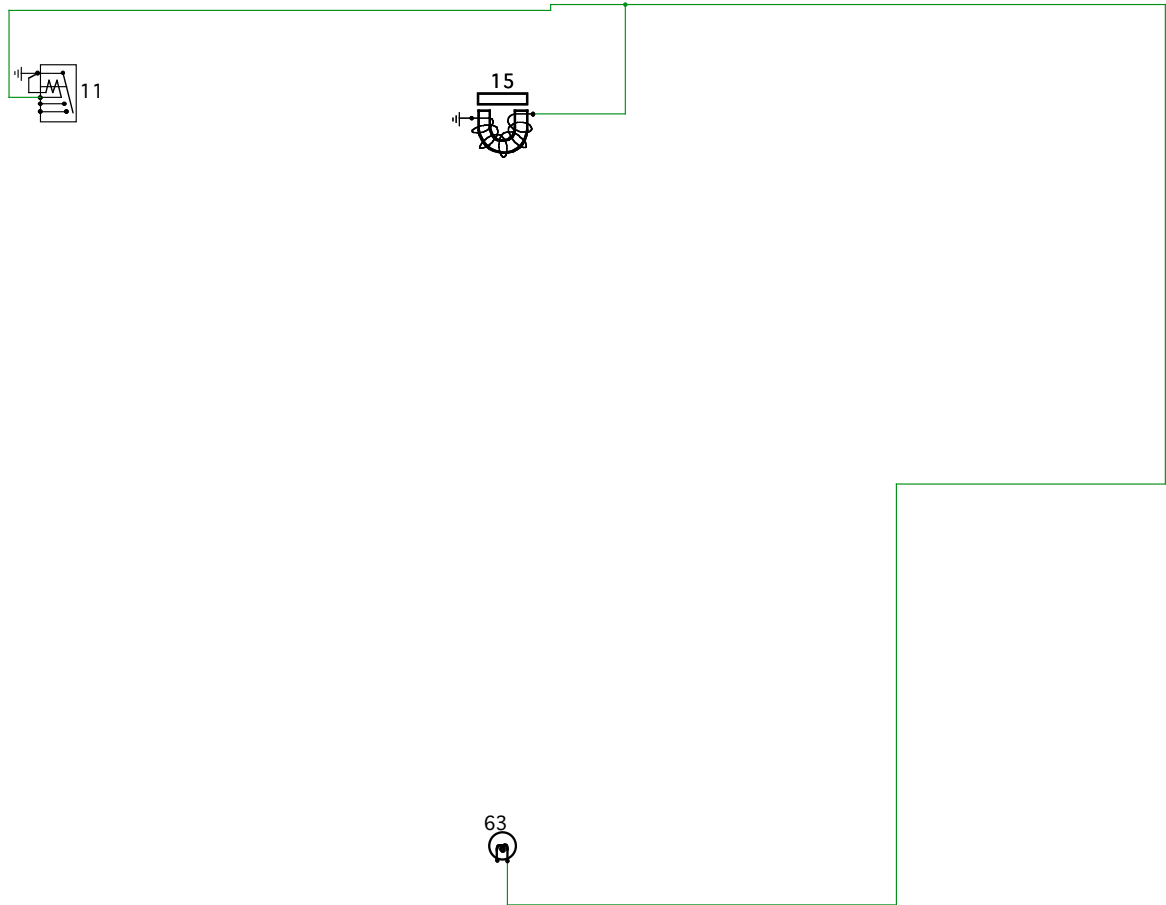

# 16 : Radiator fan motor - right

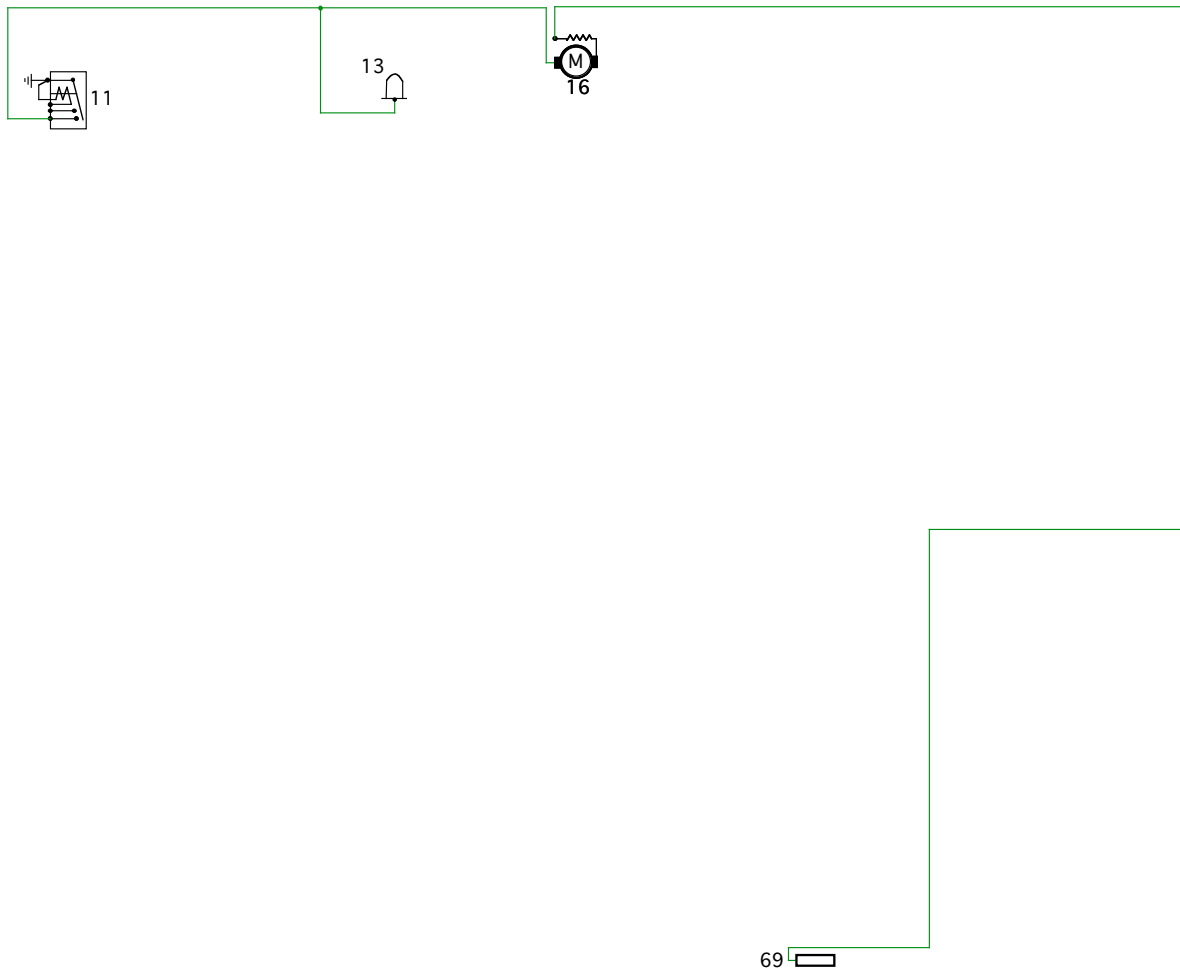

# 17 : Ignition distributor

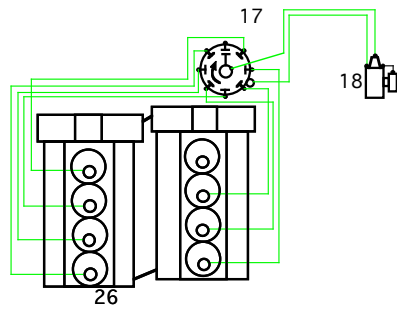

# 18 : Ignition coil

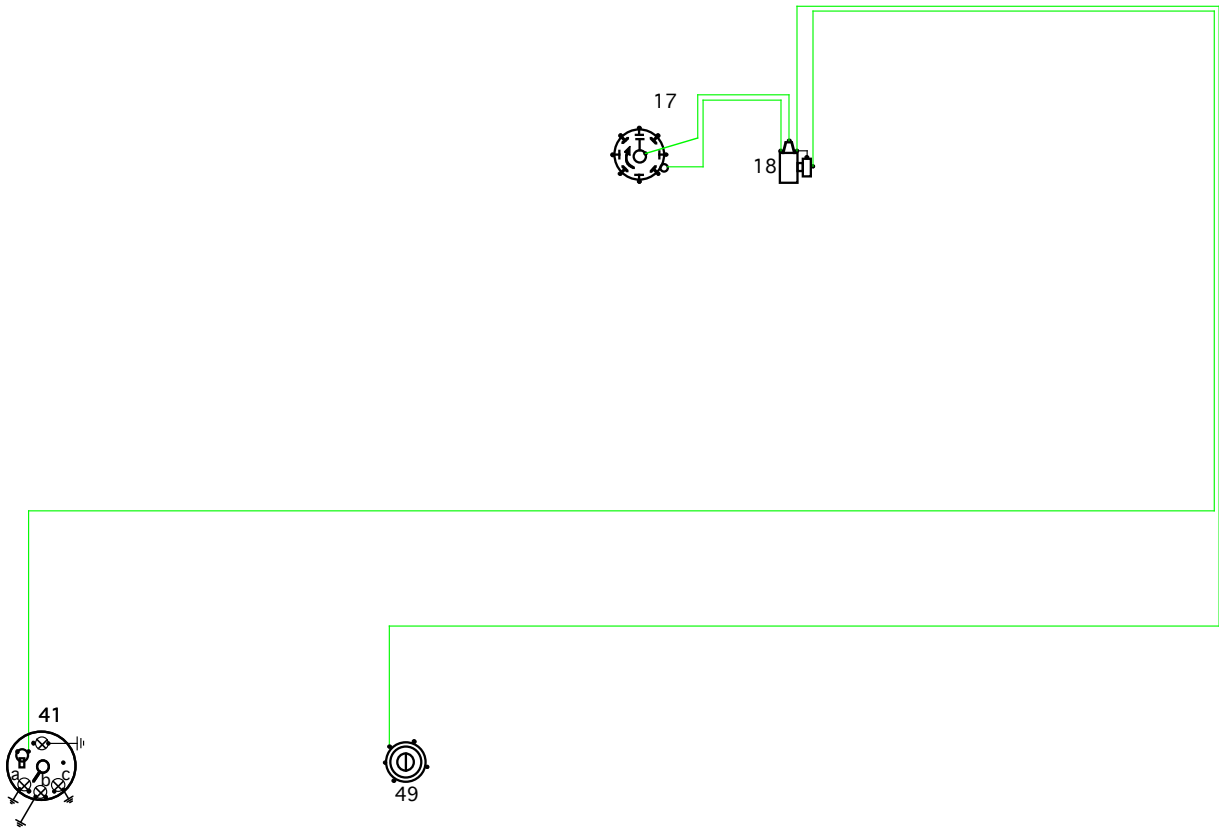

19 : Air horn compressor

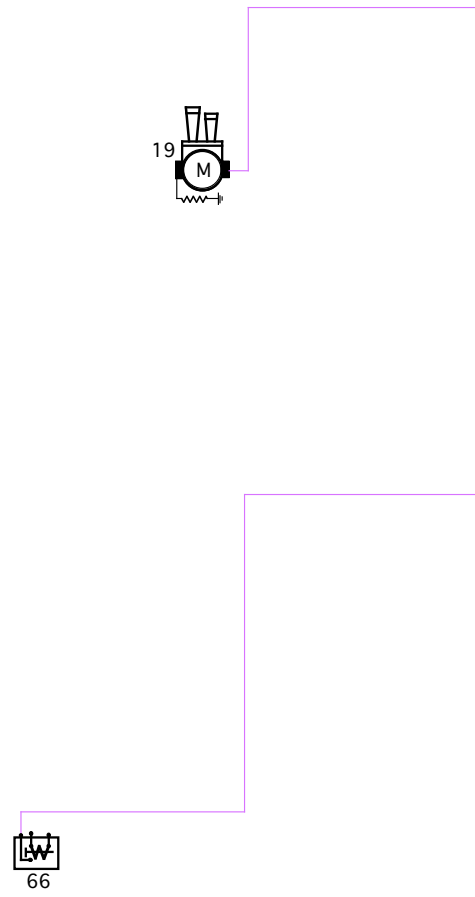

## 20 : Stop light hydraulic switch

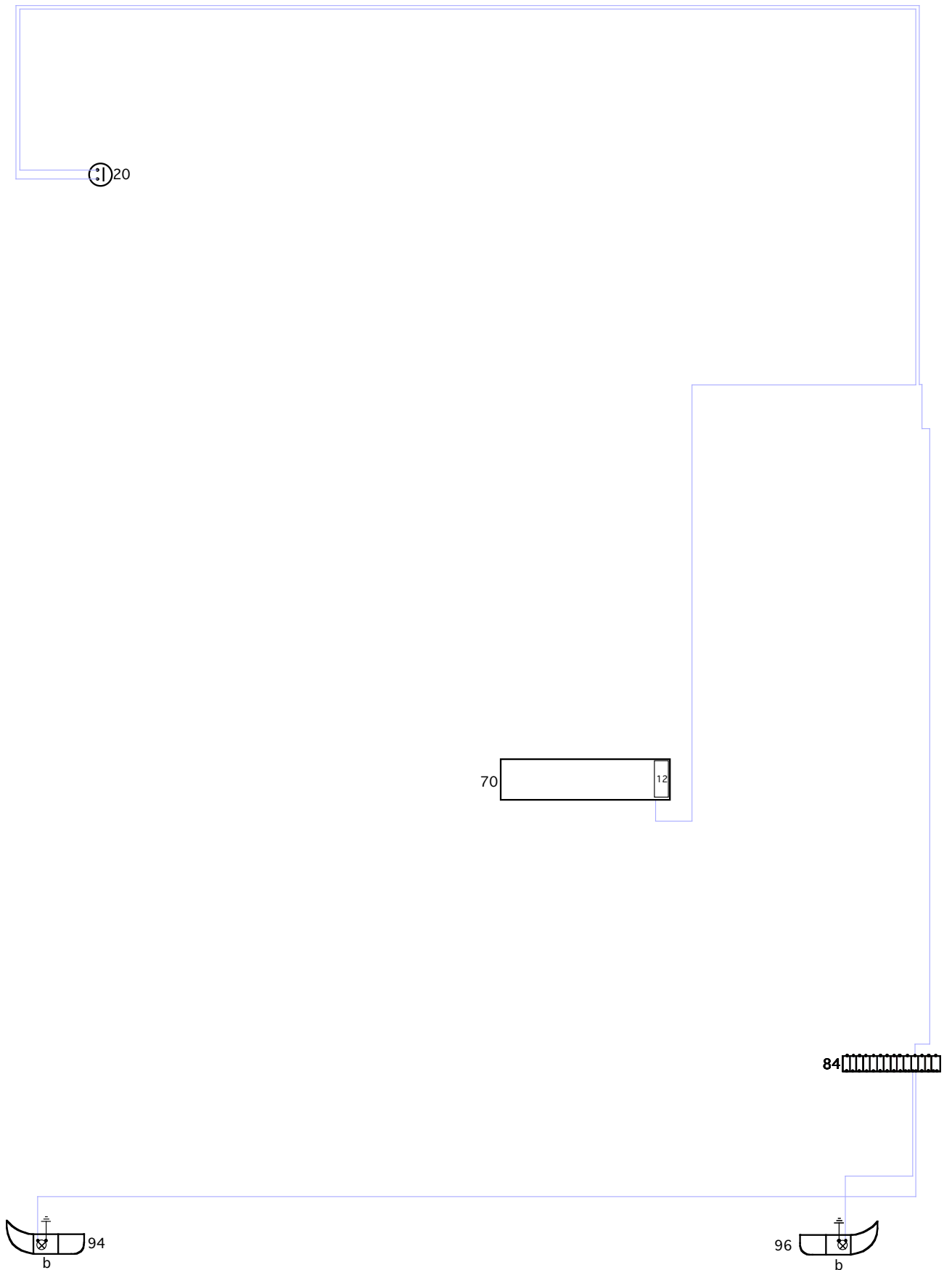

21/22 : Bonnet light / Bonnet light switch

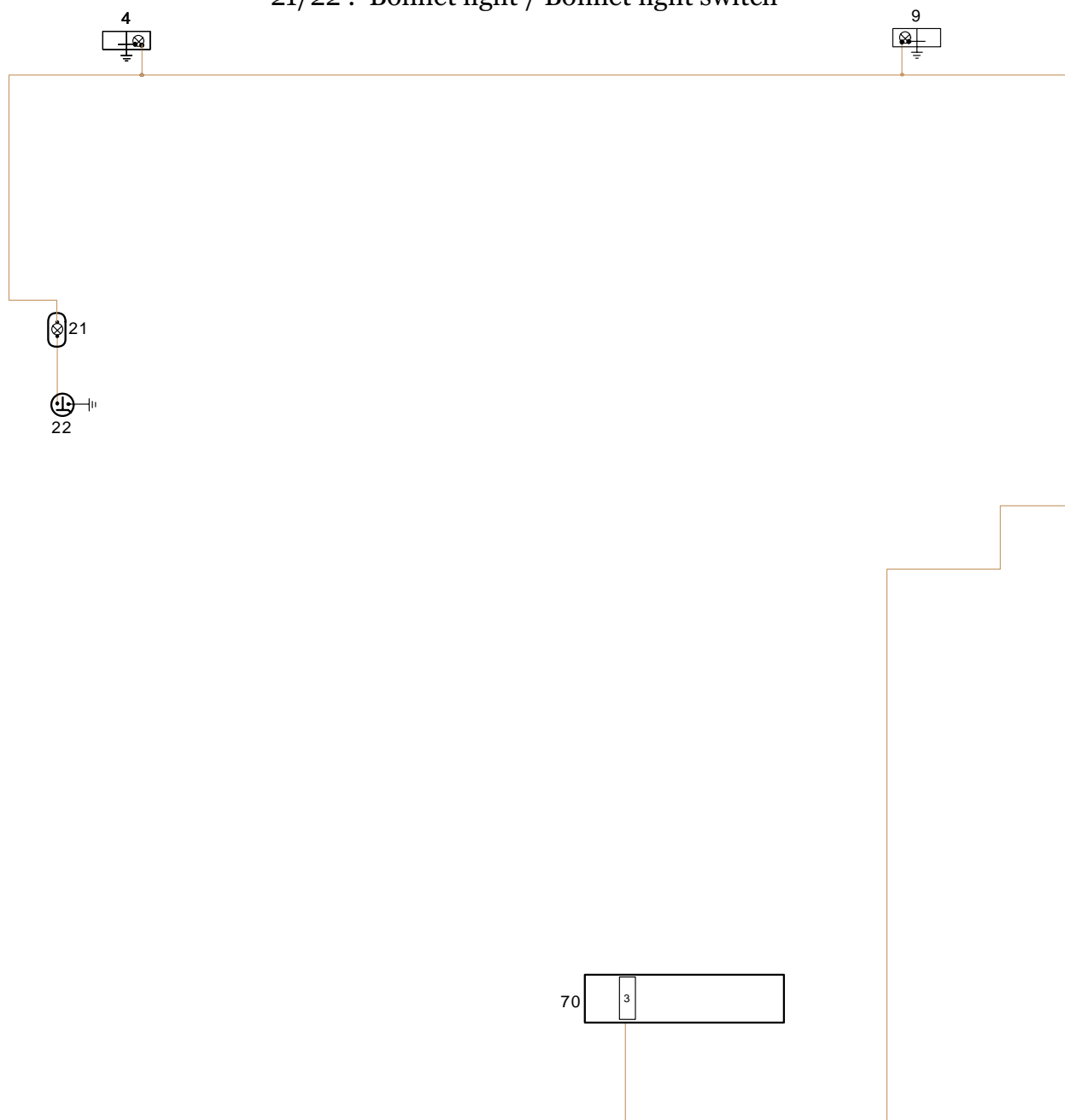



## 23 : Windscreen wiper motor

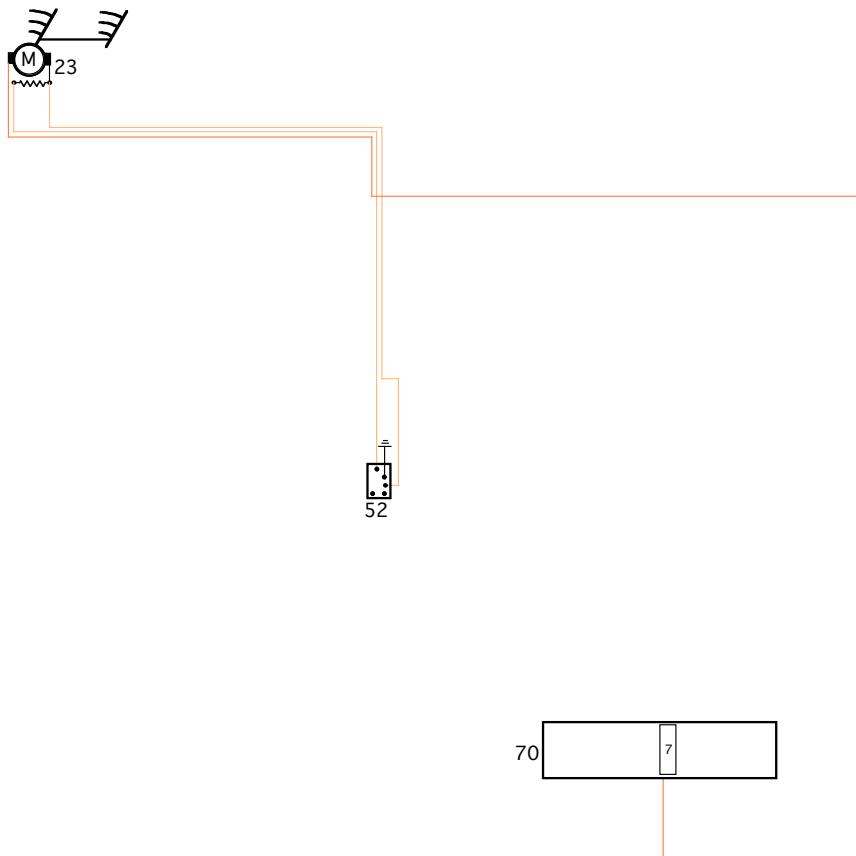

24 : Alternator

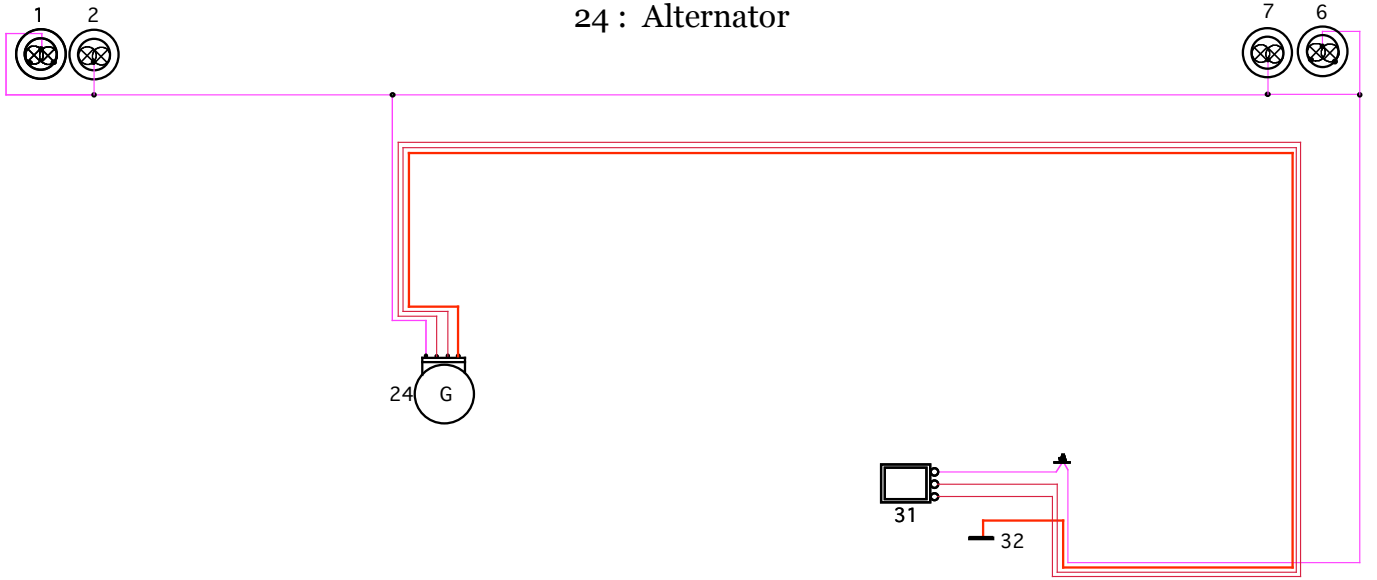

25 : Choke control-on warning light switch

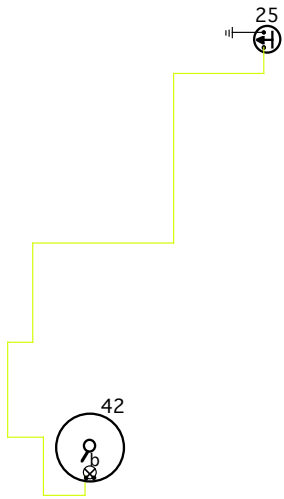

26 : Sparking plugs cable

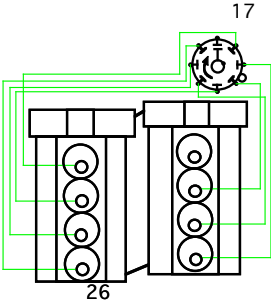

## 27 : Oil temperature sender unit

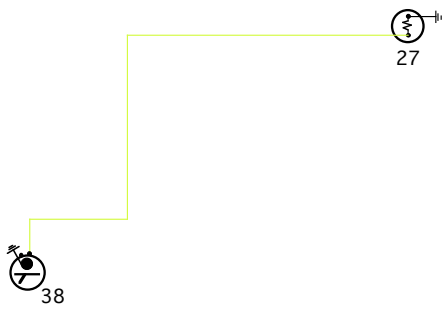

## 28 : Oil pressure sender unit

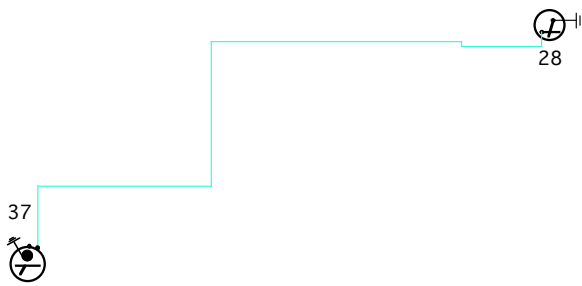

29 : Starter motor

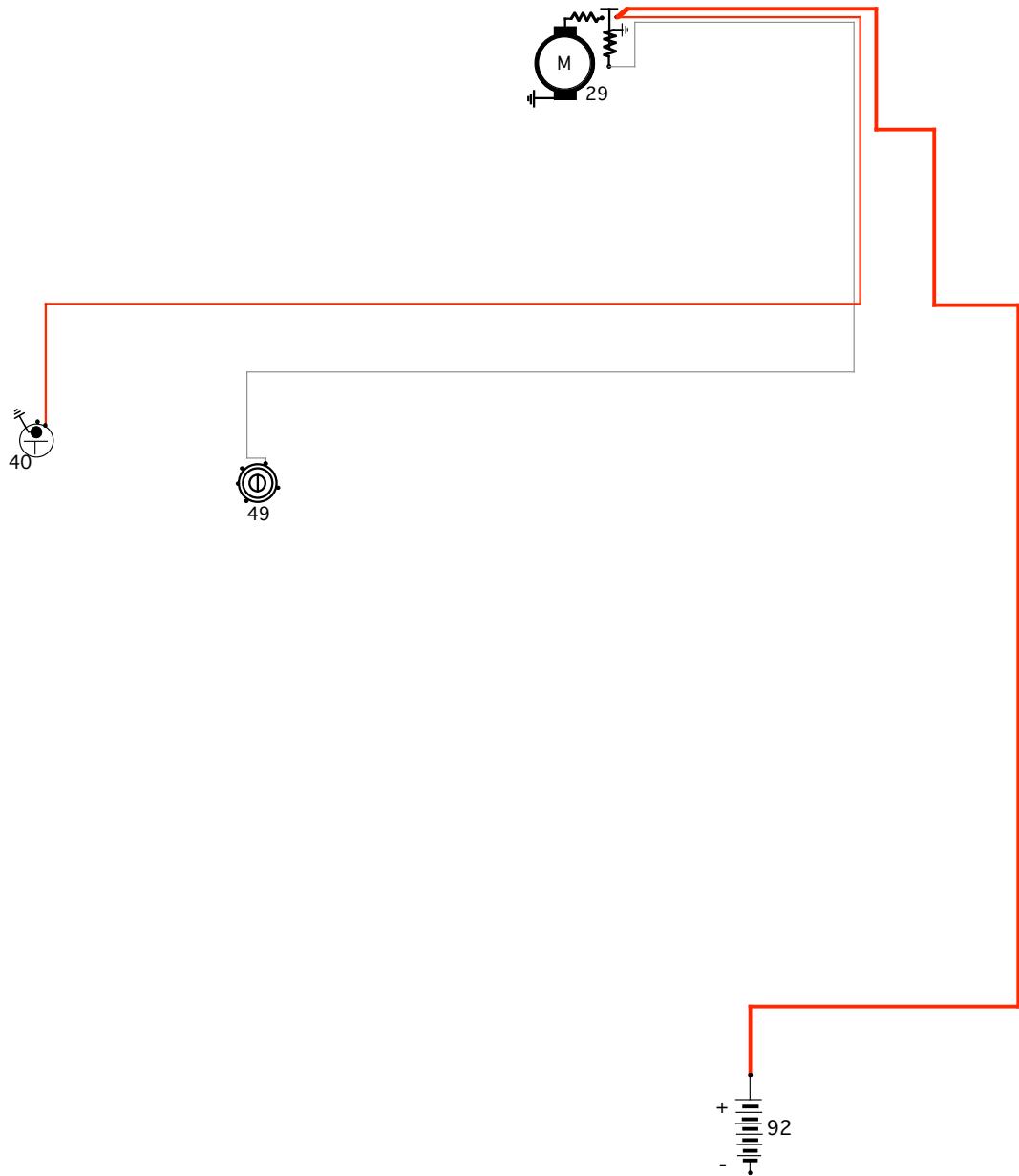

### 30: Water temperature sender unit

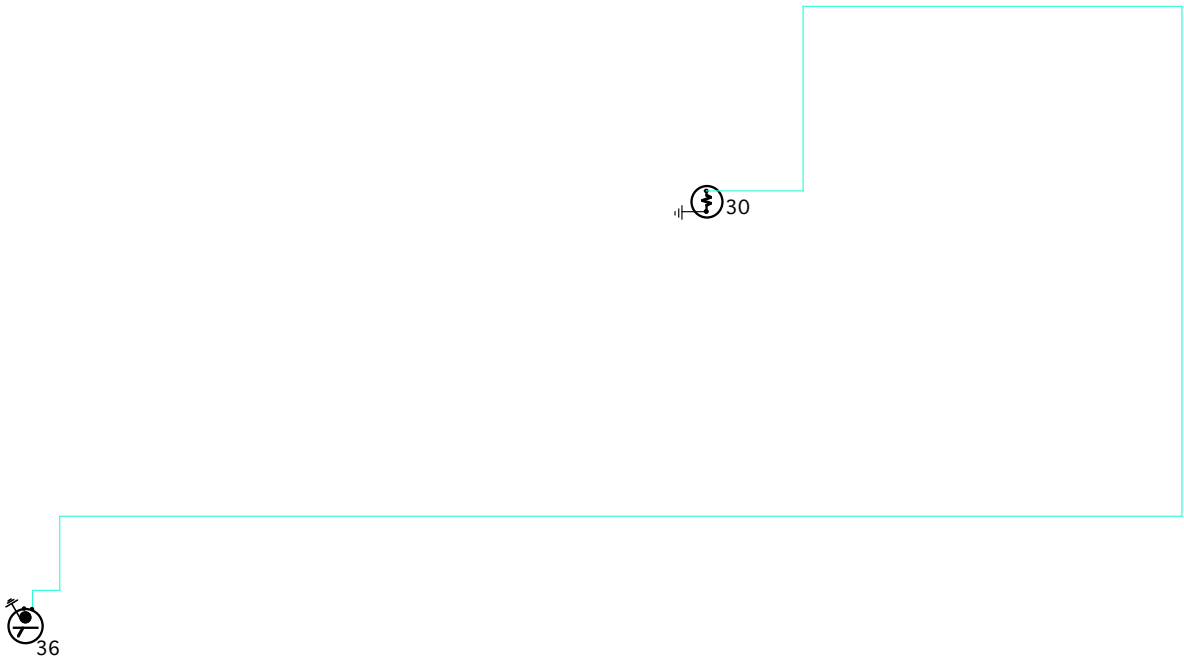



31 : Alternator voltage regulator

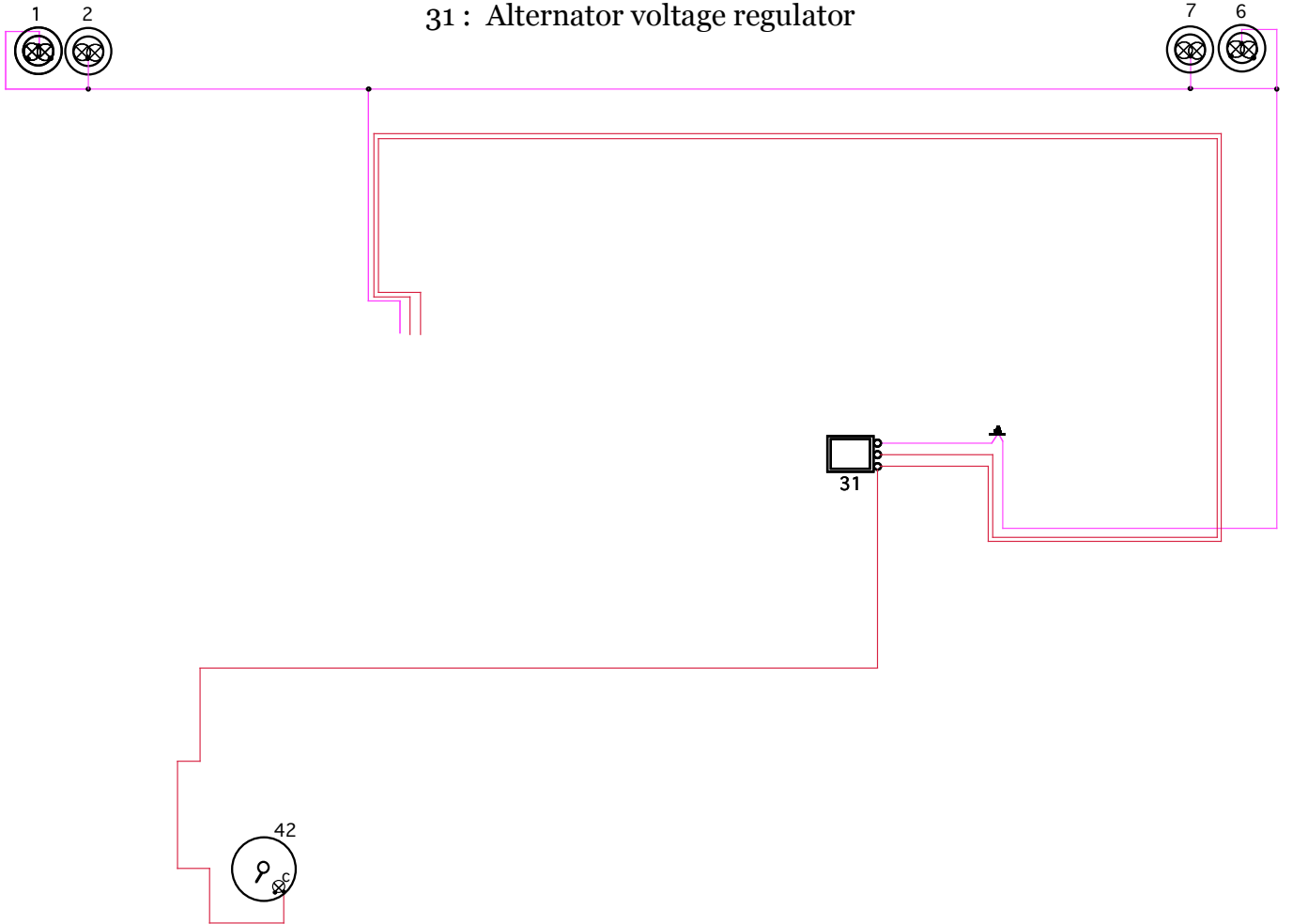

32 : Harness connection

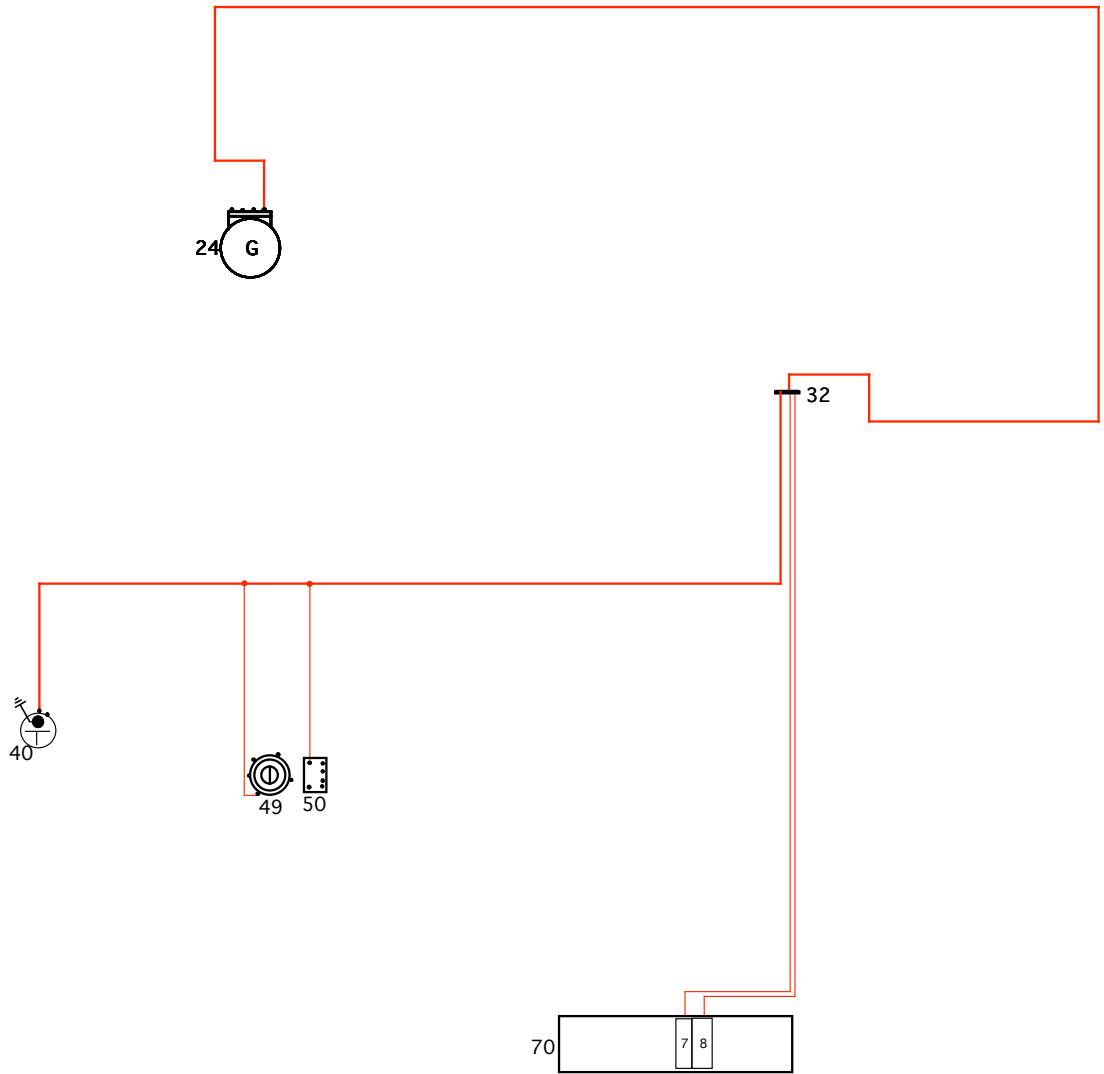

### 33: Radio aerial control motor



34 : Heating/ventilation blower motor

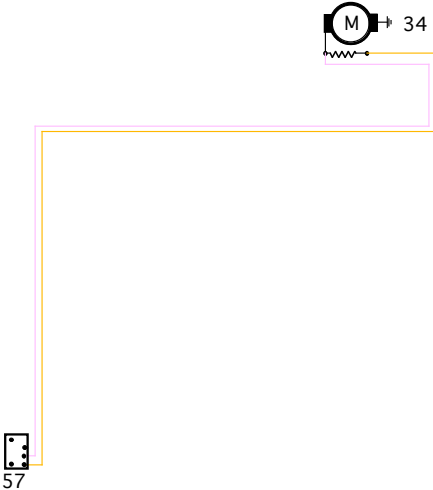

### 35 : Voltage regulators - instruments

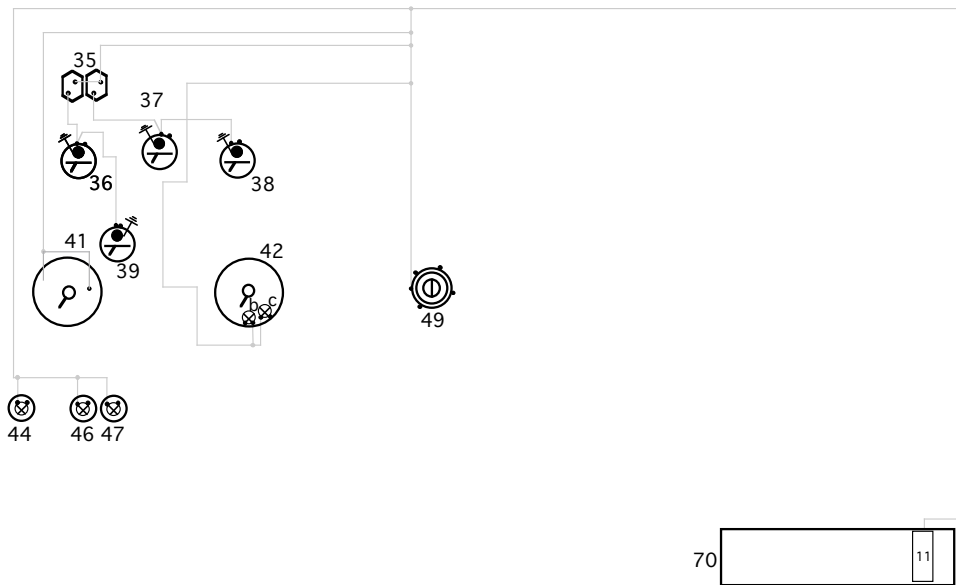

### 36 : Water temperature indicator

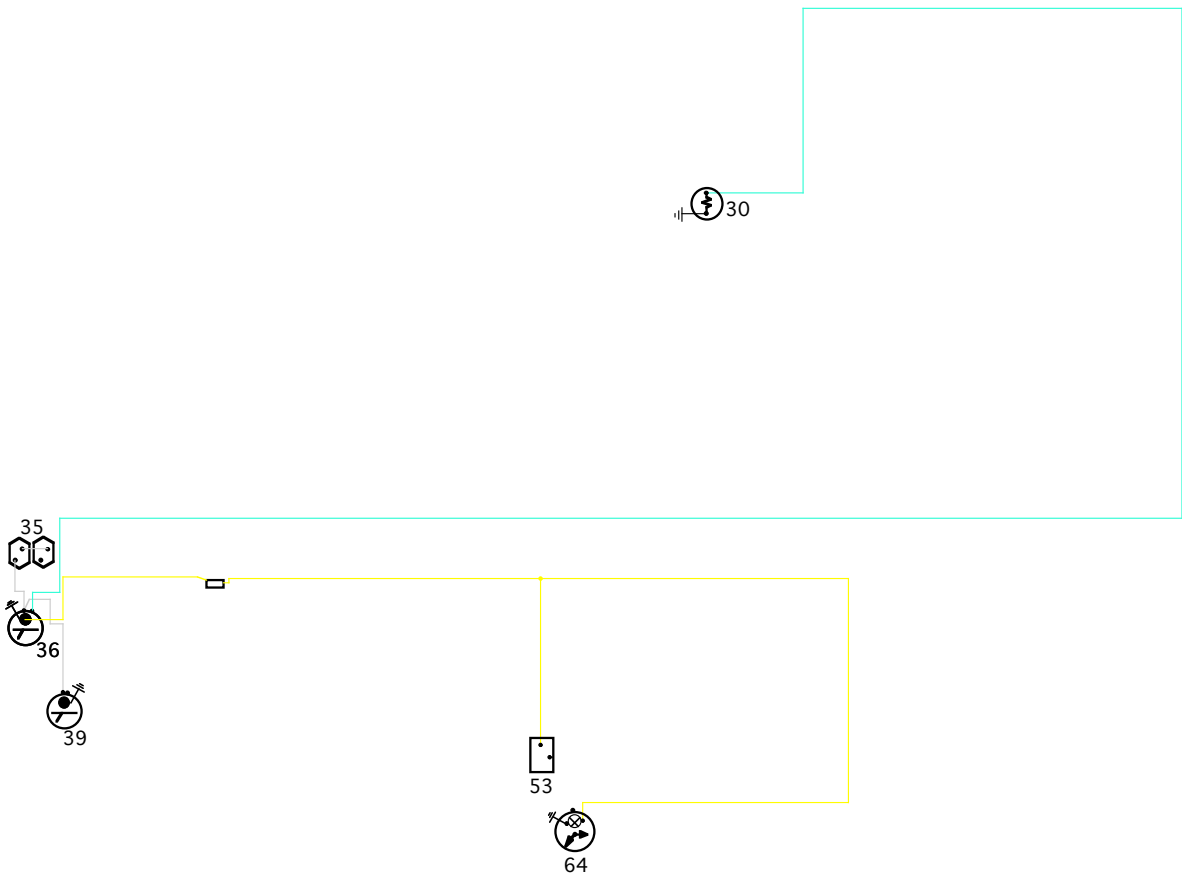

### 37: Oli pressure indicator

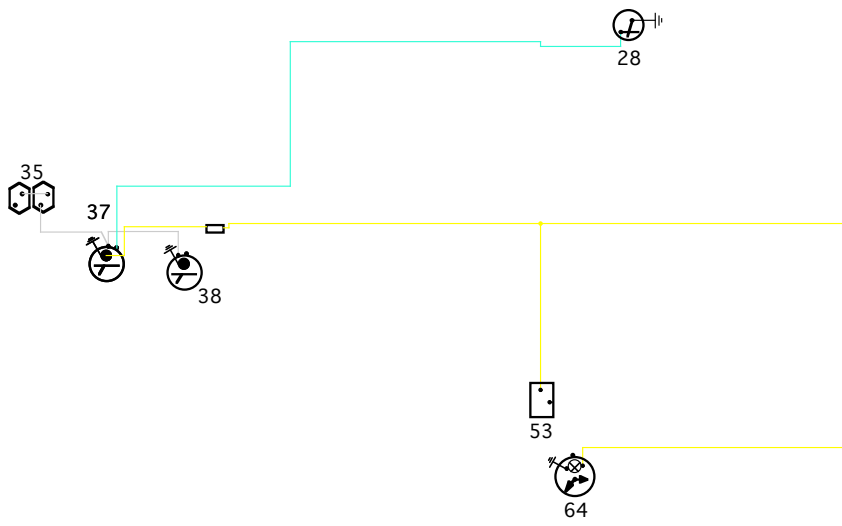

### 38 : Oil temperature indicator

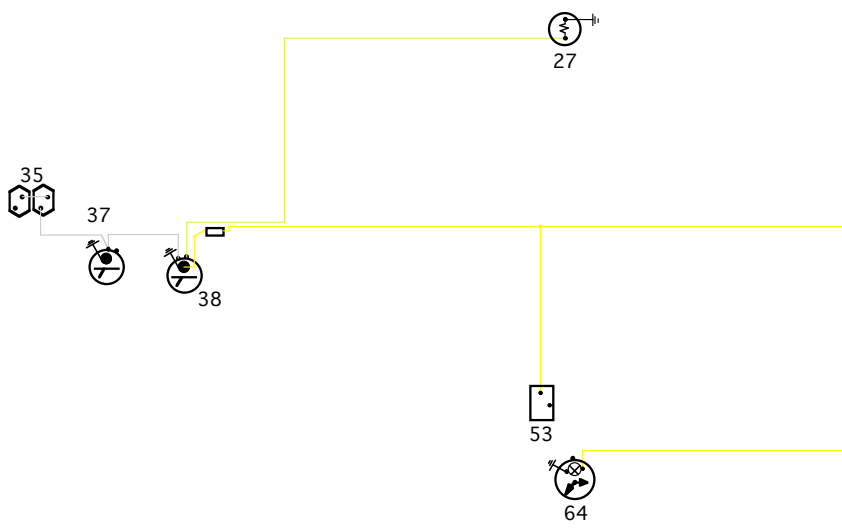



### 39 : Fuel tank level indicator

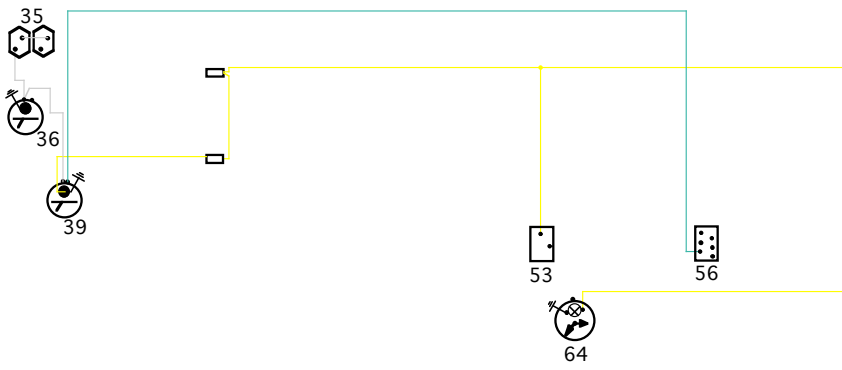

40 : Ammeter

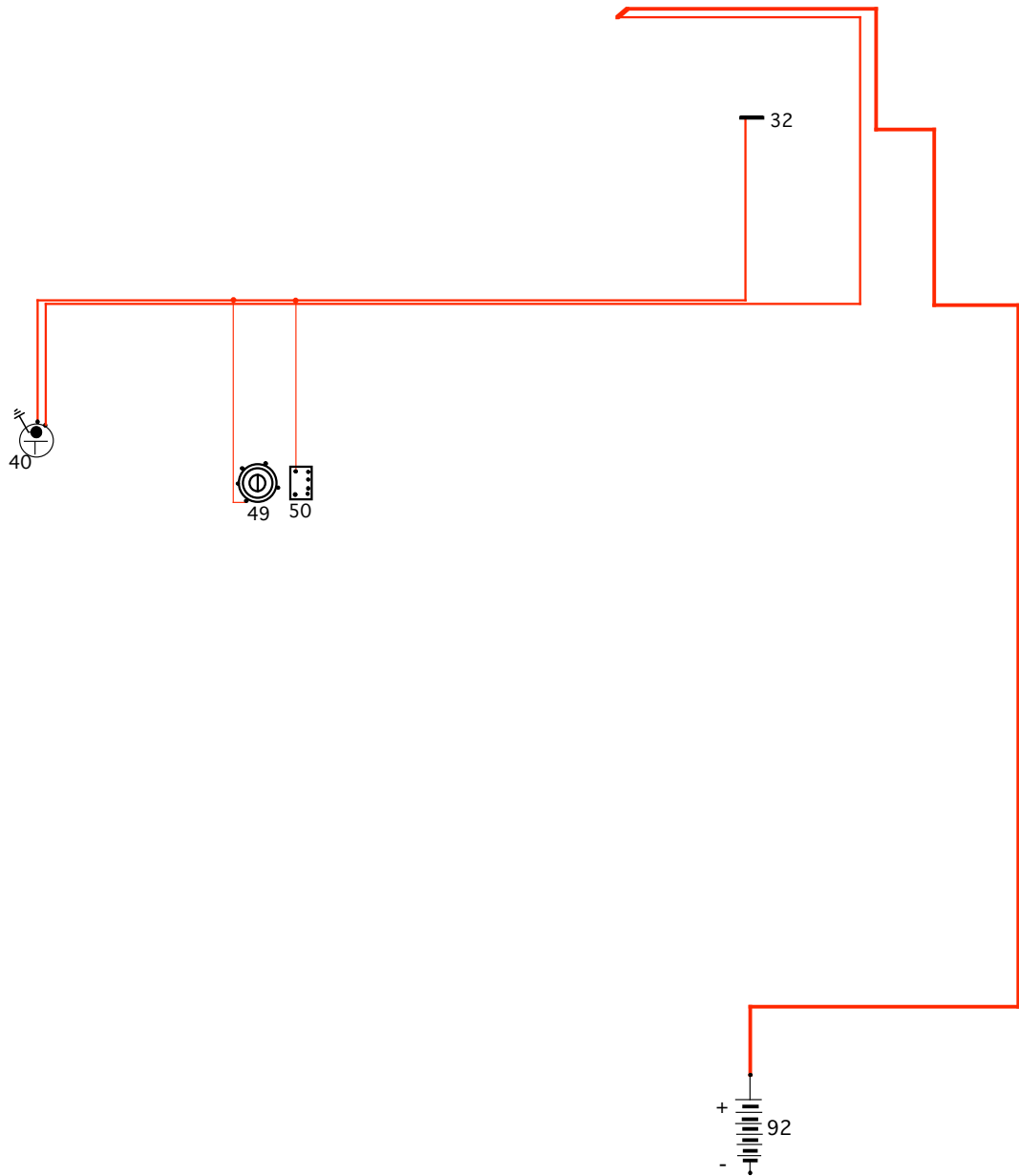

# 41 : Tachometer with warning lights

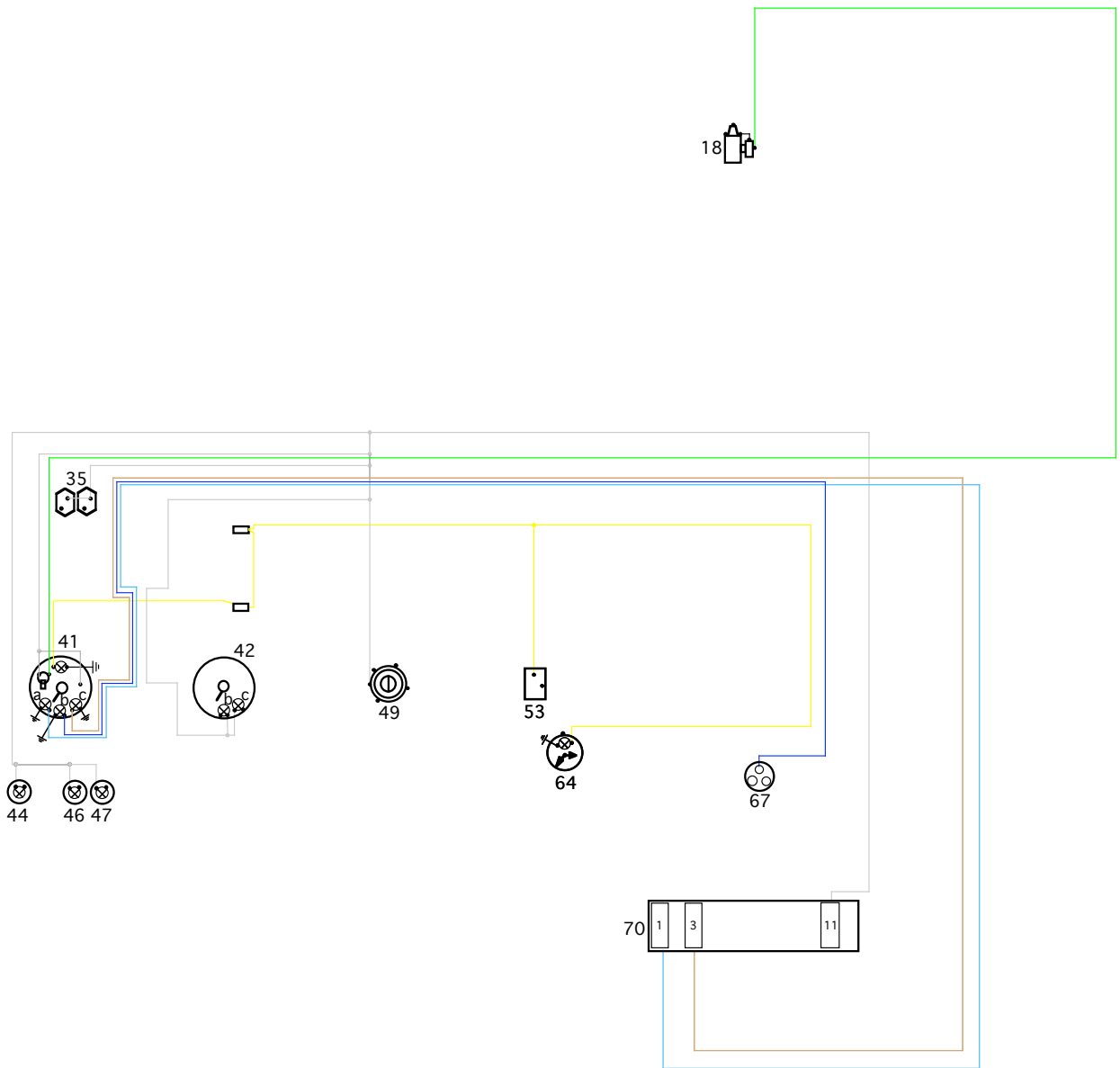

# 42 : Speedometer/kilometer counter with warning lights

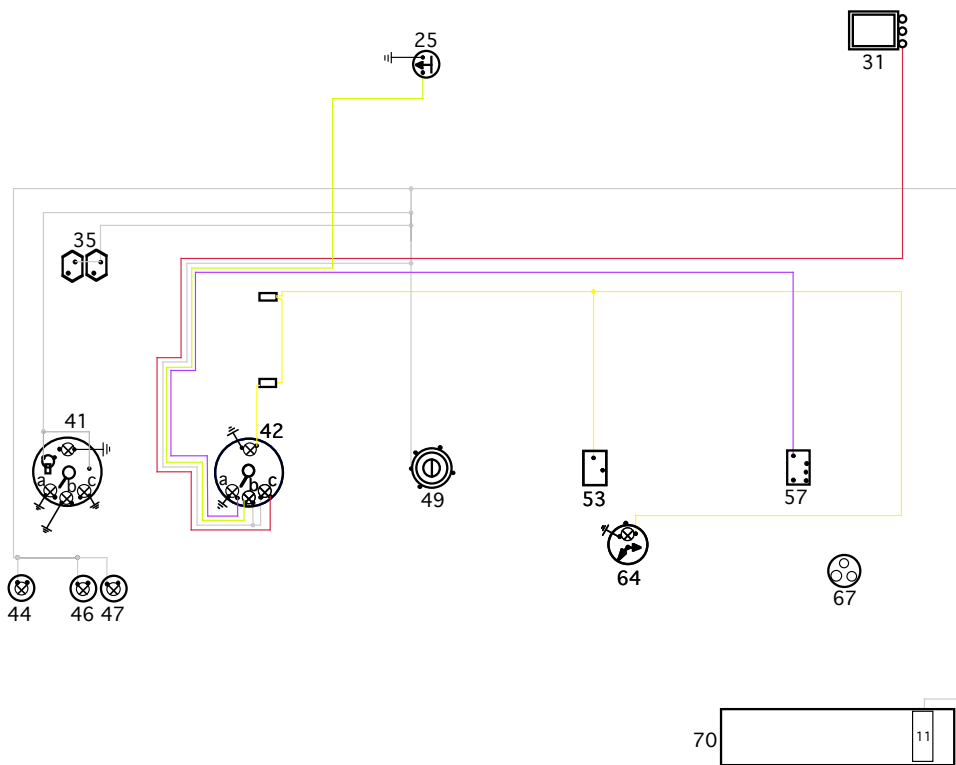

43 : Air horn wiping contact

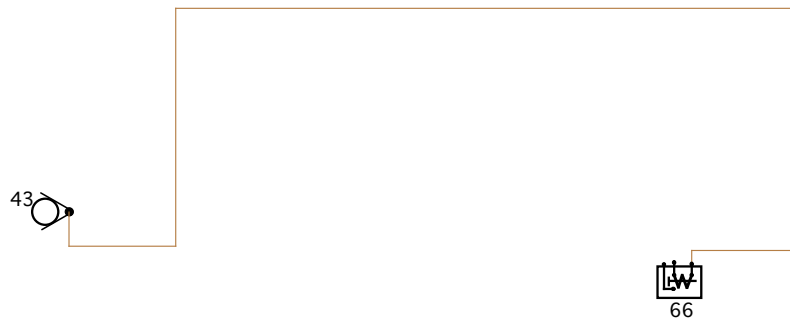

# 44 : Hand brake-on warning light

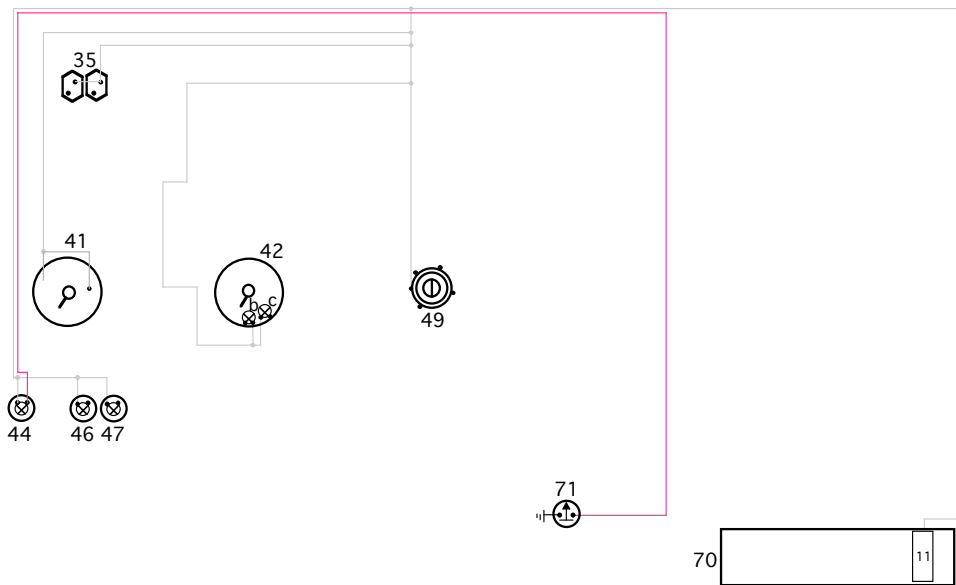

45 : Rear window defroster warning light

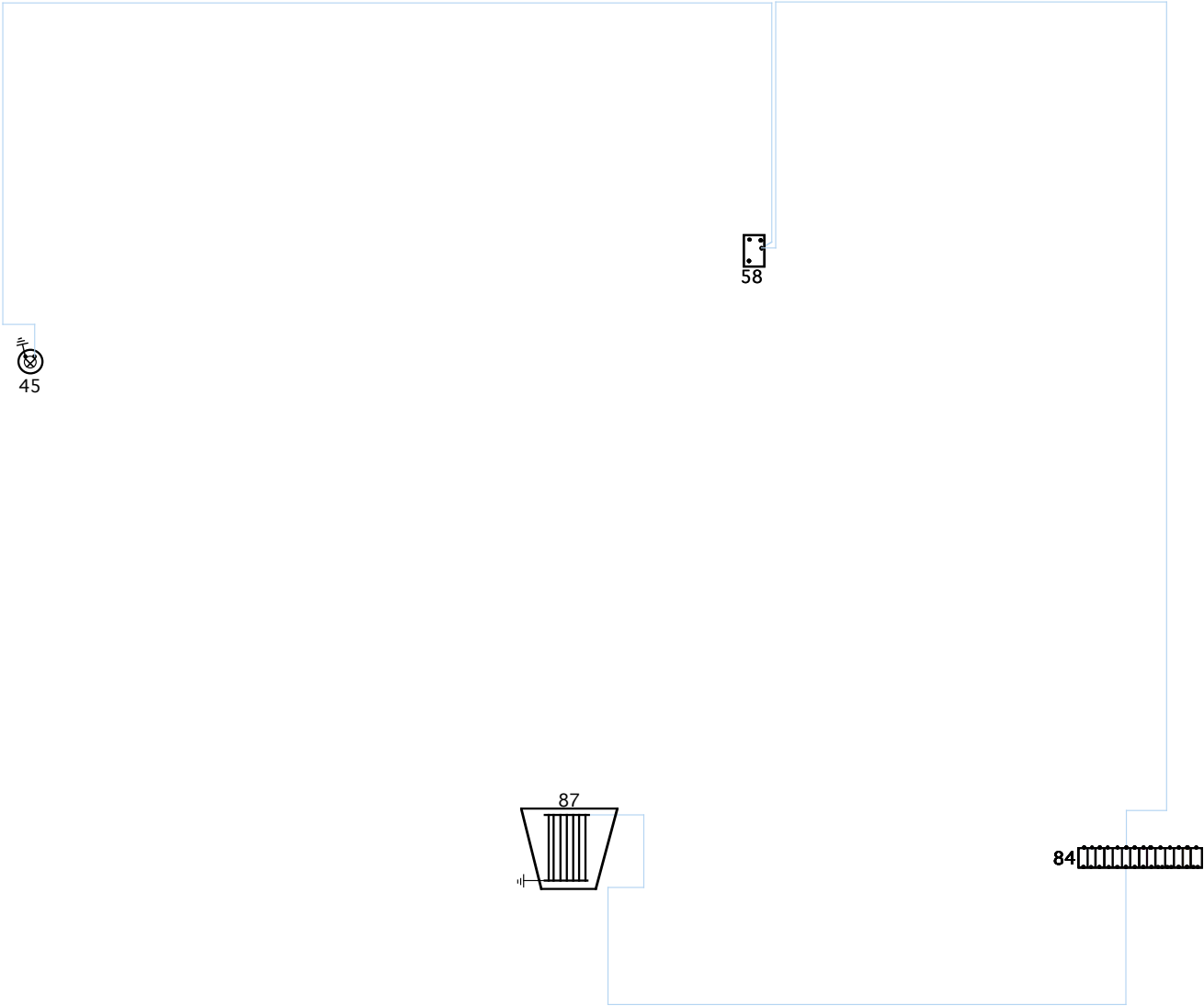

46 : Fuel reserve level warning light- left tank

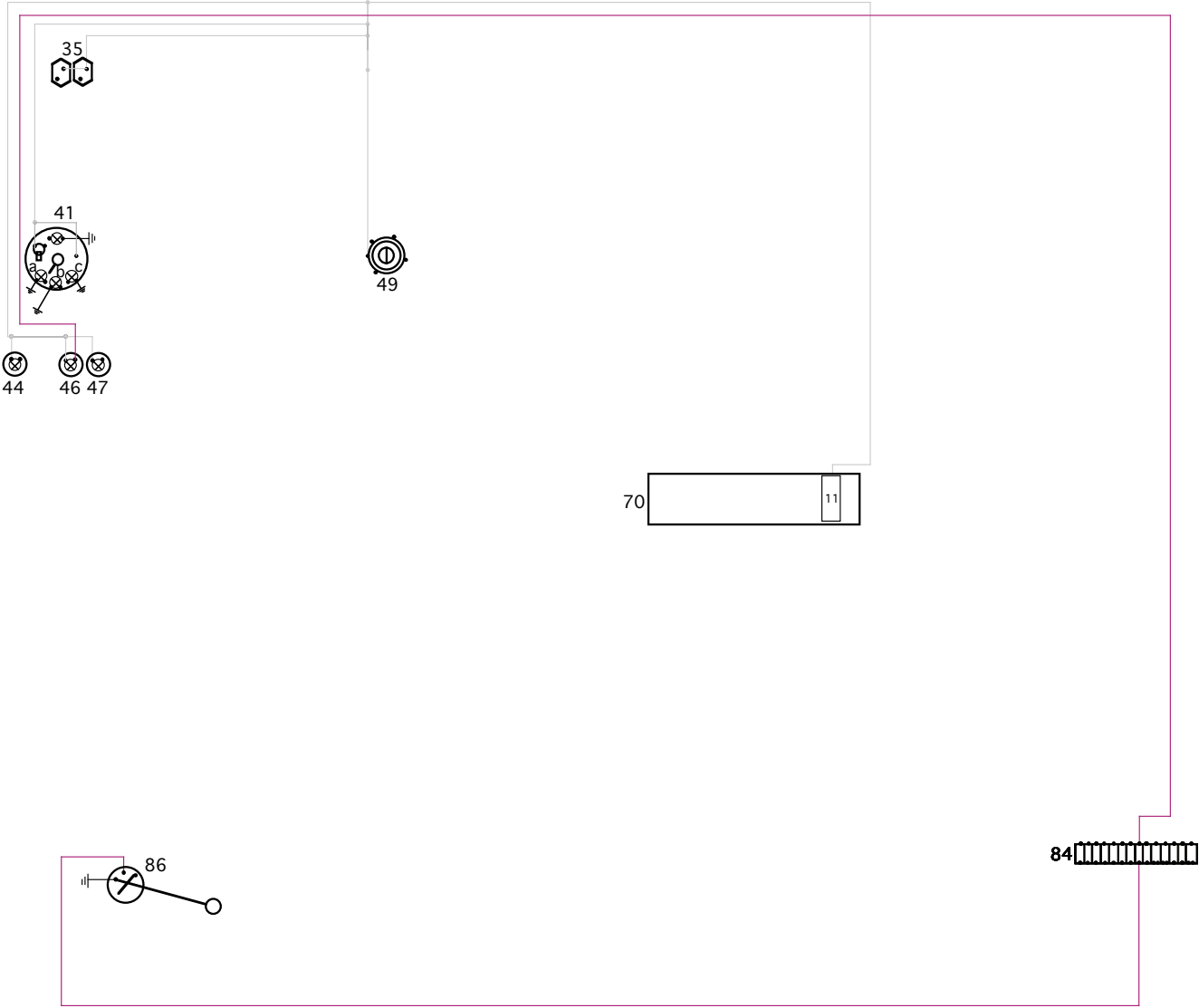



# 47 : Fuel reserve level warning light- right tank

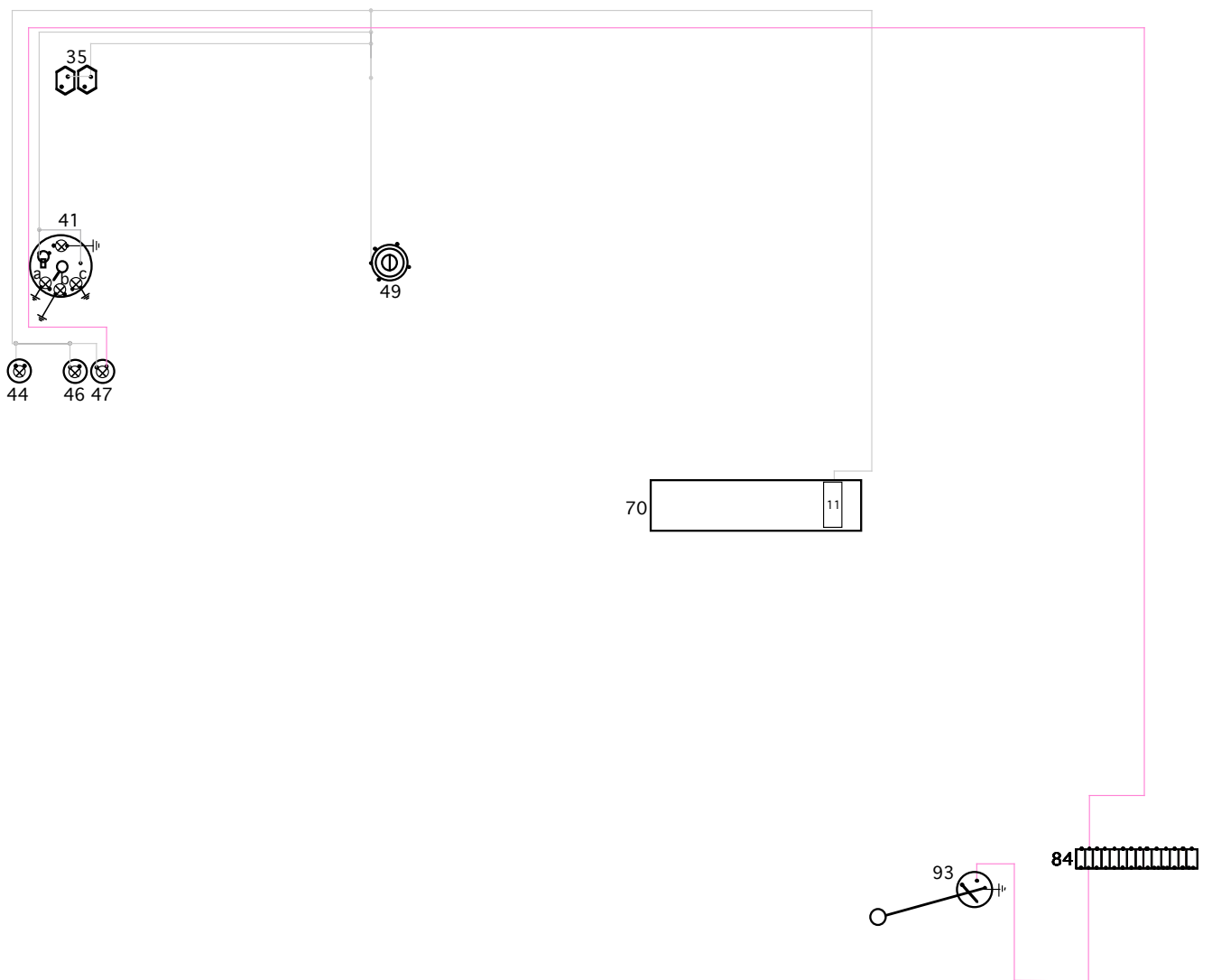

# 48 : lamp control unit on steering wheel

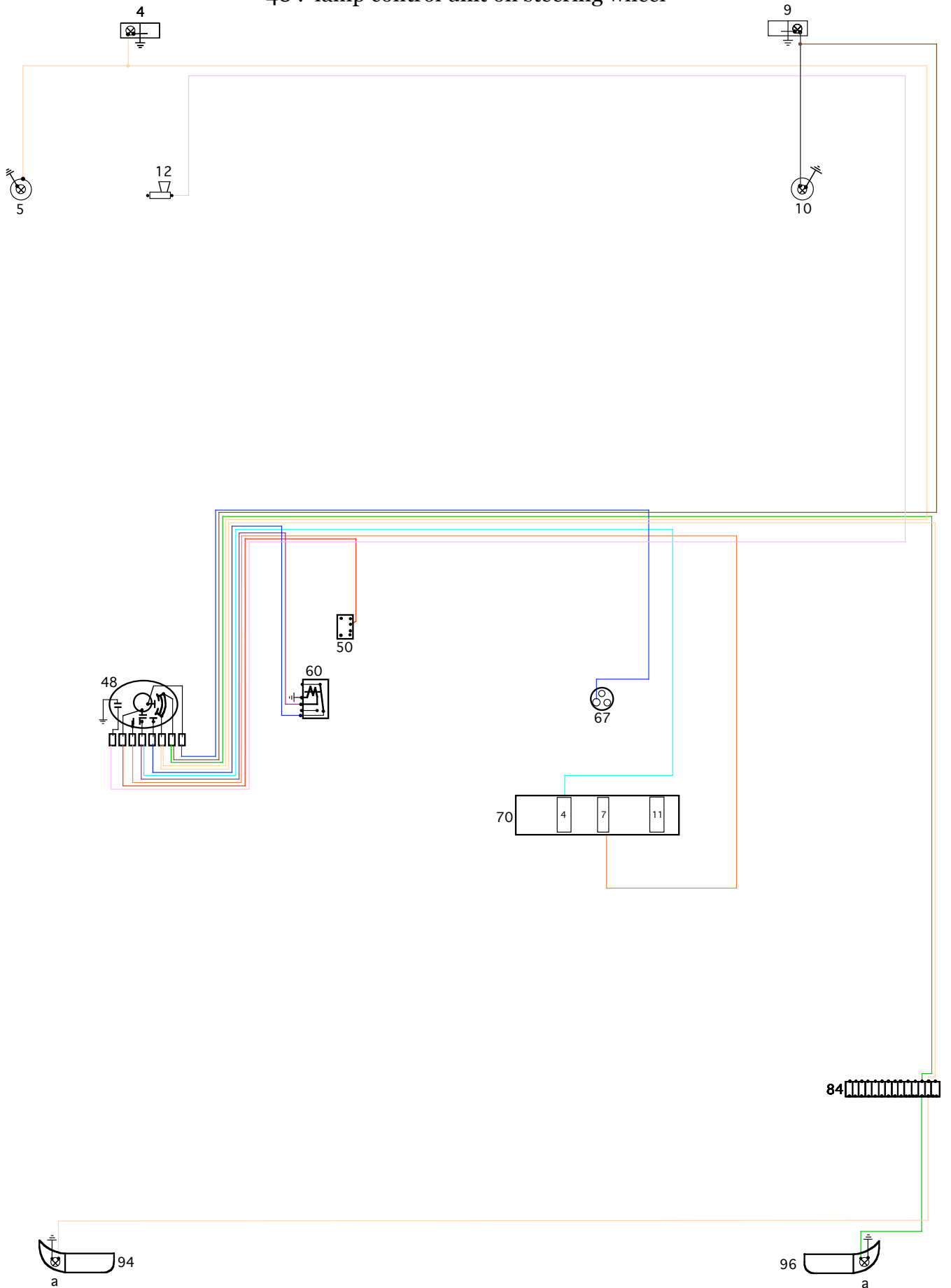

# 49 : Ignition switch

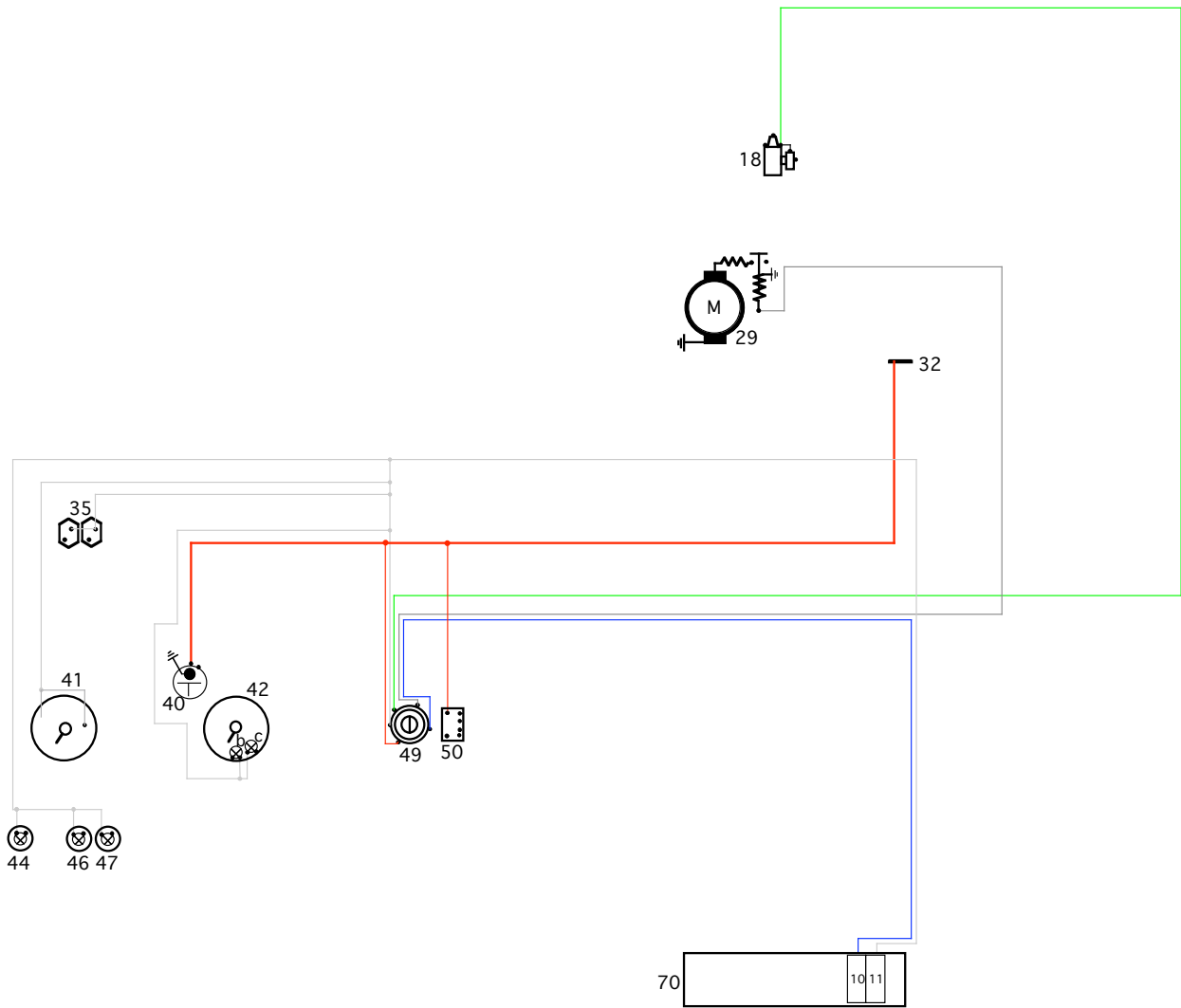

# 50 : Control switch-external lights and headlamp dipped lights

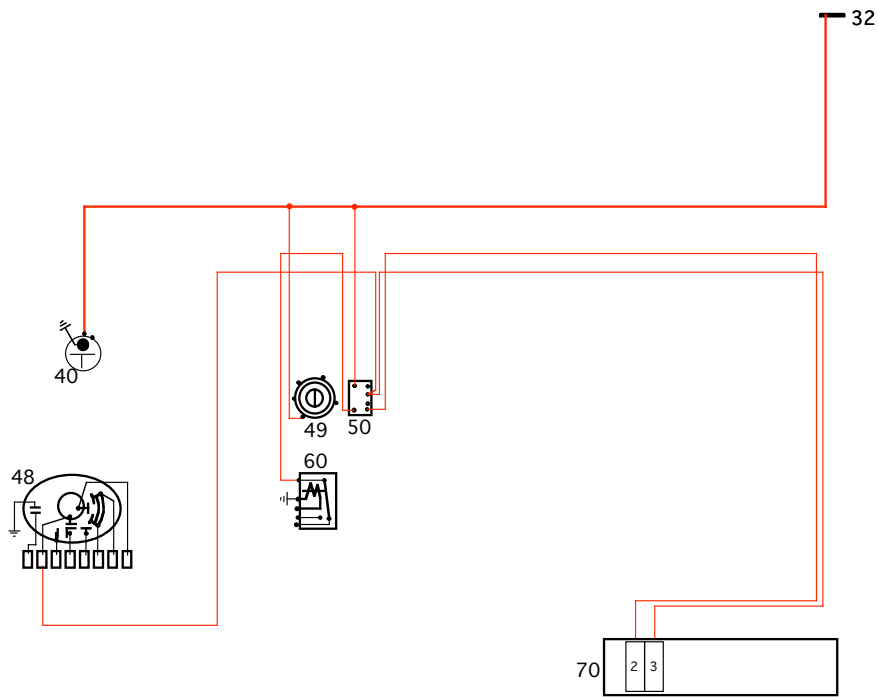

# 51 : Fog lamps and low beams control switch

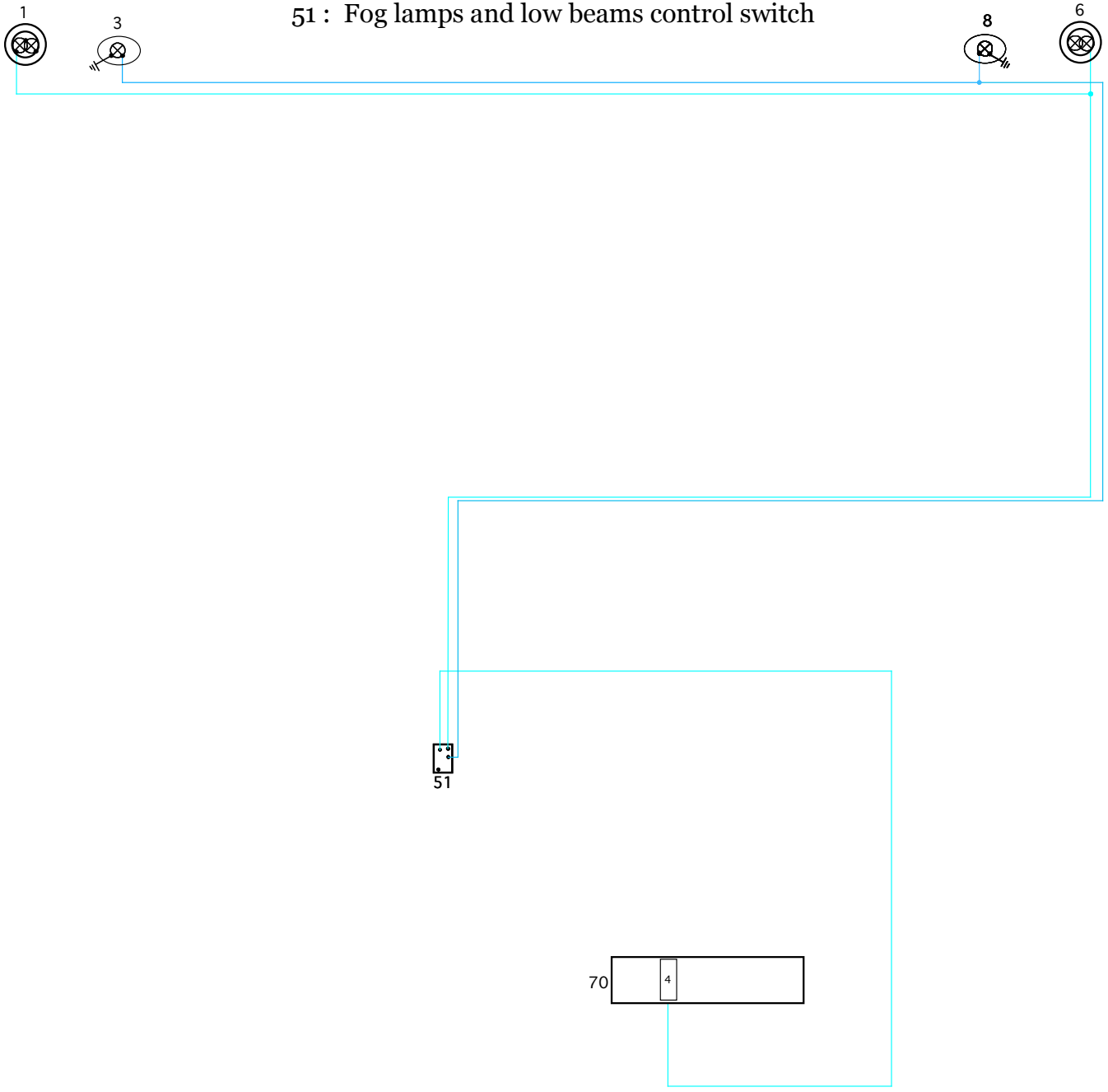

52 : Windscreen wiper two speed control switch

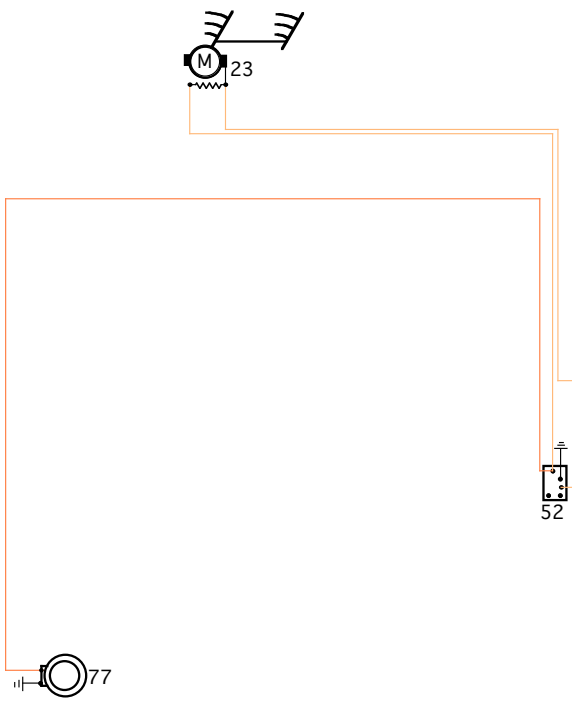

# 53 : Lightting dimmer switch - instruments

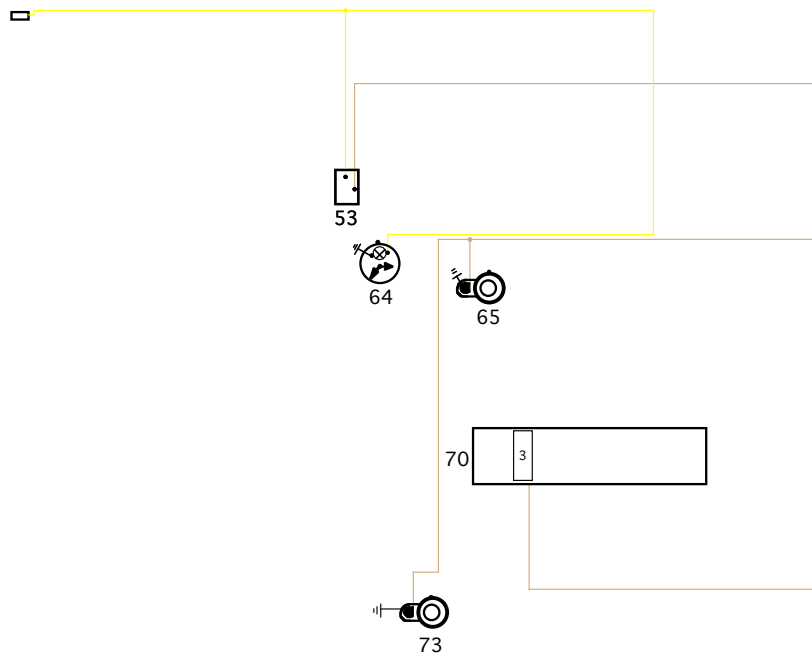

54 : Two-way switch - left door window winder

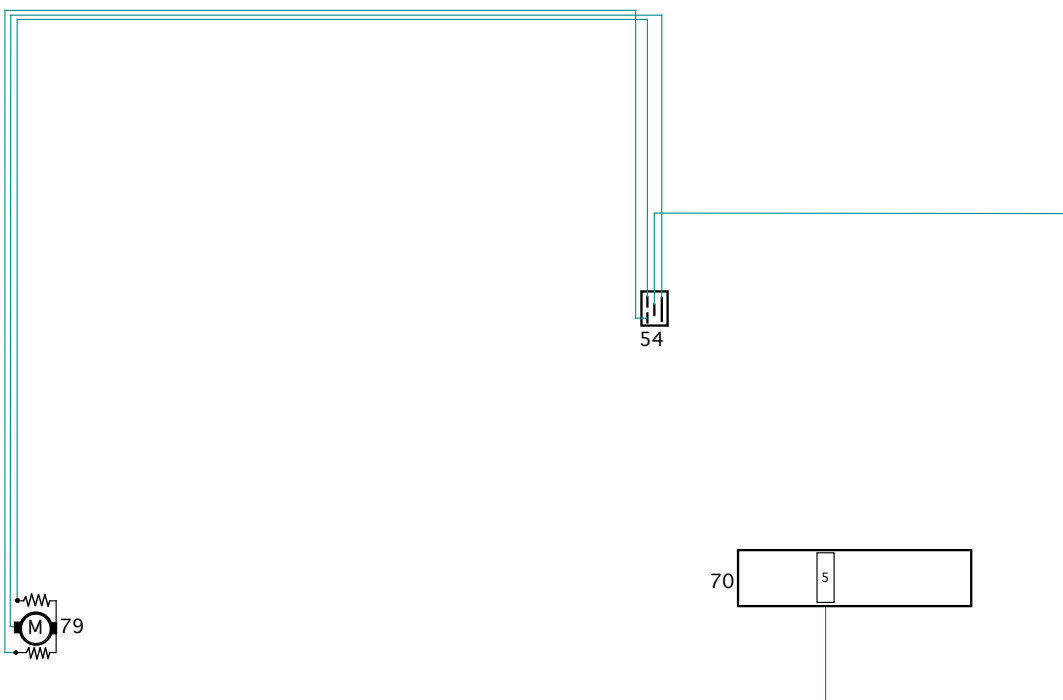



55 : Two-way switch - right door window winder

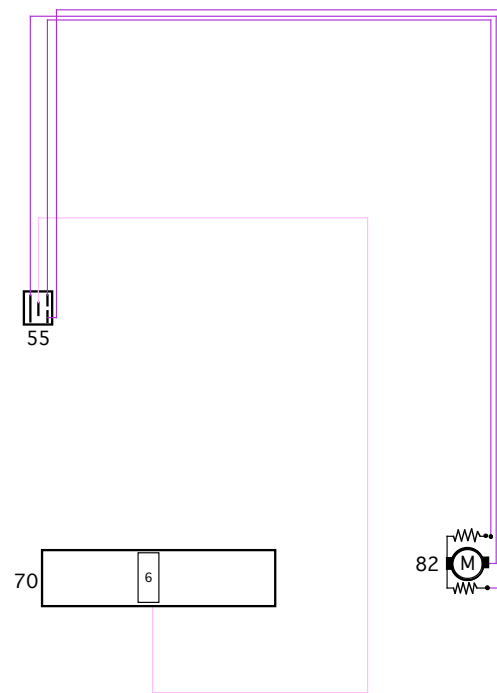

# 56 : Change-over - petrol pumps and level indicator

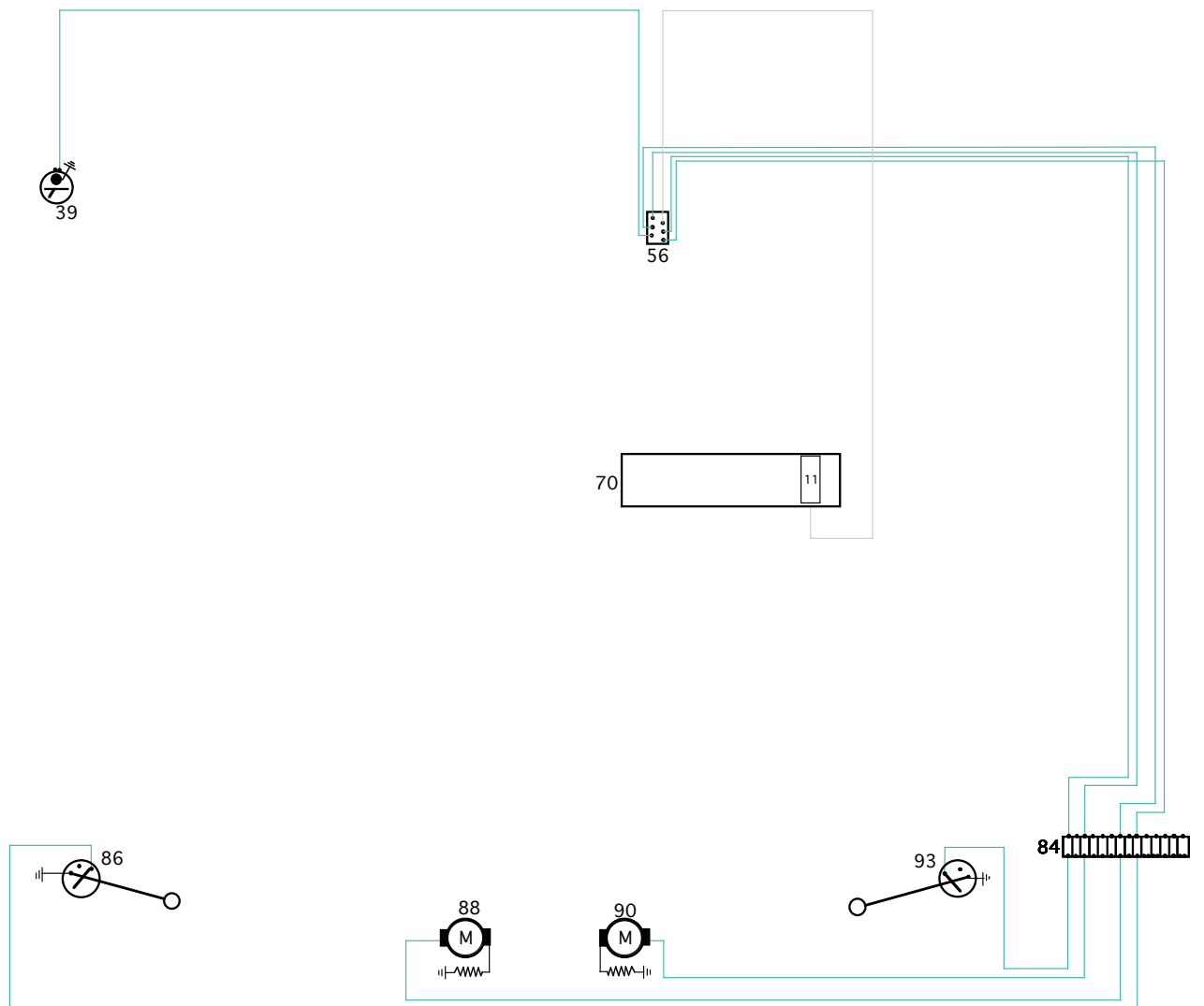

57 : Two-speed control switch - heating/ventilation blower

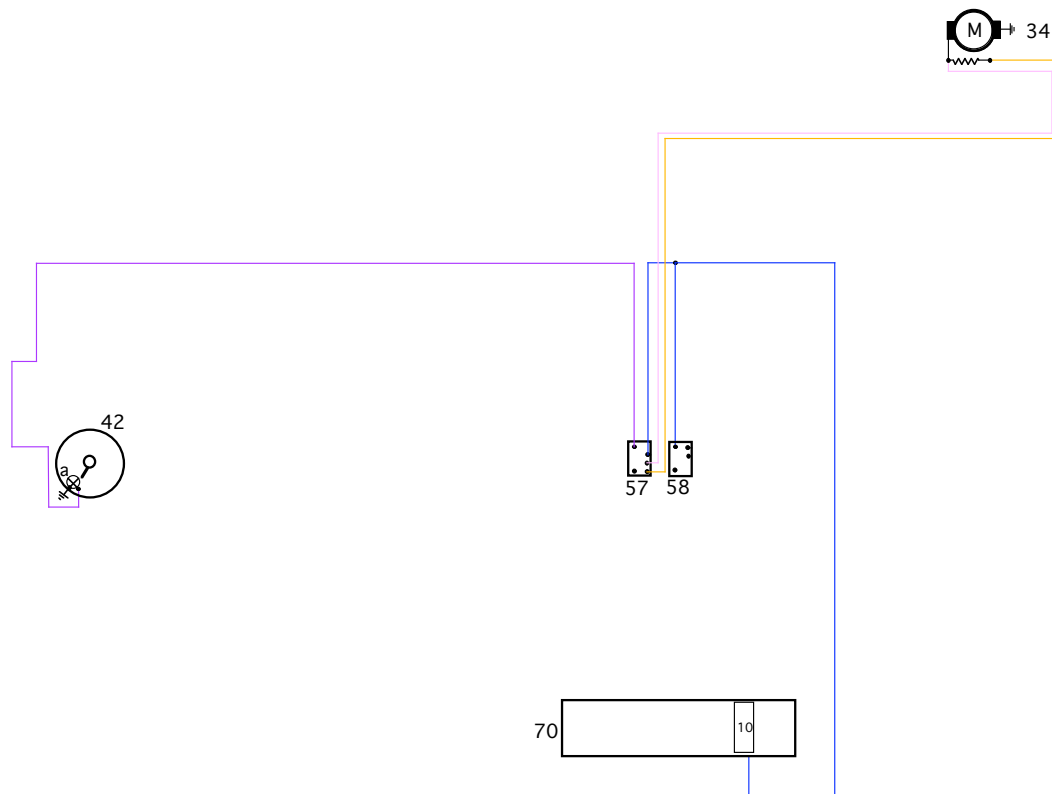

# 58 : Rear window defroster switch

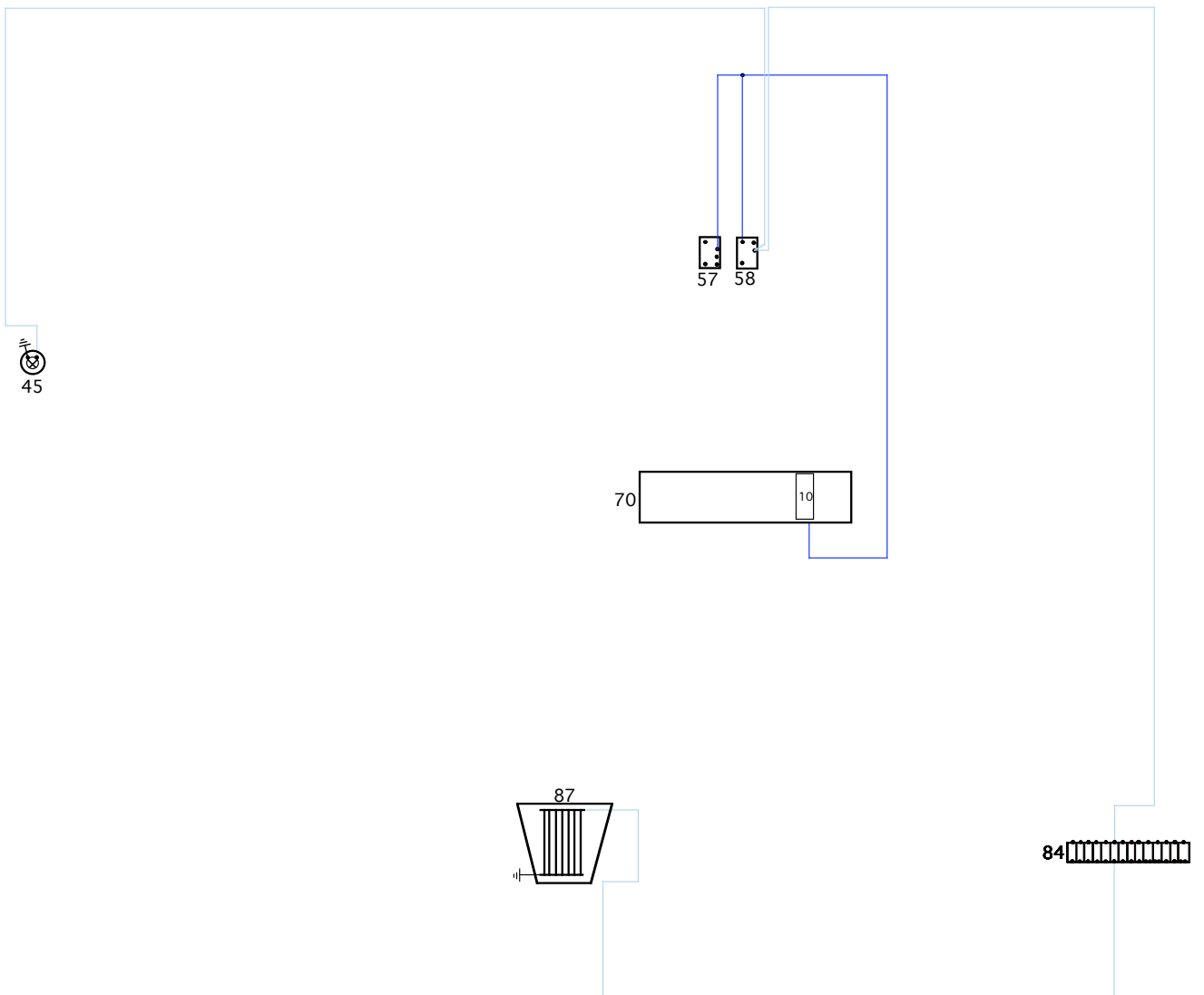

# 59 : Ceiling light switch

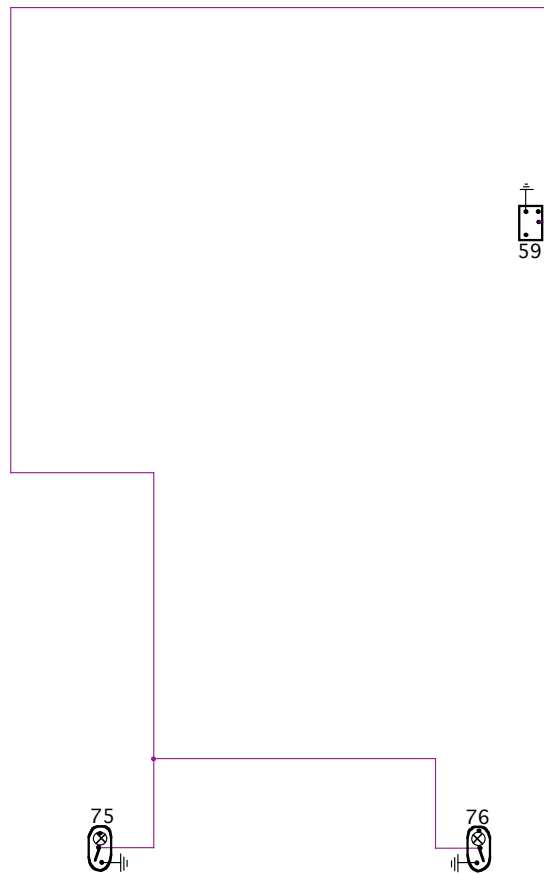

## 60 : Main beam cancelling relay - headlamp flashing unit

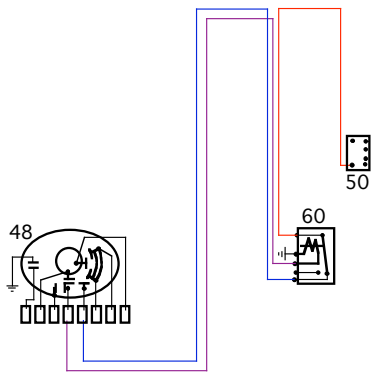

# 61 : Radio set

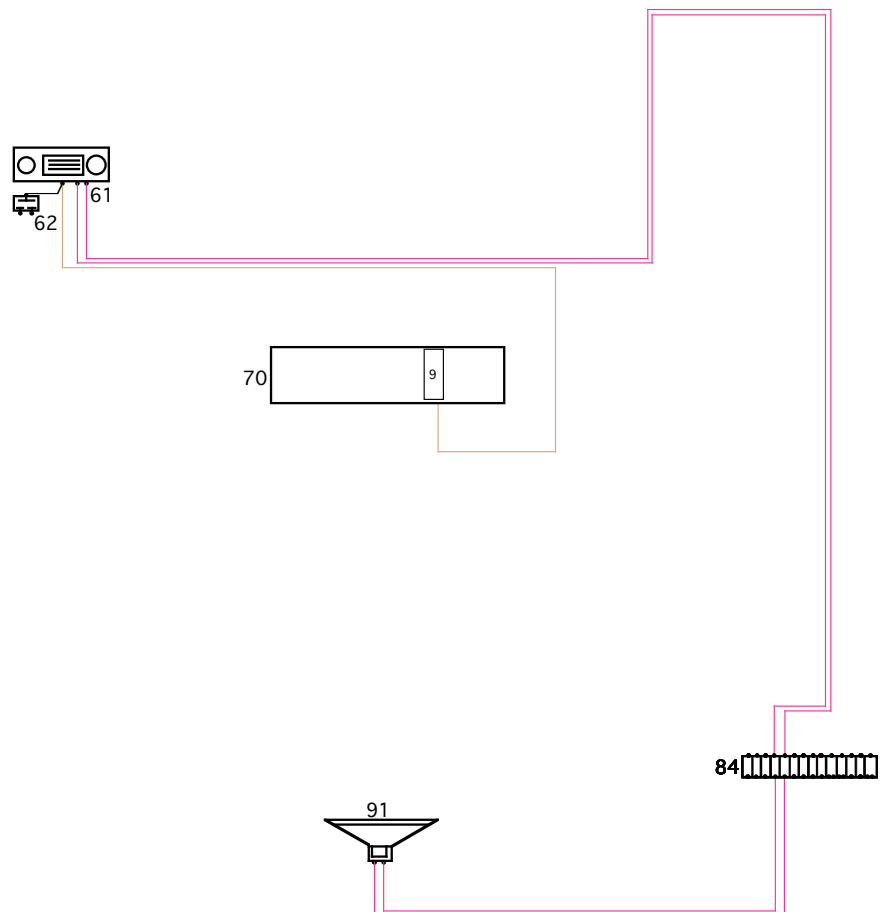

# 62 : Radio aerial control switch

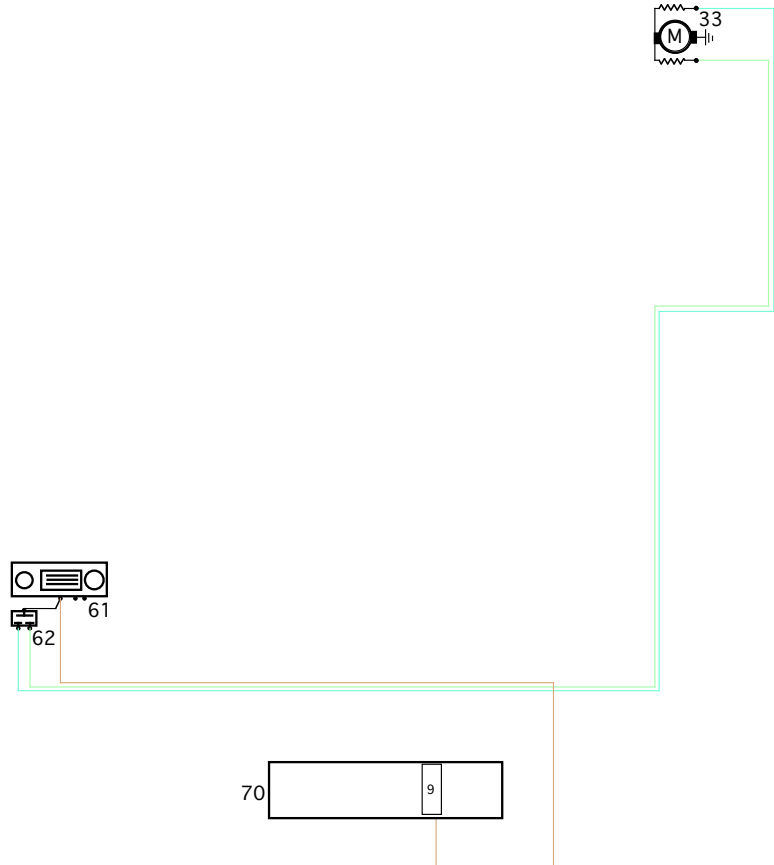



### 63 : Air conditioning compressor thermal switch

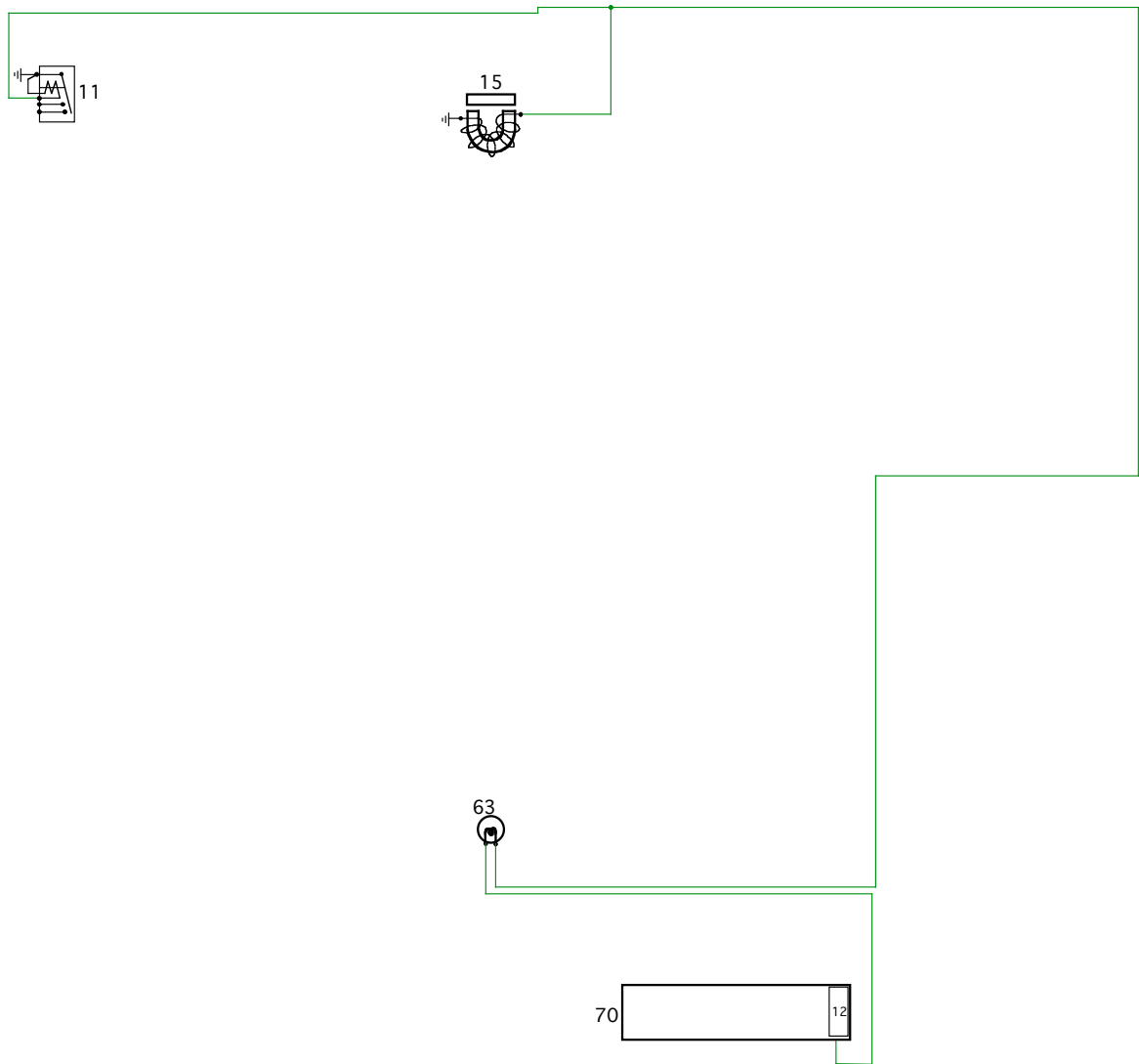

# 64 : Electric clock

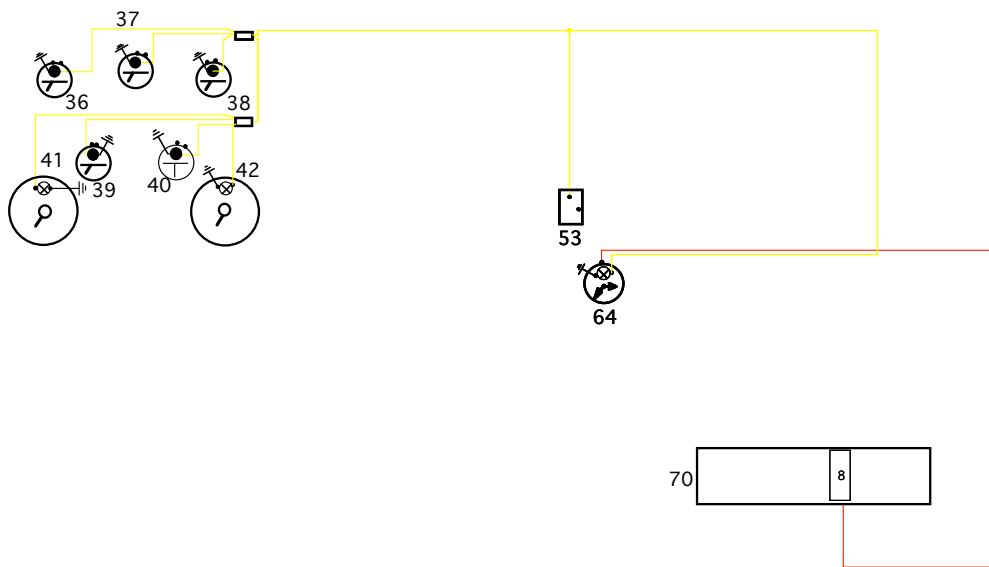

# 65 : Cigar lighter on dashboard

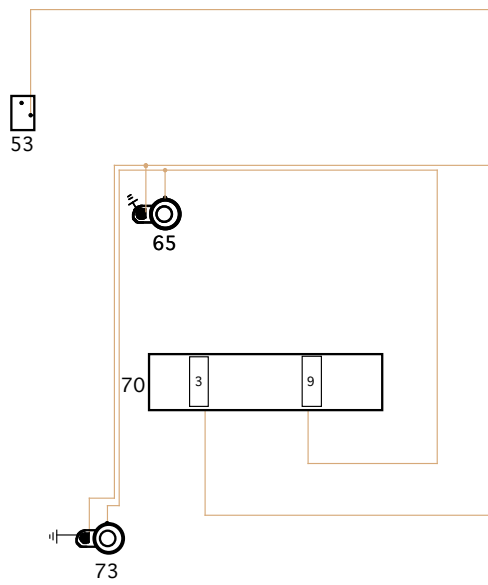

66 : Air horn relay

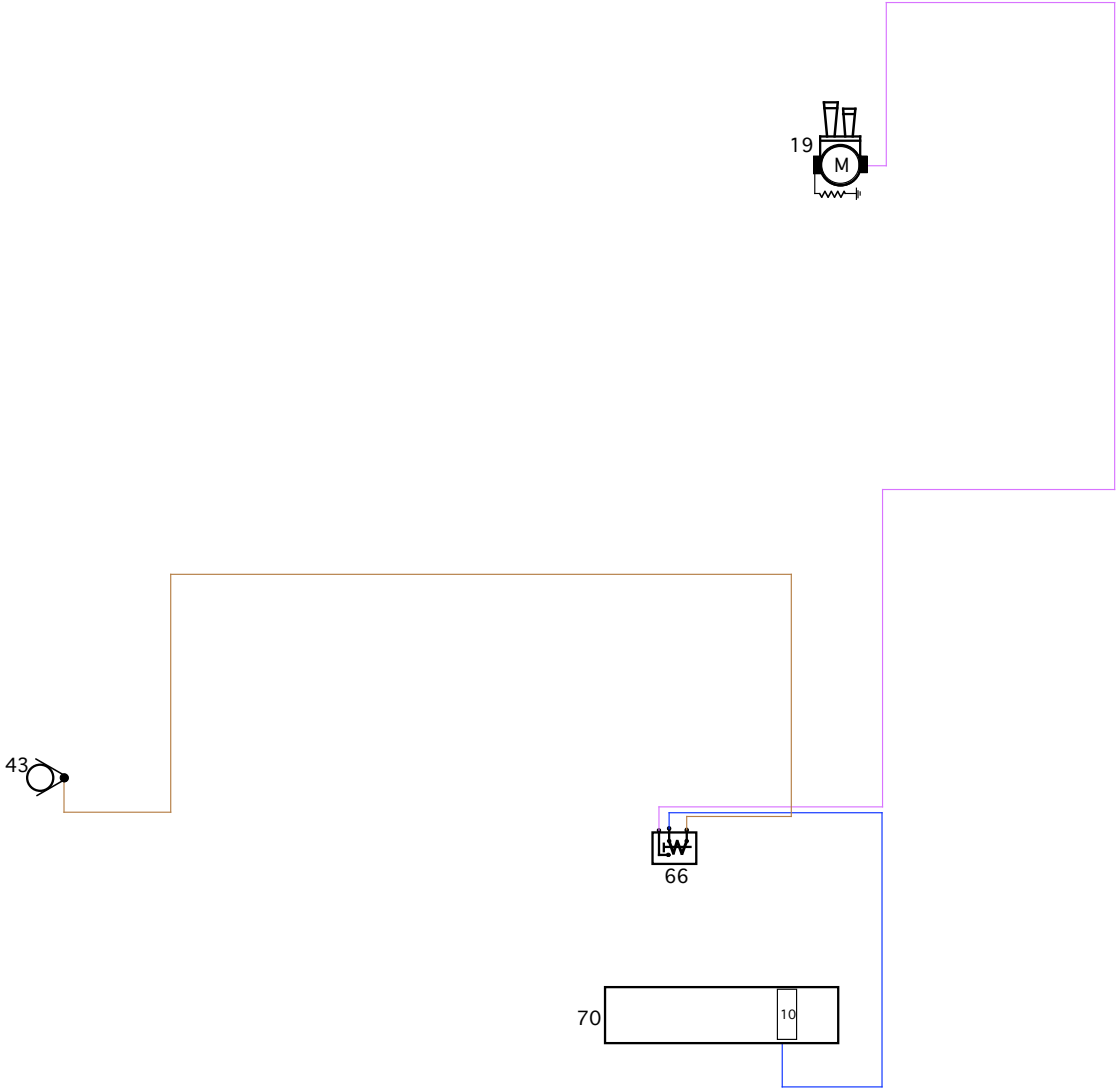

# 67 : Direction indicators flashing unit

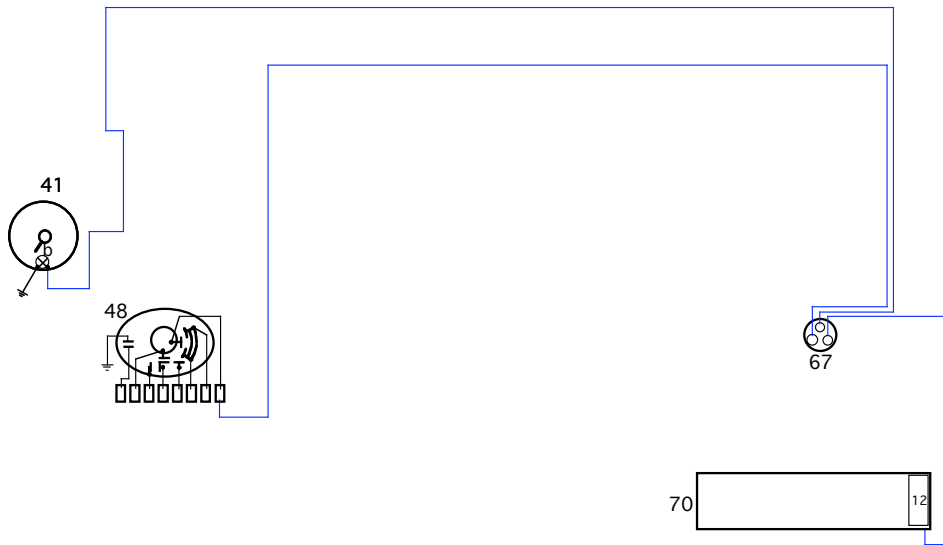

# 68 : Map-box lamp on dashboard

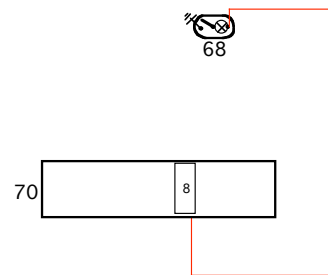

69 : Engine fans fuse valves

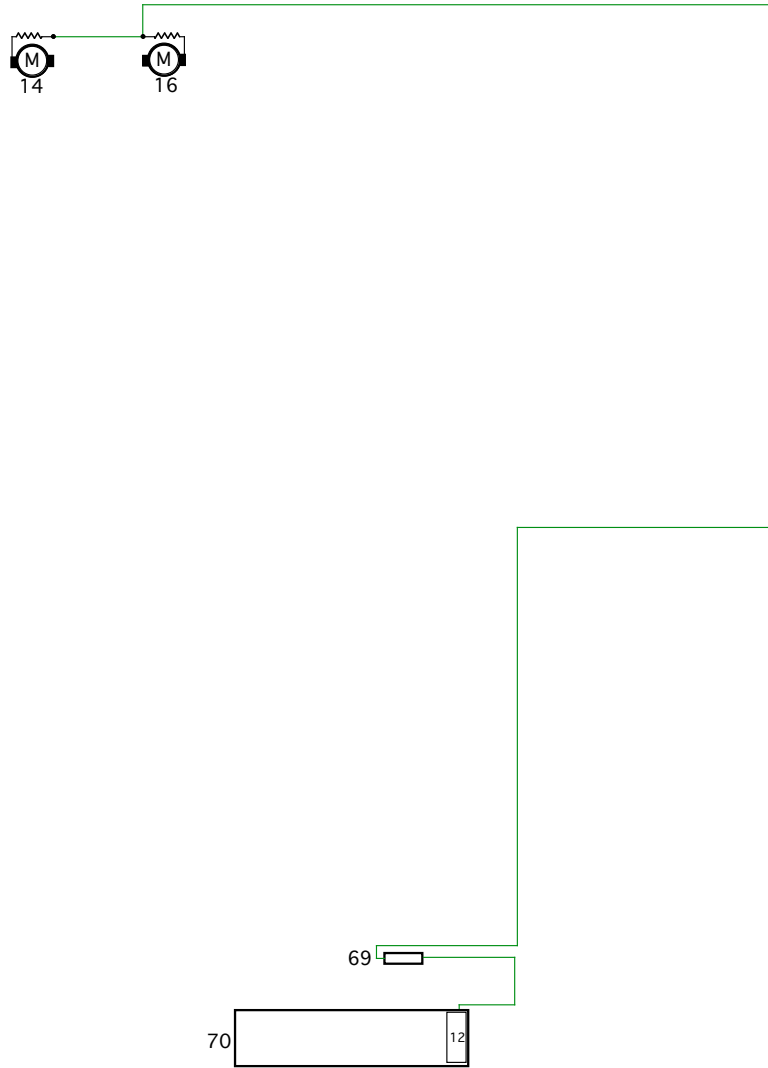

# 70 : Fuse box

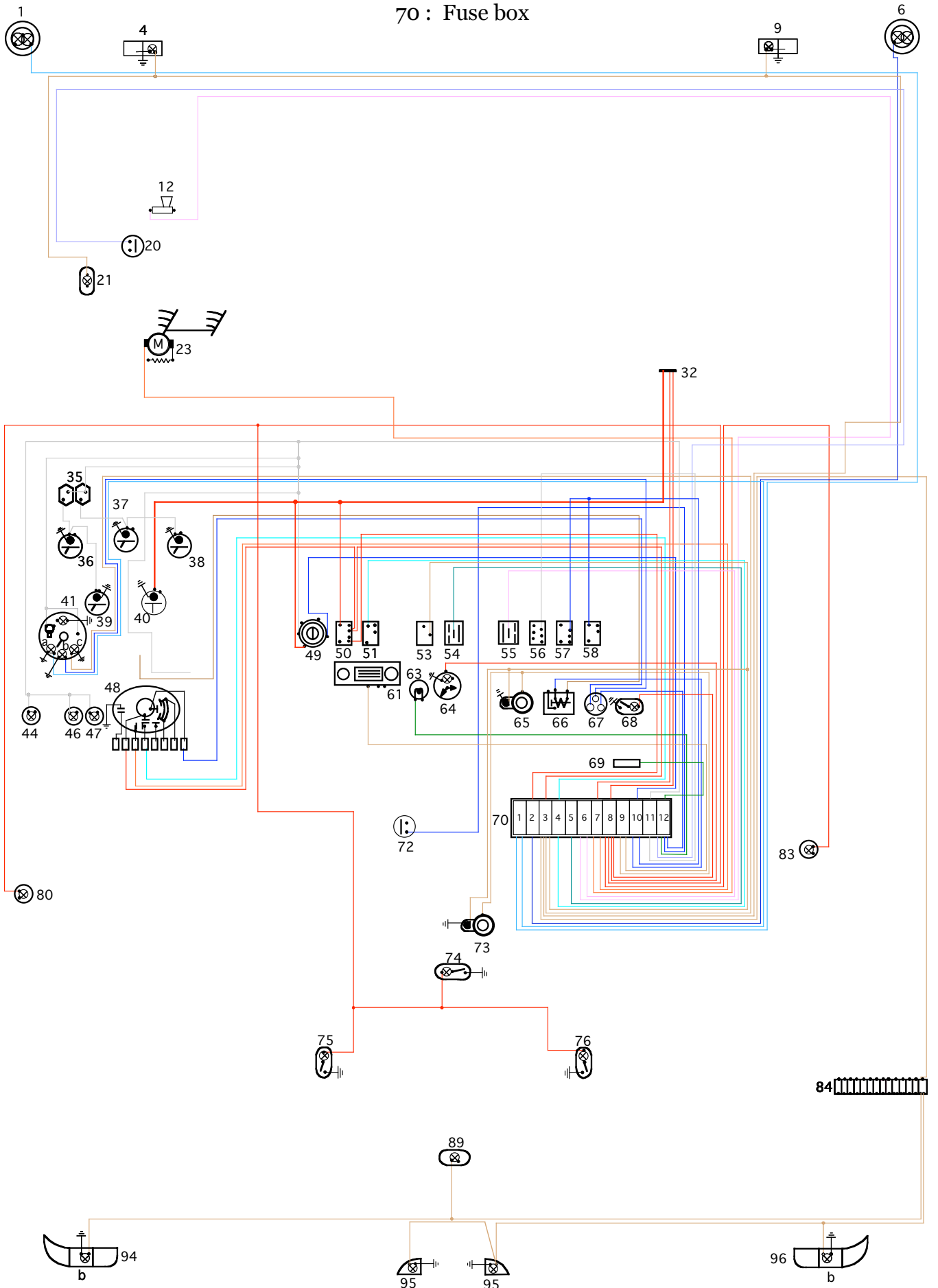



## 71 : Hand brake-on warning light switch

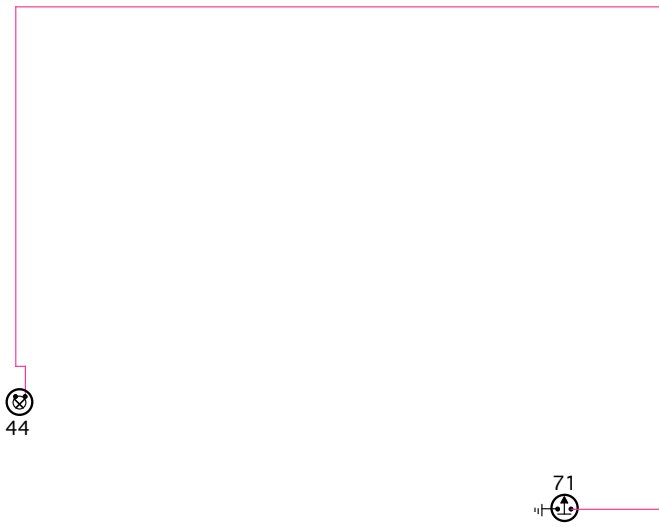

# 72 : Reserve driving lights switch

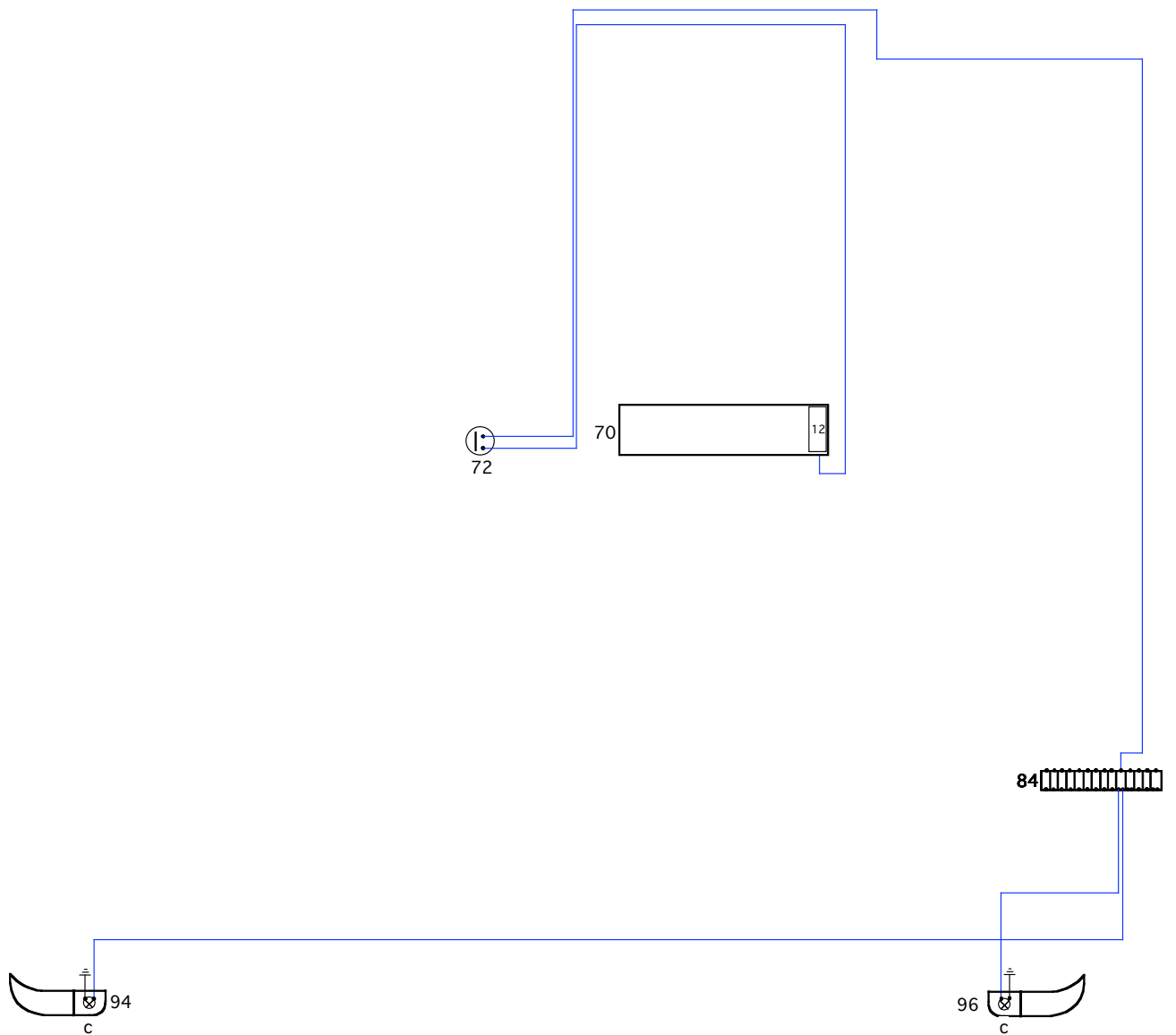

73 : Cigarette lighter on transmission cover

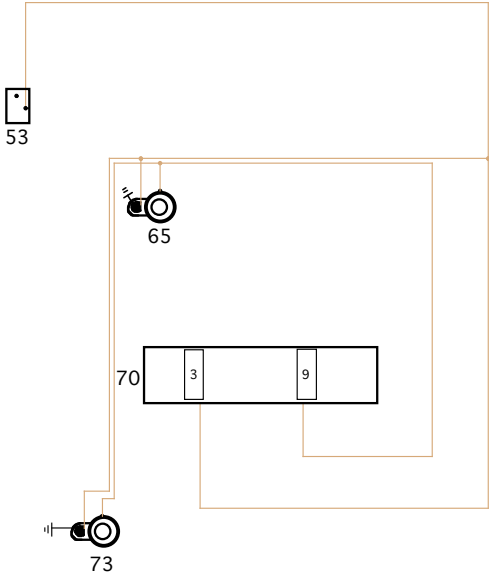

74 : Rear veiw mirror with lamp

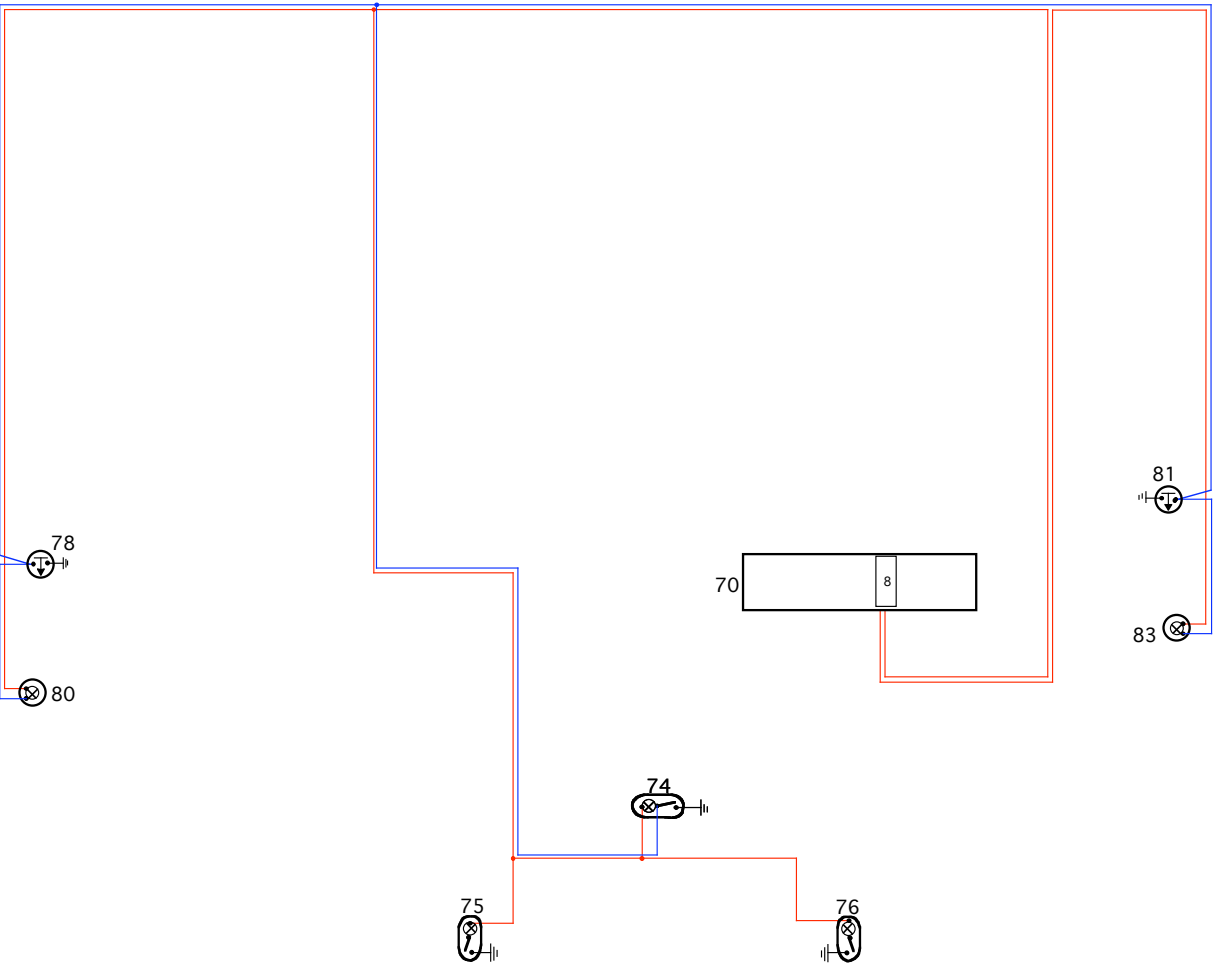

75/76 : Left/Right side lamp for internal illumination

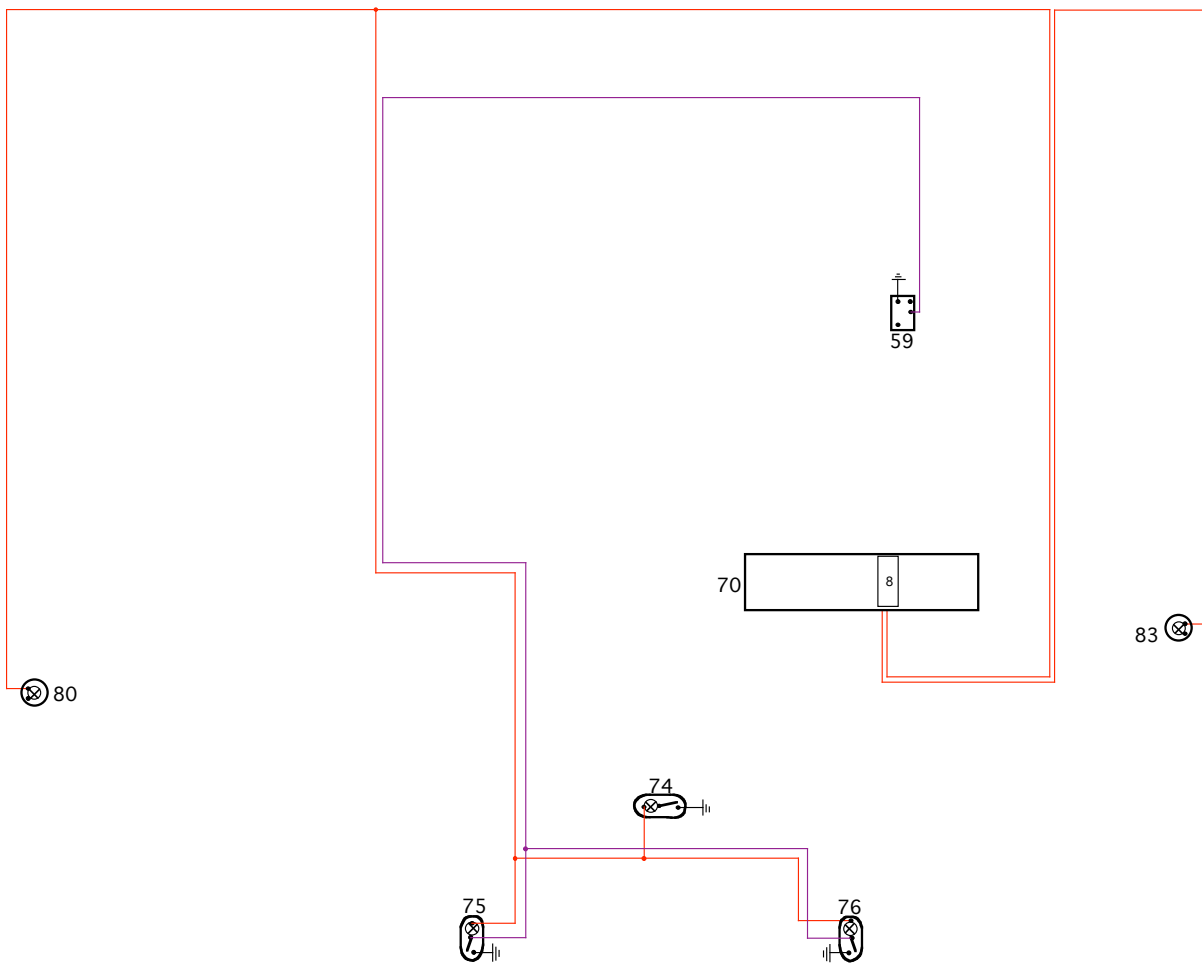

# 77 : Windscreen washer pump

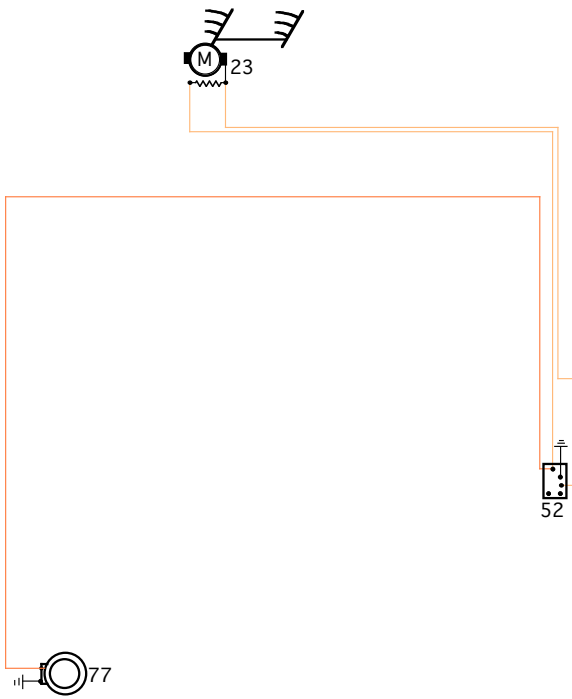

78 : Earth switch for left hand courtesy light

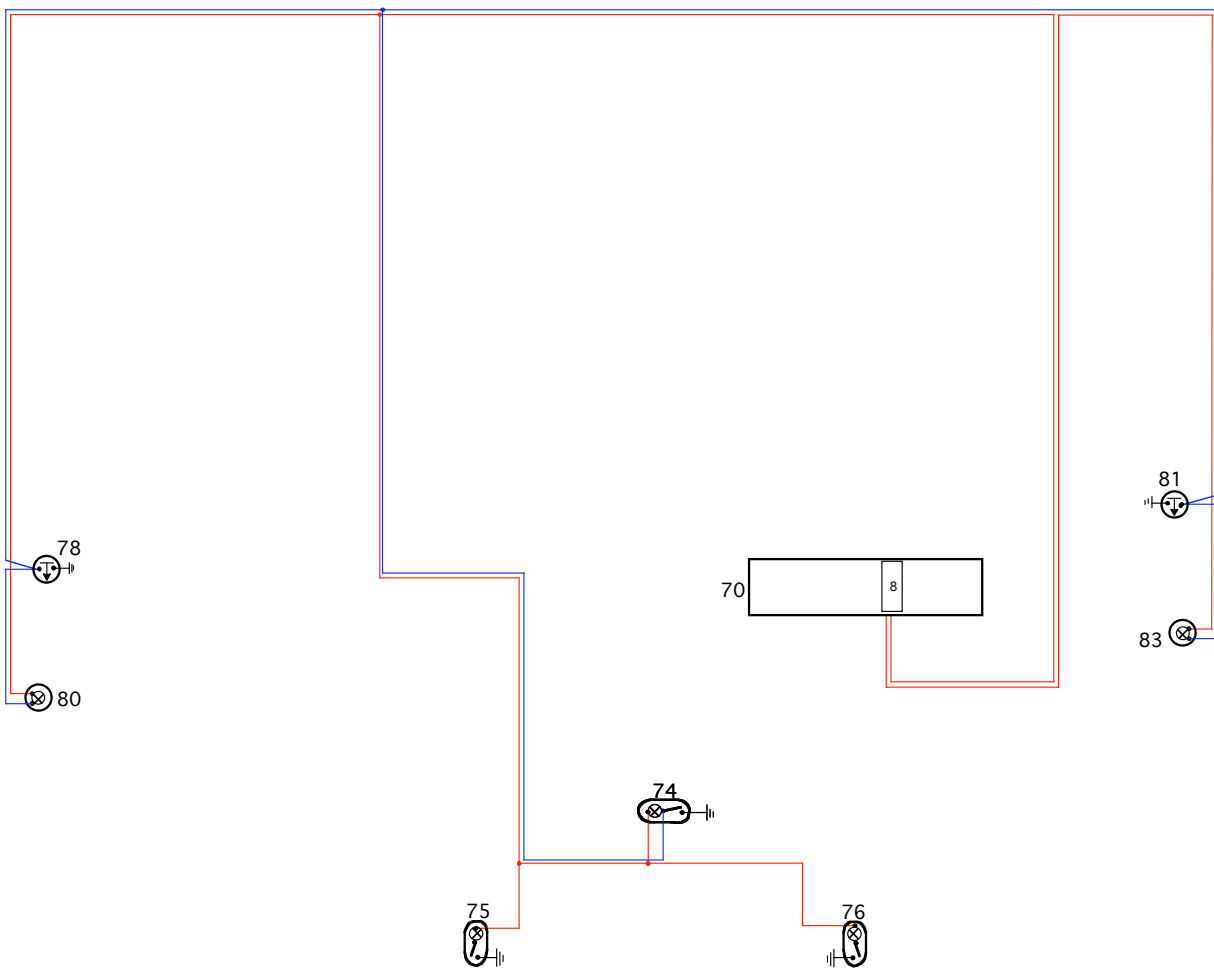

79 : Window winder motor-left door

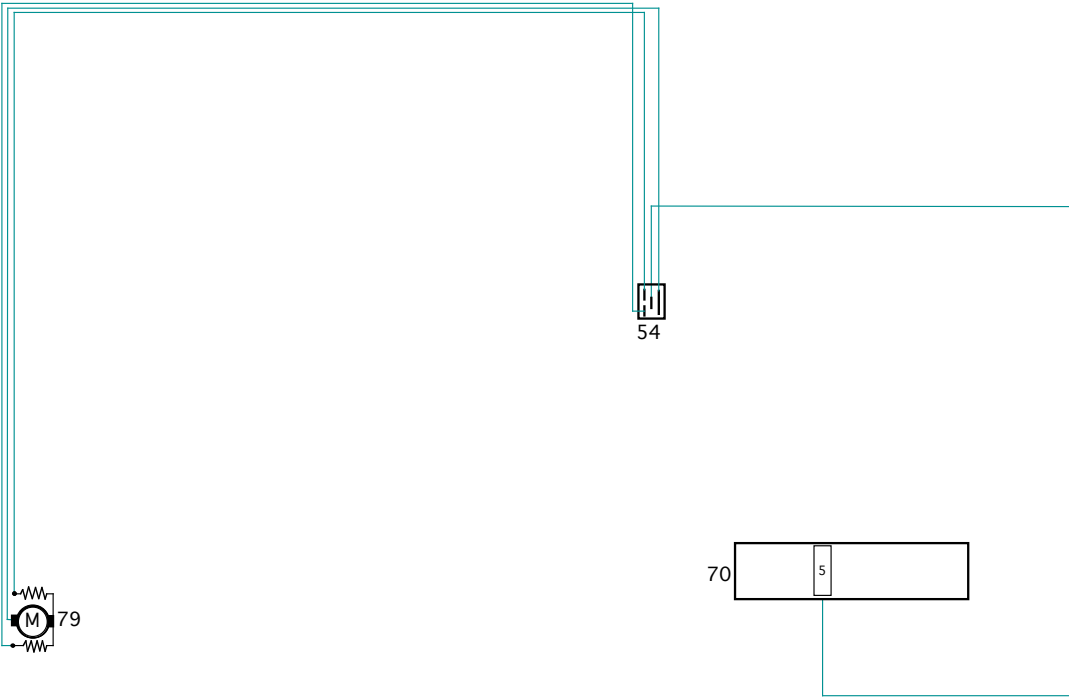



# 80 : Signalling light for left door open

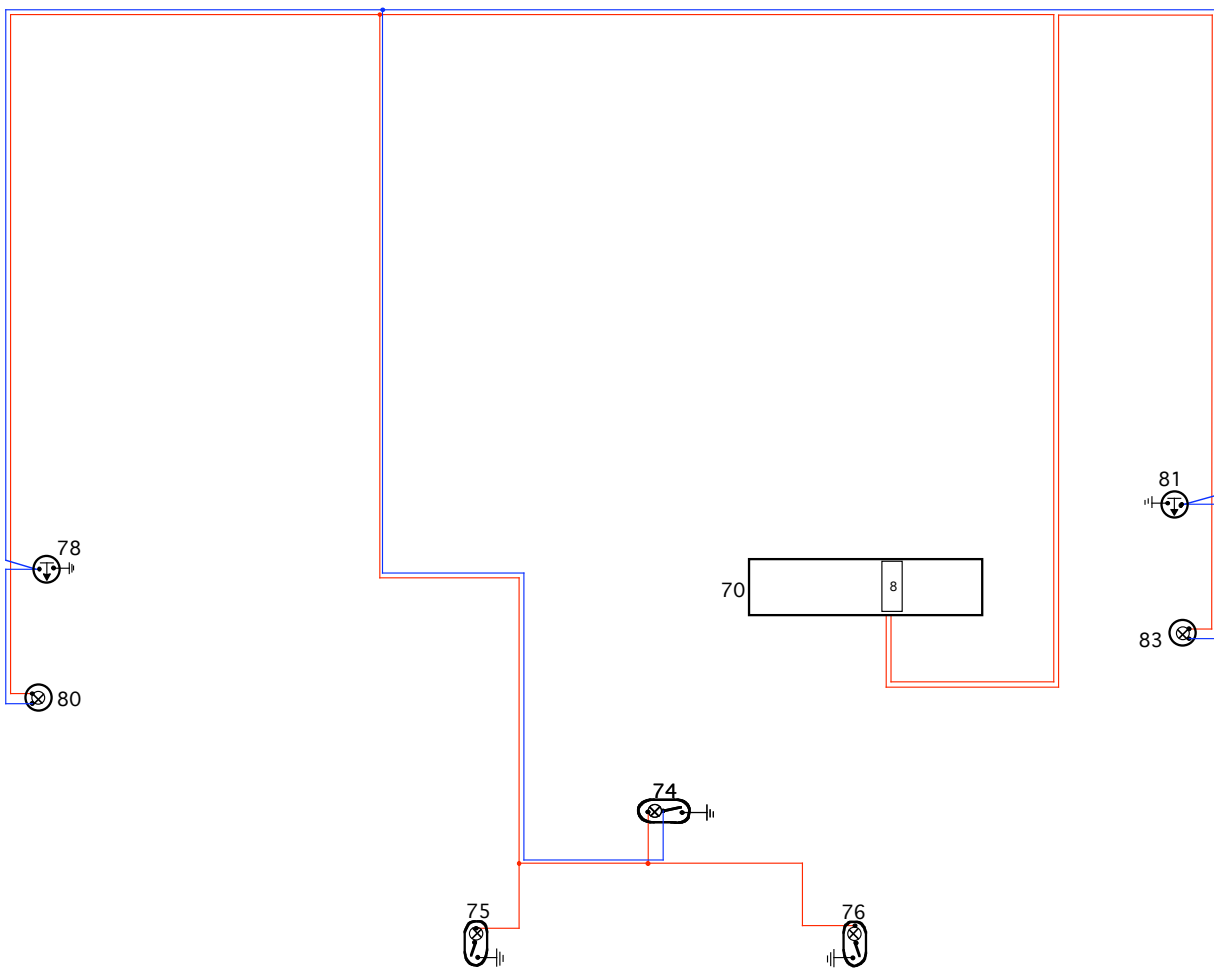

81 : Earth switch for right hand courtesy light

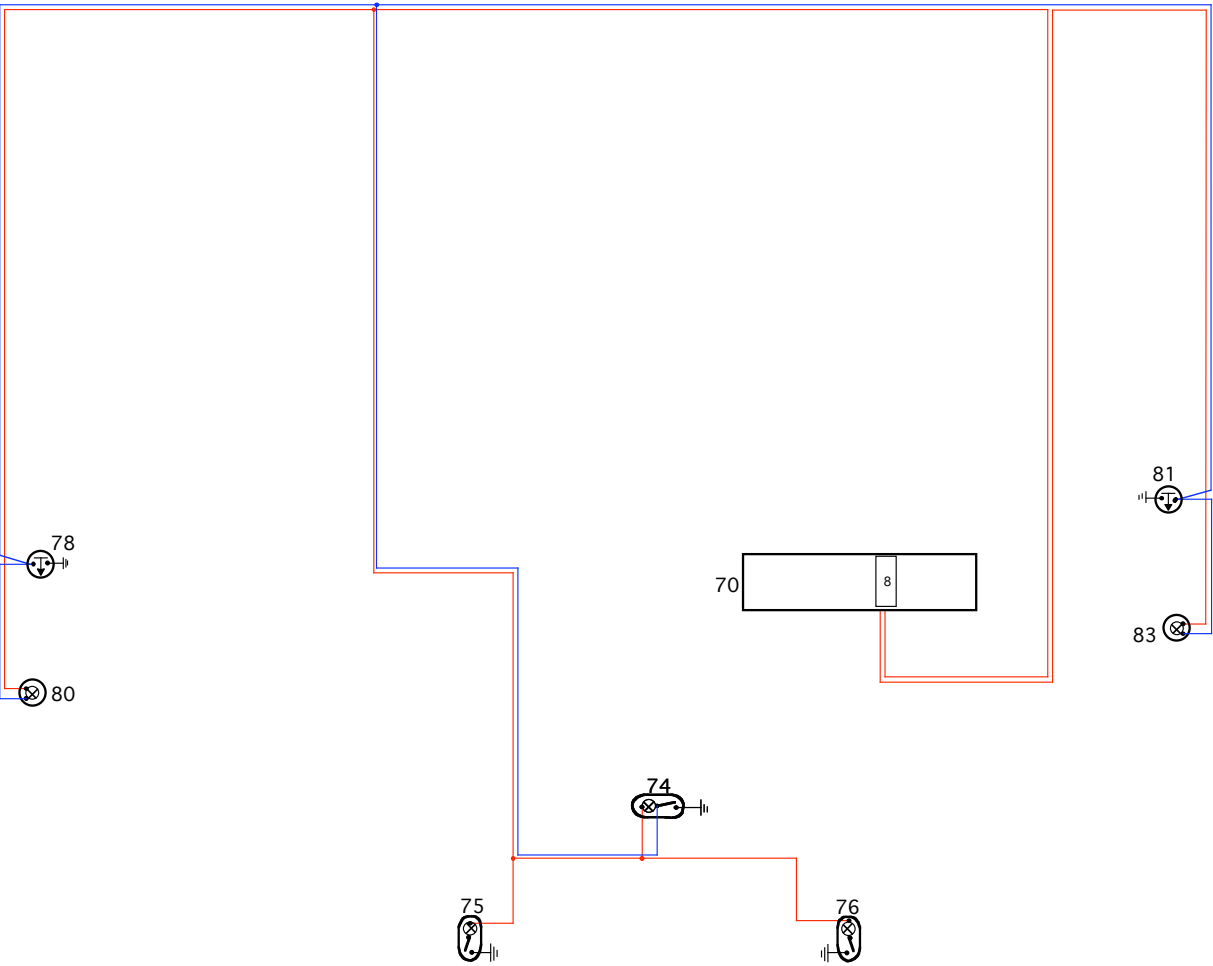

82 : Window winder motor- right door

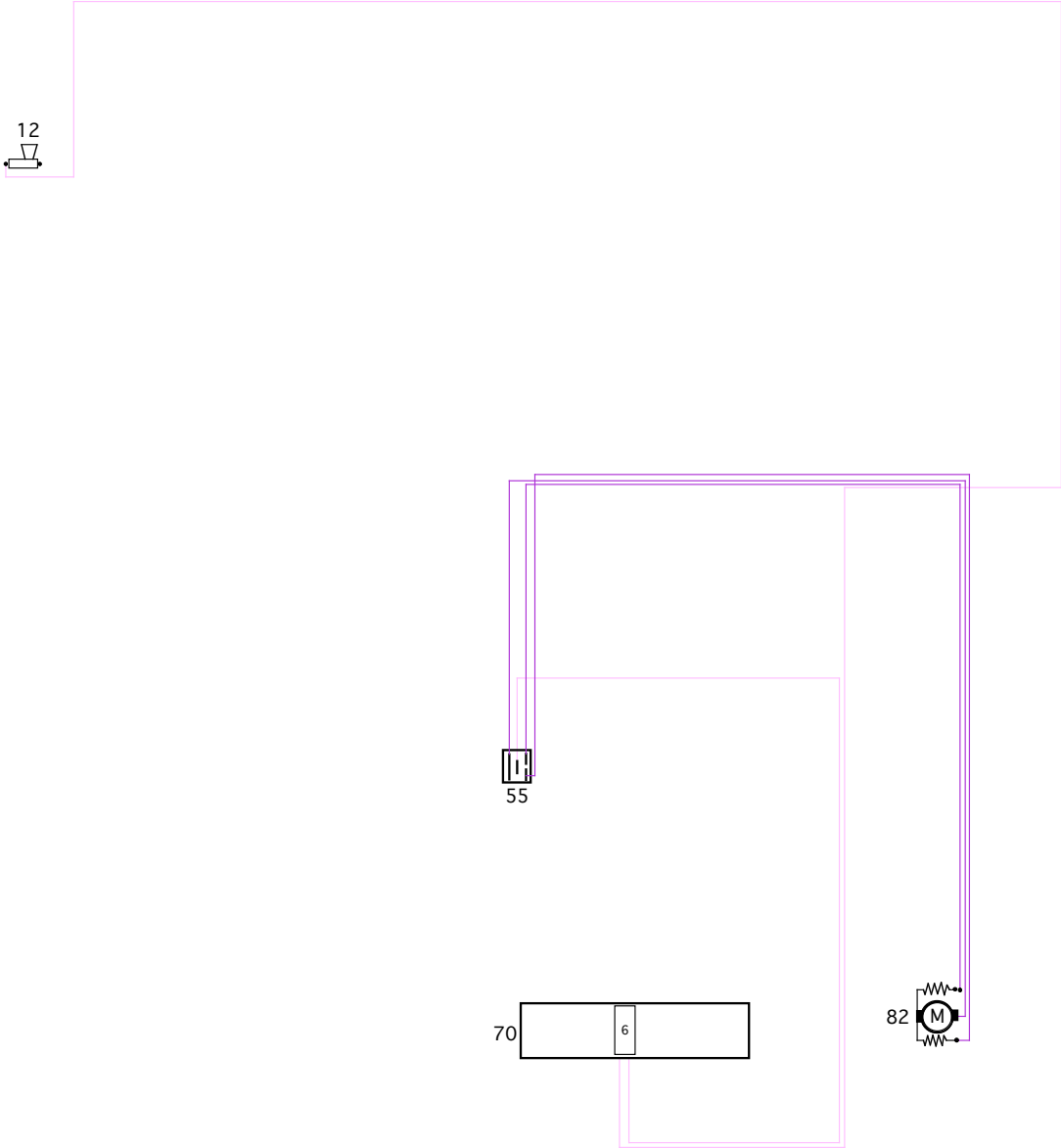

### 83 : Signalling light for right door open

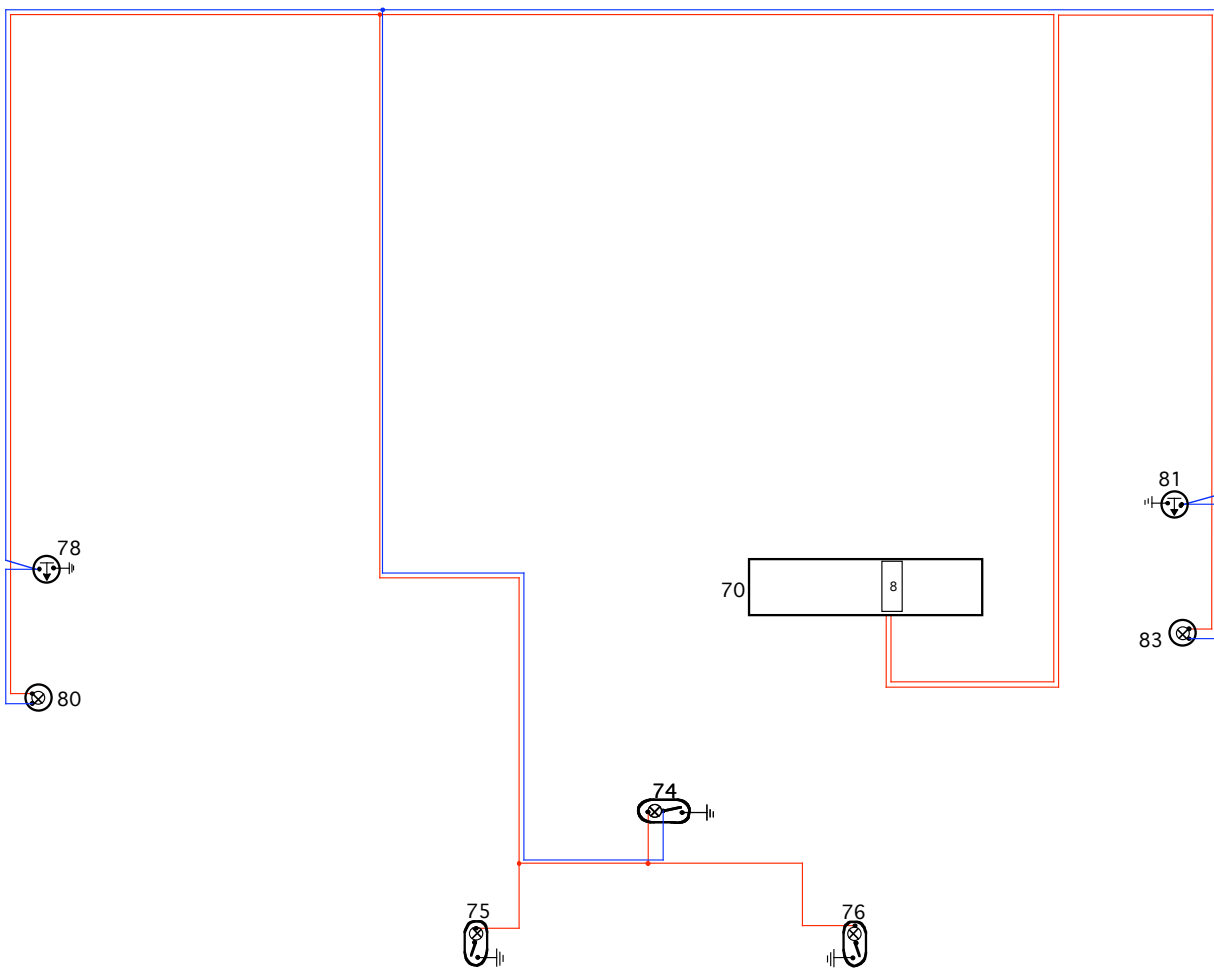

# 84 : Terminal block

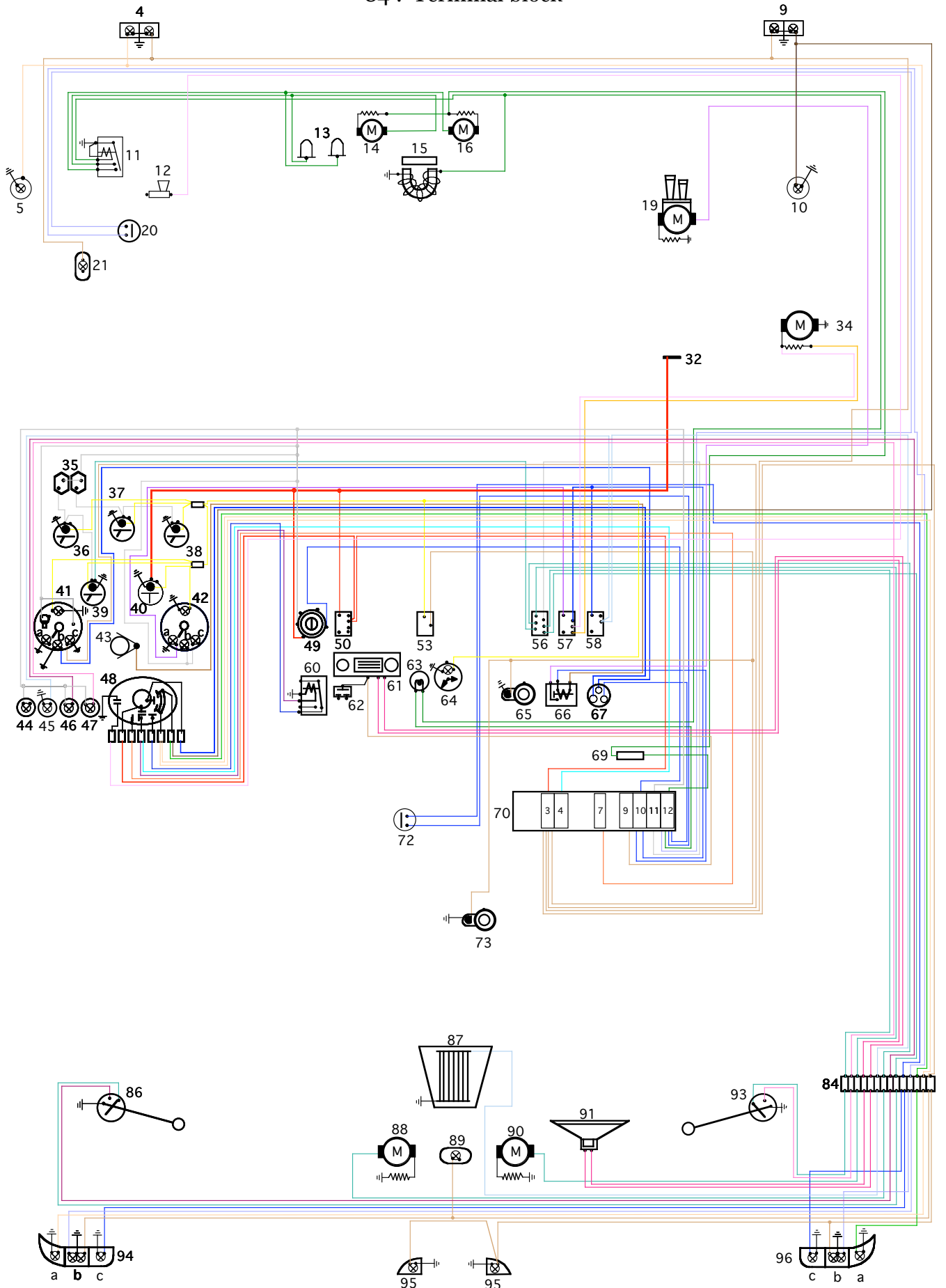

## 85 : Trunk illumination switch



86 : Petrol tank float sender unit - left tank level and reserve

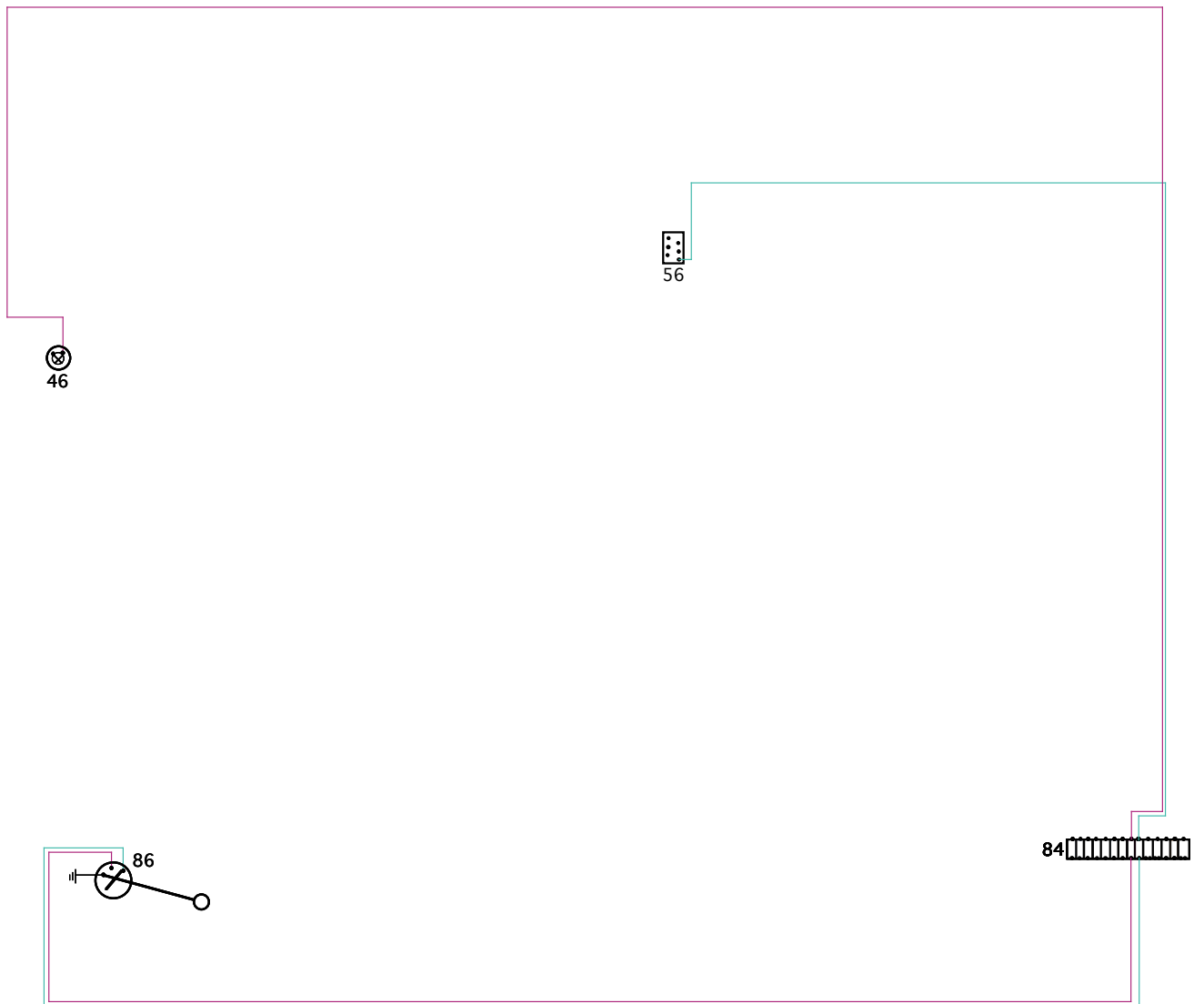

87 : Rear window resistance defroster

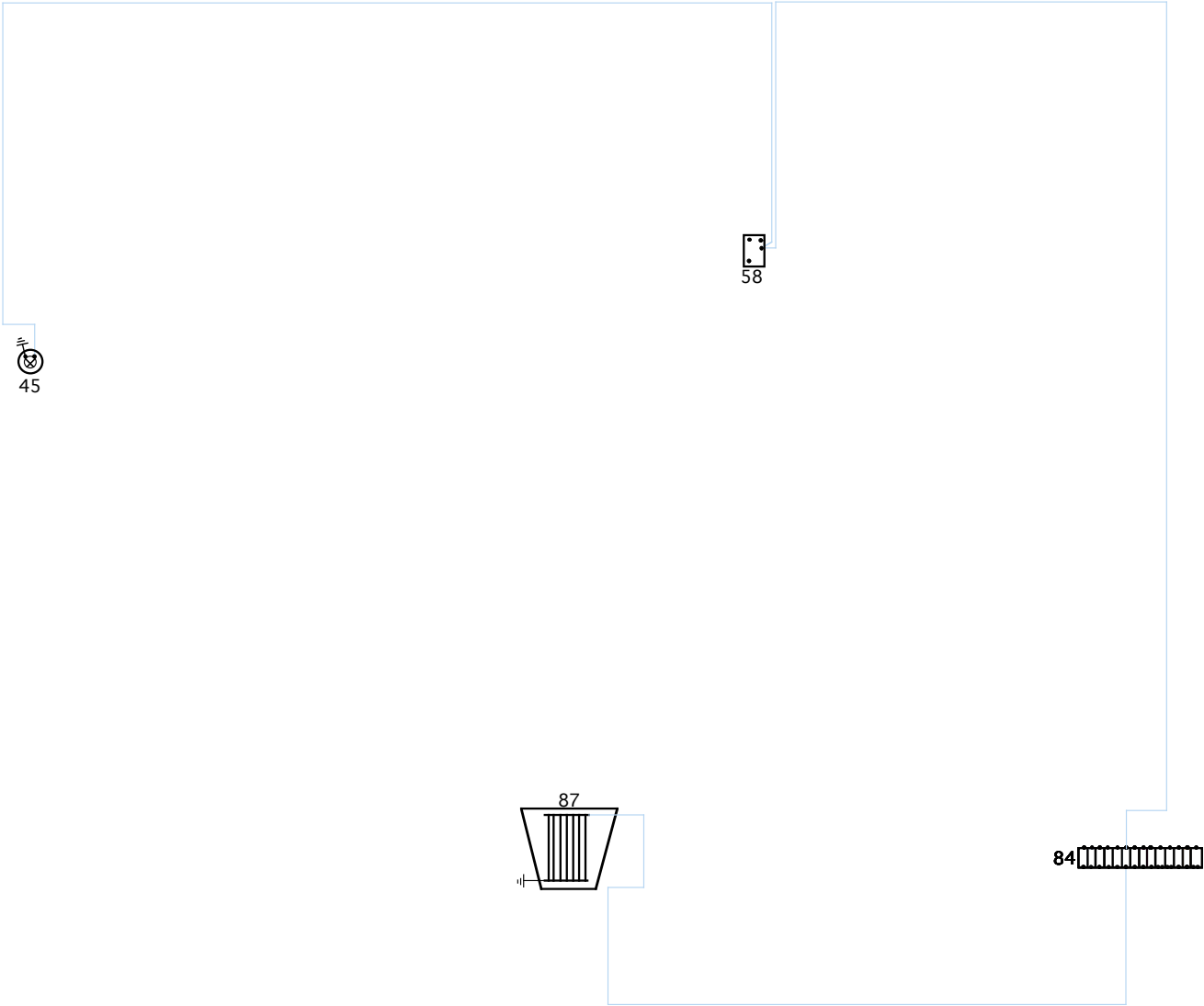



# 88 : Fuel feed pump - left tank

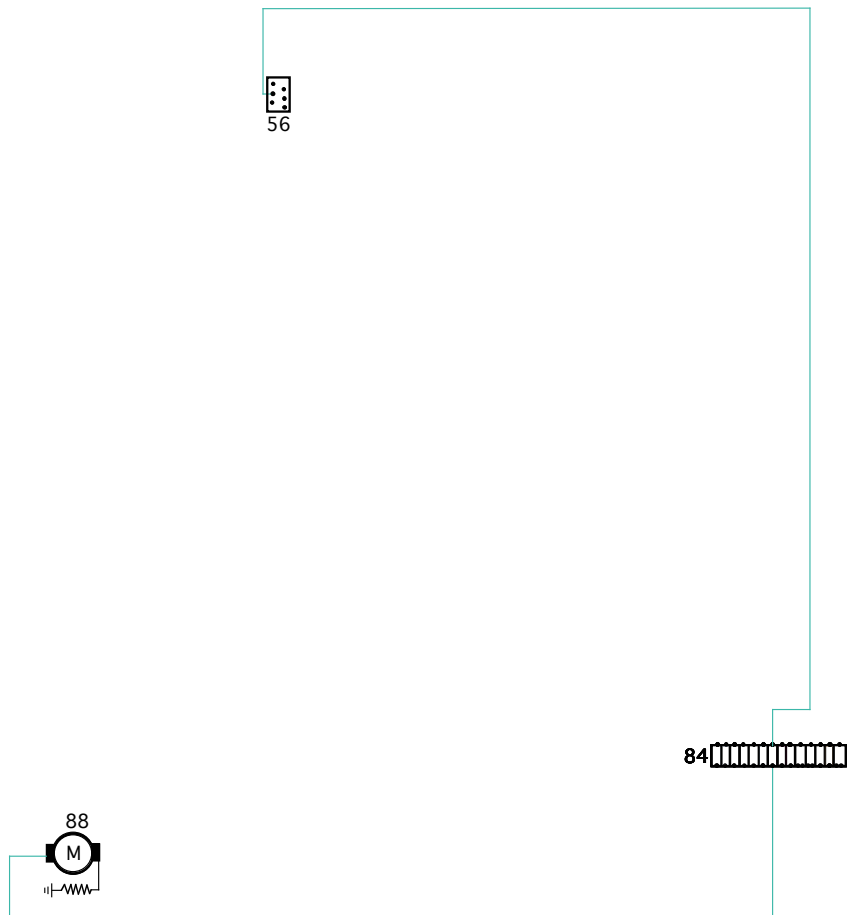

# 89 : Trunk lamp illumination

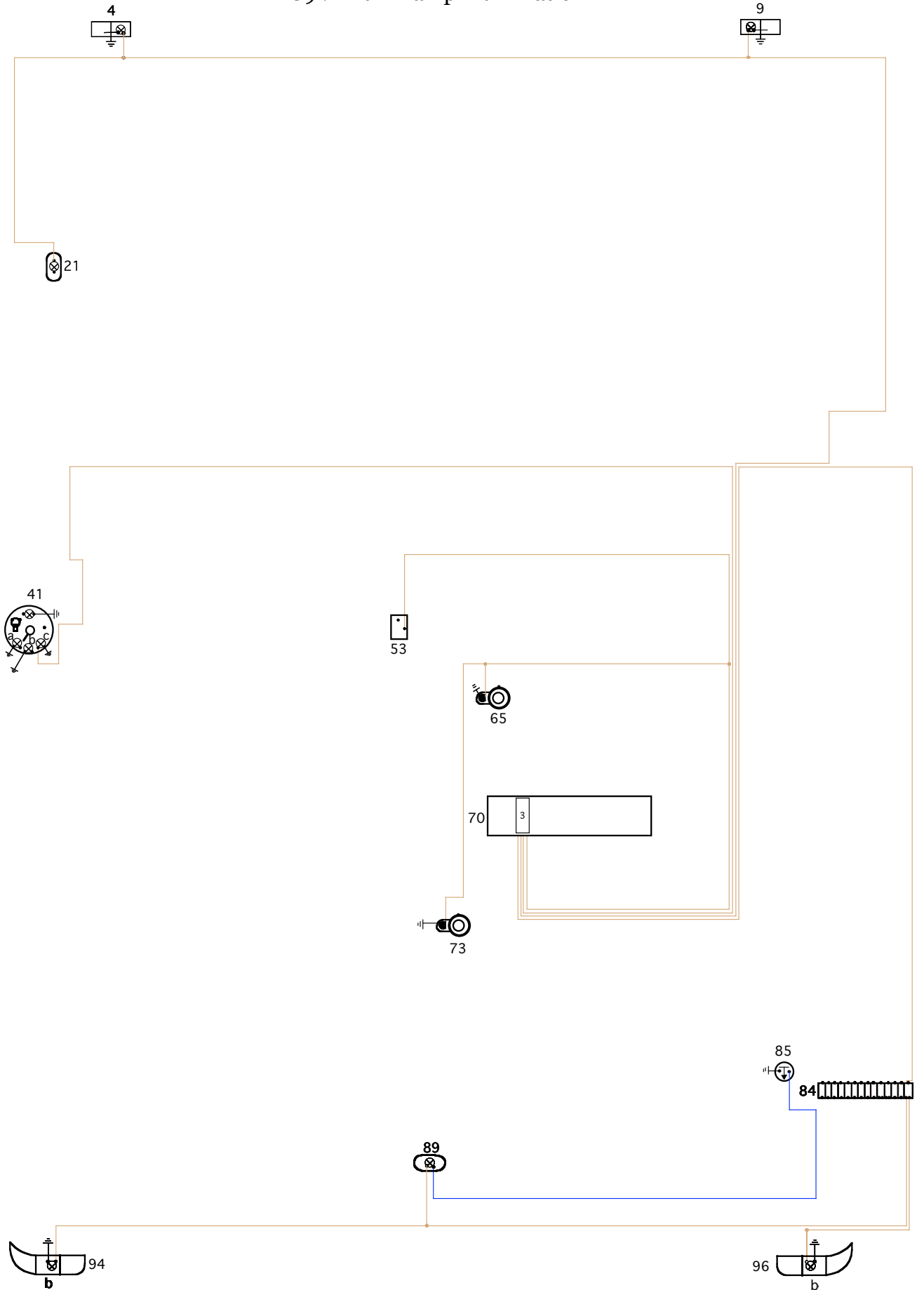

90 : Fuel feed pump - right tank

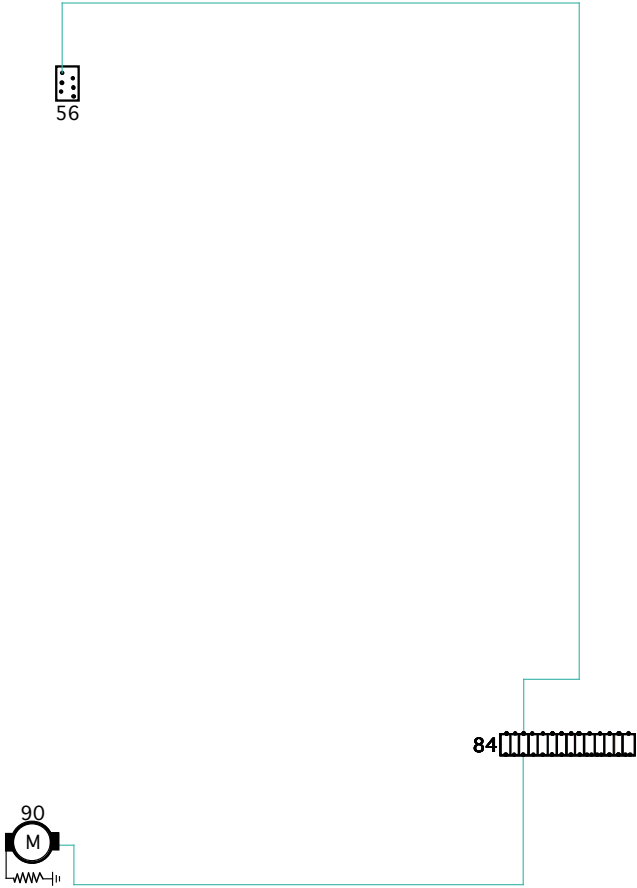

91 : Radio loudspeaker

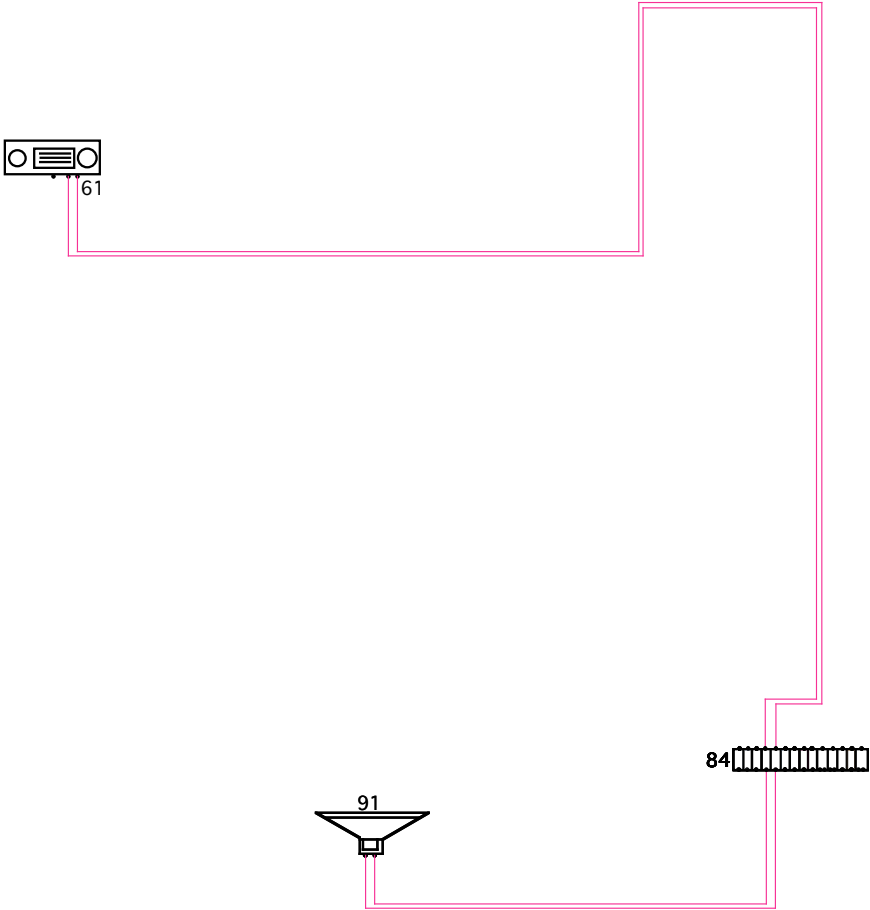

92 : Battery

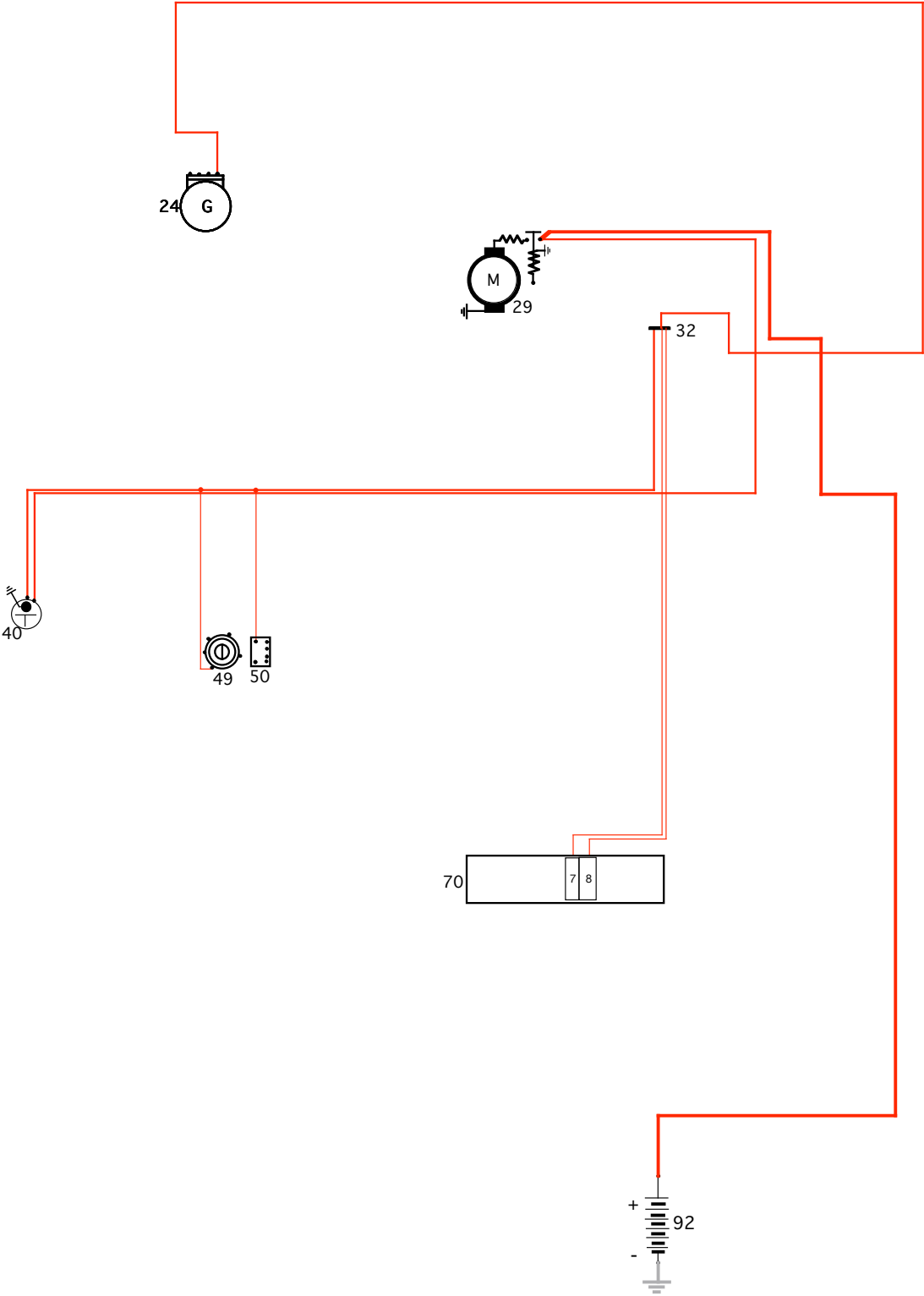

93 : Petrol tank float sender unit - right tank level and reserve

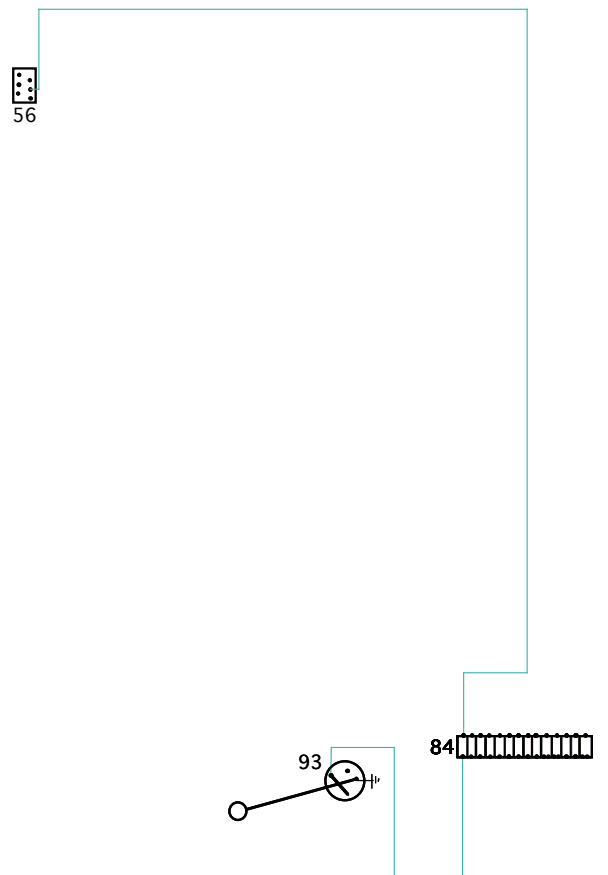

94 a : Triple lamp unit - Direction indicator light

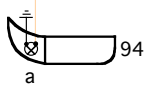
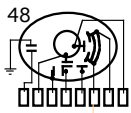

# 94 b : Triple lamp unit - Rear/stop light

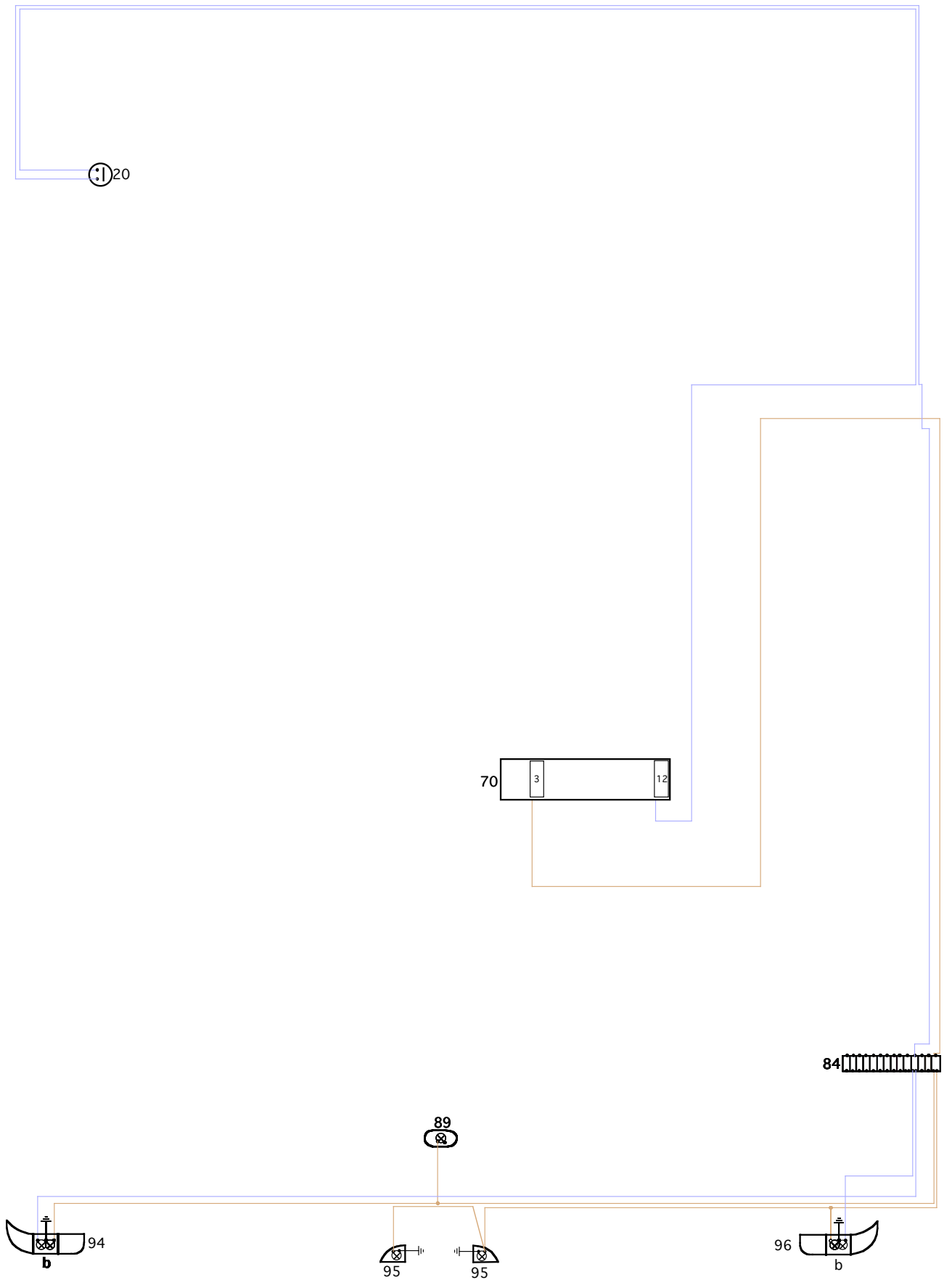



94 c : Triple lamp unit - Reverse driving light

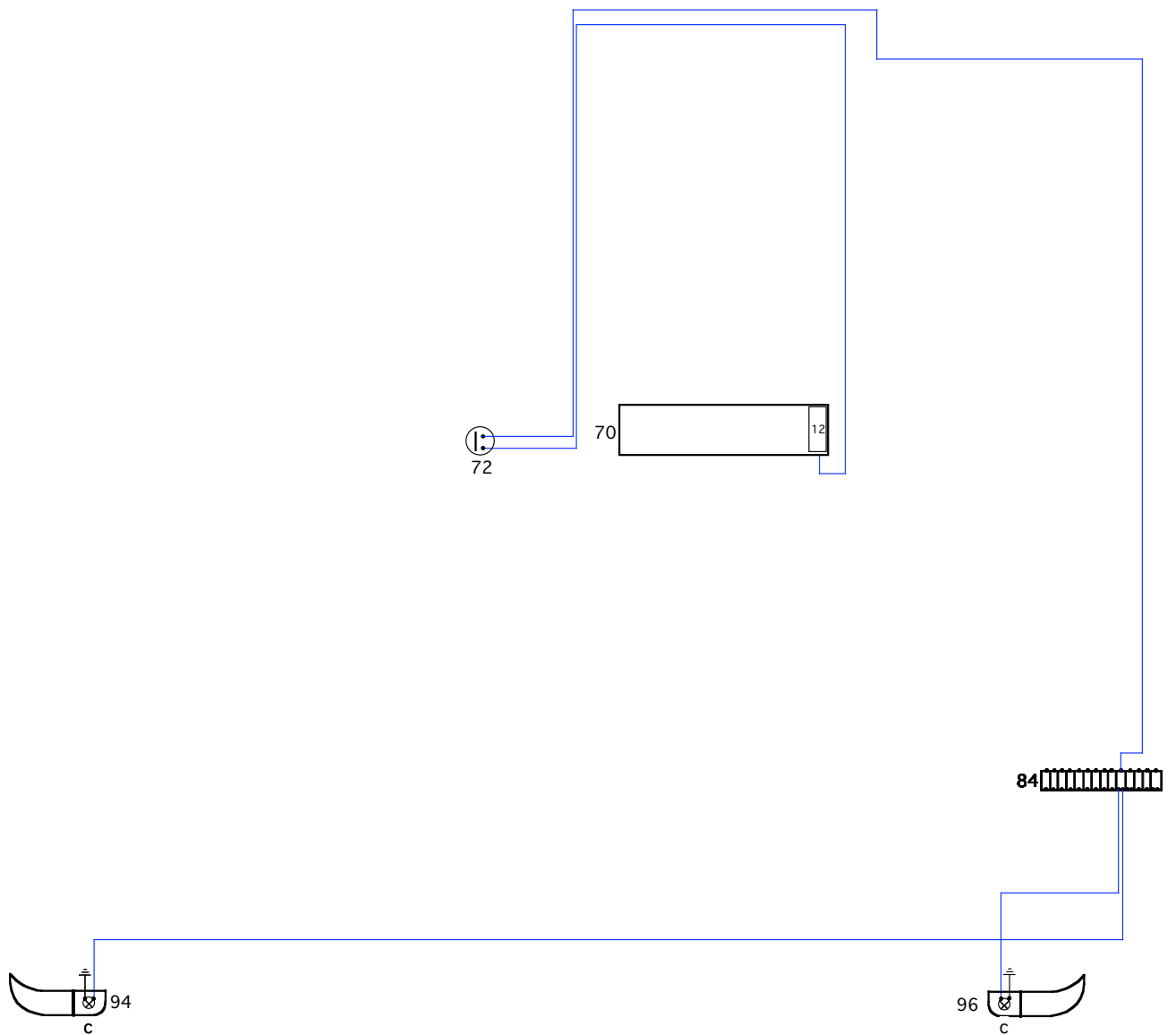

95 : Number plate rear light

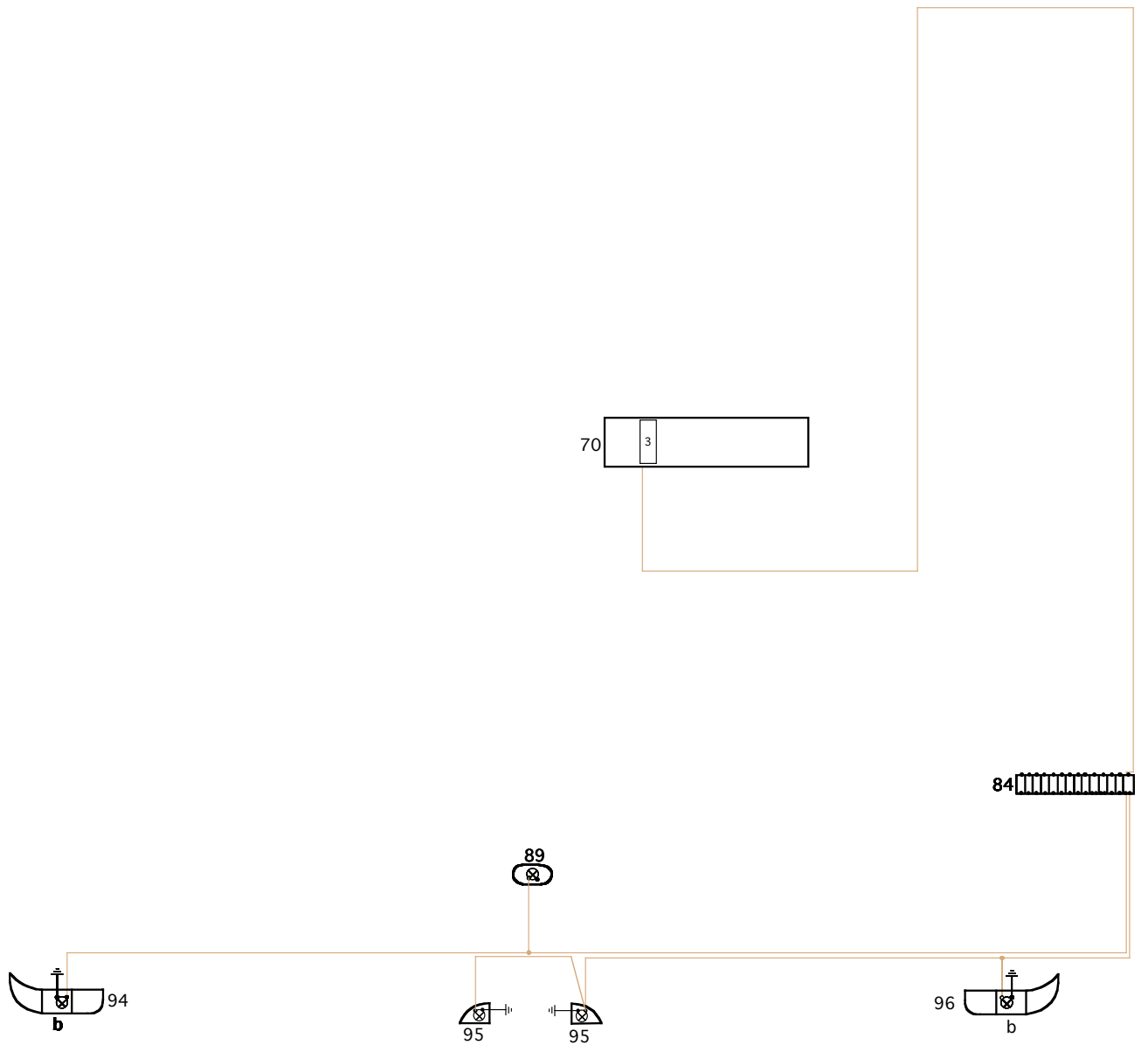

96 a : Triple lamp unit - Direction indicator light

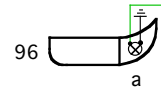
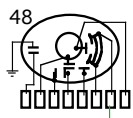

# 96 b : Triple lamp unit - Rear/stop light

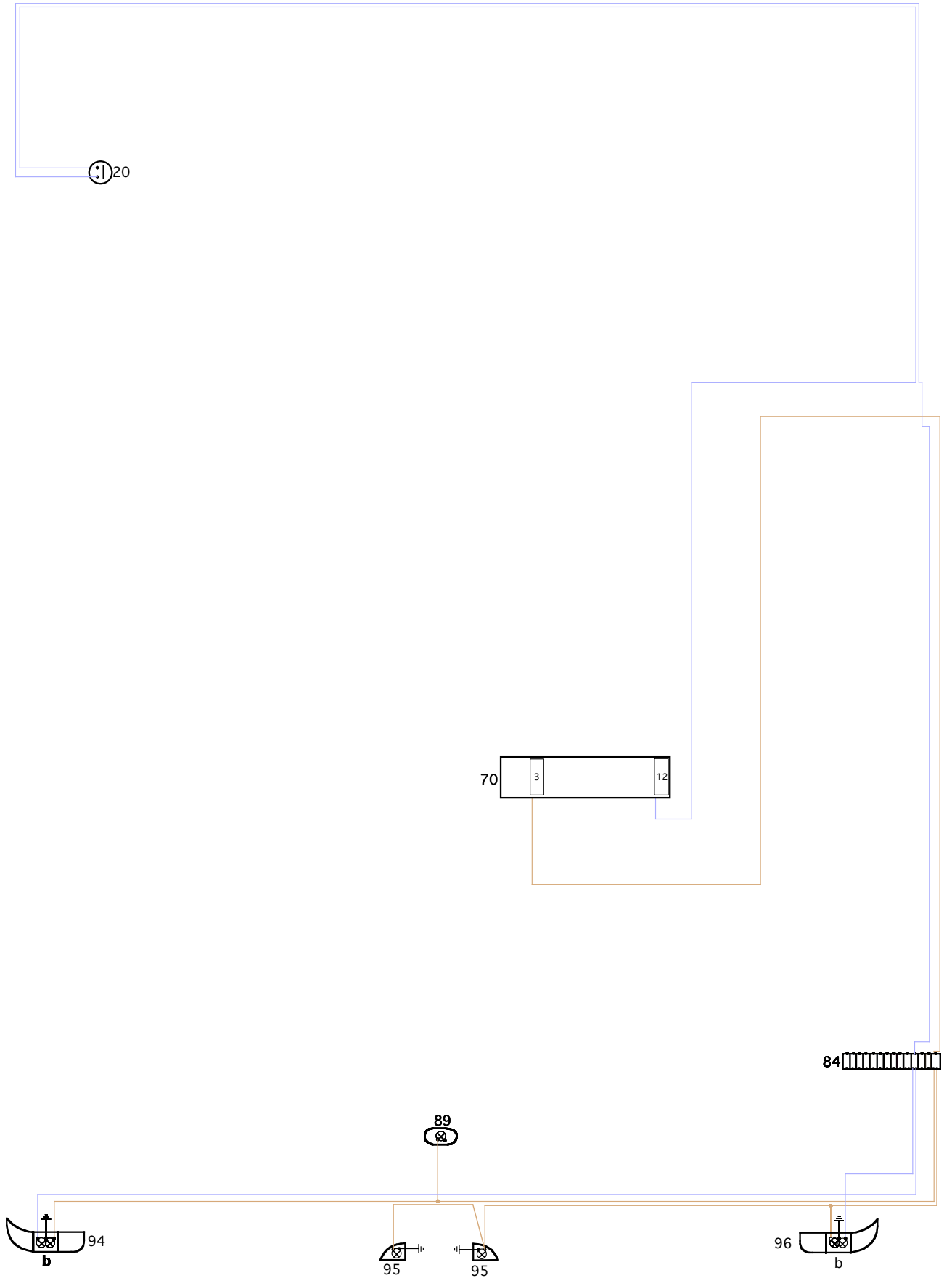

96 c : Triple lamp unit - reverse driving light

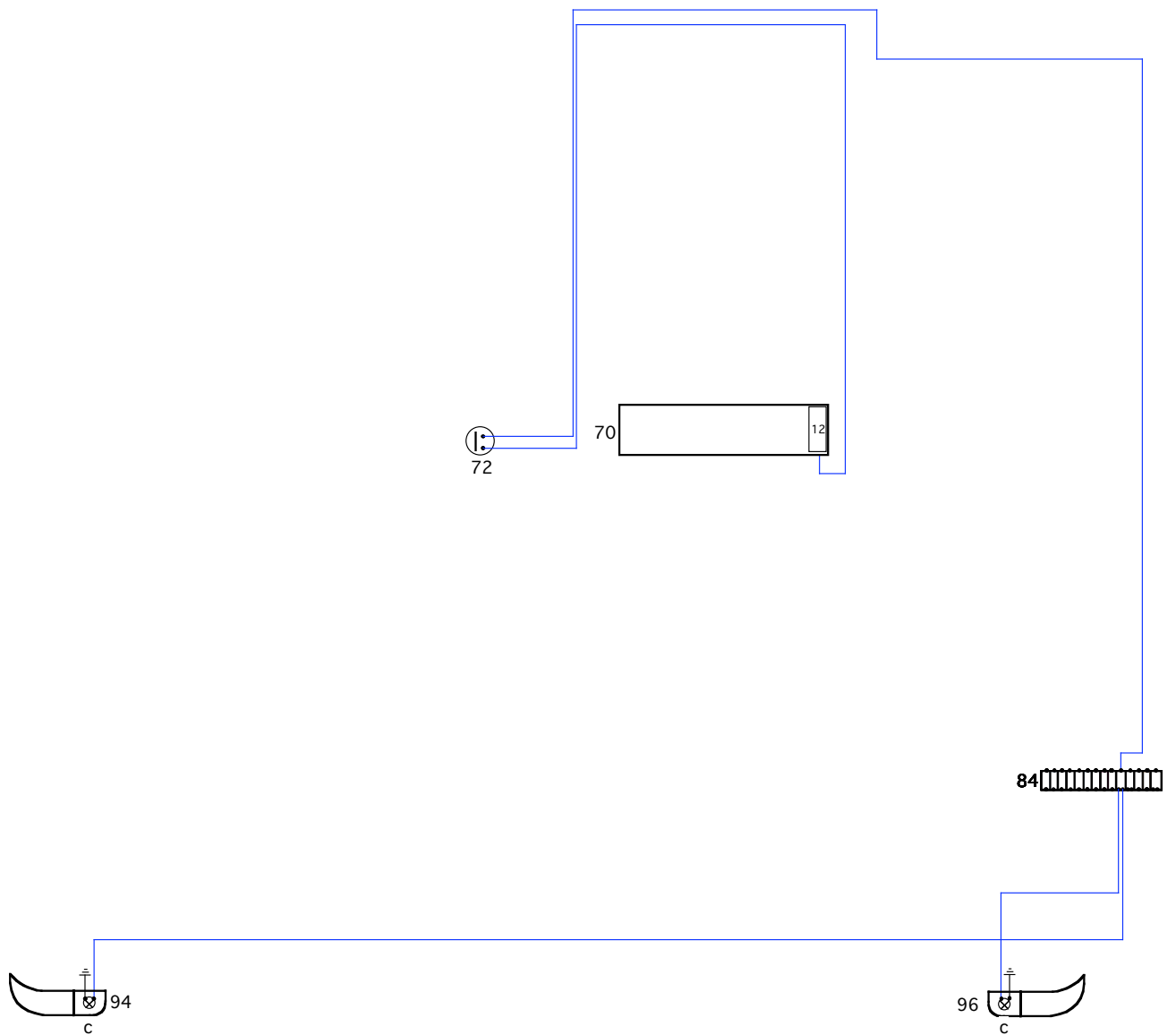

VEETTURA TIPO 112/1

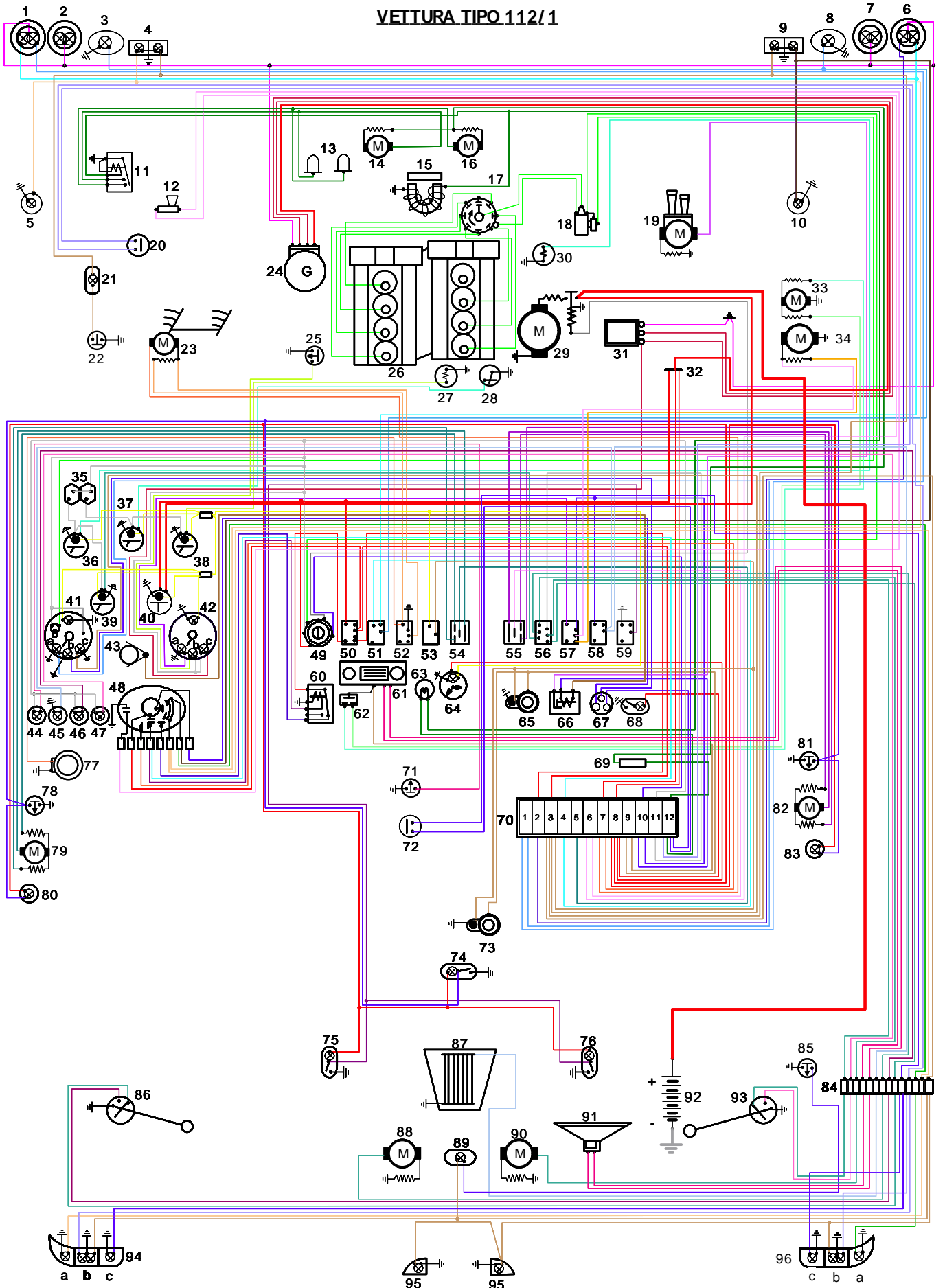

Fuse 1

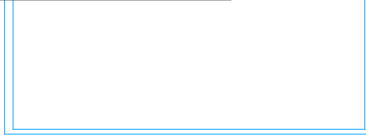
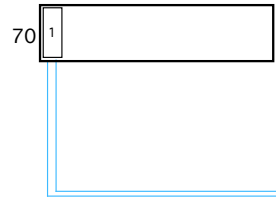
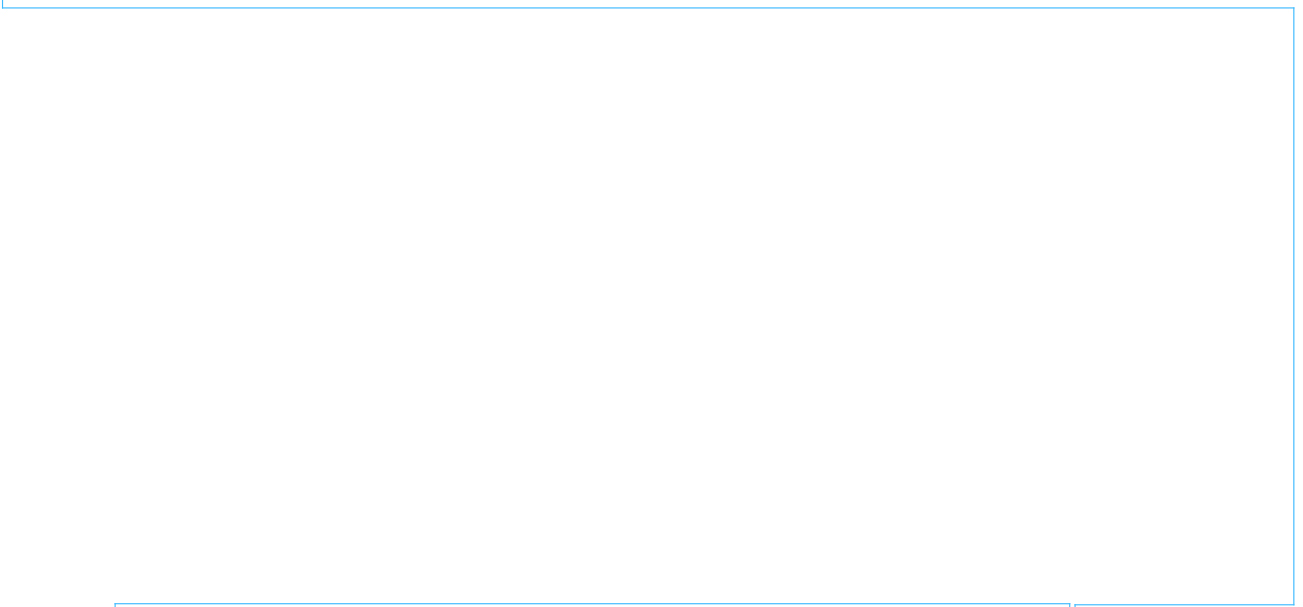

# Fuse 2

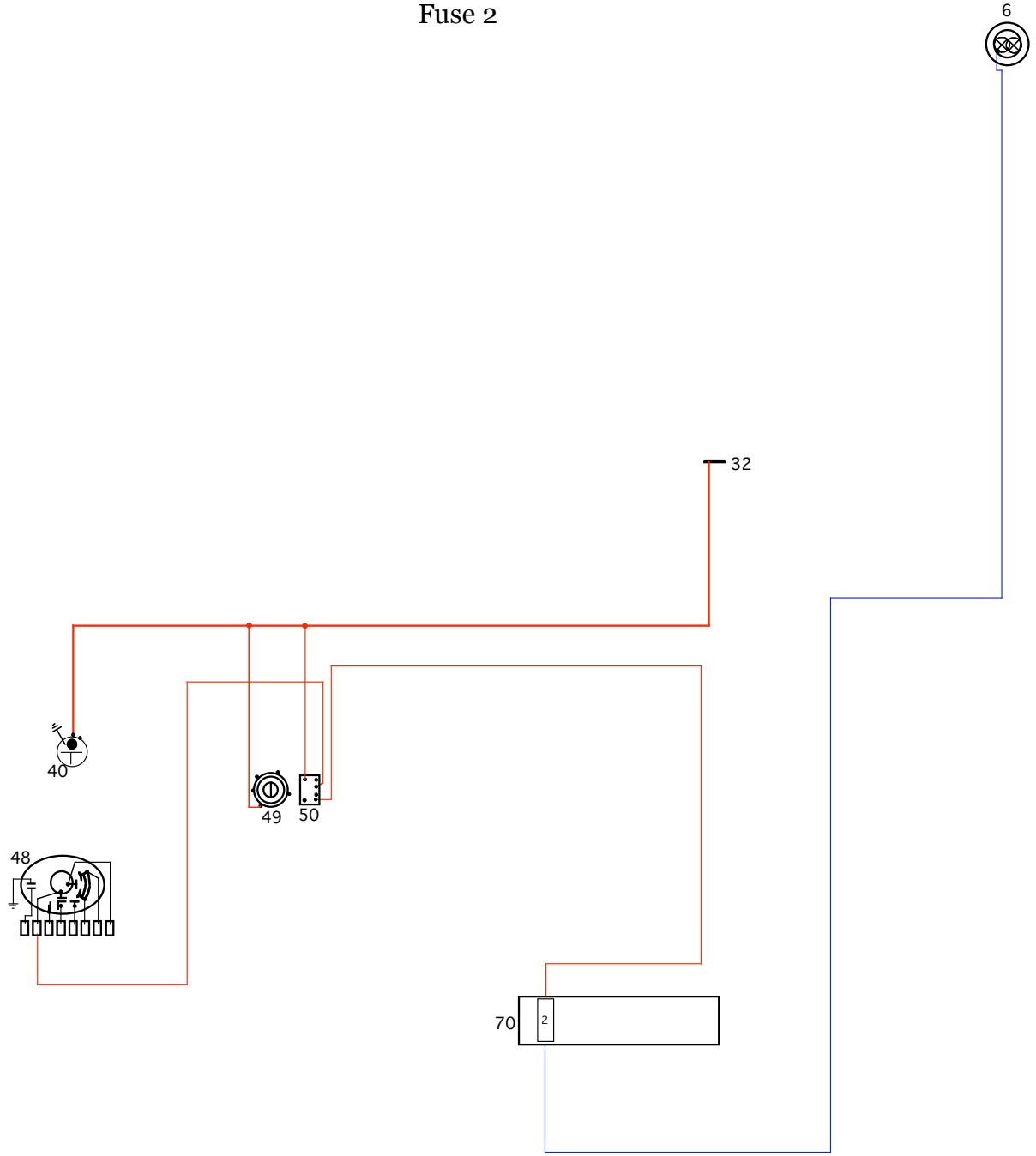



# Fuse 3

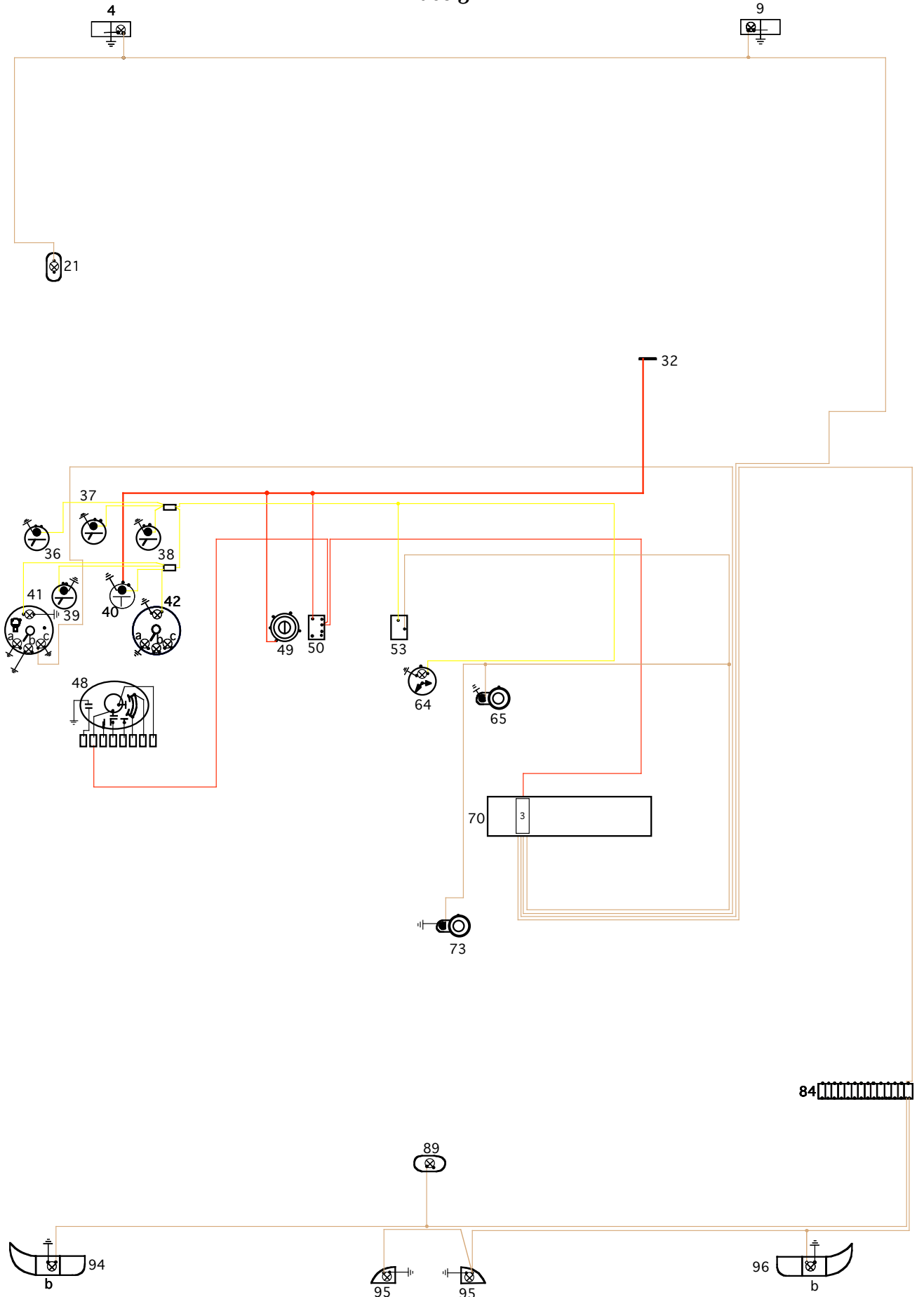

Fuse 4

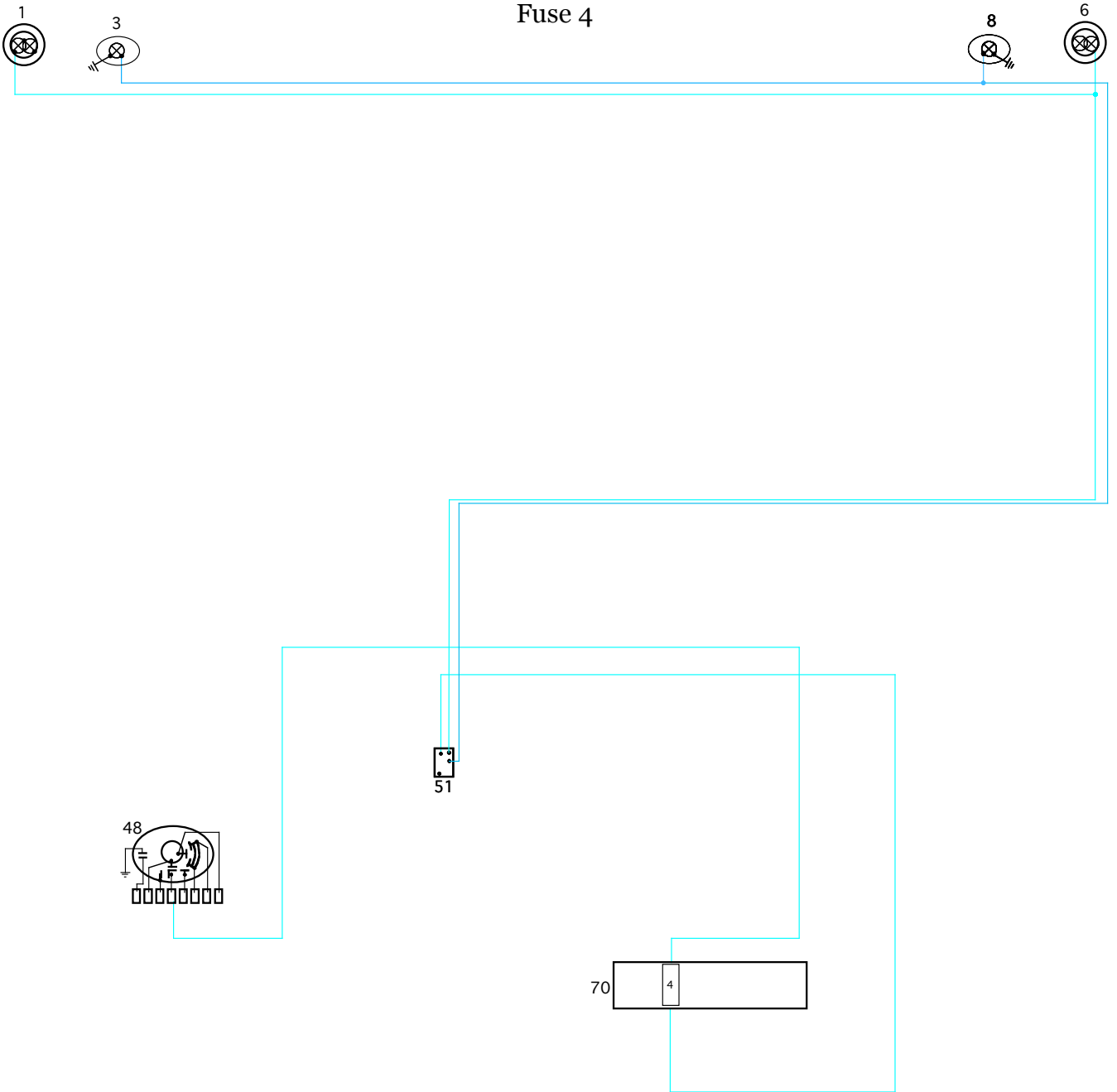

# Fuse 5

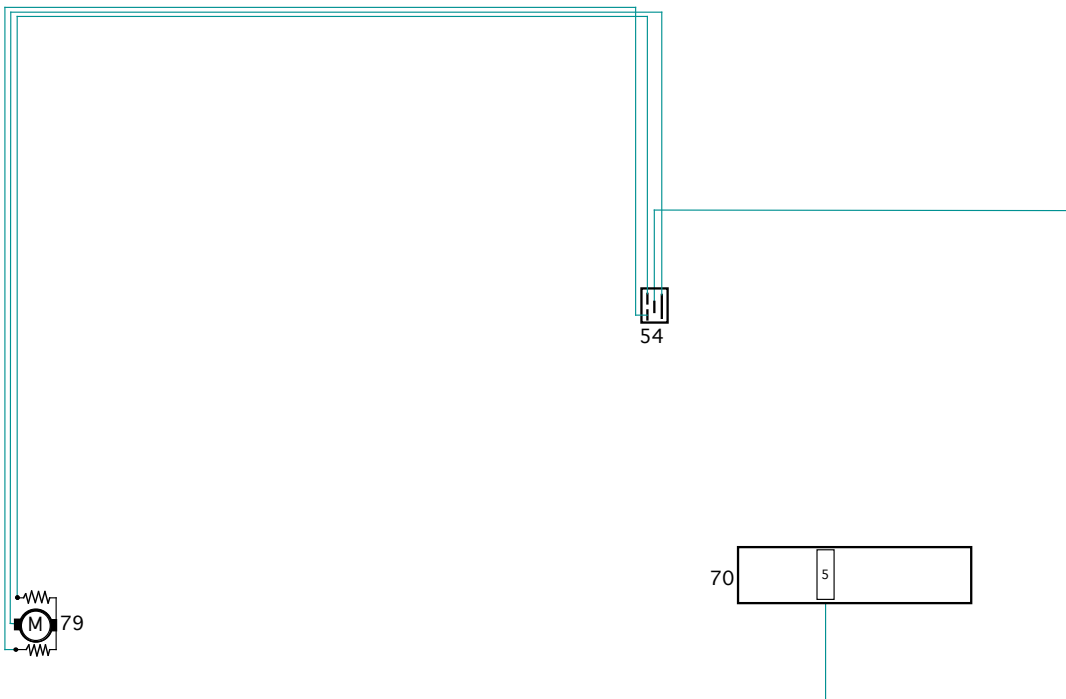

# Fuse 6

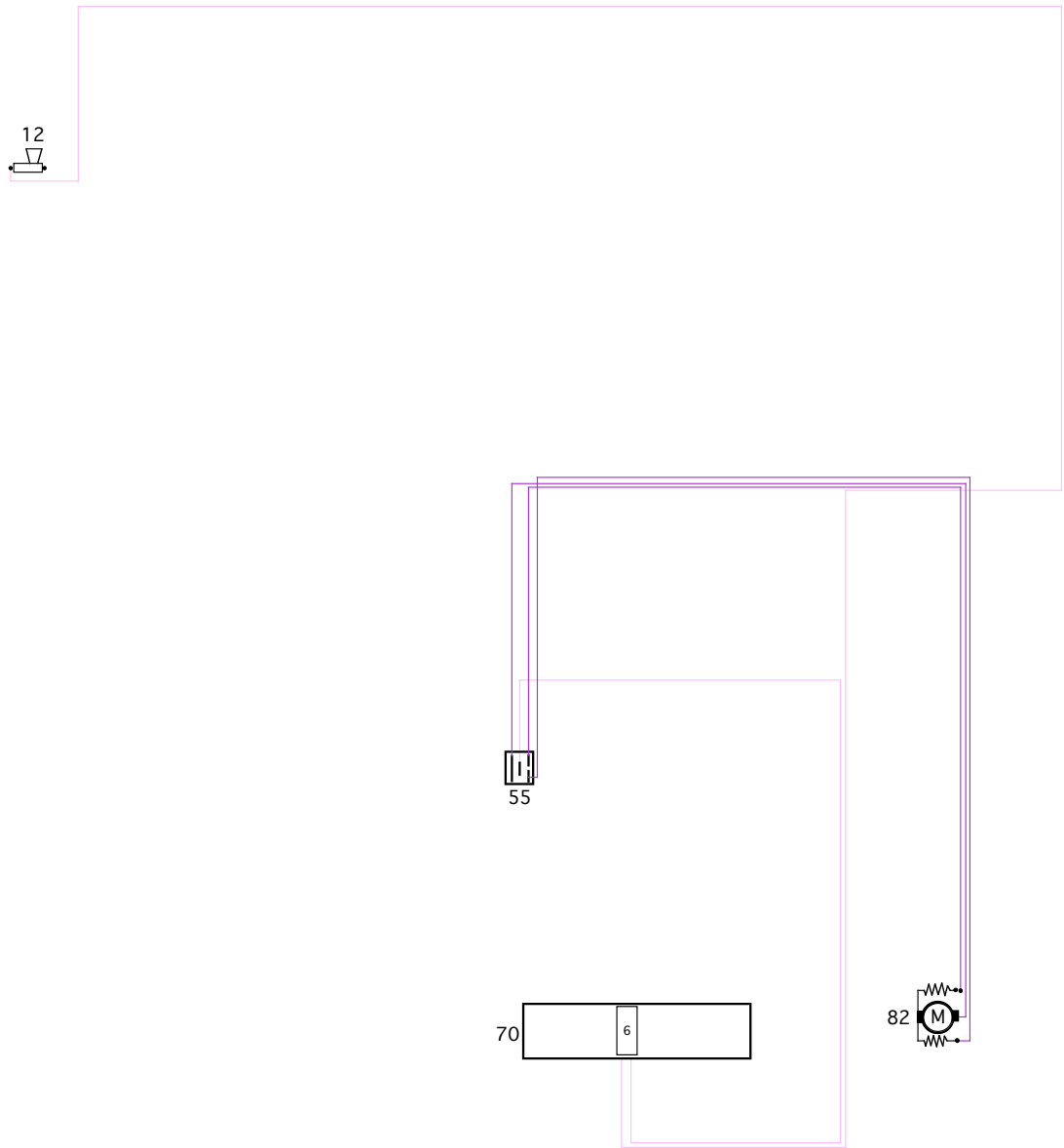

Fuse 7

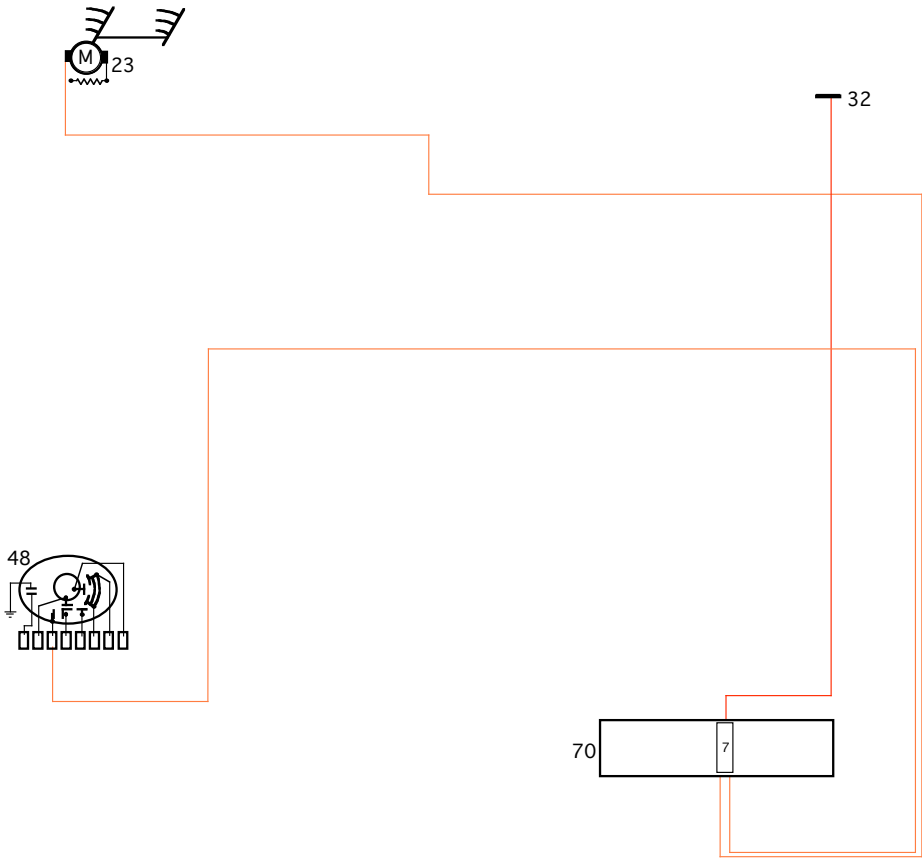

# Fuse 8

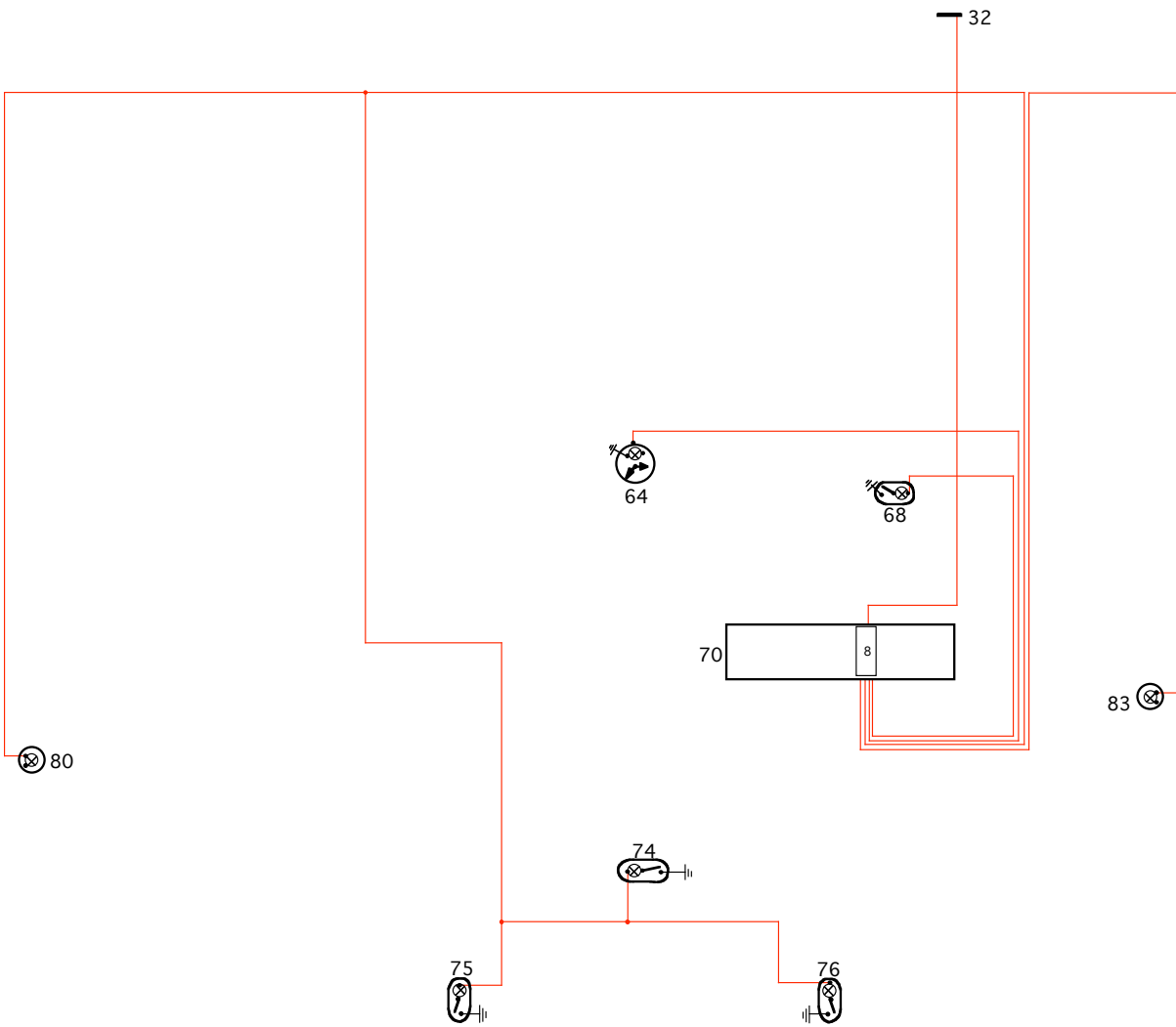

# Fuse 9

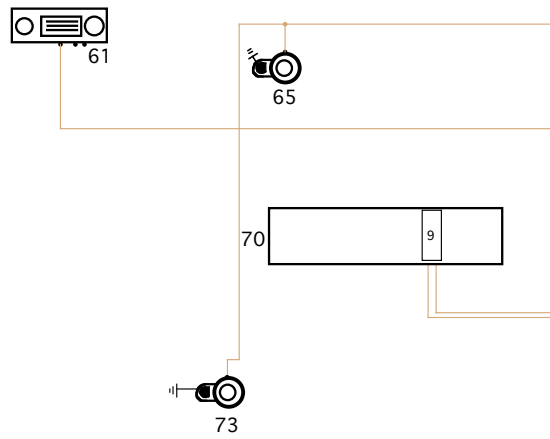

# Fuse 10

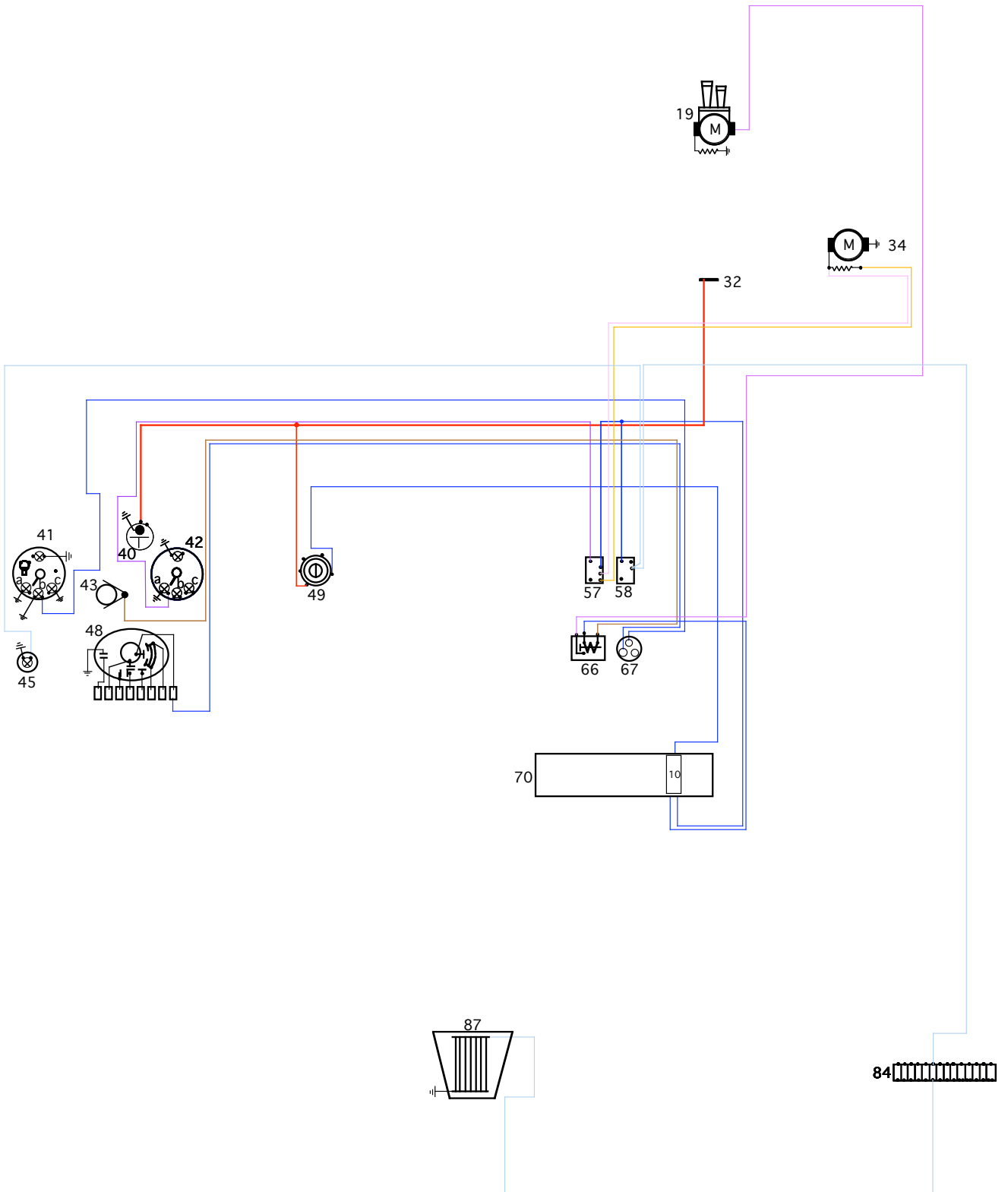



# Fuse 11

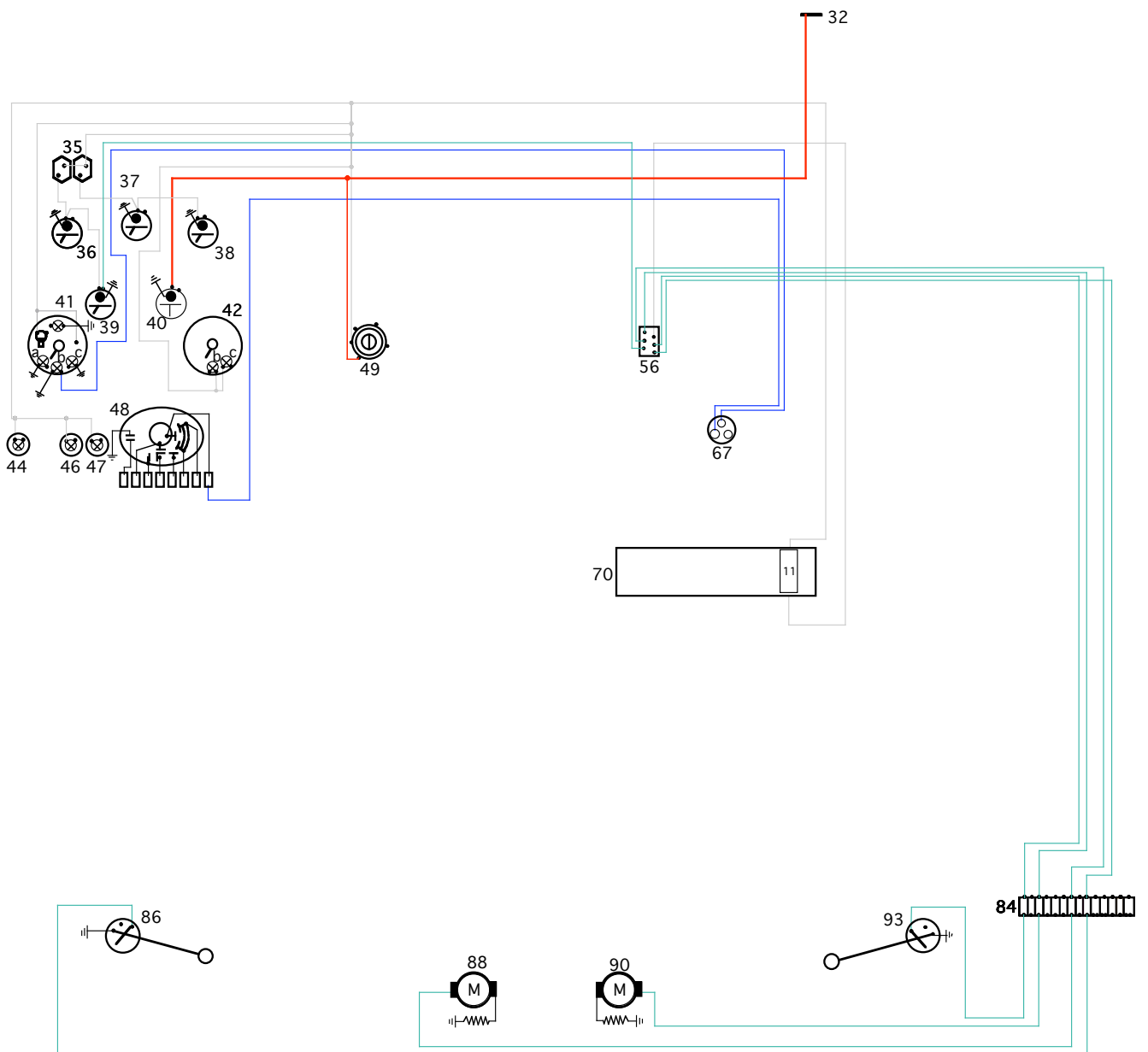

# Fuse 12

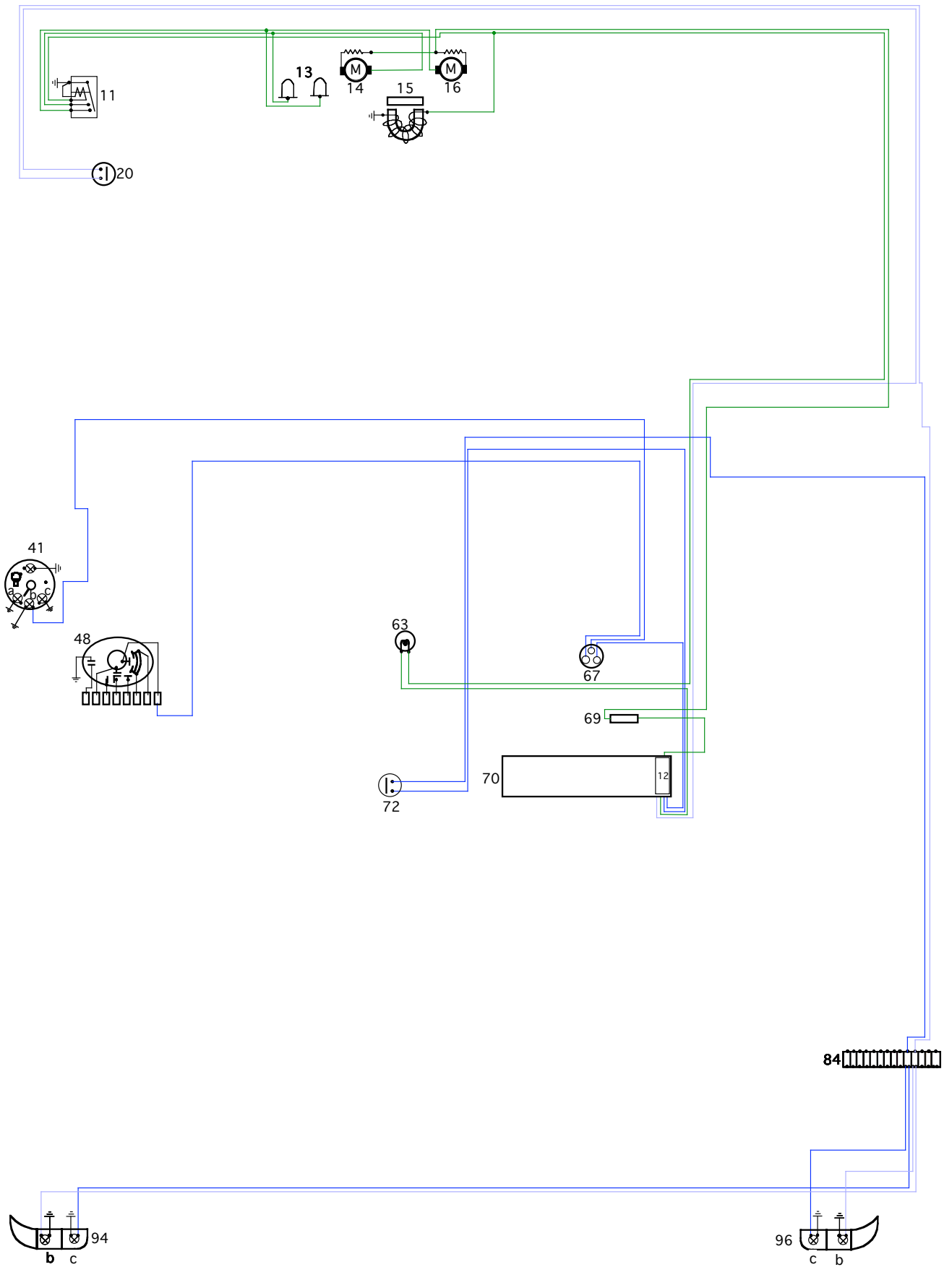

# VEETTURA TIPO 112/1

