



ASTON MARTIN

*Vantage S*

## Aston Martin Owners' Club (AMOC)

### An invitation to join the Aston Martin Owners' Club

The sporting spirit of the 1930s exists today in one of the world's most exclusive car clubs. Enthusiasts in nearly 60 countries are united by an interest in iconic cars with an enviable pedigree. Enjoy the company of like-minded owners in a wide range of activities: social evenings, weekends away or motoring tours. Something more competitive? AMOC Concours are a benchmark for connoisseurs of fine motorcars. A need for speed? We organise track days, sprints and hill climbs as well as circuit racing in venues such as Silverstone, Goodwood and Lime Rock in the USA.



Aston Martin Owners' Club

Drayton St. Leonard

Wallingford

Oxfordshire

England

OX10 7BG

Telephone:

+44 (0) 1865 400 400

Facsimile:

+44 (0) 1865 400 200

E-Mail:

[hqstaff@amoc.org](mailto:hqstaff@amoc.org)

Website:

[www.amoc.org](http://www.amoc.org)



## Aston Martin Heritage Trust

The Aston Martin Heritage Trust is an educational charity dedicated to the preservation, promotion and enhancement of over 100 years of history of Aston Martin. Its world class collection comprising the automotive museum, substantial archive and collection of historical artefacts is housed in the magnificently restored Grade II\* listed barn in Oxfordshire which it shares with the Owners' Club. As a member of the Owners' Club you become a member and supporter of the Trust, so please log on to our web site for more information, or better still pay us a visit and see the collection for yourself.



Aston Martin Heritage Trust

Drayton St. Leonard

Wallingford

Oxfordshire

England

OX10 7BG

Telephone:

+44 (0) 1865 400 414

Facsimile:

+44 (0) 1865 400 200

E-Mail:

[secretary@amht.org.uk](mailto:secretary@amht.org.uk)

Website:

[www.amht.org.uk](http://www.amht.org.uk)



Introduction .....	1
Vehicle Security .....	2
Before Driving.....	3
Controls .....	4
Driving.....	5
Infotainment .....	6
Climate Control.....	7
Audio.....	8
Hands-Free Phone .....	9
Convertible Roof .....	10
Satellite Navigation .....	11
Maintenance.....	12
Specifications .....	13
Service .....	A
Aston Martin Warranty .....	B
Aston Martin Assistance.....	C
Alphabetical Index .....	D

Every effort has been made to make sure that the information provided in this Owner's Guide is accurate and up-to-date. However neither the manufacturer or the Dealer, by whom this Owner's Guide is supplied, will in any circumstances be held responsible for any inaccuracy or the consequences thereof. All rights reserved.

No part of this publication may be reproduced, stored in a retrieval system or transmitted, in any form, electronic, mechanical, photocopying, recording or other means without prior written permission from Aston Martin Lagonda Limited.

The manufacturer reserves the right to vary specifications without notice in accordance with its policy of continual product improvement.

Produced By the Technical Publications Department  
Aston Martin Lagonda Limited,  
Banbury Road  
Gaydon  
Warwick  
CV35 0DB  
England  
Telephone:  
+44 (0)1926 644300

Issue 1: June 2016  
Part Number: HG33-19A321-AA

# Introduction

Welcome .....	1.2
Warnings, Cautions and Notes .....	1.3
Component Location .....	1.4
Vehicle Identification .....	1.4
Data Recording .....	1.5
Reporting Safety Defects .....	1.5
Vehicle Provenance.....	1.5

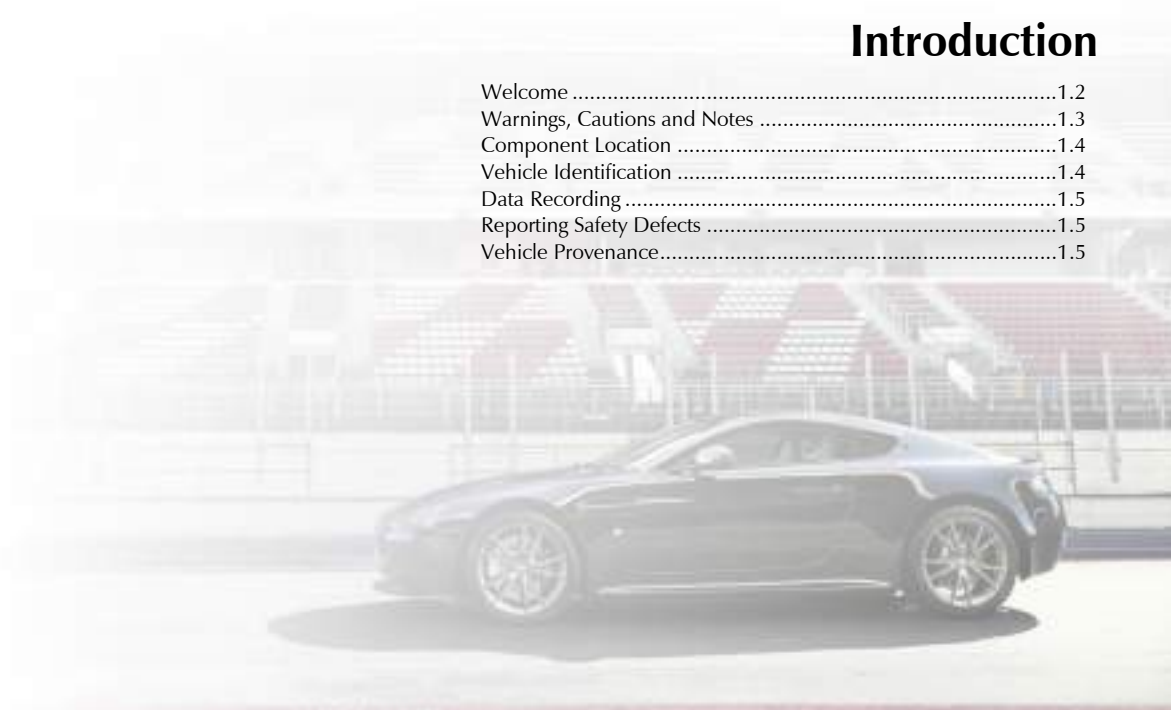

## Welcome

Welcome to your new Aston Martin V8 Vantage.

This Owner's Guide, along with other publications included in your literature pack, provides information which will enhance your pleasure from owning and driving your Aston Martin.

This Owner's Guide has been designed to explain the vehicle's operation and to make the control of its systems easy to understand and operate. All new owners are recommended to carefully study the contents of this Owner's Guide prior to driving.

This Owner's Guide forms part of the essential vehicle equipment for homologation purposes and must stay with the vehicle at all times.

### Aston Martin Franchise Dealers

A full list of Aston Martin Dealers worldwide, where sales and service are provided by companies with the facilities, knowledge and factory trained personnel can be found at:

[www.astonmartin.com](http://www.astonmartin.com)

Every effort is made to make sure that the information given in the dealer list is accurate and up-to-date. However changes amongst holders of the Aston Martin franchise can occur. Neither Aston Martin nor any listed Importer or Dealer shall in any circumstances be held liable for any inaccuracy, or the consequences thereof.

Dealers listed all aim to conform to Aston Martin standards of excellence in both sales and service. However, all vehicles sold as Aston Martins are required to meet local legislation requirements.

Should service be required in a country other than that in which this vehicle was originally purchased, every effort will be made to meet the owner's requirements, but the availability of certain parts may be affected by differences in vehicle and component specifications.

If the nearest Aston Martin Dealer is unable to help, contact Aston Martin directly:

Aston Martin Lagonda Limited

Banbury Road

Gaydon

Warwick

CV35 0DB

England

Telephone:

(+44) (0)1926 644300

Aston Martin Dealers are independent traders, they are not the Company's Agents, and therefore have no authority to bind the Company or to enter into any financial or other commitments on the Company's behalf.

Only Aston Martin Dealers are authorised to carry out warranty work.

---

### Aston Martin Authorised Body Repairers

A full list of Aston Martin Authorised Body Repairers worldwide can be found at:

[www.astonmartin.com](http://www.astonmartin.com)

All Aston Martin Approved Body Repair centres have been assessed and audited to Aston Martin Body Repair Centre standards in either Category A or B.

**Category A:** Repairs to the bonded aluminium structure and all paint related and light structural damage.

**Category B:** All paint related and light structural damage.

Every effort is made to make sure that the information given in the Aston Martin Authorised Body Repairers list is accurate and up-to-date. However changes can occur. Neither Aston Martin nor any Aston Martin Authorised Body Repairer shall in any circumstances be held liable for any inaccuracy, or the consequences thereof.

---

### Aston Martin Authorised Service Centres

A full list of Aston Martin Authorised Service Centres can be found at:  
[www.astonmartin.com](http://www.astonmartin.com)

All Aston Martin Approved Service Centres have been assessed and audited to Aston Martin standards.

Every effort is made to make sure that the information given in the Aston Martin Authorised Service Centres list is accurate and up-to-date. However changes can occur. Neither Aston Martin nor any Aston Martin Authorised Service Centre shall in any circumstances be held liable for any inaccuracy, or the consequences thereof.

---

## Warnings, Cautions and Notes

The following Warnings, Cautions and Notes are used within this Owner's Guide to call your attention to specific types of information.

### Warnings

 **Warning: Provided to show procedures which must be followed precisely to help avoid the risk of personal injury.**

### Cautions

 **Provided to show procedures which must be followed precisely to reduce the possibility of damage to your vehicle.**

### Notes

 *Provided to show procedures which will help to avoid difficulties in the operation of your vehicle.*

## Component Location

All directions for locating components are described as viewed from the driver's seat, i.e. the fuel filler flap shown on this diagram will be described as 'located at the rear left side of the vehicle'.

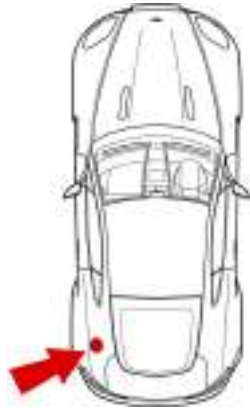

## Vehicle Identification

The Vehicle Identification Number (VIN) is shown in the left side bottom corner of the windscreen.

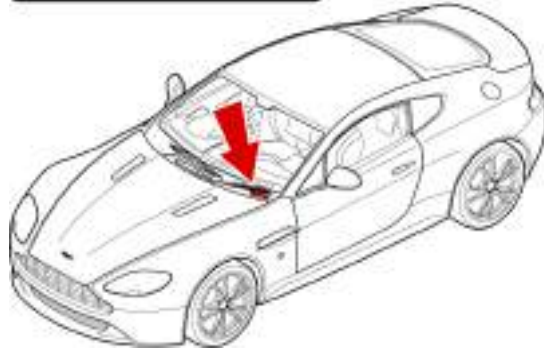

The VIN plate located in the engine bay (viewed from above) is model and market dependent:



The VIN is also stamped into the floorpan in the right side footwell.

 To view the VIN stamped into the floorpan lift the carpet up, from the front, and then lift the sound deadening material.



## Data Recording

---

Electronic modules in this vehicle are able to record detailed data, such as:

- The use of restraint systems, including seat belts by the driver and passengers.
- Information about the performance of various systems and modules in the vehicle.
- Information related to engine, throttle, steering, brake or other system status.

Any of these systems can include information on how the driver operates the vehicle, measuring vehicle speed, steering input, brake and throttle application. This information may be stored under regular operation, in a crash or in a near crash event.

This information can be read and used by:

- Aston Martin
- Service and repair facilities
- Law enforcement or government agencies
- Others who may assert a right or obtain your consent to know such information.

## Reporting Safety Defects

---

If you believe that your vehicle has a safety defect which could cause a crash or could cause injury or death, you should immediately inform your Aston Martin Dealer or the Aston Martin Client Services at the address shown.

Aston Martin Lagonda Limited  
Client Services  
Banbury Road  
Gaydon  
Warwick  
CV35 0DB  
England  
Telephone:  
+44 (0)1926 644700

## Vehicle Provenance

---

**Model:**

---

**Body Colour:**

---

**Interior Colour:**

---

**Fascia Colour:**

---

**Vehicle Identification Number:**

---

As on the VIN plate

---

**First Owner:**

---

Selling Dealer

---

Delivery Date

---

---

**Third Owner:**

---

Selling Dealer

---

Delivery Date

---

---

**Fifth Owner:**

---

Selling Dealer

---

Delivery Date

---

---

**Second Owner:**

---

Selling Dealer

---

Delivery Date

---

---

**Fourth Owner:**

---

Selling Dealer

---

Delivery Date

---

---

**Sixth Owner:**

---

Selling Dealer

---

Delivery Date

---

# Vehicle Security

Introduction .....	2.2	Deadlocking.....	2.11
Aston Martin Tracking .....	2.2	Automatic Lock .....	2.11
Emotion Control Unit.....	2.5	Approach Light.....	2.12
Emergency Key.....	2.6	Homesafe .....	2.12
Unlocking and Opening.....	2.7	Alarm .....	2.12
Locking .....	2.8	Reduced Guard.....	2.13
Master Locks .....	2.8	Immobiliser .....	2.14
Boot Lid .....	2.9	Garage Door Opener .....	2.15



## Introduction

This vehicle is protected by an electronic security system which includes:

- Remote arm and disarm
- Perimeter sensing
- Remote door, boot lid, fuel flap release lock and unlock
- Guard reduction mode
- Alarm siren with battery backup (Only in markets where audible sirens are permitted.)
- Random code encryption to prevent electronic scanning of the vehicle key identity code
- Engine Immobiliser

When the security system is armed, any attempt to forcibly open a door, the boot lid or the bonnet will result in full alarm operation.

## Aston Martin Tracking

The Aston Martin Tracking system is a stolen vehicle tracking system. It uses the latest Global Positioning System (GPS) and Global System for Mobile communications (GSM) technology providing pinpoint accuracy and unparalleled service levels.

The system, which is discretely installed in the vehicle, is an easy-to-use system that provides the following important features:

### **Automatic Driver Recognition**

Alerts the Aston Martin Tracking Secure Operating Centre immediately if your vehicle is stolen, even if the thief has your keys.

### **Engine Start Inhibit**

Activated by the Secure Operating Centre with Police authorisation, to prevent the engine from being restarted.

### **Tamper Alert**

Activated when the system battery is disconnected or discharged, or when the system wiring is cut.

### **Tow-Away Alert**

Triggered when motion is detected with the ignition switched off and the driver card is not present.

### **System Health Check**

Regular automatic self diagnostic check.

### **Transport Mode**

Set by the Secure Operating Centre when the vehicle owner has confirmed the vehicle is being transported. This will prevent false alerts being generated.

### **Vehicle Servicing Mode**

Set by the Secure Operating Centre when the vehicle has been given to the Aston Martin Dealer for maintenance.

### **Theft History**

Minute by minute theft log helps Police secure convictions.

### **Pinpoint GPS Tracking**

Accurate to within 10 metres.

### **International GSM Coverage**

Roaming SIM card gives coverage across more than 180 countries.

---

### European Coverage

Local language Police liaison and stolen vehicle recovery across Europe.

Countries covered by Aston Martin Tracking System:

Albania, Austria, Belarus, Belgium, Bosnia and Herzegovina, Bulgaria, Croatia, Cyprus, Czech Republic, Denmark, Estonia, Finland, France (Monaco), Germany, Greece, Hungary, Ireland, Italy (Vatican City, San Marino), Latvia, Lithuania, Luxembourg, Macedonia, Malta, Montenegro, Netherlands, Norway, Poland, Portugal, Romania, Russia, Serbia, Slovakia, Slovenia, South Africa, Spain (Andorra, Gibraltar), Sweden, Switzerland (Liechtenstein), Turkey, Ukraine and United Kingdom.

### Insurance Accreditation

Conforms to the highest European accreditations for stolen vehicle tracking systems - Thatcham, Incert (formerly Assuralia) and SCM and is approved by major insurers.

### Aston Martin Approved

The only vehicle tracking system approved for all Aston Martin vehicles.

---

### How the System Works

The Aston Martin Tracking system is supplied with two unique driver cards. An authorised driver must have a driver card in their possession when using the vehicle.

 *Do not leave the driver card inside the vehicle or with the vehicle key. It should be kept in a safe place and always separately from your vehicle keys.*

The system automatically arms itself after the vehicle ignition has been switched off for 70 seconds and the driver card is out of range (approximately 3 metres).

The system will automatically disarm itself when the driver card is bought back in range of the vehicle.

If your vehicle is driven approximately 100 metres and the driver card has not been detected, a silent alert is transmitted to the Secure Operating Centre to inform the advisors of a potential unauthorised movement of your vehicle. The advisors then contact you.

To avoid an alert being generated, if the engine has been started and the driver card is not in your possession, switch the ignition off and call the Secure Operating Centre for advice.

The system will additionally:

- Send an alert if your vehicle is lifted or towed away without the keys.
- Send an alert if your vehicle battery is disconnected or discharged.
- Send an alert if the GPS antenna has been disconnected.
- Send a monthly health check message to the Secure Operating Centre to confirm full system functionality.

Please consult your Aston Martin Dealer for details and subscription rates.

---

## If your Vehicle is Stolen

After an alert has been received, the Secure Operating Centre advisors attempt to contact you using the telephone number(s) that you supplied at the time of registration. A minimum of two telephone numbers must be provided at the time of activation of the contract.

The Police are not contacted until the advisors have spoken with you. This is to comply with Police procedures so that Police time is not wasted with false alarms.

Once the theft has been confirmed with you, the advisors will ask you to contact the Police to report the theft and to call the advisor back immediately with a Police incident number. Receipt of an alert does not constitute a confirmed theft, as Police Forces require key holder verification of a theft.

The Secure Operating Centre then liaises with the relevant Police Force to seek to recover your vehicle.

If your vehicle is outside the UK, the Secure Operating Centre work with the Police in their local language across Europe to recover your vehicle quickly.

In order to prevent your vehicle being moved following a theft, the Secure Operating Centre under instruction from the Police, may temporarily prevent the vehicle's engine from restarting.

Once the Police have secured the stolen vehicle, arrangements are made with you for the vehicle to be collected. The Police may require it to be taken to a secure compound for further investigation.

You will be liable for any statutory Police recovery and storage charges, payable directly to the Police.

---

## Additional Information

### False Alarms

To avoid unnecessary alerts, contact the Secure Operation Centre to inform them of any potential false alarm. Excessive false alerts may result in a charge.

### Damage Check

If you are involved in an accident or if your vehicle battery has been disconnected for any reason (for example, body work repair or paint re-spray), you must call Aston Martin Tracking Customer Services so that they can test the system to check that it is still functioning correctly.

## Change of Details

Should any of your personal details change, you must call Aston Martin Tracking Customer Services. For example:

- Changing the registration plate on the vehicle.
- Selling the vehicle.
- Change of address.
- Change of mobile phone number.
- New owner buying a pre-owned vehicle already fitted with Aston Martin Tracking System.

## Contact Details

### Aston Martin Tracking 24 Hour Secure Operating Centre:

0844 239 0035

### Or from abroad:

+44 (0) 208 305 2026

### Aston Martin Tracking Customer Services:

0844 239 0032

(Monday to Friday - 08.30 to 17.30)

### Or from abroad:

0844 239 5404

 *When registering for the Aston Martin Tracking System, you are also provided with all the same details and contact numbers needed if your vehicle is stolen. Keep these details safe and not in the vehicle otherwise you will not be able to refer to it if your vehicle is stolen.*

## Emotion Control Unit

The vehicle is supplied with three vehicle keys (Two Emotion Control Units); a glass key, a spare key and an emergency key.



Keep the spare key in a safe place. Do not leave a vehicle key in the vehicle when unattended.

 *If a vehicle key is lost, contact your Aston Martin Dealer.*

## Vehicle Key Security Functions

**[1] LOCK:** Press and release for one step vehicle locking and to arm the security system. The vehicle will deadlock after 25 seconds.

**[2] UNLOCK:** Press and release for one step vehicle unlocking.

**[3] BOOT OPEN:** Press once to release the boot lid catch (Refer to 'Boot Lid', page 2.9).

**[4] APPROACH LIGHT:** Press to set the front, rear side and interior lamps to ON (Refer to 'Approach Light', page 2.12).



## Emergency Key

In the unlikely event that either the vehicle key fails to operate or the vehicle battery is fully discharged use the emergency key to lock or unlock the vehicle.

 Do not store the emergency key in the vehicle. If the vehicle battery is fully discharged you will need the emergency key to gain access to the vehicle.

Insert the emergency key in the door lock and turn fully towards the front of the vehicle, then release, to centrally lock the vehicle, disable the boot lid and fuel flap release switches. The security system will not arm.

To centrally unlock the vehicle, enable the boot lid and fuel flap release switches, turn fully towards the rear of the vehicle, then release. If the security system was armed, the alarm will start.

To stop the alarm insert the vehicle key (even if the vehicle key has lost all power) into the ignition control and move to position 'II' (ignition ON).



 If the vehicle battery is fully discharged the emergency key will only lock or unlock a door.

 Even if the vehicle key has lost all power it will start the engine if required.

 Memory seats: The front seats and door rear view mirrors will not move to a preset position if the vehicle is unlocked using the emergency key.

 If the emergency key is lost, contact your Aston Martin Dealer.



## Unlocking and Opening

Stand within 5 m of the vehicle, point the vehicle key towards the vehicle and press the **UNLOCK** button. To show that the security system has been disarmed, the direction indicators will flash twice. All vehicle doors will unlock.

Push at point (A) and grab the emerging door release. Pull the door release to open the door.

If a door is opened while driving a warning sound will be heard until the door is closed.

 If preferred you can unlock the driver's door only with the first press of the button and the rest of the vehicle with a second press (Refer to 'Automatic Lock', page 2.11).



 For ease of use at night white LEDs are incorporated into the door handles. An LED will come ON in the door handles when the vehicle is unlocked. A door LED will go OFF once the door is opened. If a door is not opened the LEDs will go OFF after two minutes.

 If the vehicle has been opened using the spare key and the driver seat or door rear view mirrors have been adjusted, the seat and door rear view mirrors will move to the positions memorised by the key which is being used (Refer to 'Seat Memory Function', page 3.7)<sup>1</sup>.

 As the vehicle is unlocked, the interior lamps will come ON for five minutes. The lamps will go OFF 30 seconds after doors are closed or when the vehicle is started.

 If the door is left open the door puddle lamp will go OFF after eight minutes.

<sup>1</sup>. Option: Memory Seats.

## Unlocking From Inside the Vehicle

 **If reduced guard was not set to ON before locking the vehicle, deadlocking, interior movement and tilt sensors (optional) are enabled. Passengers will not be able to unlock a door from the inside.**

If reduced guard or automatic lock was set to ON before the vehicle was locked, one pull of a door handle will centrally unlock the doors, a second pull of the door handle will open that door.

(Refer to 'Automatic Lock', page 2.11).

(Refer to 'Reduced Guard', page 2.13).

Vehicle unlock from inside can be set to automatic unlock when the vehicle key is removed from the ignition control. With automatic unlock ON only one pull of a door handle will open that door.

When opening a door from inside the vehicle after reduced guard has been set to ON, the security system alarm will start. Press the **UNLOCK** button on the vehicle key to stop the alarm (there is approximately a ten second delay before the alarm is stopped).

## Locking

**!** *If passengers are to stay in the vehicle after it has been locked, reduced guard must be set to ON before locking. This will let a passenger open a door from inside the vehicle.*

Make sure that all the doors, the boot lid and the bonnet are closed (the vehicle will not lock if a door is left open). Stand within 5 m of the vehicle, point the vehicle key towards the vehicle and press the **LOCK** button once to lock the doors, disable the boot lid and fuel flap release switches and arm the security system. The direction indicators will flash once as the security system is armed .

The driver's seat and both door rear view mirror positions are memorised and will be recalled the next time the vehicle is opened using the same vehicle key.<sup>1</sup>

**📖** *The security system will arm and the doors will deadlock after 25 seconds.*

**📖** *If the vehicle is locked with the boot lid open, the vehicle will lock and arm but deadlocking, tilt and interior movement sensors (where fitted) will not operate. Close the boot lid to arm the complete security system.*

<sup>1</sup>. Option: Memory Seats.

### Automatic Re-locking

If the vehicle is locked and then unlocked but a door or the boot lid is not opened within two minutes, the vehicle will automatically lock and arm again.

### Lock Light Settings

The vehicle direction indicators can be set to flash when the security system is both armed or disarmed.

To change the vehicle lock light settings:

1. Press the **MENU** button on the console.
2. Navigate to <SYSTEM SETTINGS> **ENTER** <Light settings> **ENTER**.
3. Select from <Lock Confirmation Indication>, or <Unlock Confirmation Indication>.
4. Select *On* or *Off*

## Master Locks

All doors, fuel flap and boot lid release switches may be locked and unlocked by using the master lock switch (A). Press the switch to lock. Press again to unlock.



If the vehicle is locked using the master lock switch, one pull of a door handle will centrally unlock the doors, a second pull of the door handle will open that door.

The master lock switch will operate for seven minutes after the vehicle key has been removed from the ignition control, if the vehicle is not locked using the vehicle key.

The master lock switch will not operate if the vehicle has been locked from the outside.

Operation of the master lock switch will override automatic lock (Refer to 'Automatic Lock', page 2.11).

## Boot Lid

 When the vehicle is unlocked using the master lock switch the LED in each door handle will come ON (for 10 seconds or until the door is opened). This may aid access for passengers at night time.

 In the event of a vehicle accident the doors will automatically unlock.

### To Open the Boot Lid

Press the **BOOT OPEN** button on the vehicle key **once** to enable the release catch, then press the boot lid button (A) and lift the lid.

 If the vehicle is locked and armed the security system will disarm and the direction indicators will flash twice when the boot is opened. The doors will stay locked (Refer to 'Lock Light Settings', page 2.8).



### Opening from Inside the Vehicle

(Coupe Only)

Pull back on the boot lid release switch (B). The boot lid catch will release<sup>1</sup>. Lift the lid.



<sup>1</sup> The boot lid release switch becomes the roof raise and lower switch on the Roadster.

## To Close the Boot Lid

Pull the boot lid down, then push the boot lid down and make sure that its catch engages. Once the catch engages, it automatically closes. If the boot lid is slammed shut, this is overridden. Press the **LOCK** button on the vehicle key to lock the lid. The direction indicators will flash once as the security system is armed (Refer to 'Lock Light Settings', page 2.8).

 Always make sure that the boot lid is securely closed after use. The boot interior lamps will stay ON for seven minutes if the boot lid is left partially open and the vehicle key is removed from the ignition control.

## Vehicle Locked - Boot Lid Open

 **Do not leave the vehicle key in the boot. If the boot lid is closed there will be no access to the contents of the boot.**

 To use a battery conditioner the boot lid has to be left open (boot lid down but not latched).

If the vehicle is locked while the boot lid is open, the vehicle will lock and arm (deadlocking, tilt and interior movement sensors<sup>1</sup> will not operate). If the boot lid is then closed (latched) deadlocking, tilt and interior movement sensors will operate and the whole vehicle will be locked and armed.

---

<sup>1</sup>. Option.

## Boot Lid Emergency Open

The boot lid can be opened from inside the boot by pulling the luminous emergency release handle (C).



## Deadlocking

 **If passengers are to stay in the vehicle after locking, reduced guard must be ON before locking.**

The vehicle will automatically deadlock after 25 seconds after arming the security system. When the vehicle is deadlocked, the doors cannot be opened from the inside by pulling the interior door handle.

To open the doors use the vehicle key.

## Automatic Lock

When automatic lock is set to ON the doors and the boot lid will automatically lock as vehicle speed reaches 7 km/h. This function prevents unwanted access to the vehicle when stopped at traffic lights, etc.

To change the automatic lock feature:

1. Press the **MENU** button on the console.
2. Navigate to <SYSTEM SETTINGS> **ENTER** <Lock settings> **ENTER**.
3. Select <Doors auto lock>, <Unlock on key out> or <Doors Unlock>. Press **ENTER** to toggle between ON and OFF.

### <Doors auto lock>

Set to ON: Doors and the boot lid automatically lock when the vehicle moves off.

Set to OFF: Doors and the boot lid will not lock when the vehicle moves off.

### <Unlock on key out>

Set to ON: Doors and the boot lid automatically lock when the vehicle moves off.

Set to OFF: Doors and the boot lid will not lock when the vehicle moves off.

### <Doors unlock>

Select from <All doors> or <Driver door, then all> settings.

- <All doors>

Set to ON: All doors and the boot lid automatically lock when the vehicle moves off.

Set to OFF: All doors and the boot lid will not lock when the vehicle moves off.

- <Driver door, then all>

Set to ON: The driver door automatically locks first, then the passenger door and boot lid will lock.

Set to OFF: All doors and the boot lid will not lock when the vehicle moves off.

Press and hold **BACK** to accept and return to the main screen.

 *Automatic lock is factory set to ON.*

 *In the event of a vehicle accident all doors will automatically unlock.*

## Approach Light

When approaching the vehicle the side and interior lamps can be set to ON by pressing the **APPROACH LIGHT** button on the vehicle key.

To change the approach light duration:

1. Press the **MENU** button on the console.
2. Navigate to <SYSTEM SETTINGS> **ENTER** <Light settings> **ENTER** <Approach light duration> **ENTER**.
3. Select from <30 seconds>, <60 seconds> or <90 seconds> duration.

## Homesafe

When exiting the vehicle and the vehicle key has been removed from the ignition control, flash the main beam (pull the left side stalk up and release without latching) to set homesafe ON. The main beam and rear lamps will then stay ON for a determined amount of time and then go OFF.

To change the homesafe light duration:

1. Press the **MENU** button on the console
2. Navigate to <SYSTEM SETTINGS> **ENTER** <Light settings> **ENTER** <Homesafe light duration> **ENTER**.
3. Select from <30 seconds>, <60 seconds> or <90 seconds> duration.

## Alarm

When the alarm has started a siren will be heard for a 25 seconds cycle (ten cycles maximum) and the direction indicators flash for five minutes after which the security system returns to the armed state. The doors and boot lid will stay locked throughout.

 *Markets where visible alarm signals and audible sirens are permitted.*

Stop the alarm at any time by pressing the **UNLOCK** button on the vehicle key or by inserting the vehicle key into the ignition control (position 'II'). There is approximately a ten second delay before the alarm is stopped).

 *Insert the key to position 'II' by using the flat of a finger, as shown.*



## Reduced Guard

### Interior Movement Sensor

Optional

When the vehicle is locked and armed the interior movement sensor will sense movement inside the vehicle. If movement is detected it will start the alarm.

### Tilt Sensor

Optional

When the vehicle is locked and armed the tilt sensor will sense if the vehicle is tilted, for example, if the vehicle is being raised on a jack. If vehicle tilt is detected it will start the alarm.

 **Warning: If a passenger is to stay in the vehicle after it has been locked, reduced guard must be set to ON before locking. In an emergency this will let a passenger open a door from inside the vehicle.**

When reduced guard is ON, deadlocking, interior movement and tilt sensors<sup>1</sup> are set to OFF. This will let a passenger open a door from the inside by pulling the interior door handle and a passenger or animals to be left in the vehicle with the security system armed.

If a door is opened from the inside, while reduced guard is ON, the security system alarm will start. Press the **UNLOCK** button on the vehicle key to stop the alarm at any time.

To set reduced guard:

1. Press the **MENU** button on the console.
2. Navigate to <SYSTEM SETTINGS> **ENTER** <Reduced guard> **ENTER**.
3. Press **ENTER** to select toggle between ON and OFF.
4. Then press and hold the **BACK** button on the console to accept and return to the main screen.

 *Reduced guard stays ON until the vehicle key is inserted in the ignition control and moved to position 'II' (ignition ON).*

---

<sup>1</sup>. Where installed

## Immobiliser

 If a vehicle key is lost, a duplicate key can be created and programmed from the spare key by your Aston Martin Dealer.

### Starting the Engine

When the security system is disarmed and the vehicle key is in the ignition control, the immobiliser sends a signal to the vehicle key. The vehicle key must respond with a valid code before engine start will be enabled. If a valid code is received, the ignition system will operate normally. If the vehicle key code is not received, or is invalid, engine start stays disabled.

### Immobiliser Status

The immobiliser system state is shown by the red symbol (A) on the instrument cluster.



Ignition	Action (Valid code)
ON	Symbol comes ON for three seconds.
OFF	Symbol will flash.
OFF and the vehicle key removed from the ignition control	Symbol will flash for five minutes or one minute after the vehicle is locked using the vehicle key.

### Fault Mode

If the status symbol continues flashing when the ignition is set to ON, the vehicle will stay immobilised.

Should this situation arise try removing and then inserting the vehicle key back to position 'II' in the ignition control. If this is unsuccessful try the spare key. If successful, get a replacement for the faulty vehicle key. If problems continue with the vehicle key, consult your Aston Martin Dealer.



## Garage Door Opener

(Option: Available with automatic dim mirror only.)

The garage door opener (HomeLink® Universal Transceiver) buttons and transceiver are on the rear view mirror. The transceiver can be programmed to operate up to three transmitters to operate garage doors, entry gates, home lights, security systems, or other radio frequency operated devices.

**⚠ As a security precaution make sure that all programming is erased in the HomeLink system before selling this vehicle.**

For information or assistance, contact HomeLink at [www.homelink.com](http://www.homelink.com) or call the HomeLink hot-line:

Toll-free: (0) 0800 046 635 465

or alternatively: +49 6838 907 277 (subject to charge)

(Difficulties may be experienced trying to reach the toll-free number by some providers in certain countries .)

Alternatively, contact your Aston Martin Dealer.

**📖** A full list of radio frequency operated devices can be either obtained via the HomeLink Hot-line or through the HomeLink compatibility list which is provided on the HomeLink website.

**⚠ Warning: Do not use the transceiver with any garage door opening system that lacks the safety stop and reverse feature as required by safety standards. A garage door opening system which cannot detect an object, signalling the door to stop and reverse increases risk of serious injury or death.**

**⚠ Warning: When the transceiver is being programmed to a garage door opening system, make sure that people, the vehicle and objects are clear to prevent injury or damage as the garage door or gate will operate during the programming.**

**📖** Keep the original transmitter for future use or programming procedures if, for example, you purchase a new vehicle.

**📖** This device may suffer from interference if operated near to a mobile or fixed station transmitter. This interference can affect the hand-held transmitter as well as the in-vehicle transceiver.

**📖** The manufacturer is not responsible for any radio or TV interference caused by unauthorised modifications to this equipment. Such modifications could void the user's authority to operate the equipment.

## Programming

**📖** Step 1 erases all programming and is only necessary if programming HomeLink for the first time or when erasing all existing programming. It does not have to be followed to program the other HomeLink buttons.

**📖** The HomeLink buttons can be reprogrammed individually but not individually erased. Step 1 must be completed to erase all programming.

1. Press and hold the two outer HomeLink buttons, until the HomeLink LED (A) begins to flash after 20 seconds. All three buttons are now cleared. The HomeLink system is now in setting mode.
2. Hold the remote control for the device to be programmed at a distance of 10-30 cm away from the HomeLink transmitter unit. The LED should be kept in view.



 The distance between the remote control and the transmitter unit depends on the system being programmed and several attempts at different distances may be necessary.

3. Simultaneously push the remote control button and the desired button (1, 2 or 3).
4. Using both hands, simultaneously push the remote control button and the desired button (1, 2 or 3).
5. The LED will flash, first slowly and then rapidly to show successful programming of the new frequency signal. When the LED flashes rapidly, release both buttons.



## Operation

The vehicle should be within the operating range of the gate or garage door opener and the ignition should be ON.

The HomeLink system operates the garage door opener (or other device) in the same way as the original remote control.

With the system programmed, press the appropriate HomeLink button (1, 2, or 3) to operate the garage door opener.

The LED will come ON when the button on when a HomeLink button is pressed.

 The original remote control may also be used at any time.

The LED will stay ON while the garage door opener (or other device) operates. If it does not, your system may have a rolling code feature.



## Rolling Code Synchronisation

To check if the garage door opener (or other device) has a rolling code feature:

- Check the garage door opener manual.
- The remote control programs the HomeLink system, but HomeLink buttons do not operate the garage door opener.
- Press and hold down the programmed HomeLink button. For a rolling code system, the LED flashes quickly and then stays ON constantly for two seconds. This pattern repeats itself for up to 20 seconds.

To programme a rolling code system, it must be synchronised with this system again before it will function correctly.

To synchronise for a rolling code:

1. Locate the training or programming button on the motor head unit for the garage door opener. Refer to the operating instructions of the garage door opener.
2. Press the training button on the motor head unit for the garage door opener. This will usually set a 'training' LED to ON.

---

 *There will typically be a 30 second window in which to initiate step 3.*

3. Press and release the programmed HomeLink button. Press and release the HomeLink button a second time to complete synchronisation.

 *Some systems may require this procedure to be completed a third time.*

The garage door opener should now recognise the rolling code signal and operate when the HomeLink button is pressed.

The next two buttons may now be programmed if this has not previously been done.

---

## Reprogramming

To programme a HomeLink button to a new device:

1. Press and hold the desired HomeLink button (1, 2, or 3) for 20 seconds until the LED starts flashing slowly. Do not release the button until step 4 has been completed.
2. Hold the remote control for the device to be programmed at a distance of 10-30 cm away from the HomeLink transmitter unit. The LED should be kept in view.
3. Now press and hold the remote control button.
4. The LED will flash, first slowly and then rapidly to show successful programming of the new frequency signal. When the LED flashes rapidly, release both buttons.



ASTON MARTIN



ASTON MARTIN



ASTON MARTIN



ASTON MARTIN

## Before Driving

Checks Before Driving.....	3.2	Airbags.....	3.15
Seat Adjustment.....	3.2	Child Safety.....	3.17
Sport Seat.....	3.3	Passenger Airbag Deactivation.....	3.18
Lightweight Seat.....	3.5	ISOFIX Anchors.....	3.19
Seat Memory Function.....	3.7	Tether Anchors.....	3.20
Steering Wheel.....	3.8	Automatic Locking Retractors.....	3.21
Electric Windows.....	3.8	Child Seats.....	3.22
Interior Mirrors.....	3.9	Cabin Storage.....	3.26
Door Mirrors.....	3.10	Boot Cover.....	3.29
Restraints System.....	3.11	Accessory Sockets.....	3.30
Seat Belts.....	3.12	Ashtray and Cigar Lighter.....	3.31

## Checks Before Driving

Inspect your vehicle to make sure that everything is according to the information and specifications in this Owner's Guide.

### Outside the Vehicle:

- Visually check the road wheels, nuts and tyres.
- Check that all windows, mirrors and lamps are clear and unobstructed.
- Check that the boot lid, bonnet and fuel filler flap are securely closed.
- Check the operation of all lamps.

### Once Inside the Vehicle:

- Check that the doors are securely closed.
- Check that the seat, mirrors and steering wheel adjustments are correct.
- Check that all gauges and symbols are reading correctly.
- Check that all passengers have fastened their seat belts.

## Seat Adjustment

 **Warning: Do not attempt to adjust the drivers seat whilst driving.**

 **The vehicle key must only be inserted into the ignition control with the two indents first, as shown. To insert the larger end first the key may damage the ignition control.**



The seats can be adjusted while the vehicle key is in the ignition control. Gently insert the vehicle key up to position '1' (press down until the instrument cluster and infotainment centre lights come ON) and release.

They can also be adjusted:

- Up to six minutes after a door is unlocked and before the vehicle key is inserted into the ignition control.
- Up to six minutes after the vehicle key is removed from the ignition control.

If the seat operation times out:

- Place the vehicle key in the ignition control.
- Close or open a door.

The seat adjustment controls are located each side of the centre console (A).



## Sport Seat

### Seat Head Restraints

The driver and front passenger seats include non-adjustable head restraints (A), which limit the rearward travel of the head in a rear impact and may reduce whip lash injuries. When sitting in the seats make sure that the seat back is in an upright position and that the rear of the head is positioned in the centre of the head restraint area. The head restraints are most effective when the distance between the rear of the head and the head restraint is kept to a minimum.



### Seat Adjustment

 *Memory Seats: When making seat adjustments, i.e. moving the seat base rearwards, raising or lowering the seat base, the seat back will motor forwards whenever it approaches trim panels located behind it. If the seat back is tilted backwards the seat base will move forwards if the seat back approaches trim panels.*

### Height Adjust Seat

#### Driver's Seat and Passenger Seat



**[1]** : Raise or lower the **front** of the seat.

**[2]** : Move the seat **forwards** or **rearwards**.

**[3]** : Raise or lower the **rear** of the seat.

**[4]** : Increase or decrease the **angle of the seat back**.

 *The ignition must be ON before the lumbar support can be operated.*

### Non Height Adjust Seat

#### Passenger Seat with ISOFIX (Optional)



[1] : Move the seat **forwards** or **rearwards**.

[2] : Increase or decrease the **angle of the seat back**.

### Temperature and Lumbar Support



 The ignition must be **ON** before the lumbar support can be operated.

[1] : Press forwards or rearwards to increase or reduce the **lower lumbar support**.

[2] : Press forwards or rearwards to increase or reduce the **upper lumbar support**.

[3] : Press to the rear for the **lower** heat setting, press to the front for the **higher** heat setting. A LED shows which heat level is ON. Press to the centre position for OFF (LEDs OFF).<sup>1</sup>

<sup>1</sup>. Optional.



## Lightweight Seat

### Seat Back Release

Press and hold in button A to release the seat back, once the seat has been moved forward release the button and manually move the seat back forwards.



 In the unlikely event of power failure, a manual release strap is provided in the seat back. Pull and hold the strap to release the seat back and then move the seat back forward.



### Driver's Seat and Passenger Seat (Optional)



[1] : Raise or lower the **front** of the seat.

[2] : Move the seat **forwards** or **rearwards**.

[3] : Raise or lower the **rear** of the seat.

[4] : Increase or decrease the **angle of the seat back**.

## Easy Access

**Warning:** Make sure that no person is sitting in the seat while Easy Access is being used. Forward movement will continue further than normal seat forward movement.

Easy Access allows the seat to be moved forward, to provide greater access to the rear environment. Each seat has an Easy Access button located on each end of the dashboard. To move a seat press and hold the button (on the first press the seat will move forward). Movement will continue until the button is released.

If the button is released and pressed again within three seconds, movement will continue in the same direction. If the button is released and pressed again after four seconds the seat will start to move in the opposite direction. When moving rearwards the seat will return to its original position while the button stays pressed.

Locking the vehicle with a double press (vehicle key) will also return the seat to its driving position.



## Lumbar Support

Two adjustable lumbar pads are located in the seat back.

To adjust the lumbar pad position:

1. Grab the top of the seat back panel (A) and pull away from the seat.



2. Locate the lumbar pads (B). Pull them from their Velcro fixings and place into a new position as required.



**Warning:** Avoid placing the lumbar pads on the strip of Velcro which secures the seat back panel (C).

3. Install the seat back trim (D).
4. Repeat as required to find the correct lumbar support position.



## Seat Memory Function

(Optional)

**Warning:** Make sure that there is nothing in front of, behind, or under the seat during adjustment.

**Warning:** To avoid injury, make sure that children do not play with the switches.

**Warning:** If the seat accidentally begins to move, press any seat control button to stop the seat.

The position of the driver and passenger seats can be memorised and recalled.

Three different driving position profiles can be entered in the memory. The memory position of the driver's seat also includes both door rear view mirrors.

The memory function buttons are located in the seat adjustment controls which are located each side of the centre console (A).



### Setting a Preset Position

**Warning:** Do not attempt to adjust the seat whilst driving.

Adjust the seat and the door rear view mirrors to the desired position. The mirror memory operates only when adjusting the driver's seat. For mirror adjustment, (Refer to 'Door Mirrors', page 3.10).

Push both the memory button (M) and the desired setting button (1, 2 or 3) simultaneously and release. A chime is heard and a message will show in the message centre to confirm<sup>1</sup>. By repeating these steps and pressing an unused button, a second and third driving position can be stored in the memory.



<sup>1</sup>. Driver's seat only.

**Warning:** When making adjustments to a set driving position, reset the new position in the same memory channel. The previous memory is erased when a new driving position is entered.

### Recalling a Memorised Position

Once in the seat press and hold button 1, 2 or 3 (depending on which position required) until all movement is stopped. The seat and door mirrors (when adjusting the driver's seat) move to the programmed position. If the button is released all movement will stop, press and hold again to continue movement.

### Memory Using the Emotion Control Unit

When the vehicle is locked using the Emotion Control Unit (ECU), the driver's seat and both door rear view mirrors will remember their positions. The next time the vehicle is opened using the same ECU, the seat and door rear view mirrors will move to the memorised position once the door handle is used.

 *The seat and door rear view mirrors only move if they have been moved previously, i.e. the spare ECU has been used and the seats or mirrors have been moved.*

### Emergency Stop

If the seat accidentally begins to move, press any seat control button to stop the seat.

## Steering Wheel

 **Warning:** Do not adjust steering wheel whilst driving.

 **Warning:** Make sure that the steering column is fully locked in position. The reach and tilt release lever must be fully up, in line with the steering column.

### Reach and Tilt

The reach and tilt angle of the steering wheel are adjusted by using the release lever (A). Pull the release lever downwards and manoeuvre the steering wheel to the required position. Hold the steering wheel in the required position and lock it by pulling the release lever up.



## Electric Windows

 **Warning:** Misuse of the window switches, especially by children, can result in injury due to entrapment in the window closure. Drivers must advise all passengers of the possible danger and make sure that all obstructions are clear before raising the window.

 *The windows can be operated up to one minute after the vehicle key is removed from the ignition control.*

Each vehicle door has its own window switch and the drivers door window switch can operate both windows.

To raise and lower the windows the vehicle key must be at ignition position 'I' or 'II'.

Lightly press and hold the window switch (A) to lower the window in one movement. Lightly press and release the window switch to lower the window in stages.

Lightly pull back the window switch to raise the window.

If power to the electric windows has been interrupted for any reason, they will fail to operate correctly until reset (Refer to 'Door Window Reset', page 12.28).



## Door Sealing

 **Warning:** Make sure that all passengers are clear when the window mechanism is operating.

To minimise wind noise and to make sure that the window seal is watertight a door sealing system is used to provide a tight fit of the door glass to the seals around the top of the door opening.

When a door is opened, the window automatically lowers a small distance to clear the door seal. As the door is closed, the window automatically, after a pause, lifts against the body frame rubber seals.

## Interior Mirrors

### Rear View Mirror

#### Manual Dip

Adjust the rear view mirror on its ball mounting until a satisfactory rear view is obtained.

To avoid dazzle from headlamps of following vehicles use the dip lever to raise or lower the mirror.



### Automatic Dim

Optional

Adjust the mirror on its ball mounting until a satisfactory rear view is obtained.

The rear view mirror will dim automatically if the glare from the headlamps of following vehicles becomes too bright. The mirror will return to normal view as unwanted glare reduces to an acceptable level. If the mirror is dimmed when reverse gear is selected the mirror will revert to normal view.

### Vanity Mirror

A vanity mirror is located in each sun visor.



## Door Mirrors

To adjust the door mirrors select the left or right mirror (B). Then move the joystick (A) up, down, left or right to adjust the selected mirror.

 *The vehicle key must be at position 'I' or 'II' in the ignition control before the door mirrors can be adjusted.*

 *An amber LED shows the selected mirror.*

### Heated Mirrors

When the heated rear window is ON the heaters in the door mirrors will operate for 6.5 minutes.



### Power Fold Function

When the vehicle is locked using the vehicle key or master lock switch the mirrors will automatically fold in flat against the doors. They return to the driving position once the vehicle is unlocked.

This function can be enabled or disabled. Press **MENU** on the console. Navigate to <SYSTEM SETTINGS> **ENTER** <Mirror settings> **ENTER** <Powerfold mirrors>. Press **ENTER** to toggle between ON and OFF, then press and hold **BACK** to accept and return to the main screen.

### Manual Fold Function

To manually fold or unfold the door mirrors:

Insert the vehicle key to position 'I' or 'II' in the ignition control. Move the mirrors to the folded or unfolded position by pressing down and releasing both the left and right mirror select switches (B) together.

 **If the mirrors are manually folded they will remain folded on unlock until 10kmph (6 mph) is reached.**

 *Door mirror vibration can occur if the mirrors have been moved manually (folded or unfolded), either intentionally or accidentally. To reset the linkage manually, operate the door mirrors once to fold or unfold the mirrors.*

## Reverse Dip Function

(Optional)

This function gives a better view to the rear of the vehicle while reversing.

When reverse gear is selected:

**Automatic Mode:** When reverse gear is selected the door mirrors automatically move to the first preset dip position. If the mirror requires further lowering, press down and release the mirror joystick (A) again. If the mirror is lowered too far, press the mirror joystick up and release.

**Manual Mode:** Press down and release the mirror joystick (A). This will lower the door mirrors to preset position 1 dip. If the mirror requires further lowering, press down and release the joystick again. If the mirror is lowered too far, press the mirror joystick up and release.

In manual or automatic mode the mirrors return to driving view when reverse gear is de-selected or when either mirror button (B) is pressed.

## Reverse Mirror Dip Settings

1. Press **MENU** on the console.
2. Navigate to <SYSTEM SETTINGS> **ENTER** <Mirror settings> **ENTER** <Reverse mirror dip>.
3. Select <Passenger and driver>, <Passenger only> or <Off>.  
If set to <Passenger and driver>: Both door mirrors dip automatically when reverse gear is selected.  
If set to <Passenger only>: Only the passenger door mirror dips when reverse gear is selected.  
If set to <Off>: The door mirrors stay in manual mode.
4. Then press and hold **BACK** to accept and return to the main screen.

## Restraints System

The restraints system gives protection to the driver and passenger in a variety of impact conditions. The system consists of:

- Driver and passenger safety belts with pre-tensioners and load limiting systems
- Driver and passenger dual-stage airbags
- Driver and passenger seat side airbags (sport seats only)
- Front Passenger Airbag Deactivation (PAD) switch
- Deployable rollbar (Roadster only).

All of these systems are controlled by a Restraints Control Module (RCM). In a collision the RCM will analyse information from various sensors, including crash and seat occupancy conditions. Based on this information the RCM will deploy the appropriate safety devices. During a crash, the RCM may or may not operate the safety belt pre-tensioner(s) and none, one, or both stages of the dual-stage airbag supplemental restraints.

If the pre-tensioners or airbags do not operate in a collision it does not mean that something is wrong with the system. Rather, it means the system determined the accident conditions (crash severity, belt usage, etc.) were not appropriate to operate these safety devices.

## Seat Belts

Front airbags are designed to operate only in frontal and near-frontal collisions, not rollovers, side-impacts, or rear-impacts unless the collision causes sufficient longitudinal deceleration.

### Determining if the System is Operational

A warning symbol in the instrument cluster  shows the condition of the system. A difficulty with the system is shown by one or more of the following:

- The warning symbol will flash or stay ON.
- The warning symbol does not come ON immediately after the ignition is set to ON.

If either of these conditions occur, even intermittently, have the restraint system serviced at your Aston Martin Dealer immediately. Unless serviced, the system may not operate correctly in the event of a collision.

Aston Martin strongly recommend the use of seat belts.

 **Warning: Seat belts should not be worn with straps twisted.**

 **Warning: Each belt assembly must only be used by one occupant; it is dangerous to put a belt around a child being carried on the passengers lap. Do not put an adult seat belt around two children.**

 **Warning: When installed, the seat belt webbing must not contact any sharp edges which could abrade or cut the webbing during normal use or in an accident. If necessary, the webbing must be protected.**

 **Warning: Care should be taken to avoid contamination of the webbing with polishes, oils and chemicals, and particularly battery acid. Cleaning may safely be carried out using mild soap and water. The belt should be replaced if webbing becomes frayed, contaminated or damaged.**

 **Warning: Wearing your seat belt is crucial to your safety. Not wearing a seat belt increases chance of serious injury or death in the event of an accident.**

 **Warning: Be sure that you and your passenger always fasten their seat belts and use them correctly even though airbags are provided.**

 **Warning: Reclining the seat back decreases protection provided by the seat belt in the event of a crash. Adjust the seat back to an upright position. Make sure that the seat back is locked in place. Otherwise it could move forward in the event of a sudden stop or crash and cause injury.**

 **Warning: Seat belts are designed to bear upon the bony structure of the body, and should be worn low across the front of the pelvis, chest and shoulders; wearing the lap section of the belt across the abdominal area must be avoided.**

 **Warning: Never place the shoulder portion of belt under your arm or behind your back.**

 **Warning: Always remove rigid or breakable objects i.e. spectacles or a mobile phone, from your pockets. These items could be trapped under seat belts, possibly causing injury in the event of an accident.**



 **Warning:** Expectant mothers should seek medical advice on the most appropriate way to wear the seat belt.

 **Warning:** Seat belts must be kept clean so that the retractor works correctly. Make sure that belt webbing is not twisted, looped, frayed or obstructed in any way. If in doubt about condition or operation of seat belt installation, have it checked by your Aston Martin Dealer.

 **Warning:** No modifications or additions should be made by the user which will either prevent seat belt adjusting devices from operating, or prevent seat belt assembly from being adjusted to remove slack. Never install accessories on your seat belts.

 **Warning:** Seat belts should be adjusted as firmly as possible, consistent with comfort, to provide the protection for which they have been designed. A slack belt will greatly reduce the protection afforded to the wearer.

 **Warning:** It is essential to replace the entire seat belt assembly after it has been worn in a severe impact even if damage to the seat belt assembly is not obvious.

## Pre-tensioner and Load Limiting

All seat belts are equipped with pre-tensioner and load limiting systems.

In most moderate frontal or near frontal accidents, the front airbag and all pre-tensioner systems will deploy simultaneously.

The pre-tensioners take up slack in the seat belts as the airbags are expanding. The load limiting system releases belt webbing in a controlled manner to reduce belt force on the passenger's chest.

 *In some moderate frontal or near frontal accidents, only the pre-tensioner system will deploy.*

## Seat Belt Reminder

 A warning symbol in the instrument cluster will come ON and warning sound will be heard for six seconds (approximately) when the ignition is set to ON if the driver or passenger<sup>1</sup> seat belt is not fastened. (Market area dependent.)

If the driver seat belt is not fastened after 60 seconds or if the vehicle has reached a speed of 25 km/h, a warning sound will be heard for 30 seconds, after which the warning sound will go ON and OFF and the warning symbol will continue to show until the seat belt is fastened.

The warning messages are always available, press the **READ** button to view stored messages.

<sup>1</sup>. If a passenger is sitting in the passenger seat.

## Seat Belt Fastening

 When parked on an incline, the seat belt may lock as it is withdrawn. This is not a fault. If the mechanism locks, release the belt tension and then pull the belt very gently to avoid operation of the inertia lock.

Each seat has three point, inertia reel seat belts installed. Items (1), (2) and (3) show the three points of the seat belt. Item (3) is also the location of the belt buckle.

The inertia belt reels will automatically tension the belts to provide security with comfort. In the event of a collision or during severe braking, the belt reels will lock.

Pull out the seat belt, drawing the tongue over the shoulder and across the chest.



Push the tongue into the belt buckle until a positive click is heard.

Pull upwards on the diagonal belt to make sure that the latching is secure and to remove all slack from the belt.

Finally, double check that the lap belt is installed snugly, low down across the hips, and that there are no twists.

If it is necessary for a passenger to adjust their seat or seating position during a journey, the belt tension might be disturbed.



The passenger should therefore (as soon as it is safe to do so) gently pull down the shoulder run of the seat belt to create some slack and then immediately release it to re-tension the belt for the new seating position.



## Seat Belt Unfastening

Push the button on the buckle. While holding the seat belt tongue allow the belt to slowly retract to its stored position.



## Airbags

### Child Seat Belt Fastening

**⚠ Warning: An infant or child that is not correctly restrained can be seriously injured or killed in a crash. Seat belts are designed for adults and larger children; infants and smaller children must be restrained in an approved child safety seat.**

Make sure that there is no slack in the webbing and that the restraint installs correctly across the child's rib cage and hips. These are the parts of the body most able to take the force of impact.

The lap strap should pass across the top of the child's thighs, bearing on the pelvis, not on the abdominal area.

### Supplemental Restraints System

The vehicle is equipped with driver and passenger airbags. The airbags and seat belt pre-tensioners are electrically controlled by the restraints system.



The front airbags (A) only deploy in a serious front collision. The side airbags<sup>1</sup>, located in the front seats (B) only deploy according to which side has been impacted in a serious side collision.

The purpose of the airbags is to provide **additional** protection for the driver and passengers in the event of a serious impact (front or side impacts). The airbags are supplementary to the seat belts.

Important airbag safety labels are located on the sun visors and on the end of the instrument panel (passenger side). Make sure that the instructions on these labels are read and complied with before driving the vehicle.



<sup>1</sup>. Sport Seat Only.

## Airbag Deployment

**⚠ Warning:** *The use of accessory seat covers may prevent the deployment of the side airbags and increase the risk of injury in an accident. Do not use accessory seat covers.*

*(Sport seat only)*

**⚠ Warning:** *All passengers, including the driver, should always wear seat belts, whether or not an airbag is provided, to decrease the risk of injury or death in the event of a crash.*

**⚠ Warning:** *No objects whatsoever should be attached to the centre cover of the steering wheel or the front passenger fascia panel. Such objects could cause harm if the vehicle is in a collision severe enough to cause the airbags to deploy.*

Airbags inflate rapidly and with considerable force; there is therefore a risk of death or serious injury such as fractures, facial and eye injuries or internal injuries, particularly to passengers who are not correctly restrained by seat belts or are not sitting correctly when the airbags deploy. The risk of injury from a deploying airbag is greatest close to the trim panel covering the airbag.

The whole sequence of events from sensing the impact to full inflation of the airbag takes place in a fraction of a second. The noise and gas associated with the deployment of the airbags is not injurious to health.

Do not change, modify or tamper with the steering wheel, passenger side fascia or any other part of the airbag system. Such actions could disable the system or cause inadvertent airbag deployment.

The system will not deploy in the event of minor frontal or side impacts, such as contacts when parking.

The airbag system is not designed to protect against rear impacts.

All work on the airbag system must only be carried out by an Aston Martin Dealer.

**[A]** : Front airbag deployment

**[B]** : Seat side airbag deployment<sup>1</sup>





<sup>1</sup> Sport seats only.

## Child Safety

Aston Martin strongly recommends:

- Always use ISOFIX anchors where available.
- A child, regardless of age, should always be restrained when travelling in a vehicle.

 **Warning:** Do not allow children to travel in a vehicle without being correctly restrained. An appropriate child seat or harness should always be used.

 **Warning:** Each seat belt assembly must be used by only one passenger. It is dangerous to put a seat belt around a child being carried on the passengers lap.

 **Warning:** Make sure that an installed child seat does not rest against the door, that the child sits correctly in the seat and does not lean close to, or against, the door or window.

Your vehicle has the following devices for the installation of child restraints:

- Passenger Airbag Deactivation (PAD) switch
- ISOFIX anchors (Sport seat only: No height adjust)<sup>1</sup>
- Passenger seats Automatic Locking Retractor (ALR) seat belts
- Tether anchor points (Sport seat only: No height adjust.)

---

<sup>1</sup> Standard for installing child seats into cars and is intended to make the installation of child seats quick and simple.

## Child Seats and Front Passenger Airbag

 **Warning:** Do not place a child restraint on a seat with an active airbag.

 **Warning:** With the exception of installing a child seat on the front passenger seat, do not set the PAD switch to OFF, as the front passenger will not receive the added protection of the airbag. Serious injuries or even death could occur.

In the event of a serious frontal or side collision the vehicle airbag system is designed to deploy, to provide additional protection for the front seat occupants.

 The PAD switch does not set the front passenger side impact airbags or the seat belt pre-tensioners to OFF.

### Lightweight Seat

Aston Martin strongly recommends not to install any child seat on the passenger seat of this vehicle.

If a forward facing child seat is to be used in the passenger seat, follow the child seat manufacturer's instructions to secure the child seat and move the front passenger seat to its rearmost and lowest position.

If a child seat is to be used in the front passenger seat, the front passenger airbag **must** be set to OFF. Make sure that the child seat manufacturer's installation instructions are followed correctly.

### Sport Seat

**Warning:** With the exception of installing a child seat on the front passenger seat, do not set the PAD switch to OFF, as the front passenger will not receive the added protection of the airbag. Serious injuries or even death could occur.

**Warning:** Never place a child in a child seat or on a booster cushion on the front passenger seat if the airbag is set to ON.

If a child seat is to be used in the front passenger seat, the front passenger airbag **must** be set to OFF. Make sure that the child seat manufacturer's installation instructions are followed correctly.

### Warning Labels

**Warning:** Extreme Hazard: NEVER use a rearward facing child restraint on a seat protected by an ACTIVE AIRBAG in front of it. DEATH or SERIOUS INJURY to the Child can occur.

The following warning labels (market area dependent) are located on both sides of the sun visor and on the end of the instrument panel (passenger side).



### Passenger Airbag Deactivation

**Warning:** Before installing a child seat on the passenger seat, the passenger airbag must be set to OFF.

**Warning:** Before driving always confirm that the PAD switch is in the appropriate position according to your requirements.

**Warning:** With the exception of installing a child seat on the passenger seat, do not set the PAD switch to OFF, as the passenger will not receive the added protection of the airbag. Serious injuries or even death could occur.

The PAD switch does not set the passenger seat side impact airbags or the seat belt pre-tensioners to OFF.

The Passenger Airbag Deactivation (PAD) switch lets the airbag protecting the passenger be set to OFF. When the PAD is set to OFF a child seat may be installed on the passenger seat. At ignition ON, if the passenger airbag is set to OFF, PASS AIRBAG OFF will show in the message centre.

The PAD switch is located on the passenger end of the instrument panel and is accessible when the front passenger door is open.



The PAD switch should be inspected by an Aston Martin Dealer if any of the following conditions occur:

- The PAD warning symbol does not come ON (for six seconds) when the ignition is set to ON and the passenger airbag is set to ON.
- The PAD warning symbol does not stay ON when the ignition is set to ON and the passenger airbag set to OFF.
- The PAD warning symbol stays ON when the ignition is set to ON and the passenger airbag is set to ON.

### Set the Airbag to ON or OFF

Insert the emergency vehicle key into the PAD switch and turn clockwise for the OFF position (airbag OFF) or counterclockwise for the ON position (airbag ON). Remove the key.

#### Airbag ON

When the ignition is set to ON make sure that the PASS AIRBAG OFF symbol (A) comes ON for six seconds then goes OFF. Failure to follow the advice given above can endanger the life of the child.

#### Airbag OFF

Make sure that the PASS AIRBAG OFF symbol stays ON when the ignition is ON.



## ISOFIX Anchors

**Warning:** An unsecured child seat is dangerous. In a sudden stop or a collision it could move, causing serious injury or death to the child or other passengers. Make sure the child seat is correctly secured in place according to the manufacturer's instructions.

**Warning:** When installing the child seat, make sure that there are no seat belts or foreign objects near or around the ISOFIX anchors. If seat belts or a foreign object prevents the child seat from being securely attached to the ISOFIX anchors, the child seat could move in a sudden stop or collision causing serious injury or death to the child or other passengers.

## Tether Anchors

Sport Seat: Passenger seat without height adjust only.

This vehicle is equipped with ISOFIX (International Standards Organisation FIX) anchors for the installation of child seats on the passenger seat. The anchors are located between the seat base and the seat back.

 Move the seat rearwards, to allow clearance for installing the child seat.

Secure the child seat using the ISOFIX anchors, following the child seat manufacturer's instructions.



 **Warning: An infant or child that is not properly restrained can be seriously injured or killed in a crash. Seat belts are designed for adults and larger children; infants and smaller children must be restrained in an approved child safety seat.**

 **Warning: Child restraint anchorages are designed to withstand only those loads imposed by correctly installed child restraints. Under no circumstances are they to be used for adult seatbelts, harnesses or for attaching other items or equipment to the vehicle.**

 **Warning: Always follow the child seat manufacturer's instructions. Not following the child seat manufacturer's instructions when installing the child seat is dangerous.**

 **Warning: Make sure the child seat tether strap is free from obstructions above and below. Do not place any items on the tether strap between the child seat and the tether anchor point. Do not place tether strap over any items between the child seat and the tether anchor point.**

A tether is a strap that connects the top of a child seat to a tether anchor point on the vehicle to reduce excessive movement of the child seat in the event of a collision. The purpose of a tether strap is to provide additional protection for the child seat occupant in the event of a serious impact. The tether strap is supplementary to the seat belts.

Your vehicle has a tether anchor point for the passenger seat (optional).



## Correct Assembly of Tether Anchorages

### Front Passenger Seat

(Non-height adjust sport seat only)

The tether anchor point for the passenger seat is located at the rear base of the passenger seat. Move the seat forward to access the tether anchor point. Route the tether strap through the aperture in the seat back as shown. Engage the tether clip to the anchor point at the bottom of the passenger seat back (A) and make sure that the locking spring has fully closed to prevent accidental disengagement. Always make sure that the tether strap length is adjusted to remove any slack.



## Automatic Locking Retractors

 **Warning:** Always follow the child seat manufacturer's instructions. Not following the child seat manufacturer's instructions when installing the child seat is dangerous.

Aston Martin does not recommend any specific child seat for this vehicle **which requires the use of the vehicle seat belt for installation.**

The Automatic Locking Retractor (ALR) system is designed to securely hold child seats. The ALR system temporarily locks the seat belt that is securing a child seat.

## ALR Operation

Gently pull out the seat belt until fully extended. The ALR system will only engage at the maximum extension point of the seat belt.

Thread the belt tongue through the child seat as instructed by the child seat manufacturer. Engage the tongue into the belt buckle.

Adjust the tongue position on the belt, if necessary, to make sure that the lower belt run is tight and then allow the upper run of the seat belt to fully retract until the child seat is securely held. The ALR system will be heard 'clicking' as the seat belt retracts.

When fully retracted, pull down on the upper run of the belt to check that the ALR lock has engaged.

 *When parked on an incline, the seat belt may lock as it is withdrawn. This is not a fault. If the mechanism locks, release the seat belt tension and then pull the seat belt very gently to avoid operation of the inertia lock.*

The ALR system will disengage when the seat belt is fully retracted. The seat belt may then be worn when required as a normal seat belt. Once the ALR is disengaged, the seat belt must be fully extended to re-engage the system on the next occasion that a child seat is installed.

## Child Seats

 **Warning: Always follow the child seat manufacturer's instructions. Not following the instructions when installing the child seat is dangerous.**

 **Warning: Do not seat a child aged 12 or younger, or weighing 36 kg or less in the car without an appropriate child seat or booster cushion.**

**Aston Martin strongly recommends not to install any child seat on the front passenger seat of this vehicle.**

### Use of Child Seats

Look for the following when selecting a child seat:

- It should have a label certifying that it meets the applicable Safety Standards.
- Carefully read the instructions supplied with the child seat. Make sure you understand them and can install and use the device correctly and safely in the vehicle.
- Make sure that the child seat is appropriate for the child's weight and development. The label required by the standard or regulations, or instructions for infant seats, usually provide this information.

An infant or child that is not correctly restrained can be seriously injured or killed in a crash. Seat belts are designed for adults and larger children; infants and smaller children must be restrained in an approved child seat.

Children can be seriously injured in a crash if their child seat is not correctly secured in the vehicle.

Never hold a baby or child on your lap while riding in the vehicle.

Consult with local manufacturers of forward facing restraint and booster cushions. These manufacturers can supply you with advice on the safety of their particular child restraints.

Check the seat manufacturer's instructions for correct use and installation – use the correct size seat and correctly secure the seat in the vehicle in accordance with the manufacturer's instructions. Be sure to read and follow the 'Installation and Use Instructions' provided with the child seat.

## Child Seats - ISOFIX Installation

### Sport Seat: No Height Adjust Passenger Seat

Mass Group <sub>1</sub>	Size Class	Fixture	ISOFIX Positions
			Front Passenger
	Carry Cot	F	ISO/L1 X
		G	ISO/L2 X
'0'	Up to 10 kg (0-9 months)	E	ISO/R1 IL <sub>2</sub>
'0+'	Up to 13 kg (0-18 months)	E	ISO/R1 IL <sub>2</sub>
		D	ISO/R2 X
		C	ISO/R3 X
'1'	9 to 18 kg (9 months to 4 years)	D	ISO/R2 X
		C	ISO/R3 X
		B	ISO/F2 IUF
		B1	ISO/F2X IUF
		A	ISO/F3 IUF

<sup>1</sup>. As shown on the child safety seat packaging

<sup>2</sup>. Mass Group 0/0+ - Britax 'Cosy Tot ISOFIX' (Only to be installed with the semi-universal ISOFIX base, do not install with lap or diagonal seat belt).

Mass Group <sub>1</sub>	Size Class	Fixture	ISOFIX Positions
'II'	15 to 25 kg (4 to 12 years)	-	- X
'III'	22 to 36 kg (4 to 12 years)	-	- X

<sup>1</sup>. As shown on the child safety seat packaging

### Table Key

**IUF:** Suitable for 'ISOFIX' forward child restraints systems of universal category approved for use in the mass group.

**IL:** Suitable for particular ISOFIX Child Restraint Systems (CRS). These ISOFIX CRS are those of the 'specific vehicle', 'restricted', or 'semi-universal' categories.

**X:** ISOFIX position not suitable for ISOFIX child restraint systems in this mass group or this size class. Supplied under ECE Regulation 16.

**Child Seats - Seat Belt Installation****Lightweight Seat**

Mass Group <sub>1</sub>	Seating Position
	Front Passenger
'0' Up to 10 kg (0-9 months)	X
'0+' Up to 13 kg (0-18 months)	X
'I' 9 to 18 kg (9 months to 4 years)	X
'II' 15 to 25 kg (4 to 12 years)	X
'III' 22 to 36 kg (4 to 12 years)	X

1. As shown on the child safety seat packaging

**Sport Seat: Height Adjust Passenger Seat**

Mass Group <sub>1</sub>	Seating Position
	Front Passenger
'0' Up to 10 kg (0-9 months)	U <sub>2</sub>
'0+' Up to 13 kg (0-18 months)	U <sub>2</sub>
'I' 9 to 18 kg (9 months to 4 years)	U <sub>2</sub>
'II' 15 to 25 kg (4 to 12 years)	U <sub>2</sub>
'III' 22 to 36 kg (4 to 12 years)	U <sub>2</sub>

1. As shown on the child safety seat packaging

2. Move the passenger seat to its rearmost and highest position.

**Sport Seat: No Height Adjust Passenger Seat**

Consult with local manufacturers of forward facing restraint and booster cushions. These manufacturers can supply you with advice on the safety of their particular child restraints and also advice on installation instructions.

Mass Group <sub>1</sub>	Seating Position
	Front Passenger
'0' Up to 10 kg (0-9 months)	X
'0+' Up to 13 kg (0-18 months)	X
'I' 9 to 18 kg (9 months to 4 years)	X
'II' 15 to 25 kg (4 to 12 years)	X
'III' 22 to 36 kg (4 to 12 years)	L <sub>2</sub>

1. As shown on the child safety seat packaging

2. Mass Group II/III - Britax 'Evolva 2-3 ISOFIT'

### Table Key

**L:** Suitable for particular child restraint systems. These restraints may be of the 'specific vehicle', 'restricted' or 'semi-universal' categories.

**U:** Suitable for 'universal' category restraints approved for this mass group.

**X:** Seat position not suitable for children in the mass group.

**\***: Unsuitable for use with many child restraints due to limited space.

Supplied under ECE Regulation 16.

### Britax 'Evolva 2-3 ISOFIT' Child Seat

 **Warning: The lap or diagonal seat belt is only to be used to restrain the child in the child seat. Do not use the lap or diagonal seat belt to install the child seat. Always use the Britax 'Evolva 2-3 ISOFIT child seat ISOFIT latches.**

To prevent any forward or backward movement of the Britax 'Evolva 2-3 ISOFIT' child seat, it must be installed with the top of the child seat pressed firmly up against the top of the passenger seat as shown. To achieve this follow the child seat manufacturer's instructions, along with the following instructions for the Aston Martin seat.



Move the passenger seat fully to the rear and install the Britax 'Evolva 2-3 ISOFIT' child seat to the passenger seat ISOFIX bars as per the manufacturer's instructions. Adjust the height of the child seat headrest as required according to manufacturer's instructions. Tilt the passenger seat back forward until the top of the child seat comes into contact with the passenger seat as shown.



## Cabin Storage

### Glove Box

Press the glove box button (A) to open. Push up to close.



### Trinket Box

(Non smoking option)

Lift the lid to open.



### Storage Tray

(SportShift II Transmission Only)

The storage tray includes a mobile phone pocket and coin or credit card holder.



### Armrest Storage Tray

The armrest storage tray has 2 USB ports, a 3.5mm auxiliary socket and a 12V accessory socket.



### Armrest Storage Box

(Optional)

The armrest storage box has 2 integrated cup holders, 2 USB ports, a 3.5mm auxiliary socket and a 12V accessory socket.



 **Warning: Only use the cup holder when safe to do so.**

 **Warning: Do not place hot drinks in the cup holder while the vehicle is in motion. There is a risk of scalding if spilled.**

 **Warning: Use soft cups only. Hard cups or objects can cause personal injury in a collision.**

 **Do not put open top drinks containers in the cup holders. There is a risk of spillage under heavy braking or steering which can damage electrical components.**

### Rear Storage Tray

Including 12V accessory socket (Roadster only).



### Door Pockets

Both doors have storage pockets, which include a phone holder.



### Umbrella

*(Optional)*

An umbrella complete with holder is located in the boot storage area.



## Boot Cover

(Coupe Only)

### To Remove

Detach the two boot lid cords and fold the rear section forward.



Slightly raise the boot cover up and then back. Lower and remove the cover to the rear.



### Storage

Keep the rear section folded and turn the boot cover 180°. Place the cover in the rear section of the boot.

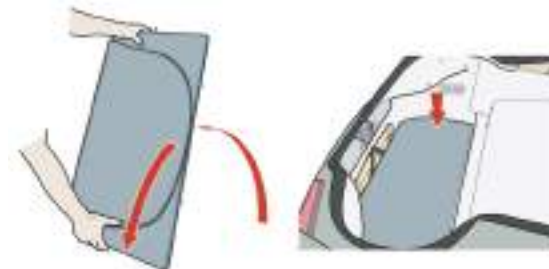

## Accessory Sockets

### To Install

Insert the boot cover, from below, and locate the two rear pins. Raise the cover. Locate the two side pins up into the area provided in the trim panel. Slightly push forward and allow to drop into position. Install the two boot lid cords.

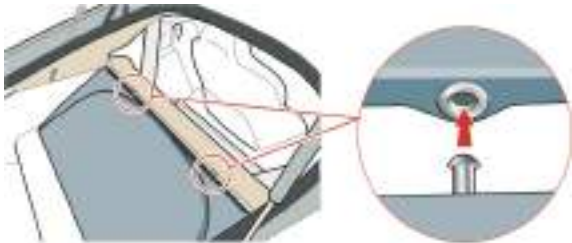

**⚠ Warning:** *Damage to electrical circuits will result if more than 10 amps is drawn from the accessory socket. Only connect accessories which are designed for use in a motor vehicle.*

**⚠ Foreign items can get into the socket and cause damage - always place the cover on the accessory socket when not in use.**

**⚠ Extended use of an accessory socket when vehicle engine is set to OFF will discharge the battery.**

Read the manufacturer's instructions and make sure that you do not connect any device which would exceed current rating of the accessory socket.

**📖** *Vehicles installed with the non-smoking kit have a third accessory socket provided in the trinket box.*

Accessory sockets are mounted in the armrest storage box or tray and the boot right side wall (A and B) and may be used to power any 12 volt vehicle accessory requiring a current of less than 10 amps.



[A] : Coupe

[B] : Roadster

Roadster Only: An accessory socket is mounted in the rear storage tray.



## Ashtray and Cigar Lighter

Optional

 **Warning:** *The cigar lighter is heated to 'red heat' when in use. Take care to avoid burns. Do not allow children to play with the cigar lighter.*

The cigar lighter may be used when the vehicle key is in ignition position 'I' or 'II'.



Push the lighter down until it clicks. The lighter will pop up when ready for use.

 **Warning:** *Foreign items can get into the socket and cause damage - always place the lighter back into the accessory socket when not in use.*

Remove the ashtray by opening the lid and pulling the glass tray upwards. Install the tray by placing it into position and push down.



ASTON MARTIN



ASTON MARTIN



ASTON MARTIN



ASTON MARTIN

# Controls

Controls Overview .....	4.2	Vehicle Horn.....	4.14
Instrument Cluster.....	4.3	Master Lamp Switch.....	4.14
Information and Warning Symbols .....	4.6	Reading Lamps.....	4.15
Centre Stack Controls.....	4.8	Trip Computer .....	4.15
Ignition Control.....	4.10	Tyre Pressure Monitoring.....	4.17
Stalk Controls.....	4.12	Ambient Temperature .....	4.19
		Cruise Control.....	4.20





**[1] FUEL FLAP RELEASE:** Press to open the fuel flap. Close the fuel flap by pressing down on the flap until the lock engages.

**Filler Flap Emergency Release:**(Refer to 'Fuel Filler Flap Emergency Release', page 5.15)

**[2] MASTER LAMP SWITCH:** Four position master lamp switch, which controls the vehicle external lamps (OFF, side lamps, main lamps and AUTO) (Refer to 'Master Lamp Switch', page 4.14).

**[3] INSTRUMENT CLUSTER:** (Refer to 'Instrument Cluster', page 4.3).

**[4] CENTRE STACK:** (Refer to 'Centre Stack Controls', page 4.8).

**[5] JOYSTICK/ENTER:** Rotate to navigate through screens and lists. Press to select an item or option (referred to as *ENTER* throughout this chapter)





[1] **FUEL GAUGE:** Shows how much fuel is in the fuel tank. Refuel as soon as possible when the low fuel symbol comes ON.

[2] **SPEEDOMETER:** Shows vehicle road speed.

[3] **MESSAGE CENTRE (LEFT):** Shows the following:

- **Vehicle Speed:** Shows the vehicle road speed in a digital format.
- **Gear Range:** Shows the transmission position and current gear selection. Possible transmission positions and gear selection are in bold.

[4] **GEAR POSITION INDICATOR :**

- **SportShift II Transmission: Gear Position Indication Display (GPID):** Shows the current gear when in paddle shift mode. Shows 'D' when in auto transmission mode (Refer to 'Auto Transmission Mode', page 5.5). A red 'R' will show when the transmission is in reverse. A red 'H' will show when in hill start assist mode (Refer to 'Park Brake', page 5.11).



- **Manual Transmission: Gear Shift Indication Display (GSID):** Shows maximum revs. in the current gear. A red 'R' will show when the transmission is in reverse (Refer to 'Manual Transmission', page 5.8).

[5] **MESSAGE CENTRE (RIGHT):** Shows the following:

- **Trip Meter (A):** Shows distances travelled since last reset of trip meters T1 and T2. Toggle between T1 and T2 by pressing **T1/T2** (E) for less than three seconds. Press **T1/T2** for more than three seconds to reset the trip meter on show.
- **Sport Mode Status (B):** (Sportshift only) Shows SPORT when sport mode is ON.
- **Cruise Status (C):** Shows CRUISE when cruise control is ON (Refer to 'Cruise Control', page 4.20).
- **Odometer (D):** Shows the total distance covered by the vehicle.



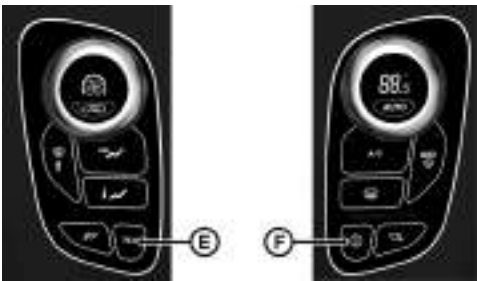

- **Driver Information and Warnings**

Messages show if an unsatisfactory condition is detected. Message priority is shown by a red or amber triangle above the message display.

**Red:** Potential personal danger or danger of damage to the vehicle.

**Amber:** Advisory, shows possible degraded vehicle performance.

Warning messages will show when the ignition is ON and will cycle automatically.

View and acknowledge messages at any time by pressing the **READ** button (F).

- **Service Intervals**

TIME FOR REGULAR SERVICE will be shown when a regular vehicle service is due. This message will show at ignition ON (for two minutes) until the regular service has taken place.

- **Trip Computer**

The message centre (right) defaults to the trip computer when there are no messages to show.

**[6] TACHOMETER:** Shows the engine speed in revolutions per minute x 1000.

**[7] ENGINE COOLANT TEMPERATURE GAUGE:** Shows the temperature of the engine coolant.



### Digital Speedometer Location

The digital speedometer can be displayed in either the left or right message centre depending on preference. All information in the opposing message centre moves to the other message centre side accordingly. To change the digital speedometer location, do the following:

Press **MENU** and navigate to <Car Settings...> **ENTER** <Digital Speedometer...> **ENTER** and select *Left* or *Right* to select the relevant message centre and press **ENTER** to confirm.

### Message Centre Clock

The message centre clock is shown in the opposite message centre to the digital speedometer. The clock is shown in either 24 hour or 12 hour display. To change the time format, do the following:

Press **MENU** and navigate to <Car Settings...> **ENTER** <Clock Format> **ENTER** and select 24 or 12 to select the relevant time format for the clock and press **ENTER** to confirm.

### Low Outside Temperature

 **Warning: Even if the ICE WARNING message does not show, there is no guarantee that at low temperatures the road is free from ice.**

At temperatures below 4°C the message ICE WARNING is shown in the message centre, this shows to the driver that frost or ice is likely to form on road surfaces.

The amber warning triangle  will also come ON.

The message and warning triangle will continue to show until the outside temperature rises to a safer level.

### Warning Symbols

As the ignition is set to ON, the electronic control units complete a self check. During these checks the following symbols will come ON for five seconds and SYSTEM CHECK will show in the message centre.



Under normal circumstances most warning symbols will go OFF at the end of the individual system check if system checks are satisfactory.

## Information and Warning Symbols



**[1] LOW FUEL WARNING:** Comes ON when only approximately 13 ltr of fuel or 80 km distance is available. At 13 ltr / 80 km and 7 ltr / 40 km an audible 'beep' will sound and the 'estimated distance' message will show (for 20 seconds) in the message centre. The arrow head shows which side of the vehicle the fuel flap is.

**[2] LEFT TURN INDICATORS:** Flashes with the indicator or hazard warning lamps (Ignition ON).

**[3] HEADLAMPS:** Shows that the main beam of the headlamps is in use.

**[4] SIDE LAMPS:** Shows that the side lamps, dip or main beams are ON.

**[5] IMMOBILISER STATUS:** If this symbol flashes continuously at ignition ON the vehicle will stay immobilised (Refer to 'Immobiliser', page 2.14).

**Warning:** Stop immediately if the check engine symbol flashes, do not drive the vehicle. Contact your Aston Martin Dealer.

**[6] CHECK ENGINE:** Steady amber shows a fault in the engine management system. Continue driving only if there are no audible, visible or physical signs of degraded engine performance. Consult your Aston Martin Dealer as soon as possible. Flashing amber shows a major fault in the engine management system. Stop immediately. Contact your Aston Martin Dealer.

**[7] IGNITION WARNING:** Comes ON when the ignition is set to ON and goes OFF when the engine is started and battery charging commences. Comes ON if battery charging fails whilst driving.

**[8] OIL PRESSURE WARNING:** Comes ON when the engine oil pressure falls below minimum. Do not continue driving if this symbol stays ON. Contact your Aston Martin Dealer immediately.

**Warning:** Do not drive the vehicle if the Supplementary Restraint System (SRS) warning symbol stays ON. Have the system checked by an Aston Martin Dealer.

**[9] SUPPLEMENTARY RESTRAINT SYSTEM:** At vehicle key position 'I' and 'II' or on vehicle start up, this symbol comes ON for a few seconds as a readiness sign. If it does not come ON, or if it does not go OFF after a few seconds, or if it comes ON whilst driving, the airbag self diagnostic system has detected a fault.



 **Warning: Do not drive the vehicle if the seat belt warning symbol stays ON. Have the system checked by an Aston Martin Dealer.**

**[10] SEAT BELT WARNING:** This warning symbol will come ON and a chime will sound for six seconds if the driver's seat belt is not fastened when the ignition is set to ON. The chime will continue to operate at different vehicle speeds until the seat belt is fastened (market dependant).



**[11] DYNAMIC STABILITY CONTROL:** When Dynamic Stability Control (DSC) is ON this symbol will flash when the DSC system is operating. If, while DSC is ON, the DSC symbol stays ON or it comes ON whilst driving, the DSC system has detected a fault. A DSC fault message will show in the message centre. Consult your Aston Martin Dealer as soon as possible.



**[12] TYRE PRESSURE:** If this symbol stays ON or comes ON while driving, a tyre(s) air pressure is below specification.



 **Warning: If the ABS warning symbol stays ON, do not drive the vehicle. Have the system checked by an Aston Martin Dealer.**

**[13] ABS WARNING:** If this symbol stays ON or comes ON while driving there is a fault in the ABS control circuits. Continue driving only if there are no audible, visible or physical signs of degraded brake performance. Consult your Aston Martin Dealer as soon as possible if this symbol stays ON.



 **Warning: If the brake warning symbol stays ON, after fully releasing the park brake do not drive the vehicle. Have the system checked by an Aston Martin Dealer.**

**[14] BRAKE WARNING:** At ignition ON this symbol comes ON when the park brake is applied and goes OFF when the park brake is fully released. If the symbol stays ON, after fully releasing the park brake, it shows that either the brake fluid level is low or that the brake pads require regular maintenance.



**[15] WARNING TRIANGLE:** Shows red or amber depending on the warning or information message priority.



**[16] REAR FOG LAMP:** Shows if the rear fog lamps are ON.



**[17] RIGHT TURN INDICATORS:** Flashes with the indicator or hazard warning lamps (Ignition ON).



**[18] HIGH COOLANT TEMPERATURE:** Shows when the engine coolant temperature exceeds 120°C.





**[1] INFOTAINMENT SCREEN:** Opens when the infotainment system is set to ON.

**[2] IGNITION CONTROL:** Insert the vehicle key for ignition positions '0', 'I', 'II' and engine start (Refer to 'Ignition Control', page 4.10).

**[3] TRANSMISSION CONTROLS:** (SportShift II Transmission Only) Sport, reverse (R), neutral (N) and drive (D) transmission buttons.

**[4] PHONE AND SATELLITE NAVIGATION:** Select phone and satellite navigation functions and move back in the menus.

**[5] PASSENGER AIRBAG STATUS:** (Market Specific) Shows the passenger airbag status (Refer to 'Passenger Airbag Deactivation', page 3.18).

**[6] CLIMATE CONTROLS:** Sets the required vehicle temperatures (Refer to 'Climate Controls', page 7.2).

**[7] MAIN MENU AND AUDIO SETTINGS:** Select radio, audio sources and menu options.

**[8] JOYSTICK/ENTER:** Rotate to navigate through screens and list. Press to select an item or option (referred to as **ENTER** throughout this chapter).

**[9] ON/OFF/VOLUME:** Press to switch the Infotainment system ON and OFF. Rotate to adjust the volume control.

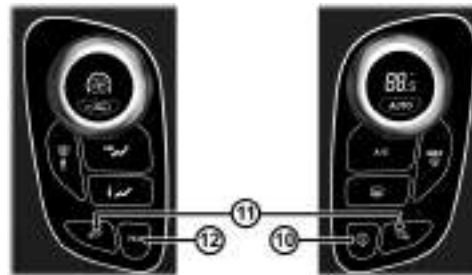

**[10] (I) / READ:** Press to view and acknowledge messages in the message centre (Refer to 'Instrument Cluster', page 4.3).

**[11] READING LAMPS:** Driver and passenger reading lamps.

**[12] T1/T2:** Select between the two trip meters in the message centre (Refer to 'Instrument Cluster', page 4.3).

## Manual Transmission.



**[A] DYNAMIC STABILITY CONTROL:** The DSC system is always ON when the ignition is ON. Press and hold for four seconds for OFF. Press and release to set to ON.

**[B] HAZARD WARNING LAMP:** Press to set the hazard warning lamps to ON or OFF.

**[C] SPORT MODE:** Press the sport button once to enter sport mode and press again to exit (Refer to 'Sport Mode', page 5.9). (Manual transmission only.)

**[D] MASTER VEHICLE LOCK:** Press to lock all doors and disable the boot lock switch. Press again to unlock (Refer to 'Master Locks', page 2.8).

**[E] BOOT OPEN:** Pull back up to open the boot lid<sup>1</sup>.

<sup>1</sup> This switch becomes the roof open and close switch on Roadster models.



**[F] REAR FOG LAMPS:** Used with the dipped beam when fog or mist is causing restricted visibility. They **must** be set to OFF when visibility clears to reduce glare to the drivers of following vehicles.

**[G] PARKING ASSIST:** Defaults to OFF at each ignition ON. Park assist comes ON when reverse gear is selected. Press and release to set parking assist to OFF (Refer to 'Parking Assist', page 5.16).

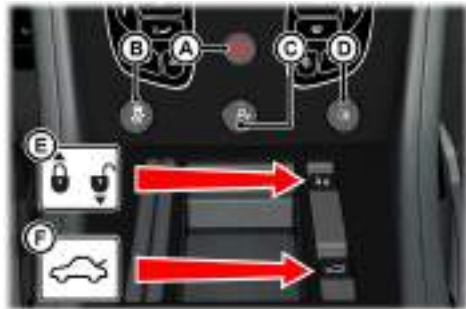
**SportShift Transmission.**

**[A] HAZARD WARNING LAMP:** Press to set the hazard warning lamps to ON or OFF.

**[B] DYNAMIC STABILITY CONTROL:** The DSC system is always ON when the ignition is ON. Press and hold for four seconds for OFF. Press and release to set to ON.

**[C] PARKING ASSIST:** Defaults to OFF at each ignition ON. Park assist comes ON when reverse gear is selected. Press and release to set parking assist to OFF (Refer to 'Parking Assist', page 5.16).

**[D] REAR FOG LAMPS:** Used with the dipped beam when fog or mist is causing restricted visibility. They **must** be set to OFF when visibility clears to reduce glare to the drivers of following vehicles.

**[E] MASTER VEHICLE LOCK:** Press to lock all doors and disable the boot lock switch. Press again to unlock (Refer to 'Master Locks', page 2.8).

**[F] BOOT OPEN:** Pull back up to open the boot lid<sup>1</sup>.

<sup>1</sup>. This switch becomes the roof open and close switch on Roadster models.

**Ignition Control**

To access vehicle functions and to start the engine the vehicle key must be inserted in to the ignition control.



**⚠ Warning:** Only use the vehicle key in the ignition control. Do not place any objects, including fingers, into the ignition control other than the vehicle key. Objects other than the vehicle key may cause the ignition control to fail.

**⚠** The vehicle key must only be inserted into the ignition control with the two indents first, as shown. Attempting to insert the larger end of the key first may damage the ignition control.



### Position '0' (Ignition OFF)

Auxiliaries OFF (infotainment centre consisting of audio, satellite navigation and hands-free phone not available), steering lock ON. Seats can be adjusted.

Gently insert the vehicle key, indents first, into the ignition control. Press in until the key clicks into place, approximately 20 mm (A) then release. The key is docked at this point.

Remove by pulling the vehicle key from the ignition control.



### Position '1' (Ignition OFF and Accessories ON)

Auxiliaries OFF (infotainment centre consisting of audio, satellite navigation and hands-free phone available), steering lock ON. Seats can be adjusted.

- If already in position '0' gently press the key until the infotainment centre and the instrument cluster lamps come ON, a further 10 mm (B) and release for position '1'.
- Or insert the key into the ignition control and move straight to position '1'. Press in until the infotainment centre and the instrument cluster lamps come ON.

Remove by pulling the vehicle key from the ignition control.



### Position 'II' (Ignition ON)

Ignition and all other electrical systems ON, steering lock OFF.

**SportShift Transmission: Do not press the brake pedal down unless intending to start the engine.**

**Manual Transmission: Do not press the clutch pedal down unless intending to start the engine.**

 Insert the key to position 'II' by using the flat of a finger, as shown.

- If the key is already in position '0' or '1' gently press the key until it is flush with the ignition control bezel and release.
- Or insert the key into the ignition control and move straight to position 'II'. Gently press the key until it is flush with the ignition control bezel and release.



The Instrument cluster lamps will come ON, the vehicle systems will wake up and the steering lock will release.

- **SportShift Transmission:**

To start the engine from this position fully press the brake pedal down and press the key fully in (Refer to 'Starting the Engine', page 5.3).

To remove the vehicle key from position 'II' press the key fully in **twice**, do not press the brake pedal and release.

- **Manual Transmission:**

To start the engine from this position fully press the clutch pedal down and press the key fully in (Refer to 'Starting the Engine', page 5.3).

To remove the vehicle key from position 'II' press the key fully in **twice**, do not press the clutch pedal and release.

The key will gently return to position 'I'. Pull the key from the ignition control. Once in position 'I' after 10 seconds the steering lock will engage.

 *If the vehicle key is pressed **fully** into the ignition control and released for position 'II', the key must be returned to position 'I' to start the engine.*

## Preventing Unnecessary Battery Drain

If the vehicle key is left in the ignition control (position '0'), some vehicle circuits will stay ON and unnecessary current will be drawn from the battery.

Always remove the vehicle key from the ignition control whenever the ignition is set to OFF.

## Stalk Controls

### Left Side Stalk

**Turn Signals:** Press up for a right turn, press down for a left turn. Returns to the centre position on completion of a manoeuvre. Hold against spring pressure to show a lane change.



**Main and Dipped Beam:** Pull forwards and latch for main beam. Pull forwards again and latch to return to dipped beam. Pull forwards and release without latching, at any time while the vehicle key is in the ignition control, to flash main beam ON and OFF.



Pull forwards and release without latching, when the vehicle key is removed, to start Homesafe (Refer to 'Homesafe', page 2.12).

**Trip Computer:** Repeated pressing of the trip function button (A) moves through the trip computer displays (Refer to 'Trip Computer', page 4.15).





## Right Side Stalk

### Windscreen Wiper Control:

[1] : OFF.

[2] : Automatic Wipe.

[3] : Normal Speed Wipe.

[4] : Fast Wipe.

**Demand Wipe:** Pull the stalk forwards.

 The windscreen wipers will return to their park position if the ignition is set to OFF or the bonnet is unlatched, regardless of the right stalk position.

**Speed Sensitive Wipe:** If the wipers are at fast wipe, when the vehicle slows down (below 11 km/h) the wipers will go to normal wipe speed.

If the wipers are at normal speed when the vehicle slows down (below 11 km/h) the wipers will go to automatic wipe (position 2).

As soon as the vehicle speeds up (above 15 km/h) the wipers will return to their original setting.



### Automatic Rain Sensor Wiper Control:

Automatic rain sensor wiper control increases or decreases the sensitivity in six steps (B). Sixth position (where the arrow is set to the bottom marker) gives the least sensitivity.

Switching from OFF to automatic wiper results in a single wipe to acknowledge that the wiper control is now automatic.

 If the automatic rain sensor wiper control is not functioning correctly, check that the sensor located at the top of the windscreen is clean and clear of debris or dirt.



**Windscreen Washer Control:** Press the button (C) for more than one second to operate the windscreen washers. Operation continues until the button is released. When released the washers stop immediately but the wipers continue for a few strokes, ending with a pause and then a final wipe.

If used during normal wiper operation, the wipers operate continually irrespective of the washer operation.

**Headlamp Washers:** Headlamp washers will operate automatically, once per journey (each ignition ON), if the windscreen washers are operated and the headlamps are ON.



## Vehicle Horn

To sound the horn press the centre pad of the steering wheel at any of the positions shown (A).



## Master Lamp Switch

[1] : All external lamps OFF.

[2] : Side, side marker, rear and registration plate lamps ON.

[3] : With the vehicle key at position 'II' in the ignition control, Headlamps ON, in addition to the side, side marker, rear and registration plate lamps.

[4] : With the vehicle key at position 'II' in the ignition control, if ambient light fades the side, side marker, rear and registration plate lamps and headlamps will switch ON automatically. If ambient light then increases, the side, side marker, rear and registration plate lamps and headlamps automatically go OFF. Automatic lamps are market specific.

 A light sensor at the top of the windscreen monitors ambient light levels for automatic lamps operation. Keep the windscreen clean and make sure that the sensor is not obscured. Obstructing the light in this area may lead to unwanted operation of the automatic lamps.



## Lamps ON Warning

If the vehicle side lamps are ON, and the driver's door is opened after the vehicle key has been removed from the ignition control, an audible warning will sound for a period of five minutes. To stop the audible warning set the lamps to OFF. The audible warning will also stop when the driver's door is shut - the lamps will stay ON.

## Day Time Running Lamps

(Denmark, Norway and Sweden only)

The dipped beams and side lamps are permanently ON.

## Instrument Brightness

During darker hours, a twilight sensor, located at the top of the windscreen, automatically reduces the brightness of the instrument cluster to a preset level.

 During the daylight hours the level of instrument brightness defaults to maximum brightness. If the twilight sensor is covered then the level of brightness will stay low as if in night time mode.

 If the master lamp switch is OFF then the instrument brightness will always be in daylight mode, unless altered manually.

Use the rotary control (B) to adjust the brightness. Push the rotary control in and release to enable the control. Push back in and release to lock the control.



## Reading Lamps

Reading lamps are located in the front environment. To operate the lamps (ON or OFF) press the individual switches mounted on the front centre console (A).

Unless set to OFF or ON they will continue to operate up to six minutes after the ignition is set to OFF.



## Trip Computer

Press the **TRIP** button (A) for less than three seconds to cycle through the trip computer functions one at a time. Trip computer information is viewed in the message centre.

 If an information message shows, after reading and acting on the information provided press the **READ** button (B) to return to the trip display.



**Range:** Shows the estimated travel distance with fuel available (no reset). When there is no available fuel, then '-----' is shown.



#### **Average Fuel and Instantaneous Fuel:**

Shows the fuel consumption over the last three seconds of travel (no reset).

Also shows the average fuel consumption since the last reset. This is indicated by the ∅ average symbol.



Press the **TRIP** button (A) for four seconds to reset the average fuel consumption. Press the **TRIP** button (A) for five seconds or more to reset both the average fuel consumption and average speed. **INFO CENTER IS RESET** is then shown in the message centre. This message disappears after a few seconds. If not, press the **READ** button to acknowledge the message.

**Average Speed:** Shows the average speed since last reset. This is indicated by the ∅ average symbol.

Press the **TRIP** button (A) for approximately four seconds to reset. Press the **TRIP** button (A) for five seconds or more to reset both the average speed and average fuel consumption. **INFO CENTER IS RESET** is then shown in the message centre. This message disappears after a few seconds. If not, press the **READ** button to acknowledge the message.

**Tyre Pressure Monitor:** Shows the current tyre pressure for all tyres (Refer to 'Tyre Pressure Monitoring', page 4.17).



## Display Units

### Distance

To change the display units to show miles or kilometres:

From the **MAIN MENU**, select **<SYSTEM SETTINGS>** **ENTER** **<Units>** **ENTER** **<Distance units>**.

Select the *Miles* or *Kilometres* check box and press **ENTER** to confirm.

### Temperature

To change the display units to show Celsius (°C) or Fahrenheit (°F):

From the **MAIN MENU**, select **<SYSTEM SETTINGS>** **ENTER** **<Units>** **ENTER** **<Temperature units>**.

Select the **°C** or **°F** check box and press **ENTER**.

## Tyre Pressure Monitoring

### Power Meter

To change the units shown on the power meter:

#### Power

From the MAIN MENU, select <SYSTEM SETTINGS> **ENTER** <Units> **ENTER** <Power Units>.

Select the *BHP*, *PS* or *Kw* check box and press **ENTER** to confirm.

#### Torque

From the MAIN MENU, select <SYSTEM SETTINGS> **ENTER** <Units> **ENTER** <Torque Units>.

Select the *LbFt* or *Nm* check box and press **ENTER** to confirm.

 When the units are changed, the ranges on the power meter will also update to suit the new units.

 **Warning:** *Driving on a significantly under-inflated tyre causes the tyre to overheat and can lead to tyre failure. Over-inflation and under-inflation also reduces fuel efficiency and tyre tread life, and may affect the vehicle's handling and stopping ability.*

Each tyre should be checked at least once every two weeks when cold, and inflated to the pressure recommended by the vehicle manufacturer on the Tyre and Loading Information placard or the tyre pressure label. If your vehicle has tyres of a different size than the size indicated on the Tyre and Loading Information placard or the tyre pressure label, you should determine the proper tyre pressure for those tyres.

### Tyre Status Screen

A tyre status screen can also be viewed in the infotainment system which gives a larger display showing tyre pressure and tyre temperature. The tyre status screen will also show the same warnings as the TPMS system in the message centre. However, the tyre status screen will not automatically be displayed in the event of a tyre warning. (Refer to 'Tyre Status', page 6.6)

### Tyre Pressure Indicator

As an added safety feature, your vehicle has been equipped with a Tyre Pressure Monitoring System (TPMS). If an over or under-inflated tyre is detected by the system, the TPMS indicator (A) is solidly illuminated. At the same time, the vehicle message centre will display the text **CHECK TYRES**. Once the message has been acknowledged an image of the vehicle will be displayed in the message centre showing which tyre(s) have low or high air pressure and the current tyre pressure. When the tyre pressure indicator comes ON, stop and check your tyres as soon as possible, and inflate or deflate them to the correct pressure.



 The TPMS is not a substitute for correct tyre maintenance, and it is the driver's responsibility to maintain correct tyre pressures, even if under-inflation has not reached the level to set the TPMS tyre pressure indicator symbol to ON.

### Malfunction Indicator

Your vehicle has also been equipped with a TPMS malfunction indicator to show when the system is not operating correctly. The TPMS malfunction indicator is combined with the tyre pressure indicator.

When the malfunction indicator is illuminated, the system may not be able to detect or signal low tyre pressure as intended. TPMS malfunctions may occur for a variety of reasons, including the installation of incompatible replacement or alternate tyres or wheels on the vehicle that prevent the TPMS from functioning properly.

Always check the TPMS malfunction indicator after replacing one or more tyres or wheels on the vehicle to make sure that the replacement or alternate tyres and wheels allow the TPMS to continue to function correctly.

When the system detects a malfunction, the indicator will flash for approximately 80 seconds and then stay ON. At the same time the vehicle message centre will display the text **TYRE SYSTEM FAULT**. Once the message has been acknowledged an image of the vehicle will be displayed in the message centre showing which tyre(s) have a fault. This sequence will continue upon subsequent vehicle start-ups as long as the malfunction exists.

### Operation

 **When a tyre pressure warning is detected reduce the vehicle speed to an appropriate safe level and stop at the first safe and convenient place to inspect the tyre(s).**

At each ignition ON there is a short delay before tyre pressures are received from the wheel and tyre transmitters, and being shown in the message centre and infotainment screen (if selected).

If the TPMS indicator symbol comes ON while driving, reduce speed to 30mph / 48 km/h and stop in a safe place as soon as possible. Check the status of the tyre(s) in the message centre:

### Warning One

#### TPMS Indicator Symbol

Constantly on.

#### Message Centre

**CHECK TYRES** (for four seconds) followed by an image that shows which tyre(s) is affected and the current tyre pressures.

#### Fault

Tyre pressure below or above specification.

#### Action

Check the tyre pressure of the affected tyre(s). Set the tyre pressure to the manufacturer's recommended pressure, as shown on the tyre label located on the edge of the driver's door or the B-Pillar.



### Warning Two

#### TPMS Indicator Symbol

Flashing for 80 seconds then constantly on.

#### Message Centre

**TYRE SYSTEM FAULT** (for four seconds) followed by an image that shows the current tyre pressures and which transmitter is at fault.

#### Fault

System failure or tyre transmitter fault.

#### Possible Cause

- The TPMS sensors have become defective.
- Wheels and tyres have been installed which do not have TPMS sensors.
- An unapproved accessory is interfering with the TPMS.
- A general fault has been detected in the TPMS.

#### Action

Continue at a reduced speed of 30mph / 48 km/h maximum. Check the control unit and the tyre transmitters at the earliest opportunity. Consult your Aston Martin Dealer.



## Ambient Temperature

The ambient temperature (outside temperature) is shown in the top right corner of the Infotainment centre display.

 *If the vehicle has been travelling and then is stopped in a shaded or enclosed area the ambient temperature may rise, this is due to the heat from the engine bay. The ambient temperature display will show the true ambient temperature once the vehicle is moving again or the engine bay cools down.*

 *If required the display units can be changed from °C to °F or °F to °C (Refer to 'Display Units', page 4.16).*

## Cruise Control

Cruise control can be used to maintain a selected vehicle speed, above 30 km/h, without having to use the accelerator.



**[1] RES:** Resume the set speed retained in memory.

**[2] SET:** Sets the speed. Press either + or - to increase or decrease the set speed.

**[3] ON/OFF:** Sets cruise control to ON or OFF.

**[4] CAN:** Cancels cruise control but keeps the set speed in memory.

### Operation

 **Warning:** Only use cruise control when conditions are favourable, for example, straight, dry, open roads with light traffic.

Use the **ON/OFF** switch to set cruise control ON and OFF. When cruise control is ON, 'CRUISE' will show in the message centre.

When travelling at the desired speed, which must be above 30 km/h, press the **SET** (+ or -) button. Cruise control will engage and maintain that speed without the need to use the accelerator pedal.

 Under certain conditions cruise control will automatically set to OFF (Refer to 'Cruise Control Automatic OFF', page 4.21).

 Cruise control will automatically disengage when the brake pedal is pressed or when the vehicle speed falls below 30 km/h.

### Changing the Set Speed

There are three ways to change the set speed:

- Accelerate or decelerate to the desired speed then press the **SET** (+ or -) button.
- Accelerate or decelerate to the desired speed by pressing and holding the **SET** (+ or -) button until the desired speed is obtained, then release.
- Accelerate or decelerate to the desired speed in steps of 2 km/h by briefly pressing and releasing the **SET** (+ or -) button until the desired speed is obtained.



---

## Resuming the Set Speed

**⚠** *RES should only be used if the driver is aware of the set speed and intends to return to it.*

**⚠** *It is not recommended to resume set speed when a low gear is selected as excessive engine speeds will occur.*

 Cruise control will not resume at speeds below 30 km/h. **RES** will not operate if the ignition has been set to OFF.

If the vehicle is accelerated above the set speed, then the set speed will be resumed when the accelerator pedal is released.

If the **CAN** button is pressed, or the brake or clutch pedal<sup>1</sup> is pressed, cruise control will disengage but the set speed memory will be kept. Press the **RES** button and the vehicle will return to the set speed.

---

<sup>1</sup>. Clutch pedal on manual transmission only

---

## Cruise Control Automatic OFF

Cruise control will automatically set to OFF and clear the memory when:

- The ignition is set to OFF.
- A fault occurs. The cruise control system will set to OFF and cannot be used until the fault is cleared.
- Maximum vehicle speed is reached.

Cruise control will automatically set to OFF but the set speed will stay in the memory when:

- The **CAN** button is pressed.
- The park brake is applied.
- The brake pedal is pressed.
- The clutch pedal is pressed. (Manual transmission only)
- Vehicle speed falls below 30 km/h.
- Neutral or Reverse gear positions are selected.
- If DSC is active.



ASTON MARTIN



ASTON MARTIN



ASTON MARTIN



ASTON MARTIN

# Driving

Driving Safety.....	5.2	Anti-lock Braking System .....	5.10
Driving Techniques .....	5.2	Park Brake.....	5.11
Starting the Engine .....	5.3	Dynamic Stability Control with Track Mode.....	5.12
SportShift Transmission .....	5.5	Fuel Filling.....	5.15
Manual Transmission.....	5.8	Catalytic Converters .....	5.16
Footbrake.....	5.10	Parking Assist.....	5.16
		Reversing Camera .....	5.18



## Driving Safety

- Always wear your seat belt.
- Never drive under the influence of alcohol or drugs.
- Always obey all speed and traffic laws and regulations. Never drive faster than the posted speed limit or than conditions allow.
- Be particularly careful driving on slippery or wet surfaces.
- This vehicle is a high performance vehicle and has handling characteristics you may not be accustomed to. Familiarise yourself with the vehicle and always drive prudently, being aware of your own limitations and the limitations of the vehicle. As with other vehicles of this type, failure to operate the vehicle correctly can result in accident and injury.
- Follow the maintenance schedule approved in this guide.
- Never allow the vehicle to be driven by inexperienced drivers.

 *Make sure that you are wearing appropriate footwear to efficiently operate the control pedals. Make sure that pedal movement is not restricted by floor mats or other objects trapped beneath pedals.*

## Driving Techniques

Procedures for driving this vehicle may be unfamiliar to many new owners. To make sure that you have a safe and enjoyable entry into this new phase of Aston Martin motoring, please take time to safely acquire the necessary new driving skills. Practise in safe, lower speed conditions before investigating the high performance potential of the vehicle.

Performance driving courses are available to enable you to fully understand the control functions of your vehicle and also the basic principles of performance driving. Contact your Aston Martin Dealer for further information.

### Running-In

This vehicle is fully hot tested during manufacture and no special running-in procedures are necessary. Nevertheless it is recommended to limit engine loads (e.g. by accelerating gently and by using lower gears on steep hills or when negotiating tight turns) during the first 1500 km/900miles.

### Track Days

Before using this vehicle on track days contact your Aston Martin Dealer for vehicle set up, service parts and recommendations.

### Wet Conditions

When driving in wet conditions, water can build up under your tyres so that they ride on a layer of water. This is called aquaplaning or hydroplaning. When this happens, you have little or no control. Aquaplaning is more prone to happening at higher road speeds if there is a lot of water on the road and particularly if the tyres are also under inflated or approaching minimum tread depth.

It is important to take bends or curves at a safe, reasonable speed, particularly when driving on wet or slippery road surfaces.

**Slow down when it is raining.**

## Starting the Engine

### Driving Through Deep Water

If in any doubt whether to drive through deep water, always take the side of caution to avoid potentially costly damage to the vehicle's engine or other essential systems.

**⚠** *Never drive in water deeper than the lower edge of the front bumper. Water can be splashed up into the engine air intakes located in the front upper grille and cause extensive damage to the engine or the vehicle may stall. Always proceed with extreme caution, especially when the depth is not known.*

When driving through water, traction or brake capability may be limited. Once through the water, always dry the brakes by driving slowly while applying light pressure on the brake pedal.

**📖** *Waves caused by other vehicles or natural causes can also splash water in the engine air intakes.*

**⚠** *Warning: Only use the vehicle key in the ignition control. Do not place any objects, including fingers, into the ignition control other than the vehicle key. Objects other than the vehicle key may cause the ignition control unit to fail.*

**⚠** *In extreme low temperatures (-20°C and below) do not allow the engine to 'rev' above 4000 rpm, while at standstill or when moving off, until the coolant temperature gauge reaches normal operating temperature. Revving the engine before fully warmed up may cause severe engine and transaxle damage.*

**⚠** *Do not press the vehicle key while driving. If the key is pressed in and released the engine will stop. If the key is removed from the ignition control while driving the engine will stop but the steering lock will not engage until the vehicle has come to a complete stop.*

**⚠** *The vehicle key must only be inserted into the ignition control with the two indents first, as shown. Attempting to insert the larger end of the key first may damage the ignition control.*



### Ignition Sequence

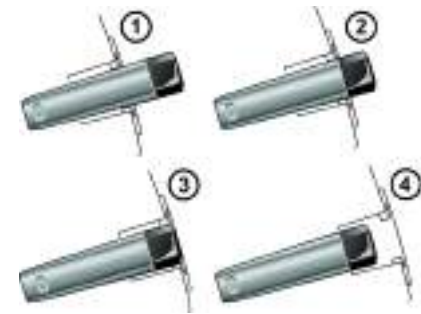

[1] : Position '0' (Ignition OFF)

[2] : Position 'I' (Ignition OFF and Accessories ON)

[3] : Position 'II' (Ignition ON)

[4] : Engine start

## Engine Start

Check that the park brake is applied.

- **SportShift II transmission:** Fully press the brake pedal down.
- **Manual transmission:** Fully press the clutch pedal down.



Insert the vehicle key into the ignition control and press the key fully in (the ignition control will show red), hold in until the engine starts then release.

The vehicle key will sit flush with the ignition control bezel while the engine is running. The ignition control will show a white light when the engine is running, and then fade out.

 When starting the engine the vehicle system will take a short time (approximately one second) to complete a system check and release the steering lock before allowing the engine to crank.

 Sportshift II: When starting the engine from cold let the engine run at idle speed for ten seconds before selecting a gear. This lets the Sportshift II system do a system check and maintains optimum Sportshift II performance.

If the engine fails to start, remove the key, then press the key fully in again **without the**

- **SportShift II transmission:** Brake pedal
- **Manual transmission:** Clutch pedal

**pressed down** and release. The key will gently return to position 'I'. Start the engine start procedure again.

## Starting From Cold

The Engine Control Module (ECM) automatically compensates for cold or warm start conditions and makes appropriate adjustments to the fuel and air mixture and ignition timing.

## Stopping the Engine

Press the vehicle key fully in and release. The engine will stop as the key returns to position 'I'. Withdraw the vehicle key from the ignition control.



**SportShift II Transmission:** As the ignition is set to OFF first or reverse gear (depending if the vehicle was set to OFF while in first or reverse) will stay selected. If the transmission is in neutral then first gear will be selected.

 If this vehicle is required to be towed, neutral can be selected at ignition OFF (Refer to 'Vehicle Recovery', page 12.16).

## Maximum Engine Speed

The maximum safe engine speed is 7,300 rpm. If this speed is exceeded, fuel supply to the engine is reduced. As the engine speed reduces back to a safe level, fuel supply is progressively restored.

## SportShift Transmission

**Warning:** Always secure the vehicle with the brakes when stopped. As with any transmission using a gearbox and clutch arrangement the vehicle will roll once the clutch is disengaged.

Vehicles installed with the SportShift II transmission have a manual gearbox and clutch arrangement. Most manual gearbox and clutch arrangements have a clutch pedal which when pressed lifts the clutch away from the flywheel, disengaging the engine from the drive line, enabling gearshifts. The SportShift III transmission uses a Transmission Control Module and an Electro-hydraulic Control Unit to replace the clutch pedal and make gearshifts.

Two modes of gear selection are available.

- Auto Transmission Mode
- Paddle Shift Mode

### Auto Transmission Mode

In auto transmission mode, gearshifts are made according to various driving parameters, i.e. road speed, current selected gear and accelerator demands. Forward, reverse and neutral gears are selected by using the auto transmission buttons. While in auto transmission mode, move to paddle shift mode at any time by pulling back on either the upshift or downshift gearshift paddles, mounted behind the steering wheel.



**[1] SPORT:** Press and release at any time while driving to start (button LED ON) and stop sport mode.

**[2] REVERSE:** When stationary and with the footbrake applied, press and release to select reverse. When reverse is selected, **R** will show red in the Gear Position Indicator Display (GPID) (B) and a warning will be heard.

**[3] NEUTRAL:** When stationary and with the footbrake applied, press and release to select neutral.

**[4] DRIVE:** When stationary and with the footbrake applied, press and release to select forward gears.

**Warning:** If the brake pedal is not pressed the message centre will show **PRESS BRAKE PEDAL** and a warning will sound.

The message centre (A) shows the current gear selection R, D1, D2, etc., while the GPID (B) shows **D** (Drive), or **R** (Reverse) according to current gear position.

As vehicle speed reduces, the SportShift II system will open and close the clutch and downshift as engine speed drops.



### Kick-Down

Kick-down is used in circumstances where rapid acceleration is required, i.e. when overtaking. Kick-down is when the accelerator pedal is quickly depressed, causing the transmission to change down to the lowest gear possible to achieve maximum acceleration. The gear engaged depends on the road speed at the time of kick-down.

### Paddle Shift Mode

Forward gearshifts are selected by pulling back and releasing the gearshift paddles mounted on the steering column in paddle shift mode. Neutral is selected by pulling back both paddles together and releasing. Reverse is selected by using the centre stack mounted auto transmission buttons.

**[1]** : Downshift paddle.

**[2]** : Upshift paddle.

 *Neutral can also be selected by pressing **N** on the centre stack.*

To move back to auto transmission mode press the **DRIVE** button.





From reverse or neutral, and with the footbrake applied, pull back on either the upshift or downshift gearshift paddle to enter paddle shift mode. As the vehicle speed increases and decreases, make upshifts and downshifts by pulling and releasing the upshift or downshift gearshift paddle. A minimum upshift speed is required. When shifting up through the gears, reduce, but do not completely remove, foot pressure on the accelerator pedal.

 If a downshift request is not detected in either **NORMAL** or **SPORT** during speed reduction, downshifts will automatically occur as engine speed drops.

 By pulling and releasing the upshift or downshift paddle in quick succession up and down shifts can be 'skipped', i.e. fifth to third or third to fifth (if the up or down shift requests are within the engine and transmission operating limits).

The message centre and the GPID will show the current gear selection. If the vehicle engine speed reaches its upper operating limit in a particular gear an upshift will not be made until a paddle upshift request has been detected. To inform the driver that the upper operating limit has been reached the GPID gear symbol will change from white to flashing red.



#### Hyper-shift

When an upshift is made with the engine speed at or above 5,500 rpm and the accelerator pedal is fully depressed, the requested upshift will be accelerated, providing a quicker, sportier driving experience.

## SportShift Features

### Sport Mode

Sport mode gives you a more engaging driving experience. To maximise the vehicle's response the Engine Control Module (ECM) adjusts the engine throttle response, exhaust valve operation and available engine torque.



Sport mode can be selected while in auto transmission or paddle shift modes. Press and release the **SPORT** button to enter or exit sport mode. The **SPORT** button LED will come ON and SPORT will show in the message centre when sport mode is ON.

**Auto Transmission Mode:** Upshifts and downshifts occur at higher engine speeds to provide a sportier drive.

**Paddle Shift Mode:** Automatic upshifts are prevented in gears 2 and above. The upshift paddle must be pulled back and released to make an upshift (downshifts will occur automatically if the engine speed lowers to its minimum operating limits).

To maintain speed and smoothness while driving in paddle shift sport mode, the current gear shown in the Gear Position Indicator Display (GPID), will flash red at the optimum time to make an upshift.

### Clutch Self-Learn

After a cold start, the **NEUTRAL** button LED will flash for up to 8 seconds. After 8 seconds, the LED will stay on while in neutral. The LED flashes while the vehicle is doing a clutch self-learn. This will happen at every cold start. It will not prevent a gear being selected and driving away, but we recommend that you let the self-learn complete as it improves the driving experience. If you start the vehicle when it is warm or hot, the clutch self-learn will not occur and therefore not cause the **NEUTRAL** button LED to flash.

### Clutch Warnings

Excessive demands placed on the clutch, for example, from holding the vehicle on an incline using the throttle only will operate a two stage clutch overheat warning.

#### Stage One

The amber warning symbol will come ON, and a single audible warning will sound. The message centre will show the message CLUTCH OVERHEAT BRAKE OR PULL AWAY. The driver should reduce the demand on the clutch by stabilising the demand on the accelerator pedal or releasing the accelerator pedal and applying the footbrake or park brake.

If the demand on the clutch is not reduced and the clutch temperature continues to increase, the second stage of clutch overheat strategy shall be invoked.

#### Stage Two

The message CLUTCH PROTECT MODE and SHIFT COMFORT REDUCED will show as a rolling message with the amber triangle until the clutch temperature returns to normal operating limits. During this time gearshift and moving off performance will be degraded to let the clutch to cool.

## Manual Transmission

The manual transmission features a six speed gearbox.



## Gearshifts

 Make sure that the clutch pedal is fully pushed down when changing gear.

 **Do not drive with your foot resting on the clutch pedal. This will cause excessive clutch wear.**

The Gear Shift Indicator Display (GSID) shows an increasing number of bars (one bar, up to three bars flashing) to show the engine speed is at near its limit. To avoid hitting the engine speed limiter, change gear before or when the GSID reaches three flashing bars.

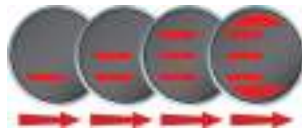

## Reverse Gear

 You must overcome spring resistance to move the gearstick left to select reverse gear

A red 'R' will show in the GSID and a single audible warning will sound when the transmission is in reverse.



## Sport Mode

Sport mode gives you a more engaging driving experience. To maximise the vehicle's response the Engine Control Module (ECM) adjusts the engine throttle response, exhaust valve operation and available engine torque.





At engine start Sport mode will be OFF by default. Press the SPORT button (A) once to enter Sport mode (button LED ON) and press again to exit. Greater care should be taken when operating this vehicle in Sport mode in wet weather, low grip conditions, low outside temperatures (below 7°C) or when winter tyres are installed.

## Footbrake

The footbrake operates through a vacuum boosted, dual (diagonal split) circuit, hydraulic system incorporating an Anti-lock Brake System (ABS).

 **Warning:** *In the event of a brake failure bring the vehicle to a halt as soon as it is safe to do so. Do not continue to drive.*

 **If vacuum boost fails or one circuit fails the footbrake will still operate but with greater pedal pressure, increased pedal travel and longer stopping distances.**

 **After a long drive over salted or gritted roads or if driving in heavy rain, through water or a vehicle wash, the braking action may be delayed and increased braking pressure may be required.**

 Vacuum boost is only available while the engine is running.

 The high performance brake system used on this vehicle is designed to provide optimal braking under all operating conditions. However, an inherent characteristic of this braking system is some brake noise. Certain combinations of speed, braking forces and ambient conditions may also cause the brakes to squeal.

## Brake Warnings

 **Warning:** *If the brake warning symbol comes ON, you should immediately be prepared for possible increased stopping distances and possible partial failure of the braking system.*

While driving, if the brake warning symbol  comes ON, it shows either that:

- The park brake is not fully released.
- The brake pads require regular maintenance.
- The brake fluid level has fallen below an acceptable level.
- The Electronic Brake Distribution (EBD) system has stopped working.

 A warning message will show in the message centre.

Stop as soon as possible in a safe and convenient place. Apply the footbrake and make sure that the park brake is fully released. If the park brake is fully released and the warning symbol stays ON, **do not drive** the vehicle. Contact the nearest Aston Martin Dealer. It is essential that the brake system is checked immediately, preferably by an Aston Martin Dealer.

## Anti-lock Braking System

The Anti-lock Braking System (ABS) helps prevent the road wheels from locking and skidding during emergency braking. This also assists the driver in maintaining steering and directional stability.

If, in an emergency braking situation, the braking force applied begins to exceed the tyre to road adhesion, the ABS operates to prevent the road wheels locking. When this happens a pulsating effect is felt through the brake pedal. This is a normal ABS effect.

### Safety

In all cases it is always the drivers responsibility to drive safely according to the law and with due regard to prevailing conditions. The fact that a vehicle is equipped with ABS must never let the driver to be tempted into taking risks which could affect his or her safety or that of other road users.

The addition of ABS cannot overcome the consequences of trying to stop in too short a distance, cornering at too high a speed, or the risk of aquaplaning (where the tyres are prevented from contacting the road surface by a layer of water).

The driver should always take road conditions into account. A slippery road surface always requires more braking distance for a given speed, even with ABS. Possible extensions of stopping distance compared to locked wheels may occur during ABS operation on slushy snow, gravel, sand or certain heavily corrugated or ridged warning sections of road surfaces.

If any braking system malfunction occurs, immediately have the braking and ABS systems checked by your Aston Martin Dealer.

### ABS Warning

 **Warning: If the ABS warning symbol comes ON, you should be aware that wheels could lock during extreme braking or when braking on slippery surfaces.**

ABS is monitored for correct operation while the ignition is ON. If a fault is detected, the ABS warning symbol  will come ON and the ABS will be partly or fully OFF. Normal braking will continue to function without ABS.

In the event of an ABS fault, consult your Aston Martin Dealer immediately.

## Park Brake

 **Always fully apply the park brake before leaving the vehicle.**

### To Apply the Park Brake

Press the footbrake pedal firmly down. Keep the pedal pressed down and pull the park brake lever up until resistance is felt. At this point press the park brake button and continue to pull the park brake lever up to its fullest extent. Release the button and allow the lever to lower.

 *To show that the park brake is applied the brake warning symbol on the instrument cluster will come ON (if the ignition is ON).*



### To Release the Park Brake

Press the footbrake pedal firmly down. Keep the pedal pressed down and pull the park brake lever up until resistance is felt. Pull up against the resistance and press the release button. Keep the button pressed and push the lever down. If the park brake lever is not fully OFF, the brake warning symbol will stay ON.

 **Always check that the brake warning symbol is OFF before moving off. Do not attempt to drive the vehicle if the brake warning symbol stays ON.**

 *An audible warning will sound if the vehicle is moving and the park brake is still applied.*

- If the vehicle is parked on a hill and facing uphill, turn the steering wheel away from the kerb.
- If the vehicle is parked on a hill and facing downhill, turn the steering wheel towards the kerb.

## Dynamic Stability Control with Track Mode

### Hill Start Assist

The hill start assist function gives assistance and safety when driving off an up or down gradient. As you change from the brake to the accelerator pedal, the brake pressure is retained for a brief moment, the vehicle will remain stationary for long enough so that you can move off without rolling in the unintended direction.

The hill start assist function will work on inclines of 4% and greater. On inclines of less than 4%, the park brake should be applied when stationary to prevent roll-back.

 **Warning:** *It is the driver's responsibility to drive safely according to the law and with due regard to prevailing conditions.*

 **Warning:** *Dynamic Stability Control (DSC) must never let the driver be tempted into taking risks which could affect his or her safety or that of other road users. DSC cannot overcome consequences of applying too much engine power for prevailing conditions.*

Dynamic Stability Control (DSC) is a system designed to enhance driving safety by improving the vehicle handling when the tyres are at the limits of their grip capabilities. This is achieved through the reduction of engine torque and strategic application of the brakes at individual wheels.

### Driver Interface and Control

 **If repair or replacement of the steering or other surrounding equipment is necessary, always refer to your Aston Martin Dealer. There is a sensor in the steering system which detects steering angle. If the centre position of the steering deviates, the DSC system may not operate correctly.**

 **The DSC system may not operate correctly when using tyre chains or a temporary spare tyre.**

 **Use tyres of the same manufacturer, brand, type, tread pattern and correct size specified for this vehicle on all four road wheels. Do not mix new and worn tyres on the same axle.**

DSC has three modes of operation:

**ON:** The DSC system sets to ON each time the engine is started. DSC is controlling engine torque and applying strategic application of the brakes at individual wheels.

While the DSC system operates to correct the vehicle stability the

DSC symbol  on the instrument cluster, will flash.



**TRACK MODE:** Press and hold the DSC button (A) for four seconds and release. DSC TRACK MODE SELECTED will show in the message centre. This raises the thresholds at which the DSC system operates. While the DSC system operates to correct the vehicle stability the DSC symbol will flash.

**OFF:** From Track mode, press and hold the DSC button for four seconds and release to set the DSC to OFF. DSC OFF can not be selected from DSC ON. DSC FUNCTION OFF will show in the message centre. DSC is no longer controlling engine torque and applying strategic application of the brakes at individual wheels. At any time while in track or off mode, press and release the DSC button to start DSC.

 *In Track mode or OFF, the DSC button LED will come ON and the amber warning triangle will be shown in the instrument cluster.*

## Fault Signs

A malfunction in the DSC control system will be shown by the following:

- The DSC symbol in the instrument cluster will come ON.
- A warning message will show in the message centre depending on the fault detected.

## Traction Control

 **Warning:** *It is always the drivers responsibility to drive safely according to the law and with due regard to prevailing conditions.*

 **Warning:** *Traction control must never let the driver be tempted into taking risks which could affect his or her safety or that of other road users.*

 **Warning:** *Traction control cannot overcome consequences of applying too much engine power for prevailing conditions.*

Traction control is a function of DSC, and is operated in association with the DSC system. Traction control prevents excessive wheel spin at standing starts, or during acceleration. Wheel spin is usually caused by excessive use of the accelerator pedal, or slippery, loose or bumpy road surfaces.

To prevent excessive wheel spin and maintain vehicle stability in such situations the traction control system will:

- Brake either of the driven wheels when they start to slip
- Adapt the engine torque to a level corresponding to the traction available on the road surface.

 *These symptoms are normal and will clear as wheel spin is eliminated and normal engine power is restored.*

 *If cruise control is on it will automatically go OFF when DSC is operating.*

During operation, the DSC warning symbol will flash. The driver may experience a loss in power or temporary 'misfire' as engine power is reduced.

If traction control cuts in when driving on extended icy or slippery surfaces, reduce engine power as necessary until the DSC warning symbol goes OFF.

Traction control is always ON when DSC is ON.

## Positive Torque Control (PTC)

ABS and traction control are complemented by the addition of an engine drag-torque control system - Positive Torque Control (PTC). On slippery road surfaces, a downshift or sudden throttle closing can cause a braking effect at the driven (rear) wheels due to engine braking. This may cause a loss of traction between the rear road wheels and the road. PTC increases engine torque via the engine management system, to keep the speed of the driven (rear) wheels within the optimum range.



## Fuel Filling

 The fuel tank filler neck has a restricted opening which will only accept the fuel supply nozzle of unleaded fuel pumps.

Open the fuel flap by pressing the fuel flap release button (A) located in the driver's footwell. If the filler flap will not open when the release button is pressed, use the fuel filler flap emergency release.



Turn the cap counter-clockwise past resistance, then lift off and place the cap into its holder. Install the cap by turning clockwise past resistance, until three 'clicks' are felt as the cap is fully tightened. Close and latch the fuel flap.



**[A]** : Coupe

**[B]** : Roadster

The fuel system will not let the fuel tank overfill but there will be times when the fuel nozzle will shut OFF prematurely. If this happens only try to fill the fuel tank one more time, continued attempts will result in fuel spillage. Wait 10 seconds before removing the refuelling nozzle.

### Fuel Filler Bowl

The fuel filler bowl has a pipe to let the water drain from the bowl. During fuel filling, check and make sure that any debris which may block the pipe is removed.

## Fuel Filler Flap Emergency Release

If the filler flap will not open when the release button is pressed, open the filler flap manually.

**[1] ROADSTER:** Reach through the left side boot trim to access the manual fuel filler flap release. Pull the lever (B) to open the filler flap.



**[2] COUPE:** Remove the left side boot trim to access the manual fuel filler flap release. Pull the lever (B) to open the filler flap.



## Fuel Cut-OFF

In the event of a vehicle accident the vehicle electronics will enter crash mode. Power to the fuel pumps will stop, thereby reducing fire risk.

## Engine Oil Level

**⚠ It is important to check the engine oil level regularly. Running the engine with engine oil below the lower mark or above the upper mark can cause serious engine damage.**

Check the engine oil level every fourth fuel tank fill or weekly - whichever is the sooner.

## Catalytic Converters

**⚠ Warning: Do not park over dry grass, leaves or other combustible material. Significant fire risk exists because of residual heat in the catalytic converters.**

**⚠ Warning: Do not drive through deep water. Rapid cooling of catalysts may cause them to break up.**

Catalytic converters convert harmful exhaust gasses into less noxious substances and so reduce environmental pollution. They operate at high temperatures and continue to radiate a considerable amount of heat after the ignition has been set to OFF.

## Parking Assist

**⚠ Warning: Parking assist does not replace need for total vigilance and caution when parking or reversing.**

**⚠ It is always the driver's responsibility to detect obstacles and estimate the vehicle's distance from them. Some overhanging objects, barriers, thin obstructions or painted surfaces which could possibly cause damage to the vehicle may not be detected by the system. Always be vigilant when using parking assist.**

**⚠ Do not turn and hold the steering on full lock for any more than 10 seconds. If the steering is held on full lock for more than 10 seconds the power steering pump can fail.**

**⚠ The rear sensors are not ON when neutral is selected, therefore care should be taken if moving the vehicle as the warning sound will not be heard.**

**⚠ Do not clean the sensors with abrasive or sharp objects.**

 For reliable operation, the sensors in the front and rear bumpers should be kept free from ice, frost and grime.

 When using a high pressure spray the sensors should only be sprayed briefly and not from a distance of less than 200 mm. Do not clean the sensors with abrasive materials.

When activated, a warning will be heard when driving forwards or rearwards, if objects are detected within range of the vehicle.

## Operation

(Including optional front park assist)

 **If you are driving in a confined space, such as a home garage, the outer sensors will detect the side walls and after three seconds the tone will stop. However, as movement continues, the inner sensors will eventually detect the rear wall and will start the tone again.**

 **In heavy rain or similar adverse conditions, the rear parking assist sensors may not always be able to accurately measure distance to close objects. A fully laden vehicle or irregular obstacles may also cause inaccurate measurements.**

The parking assist system defaults to OFF when the ignition is set to ON. The system comes ON when reverse gear is selected, or if the parking assist button (A) is pressed at speeds below 17 km/h (10 mph). The system will set to OFF when the vehicle moves forwards above 17 km/h (10 mph). The parking assist button LED will come ON when the system is set to ON.



If an obstacle is detected at the front or rear of the vehicle, a series of beeps will be heard from the front or rear speaker respectively, which increases in rate as the vehicle nears the obstacle.

The beep becomes a continuous tone when an obstacle is detected at or within approximately 300 mm from the rear or 250 mm from the front of the vehicle.

The LED will flash if a fault is detected in the system and a single three second tone will be heard (only once per ignition cycle). The system is automatically disabled when a fault is detected.

 Parking assist may sound spurious tones if it detects an ultrasonic frequency using the same band as the sensors.

 The system consists of inner and outer sensors. When manoeuvring forward into a garage, the front outer sensors will cease detection if they detect a stationary or receding object for three seconds or more, this allows detection directly at the front of the vehicle in this type of manoeuvre.

## Reversing Camera

(Market Specific Option)

 **Warning: The parking camera does not replace the need for total vigilance and caution when parking or reversing.**

 **It is always the driver's responsibility to detect obstacles and estimate the vehicle's distance from them. When parking or reversing make full use of rearward and forward vision and all mirrors to be aware of persons or objects in the vicinity of the vehicle. Take appropriate measures to protect them from danger.**

 For reliable operation, the parking camera lens in the rear bumper should be kept free from ice, frost and grime.

 When using a high pressure spray the parking camera lens should only be sprayed briefly and not from a distance of less than 600 mm. Do not clean the camera lens with abrasive materials.



In addition to the parking assist system, a rear parking camera, located above the rear registration number plate, gives a view from the rear of the vehicle as the vehicle is moved backwards while parking or reversing. When reverse gear is selected the camera view is shown on the infotainment screen.



If the infotainment screen is ON when reverse gear is selected the screen will show the camera view until reverse gear is deselected. When reverse gear is deselected the screen will continue to show the camera view for approximately ten seconds or when the vehicle reaches a speed of 16 km/h (whichever is sooner), then return to the infotainment screen.

Press the **BACK** button to move between the parking camera and infotainment screens, at any time, while reverse is selected. If the infotainment screen is OFF the screen will raise when reverse gear is selected and lower when reverse gear is deselected.

The screen can be set to not raise when reverse gear is selected if the infotainment screen is OFF. Press **MENU** and navigate to <SYSTEM SETTINGS> **ENTER** <Disable rear camera if display off>. Press **ENTER** to set the camera ON or OFF, and then press **BACK** to return to the previous screen(s).

### Camera Operation

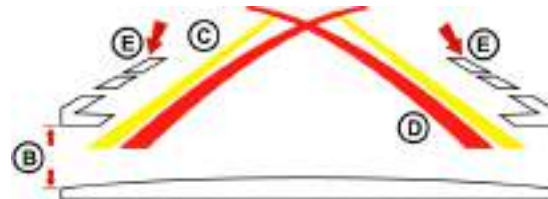

The camera overlay shows the fixed movement angle of the rear of the vehicle with the road wheels on full lock (D) red lines and the actual movement of the vehicle road wheels (C) yellow lines. As the steering wheel is turned the yellow lines will show the predicted vehicle movement.

The outer edge of the two markers (E) show the width of the vehicle including the mirrors.

The distance from the beginning edge of the two markers (E) to the rear of the vehicle is 300 mm (B).



ASTON MARTIN



ASTON MARTIN



ASTON MARTIN



ASTON MARTIN



# Infotainment

Infotainment Controls.....	6.2
Infotainment System.....	6.2
Infotainment Personalisation.....	6.4
Bluetooth Pairing.....	6.4
Vehicle Status.....	6.5
Apple CarPlay .....	6.7



[1] **VOLUME/ON/OFF:** Volume control. Press to mute the audio system. Press and hold to turn the infotainment screen on or off.

[2] **ENTER:** Press to confirm selection of an item or option.

[3] **MENU:** Opens the main menu.

[4] **JOYSTICK:** Use to navigate in menus.

[5] **DISPLAY:** Shows options, menus and information.

[6] **PHONE:** Press to open the phone menu.

[7] **NAV:** Press to open the navigation menu.

[8] **BACK:** Move back in the menu or cancel a selection.

The infotainment system provides control over a number of systems in the vehicle. These systems include:

- Parking Cameras
- Satellite Navigation
- Audio Media
- Hands-free Phone
- Tyre Pressure Monitoring
- Vehicle Power Output Displays

### Menu Paths

Menu paths are shown for each operation in the following format:

<item to select> **BUTTON TO PRESS**

For example: <Sound settings...> **ENTER**

Several menu options require a tick in a box to select an option. Once the menu item is highlighted press **ENTER** to either check or uncheck the box. Then press and hold **BACK** to accept and return to the main screen.

 In this chapter when asked to 'Press' a button, this means 'Press and release'. When this is not the case it will be clear in the text.

When asked to press **ENTER**, this means press the centre of the joystick.



## Using the Controls

The console has touch sensitive glass surface buttons. The button area vibrates (haptic feedback) to acknowledge that the system recognises that the button has been pressed. To turn the haptic touch feedback on or off when pressing the buttons, access the *SYSTEM SETTINGS* menu and select <Centre Stack>.

Turn the joystick to access different menus. Press the joystick to confirm a menu selection (this is also referred to as **ENTER**).

## Infotainment On and Off

The infotainment system is available with the vehicle key at least in position 'I' and is available until the vehicle key is removed from the ignition control.

 Pressing the **RADIO** or **SOURCE** buttons changes the current infotainment source.

## ON/OFF: Short Press and Release

If an audio source is ON and playing, one short press will switch the audio playback to OFF and any media playback will be paused if applicable. The screen will show the main menu. If the navigation application is working, the Route Guidance screen is shown.

If there is no working media application, one short press will start playback of the previous media source. If the navigation application is OFF, the 'Now Playing' screen of the media source is shown. If the navigation application is ON, the current screen stays shown and the audio source works in the background.

## ON/OFF: Long Press and Release

One long-press and release sets the screen to ON / OFF and raises or lowers the screen accordingly.

## Operation

When the infotainment system is switched ON, the screen rises from the console to display the Aston Martin Welcome screen and model name.

The welcome screen fades to display the main menu. At any time while the infotainment system is ON press **MENU** to view the Main Menu screen.



Use the **JOYSTICK** to navigate the menu system. Select from:

- VEHICLE STATUS
- REVERSE CAMERA
- NAVIGATION
- AUDIO
- PHONE
- SYSTEM SETTINGS

## Infotainment Personalisation

The infotainment screen can be personalised with a choice of display languages, background images and text colours.

### Language

To change the language in the infotainment, access the *SYSTEM SETTINGS* menu. Press **ENTER** <Language>. Select from:

- English (UK)
- English (US)
- French
- Spanish
- German
- Italian
- Japanese
- Russian
- Swedish
- Czech
- Polish
- Chinese (Simplified)
- Chinese (Traditional)
- Greek

### Colour Settings

To change the display colours, access the *SYSTEM SETTINGS* menu.

Press **ENTER** <Appearance> **ENTER** <Colour Settings>. Select from:

- Flugplatz Blue
- Volcano Red
- Cinnabar Orange
- Sunshine Yellow
- Appletree Green
- Lightning Silver
- Transparent

### Image Settings

To change the display back ground, access the *SYSTEM SETTINGS* menu. Press **ENTER** <Appearance> **ENTER** <Image Settings>. Select from:

- Carbon Fibre
- None
- Highlight
- Water Droplets
- Leather
- Cedar
- Sand

## Bluetooth Pairing

A mobile phone, tablet or other device<sup>1</sup> can be connected using Bluetooth®<sup>2</sup> wireless technology for hands-free call functions and to stream music to the infotainment system.

 *Mobile phones must support A2DP Bluetooth® wireless technology. All streaming features are mobile phone and network dependent.*

---

<sup>1</sup>. Bluetooth® devices will be referred to as 'phone' or 'mobile phone' in this manual.

<sup>2</sup>. The Bluetooth® word mark and logos are registered trademarks owned by Bluetooth SIG, Inc., and any use of such marks by Aston Martin is under license. Other trademarks and trade names are those of their respective owners.

## Device Pairing

Use this procedure when pairing the first mobile phone to the infotainment system.

Press **PHONE** and select **ADD A NEW HANDSET**. Press **BACK** to cancel. Press **ENTER**.

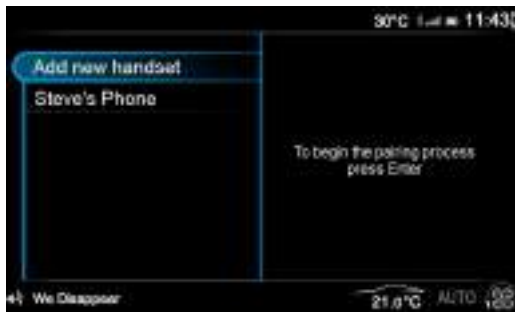

The infotainment system will ask if Bluetooth® wireless technology is in discoverable mode (refer to the mobile phone manufacturer's instructions). If yes, press **ENTER**.

Follow the mobile phone manufacturer's instructions to search and connect to a new Bluetooth® wireless technology device. The phone will search for discoverable Bluetooth® wireless technology devices in its range.

Select **Vantage S** from the device list.

 If **Vantage S** does not show then check that the infotainment system is **ON** and search again

Follow the instructions shown on the phone and the display to pair the phone.

Once synchronising has completed the mobile phone is ready for use with the vehicle audio and hands-free system. The vehicle will also request access to call history and messages.<sup>1</sup>

To add more devices when a device is already connected, press **PHONE** and then navigate to **BT Devices** to open the device manager. Select **ADD A NEW HANDSET** and follow the above steps to add an additional device.

---

<sup>1</sup>. Dependant on phone model and software.

## Vehicle Status

 **Warning: Failure to avoid potentially hazardous situations could result in an accident or collision resulting in death or serious injury.**

 **Warning: The vehicle status screens are intended for track only. It is the driver's responsibility to use these features in a responsible manner. Always use your best judgement, and operate the vehicle in a safe manner. Minimise the amount of time spent viewing the screen while driving and always be fully aware of all driving conditions.**

 **Warning: Do not allow yourself to become distracted and minimise the amount of time spent viewing the screen while driving and always be fully aware of all driving conditions.**

### Display Units

To change the units shown on the vehicle status screens (Refer to 'Display Units', page 4.16).

## Tyre Status

The infotainment display can show a tyre status screen which shows tyre pressure and temperature on a larger display. To show the tyre status screen, navigate to <VEHICLE STATUS> **ENTER** <Tyre Status>.



The tyre status screen is to be used as a visual support for the TPMS indicator in the message centre. If the tyre status screen is not selected in the infotainment screen and a tyre fault does occur, warnings will **only** appear in the message centre.

Tyre temperatures are indicative only and can vary with driving conditions and should not be used to assess the condition of a tyre. Always use the tyre pressure to check for correct inflation and visual inspection for tyre condition.

## Power Meter

**The power meter is intended for track use only.**

The infotainment system is able to show vehicle's engine power and torque as a live updated display. To show the display, navigate to <VEHICLE STATUS> **ENTER** <POWER METER>.



## Apple CarPlay

The screen will show both power and torque along with engine speed. On the power and torque dials there will be two readings:

**[1] LIVE VALUE:** Instant values as read from the vehicle. Shown in selected infotainment display colour (Refer to 'Infotainment Personalisation', page 6.4)

**[2] PEAK VALUE:** Peak values are shown in grey. These values are removed:

- After 8 Seconds.
- When value is exceeded and a new peak value is reached.

 *Indicated values may differ from quoted manufacturer figures due to a number of driving environment differences such as, but not limited to, temperature, altitude, air density and engine load and, as a result, accuracy of data is not warranted. Any differences in values should not be taken as an indication of an engine not performing correctly.*

Apple CarPlay is a smarter, safer way to use your iPhone or other compatible Apple device in your vehicle by using the vehicle infotainment screen. When connected, the infotainment system can be used to make calls, send and receive messages, view navigation and listen to music.

 *By using Apple CarPlay, you acknowledge the following: Apple CarPlay is a service provided by Apple Inc. under its terms and conditions. Aston Martin Lagonda is not responsible for Apple CarPlay or its applications. When using Apple CarPlay, certain information from your vehicle (such as its position) is transferred to your iPhone.*

### Initial Connection

1. Connect the iPhone to the CarPlay USB port (A) with a suitable cable.



2. Navigate to the **CARPLAY** icon from the main menu and press **ENTER**.
3. The Apple CarPlay menu will now open.



To begin Apple CarPlay, select the **CARPLAY** icon from the Infotainment menu and press **ENTER**.

The Apple CarPlay menu will then open.



## Apple CarPlay Controls

Whilst in the Apple CarPlay system, use the **JOYSTICK** to navigate the menus and **ENTER** to select items.

*Information about which apps are supported and which phones are compatible is available on Apple's Website [www.apple.com/ios/carplay](http://www.apple.com/ios/carplay).*

To exit CarPlay and return to the vehicle menu press the **AMi** app in the CarPlay menu. The **MENU**, **NAV** and **RADIO** buttons will also function as normal and will open menus outside of CarPlay.

*The **PHONE** function, **PHONE** button and second **USB** port are all disabled when Apple CarPlay is in use. Devices connected to the vehicle with Bluetooth or USB will not be available when Apple CarPlay is active.*

When CarPlay is connected, **SOURCE** is used to return to the main CarPlay screen. **SOURCE** will not change between audio sources whilst CarPlay is connected.

### **SIRI**

Apple CarPlay apps can be voice operated using SIRI. To activate SIRI press an hold the **CALL** button.

# Climate Control

Operating Tips .....	7.2
Climate Controls .....	7.2
Airflow Modes.....	7.4
Automatic Operation .....	7.5
Manual Operation.....	7.6



## Operating Tips

- A solar sensor is installed on top of the instrument panel, this should not be covered when driving.
- The intake grille of the in-vehicle temperature sensor is located in the driver's knee bolster, close to the centre console. To maintain the optimum temperature this grille should not be obstructed.
- Moisture which forms on the evaporator in the air conditioning unit is discharged via a drain tube onto the road. After stopping, small puddles of water may form underneath the vehicle. This is normal and does not show a system malfunction.
- Operate the climate control system with the engine operating.
- Clear all obstructions like leaves, snow and ice from the bonnet and the air inlet in the front grille to improve the system efficiency.
- Windows can fog up easily in humid weather. Use the climate control system to demist the windows.
- To help demist the windows, operate the air conditioner to dehumidify the air.

- Use the 'outside air' position in normal conditions. The 'recirculated air' position should be used temporarily when driving on dusty roads or for quick cooling or heating of the interior.
- If the vehicle has been parked in direct sunlight during hot weather, open the windows to let warm air escape, then close the windows and operate the climate control system.
- Operate the climate control system at least once a month to keep internal parts lubricated.
- Have the climate control system checked before the weather gets hot. If the climate control system is low on refrigerant or has a malfunction, consult your Aston Martin Dealer.
- This vehicle is equipped with a pollen filter. It is necessary to change the filter periodically as shown in the scheduled maintenance. Consult your Aston Martin Dealer.
- Air conditioning may not function when the outside temperature approaches 0°C (indicator stays ON even when system is OFF).

## Climate Controls





**[1] AUTO:** Press for automatic climate control operation (Refer to 'Automatic Operation', page 7.5).

**[2] TEMPERATURE:** Set the required in vehicle temperature. Turn clockwise for hot and counter-clockwise for cold. The selected temperature is shown on the dial display.

**[3] A/C:** When in manual mode press and release to set the air conditioning ON or OFF.

**[4] MAX :** Press for maximum defrost or demist ON or OFF. Outside air intake is automatically selected and air conditioning is automatically started.



**[5] HEATED REAR WINDOW:** Press to operate the rear window heater. Goes OFF after 20 minutes if not manually set to OFF. When the heated rear window is ON the door mirror heaters will work for 6 minutes, then go OFF.

**[6] AIRFLOW MODES:** Press and release to select an airflow mode. (Refer to 'Airflow Modes', page 7.4)

 **Warning: Do not select recirculated air in cold or rainy weather, it can cause the interior glass to mist up.**

**[7] AIR CIRCULATION:** Controls the source of air entering the vehicle. Press to select recirculated air (button LED ON). Press again to select outside air as source.

Use the recirculated air position when going through tunnels, driving in congested traffic (high engine exhaust areas) or when maximum cooling is required. On start up the default position is outside air as source. Use this position for normal conditions and demisting.

**[8] FAN SPEED:** Turn to set the required fan speed (clockwise for fast speed and counter-clockwise for low speed). The fan speed is shown on the display.

## Display Units

To change the display units to show Celsius (°C) or Fahrenheit (°F) (Refer to 'Display Units', page 4.16)

## Solar and Temperature Sensors

The automatic air conditioner function measures inside and outside temperatures, and sunlight. It then sets the interior temperature accordingly. To maintain effective operation do not obscure the following sensors:

**[1]** : Solar sensor.

**[2]** : In-vehicle temperature sensor.



## Airflow Modes

Press and release each button for an airflow mode. By pressing one or more buttons at a time, five airflow modes are available. Selected airflow modes are also shown on the infotainment screen.



Mode	Button(s)
Windscreen and Door Windows <i>In addition a small bleed of air is directed into the face vents.</i>	(A)
Face Only	(B)
Feet Only <i>In addition a small bleed of air is directed to the face vents, the windscreen and door windows.</i>	(C)
Windscreen, Door Windows and Feet <i>In addition a small bleed of air is directed into the face vents.</i>	(A)+(C)
Face and Feet	(B)+(C)



## Adjusting the Vents

To adjust the air flow vents:





## Automatic Operation

Press **AUTO**. Using the **TEMPERATURE** dial set the required in-vehicle temperature (read the actual temperature setting in the top left of the display). The **A/C** button LED will come ON.

Adjustments to fan speed, air flow and air re circulation will be made automatically according to the set temperature, interior and exterior conditions.

 *Maximum fan speed will not be available to heat the cabin until the engine has reach its normal operating temperature.*

 *When using the air conditioner, mist may come out from the vents. This is not a sign of trouble but a result of humid air being suddenly cooled.*

 *If resetting climate control functions other than the fan speed, the fan speed will stay set as in automatic mode. Adjustments to the fan speed will cancel Auto Mode.*

## Defrost and Demist

 **To defrost or demist the windscreen on vehicle start up in extreme cold weather conditions, run the engine at 1500rpm. Always make sure that neutral is selected and the park brake is applied.**

Press **MAX** . The outside air intake is automatically selected, the temperature is set to maximum and air conditioning is started.

 *If the cabin temperature is cold the air conditioner will not start up until the engine has started to warm up.*

To cancel automatic defrost or demist either:

- Press **MAX**  again.

or

- Press **AUTO**.

or

- Press any of the airflow mode buttons.

 *The automatic defrost setting times out after 6 minutes.*

## Manual Operation

Set the required:

- Fan speed
- Temperature
- Air flow.

 *The fan speed and temperature setting will show on the display.*

 *When using the air conditioner, mist may come out from the vents. This is not a sign of trouble but a result of humid air being suddenly cooled.*

 *Setting the temperature to maximum high or low will not provide the required temperature at a faster rate. To prevent cool air blowing from the vents when heating immediately after starting a cold engine, the amount of airflow is reduced until the air warms up.*

 *The vehicle heater will continue to produce the selected temperature regardless of in-vehicle conditions.*

If dehumidifying is required, press the **A/C** button (LED ON). To stop dehumidifying press **A/C** button again (LED OFF).

When maximum cooling is required, set the **TEMPERATURE** dial to the extreme cold position and press the **AIR CIRCULATION** button to the re circulated air position ( will show in the display), then set a fast fan speed.

## Defrost and Demist

 **To defrost or demist the windscreen on vehicle start up in extreme cold weather conditions, run the engine at 1500rpm. Always make sure that neutral is selected and the park brake is applied.**

Press **A/C**. Press the   airflow button.

Set the required:

- Temperature
- Fan speed.

 *If the engine is cold the air conditioning will not start up until the engine has started to warm up.*

 *For maximum defrost or demist set the temperature and fan speed dials to maximum.*

# Audio

Audio Essentials.....	8.2
Audio Controls.....	8.4
Radio Functions.....	8.7
Traffic Announcements.....	8.9
Automatic Frequency Updating.....	8.9
Radio Data System.....	8.9
DAB Radio Functions.....	8.10
iPod and USB Functions.....	8.11
Bluetooth Streaming.....	8.13
Auxiliary Functions.....	8.14



# Audio Essentials

## Aston Martin Premium Audio

### Radio:

- Digital Audio Broadcasting (DAB) radio.
- AM and FM radio.

### Audio Inputs

- USB Device
  - 2 x Connection port in cubby box.
  - iPod / iPhone / iPad Compatible.<sup>1</sup>
- Auxiliary Input
  - 1 x 3.5mm Connection port in cubby box
- Bluetooth® Wireless Technology Audio and hands-free phone.

**Surround Sound:** Dolby® Pro-Logic II.

**Power Output:** 700W.

### Speakers

**[1]** : 100W centre-fill speaker.

**[2]** : Two door-mounted 100W speakers, each with mid-range and tweeter units.

**[3]** : Two rear environment 100W speakers, each with mid-range and tweeter units.

**[4]** : 200W subwoofer housed under the rear environment left side.



<sup>1</sup> iPod iPhone and iPad are trademarks of Apple Inc.

## Bang & Olufsen BeoSound Audio

Optional

### Radio:

- Digital Audio Broadcasting (DAB) radio.
- AM and FM radio.

### Audio Inputs

- USB Device
  - 2 x Connection port in cubby box.
  - iPod / iPhone / iPad Compatible.<sup>1</sup>
- Auxiliary Input
  - 1 x 3.5mm Connection port in cubby box
- Bluetooth® Wireless Technology Audio and hands-free phone.

**Power Output:** 1000W

<sup>1</sup>. iPod iPhone and iPad are trademarks of Apple Inc.

## Speakers

**[1]** : Two 19 mm (soft dome) tweeters incorporating Acoustic Lens Technology (ALT).

**[2]** : Centre: Two speakers: One 90 mm mid-range in closed cabinet and one 19 mm (soft dome) tweeter.

**[3]** : Footwell: Two 140 mm woofers in closed cabinets.

**[4]** : One 90 mm mid-range speaker, in closed cabinet, in each front door.

**[5]** : One 200 mm subwoofer housed in closed cabinet under the rear environment left side.

**[6]** : Two speakers: One 90 mm mid-range and one 19 mm (soft dome) tweeter in each rear quarter.

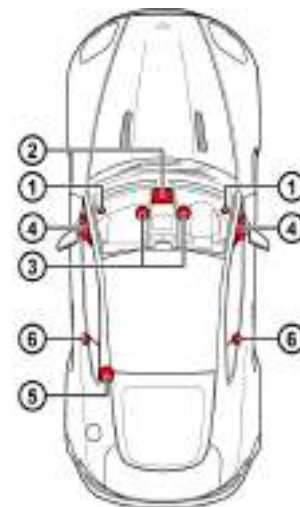

### Acoustic Lens Technology

(Bang and Olufsen audio only)

Acoustic Lens Technology (ALT) gives a wide (180°) horizontal dispersion of high frequencies. This prevents the loss of critical sound and gives listeners an improved sense of space, staging and realism, even when not sitting in the optimal location<sup>1</sup> for listening to two-channel stereo reproductions.



Two motorised acoustic lenses, mounted on either side of the dashboard, rise when the system is set to ON and stay raised until the audio system is set to OFF.



[1] **ENTER:** Push the **JOYSTICK** button (referred to as **ENTER** throughout this chapter) to select items within a menu or to open a selection.

[2] **JOYSTICK:** Navigate in the menus by clicking left, right, up or down. Turn the rotary controller to scroll menu items.

[3] **BACK:** Press to move back one action. Press and hold to move back to the default screen.

[4] **VOLUME:** Volume control.

[5] **ON/OFF:** Press for audio ON and OFF.

[6] **MENU:** Opens the main menu.

[7] **RADIO:** Press to navigate between the radio bands.

[8] **SOURCE:** Press to select other audio sound sources.

[9] **VOLUME:** Volume control.

[10] **SCROLL:**

- **Radio:** Searches up and down the frequency band for the next available radio station.
- **iPod / USB:** Skip forward or backwards through music tracks.

<sup>1</sup> For the optimal location to listen to two-channel stereo reproductions, the listener should be sitting equidistant from both loudspeakers on the apex of an equilateral triangle.



## Operation

The audio system is available with the vehicle key at least in position 'I' and is available until the vehicle key is removed from the ignition control.

If the audio system is ON when the ignition is set to OFF and the vehicle key removed, it will automatically start the next time the vehicle key is moved to position 'I'.

Press **ON/OFF** to set the audio system ON or OFF.

## Sound Source

To select radio, at any time while the audio system is ON, press the **RADIO** button repeatedly to navigate between the radio bands.

To select other audio sound sources press the **SOURCE** button to navigate through the audio source choices.

## Battery Protection Mode

Using the audio system, with the vehicle key at position 'I' (ignition OFF) will drain the battery charge. A warning message will show in the message centre when the battery charge is low (Refer to 'Battery Protection Mode', page 12.22). The audio and USB ports are disabled after a two minute warning to protect the battery.

## Menus

Press **MENU** to access the main menu to navigate to the required location.

## Aston Martin Audio Sound Settings

To access sound settings, select <SETTINGS> from the <AUDIO> menu. Select <AUDIO SETTINGS> press **ENTER**. Select required features and adjust to desired settings.

 *The level for the centre speaker can only be set if either Dolby Pro-Logic II or 3 Channel has been selected from the sound source menu.*

## Premium Audio

**Bass:** Level for bass.

**Treble:** Level for treble.

**Balance:** Balance between the left and right speakers.

**Fader:** Balance between the front and rear speakers.

**Subwoofer:** Level for subwoofer.

**Centre:** Level for centre speaker.

**Surround:** Level for surround sound.

**Surround Equaliser:** Select <Dolby Pro-Logic II><sup>1</sup>, <3 Channel> or <Off>.

**Auto Volume Control:** Auto volume control adjusts tone based on the output level to maintain tonal balance at all volume levels. Select from <Low>, <Medium> and <High>.

---

<sup>1</sup>. Dolby Pro-Logic II is not available for radio sources.

## Dolby Surround Pro-Logic II

Dolby Surround Pro-Logic II, with its centre speaker in the dashboard, provides more realistic sound reproduction.

The normal left and right stereo channels are divided into left-centre-right. In addition, ambient surround sound is produced through the rear speaker channels.

Not available in Radio mode.

 *Dolby Surround Pro-Logic II and the Dolby icon are trade-marks of Dolby Laboratories Licensing Corporation. The Dolby Pro-Logic II Surround System is manufactured under license from Dolby Laboratories Licensing Corporation.*



## Bang & Olufsen Audio Sound Settings

To access sound settings, select <SETTINGS> from the <AUDIO> menu. Select <AUDIO SETTINGS> and press **ENTER**. Select required features and adjust settings using the rotary joystick and press **ENTER** to confirm.

**Bass:** Level for bass.

**Treble:** Level for treble.

**Balance:** Balance between the left and right speakers.

**Fader:** Balance between the front and rear speakers.

**Surround:** Level for surround sound.

**Auto Volume Control:** Auto volume control adjusts tone based on the output level to maintain tonal balance at all volume levels.

Select from <Off>, <Low>, <Optimum>, and <High>.

## Sound Focus

The focus of the sound from the audio system can be optimised for either the driver or the driver and passenger. Select:

 *The audio system detects seat occupancy by seat belt engagement.*

**Auto:** The audio system automatically detects if driver only or driver and passenger(s) are in the vehicle.

**Driver:** The focus of the sound is optimised for the driver only.

**Front:** The focus of the sound is optimised for both the driver and the passenger.

## Radio Functions

### Radio Menu

From the AUDIO menu, select the <RADIO> option to display the radio menu.

The RADIO menu allows you to select <AM>, <FM>, <DAB> and <SETTINGS>.

 In the RADIO menu, a music note icon appears above the current radio frequency image.

 DAB is market specific.

### Automatic Tuning

To automatically tune stations:

1. From the RADIO menu, select <AM>, <FM> or <DAB> to display the specific tuner.



2. Press the **JOYSTICK** left to select the previous available station or right to select the next available station.
3. Rotate the **JOYSTICK** to view the list of available stations
4. Press **ENTER** to view the favourites list.

### Manual Tune By Frequency

To tune AM or FM stations manually:

1. From the RADIO screen, push the **JOYSTICK** down to select <SETTINGS>. The SYSTEM SETTINGS screen is shown.
2. Select <Manual Tune> and press **ENTER** to confirm.
3. Rotate the **JOYSTICK** to manually search for stations.
4. Push the **JOYSTICK** up or down to move along the frequency band by 1.0MHz for faster searching.
5. When the desired frequency is reached, press **ENTER** to confirm.

---

## Station List

To view and select from the list of available stations:

1. From the RADIO screen, push the **JOYSTICK** down to select *<RADIO OPTIONS>*.
2. Select *<Station List>* from the list and press **ENTER** to confirm.

Or:

1. From the RADIO screen, rotate the **JOYSTICK**. A new window appears displaying the list of available stations.
2. Rotate the **JOYSTICK** or push it up and down to select a specific station.
3. Press **ENTER** to confirm.

The selected station then starts playing.

---

## Favourite Stations

To view and select a favourite station:

1. From the RADIO screen, push the **JOYSTICK** down to select *<OPTIONS>*.
2. Select *<Favourites>* from the list and press **ENTER** to confirm. Only stations saved as a favourite are shown in the list.

Or:

1. From the RADIO screen, press **ENTER**. A new window appears displaying the list of favourite stations.
2. Rotate the **JOYSTICK** or push it up and down to select a specific station.
3. Press **ENTER** to confirm.

The selected favourite station then starts playing.

### **Adding A Favourite Station**

Press and hold **ENTER** to add the current station to your favourites list.

---

## Sort Stations

The list of available or favorite stations can be order either in alphabetical order or in frequency order. To change the sort order of stations:

1. From the RADIO screen, push the **JOYSTICK** down to select *<OPTIONS>*.
2. Select *<Sort>* from the list and choose either *<By Name>* or *<By Frequency>*. Press **ENTER** to confirm.

## Traffic Announcements

The Traffic Announcement (TA) function makes sure that all traffic announcements interrupt radio programmes.

To turn the traffic announcement function ON or OFF:

1. From the NOW PLAYING screen, push the **JOYSTICK** down to select <OPTIONS>.
2. Select <Traffic announcements> from the list.
3. Press **ENTER** to switch between ON and OFF.

When the traffic announcements are ON, 'TA' is shown on the display.<sup>1</sup>

---

<sup>1</sup>. AM/FM Radio Only

## Automatic Frequency Updating

(AM/FM Radio Only)

The Automatic Frequency (AF) updating function is normally ON and makes sure that the radio tunes to the strongest available transmitter.

To turn the automatic frequency ON or OFF:

1. From the RADIO screen, push the **JOYSTICK** down to select <Options>.
2. The RADIO OPTIONS screen is shown. Select <Options> from the list.
3. Select <Tuner AF>.
4. Press **ENTER** to switch between <ON> and <OFF>.

When automatic frequency is ON, then 'AF' is shown on the display.

## Radio Data System

Radio Data System (RDS) is a system that links together specific network transmitters. It is used, for example, to tune the correct frequency of a station irrespective of the transmitter or the current audio source (e.g. CD). The system can also be used for receiving traffic information (TP) and for finding broadcasts of a specific type. Radio text is also a component of RDS. A radio station can transmit information about the radio programme currently being broadcast.

Messages with a programme code (such as news from RDS stations) will interrupt other audio sources at the volume set for this. As soon as the news broadcast is finished, the audio system returns to the previous audio source and resumes the previous volume setting.

 Some radio stations do not use RDS or only use a limited range of its features.

## DAB Radio Functions

Digital Audio Broadcasting (DAB) radio broadcasts digitally via a network of transmitters. DAB radio provides more stations, more information and a clearer sound quality. DAB is market specific.

### DAB Ensembles

DAB ensembles are groups of DAB broadcasters that transmit multiple digital radio stations on a single radio transmission. There are usually between 6-10 radio stations per ensemble.

 *If the vehicle is in motion and DAB reception is lost, the vehicle may be out of range of the ensemble.*

 *The DAB radio sound quality may be reduced if any auxiliary electrical equipment is connected to the vehicle.*

### Learn

Learn scans the DAB radio frequencies and automatically repopulates the station list with all available stations. Learn is automatic and performs this scan in the background each time the audio is switched ON. To perform the learn process at any time, complete the following:

1. From the DAB screen, push the **JOYSTICK** down to select *<Options>*.
2. Select *<LEARN>* from the list. A message is shown in the screen explaining about the function.
3. Press **ENTER** to start the learn function.
4. The screen shows the progress status of the scan and the number of stations found. Once complete the station list is updated. The first station in the list is then played.

### Current Station Information

To view current station information:

1. From the DAB screen, push the **JOYSTICK** down to select *<Options>*.
2. Select *<Station Info>* from the list.
3. The station name, ensemble name and frequency block for the current station are then shown.

### Station Link

A DAB station link creates a link between the same DAB stations within different ensembles. Therefore if the radio reception on the current station drops below an acceptable level, the DAB system searches other ensembles and if the same station is found and has a better signal, then this station is then used. A 'no signal' message maybe shown whilst the system is searching.

To enable DAB links:

1. From the DAB menu, push the **JOYSTICK** down to select *<Options>*.
2. Select *<DAB link>* from the list.
3. Press **ENTER** to switch between *<ON>* and *<OFF>*.

### Comfort Noise

Comfort noise is a low synthetic background noise which is used to fill the silence when using certain DAB functions. This indicates that the DAB system is still working.

To enable the comfort noise:

1. From the DAB menu, push the **JOYSTICK** down to select *<Options>*.
2. Select *<Options>* from the list.
3. Select *<Comfort Noise>*.
4. Press **ENTER** to switch between *<ON>* and *<OFF>*.

### Skip AM

When selecting between different radio tuners using the **RADIO** button on the console, the selection can be limited by not showing AM stations. This makes it easier to select between FM and DAB radio tuners.

To skip the AM radio tuner when using the **RADIO** button for selection:

1. From the DAB menu, push the **JOYSTICK** down to select *<Options>*.
2. Select *<Options>* from the list.
3. Select *<Skip AM>*.
4. Press **ENTER** to switch between *<ON>* and *<OFF>*.

### iPod and USB Connection

 On initial connection and on every engine start the system will synchronise with the connected device. This will take a short while to complete.

 The iPod controls will not operate while connected to the vehicle audio system. All functionality will be from the vehicle audio system.

 Aston Martin recommend using a genuine Apple™ cable (available separately) when connecting an iPhone, iPod or iPad. Non-genuine cables can provide limited functionality.

There are two USB sockets located in the front cubby box. Locate the required socket and connect:

- an iPod player using a suitable iPod USB cable.



 If a *Apple Carplay* compliant device is connect to the *Carplay USB* socket, *Apple Carplay* will launch (Refer to '*Apple CarPlay*', page 6.7).

- a USB device.

If not already ON, set the audio system to ON. Press the **SOURCE** button to cycle the audio sources until either the required *<iPod>* or *<USB>* shows on the display.

The iPod or USB device can now be operated by the audio system and are shown and access in order of connectivity.

## Playing Tracks

Once the mode has been set to either iPod or USB play automatically starts.



## Selecting Tracks

Press the **JOYSTICK** down to show the music folder list. Select from *<Tracks>*, *<Albums>*, *<Artists>* and *<Playlists>* (if using an iPod) to navigate to the required music tracks. Press **ENTER** to open a folder or play a track.

## Pause Mode

Press **ENTER** to pause a track whilst playing. Press **ENTER** again to start play.

When the volume is at zero, play will pause. Start play by turning the volume up.

## Fast Forward and Rewind

Press and hold the **JOYSTICK** (left or right) to search within a track or the whole music folder. The search continues as long as the **JOYSTICK** is held.



### Album Search

Press the **JOYSTICK** up to show available music albums. Any album art that has been previously synchronised will also be shown (Refer to 'Album Art', page 8.13). Rotate the joystick to search through available albums or quickly rotate the joystick to start a quick search. Press **ENTER** to select an album and begin audio playback.

### Changing Tracks

Press the **JOYSTICK** (left or right) to play the next or previous track.

### RDS Radio Stations

Traffic Announcements (TA) are also available when in USB or iPod mode. (Refer to page 8.9)

### Album Art

When an iPod, iPhone, iPad or USB device is connected to the vehicle and a music album is played, album art for that music album is synchronised and stored on the vehicle. The album art will then be shown whenever the associated music is played.

To synchronise all available artwork from a device onto the vehicle, press the **JOYSTICK** down to show the music folder list. Select <Sync Artwork> and press **ENTER** to synchronise all available album art. A progress bar will be shown with the number of synchronised files and total number of files<sup>1</sup>. Whilst album artwork is synchronising there will be no audio playback.

Any album art files previously saved will be passed over but included in the number of files to be synchronised. Synchronising can be stopped at any time by pressing **ENTER** again, or navigating away from the <Sync Artwork> screen. For example, pressing the **RADIO** button.

A maximum of 1000 album art files can be saved to the vehicle. Any further art that is added will replace the oldest unused files.

---

<sup>1</sup>. The time taken will depend on number of files to be synchronised.

### Connecting a Mobile Phone or MP3 Device

Enable Bluetooth® wireless technology on the required mobile phone or MP3 device. The mobile phone or MP3 device must be paired to the vehicle. If the mobile phone or MP3 device is not yet paired, follow the pairing phones information (Refer to 'Bluetooth Pairing', page 6.4).

### Selecting the Mobile Phone or MP3 Device

Select the required Bluetooth® enabled device by using the **SOURCE** button. All connected devices are shown in the Audio menu.

The artist, track name, album and time are then shown in the display.

 *Some devices may play erratically if more than one device is connected by Bluetooth®. If such playback issues do occur, disconnect devices that are not in use.*

### Changing Tracks

Push the **JOYSTICK** (left or right) to play the next or previous track. Changing tracks is also available from the mobile phone or MP3 device whilst connected via the Bluetooth® wireless technology.

### Audio Volume

Upon initial connection, audio playback may be a lower volume than any other media inputs. The volume level of the device can also be increased or decreased independent of the vehicle's audio system. Please check that the device volume is not set too low.

### Album Art

Album art is unable to be sent to the vehicle with a Bluetooth® connection. However if a music track is played and the album art associated with that track has previously been saved to the vehicle, then the album art will be shown. (Refer to 'Album Art', page 8.13)

## Auxiliary Functions

### Audio Device Connection

The auxiliary input socket is provided to connect audio devices which can not be connected using the iPod or USB connections.

 *Only volume control will be available from the vehicle audio system. All other functionality will be from the audio device.*

Locate the auxiliary socket in the front armrest cubby box. Connect the audio device to the auxiliary socket using a suitable cable.

If not already ON, set the audio system to ON. Press the **SOURCE** button until AUX is highlighted on the display.

The media device now plays through the Infotainment system.



### Audio Device Volume

The vehicle audio system volume can be set at a higher or lower starting volume for the audio device.

From the AUDIO menu, select <AUXILIARY INPUT> **ENTER** <AUXILIARY GAIN>. Rotate the **JOYSTICK** to set the auxiliary gain level.

Press **BACK** to return to the main display.



# Hands-Free Phone

Introduction .....	9.2
Hands-Free Functions .....	9.2
Bluetooth Device Management .....	9.3
Using a Phone .....	9.4

## Introduction

A mobile phone device equipped with Bluetooth® technology can be connected wirelessly to the vehicle's hands-free phone system. The vehicle's hands-free phone system then lets you have remote control of a range of the mobile phone's functions. The mobile phone can always be operated by its own keys regardless of whether or not it is connected.

The hands-free system is available when the vehicle key is in ignition position 'I' or 'II'. If, during a call, the vehicle key is moved to position '0' or removed the call will transfer to the mobile phone after approximately six seconds.

The system microphone is located in the vehicle roof above the drivers head and the speech from an incoming call is from the two door speakers.

 *The hands-free phone system uses the internal antenna of the mobile phone.*

 *The hands-free phone system uses the internal antenna of the mobile phone. Placing the mobile phone in the trinket tray may degrade the hands-free system performance.*

## Bluetooth Pairing

Before the hands-free system can be used, a phone must be 'paired' to the infotainment system (Refer to 'Bluetooth Pairing', page 6.4)

The hands-free phone system will not recognise a mobile phone, even if it was previously 'paired', if the mobile phone does not have the Bluetooth® wireless technology switched ON. For more information refer to the user's guide for your mobile phone.

## Hands-Free Functions



[1] **VOLUME:** Volume control.

[2] **ENTER:** Press to answer or make a call, select in the menu or open a selection.

[3] **MENU:** Opens the main menu.

[4] **JOYSTICK:** Navigate in the menus, move forwards or backwards when entering text and digits.

[5] **DISPLAY:** Shows options, menus and information.

[6] **PHONE:** Press to access the phone menu.

[7] **BACK:** End a call, navigate back in the menu, cancel a selection or erase the previous character when entering text and numbers.

[8] **CALL:** Press to answer a call or press to return to hands-free mode from audio when hands-free mode is ON.

[9] **VOLUME:** Volume control during a call.

[10] **SCROLL:** Navigate in the menus.

[11] **CANCEL:** Press to end a call or press to enter audio mode when hands-free mode is selected.



## Audio Settings

### Call Volume

During a call the call volume can be regulated using the **VOLUME** dial or the volume controls on the steering wheel.

### Audio System Volume

All audio sources will be automatically muted for incoming calls

## Bluetooth Device Management

### Connecting and Disconnecting Devices

Once the infotainment system and a mobile device are paired (Refer to 'Bluetooth Pairing', page 6.4), the infotainment system automatically connects to the last connected mobile device when the ignition is set to ON<sub>1</sub>.

To connect or disconnect additional paired mobile devices to or from the infotainment system, press **PHONE**, and navigate to <BT DEVICES>. Scroll through available devices and push the **JOYSTICK** right to access the device connection options. Select *Connect* to set the selected device as the active phone for calls and messages.

Only one device can have an active connection to the infotainment system. Connecting another device disconnects the previously connected device.

 *Disconnected devices are still stored in the infotainment system.*

<sup>1</sup>. Bluetooth® wireless technology must be activate on the mobile phone



The vehicle will **automatically** disconnect the connected device when the ignition is switched OFF. Any active calls will be transferred back to the mobile phone.

### Deleting a Device

The vehicle infotainment system supports paired links with up to 10 mobile devices. If additional devices are to be connected, one of the existing paired devices must be deleted.

To delete a device, select *Delete handset* from the device connection options.

## Using a Phone

### Making a Call

Check that the hands-free system is paired.

Press **PHONE** on the centre stack, or **CALL** on the steering wheel controls to view the call history list. Press **PHONE** again to view the menu.

- Navigate to the phonebook or the recent calls list, and select a contact to call. Press **CALL** or **ENTER** to call.

Or

- Navigate to the keypad and dial the number using the keypad. Press **CALL** or **ENTER** to call. Press **BACK** to erase a number. Press and hold **BACK** to erase the whole number.

### Ending Calls

To end a call press **CANCEL** or **BACK**.

### Receiving Calls

To answer an incoming call press **CALL** or **ENTER**.

### Reject a Call

Press **CANCEL** or **BACK** while the phone is ringing.

---

## Text Messages

The text message in the infotainment system is dependant on the mobile phone being used.

Text messages can be either displayed on the infotainment screen<sup>1</sup> or read aloud by the hands free system. For the vehicle to access phone messages, access must be allowed during initial pairing.<sup>2</sup>

When a new message is received, there are the following four options:

**[A] LISTEN:** Hear text message through the vehicle speaker system.

**[B] MSG CENTRE:** View messages on the infotainment display. New messages will have a red dot in the corner of the envelope symbol. (Not available if the vehicle is moving at more than 5 mph).

**[C] CANCEL:** Return to the *Phone Menu*.

**[D] CONTACTS:** View phone contacts.

---

<sup>1</sup> Messages are only available to read if the vehicle is stopped or travelling below 5 mph.

<sup>2</sup> iPhone users must manually set notifications to ON during initial pairing with the vehicle. If notifications are set to ON after pairing with the vehicle the phone will need to synchronise with the vehicle again.

You can also view any previously received messages. From the *Phone Menu* select *Messages* to view the message menu. Any unread messages are marked with a red dot.



ASTON MARTIN



ASTON MARTIN



ASTON MARTIN



ASTON MARTIN





# Convertible Roof

Roof Operation .....	10.2
Conditions for Operating the Roof.....	10.2
Door Windows Reset .....	10.4
Roof Reset.....	10.5
Manual Raise and Lock .....	10.6
Deployable Rollbars .....	10.9
Roof Maintenance.....	10.10
Wind Deflector .....	10.10



## Roof Operation

 **Warning:** Before raising or lowering the roof, make sure that all occupants are clear of the roof linkage, the windscreen frame and door windows.

 **Warning:** Misuse of the roof switch, especially by children, can result in injury due to entrapment in the roof mechanism and locking points.

 **Tip:** Aston Martin recommend that the roof is not operated at temperatures of 0°C and below.

 **Tip:** Make sure that the roof is always fully raised or fully lowered.

 **Tip:** Avoid repetitive use of the roof; this may cause the roof pump to over heat. If the pump over heats roof movement will be inhibited until the pump has cooled.

 **Tip:** Do not attempt to lower the roof if any objects or clothing are laying on top of the roof.

 **Tip:** Continuous use of the roof without the engine operating will cause the vehicle battery to rapidly discharge.

 **Tip:** Do not store objects or items in the roof storage area. Any objects or items stored there may cause damage to the roof when attempting to lower it. Even small objects can cause damage.

## Conditions for Operating the Roof

 **Warning:** Keep the vehicle road speed down to a minimum until the roof has completed its operation.

 **Tip:** Aston Martin recommend that the roof is only operated while the vehicle is stationary.

 **Tip:** Aston Martin recommend that the engine is always running when operating the roof mechanism to maintain optimal battery performance.

 **Information:** The boot lid will lock and will stay locked during roof lowering and raising operations.

- The boot lid must be closed.
- The ignition must be ON and the engine running.
- Outside temperature must be above -10°C.
- Headroom (A) 1865 mm is available for the roof to raise or lower.



If the vehicle is moving while the roof is being raised or lowered, roof movement will continue, while the roof switch is pressed, until the roof has locked in the raised or lowered position.

While operating the roof the following warnings will show, depending on the vehicle speed:

**4 to 5 km/h:** STOP SAFELY FOR ROOF OPERATION will show in the message centre.

**5 to 65 km/h:** STOP SAFELY FOR ROOF OPERATION will show in the message centre, the amber warning triangle will show and a single audible warning will sound. Roof movement will continue.

**Over 65 km/h:** ROOF FAILURE POSSIBLE will show in the message centre, the amber warning triangle will show and a continuous audible warning will sound. Roof movement will continue.

It is not possible to start roof operation at speeds of 50 km/h or above. NO ROOF OPERATION POSSIBLE will show in the message centre, the amber warning triangle will show and a single audible warning will sound. While operating the roof, if the roof switch is released when travelling at 50 km/h or more, no roof movement will be available until the vehicle speed drops below 50 km/h.

**⚠ As soon as it is safe to do so continue the roof movement. If the roof is left in pause for ten minutes, hydraulic pressure will be lost. The roof and tonneau lid will relax and gently fall back. Powered roof operation will be stopped until the roof has been manually fully raised or lowered.**

The roof operation switch (A) is located on the centre console. If at any time during the lowering or raising procedure the switch is released – the roof will stop immediately. ROOF MOVEMENT PAUSED will show in the message centre and an audible warning will sound until the roof continues to raise or lower.



If at any time during the lowering or raising procedure the switch is released – roof movement will stop immediately. ROOF MOVEMENT PAUSED will show in the message centre and a continuous audible warning will sound until the roof continues to lower or raise.

### Operation

 **Warning: Roof movement has not finished and locked until ROOF MOVEMENT COMPLETE shows in the message centre.**

#### Lowering The Roof

Pull the roof switch rearwards and hold until ROOF MOVEMENT COMPLETE shows in the message centre.



#### Raising the Roof

Push the roof switch forwards and hold until ROOF MOVEMENT COMPLETE shows in the message centre and a single audible warning sounds.

If the door windows are required to be raised continue to press the switch after ROOF MOVEMENT COMPLETE shows until the door windows have fully raised.



## Door Windows Reset

In the unlikely event of the roof failing while in the fully raised or lowered position, check for correct operation of the vehicle door windows.

To check the door windows operation use the door window reset procedure (Refer to 'Door Window Reset', page 12.28). Once correct operation of the windows is confirmed, check roof operation again. If the roof will not work then manually raise and lock the roof (if required) and contact your Aston Martin Dealer.

## Roof Reset

**⚠ Warning:** *Aston Martin recommend that a minimum of two people are required to manually lower the roof. The roof mechanism is heavy and will move very slowly when being moved manually.*

**⚠ Warning:** *Keep fingers clear of the roof linkage when moving the roof manually.*

If the roof stalls or is left in 'Pause' for ten minutes or more, hydraulic pressure will be lost. The roof and tonneau lid will relax and, gently, fall back. Powered roof operation will be stopped until the roof has been reset by manually fully raising or lowering the roof.

It is recommended to fully lower the roof to reset.

1. Remove the vehicle key from the Ignition control.

2. With a person each side, support the tonneau lid (A) in the raised position.

While supporting the lid raise the tension bow (B) towards the header of the roof (C).

When the tension bow has reached its mechanical stop bring the header of the roof down towards the tension bow.



**⚠** *Make sure that the tension bow and header lower together. It is possible to damage the roof if the tension bow is allowed to lower without the header.*



3. Continue to support the tonneau lid and lower the tension bow and the header together into the roof storage area. Once the tension bow and the header are stored let the tonneau lid lower.

4. In the areas shown (D), push the tonneau lid down and engage both tonneau lid catches, one each side.



## Manual Raise and Lock

Once the catches have engaged the roof will reset and ROOF MOVEMENT COMPLETE will show in the message centre. Operate the roof using the roof switch.

If the roof does not work contact your Aston Martin Dealer. If the vehicle is to be left unattended or in case of inclement weather, it is recommended that the roof be raised and locked.

 Raising and locking the roof may reset the roof. If ROOF MOVEMENT COMPLETE shows in the message centre use the roof switch to operate the roof.

In the unlikely event of the roof failing during raising or lowering, it can be manually raised and locked, if required.

 **Warning:** *Aston Martin recommend that a minimum of two people are required to manually raise and lock the roof. The roof mechanism is heavy and will move very slowly when being raised manually.*

 **Warning:** *Keep fingers clear of the roof linkage when moving the roof manually.*

 **Vehicle Security:** *If the roof fails always raise and lock the roof. Do not lower the roof. Tonneau lid locks will not be available.*

 *If the roof fails in the stored position it can stay stored and locked if required. Contact your Aston Martin Dealer.*

 *If the roof fails after the tonneau locks have been released the message ROOF FAIL will show in the message centre and a continuous audible warning will sound until the roof has been locked in the raised position.*

1. If installed, remove and store the wind deflector (Refer to 'Wind Deflector', page 6.11).
2. Remove the Allen key from the vehicle tool kit (A).

 *The Allen key is required to lock the roof in position.*

3. Remove the vehicle key and wait for a minimum of five seconds.

 *During this time the roof hydraulics will relax allowing manual movement of the roof. Some hydraulic fluid resistance will still be in the operating rams. It may take considerable effort to fully raise the roof manually.*

4. If the tonneau lid is locked or unlocked but still on its secondary catches.

 *If required power the drivers seat forward.*



5. Remove the vehicle battery cover. Remove the foam insert and locate the two tonneau lid manual release cables. Pull the tonneau lid manual release cables, releasing the tonneau lid.

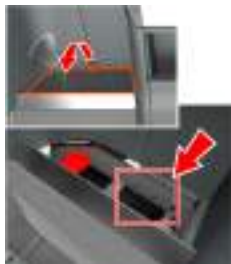

 While pulling the manual release cables, apply slight downward pressure in the middle of the tonneau lid at point B.





6. With a person each side, manually lift the tonneau lid to its fullest extent.

7. With a person each side, support the tonneau lid in the fully raised position, while raising the roof. Place one hand under the roof lining and the other hand under the roof tension bow (positions shown) - lift, both sides, until the tension bow clears the tonneau lid.



8. When the rear tension bow has cleared the tonneau lid, let the tonneau lid lower.

 Hold the roof in position while the tonneau lid lowers.

 It will not be possible to lock the tonneau lid in its lowered position. The raised roof with the tension bow laying on the tonneau lid will be sufficient to secure the tonneau lid when driving.



**⚠ Do not allow the tonneau lid to rest on the roof fabric.**

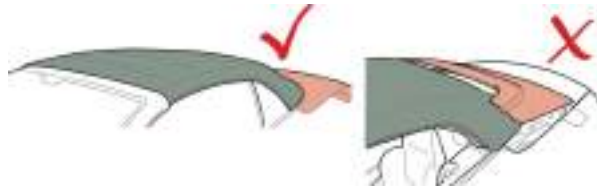

9. Lower the tension bow onto the tonneau lid. At the same time the front of the roof will lower to the top of the windscreen.

10. From inside the vehicle cabin, remove the trim plug.



11. With a person in each seat reach out and pull the roof down (position shown) to make sure that the two lock arms are located in their catches.

**⚠ Warning: Make sure that fingers and hands are not between the roof and the top of the windscreen while locking the roof in position.**





## Deployable Rollbars

12. While the roof is being held down with the two lock arms located in their catches, use the Allen key, from the vehicle tool kit, to lock the roof in position.

 The Allen key must be turned many times to lock the roof.

13. Continue to turn the Allen key until no more movement is possible.

 **Do not use power tools. The roof manual lock and unlock mechanism may be damaged if power tools, i.e. an electric drill, are used to lock or unlock the roof.**





 **Warning: Do not attempt to service or modify the deployable rollbar system.**

 **Warning: Do not allow any person to sit on the deployable rollbar covers at any time.**

 **Warning: Do not place any objects on the top of the deployable rollbar covers.**

 **Warning: Do not attempt to reset the deployable rollbar system after it has deployed.**

 **Warning: Do not attempt to raise or lower the roof after the deployable rollbar system has deployed.**

 **If the roof is raised the deployable rollbars will break through the rear glass.**

 **Extreme manoeuvres may cause the system to predict a roll over and deploy the rollbars for protection of the occupants. If such driving events are anticipated by the customer (e.g. track day driving) the roof should be fully lowered to let the rollbars deploy without damaging the vehicle.**

 The deployable rollbar system and the airbag system react independently. The deployable rollbars and the airbags may deploy together or alone, depending on the type of impact.

The deployable rollover system has electronic sensors mounted to the vehicle body that monitors and determines if a rollover has taken place. If the system senses a rollover, two 'U' shaped roll bars, concealed by trim panels in the tonneau lid (A), will deploy to protect vehicle occupants.

If the deployable rollbar system has been deployed, contact your nearest Aston Martin Dealer.



## Warning Labels

The following warning is located on the deployable rollbar system:



## Roof Maintenance

⚠ ***Do not use automatic vehicle washes. Brushes, detergents and pressurised water jets may damage the roof fabric.***

⚠ ***Do not use power washers. Jets of water may damage the weather seals and the roof fabric.***

⚠ ***Do not use spot cleaners, chemical diluents or any organic cleaners. If in doubt, contact your Aston Martin Dealer.***

⚠ ***Do not leave the roof in the lowered (folded) position for extended periods of vehicle storage. Permanent damage may occur to the roof fabric.***

### Roof Fabric Maintenance

(Refer to 'Convertible Roof Fabric', page 11.37)

## Wind Deflector

### Option

A wind deflector can be installed to enhance comfort when driving with the roof lowered:

- Wind turbulence is greatly reduced.
- It easily installs to existing mounts within your vehicle.
- The wind deflector can be left in place with the roof raised or lowered.
- Easily folded and stowed away when not used.

⚠ ***Take care when adjusting the driver or passenger seat position with the wind deflector installed. Make sure that the seats do not come into contact with the wind deflector.***

## Storage

When the wind deflector is not required, remove it from the vehicle and place it in the storage bag. The bag is secured to the back wall of the boot at four location points.

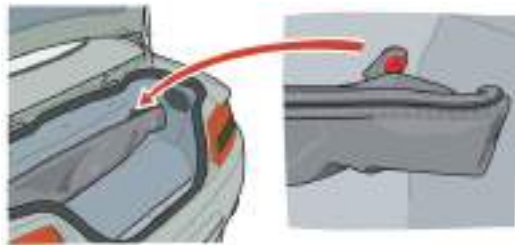

 *The bag installs as shown with the four tabs towards the boot wall.*



## Install and Remove

Remove the wind deflector from the storage bag located in the boot and unfold.



Locate the two tabs on the wind deflector into the slots provided in the top seat belt mounts.



Push down at the points shown. Make sure that the mounts fully clip into place and are secure.



To remove the wind deflector pull up at the points shown to un-clip the two tabs from the top seat belt mounts. Remove the wind deflector from the vehicle, fold it flat, put it in the storage bag and place the bag in the storage area in the vehicle boot.



ASTON MARTIN

# Satellite Navigation

Important Safety and Product Information .....	11.2
Navigation Controls.....	11.2
Navigation Menu.....	11.3
Navigate.....	11.4
Map .....	11.6
Points of Interest (POI) .....	11.8
Traffic .....	11.9
Settings .....	11.10

## Important Safety and Product Information

**Warning:** Failure to avoid the following potentially hazardous situations could result in an accident or collision resulting in death or serious injury.

**Warning:** Always use your best judgement, and operate the vehicle in a safe manner. Do not become distracted by the navigation system while driving, and always be fully aware of all driving conditions. Minimise the amount of time spent viewing the screen while driving and use voice prompts when possible.

**Warning:** Do not input destinations, change settings, or access any functions requiring prolonged use of the navigation system controls while driving. Bring the vehicle to a halt in a safe and legal manner before attempting such operations.

**Warning:** When navigating, carefully compare information shown on the screen to all available navigation sources, including road signs, road closures, road conditions, traffic congestion, weather conditions, and other factors that may affect safety while driving. For safety, always resolve any discrepancies before continuing navigation, and defer to posted road signs and road conditions.

**Warning:** The navigation software is designed to provide route suggestions. It is not a replacement for driver attentiveness and good judgement. Do not follow route suggestions if they suggest an unsafe or illegal manoeuvre or would place the vehicle in an unsafe situation.

## Navigation Controls

### Operation

The navigation system is available with the vehicle key in position 'I' or 'II'.

Press **NAV** on the centre stack, or select the Navigation icon and press **ENTER** if already in the Infotainment menu.



## Navigation Menu

**[1] SCREEN:** Shows maps and provides detailed information on route type, distance, etc.

**[2] BACK:** Press to return to the previous menu or to undo a choice.

**[3] NAV:** Press to open the *Map* screen (Refer to 'Map', page 11.6).

A second press will open the *Navigation Menu* screen (Refer to 'Navigation Menu', page 11.3).

**[4] JOYSTICK:** Navigate through different menu options, traffic messages, etc.

Rotate to zoom the map in or out.

**[5] ENTER:** Press to confirm, select or navigate from one submenu to the next submenu.



The Navigation menu opens with several options available:

**[1] DESTINATION COUNTRY:** To change the destination country, rotate the **JOYSTICK** to cycle through letters and press **ENTER** to confirm a selection.

To delete a character, push the **JOYSTICK** to the left.

**[2] NAVIGATE:** (Refer to 'Navigate', page 11.4)

**[3] POI:** (Refer to 'Points of Interest (POI)', page 11.8)

**[4] DISPLAY MAP:** (Refer to 'Map', page 11.6)

**[5] CANCEL NAVIGATION:** Press to cancel the navigation route (if one is set).

**[6] GPS:** Shows satellite information such as available number of satellites and signal quality

# Navigate

## Address Entry

The a destination can be set one of two ways in the **Navigate** menu:

- Address Entry
- Recent Addresses



## Address Entry

Rotate the **JOYSTICK** to cycle through letters and numbers and press **ENTER** to confirm a selection. The address list will show available addresses from the characters entered.

Once a letter or number has been selected, only the characters that follow in any available matches will be selectable.

To delete a character, push the **JOYSTICK** to the left.



 A street name cannot be selected until a town or city has been set.

 A street name cannot be entered if a 7 character post code is entered.

Push the **JOYSTICK** to the right to access the address list along with a map showing each address location.





---

### Recent Address

To select a HOME, WORK or recent destinations<sup>1</sup>, press the **JOYSTICK** right to access the address list along with a map showing each address location. Rotate the **JOYSTICK** to scroll available addresses and press **ENTER** to select a destination.

### Destination Selection Options

Press **ENTER** on an entry in the address list to open the options below:

- Navigate to here  
Opens the map screen and calculates a route.
- Enter Street/Enter Building Number  
Opens the address entry screen to further refine the destination location.
- Near to Here  
Opens the Destination POI screen with the origin point set to the current selection. (For example, Chelmsford).
- Save as HOME  
Saves the selected destination as your *HOME* address.
- Save as WORK  
Saves the selected destination as your *WORK* address.



---

<sup>1</sup>. HOME and WORK addresses are only shown once they have a saved address.

## Guidance Start

If *Alternative Routes* has been set to ON in the navigation settings menu, three routes will be calculated in order of quickest time. Each will show total distance and arrival time with an overview of the proposed route.

Rotate the **JOYSTICK** and press **ENTER** to select a route.



## Map

### Map Controls

Push the **JOYSTICK** up or down to display the map view menu.



[1] **NAVIGATION:** Opens the **Address Entry** screen.

[2] **CANCEL ROUTE:** Cancel the selected route.

[3] **TRAFFIC:** Open the **Traffic** screen.

[4] **HEADING ORIENTATION:** Press to cycle between:

- 2D North  
2 dimensional map with north always at the top of the screen.
- 2D Heading  
2 dimensional map with the vehicles direction always at the top of the screen.
- 3D heading  
3 dimensional map with the vehicles direction always at the top of the screen.

[5] **VOICE MUTE:** Set voice instructions on or off.

[6] **ROUTE OVERVIEW:** Shows an overview of the navigation route.

[7] **SETTINGS:** Open the Settings menu



**Map Zoom**

Rotate the **JOYSTICK** clockwise to zoom in and counter-clockwise to zoom out of the map.

**Map Browse**

Press and hold **ENTER** to enable browse map.

**Information Bars**

Press **ENTER** to cycle if the upper and lower information bars are shown.

Estimated time of arrival (ETA) will be shown at the top of the screen.

**Next Turn**

If there is an approaching turn, the distance and street name are shown at the top of the screen.



Push the **JOYSTICK** left or right to cycle if the turn information window is shown.

The turn information window will show a view of the next turn or junction and the gauge on the left illuminates as you approach the junction.

**Browse Map**

Whilst in map browse, press and hold **ENTER** to open the browse map function, and push the **JOYSTICK** up, down, left or right to move the cursor around the map.

Press **ENTER** to place a marker on the cursor position. This will open the POI window and allow you to search for locations in the area chosen.



## Points of Interest (POI)

Press **BACK** to cancel the set marker window and return to the map browse screen.

Press **BACK** to move the cursor back to the vehicle. Press **BACK** again or press and hold **ENTER** to return to the **Map** screen.

Rotate the **JOYSTICK** to cycle through letters and numbers and press **ENTER** to confirm a selection.

Once a location name or partial name has been entered, push the **JOYSTICK** to the right to access the category list. Scroll and select a category to search.



The results list will then show a list of available POIs in distance order within that category and a map to show location. The map will update to centre on the selected result from the results list.

## Traffic

### POIs on Route

If a route is already set, you will have additional options when opening the POI menu:

- Waypoint  
Adds POI into the set route.
- Destination  
Adds POI as a destination after the set route.
- New Route  
Cancel the set route and set a new destination.



The *Trafficscreen* shows delays on a selected navigation route. Any delays will be shown as time delays in hours and minutes.

### All Delays On Route



Any delays on the selected route will be shown, along with how far along the route each individual delay is. The top traffic information bar will also describe:

- The type of delay,
- The road the delay is on,
- How far away the delay is,
- How long the delay is in distance,
- The time added to your journey.

Delays are also shown by their severity.

**Green:** Traffic is moving freely - Low severity

**Orange:** Traffic is moving but with some congestion - Medium severity

**Red:** Traffic is not moving or is moving slowly - High severity

# Settings

## Map Settings

 Navigation settings are also accessed from the vehicle settings menu.

### Map Orientation

Select from:

- 2D North  
2 dimensional map with north always at the top of the screen.
- 2D Heading  
2 dimensional map with the vehicles direction always at the top of the screen.
- 3D Perspective  
3 dimensional view of 2D Heading

### Display Mode

Select from:

- Auto  
Automatically change between *Day* and *Night* mode.
- Day  
Set the display to use brighter colours suitable for daytime driving.
- Night  
Set the display to use darker colours to reduce glare from the navigation screen when driving at night.

### Show POIs on Map

Set whether to show Points of Interest (POIs) on the map.

### Show Landmarks on Map

Set whether to show landmarks on the map.

### Show 3D Buildings

Set whether to show buildings on the map.

### Satellite Images

Set whether to show satellite images on the map.

### Automatic Zoom

Set whether to automatically zoom in and out of the map depending on speed and distance to junctions.

## Navigation Options

### Voice Prompts

Sets voice announcements ON or OFF.

### Voice Language

Sets the language for voice announcements<sup>1</sup> (Final List TBD)

### Street Names

Set to add street names on map.

### Alternative Routes

Set whether alternative routes are offered when a destination is selected.

---

<sup>1</sup> Navigation language can be set independently of infotainment system language.

---

***Avoid Options***

Select features to avoid when calculating navigation routes. Select the following check-boxes:

- Avoid Motorways
- Avoid Toll Roads
- Avoid Ferries
- Avoid Motorail Trains
- Avoid Tunnels
- Avoid Unpaved Roads
- Avoid Car Pool Lanes

***Speed Limits***

Show current speed limit on map.

***Re-routing***

Allow automatic re-routing.

---

***Restore to Default******Clear Recent***

Clear recent address, HOME and WORK history.

***Reset All***

Restore all navigation settings to default



ASTON MARTIN



ASTON MARTIN



ASTON MARTIN



ASTON MARTIN



# Maintenance

Introduction .....	12.2	Brake Pad Bedding-in.....	12.11	Headlamp .....	12.25
Vehicle Jacking.....	12.3	Tyres .....	12.12	Other External Lamps.....	12.26
Servicing Precautions.....	12.3	Winter Tyres .....	12.13	Boot Lamps .....	12.27
Emergency Items .....	12.5	Tyre Sealant Kit .....	12.14	Internal Lamps .....	12.27
Owner Maintenance .....	12.6	Vehicle Recovery .....	12.16	Door Window Reset.....	12.28
Bonnet Release .....	12.7	Vehicle Battery .....	12.18	Front Seat Reset .....	12.28
Fluid Levels .....	12.8	Vehicle Battery Charge.....	12.20	Bodywork Maintenance .....	12.29
Windscreen Blade Replacement.....	12.11	Battery Protection Mode .....	12.22	Vehicle Cleaning .....	12.29
		Fuse Boxes .....	12.23	Vehicle Storage .....	12.33

## Introduction

Each item in the service schedules must be performed on time as failure to do so may void the new vehicle warranty or other warranties. It is the owner's responsibility to see that the vehicle is maintained correctly and in accordance with the manufacturer's service schedules.

Due to the sophistication of the various systems and the specialised equipment required to maintain this vehicle, owner maintenance should be restricted to the routine procedures described in this owner's guide.

If you think that this vehicle is not functioning correctly, please return it to an Aston Martin Dealer to be checked professionally.

### Restraint Systems

Aston Martin recommend that the inflatable (airbags) restraint systems and seat belt components installed to this vehicle are replaced at 10 year intervals from the date of manufacture on the certification label.

### Electronic Fuel Injection

 **Warning: If the fuel system is allowed to run dry, irreparable damage to the fuel pumps may occur.**

 **Warning: Any modifications or additions to the fuel system not specifically designed by Aston Martin are prohibited. If carried out, they may cause damage to the fuel system which in some circumstances could result in fire. All Service Action and Safety Recall Campaigns must be undertaken by an Aston Martin Dealer.**

The electronic fuel injection system requires special equipment and test facilities to set up and maintain so that the vehicle gives maximum performance coupled with economy, reliability and safe vehicle emissions. You are, therefore, strongly advised to entrust all service work to an Aston Martin Dealer.

### Parts and Lubricants

When undertaking a servicing task only parts, materials, lubricants, etc. that are specifically recommended by Aston Martin should be used. Failure to do so can result in damage to your vehicle and may invalidate your new vehicle warranty or other warranties (Refer to 'Aston Martin Warranty', page B.1).

 **Your vehicle's warranty may be invalidated if damage is caused by the use of incorrect engine oil. Low quality or obsolete oils do NOT provide the protection required by modern, high performance engines. Failure to use engine oil that meets the required specification could cause excessive engine wear, a build up of sludge and deposits, and increased pollution. It could also lead to engine failure.**

## Vehicle Jacking

 **Warning:** Make sure that no persons are in the vehicle before jacking commences.

 **Warning:** Make sure that the park brake is ON and that the vehicle transmission is in first gear.

 **Warning:** Make sure that the vehicle is parked on firm and level ground to give a secure base for the jack.

 **Do not raise the vehicle by placing a vehicle jack under the suspension arms.**

If this vehicle is to be raised using a vehicle jack make sure that the following jacking points are used.

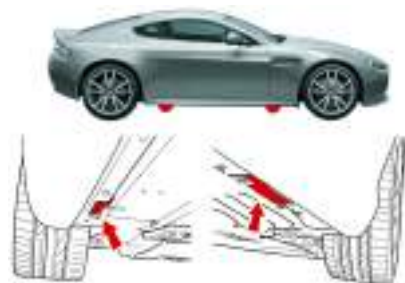



## Servicing Precautions

To avoid personal injury, the following safety precautions must be observed when the bonnet is open and the engine is operating or the ignition is ON.

 **Warning:** Protect yourself against dangerous substances .

 **Warning:** Keep hands, hair, tools, items of clothing and jewellery clear of all drive belts, pulleys and operating mechanisms. The cooling fans may operate even though the engine is not operating.

 **Warning:** Avoid skin contact with all exhaust system and engine components, engine fluids and escaping steam. They may be hot and can cause scalding or burns.

 **Warning:** Do not breathe exhaust fumes. Exhaust fumes contain carbon monoxide. Carbon monoxide is a dangerous gas, which is colourless and odourless and can cause unconsciousness and may be fatal. Never start or leave the engine running in an enclosed, unventilated area.

 **Warning:** Do not work beneath the vehicle with a vehicle lifting jack as the only support. Place suitable stands under the vehicle.

 **Warning:** Keep children and pets clear of the vehicle. Do not let anyone inside the vehicle unless specifically working to your instructions.

 **Warning:** Whenever possible, work in the engine compartment with the engine cool, the ignition OFF and the vehicle battery disconnected.

 **Warning:** Petrol is highly flammable and, in confined spaces, is also explosive and toxic. In the event of spillage, set the engine to OFF. Do not use a flame or spark near fuel or fuel vapour. Do not smoke near fuel or fuel vapour. Do not inhale fuel vapour or fumes.

## Dangerous Substances

 **Warning:** Dangerous substances should be kept out of reach of children.

 **Warning:** Many liquids and other substances used in motor vehicles are poisonous and should under no circumstances be consumed and should, so far as possible, be kept from contact with the skin. These substances include battery electrolyte, antifreeze, oil, brake and clutch fluid, petrol, windscreen washer additives, lubricants, refrigerant and various adhesives.

 **Warning:** Particular care should be taken to avoid unnecessary contact with used engine oil. Always read carefully the instructions printed on labels or stamped on components and follow them carefully. Such instructions are included for reasons of your health and personal safety. Never disregard them.

## Engine Oils

 **Warning:** Prolonged and repeated contact with used engine oils can cause serious skin disorders, including dermatitis and cancer. Avoid excessive contact, wash thoroughly after contact. Keep out of reach of children. When your oil is changed, be sure that it is done by an experienced person. In addition, observe all laws regarding the disposal of waste oil and toxic fluids.

## Emergency Items

### Protect The Environment

 **Warning:** It is illegal to pollute drains, water courses, or soil. Use authorised waste disposal facilities, including civic amenity sites and garages providing facilities for receipt of used oil. If in doubt, contact your local authority for advice.

[1] : Tyre Sealant Kit (not shown) (Refer to 'Tyre Sealant Kit', page 12.14).

 **Always follow local regulations when placing a warning triangle.**

[2] : Warning Triangle.

[3] : First Aid Kit (optional).

[4] : Tool kit consisting of:

- Towing eye (Refer to 'Vehicle Recovery', page 12.16)
- Allen key (roadster only) (Refer to 'Manual Raise and Lock', page 10.6)
- Road wheel lock nut socket (optional)



[A] : Coupe

[B] : Roadster

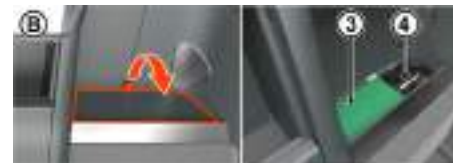

## Owner Maintenance

In the interests of safety and reliability, it is advisable to carry out the following checks at the intervals suggested (more frequently if your vehicle is heavily used or operating in adverse conditions), and always before starting on a long journey. Refer to the following pages for advice and check procedures.

### Before Use Check:

- Operation of lamps, horn, indicators, wipers, washers and warning symbols
- Check there is sufficient fuel for the intended journey, particularly at night and before entering motorways
- Operation of the seat belts
- Operation of the brakes
- Check for fluid deposits underneath the vehicle.

### Weekly Checks

(daily if covering high mileage or touring)

- Tyres
- Coolant level
- Brake fluid level
- Power steering level
- Operate air conditioning
- Windscreen washer fluid level
- Check operation of windscreen washers.

### Fuel Filler Bowl

During fuel filling check that the fuel filler bowl drain pipe is free from debris which may block the pipe. If the pipe is blocked water can not drain from the bowl and can overflow into the fuel tank.

### Engine Oil Level

 ***It is important to check the engine oil level regularly. Running the engine with engine oil below the lower mark or above the upper mark can cause serious engine damage.***

Check the engine oil level every fourth fuel tank fill or weekly - whichever is the sooner.

### Battery Conditioner

A battery conditioner is located in the boot storage area. This is an optional item.

(Refer to 'Battery Conditioner', page 12.20)

## Bonnet Release

⚠ **Do not press down hard on the bonnet if it has not closed correctly. This may damage the bonnet.**

⚠ **Take care to not unintentionally pull on or catch the bonnet release lever.**

⚠ **Warning: Do not pull on the bonnet secondary catch to close the bonnet. This may displace the bonnet secondary catch and cause it to not align correctly.**

📖 The windscreen wipers will temporarily rest in the park position if the bonnet is unlatched.

📖 Remove any tools, cleaning cloths, etc. from the engine compartment before closing the bonnet. Make sure that no one is obstructing the 'closing' area and that hands, clothing etc. are clear.

📖 If the bonnet does not fully close or it opens during driving, the message centre will show BONNET OPEN.



Pull the bonnet release lever (A) located in the left front footwell. The bonnet will release, but stay secured by the bonnet secondary catch.

Slightly lift the front edge of the bonnet whilst pulling upward on the bonnet secondary catch (B) to release it. Lift the bonnet until fully open. The bonnet is held open by two gas struts.



To close the bonnet, lower the bonnet until it starts to fall under its own weight and allow it to close.

If the bonnet does not shut, open and close the bonnet again, but gently push down as the bonnet falls.

## Fluid Levels

 **Warning:** Engine components may be hot and could cause severe burns.



- [1] : Washer fluid reservoir.
- [2] : Brake fluid reservoir<sub>1</sub>.
- [3] : Engine coolant reservoir.
- [4] : Power steering fluid reservoir.
- [5] : Engine oil filler cap and oil dipstick.

---

<sub>1</sub>. Changes sides for left and right hand drive.

## Windscreen Wash Fluid Level

Top up as required. Increase the fluid concentration in winter to prevent the windscreen wash fluid (refer to the manufacturers recommendations on the windscreen wash fluid container).



When the windscreen wash fluid is low a warning message will show in the message centre and an amber warning symbol will come ON.

**Local or state regulations may restrict the use of volatile organic compounds (VOCs), which are commonly used as antifreeze agents in windscreen washer fluid. A windscreen washer fluid with limited VOC content should be used only if it provides adequate freeze resistance for all regions and climates in which the vehicle will be operated.**

## Windscreen Washer Jets

The washer jets are located on the rear edge of the bonnet.

If adjustment is required, adjust so that the fluid strikes between a third and half way up the windscreen.



## Brake Fluid Level

 **Warning:** Do not drive the vehicle if the brake fluid level is below the minimum mark.

 Make sure that the brake fluid does not contact the paint work during the topping up operation. Serious paint work damage can result. If a spillage does occur, immediately flush any brake fluid from the paint work with clean, fresh water and then wipe with a clean damp cloth.

The brake fluid level should read between the Min. and Max. marks.

1. Remove the reservoir cap. Top up to the Max. level.
2. Install the reservoir cap securely.



## Engine Coolant Level

 **Warning:** Do not remove the filler cap until the coolant system has cooled. Scalding can be caused by escaping steam or coolant.

 Use a cloth or glove to protect hands and protect face and arms adequately.

1. Remove the pressure cap to check the coolant level. The correct coolant level is to the top of the reservoir tank. Top up with the correct antifreeze mix, if required (Refer to 'Fluids and Capacities', page 13.4).
2. Make sure that the filler cap is secure after topping up.

 **Do not over tighten.**



## Power Steering Fluid Level

 Make sure that the power steering fluid does not contact the paint work during topping up. Serious paint work damage can result. If a spillage does occur, immediately flush any power steering fluid from the paint work with clean fresh water, then wipe with a clean damp cloth.

Always check the reservoir level when the engine is cold and with the front road wheels in the straight ahead position.

Wipe the reservoir cap clean before removing to prevent an ingress of contaminants.

1. Remove the reservoir cap and wipe the dipstick clean with a lint free cloth. Replace and remove again. The fluid level should read between the Min. and Max. marks.
2. If required, top up fluid level. **Do not overfill.**



## Engine Oil Level

**⚠ Warning: Engine oil or components may be hot and could cause severe burns.**

**⚠ Running the engine with engine oil below the lower mark or above the upper mark can cause serious engine damage.**

**⚠ This vehicle's warranty may be invalidated if damage is caused by the use of incorrect engine oil. Low quality or obsolete oils do NOT give the protection required by modern, high performance engines.**

**⚠ Failure to use engine oil that meets the required specification could cause excessive engine wear, a build up of sludge and deposits, and increased pollution. It could also lead to engine failure (Refer to 'Fluids and Capacities', page 13.4).**

**⚠ Make sure that there is oil in the reservoir before the engine is started. Look for a sign of engine oil on the dipstick. Running the engine with no engine oil in the reservoir can cause serious engine damage.**

The vehicle should be on level ground.

Check the oil level when the engine is completely cold

Before starting the engine to check the oil level, remove the oil reservoir cap and wipe the dipstick clean with a lint free cloth. Replace the cap fully tighten and then remove. Check that there is engine oil on the dipstick. If there is no oil on the dipstick top up the reservoir until oil registers on the dipstick. Replace the cap and fully tighten.

## Oil Level Check:

**📖 Oil will expand when hot. For an accurate check, check the engine oil level when the engine is cold.**

- Operate the engine at 1500 - 2000 rpm for 20 seconds then set the engine to OFF.
- Wait 30 seconds then remove the oil reservoir cap and wipe the dipstick clean with a lint free cloth. Replace the cap and fully tighten.
- Remove the cap again - avoid contact with the sides of the tank. If the level is below Max., top up to the Max. mark with the recommended engine oil.

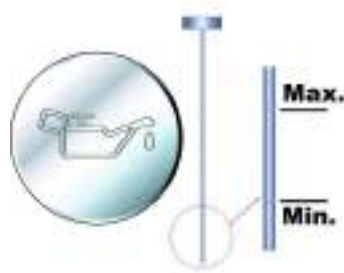

**📖 Approximately one litre is required to bring the level from Min. to Max.**

- Repeat from step 1 to check the level.

## Windscreen Blade Replacement

To replace the windscreen wiper blades, the vehicle must be in wiper service mode.

Set the ignition to position 'I' (ignition OFF and accessories ON).

From the Infotainment system, select <SYSTEM SETTINGS>**ENTER**<Wiper service>**ENTER**. Pressing **ENTER** then enables the wiper service mode.

Set the ignition to position 'II' (ignition ON). This moves the wiper blade arms to the 90° position. Set the ignition to position '0'.

Lift the wiper arm(s) up, press at point (B) and remove the worn wiper blade(s). Install the new wiper blade(s) and lower the wiper arm(s).

After replacing the wiper blade either:

- Move the vehicle key back through to position 'II' to lower the wiper arms. Return the vehicle key to position '0' or remove.
- Operate the wiper stalk - the wiper arms will complete the request and then park.



## Brake Pad Bedding-in

**⚠ Failure to bed-in new brake pads will result in reduced brake performance and possible brake judder or squeal.**

After the installation of new brake pads, brake performance will be reduced, as the brake discs and pads need to be 'bedded-in'. For the first few hundred kilometres of new brake pad use, avoid excessive braking (hard stops from high speed, alpine descents, etc.).

## Tyres

Tyres of the correct type, manufacturer and dimensions, with correct cold inflation pressures are an integral part of every vehicle's design. Regular maintenance of tyres contributes not only to safety, but to the designed function of the vehicle.

Road holding, steering and braking are especially vulnerable to incorrectly pressurised, badly installed or worn tyres.

Tyres of the correct size and type, but made by different manufacturers can have widely varying characteristics. Only install tyres approved by Aston Martin.

### Tyre Pressures

Make sure that correct tyre pressures are carefully maintained. Road holding, steering, braking and tyre wear are especially vulnerable to incorrect tyre pressures.

Check tyre pressures regularly and before starting any journey, and adjust accordingly.

Tyre pressures increase slightly when the tyres are hot. For an accurate reading, tyre pressures should be checked when the tyres are cold. After adjusting the tyre pressures, make sure that the valve caps are securely replaced to provide an additional air seal and to prevent the ingress of dirt.

### Tyre Service

 *Because of the high performance potential of this vehicle, Aston Martin strongly recommend replacement of any damaged or worn tyre.*

The recommended tyres for this vehicle are asymmetrical and must be installed to the wheel with the tyre mark 'OUTSIDE' on the outside of the wheel rim.

The tyres are also of different sizes on the front and rear axles, therefore complete wheels cannot be swapped between axles. Complete wheels can, however, be swapped from side to side on the same axle.

### Damage

Tyres should be examined at regular intervals for wear and damage. Inspect the tyre treads and sidewalls for damage, i.e. bulges in the tread or the sidewalls, cracks in the tread groove and separation in the tread or the sidewalls. If damage is observed or suspected have the tyre inspected by a tyre professional.

Stones or other objects which have become lodged in the tyre treads should be carefully removed.

### Flat Spots

It is a characteristic of high performance tyres that temporary 'flat spots' may develop if the vehicle is left standing in high or low ambient temperatures for any length of time.

These 'flat spots' will manifest themselves as minor vibrations when the vehicle is first driven from cold. As the tyres warm up to operating temperature, normal tyre shape should be restored and the vibrations cease. If vibrations persist, consult your Aston Martin Dealer.

## Age

 Local regulations on tyre life may apply.

Tyres degrade over time, even when they are not being used. It is recommended that tyres generally be replaced after six years of normal service. Heat caused by hot climates or frequent high loading conditions can accelerate the aging process.

## New Tyres

When new tyres are required consult your Aston Martin Dealer for advice if the rear tyres are also worn. Each wheel and tyre unit must be balanced dynamically and measured for Radial Force Variation (RFV) to make sure of efficient steering, optimum tyre wear and maximum ride comfort. Because of the potentially high speeds, it is essential that wheel balancing is carried out when new tyres are installed. Contact your Aston Martin Dealer for more information.

## Running-In New Tyres

When new tyres have been installed, speed should be limited, particularly during the first 80 km or so of driving. Fast cornering, hard braking, and harsh acceleration should also be avoided during this period.

## Tread Wear Marks

Tread wear marks (A) are incorporated into the construction of all tyres. These marks are integral moulded ribs spaced at regular intervals around the circumference of the tyre and extend across the full width of the tread, in all primary grooves.

When a tyre has worn causing one or more of the marks to be flush with the outer face of the tread the tyre has reached its wear limit. It then becomes illegal in certain countries and must be replaced.



## Winter Tyres

The tyres installed as original equipment are designed with a rubber compound, tread pattern and width specially suited for high speeds in normal road conditions, but they are less suitable during extremes of low temperatures, snow and ice. The use of winter tyres will considerably improve handling during these conditions.

Only use Aston Martin approved winter tyres.

 **Warning: When winter tyres are fitted, the maximum speed limit of the vehicle could be reduced. Winter tyre speed limits and information should be provided upon installation of the winter tyres. Please consult your Aston Martin Dealer for more information.**

Winter tyres must be used in vehicle sets, that is, installed on all four wheels. Do not exceed the tyre speed rating when using winter tyres.

## Snow Traction Devices

**⚠ Warning:** The maximum speed when using snow traction devices is 48 km/h. Remove the snow traction devices immediately when the roads are clear of snow.

These are for temporary use when driving in heavy snow conditions. Snow traction devices should only be installed to the rear (driven) wheels. For more information regarding the correct snow traction device to fit to your vehicle, contact your Aston Martin Dealer.

## Tyre Sealant Kit

**⚠ Warning:** Do not use the system to seal a tyre that was damaged while driving with insufficient air pressure (e.g. tyre cuts, cracks, bumps or similar damage). Do not use the system to seal tyres with side wall damage. Only punctures in the tread area of tyres may be sealed.

**⚠ Warning:** Do not stand directly beside the tyre while the compressor is pumping. Watch the side wall of the tyre. If there are any cracks, bumps or similar damage set the compressor to OFF. The journey should not be continued. Contact your nearest Aston Martin Dealer.

**⚠ Warning:** If a tyre pressure of 1.8 bar (26 Psi) cannot be reached then the tyre can not be sealed. Do not attempt to re-inflate the tyre. Contact your Aston Martin Dealer.

**⚠ Warning:** If the pressure in the tyre after driving for 3 km is below 1.3 bar (19 PSI) the tyre has not been effectively sealed. The journey should not be continued. Contact your nearest Aston Martin Dealer.

**⚠ Warning:** After a longer period of rest, the tyre pressure should be rechecked.

**⚠ Warning:** The tyre sealant kit only provides temporary mobility. Always refer to local laws and regulations on the use and repair of tyres that have been treated with any form of temporary mobility aid. Consult a tyre specialist for advice.

**📖** Inform the tyre specialist that the tyre contains sealant.

### Location



## Operation

Remove the tyre sealant kit from its location in the boot. Follow the instructions detailed on the lid.

Read the following instructions and warnings carefully before using the tyre sealant kit. Compliance with these instructions is vital to make sure of vehicle and user safety. Non-compliance with these instructions means risking severe tyre damage and hazardous vehicle behaviour which can lead to a road accident involving damage to property or injury to persons.

- Make sure that the vehicle is parked far enough from traffic so that there is no danger from passing vehicles and so that you do not disrupt the traffic. Warn other vehicles using the warning triangle.
- The system should only be used between temperatures of – 40°C and 70°C.
- A maximum speed of 80 km/h (50 mph) may not be exceeded at any time after sealing the tyre with the system.
- The system provides only a **temporary emergency repair** for continuing the journey up to 200 km (125 miles) or to the nearest Aston Martin Dealer.
- If the nearest Aston Martin Dealer is over 200 km (125 miles) away, arrange for collection with Aston Martin Assistance.
- The system will effectively seal a tyre that was punctured by an object with a diameter of up to 6 mm. It is possible that a tyre, especially with greater damage, will not be sealed. Do not remove objects that punctured the tyre if they are still lodged in the tyre.

- The sealant bottle needs to be exchanged before it expires. **Do not** use the system after the expiry date on the sealant bottle or casing has been reached. Contact your nearest Aston Martin Dealer.
- Do not attempt to inflate other objects without using a system adapter and do not inflate objects with a volume greater than 50 litre (air mattresses, rubber boats, etc.). Do not let the system pump air for more than 10 minutes without stopping it and allowing it to cool down.

Both the hose and the bottle of sealant need to be replaced after using the system. Sealant deposits in a used hose may cause the system to operate incorrectly. New bottles of sealant can be purchased from your Aston Martin Dealer.

Dispose of empty sealant bottles together with normal household waste.

Remains of liquid sealant must be handed over to your dealer or disposed of in compliance with local waste disposal regulations.

## Vehicle Recovery

⚠ **When moving the vehicle by transporter make sure that the vehicle is not strapped down to the transporter by the suspension control arms.**

⚠ **Power braking and power steering are not available with the engine OFF. Substantially higher brake pedal pressures and steering effort are required.**

⚠ **If there is a transmission fault, this vehicle must be transported.**

Your vehicle should always be recovered on a vehicle transporter<sup>1</sup> and should only be towed for **short distances**, for example, if it is causing an obstruction or if it requires winching onto a transporter.

**SportShift Transmission Only:** If the transmission is in neutral then first gear will be selected at ignition OFF. If the transmission is in first or reverse gear, the transmission will stay in the selected gear at ignition OFF. To enable neutral to be selected at ignition OFF, set the ignition to ON then press and release the neutral button twice, or pull back and release the gear shift paddles twice, before the ignition is set to OFF. An audible warning will sound three times while the message centre will show GEARBOX IN NEUTRAL and APPLY PARK BRAKE.

If moving the vehicle in such a situation:

1. Remove the towing eye from its storage location in the vehicle tool kit (located in the boot storage area). Insert the towing eye carefully through the grill and install to the exposed female threads (A) until fully engaged against the vehicle body.



📖 *The towing eye has a left hand thread.*

📖 *Protect vehicle paint work when installing the towing eye.*

2. Put the transmission into neutral. Move the vehicle key to position 'II' (ignition ON) to release the steering lock.
3. When being towed use the footbrake very gently when required, to prevent excessive slack in the tow rope.

---

<sup>1</sup> The recommended method for a recovering vehicle is to have it transported in a purpose built, covered, vehicle transporter.



## Jump Start From Another Vehicle

 **Warning:** *The donor vehicle must have a 12 volt battery and a negative (-) earth terminal to make sure that the correct battery polarity is maintained.*

 *Apart from vehicle recovery, this vehicle must not be driven if the vehicle battery is incapable of starting the engine. In this case the vehicle battery must be replaced.*

 *If the voltage or earth of the donor vehicle is different or not known, do not attempt starting in the way described.*

If this vehicle will not start due to a discharged battery, it may be started, **for vehicle recovery**, by connecting the battery from another vehicle (donor) to this vehicle (recipient).

## Jump Start Procedure

 *Remove rings, metal watch bands and any other jewellery.*

 *Set all electrical motors and ancillaries in both vehicles to OFF.*

 *Set all lamps to OFF except those needed to protect vehicles or illuminate the work area.*

 *Recharge time will depend on the initial 'state of health' of the discharged battery.*

 *If the vehicle still will not start, consult your Aston Martin Dealer.*

1. Position the donor vehicle so that the connecting cables will reach into the recipient engine bay. Apply the park brake and leave the engine running.
2. Access the jump start terminal in the recipient engine bay.
3. Connect the positive cable between the positive terminal of the donor battery and the jump start terminal of the recipient vehicle (A).
4. Connect the negative cable between the negative terminal of the donor battery and a good earth (negative) point in the recipient engine bay (B).
5. Start the donor vehicle engine and increase the engine speed and run at about 1500 – 2000 rpm for two minutes<sup>1</sup>.

 *The donor vehicle must be set to OFF. If the donor vehicle is not set to OFF the recipient vehicle will not start.*

6. Set the donor vehicle off.
7. Start the engine of the recipient vehicle.

---

<sup>1</sup>. Charge time can depend on the battery state of the donor vehicle.

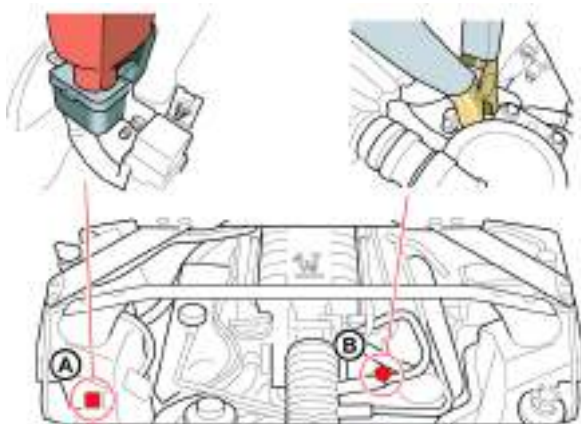

8. Leave the jump start cables attached and the engines running for 2 to 3 minutes to allow the battery to charge.
9. Remove the jump start cables, first the negative cable from both vehicles and then the positive cable from both vehicles. Allow the recipient engine to run until the discharged battery is sufficiently recharged (15 to 20 minutes) to start the engine without assistance. Set the engine to OFF and restart the engine. Take the vehicle on a long run to fully charge the battery. Contact your Aston Martin Dealer to have the battery checked or replaced.

## Vehicle Battery

**⚠ Warning: Battery posts, terminals and related accessories contain lead and lead compounds. Wash hands after handling.**

**⚠ Warning: Do not allow flames, sparks or lighted substances to come near the battery. Batteries normally produce explosive gases which can cause personal injury. When working near the battery, always shield your face and protect your eyes. Always have sufficient ventilation.**

**⚠ Warning: When lifting a plastic cased battery, excessive pressure on the end walls could cause acid to flow through the vent caps, resulting in personal injury, damage to the vehicle or battery. Lift the battery with a battery carrier or with your hands on opposite corners.**

**⚠ Warning: Keep batteries out of reach of children.**

**⚠ Warning: Batteries contain sulphuric acid. Avoid contact with skin, eyes or clothing. Shield your eyes when working near the battery to protect against possible splashing of acid solution. In case of acid contact with skin or eyes, flush immediately with water for a minimum of 15 minutes and get prompt medical attention. If acid is swallowed, get medical help immediately.**

**⚠ The engine must never be run with the vehicle battery disconnected.**

**⚠ Apart from vehicle recovery, this vehicle must not be driven if the vehicle battery is incapable of starting the engine. In this case the vehicle battery must be replaced. Contact your Aston Martin Dealer.**

The vehicle battery is maintenance free and should only require checking by your Aston Martin Dealer during regular vehicle services. To access the vehicle battery (A) remove the trim panel located in the right rear environment.

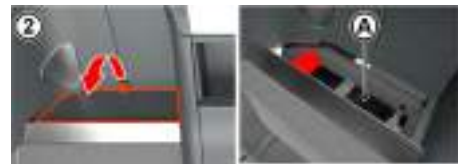
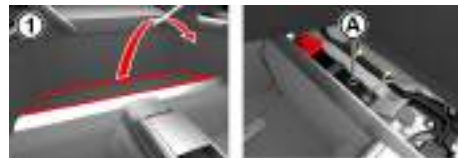

[1] : Coupe

[2] : Roadster

## Vehicle Battery Disposal

It is the responsibility of the vehicle owner when disposing of automotive batteries to do it in an environmentally correct manner. The incorrect disposal of a vehicle (lead-acid) battery can be extremely hazardous to health and the environment. Most batteries contain materials that, when disposed of incorrectly, may leak into the environment. This can contribute to soil and water pollution and endanger wildlife.

Do not dispose of a battery in fire or water.

Follow your local authorised standards for disposal. Call your local authorised recycling centre to find out more about recycling automotive batteries.

Do not dispose of your vehicle battery in the household waste.



## Vehicle Battery Charge

### Warnings

The following warnings are located on the vehicle battery.



Various systems, such as the clock, security systems and Infotainment centre system continue to drain battery power even with the ignition OFF.

A **new fully charged** battery has the ability to start this vehicle, if left unused, for up to 45 days without a battery conditioner being used.

*In cold climates this time may be reduced.*

*Aston Martin recommend that if this vehicle is to be left unused for 10 days or more a battery conditioner should be used if mains power is available.*

Battery charge can be drained excessively in a number of ways:

- If the vehicle is unused for long periods of time.
- If the vehicle is used regularly but only for short journeys, e.g. less than 48 km (30 mile) a journey.
- If electrical systems are in use without the vehicle engine running.
- If the vehicle key is left in the ignition control for long periods of time without the engine operating.

Excessive battery drain would ultimately mean that the battery would not be able to start the engine.

### Battery Conditioner

(Option)

**Warning: Do not attempt to start the vehicle with a battery conditioner connected to the mains supply.**

**Warning: Do not smoke near the vehicle battery. Prevent flames and sparks. Explosive gasses are given off by batteries during charging.**

**A battery conditioner is designed for conditioning of partially or fully charged batteries. It will not effectively charge a discharged battery.**

**For indoor use only. Disconnect mains supply before connecting or disconnecting the battery charger to the vehicle.**

*The Aston Martin battery conditioner is suitable for use on all types of 12 volt lead acid batteries.*

If this vehicle is not going to be used for a period of time, and **mains power is available**, use a battery conditioner to maintain the battery charge level.



When connected the battery conditioner will maintain a small trickle charge to keep the battery in a fully charged state. The battery conditioner may be left in this state indefinitely.

#### To Connect a Battery Conditioner

1. Insert the accessory socket plug (B) into the accessory socket (A) located in the boot right side.
2. Insert the mains plug (C) into the mains supply.
3. Gently close, but do not latch, the boot lid. This avoids possible damage to the boot lid water seal from the battery conditioner power cable.



[1] : Coupe

[2] : Roadster

To remove the battery conditioner first disconnect from the mains supply, then remove from the vehicle accessory socket.

## Battery Protection Mode

**⚠** *Replace the battery as soon as possible, if the battery is not capable of starting the engine.*

Using the vehicle electrical systems, i.e. the infotainment system, with the vehicle key at position '1' (ignition OFF) will drain the battery charge. Eventually the battery will drain to such a low level that it will not start the engine.

To avoid this happening, a series of safety mechanisms shut down non-essential electrical systems before excessive battery drain takes place.

### Frequently Asked Questions

**What is the first sign of battery protection mode?**

Warning messages are shown in the message centre.

**What should I do next?**

Set all unnecessary electrical systems to OFF to reduce battery drain. Start the engine to recharge the battery. Run the engine for a reasonable length of time.

**What happens if I ignore the warning messages?**

After approximately 2 to 10 minutes (dependent on the rate of battery charge drain) the following message is shown in the infotainment display<sup>1</sup>:



If the audio system is ON, the audio will then stop playing.

**What should I do if these messages are shown?**

Set all unnecessary electrical systems to OFF. Start the engine to recharge the battery. Run the engine for a reasonable length of time.

**What happens if I ignore second warning messages?**

The infotainment system will shut down in two minutes. No other electrical system will be shut down. This significantly reduces the rate of battery drain. The following functionality will be lost:

- Navigation System
- Audio System

**What should I do if the infotainment system shuts down?**

Start the engine to recharge the battery. Run the engine for a reasonable length of time.

The infotainment system will not operate without the engine running until the battery has regained its charge. With the engine running the infotainment system will start up.

<sup>1</sup> Vantage S models will display a Vantage S logo

## Fuse Boxes

### What is a reasonable length of time to run the engine?

The vehicle battery normally requires a journey of approximately 48 km (30 miles) to recharge. Additionally, you can use the battery conditioner to restore the vehicle battery charge when the vehicle is parked.

### What if I cannot restart the engine?

If the battery has been run down to a point where it will not start the engine then an external battery charger<sup>1</sup> will be required or your vehicle will require a 'jump start' (Refer to 'Jump Start From Another Vehicle', page 12.17).

---

<sup>1</sup>. A battery conditioner is designed for conditioning of partially or fully charged batteries. It will not effectively charge a discharged battery.

Electrical systems are protected by fuses. If any lamps, accessories, or controls do not function, inspect the applicable fuse.

If a fuse has blown, the inside element will be melted. If the same fuse blows again, avoid using that system and consult your Aston Martin Dealer as soon as possible.



### Fuse Box Location

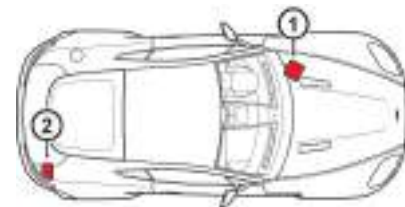

**[1]** : Engine bay fuse box (passenger side)

**[2]** : Boot fuse box (Coupe: right side of boot) - (Roadster: left side of boot)

**Engine Bay Fuse Box**

<b>Fuse</b>	<b>Rating</b>	<b>Function</b>	<b>Fuse</b>	<b>Rating</b>	<b>Function</b>	<b>Fuse</b>	<b>Rating</b>	<b>Function</b>
F1	10A	Alternator (Battery Sense)	F13	20A	Fuel Injectors	F25	5A	Not Available
F2	10A	Not Available	F14	10A	Not Available	F26	20A	Headlamp Wash Pump
F3	10A	Secondary Air Injection	F15	25A	Starter Motor Solenoid	F27	40A	Anti-lock Braking System Module
F4	20A	Engine Management Powertrain Control Module	F16	15A	Ignition Coils / Suppressors	F28	10A	Anti-lock Braking System Module, Steering Angle Sensor, Vehicle Key Reader, Fuel Tank Leakage Diagnostic Pump
F5	20A	Not Available	F17	5A	Airbox Valves	F29	20A	Anti-lock Braking System Module
F6	15A	Not Available	F18	15A	Exhaust Gas Oxygen Sensors, Catalyst Monitor Sensor, Variable Camshaft Timing Solenoids	F30	5A	Anti-lock Braking System Module
F7	15A	Not Available	F19	30A	Not Available	F31	40A	Secondary Air Pump
F8	10A	Engine Coolant Level Sensor, Valve Electric Vapour Management	F20	30A	Not Available	F32	30A	Windscreen Wiper Motor (Slow)
F9	20A	Not Available	F21	30A	Not Available	F33	30A	Windscreen Wiper Motor (Fast)
F10	10A	Air Conditioner Compressor Clutch	F22	5A	Mass Airflow Sensor (Left and Right Side)	F34	15A	Not Available
F11	15A	Horn	F23	-	Not Available	F35	80A	Cooling Fan Module
F12	10A	Permanent Power Feed	F24	5A	Alternator (Ignition)			





## Boot Fuse Box

Fuse	Rating	Function
F1	5A	Not Available
F2	20A	Power Outlet Boot
F3	30A	Heated Rear Windscreen
F4	20A	Not Available
F5	30A	Audio Amplifier
F6	20A	Not Available
F7	5A	Not Available
F8	30A	Sportshift Transmission Hydraulic Pump
F9	30A	Fuel Pump Driver Module
F10	30A	Convertible Roof Module (Roadster)
F11	10A	Tonneau Lid Module (Roadster)

Fuse	Rating	Function
F12	20A	Sportshift Transmission Module
F13	10A	Sportshift Transmission Module
F14	5A	Parking Distance Control Electronic Control Unit / Adaptive Damping System Electronic Control Unit
F15	5A	Exhaust Bypass (Pump and Valve)
F16	30A	Convertible Roof Pump
F17	5A	Boot Lamps
F18	30A	Alpine Subwoofer / B&O DSP Amplifier
F19	5A	Not Available
F20	20A	Tonneau Lid Module
F21	30A	Not Available
F22	20A	Rear Cubby Box Power Outlet (Roadster)

## Headlamp

 *Continental Driving (UK Only): UK owners wishing to take this vehicle to the continent should contact their Aston Martin Dealer for headlamp and dipped beam alignment checks and adjustments.*

 *Headlamp Units: Condensation: The headlamp units will generate condensation under certain conditions. However, this should clear after approximately 10 minutes after the headlamps have been set to ON.*

### Dipped Beam Bulb

 **Warning: High Intensity Discharge (HID) bulbs produce a very high voltage. They should only be serviced by an Aston Martin Dealership.**

High Intensity Discharge (HID) bulbs are used for the dipped beam. HID systems produce a brilliant white light by establishing a high voltage electrical arc between two electrodes within a sealed glass tube. Once the arc is established, the voltage lowers to normal operating conditions.

**HID bulbs are not renewable.** Contact your Aston Martin Dealer if a HID bulb fails to operate.

## Main Beam Bulb

Access to the headlamp bulbs is through a panel in each wheel arch liner. Turn the steering to the opposite lock from the headlamp unit with the defective bulb. Using a flat blade, i.e. a screwdriver or a small coin, release the screw on the access panel and remove the panel.

Using a screwdriver release the two knurled screws and remove the headlamp unit cover.

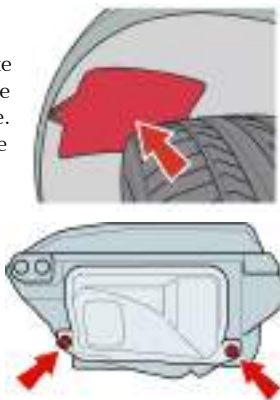

**[A]** : Dipped beam

**[B]** : Main beam

 *The main beam bulb (B) is inboard on both the left and right headlamp units.*

Remove the access cover and turn the bulb unit a quarter turn counterclockwise. Withdraw the unit and disconnect the wiring harness plug.

Connect a new bulb unit (Refer to 'Bulbs', page 13.7), insert the bulb unit and turn a quarter turn clockwise to lock. Install the headlamp access cover and wheel arch liner access panel.

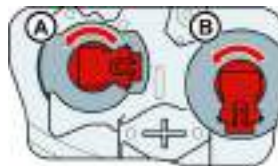

## Other External Lamps

### High Level Stop Lamp

The high level mounted stop lamp unit consists of LEDs and is not repairable. If a high level mounted stop lamp LED fails, contact your Aston Martin Dealer.

### Front Indicator and Parking Lamps

If a front indicator or parking bulb fails to operate, contact your Aston Martin Dealer. These lamps consist of LEDs and are not repairable.

### Side Indicators

The side indicators comprise of LEDs and are not repairable. If a side indicator lamp bulb fails, contact your Aston Martin Dealer.

### Registration Plate Lamps

Specialist tools are required to access the registration bulb. If a registration lamp bulb fails, contact your Aston Martin Dealer.

### Rear Lamp Clusters

The rear indicators, stop and tail, reversing lamps and rear fog LEDs are contained in a sealed lamp cluster unit, one either side of the vehicle. The lamp cluster is not repairable. If a rear lamp fails, contact your Aston Martin Dealer.

## Boot Lamps

Take care not to damage the vehicle trim.

Lever out the lens unit. Replace the defective bulb (C10W 10W) and clip the lens unit back into its housing.

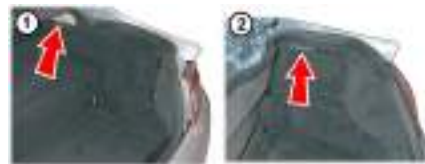

[1] : Coupe

[2] : Roadster

## Internal Lamps



[1] : Front footwell lamps: Type: W5W (Blue). Rating: 5W.

[2] : Door puddle lamps: Type: C5W (Festoon). Rating: 5W.

[3] : Reading lamps: LED

LEDs are not repairable. If an LED lamp fails to operate, contact your Aston Martin Dealer.

## Door Window Reset

To renew a bulb:

1. Take care not to damage the vehicle trim.
2. Lever out the lens unit and replace the faulty bulb. **Door puddle lamps only:** Open the access flap and replace the faulty bulb.
3. Press the lens unit into its housing until it clips into position.

If power to the electric windows has been interrupted for any reason, they will fail to operate correctly until reset.

1. Sit in the driver's seat with all doors closed, insert the vehicle key into the ignition control and move to position 'II' (ignition ON).
2. Press firmly and hold the window switch until the window is at the maximum down position. Continue to hold the button for five seconds then release.
3. Pull back and hold the window switch until the window is in the maximum up position. Continue to hold the switch for a further five seconds, then release.
4. The window is now reset. Repeat for the other door windows.

## Front Seat Reset

Should a front seat fail to move or the seat memory position fails to work this may show a loss of seat position in the vehicle's memory. If so, complete the seat reset procedure detailed below:

 **Warning: Do not sit in the seat while you do the seat reset procedure. Seat movement will restrict the occupancy area.**

 **Warning: Make sure that there is nothing in front of, behind, or under the seat during the seat reset procedure.**



 *The seat must be moved to its limit of travel and allowed to stall for 1 second for each axis. If the seat is not held at its limit of travel, the seat memory will not learn this as its fully travelled position.*

## Bodywork Maintenance

1. Press the seat forward button (2) until the seat is fully forward.
2. Press the seat back button (4) until the seat back is fully backwards.
3. Press the seat down button (1) until the front of the seat is fully down.
4. Press the seat down button (3) until the rear of the seat is fully down.

The seat movement and position memory should now work correctly, if not contact your Aston Martin Dealer.

### Door Drain Holes

Check the drain holes in the bottom face of each door periodically and clear if necessary with, for example, a short length of wire or a pipe cleaner.

## Vehicle Cleaning

### Paint Work

Modern water based paints are much safer and more environmentally friendly than solvent based paints. Water based paints are however more susceptible to contamination and marking by corrosive substances. The following list is not exhaustive but does show the most common contaminants which may adversely affect your paint work:

- Bird droppings,
- Antifreeze,
- Tree sap,
- Oils and greases,
- Insect remains.

Wash such substances from the vehicle using clean warm water with vehicle shampoo at the earliest opportunity, especially in sunny weather which can accelerate contamination.

 *Other groups of contaminants may be added to this list as experience of water based paints and finishes increases.*

## Washing

 **Warning: Washing and polishing agents containing silicone should not be applied to glass. This will reduce the efficiency of the windscreen wipers, causing smears which will reduce visibility, particularly during darkness and in the rain.**

 **Commercially operated automatic vehicle washes, jet washes and power operated mops are not recommended. The detergents used can contain certain chemicals which may, over time, be detrimental to some exterior parts of the vehicle. Prolonged usage of automatic vehicle washes and power operated mops will also cause fine scratches in the paint surface.**

Aston Martin recommends the use of AUTOGLYM vehicle care products or preparations of similar reputable manufacture for adding to the washing water. Make sure that the manufacturer's instructions are followed.

During the winter months, it is advisable to wash the vehicle more frequently, paying particular attention to the underside to combat the detrimental effects of any salt and sand contamination picked up from treated roads.

To delay the onset of corrosion developing on the brake components Aston Martin recommend that after washing this vehicle, the vehicle should be driven a short distance to make sure that all water and cleaning products have dried off.

For best results:

- Do not wash the vehicle in strong sunlight. Let the vehicle cool before washing.
- Do not use household soaps or detergents.
- Do not direct water hoses at full force around the door and boot lid seals.
- Do not use a brush on the car body as this will leave little scratches.

Suggested washing method:

1. Fill two buckets with water. Add a mild neutral detergent, as directed by the detergent manufacturer to one of the buckets.
2. Use a hose to remove all dust and mud residue from the vehicle. Don't use a strong jet, as this can rub grit over the paint and scratch it.
3. Soak a large clean wash mitt or a soft clean sponge in the soapy water, and begin applying it to the vehicle. Wash the vehicle section by section, starting at the top. Circle around the car several times, washing lower areas with each round.
4. Rinse the dirt out of the wash mitt or soft sponge in the bucket with plain water frequently.
5. After one section is washed, rinse it with the hose before moving on, don't let the soap dry on the paint as this can stain it. Always keep the vehicle wet, this will prevent droplets from drying on the paint and leaving water-spots.
6. Dry the car with a chamois leather before it air-dries.

### Front Grille

Wash and clean the vehicle's front grille in the same way as the paint work, but make sure that the front grille is dried off completely leaving no water droplets on the grille (wipe the front grille last using a chamois leather): Chrome polish or other abrasive cleaners must not be used.

### Road Wheels

To avoid possible damage to the alloy road wheels, wheel nuts and wheel centre trims, from a build up of brake dust wash and clean the alloy road wheels frequently, using a mild soapy water solution only. Do not use chemical alloy road wheel cleaners, as they can often have a high acid or alkaline content and could cause discolouration. Always clean one wheel at a time and do not allow the cleaning solution to dry on the wheel. Fully flush off with clean water.

### Headlamp Lenses

Only use a mild soapy water solution when washing the headlamp lenses. Do not use cleaning materials which contain solvents.

Cleaning materials which contain solvents, i.e. tar remover, petrol, waxes or polishes, may damage the headlamp lens.

### Polishing

Approximately twice a year, a good quality polish should be applied to the body work and then buffed, using a soft lint free cloth.

The alloy wheel rims should be treated with a cleaner which is specifically manufactured for this purpose.

### Upholstery, Trim, Carpets and Seats

 **Warning: Fumes from cleaning solvents may be dangerous in confined spaces. Make sure that the vehicle is well ventilated and follow the manufacturer's printed instructions when using these products.**

 **Certain types of clothing, such as denim and vegetable tanned leather, are prone to 'dye transfer'. This can cause discolouration in the leather. Make sure that the affected areas are cleaned and re-protected as soon as possible.**

The seats and soft trimmed components of this vehicle are covered in hand crafted leather. In order to maintain the beauty of leather it will require regular cleaning, which, if neglected, may cause deterioration. Where dust and dirt are allowed to accumulate and become ingrained in the surface the leather may become permanently damaged. Leather faced features should be cleaned with a damp cloth moistened with an undiluted leather cleaner.

**Do not** use detergents, quick cleansers or furniture polishes. These products may initially give an impressive result, but their use will lead to rapid deterioration of the leather and will invalidate the warranty. Several times a year, a leather conditioner or preservative should be used. Appropriate care materials are obtainable from your Aston Martin Dealer.

Alcantara roof linings and other soft trimmed areas may be brushed with a soft brush. Stains from water based substances such as coffee, tea or soft drinks should be cleaned as soon as possible with mild soap and water.

The brushed and anodised aluminium trim should be cleaned using a dry clean lint free cloth.

Consult your Aston Martin Dealer for instructions on the removal of more difficult stains such as oil, grease or ballpoint ink.

Carpets should be cleaned regularly with a vacuum cleaner. Any stains or grease marks should be removed with a good quality solvent suitable for use on carpets.

### Care and Maintenance of Seat Belts

**⚠ Do not allow seat belts to be retracted until they are completely dry.**

To make sure that the restraint webbings are in correct working order, regularly check the seat belts. Look for fraying, cuts, burns and similar problems. Make sure that the latches and buckles operate correctly. If a seat belt is not in good condition or is not working correctly, consult your Aston Martin Dealer.

Any seat belt that has been worn during a serious collision should be replaced by an Aston Martin Dealer.

To clean the seat belts, use mild soap and water; do not use bleach, solvents or dyes, as they can weaken the material. Allow the seat belts to dry thoroughly before use.

### Under Bonnet Cleaning

Under bonnet cleaning using high pressure hoses or steam cleaners should not be carried out. The electronic control module connections and fuse boxes can be damaged by indiscriminate use of high pressure cleaning equipment.

### Convertible Roof Cleaning

(Roadster only)

**⚠ Do not leave the roof in the lowered (folded) position for extended periods of vehicle storage. Permanent damage to the convertible roof fabric may occur including soiling and fading along folds.**

**⚠ Do not use automatic vehicle washes. Brushes, detergents and pressurised water jets may damage the roof fabric. Do not use power washers. Jets of water may damage the weather seals and the roof fabric. Do not use spot cleaners, chemical diluents or any organic cleaners. If in doubt, contact your Aston Martin Dealer.**

To maintain the appearance and condition of the roof fabric the cleaning recommendations given below should be followed. This is of particular importance in the case of light coloured roof fabrics.



## Vehicle Storage

### Cleaning

Always remove bird droppings as soon as possible. The organic acids in bird lime can adversely affect the roof fabric.

Carefully vacuum clean the roof fabric to remove any loose particles. Gently, and evenly, wash the roof fabric using a mild soap solution and a soft brush.

 *A hard brush will damage the fabric fibres.*

Rinse the roof fabric thoroughly with clean water to remove any traces of soap. Allow the roof fabric to completely dry before operating the roof.

### Recommendations

 *These recommendations apply to new and pre-owned vehicles either in dealer or customer ownership.*

If your vehicle is not to be used for periods in excess of three months it should be stored in a dry, well ventilated building.

1. Drive the vehicle for a sufficient distance to warm the oil in the engine and the transaxle; make sure that the internal components of the engine are lubricated.
2. Check the engine coolant level. Top up if necessary with the correct antifreeze and water solution.
3. In order to take the weight off the tyres, raise the vehicle with a jack and place supports under the front and rear suspension. If the vehicle is not raised from the ground, increase the tyre pressures to 3.4 bar. Cover the tyres to exclude any light. Turn the wheels ¼ turn every month to avoid tyre flat spots.
4. Close the convertible roof, if installed.

 *It is recommended that the convertible roof remains in the closed position. Do not leave the roof in the lowered (folded) position as permanent damage may occur to the roof fabric.*

5. If mains power is available, use a battery conditioner to maintain the battery in a fully charged state.
6. Once a month:
  - 6.1 Disconnect the battery conditioner (if installed).
  - 6.2 Start and operate the engine until it is fully warmed up.
  - 6.3 Check there are no fluid leaks.
  - 6.4 Set the ignition to OFF.
  - 6.5 Connect a battery conditioner.
  - 6.6 Check and correct tyre pressures if necessary. When returning the vehicle to normal service, set the tyre pressures to normal specification before driving on the road.

 *Excessive sunlight and humidity can increase the vehicle temperature, which can cause damage to the vehicle interior and trim. If storing the vehicle in these conditions, Aston Martin recommend using a solar reflecting car cover to prevent any potential damage due to high temperatures.*

## Extended Storage

For storage periods exceeding six months the following measures are recommended:

 *Do not drain the fuel system.*

1. Operate the engine until there is as small a quantity of fuel in the tank as is practical for storage purposes.
2. Inspect rubber connections of coolant system and have them renewed if necessary.
3. Wash the vehicle bodywork thoroughly and repair any paint blisters or patches of corrosion in order to prevent any further deterioration. Apply a suitable polish.
4. Clean the carpets and upholstery thoroughly. Treat all leather upholstery with an application of a leather conditioner or preservative.
5. Close the convertible roof, if installed.

 *It is recommended that the convertible roof remains in the closed position. Do not leave the roof in the lowered (folded) position as permanent damage may occur to the roof fabric.*

6. If the storage building is dry then leave vehicle windows slightly open. If there is any tendency towards dampness close vehicle doors and windows and place an anti-moisture compound such as silica desiccant bags in an open metal container inside vehicle.
7. Cover vehicle with a cotton or fabric cover.

## Recommissioning after Storage

Provided that the vehicle has been stored in accordance with the recommended procedure, only the following points should need attention before using your vehicle on the road.

1. Check the tyre pressures, inflate if necessary, lower the vehicle to ground.
2. Check the coolant level and, if necessary, top up with the correct antifreeze to water solution.
3. Check all fluid levels and top up as necessary.
4. Fill the fuel tank.

 ***Starting the engine without sufficient lubrication can cause serious engine damage. Make sure that the engine oil pressure is established before starting the engine.***

- 
5. Obtain engine oil pressure:
    - 5.1 Press and hold the accelerator pedal hard to the floor (this temporarily stops fuel injection during cranking).
    - 5.2 Fully press the brake (SportShift II transmission) or clutch (manual transmission) pedal down. Insert the vehicle key into the ignition control and move through to engine start. Allow the engine to crank until the oil pressure symbol in the instrument cluster  goes OFF (showing oil pressure in the engine).
    - 5.3 Set the ignition to OFF. Release the vehicle key and accelerator pedal.
  6. Start the engine normally and allow the engine to idle. Check that the oil pressure and ignition warning symbols go OFF (correct oil pressure and battery charging).
  7. Raise the bonnet and check for leaks of fuel, oil and coolant.

8. Check the operation of the convertible roof (if installed) and check for oil leaks. If the roof does not operate correctly during first use, operate the roof a few times (with the engine running to keep the battery at full voltage). If the roof still does not operate correctly contact your Aston Martin Dealer.
9. Carefully test drive your vehicle and check the operation of all functions.

Braking performance can be impaired, initially, due to a fine film of corrosion on the brake disc surface. Drive conservatively and, when safe to do so, frequently apply the brakes until disc surfaces have been cleaned. Full braking performance should then be restored.

If in any doubt about the condition of your vehicle, have it checked by your Aston Martin Dealer.



ASTON MARTIN



ASTON MARTIN



ASTON MARTIN



ASTON MARTIN

# Specifications

Engine .....	13.2
Transmission .....	13.2
Power and Torque .....	13.3
Performance .....	13.3
Fluids and Capacities.....	13.4
Steering.....	13.5
Suspension.....	13.5
Brakes .....	13.5
Wheels.....	13.6
Tyres .....	13.6
Bulbs.....	13.7
Vehicle Specification .....	13.8



## Engine

All alloy, quad overhead cam 32 valve V8. Four knock sensors - two per cylinder head. Cylinder block heater (optional). Variable inlet camshaft timing.

**Capacity:** 4735 cc

**Firing Order:** 1 - 5 - 4 - 2 - 6 - 3 - 7 - 8

**Idle Speed:** 750 rpm

**Bore:** 91.0 mm

**Stroke:** 91.0 mm

**Spark Plugs:** NGK: IFR7N-10

**Spark Plug Gap:** 0.9 - 1.0 mm

**Compression Ratio:** 11.3:1

**Ignition:** 'Coil on Plug' ignition system.

**Emission Control:** Four oxygen sensors and three-way catalytic converters. Evaporative loss purge.

**Lubrication:** Dry sump pressurised lubrication. Oil reservoir.

**Fuel Delivery System:** Multi point sequential fuel injection.

## Electrics

**Alternator:** Denso SC2 150 Amps

**Voltage Regulation:** 14.4V  $\pm$ 0.5V @ 20°C

**Battery:** Banner 88 AH

## Transmission

### Manual Transmission

Graziano six speed transmission with integrated shifter bellcrank system (Cable Operated).

### Gear Ratios

1st	3.15:1
2nd	1.95:1
3rd	1.43:1
4th	1.15:1
5th	0.94:1
6th	0.76:1
Reverse	2.38:1

### Final Drive

Ratio: 4.182:1. Multi-plate limited slip differential.

### Clutch

Single plate / 267 mm diameter.

## Power and Torque

### SportShift Transaxle

Graziano seven speed transaxle with integrated, electronically-controlled hydraulic shifting system.

#### Gear Ratios

1st	3.286:1
2nd	2.158:1
3rd	1.609:1
4th	1.269:1
5th	1.034:1
6th	0.848:1
7th	0.675:1
Reverse	3.286:1

### Final Drive

Ratio: 4.182:1. Multi-plate limited slip differential.

### Clutch

Single plate / 267 mm diameter.

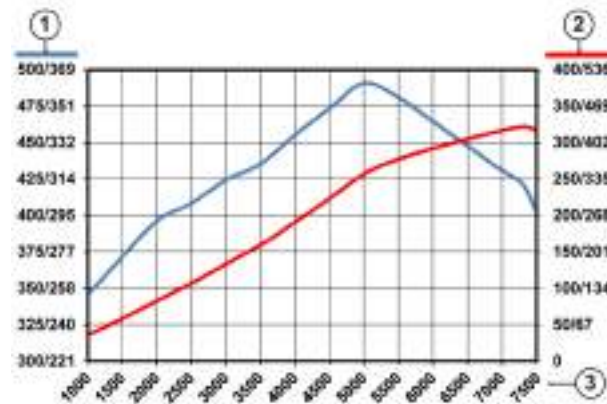

[1] : Torque (Nm / lbft)

[2] : Power (kW / Bhp)

[3] : Engine speed (rpm)

## Performance

### Coupe and Roadster (Manual and SportShift II Transmission)

**Maximum Power:** 430 bhp (320kW) @ 7300 rpm

**Maximum Torque:** 361 lb.ft (490 Nm) @ 5000 rpm

**Maximum Speed (Where permitted):** 190 mph (305 km/h)

**0-62 mph (0-100 km/h):** 4.8 seconds

**Maximum Engine Speed:** 7300 rpm

## Fluids and Capacities

### Recommended Fluids

**Fuel:** Recommended 98 RON Super Unleaded for optimum performance. 95 RON minimum.

Use of fuels containing more than 10% Ethanol are not recommended.

**Engine Oil:** The engine in your vehicle has been engineered and fully tested to run with:

- Castrol Edge Sport 10w-60
- or:
- Castrol Formula RS 10w-60

However, if these oils are not available, a fully synthetic 10w-60 oil meeting the specification ACEA A3/B3 can be used. No other viscosity grades or specifications are acceptable.

**Engine Coolant:** 50% water, 50% Havoline XLT

**Brake Fluid:** React Performance DOT 4

**Clutch Fluid:** React Performance DOT 4

**SportShift Unit Fluid:** Pentosin CHF-11S

**Power Steering Fluid:** Pentosin CHF-11S

**Air Conditioner Refrigerant:** (Market Dependent)

HFO 1234YF

HFC 134A

 Vehicle air conditioning refrigerant is shown on air conditioning label on the right side of the engine bay.

 **Refrigerant gas types must not be mixed. If you do, the air conditioning system can be damaged. If in doubt, consult your Aston Martin Dealer.**

### Capacities

**Engine Sump (including filter):** 10 litres

**Engine Cooling System:** 14 litres

**Screen Washer Reservoir:** 5.5 litres

**Fuel Tank:** 80.0 litres (Approximately 78.0 litres usable.)



## Steering

Rack and pinion, power assisted steering. Column tilt and reach adjustments.

**Turns Lock to Lock:** 2.62

**Turning Circle:** 11.38 m (Kerb to Kerb)

**Total Toe:** Refer to your Aston Martin Dealer for the correct data.

## Suspension

**Front:** Aluminium independent double wishbone. Coil over aluminium monotube dampers and anti-roll bar.

**Rear:** Aluminium independent double wishbone. Coil over aluminium monotube dampers and anti-roll bar.

### Features

- Dynamic Stability Control (DSC)

## Brakes

### Footbrake

#### Combination Cast Ventilated Discs

Combination cast front discs with aluminium centre bell and steel ventilated and grooved discs. Rear discs are ventilated and grooved steel discs.

	Front	Rear
Diameter	380 mm	330 mm
Calipers	Six piston	Four piston

### Park Brake

Lever and cable operated independent park brake calipers on each rear brake disc.

### Brake System Features

- Anti-lock Braking System (ABS)
- Hydraulic Brake Assist (HBA)
- Electronic Brake force Distribution (EBD)
- Traction Control (TCS)

## Wheels

### Aston Martin Aluminium Alloy

Front	Rear
8.5J x 19	10J x 19

### Aston Martin Forged Aluminium Alloy

Front	Rear
8.5J x 19	10J x 19

### Wheel Nut Torque

Tighten all wheel nuts in two stages.

1. Tighten every second nut (as shown in the diagram) to 80 Nm (60 lb/ft) until all five nuts are tightened.
2. Tighten every second nut (as shown in the diagram) to 180 Nm (133 lb/ft) until all five nuts are tightened.



## Tyres

 The original equipment tyres, including winter tyres, installed to this vehicle are an approved specification, designated either by: 'A2A' (19" Bridgestone) for summer tyres or 'AM9' (19" Pirelli) for winter tyres on the sidewall.

### Summer Tyres

	Front	Rear
Bridgestone RE050	245/40 Y 19 (94Y)	285/35 Y 19 (99Y)

## Winter Tyres

 **Warning:** When winter tyres are fitted, the maximum speed limit of the vehicle could be reduced. Winter tyre speed limits and information should be provided upon installation of the winter tyres. Please consult your Aston Martin Dealer for more information.

	Front	Rear
Pirelli Sotto Zero	235/40 R19 (96W) XL	275/35 R19 (100W) XL

## Tyre Loading

Tyres installed to this vehicle shall have a maximum load rating not less than 670 kg (1477 lbs) front and 775 kg (1709 lbs) rear, or a load index of 94 (front) and 99 (rear) and a speed category of Y.

## Tyre Air Pressures

### Cold Inflation (All Tyres)

Front	Rear
2.3 bar	2.5 bar

## Bulbs

	Rating	Type
Headlamp dipped beam (HID)	35W	D1S
Headlamp main beam	65W	H9
Registration plate, footwell (blue) lamps	5W	W5W
Door lamps	5W	C5W
Boot lamps	10W	C10W
Front indicator lamps		LED
Side repeater		LED
Reading lamps		LED
High mounted stop lamp		LED

The rear lamp cluster is a sealed unit. If any rear cluster lamp fails to operate contact your Aston Martin Dealer.

## Vehicle Specification

### Body

- Two door coupe with tailgate and 2+0 seating.
- Two door roadster with 2+0 seating.

Extruded bonded aluminium body structure with aluminium, magnesium alloy, composite and steel body panels and extruded aluminium door side impact beams.

### Towing

This vehicle is not engineered to tow any form of caravan, boat or trailer.

No towing devices are approved to install to this vehicle, other than a front towing eye to aid recovery or loading of this vehicle onto a transporter.

### Vehicle Weights

	Coupe	Roadster
<b>Kerb Weight</b>	1610 kg	1690 kg
<b>Gross Vehicle Weight (GVW)</b>	1910 kg	1990 kg
<b>Boot Load<sup>1</sup></b>	40 kg	40 kg

<sup>1</sup>. (Maximum load, evenly distributed.)

### Interior Dimensions

	Coupe	Roadster
<b>Effective Headroom</b>	933 mm	927 mm
<b>Effective Legroom</b>	1086 mm	1086 mm
<b>Boot Volume</b>	239 ltr	197 ltr

## Exterior Dimensions

 Ride height is measured at Gross Vehicle Weight (GVW). Dimensions shown in millimetres.

### Coupe

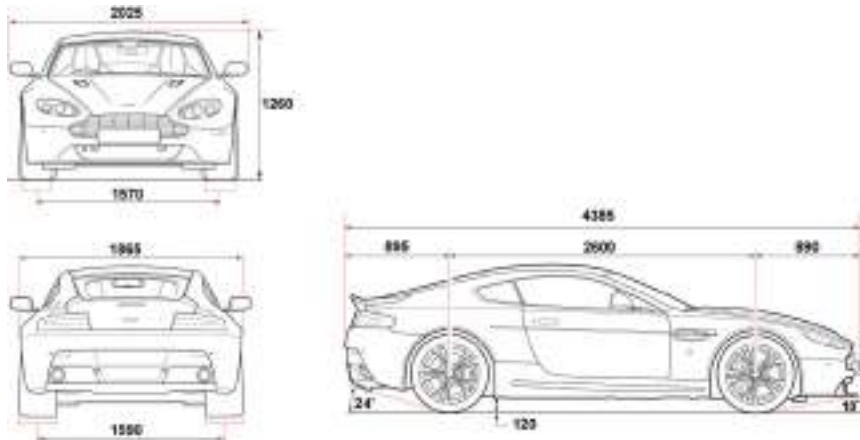

### Roadster

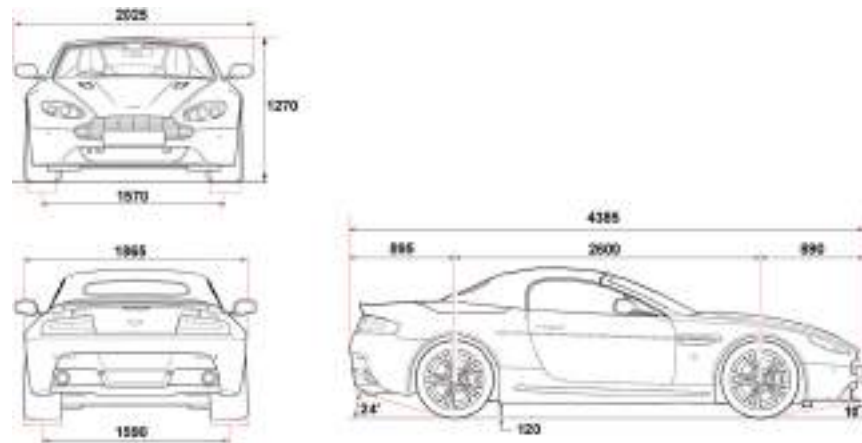



ASTON MARTIN



ASTON MARTIN



ASTON MARTIN



# Service

Pre-delivery Inspection .....	A.2
Servicing .....	A.4
Service Record .....	A.7
Sportshift Clutch Change History .....	A.28
Replacement of Airbag Units .....	A.28
Replacement of Seat Belt Pre-tensioners .....	A.29
Field Service Actions .....	A.29
Service Action Recalls.....	A.30

## Pre-delivery Inspection

This free series of checks is carried out on the vehicle by the Selling Dealer before delivery. The checks make sure that you receive a vehicle which matches the high quality standards set by Aston Martin Limited.

The list below applies to all Aston Martin vehicles. Your Aston Martin may or may not have all or some of the functionality listed.

Make sure that the entry is stamped and signed as completed. The following checks will be made:

### Levels and Leaks

- Engine oil
- Power steering oil
- Brake fluid
- Clutch fluid
- Engine coolant level
- Engine coolant specific gravity
- Windscreen washer fluid
- Fuel system
- Transaxle leak check
- Lift glass
- Battery.

### Mechanical Functions

- Gear selection
- Clutch operation
- Throttle pedal operation
- Park brake operation
- Steering column adjustment and lock operation
- Seat adjuster rails
- Bonnet release and catch
- Door operation and locks
- Storage compartments
- Rear view mirror
- Boot release and catch
- Lift glass release and catch
- Seat belt operation.

### Electrical Checks

- Battery condition
- Gear selection
- Heated rear window
- Windscreen and headlamp washers
- Windscreen wipers
- Climate control

- Infotainment centre operation
- All speakers
- Reversing, registration plate and brake lamps
- Side and headlamps
- Rear fog lamps
- Hazard warning lamps
- Instrument illumination and dimmer
- Gauges and warning symbols
- Centre stack controls
- Horns
- Reset clock
- Blower motor
- Seat belt warning system
- Security system and vehicle key
- Interior lamps
- Cigar lighter (Option)
- All seat functions
- Door window mechanisms
- Door and boot lamps
- Central locking system
- Filler flap lock operation
- Clutch pedal start inhibit



- Door mirror adjustments
- Interrogate fault codes
- Record battery open-circuit voltage
- Tyre pressure sensing
- Centre console controls.

### Wheels and Tyres

- Install locking road wheel nuts (option)
- Check road wheel nuts torque
- Tyre pressures
- Tyre orientation.

### Road Test

- Engine
- Clutch
- Transaxle
- Steering
- Brakes
- Wheel balance
- Adaptive dampers
- Dampers
- Exhaust by-pass system
- Gear shift operation

- Noise, vibration or harshness
- Climate control performance
- Instruments operation
- Seat belt and buckle operation
- Steering wheel alignment
- Dynamic stability control, traction control, adaptive damping and anti-lock braking system operation
- Transmission oil cooler.

### Final Checks

- Drive belt tensioner operation
- Fuel and brake pipe security
- Fuel and fluid leaks
- Security of cooling hoses
- Exhaust catalyst security.

### Hand-over Preparation

- Check function of locks and vehicle keys
- Clean bodywork and road wheel arch liners.
- Clean off all transit labels
- Valet vehicle
- De-grease windscreen
- Install carpets

- Remove interior protection
- Check owner's guidebook
- Check tools
- Install registration plates
- Tyre sealant kit
- Towing eye
- Battery conditioner (option)
- Field service actions and recall status.

Free Pre-delivery Inspection	
Service Actions Checked:	Yes / No
Open Service Actions Completed:	Yes / No
Signature:	
Date:	

# Servicing

## Service Periods

Vehicle servicing is every 10,000 miles or 12 months, which ever occurs first.

- 10,000 mile or 12 months
- 20,000 mile or 24 months
- 30,000 mile or 36 months

## Service Tables

The following service schedules are recommended for this vehicle. The schedules may be modified if necessary. Please consult your Aston Martin Dealer for details of any service schedule updates.

<b>10,000 miles / 12 months</b>	<b>20,000 miles / 24 months</b>	<b>Item</b>
<b>Pre Maintenance Work</b>		
		Install the vehicle protection kit.
		Check the Diagnostic Trouble Codes (DTCs).
<b>Under Body</b>		
x	x	Examine the condition, operation and attachment of the engine, transmission mounting system and check for leaks.
x	x	Examine the condition, operation and attachment of the exhaust system, heat shields, bypass valve operation and check for leaks.
x	x	Examine the condition, operation and attachment of the suspension and steering system for wear. Examine for leaks.
x	x	Examine the condition, operation and attachment of the braking system for wear and adjustment. Examine for leaks.

10,000 miles / 12 months	20,000 miles / 24 months	Item
x	x	Examine the condition, operation and attachment of the park brake system for wear and adjustment.
x	x	Examine the condition, operation and attachment of the drive shafts.
x	x	Examine the condition, operation and attachment of the wheel arch liners and under body protection.
x	x	Examine the condition, operation and attachment of the cooling pack assembly. Examine for leaks..
x	x	Examine the condition, operation and attachment of all under body fluid pipes and hoses and check for leaks.
5 Years		Replace engine coolant.
	x	Manual transaxle: Check the oil level. Fill if necessary
40,000 mls/64,000 km		Manual transaxle: Replace the oil and clean the filter.
	x	Automatic Transmission: Check and adjust the oil level in the differential.
60,000 mls/96,000 km		Automatic Transmission: Replace the oil and clean the filter in the differential.
	x	Replace the brake fluid.

10,000 miles / 12 months	20,000 miles / 24 months	Item
<b>Upper Body</b>		
x	x	Replace the engine oil.
x	x	Replace the engine oil filter.
20,000 mls/32,000 km		Replace the pollen filter and air filter (optional).
x	x	Examine the condition, operation and attachment of the accessory drive belt.
x	x	Examine the condition, operation and attachment of the power steering system. Examine for leaks.
x	x	Examine the condition, operation and attachment of the brake system. Examine for leaks.
x	x	Examine the condition, operation and attachment of the fuel system. Examine for leaks.
x	x	Examine the condition, operation and attachment of the air conditioning system. Examine for leaks.
x	x	Check all power steering system fluid levels and adjust accordingly. Check for leaks.

10,000 miles / 12 months	20,000 miles / 24 months	Item
x	x	Check all braking system fluid levels and adjust accordingly. Check for leaks.
x	x	Check all cooling system fluid levels and adjust accordingly. Check for leaks.
x	x	Check all screen and headlight wash system fluid levels and adjust accordingly. Check for leaks.
70,000 mls/112,000 km		Replace the spark plugs.

10,000 miles / 12 months	20,000 miles / 24 months	Item
<b>General</b>		
x	x	Examine the condition, operation and attachment of all the occupant restraint systems.
x	x	Examine the condition, operation and attachment of all the door locks, latches, hinges, bonnet catches. Lubricate if necessary.
x	x	Examine the condition, operation and attachment of the wiper blades and wash system including headlights.
x	x	Examine the condition, operation and attachment of all the light units and the horn.
x	x	Examine the condition of the road wheels. Check the wheel nut torque is correct.
x	x	Complete the tyre report. If necessary, adjust the tyre pressures.
x	x	Complete the functional test of the tyre pressure sensor system.
x	x	Reset the service interval indicator.

## Service Record

The following service records cover the regular services at 10,000 miles or 12 months intervals, which ever occurs first. Make sure that at each service the appropriate entry is stamped and signed as completed.

<b>10,000 miles / 12 months</b>	<b>20,000 miles / 24 months</b>	<b>Item</b>
		<b>Road Test</b>
x	x	Check the powertrain system for excessive noise, vibration and harshness.
x	x	Check the braking system for excessive noise, vibration and harshness.
x	x	Check the suspension system for excessive noise, vibration and harshness.
x	x	Check the steering system for excessive noise, vibration and harshness.
x	x	Check the wheels and tyres for excessive noise, vibration and harshness.
x	x	Check the cabin environment for excessive noise, vibration and harshness.
x	x	Check the driver information and warning system operation.

**Vehicle Model:**

\_\_\_\_\_

**Registration Number:**

\_\_\_\_\_

**Vehicle Identification Number (VIN):**

\_\_\_\_\_

**Delivery Date:**

\_\_\_\_\_

**10,000 Miles or 1st Year**

Odometer:

Technician Name:

Date:

Next Service Due:

Authorised Dealer Stamp

Service Advisor Name:

Service Advisor Signature:

**Service Details**

Service Actions Checked: Yes / No

Air Filter Changed: Yes / No

Pollen Filter Changed: Yes / No

Spark Plugs Changed: Yes / No

Anti Corrosion Inspection: Yes / No

Fluids Changed:

**Additional Service Information**

**20,000 Miles or 2nd Year**

Odometer:

Technician Name:

Date:

Next Service Due:

Authorised Dealer Stamp

Service Advisor Name:

Service Advisor Signature:

**Service Details**

Service Actions Checked: Yes / No

Air Filter Changed: Yes / No

Pollen Filter Changed: Yes / No

Spark Plugs Changed: Yes / No

Anti Corrosion Inspection: Yes / No

Fluids Changed:

**Additional Service Information**

**30,000 Miles or 3rd Year**

Odometer:

Technician Name:

Date:

Next Service Due:

Authorised Dealer Stamp

Service Advisor Name:

Service Advisor Signature:

**Service Details**

Service Actions Checked: Yes / No

Air Filter Changed: Yes / No

Pollen Filter Changed: Yes / No

Spark Plugs Changed: Yes / No

Anti Corrosion Inspection: Yes / No

Fluids Changed:

**Additional Service Information**



**40,000 Miles or 4th Year**

Odometer:

Technician Name:

Date:

Next Service Due:

Authorised Dealer Stamp

Service Advisor Name:

Service Advisor Signature:

**Service Details**

Service Actions Checked: Yes / No

Air Filter Changed: Yes / No

Pollen Filter Changed: Yes / No

Spark Plugs Changed: Yes / No

Anti Corrosion Inspection: Yes / No

Fluids Changed:

**Additional Service Information**

**50,000 Miles or 5th Year**

Odometer:

Technician Name:

Date:

Next Service Due:

Authorised Dealer Stamp

Service Advisor Name:

Service Advisor Signature:

**Service Details**

Service Actions Checked: Yes / No

Air Filter Changed: Yes / No

Pollen Filter Changed: Yes / No

Spark Plugs Changed: Yes / No

Anti Corrosion Inspection: Yes / No

Fluids Changed:

**Additional Service Information**

**60,000 Miles or 6th Year**

Odometer:

Technician Name:

Date:

Next Service Due:

Authorised Dealer Stamp

Service Advisor Name:

Service Advisor Signature:

**Service Details**

Service Actions Checked: Yes / No

Air Filter Changed: Yes / No

Pollen Filter Changed: Yes / No

Spark Plugs Changed: Yes / No

Anti Corrosion Inspection: Yes / No

Fluids Changed:

**Additional Service Information**

**70,000 Miles or 7th Year**

Odometer:

Technician Name:

Date:

Next Service Due:

Authorised Dealer Stamp

Service Advisor Name:

Service Advisor Signature:

**Service Details**

Service Actions Checked: Yes / No

Air Filter Changed: Yes / No

Pollen Filter Changed: Yes / No

Spark Plugs Changed: Yes / No

Anti Corrosion Inspection: Yes / No

Fluids Changed:

**Additional Service Information**

**80,000 Miles or 8th Year**

Odometer:

Technician Name:

Date:

Next Service Due:

Authorised Dealer Stamp

Service Advisor Name:

Service Advisor Signature:

**Service Details**

Service Actions Checked: Yes / No

Air Filter Changed: Yes / No

Pollen Filter Changed: Yes / No

Spark Plugs Changed: Yes / No

Anti Corrosion Inspection: Yes / No

Fluids Changed:

**Additional Service Information**

**90,000 Miles or 9th Year**

Odometer:

Technician Name:

Date:

Next Service Due:

Authorised Dealer Stamp

Service Advisor Name:

Service Advisor Signature:

**Service Details**

Service Actions Checked: Yes / No

Air Filter Changed: Yes / No

Pollen Filter Changed: Yes / No

Spark Plugs Changed: Yes / No

Anti Corrosion Inspection: Yes / No

Fluids Changed:

**Additional Service Information**

**100,000 Miles or 10th Year**

Odometer:

Technician Name:

Date:

Next Service Due:

Authorised Dealer Stamp

Service Advisor Name:

Service Advisor Signature:

**Service Details**

Service Actions Checked: Yes / No

Air Filter Changed: Yes / No

Pollen Filter Changed: Yes / No

Spark Plugs Changed: Yes / No

Anti Corrosion Inspection: Yes / No

Fluids Changed:

**Additional Service Information**

**110,000 Miles or 11th Year**

Odometer:

Technician Name:

Date:

Next Service Due:

Authorised Dealer Stamp

Service Advisor Name:

Service Advisor Signature:

**Service Details**

Service Actions Checked: Yes / No

Air Filter Changed: Yes / No

Pollen Filter Changed: Yes / No

Spark Plugs Changed: Yes / No

Anti Corrosion Inspection: Yes / No

Fluids Changed:

**Additional Service Information**



**120,000 Miles or 12th Year**

Odometer:

Technician Name:

Date:

Next Service Due:

Authorised Dealer Stamp

Service Advisor Name:

Service Advisor Signature:

**Service Details**

Service Actions Checked: Yes / No

Air Filter Changed: Yes / No

Pollen Filter Changed: Yes / No

Spark Plugs Changed: Yes / No

Anti Corrosion Inspection: Yes / No

Fluids Changed:

**Additional Service Information**

**130,000 Miles or 13th Year**

Odometer:

Technician Name:

Date:

Next Service Due:

Authorised Dealer Stamp

Service Advisor Name:

Service Advisor Signature:

**Service Details**

Service Actions Checked: Yes / No

Air Filter Changed: Yes / No

Pollen Filter Changed: Yes / No

Spark Plugs Changed: Yes / No

Anti Corrosion Inspection: Yes / No

Fluids Changed:

**Additional Service Information**

**140,000 Miles or 14th Year**

Odometer:

Technician Name:

Date:

Next Service Due:

Authorised Dealer Stamp

Service Advisor Name:

Service Advisor Signature:

**Service Details**

Service Actions Checked: Yes / No

Air Filter Changed: Yes / No

Pollen Filter Changed: Yes / No

Spark Plugs Changed: Yes / No

Anti Corrosion Inspection: Yes / No

Fluids Changed:

**Additional Service Information**

**150,000 Miles or 15th Year**

Odometer:

Technician Name:

Date:

Next Service Due:

Authorised Dealer Stamp

Service Advisor Name:

Service Advisor Signature:

**Service Details**

Service Actions Checked: Yes / No

Air Filter Changed: Yes / No

Pollen Filter Changed: Yes / No

Spark Plugs Changed: Yes / No

Anti Corrosion Inspection: Yes / No

Fluids Changed:

**Additional Service Information**

**160,000 Miles or 16th Year**

Odometer:

Technician Name:

Date:

Next Service Due:

Authorised Dealer Stamp

Service Advisor Name:

Service Advisor Signature:

**Service Details**

Service Actions Checked: Yes / No

Air Filter Changed: Yes / No

Pollen Filter Changed: Yes / No

Spark Plugs Changed: Yes / No

Anti Corrosion Inspection: Yes / No

Fluids Changed:

**Additional Service Information**

**170,000 Miles or 17th Year**

Odometer:

Technician Name:

Date:

Next Service Due:

Authorised Dealer Stamp

Service Advisor Name:

Service Advisor Signature:

**Service Details**

Service Actions Checked: Yes / No

Air Filter Changed: Yes / No

Pollen Filter Changed: Yes / No

Spark Plugs Changed: Yes / No

Anti Corrosion Inspection: Yes / No

Fluids Changed:

**Additional Service Information**

**180,000 Miles or 18th Year**

Odometer:

Technician Name:

Date:

Next Service Due:

Authorised Dealer Stamp

Service Advisor Name:

Service Advisor Signature:

**Service Details**

Service Actions Checked: Yes / No

Air Filter Changed: Yes / No

Pollen Filter Changed: Yes / No

Spark Plugs Changed: Yes / No

Anti Corrosion Inspection: Yes / No

Fluids Changed:

**Additional Service Information**

**190,000 Miles or 19th Year**

Odometer:

Technician Name:

Date:

Next Service Due:

Authorised Dealer Stamp

Service Advisor Name:

Service Advisor Signature:

**Service Details**

Service Actions Checked: Yes / No

Air Filter Changed: Yes / No

Pollen Filter Changed: Yes / No

Spark Plugs Changed: Yes / No

Anti Corrosion Inspection: Yes / No

Fluids Changed:

**Additional Service Information**



**200,000 Miles or 20th Year**

Odometer:

Technician Name:

Date:

Next Service Due:

Authorised Dealer Stamp

Service Advisor Name:

Service Advisor Signature:

**Service Details**

Service Actions Checked: Yes / No

Air Filter Changed: Yes / No

Pollen Filter Changed: Yes / No

Spark Plugs Changed: Yes / No

Anti Corrosion Inspection: Yes / No

Fluids Changed:

**Additional Service Information**

## Sportshift Clutch Change History

(Sportshift Vehicles Only)

Clutch position should be measured with AMDS and recorded during vehicle Pre-delivery Inspection and when the clutch is changed.

### Clutch Position - PDI

Clutch First Position:	Counts
Signature:	Date:

### Clutch Position

Clutch First Position:	Counts
Signature:	Date:

### Clutch Position

Clutch First Position:	Counts
Signature:	Date:

## Replacement of Airbag Units

Aston Martin recommend that all airbag units are replaced every 10 years from the date of manufacture. To make sure this is completed correctly and safely, this work should be carried out by your Aston Martin Dealership.

### Airbag Replacement 10th Year

Odometer:

Date:

Signature:





# Aston Martin Warranty

Vehicle Warranties.....	B.2	Consumer Law.....	B.7
Warranty Period.....	B.3	Owner Details.....	B.8
Who May Repair the Vehicle.....	B.3	Vehicle Details.....	B.8
Wear and Tear Items.....	B.4	Owner Warranty Transfer (3).....	B.9
What is Not Covered.....	B.5	Owner Warranty Transfer (2).....	B.9
Customer Responsibility.....	B.6	Owner Warranty Transfer (1).....	B.9
Warranty Coverage when Touring.....	B.7	Owner Warranty Transfer (6).....	B.11
Aston Martin Extended Warranty.....	B.7	Owner Warranty Transfer (5).....	B.11
		Owner Warranty Transfer (4).....	B.11



## Vehicle Warranties

Aston Martin gives a Warranty for each new Aston Martin vehicle and each replacement vehicle or assembly manufactured or supplied by the Company to be free from defects in material and workmanship under normal use and service for the applicable Warranty period.

The warranties provided herein are for the benefit of the original purchaser and any subsequent owner during the relevant Warranty Period (defined below) in the Serviced Countries (defined below).

An Aston Martin vehicle is built and homologated to support the Region for which it is manufactured and is compliant with the local regulatory requirements of that Region. As a result, the warranties cover Aston Martin vehicles that are built for and supplied to the Region.

For the purposes of this Owner's Guide, Region means one of the following territories:

- the Americas, including the United States, Canada, and South America; or
- the United Kingdom, Europe, Russia and South Africa; or
- the Middle East, North Africa and India; or
- Asia Pacific, including China, Japan, Taiwan, Hong Kong, Singapore, Australia and New Zealand.

**'Serviced Countries'** means either: (a) any country in the Region from which your Aston Martin vehicle was purchased, where there is an Aston Martin authorised dealer or repairer; or (b) any country agreed in writing with Aston Martin.

 *Tyres are covered separately by the tyre manufacturer. Dealers are expected to offer assistance to the customer in pursuing a claim against the tyre manufacturer.*

## Exchange Parts Under Warranty

New parts will only be used for repairs at PDI and during the first three months or 5000 km/3000 miles (which ever occurs first) from the date the vehicle is handed over to the first retail customer. Thereafter exchange parts must be used where available under Aston Martin's exchange plan.

---

**Anti Perforation Corrosion Protection Warranty**

The vehicles bodywork is protected by an Anti Perforation Corrosion Warranty. Should any part of the bodywork of the Aston Martin vehicle be perforated, the panel(s) affected by the perforation will be repaired or replaced.

The term 'perforation' means a hole that penetrates through a body panel from the inside.

---

**Warranty Period**

The period of cover for all types of warranty commences on the day the vehicle is handed over to the first registered keeper of the car (first registered keeper shall mean the Dealer in the context of demonstration vehicles).

The Vehicle Warranty period of cover is three years with unlimited mileage.

The Anti Perforation Corrosion Warranty period of cover is ten years with unlimited mileage.

---

**Who May Repair the Vehicle**

Franchise Holders or Approved Repairers, who are appointed and receive full technical support from Aston Martin, provide facilities for the servicing and repair of Aston Martin motorcars. Only such Franchise Holders or Approved Repairs will under the terms of this warranty, repair replace or readjust, free of charge to the owner, any part or assemble proved to Aston Martins satisfaction to show a defect in materials or workmanship within the applicable period.

## Wear and Tear Items

Items that are subject to wear and tear are generally divided into two categories, namely those specified for replacement or adjustment during scheduled maintenance and those that require replacement or adjustment dependent upon conditions of use.

### Scheduled Maintenance Items

The items listed below are covered by the Vehicle Warranty up to the first scheduled change point that replacement or adjustment is required during scheduled maintenance operations. The customer literature supplied with the new Vehicle includes a service book setting out such scheduled maintenance operations.

- Drive belts
- Spark plugs
- Oil, air, pollen and fuel filters.

 *The period of warranty cover for any item may not exceed the time and distance limitation of the vehicle warranty.*

### Wear and Tear Items

The items listed below are recognised as having a limited service life or are subject to wear or damage. However, these items are covered by the vehicle warranty for up to one year or the first service, whichever ever occurs first.

- Wiper blades.
- All light bulbs.  
HID headlamp bulbs and instrumentation illumination bulbs are covered by the full vehicle warranty.
- Wheel alignment and balancing.
- Adjustments, including but not limited to: headlamp and hinged panel adjustments, suspension tightening, steering geometry adjustments, emission and fuel systems checks and park brake cable adjustments.
- Remote handset batteries.

 *Brake pads, brake discs, clutches and other friction related components are not covered when replacement is due to wear and tear, but they are covered against manufacturing defects (whether in material or workmanship) for the duration of the Vehicle Warranty.*

### Consumables

Replacement or top up of consumable fluids, e.g. oils, antifreeze, brake fluid, windscreen wash solution and refrigerant, will only be covered when they are used as part of a warranty repair.



## What is Not Covered

---

### Vehicle Warranty

Aston Martin is **not** responsible for any repair or replacement that is required as a direct result of:

- Normal wear and tear.
- Friction related components, e.g. clutch, brake pads and brake discs.
- Failure to properly maintain the vehicle in accordance with Aston Martin's maintenance schedules and service instructions.
- Failure to use Aston Martin specified parts or fluids during a warranty repair (or parts of equivalent quality during a retail repair).
- Damage resulting from neglect, accident, flooding or improper use.
- Any modification of the vehicle or parts which is not authorised by Aston Martin, including any engine performance enhancement modifications.
- Refilling or topping up with incorrect fuel, e.g. diesel instead of petrol.
- Use of bio ethanol alternative fuels.

- Use of a fuel not approved or recommended by Aston Martin in the Owner's Guide is considered misfuelling, and that any damage resulting from mis-fuelling is not covered by the vehicle warranty.
- Defects caused as a result of the vehicle being used in motor sport or track events or for any other purpose other than normal private or commercial use.
- Any vehicle that has had its vehicle identification number altered or removed, or on which the odometer reading has been unlawfully altered.

### Paint Surface and Corrosion Protection

Aston Martin is not responsible for any repair or replacement that is required as a direct result of the following:

- Failure to properly maintain paint and bodywork by regular cleaning in accordance with Aston Martin instructions.
- Factors beyond Aston Martin's control, such as environmental hazards (including industrial fallout, storm damage, acid rain) and damage (including stone chips, scratches and use of unsuitable cleaning agents).
- Accident repairs using materials or methods of repair that have not been approved by Aston Martin.
- Alterations of the vehicle from Aston Martin's original specification.
- Failure to rectify on a timely basis any paint or corrosion damage as recorded in the vehicle documentation by a dealer at the time of the annual inspection.

## Other Exclusions

The Aston Martin warranty excludes liability for any lost time, inconvenience, loss of transportation, or any other incidental or consequential damage you (or anyone else) may incur as a result of a defect covered by this warranty.

## Customer Responsibility

The customer literature will describe the proper care and use of the vehicle. Proper maintenance and use guard against major repair expenses resulting from misuse, neglect or inadequate maintenance, and may help increase the value that the customer may receive when selling the vehicle.

The Customer is responsible to:

- Make sure that the vehicle is maintained in accordance with the vehicle service and maintenance guide published in the customer literature.  
Failure to perform maintenance promptly and in accordance with Aston Martin's specified service intervals will invalidate warranty coverage on the parts affected.
- The customer is required to take the vehicle to a dealer for any warranty repairs as soon as practicable after a defect is detected.
- Make sure that the Service and Maintenance schedule has been stamped by the servicing dealer after the completion of a scheduled service operation.
- Make sure that paint and bodywork is maintained by regular cleaning in accordance with the vehicle manufacturer's instructions.

- Make sure that the body panels are examined annually by an authorised Aston Martin Dealer and that this inspection is recorded in the Owner's Guide.

## Warranty Coverage when Touring

---

Aston Martin has a comprehensive service network in most parts of the world. Any authorised Aston Martin Dealer can carry out repairs under the terms of the vehicle warranty. Under normal circumstances, the customer should not be required to pay for any warranty work performed by an Aston Martin Dealer.

It is the customer's responsibility to produce the warranty documentation issued with the new vehicle. This establishes the customer's right to warranty coverage and the relevant maintenance and service records. If the customer is unable to do so, the dealer should seek advice from Aston Martin.

## Aston Martin Extended Warranty

---

Aston Martin Extended Warranty is specifically designed to provide the customer with first class after-sales protection from unexpected repair costs when the vehicle warranty has expired, and the knowledge that your Aston Martin will be repaired by trained technicians using only genuine Aston Martin parts.

Contact your Aston Martin Dealer for more information on the benefits and protection provided by the Aston Martin Extended Warranty.

## Consumer Law

---

The Warranty is a manufacturer's warranty that supplements and does not affect the Owner's legal rights under the vehicle purchase agreement or under applicable national legislation governing the sale of consumer goods.

**Owner Details****Name:****Address:**

:

:

:

**Post Code:**

Signature:

Date:

**Dealer Stamp****Vehicle Details****Registration Plate No.:****VIN No.:****Engine No.:****Warranty Start Date:**

If the vehicle is sold, the benefits of any un-expired portion of the warranties can be transferred to the new owner.

The new owner should complete a 'tear off' sheet (next page) and send the new details to:

Aston Martin Warranty Department

Aston Martin Lagonda Limited

Banbury Road

Gaydon

Warwick

CV35 0DB

England

**Owner Warranty Transfer (3)****Owner Warranty Transfer (2)****Owner Warranty Transfer (1)**

VIN No.:

VIN No.:

VIN No.:

Odometer:

Odometer:

Odometer:

Date of Purchase:

Date of Purchase:

Date of Purchase:

Name:

Name:

Name:

Address:

Address:

Address:

:

:

:

:

:

:

:

:

:

Post Code:

Post Code:

Post Code:

Telephone No.:

Telephone No.:

Telephone No.:

Email Address:

Email Address:

Email Address:

Signature:

Signature:

Signature:

Date:

Date:

Date:



ASTON MARTIN



ASTON MARTIN



ASTON MARTIN

**Owner Warranty Transfer (6)**

VIN No.:

Odometer:

Date of Purchase:

Name:

Address:

:

:

:

Post Code:

Telephone No.:

Email Address:

Signature:

Date:

**Owner Warranty Transfer (5)**

VIN No.:

Odometer:

Date of Purchase:

Name:

Address:

:

:

:

Post Code:

Telephone No.:

Email Address:

Signature:

Date:

**Owner Warranty Transfer (4)**

VIN No.:

Odometer:

Date of Purchase:

Name:

Address:

:

:

:

Post Code:

Telephone No.:

Email Address:

Signature:

Date:



ASTON MARTIN



ASTON MARTIN



ASTON MARTIN



# Aston Martin Assistance

Emergency Assistance .....	C.2
Benefits .....	C.3
Alternative Travel Arrangements .....	C.4
What To Do In An Emergency .....	C.7
European Autoroute Restrictions .....	C.8
What is not Covered .....	C.8
Schedule - Eligible Vehicles .....	C.11



## Emergency Assistance

---

As the owner of an Aston Martin vehicle you should enjoy a high standard of trouble free motoring. However, should the unexpected occur, our worldwide Dealer network is there to help you. Details and contact telephone numbers are shown in the Dealer Directory. In the UK and specific countries within Europe, a special additional emergency service, known as '**Aston Martin Emergency Assistance**', has been designed to provide you and your passengers with the help you need quickly and efficiently should your vehicle suffer a Breakdown Incident <sup>1</sup>.

### Vehicles Covered

The benefits of Aston Martin Emergency Assistance are applicable to new and / or used Aston Martin vehicles purchased from an authorised Aston Martin Dealer. Refer to [www.astonmartin.com](http://www.astonmartin.com) for a list of all authorised Aston Martin Dealers.

At completion of your purchase, your Aston Martin Dealer will register your vehicle for Aston Martin Emergency Assistance. From registration, your vehicle will be entitled to Aston Martin Emergency Assistance (the '**Vehicle**'). For more details of what constitutes an eligible Vehicle, please refer to the Schedule.

An eligible Vehicle is entitled to receive Aston Martin Emergency Assistance for a period of 36 months from the date of registration with the service provider. Owners of eligible Vehicles can also obtain Aston Martin Emergency Assistance when travelling temporarily outside their Country <sup>2</sup>, within Europe.

### Europe is defined as:

Andorra, Austria, Belgium, Bosnia-Herzegovina, Bulgaria, Crete, Croatia, Czech Republic, Denmark, Estonia, Finland, France, Germany, Gibraltar, Greece, Hungary, Italy, Latvia, Liechtenstein, Lithuania, Luxembourg, Monaco, Netherlands, Norway, Poland, Portugal (not Madeira), Republic of Ireland, Romania, Russia, San Marino, Slovakia, Slovenia, Spain (including the Balearic Islands and Canary Islands), Sweden, Switzerland, Turkey (European Part), Ukraine, and Vatican City.

### United Kingdom (UK) is defined as:

England, Scotland, Wales, Northern Ireland, Channel Islands and Isle of Man.

---

<sup>1</sup> A **Breakdown Incident** means an event where an eligible Vehicle is immobilised due to a breakdown in circumstances where it qualifies for Aston Martin Emergency Assistance, including home-starts or broken glass. Furthermore, Aston Martin Emergency Assistance covers you in the event of safety-related defects, which render the Vehicle illegal to drive. These defects relate to, for example, failure of the seat belts, windscreen wipers, direction indicators, front and rear lamps.

---

<sup>2</sup> '**Country**' means the country in which your Vehicle is registered.

## Benefits

---

The service provider, appointed by Aston Martin to provide the Aston Martin Emergency Assistance services (the 'Service Provider') will provide the following benefits dependent on requirements to entitled Vehicles in both the home Country and Europe as defined.

### Roadside Assistance

The Service Provider's Agent vehicle should promptly arrive with you after your call has been placed. You may also book an appointment for a convenient time.

Aston Martin Emergency Assistance shall provide you with updates on its estimated time of arrival via your preferred communication method.

If following a Breakdown Incident in an area of coverage, your journey cannot be completed, and where the Vehicle cannot be repaired at the roadside, Aston Martin Emergency Assistance shall organise recovery of the Vehicle, including any luggage contained in the Vehicle at the time. Your Vehicle and luggage shall be transported to the nearest Aston Martin Dealer, without distance or financial limitation.

If the Vehicle cannot be repaired at the roadside or at your home address within a reasonable time period (45 minutes), the Service Provider will take you, the Vehicle and your passengers to the nearest Aston Martin Dealer. In the event that you (or your passengers) need to keep an important appointment, you will be taken there before the disabled Vehicle is transported to its required destination.

Should the Breakdown Incident occur outside of workshop hours, Aston Martin Emergency Assistance shall arrange for secure storage of the Vehicle until the next working day. The Vehicle shall arrive at the Dealer by midday on the next day.

If the nearest Dealer, to where the eligible Vehicle has been towed, is able to carry out the repairs at its premises, then the Vehicle will be repaired there.

Once the Vehicle is at a Dealership for repair, Aston Martin Emergency Assistance will keep in contact with the Dealer to follow the progress of the repair, and if necessary, arrange any extension of a replacement vehicle with Aston Martin Customer Service.

### Home Start

Aston Martin Emergency Assistance will provide all the benefits of Roadside Assistance at the Vehicle's registered address.

### Recovery

If Aston Martin Emergency Assistance cannot repair your Vehicle at the roadside, the Service Provider will arrange recovery of you and your Vehicle to the nearest Aston Martin Dealer.

If your Vehicle has been involved in an accident or has gone off the road and needs to be salvaged before towing, Aston Martin Emergency Assistance will charge you for services on a 'Pay for Use' basis and you may be able to claim these back from your insurance company.

You will be covered for costs of recovery and towing (including any handling fee) but you may be charged for any costs incurred if the Vehicle is, for example, disabled by floods or snow-affected roads, is embedded in sand or mud, or is not easily accessible.

If your Vehicle cannot be repaired and / or recovery is initiated to an Aston Martin Dealer, the Service Provider will provide alternative travel options for you. You will be entitled to receive one of the following additional services:

- A replacement vehicle for up to two working days in your Country, or 14 days if the Breakdown Incident occurs outside your Country (a collection and delivery service, or equivalent, is available from chosen suppliers subject to availability and supplier's terms and conditions);
- Onward transportation;
- Overnight accommodation.

### **Vehicle Collection Following Repair**

Following repairs organised by Aston Martin Emergency Assistance, the cost of a first class rail ticket or (if rail transport would normally exceed six hours) a business class air ticket will be met to permit you or a person you designate to collect the repaired Vehicle. Alternatively, arrangements can be made for your Vehicle to be returned to your home or business address, whichever is the nearest to the repairing Dealer. Alternative addresses closer to the repairing Dealer may also be considered.

### **Alternative Travel Arrangements**

If the Service Provider estimates that the repairs to your Vehicle will take more than eight hours, the Aston Martin Emergency Assistance will cover your reasonable costs for alternative necessary travel, including for members of your party.

Reasonable additional expenses shall be covered for one or a combination of the following:

- Replacement vehicle costs to a maximum of two working days in your Country and up to 14 days outside your Country.
- Air fares (business class ticket).
- Rail fares (first class ticket).
- Local taxi fares.
- Any other transport equivalent to first class rail fares.

---

## Replacement Vehicle

If following a Breakdown Incident:

- Your Vehicle is immobilised.
- Roadside repairs are unsuccessful.
- If repair of the Vehicle is not possible within the same day after towing to the Dealer.

Aston Martin Emergency Assistance will organise free of charge, a replacement vehicle for you until completion of the repairs. The replacement vehicle will include fully comprehensive insurance <sup>1</sup>, with an option to upgrade to include collision damage waiver.

The loan of this replacement vehicle will not exceed two working days (in your Country) or, if the Breakdown Incident occurred outside your Country, 14 days plus two working days after your return to your home country.

Aston Martin Emergency Assistance aim to make sure that the replacement vehicle is a suitable vehicle for you. Specially adapted replacement vehicles will not be provided.

The replacement vehicle will be delivered to you, where possible, but if you prefer, taxi costs for collecting the replacement vehicle, will be met by Aston Martin Emergency Assistance.

You will be responsible for fuelling and basic maintenance of the replacement vehicle, while under your care. You will also be responsible for paying any deposit required by the vehicle Hire Company.

Once the repair on your Vehicle is complete, the replacement vehicle will then either be returned to the vehicle Hire Company or collection will be arranged where possible, at your request.

If the replacement vehicle has been kept beyond the term of the permitted loan period (as noted above), you will be responsible for any additional charges incurred for the extended period. If you cannot fulfil the nominated vehicle Hire terms and conditions, or circumstances prevent you from qualifying to hire the vehicle, and alternative mobility arrangements are more appropriate, then onward travel arrangements or hotel accommodation will be provided instead. The vehicle hire agreement will be between you and the relevant supplier and will be subject to that supplier's Terms and Conditions. These will usually require or include (amongst other things):

- Production of a full driving licence valid at the time of issue of the hire vehicle.
- Limits on acceptable endorsements.
- Limitations on the availability and, or engine capacity of the replacement vehicle.
- A deposit, e.g. for fuel.
- Drivers to be aged at least 21 years depending on Country, and to have held a full driving licence for at least 12 months.

---

<sup>1</sup>. Unless the driver is under 21 years of age, where there may be an additional charge incurred.

## Onward or Home Journey

If following a Breakdown Incident that occurs more than 80 km (50 miles) from your place of residence, your Vehicle cannot be repaired at the roadside on the same day of the Breakdown Incident, Aston Martin Emergency Assistance will cover:

- The costs of the journey from the place of the Breakdown Incident to the nearest Dealer.
- The costs of a replacement vehicle as outlined above.
- Where necessary, taxi costs for one journey to the nearest accessible train station or airport, for you and your passenger(s).
- Where necessary, the costs of a first class train journey for you and your passenger(s). If the train journey exceeds six hours, the cost of a scheduled flight (Business Class) for you and your passenger(s).

Aston Martin Emergency Assistance will reimburse you for reasonable costs incurred relating to the above, upon receipt of a claim letter from you, detailing the circumstances of the claim, along with receipts for all transport costs claimed. All claim letters must be directed to Aston Martin Emergency Assistance at Aston Martin Customer Service, Aston Martin Lagonda Limited, Banbury Road, Gaydon, Warwick, CV35 0DB. Only costs directly connected with the Breakdown Incident will be covered.

The refund process to you shall be managed by Aston Martin Emergency Assistance.

## Repaired Vehicle Re-delivery

Aston Martin Emergency Assistance will attempt to contact you within 24 hours of successful repair at the Dealer in order to arrange re-delivery of the repaired Vehicle to either your home or place of work, as you request. Alternative addresses closer to the Repairing Dealer may also be considered.

## Hotel

If following a Breakdown Incident that occurs more than 80 km/50 miles from your place of residence, and your Vehicle cannot be repaired at the roadside on the day of the Breakdown Incident, accommodation costs for you and your passenger(s) shall be covered for the duration of the repair, for up to a maximum of two nights if the Breakdown Incident occurs in your Country, or seven nights if the Breakdown Incident occurs outside your Country. You shall be responsible for any excess costs.

## What To Do In An Emergency

### Repatriation of Un-repaired Vehicle from Abroad

If the Vehicle cannot be repaired by Aston Martin Emergency Assistance within an agreed time schedule (three working days), the costs for transporting the Vehicle and its contents from the Dealer to the home Country Dealer, will be covered by Aston Martin Emergency Assistance.

Aston Martin Emergency Assistance shall arrange the safe repatriation of the Vehicle at the least cost, while respecting the need to deliver the Vehicle to the home Dealer within 14 consecutive days.

Aston Martin Emergency Assistance will cover the costs for parking the Vehicle, pending repatriation or import.

Should assistance be required in the unlikely event of a Breakdown Incident, simply contact Aston Martin Emergency Assistance using the relevant telephone number listed below.

 *It may be helpful to have the relevant telephone numbers entered into your mobile phone 'phone book'.*

00 800 28 86 28 86 <sup>1</sup>

+44 208 603 9875

When connected, enter the 2 digit number as prompted for your home country. Please do not make your own arrangements as Aston Martin Emergency Assistance will be not be able to reimburse you. If you are in a remote location and need assistance, the time taken to receive the assistance may be longer because of distance and local restrictions.

---

<sup>1</sup>. Calls from landlines shall be free. Calls from mobile phones will be charged at standard mobile network rates.

### Vehicle Identification and Location

To minimise delay, please have the following information available:

- Your name.
- Aston Martin model.
- The Vehicle Identification Number (VIN). The last six digits from the VIN label in the corner of the windscreen.
- The location of the vehicle.
- Vehicle registration number and colour.
- Telephone number where you can be contacted.
- Description of the concern experienced.

## European Autoroute Restrictions

If assistance is required on a French Autoroute or on certain Autoroutes in other European countries, you must use the official SOS boxes at the side of the road in order to arrange initial assistance or recovery. You will be connected to the authorised Autoroute Assistance Service because these roads are privatised. Neither Aston Martin Emergency Assistance nor any other assistance organisations are allowed to assist on these roads.

Once your Aston Martin has been recovered from the Autoroute, you should contact Aston Martin Emergency Assistance at the earliest opportunity to make sure that any further assistance arrangements you require can be made on your behalf.

Aston Martin Emergency Assistance will advise you how to reclaim costs incurred for recovery from the Autoroute.

## What is not Covered

Aston Martin Emergency Assistance is thorough and comprehensive; however, claims cannot be met as a result of any of the following:

1. Where you, or anyone else acting on your behalf, make repair or service arrangements without authorisation (and a file number) from Aston Martin Emergency Assistance.
2. Where any loss, theft, damage, death, bodily injury, cost or expense that is not directly associated with the incident that caused you to claim, unless expressly stated in this policy.
3. If the Breakdown Incident is due to fire, theft, accident or vandalism, your costs will not be covered by Aston Martin Emergency Assistance but should be met by third party insurance covering the incident.
4. Damage or injury intentionally caused by you or resulting from your participation in a criminal offence.
5. If your Vehicle is kept in an un-roadworthy condition or has not been serviced in accordance with the Manufacturer's recommendations.
6. Any costs that would have been payable by you, such as petrol, toll charges, parking fees, cost of meals, drinks, telephone calls and/ or newspapers or any other costs not specifically stated as being covered by Aston Martin Emergency Assistance, which may be incurred by you and/ or the other member(s) of your party as a result of and/ or in connection with the Breakdown Incident.
7. Release fees: Should your Vehicle be stolen and subsequently recovered by the police, you may be asked to pay a release fee before we can remove your Vehicle to an authorised Aston Martin Dealer.
8. Specialist charges: In the event that the use of specialist equipment is required to give assistance when your Vehicle has, for example, gone off the road, is in a ditch, is standing on soft ground, sand, shingle, stuck in water or snow or has been immobilised by the removal of its wheels, we will arrange recovery but you will be responsible for the costs of any specialist equipment required. The costs may be refundable under the terms of your motor insurance policy.



9. Adverse weather conditions: On those occasions when we experience adverse weather conditions, such as high winds, snow, floods, etc., external resources may be stretched and some operations become physically impossible until the weather improves. At such times, our priority is to make sure that you and your passengers are taken to a place of safety and so the recovery of your Vehicle may not be possible until weather conditions permit.

10. Customer induced breakdown incidents are not covered under Aston Martin Emergency Assistance. However, Aston Martin and the Service Provider will, at their sole discretion, assist you if you request it. However we are not obligated to provide assistance and you shall be responsible for any charges resulting from any assistance given caused by a customer induced fault. In such circumstances, a swipe card deposit may be taken by the Service Provider. Assistance in such circumstances will not include additional benefits (replacement vehicle, onward journey, hotel accommodation).

Customer induced faults may include, for example, the following:

- Lock-outs / lost keys
- Broken keys

- Discharged battery
- Running out or loss of fuel
- Use of wrong fuel (no replacement at the location of breakdown, only towing)
- Tyre damage
- Road traffic accidents.

11. Lockout / lost keys: Whilst we will always try to provide assistance by the most practical method, should you be unable to gain entry to your Vehicle, modern security systems make it extremely difficult for this to be done should spare keys not be available. If a forced entry is required, you will be asked to sign a declaration stating that you have given permission for this to take place and that any costs for resultant damage will be your sole responsibility.

12. Aston Martin Emergency Assistance shall not be required to provide services in the following circumstances:

- 12.1 In respect of Vehicles not displaying a valid road fund licence.
- 12.2 In respect of eligible Vehicles situated on private property (for example garage premises) unless you can establish to the reasonable satisfaction of Aston Martin Emergency Assistance that permission has been given by the relevant owner or occupier.
- 12.3 Vehicle servicing or re-assembly where this is required as a result of neglect or unsuccessful work on the Vehicle other than on the part of the Service Provider or its agents.
- 12.4 The recovery of any Vehicles bearing trade plates or which Aston Martin Emergency Assistance has reason to believe have just been imported or purchased at auction.
- 12.5 The transportation of immobilised Vehicles where Aston Martin Emergency Assistance considers this to be part of a commercial activity.

- 
- 12.6 Assistance for Vehicles broken down as a result of taking part in any 'Motor Sport Event', including, without limitation, motor racing, rallying, speed or duration tests or practice thereof, trials or time-trials, auto test (other than auto tests performed by the Client using roadworthy, road legal cars on public roads), but excluding 'Concours d'elegance' events, track test days for road-legal Vehicles or rallies held exclusively on open public roads where participants are required to comply with the normal rules of the road (save for Aston Martin organised and controlled track day events).
- 12.7 Where the police, highways agency and / or other emergency service require that your Vehicle be recovered by a third party.
- 12.8 Where your entitlement to Aston Martin Emergency Assistance lapses or if your Vehicle is no longer considered eligible for Aston Martin Roadside Assistance, the Service Provider may charge you directly for the Services provided. Any such charges will be charged on a 'pay for use' basis and will constitute a direct contract between you and the Service Provider. If it is determined that Aston Martin is at fault for the Vehicle not being recorded as an eligible Vehicle, then Aston Martin shall pay the relevant charges.
- 12.9 Assistance for routine maintenance and running repairs of the Vehicle such as fixing faulty radios, interior light bulbs and heated rear windows.
- 12.10 For transit risk insurance, which Aston Martin Emergency Assistance recommends you take out where a Vehicle is to be repatriated.
- 12.11 Where locksmiths, body-glass or tyre specialists are required. Aston Martin Emergency Assistance will endeavour to arrange for their assistance on your behalf, however, you will be responsible for the costs of their services. Further, if use of a locksmith or other specialist would, in Aston Martin Emergency Assistance's opinion, mobilise the vehicle, no further service will be given for the breakdown in question.
- 12.12 The transportation of any animal or pets shall be at the sole discretion of the Service Provider.

## Schedule - Eligible Vehicles

13. The Service Provider may charge you directly for:

- Any replacement component, lubricant and / or fuel (the 'Parts') or consumable items supplied (except where Aston Martin has provided or paid for such Parts)
- Any extension of the Services which you are entitled to receive in connection with this Agreement (which shall be performed by the Service Provider (in its absolute discretion) at your request.
- The use of any specialist lifting or towing assistance needed to recover your Vehicle if your Vehicle has gone off the road, is in a ditch, sunk in soft ground, sand or shingle or when it is stuck in snow or flood water.
- Any additional charges resulting from the failure to carry legal and serviceable spare wheel(s) or tyre(s) in the Vehicle. Aston Martin Emergency Assistance will endeavour to arrange assistance from a third party on your behalf but you will be responsible for the costs of the call out and/ or for any repair.
- The cost of garage or other labour required to repair the Vehicle, other than that provided by Aston Martin Emergency Assistance at the scene of the Breakdown Incident.

- Any costs of draining or removing fuel, lubricants or other fluids as a result of the introduction of an inappropriate substance.
  - Transportation of personal effects, goods, vehicles, boats or other waterborne craft on or in the Vehicle and any trailer or caravan. Aston Martin Emergency Assistance will not consider any claim for loss resulting from damage to / loss of use of these items. Such items remain your responsibility at all times.
14. If following a Breakdown Incident, the Service Provider, its third party garage agent or subcontractor makes a temporary repair to your Vehicle (for these purposes, a temporary repair shall mean temporary repairs of the Vehicle where the underlying cause of the Vehicle's failure is not resolved), then the Service Provider, its third party garage agent or subcontractor shall recommend you to have such temporary repair made good by a Dealer.

### **New Vehicles**

Any Aston Martin vehicle which is sold directly by Aston Martin or a Dealer in the UK or European Territories and which is first registered in the UK or European Territories (as appropriate, (Refer to page C.2)).

### **Used Vehicles**

Those used vehicles registered in the UK or the European Territories in respect of which an Extended Warranty has been started.

### **In All Cases**

- Maximum Gross Vehicle Weight (including any caravans or trailers being towed at the time of the Breakdown Incident): 3500 Kg
- Maximum Vehicle Length: 5.5 m
- Maximum Vehicle Width (including any caravans or trailers being towed at the time of the Breakdown Incident): 2.3 m
- Maximum Vehicle Height: 3 m

---

The dimensions detailed above will be calculated taking into account anything attached to the relevant eligible Vehicle at the time of the relevant Breakdown Incident and any trailer or caravan, including but not limited to towing equipment, any carriers or racks (e.g. bike or luggage), or anything else attached to the Vehicle or the carriers / racks.

Vehicles must be built to manufacturer's specifications, display a road fund licence, and where applicable, hold a certificate of roadworthiness.



ASTON MARTIN



ASTON MARTIN

# Alphabetical Index

## A

Accessory Power Sockets .....	3.30
Airbags .....	3.15
Passenger Deactivation Switch .....	3.18
Alarm .....	2.12
Movement Sensor .....	2.13
Reduced Guard .....	2.13
Tilt Sensor .....	2.13
Ambient TemperatureDisplay .....	4.19
Anti-lock Braking System .....	5.10
Apple CarPlay .....	6.7
Approach Light .....	2.12
Ashtray and Cigar Lighter .....	3.31
Aston Martin Assistance .....	C.1
Aston Martin Tracking .....	2.2
Aston Martin Warranty .....	B.1
Audio .....	8.1
Battery Protection Mode .....	8.5
Essentials .....	8.2
Automatic Lock .....	2.11

## B

Battery .....	12.20
Maintenance .....	12.20
Protection Mode .....	8.5
Battery Charge .....	12.20
Battery Conditioner .....	12.20
Battery Disposal .....	12.20
Battery Protection Mode .....	12.22
Bluetooth Device Management .....	9.3
Bonnet Release .....	12.7
Boot Cover .....	3.29
Boot Lamps .....	12.27
Boot Lid .....	2.9
Brake Pad Bedding-in .....	12.11
Brakes .....	
Anti-lock Braking System .....	5.10
Park Brake .....	5.11

## C

Cabin Storage .....	3.26
Catalytic Converters .....	5.16

Child Safety .....	3.17
Child Seats .....	3.22
Passenger Airbag Deactivation .....	3.18
Climate Control .....	
Automatic Operation .....	7.5
Controls .....	7.2
Manual Operation .....	7.6
Operating Tips .....	7.2
Component Location .....	1.4
Condensation, Headlamp Units .....	12.25
Controls .....	
CentreStack .....	4.8
Information and Warning Symbols .....	4.6
Instrument Cluster .....	4.3
StalkControls .....	4.12
Controls Overview .....	4.2
Cruise Control .....	4.20

## D

Data Recording .....	1.5
Day Time RunningLamps .....	4.14
Deadlocking .....	2.11

Defrosting and Demisting	
Automatic .....	7.6
Manual .....	7.6
Driving Techniques .....	5.2
Dynamic Stability Control .....	5.12
<b>E</b>	
Electric Windows .....	3.8
Emergency Items .....	12.5
Emotion Control Unit .....	2.5
External Lamps .....	12.26
<b>F</b>	
Fluid Levels .....	12.8
Footbrake .....	5.10
Front Seat Reset .....	12.28
Fuel	
Catalytic Converters .....	5.16
Fuel Filling .....	5.15
Fuse Boxes .....	12.23
<b>G</b>	
Garage Door Opener .....	2.15
Operation .....	2.16
Programming .....	2.15

D.2

Reprogramming .....	2.17
Rolling Code Synchronisation .....	2.16
<b>H</b>	
Hands-Free Phone .....	9.1
Using a Phone .....	9.4
Headlamp .....	12.25
Headlamp Condensation .....	12.25
Homesafe .....	2.12
<b>I</b>	
Ignition Control .....	4.10
Immobiliser .....	2.14
Infotainment	
Bluetooth Pairing .....	6.4
Infotainment Controls .....	6.2
Infotainment Personalisation .....	6.4
Infotainment System .....	6.2
Power Meter .....	6.6
Tyre Status .....	6.6
Vehicle Status .....	6.5
Interior Mirrors .....	3.9
Internal Lamps .....	12.27

**J**

Jump Start From Another Vehicle .....	12.17
---------------------------------------	-------

**L**

Lamps	
Boot .....	12.27
External .....	12.26
Headlamp .....	12.25
Internal .....	12.27
LampsOn Warning .....	4.14
Locking the Vehicle .....	2.8
Low Outside Temperature Warning .....	4.5

**M**

Maintenance .....	12.1, 12.6
Vehicle Jacking .....	12.3
Maintenance Items	
Battery Conditioner .....	12.6
Manual Transmission .....	5.8
Map	
Browse .....	11.7
Master LampSwitch .....	4.14
Master Vehicle Lock .....	2.8
Memory Seats .....	3.7

Mirrors	Replacement of Seat Belt Pre-tensioners Record	A.29	Steering	13.5
Door	Restraints System	3.11	Suspension	13.5
Interior	Determining if the System is Operational	3.12	Transmission	13.2
Power Fold Function (Door Mirrors)	Reversing Camera	5.18	Tyres	13.6
Reverse Dip Function (Door Mirrors)	<b>S</b>		Vehicle Type	13.8
<b>N</b>	Safety Defects - Reporting	1.5	Wheels	13.6
Navigation	Seat Adjustment	3.2	Sport Mode	
Map	Sport Seat	3.3	Manual Transmission	5.9
Menu	Seat Adjustment - Lightweight Seat	3.5	Sportshift	5.7
Navigate	Seat Belts	3.12	Sportshift Clutch Change History	A.28
POI	Care and Maintenance	12.32	SportShift Transmission	5.5
Settings	Child	3.15	Auto Transmission Mode	5.5
Traffic	Seats		Paddle Shift Mode	5.6
Navigation Controls	Memory Function	3.7	Sportshift Features	5.7
Operation	Service Record	A.7	Starting the Engine	5.3
<b>P</b>	Servicing	A.4	Steering Wheel	3.8
Park Brake	Servicing Precautions	12.3	Supplemental Restraints System	3.15
Parking Assist	Specifications	13.1	<b>T</b>	
Passenger Airbag Deactivation	Brakes	13.5	Track Days	5.2
<b>R</b>	Bulbs	13.7	Traction Control	5.14
Reading Lamps	Electrics	13.2	TripComputer	4.15
Replacement of Airbag Units Record	Engine	13.2	Tyre Sealant Kit	12.14
	Fluids and Capacities	13.4	TyrePressure Monitoring	4.17

Tyres .....12.12  
 Winter .....12.13

**U**

Unlocking the Vehicle .....2.7

**V**

Vehicle Battery .....12.18  
 Vehicle Cleaning .....12.29  
 Vehicle Horn .....4.14  
 Vehicle Identification .....1.4  
 Vehicle Key .....2.5  
 Vehicle Recovery .....12.16  
 Vehicle Storage .....12.33

**W**

Wheel Nut Torque .....13.6  
 Window Reset .....12.28  
 Windscreen Blade Replacement .....12.11  
 Wipers  
 WiperControl .....4.13



ASTON MARTIN



ASTON MARTIN