

ASTRA

Owner's Manual



Contents

Introduction	2
In brief	6
Keys, doors and windows	18
Seats, restraints	31
Storage	48
Instruments and controls	56
Lighting	93
Climate control	106
Driving and operating	115
Vehicle care	138
Service and maintenance	177
Technical data	180
Customer information	188
Index	198

Introduction

Fuel	Designation	<input type="text"/>		
Engine oil	Grade	<input type="text"/>		
	Viscosity	<input type="text"/>		
Tyre pressure	Tyre size		Front	Rear
	Summer tyres	<input type="text"/>	<input type="text"/>	<input type="text"/>
	Winter tyres	<input type="text"/>	<input type="text"/>	<input type="text"/>
Weights	Gross vehicle weight rating	<input type="text"/>		
	- Kerb weight, basic model	<input type="text"/>		
	= Loading	<input type="text"/>		

Vehicle specific data

Please enter your vehicle's data on the previous page to keep it easily accessible.

Refer to the sections "Service and maintenance", "Technical data", the vehicle's identification plate and national registration documents.

Introduction

Your vehicle is a designed combination of advanced technology, safety, environmental friendliness and economy.

This Owner's Manual provides you with all the necessary information to enable you to drive your vehicle safely and efficiently.

Make sure your passengers are aware of the possible risk of accident and injury which may result from improper use of the vehicle.

You must always comply with the specific laws and regulations of the country that you are in. These laws may differ from the information in this Owner's Manual.

Disregarding the description given in this manual may affect your warranty.

When this Owner's Manual refers to a workshop visit, we recommend your Opel Service Partner.

All Opel Service Partners provide first-class service at reasonable prices. Experienced mechanics trained by Opel work according to specific Opel instructions.

The customer literature pack should always be kept ready to hand in the vehicle.

Using this manual

- This manual describes all options and features available for this model. **Certain descriptions, including those for display and menu functions, may not apply to your vehicle due to model variant, country specifications, special equipment or accessories.**
- The "In brief" section will give you an initial overview.

- The table of contents at the beginning of this manual and within each section shows where the information is located.
- The index will enable you to search for specific information.
- This Owner's Manual depicts left-hand drive vehicles. Operation is similar for right-hand drive vehicles.
- The Owner's Manual uses the engine identifier code. The corresponding sales designation and engineering code can be found in the section "Technical data".
- Directional data, e.g. left or right, or front or back, always relate to the direction of travel.
- Displays may not support your specific language.
- Display messages and interior labelling are written in **bold** letters.

Danger, Warnings and Cautions

Danger

Text marked ** Danger** provides information on risk of fatal injury. Disregarding this information may endanger life.

Warning

Text marked ** Warning** provides information on risk of accident or injury. Disregarding this information may lead to injury.

Caution

Text marked **Caution** provides information on possible damage to the vehicle. Disregarding this information may lead to vehicle damage.

Symbols

Page references are indicated with ⇨.
⇨ means "see page".

Page references and index entries refer to the indented headings given in the section table of content.

We wish you many hours of pleasurable driving.

Your Opel Team

In brief

Initial drive information

Vehicle unlocking



Press  to unlock the doors and load compartment. Open the doors by pulling the handles.



Press  on the remote control for at least two seconds; the boot lid opens slightly.

Radio remote control ↗ 19, Central locking system ↗ 20, Load compartment ↗ 23.

Seat adjustment

Longitudinal adjustment



Pull handle, slide seat, release handle. Try to move the seat back and forth to ensure that the seat is locked in place.

Seat position ⇄ 32, Manual seat adjustment ⇄ 33.

Backrest inclination



Pull lever, adjust inclination and release lever. Allow the seat to engage audibly.

Seat position ⇄ 32, Manual seat adjustment ⇄ 33.

Seat height

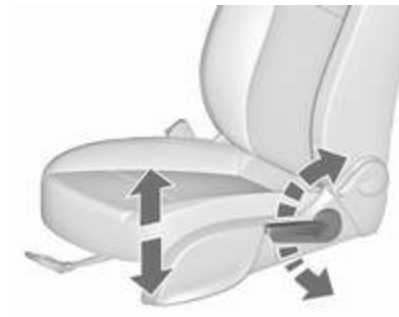

Lever pumping motion

up : seat higher
down : seat lower

Seat position ⇄ 32, Manual seat adjustment ⇄ 33.

Seat inclination

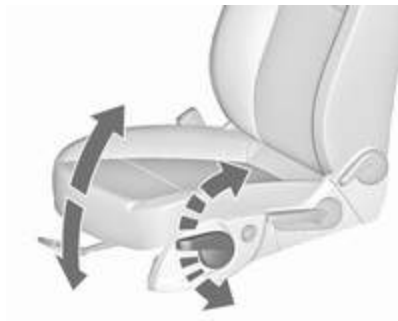

Lever pumping motion
up : front end higher
down : front end lower

Seat position ⇨ 32, Manual seat adjustment ⇨ 33.

Head restraint adjustment



Press release button, adjust height, engage.
Head restraints ⇨ 31.

Seat belt



Pull out the seat belt and fasten in belt buckle. The seat belt must not be twisted and must fit close against the body. The backrest must not be tilted back too far (maximum approx. 25 °).
To unfasten belt, press red button on belt buckle.

Seat position ⇨ 32, Seat belts ⇨ 36, Airbag system ⇨ 39.

Mirror adjustment

Interior mirror

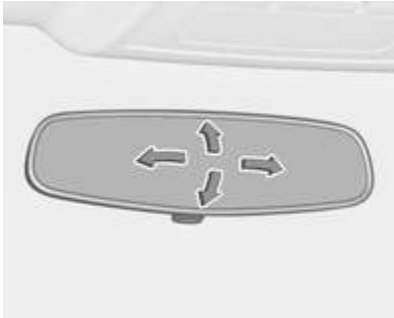

To adjust the mirror, move the mirror housing in the desired direction.

Manual anti-dazzle interior mirror ⇨ 26, Automatic anti-dazzle interior mirror ⇨ 27.

Exterior mirrors

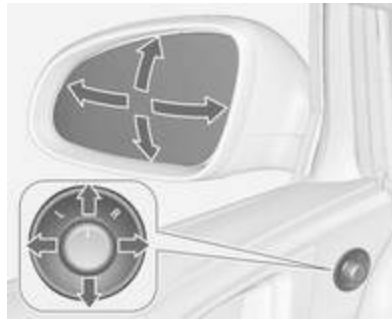

Select the relevant exterior mirror and adjust it.

Convex exterior mirrors ⇨ 25, Electric adjustment ⇨ 25, Folding exterior mirrors ⇨ 25, Heated exterior mirrors ⇨ 26.

Steering wheel adjustment



Unlock the lever, adjust the steering wheel, then engage the lever and ensure it is fully locked.

Do not adjust the steering wheel unless the vehicle is stationary and the steering wheel lock has been released.

Airbag system ⇨ 39, Ignition positions ⇨ 116.

Instrument panel overview

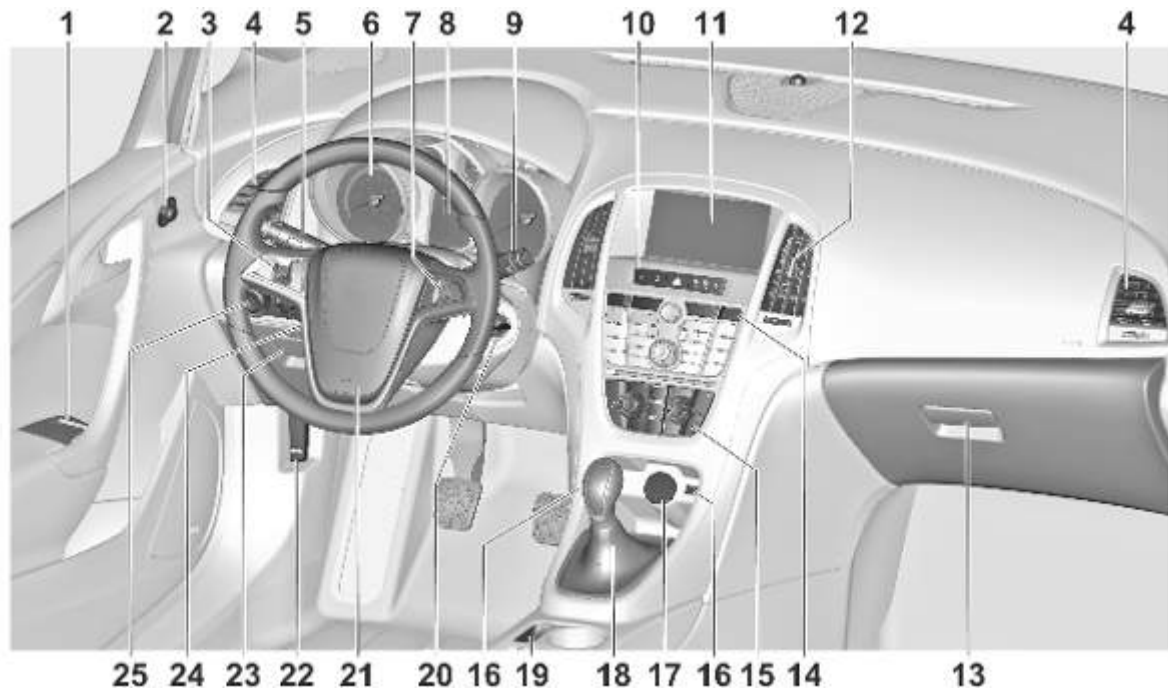

<p>1 Power windows 28</p> <p>2 Exterior mirrors 25</p> <p>3 Cruise control 130</p> <p style="padding-left: 20px;">Speed limiter 131</p> <p>4 Side air vents 113</p> <p>5 Turn and lane-change signals, headlight flash, low beam and high beam, high beam assist 100</p> <p style="padding-left: 20px;">Exit lighting 104</p> <p style="padding-left: 20px;">Parking lights 101</p> <p style="padding-left: 20px;">Buttons for Driver Information Centre 73</p> <p>6 Instruments 62</p> <p>7 Steering wheel controls 57</p> <p>8 Driver Information Centre 73</p> <p>9 Windscreen wiper, windscreen washer system, headlight washer system, rear window wiper, rear window washer system 58</p> <p>10 Central locking system 20</p> <p style="padding-left: 20px;">Hazard warning flashers 100</p>	<p style="padding-left: 20px;">Control indicator for airbag deactivation 68</p> <p style="padding-left: 20px;">Control indicator for front passenger seat belt 68</p> <p>11 Info Display 77</p> <p>12 Centre air vents 113</p> <p>13 Glovebox 48</p> <p>14 Traction Control system (TC) 128</p> <p style="padding-left: 20px;">Electronic Stability Control (ESC) 129</p> <p style="padding-left: 20px;">Parking assist systems 133</p> <p style="padding-left: 20px;">Unlock button for boot lid 23</p> <p>15 Climate control system 106</p> <p>16 AUX input, USB input, SD card slot 10</p> <p>17 Power outlet 62</p> <p>18 Selector lever, manual transmission 124</p> <p style="padding-left: 20px;">Automatic transmission 121</p> <p>19 Electric parking brake 126</p> <p>20 Ignition switch with steering wheel lock 116</p>	<p>21 Horn 58</p> <p style="padding-left: 20px;">Driver airbag 40</p> <p>22 Bonnet release lever 140</p> <p>23 Storage compartment, fuse box 157</p> <p>24 Steering wheel adjustment . . 57</p> <p>25 Light switch 93</p> <p style="padding-left: 20px;">Headlight range adjustment 96</p> <p style="padding-left: 20px;">Front fog lights 101</p> <p style="padding-left: 20px;">Rear fog light 101</p> <p style="padding-left: 20px;">Instrument illumination 102</p>
---	---	--

Exterior lighting



Turn light switch:

- O** : lights off
- ≡** : sidelights
- ≡D** : low beam



Automatic light control

- AUTO** : automatic light control: exterior lighting is switched on and off automatically
- ⊕** : activation or deactivation of the automatic light control
- ≡** : sidelights
- ≡D** : low beam

Fog lights

Press light switch:

- ≡D** : front fog lights
- ⊕** : rear fog light

Lighting ⇨ 93.

Headlight flash, high beam and low beam



- headlight flash : pull lever
- high beam : push lever
- low beam : push or pull lever

Automatic light control ⇨ 94, High beam ⇨ 95, Headlight flash ⇨ 95, Adaptive forward lighting ⇨ 97.

Turn and lane-change signals



lever up : right turn signal
lever down : left turn signal

Turn and lane-change signals
↪ 100, Parking lights ↪ 101.

Hazard warning flashers



Operated by pressing .
Hazard warning flashers ↪ 100.

Horn



Press .

Climate control

Heated rear window, heated exterior mirrors



The heating is operated by pressing .

Heated rear window ⇨ 30.

Demisting and defrosting the windows



Press .

Set the temperature control to the highest level.

Heated rear window  on.

Climate control system ⇨ 106.

Washer and wiper systems

Windscreen wiper

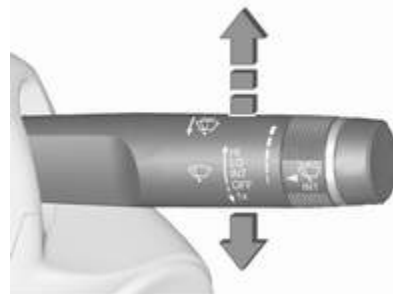

HI : fast

LO : slow

INT : interval wiping or automatic wiping with rain sensor

OFF : off

For a single wipe when the windscreen wiper is off, press the lever down to position **1x**.

Windscreen wiper ⇨ 58, Wiper blade replacement ⇨ 145.

Windscreen and headlight washer



Pull lever.

Windscreen and headlight washer system ⇨ 58, Washer fluid ⇨ 143.

Transmission

Manual transmission



Reverse: with the vehicle stationary, depress clutch pedal, press the release button on the selector lever and engage the gear.

If the gear does not engage, set the lever to neutral, release the clutch pedal and depress again; then repeat gear selection.

Manual transmission ⇨ 124.

Automatic transmission



P : park

R : reverse

N : neutral

D : automatic mode

M : manual mode: move selector lever from **D** to the left.

+ : manual mode upshifting

- : manual mode downshifting

The selector lever can only be moved out of **P** when the ignition is on and the brake pedal is applied. To engage **P** or **R**, press the release button.

Automatic transmission ⇨ 121.

Starting off

Check before starting off

- Tyre pressure and condition
⇨ 160, ⇨ 186.
- Engine oil level and fluid levels
⇨ 141.
- All windows, mirrors, exterior lighting and number plates are free from dirt, snow and ice and are operational.
- Proper position of mirrors, seats, and seat belts ⇨ 25, ⇨ 32, ⇨ 37.
- Brake function at low speed, particularly if the brakes are wet.

Starting the engine

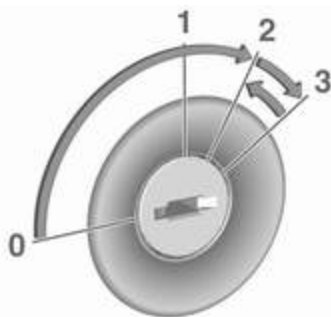

- Turn key to position **1**.
- Move the steering wheel slightly to release the steering wheel lock.
- Operate clutch and brake.
- Automatic transmission in **P** or **N**.
- Do not operate accelerator pedal.
- Turn key to position **3** and release.

Starting the engine ⇨ 117.

Parking

⚠ Warning

- Do not park the vehicle on an easily ignitable surface. The high temperature of the exhaust system could ignite the surface.
- Always apply the parking brake. Activate the manual parking brake without pressing the release button. Apply as firmly as possible on a downhill slope or uphill slope. Depress brake pedal at the same time to reduce operating force.
For vehicles with electric parking brake, pull switch (Ⓢ) for approx. one second.
The electric parking brake is applied when control indicator (Ⓢ) illuminates ⇨ 69.
- Switch off the engine.
- If the vehicle is on a level surface or uphill slope, engage first gear or set the selector

lever to position **P** before removing the ignition key. On an uphill slope, turn the front wheels away from the kerb.

If the vehicle is on a downhill slope, engage reverse gear or set the selector lever to position **P** before removing the ignition key. Turn the front wheels towards the kerb.

- Close the windows.
- Remove the ignition key from the ignition switch. Turn the steering wheel until the steering wheel lock is felt to engage.
For vehicles with automatic transmission, the key can only be removed when the selector lever is in position **P**.
- Lock the vehicle by pressing  on the radio remote control.
- The engine cooling fans may run after the engine has been switched off ⇨ 140.

Caution

After running at high engine speeds or with high engine loads, operate the engine briefly at a low load or run in neutral for approx. 30 seconds before switching off, in order to protect the turbocharger.

Keys, locks ⇨ 18, Laying the vehicle up for a long period of time ⇨ 139.

Keys, doors and windows

Keys, locks	18
Keys	18
Radio remote control	19
Memorised settings	20
Central locking system	20
Automatic locking	22
Child locks	22
Doors	23
Load compartment	23
Vehicle security	24
Anti-theft locking system	24
Immobiliser	24
Exterior mirrors	25
Convex shape	25
Electric adjustment	25
Folding mirrors	25
Heated mirrors	26
Interior mirrors	26
Manual anti-dazzle	26
Automatic anti-dazzle	27
Windows	27
Windscreen	27
Manual windows	27

Power windows	28
Heated rear window	30
Sun visors	30

Keys, locks

Keys

Caution
Do not attach heavy or bulky items to the ignition key.

Replacement keys

The key number is specified on a detachable tag.

The key number must be quoted when ordering replacement keys as it is a component of the immobiliser system.

Locks ⇨ 174.

The code number of the adapter for the locking wheel nuts is specified on a card. It must be quoted when ordering a replacement adapter.

Wheel changing ⇨ 166.

Key with foldaway key section



Press button to extend. To fold the key, first press the button.

Radio remote control



Used to operate:

- central locking system
- anti-theft locking system
- power windows

The radio remote control has a range of approx. 20 metres. It can be restricted by external influences. The hazard warning flashers confirm operation.

Handle with care, protect from moisture and high temperatures and avoid unnecessary operation.

Fault

If the central locking system cannot be operated with the radio remote control, it may be due to the following:

- Range is exceeded.
- Battery voltage is too low.
- Frequent, repeated operation of the radio remote control while not in range, which will require re-synchronisation.
- Overload of the central locking system by operating at frequent intervals, the power supply is interrupted for a short time.
- Interference from higher-power radio waves from other sources.

Unlocking ⇨ 20.

Basic settings

Some settings can be changed in the Settings menu in the Info-Display. Vehicle personalisation ⇨ 84.

Radio remote control battery replacement

Replace the battery as soon as the range reduces.



Batteries do not belong in household waste. They must be disposed of at an appropriate recycling collection point.

Key with foldaway key section

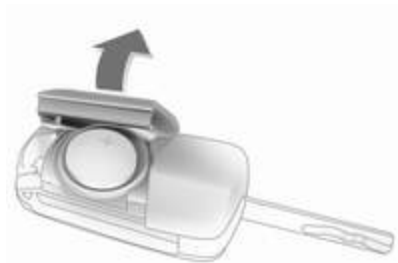

Extend the key and open the unit. Replace the battery (battery type CR 2032), paying attention to the installation position. Close the unit and synchronise.

Memorised settings

Whenever the ignition is switched off, some functions of the following settings may be automatically memorised by the remote control unit:

- lighting
- Infotainment system
- central locking system
- comfort settings

The saved settings are automatically used the next time the memorised key is inserted into the ignition switch and turned to position 1 ↻ 116.

A precondition is that **Personalization by driver** is activated in the personal settings of the Graphic-Info-Display. This must be set for each key used. On vehicles equipped with Colour-Info-Display, the personalisation is permanently activated.

Vehicle personalisation ↻ 84.

Central locking system

Unlocks and locks doors, load compartment and fuel filler flap.

A pull on an interior door handle unlocks the respective door. Pulling the handle once more opens the door.

Note

In the event of an accident in which airbags or belt pretensioners are deployed, the vehicle is automatically unlocked.

Note



A short time after unlocking with the remote control, the doors are relocked automatically if no door has been opened.

Unlocking



Press .

Two settings are selectable:

- To unlock only the driver's door and fuel filler flap, press  once. To unlock all doors, press  twice.
- Press  once to unlock all doors, load compartment and fuel filler flap.

The setting can be changed in the Settings menu in the Info-Display. Vehicle personalisation ⇨ 84.

The setting can be saved for the key being used. Memorised settings ⇨ 20.

Unlocking and opening the tailgate ⇨ 23.

Locking

Close doors, load compartment and fuel filler flap.



Press .

If the driver's door is not closed properly, the central locking system will not work.

Central locking buttons

Locks or unlocks all doors, the load compartment and fuel filler flap from inside the passenger compartment.



Press  to lock.

Press  to unlock.

Fault in radio remote control system

Unlocking



Manually unlock the driver's door by turning the key in the lock. Switch on the ignition and press the central locking button  to unlock the other doors, load compartment and fuel filler flap.

Locking

Manually lock the driver's door by turning the key in the lock.

Fault in central locking system

Unlocking

Manually unlock the driver's door by turning the key in the lock. The other doors can be opened by pulling the interior handle twice. The load compartment and fuel filler flap cannot be opened.

Locking

Push inside locking knob of all doors except driver's door. Then close the driver's door and lock it from the outside with the key. The fuel filler flap and tailgate cannot be locked.

Automatic locking

This security feature can be configured to automatically lock all doors, load compartment and fuel filler flap as soon as a certain speed is exceeded.

Additionally, it is configurable to unlock the driver's door or all doors after the ignition is switched off and the ignition key is removed (manual

transmission) or the selector lever is moved to position **P** (automatic transmission).

Settings can be changed in the Settings menu in the Info-Display. Vehicle personalisation ⇨ 84.

The settings can be saved for the key being used ⇨ 20.

Child locks



Warning

Use the child locks whenever children are occupying the rear seats.

Using a key or suitable screwdriver, turn the child lock in the rear door to the horizontal position. The door cannot be opened from the inside.



To deactivate, turn the child lock to the vertical position.

Doors

Load compartment

Opening



To unlock the boot lid, press  on the remote control for at least two seconds, or, to open from the inside, press  in the centre console; the boot lid is opened slightly.



With the doors centrally locked, the boot lid cannot be opened by pressing  in the centre console.

Closing



Use the interior handle.
Central locking system ⇨ 20.

Vehicle security

Anti-theft locking system

Warning

Do not use the system if there are people in the vehicle! The doors cannot be unlocked from the inside.

The system deadlocks all the doors. All doors must be closed otherwise the system cannot be activated.

If the ignition was on, the driver's door must be opened and closed once so that the vehicle can be secured.

Unlocking the vehicle disables the mechanical anti-theft locking system. This is not possible with the central locking button.

Activating



Press  on the radio remote control twice within 15 seconds.

Immobiliser

The system is part of the ignition switch and checks whether the vehicle is allowed to be started with the key being used.

The immobiliser is activated automatically after the key has been removed from the ignition switch.

If the control indicator  flashes when the ignition is on, there is a fault in the system; the engine cannot be started. Switch off the ignition and repeat the start attempt.

If the control indicator continues flashing, attempt to start the engine using the spare key and seek the assistance of a workshop.

Note

The immobiliser does not lock the doors. Always lock the vehicle after leaving it  20.

Control indicator   72.

Exterior mirrors

Convex shape

The shape of the mirror makes objects appear smaller, which will affect the ability to estimate distances.

Electric adjustment



Select the relevant exterior mirror by turning the control to left (**L**) or right (**R**). Then swivel the control to adjust the mirror.

In position **0** no mirror is selected.

Folding mirrors



For pedestrian safety, the exterior mirrors will swing out of their normal mounting position if they are struck with sufficient force. Reposition the mirror by applying slight pressure to the mirror housing.

Electric folding



Turn control to **0**, then push the control down. Both exterior mirrors will fold.

Push the control down again - both exterior mirrors return to their original position.

If an electrically folded mirror is manually extended, pressing down the control will only electrically extend the other mirror.

Heated mirrors



Operated by pressing .

Heating works with the engine running and is switched off automatically after a short time.

Interior mirrors

Manual anti-dazzle

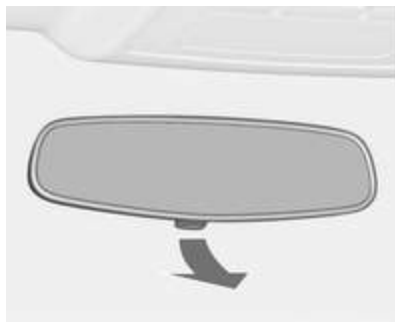

To reduce dazzle, adjust the lever on the underside of the mirror housing.

Automatic anti-dazzle



Dazzle from following vehicles is automatically reduced, when driving in the dark.

Windows

Windscreen

Heat-reflecting windscreen

The heat-reflecting windscreen has a coating which reflects solar radiation. Also data signals, e.g. from toll stations, might be reflected.



The marked areas on the windscreen are not covered with the coating. Devices for electronic data recording and fee payment must be attached in these areas. Otherwise data recording malfunctions may occur.

Windscreen stickers

Do not attach stickers such as toll road stickers or similar on the windscreen in the area of the interior mirror. Otherwise the detection zone of the sensor and the view area of the camera in the mirror housing could be restricted.

Windscreen replacement

Caution

If the vehicle has a front-looking camera sensor for the driver assistance systems, it is very important that any windscreen replacement is performed accurately according to Opel specifications. Otherwise, these systems may not work properly and there is a risk of unexpected behaviour and/or messages from these systems.

Manual windows

The door windows can be opened or closed with the window cranks.

Power windows

⚠ Warning

Take care when operating the power windows. Risk of injury, particularly to children.

If there are children on the rear seats, switch on the child safety system for the power windows.

Keep a close watch on the windows when closing them. Ensure that nothing becomes trapped in them as they move.

Switch on ignition to operate power windows. Retained power off ⇨ 116.



Operate the switch for the respective window by pushing to open or pulling to close.

Pushing or pulling gently to the first detent: window moves up or down as long as the switch is operated.

Pushing or pulling firmly to the second detent and then releasing: window moves up or down automatically with safety function enabled. To stop movement, operate the switch once more in the same direction.

Safety function



If the window glass encounters resistance above the middle of the window during automatic closing, it is immediately stopped and opened again.

Override safety function

In the event of closing difficulties due to frost or the like, switch on the ignition, then pull the switch to the first detent and hold. The window moves up without safety function enabled. To stop movement, release the switch.

Child safety system for rear windows





Press  to deactivate rear door power windows; the LED illuminates. To activate, press  again.

Operating windows from outside

The windows can be operated remotely from outside the vehicle.



Press and hold  to open windows.
Press and hold  to close windows.
Release button to stop window movement.

If the windows are fully opened or closed, the hazard warning lights will flash twice.

Overload

If the windows are repeatedly operated within short intervals, the window operation is disabled for some time.

Initialising the power windows

If the windows cannot be closed automatically (e.g. after disconnecting the vehicle battery), a warning message or a warning code is displayed in the Driver Information Centre.

Vehicle messages ⇨ 79.

Activate the window electronics as follows:

1. Close doors.
2. Switch on ignition.
3. Pull switch until the window is closed and keep pulling for additional two seconds.
4. Repeat for each window.

Heated rear window



Operated by pressing .

Heating works with the engine running and is switched off automatically after a short time.

Sun visors

The sun visors can be folded down or swivelled to the side to prevent dazzling.

If the sun visors have integral mirrors, the mirror covers should be closed when driving.

A ticket holder is located on the backside of the sun visor.

Seats, restraints

Head restraints	31
Front seats	32
Seat position	32
Manual seat adjustment	33
Armrest	35
Heating	35
Rear seats	36
Armrest	36
Seat belts	36
Three-point seat belt	37
Airbag system	39
Front airbag system	40
Side airbag system	40
Airbag deactivation	41
Child restraints	43
Child restraint systems	43
Child restraint installation locations	45

Head restraints

Position

⚠ Warning

Only drive with the head restraint set to the proper position.



The upper edge of the head restraint should be at upper head level. If this is not possible for extremely tall people, set to highest position, and set to lowest position for small people.

Adjustment

Head restraints on front seats

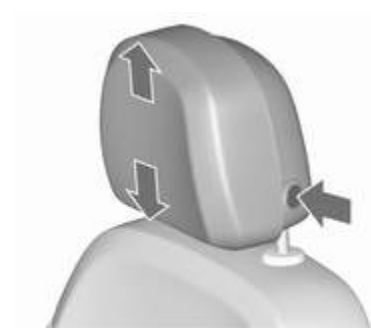

Height adjustment

Press release button, adjust height, engage.

Head restraints on rear seats



Height adjustment

Pull the head restraint upwards or press the catch to release and push the head restraint downwards.

Removal

Press both catches, pull the head restraint upwards and remove.

Front seats

Seat position

⚠ Warning

Only drive with the seat correctly adjusted.

⚠ Warning

Never adjust seats while driving as they could move uncontrollably.

⚠ Danger

Do not sit closer than 25 cm to the steering wheel, to permit safe airbag deployment.

⚠ Warning

Never store any objects under the seats.



- Sit with buttocks as far back against the backrest as possible. Adjust the distance between the seat and the pedals so that legs are slightly angled when pressing the pedals. Slide the front passenger seat as far back as possible.
- Set seat height high enough to have a clear field of vision on all sides and of all display instruments. There should be at least one hand of clearance between head and the roof frame. Your thighs should rest lightly on the seat without pressing into it.

- Sit with shoulders as far back against the backrest as possible. Set the backrest rake so that it is possible to easily reach the steering wheel with arms slightly bent. Maintain contact between shoulders and the backrest when turning the steering wheel. Do not angle the backrest too far back. We recommend a maximum rake of approx. 25°.
- Adjust seat and steering wheel in a way that the wrist rests on top of the steering wheel while the arm is fully extended and shoulders on the backrest.
- Adjust the steering wheel ⇨ 57.
- Adjust the head restraint ⇨ 31.
- Adjust the height of the seat belt ⇨ 37.
- Adjust the thigh support so that there is a space approx. two fingers wide between the edge of the seat and the hollow of the knee.
- Adjust the lumbar support so that it supports the natural shape of the spine.

Manual seat adjustment

Drive only with engaged seats and backrests.

Longitudinal adjustment



Pull handle, slide seat, release handle. Try to move the seat back and forth to ensure that the seat is locked in place.

Backrest inclination



Pull lever, adjust inclination and release lever. Allow the backrest to engage audibly.

Seat height

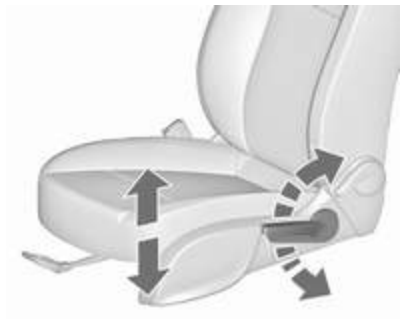

Lever pumping motion
up : seat higher
down : seat lower

Seat inclination



Lever pumping motion
up : front end higher
down : front end lower

Lumbar support



Adjust lumbar support using the four-way switch to suit personal requirements.

Moving support up and down: push switch up or down.

Increasing and decreasing support: push switch forwards or backwards.

Adjustable thigh support



Pull the lever and slide the thigh support.

Armrest

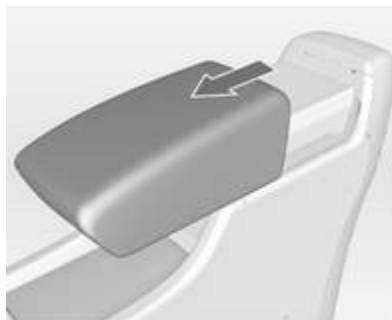

The armrest can be slid forwards by 10 cm. Under the armrest there is a storage compartment.

Armrest storage ⇨ 50.

Heating



Adjust heating to the desired setting by pressing  for the respective seat one or more times. The control indicator in the button indicates the setting.

Prolonged use of the highest setting for people with sensitive skin is not recommended.

Seat heating is operational when engine is running.

Rear seats

Armrest



Fold armrest down. The armrest contains cupholders and a storage box.

Seat belts



The seat belts are locked during hard acceleration or deceleration of the vehicle, holding the occupants in the seat position. Therefore the risk of injury is considerably reduced.

⚠ Warning

Fasten seat belt before each trip.

In the event of an accident, people not wearing seat belts endanger their fellow occupants and themselves.

Seat belts are designed to be used by only one person at a time. Child restraint system ⇨ 43.

Periodically check all parts of the belt system for damage, soiling and proper functionality.

Have damaged components replaced. After an accident, have the belts and triggered belt pretensioners replaced by a workshop.

Note

Make sure that the belts are not damaged by shoes or sharp-edged objects or trapped. Prevent dirt from getting into the belt retractors.

Seat belt reminder

Front seats are equipped with a seat belt reminder, indicated for driver seat by control indicator  in the tachometer ⇨ 68 and for passenger seat by the control indicators in the centre console ⇨ 65.

Belt force limiters



On the front seats, stress on the body is reduced by the gradual release of the belt during a collision.

Belt pretensioners

In the event of a head-on or rear-end collision of a certain severity, the front seat belts are tightened.

⚠ Warning

Incorrect handling (e.g. removal or fitting of belts) can trigger the belt pretensioners.

Deployment of the belt pretensioners is indicated by continuous illumination of control indicator   68.

Triggered belt pretensioners must be replaced by a workshop. Belt pretensioners can only be triggered once.

Note

Do not affix or install accessories or other objects that may interfere with the operation of the belt pretensioners. Do not make any modifications to belt pretensioner components as this will invalidate the operating permit of your vehicle.

Three-point seat belt

Fasten





Withdraw the belt from the retractor, guide it untwisted across the body and insert the latch plate into the buckle. Tighten the lap belt regularly whilst driving by pulling the shoulder belt.



Loose or bulky clothing prevents the belt from fitting snugly. Do not place objects such as handbags or mobile phones between the belt and your body.

⚠ Warning

The belt must not rest against hard or fragile objects in the pockets of your clothing.

Seat belt reminder   68.

Height adjustment



1. Pull belt out slightly.
2. Shift the height adjuster upwards or press button to disengage and push the height adjuster downwards.



Adjust the height so that the belt lies across the shoulder. It must not lie across the throat or upper arm.

Do not adjust while driving.

Unfasten



To release belt, press red button on belt buckle.

Seat belts on the rear seats

The seat belt for the rear centre seat can only be withdrawn from the retractor if the backrest is engaged in upright position.

Using the seat belt while pregnant



⚠ Warning

The lap belt must be positioned as low as possible across the pelvis to prevent pressure on the abdomen.

Airbag system

The airbag system consists of a number of individual systems depending on the scope of equipment.

When triggered, the airbags inflate within milliseconds. They also deflate so quickly that it is often unnoticeable during the collision.

⚠ Warning

The airbag system deploys in an explosive manner, repairs must be performed by skilled personnel only.

⚠ Warning

Adding accessories that change the vehicle's frame, bumper system, height, front end or side sheet metal, may keep the airbag system from working properly. The operation of the airbag system can also be affected by changing any parts of the front seats, seat belts,

airbag sensing and diagnostic module, steering wheel, instrument panel, inner door seals including the speakers, any of the airbag modules, ceiling or pillar trim, front sensors, side impact sensors or airbag wiring.

Note

The airbag systems and belt pretensioner control electronics are located in the centre console area. Do not put any magnetic objects in this area.

Do not affix any objects onto the airbag covers and do not cover them with other materials. Have damaged covers replaced by a workshop.

Each airbag is triggered only once. Have deployed airbags replaced by a workshop. Furthermore, it may be necessary to have the steering wheel, the instrument panel, parts of the panelling, the door seals, handles and the seats replaced.

Do not make any modifications to the airbag system as this will invalidate the vehicle operating permit.

Control indicator  for airbag systems
 ⇨ 68.

Front airbag system

The front airbag system consists of one airbag in the steering wheel and one in the instrument panel on the front passenger side. These can be identified by the word **AIRBAG**.



Additionally, there is a warning label on the side of the instrument panel, visible when the front passenger door is open, or on the front passenger sun visor.

The front airbag system is triggered in the event of a front-end impact of a certain severity. The ignition must be switched on.



The inflated airbags cushion the impact, thereby reducing the risk of injury to the upper body and head of the front seat occupants considerably.

Warning

Optimum protection is only provided when the seat is in the proper position.

Seat position ⇨ 32.

Keep the area in which the airbag inflates clear of obstructions.

Fit the seat belt correctly and engage securely. Only then is the airbag able to protect.

Side airbag system



The side airbag system consists of an airbag in each front seat backrest. This can be identified by the word **AIRBAG**.

The side airbag system is triggered in the event of a side impact of a certain severity. The ignition must be switched on.



The inflated airbags cushion the impact, thereby reducing the risk of injury to the upper body and pelvis in the event of a side-on collision considerably.

⚠ Warning

Keep the area in which the airbag inflates clear of obstructions.

Note

Only use protective seat covers that have been approved for the vehicle. Be careful not to cover the airbags.



Airbag deactivation

The front passenger airbag system must be deactivated if a child restraint system is to be fitted on this seat. The side airbag and curtain airbag systems, the belt pretensioners and all driver airbag systems will remain active.



The front passenger airbag system can be deactivated via a key-operated switch on the passenger side of the instrument panel.

Use the ignition key to choose the position:

-  OFF : front passenger airbag is deactivated and will not inflate in the event of a collision. Control indicator  OFF illuminates continuously in the centre console. A child restraint system can be installed in accordance with the chart **Child restraint installation locations** ⇨ 45. No adult person is allowed to occupy the front passenger seat
-  ON : front passenger airbag is active. A child restraint system must not be installed

Danger

Risk of fatal injury for a child using a child restraint system on a seat with activated front passenger airbag.

Risk of fatal injury for an adult person on a seat with deactivated front passenger airbag.



Control indicator for airbag deactivation ⇨ 68.

If the control indicator  illuminates for approx. 60 seconds after the ignition is switched on, the front passenger airbag system will inflate in the event of a collision.

If both control indicators are illuminated at the same time, there is a system failure. The status of the system is not discernible, therefore no person is allowed to occupy the front passenger seat. Contact a workshop immediately.

Change status only when the vehicle is stopped with the ignition off.

Status remains until the next change.

Child restraints

Child restraint systems

We recommend the Opel child restraint system which is tailored specifically to the vehicle.

When a child restraint system is being used, pay attention to the following usage and installation instructions and also those supplied with the child restraint system.

Always comply with local or national regulations. In some countries, the use of child restraint systems is forbidden on certain seats.

Warning

When using a child restraint system on the front passenger seat, the airbag systems for the front passenger seat must be deactivated; if not, the triggering of the airbags poses a risk of fatal injury to the child.

This is especially the case if rear-facing child restraint systems are used on the front passenger seat.

Airbag deactivation ⇨ 41.

Airbag label ⇨ 39.

Selecting the right system

The rear seats are the most convenient location to fasten a child restraint system.

Children should travel facing rearwards in the vehicle as long as possible. This makes sure that the child's backbone, which is still very weak, is under less strain in the event of an accident.

Suitable are restraint systems that comply with valid UN ECE regulations. Check local laws and regulations for mandatory use of child restraint systems.

Ensure that the child restraint system to be installed is compatible with the vehicle type.

Ensure that the mounting location of the child restraint system within the vehicle is correct, see following tables.

Allow children to enter and exit the vehicle only on the side facing away from the traffic.

When the child restraint system is not in use, secure the seat with a seat belt or remove it from the vehicle.

Note

Do not affix anything on the child restraint systems and do not cover them with any other materials.

A child restraint system which has been subjected to stress in an accident must be replaced.

Child restraint systems can be fastened with:

- Three-point seat belt
- ISOFIX brackets
- Top-tether anchor

Three-point seat belt

Child restraint systems can be fastened by using a three-point seat belt. Depending on the size of the used child restraint systems, up to three child restraint systems can be attached to the rear seats. After fastening the child restraint system the seat belt has to be tightened ⇨ 45.

ISOFIX child restraint systems



Fasten vehicle-approved ISOFIX child restraint systems to the ISOFIX mounting brackets. Specific vehicle ISOFIX child restraint system positions are marked in the table by IL.

ISOFIX mounting brackets are indicated by a label on the backrest.

Top-tether anchors

Depending on country specific equipment, the vehicle might have two or three anchors.

Top-Tether anchors are marked with the symbol  for a child seat.



Open the flap of the required fastening eye on the placement area behind the head restraints, marked by the child seat symbol.

In addition to the ISOFIX mounting, fasten the Top-Tether strap to the Top-Tether anchors.

ISOFIX child restraint systems of universal category positions are marked in the table by IUF.

Child restraint installation locations

Permissible options for fitting a child restraint system

Weight class	On front passenger seat		On rear outboard seats	On rear centre seat
	activated airbag	deactivated airbag		
Group 0: up to 10 kg	X	U ¹	U	U
Group 0+: up to 13 kg	X	U ¹	U	U
Group I: 9 to 18 kg	X	U ¹	U	U
Group II: 15 to 25 kg	X	X	U	U
Group III: 22 to 36 kg	X	X	U	U

¹ : if the child restraint system is being secured using a three-point seat belt, move seat height adjustment to uppermost position and ensure that vehicle seat belt runs forwards from the upper anchorage point. Adjust seat backrest inclination as far as necessary to a vertical position to ensure that the belt is tight on the buckle side.

U : universal suitability in conjunction with three-point seat belt.

X : no child restraint system permitted in this weight class.

Permissible options for fitting an ISOFIX child restraint system

Weight class	Size class	Fixture	On front passenger seat	On rear outboard seats	On rear centre seat
Group 0: up to 10 kg	E	ISO/R1	X	IL	X
Group 0+: up to 13 kg	E	ISO/R1	X	IL	X
	D	ISO/R2	X	IL	X
	C	ISO/R3	X	IL	X
Group I: 9 to 18 kg	D	ISO/R2	X	IL	X
	C	ISO/R3	X	IL	X
	B	ISO/F2	X	IL, IUF	X
	B1	ISO/F2X	X	IL, IUF	X
	A	ISO/F3	X	IL, IUF	X
Group II: 15 to 25 kg			X	IL	X
Group III: 22 to 36 kg			X	IL	X

IL : suitable for particular ISOFIX restraint systems of the 'specific-vehicle', 'restricted' or 'semi-universal' categories.

The ISOFIX restraint system must be approved for the specific vehicle type.

IUF : suitable for ISOFIX forward-facing child restraint systems of universal category approved for use in this weight class.

X : no ISOFIX child restraint system approved in this weight class.

ISOFIX size class and seat device

A – ISO/F3 : forward-facing child restraint system for children of maximum size in the weight class 9 to 18 kg

B – ISO/F2 : forward-facing child restraint system for smaller children in the weight class 9 to 18 kg

-
- B1 – ISO/F2X : forward-facing child restraint system for smaller children in the weight class 9 to 18 kg
C – ISO/R3 : rear-facing child restraint system for children of maximum size in the weight class up to 18 kg
D – ISO/R2 : rear-facing child restraint system for smaller children in the weight class up to 18 kg
E – ISO/R1 : rear-facing child restraint system for young children in the weight class up to 13 kg

Storage

Storage compartments	48
Glovebox	48
Cupholders	48
Front storage	49
Underseat storage	49
Armrest storage	50
Centre console storage	50
Load compartment	51
Lashing eyes	52
Warning triangle	53
First aid kit	53
Roof rack system	53
Roof rack	53
Loading information	54

Storage compartments

⚠ Warning

Do not store heavy or sharp objects in the storage compartments. Otherwise, the storage compartment lid could open and vehicle occupants could be injured by objects being thrown around in the event of hard braking, a sudden change in direction or an accident.

Glovebox



The glovebox features a pen holder, a credit card holder, a coin holder and an adapter for the locking wheel nuts.

The glovebox should be closed whilst driving.

Cupholders

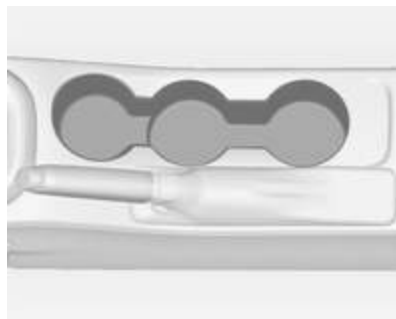

Cupholders are located in the centre console.

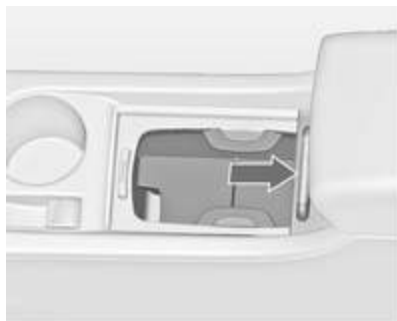

Depending on the version, cupholders are located under a cover in the centre console. Slide cover backwards. Bottles can be stowed after folding up the intermediate shelf
⇨ 50.

Front storage

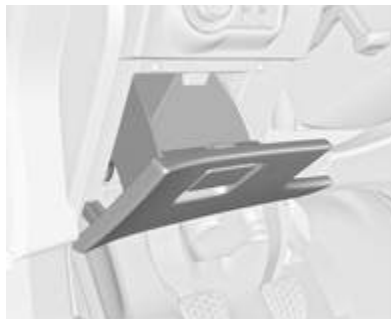

A storage compartment is located next to the steering wheel.

Underseat storage



Press button in the recess and pull out drawer. Maximum load: 3 kg. To close, push in and engage.

Armrest storage

Storage under the front armrest

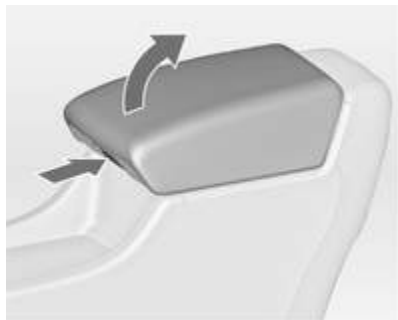

Press button to fold up the armrest. The armrest must be in rearmost position.

Centre console storage

Front console



The storage container can be used to store small items.

Depending on the version, a storage compartment is located under a cover.

Slide cover backwards.

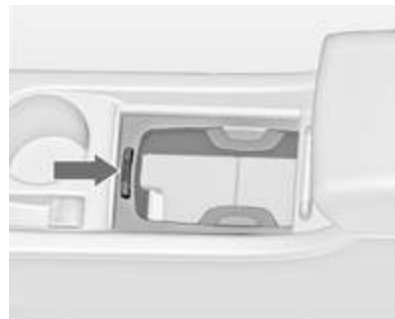

Press button to remove the frame of the cupholder. The frame can be stowed in the glovebox.

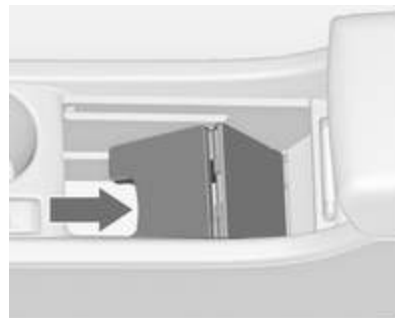

A further storage compartment is located under the intermediate shelf. Fold up the intermediate shelf and fix it in the vertical position. The frame of the cupholder can be reintegrated to stow bottles.

Rear console



Pull out the drawer.

Caution

Do not use for ash or for other combustible items.

Load compartment

The rear seat backrest is divided into two parts. Both parts can be folded down.

Load compartment extension

- Press and hold the catch to push the head restraints down ↻ 31.
- Fold up the rear armrest.



- Guide the seat belts through side supports to protect them against damage. When folding the backrests, pull the seat belts along with them.

- Pull the release lever on one or both sides and fold down the backrests onto the seat cushion.



- Take the seat belt out of the seat backrest guide and put it behind the retainer as shown in the illustration.

To fold up, raise the backrests and guide them into an upright position until they engage audibly.

Ensure that the seat belts of the outboard seats are placed in the corresponding belt guides.



The backrests are properly engaged when the red marks on both sides near the release lever are no longer visible.

Warning

When folding up, ensure that backrests are securely locked in position before driving. Failure to do so may result in personal injury or damage to the load or vehicle in the event of hard braking or a collision.



The seat belt of the centre seat could be blocked when the backrest is folded up too quickly. To unlock the retractor, push in the seat belt or pull it out by approx. 20 mm then release.

Lashing eyes



The lashing eyes are designed to secure items against slippage, e.g. using lashing straps or luggage net.

Warning triangle



Stow the warning triangle in the recess on the left side of the load compartment.

First aid kit



Stow the first aid kit in the space behind the mesh net on the right side of the load compartment.

Roof rack system

Roof rack

For safety reasons and to avoid damage to the roof, the vehicle approved roof rack system is recommended. For further information contact your workshop.

Follow the installation instructions and remove the roof rack when not in use.

Mounting roof rack



Detach the cover from each mounting point by using a coin.

Loading information



- Heavy objects in the load compartment should be placed against the seat backrests. Ensure that the backrests are securely engaged. If objects can be stacked, heavier objects should be placed at the bottom.
- Prevent sliding of loose objects by securing them with straps attached to the lashing eyes ↪ 52.

- Use the four hooks on the sidewalls of the load compartment for hanging up carrier bags. Maximum load: 5 kg per hook.
- When transporting objects in the load compartment, the backrests of the rear seats must not be angled forward.
- Do not allow the load to protrude above the upper edge of the backrests.
- Do not place any objects on the load compartment cover or the instrument panel, and do not cover the sensor on top of the instrument panel.
- The load must not obstruct the operation of the pedals, parking brake and selector lever, or hinder the freedom of movement of the driver. Do not place any unsecured objects in the interior.
- Do not drive with an open load compartment.

⚠ Warning

Always make sure that the load in the vehicle is securely stowed. Otherwise objects can be thrown around inside the vehicle and cause personal injury or damage to the load or car.

- The payload is the difference between the permitted gross vehicle weight (see identification plate ↪ 180) and the EC kerb weight.
To calculate the payload, enter the data for your vehicle in the weights table at the front of this manual.
The EC kerb weight includes weights for the driver (68 kg), luggage (7 kg) and all fluids (fuel tank 90% full).
Optional equipment and accessories increase the kerb weight.
- Driving with a roof load increases the sensitivity of the vehicle to cross-winds and has a

detrimental effect on vehicle handling due to the vehicle's higher centre of gravity.

Distribute the load evenly and secure it properly with retaining straps. Adjust the tyre pressure and vehicle speed according to the load conditions. Check and retighten the straps frequently.

Do not drive faster than 120 km/h.

The permissible roof load is 75 kg. The roof load is the combined weight of the roof rack and the load.

Instruments and controls

Controls	57
Steering wheel adjustment	57
Steering wheel controls	57
Heated steering wheel	57
Horn	58
Windscreen wiper and washer ..	58
Outside temperature	60
Clock	60
Power outlets	62
Warning lights, gauges and indicators	62
Instrument cluster	62
Speedometer	62
Odometer	63
Trip odometer	63
Tachometer	63
Fuel gauge	63
Engine coolant temperature gauge	64
Service display	64
Control indicators	65
Turn lights	67
Seat belt reminder	68
Airbag and belt tensioners	68

Airbag deactivation	68
Charging system	68
Malfunction indicator light	69
Service vehicle soon	69
Brake and clutch system	69
Operate pedal	69
Electric parking brake	69
Electric parking brake fault	70
Antilock brake system (ABS)	70
Upshift	70
Power steering	70
Parking assist	70
Electronic Stability Control off ..	71
Electronic Stability Control and Traction Control system	71
Traction Control system off	71
Exhaust filter	71
Tyre pressure monitoring system	71
Engine oil pressure	72
Low fuel	72
Immobiliser	72
Reduced engine power	72
Exterior light	72
High beam	72
High beam assist	72
Adaptive forward lighting	73
Front fog lights	73
Rear fog light	73
Low washer fluid	73

Cruise control	73
Door open	73
Displays	73
Driver Information Centre	73
Info Display	77
Vehicle messages	79
Warning chimes	81
Battery voltage	81
Trip computer	82
Vehicle personalisation	84
Telematics service	88
OnStar	88

Controls

Steering wheel adjustment



Unlock lever, adjust steering wheel, then engage lever and ensure it is fully locked.

Do not adjust steering wheel unless vehicle is stationary and steering wheel lock has been released.

Steering wheel controls



The Infotainment system, the cruise control and a connected mobile phone can be operated via the controls on the steering wheel.

Further information is available in the Infotainment manual.

Driver assistance systems ⇨ 130.

Heated steering wheel



Activate heating by pressing . Activation is indicated by illumination of the LED in the button.



The recommended grip areas of the steering wheel are heated quicker and to a higher temperature than the other areas.

Heating is operational when the engine is running.

Horn



Press .

Windscreen wiper and washer

Windscreen wiper

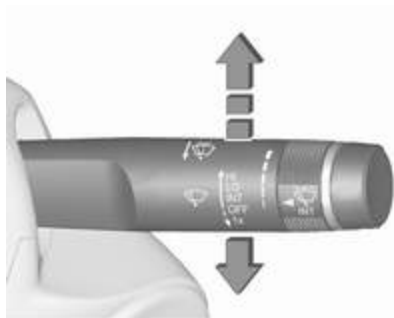

- HI** : fast
- LO** : slow
- INT** : interval wiping or automatic wiping with rain sensor
- OFF** : off

For a single wipe when the windscreen wiper is off, press the lever down to position **1x**.

Do not use if the windscreen is frozen.

Switch off in car washes.

Adjustable wiper interval



Wiper lever in position **INT**.

Turn the adjuster wheel to adjust the desired wipe interval:

- short interval : turn adjuster wheel upwards
- long interval : turn adjuster wheel downwards

Automatic wiping with rain sensor



INT : automatic wiping with rain sensor

The rain sensor detects the amount of water on the windscreen and automatically regulates the frequency of the windscreen wiper.

If the wiper frequency is above 20 seconds, the wiper arm moves slightly down to the park position.

Adjustable sensitivity of the rain sensor



Turn the adjuster wheel to adjust the sensitivity:

- low sensitivity : turn adjuster wheel downwards
- high sensitivity : turn adjuster wheel upwards



Keep the sensor free from dust, dirt and ice.

Windscreen and headlight washer



Pull lever. Washer fluid is sprayed onto the windscreen and the wiper wipes a few times.

If the headlights are on, washer fluid is also sprayed onto the headlights, provided that the lever is pulled sufficiently long. Afterwards, the headlight washer system is inoperable for 5 wash cycles or until engine or headlights have been switched off and on again.

Outside temperature



20153

A drop in temperature is indicated immediately and a rise in temperature after a time delay.



If outside temperature drops to 3 °C, a warning message is displayed in the Driver Information Centre with Uplevel-Combi-Display.

Warning

The road surface may already be icy even though the display indicates a few degrees above 0 °C.

Clock

Date and time are shown in the Info-Display.

Time and date settings

CD 400plus/CD 400/CD 300

Press **CONFIG**. The menu **Settings** is displayed.

Select **Time Date**.

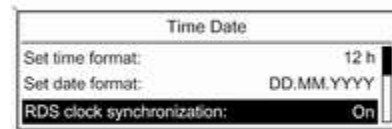

20136

Selectable setting options:

- **Set time:** Changes the time shown on the display.
- **Set date:** Changes the date shown on the display.
- **Set time format:** Changes the indication of hours between **12 h** and **24 h**.

- **Set date format:** Changes indication of date between **MM/DD/YYYY** and **DD.MM.YYYY**.
- **Display clock:** Switches on/off indication of time on the display.
- **RDS clock synchronization:** The RDS signal of most VHF transmitters automatically sets the time. RDS time synchronisation can take a few minutes. Some transmitters do not send a correct time signal. In such cases, it is recommended to switch off automatic time synchronisation.

Vehicle personalisation ⇨ 84.

Time and date settings

Navi 950/Navi 650/CD 600

Press **CONFIG** and then select the **Time and Date** menu item to display the respective submenu.

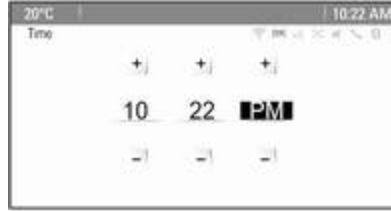

Note

If **RDS Auto Time Adjust** is activated, time and date are automatically set by the system.

See Infotainment manual for further information.

Set time

To adjust the time settings, select the **Set Time** menu item. Turn the multifunction knob to adjust the first setting.

Press the multifunction knob to confirm the input. The coloured background moves to the next setting.

Adjust all settings.

Set date

To adjust the time settings, select the **Set Date** menu item. Turn the multifunction knob to adjust the first setting.

Press the multifunction knob to confirm the input. The coloured background moves to the next setting.

Adjust all settings.

Time format

To choose the desired time format, select **12 hr / 24 hr Format**. Activate **12 Hour** or **24 Hour**.

Vehicle personalisation ⇨ 84.

Power outlets



A 12 Volt power outlet is located in the front console.

Do not exceed the maximum power consumption of 120 watts.

With ignition off, the power outlets are deactivated. Additionally, the power outlets are deactivated in the event of low vehicle battery voltage.

Electric accessories that are connected must comply with the electromagnetic compatibility requirements laid down in DIN VDE 40 839.

Do not connect any current-delivering accessories, e.g. electric charging devices or batteries.

Do not damage the outlet by using unsuitable plugs.

Warning lights, gauges and indicators

Instrument cluster

In some versions, the needles of the instruments briefly rotate to the end position when the ignition is switched on.

Speedometer



Indicates vehicle speed.

Odometer



The bottom line displays the recorded distance in km.

Trip odometer

The top line displays the recorded distance since the last reset.

To reset, press **SET/CLR** on the turn signal lever for a few seconds
⇨ 73.

Some versions are equipped with a reset knob between speedometer and Driver Information Centre: to reset press and hold the knob for a few seconds with the ignition on.

Trip odometer counts up to a distance of 9,999 km and then restarts at 0.

Tachometer



Displays the engine speed.

Drive in a low engine speed range for each gear as much as possible.

Caution

If the needle is in the red warning zone, the maximum permitted engine speed is exceeded. Engine at risk.

Fuel gauge



Displays the fuel level in the tank.

Control indicator ● illuminates if the level in the tank is low. Refuel immediately if it flashes.

Never run the tank dry.

Because of the fuel remaining in the tank, the top-up quantity may be less than the specified tank capacity.

Engine coolant temperature gauge



Displays the coolant temperature.

- left area : engine operating temperature not yet reached
- central area : normal operating temperature
- right area : temperature too high

Caution

If engine coolant temperature is too high, stop vehicle, switch off engine. Danger to engine. Check coolant level.

Service display

The engine oil life system informs when to change the engine oil and filter. Based on driving conditions, the interval at which an engine oil and filter change will be indicated can vary considerably.

When the system has calculated that engine oil life has diminished, a warning message appears in the Driver Information Centre. Have engine oil and filter changed by a workshop within one week or 500 km, whichever occurs first.

This can be an additional engine oil and filter change or part of a regular service.

To display the remaining engine oil life duration use turn signal lever buttons:

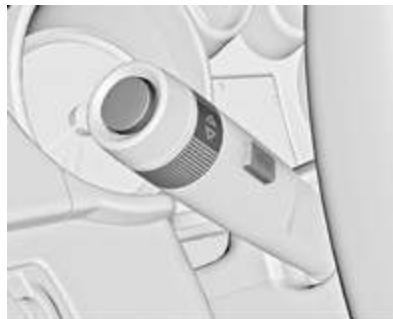

Press **MENU** to select the **Vehicle Information Menu** .

Turn the adjuster wheel to select **Remaining Oil Life**.

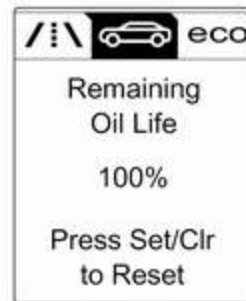

The remaining engine oil life duration is displayed in percent in the Driver Information Centre.

Reset

Press **SET/CLR** on turn signal lever for several seconds to reset. The remaining engine oil life duration page must be active. Switch on ignition, but not the engine.

The system must be reset every time the engine oil is changed, to ensure proper functionality. Seek the assistance of a workshop.

Next service

A message appears in the Driver Information Centre, when maintenance of the vehicle is required. Have maintenance work carried out by a workshop within one week or 500 km, whichever occurs first.

Service information ⇨ 177.

Control indicators

The control indicators described are not present in all vehicles. The description applies to all instrument versions. Depending on the equipment, the position of the control indicators may vary. When the ignition is switched on, most control indicators will illuminate briefly as a functionality test.

The control indicator colours mean:

- red : danger, important reminder
- yellow : warning, information, fault
- green : confirmation of activation
- blue : confirmation of activation
- white : confirmation of activation

Control indicators in the instrument cluster

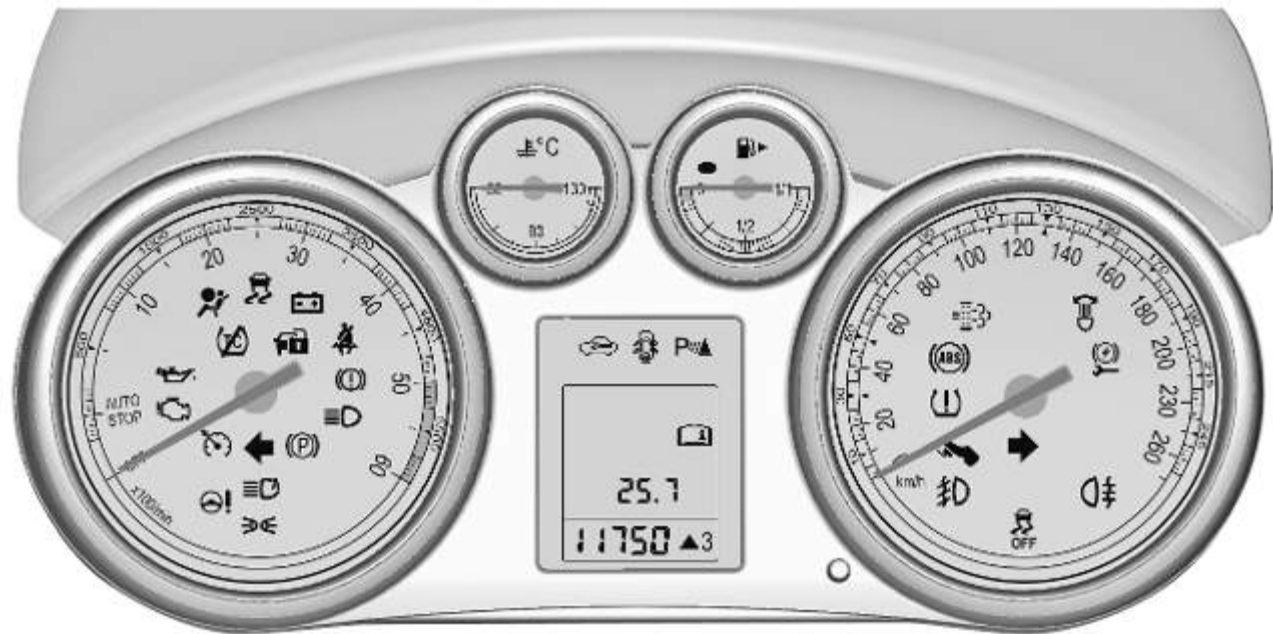

Control indicators in the centre console



Overview

- ↔ Turn signal ⇨ 67
- 🚗 Seat belt reminder ⇨ 68
- 🚗 Airbag and belt tensioners ⇨ 68
- 🚗 Airbag deactivation ⇨ 68
- 🔌 Charging system ⇨ 68
- 🚗 Malfunction indicator light ⇨ 69
- 🚗 Service vehicle soon ⇨ 69

- 🚗 Brake and clutch system ⇨ 69
- 🚗 Operate pedal ⇨ 69
- 🚗 Electric parking brake ⇨ 69
- 🚗 Electric parking brake fault ⇨ 70
- 🚗 Antilock brake system (ABS) ⇨ 70
- 🚗 Upshift ⇨ 70
- 🚗 Power steering ⇨ 70
- 🚗 Parking assist ⇨ 70
- 🚗 Electronic Stability Control off ⇨ 71
- 🚗 Electronic Stability Control and Traction Control system ⇨ 71
- 🚗 Traction Control system off ⇨ 71
- 🚗 Exhaust filter ⇨ 71
- 🚗 Tyre pressure monitoring system ⇨ 71
- 🚗 Engine oil pressure ⇨ 72

- Low fuel ⇨ 72
- 🚗 Immobiliser ⇨ 72
- 🚗 Reduced engine power ⇨ 72
- 🚗 Exterior light ⇨ 72
- 🚗 High beam ⇨ 72
- 🚗 High beam assist ⇨ 72
- 🚗 Adaptive forward lighting ⇨ 73
- 🚗 Fog light ⇨ 73
- 🚗 Rear fog light ⇨ 73
- 🚗 Low washer fluid ⇨ 73
- 🚗 Cruise control ⇨ 73
- 🚗 Door open ⇨ 73

Turn lights

↔ illuminates or flashes green.

Illuminates briefly

The parking lights are switched on.

Flashes

A turn signal or the hazard warning flashers are activated.

Rapid flashing: failure of a turn signal light or associated fuse.

Bulb replacement ⇨ 145, Fuses ⇨ 154.

Turn signals ⇨ 100.

Seat belt reminder

Seat belt reminder on front seats

 for driver's seat illuminates or flashes red.

 for front passenger seat illuminates or flashes red, when the seat is occupied.

Illuminates

After the ignition has been switched on until the seat belt has been fastened.

Flashes

After having started the engine for a maximum of 100 seconds until the seat belt has been fastened.

Airbag and belt tensioners

 illuminates red.

When the ignition is switched on, the control indicator illuminates for approx. four seconds. If it does not illuminate, does not go out after four seconds or illuminates whilst driving, there is a fault in the airbag system. Seek the assistance of a workshop. The airbags and belt pretensioners may fail to trigger in the event of an accident.

Deployment of the belt pretensioners or airbags is indicated by continuous illumination of .

Warning

Have the cause of the fault remedied immediately by a workshop.

Belt pretensioners, airbag system
⇨ 36, ⇨ 39.

Airbag deactivation

 illuminates yellow.

Illuminates for approx. 60 seconds after the ignition is switched on. The front passenger airbag is activated.

 illuminates yellow.

The front passenger airbag is deactivated ⇨ 41.

Danger

Risk of fatal injury for a child using a child restraint system together with activated front passenger airbag.

Risk of fatal injury for an adult person with deactivated front passenger airbag.

Charging system

 illuminates red.

Illuminates when the ignition is switched on and extinguishes shortly after the engine starts.

Illuminates when the engine is running

Stop, switch off engine. Vehicle battery is not charging. Engine cooling may be interrupted. The brake servo unit may cease to be effective. Seek the assistance of a workshop.

Malfunction indicator light

 illuminates or flashes yellow.

Illuminates when the ignition is switched on and extinguishes shortly after the engine starts.

Illuminates when the engine is running

Fault in the emission control system. The permitted emission limits may be exceeded. Seek the assistance of a workshop immediately.

Flashes when the engine is running

Fault that could lead to catalytic converter damage. Ease up on the accelerator until the flashing stops. Seek the assistance of a workshop immediately.

Service vehicle soon

 illuminates yellow.

Additionally, a warning message or a warning code is displayed.

The vehicle needs a service.

Seek the assistance of a workshop.

Vehicle messages ⇨ 79.

Brake and clutch system

 illuminates red.

The brake and clutch fluid level is too low ⇨ 143.

Warning

Stop. Do not continue your journey. Consult a workshop.

Illuminates after the ignition is switched on if the manual parking brake is applied ⇨ 126.

Operate pedal

 illuminates or flashes yellow.

Illuminates

Brake pedal needs to be depressed to release the electric parking brake ⇨ 126.

Flashes

Clutch pedal needs to be depressed for a main start of the engine ⇨ 16, ⇨ 117.

On some versions the operate pedal message is indicated in the Driver Information Centre ⇨ 79.

Electric parking brake

 illuminates or flashes red.

Illuminates

Electric parking brake is applied ⇨ 126.

Flashes

Electric parking brake is not fully applied or released. Switch on ignition, depress brake pedal and attempt to reset the system by first releasing and then applying the electric parking brake. If  remains flashing, do not drive and seek the assistance of a workshop.

Electric parking brake fault

 illuminates or flashes yellow.

Illuminates

Electric parking brake is operating with reduced performance ⇨ 126.

Flashes

Electric parking brake is in service mode. Stop vehicle, apply and release the electric parking brake to reset.

Warning

Have the cause of the fault remedied immediately by a workshop.

Antilock brake system (ABS)



 illuminates yellow.

Illuminates for a few seconds after the ignition is switched on. The system is ready for operation when the control indicator extinguishes.

If the control indicator does not go out after a few seconds, or if it illuminates while driving, there is a fault in the ABS. The brake system remains operational but without ABS regulation.

Antilock brake system ⇨ 125.

Upshift

 illuminates green as a control indicator, or is shown as a symbol  with the number of a higher gear in the

Driver Information Centre, when upshifting is recommended for fuel saving reasons.

On some versions, gearshift indication is popped-up as full page in the Driver Information Centre.

Driver Information Centre ⇨ 73.

Power steering

 illuminates yellow.

Illuminates with power steering reduced

Power steering is reduced due to overheating of the system. Control indicator extinguishes when the system has cooled down.

Illuminates with power steering disabled

Failure in the power steering system. Consult a workshop.

Parking assist

 illuminates yellow.

Fault in system

or

Fault due to sensors that are dirty or covered by ice or snow

or

Interference due to external sources of ultrasound. Once the source of interference is removed, the system will operate normally.

Have the cause of the fault in the system remedied by a workshop.

Parking assist  133.

Electronic Stability Control off

 illuminates yellow.

The system is deactivated.

Electronic Stability Control and Traction Control system

 illuminates or flashes yellow.

Illuminates

A fault in the system is present. Continued driving is possible. Driving stability, however, may deteriorate depending on road surface conditions.

Have the cause of the fault remedied by a workshop.

Flashes

The system is actively engaged. Engine output may be reduced and the vehicle may be braked automatically to a small degree.

Electronic Stability Control (ESC)  129, Traction Control system (TC)  128.

Traction Control system off

 illuminates yellow.

The system is deactivated.

Exhaust filter

 illuminates or flashes yellow.

The exhaust filter requires cleaning.

Continue driving until  extinguishes. If possible, do not allow engine speed to drop below 2000 rpm.

Illuminates

The exhaust filter is full. Start cleaning process as soon as possible.

Flashes

The maximum filling level of the filter is reached. Start cleaning process immediately to avoid damage to the engine.

Exhaust filter  119.

Tyre pressure monitoring system

 illuminates or flashes yellow.

Illuminates

Tyre pressure loss. Stop immediately and check tyre pressure.

Flashes

Fault in system or tyre without pressure sensor mounted (e.g. spare wheel). After 60-90 seconds the control indicator illuminates continuously. Consult a workshop.

Engine oil pressure

 illuminates red.

Illuminates when the ignition is switched on and extinguishes shortly after the engine starts.

Illuminates when the engine is running

Caution

Engine lubrication may be interrupted. This may result in damage to the engine and/or locking of the drive wheels.

1. Depress clutch.
2. Select neutral gear, set selector lever to **N**.

3. Move out of the flow of traffic as quickly as possible without impeding other vehicles.
4. Switch off ignition.

Warning

When the engine is off, more force is needed to brake and steer.

Do not remove key until vehicle is stationary, otherwise the steering wheel lock could engage unexpectedly.

Keep engine turned off and let the vehicle be towed to a workshop.

Low fuel

 illuminates or flashes yellow.

Illuminates

Level in fuel tank is too low.

Flashes

Fuel used up. Refuel immediately. Never run the tank dry.
Catalytic converter ↗ 120.

Immobiliser

 flashes yellow.

Fault in the immobiliser system. The engine cannot be started.

Reduced engine power

 illuminates yellow.

The engine power is limited. Consult a workshop.

Exterior light

 illuminates green.

The exterior lights are on ↗ 93.

High beam

 illuminates blue.

Illuminates when high beam is on or during headlight flash ↗ 95, or when high beam is on with high beam assist or intelligent light range ↗ 97.

High beam assist

 illuminates green.

The high beam assist or intelligent light range is activated ⇨ 95, ⇨ 97.

Adaptive forward lighting

☾ illuminates or flashes yellow.

Illuminates

Fault in system.

Seek the assistance of a workshop.

Flashes

System switched to symmetrical low beam.

Control indicator ☾ flashes for approx. four seconds after the ignition is switched on as a reminder that the system has been activated ⇨ 96.

Automatic light control ⇨ 94.

Front fog lights

☾D illuminates green.

The front fog lights are on ⇨ 101.

Rear fog light

☾H illuminates yellow.

The rear fog light is on ⇨ 101.

Low washer fluid

☾W illuminates yellow.

The washer fluid level is low.

Washer fluid ⇨ 143.

Cruise control

☾C illuminates white or green.

Illuminates white

The system is on.

Illuminates green

Cruise control is active.

Cruise control ⇨ 130.

Door open

☾D illuminates red.

A door or the tailgate is open.

Displays

Driver Information Centre

The Driver Information Centre is located in the instrument cluster between speedometer and tachometer. It is available as Midlevel-Display or Uplevel-Combi-Display.



Midlevel-Display indicates:

- overall odometer
- trip odometer
- some control indicators
- vehicle information

- trip/fuel information
- vehicle messages, displayed as code numbers ↷ 79.



In the Uplevel-Combi-Display, menu pages can be selected by pressing **MENU**. Menu symbols are indicated in the top line of the display:

- **Vehicle Information Menu**
- **Trip/Fuel Information Menu**
- **ECO ECO Information Menu**
- **Performance Menu**

Some of the displayed functions differ when the vehicle is being driven or at a standstill. Some functions are only available when the vehicle is being driven.

Vehicle personalisation ↷ 84.

Memorised settings ↷ 20.

Selecting menus and functions

The menus and functions can be selected via the buttons on the turn signal lever.



Press **MENU** to switch between the menus or to return from a submenu to the next higher menu level.



Turn the adjuster wheel to highlight a menu option or to set a numeric value.



Press **SET/CLR** to select a function or confirm a message.

Vehicle Information Menu

Press **MENU** to select the **Vehicle Information Menu** or, on Uplevel-Combi-Display, select .

Turn the adjuster wheel to select a submenu. Press **SET/CLR** to confirm.

Follow the instructions given in the submenus.

Possible submenus can include, depending on the version:

- **Unit:** Displayed units can be changed.
- **Tyre Pressure:** Checks tyre pressure of all wheels during driving ↻ 161.
- **Tyre Load:** Select tyre pressure category according to the current actual tyre inflation pressure ↻ 161.



- **Remaining Oil Life:** Indicates when to change the engine oil and filter ↻ 64.



- **Speed Warning:** If exceeding the preset speed, a warning chime will be activated.

Selection and indication can be different between Midlevel-Display and Uplevel-Combi-Display.

Trip/Fuel Information Menu

Press **MENU** to select the **Trip/Fuel Information Menu**, or select  on Uplevel-Combi-Display.

Turn the adjuster wheel to select a submenu. Press **SET/CLR** to confirm.



- trip odometer 1
- trip odometer 2
- digital speed

Trip odometer 2 and digital speed are only available on vehicles with Uplevel-Combi-Display.

Reset trip odometer by pressing **SET/CLR** on the turn signal lever for a few seconds or by pressing the reset knob between speedometer and Driver Information Centre with the ignition on.

On vehicles with trip computer, more submenus are available.

Selection and indication can be different between Midlevel-Display and Uplevel-Combi-Display.

Trip/Fuel Information Menu, Trip Computer ↷ 82.

ECO Information Menu

Press **MENU** to select **ECO** in the top line of the Uplevel-Combi-Display.

Turn the adjuster wheel to select a submenu. Press **SET/CLR** to confirm.

Submenus are:

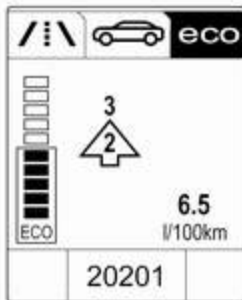

- **Shift indication:** Current gear is indicated inside an arrow. The figure above recommends

upshifting for fuel saving reasons.

Eco index display: The current fuel consumption is indicated on a segment display. For economical driving, adapt your driving characteristic to keep the filled segments within the Eco area. The more segments are filled, the higher the fuel consumption. Simultaneously the current consumption value is indicated.



- **Top Consumers:** List of top comfort consumers currently switched on is displayed in descending order. Fuel saving

potential is indicated. A switched off consumer disappears from the list and the consumption value will be updated.

During sporadic driving conditions, the engine will activate the heated rear window automatically to increase the engine load. In this event, the heated rear window is indicated as one of the top consumers, without activation by the driver.

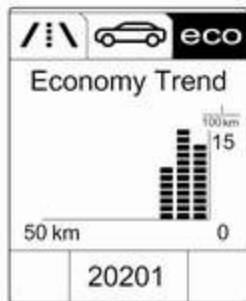

- **Economy Trend:** Displays the average consumption development over a distance of 50 km. Filled segments display the consumption in 5 km steps

and shows the effect of topography or driving behaviour on fuel consumption.

Info Display

Depending on the vehicle configuration the vehicle has a Graphic-Info-Display or Colour-Info-Display. The Info-Display is located in the instrument panel above the Infotainment system.

Graphic-Info-Display

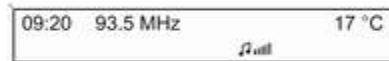

Depending on the Infotainment system, the Graphic-Info-Display is available in two versions.



20153

Graphic-Info-Display indicates:

- time ⇄ 60
- outside temperature ⇄ 60
- date ⇄ 60
- Infotainment system, see description in the Infotainment manual
- settings for vehicle personalisation ⇄ 84

Colour-Info-Display



The Colour-Info-Display indicates in colour:

- time ↻ 60
- outside temperature ↻ 60
- date ↻ 60
- Infotainment system, see description in the Infotainment manual
- navigation, see description in the Infotainment manual
- system settings

- vehicle messages ↻ 79
- settings for vehicle personalisation ↻ 84

The type of information and how it is displayed depends on the equipment of the vehicle and the settings made.

Selecting menus and settings

Menus and settings are accessed via the display.



Selections are made via:

- menus
- function buttons and multifunction knob of the Infotainment system

Selecting with the Infotainment system



Select a function via the Infotainment system buttons. The menu of the selected function is displayed.

The multifunction knob is used to select an item and to confirm.

Multifunction knob

The multifunction knob is the central control element for the menus:

Turn

- to highlight a menu option
- to set a numeric value or to display a menu option

Press (the outer ring)

- to select or activate the highlighted option
- to confirm a set value
- to switch a system function on/off

BACK

Press **BACK** to:

- exit a menu without changing settings
- return from a submenu to a higher menu level
- delete the last character in a character sequence

Press and hold the **BACK** for a few seconds to delete the entire entry.

Vehicle personalisation ⇄ 84.

Memorised settings ⇄ 20.

Vehicle messages

Messages are indicated mainly in the Driver Information Centre, in some cases together with a warning chime.

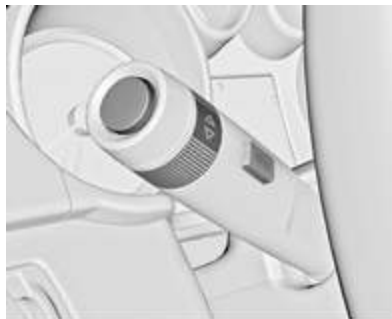

Press **SET/CLR, MENU** or turn the adjuster wheel to confirm a message.

Vehicle messages on the Midlevel-Display

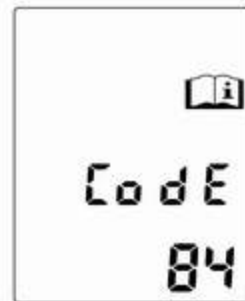

The vehicle messages are displayed as code numbers.

No. Vehicle message

- 2 No radio remote control detected, depress clutch pedal to restart
- 4 Air conditioning off
- 5 Steering wheel is locked
- 6 Depress brake pedal to release electric parking brake

No. Vehicle message

- 7 Turn steering wheel, switch ignition off then on
- 9 Turn steering wheel, restart engine
- 12 Vehicle overloaded
- 13 Compressor overheated
- 15 Centre high-mounted brake light failure
- 16 Brake light failure
- 17 Headlight levelling malfunction
- 18 Left low beam failure
- 19 Rear fog light failure
- 20 Right low beam failure
- 21 Left sidelight failure
- 22 Right sidelight failure
- 23 Reversing light failure
- 24 Number plate light failure
- 25 Left front turn signal failure

No. Vehicle message

- 26 Left rear turn signal failure
- 27 Right front turn signal failure
- 28 Right rear turn signal failure
- 35 Replace battery in radio remote control
- 53 Tighten fuel filler cap
- 55 Exhaust filter is full ⇨ 119
- 56 Tyre pressure imbalance on front axle
- 57 Tyre pressure imbalance on rear axle
- 58 Tyres without TPMS sensors detected
- 59 Open then close driver window
- 60 Open then close front passenger window
- 61 Open then close rear left window
- 62 Open then close rear right window

No. Vehicle message

- 65 Theft attempted
- 67 Service steering wheel lock
- 68 Service power steering
- 69 Service suspension system
- 70 Service level control system
- 71 Service rear axle
- 74 Service AFL
- 75 Service air conditioning
- 79 Top up engine oil
- 81 Service transmission
- 82 Change engine oil soon
- 84 Engine power is reduced
- 89 Service vehicle soon
- 94 Shift to park position before exiting
- 95 Service airbag
- 128 Bonnet open

No. Vehicle message

134 Park assist fault, clean bumper

136 Service parking assist

145 Check washer fluid level

174 Low vehicle battery

258 Parking assist off

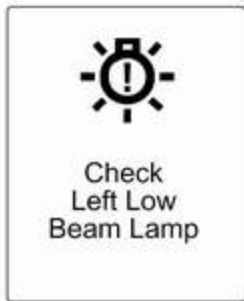
Vehicle messages on the Uplevel-Combi-Display

The vehicle messages are displayed as text. Follow the instructions given in the messages.

Vehicle messages on the Colour-Info-Display

Some important messages appear additionally in the Colour-Info-Display. Press the multifunction knob to confirm a message. Some messages only pop-up for a few seconds.

Warning chimes

If several warnings appear at the same time, only one warning chime will sound.

When starting the engine or whilst driving

The warning chime regarding unfastened seat belts has priority over any other warning chime.

- If seat belt is not fastened.
- If a door or the tailgate is not fully closed when starting off.
- If a certain speed is exceeded with parking brake applied.
- If a programmed speed is exceeded.

- If a warning message or a warning code appears in the Driver Information Centre.
- If the parking assist detects an object.
- If an unintended lane change occurs.
- If the exhaust filter has reached the maximum filling level.

When the vehicle is parked and/or the driver's door is opened

- With exterior lights on.

Battery voltage

When the vehicle battery voltage is running low, a warning message or warning code 174 will appear in the Driver Information Centre.

1. Switch off immediately any electric consumers which are not required for a safe ride, e.g. seat heating, heated rear window or other main consumers.
2. Charge the vehicle battery by driving continuously for a while or by using a charging device.

The warning message or warning code will disappear after the engine has been started twice consecutively without a voltage drop.

If the vehicle battery cannot be recharged, have the cause of the fault remedied by a workshop.

Trip computer

The menus and functions can be selected via the buttons on the turn signal lever ↪ 73.



Press **MENU** to select the **Trip/Fuel Information Menu**, or select \swarrow/\searrow on the Uplevel-Combi-Display.



Trip/Fuel Information Menu on Uplevel-Combi-Display

Turn the adjuster wheel to select the submenus:



- trip odometer 1
- average consumption 1
- average speed 1



- trip odometer 2

- average consumption 2
- average speed 2



- digital speed
- range
- instantaneous consumption
- route guidance

Trip computer 1 and 2

The information of two trip computers can be reset separately for odometer, average consumption and average speed by pressing **SET/CLR**, making it possible to display different trip information for different drivers.



Trip odometer

Trip odometer displays the recorded distance since a certain reset.

Trip odometer counts up to a distance of 2000 km and then restarts at 0.

To reset, press **SET/CLR** for a few seconds.

Range

Range is calculated from current fuel tank content and current consumption. The display shows average values.

After refuelling, the range is updated automatically after a brief delay.

When the fuel level in the tank is low, a message appears on vehicles with Uplevel-Combi-Display.

When the tank needs to be refuelled immediately, a warning code or warning message is displayed on vehicles with Midlevel-Display or Uplevel-Combi-Display.

Additionally, control indicator ● illuminates or flashes in the fuel gauge ⇨ 72.

Average consumption

Display of average consumption. The measurement can be reset at any time and starts with a default value.

To reset, press **SET/CLR** for a few seconds.

Instantaneous consumption

Display of the instantaneous consumption.

Average speed

Display of average speed. The measurement can be reset at any time.

To reset, press **SET/CLR** for a few seconds.

Digital speed

Digital display of the instantaneous speed.

Route guidance

In addition to the navigation information in the Colour-Info-Display, route guidance is displayed in the Driver Information Centre.

Vehicle personalisation

The vehicle's behaviour can be personalised by changing the settings in the Info-Display.

Some of the personal settings for different drivers can be memorised individually for each vehicle key. Memorised settings ⇨ 20.

Depending on vehicle equipment and country-specific regulations some of the functions described below may not be available.

Some functions are only displayed or active when the engine is running.

Personal settings in the Graphic-Info-Display

CD 400plus/CD 400/CD 300



Press **CONFIG**. The menu **Settings** is displayed.

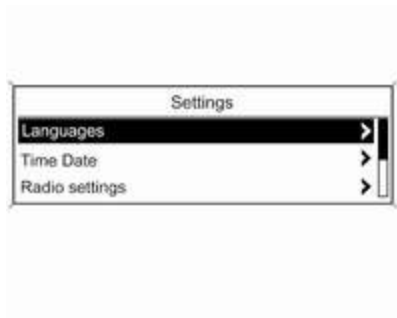

The following settings can be selected by turning and pressing the multifunction knob:

- **Languages**
- **Time Date**
- **Radio settings**
- **Phone settings**
- **Vehicle settings**

In the corresponding submenus the following settings can be changed:

Languages

Selection of the desired language.

Time Date

See Clock ⇨ 60.

Radio settings

See description in the Infotainment manual for further information.

Phone settings

See description in the Infotainment manual for further information.

Vehicle settings

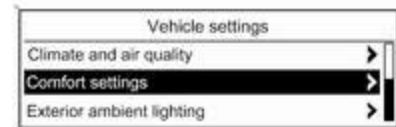

- **Climate and air quality**

Auto fan speed: Modifies the level of the cabin airflow of the climate control in automatic mode.

Climate control mode: Controls the state of the cooling compressor when the vehicle is started. Last setting (recommended) or at vehicle start is either always ON or always OFF.

Auto rear demist: Activates heated rear window automatically.

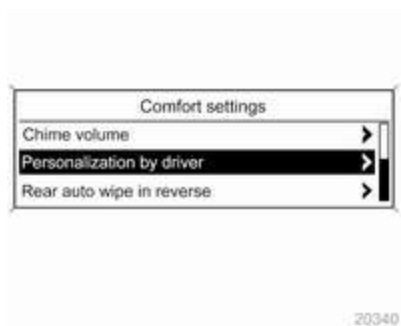

- **Comfort settings**

Chime volume: Changes the volume of warning chimes.

Personalization by driver: Activates or deactivates the personalisation function.

- **Park assist / Collision detection**

Park assist: Activates or deactivates the parking assist.

- **Exterior ambient lighting**

Duration upon exit of vehicle: Activates or deactivates and changes the duration of exit lighting.

Exterior lighting by unlocking:

Activates or deactivates the welcome lighting.

- **Power door locks**

Auto door lock: Activates or deactivates the automatic door unlocking function after switching off ignition. Activates or deactivates the automatic door locking function after driving-off.

Stop door lock if door open:

Activates or deactivates the automatic door locking function while a door is open.

Delayed door lock: Activates or deactivates the delayed door locking function.

- **Remote locking, unlocking, starting**

Remote unlock feedback:

Activates or deactivates the hazard warning flasher feedback whilst unlocking.

Remote door unlock: Changes the configuration to unlock only the driver's door or the whole vehicle whilst unlocking.

Auto relock doors: Activates or deactivates the automatic relock function after unlocking without opening the vehicle.

- **Restore factory settings**

Restore factory settings: Resets all settings to the default settings.

Settings in the Colour-Info-Display

Navi 950/Navi 650/CD 600

Press **CONFIG** on the Infotainment system faceplate to enter the Configuration menu.

Turn the multifunction knob to scroll upwards or downwards in the list. Press the multifunction knob (Navi 950 / Navi 650: press the outer ring) to select a menu item.

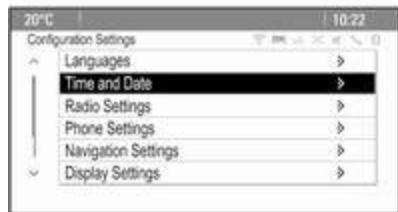

- Languages
- Time and Date
- Radio Settings
- Phone Settings
- Navigation Settings
- Display Settings
- Vehicle Settings

In the corresponding submenus the following settings can be changed:

Languages

Selection of the desired language.

Time and Date

See Infotainment manual for further information.

Radio Settings

See Infotainment manual for further information.

Phone Settings

See Infotainment manual for further information.

Navigation Settings

See Infotainment manual for further information.

Display Settings

- **Home Page Menu:**
See Infotainment manual for further information.
- **Display Off:**
See Infotainment manual for further information.
- **Map Settings:**
See Infotainment manual for further information.

Vehicle Settings

- **Climate and Air Quality**
Auto Fan Speed: Modifies the fan regulation. Changed setting will be active after switching the ignition off and on again.

Air Conditioning Mode: Activates or deactivates cooling when switching on the ignition or uses the last chosen setting.

Auto Demist: Activates or deactivates auto demist.

Auto Rear Demist: Activates the heated rear window automatically.

- **Comfort and Convenience**

Chime Volume: Changes the volume of warning chimes.

Personalisation by Driver: Activates or deactivates the personalisation function.

Auto Reverse Gear Wiper: Activates or deactivates automatic switching on of the rear window wiper when reverse gear is engaged.

- **Collision Detection Systems**

Park Assist: Activates or deactivates the ultrasonic sensors.

- **Lighting**

Vehicle Locator Lights: Activates or deactivates the entry lighting.

Exit Lighting: Activates or deactivates and changes the duration of exit lighting.

- **Power Door Locks**

Open Door Anti Lock Out:

Activates or deactivates the automatic door locking function while a door is open.

Auto Door Lock: Activates or deactivates the automatic door unlocking function after switching off ignition. Activates or deactivates the automatic door locking function after driving-off.

Delay Door Lock: Activates or deactivates the delayed door locking function.

- **Remote Lock/Unlock/Start**

Remote Lock Feedback:

Activates or deactivates the hazard warning flasher feedback whilst locking.

Remote Unlock Feedback:

Activates or deactivates the hazard warning flasher feedback whilst unlocking.

Remote Door Unlock: Changes the configuration to unlock only

the driver's door or the whole vehicle whilst unlocking.

Relock Remotely Unlocked

Doors: Activates or deactivates the automatic relock function after unlocking without opening the vehicle.

- **Return to Factory Settings?:**
Resets all settings to the default settings.

Telematics service

OnStar

OnStar is a personal connectivity and service assistant with integrated Wi-Fi hotspot. The OnStar service is available 24 hours a day, seven days a week.

Note

OnStar is not available for all markets. For further information, contact your workshop.

Note

In order to be available and operational, OnStar needs a valid OnStar subscription, functioning vehicle electrics, mobile service and GPS satellite link.

To activate the OnStar services and set up an account, press  and speak with an advisor.

Depending on the equipment of the vehicle, the following services are available:

- Emergency services and support in the case of a vehicle breakdown
- Wi-Fi hotspot
- Smartphone application
- Remote control, e.g. location of the vehicle, activation of horn and lights, control of central locking system
- Stolen vehicle assistance
- Vehicle diagnostics
- Destination download

Note

The OnStar module of the vehicle is deactivated after ten days without an ignition cycle. Functions requiring a data connection will be available again after switching on the ignition.

OnStar buttons





Note

Depending on the equipment, the OnStar buttons can also be integrated in the rear view mirror.

Privacy button

Press and hold  until a message is heard to activate or deactivate the transmission of the vehicle location.

Press  to answer a call or to end a call to an advisor.

Press  to access the Wi-Fi settings.

Service button

Press  to establish a connection to an advisor.

SOS button

Press  to establish a priority emergency connection to a specially trained emergency advisor.

Status LED

Green: The system is ready with activated transmission of the vehicle location.

Green flashing: The system is on a call.

Red: A problem arose.

Off: The system is ready with deactivated transmission of the vehicle location or the system is in standby mode.

Red / green flashing for a short period of time: The transmission of the vehicle location has been deactivated.

OnStar services

General services

If you need any information e.g. opening hours, points of interest and destinations or if you need any support e.g. in the case of a vehicle

breakdown, a flat tyre and empty fuel tank, press  to establish a connection to an advisor.

Emergency services

In the case of an emergency situation, press  and talk to an advisor. The advisor then contacts emergency or assistance service providers and directs them to your vehicle.

In the case of an accident with activation of airbags or belt tensioners, an automatic emergency call is established. The advisor is immediately connected to your vehicle to see whether help is needed.

Wi-Fi hotspot

The Wi-Fi hotspot of the vehicle provides internet connectivity with a maximum speed of 4G/LTE.

Note

The Wi-Fi hotspot functionality is not available for all markets.

Up to seven devices may be connected.

To connect a mobile device with the Wi-Fi hotspot:

1. Press  and then select Wi-Fi settings on the Info-Display. The settings displayed include the Wi-Fi hotspot name (SSID), password and connection type.
2. Start a Wi-Fi network search on your mobile device.
3. Select your vehicle hotspot (SSID) when listed.
4. When prompted, enter the password on your mobile device.

Note

To change the SSID or password, press  and talk to an advisor or log in to your account.

To switch off the Wi-Fi hotspot functionality, press  to call an advisor.

Smartphone app

With the myOpel smartphone app, some vehicle functions can be operated remotely.

The following functions are available:

- Lock or unlock vehicle.
- Honk horn or flash lights.
- Check fuel level, engine oil life and tyre pressure (only with tyre pressure monitoring system).
- Send navigation destination to the vehicle, if equipped with a built-in navigation system.
- Locate vehicle on a map.
- Manage Wi-Fi settings.

To operate these functions, download the app from App Store® or Google Play™ Store.

Remote control

If desired, use any phone to call an advisor, who can remotely operate specific vehicle functions. Find the respective OnStar phone number on our country-specific website.

The following functions are available:

- Lock or unlock vehicle.
- Provide information on the vehicle location.
- Honk horn or flash lights.

Stolen vehicle assistance

If the vehicle is stolen, report the theft to the authorities and request OnStar stolen vehicle assistance. Use any phone to call an advisor. Find the respective OnStar phone number on our country-specific website.

OnStar can provide support in locating and recovering the vehicle.

Restart prevention

By sending remote signals, OnStar can prevent the vehicle from restarting once it has been turned off.

On-demand diagnostics

At any time e.g. if the vehicle displays a vehicle message, press  to contact an advisor and ask to complete a real-time diagnostic check to directly determine the issue. Depending on the results, the advisor will provide further support.

Diagnostic report

The vehicle automatically transmits diagnostic data to OnStar which sends a monthly email report to you and your preferred workshop.

Note

The workshop notification function can be disabled in your account.

The report contains the status of key operating systems of the vehicle like engine, transmission, airbags, ABS, and other major systems. It also provides information on possible maintenance items and tyre pressure (only with tyre pressure monitoring system).

To look at the information in greater detail, select the link within the email and log in to your account.

Destination download

A desired destination can be directly downloaded to the navigation system. Press  to call an advisor and describe the destination or point of interest.

The advisor can look up any address or point of interest and directly send the destination to the built-in navigation system.

OnStar settings**OnStar PIN**

To have full access to all OnStar services, a four-digit PIN is required. The PIN has to be personalised when first talking to an advisor.

To change the PIN, press  to call an advisor.

Account data

An OnStar subscriber has an account where all the data is stored. To request a change of the account information, press  and talk to an advisor or log in to your account.

If the OnStar service is used on another vehicle, press  and request that the account be transferred to the new vehicle.

Note

In any case, if the vehicle is disposed of, sold or otherwise transferred, immediately inform OnStar about the changes and terminate the OnStar service on this vehicle.

Vehicle location

The vehicle location is transmitted to OnStar when service is requested or triggered. A message on the Info-Display informs about this transmission.

To activate or deactivate the transmission of the vehicle location, press and hold  until an audio message is heard.

The deactivation is indicated by the status light flashing red and green for a short period of time and each time the vehicle is started.

Note

If the transmission of the vehicle location is deactivated, some services are no longer available.

Note

The vehicle location always remains accessible to OnStar in the case of an emergency.

Find the privacy policy in your account.

Software updates

OnStar may remotely carry out software updates without further notice or consent. These updates are to enhance or maintain safety and security or the operation of the vehicle.

These updates may concern privacy issues. Find the privacy policy in your account.

Lighting

Exterior lighting	93
Light switch	93
Automatic light control	94
High beam	95
High beam assist	95
Headlight flash	95
Headlight range adjustment	96
Headlights when driving abroad	96
Daytime running lights	97
Adaptive forward lighting	97
Hazard warning flashers	100
Turn lights	100
Front fog lights	101
Rear fog light	101
Parking lights	101
Reversing lights	102
Misted light covers	102
Interior lighting	102
Instrument panel illumination control	102
Interior lights	102
Reading lights	103
Sunvisor lights	103

Lighting features	104
Centre console lighting	104
Entry lighting	104
Exit lighting	104
Battery discharge protection	105

Exterior lighting

Light switch



Turn light switch:



- 0** : lights off
- ↔** : sidelights
- ☰** : low beam

Control indicator ↔ ↻ 72.

Light switch with automatic light control





Turn light switch:

- AUTO** : automatic light control: low beam is switched on and off automatically depending on external lighting conditions
-  : activation or deactivation of the automatic light control. Switch turns back to **AUTO**
-  : sidelights
-  : low beam

In the Driver Information Centre with Uplevel-Combi-Display, the current status of the automatic light control is displayed.

When switching on the ignition, automatic light control is active.

When low beam is on,  illuminates. Control indicator   72.

Tail lights

Tail lights are illuminated together with low/high beam and sidelights.

Automatic light control



When the automatic light control function is switched on and the engine is running, the system switches between daytime running light and headlights automatically

depending on the lighting conditions and information given by the rain sensor system.

When the automatic light control function is switched on and the engine is running, the system switches between daytime running lights and headlights automatically depending on the external lighting conditions.

Daytime running light  97.

Automatic headlight activation

During poor lighting conditions the headlights are switched on.

Furthermore the headlights are switched on if the windscreen wipers have been activated for several wipes.

Tunnel detection

When a tunnel is entered the headlights are switched on immediately.

Adaptive forward lighting  97.

High beam

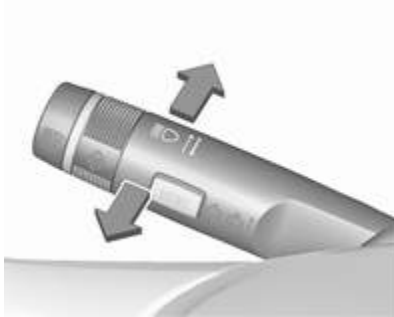

To switch from low to high beam, push lever.

To switch to low beam, push lever again or pull.

High beam assist

Description for version with halogen headlights. High beam assist with adaptive forward lighting ↻ 97.

This feature automatically activates the high beam at night when vehicle speed is faster than 40 km/h.

It switches automatically back to low beam when:



- A sensor detects the lights of oncoming or preceding vehicles.
- The vehicle speed is slower than 20 km/h.
- It is foggy or snowy.
- Driving in urban areas.

If there are no restrictions detected, the system switches back to high beam.

Activation



The high beam assist is activated by pushing the indicator lever twice with a speed above 40 km/h.

The green control indicator  illuminates continuously when the assist is activated, the blue one  illuminates when high beam is on. Control indicator  ↻ 72.

Deactivation

Push indicator lever once. It is also deactivated when front fog lights are switched on.

If a headlight flash is activated when the high beam is on, the high beam assist will be deactivated.

If a headlight flash is activated when the high beam is off, the high beam assist will stay activated.

The latest setting of the high beam assist will remain after the ignition is switched on again.

Headlight flash

To activate the headlight flash, pull lever.

Headlight range adjustment

Manual headlight range adjustment



To adapt headlight range to the vehicle load to prevent dazzling: turn thumb wheel  to required position.

0 : front seats occupied

1 : all seats occupied

2 : all seats occupied and load compartment laden

3 : driver's seat occupied and load compartment laden

Dynamic automatic headlight levelling  97.

Headlights when driving abroad

The asymmetrical headlight beam extends visibility at the edge of the road at the passenger side.

However, when driving in countries where traffic drives on the opposite side of the road, adjust the headlights to prevent dazzling of oncoming traffic.

Vehicles with halogen headlight system

The headlights do not have to be adjusted.

Vehicles with Xenon headlight system



1. Key in ignition switch.
2. Pull turn signal lever and hold (headlight flash).
3. Switch on ignition.
4. After approx. five seconds the control indicator  starts flashing and an acoustic signal sounds.

Control indicator   73.

Every time the ignition is switched on,  flashes as a reminder for approx. four seconds.

For deactivation, operate the same procedure as described above. ☞ will not flash when function is deactivated.

Daytime running lights

Daytime running lights increase visibility of the vehicle during daylight.

They are switched on automatically when ignition is on.

If the vehicle is equipped with automatic light control function, the system switches between daytime running light and low/high beam automatically depending on the lighting conditions and information given by the rain sensor system. Automatic light control ⇨ 94.

Adaptive forward lighting

The Adaptive forward lighting functions are only available with Bi-Xenon headlights. Light range, light distribution and intensity of light are variably triggered depending on the light conditions, weather and road type.

With the light switch in position **AUTO** all lighting functions are available.

The following functions are available also with light switch in position **☞**:

- dynamic curve lighting
- cornering light
- reversing function
- dynamic automatic headlight levelling

Playstreet lighting

Activated automatically at low speed up to approx. 30 km/h. The light beam is turned at an angle of 8° to the roadside.

Town lighting

Activated automatically at a speed range between approx. 40 and 55 km/h and when street lights are detected by the light sensor. The light range is reduced by an extended light distribution.

Country lighting

Activated automatically at a speed range between approx. 55 and 115 km/h. The beam of light and the brightness is different between the left and the right side.

Motorway lighting

Activated automatically at a speed above approx. 115 km/h and minimal steering movements. It switches on after a delay or directly when the vehicle is powerfully accelerated. The light beam is longer and brighter.

Adverse weather lighting

Activated automatically up to a speed of approx. 70 km/h, when the rain sensor recognizes condensation or the wiper operates continuously. The range, distribution and light intensity is regulated variably depending on visibility.

Dynamic curve lighting



The light beam pivots based on steering wheel angle and speed, improving lighting in curves.

Control indicator  73.

Corner lighting



On tight bends or when turning off, depending on the steering angle or the turn signal light, an additional left or right reflector is switched on which illuminates the road at a right angle to the direction of travel. It is activated up to a speed of 40 km/h.

Control indicator  73.

Reversing function

If the headlights are on and reverse gear is engaged, both corner lights are switched on. They remain illuminated for 20 seconds after disengaging reverse gear or until driving faster than 17 km/h in a forward gear.

High Beam Assist

This feature allows high beam as main driving light by night and when vehicle speed is faster than 40 km/h.

It switches to low beam when:



- The camera in the windscreen detects the lights of oncoming or preceding vehicles.
- The vehicle speed is slower than 20 km/h.
- It is foggy or snowy.
- Driving in urban areas.

If there are no restrictions detected, the system switches back to high beam.

Activation



The high beam assist is activated by pushing the indicator lever twice with a speed above 40 km/h.

The green control indicator  illuminates continuously when the assist is activated, the blue one  illuminates when high beam is on.

Control indicator  72.

Deactivation

Push indicator lever once. It is also deactivated when front fog lights are switched on.

If a headlight flash is activated when the high beam is on, the high beam assist will be deactivated.

If a headlight flash is activated when the high beam is off, the high beam assist will stay activated.

High beam assist is always active after the ignition is switched on.

Intelligent light ranging with automatic high beam activation

Intelligent light ranging uses the properties of Bi-Xenon headlights to extend the light range of the low beam by up to 400 metres and additionally activates automatic high beam without dazzling or disturbing oncoming or preceding traffic.

High beam is deactivated and the low beam light range is reduced to avoid dazzling when the following restrictions are detected by the front camera in the windscreen:

- A preceding vehicle is recognised.
- An oncoming vehicle is recognised.

- Urban areas are entered.
- It is foggy or snowy.

If there are no restrictions detected, the system switches back to high beam.

When the system is active, the front camera monitors the area ahead of the vehicle and ensures an optimum light distribution for maximum driver vision during almost all conditions.

Intelligent light ranging with automatic high beam activation therefore reduces the difference between conventional low and high beam without drastic changes in light-range, distribution and intensity.

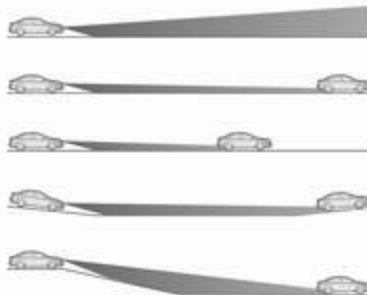



A special topographical evaluation function detects preceding vehicles on hills or slopes by recognising the rear light moving ahead. The system adjusts the height of the light range to ensure optimum illumination on the road ahead without dazzling.

Activation



Intelligent light ranging and automatic high beam activation are switched on together by pushing the indicator lever twice. They can be switched on with ignition on.

Automatic high beam activation operates at a speed above 40 km/h and deactivates below 20 km/h. Intelligent light ranging operates above 55 km/h.

The green control indicator  illuminates continuously when the function is activated, the blue one  illuminates when high beam switches on automatically.

Deactivation

Push indicator lever once. It is also deactivated when front fog lights are switched on.

Dynamic automatic headlight levelling

To prevent oncoming traffic from dazzle, headlight levelling is automatically adjusted based on inclination information measured by front and rear axle, acceleration or deceleration and vehicle speed.

Fault in adaptive forward lighting system

When the system detects a failure in the Adaptive forward lighting system, the system moves to a preset position to avoid dazzling of oncoming traffic. If this is not possible the affected headlight will be automatically switched off. In any case one headlight will stay on. A warning is displayed in the Driver Information Centre.

Hazard warning flashers



Operated by pressing .

In the event of an accident with airbag deployment the hazard warning flashers are activated automatically.

Turn lights

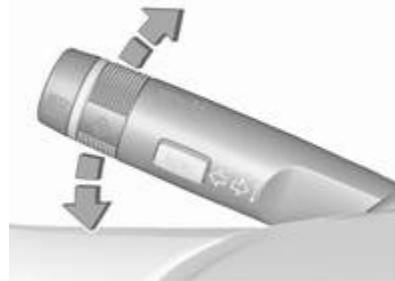

lever up : right turn signal
lever down : left turn signal

A resistance point can be felt when moving the lever.

Constant flashing is activated when the lever is being moved beyond the resistance point. It is deactivated when the steering wheel is moved in

the opposite direction or lever is manually moved back to its neutral position.

Activate temporary flashing by holding the lever just before the resistance point. Turning lights will flash until lever is being released.

To activate three flashes, tap the lever briefly without passing the resistance point.

Front fog lights



Operated by pressing $\#D$.

Light switch in position **AUTO**: switching on front fog lights will switch headlights on automatically.

Rear fog light



Operated by pressing $\#E$.

Light switch in position **AUTO**: switching on rear fog light will switch headlights on automatically.

Light switch in position $\Rightarrow\Leftarrow$: rear fog light can only be switched on with front fog lights.

The vehicle rear fog light is deactivated when towing.

Parking lights



When the vehicle is parked, the parking lights on one side can be activated:

1. Switch off ignition.
2. Move turn signal lever all the way up (right parking lights) or down (left parking lights).

Confirmed by a signal and the corresponding turn signal indicator.

Reversing lights

The reversing light comes on when the ignition is on and reverse gear is selected.

Misted light covers

The inside of the light housing may mist up briefly in poor, wet and cold weather conditions, in heavy rain or after washing. The mist disappears quickly by itself; to help switch on the headlights.

Interior lighting

Instrument panel illumination control



Brightness of the following lights can be adjusted when the exterior lights are on:

- instrument panel illumination
- Info-Display
- illuminated switches and operation elements

Turn thumb wheel  and hold until the desired brightness is obtained.

On vehicles with light sensor, the brightness can only be adjusted when the exterior lights are on and the light sensor detects night conditions.

Interior lights



During entry and exit of the vehicle, the front and rear courtesy lights automatically switch on and then off after a delay.

Note

In the event of an accident with airbag deployment the courtesy lights are turned on automatically.



Front courtesy light



-  : automatic switching on and off
- press  : on
- press  : off



Rear courtesy lights



- Illuminates in conjunction with the front courtesy light.
- Press  or  to switch on manually.

Reading lights



- Operated by pressing  and  in front and rear courtesy lights.

Sunvisor lights

- Illuminates when the cover is opened.

Lighting features

Centre console lighting

Spotlight incorporated in the interior lighting comes on when headlights are switched on.

Entry lighting

Welcome lighting

The following lights are switched on for a short time by unlocking the vehicle with the radio remote control:

- headlights
- tail lights
- number plate lights
- instrument panel light
- interior lights
- door and console lights
- puddle lights

Some functions work only in the dark and facilitates locating the vehicle.

The lighting switches off immediately when the ignition key is turned to position 1 ⇨ 116.

Activation or deactivation of this function can be changed in the Settings menu in the Info-Display. Vehicle personalisation ⇨ 84.

The settings can be saved for the key being used ⇨ 20.

The following lights will additionally switch on when the driver's door is opened:

- illumination of some switches
- Driver Information Centre
- door pocket lights
- console lights

Exit lighting

The following lights switch on if the key is removed from the ignition switch:

- interior lights
- instrument panel light (only when it is dark)
- door lights
- puddle lights

They will switch off automatically after a delay and will be activated again if the driver's door is opened.

Path lighting

Headlights, tail lights and number plate lights illuminate the surrounding area for an adjustable time after leaving the vehicle.

Activating



1. Switch off ignition.
2. Remove ignition key.
3. Open driver's door.
4. Pull turn signal lever.
5. Close driver's door.

If the driver's door is not closed the lights switch off after two minutes.

Exit lighting is switched off immediately if the turn signal lever is pulled while the driver's door is open. Activation, deactivation and duration of this function can be changed in the Settings menu in the Info-Display. Vehicle personalisation ⇨ 84.

The settings can be saved for the key being used ⇨ 20.

Battery discharge protection

Vehicle battery state of charge function

The function guarantees longest vehicle battery life via a generator with controllable power output and optimised power distribution.

To prevent discharge of the vehicle battery when driving, the following systems are reduced automatically in two stages and finally switched off:

- Heated rear window and mirrors
- Heated seats
- Fan

In the second stage a message which confirms the activation of the vehicle battery discharge protection will be displayed in the Driver Information Centre.

Switching off electric lights

To prevent discharge of the vehicle battery when the ignition is switched off, some interior lights are switched off automatically after some time.

Climate control

Climate control systems	106
Heating and ventilation system	106
Air conditioning system	107
Electronic climate control system	109
Air vents	113
Adjustable air vents	113
Fixed air vents	113
Maintenance	113
Air intake	113
Air conditioning regular operation	114
Service	114

Climate control systems

Heating and ventilation system



Controls for:

- temperature
- air distribution
- fan speed
- demisting and defrosting



Heated rear window  ⇨ 30.

Temperature

red : warm
blue : cold

Heating will not be fully effective until the engine has reached normal operating temperature.

Air distribution

-  : to windscreen and front door windows
-  : to head area via adjustable air vents
-  : to foot well and windscreen

All combinations are possible.

Fan speed

Adjust the air flow by switching the fan to the desired speed.

Demisting and defrosting



- Press : fan automatically switches to higher speed, the air distribution is directed towards the windscreen.
- Set temperature control to warmest level.
- Switch on heated rear window .
- Open side air vents as required and direct them towards the door windows.

Air conditioning system



In addition to the heating and ventilation system, the air conditioning system has controls for:

- : cooling
- : air recirculation

Heated seats ↗ 35, Heated steering wheel ↗ 57.

Cooling



Press to switch on cooling. The LED in the button illuminates to indicate activation. Cooling is only functional when the engine is running and climate control fan is switched on.

Press again to switch off cooling.

The air conditioning system cools and dehumidifies (dries) as soon as the outside temperature is slightly above the freezing point. Therefore condensation may form and drip from under the vehicle.

If no cooling or drying is required, switch off the cooling system for fuel saving reasons.

Air recirculation system 

Press  to activate air recirculation mode. The LED in the button illuminates to indicate activation.

Press  again to deactivate air recirculation mode.

Warning

The exchange of fresh air is reduced in air recirculation mode. In operation without cooling the air humidity increases, so the windows may mist up from inside. The quality of the passenger



compartment air deteriorates, which may cause the vehicle occupants to feel drowsy.

In warm and very humid ambient air conditions, the windscreen may mist up from outside when cold air is directed towards it. If windscreen mists up from outside, activate windscreen wiper and deactivate .

Maximum cooling



Briefly open the windows so that hot air can disperse quickly.

- Switch on cooling .
- Air circulation system  on.

- Press air distribution switch .
- Set temperature control to coldest level.
- Set fan speed to highest level.
- Open all vents.

Demisting and defrosting the windows



- Press : fan automatically switches to higher speed, the air distribution is directed towards the windscreen.
- Set temperature control to warmest level.

- Switch on heated rear window .
- Open side air vents as required and direct them towards the door windows.

Electronic climate control system

The dual zone climate control allows different climatisation temperatures for driver side and front passenger side.

In automatic mode, temperature, fan speed and air distribution are regulated automatically.



Controls for:

- temperature on driver side
- air distribution
- fan speed
- temperature on front passenger side

 : cooling

AUTO : automatic mode

 : manual air recirculation

 : demisting and defrosting

Heated rear window  ⇨ 30, Heated seats  ⇨ 35, Heated steering wheel  ⇨ 57.

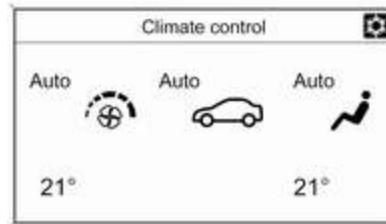

Each change of settings is shown in the Info-Display for a few seconds.

The electronic climate control system is only fully operational when the engine is running.

Automatic mode AUTO



Basic setting for maximum comfort:

- Press **AUTO**, the air distribution and fan speed are regulated automatically.
- Open all air vents to allow optimised air distribution in automatic mode.

- Press  to switch on optimal cooling and demisting. The LED in the button illuminates to indicate activation.
- Set the preselected temperatures for driver and front passenger using the left and right rotary knobs. Recommended temperature is 22 °C.

The fan speed regulation in automatic mode can be changed in the Settings menu.

Vehicle personalisation ⇨ 84.

Temperature preselection

Set temperatures to the desired value.





If the minimum temperature **Lo** is set, the climate control system runs at maximum cooling, if cooling  is switched on.

If the maximum temperature **Hi** is set, the climate control system runs at maximum heating.

Demisting and defrosting the windows



- Press . The LED in the button illuminates to indicate activation.
- Temperature and air distribution are set automatically and the fan runs at high speed.
- Switch on heated rear window .
- To return to previous mode: press . To return to automatic mode: press **AUTO**.

Setting of automatic rear window heating can be changed in the Settings menu in the Info-Display. Vehicle personalisation ⇨ 84.

Manual settings

Climate control system settings can be changed by activating the buttons and rotary knobs as follows. Changing a setting will deactivate the automatic mode.

Fan speed



Press lower button to decrease or upper button to increase fan speed. The fan speed is indicated by the number of segments in the display.

Pressing the lower button for longer: fan and cooling are switched off.



Pressing the upper button for longer: the fan runs at maximum speed.

To return to automatic mode: Press **AUTO**.

Air distribution , ,



Press appropriate button for desired adjustment. The LED in the button illuminates to indicate activation.

-  : to windscreen and front door windows (air conditioning is activated in the background to help preventing windows from fogging)
-  : to head area via adjustable air vents
-  : to foot well and windscreen

All combinations are possible.

Return to automatic air distribution: press **AUTO**.

Cooling



Press  to switch on cooling. The LED in the button illuminates to indicate activation. Cooling is only functional when the engine is running and climate control fan is switched on.

Press  again to switch off cooling.

The air conditioning system cools and dehumidifies (dries) when outside temperature is above a specific level. Therefore condensation may form and drip from under the vehicle.

If no cooling or drying is required, switch off the cooling system for fuel saving reasons.

The display will indicate **ACON** when cooling is activated or **ACOFF** when the cooling is deactivated.

Activation or deactivation of cooling operation after engine start can be changed in the Settings menu in the Info-Display. Vehicle personalisation ⇨ 84.

Air recirculation mode



Press  to activate the air recirculation mode. The LED in the button illuminates to indicate activation.

Press  again to deactivate recirculation mode.

Warning

The exchange of fresh air is reduced in air recirculation mode. In operation without cooling the air humidity increases, so the windows may mist up from inside. The quality of the passenger compartment air deteriorates, which may cause the vehicle occupants to feel drowsy.

In warm and very humid ambient air conditions, the windscreen may mist up from outside when cold air is directed towards it. If windscreen mists up from outside, activate windscreen wiper and deactivate .

Basic settings

Some settings can be changed in the Settings menu in the Info-Display. Vehicle personalisation ⇨ 84.

Air vents

Adjustable air vents

At least one air vent must be open while the cooling is on.



To open the vent, turn the adjuster wheel towards the bigger ■ symbol. Adjust the air amount at the vent outlet by turning the adjuster wheel.



Direct the flow of air by tilting and swivelling the slats.

To close the vent, turn the adjuster wheel towards the smaller ■ symbol.

⚠ Warning

Do not attach any objects to the slats of the air vents. Risk of damage and injury in case of an accident.

Fixed air vents

Additional air vents are located beneath the windscreen and door windows and in the foot wells.

Maintenance

Air intake



The air intake in front of the windscreen in the engine compartment must be kept clear to allow air intake. Remove any leaves, dirt or snow.

Air conditioning regular operation

In order to ensure continuously efficient performance, cooling must be operated for a few minutes once a month, irrespective of the weather and time of year. Operation with cooling is not possible when the outside temperature is too low.

Service

For optimal cooling performance, it is recommended to annually check the climate control system, starting three years after initial vehicle registration, including:

- functionality and pressure test
- heating functionality
- leakage check
- check of drive belts
- cleaning of condenser and evaporator drainage
- performance check

Note

Refrigerant R-134a contains fluorinated greenhouse gases.

Driving and operating

Driving hints	115
Control of the vehicle	115
Steering	116
Starting and operating	116
New vehicle running-in	116
Ignition switch positions	116
Retained power off	116
Starting the engine	117
Overrun cut-off	117
Parking	118
Engine exhaust	119
Exhaust filter	119
Catalytic converter	120
Automatic transmission	121
Transmission display	121
Selector lever	121
Manual mode	122
Electronic driving programmes	123
Fault	123
Interruption of power supply	123
Manual transmission	124
Brakes	125
Antilock brake system	125

Parking brake	126
Brake assist	127
Hill start assist	128
Ride control systems	128
Traction Control system	128
Electronic Stability Control	129
Driver assistance systems	130
Cruise control	130
Speed limiter	131
Parking assist	133
Fuel	135
Fuel for petrol engines	135
Refuelling	136

Driving hints

Control of the vehicle

Never coast with engine not running

Many systems will not function in this situation (e.g. brake servo unit, power steering). Driving in this manner is a danger to yourself and others.

Idle boost

If charging of the vehicle battery is required due to battery condition, the power output of the generator must be increased. This will be achieved by an idle boost which may be audible.

A message is displayed in the Driver Information Centre.

Pedals

To ensure the pedal travel is uninhibited, there must be no mats in the area of the pedals.

Use only floor mats which fit properly and are fixed by the retainers on the driver's side.

Steering

If power steering assist is lost because the engine stops or due to a system malfunction, the vehicle can be steered but may require increased effort.

Control indicator  70.

Caution

Vehicles equipped with hydraulic power steering:

If the steering wheel is turned until it reaches the end of its travel, and is held in that position for more than 15 seconds, damage may occur to the power steering system and there may be loss of power steering assist.

Starting and operating

New vehicle running-in

Do not brake unnecessarily hard for the first few journeys.

During the first drive, smoke may occur because of wax and oil evaporating off the exhaust system. Park the vehicle in the open for a while after the first drive and avoid inhaling the fumes.

During the running-in period fuel and engine oil consumption may be higher and the cleaning process of the exhaust filter may take place more often.

Exhaust filter  119.

Ignition switch positions

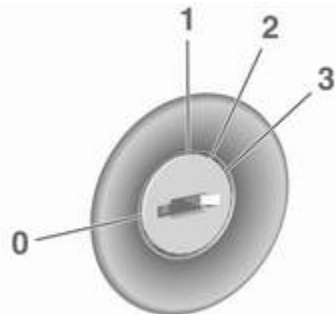

- 0 : ignition off
- 1 : steering wheel lock released, ignition off
- 2 : ignition on
- 3 : starting

Retained power off

The following electronic systems can work until the driver's door is opened or at the latest for ten minutes after the ignition is switched off:

- power windows
- power outlets

Power to the Infotainment system will continue to operate for 30 minutes or until the key is removed from the ignition switch, regardless of whether any door will be opened.

Starting the engine

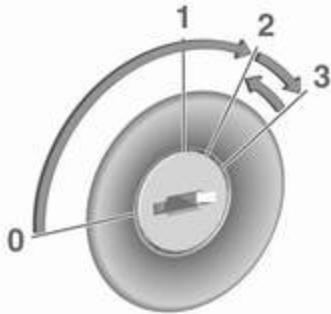

Manual transmission: operate clutch.

Automatic transmission: operate brake and move the selector lever to **P** or **N**.

Do not operate the accelerator pedal.

Turn the key briefly to position **3** and release: an automatic procedure operates the starter with a short delay as long as the engine is running, see Automatic Starter Control.

Before restarting or to switch off the engine, turn the key back to position **0**.

Starting the vehicle at low temperatures

Starting the engine without additional heaters is possible down to $-30\text{ }^{\circ}\text{C}$ for petrol engines. Required is an engine oil with the correct viscosity, the correct fuel, performed services and a sufficiently charged vehicle battery. With temperatures below $-30\text{ }^{\circ}\text{C}$ the automatic transmission needs a warming phase of approx. five minutes. The selector lever must be in position **P**.

Automatic Starter Control

This function controls the engine starting procedure. The driver does not need to hold the key in position **3**. Once applied, the system will go on starting automatically until the engine

is running. Because of the checking procedure, the engine starts running after a short delay.

Possible reasons for a non-starting engine:

- Clutch pedal not operated (manual transmission).
- Brake pedal not operated or selector lever not in **P** or **N** (automatic transmission).
- Timeout occurred.

Turbo engine warm-up

Upon start-up, engine available torque may be limited for a short time, especially when the engine temperature is cold. The limitation is to allow the lubrication system to fully protect the engine.

Overrun cut-off

The fuel supply is automatically cut off during overrun, i.e. when the vehicle is driven with a gear engaged but accelerator pedal is released.

Depending on driving conditions, the overrun cut-off may be deactivated.

Parking

⚠ Warning

- Do not park the vehicle on an easily ignitable surface. The high temperature of the exhaust system could ignite the surface.

- Always apply the parking brake. Activate the manual parking brake without pressing the release button. Apply as firmly as possible on a downhill slope or uphill slope. Depress brake pedal at the same time to reduce operating force.

For vehicles with electric parking brake, pull switch (P) for approx. one second.

The electric parking brake is applied when control indicator (P) illuminates ⇨ 69.

- Switch off the engine.
- If the vehicle is on a level surface or uphill slope, engage first gear or set the selector

lever to position **P** before removing the ignition key. On an uphill slope, turn the front wheels away from the kerb.

If the vehicle is on a downhill slope, engage reverse gear or set the selector lever to position **P** before removing the ignition key. Turn the front wheels towards the kerb.

- Close the windows.
- Remove the ignition key from the ignition switch. Turn the steering wheel until the steering wheel lock is felt to engage.

For vehicles with automatic transmission, the key can only be removed when the selector lever is in position **P**.

- Lock the vehicle.
- The engine cooling fans may run after the engine has been switched off ⇨ 140.

Caution

After running at high engine speeds or with high engine loads, operate the engine briefly at a low load or run in neutral for approx. 30 seconds before switching off, in order to protect the turbocharger.

Note

In the event of an accident with airbag deployment, the engine is turned off automatically if the vehicle comes to a standstill within a certain time.

Engine exhaust

Danger

Engine exhaust gases contain poisonous carbon monoxide, which is colourless and odourless and could be fatal if inhaled.

If exhaust gases enter the interior of the vehicle, open the windows. Have the cause of the fault rectified by a workshop.

Avoid driving with an open load compartment, otherwise exhaust gases could enter the vehicle.

Exhaust filter

The exhaust filter is a particle filter for diesel and gasoline engines.

Automatic cleaning process

The exhaust filter system filters soot particles out of the exhaust gases. The system includes a self-cleaning function that runs automatically during driving without any notification. The filter is cleaned by periodically burning off the soot particles at high temperature. This process takes place automatically under set driving conditions and may take up to 25 minutes. Typically it needs between seven and twelve minutes. Fuel consumption may be higher during this period. The emission of smells and smoke during this process is normal.

System requires cleaning



Under certain conditions, e.g. driving short distances, the system cannot clean itself automatically.

If cleaning of the filter is required and if previous driving conditions did not enable automatic cleaning, it will be indicated by illumination of  and a warning message in the Driver Information Centre.

 illuminates along with a warning message when exhaust filter is full. Start cleaning process as soon as possible.

☞ flashes along with a warning message when exhaust filter has reached the maximum filling level. Start cleaning process immediately to avoid damage to the engine.

Activate self-cleaning process

To activate cleaning process, continue driving, keep engine speed above 2000 rpm. Shift down if necessary. Exhaust filter cleaning is then started.

Cleaning process is completed more quickly at high engine speeds and loads.

Control indicator ☞ extinguishes as soon as the self-cleaning operation is complete. Keep on driving until self-cleaning operation is complete.

Caution

If possible, do not interrupt cleaning process. Drive until cleaning is completed to avoid the need for service or repair by a workshop.

Cleaning process not possible

If cleaning is not possible for any reason, control indicator ☞ illuminates additionally. Engine power may be reduced. Seek the assistance of a workshop immediately.

Catalytic converter

The catalytic converter reduces the amount of harmful substances in the exhaust gases.

Caution

Fuel grades other than those listed on pages ☞ 135, ☞ 184 could damage the catalytic converter or electronic components.

Unburnt petrol will overheat and damage the catalytic converter. Therefore avoid excessive use of the starter, running the fuel tank dry and starting the engine by pushing or towing.

In the event of misfiring, uneven engine running, a reduction in engine performance or other unusual problems, have the cause of the fault rectified by a workshop as soon as possible. In an emergency, driving can be continued for a short period, keeping vehicle speed and engine speed low.

Automatic transmission

The automatic transmission permits automatic gearshifting (automatic mode) or manual gearshifting (manual mode).

Manual shifting is possible in manual mode by tapping the selector lever
 ⇨ 122.

Transmission display

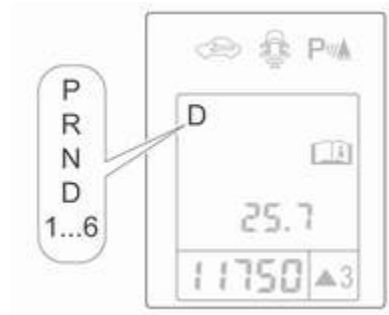

The mode or selected gear is shown in the transmission display.

In automatic mode, the driving programme is indicated by **D** in the Driver Information Centre.

R indicates reverse gear.

N indicates neutral position.

P indicates park position.

Midlevel display: in manual mode the number of the selected gear is indicated.

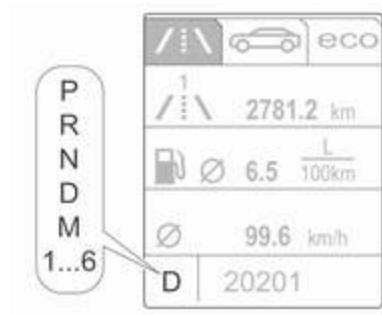

Uplevel display: in manual mode, **M** and the number of the selected gear is indicated.

Selector lever



P : park position, press release button, wheels are locked, engage only when the vehicle is stationary and parking brake is applied

R : reverse gear, press release button, engage only when vehicle is stationary

N : neutral

D : automatic mode

M : manual mode: move selector lever from **D** to the left.

- + : manual mode upshifting: move selector lever in position **M** and tap upwards
- : manual mode downshifting: move selector lever in position **M** and tap rearwards

The selector lever is locked in **P** and can only be moved when the ignition is on and the brake pedal is applied.



Without brake pedal applied, the control indicator  illuminates.

If the selector lever is not in **P** when the ignition is switched off, the control indicators  and **P** flash.

To engage **P** or **R**, press the release button.

The engine can only be started with the lever in position **P** or **N**. When position **N** is selected, press the brake pedal or apply the parking brake before starting.

Do not accelerate while engaging a gear. Never depress the accelerator pedal and brake pedal at the same time.

When a gear is engaged, the vehicle slowly begins to creep when the brake is released.

Engine braking

To utilise the engine braking effect, select a lower gear in good time when driving downhill, see manual mode.

Rocking the vehicle

Rocking the vehicle is only permissible if the vehicle is stuck in sand, mud or snow. Move the selector lever between **D** and **R** in a repeat pattern. Do not race the engine and avoid sudden acceleration.

Parking

Apply the parking brake and engage **P**.

The ignition key can only be removed when the selector lever is in position **P**.

Manual mode



Move selector lever out of position **D** towards the left to select manual mode **M**.

Tap selector lever

forwards + : shift to a higher gear

backwards - : shift to a lower gear

The selected gear is indicated in the instrument cluster.

If a higher gear is selected when vehicle speed is too low, or a lower gear when vehicle speed is too high, the shift is not executed. This can cause a message in the Driver Information Centre.

In manual mode, no automatic shifting to a higher gear takes place at high engine revolutions.

Electronic driving programmes

- Following a cold start, the operating temperature programme increases engine speed to quickly bring the catalytic converter to the required temperature.
- The automatic neutral shift function automatically shifts to idling when the vehicle is stopped with a forward gear engaged and the brake pedal is pressed.

- Special programmes automatically adapt the shifting points when driving up inclines or down hills.
- When starting off in snowy or icy conditions or on other slippery surfaces, the electronic transmission control selects a higher gear automatically.

Kickdown

If the accelerator pedal is pressed down completely in automatic mode, the transmission shifts to a lower gear depending on engine speed.

Fault

In the event of a fault, control indicator  illuminates. Additionally, a code number or a vehicle message is displayed in the Driver Information Centre. Vehicle messages ⇨ 79.

The transmission no longer shifts automatically. Continued travel is possible with manual shifting.

Only the highest gear is available. Depending on the fault, 2nd gear may also be available in manual mode. Shift only when vehicle is at a standstill.

Have the cause of the fault remedied by a workshop.

Interruption of power supply

In the event of an interruption of power supply, the selector lever cannot be moved out of the **P** position. The ignition key cannot be removed from the ignition switch.

If the vehicle battery is discharged, start the vehicle using jump leads ⇨ 170.

If the vehicle battery is not the cause of the fault, release the selector lever.

1. Apply the parking brake.



2. Release the selector lever trim from the centre console at the front, fold it upwards and rotate it to the left.

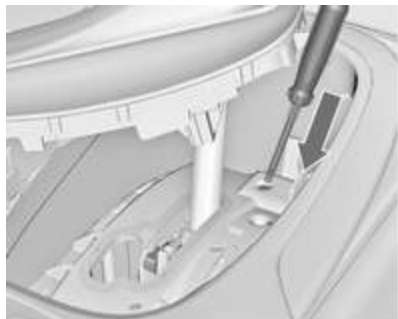

3. Insert a screwdriver into the opening as far as it will go and move the selector lever out of **P** or **N**. If **P** or **N** is engaged again, the selector lever will be locked in position again. Have the cause of the power supply interruption remedied by a workshop.
4. Mount the selector lever trim onto the centre console and refit.

Manual transmission



To engage reverse, with the vehicle stationary, depress clutch pedal, press the release button on the selector lever and engage the gear.

If the gear does not engage, set the lever to neutral, release the clutch pedal and depress again; then repeat gear selection.

Do not slip the clutch unnecessarily.

When operating, depress the clutch pedal completely. Do not use the pedal as a foot rest.

Caution

It is not advisable to drive with the hand resting on the selector lever.

Upshift indication ⇨ 70.

Brakes

The brake system comprises two independent brake circuits.

If a brake circuit fails, the vehicle can still be braked using the other brake circuit. However, braking effect is achieved only when the brake pedal is depressed firmly. Considerably more force is needed for this. The braking distance is extended. Seek the assistance of a workshop before continuing your journey.

When the engine is not running, the support of the brake servo unit disappears once the brake pedal has been depressed once or twice.

Braking effect is not reduced, but braking requires significantly greater force. It is especially important to bear this in mind when being towed.

Control indicator (Ⓢ) ⇨ 69.

Antilock brake system

Antilock brake system (ABS) prevents the wheels from locking.

ABS starts to regulate brake pressure as soon as a wheel shows a tendency to lock. The vehicle remains steerable, even during hard braking.

ABS control is made apparent through a pulse in the brake pedal and the noise of the regulation process.

For optimum braking, keep the brake pedal fully depressed throughout the braking process, despite the fact that the pedal is pulsating. Do not reduce the pressure on the pedal.

After starting off the system performs a self-test which may be audible.

Control indicator (Ⓢ) ⇨ 70.

Adaptive brake light

During full braking, all three brake lights flash for the duration of ABS control.

Fault

⚠ Warning

If there is a fault in the ABS, the wheels may be liable to lock due to braking that is heavier than normal. The advantages of ABS are no longer available. During hard braking, the vehicle can no longer be steered and may swerve.

Have the cause of the fault remedied by a workshop.

Parking brake

Manual parking brake

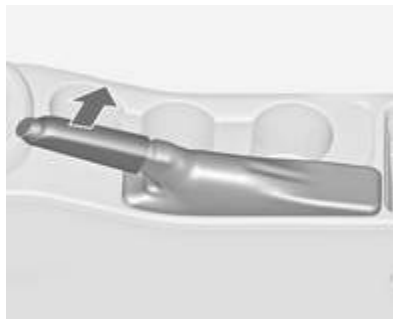
**⚠ Warning**

Always apply parking brake firmly without operating the release button, and apply as firmly as possible on a downhill or uphill slope.

To release the parking brake, pull the lever up slightly, press the release button and fully lower the lever.

To reduce the operating forces of the parking brake, depress the brake pedal at the same time.

Control indicator (D) ⇨ 69.

Electric parking brake



Applying when vehicle is stationary

⚠ Warning

Pull switch (C) for approx. one second, the electric parking brake operates automatically with

adequate force. For maximum force, e.g. parking with trailer or on inclines, pull switch (P) twice.

The electric parking brake is applied when control indicator (P) illuminates ⇨ 69.

The electric parking brake can always be activated, even if the ignition is off.

Do not operate electric parking brake system too often without engine running, as this will discharge the vehicle battery.

Before leaving the vehicle, check the electric parking brake status. Control indicator (P) ⇨ 69.

Releasing

Switch on ignition. Keep brake pedal depressed and then push switch (P).

Drive away function

Vehicles with manual transmission: Depressing the clutch pedal and then slightly releasing the clutch pedal and slightly depressing the accelerator pedal releases the electric parking

brake automatically. This is not possible when the switch (P) is pulled at the same time.

Vehicles with automatic transmission: Engaging **D** and then depressing the accelerator pedal releases the electric parking brake automatically. This is not possible when the switch (P) is pulled at the same time.

Dynamic braking when vehicle is moving

When the vehicle is moving and the switch (P) is kept pulled, the electric parking brake system will decelerate the vehicle, but will not apply statically.

As soon as the switch (P) is released, dynamic braking will be stopped.

Fault

Failure mode of electric parking brake is indicated by control indicator (P) and by a code number or a vehicle message which is displayed in the Driver Information Centre. Vehicle messages ⇨ 79.

Apply electric parking brake: pull and hold the switch (P) for more than five seconds. If control indicator (P) illuminates, electric parking brake is applied.

Release electric parking brake: push and hold the switch (P) for more than two seconds. If control indicator (P) extinguishes, electric parking brake is released.

Control indicator (P) flashes: electric parking brake is not fully applied or released. When continuously flashing, release electric parking brake and retry applying.

Brake assist

If the brake pedal is depressed quickly and forcefully, maximum brake force is automatically applied (full braking).

Maintain steady pressure on the brake pedal for as long as full braking is required. Maximum brake force is automatically reduced when the brake pedal is released.

Hill start assist

The system helps prevent unintended movement when driving away on inclines.

When releasing the brake pedal after stopping on an incline, the brakes remain on for a further two seconds. The brakes release automatically as soon as the vehicle begins to accelerate.

Ride control systems

Traction Control system

The Traction Control system (TC) is a component of the Electronic Stability Control (ESC) ⇨ 129.

TC improves driving stability when necessary, regardless of the type of road surface or tyre grip, by preventing the drive wheels from spinning.

As soon as the drive wheels starts to spin, engine output is reduced and the wheel spinning the most is braked individually. This considerably improves the driving stability of the vehicle on slippery road surfaces.

TC is operational after each engine start as soon as control indicator  extinguishes.

When TC operates  flashes.

Warning

Do not let this special safety feature tempt you into taking risks when driving.



Adapt speed to the road conditions.

Control indicator  ⇨ 71.

Deactivation



TC can be switched off when spinning of drive wheels is required:

press  briefly to deactivate TC,  illuminates. Deactivation is displayed as status message in the Driver Information Centre.

TC is reactivated by pressing  again.

TC is also reactivated the next time the ignition is switched on.

Electronic Stability Control

Electronic Stability Control (ESC) improves driving stability when necessary, regardless of the type of road surface or tyre grip. It also prevents the drive wheels from spinning. ESC operates in combination with the Traction Control system (TC)  128.

As soon as the vehicle starts to swerve (understeer/oversteer), engine output is reduced and the wheels are braked individually. This considerably improves the driving stability of the vehicle on slippery road surfaces.

ESC is operational after each engine start as soon as the control indicator  extinguishes.

When ESC operates  flashes.

Warning

Do not let this special safety feature tempt you into taking risks when driving.





Adapt speed to the road conditions.

Control indicator   71.

Deactivation



For a more sporty behaviour ESC and TC can be deactivated separately:

- Press  briefly: only Traction control system is inactive, ESC remains active,  illuminates.
- Press and hold  for min. five seconds: TC and ESC are deactivated,  and  illuminate.

Additionally, the selected mode is displayed as status message in the Driver Information Centre.

If the vehicle comes into threshold with deactivated ESP, the system will reactivate ESP for the time duration of the threshold, when the brake pedal is depressed once.

ESC is reactivated by pressing  again. If the TC system was previously disabled, both TC and ESC are reactivated.

ESC is also reactivated the next time the ignition is switched on.

Driver assistance systems

⚠ Warning

Driver assistance systems are developed to support the driver and not to replace the driver's attention.

The driver accepts full responsibility when driving the vehicle.

When using driver assistance systems, always take care regarding the current traffic situation.

Cruise control

The Cruise control can store and maintain speeds of approx. 30 to 200 km/h. Deviations from the stored speeds may occur when driving uphill or downhill.

For safety reasons, the cruise control cannot be activated until the brake pedal has been operated once. Activating in first gear is not possible.





Do not use the cruise control if it is not advisable to maintain a constant speed.

With automatic transmission, only activate cruise control in automatic mode.

Control indicator  \leftrightarrow 73.

Switching on the system



Press ; control indicator  in instrument cluster illuminates white.

Activation of the functionality

Accelerate to the desired speed and turn thumb wheel to **SET/-**; the current speed is stored and maintained. Control indicator  in instrument cluster illuminates green. Accelerator pedal can be released.

Vehicle speed can be increased by depressing the accelerator pedal. When the accelerator pedal is released, the previously stored speed is resumed.

Cruise control remains activated while gearshifting.

Increase speed

With cruise control active, hold thumb wheel turned to **RES/+** or briefly turn to **RES/+** repeatedly: speed increases continuously or in small increments.



Alternatively, accelerate to the desired speed and store by turning to **SET/-**.



Reduce speed

With cruise control active, hold thumb wheel turned to **SET/-** or briefly turn to **SET/-** repeatedly: speed decreases continuously or in small increments.

Deactivation of the functionality

Press ; control indicator  in instrument cluster illuminates white. Cruise control is deactivated. Last stored speed remains in memory for later speed resume.



Automatic deactivation:

- Vehicle speed is below approx. 30 km/h.
- Vehicle speed is above approx. 200 km/h.
- The brake pedal is depressed.
- The clutch pedal is depressed for a few seconds.
- Selector lever is in **N**.
- Engine speed is in a very low range.
- The Traction Control system (TC) or Electronic Stability Control (ESC) is operating.

Resume stored speed

Turn thumb wheel to **RES/+** at a speed above 30 km/h. The stored speed will be obtained.

Switching off the system

Press ; control indicator  in instrument cluster extinguishes. The stored speed is deleted.

Pressing  for activating speed limiter or switching off the ignition also switches off cruise control and deletes the stored speed.

Speed limiter

The speed limiter prevents the vehicle exceeding a preset maximum speed.



The maximum speed can be set at a speed above 25 km/h.

The driver can only accelerate up to the preset speed. Deviations from the limited speed may occur when driving downhill.

The preset speed limit is displayed in the top line of the Driver Information Centre when the system is active.

Activation of the functionality



Press . If cruise control has been activated before, it is switched off when speed limiter is activated and control indicator  extinguishes.

Set speed limit



With speed limiter active, hold thumb wheel turned to **RES/+** or briefly turn to **RES/+** repeatedly until the desired maximum speed is displayed in the Driver Information Centre.

Alternatively accelerate to the desired speed and briefly turn thumb wheel to **SET/-**: the current speed is stored as maximum speed. Speed limit is displayed in the Driver Information Centre.



Change speed limit

With speed limiter active, turn thumb wheel to **RES/+** to increase or **SET/-** to decrease the desired maximum speed.

Exceeding the speed limit

In the event of an emergency, it is possible to exceed the speed limit by depressing the accelerator pedal firmly beyond the point of resistance.

The limited speed will flash in the Driver Information Centre and (depending on vehicle) additionally a chime sounds during this period.

Release the accelerator pedal and the speed limiter function is reactivated once a speed lower than the limit speed is obtained.

Deactivation of the functionality

Press : speed limiter is deactivated and the vehicle can be driven without speed limit.

The limited speed is stored and a corresponding message appears in the Driver Information Centre.

Resume limit speed

Turn thumb wheel to **RES/+**. The stored speed limit will be obtained.

Switching off the system

Press , the speed limit indication in the Driver Information Centre extinguishes. The stored speed is deleted.

By pressing  to activate cruise control or by switching off the ignition, speed limiter is also deactivated and the stored speed is deleted.

Parking assist

Rear parking assist

Warning

The driver bears full responsibility for the parking manoeuvre.

Always check the surrounding area while reversing and using the rear parking assist system.

The rear parking assist makes parking easier by measuring the distance between the vehicle and rear obstacles. It informs and warns the driver by giving acoustic signals.



The system has four ultrasonic parking sensors in the rear bumper.

Activation

When reverse gear is engaged, the system is ready to operate automatically.

An illuminated LED in the parking assist button  indicates that the system is ready to operate.

Indication

The system warns the driver with acoustic signals against potentially hazardous obstacles behind the vehicle. The interval between the sounds becomes shorter as the vehicle gets closer to that obstacle. When the distance is less than approx. 30 cm, the sound is continuous.

Additionally, the distance to obstacles may be shown in the Driver Information Centre.

Deactivation



The system automatically switches off when reverse gear is disengaged. To switch on the system again, engage reverse gear.

Manual deactivation is also possible by pressing **P**▲.

When the system is deactivated, the LED in the button extinguishes.

Additionally, a message pops-up in the Driver Information Centre when the system is deactivated manually.

Fault

In the event of a fault in the system or if the system does not work due to temporary conditions, e.g. ice covered sensors, control indicator **P**▲ illuminates or a message is displayed in the Driver Information Centre.

Vehicle messages ⇨ 79.

Control indicator **P**▲ ⇨ 70.

Fault

In the event of a fault in the system or if the system does not work due to temporary conditions, e.g. ice covered sensors, control indicator **P**▲ illuminates or a message is displayed in the Driver Information Centre.

Vehicle messages ⇨ 79.

Control indicator **P**▲ ⇨ 70.

Basic notes on parking assist systems

⚠ Warning

Under certain circumstances, various reflective surfaces on objects or clothing as well as external noise sources may cause the system to fail to detect obstacles.

Special attention must be paid to low obstacles which can damage the lower part of the bumper.

Caution

Performance of the system can be reduced when sensors are covered, e.g. by ice or snow.

Performance of the parking assist system can be reduced due to heavy loading.

Special conditions apply if there are taller vehicles in the vicinity (e.g. off-road vehicles, mini vans, vans). Object identification and

correct distance indication in the upper part of these vehicles cannot be guaranteed.

Objects with a very small reflection cross-section, e.g. objects of narrow size or soft materials, may not be detected by the system.

Parking assist systems do not detect objects outside the detection range.

Note

The parking assist system can be activated and deactivated by changing the settings in the Info-Display.

Vehicle personalisation ⇨ 84.

Note

The sensor may detect a non-existent object (echo disturbance) caused by external acoustic or mechanical disturbances.

Fuel

Fuel for petrol engines

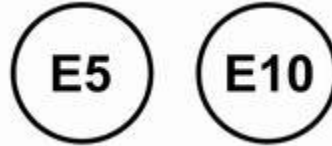

Only use unleaded fuel that complies with European standard EN 228 or equivalent.

The engine is capable of running with fuel that contains up to 10% ethanol (e.g. named E10).

Use fuel with the recommended octane rating. A lower octane rating can reduce engine power and torque and slightly increases fuel consumption.

Caution

Do not use fuel or fuel additives that contain metallic compounds such as manganese-based additives. This may cause engine damage.

Caution

Use of fuel that does not comply to EN 228 or equivalent can lead to deposits or engine damage.

Caution

Use of fuel with a lower octane rating than the lowest possible rating could lead to uncontrolled combustion and engine damage.

The engine specific requirements regarding octane rating are given in the engine data overview ⇨ 184. A country specific label at the fuel filler flap can supersede the requirement.

Fuel additive

Fuel should contain detergent additives that help prevent engine and fuel system deposits from forming. Clean fuel injectors and intake valves will allow the emission control system to work properly. In certain countries fuel does not contain sufficient quantities of additive to keep fuel injectors and intake valves clean. In these countries a fuel additive is required for some engines to make up for this lack of detergency. Only use fuel additive approved for the vehicle.

Adding fuel additive to the filled fuel tank is required at least every 15,000 km or after one year, whichever occurs first. For further information, contact your workshop.



Prohibited fuels

Fuels containing oxygenates such as ethers and ethanol, as well as reformulated fuel, are available in some cities. If these fuels comply with the previously described specification, then they are acceptable to use. However, E85

(85% ethanol) and other fuels containing more than 15% ethanol must be used only in FlexFuel vehicles.

Caution

Do not use fuel containing methanol. It can corrode metal parts in the fuel system and also damage plastic and rubber parts. This damage would not be covered by the vehicle warranty.

Some fuels, mainly high octane racing fuels, can contain an octane enhancing additive called methylcyclopentadienyl manganese tricarbonyl (MMT). Do not use fuels or fuel additives with MMT as they can reduce spark plug life and affect emission control system performance. The malfunction indicator light  may illuminate  69. If this occurs, seek the assistance of a workshop.

Refuelling**⚠ Danger**

Before refuelling, switch off ignition and any external heaters with combustion chambers. Switch off any mobile phones.

Follow the operating and safety instructions of the filling station when refuelling.

⚠ Danger

Fuel is flammable and explosive. No smoking. No naked flames or sparks.

If you can smell fuel in your vehicle, have the cause of this remedied immediately by a workshop.

A label with symbols at the fuel filler flap is indicating the allowed fuel types. In Europe the pump nozzles of the filling stations are marked with these symbols. Refuel only the allowed fuel type.

Caution

In case of misfuelling, do not switch on ignition.

Fuel filler flap is located at right rear side of the vehicle.



The fuel filler flap can only be opened if the vehicle is unlocked. Release the fuel filler flap by pushing the flap.

To open, turn the cap slowly anticlockwise.



The fuel filler cap can be retained in the bracket on the fuel filler flap.

To refuel, fully insert the pump nozzle and switch it on.

After the automatic cut-off, the tank can be topped up by operating the pump nozzle a maximum of two more times.

Caution

Wipe off any overflowing fuel immediately.

To close, turn the fuel filler cap clockwise until it clicks.

Close the flap and engage.

Fuel filler cap

Only use genuine fuel filler caps.

Vehicle care

General Information	138
Accessories and vehicle modifications	138
Vehicle storage	139
End-of-life vehicle recovery	139
Vehicle checks	140
Performing work	140
Bonnet	140
Engine oil	141
Engine coolant	142
Power steering fluid	142
Washer fluid	143
Brakes	143
Brake fluid	143
Vehicle battery	144
Wiper blade replacement	145
Bulb replacement	145
Halogen headlights	146
Adaptive forward lighting	148
Front fog lights	149
Front turn lights	150
Tail lights	151
Side turn lights	152
Number plate light	153

Interior lights	153
Instrument panel illumination ...	153
Electrical system	154
Fuses	154
Engine compartment fuse box .	155
Instrument panel fuse box	157
Load compartment fuse box ...	158
Vehicle tools	159
Tools	159
Wheels and tyres	159
Winter tyres	159
Tyre designations	160
Tyre pressure	160
Tyre pressure monitoring system	161
Tread depth	164
Changing tyre and wheel size .	165
Wheel covers	165
Tyre chains	165
Wheel changing	166
Spare wheel	167
Jump starting	170
Towing	172
Towing the vehicle	172
Towing another vehicle	173
Appearance care	174
Exterior care	174
Interior care	176

General Information

Accessories and vehicle modifications

We recommend the use of genuine parts and accessories and factory approved parts specific for your vehicle type. We cannot assess or guarantee reliability of other products - even if they have a regulatory or otherwise granted approval.

Any modification, conversion or other changes made to standard vehicle specifications (including, without limitation, software modifications, modifications of the electronic control units) may invalidate the warranty offered by Opel. Furthermore, such changes may affect driver assistance systems, may impact fuel consumption, CO₂ emissions and other emissions of the vehicle and cause the vehicle to no longer conform to the operating permit, impacting the validity of your vehicle registration.

Caution
When transporting the vehicle on a train or on a recovery vehicle, the mud flaps might be damaged.

Vehicle storage

Storage for a long period of time

If the vehicle is to be stored for several months:

- Wash and wax the vehicle.
- Have the wax in the engine compartment and underbody checked.
- Clean and preserve the rubber seals.
- Fill up fuel tank completely.
- Change the engine oil.
- Drain the washer fluid reservoir.
- Check the coolant antifreeze and corrosion protection.
- Adjust tyre pressure to the value specified for full load.

- Park the vehicle in a dry, well ventilated place. Engage first or reverse gear or set selector lever to **P**. Prevent the vehicle from rolling.
- Do not apply the parking brake.
- Open the bonnet, close all doors and lock the vehicle.
- Disconnect the clamp from the negative terminal of the vehicle battery. Beware that all systems are not functional.

Putting back into operation

When the vehicle is to be put back into operation:

- Connect the clamp to the negative terminal of the vehicle battery. Activate the electronics of the power windows.
- Check tyre pressure.
- Fill up the washer fluid reservoir.
- Check the engine oil level.
- Check the coolant level.
- Fit the number plate if necessary.

End-of-life vehicle recovery

Information on end-of-life vehicle recovery centres and the recycling of end-of-life vehicles is available on our website, where legally required. Only entrust this work to an authorised recycling centre.

Gas vehicles must be recycled by a service centre authorised for gas vehicles.

Vehicle checks

Performing work



⚠ Warning

Only perform engine compartment checks when the ignition is off.
The cooling fan may start operating even if the ignition is off.

⚠ Danger

The ignition system and Xenon headlights use extremely high voltage. Do not touch.

Bonnet

Opening



Pull the release lever and return it to its original position.



Move the safety catch sideways to the left vehicle side and open the bonnet.

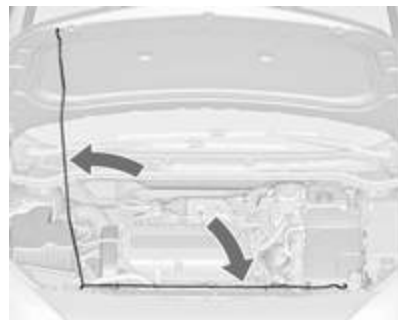

Secure the bonnet support.

Closing

Before closing the bonnet, press the support into the holder.

Lower the bonnet and allow it to fall into the latch from a low height (20-25 cm). Check that the bonnet is engaged.

Caution

Do not press the bonnet into the latch, to avoid dents.

Engine oil

Check the engine oil level manually on a regular basis to prevent damage to the engine. Ensure that the correct specification of oil is used.

Recommended fluids and lubricants
 ⇨ 178.

The maximum engine oil consumption is 0.6 l per 1000 km.

Check with the vehicle on a level surface. The engine must be at operating temperature and switched off for at least five minutes.

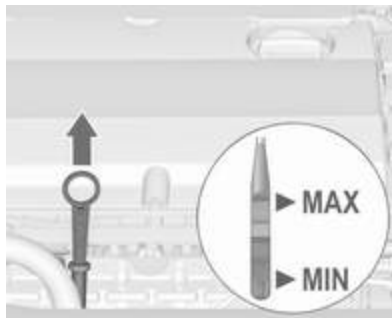

Pull out the dipstick, wipe it clean, reinsert it fully, pull out and read the engine oil level.

Different dipsticks are used depending on engine variant.

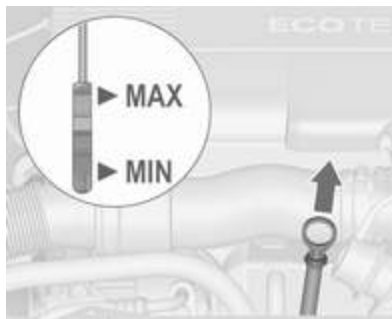

When the engine oil level has dropped to the **MIN** mark, top up engine oil.

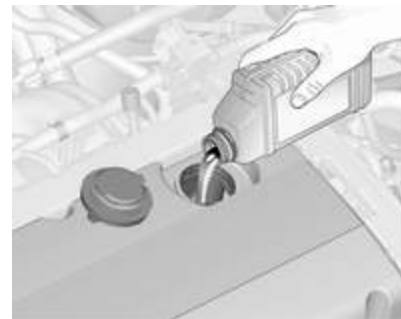

We recommend the use of the same grade of engine oil that was used at last change.

The engine oil level must not exceed the **MAX** mark on the dipstick.

Caution

Overfilled engine oil must be drained or suctioned out. If the oil exceeds the maximum level, do not start the vehicle and contact a workshop.

Capacities ⇨ 185.

Fit the cap on straight and tighten it.

Engine coolant

The coolant provides freeze protection down to approx. -28 °C. In cold regions with very low temperatures, the factory filled coolant provides frost protection down to approx. -37 °C.

Caution

Only use approved antifreeze.

Coolant and antifreeze ⇨ 178.

Coolant level

Caution

Too low a coolant level can cause engine damage.

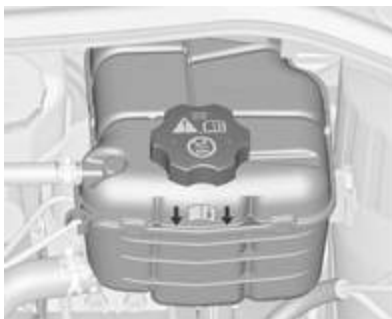

If the cooling system is cold, the coolant level should be above the filling line mark. Top up if the level is low.

Warning

Allow the engine to cool before opening the cap. Carefully open the cap, relieving the pressure slowly.

To top up, use a 1:1 mixture of approved coolant concentrate mixed with clean tap water. If no coolant concentrate is available, use clean tap water. Install the cap tightly. Have

the coolant concentration checked and have the cause of the coolant loss remedied by a workshop.

Power steering fluid

Caution

Extremely small amounts of contamination can cause steering system damage and cause it to not work properly. Do not allow contaminants to contact the fluid side of the reservoir cap/dipstick or from entering the reservoir.



Power steering fluid level normally does not have to be checked. If an unusual noise sounds during steering or the power steering reacts unusually, seek the assistance of a workshop.

Washer fluid



Fill with clean water mixed with a suitable quantity of approved windscreen washer fluid which contains antifreeze.

Caution

Only washer fluid with a sufficient antifreeze concentration provides protection at low temperatures or after a sudden drop in temperature.

Use of washer fluid containing isopropanol can damage exterior lamps.

Washer fluid ⇨ 178.

Brakes

In the event of minimum thickness of the brake lining, a squealing noise sounds during braking.

Continued driving is possible but have the brake lining replaced as soon as possible.

Once new brake linings are installed, do not brake unnecessarily hard for the first few journeys.

Brake fluid

⚠ Warning

Brake fluid is poisonous and corrosive. Avoid contact with eyes, skin, fabrics and painted surfaces.



The brake fluid level must be between the **MIN** and **MAX** marks.

If fluid level is below **MIN** seek the assistance of a workshop.

Brake and clutch fluid ⇨ 178.

Vehicle battery

The vehicle battery is maintenance-free provided that the driving profile allows sufficient charging of the battery. Short-distance-driving and frequent engine starts can discharge the battery. Avoid the use of unnecessary electrical consumers.



Batteries do not belong in household waste. They must be disposed of at an appropriate recycling collection point.

Laying up the vehicle for more than four weeks can lead to battery discharge. Disconnect the clamp from the negative terminal of the vehicle battery.

Ensure the ignition is switched off before connecting or disconnecting the vehicle battery.

Vehicle battery discharge protection
 ⇨ 105.

Disconnecting the battery

If the vehicle's battery is to be disconnected (e.g. for maintenance work), the alarm siren must be deactivated as follows: Switch the ignition on then off, then disconnect the vehicle's battery within 15 seconds.

Replacing the vehicle battery

When the vehicle battery is being replaced, please ensure that there are no open ventilation holes in the vicinity of the positive terminal. If a ventilation hole is open in this area, it must be closed off with a dummy cap, and the ventilation in the vicinity of the negative terminal must be opened.

Only use vehicle batteries that allow the fuse box to be mounted above the vehicle battery.

Ensure that the battery is always replaced by the same type of battery.

We recommend that you have the vehicle battery replaced by a workshop.

Warning label



Meaning of symbols:

- No sparks, naked flames or smoking.
- Always shield eyes. Explosive gases can cause blindness or injury.
- Keep the vehicle battery out of reach of children.

- The vehicle battery contains sulphuric acid which could cause blindness or serious burn injuries.
- See the Owner's Manual for further information.
- Explosive gas may be present in the vicinity of the vehicle battery.

Wiper blade replacement

Windscreen



Lift the wiper arm until it stays in the raised position, press button to disengage the wiper blade and remove.

Attach the wiper blade slightly angled to the wiper arm and push until it engages.

Lower wiper arm carefully.

Bulb replacement

Switch off the ignition and switch off the relevant switch or close the doors.

Only hold a new bulb at the base. Do not touch the bulb glass with bare hands.

Use only the same bulb type for replacement.

Replace headlight bulbs from within the engine compartment.

Bulb check

After a bulb replacement switch on the ignition, operate and check the lights.

Halogen headlights

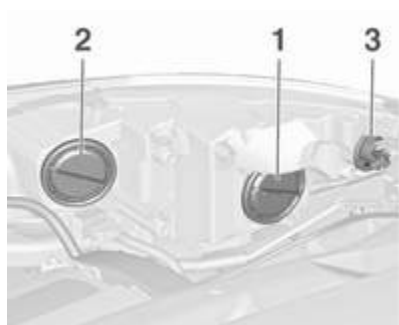

Halogen headlights with separate bulbs for low beam and high beam.

Low beam (1) outer bulb.

High beam (2) inner bulb.

Sidelight/Daytime running light (3).

Low beam (1)



1. Rotate the cap (1) anticlockwise and remove it.



2. Rotate the bulb holder anticlockwise to disengage. Withdraw the bulb holder from the reflector.

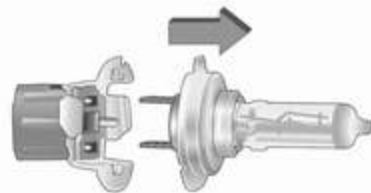

3. Detach the bulb from the bulb holder and replace the bulb.
4. Insert the bulb holder, engaging the two lugs into the reflector and rotate clockwise to secure.
5. Fit the cap and rotate clockwise.

High beam (2)



1. Rotate the cap (2) anticlockwise and remove it.
2. Rotate the bulb holder anticlockwise to disengage. Withdraw the bulb holder from the reflector.
3. Detach the bulb from the bulb holder and replace the bulb.
4. Insert the bulb holder, engaging the two lugs into the reflector and rotate clockwise to secure.
5. Fit the cap and rotate clockwise.

Sidelights/Daytime running light (3)



1. Rotate the cap (3) anticlockwise and remove it. Use the screwdriver to rotate the cap.

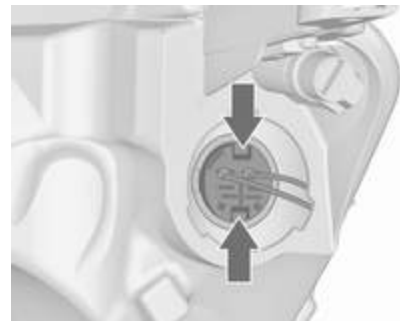

2. Press latches together and withdraw the bulb holder from the reflector.

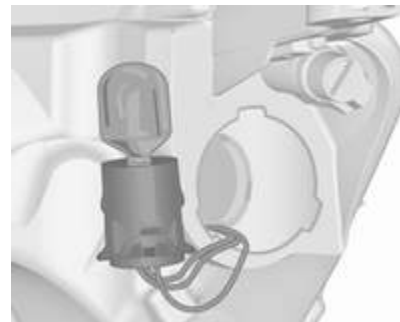

3. Remove the bulb from the socket and replace the bulb.
4. Insert the bulb holder into the reflector. Fit the cap and rotate clockwise.

Adaptive forward lighting

⚠ Danger

Adaptive forward lighting system uses Xenon headlights.

Xenon headlights work under extremely high electrical voltage. Do not touch. Have bulbs replaced by a workshop.

Sidelight/Daytime running lights are designed as Light Emitting Diodes (LEDs) and cannot be changed.

Bulbs for corner lighting can be changed.

Corner lighting

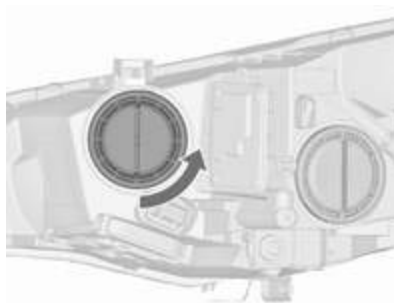

1. Rotate the cap anticlockwise and remove it.



2. Rotate the bulb holder anticlockwise to disengage. Withdraw the bulb holder from the reflector.

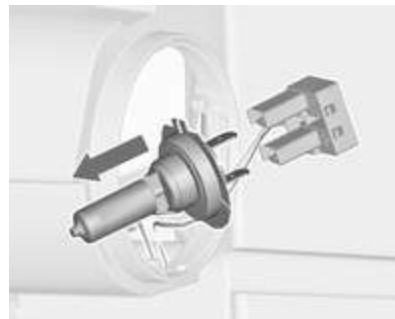

3. Disengage the bulb from the plug connector by pulling.
4. Replace the bulb and connect bulb holder with the plug connector.
5. Insert the bulb holder, engaging the two lugs into the reflector and rotate clockwise to secure.
6. Fit the cap and rotate clockwise.

Front fog lights



1. Wrap a cloth around the tip of a flat screwdriver to prevent paint damage. Release both caps with the screwdriver at the marked area.



2. Unscrew both screws and remove turn light assembly from the bumper.

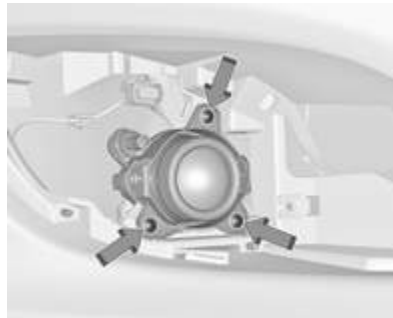

3. Unscrew three screws and remove fog light assembly from the bumper.



4. Turn the bulb socket anticlockwise and remove it from the reflector housing.
5. Disengage the bulb socket from the plug connector by pressing the retaining lug.
6. Replace and insert bulb socket into the reflector housing, turn bulb socket clockwise and attach the plug connector.
7. Attach fog light assembly into the bumper and fix with three screws.

8. Attach turn light assembly into the bumper and fix with two screws.
9. Engage both caps.

Front turn lights



1. Release both caps with a screwdriver at the marked area.



2. Unscrew both screws and remove light assembly from the bumper.



3. Disengage the bulb socket from the reflector housing by pressing both retaining lugs.



4. Disengage the plug connector from the bulb socket by pressing the retaining lug.
5. Remove and replace the bulb socket with bulb.
6. Insert the bulb socket into the reflector housing and attach the plug connector.
7. Attach light assembly into the bumper and fix with both screws.
8. Engage both caps.

Tail lights



1. Remove cover on the responding side.



2. Unscrew two plastic securing nuts from the inside by hand.

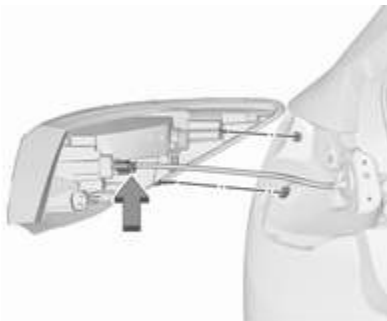

3. Carefully withdraw tail light assembly from recesses and remove. Make sure that the cable duct remains in position.
4. Detach wiring plug from bulb carrier.

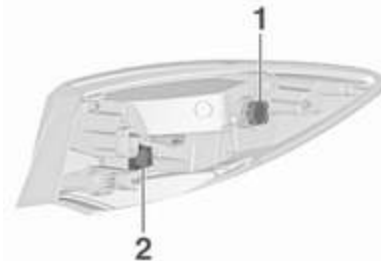

5. Remove the bulb holder by turning and replace the bulb by withdrawing or pushing the bulb slightly into the socket and rotating anticlockwise:
Tail light/Brake light (1)
Turn signal light (2)
6. Insert bulb holder and turn clockwise. Connect the wiring plug. Fit light assembly with the retaining pins into the recesses of the vehicle body and tighten the plastic securing nuts from the inside of the load compartment. Attach cover.

Light assembly in the boot lid



1. Open the boot lid and remove the cover on the respective side.

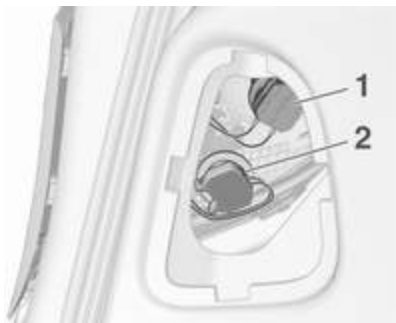

2. Remove the bulb holder by turning and replace the bulb by withdrawing or pushing the bulb slightly into the socket and rotating anticlockwise:

Tail light (1)

Rear fog light/Reverse light (2), depending on the side of the vehicle.

3. Insert bulb holder and turn clockwise. Attach cover.

Side turn lights

To replace bulb, remove lamp housing:



1. Slide lamp to its left side and remove at its right end.



2. Turn bulb holder anticlockwise and remove from housing.



3. Pull bulb from bulb holder and replace it.
4. Insert bulb holder and turn clockwise.
5. Insert left end of the lamp, slide to the left and insert right end.

Number plate light



1. Insert screwdriver in recess of the cover, press to the side and release spring.



2. Remove lamp downwards, taking care not to pull on the cable.

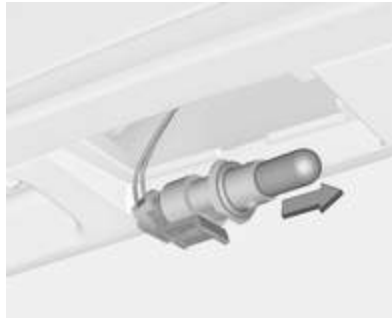

3. Remove bulb holder from lamp housing by turning anticlockwise.

4. Pull bulb from bulb holder and replace it.
5. Insert bulb holder into lamp housing and turn clockwise.
6. Insert lamp into bumper and let engage.

Interior lights

Courtesy light, reading lights

Have bulbs replaced by a workshop.

Load compartment light

Have bulbs replaced by a workshop.

Instrument panel illumination

Have bulbs replaced by a workshop.

Electrical system

Fuses

Data on the replacement fuse must match the data on the defective fuse.

There are three fuse boxes in the vehicle:

- in the front left of the engine compartment
- in left-hand drive vehicles, in the interior behind the storage compartment, or, in right-hand drive vehicles, behind the glovebox
- behind a cover on the left side of the load compartment

Before replacing a fuse, turn off the respective switch and the ignition.

A blown fuse can be recognised by its melted wire. Do not replace the fuse until the cause of the fault has been remedied.

Some functions are protected by several fuses.

Fuses may also be inserted without existence of a function.



Fuse extractor

A fuse extractor may be located in the fuse box in the engine compartment.

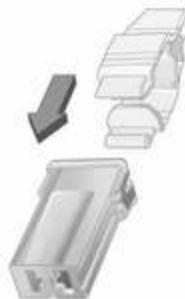
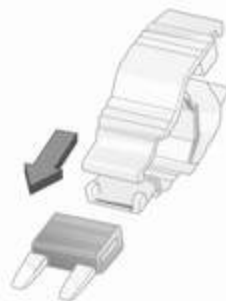

Place the fuse extractor on the various types of fuse from the top or side, and withdraw fuse.

Engine compartment fuse box

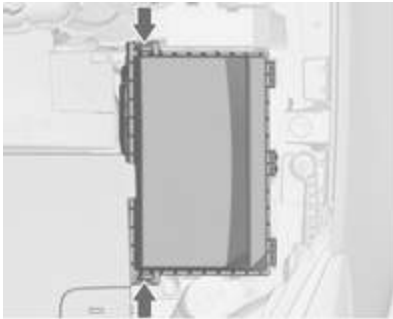

The fuse box is in the front left of the engine compartment.

Disengage the cover and fold it upwards until it stops. Remove the cover vertically upwards.



No. Circuit

- | No. | Circuit |
|-----|---|
| 1 | Engine control module |
| 2 | Lambda sensor |
| 3 | Fuel injection/Ignition system |
| 4 | Fuel injection/Ignition system |
| 5 | – |
| 6 | Mirror heating |
| 7 | Fan control/Engine control module/Transmission control module |
| 8 | Lambda sensor/Engine cooling |
| 9 | Rear window sensor |
| 10 | Vehicle battery sensor |
| 11 | Boot lid release |
| 12 | Adaptive forward lighting/Auto-automatic light control |
| 13 | ABS |
| 14 | – |
| 15 | Engine control module |

No. Circuit

- 16 Starter
- 17 Transmission control module
- 18 Heated rear window
- 19 Front power windows
- 20 Rear power windows
- 21 Rear electrical centre
- 22 Left high beam (Halogen)
- 23 Headlamp washer system
- 24 Right low beam (Xenon)
- 25 Left low beam (Xenon)
- 26 Front fog lights
- 27 –
- 28 –
- 29 Electric parking brake
- 30 ABS
- 31 –
- 32 Airbag

No. Circuit

- 33 Adaptive forward lighting/Auto-matic light control
- 34 Exhaust gas recirculation
- 35 Exterior mirror/Rain sensor
- 36 Climate control
- 37 Canister vent solenoid
- 38 Vacuum pump
- 39 Central control module
- 40 Windscreen washer
- 41 Right high beam (Halogen)
- 42 Radiator fan
- 43 Windscreen wiper
- 44 Windscreen wiper
- 45 Radiator fan
- 46 –
- 47 Horn
- 48 Radiator fan
- 49 Fuel pump

No. Circuit

- 50 Headlamp levelling/Adaptive forward lighting
- 51 Air shutter
- 52 –
- 53 Transmission control module/Engine control module
- 54 Vacuum pump/Instrument panel cluster/Heating ventilation/Air conditioning system

After having changed defective fuses, close the fuse box cover and press until it engages.

If the fuse box cover is not closed correctly, malfunction may occur.

Instrument panel fuse box

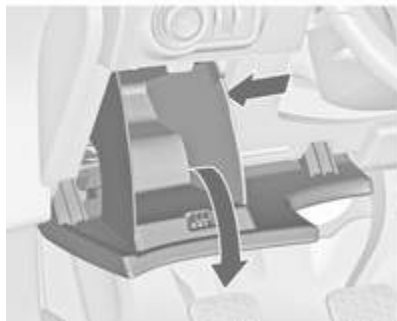

The fuse box is behind the storage compartment in the instrument panel. Open the compartment and push it to the left to unlock. Fold the compartment down and remove it.



No. Circuit

- | | |
|---|-------------------------------------|
| 1 | Displays |
| 2 | Exterior lights/Body control module |
| 3 | Exterior lights/Body control module |
| 4 | Infotainment system |
| 5 | Infotainment system/Instrument |
| 6 | Power outlet |
| 7 | Power outlet |
| 8 | Left low beam/Body control module |

No. Circuit

- | | |
|----|--|
| 9 | Right low beam/Body control module/Airbag module |
| 10 | Door locks/Body control module |
| 11 | Interior fan |
| 12 | – |
| 13 | – |
| 14 | Diagnostic connector |
| 15 | Airbag |
| 16 | Power outlet |
| 17 | Air conditioning system |
| 18 | Logistics |
| 19 | Body control module |
| 20 | Body control module |
| 21 | Instrument panel cluster |
| 22 | Ignition sensor |
| 23 | Body control module |
| 24 | Body control module |

No. Circuit

25 -

26 -

Load compartment fuse box

The fuse box is on the left side of the load compartment behind a cover.

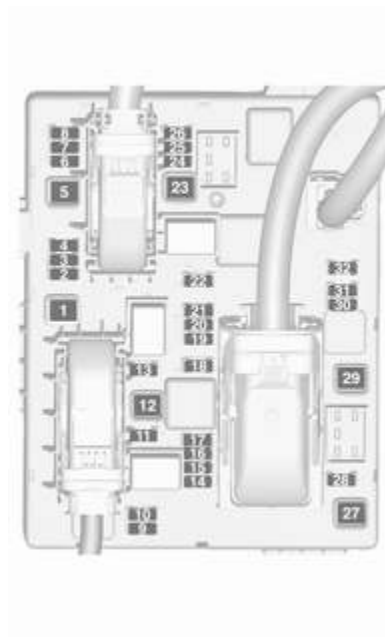

Remove the cover.

Fuse assignments**No. Circuit**

1 -

2 -

3 Parking assist

4 -

5 -

6 -

7 -

8 -

9 -

10 -

11 -

12 -

13 -

14 Rear seat/Electrical folding

15 -

16 Interior mirror

17 Power outlet

No. Circuit

18	–
19	Steering wheel heating
20	–
21	Heated front seats
22	–
23	–
24	–
25	–
26	Deactivated logistic mode
27	–
28	–
29	–
30	–
31	Amplifier/Subwoofer
32	Active damping system

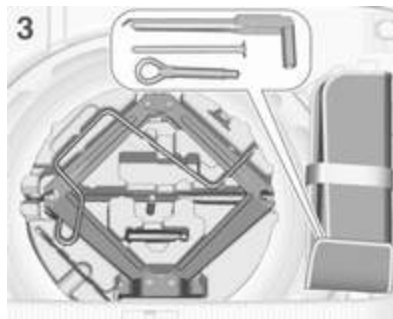
Vehicle tools**Tools**

The jack and the tools are in the tool box below the spare wheel in the load compartment. The wheel wrench, the towing eye and an extension bolt for securing a damaged wheel are in the tool bag located in the spare wheel well near the tool box. Spare wheel ⇨ 167.

Wheels and tyres**Tyre condition, wheel condition**

Drive over edges slowly and at right angles if possible. Driving over sharp edges can cause tyre and wheel damage. Do not trap tyres on the kerb when parking.

Regularly check the wheels for damage. Seek the assistance of a workshop in the event of damage or unusual wear.

Winter tyres

Winter tyres improve driving safety at temperatures below 7 °C and should therefore be fitted on all wheels.

In accordance with country-specific regulations, affix the speed sticker in the driver's field of view.

⚠ Danger

Use winter tyres at temperatures below 0 °C, otherwise damage of the high performance sports tyres is possible.

Tyre designations

E.g. **215/60 R 16 95 H**

215 : tyre width, mm

60 : cross-section ratio (tyre height to tyre width), %

R : belt type: Radial

RF : type: RunFlat

16 : wheel diameter, inches

95 : load index e.g. 95 is equivalent to 690 kg

H : speed code letter

Speed code letter:

Q : up to 160 km/h

S : up to 180 km/h

T : up to 190 km/h

H : up to 210 km/h

V : up to 240 km/h

W : up to 270 km/h

Choose a tyre appropriate for the maximum speed of your vehicle.

The maximum speed is achievable at kerb weight with driver (75 kg) plus 125 kg payload. Optional equipment could reduce the maximum speed of the vehicle.

Directional tyres

Fit directional tyres such that they roll in the direction of travel. The rolling direction is indicated by a symbol (e.g. an arrow) on the sidewall.

Tyre pressure

Check the pressure of cold tyres at least every 14 days and before any long journey. Do not forget the spare wheel. This also applies to vehicles with tyre pressure monitoring system.



Tyre pressure ⇨ 186.

The tyre pressure information label on the front left or right door frame indicates the original equipment tyres and the correspondent tyre pressures.

The tyre pressure data refers to cold tyres. It applies to summer and winter tyres.

Always inflate the spare tyre to the pressure specified for full load.

The ECO tyre pressure serves to achieve the smallest amount of fuel consumption possible.

Incorrect tyre pressures will impair safety, vehicle handling, comfort and fuel economy and will increase tyre wear.

The tyre pressure tables show all possible tyre combinations ⇨ 186.

For the tyres approved for your vehicle, refer to the EEC Certificate of Conformity provided with your vehicle or other national registration documents.

The driver is responsible for correct adjustment of tyre pressure.

⚠ Warning

If the pressure is too low, this can result in considerable tyre warm-up and internal damage, leading to tread separation and even to tyre blow-out at high speeds.

⚠ Warning

For specific tyres the recommended tyre pressure as shown in the tyre pressure table may exceed the maximum tyre

pressure as indicated on the tyre. Never exceed the maximum tyre pressure as indicated on the tyre.

If the tyre pressure must be reduced or increased on a vehicle with tyre pressure monitoring system, switch off ignition.

Temperature dependency

The tyre pressure depends on the temperature of the tyre. During driving, tyre temperature and pressure increase. Tyre pressure values provided on the tyre information label and tyre pressure chart are valid for cold tyres, which means at 20 °C.

The pressure increases by nearly 10 kPa for a 10 °C temperature increase. This must be considered when warm tyres are checked.

The tyre pressure value displayed in the Driver Information Centre shows the real tyre pressure. A cooled down tyre will show a decreased value, which does not indicate an air leak.

Tyre pressure monitoring system

The tyre pressure monitoring system (TPMS) checks the pressure of all four tyres once a minute when vehicle speed exceeds a certain limit.

Caution

Tyre pressure monitoring system warns only about low tyre pressure condition and does not replace regular tyre maintenance by the driver.

All wheels must be equipped with pressure sensors and the tyres must have the prescribed pressure.

Note

In countries where the tyre pressure monitoring system is legally required, the use of wheels without pressure sensors will invalidate the vehicle operating permit.

The current tyre pressures can be shown in the **Vehicle Information Menu** in the Driver Information Centre.

The menu can be selected by the buttons on the turn signal lever.

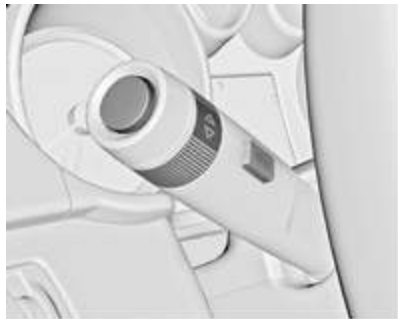

Press **MENU** to select the **Vehicle Information Menu** .

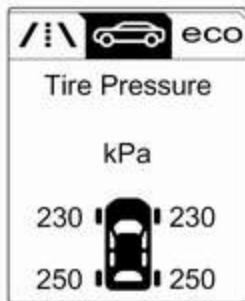



Turn the adjuster wheel to select the tyre pressure monitoring system.

System status and pressure warnings are displayed by a message with the corresponding tyre flashing in the Driver Information Centre.

The system considers the tyre temperature for the warnings.



A detected low tyre pressure condition is indicated by illumination of control indicator  \rightarrow 71.

If  illuminates, stop as soon as possible and inflate the tyres as recommended \rightarrow 186.

If  flashes for 60-90 seconds and then illuminates continuously, there is a fault in the system. Consult a workshop.

After inflating, driving may be required to update the tyre pressure values in the Driver Information Centre. During this time  may illuminate.

If  illuminates at lower temperatures and extinguishes after some driving, this could be an indicator for approaching a low tyre pressure condition. Check tyre pressure.

Vehicle messages \rightarrow 79.

If the tyre pressure must be reduced or increased, switch off ignition.

Only mount wheels with pressure sensors, otherwise the tyre pressure will not be displayed and  illuminates continuously.

A spare wheel or temporary spare wheel is not equipped with pressure sensors. The tyre pressure monitoring system is not operational for these wheels. Control indicator 

illuminates. For the further three wheels the system remains operational.

The use of commercially available liquid tyre repair kits can impair the function of the system. Factory-approved repair kits can be used.

Operating electronic devices or being close to facilities using similar wave frequencies could disrupt the tyre pressure monitoring system.

Each time the tyres are replaced, tyre pressure monitoring system sensors must be dismantled and serviced. For the screwed sensor: replace valve core and sealing ring. For clipped sensor: replace complete valve stem.

Vehicle loading status

Adjust tyre pressure to load condition according to the tyre information label or tyre pressure chart ⇨ 186, and select the appropriate setting in the **Tyre load** menu in the Driver Information Centre ⇨ 73. This setting is the reference for the tyre pressure warnings.

The **Tyre Load** menu only appears if the vehicle is in a standstill and the parking brake is applied. On vehicles with automatic transmission, the selector lever must be in **P**.

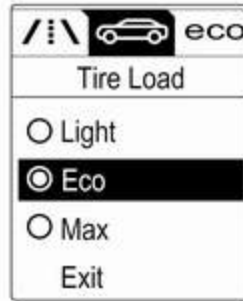

Select:

- **Light** for comfort pressure up to 3 people.
- **Eco** for Eco pressure up to 3 people.
- **Max** for full load.

Tyre pressure sensor matching process

Each tyre pressure sensor has a unique identification code. The identification code must be matched to a new wheel position after rotating the wheels or exchanging the complete wheel set and if one or more tyre pressure sensors were replaced. The tyre pressure sensor matching process should also be performed after replacing a spare wheel with a road wheel containing the tyre pressure sensor.

The malfunction light (⚠) and the warning message or code should extinguish at the next ignition cycle. The sensors are matched to the wheel positions using a relearn tool, in the following order: left side front wheel, right side front wheel, right side rear wheel and left side rear wheel. The turn signal light at the current active position is illuminated until the sensor is matched.

Consult a workshop for service. There are two minutes to match the first wheel position, and five minutes overall to match all four wheel

positions. If it takes longer, the matching process stops and must be restarted.

The tyre pressure sensor matching process is:

1. Apply the parking brake.
2. Turn the ignition on.
3. On vehicles with automatic transmission: set the selector lever to **P**.
On vehicles with manual transmission: select neutral.
4. Use **MENU** on the turn signal lever to select the **Vehicle Information Menu** in the Driver Information Centre.
5. Turn the adjuster wheel to scroll to the tyre pressure menu.
6. Press **SET/CLR** to begin the sensor matching process. A message requesting acceptance of the process should be displayed.

Press **SET/CLR** again to confirm the selection. The horn sounds twice to indicate the receiver is in relearn mode.

7. Start with the left side front wheel.
8. Place the relearn tool against the tyre sidewall, near the valve stem. Then press the button to activate the tyre pressure sensor. A horn chirp confirms that the sensor identification code has been matched to this wheel position.
9. Proceed to the right side front wheel, and repeat the procedure in Step 8.
10. Proceed to the right side rear wheel, and repeat the procedure in Step 8.
11. Proceed to the left side rear wheel, and repeat the procedure in Step 8. The horn sounds twice to indicate the sensor identification code has been matched to the left side rear tyre, and the tyre pressure sensor matching process is no longer active.
12. Turn off the ignition.

13. Set all four tyres to the recommended air pressure level as indicated on the tyre pressure label.
14. Ensure the tyre loading status is set according to the selected pressure ⇨ 73.

Tread depth

Check tread depth at regular intervals.

Tyres should be replaced for safety reasons at a tread depth of 2-3 mm (4 mm for winter tyres).

For safety reasons it is recommended that the tread depth of the tyres on one axle should not vary by more than 2 mm.



The legally permissible minimum tread depth (1.6 mm) has been reached when the tread has worn down as far as one of the tread wear indicators (TWI). Their position is indicated by markings on the sidewall.

If there is more wear at the front than the rear, swap round front wheels and rear wheels periodically. Ensure that the direction of rotation of the wheels is the same as before.

Tyres age, even if they are not used. We recommend tyre replacement every 6 years.

Changing tyre and wheel size

If tyres of a different size than those fitted at the factory are used, it may be necessary to reprogramme the nominal tyre pressure and make other vehicle modifications.

After converting to a different tyre size, have the label with tyre pressures replaced. ⇨ 161

⚠ Warning

The use of unsuitable tyres or wheels may lead to accidents and will invalidate the vehicle operating permit.

Wheel covers

Wheel covers and tyres that are factory approved for the respective vehicle and comply with all of the relevant wheel and tyre combination requirements must be used.

If the wheel covers and tyres used are not factory approved, the tyres must not have a rim protection ridge.

Wheel covers must not impair brake cooling.

⚠ Warning

Use of unsuitable tyres or wheel covers could lead to sudden pressure loss and thereby accidents.

Vehicles with steel wheels: When using locking wheel nuts, do not attach wheel covers.

Tyre chains



Use tyre chains only on front wheels.

⚠ Warning

Damage may lead to tyre blowout.

Always use fine mesh chains that add no more than 10 mm to the tyre tread and the inboard sides (including chain lock).

Tyre chains are only permitted on tyres of size 205/60 R16 and 215/50 R17.

The use of tyre chains is not permitted on the temporary spare wheel.

Wheel changing

Make the following preparations and observe the following information:

- Park the vehicle on a level, firm and non-skid surface. The front wheels must be in the straight-ahead position.
- Apply the parking brake and engage first gear, reverse gear or **P**.

- If the ground on which the vehicle is standing is soft, a solid board (max. 1 cm thick) should be placed under the jack.
- Take heavy objects out of the vehicle before jacking up.
- No people or animals may be in the vehicle when it is jacked-up.
- Never crawl under a jacked-up vehicle.
- Do not start the vehicle when it is raised on the jack.
- Clean wheel nuts and thread with a clean cloth before mounting the wheel.

⚠ Warning

Do not grease wheel bolt, wheel nut and wheel nut cone.

Jacking positions

The jacking positions shown refer to the use of lifting arms and accessory jacks used for changing winter / summer tyres.

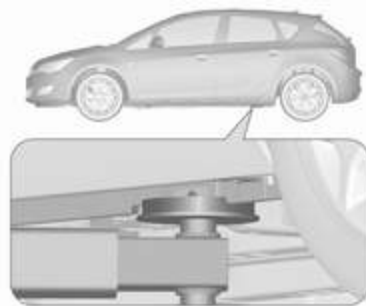

Rear arm position of the lifting platform centrally under the recess of the sill.



Front arm position of the lifting platform at the underbody.

Spare wheel

The spare wheel can be classified as a temporary spare wheel depending on the size compared to the other mounted wheels and country regulations. In this case a permissible maximum speed applies, even though no label at the spare wheel indicates this.

Only mount one temporary spare wheel. Do not drive faster than 80 km/h. Take curves slowly. Do not use for a long period of time.

Caution

The use of a spare wheel that is smaller than the other wheels or in combination with winter tyres could affect driveability. Have the defective tyre replaced as soon as possible.



The spare wheel is located in the load compartment beneath the floor covering. It is secured with a wing nut.

To remove:

1. Open the floor cover.
2. The spare wheel is secured with a wing nut. Loosen nut to take out the spare wheel.

Under the spare wheel there is the box with vehicle tools.

3. When, after a wheel change, no wheel is placed in the spare wheel well, secure the tool box by tightening the wing nut and close the floor cover.

Fitting the spare wheel

Make the following preparations and observe the following information:

- Park the vehicle on a level, firm and non-skid surface. The front wheels must be in the straight-ahead position.
- Apply the parking brake and engage first gear, reverse gear or **P**.
- Remove the spare wheel ↗ 167.
- Never change more than one wheel at once.
- Use the jack only to change wheels in case of puncture, not for seasonal winter or summer tyre change.
- The jack is maintenance-free.
- If the ground on which the vehicle is standing is soft, a solid board (max. 1 cm thick) should be placed under the jack.
- Take heavy objects out of the vehicle before jacking up.
- No people or animals may be in the vehicle when it is jacked-up.

- Never crawl under a jacked-up vehicle.
- Do not start the vehicle when it is raised on the jack.
- Clean wheel nuts and thread with a clean cloth before mounting the wheel.

⚠ Warning

Do not grease wheel bolt, wheel nut and wheel nut cone.

1. Disengage wheel nut caps with a screwdriver and remove. Pull off the wheel cover. Vehicle tools ⇨ 159.

Alloy wheels: Disengage wheel nut caps with a screwdriver and remove. To protect the wheel, place a soft cloth between the screwdriver and the alloy wheel.



2. Fold out the wheel wrench and install ensuring that it locates securely and loosen each wheel nut by half a turn.

Vehicle tools ⇨ 159

The wheels might be protected by locking wheel nuts. To loosen these specific nuts first attach the adapter onto the head of the nut before installing the wheel wrench. The adapter is located in the glovebox.



3. Ensure the jack is correctly positioned under the relevant vehicle jacking point.

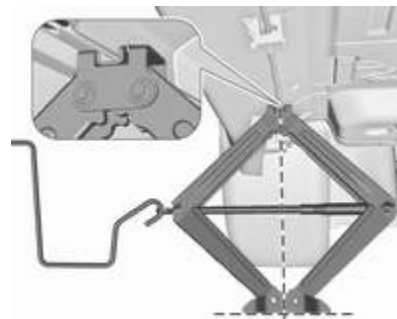

4. Set the jack to the necessary height. Position it directly below

the jacking point in a manner that prevents it from slipping.



Attach jack handle and with the jack correctly aligned rotate handle until wheel is clear of the ground.

5. Unscrew the wheel nuts.
6. Change the wheel.
7. Screw on the wheel nuts.
8. Lower the vehicle and remove jack.
9. Install the wheel wrench ensuring that it is located securely and tighten each nut in a crosswise sequence. Tightening torque is 140 Nm.

10. Align the valve hole in the wheel cover with the tyre valve before installing.

Install wheel nut caps.

Install centre cap on alloy wheels.

11. Install vehicle jacking point cover on versions with sill panels.
12. Stow the replaced wheel, the vehicle tools ↻ 159 and the adapter for the locking wheel nuts ↻ 48.
13. Check the tyre pressure of the installed tyre and the wheel nut torque as soon as possible.

Stowing a damaged full size wheel in the spare wheel well



A damaged full size wheel must be stowed outside up in the spare wheel well secured with the wing nut.

The floor cover can be placed on the projecting wheel.

Stowing the spare wheel back in the well after replacing the damaged wheel

1. Open the floor cover, loosen and remove wing nut.
2. Place the tools in the tool box or the tool bag ↻ 159.

3. Place spare wheel facing upwards, in the wheel well and secure by tightening the wing nut.

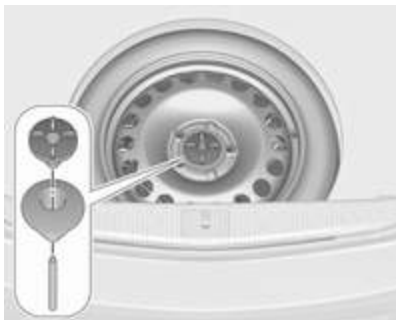

4. Close floor cover.

⚠ Warning

Storing a jack, a wheel or other equipment in the load compartment could cause injury if they are not secured properly. During a sudden stop or a collision, loose equipment could strike someone.

Always store jack and tools in the respective storage compartments and secure them by fixing.

Damaged wheel placed in the load compartment must always be secured with the strap.

Spare wheel with directional tyre

Fit directional tyres such that they roll in the direction of travel. The rolling direction is indicated by a symbol (e.g. an arrow) on the sidewall.

The following applies to tyres fitted opposing the rolling direction:

- Driveability may be affected. Have the defective tyre renewed or repaired as soon as possible and fit it instead of the spare wheel.
- Drive particularly carefully on wet and snow-covered road surfaces.

Jump starting

Do not start with quick charger.

A vehicle with a discharged vehicle battery can be started using jump leads and the vehicle battery of another vehicle.

⚠ Warning

Be extremely careful when starting with jump leads. Any deviation from the following instructions can lead to injuries or damage caused by battery explosion or damage to the electrical systems of both vehicles.

⚠ Warning

Avoid contact of the battery with eyes, skin, fabrics and painted surfaces. The fluid contains sulphuric acid which can cause injuries and damage in the event of direct contact.

- Never expose the vehicle battery to naked flames or sparks.

- A discharged vehicle battery can already freeze at a temperature of 0 °C. Defrost the frozen vehicle battery before connecting jump leads.
- Wear eye protection and protective clothing when handling a vehicle battery.
- Use a booster vehicle battery with the same voltage (12 Volts). Its capacity (Ah) must not be much less than that of the discharged vehicle battery.
- Use jump leads with insulated terminals and a cross section of at least 16 mm².
- Do not disconnect the discharged vehicle battery from the vehicle.
- Switch off all unnecessary electrical consumers.
- Do not lean over the vehicle battery during jump starting.
- Do not allow the terminals of one lead to touch those of the other lead.
- The vehicles must not come into contact with each other during the jump starting process.

- Apply the parking brake, transmission in neutral, automatic transmission in **P**.
- Open the positive terminal protection caps of both vehicle batteries.

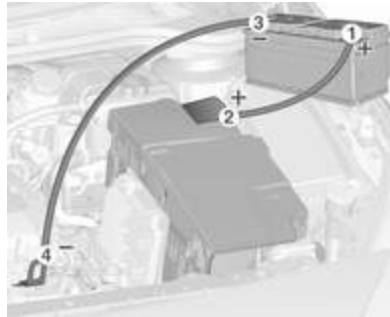

Lead connection order:

1. Connect the red lead to the positive terminal of the booster vehicle battery.
2. Connect the other end of the red lead to the positive terminal of the discharged vehicle battery.

3. Connect the black lead to the negative terminal of the booster vehicle battery.
4. Connect the other end of the black lead to a vehicle grounding point, such as the engine block or an engine mounting bolt. Connect as far away from the discharged vehicle battery as possible, however at least 60 cm.

Route the leads so that they cannot catch on rotating parts in the engine compartment.

To start the engine:

1. Start the engine of the vehicle providing the jump.
2. After five minutes, start the other engine. Start attempts should be made for no longer than 15 seconds at an interval of one minute.
3. Allow both engines to idle for approx. three minutes with the leads connected.

4. Switch on electrical consumers (e.g. headlights, heated rear window) of the vehicle receiving the jump start.
5. Reverse above sequence exactly when removing leads.

Towing

Towing the vehicle



Wrap a cloth around the tip of a flat screwdriver to prevent paint damage. Insert the screwdriver in the slot at the lower part of the cap. Release the cap by carefully moving the screwdriver downwards.

The towing eye is stowed with the vehicle tools ↪ 159.



Screw in the towing eye as far as it will go until it stops in a horizontal position.

Attach a tow rope – or better still a tow rod – to the towing eye.

The towing eye must only be used for towing and not for recovering the vehicle.

Switch on ignition to release steering wheel lock and to permit operation of brake lights, horn and windscreen wiper.

Switch the selector lever to neutral.
Release the parking brake.

Caution

Drive slowly. Do not drive jerkily. Excessive tractive force can damage the vehicle.

When the engine is not running, considerably more force is needed to brake and steer.

To prevent the entry of exhaust gases from the towing vehicle, switch on the air recirculation and close the windows.

Vehicles with automatic transmission: The vehicle must be towed facing forwards, not faster than 80 km/h nor further than 100 km. In all other cases and when the transmission is defective, the front axle must be raised off the ground.

Seek the assistance of a workshop.

After towing, unscrew the towing eye.

Insert cap at the top and engage downwards.

Towing another vehicle



Wrap a cloth around the tip of a flat screwdriver to prevent paint damage. Insert the screwdriver in the slot at the lower bend of the cap. Release the cap by carefully moving the screwdriver downwards.

The towing eye is stowed with the vehicle tools ↪ 159.



Screw in the towing eye as far as it will go until it stops in a horizontal position.

The lashing eye at the rear underneath the vehicle must never be used as a towing eye.

Attach a tow rope – or even better a tow bar – to the towing eye.

The towing eye must only be used for towing and not for recovering a vehicle.

Caution

Drive slowly. Do not drive jerkily. Excessive tractive force can damage the vehicle.

After towing, unscrew the towing eye. Insert cap at the top and engage downwards.

Appearance care**Exterior care****Locks**

The locks are lubricated at the factory using a high quality lock cylinder grease. Use de-icing agent only when absolutely necessary, as this has a degreasing effect and impairs lock function. After using a de-icing agent, have the locks regreased by a workshop.

Washing

The paintwork of your vehicle is exposed to environmental influences. Wash and wax your vehicle regularly. When using automatic vehicle washes, select a programme that includes waxing.

Bird droppings, dead insects, resin, pollen and the like should be cleaned off immediately, as they contain aggressive constituents which can cause paint damage.

If using a vehicle wash, comply with the vehicle wash manufacturer's instructions. The windscreen wiper and rear window wiper must be switched off. Remove antenna and external accessories such as roof racks etc.

If you wash your vehicle by hand, make sure that the insides of the wheel housings are also thoroughly rinsed out.

Clean edges and folds on opened doors and the bonnet as well as the areas they cover.

Clean bright metal mouldings with a cleaning solution approved for aluminium to avoid damages.

Caution

Always use a cleaning agent with a pH value of four to nine.

Do not use cleaning agents on hot surfaces.

Have the door hinges of all doors greased by a workshop.

Do not clean the engine compartment with a steam-jet or high-pressure jet cleaner.

On vehicles with emblem touchpad: when cleaning with a high-pressure jet cleaner ensure a minimum distance of 30 cm when working around the tailgate to prevent unintended unlocking.

Thoroughly rinse and leather-off the vehicle. Rinse leather frequently. Use separate leathers for painted and glass surfaces: remnants of wax on the windows will impair vision.

Do not use hard objects to remove spots of tar. Use tar removal spray on painted surfaces.

Exterior lights

Headlight and other light covers are made of plastic. Do not use any abrasive or caustic agents, do not use an ice scraper, and do not clean them dry.

Polishing and waxing

Wax the vehicle regularly (at the latest when water no longer beads). Otherwise, the paintwork will dry out.

Polishing is necessary only if the paint has become dull or if solid deposits have become attached to it.

Paintwork polish with silicone forms a protective film, making waxing unnecessary.

Plastic body parts must not be treated with wax or polishing agents.

Windows and wiper blades

Switch off wipers before handling in their areas.

Use a soft lint-free cloth or chamois leather together with window cleaner and insect remover.

When cleaning the rear window from inside, always wipe in parallel to the heating element to prevent damage.

For mechanical removal of ice, use a sharp-edged ice scraper. Press the scraper firmly against the glass so that no dirt can get under it and scratch the glass.

Remove dirt residues from smearing wiper blades by using a soft cloth and window cleaner. Also make sure to remove any residues such as wax, insect residues and similar from the window.

Ice residues, pollution and continuous wiping on dry windows will damage or even destroy the wiper blades.

Glass panel

Never clean with solvents or abrasive agents, fuels, aggressive media (e.g. paint cleaner, acetone-containing solutions etc.), acidic or highly alkaline media or abrasive pads. Do not apply wax or polishing agents to the glass panel.

Wheels and tyres

Do not use high-pressure jet cleaners.

Clean rims with a pH-neutral wheel cleaner.

Rims are painted and can be treated with the same agents as the body.

Paintwork damage

Rectify minor paintwork damage with a touch-up pen before rust forms. Have more extensive damage or rust areas repaired by a workshop.

Underbody

Some areas of the vehicle underbody have a PVC undercoating while other critical areas have a durable protective wax coating.

After the underbody is washed, check the underbody and have it waxed if necessary.

Bitumen/rubber materials could damage the PVC coating. Have underbody work carried out by a workshop.

Before and after winter, wash the underbody and have the protective wax coating checked.

Towing equipment

Do not clean the coupling ball bar with a steam-jet or high-pressure jet cleaner.

Air shutter

Clean the shutter system in the front bumper to maintain correct functionality.

Interior care

Interior and upholstery

Only clean the vehicle interior, including the instrument panel fascia and panelling, with a dry cloth or interior cleaner.

Clean the leather upholstery with clear water and a soft cloth. In case of heavy soiling, use leather care.

The instrument cluster and the displays should only be cleaned using a soft damp cloth. If necessary use a weak soap solution.

Clean fabric upholstery with a vacuum cleaner and brush. Remove stains with an upholstery cleaner.

Clothing fabrics may not be colourfast. This could cause visible discolourations, especially on light-

coloured upholstery. Removable stains and discolourations should be cleaned as soon as possible.

Clean seat belts with lukewarm water or interior cleaner.

Caution

Close Velcro fasteners as open Velcro fasteners on clothing could damage seat upholstery.

The same applies to clothing with sharp-edged objects, like zips or belts or studded jeans.

Plastic and rubber parts

Plastic and rubber parts can be cleaned with the same cleaner as used to clean the body. Use interior cleaner if necessary. Do not use any other agent. Avoid solvents and petrol in particular. Do not use high-pressure jet cleaners.

Service and maintenance

General information	177
Service information	177
Recommended fluids, lubricants and parts	178
Recommended fluids and lubricants	178

General information

Service information

In order to ensure economical and safe vehicle operation and to maintain the value of your vehicle, it is of vital importance that all maintenance work is carried out at the proper intervals as specified.

The detailed, up-to-date service schedule for your vehicle is available at the workshop.

Service display ⇨ 64.

European service intervals

Maintenance of your vehicle is required every 30,000 km or after one year, whichever occurs first. Additional engine oil and filter change is indicated by the engine oil life system, when required earlier than maintenance.

A shorter service interval can be valid for severe driving behaviour, e.g. for taxis and police vehicles.

The European service intervals are valid for the following countries:

Andorra, Austria, Belgium, Bosnia-Herzegovina, Bulgaria, Croatia, Cyprus, Czech Republic, Denmark, Estonia, Finland, France, Germany, Greece, Greenland, Hungary, Iceland, Ireland, Italy, Latvia, Liechtenstein, Lithuania, Luxembourg, Macedonia, Malta, Monaco, Montenegro, Netherlands, Norway, Poland, Portugal, Romania, San Marino, Serbia, Slovakia, Slovenia, Spain, Sweden, Switzerland, United Kingdom.

Service display ⇨ 64.

International service intervals

Maintenance of your vehicle is required every 15,000 km or after one year, whichever occurs first. Additional engine oil and filter change is indicated by the engine oil life system, when required earlier than maintenance.

Severe operating conditions exist if one or more of the following circumstances occur frequently: Cold starting, stop and go operation, trailer operation, mountain driving, driving on poor and sandy road surfaces,

increased air pollution, presence of airborne sand and high dust content, driving at high altitude and large variations of temperature. Under these severe operating conditions, certain service work may be required more frequently than the regular service interval.

The international service intervals are valid for the countries which are not listed in the European service intervals.

Service display ⇨ 64.

Confirmations

Confirmation of service is recorded in the Service and Warranty Booklet. The date and mileage is completed with the stamp and signature of the servicing workshop.

Make sure that the Service and Warranty Booklet is completed correctly as continuous proof of service is essential if any warranty or goodwill claims are to be met, and is also a benefit when selling the vehicle.

Recommended fluids, lubricants and parts

Recommended fluids and lubricants

Only use products that meet the recommended specifications.

Warning

Operating materials are hazardous and could be poisonous. Handle with care. Pay attention to information given on the containers.

Engine oil

Engine oil is identified by its quality and its viscosity. Quality is more important than viscosity when selecting which engine oil to use. The oil quality ensures e.g. engine cleanliness, wear protection and oil aging control, whereas viscosity grade gives information on the oil's thickness over a temperature range.

Dexos is the newest engine oil quality that provides optimum protection for petrol and diesel engines. If it is unavailable, engine oils of other listed qualities must be used.

Recommendations for petrol engines are also valid for Compressed Natural Gas (CNG), Liquefied Petroleum Gas (LPG) and Ethanol (E85) fuelled engines.

Select the appropriate engine oil based on its quality and on the minimum ambient temperature ⇨ 182.

Topping up engine oil

Caution

In case of any spilled oil, wipe it up and dispose it properly.

Engine oils of different manufacturers and brands can be mixed as long as they comply with the required engine oil quality and viscosity.

Use of engine oils for all petrol engines with only ACEA quality is prohibited, since it can cause engine damage under certain operating conditions.

Select the appropriate engine oil based on its quality and on the minimum ambient temperature ↗ 182.

Additional engine oil additives

The use of additional engine oil additives could cause damage and invalidate the warranty.

Engine oil viscosity grades

The SAE viscosity grade gives information of the thickness of the oil.

Multigrade oil is indicated by two figures, e.g. SAE 5W-30. The first figure, followed by a W, indicates the low temperature viscosity and the second figure the high temperature viscosity.

Select the appropriate viscosity grade depending on the minimum ambient temperature ↗ 182.

All of the recommended viscosity grades are suitable for high ambient temperatures.

Coolant and antifreeze

Use only organic acid type-long life coolant (LLC) antifreeze approved for the vehicle. Consult a workshop.

The system is factory filled with coolant designed for excellent corrosion protection and frost protection down to approx. -28 °C. In cold regions with very low temperatures, the factory filled coolant provides frost protection down to approx. -37 °C. This concentration should be maintained all year round. The use of additional coolant additives that intend to give additional corrosion protection or seal against minor leaks can cause function problems. Liability for consequences resulting from the use of additional coolant additives will be rejected.

Washer fluid

Use only washer fluid approved for the vehicle to prevent damage of wiper blades, paintwork, plastic and rubber parts. Consult a workshop.

Brake and clutch fluid

Over time, brake fluid absorbs moisture which will reduce braking effectiveness. The brake fluid should therefore be replaced at the specified interval.

Technical data

Vehicle identification	180
Vehicle Identification Number ..	180
Identification plate	180
Engine identification	181
Vehicle data	182
Recommended fluids and lubricants	182
Engine data	184
Vehicle dimensions	186
Tyre pressures	187

Vehicle identification

Vehicle Identification Number



The Vehicle Identification Number may be stamped on the identification plate and on the floor pan, under the floor covering, visible under a cover.

The Vehicle Identification Number may be embossed on the instrument panel, visible through the windscreen, or in the engine compartment on the right body panel.

Identification plate



The identification plate is located on the front left or right door frame.

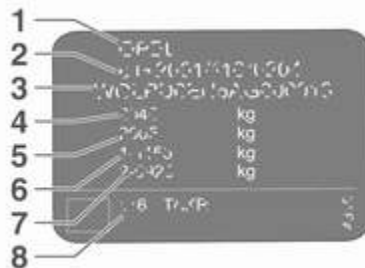

Information on identification label:

- 1 : manufacturer
- 2 : type approval number
- 3 : vehicle identification number
- 4 : permissible gross vehicle weight rating in kg
- 5 : permissible gross train weight in kg
- 6 : maximum permissible front axle load in kg
- 7 : maximum permissible rear axle load in kg
- 8 : vehicle-specific or country-specific data

The combined total of front and rear axle loads must not exceed the permissible gross vehicle weight. For example, if the front axle is bearing its maximum permissible load, the rear axle can only bear a load that is equal to the gross vehicle weight minus the front axle load.

The technical data is determined in accordance with European Community standards. We reserve the right to make modifications. Specifications in the vehicle documents always have priority over those given in this manual.

Engine identification

The technical data tables show the engine identifier code. Engine data ⇨ 184.

To identify the respective engine, refer to the engine power in the EEC Certificate of Conformity provided with your vehicle or other national registration documents.

Vehicle data

Recommended fluids and lubricants

European service schedule

Required engine oil quality

All European countries with European service interval ⇨ 177

Engine oil quality D14NET

dexos1 Gen2 ✓

Engine oil viscosity grades

All European countries with European service interval ⇨ 177

Ambient temperature

down to -25 °C SAE 0W-30 or SAE 0W-40

SAE 5W-30 or SAE 5W-40

below -25 °C SAE 0W-30 or SAE 0W-40

International service schedule

Required engine oil quality

All countries with international service interval ↻ 177

Engine oil quality D14NET

dexos1 Gen2 ✓

Engine oil viscosity grades

All countries with international service interval ↻ 177

Ambient temperature

down to -25 °C SAE 0W-30 or SAE 0W-40

SAE 5W-30 or SAE 5W-40

below -25 °C SAE 0W-30 or SAE 0W-40

down to -20 °C SAE 10W-30¹⁾ or SAE 10W-40¹⁾

1) Permitted, but usage of oils with dexos quality is recommended.

Engine data

Engine identifier code	D14NET
Sales designation	1.4 Turbo
Piston displacement [cm ³]	1364
Engine power [kW]	103
at rpm	4900-6000
Torque [Nm]	200
at rpm	1850-4900
Fuel type	Petrol
Octane rating RON ²⁾	
recommended	95
possible	98
possible	91

2) A country specific label at the fuel filler flap can supersede the engine specific requirement.

Vehicle data

Maximum speed manual transmission [km/h]	207
Maximum speed automatic transmission [km/h]	205
Kerb weight manual transmission without / with air conditioning [kg] ³⁾	1437 / 1449
Kerb weight automatic transmission without / with air conditioning [kg] ⁴⁾	– / 1483
Engine oil including filter [l]	4.0
Engine oil between MIN and MAX [l]	1.0
Fuel tank refilling quantity [l]	56

3) Optional accessories increase the kerb weight.

4) Optional accessories increase the kerb weight.

Loading information ⇨ 54.

Vehicle dimensions

Length [mm]	4658
Width without exterior mirrors [mm]	1814
Width with two exterior mirrors [mm]	2013
Height (without antenna) [mm]	1500
Length of load compartment floor [mm]	1084
Length of load compartment with folded rear seats [mm]	1778
Load compartment width [mm]	976
Load compartment height [mm]	546
Wheelbase [mm]	2685
Turning circle diameter [m]	11.5

Tyre pressures

Tyres	Comfort with up to 3 people		ECO with up to 3 people		With full load	
	front	rear	front	rear	front	rear
	[kPa/bar] ([psi])	[kPa/bar] ([psi])	[kPa/bar] ([psi])	[kPa/bar] ([psi])	[kPa/bar] ([psi])	[kPa/bar] ([psi])
205/60 R16, 215/50 R17	220/2.2 (32)	220/2.2 (32)	270/2.7 (39)	270/2.7 (39)	230/2.3 (33)	270/2.7 (39)
Temporary spare wheel T115/70 R16	420/4.2 (61)	420/4.2 (61)	–	–	420/4.2 (61)	420/4.2 (61)

Customer information

Customer information	188
Declaration of conformity	188
REACH	191
Software acknowledgement	191
Registered trademarks	193
Vehicle data recording and privacy	193
Event data recorders	193
Radio Frequency Identification (RFID)	196

Customer information

Declaration of conformity

Radio transmission systems

This vehicle has systems that transmit and / or receive radio waves subject to Directive 2014/53/EU. The manufacturers of the systems listed below declare conformity with Directive 2014/53/EU. The full text of the EU declaration of conformity for each system is available at the following internet address: www.opel.com/conformity.

Importer is
Opel / Vauxhall, Bahnhofspatz,
65423 Ruesselsheim am Main,
Germany.

Infotainment system Navi 950 / Navi 650 / CD 600

Panasonic Automotive & Industrial
Systems Europe GmbH
Robert-Bosch-Straße 27-29,
D-63225 Langen, Germany

Operation frequency (MHz)	Maximum output (dBm)
---------------------------	----------------------

2402.0 - 2480.0	7.67
-----------------	------

Infotainment system CD 300 / CD 400

Panasonic Automotive & Industrial
Systems Europe GmbH
Robert-Bosch-Straße 27-29,
D-63225 Langen, Germany

Operation frequency (MHz)	Maximum output (dBm)
---------------------------	----------------------

N/A	N/A
-----	-----

DAB+ Module

Panasonic Automotive & Industrial
Systems Europe GmbH
Robert-Bosch-Straße 27-29,
D-63225 Langen, Germany

Operation frequency: N/A

Maximum output: N/A

Antenna Laird

Laird

Daimlerring 31, D-31135 Hildesheim,
Germany

Operation frequency: N/A

Maximum output: N/A

Antenna Kathrein

Kathrein Automotive GmbH

Roemerring 1, D-31137 Hildesheim,
Germany

Operation frequency: N/A

Maximum output: N/A

OnStar module

LG Electronics European Shared
Service center B.V.

Krijgsman 1, 1186 DM Amstelveen,
The Netherlands

Operation frequency (MHz)	Maximum output (dBm)
---------------------------	----------------------

2402 - 2480	4
-------------	---

2412 - 2462	18
-------------	----

880 - 915	33
-----------	----

1710 - 1785	24
-------------	----

1850 - 1910	24
-------------	----

1920 - 1980	24
-------------	----

2500 - 2570	23
-------------	----

Immobiliser

Continental Automotive GmbH

Siemensstrasse 12, D-93055
Regensburg, Germany

Operation frequency: 125 kHz

Maximum output:

5.1 dBuA/m @ 10m

Radio remote control receiver

Continental Automotive GmbH

Siemensstrasse 12, D-93055
Regensburg, Germany

Operation frequency: N/A

Maximum output: N/A

Radio remote control transmitter

Continental Automotive GmbH

Siemensstrasse 12, D-93055
Regensburg, Germany

Operation frequency: 433.92 MHz

Maximum output: -5,7 dBm

Tyre pressure sensors

Schrader Electronics Ltd.

11 Technology Park, Belfast Road,
Antrim BT41 1QS, Northern Ireland,
United Kingdom

Operation frequency: 433.92 MHz

Maximum output: 10 dBm



Konformitätserklärung

nach EG Richtlinie 2006/42/EG

Hiermit erklären wir, dass das Produkt:

Produktbezeichnung: Wagenheber

Typ/IGW-Teilenummern: 13576735

den Bestimmungen der Richtlinie 2006/42/EG entspricht.

Angewendete technische Normen:

GM49737 Jacking
 GM 14337 Standard Equipment Jack - Hydraulic Tech
 GM45127 Vehicle Integrity-Loading and Service Station Jacking
 GMW 15025 Standard Equipment Jack and Spare Tire, Vehicle Tire
 ISO TS 16949 Qualitätsmanagementsystem

Der Unterzeichner ist Bevollmächtigter für die Zusammenstellung der technischen Unterlagen.

Münchheim, 31. Januar 2014



Ralf P. Metzger
 Engineering Group Manager Chassis & Structure
 Opel Opel AG

Opel Opel AG
 63073 Frankfurt
 www.opel.de

Hersteller:
 Opel Opel AG
 Opel Opel AG
 Opel Opel AG

Hersteller:
 Opel Opel AG

Hersteller:
 Opel Opel AG

Translation of the original declaration of conformity

Declaration of conformity according to EC Directive 2006/42/EC

We declare that the product:

Product designation: Jack

Type/GM part number: 13576735

is in compliance with the provisions of Directive 2006/42/EC.

Applied technical standards:

GMN9737	: jacking
GM 14337	: standard equipment jack – hardware tests
GMN5127	: vehicle integrity – hoisting and service station jacking
GMW15005	: standard equipment jack and spare tyre, vehicle test
ISO TS 16949	: quality management systems

The signatory is authorised to compile the technical documentation.

Rüsselsheim, 31st January 2014

signed by

Hans-Peter Metzger

Engineering Group Manager Chassis & Structure

Adam Opel AG

D-65423 Rüsselsheim

REACH

Registration, Evaluation, Authorisation and Restriction of Chemicals (REACH) is a European Union regulation adopted to improve the protection of human health and the environment from the risks that can be posed by chemicals. Visit www.opel.com/reach for further information and for access to the Article 33 communication.

Software acknowledgement

Certain OnStar components include libcurl and unzip software and other third party software. Below are the notices and licenses associated with libcurl and unzip and for other third party software please see <http://www.lg.com/global/support/opensource/index>.

libcurl

Copyright and permission notice

Copyright (c) 1996 - 2010, Daniel Stenberg, <daniel@haxx.se>.

All rights reserved.

Permission to use, copy, modify, and distribute this software for any purpose with or without fee is hereby granted, provided that the above copyright notice and this permission notice appear in all copies.

The software is provided "as is", without warranty of any kind, express or implied, including but not limited to the warranties of merchantability, fitness for a particular purpose and noninfringement of third party rights. In no event shall the authors or

copyright holders be liable for any claim, damages or other liability, whether in an action of contract, tort or otherwise, arising from, out of or in connection with the software or the use or other dealings in the software.

Except as contained in this notice, the name of a copyright holder shall not be used in advertising or otherwise to promote the sale, use or other dealings in this Software without prior written authorization of the copyright holder.

unzip

This is version 2005-Feb-10 of the Info-ZIP copyright and license. The definitive version of this document should be available at <ftp://ftp.info-zip.org/pub/infozip/license.html> indefinitely.

Copyright (c) 1990-2005 Info-ZIP. All rights reserved.

For the purposes of this copyright and license, "Info-ZIP" is defined as the following set of individuals:

Mark Adler, John Bush, Karl Davis, Harald Denker, Jean-Michel Dubois, Jean-loup Gailly, Hunter Goatley, Ed

Gordon, Ian Gorman, Chris Herborth, Dirk Haase, Greg Hartwig, Robert Heath, Jonathan Hudson, Paul Kienitz, David Kirschbaum, Johnny Lee, Onno van der Linden, Igor Mandrichenko, Steve P. Miller, Sergio Monesi, Keith Owens, George Petrov, Greg Roelofs, Kai Uwe Rommel, Steve Salisbury, Dave Smith, Steven M. Schweda, Christian Spieler, Cosmin Truta, Antoine Verheijen, Paul von Behren, Rich Wales, Mike White.

This software is provided "as is," without warranty of any kind, express or implied. In no event shall Info-ZIP or its contributors be held liable for any direct, indirect, incidental, special or consequential damages arising out of the use of or inability to use this software.

Permission is granted to anyone to use this software for any purpose, including commercial applications, and to alter it and redistribute it freely, subject to the following restrictions:

1. Redistributions of source code must retain the above copyright notice, definition, disclaimer, and this list of conditions.
2. Redistributions in binary form (compiled executables) must reproduce the above copyright notice, definition, disclaimer, and this list of conditions in documentation and/or other materials provided with the distribution. The sole exception to this condition is redistribution of a standard UnZipSFX binary (including SFXWiz) as part of a self-extracting archive; that is permitted without inclusion of this license, as long as the normal SFX banner has not been removed from the binary or disabled.
3. Altered versions--including, but not limited to, ports to new operating systems, existing ports with new graphical interfaces, and dynamic, shared, or static library versions--must be plainly marked as such and must not be misrepresented as being the

original source. Such altered versions also must not be misrepresented as being Info-ZIP releases—including, but not limited to, labeling of the altered versions with the names “Info-ZIP” (or any variation thereof, including, but not limited to, different capitalizations), “Pocket UnZip,” “WiZ” or “MacZip” without the explicit permission of Info-ZIP. Such altered versions are further prohibited from misrepresentative use of the Zip-Bugs or Info-ZIP e-mail addresses or of the Info-ZIP URL(s).

4. Info-ZIP retains the right to use the names “Info-ZIP,” “Zip,” “UnZip,” “UnZipSFX,” “WiZ,” “Pocket UnZip,” “Pocket Zip,” and “MacZip” for its own source and binary releases.

Registered trademarks

Apple Inc.

Apple CarPlay™ is a trademark of Apple Inc.

App Store® and iTunes Store® are registered trademarks of Apple Inc.

iPhone®, iPod®, iPod touch®, iPod nano®, iPad® and Siri® are registered trademarks of Apple Inc.

Bluetooth SIG, Inc.

Bluetooth® is a registered trademark of Bluetooth SIG, Inc.

DivX, LLC

DivX® and DivX Certified® are registered trademarks of DivX, LLC.

EnGIS Technologies, Inc.

BringGo® is a registered trademark of EnGIS Technologies, Inc.

Google Inc.

Android™ and Google Play™ Store are trademarks of Google Inc.

Stitcher Inc.

Stitcher™ is a trademark of Stitcher, Inc.

Vehicle data recording and privacy

Event data recorders

Electronic control units are installed in your vehicle. Control units process data which is received by vehicle sensors, for example, or which they generate themselves or exchange amongst themselves. Some control units are necessary for the safe functioning of your vehicle, others assist you while you drive (driver assistance systems), while others provide comfort or infotainment functions.

The following contains general information about data processing in the vehicle. You will find additional information as to which specific data is uploaded, stored and passed on to third parties and for what purpose in your vehicle under the key word Data Protection closely linked to the references for the affected functional characteristics in the relevant owner's manual or in the general terms of sale. These are also available online.

Operating data in the vehicle

Control units process data for operation of the vehicle.

This data includes, e.g.:

- vehicle status information (e.g. speed, movement delay, lateral acceleration, wheel rotation rate, "seat belts fastened" display)
- ambient conditions (e.g. temperature, rain sensor, distance sensor)

As a rule such data is transient, not stored for longer than an operational cycle, and only processed on board the vehicle itself. Control units often include data storage (including the vehicle key). This is used to allow information to be documented temporarily or permanently on vehicle condition, component stress, maintenance requirements and technical events and errors.

Depending on technical equipment level, the data stored is as follows:

- system component operating states (e.g. fill level, tyre pressure, battery status)
- faults and defects in important system components (e.g. lights, brakes)
- system reactions in special driving situations (e.g. triggering of an airbag, actuation of the stability control systems)
- information on events damaging the vehicle
- for electric vehicles the amount of charge in the high-voltage battery, estimated range

In special cases (e.g. if the vehicle has detected a malfunction), it may be necessary to save data that would otherwise just be volatile.

When you use services (e.g. repairs, maintenance), the operating data saved can be read together with the vehicle identification number and used where necessary. Staff working for the service network (e.g. garages, manufacturers) or third parties (e.g.

breakdown services) can read the data from the vehicle. The same applies to warranty work and quality assurance measures.

Data is generally read via the OBD (On-Board Diagnostics) port prescribed by law in the vehicle. The operating data which is read out, documents the technical condition of the vehicle or individual components and assists with fault diagnosis, compliance with warranty obligations and quality improvement. This data, in particular information on component stress, technical events, operator errors and other faults, is transmitted to the manufacturer where appropriate, together with the vehicle identification number. The manufacturer is also subject to product liability. The manufacturer potentially also uses operating data from vehicles for product recalls. This data can also be used to check customer warranty and guarantee claims.

Fault memories in the vehicle can be reset by a service company when carrying out servicing or repairs or at your request.

Comfort and infotainment functions

Comfort settings and custom settings can be stored in the vehicle and changed or reset at any time.

Depending on the equipment level in question, these include

- seat and steering wheel position settings
- chassis and air conditioning settings
- custom settings such as interior lighting

You can input your own data in the infotainment functions for your vehicle as part of the selected features.

Depending on the equipment level in question, these include

- multimedia data such as music, videos or photos for playback in an integrated multimedia system
- address book data for use with an integrated hands-free system or an integrated navigation system

- input destinations
- data on the use of online services

This data for comfort and infotainment functions can be stored locally in the vehicle or be kept on a device that you have connected to the vehicle (e.g. a smartphone, USB stick or MP3 player). Data that you have input yourself can be deleted at any time.

This data can only be transmitted out of the vehicle at your request, particularly when using online services in accordance with the settings selected by you.

Smartphone integration, e.g. Android Auto or Apple CarPlay

If your vehicle is equipped accordingly, you can connect your smartphone or another mobile device to the vehicle so that you can control it via the controls integrated in the vehicle. The smartphone image and sound can be output via the multimedia system in this case. At the same time, specific information is transmitted to your smartphone. Depending on the type of integration,

this includes data such as position data, day / night mode and other general vehicle information. For more information, please see the operating instructions for the vehicle / infotainment system.

Integration allows selected smartphone apps to be used, such as navigation or music playback. No further integration is possible between smartphone and vehicle, in particular active access to vehicle data. The nature of further data processing is determined by the provider of the app used. Whether you can define settings, and if so which ones, is dependent on the app in question and your smartphone's operating system.

Online services

If your vehicle has a radio network connection, this allows data to be exchanged between your vehicle and other systems. The radio network connection is made possible by means of a transmitter device in your vehicle or a mobile device provided by you (e.g. a smartphone). Online functions can be used via this radio network connection. These include online services and applications / apps provided to you by the manufacturer or other providers.

Proprietary services

In the case of the manufacturer's online services, the relevant functions are described by the manufacturer in an appropriate location (e.g. Owner's Manual, the manufacturer's website) and the associated data protection information is provided. Personal data may be used to provide online services. Data exchange for this purpose takes place via a protected connection, e.g. using the manufacturer's IT systems provided for the purpose. Collection,

processing and use of personal data for the purposes of preparation of services take place solely on the basis of legal permission, e.g. in the case of a legally prescribed emergency communication system or a contractual agreement, or by virtue of consent.

You can activate or deactivate the services and functions (which are subject to charges to some extent) and, in some cases, the vehicle's entire radio network connection. This does not include statutory functions and services such as an emergency communication system.

Third party services

If you make use of online services from other providers (third parties), these services are subject to the liability and data protection and usage conditions of the provider in question. The manufacturer frequently has no influence over the content exchanged in this regard.

Therefore, please note the nature, scope and purpose of the collection and use of personal data within the scope of third party services provided by the service provider in question.

Radio Frequency Identification (RFID)

RFID technology is used in some vehicles for functions such as tyre pressure monitoring and immobiliser. It is also used in connection with conveniences such as radio remote controls for door locking / unlocking and starting. RFID technology in Opel vehicles does not use or record personal information or link with any other Opel system containing personal information.

Index

A

Accessories and vehicle modifications	138
Adaptive forward lighting	73, 97, 148
Adjustable air vents	113
Airbag and belt tensioners	68
Airbag deactivation	41, 68
Airbag system	39
Air conditioning regular operation	114
Air conditioning system	107
Air intake	113
Air vents.....	113
Antilock brake system	125
Antilock brake system (ABS)	70
Anti-theft locking system	24
Appearance care.....	174
Armrest.....	35, 36
Armrest storage	50
Automatic anti-dazzle	27
Automatic light control	94
Automatic locking	22
Automatic transmission	121

B

Battery discharge protection	105
Battery voltage	81
Belts.....	36
Bonnet	140
Brake and clutch fluid.....	178

Brake and clutch system	69
Brake assist	127
Brake fluid	143
Brakes	125, 143
Breakdown.....	172
Bulb replacement	145

C

Catalytic converter	120
Central locking system	20
Centre console lighting	104
Centre console storage	50
Changing tyre and wheel size ...	165
Charging system	68
Child locks	22
Child restraint installation locations	45
Child restraints.....	43
Child restraint systems	43
Climate control	14
Climate control systems.....	106
Clock.....	60
Code.....	79
Control indicators.....	65
Control of the vehicle	115
Controls.....	57
Convex shape	25
Coolant and antifreeze.....	178
Cruise control	73, 130

Cupholders	48
Curve lighting.....	97

D

Danger, Warnings and Cautions ...	4
Daytime running lights	97
Declaration of conformity.....	188
Door open	73
Doors.....	23
Driver assistance systems.....	130
Driver Information Centre.....	73
Driving hints.....	115

E

Electric adjustment	25
Electrical system.....	154
Electric parking brake.....	69, 126
Electric parking brake fault.....	70
Electronic climate control system	109
Electronic driving programmes ..	123
Electronic Stability Control.....	129
Electronic Stability Control and Traction Control system.....	71
Electronic Stability Control off.....	71
End-of-life vehicle recovery	139
Engine compartment fuse box ...	155
Engine coolant	142
Engine coolant temperature gauge	64
Engine data	184
Engine exhaust	119

Engine identification.....	181
Engine oil	141, 178, 182
Engine oil pressure	72
Entry lighting	104
Event data recorders.....	193
Exhaust filter.....	71, 119
Exit lighting	104
Exterior care	174
Exterior light	72
Exterior lighting	12, 93
Exterior mirrors.....	25

F

Fault	123
First aid.....	53
First aid kit	53
Fixed air vents	113
Folding mirrors	25
Front airbag system	40
Front fog lights	73, 101, 149
Front seats.....	32
Front storage.....	49
Front turn lights	150
Fuel.....	135
Fuel for petrol engines	135
Fuel gauge	63
Fuses	154

G

Gauges.....	62
Glovebox	48

H

Halogen headlights	146
Hand brake.....	125, 126
Hazard warning flashers	100
Headlight flash	95
Headlight range adjustment	96
Headlights.....	93
Headlights when driving abroad ..	96
Head restraint adjustment	8
Head restraints	31
Heated mirrors	26
Heated rear window	30
Heated steering wheel	57
Heating	35
Heating and ventilation system .	106
High beam	72, 95
High beam assist.....	72, 95
Hill start assist	128
Horn	13, 58

I

Identification plate	180
Ignition switch positions	116
Immobiliser	24, 72
Indicators.....	62
Info Display.....	77
Information displays.....	73
Instrument cluster	62
Instrument panel fuse box	157
Instrument panel illumination	153

Instrument panel illumination control	102
Instrument panel overview	10
Interior care	176
Interior lighting	102
Interior lights	102, 153
Interior mirrors	26
Interruption of power supply	123
Introduction	3

J

Jump starting	170
---------------------	-----

K

Key, memorised settings	20
Keys	18
Keys, locks	18

L

Lashing eyes	52
Lighting features	104
Light switch	93
Load compartment	23, 51
Load compartment fuse box	158
Loading information	54
Low fuel	72
Low washer fluid	73

M

Malfunction indicator light	69
Manual anti-dazzle	26

Manual mode	122
Manual seat adjustment	33
Manual transmission	124
Manual windows	27
Memorised settings	20
Midlevel-Display	73
Mirror adjustment	9
Misted light covers	102

N

New vehicle running-in	116
Number plate light	153

O

Object detection systems	133
Odometer	63
Oil, engine	178, 182
OnStar	88
Operate pedal	69
Outside temperature	60
Overrun cut-off	117

P

Parking	16, 118
Parking assist	70, 133
Parking brake	126
Parking lights	101
Particulate filter	119
Performing work	140
Power outlets	62
Power steering	70

Power steering fluid	142
Power windows	28
Puncture	167

R

Radio Frequency Identification (RFID)	196
Radio remote control	19
REACH	191
Reading lights	103
Rear fog light	73, 101, 151
Rear seats	36
Recommended fluids and lubricants	178, 182
Reduced engine power	72
Refuelling	136
Registered trademarks	193
Retained power off	116
Reversing lights	102
Ride control systems	128
Roof load	54
Roof rack	53

S

Safety belts	36
Seat adjustment	7
Seat belt	8
Seat belt reminder	68
Seat belts	36
Seat heating	35
Seat position	32

Selector lever	121
Service	114, 177
Service display	64
Service information	177
Service vehicle soon	69
Side airbag system	40
Sidelights.....	93
Side turn lights	152
Software acknowledgement.....	191
Spare wheel	167
Speed limiter.....	131
Speedometer	62
Starting and operating.....	116
Starting off	16
Starting the engine	117
Steering.....	116
Steering wheel adjustment	9, 57
Steering wheel controls	57
Storage.....	48
Storage compartments.....	48
Sunvisor lights	103
Sun visors	30
Symbols	4

T

Tachometer	63
Tail lights	151
Three-point seat belt	37
Tools	159
Towing.....	172

Towing another vehicle	173
Towing the vehicle	172
Traction Control system	128
Traction Control system off.....	71
Transmission	15
Transmission display	121
Tread depth	164
Trip computer	82
Trip odometer	63
Turn lights	67, 100
Tyre chains	165
Tyre designations	160
Tyre pressure	160
Tyre pressure monitoring system.....	71, 161
Tyre pressures	187

U

Underseat storage	49
Upholstery.....	176
Uplevel-Combi-Display.....	73
Upshift.....	70
Using this manual	3

V

Vehicle battery	144
Vehicle checks.....	140
Vehicle data.....	182, 185
Vehicle data recording and privacy.....	193
Vehicle dimensions	186

Vehicle Identification Number	180
Vehicle jack.....	159
Vehicle messages	79
Vehicle personalisation	84
Vehicle security.....	24
Vehicle specific data	3
Vehicle storage.....	139
Vehicle tools.....	159
Vehicle unlocking	6
Ventilation.....	106

W

Warning chimes	81
Warning lights.....	62
Warning triangle	53
Washer and wiper systems	14
Washer fluid	143
Wheel changing	166
Wheel covers	165
Wheels and tyres	159
Windows.....	27
Windscreen.....	27
Windscreen wiper and washer ...	58
Winter tyres	159
Wiper blade replacement	145

www.opel.com

Copyright by Opel Automobile GmbH, Rüsselsheim, Germany.

The information contained in this publication is effective as of the date indicated below. Opel Automobile GmbH reserves the right to make changes to the technical specifications, features and design of the vehicles relative to the information in this publication as well as changes to the publication itself.

Edition: October 2018, Opel Automobile GmbH, Rüsselsheim.

Printed on chlorine-free bleached paper.

ID-OASJOBSE1810-en

