



BYD S6, S6A, S6K Owner's Manual



BYD Auto Sincere Service Commitment

Dear Users:

Thanks for your choice. Thanks to your concern, some of our services are superior to the industry standard; thanks to your suggestions, we continue to pursue better service. In order to provide you with excellent service, we are committed to:

1. Keep smile and enthusiastic whenever and wherever;
2. Provide you with a clean environment for rest;
3. Provide you with warm reception the first time you enter into the shop;
4. Valuate the machine repair items before servicing; give the final price of maintenance items; new items will subject to your confirmation; before settlement, we will check with you item by item again;
5. Estimate the servicing time and follow up; notify you immediately if there is any delay. If you want to check the servicing process, I will reply in 10 minutes;
6. In the servicing process, I use the six-piece suit interior protection and three-piece exterior protection for your car.
7. Only use genuine parts;
8. Whatever question or need, I will reply immediately until solved;
9. I will pay a return visit within three days to ensure that your car drives normally;
10. Any opinion and suggestion are appreciated.

Version 201211

Copyright © BYD Auto Industry Company Limited

Without the written permission of BYD, it is prohibited to reproduce or photocopy any part of this manual.

All rights reserved





Foreword

Thank you for choosing a BYD AUTO. To help you use and maintain your BYD AUTO, please read the Instruction Manual carefully. If you have any doubts about the instructions, please contact the BYD auto sales service station for help. For more detailed car information, please visit <http://www.bydauto.com.cn/service/manual/index.php>

As BYD AUTO adopts the EFI (electronic fuel injection) engine and as its electric wiring structure is complicated, do not install additional electric appliances yourself, such as anti-theft systems, multi-media systems, and xenon headlights. Please use original spare parts from BYD. Otherwise, any faults caused will not be covered by BYD's warranty (guarantee of repair, replacement and return). To prevent loss caused by vehicle accidents, it is suggested that vehicle insurances including the "self-ignition loss insurance" and the "theft & robbery insurance", etc be purchased. In addition, please do not leave valuables in your car so as protect your car better and protect your valuables from being stolen.

The manual aims to help you use the car correctly, but does not include all instructions about its configuration. For the configuration, please consult the contract related to the product (if any), or consult the dealer selling the product to you. Figures in the manual are for reference only. If any figure in the manual is inconsistent with the actual object, the actual product will prevail.

BYD Auto Industry Company Limited reserves the right for revising the technical characteristics and contents and the spare part status alteration in this manual without prior notice.



Please follow the instructions where "Tips" and "Warning" are indicated in this manual to avoid the possibility of injuries or damage.

The notice types and their details of use are as follows:

Tips
Precautions to be followed to make maintenance easier

 WARNING
Precautions to avoid vehicle damage or personal injury

Thank you for choosing a BYD Auto. Your opinions and suggestions are welcome. To provide better service to you, please provide accurate contact details, and contact a BYD Sales service station for your information updates. Please obtain the number plate for your vehicle as soon as possible and pay attention to relevant state laws and regulations. For car usage communication, please visit BYD Auto Club BBS: <http://club.bydauto.com/bbs/>



Table of Contents

Vehicle Performance Parameters of BYD AUTO.....	1
Chapter 1 Operation of Instruments and Controls.....	1-1
Chapter 2 Driving Guidelines	2-1
Chapter 3 Starting and Driving	3-1
Chapter 4 Emergency Treatment	4-1
Chapter 5 Vehicle Exterior Maintenance	5-1
Chapter 6 Maintenance Instructions.....	6-1
Chapter 7 Self-maintenance.....	7-1



Vehicle Performance Parameters of BYD AUTO

Product Model		S6	S6A	S6K
Basic Type		Load-type vehicle body structure, 5 doors/1 lid/2 carriages		
Drive Mode		Front transverse engine, front-wheel drive		
Dimensions	L×W×H mm	4810×1855×1725 (1680, excluding the luggage rack) (no load)		
Wheelbase	mm	2720		
Tread	Front mm	(Front/rear) 1580/1555		
Wheel Alignment	Front wheel chamber	-0.4°±45′		
	Front wheel toe-in	0±2mm		
	Kingpin inclination angle	10°40′±45″		
	Kingpin caster angle	2.35±45′		
	Rear wheel chamber	-0.45±45′		
	Rear wheel toe-in	3±2 mm		
Curb Weight	kg	1620	1665	1695
Gross Weight	kg	1995	2040	2070
Front/Rear Axle Load (Gross Weight)	kg	1050/945	1055/985	1085/985
Maximum Design Speed	km/h	180	185	185
Tyre Size (Spare)		225/65R17		
Tyre Pressure	kPa	210		
Approach Angle	° (degree)	23.5		



BYD AUTO S6, S6A, S6K Owner's Manual

Departure Angle	°(degree)	22		
Front Overhang	mm	1010		
Rear Overhang	mm	1080		
Minimum Ground Clearance	mm	≥190		
Minimum Turning Radius	m	≤11.8		
Passenger Capacity	persons	5		
Boot Capacity	L	(1084L/ lay down the second row seats 2398L) ±5 L		
Maximum Grade	%	≥30		
Brake Pedal Free Travel	mm	1-5		
Engine Model		BYD483QB	BYD488QA	BYD488QA
Engine Type		In-line four cylinders/16valves, MPI fuel injection, dual overhead camshaft DOHC	In-line four cylinders/16 valves, MPI fuel injection, single overhead camshaft SOHC	In-line four cylinders, forced circulation water cooling, dual overhead camshaft, four strokes
Displacement	ml	1991	2362	2362
Max. Torque	Nm/rpm	172/4750	229/4000	229/4000
Max. Output Power	kw/rpm	95/5800	118/5800	118/5800
Fuel Consumption	K/100km	9.2	9.8	9.8
Tyre Balancing Requirement		The imbalance amount measured after counterbalance is clamped on each side of the wheel assembly should be less than 10g		



Chapter 1

Section 1

Operation of Instruments and Controls

Anti-theft System

Keys	1-4
Wireless Remote Control Function.....	1-6
Intelligent Key Access and Starting Function	1-8
Steering Lock Function.....	1-10
The Battery in the Tntelligent Key Runs out of Power	1-10
Anti-theft System.....	1-12
Power Windows	1-13
Power Door Lock.....	1-13
Back Door	1-15
Sunroof.....	1-15



BYD Passenger Car Identification Identification Number of Engine and Transmission

Your car has several identification numbers located at different positions.

1. Engine model and engine number are printed on the engine block.
2. The transmission number is located on the label on the top of the transmission.

Do not confuse the transmission number with the engine number.

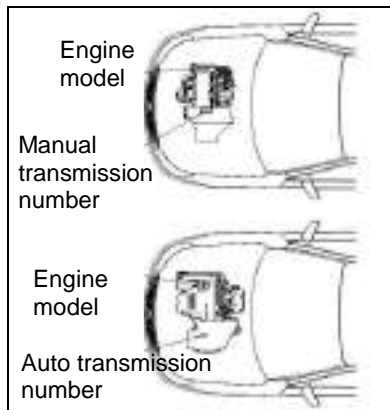

Emission system identification

The pollutant emission system of the car has two identifications:

1. Front three-way catalyst

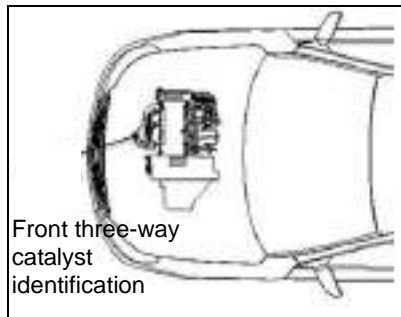

The other emission system identification is on the rear three-way catalyst, in the bottom of the car, as shown below



Emission system
identification

Tips

When the engine is started or just flames out, do not touch it because it is still hot.

For S6 models in the sale, the emission identification depends on the power assembly:

Vehicle Identification Number

The vehicle identification number is marked on the upper left of the instrument panel and the floor beam of the front passenger seat respectively as shown below. The vehicle identification number is used

for owner registration.

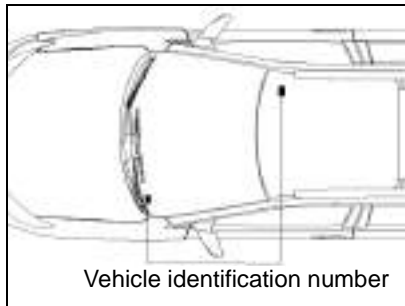

As shown in the figure below, the manufacture nameplate in the bottom of the right side wall B pillar is also marked with the vehicle identification number.

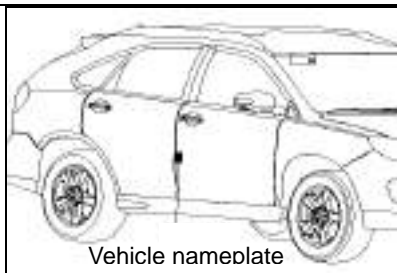

The figure below is the fuel grade nameplate, which is attached to the inside of the filler cap.

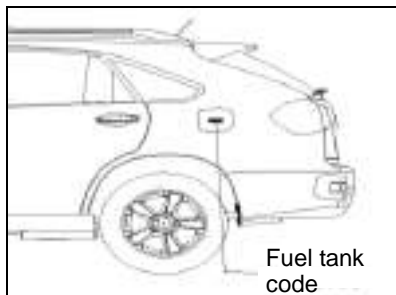

Warning & Tips

The cooling fan warning label and

engine coolant replacement signage are attached to the inside of the engine room.

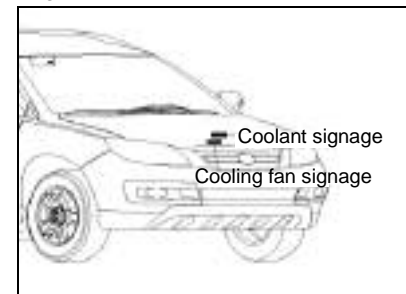

Airbag warning label is attached to the right sun visor.



Airbag warning label

The label of front passenger's airbag is on the right of the instrument panel.

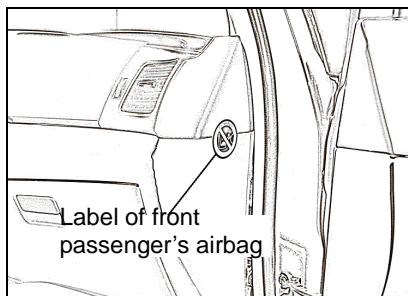

Label of front passenger's airbag

The signage of child protection device

is attached below the lock ring of the back door.

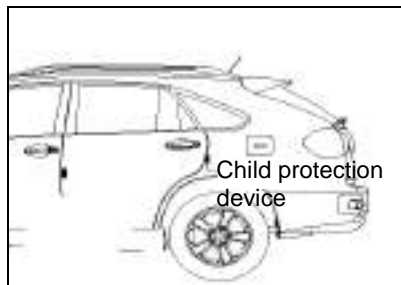

Child protection device

Tyre pressure signage is below the left pillar "B".

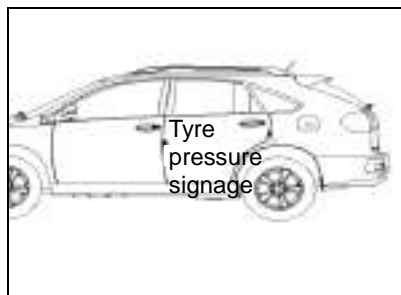

Tyre pressure signage

Keys

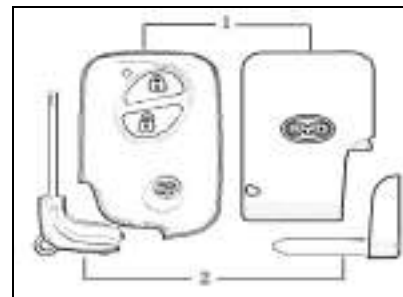

Intelligent Keys and Mechanical Keys

1. Intelligent Key - used to lock/unlock all doors and available in two types: electronic intelligent key and card-type intelligent key. The electronic intelligent key can be used to lock/unlock doors, open the back door, and search for the car nearby.

2. Mechanical Key - used to lock/unlock the driver door as well as the back door.

 **WARNING**

Pay attention to the following items when using intelligent keys:

- People with a pacemaker, a cardiac defibrillator or other electronic medical device should keep away from the aerials of the intelligent access and intelligent key starting system, as the electromagnetic waves may affect the normal use of such devices.
- Do not attach any object which may block electromagnetic waves (such as a metal sealing part) to the key.
- Do not hit other objects with the

intelligent key.

- Do not place the key in areas of high-temperature for prolonged periods of time, e.g. on the dashboard exposed to direct sunlight.
- Do not immerse the intelligent key into any liquid.
- It is suggested not to place the intelligent key near any device which may produce electromagnetic waves, such as a mobile phone.

Use of the mechanical key





Key Number Plate



The key ID number is shown on the number plate. It is suggested that you remember the ID number and keep the number plate in a safe place.

Wireless Remote Control Function

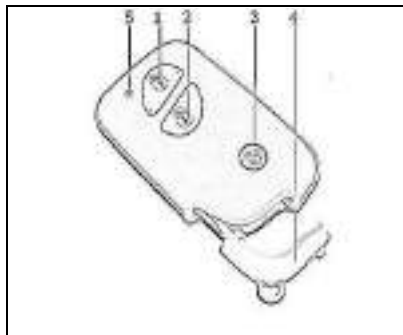

1. Locking button
2. Unlocking button
3. Back door unlocking button
4. Mechanical key
5. Indicator Light

The wireless remote control function is used for locking/unlocking all doors and other additional functions within a short distance. The indicator light will flash once for each switch operated.

If the electronic key cannot function well at a short distance, or when the indicator light on the key is dim or off:

- 1) Check whether there is radio equipment (radio station, or radio transmitter, etc) nearby which may interfere with the normal operation of the key.
- 2) The battery may run out of power. Inspect and replace the battery inside the electronic intelligent key.
- 3) If the electronic intelligent key still does not work normally, please contact the BYD service shops as soon as possible.

If the electronic intelligent key is lost, please contact the BYD service shops as soon as possible to prevent the car from being stolen or other accidents.

Locking Operation



Unlocking Operation



Locking: all doors will be locked simultaneously by pressing down the locking switch. At this moment, the exterior ear-view mirrors (if any) will be folded, and the steering signal lights will flash once. Check whether all doors are securely locked.

If any door is not closed, the locking switch will not be able to lock the doors. In this case, the doors will be unlocked first before locked, the external rear-view mirrors will not be folded and the steering signal lights will not flash. Meanwhile, the alarm will be sounded.

Unlocking: all doors will be unlocked by pressing down the unlocking button. At this moment, the steering signal lights will flash twice in the non-anti-theft case and flash twice times in the anti-theft case.

If the power gear is at the position of ACC or ON, the remote intelligent key will not work.

When the electronic intelligent key is used for unlocking, even if the doors are not open, the interior lights will be turned on and remain on for 15 seconds before going out.

When using the electronic intelligent key to unlock doors, please open a door manually within 30 seconds. Otherwise all doors will be locked automatically in the anti-theft case.



Intelligent Key System Intelligent Key Access and Starting Function

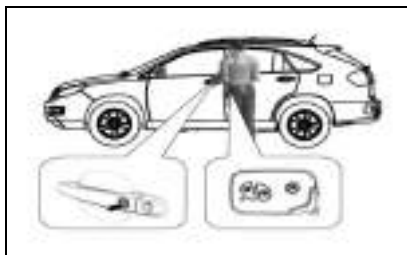

With the intelligent key, the doors can be locked or unlocked and the engine can be started.

Active Region

After an intelligent key is registered, the access and starting engine function is available in the active region.

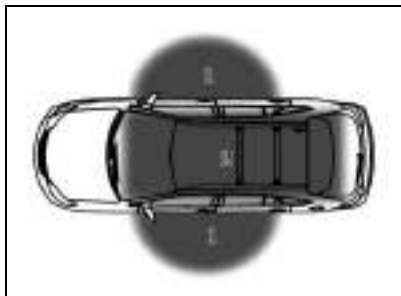

1. Access function active region - within the range of about 1m away from the micro switch of the front door handle.
2. Starting engine function active region - in carriage.

When the intelligent key of another

car is near to the intelligent key of your car, it may take longer to unlock the doors, which is normal.

Access Function - Door locking and unlocking.

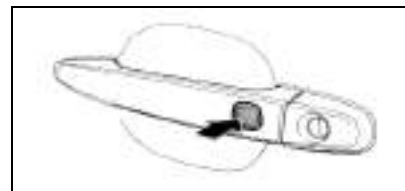

Locking

By pressing down the micro switch of the external door handle, all doors will be locked and the steering signal lights will flash once.

In the following cases, the doors will not be locked by pressing down the micro-switch.



- 1) The doors are not closed well.
- 2) The start button is at gear position ACC or ON.

Unlocking

After you are in the access function active region, footlights of the external rear-view mirror (if any) will be on for 15s. In this case, all doors and the back door can be unlocked by pressing down the micro switch of the door handle.

If the doors are not unlocked by pressing down the micro switch, please press the switch again.

When the doors are unlocked, open a door within 30 seconds. Otherwise all doors will lock automatically.

Starting function - used to switch the power mode and start the engine.

Tips

In the following cases, functions of intelligent access and engine starting may not work normally.

- There are devices giving off a strong electromagnetic wave nearby, e.g. TV tower, power station, and radio station.
- The intelligent key is carried together with communication devices, like an interphone and mobile phone.
- The intelligent key is touched or covered by metal objects.
- The door handle is operated quickly.
- The intelligent key is close to the door handle when starting the engine.
- The battery is in a state of low power.

- The intelligent key is near high voltage devices or noise-generating devices.
- The intelligent key is carried together with intelligent keys of other cars.
- The intelligent key may not work normally in certain positions (e.g. on the dashboard, in the glove box, or on the floor) even if in the active region.

Steering Lock Function

When the wireless remote control, the micro switch or the mechanical key is used for locking, the steering wheel will be locked.

After the power is switched to ACC or ON by pressing down the start button, the steering lock will be released automatically. If the indicator light on the start button turns green and



flashes, it means that the steering lock function is abnormal; please contact the BYD service shops for inspection.

Tips

When the intelligent key battery runs out of power, the steering lock function can be realized only by front left locking with the mechanical key.

The Battery in the Intelligent Key Runs out of Power

If the indicator light of the remote intelligent key does not flash and the engine cannot be started through the starting function, the battery may have run out of power and should be replaced as soon as possible.

Replace Card-type Intelligent Key Battery

You can replace the battery yourself. The battery type is CR2025.

1. Pull out the mechanical key in the arrow direction.



2. Take out the battery.



3. Insert the new battery into the intelligent key, and then put the mechanical key back into the card-type intelligent key.

After battery replacement, check whether the card-type intelligent key works normally. If it still does not work, please contact the BYD service shops.

Replace Remote Intelligent Key Battery

If the intelligent key battery runs out of power, please entrust the BYD service shops to have it replaced.

Tips

- Make sure that the battery poles are installed properly.
- Do not replace the battery with wet hands.

Start the engine with the intelligent key whose battery has run out of power

1. Unlock with the mechanical key.



Unlock turn the key clockwise
Lock turn the key anticlockwise

2. When the start button is pressed, the intelligent key system alarm light is turned on and the buzzer inside the car beeps once.
3. Place the electronic intelligent key near the starting switch within 30 seconds

after the buzzer beeps, the buzzer will beep once again, indicating that you can start the engine.

4. Start the engine within 5 s.

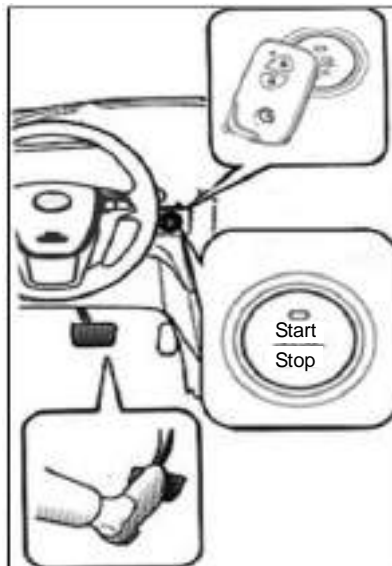

Power saving

The key will communicate with the car even when you are not driving the car. Do not leave the key inside the car or within a range of 2 m from the car.

If an intelligent key receives strong electromagnetic waves for long period, the battery will run low quickly. Intelligent keys must be kept at least 2m away from the following devices:

- 1) TV sets
- 2) PCs
- 3) Mobile phone chargers
- 4) Lamp holders
- 5) Fluorescent reading lights

If the car is not used for a long time, the storage battery may run out of power, so its cathode terminals should be disconnected to prevent power consumption. Please use any one of



the following methods to apply the intelligent access and starting function, after the storage battery is mounted again.

- 1) When the intelligent key is available, press the micro switch on the door handle.
- 2) Make wireless remote control operation.
- 3) Insert the mechanical key into the lock hole in the driver door and turn the key.

If the intelligent access and starting function is abnormal, please take all intelligent keys to the BYD auto sales service stations for inspection.

Anti-theft System

Anti-theft setting system

1. When the engine is stopped and all

doors are locked (anti-theft setting isn't available for center control), the anti-theft indicator light will remain on. The anti-theft system will be set automatically after 10 seconds. The anti-theft indicator light will start flashing after the system is set.

2. Make sure the indicator light is flashing before you leave the car.

If anyone in the car unlocks the door, the anti-theft system alarm will be activated. So do not leave anybody in the car when the system is set.

Alarm triggering

After the system is set, it will give out an alarm in the following cases:

- 1) Any door or the front cabin lid is opened without using the intelligent key access function or the wireless

remote control function.

- 2) The power supply is turned on when the intelligent key starting function is not used.

Disable Anti-theft System

You can use the following means to disable anti-theft alarm:

- 1) Unlock doors with the remote control function.
- 2) Unlock doors with the micro switch.
- 3) Press the start button and detect the key.

Finding Car Operation

When the car is in the anti-theft state, the alarm will make a long sound and the steering signal lights will flash for 15 s by holding the locking button.

Power Windows

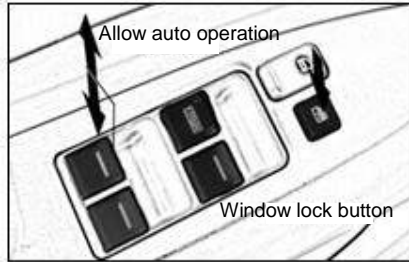

When the start button is at the gear of ON, the glass of each door can be controlled to ascend or descend with the switch of each door. There are four window control switches at the driver side door to control ascending and descending of glass for four doors respectively.

Automatic operation of driver-side window - Press down the button (AUTO) at the driver-side completely and then release it; the driver-side

window will be opened completely. If it has to be stopped midway, just press the button slightly.

When the window lock button is pressed down, only the driver-side window will ascend or descend, while the passenger-side windows will not.

When the start button is switched to OFF, the power windows can continue to work for 10 minutes at the most. The delay function can be cancelled immediately by opening either front door.

Tips

- Please be aware of safety as the power windows are not provided with the anti-clamping function.
- When there is a child in the car, please press down the window locking button.

Central-controlled door lock

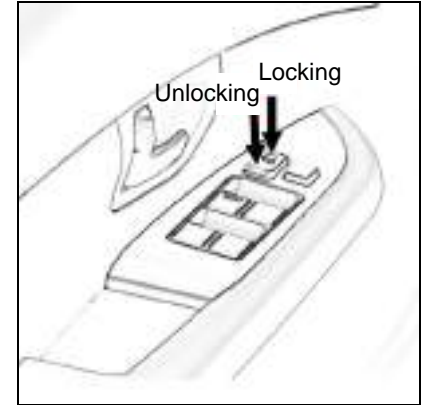

The driver-side door and the front passenger-side door are equipped with power door lock switches, either of which can lock or unlock all car doors.

Locking - press down the front end of switch

Unlocking - press down the rear end of switch



Car door self-locking/unlocking

When the vehicle speed is over 20 km/h, all doors will be locked automatically.

Pressing the start button, the power will shift from Gear ON to Gear OFF and all doors will be unlocked automatically.

Internal lock knob locking and unlocking

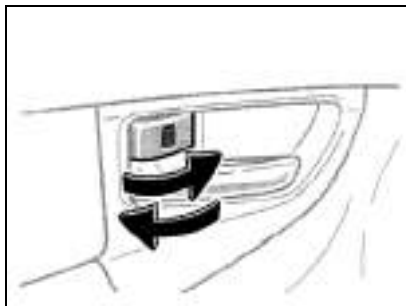

Locking: push the lock knob forward.
Unlocking: pull the lock knob backward.

When you push the lock knob forward in the left front door, all car doors will be locked. However, if you pull the lock knob backward, only the left front door can be unlocked.

The lock knob in each passenger-side door can only lock or unlock the respective door.

Rear door child protection lock

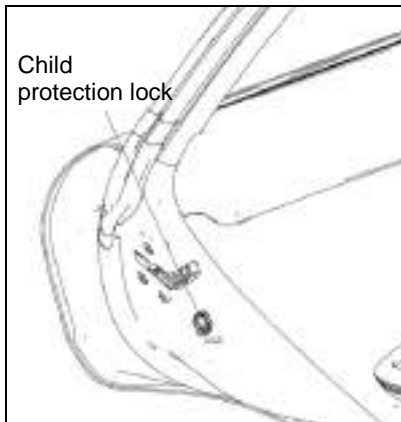

As shown in the figure, pull the lock latch to the position of "LOCK"

When the child protection lock is locked, the rear doors cannot be opened with the internal handle. As long as there is a child in the car, we suggest that you use the function.

Tips

- As the front door lock is provided with the anti-mislocking function, the car doors will not be locked when the front door is closed directly, if the internal lock knob is set to the locking position.
- Normally, if the front door has to be locked externally, all doors should be closed and the key taken outside the car and then locked with the mechanical key, the micro switch or the wireless

remote control function.

- Even if the internal lock knob is at the locking position, the left front door can be opened with the internal handle. Therefore, do not pull the internal handle of left front door whilst driving.

Back Door

1. Unlock using the wireless remote control function or by turning the mechanical key clockwise.
2. The back door can be opened by pulling up its external handle.

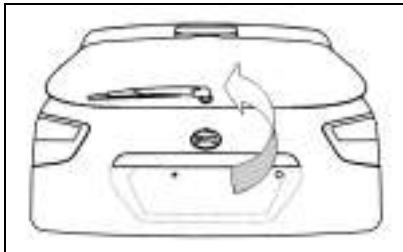

3. Back door closing

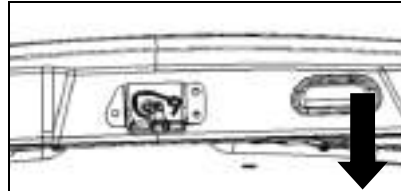

Pull down the back door and then press it down.

Sunroof

Sunroof tilting

Tilt operation

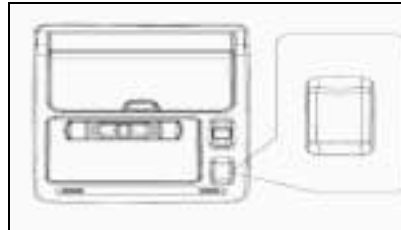

Tilting upwards: the sunroof is opened upwards by pressing down the switch.

Tilting downwards: pull down the switch until it is closed completely.

Horizontal opening and closing

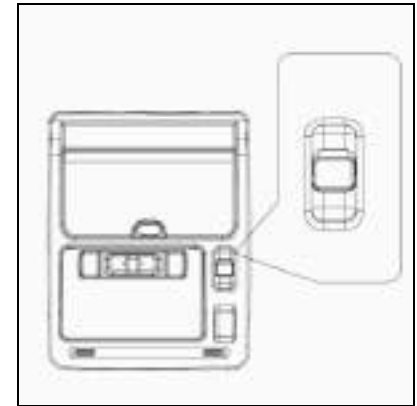

Opening: push the button backward to open the sunroof.



Closing: push the button forward to close the sunroof.

Tips
If the sunroof is operated after rain, snow or car washing, water may enter the car. Therefore, please wipe the sunroof with a dry cloth before operation.



Chapter 1

Section 2

Operation of Instruments and Controls

Driver and Passenger Safety

Safety Precautions	1-18
Seats	1-19
Child Seat Protection Device.....	1-20
Seat Belts.....	1-26
SRS(optional).....	1-28
Danger of CO Intoxication.....	1-36



Safety Precautions

Steering Wheel Adjustment



WARNING

- Do not adjust the steering wheel while driving. Otherwise, it may cause incorrect operation of the car, and result in an accident.
- After adjustment, shake the steering wheel upward and downward to make sure it is locked firmly.

Appropriate arrangement of children



WARNING

Do not leave a child alone in the car at any time.

Driving after drinking alcohol is prohibited

Even the smallest amount of consumed alcohol will reduce your reaction ability to the road traffic conditions. The more alcohol you have drunk, the slower you will become. Therefore, driving after drinking alcohol is prohibited.

Control your speed

Speeding is the major cause of car accidents and casualties. Generally speaking, the greater the speed, the greater the danger will be. Please drive at a safe speed according to the road traffic conditions.

Keep the car at the state of safe driving

It is extremely dangerous to have a

flat tyre or mechanical failure. To reduce such possibilities, please inspect the car carefully and complete the various inspection items specified in the regular maintenance form.

Pre-driving inspection

To ensure that you and your passengers receive the maximum protection from the safety equipment of the car, please inspect the following items every time before driving:

1. All adults and children not applicable to the children protection device wear the seat belts correctly.
2. All infants are arranged properly in the children protection device on the back seat.
3. The driver sits straight and leans back as far as possible, and keeps a proper distance from the steering wheel and the dashboard.

4. The seat backrest should stay upright.
5. The headrest should be adjusted to the proper height.
6. After all passengers get into the car, make sure all doors are locked.



A monitor light of car door and back door opening on the dashboard is used to indicate that a door or the back door is not properly closed.

7. All luggage should be positioned and secured properly.

Seats



WARNING

- When the driver and passengers sit straight and lean against the backrest, the seat belts can provide

the maximum protection in the event of a collision. If they lean laterally on the seats, the lumbar seat belt may slide over the hip and exert pressure directly on the abdomen. In the event of a front collision, over-tilting of seats may increase the danger of personal casualties.

- The car must not be started until all passengers are well seated. It is prohibited to sit on the folded backrest or luggage. During emergency braking or in the event of a collision, people who do not sit or wear the seat belts correctly may be seriously injured.
- It is prohibited for passengers to stand-up or move between seats. Otherwise, during emergency braking or a collision, they may be seriously injured.
- When driving, do not adjust the

driver seat, as seat moving may make the driver lose control of the car.

- When adjusting seats, take care to avoid collision between the seat and passengers or luggage.
- After seat adjustment, make sure the seat is locked in position.
- Do not place any objects under seats or tie rope to the rail unlocking lever, which can affect the locking mechanism of the seats, cause sudden movement of seats, and cause the driver to lose control of the car.
- During seat adjustment, do not put your hands under the seat or near the moving parts; otherwise, your hands or fingers may be injured.



Child Seat Protection Device

BYD strongly recommends the child seat protection device.

Tips

- The studies have shown that it is safer to install the child protection device in the rear seats than in the front passenger's seat.
- Please select the appropriate child protection device according to the age and body of your child.
- For installation details, please refer to the manual coming with the child protection device.

Type of Child Protection Device

The protection devices are classified into the following three types according to the ages and bodies of the children:

1. Baby (infant) seat



2. Child seat (convertible)



3. Youth seat (auxiliary)



When the child seat protection device isn't in use

Please fix the child protection device on the seat properly. Do not place the device on the passenger's seats or in the luggage compartment.

Select appropriate child protection device

Please select appropriate protection device for your child. If the body of your child is too big to use the protection device, let your child sit in

the back seat and use the seat belt.

Install the child protection device

Please follow the installation instructions of the manufacturer.

Fasten the child protection device to the outer back seat with the seat belt or the fastening strap under the child protection device. While installing the child protection device, fix the top drawstring



Seat belt equipped with child protection device locking mechanism

(rear seat ALR/ELR seat belt)



ISOFIX rigid anchor (ISOFIX child protection device): The outer rear seat is provided with dedicated fixing lever (the label showing the anchoring position is attached to the seat).



Fixing anchor support (for top

drawstring): The outer rear seat is provided with fixing anchor support.

Install the child protection device with seat belt (for child protection device locking)

1. Rearward child seat - baby (infant) seat / child seat (convertible): Install the child seat in the rear seat and keep it facing to the rear of the car.

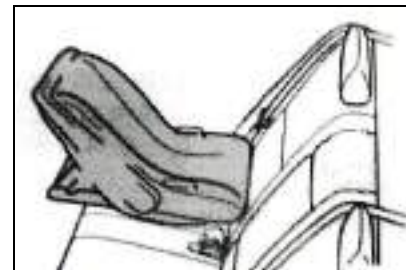

Insert the seat belt through the child seat and insert the belt tip into the buckle; make sure that the seat belt isn't twisted.

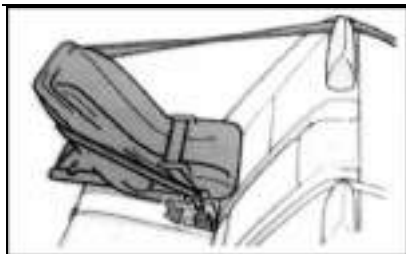

Forward child seat (convertible)

Install the child seat in the rear seat and keep it facing to the forward of the car.

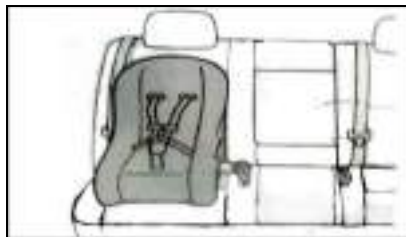

Insert the seat belt through the child seat and insert the belt tip into the

buckle; make sure that the seat belt isn't twisted.

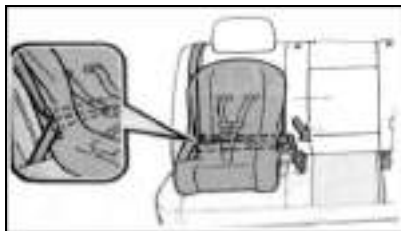

Pull out the shoulder safety belt completely, and then let it retract slightly to enter the locking mode, in which the seat belt only can be retracted.



Tighten the child seat in the rear seat, and let the shoulder safety belt fully retract, until the child seat is fixed firmly. When the shoulder safety belt is fully taut, pull the seat belt to make sure that it can't be pulled out.

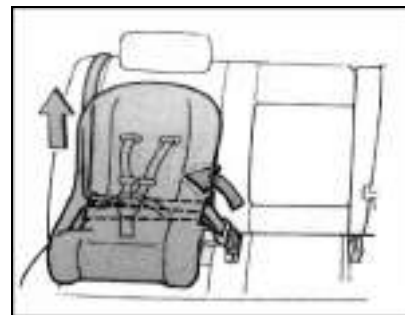

Youth seat (auxiliary)

Install the child seat in the rear seat and keep it facing to the forward of the car.



Let the child sit in the child seat.
Follow the manufacturer's instruction to fix the child seat with the seat belt, and insert the belt tip into the buckle. Make sure that the seat belt isn't twisted.
Check if the shoulder safety belt crosses the child's shoulder properly, and keep the waist belt as low as possible.



Remove the child protection device fixed with seat belt.
Press the buckle release button to retract the seat belt completely.

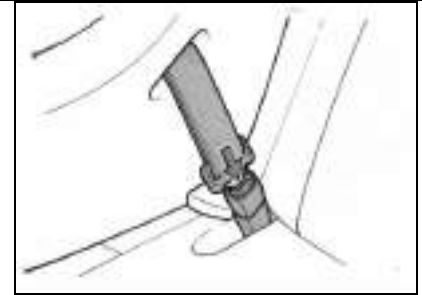

Install child protection device with ISOFIX rigid anchor (ISOFIX child protection device)

Check the position of the dedicated fixing lever and install the child protection device onto the seat. Install the fixing lever in the gap between the seat cushion and backrest.
If the child protection device is equipped with top drawstring, fix the drawstring onto the anchoring device.



Child protection device with top drawstring

Fix the child protection device with seat belt or ISOFIX rigid anchor, and remove the headrest.



Open the cover of the anchor support, buckle the hook to the anchor support, and tighten the top drawstring. Make sure that the top drawstring is buckled firmly.

1. Hook
2. Top drawstring
3. Anchor support

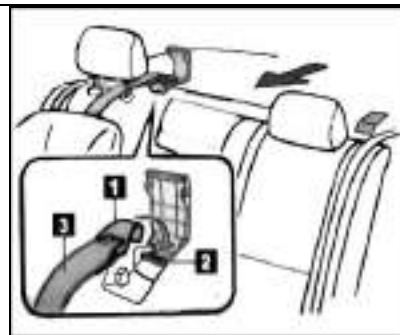

Reinstall the headrest.

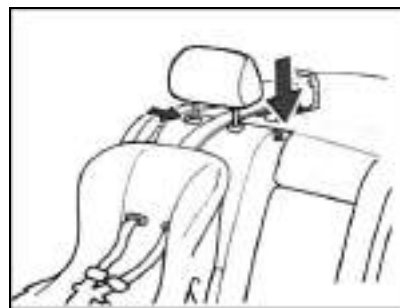

Install the child protection device onto the front passenger's seat

To install the child protection device onto the front passenger's seat with locking buckle, please follow the manufacturer's instruction.



Warning

- Do not fully stretch the shoulder safety belt to avoid the seat belt entering into locking mode.
- In locking mode, the seat belt can be retracted only, which may cause injury or discomfort.
- Do not let the child play with the seat belt, or else it may cause serious injury or even death to the child.
- While installing the child protection device, please follow the instructions in the manual and fix the protection device

firmly. If the device isn't fixed, it may cause serious injury or even death to the child in case of emergency braking or accident.

Install youth seat (auxiliary)

1. If the driver's seat obstructs the proper installation of the child protection device, please install the device onto the right rear seat.



2. Install the forward child seat or youth (auxiliary) seat onto the front passenger's seat only when inevitable;

for installation, move the seat backward as much as possible, or else it may cause serious injury or even death when the airbag explodes (inflated).



Install child protection device

Never install the rearward child protection device in the front passenger's seat, or else it may cause serious injury or even death when the airbag explodes.

1. The instrument panel at front passenger's side has a warning label, which reminds you never install the rearward child protection device in the



front passenger's seat.

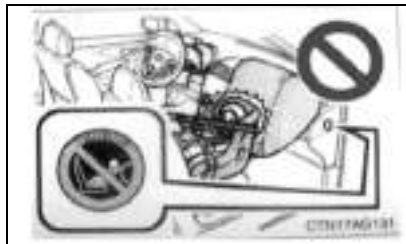

2. While installing youth (auxiliary) seat, make sure that the seat belt crosses the center of the child's shoulder. The seat belt should be away from the child's neck and shouldn't slip from the shoulder, or else it may cause serious injury or even death to the child in case of emergency braking or accident.

3. Make sure that the seat belt and the belt tip are fixed, and the seat belt isn't twisted.

4. Pull and push the child seat to different directions to make sure that it

is installed firmly.

5. Please follow the instructions of the manufacturer of the child protection device.

Fix the child seat to the anchoring device properly

When using lower anchoring device, make sure there is no foreign matter around the anchoring device and the seat belt isn't jammed behind the child seat. Make sure that the child seat is fixed firmly, or else it may cause serious injury or even death to the child in case of emergency braking or accident.

Seat Belts

The driver and passengers should adjust the shoulder height of the three-point seat belts to the appropriate position according to their own body size.

The length of the seat belt can be automatically adjusted according to the passenger size and the seat position.

Keep the seat belt as low as possible at the hip - do not lock it around the waist. Move the shoulder belt up through the lock plate to adjust the belt to the proper position.

If the seat belt fails to retract smoothly and automatically, please pull it out to check whether it is knotted or distorted. If so, please contact the BYD auto sales service stations for inspection.

Seat belts with the pre-tensioning device (If any)

The driver and front seat belts are provided with a pre-tensioning device,



it is activated in the case of a serious front collision.

When the sensor detects a serious front collision, the retractor will retract the front seat belts rapidly to protect the passenger's safety effectively.

Even if there is not a passenger in the front seat, the pre-tensioning device of the seat belts will be activated as well.

In the event of a collision, the front seat belt pre-tensioning device and the SRS air bag may not be activated at the same time.

In the event of a collision, when the seat belt pre-tensioning device is activated, noise may be made and a small amount of innocuous gas may be released. The gas does not indicate a fire and is generally harmless to humans.

Tips

- The seat belts equipped on the car are designed according to the adult frame. Children should be prudent in using the seat belts.
- Position the child seat on the back seat and seat the child in the child seat. Meanwhile, the seat belt should be fastened well for protection. It is prohibited for children to sit in the front seat.
- Do not seat a child on their knees or arms. Otherwise, the child may be seriously injured or even killed.
- Do not let children stand or kneel on the front or back seat. During emergency braking or a collision, unprotected children may be seriously injured.
- Whilst driving, passengers in the car must fasten the seat belts

correctly. Otherwise, during emergency braking or a collision, they are more prone to be severely injured.

- One seat belt must be applied to one passenger only. It is prohibited for one seat belt to be shared by two or more passengers - even by children.
- Do not over-tilt the backrest. The seat belt provides the best protection when the backrest is in the upright position.
- Do not damage the seat belts, or inhibit or trap them in the seats or car doors.
- Check the seat belt regularly to see whether it is cut, worn or loose. Damaged parts must be replaced with new ones. Do not disassemble or modify the system.



- Keep the seat belts clean and dry. Do not place any decorative articles on the seat belts.
- After a serious collision, the seat belt system (including bolts) must be replaced. Even if the damage is not obvious, the whole system still has to be replaced.
- After the latch is inserted, make sure it is locked up to the buckle firmly and the seat belt is not twisted.
- Do not leave objects, such as coins, and paper clips, etc. in the buckle, as they may affect the proper connection of the latch and the buckle.
- If the seat belts fail to function well, please contact the BYD auto sales service station immediately. The seat belts cannot provide any protection for passengers until

they are repaired. Sit upright and as far back in the seat as possible, and keep a proper distance from the steering wheel and the dashboard, this will enable the seat belts and SRS to exert their maximum protection.

- Make sure the shoulder safety belt is at the middle of your shoulder. Keep the belt away from the neck, but also prevent it from falling off the shoulder. Otherwise, in the case of accidents, the belt's protection performance will be reduced.
- For safety, the shoulder safety belt shall not be lower than the upper arm.

SRS (optional)

SRS provides additional protection of the passenger head and chest in the

event of a frontal collision of a certain magnitude to reduce the possibility of severe injury and even death to passengers inside the car.

SRS cannot take the place of seat belts. It is only a part of the whole passive safety protection system of the car. Note that SRS only provides the optimum protection performance when working together with the fastened seat belts. For the safety of yourself and your family, please pay special attention to the "Tips" in this section.

SRS airbag triggering conditions

The SRS air bag triggering conditions are designed as follows: in the event of a frontal collision of a certain magnitude, the front SRS air bag will be triggered; in the event of special collisions, the SRS air bag may be

triggered.

In the event of minor frontal collision, side collision, rear collision or roll-over, generally the SRS airbag won't be triggered. In such accidents, the seat belts, if properly fastened, can protect the driver and passengers.

The decisive factor of triggering the airbag system: compare and judge the deceleration curve generated in collision and obtained by the electronic control unit (ECU) with the set value comprehensively. If the deceleration and other signals generated and measured in case of collision is lower than the reference value preset in the ECU, the airbag will not be triggered, even though the car may have already severely deformed in the accident.

BYD Auto has fully taken into account the various misuse and road

conditions in setting ECU of the airbag system. Please use the car correctly by following the instruction manual. Otherwise, the expected effect of SRS cannot be guaranteed.

Tips

- A loud noise occurs when the air bag is deployed. Generally, no injury will be caused (however, it is not excluded that tinnitus or temporary threshold shift may be caused, but it will be recovered quickly). Gas released at SRS air bag deployment may have some odour and affect the appetite, but will not lead to poisoning of passengers. After the SRS air bag has been deployed, a small amount of smoke will be released. This is a normal phenomenon.
- Passengers who come into contact with a deploying SRS air

bag may suffer some minor bruising.

- When the SRS air bag is deployed, white powder may be produced, which may be of discomfort to some people (e.g. pregnant women, allergic patients or respiratory disease sufferers). Please open the doors or windows for ventilation, or leave the car if it is safe to do so, and clear off any residue from the body as soon as possible.

Driver's and front passenger's airbags





If your car is equipped with front airbag supplemental restraint system (SRS AIRBAG), the driver's airbag and front passenger's airbag will explode in case of moderate to severe frontal collision, to protect the heads and chests of the driver and the front passenger and reduce the injury.

How the frontal airbag works



In case of moderate to severe frontal collision, the sensor will detect that

the car is decelerating sharply and send signal to the control device to explode the frontal airbag immediately.

In case of frontal collision, the seat belt will secure your lower body and torso, while the airbag acts as a cushion to help stabilize and protect your head and chest.

Since the two airbags use the same sensor, the airbags will explode at the same time. However, only one airbag explodes sometimes.

This may be that the severity of the collision is at the critical value of airbag explosion. In this case, the seat belt will provide the primary protection, while the auxiliary protection provided by the airbag is very little.



The frontal airbag inflates and deflates immediately, so that it won't block the driver's sight or affect the operation of steering wheel and other control devices.

The airbags explode rapidly to provide additional protection for the driver and passengers in an accident.

A loud noise occurs when the air bag is deployed. Generally, no injury will be caused (however, it is not excluded that tinnitus or temporary threshold shift may be caused, but it will be recovered quickly). After the collision, you may see smoke-like substance, which is actually

the powder from the airbag surface. Although the powder is non-toxic, the passengers with respiratory tract disorders may still feel discomfort temporarily. If this happens, leave the car as soon as possible if the traffic safety allows.

Side airbags for front seats (optional)



If your car is equipped with side

airbags for front seats, the airbags will explode in moderate to severe frontal collision, to protect the upper body of the driver and the front passenger and reduce the injury.

Curtain airbag (optional)



If your car is equipped with curtain airbags, the airbags will explode in moderate to severe side collision, to protect the heads of the driver and the passengers and reduce the injury.

In cars equipped with the side airbag

Tips

- The front seats and backrests should be protected from water. Otherwise, normal operation of the SRS air bag may be affected.
- For cars equipped with side airbags, please do not attach hard objects on or near the doors. Do not place any objects between the side airbag and the passenger.
- Do not exert excessive force on the side of seats equipped with a side airbag.
- Improper front seat covering or covering substitute may reduce the SRS air bag performance or cause injury to passengers in the event of a collision.



Notices for front airbag maintenance



In the following cases, please contact the BYD auto sales service stations immediately.

- 1) SRS air bag has been deployed.
- 2) In the event of a collision with the front of the car (the shaded section in the figure), the SRS air bag will not be deployed.

- 3) The steering wheel decorating board surface or the front passenger airbag cover (the shaded section shown in the figure) has been scratched, cracked or been damaged in other ways.
- 4) The SRS air bag should be replaced.

Notice for side airbag maintenance

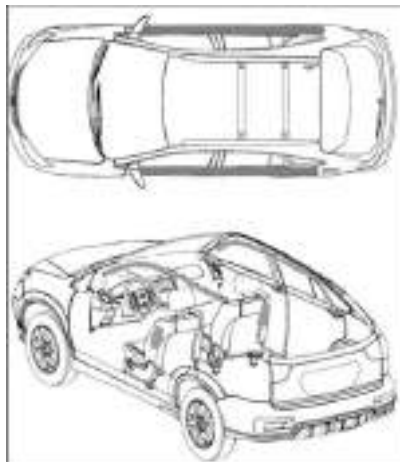

In the following cases, please contact

the BYD auto sales service stations immediately.

- 1) Both the side airbags and the curtain airbags have been deployed.
- 2) In the event of a collision with the car doors (the shaded section in the figure), the SRS air bag will not be deployed.
- 3) The surface of seats equipped with side airbags (the shadowed section in the figure) has been scratched, cracked or been damaged in other ways.
- 4) The decoration (pad) sections (the shaded section shown in the figure) of Pillar A with curtain airbag, the top longitudinal beam and Pillar C have been scratched, cracked or been damaged in other ways.

Air bag disabled

According to applicable regulations,

airbags for the driver and the front passenger can only be disabled in the cases below:

- 1) When it is impossible to keep a 25 cm distance between the center of the steering wheel and the chest of the driver even though the driver seat is adjusted properly.
- 2) When special equipment needs to be installed for the disabled within the range of the steering wheel.
- 3) When adjustment of the front seat is required for specific reasons, the seat cannot be kept within the scope set by the manufacturer.

The airbag system must be disabled by a BYD auto sales service station. After an airbag is disabled, the BYD sales shops will attach a label to the corresponding position and make a record in the Guarantee Manual.

Tips

- If the air bag system has to be disabled on special occasions, please have it done at a BYD auto sales service station. Otherwise, it may cause serious injuries or death!
- To restore the protection function of the air bag, you should enable the closed air bag as quickly as possible!

Cases for possible deployment of SRS air bag

In instances where the car hits a bump on the side of the road, a traffic island or stones on the road side, etc.

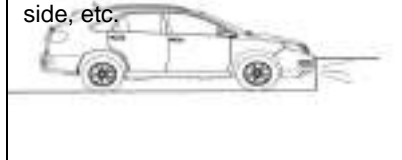

The car hits a pothole.

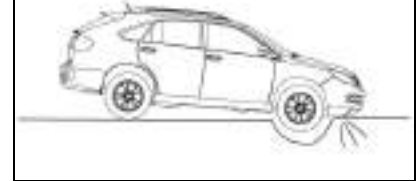

Come into contact with the ground when going downhill





Cases for SRS air bag will not necessarily deploy

The car crashes into a concrete column, a tree or other long and thin objects



The car bumps into a truck



The car crashes into a wall but not head-on

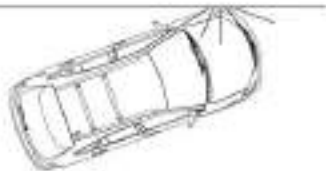

Other vehicles hit the rear of the car



The car rolls laterally



The car sides are hit by other vehicles (side airbags not installed)

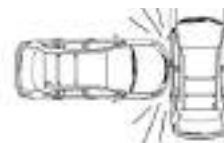



Tips

- SRS is developed specially for specified car models. Any change to the suspension, tyre size, bumper, chassis and original equipment will cause adverse influences on SRS. Any component of SRS is prohibited to be used on other car models. Otherwise, SRS may be ineffective and personal injury may be caused.
- BYD S6 SRS has taken into full consideration various misuses and road conditions. However, avoid serious impact to the bottom of the car and do not drive erratically in poor road conditions in order to prevent accidents.
- It is very important for the driver to maintain a distance of at least 25 cm between the chest and the

steering wheel, which allows maximum protection when SRS is triggered. That is to say, it is necessary to adjust the front seats and the headrest according to the size of each occupant; in addition, the driver's arms must only be slightly bent.

- Do not attach any object on or cover the surface of the steering wheel trim cover or the surface of the front passenger airbag; and do not make any other decorative treatment at such places. These two places must only be cleaned with a dry or slightly damp cloth, and should not be knocked violently.
- There should not be other persons, animals or objects between the driver/front passenger and the SRS airbag deployment range.

- Any accessories, such as the phone holder, cup holder and ashtray, must not be installed on the SRS airbag decorating board or within the airbag deployment range. Otherwise, when the SRS airbag is triggered, there may be increased risk of personal injury.
- Do not sit on the seat edge or bend over the dashboard whilst driving, as the front SRS airbag may be deployed at very high speed and at great pressure. Directly touching SRS airbags or being close to them, can cause serious injury or death to passengers.
- Children, the elderly and infirm as well as pregnant women are prohibited to sit on the front seat. It is suggested that pregnant women consult doctors and follow the advice of doctors. When the seat belts are used, the



lumbar belt should be fastened properly. Otherwise, serious personal injury may be caused when the SRS airbag is deployed (inflated).

- Do not make any modification to any component of the SRS airbag, including corresponding labels.
- Any maintenance to the SRS air bag (including disassembly of SRS components due to maintenance of other sections) must only be carried out by a BYD auto sales service station.
- SRS must be replaced in a BYD auto sales service station within 15 years as of the date of delivery (manufacture date indicated in the quality certificate and nameplate). If certain SRS components have been replaced before that date, this must be

recorded in the Guarantee Manual.

- Please hand over all material supplied with the car to the next owner when transferring the car.
- When the car or SRS components are to be discarded, please follow relevant safety regulations and scrapping procedures.
- SRS is supplied with a strong anti-interference capability for surrounding electromagnetic interference. However, please do not use the car in electromagnetic environments not permitted by the state to prevent accidents.
- After SRS deploys, direct contact with the SRS airbag module components should be avoided (otherwise, scalding or discomfort

may be caused to the body).

- If the SRS airbag fails to be triggered, it does not mean that something is wrong with SRS. Abnormal repair or use of damaged components will affect normal operation of SRS.
- The SRS airbag can only provide protection in one accident. Once the SRS airbag is triggered or damaged, the system must be replaced.
- For any damage caused by operation inconsistent with the above instructions, BYD will not bear any direct or indirect loss.

Danger of CO Intoxication

The engine exhaust contains carbon monoxide. If your car is maintained correctly, the carbon monoxide will not enter the car during driving.

The exhaust system should be checked for any leakage in the following cases:

- a. Abnormal exhaust noise
- b. The car has suffered from an accident that may have damaged the bottom of car.



WARNING

●CO intoxication. Inhalation of CO may lead to loss of consciousness or even death. Please keep away from any enclosed environment and activity that may cause CO intoxication.

●High-concentrations of CO will accumulate quickly in an enclosed area, e.g. a garage. Do not start the engine while the garage door is closed. Even if the garage door is

open, the engine should only be run enough to drive the car out.

●When the back door is opened, exhaust gases can enter the car with air and cause a dangerous environment. If the engine has to be started when the back door is open, please open all windows and adjust the internal air environment control system as follows:

- a. Select "External Circulation" mode.
- b. Select  mode.
- c. The fan speed is set at "High Rotation Speed".



Chapter 1

Section 3

Operation of Instruments and Controls

Lights, Wiper and Defroster

Headlights	1-40
Fog Light (optional)	1-41
Front and Rear Windscreen Wiper	1-41
Rear Window Defroster	1-42
External Rear-view Mirror Defroster (if equipped)	1-43



Headlights

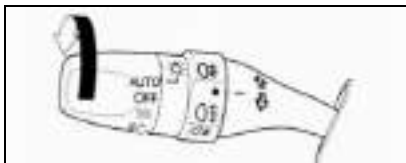

Turn the dimmer knob at the top end of the left combination switch and turn on the following lights:

OFF Position - Turn off all headlights.

 Width-indicator position - Turn on the width-indicators (including the front position light, the rear position light, the number plate light, the dashboard background light, the width-indicating light indicator and certain background lights, etc).

 Headlight position - Turn on the

dipped beam headlights and width-indicators.

AUTO position - Turn on the dipped beam headlights and width-indicators. These lights will be turned on or off automatically according to the solar intensity sensed by the light intensity sensor.

The solar intensity sensor is on the top of the dashboard. Do not cover the sensor or allow any liquid to come into contact with it.

Tips

To prevent the battery from discharging, when the engine is not running, do not keep lights on for a long time.

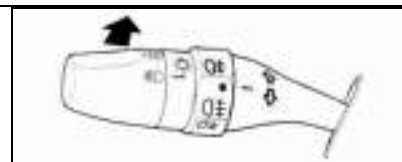

Main/dipped beam light - Push the indicator stalk until a click is heard. At this point, the main beam indicator light is on. If it is to be switched back to dipped beam light, simply pull the indicator stalk back.

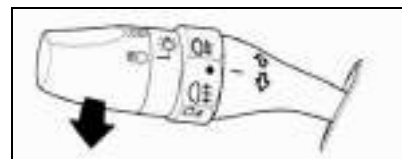

Main beam light flashing - Pull the indicator stalk back lightly and then release it.



The main beam light will also flash by

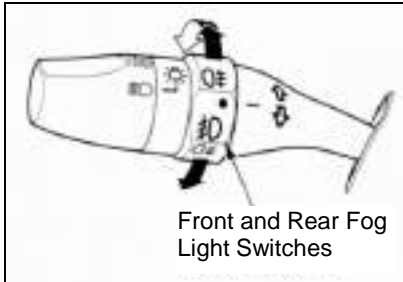

putting the dimming knob at the gear "OFF".

Fog Light (optional)





If the headlights are turned on, the fog lights can be turned on with the fog light switch.

Turn on front fog lights - turn the switch upward to the position , and then the dashboard indicator light  will be on.

Turn on front and rear fog lights - after the front fog lights are turned on, turn the switch to the position  and then release it. The dashboard  indicator light will then be on.

Turn on rear fog lights - turn the switch from the position (●) downward to the position , and then release it.

When you turn the dimming knob to the position OFF to turn off the headlights, the front & rear fog lights will be turned off.

When you turn the light control switch to the position  or  again, the front fog lights will be turned on. If you want to turn off the front fog lights completely, please turn the fog light switch downward to the position (●).

Front and Rear Windscreen Wiper

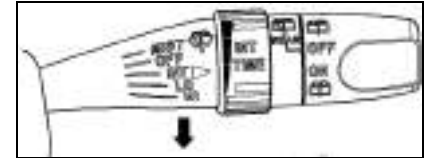

The control handle is used to control the front and rear windscreen wipers and washers. The front windscreen wiper has five speeds;

MIST: Mist mode
 OFF: stop
 INT: intermittent
 LO: low-speed wiping
 HI: high-speed wiping

In the INT gear, with the intermittent time adjusting knob, as the wiping speed band gets narrower, the intermittent time of wiping is 1 s, 3 s, 5 s and 7 s respectively.

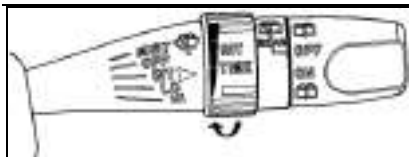

Front windscreen washer

When the wiper handle is pulled back and the acting time is short (within 0.5 s), the washer will just spray water and there will be no wiping action; when the acting time is long, the washer will keep spraying water and wiping will occur at a low speed; moreover, it will wipe water automatically three times and then return to the original position after the handle is released.

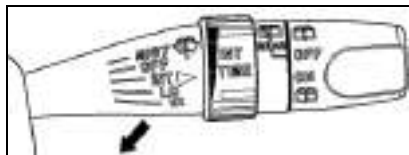

Rear windscreen wiper and washer

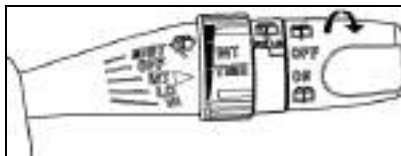

Shifting the switch knob to the "ON" position; the rear windscreen wiper will start; shifting it to the "OFF" position; the wiper will stop.

Turning the switch knob to the  position; the rear windscreen wiper and washer will start simultaneously.

Turn the switch knob downward to position  and release it. The wiper will wipe twice more after detergent is sprayed.

Tips

- The wiper blades should be inspected periodically, and dirt on the blades should be cleared away.
- Dry wiping is prohibited. If the wiper is started immediately after it rains, the wiper blades will not only fail to clean the windscreen, but also cause an unclear view at that moment and affect driving safety, this is because the rainwater may be mixed with solids, sand, and dust.
- Please use the glass cleanser. Water or other types of cleanser may lead to damage of the washer motor.

Rear Window Defroster

The rear window defroster can clear away mist, frost and thin ice on the rear window.



The defroster can be started or stopped by pressing the defrosting button. When the light inside the button is on, it means that the defroster is operating. After the power supply is cut off, the defroster will stop as well. After the car is started again, the defroster will start as well.

Please ensure the rear window is clean to guarantee a good view before driving.

Tips

- To prevent the storage battery feeding, make sure the defroster is turned off if the rear window is clear.
- The rear window should be wiped laterally. Otherwise, the heating wires and the aerial wire of the defroster inside the rear window may be damaged by accident.

External Rear-view Mirror Defroster (if equipped)

When the defroster switch of the rear window is pressed down, the heating panel in the external rear-view mirror will make the mirror clear quickly.

Tips

- Do not adjust the external rear-view mirror whilst driving. Otherwise, it may cause incorrect operation of the car, and result in an accident.
- Prolonged use of the electric-heating defrosting function for the rear-view mirror may lead to premature aging of the mirrors, therefore, please turn off the electric-heating defrosting switch when not in use.



Chapter 1

Section 4

Operation of Instruments and Controllers

Instruments and Indicator Lights

Speedometer.....	1-48
Outdoor Temperature Display	1-48
Mileage Information Display	1-48
Gear Display (optional).....	1-48
Tachometer	1-48
Coolant Thermometer	1-48
Fuel Gauge	1-49
Driving Information Display	1-49
Menu Adjustment Display.....	1-50
Indication Information Display	1-53
Fault Information Display.....	1-53
Indicator for Unfastened Front Passenger Seat Belt	1-54
Low Engine Oil Pressure Indicator Light	1-55



Charging Indicator	1-55
Engine Fault Indicator Light	1-55
Parking Brake System Indicator Light.....	1-56
SRS Indicator Light.....	1-56
ABS Indicator.....	1-56
Car Doors and Back Door Opening Monitor Light.....	1-57
Steering Signal and Danger Alarm Indicator Light.....	1-57
Width-indicating Light Indicator.....	1-57
Low Fuel Indicator Light.....	1-57
Safety System Indicator Light	1-57
Main Beam Indicator Light	1-58
Front Fog Light Indicator.....	1-58
Rear Fog Light Indicator	1-58
Main Indicator Light for Cruise Control (optional).....	1-58
Cruise Control Indicator Light (optional)	1-58
SVS Indicator Light	1-58
Smart Key, Key Position Indicator	1-58
Emergency Light.....	1-58
Sunroof not Closed Alarm Function (optional)	1-58

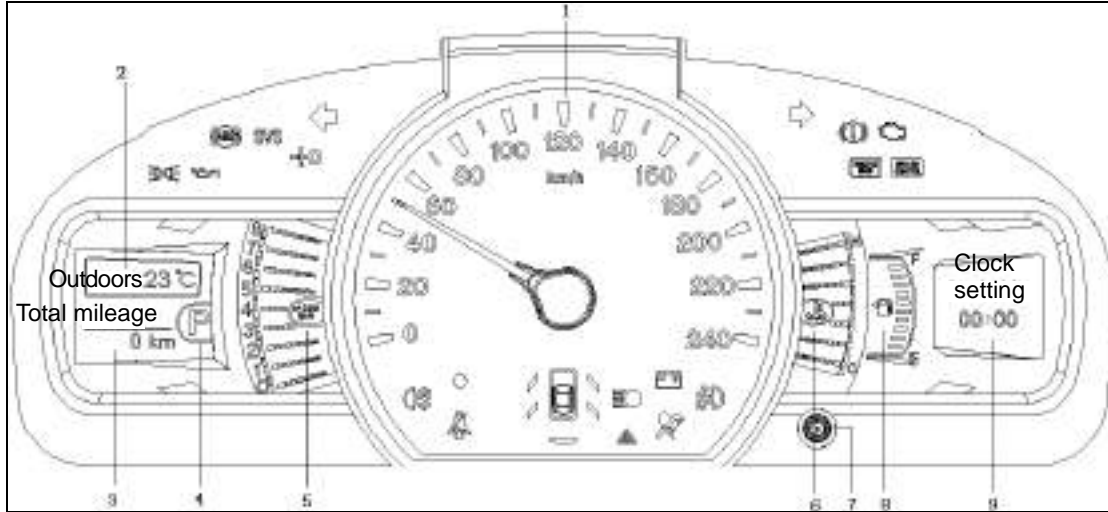

1. Speedometer
2. Outdoor temperature display
3. Mileage information display
4. Gear Display
5. Tachometer
6. Coolant thermometer
7. Travel reset button
8. Fuel Gauge
9. Driving information display



Speedometer

The speedometer displays the car speed in km/h.

Outdoor Temperature Display

Pressing gear ON on the start button; the instrument will display the present outdoor temperature at $^{\circ}\text{C}$ accurately.

Mileage Information Display

Mileage information display content includes the total mileage, mileage 1 and mileage 2.

Total mileage: the total accumulated mileage of your car.

Mileage 1/Mileage 2: the mileage calculated after the last reset. Mileage 1 and mileage 2 are independent of each other, so there will be two kinds of travel records.

By pressing the travel reset button for a short time repeatedly, information of the total mileage, Mileage 1 and Mileage 2 can be displayed in turn.

When the power is at gear ON, the selection at the last power-off is displayed.

Resetting operation: first select Mileage 1 or Mileage 2 to be reset, and then press & hold the travel reset button until the displayed value is "0.0 km".

Gear Display (optional)

Displays the current gear.

Tachometer

The tachometer indicates the rotation speed in rpm (revolutions per minute). It is used to select the correct moment for gear shifting during driving.

Driving at high engine speeds will lead to excessive wear of the engine and higher fuel consumption.



WARNING

Do not allow the needle to enter the

red area, which indicates danger to the engine and may result in severe damage.

Coolant Thermometer

By shifting the start button on the gear ON, the thermometer displays the temperature of the engine cooling fluid.

During normal operation, the needle should ascend from the bottom mark to the middle.

Under adverse driving conditions, e.g. hot seasons, long uphill driving or high-speed driving, the engine may overheat.

If the needle of the coolant thermometer moves to the red area, the cooling fluid temperature icon  will turn red, and the right-hand information display will show "Over-high temperature of cooling fluid" at the same time, which means



that the engine temperature is too high. Please park your car on a safe section of road immediately to allow the engine to cool down and contact the BYD auto sales service station.

Fuel Gauge

It is used to indicate the approximate amount of fuel remaining in the fuel tank.

The displayed value will be more accurate when the car is driven on a smooth road. The indicated actual amount of fuel remaining will deviate slightly when the car is driven round bends or on rough roads.

Pressing down the start button and putting the power at the gear ON; the corresponding liquid crystal band in the instrument will illuminate to indicate the present approximate fuel amount remaining in the fuel tank. After the power is turned to gear OFF,

the fuel indication band will switch off.

In the following cases, fuel in the fuel tank may move around and the indicated fuel amount on the fuel gauge may vary and the indicator light for low fuel may come on earlier.

- 1) Emergency braking, accelerating or turning;
- 2) When driving on a slope or bend.

If the remaining fuel is consumed to a certain amount, the first point on the scale of the fuel indicator will flash, and the indicator light for low fuel will come on as well. Meanwhile, the right liquid crystal display shows "Please add fuel" to remind the user to refill with fuel as soon as possible.



WARNING

- Avoid driving with a low fuel

level. When all fuel is used up, the engine will stall and the catalytic converter will be damaged.

Driving Information Display

The driving information includes the fuel consumption, the average fuel consumption, the transient fuel consumption, cruising range, the average car speed and the driving time.

Fuel consumption: used to indicate the amount of fuel consumed from the last reset to the present; the value is not entirely the same as the actual one.

Average fuel consumption: used to indicate the average fuel consumption per 100 km from the last reset to the present. The information will be displayed until the car has been driven a certain distance. It is





indicated in L/100 km.

Transient fuel consumption: when the start button is at gear ON, the transient fuel consumption is indicated in litres per hour (L/h) in the case of idle speed, and indicated in litre per 100 km (L/100 km) after the car speed reaches a certain value. The information is closely related to the action of accelerating and braking.

Cruising range: used to indicate the remaining travelling distance calculated from the amount of remaining fuel in the fuel tank. The value is not entirely the same as the actual one. When the fuel level is low and the driving mileage is below a certain value, the cruising range is displayed as "- - km".

Average car speed: used to indicate the average car speed from the last reset to the present. It is indicated in km/h.

Driving time: used to indicate the time of idle speed and driving accumulated from the last reset to the present.



Driving information operation: press button   on the steering wheel to switch the displayed driving information. Select any interface of fuel consumption/average fuel consumption/average car speed/driving time and hold button , and then the value in the selected interface will reset to zero.

Menu Adjustment Display

It is used to display the car status information and set the car functions and instrument display effects, etc.

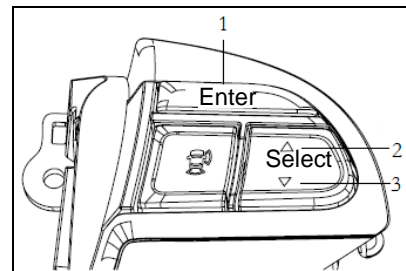
By operating the buttons on the steering wheel, the driving information display on the right LCD is switched to the menu adjustment interface.



1.  used to ascertain the selected menu option.
2.  used to scroll up the menu bar.
3.  used to scroll down the menu bar.

The menu structure is shown as follows:

- Maintenance
 - ◆ Maintenance interval
 - ◆ Maintenance mileage
 - ◆ Check
- Language



- Individual setting
 - ◆ Subject element
 - ◆ Car speed alarm
- Reset

The menu functions are shown as follows:

1. Maintenance: set the maintenance functions and status

When the maintenance function is initiated, if maintenance is due or overdue, by pressing down the button, the car will be at the power gear ON and the right LCD will display the corresponding indication information.

1.1 Maintenance interval: set the maintenance interval status

Display item	Function
Maintenance interval	Menu name
XX days	Maintenance interval

or - - -	set currently or if the function is disabled, three short dashes will be displayed
ON/OFF	Initiate or disable the function for maintenance interval
+30 days	30 days as the increment to extend the maintenance interval
-30 days	30 days as the increment to shorten the maintenance interval
reset	Reset the maintenance interval
return	Exit from the menu of maintenance interval and return to the previous menu

1.2 Maintenance mileage: set the

maintenance mileage state	
Display item	Function
Maintenance mileage	Menu name
X km or - - -	Maintenance mileage set currently or if the function is disabled, three short dashes will be displayed
ON/OFF	Initiate or disable the function of maintenance mileage
+500 km	500 km as the increment to increase the maintenance mileage
-500 km	500 km as the increment to reduce the maintenance mileage
reset	Reset the maintenance mileage
return	Exit from the menu for



the factory default value.

	maintenance mileage and return to the previous menu
--	---

1.3 Check: check the current remained maintenance interval and maintenance mileage.

2. Language: set the display language type

3. Individual setting: set the individualised functions

3.1 Subject element: set the subject colour for the left and right LCD

3.2 Car speed alarm: set the value for the car speed alarm

If the car speed reaches the set alarm value, the alarm information will be displayed in the right LCD of the dashboard.

Display item	Function
Car speed	Menu name

alarm	
X km/h or - - -	Alarm speed set currently or if the function is disabled, three short dashes will be displayed
ON/OFF	Initiate or disable the function of car speed alarm
+10 km/h	10 km/h as the increment to increase the alarm speed
-10 km/h	10 km/h as the increment to reduce the alarm speed
return	Exit from the menu for car speed alarm and return to the previous menu

4. Restore factory settings: after the function is selected, the current set values will be deleted and reset to



Indication Information Display

It is displayed in the right LCD and used to remind the user of the car state change.

Display description or buzzer tone	Description
Key is not detected	If key is not detected, this information will be displayed after pressing starting switch.
Low key battery	This information prompts key battery is running low. Please change battery.
Parking brake is not released.	When the vehicle speed exceeds 5 km/h and the parking braking is

	not completely released, this information will be displayed with a buzzer warning.
Please refill fuel	When remaining fuel is low, this information will be displayed with buzzer warning.
XX days to the maintenance date	The information is displayed to indicate when the maintenance interval is due soon.
XX km to the maintenance mileage	The information is displayed to indicate when the maintenance mileage is due soon.
XX days XXX km to the	The information is displayed to indicate

maintenance date	when both the maintenance interval and the maintenance mileage are due.
It is time for maintenance	The information is displayed to indicate when the maintenance interval or the maintenance mileage is due.
Please ensure the main menu is initiated for safe driving	When the vehicle speed exceeds 5 km/h and the menu interface is accessed, the information will be displayed.

Fault Information Display

It is displayed in the right LCD and



used to indicate the user to faults with the car. In this case, you have to contact the BYD auto sales service station for repair.

Display description or buzzer tone	Description
Cooling fluid temperature is over high	This information will be displayed when the cooling fluid temperature is above high. Stop the car immediately and contact BYD auto sales service station.
Low engine oil pressure	The engine oil is not sufficient. Stop driving and contact the BYD auto sales service station immediately.
Check charging	This information indicates that there is

system	fault with the charging system. Stop the car immediately and contact the BYD auto sales service station.
Check brake system	This information indicates that the brake fluid level is low or there is a fault with the braking system. Stop the car immediately and contact the BYD auto sales service station.
Check the ABS system	This information will be displayed when there is fault with the ABS or braking system. Contact the BYD auto sales service station for inspection immediately.
Check the	The information will be

SRS system	displayed when faults are found with the SRS. Contact the BYD auto sales service station for inspection immediately.
Please inspect the vehicle network	This information will be displayed when the vehicle network is abnormal. Stop the car immediately and contact the BYD auto sales service station.

Indicator for Unfastened Front Passenger Seat Belt

The driver seat belt prompt system works via the indicator light and the buzzer and is used to remind the driver and the passenger to fasten the seat belts.



Pressing the start button when the power is at gear ON; the indicator light will flash and buzzer beep to remind the driver to fasten the seat belt. When driving, the indicator light will flash repeatedly and the buzzer sound. If the seat belts remain unfastened for some time, the indicator light stays on constantly.

If both the driver and the passenger have fastened the seat belts, the indicator light will turn off and the buzzer will stop beeping.



Low Engine Oil Pressure Indicator Light

The indicator light will come on to indicate that the engine oil pressure is low.

If the light flashes or is on constantly whilst driving, the car should be driven

away from the road and parked in a safe place, and the engine should be stopped immediately. Ask for help from the BYD auto sales service station.

When the engine runs at idle speed, the indicator light may flash at intervals or come on temporarily after emergency braking. When the engine is accelerated gradually, the indicator light may go out, which is normal.



WARNING

When the indicator light for low engine oil pressure comes on, park the car safely and stop the engine immediately. Otherwise, the engine will be damaged.



Charging Indicator

If the light comes on during engine operation, it means that something is wrong with the charging system. When the start button is at gear ON, the indicator light will come on. Normally, after the engine is started, the indicator light will go out.

NOTE

When the charging indicator is on and the right LCD displays "Please check the charging system", stop the car and the engine as soon as possible and contact the BYD service shops.



Engine Fault Indicator Light

Pressing the start button to put the power at gear ON; the indicator light will come on for several seconds and then go out. If the indicator light comes on in other cases, it means



that something is wrong with the engine's EFI (electrical fuel injection) system. Please contact the BYD service shops for inspection/as soon as possible.

Parking Brake System Indicator Light

When the start button is at gear ON, the indicator light will come on in the following cases:

- 1) When the brake fluid level is under the minimum.
- 2) The car is stopped and the parking brake handle is pulled up.



WARNING

When the parking brake system indicator light comes on, please inspect the car immediately, as it is

quite dangerous to keep driving.

Contact the BYD service shops to inspect the car in the following cases:

- 1) When the start button is at gear ON; the indicator light will not come on even if the parking brake is engaged.
- 2) When the start button is at gear ON; the indicator light will not go out even if the parking brake is released.



SRS Indicator Light

The indicator light is used to monitor the air bag system.

When the start button is at gear ON, the indicator light will come on for about 5 s and then go out, which means that SRS is working normally.

If any of the following occurs, it means

that something is wrong with SRS. Please contact the BYD service shops for inspection as soon as possible:

- When the start button is at gear ON, the indicator light is not on or is on constantly.
- This light comes on or flashes whilst driving.



ABS Indicator

When the start button is at gear ON, the indicator light will come on for several seconds and then go out.

If the indicator light is not on when the start button is at gear ON, or is on at any other moment, it means that something is wrong with the ABS. Please contact the BYD auto sales service station as soon as possible.

If the indicator light comes on, the car will still have normal braking ability but not the ABS function.

The instantaneous flashing of the indicator light during operation does not indicate any fault.



Car Doors and Back Door Opening Monitor Light

If the back door or any of car doors is not closed properly, the corresponding lights on the monitor light will come on.



Steering Signal and Danger Alarm Indicator Light



When you indicate, the left or right steering signal light will flash. If the light doesn't flash or flashes rapidly, it generally means that something is wrong with the steering signal or the

relevant circuit.

When the danger alarm button is pressed, both the dashboard light and the steering signal light will come on. All external steering signal lights will flash as well.



Width-indicating Light Indicator

When the headlight switch is at position  or , the indicator light will come on. If you have turned the power to gear ACC/OFF and the headlights have not been turned off, the indicator light will stay on constantly.

After the headlight switch is put to position , the background light intensity of the combination instrument and the dashboard can be

adjusted by turning the travel reset button on the instrument.

When the background light is adjusted, the right LCD will show the levels of background light adjustment.



Low Fuel Indicator Light

The indicator light is on the fuel gauge. If the indicator light is on, it means that there is not much fuel remaining in the tank and reminds the user to refill with fuel as soon as possible. On a slope or bend, the low fuel indicator light may come on earlier due to fuel moving around in the tank.



Safety System Indicator Light

When the safety system is set, the indicator light will come on constantly for several seconds and then start flashing, which means that the car has entered the anti-theft state.



Main Beam Indicator Light

When the main beam headlights are used, the light will come on.

Front Fog Light Indicator

When the front fog lights are turned on, the indicator light will come on.

Rear Fog Light Indicator

When the rear fog lights are turned on, the indicator light will come on.

Main Indicator Light for Cruise Control (optional)

The indicator light will come on when the car enters cruise control, which means the car runs at a set speed.

Cruise Control Indicator Light (optional)

The indicator will come on when you press down the master cruise control button.

SVS SVS Indicator Light

Pressing the start button and putting the power at gear ON; the light will come on for several seconds and then go out. If the indicator light is turned on or flashes at other times, it means that something is wrong with the AT transmission box or the engine control system. In this case, the car should be driven to the BYD auto sales service station for inspection.

Smart Key, Key Position Indicator

Pressing the start button, if there is not a key; the indicator light will come on for several seconds and the buzzer will beep; if the indicator light flashes, it means that the power of the smart key is low. If the indicator light is not on, please supply power for starting.

If the key is taken into the car several seconds after the indicator light is on, power can be supplied for starting

when the indicator light is off.

Emergency Light

Once the warning light is on, the right LCD will display the fault information or prompt information. The light is on to remind the user.

Sunroof not Closed Alarm Function (optional)

When the power is at gear OFF and the sunroof is not closed, the instrument buzzer will beep if the driver opens the driver-side door. Meanwhile, the right LCD will show "Sunroof Unclosed" to remind the user that the sunroof is open presently.

When the sunroof is open and the power gear is shifted from ON to OFF, the buzzer will also beep and the LCD will show the prompt information as well.



Chapter 1

Section 5

Operation of Instruments and Controls

Comfort and Convenience Devices

Indoor Air Environment Control System	1-60
CD Multimedia System (if equipped)	1-65
Cigar Lighter	1-66
Ashtray	1-66
Accessory Power Socket (optional)	1-66
Coat Hook	1-67
Interior Rear-view Mirror	1-67
Carpet and Mat	1-68
Cruise Control (optional)	1-70
Auxiliary Parking System (optional)	1-71
Parking Imaging System (optional)	1-74



Indoor Air Environment Control System

Air conditioner panel (standard)

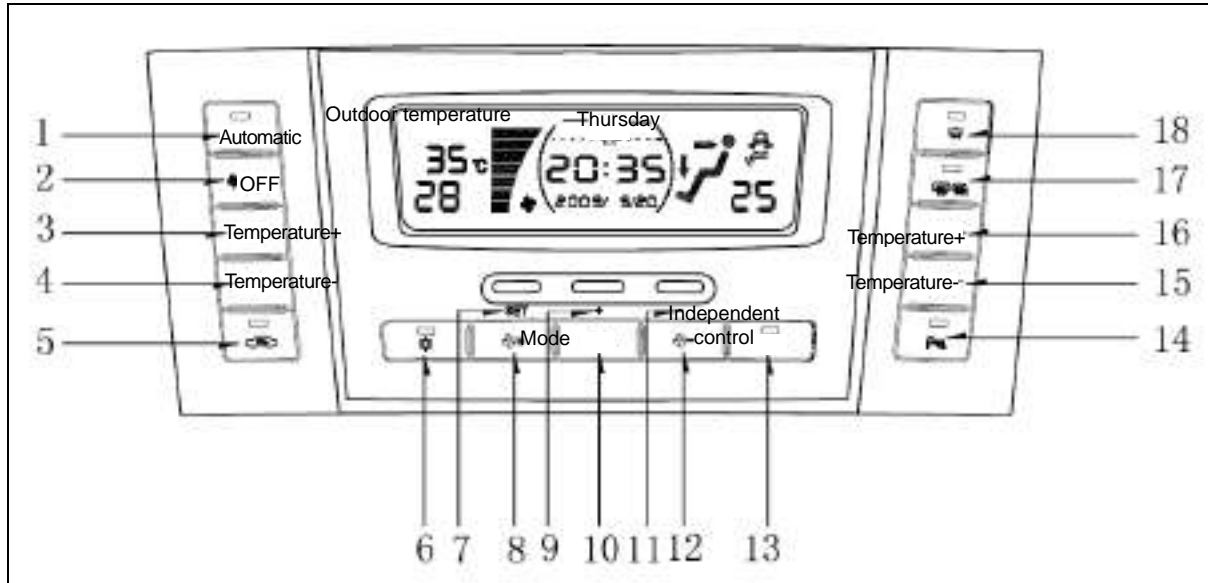



1. Automatic Control	2. Turn Off Air Conditioner	3, 4. Driver Temperature Adjustment Button	5. Internal & External Circulation Mode
6. Cooling Button	7, 9, 11. Electronic Clock Adjustment Button	8, 12. Blower Capacity Adjustment Button	10. Supply Mode Button
15, 16. Passenger-side Temperature Adjustment Button	17. Rear Defrosting	18. Front Defrosting Button	

Note: Strong Cooling Button: When this button is pressed down, the indicator is lit and the temperature turns to the lowest (LO) automatically, the circulation mode turns to "Internal" and the capacity turns to highest. This feature will decrease the interior temperature as soon as possible.



BYD AUTO S6, S6A, S6K Owner's Manual

Air conditioner panel (deluxe)

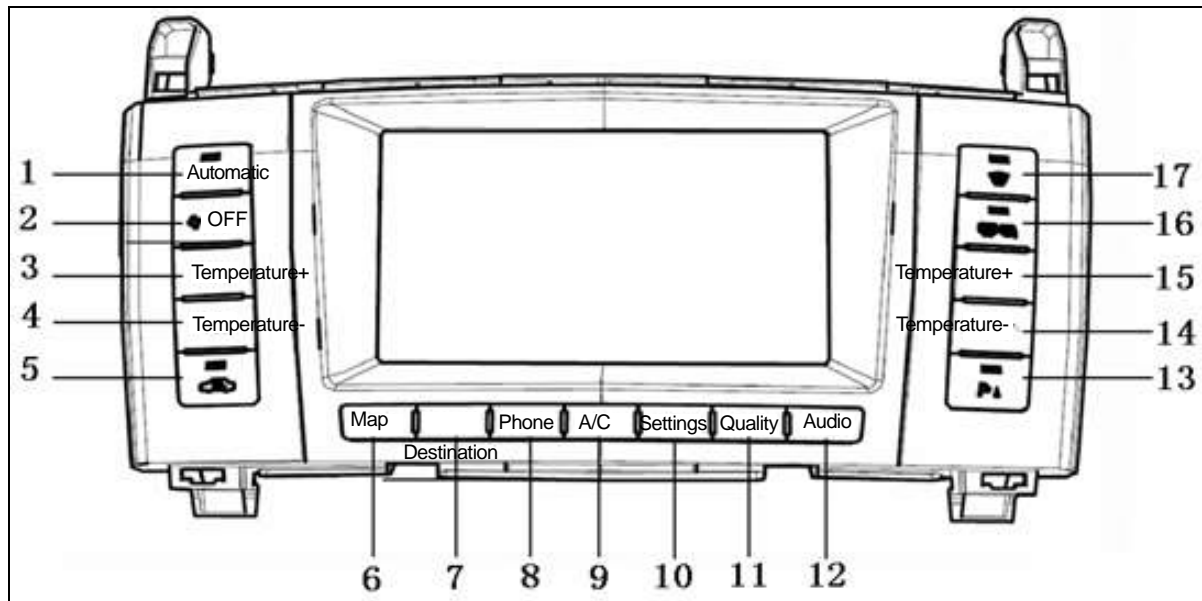

1. Automatic Control, 2. Turn off Air Conditioner, 3, 4. Driver Temperature Adjustment Button, 5. Internal & External Circulation Mode Button, 6. Map Navigation Button, 7. Destination Setting Button, 8. Phone Button, 9. Air Conditioner Control Button, 10. Settings Button, 11. Image Quality Adjustment Button, 12. Audio System Button, 13. Reversing Radar Switch, 14, 15 Passenger –side Temperature Adjustment Button, 16. Rear Defrosting Button, 17. Front Defrosting Button

Multifunction Display

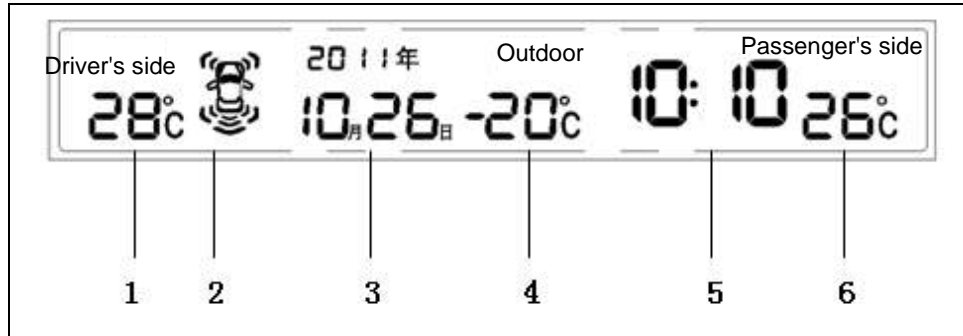

1. Driver-side Interior Temperature Display, 2. Reversing Radar Display, 3. Date Display, 4. Exterior Temperature Display, 5. Time Display, 6. Passenger-side Interior Temperature Display

Tips

If turning to ON position or started in extreme temperature, the multifunction display may be abnormal (e.g. LCD can't be lit). When the temperature resumes normal, the display will work normally.



Automatic operation

After the automatic operation button is pressed, the air conditioning will be turned on and the system is set to fully automatic mode. The cooling or heating air ratio and air volume will be adjusted automatically to raise or reduce the current indoor temperature to the set temperature.

When the temperature is set to the low limit (LOW) or the high limit (HI), the air conditioning system will just run in the cooling mode or heating mode.

Internal & external circulation button

After the button is pressed, the indicator light on the button will come on and air from inside the car will be sent into the car again via the system (internal circulation mode). When the button is pressed again, the indicator

light will go off and air will enter from outside the car (fresh air mode, i.e. external circulation mode).

Independent temperature control

When the independent control button (the indicator light is on) is pressed, the driver-side and the passenger-side temperature can be adjusted respectively.

When the independent control button is pressed again (the indicator light is off), the temperature of the driver side and the passenger side will be the same if the driver-side temperature button is adjusted.

Mode Button

Air direction can be selected by pressing the button.

Front defrost button

When the button is pressed, the indicator light will come on and the

main air flow will blow to the front windscreen for fast defrosting. Whichever mode has been selected, the mode specified using the button will be the top priority. The air conditioning will be turned on and operated automatically. The system will select the fresh air mode. For fast defrosting, the fan must be set to the highest speed manually. Also, the air flow to the windscreen can be increased by closing the side air outlet of the dashboard.

When the button is pressed again, the system will be reset to the original setting.

Tips

To disconnect the compressor

- In auto mode, the AUTO key lamp is lit, and the compressor is turned on by default. At this moment, tap the A/C key on the



multifunction display twice (the key turns to grey, and the AUTO key lamp is off) to disconnect the compressor.

- In semi-auto mode, the compressor actuates/disconnects intermittently. At this moment, tap the A/C key on the multifunction display (the key turns to grey) to disconnect the compressor.
- In manual mode, tap the A/C key on the multifunction display to light the key lamp, and the compressor actuates. Then, tap the A/C key to turn it to grey and disconnect the compressor.

Tips

Air conditioner odor:

- After the air conditioner is turned on for 10-20S, there may be

musty odor. It is normal because the water vapor in the air condenses into water droplets attaching to the surface of the evaporator core when the air conditioner is working, and the water absorbs part of the body sweat, smoke, and dust in the car.

- The water absorbing odor and dust will be discharged through the drain pipe, but it can't be drained completely. After a long time, the evaporator surface will be moldy due to a lot of dust and impurities attached.

Odor processing method:

- Clean the air conditioner evaporator with degreasing solvents.

Odor prevention method:

- Before stopping the car, turn off the cooling air and turn on the

natural wind to maintain relatively dry;

- Check and replace the filter regularly;
- Keep the interior clean and fresh.

CD Multimedia System (if equipped)

Tips

- Before the engine is started, please do not use the audio system for a long time to prevent the storage battery from running out of power.
- The internal and external edges of new laser CDs may be rough, therefore remove any burrs before they are used. Otherwise, the plastic on the rough edges may cause interrupted playback and



cause the CD pickup to become damaged.

- Do not insert any foreign materials into the CD player.
- Please use standard-size genuine discs. Some pirated discs may jam in the CD pickup and damage the CD pickup.
- USB device prompt:

- 1) It is suggested the data cable provided with the car be used to connect the flash memory stick.
- 2) The USB port is only for the flash memory sticks with capacities lower than 8 GB rather than the mobile hard disk.
- 3) The USB port only supports music files that adopt the FAT system and MP3 format.
- 4) The USB port may not support a USB storage device with low

compatibility.

- In the event of smoke or odour for example, please cut the power supply immediately and contact the BYD auto sales service station. Do not handle it by yourself.

Cigar Lighter



WARNING

If the cigarette lighter can not be ejected by itself after being pressed, please contact the BYD auto sales service station for inspection as soon as possible.

Ashtray



WARNING

- Close the ashtray completely after use, so as to reduce the possibility of accidents while driving or injury during emergency braking.
- The ashtray can only be used to extinguish cigarettes and cigars etc. To prevent damage to your car through fire, please do not place paper or other combustibles in the ashtray.

Accessory Power Socket (optional)



WARNING

The accessory power socket can only provide 12 V DC power to accessories whose rating power is

no more than 120 W. The cigarette lighter must not be inserted into the socket. Large-power accessories are prohibited to be used.

Coat Hook

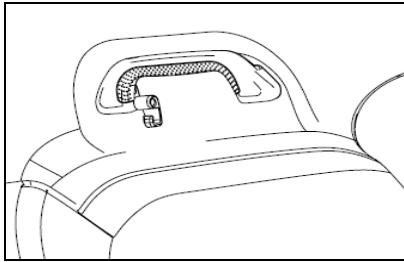

Please pull down the coat hook when using it.

Tips

Please hang the coat or cap directly on the hook. Do not hang other objects on it (e.g. clothes rack or

sharp objects). Otherwise, when the curtain air bag (if equipped) is deployed, these objects may be thrown out due to the strong impulsive force, which may prevent the air bag from being deployed.

Interior Rear-view Mirror Interior Rear-view Mirror (standard)

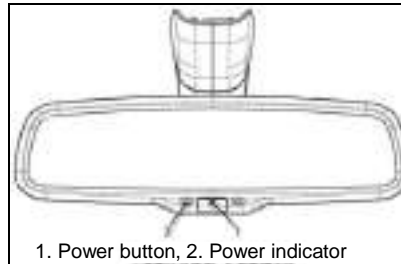

Interior Rear-view Mirror (deluxe)

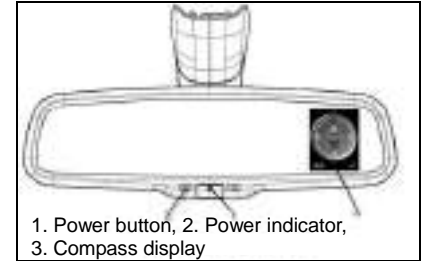

1. Adjust the position of the interior rear-view mirror to enable watching the rear vision of the car through the rear windshield.
2. The automatic electronic anti-glare feature is available for all models.
 - (1) Enable the electronic anti-glare feature—The power indicator is lit; The interior rear-view mirror may have two conditions:
 - Daytime: the mirror shows clear rear vision.
 - Night: When headlights irradiate from



the rear side, enable the anti-glare feature, and the mirror reflectance decreases; when there is no headlights irradiation from the rear side, disable the anti-glare feature, and the mirror reflectance resumes normal.

(2) Enable the electronic anti-glare feature—The power indicator is off. It is recommended to disable this feature when backing the car in the evening.

3. Compass display precautions of electronic compass interior rear-view mirror



- (1) The electronic compass shows when the car is started and hides when the engine flames out;
- (2) If the reversing radar is turned on, the electronic compass does not show during backing;

(3) The direction indicated by the car front in the figure is the actual running direction;

(4) Altitude shows the altitude at which the car is located; it is normal if the accuracy error is less than 50m.

 Warning
Do not adjust the interior rear-view mirror while driving, or else it may make the driver unable to control the car, leading to the accident and causing casualties.

Carpet and Mat



Carpet and mat: the mat fixing clamp is standard equipment. The carpet or mat provided by BYD is equipped with a fixing clamp, and is designed so that it can be clamped by the fixing clamp and nylon catches are sewn or welded on its back, which can prevent disruptions to the operation on the pedal due to forward slipping of the mat. For the S6, only the left front (driver) mat is equipped with the fixing clamp.

a. Left front (driver) mat installation methods are as follows:

(1). Install the mat fixing clamp:

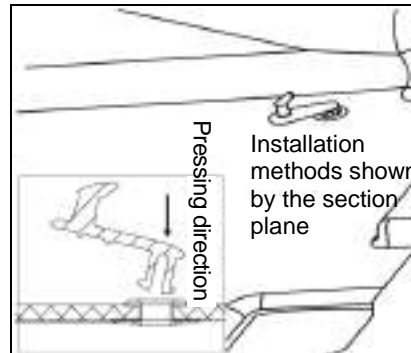
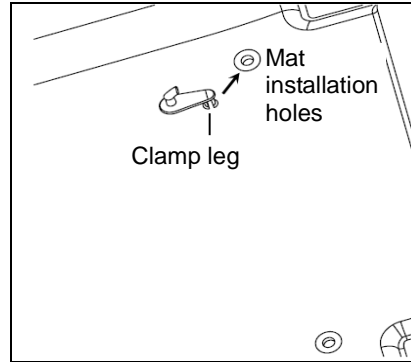

As shown in figure, press the clamp down a certain angle. The mat can be installed after ensuring that the clamp is installed well.

(2). Tear off the three non-woven fabric strips on the nylon catches on the back of the left front mat, and attach the nylon catches and the carpet together firmly.

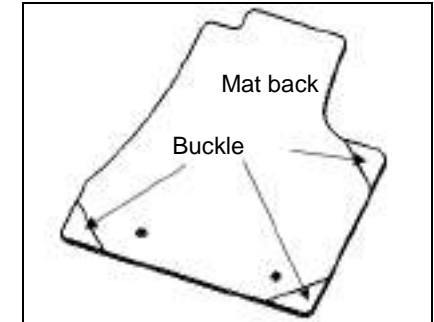

b. Right front (passenger) mat installation methods are as follows:



Tear off the three non-woven fabric strips on the nylon catches on the back of the right front mat, and attach the nylon catches and the carpet together firmly.

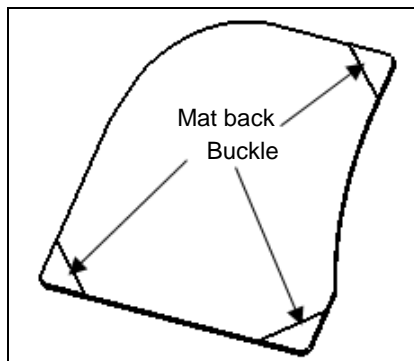

c. Rear mat installation methods are as follows:

Tear off the six non-woven fabric strips on the buckle on the back of the

rear mat, and attach the buckle and the carpet together firmly.

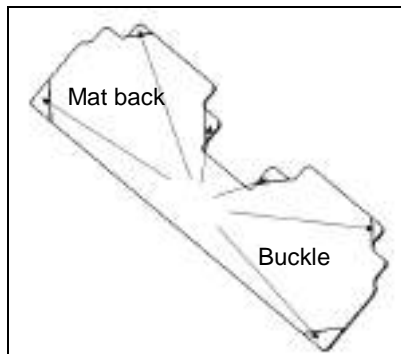

Tips

- Make sure the mat is placed on the floor correctly and is fixed with the fixing clamp to avoid sliding or rolling.

Cruise Control (optional)

With cruise control, you can maintain

a preset speed higher than 40 km/h without having to depress the accelerator pedal. The function can be initiated for driving on straight and smooth motorways.

Initiation of cruise control

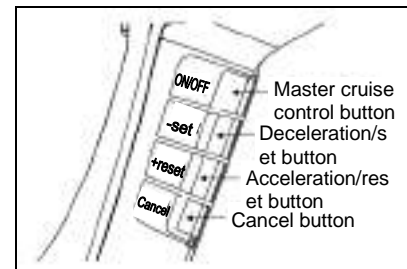

a. Press the master cruise control button (ON/OFF) on the right of the steering wheel and the indicator light for cruise control on the dashboard comes on.

b. Increase the car speed to above 40



km/h.

c. Press the deceleration/set (-/SET) button to initiate the cruise control.

d. The cruise control cannot maintain the set speed when the car is going up or down a slope.

Changing a set speed

The preset cruise speed can be raised with any of the following methods:

- The car can be accelerated continuously by holding the acceleration/reset (+/RES) button. When the expected cruise speed is reached, simply release the button.
- Depress the accelerator pedal. Press the deceleration/set (-/SET) button after the expected cruise speed is reached.
- If you want to raise the speed slightly, you can press the

acceleration/reset (+/RES) button repeatedly. The speed will increase by 1.6 km/h for each press.

The preset cruise speed can be reduced with any of the following methods.

- The car can be decelerated by holding the deceleration/set (-/SET) button. When the expected cruise speed is reached, simply release the button.
- Depress the brake pedal lightly. When the car is decelerated to the expected speed (over 40 km/h), press the deceleration/set (-/SET) button. The car will maintain the expected speed.
- If you want to reduce the speed slightly, you can press the deceleration/set (-/SET) button repeatedly. The speed will decrease by 1.6 km/h for each press.

Canceling cruise control

Cruise control can be cancelled with any of the following methods:

- Depress the brake pedal.
- Press the cancel (CANCEL) button on the steering wheel.
- Press the master cruise control button (ON/OFF).
- Exit from gear D.

Auxiliary Parking System (optional)



WARNING

- When the speed is over 10 km/h, the auxiliary parking system will stop working.
- Do not add any other object within the working range of the sensor.
- Do not wash the sensor with water or steam. Otherwise, the



sensor may be damaged.

During parking, the auxiliary parking system will remind the driver of the distance between the car and the barrier through the multi-functional display, touch screen and buzzer. A sensor is used in this system to detect the barrier.

Auxiliary parking switch (optional)

On the air conditioning panel

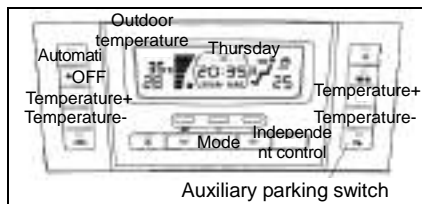

After the switch is pressed, the multi-functional display will illuminate

the car-shaped icon  to inform the

user that the system is working.

Display

When the sensor detects a barrier, the icon will be displayed on the multi-functional display/air conditioning panel and touch screen according to the shape of the barrier and the distance between the car and the barrier.

◆ Multi-functional display/air conditioning panel



◆ Touch screen

When the car moves forward, the touch screen will show the full-screen display.

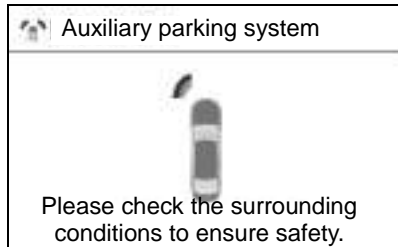

When the car reverses
The top right of the screen will display





Distance display and buzzer

When the sensor detects a barrier, the direction of the barrier and the approximate distance between the car





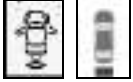

and the barrier will be displayed and the buzzer will beep.

Illustration of the rear central sensor operation

Approximate distance	Display illustration	Alarm sound
1.2m to 0.8 m		Slow
0.8m to 0.50 m		Fast
0.5m or shorter		Long beep

Angle sensor operation illustration

Approximate distance	Display illustration	Alarm sound

0.6m to 0.5m			Fast
0.5m or shorter			Long beep

Sensor detecting range

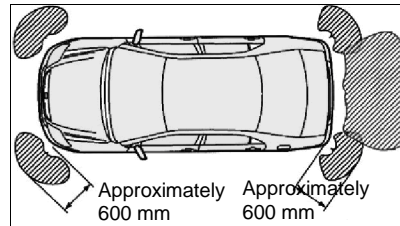

When the car moves forward, the front sensor will work; when the car reverses, all sensors will work.

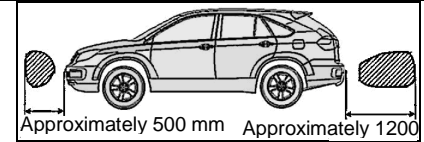

Some car conditions and the surrounding environment may affect the performance of the sensors to detect barriers accurately. Details are shown as follows:

- There is dirt, accumulated water or mist on the sensor;
- There is snow on the sensor or the sensor is frozen;
- The sensor is covered with any manner;
- The car inclines laterally or is over-loaded;
- The car is driven on very bumpy roads, slopes, gravel roads or grass;
- The sensor is re-painted;



- It is quite noisy around the car due to the noise produced by vehicle horns, motorbike engines, pneumatic braking sounds of large vehicles, or other noises that may produce ultrasonic waves.
- There is another vehicle equipped with an auxiliary parking system nearby;
- The car is equipped with towing rings;
- The bumper or the sensor suffers a strong impact;
- The car is approaching a high or twisty road edge;
- In the heat of the sun or severe cold weather;
- Non-original suspension is installed.

Except the above cases, the sensor may fail to judge the actual distance to some barriers correctly due to their shape and materials. Please pay

particular attention to the following barriers.

- Electric cables, fences and ropes, etc;
- Cotton covers, snow, and other materials that absorb radio waves;
- Objects with sharp edges or corners;
- Low barriers;
- High barriers whose upper section stretches out toward your car;
- Objects under the bumper;
- Objects close to the car;
- People around the car (dependent on their clothing).

If the multi-functional display or the touch screen shows a picture or the buzzer beeps, it may be that a sensor has detected a barrier or the sensor has experienced external interference. If the phenomenon continues, you can contact the BYD service shops for

inspection.

Parking Imaging System (optional)

The parking imaging system helps the driver park the car by displaying the pictures of surrounding objects in real-time.

The parking imaging system is an additional means for parking and is divided into reversing camera mode and right front camera mode.

Reversing camera mode

When the start button is at gear "ON", move the shift lever to gear "R" to initiate reversing camera mode.

The reversing camera is installed on the back door.

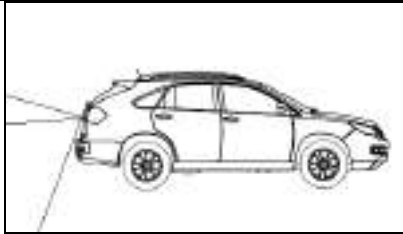

Display on the touch screen

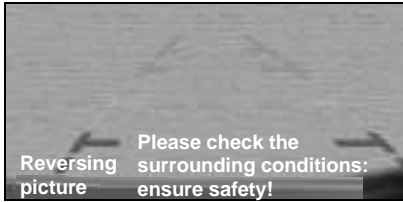

The two lines in the picture are the reversing safety lines.

Red: within 0-0.5 m

Yellow: within 0.5-2 m

Green: over 2 m

Right front camera mode

When the start button is at gear ON,

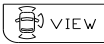
press button  on the steering wheel to initiate right front camera mode. If the external environment is dark, the right front picture footlight will be lit to provide light for the camera, so that the surrounding objects can be seen clearly. To turn off the camera system,

press button  on the steering wheel.

The right front camera is installed at the right external rear-view mirror.

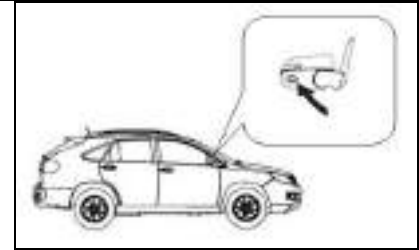

Display on the touch screen



The displayed area varies with the car directions and the road conditions.

Limitation of the parking imaging system



Objects close to the two side corners of the bumper bar or under the bumper can not be seen in the reversing picture.

As shown in the following figure:

Objects close to the side corners of the bumper

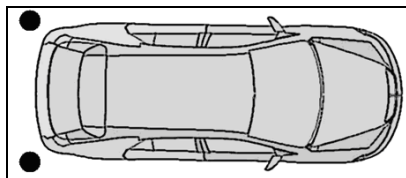

Objects under the bumper

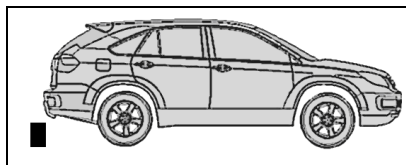

Objects right in front of the car or to the rear right of the car cannot be seen in the right front picture.

As shown in the following figure:

Object is straight ahead of the vehicle.

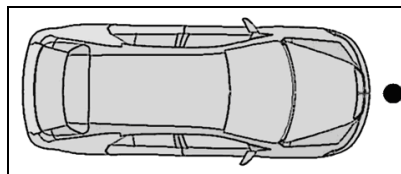

Object is at the rear to the right of the vehicle.

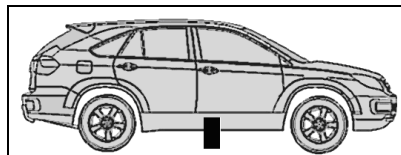

Tips

- Do not overly rely on the parking imaging system. Pay attention to your surroundings before parking.

- Never park by only looking at the screen. The distance displayed on the screen is different from the actual distance between the vehicle and the obstacle.
- If the rear door is not completely closed, do not use this system.
- The position and installation angle of a camera may alter during a rear-end collision or in the event of colliding with an obstacle. Please contact a BYD service station to check the position and installation angle of the camera.
- Do not remove, disassemble or modify the camera as there are dust prevention and waterproof structures on it.
- Exposing the system to sudden temperature changes, such as pouring hot water on the vehicle



in very cold weather, may affect proper function.

- If water, snow or mud covers the camera, wash with water and wipe the lens with a piece of soft cloth. For difficult to clean foreign matters, such as oil and rubber, use mild cleaner and water to wash and wipe it with a piece of soft cloth.
- Prevent organic solvents, waxes, glass cleaners or glass coatings from adhering to the camera. Remove immediately if attached to the camera.
- Since flashing screens on the display may appear due to blinking lights, which may affect your vision, please switch off the parking assist system with rear view camera in the event of blinking lights, such as indicator lights.

It is difficult to display an image even if the system functions normally under the following circumstances:

- 1) When the camera is in a dark area (such as at night)
- 2) When the camera is exposed to very high or very low temperatures
- 3) There is water or mist on the lens (for example, when it is raining)
- 4) The lens is dirty with snow, mud, etc. There are scratches or dirt on the lens
- 5) A strong light hits the camera



Chapter 2

Driving Guidelines

Run-in Period	2-2
Fuel	2-2
Engine Exhaust Warning.....	2-3
Brake System.....	2-4
Carrying Luggage.....	2-6
Cover Curtain (if equipped)	2-7



Run-in Period

Drive the car stably and do not drive at high speed.

BYD S6 does not have a complicated run-in procedure. During the first 3,000 kilometres, please follow the tips below to save fuel and extend the service life of the vehicle:

1. When starting and driving, avoid sudden acceleration.
2. Do not let the engine run overspeed.
3. Avoid emergency braking during the first 300 kilometres.
4. Do not drive the car for a long time at the same speed, high or low.

Fuel

Appropriately selected fuel can benefit engine performance, and is the key to controlling exhaust emissions and

protecting relevant components.

Only use #93 or above unleaded petrol.

Tips

- Do not use leaded petrol, which may cause failure of the three-way catalytic converter and abnormality of the emission pollution control device. It will also increase maintenance expense.
- Engine damage or noncompliance of emissions as a result of improper fuel is not covered by BYD S6 warranty.

Refill fuel

Fuel filler cap opening button

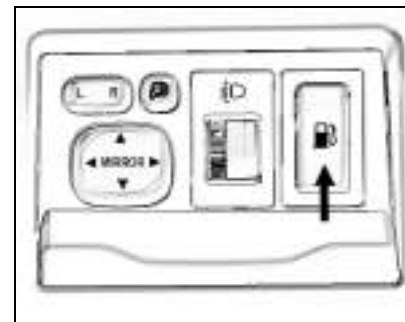

Tips

- Please refill fuel at an authorised filling station.
- Please observe the rules of the filling station.
- When the fuel tank cap is loosened, do not remove it immediately. In hot weather, if the



fuel filler cap is removed suddenly, pressurised fuel may spray out of the filler and cause injury.

Engine Exhaust Warning



WARNING

● Large amounts of un-combusted mixture gas entering the three-way catalytic converter may cause overheating of the converter and even fire. To prevent dangers, please follow the instructions below:

- 1) Do not drive the car when the fuel level is extremely low; insufficient fuel may cause misfire in the engine and overload in the three-way catalytic converter.
- 2) Do not let the engine run for over

10 minutes at high idle speed or over 20 minutes at low idle speed.

- 3) Do not let the engine run overspeed.
- 4) Do not push or pull the car for starting.
- 5) Do not press the start button when driving.
- 6) Always keep the engine at an optimum condition. If the electrical system, electronic ignition system or fuel system has a fault, the three-way catalytic converter will overheat.
- 7) If the engine has trouble in starting or stalls frequently, please check it immediately.
- 8) To ensure that the three-way catalytic converter and the exhaust emission control device function properly, BYD S6 should be

inspected periodically according to the maintenance instructions.

- Avoid inhaling exhaust gases from the engine.
- Make sure the exhaust system has no leakage or loose connections. Please check the exhaust system regularly. If the car has a collision with any objects or when you hear abnormal exhaust noise, please check the exhaust system immediately.



WARNING

- Do not run the engine for a long period in a garage or unventilated site, as exhaust gases may accumulate and cause serious danger.



- Do not stop the car with the engine running for a long time. If you have to do so, park the car in a well-ventilated area and adjust the air conditioning system to external circulation mode to allow fresh air to enter the car.
- The back door should be closed when driving. An open or partly closed back door may lead exhaust gases into the vehicle.
- To ensure normal operation of the ventilation system, keep the intake grille in front of the windscreen free from snow, leaves or other objects.
- If you smell exhaust gas inside the car, open the window immediately, find out from where the exhaust gas has entered.
- anyone and inflammables away

from the exhaust pipe.

- Do not make the engine run at idle speed or park the vehicle on ground surfaces covered with inflammable grass, leaves, paper or rags (especially wheat-straw in summer). Please avoid driving on such roads.

Brake System

The brake system is a cross hydraulic system with independent dual circuits.



WARNING

- If the engine stalls, do not depress the brake pedal repeatedly, as the vacuum pressure will be consumed gradually at each depression.
- Even if the vacuum is consumed completely, the brake can still

function effectively. But you must apply much greater depressing force on the brake pedal and the brake distance becomes longer.

- Never creep the vehicle when the engine has stalled.

Brake Pad Warning Plate

When it is necessary to replace the brake pad due to wear, the brake pad warning plate will sound. If you hear the sound continuously during driving, allow the nearest BYD service station inspect and replace the brake pad. Do not continue to drive the vehicle when hearing the alarm.

It is a normal phenomenon for friction between brake pad and brake disc to occur and sometimes make a sound during braking.

Tips
Free travel of the brake pedal is (1-5)mm, and the brake clearance is ≤ 0.15 mm.

ABS (Anti-lock Brake System)

The ABS helps prevent the wheels from locking when the brakes are applied suddenly and firmly or applied on a slippery surface, helping to ensure excellent driving stability and steering performance of the vehicle.

.It is easy to activate the ABS in wet weather conditions such as rain or snow, when depressing the brake pedal on roads with a low friction coefficient. You just need to depress the brake pedal firmly to activate ABS, so do not depress the brake pedal repeatedly in emergency braking.

When ABS is operating, the following

may occur, but they are normal phenomena:

1. Hear the ABS operating sound, or feel the pulse of brake pedal and the vibration of steering wheel.
2. When the vehicle starts or stops, you may hear some operating sounds of the ABS solenoid valve and hydraulic pump for a few seconds from the engine cabin.
3. At the end of the ABS operation, the brake pedal may move forward.

**WARNING**

- Though the ABS is helpful to keep the vehicle stable, it is also very important to observe all precautions, maintain proper driving speed and safe vehicle-to-vehicle distance. There

is a limitation of ABS's effects on vehicle stability and steering wheel controlling capability, even if the ABS functions normally.

- If the anti-skid performance of tyres is beyond their capability or wheelspin occurs when driving at high speed, it is hard for ABS to continue to control the vehicle. The size and pressure of all tyres should be as specified for the original car: the ABS uses wheel speed sensors to measure the speed of each wheel to obtain the speed of a vehicle. If you use a non-specified tyre, it may result in incorrect wheel rotation speed, and even abnormal ABS function.

- ABS is not designed to shorten the braking distance. Under the following conditions, vehicles with



ABS may need longer braking distance, compared with vehicles without ABS:

- Driving on an uneven, gravel or snowy road.
 - 1) Driving when using tyre chains.
 - 2) Driving on a pitted or rough road.

Carrying Luggage

There are many storage features on the vehicle that aid in carrying luggage safely. If luggage is overloaded or improperly loaded, it may affect the driving stability, manoeuvrability and normal operation of the vehicle, and reduce vehicle safety. Therefore, make sure to read the following instructions before loading luggage.

Roof Rack (if equipped)



WARNING

- The vehicle manoeuvrability and stability may be affected by overloading or improper loading, which may result in collisions involving injuries or death.
- When loading luggage, the total weight of the vehicle body, passengers and luggage should not exceed the maximum allowable gross weight.
- Put objects that might come into contact with persons in place or secure them.
- When loading luggage in the passenger zone:
 - 1) Do not place any objects on the package tray shelf as this can restrict your view and may result in passenger injury in the event of emergency braking.

- 2) For the sake of safety, do not stack dolls in the vehicle.
 - 3) Make sure that objects on the rear floor, under the front seats cannot roll around, to avoid influencing pedal operation or seat adjustment.
 - 4) Do not stack luggage over the front seatbacks.
 - 5) Make sure to close the package tray before driving, or else the passenger knees would be injured in emergency braking.
- When loading luggage in the luggage compartment:
 - 1) Place the luggage on the luggage compartment floor evenly. Make sure to place heavy luggage on the bottom and as far forward as possible.
 - 2) Secure the luggage with a strap or chain and make sure they cannot move whilst driving. Do not

stack the luggage over the front seatbacks.

3) If the loading objects are too big to allow you to close the back door, exhaust gases will fill the passenger zone. To avoid carbon monoxide poisoning, please see the instructions for carbon monoxide hazards in this manual.

● When loading luggage on the roof rack:

- 1) The length and width of objects should not exceed the vehicle length and width.
- 2) Ensure that luggage on the roof rack is securely attached before driving.
- 3) After loading on the roof rack, the vehicle's centre of gravity will be higher, avoid driving at high speed, urgent acceleration, sharp cornering and emergency braking.
- 4) When driving on a rough road

for a long distance, stop and check whether the luggage is still in the original location halfway.

5) The cargo weight on the roof rack should not exceed 75 kg.

Cover Curtain (if equipped)

Cover curtain installation

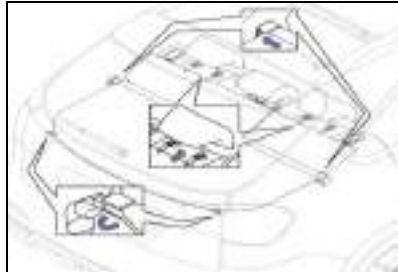

- a. Move the seat to its rearward position and lock it, adjust the seatback and headrest in place.
- b. Squeeze the two connectors of the cover curtain centrally, then install it

on the two holes on the rear side panel.

- c. Pull the rear curtain to its two connectors, then lock it.
- d. Lock the 4 pins of the front curtain onto the headrest lever.

Cover curtain removal

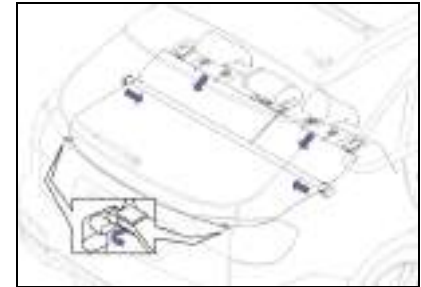

- a. Remove the two connectors from the rear curtain
- b. Remove the 4 pins from the front curtain
- c. Remove the left and right



connectors



WARNING

- Do not place any objects on the cover curtain, otherwise it may result in passenger injury in the event of emergency braking.
- Make sure to secure the cover curtain in place so as to avoid passenger injury in case of accident.



Chapter 3

Starting and Driving

Safety Check before Driving.....	3-2
Before Starting Engine	3-3
How to Start Engine	3-3
Manual Transmission	3-4
Driving Tips under Certain Conditions.....	3-5
Driving Tips in Winter	3-7
Parking Notice.....	3-8
Towing Trailer	3-9
Auto Fire Prevention Tips.....	3-10

**Safety Check Before Driving**

It is recommended to perform a safety check or have them checked by a BYD service station before driving.

Check Engine Before Starting**Vehicle Exterior Conditions**

Tyres: check the tyre pressure using a tyre gauge, inspect carefully if there are notches, breakage and foreign materials on the wheel tread, and if the tyres are abnormally or excessively worn. If yes, please check the wheel alignment and related items in a BYD service station as soon as possible.

Wheel alignment parameters

Wheel alignment	Front wheel chamber	$-0\pm 45'$
	Front	$0\pm 2\text{mm}$

wheel toe-in	$(0\pm 0.08^\circ)$
Kingpin inclination angle	$10\pm 45'$
Kingpin caster angle	$23\pm 45'$
Rear wheel chamber	$-0\pm 45'$
Rear wheel toe-in	$3\pm 2\text{mm}$ $0.12\pm 0.08^\circ$

Tyre (including spare tyre) pressure

S6 standard tyre pressure	Front wheel	Rear wheel
	210kPa	210kPa

Wheel Nuts: make sure no nuts are

loose or missing.

Leakage: after the car has stopped, check for fuel, engine oil, coolant or other fluid leakage under the car. (Water drops produced by the AC system are normal.)

Lighting: make sure headlights, parking lights, width-indicator lights, steering lights and other lights work normally. Check illumination intensity of headlights.

Vehicle Interior Conditions

Spare tyre, jack and wheel nut wrench: check tyre pressure and make sure the jack and wrench are in place.

Seat belt: check whether the buckle fastens the seat belt firmly. Make sure the seat belt has no wear or scratching.

Meters and Controllers: confirm that meter indicators, lights and defrost system function normally.



Brake: make sure the pedal has enough free play.

Engine Cabin Interior Conditions

Coolant level: check that the coolant level is correct.

Engine oil level: stop the car on level ground, then check the oil level with the oil gauge dipstick. (Refer to description in section 7.)

Battery and cables: check if the connectors are loose or corroded and if there are cracks on the battery housing.

Fuel Pipe: check if there is fuel leakage or poor connection in the fuel pipe.

Before Starting Engine

- a. Check the environment around the car before getting in.
- b. Adjust seat position, seat cushion height, seatback angle, headrest

height, steering wheel angle.

- c. Adjust inner and outer rear-view mirrors.
- d. Close all doors.
- e. Fasten seat belts.

How to Start Engine

Before starting

MT:

- a. Check parking brake.
- b. Turn off all electrical devices.
- c. Move the shift lever to the neutral position.

AT:

- a. Check parking brake.
- b. Turn off all electrical devices.
- c. Move the shift lever to the "P" position. When starting the engine after parking, you may also select the "N" position. If the shift lever is in other positions, the starter cannot operate.

Starting

Make sure that the procedures in "Before starting" have been carried out before engine starting.

Normal Starting

The electrically controlled multiport fuel injection system will adjust the optimal air fuel ratio for engine starting automatically. Please perform the following procedures to start the engine:

1. Depress the brake pedal and press the start button to start the engine. Release this button after the engine has started.
2. Restart the engine following the normal starting procedure if it stalls.
3. If the engine cannot start up, please see "If the Car Cannot Start Up" in Chapter 4.



WARNING

- During engine starting, do not press the start button longer than 5 seconds, and the starting interval should not be less than 15 seconds. Otherwise it may cause engine and circuit overheating.
- Do not let the engine run overspeed.
- Check the engine immediately if it has difficulty in starting or stalls frequently.

Tips

To shift the six-speed transmission to R position, lift the upper limit mechanism of the gear shifting mechanism, and then push the shift lever to R position.

After starting

Warm-up: warm up the engine before driving. Extend the warm-up time in very cold weather.

Exhaust system: if exhaust leakage is found, go to maintenance immediately.

In Driving

Meters: check that the meters indicate properly.



WARNING

Make sure that there is a sufficient amount of fuel in the fuel tank, this means the indicator needle for the fuel gauge must indicate at the position above the 1 scale unit, this prevents burning out of the fuel pump due to lack of fuel.

Brake: under safe traffic conditions,

make sure braking does not result in deviation of the vehicle.

Other Abnormalities: check if there is any leakage, poor connection, or abnormal noise.

Manual Transmission

To ensure smooth operation, the manual transmissions in all forward gears are equipped with a synchronizer. The five-speed manual transmission has a locking device, to avoid direct shift from fifth gear to reverse gear. For shifting, step on the clutch pedal to the bottom; if shifting isn't needed, do not step on the clutch pedal, otherwise it will accelerate the wear of the clutch.

Shift the control mechanism to the R position and perform the reversing function only after the car is stopped completely. It will damage the transmission if the gear is shifted to reverse before the vehicle is



completely static. After stepping on the clutch pedal, and before shifting to the reverse gear, wait for a few seconds, or shift to a forward gear and stay awhile. This will make the gear stop turning, thus avoiding mutual "grinding".

While decelerating, additional braking force can be obtained from the engine through downshifting. This additional braking force helps maintain a safe speed and prevent brake overheating when going downhill. Before downshifting, ensure that the speed display of the engine does not enter the red zone of the tachometer in low gear position. See the table of maximum allowable speed.



Warning

When the car is running and the clutch pedal isn't depressed, do not

put your hand on the shift control mechanism, to avoid abnormal wear of the transmission parts.

Driving Tips Under Certain Conditions

Due to decrease in tyre adhesion and poor visibility in some weather conditions such as rain, fog, or snow, you should master different driving techniques, while performing general maintenance for your vehicle. Take extra care when you have to drive in bad weather conditions.

Do not use the cruise control function in these conditions, and drive at slower speeds than in dry weather. The vehicle needs more time to respond to your operational inputs, so please apply even and smooth force to each control unit.

Sharp steering movements or sudden

braking may cause the vehicle to veer out of control in wet weather conditions, especially in snow. Make sure to drive with greater caution during the first few kilometres before becoming accustomed to the new driving conditions. Over the summer period, you may forget some driving tips for driving on snow covered roads and therefore need to master these tips through practice.

After long dry period, you shall be careful when driving in rainy days. In the first rainy days after long dry period, oil on the road will float on the top of water, making the road slippery.

Visibility - during all weather conditions, it is very important for a driver to see their surroundings and to be seen by other drivers clearly. In poor weather, you should turn on headlights and fog lights even in



daytime for better visibility.

Check the windscreen wipers and washers periodically. Make sure that there is sufficient fluid in the windscreen washer fluid tank. In addition, you may use defroster and air conditioner to prevent condensation from generating mist on the vehicle's inner windows.

Tyre adhesion - check tyre wear periodically, and make sure the tyre pressures are suitable. The above two conditions are important to prevent the vehicle from sliding (when driving on wet roads and tyre adhesion is lost).

Whilst driving you must check the ever-changing road conditions. Damp leaves may be as slippery as snow, "Clean" roads may be covered with thin ice. When the external temperature is near freezing point,

driving is very dangerous as the road may be covered by water and ice alternately. As a result, grip may change suddenly.

When downshift, take special care. If the adhesive force is low, the driving wheels may be locked up for an instant, which may also cause skidding.



WARNING

- It is prohibited to shut down the engine when driving down a slope. The power steering and vacuum booster will be disabled when the engine is off. Similarly, exhaust emission control devices only function when the engine is running.
- When overtaking or being overtaken, take special care as water splashed up by large

vehicles may inhibit your view and the air shock waves caused by large vehicles may lead to losing control of the car.

- Do not drive on a road covered with deep water, which may cause damage or failure of engine and electrical systems.
- Before driving, make sure that the parking brake is released fully and the parking brake indicator goes out.
- Do not leave the car when the engine is running.
- Do not rest your feet on the brake pedal when driving, which may lead to brake discs overheating, wear and excess fuel consumption.
- When driving down a long steep hill, you should decrease your



speed and switch to a low gear.

- Take special care when speeding up, shifting to higher/lower gear, or braking on slippery road surfaces. Hard acceleration or engine braking may result in skidding or spinning of the car.
- Do not stretch any part of your body, head or hand, out of the window when driving to avoid severe accidents and severe personal injury. Observe particular caution with children in the car.

Driving Tips in Winter

Make sure the coolant can provide anti-freezing protection.

Only use coolant authorised by your BYD service station. Choose and add suitable type of cooling fluid into

cooling system according to ambient temperature.

Improper cooling fluid may damage engine cooling system.

Check Battery and Cable Status

The battery may become weak in cold weather. Therefore, it should store enough power to start the engine in winter.

Make sure viscosity of the engine oil is suitable for driving in winter.

Avoid Door Lock Freezing.

Spray some deicing agent or glycerin in door lock hole to prevent the lock from freezing.

Use washer fluid with antifreeze.

They are available at BYD service stations.

Do not apply parking brake if it may be frozen.

When parking, move the shift lever to the "N" position and place chocks around the rear wheels to prevent the car moving. Do not apply the parking brake as it may be frozen by water or snow, resulting in difficulty to release the parking brake.

Prevent snow from staying under mudguard.

Snow or ice under mudguard may make steering difficult and clog the radiator electric fan. When driving in winter, you must stop regularly to check whether there is ice or snow under mudguard.

It is recommended to keep certain



emergency tools in the car according to your region.

Tyre chains, window scraper, a bag of sand or salt, signal flash device, small spade, connecting cable and so on.

Parking Notice

- a. Confirm that the roof (if equipped) and car windows are closed.
- b. Turn the headlights off.
- c. Put all handbags and precious items in the luggage compartment or carry them on your person.
- d. Use your mechanical key or smart key to lock all doors and check that the back door is locked firmly. Check the indicators on the combination meter to confirm that the anti-theft system is working.
- e. Do not park on flammable objects such as dry leaves, tall grass, since

the three-way catalytic converter is extremely hot and may set these objects on fire.

- f. When parking, steer the front wheels against the curb when the vehicle is facing the slope top. If the vehicle is equipped with a manual transmission, leave it in first gear.
- g. When parking, steer the front wheels towards the curb when the vehicle is facing the slope bottom. If the vehicle is equipped with a manual transmission, leave it in reverse gear.
- h. Check that the parking handle has been released completely before driving. Otherwise it may cause the rear brake to overheat and become damaged.

Towing Trailer

Your vehicle is not designed to tow a

trailer. If you attempt to install a tow bar on the vehicle, the chassis may be damaged severely.

Auto Fire Prevention Tips

To prevent vehicle fire timely and effectively, please be familiar with and observe the following precautions:

- a. **It is prohibited to step on the accelerator pedal continuously to run the engine at high speed**
- b. **Do not leave inflammable and explosive materials in the vehicle.**

When a vehicle is subjected to prolonged exposure to direct sunlight during the summer, the inner temperature may exceed 60-70 ℃. It is possible that fire may occur, even explosion if there is inflammable and explosive material in the vehicle, such



as cigarette-lighter, cleaner, perfume, etc.

c. Ensure that any cigarette butts have been extinguished completely after smoking

Smoking is not only harmful to your health, but can also be the root of fire. It is possible to cause a fire if the butt is not extinguished completely.

d. Contact a BYD service station and have your vehicle inspected regularly.

Check the engine for oil leakage regularly and clean any oil dirt and stains from it regularly.

Perform regular checks on the circuits and cables. Check if the connection, insulation and fixing positions between connectors and wire harness are normal. Take appropriate action if there are any problems.

e Do not modify the vehicle circuits and do not attach additional electrical devices.

Attaching electric devices (such as high-power audio system and lights) on the vehicle may cause excessive circuit load, and cause wire harness overheating and fire. Irregular modification of electric devices and circuits may cause contact resistance, overheating and fire. Never use fuses beyond the rated power specification of electric devices or use other metal wires instead of fuses.

f. Choose a proper parking site

Make sure to check for flammable objects such as dry grass, deadwood sticks, and wheat straws under the vehicle before parking, especially in summer. Since the three-way catalytic converter is very hot after driving a long distance, it may cause a fire if there are

flammable objects under the vehicle; You should try to avoid driving on roads covered with leaves, wheat straws and grass, or immediately stop and check if there are any flammable objects attached under the vehicle when you passed these kind of roads. When parking, avoid having your vehicle exposed to direct sunlight.

g. Keep a lightweight extinguisher to hand and know how to use it.

For the sake of safety, keep an extinguisher in the vehicle and check and replace it regularly; meanwhile, you should be familiar with the use of extinguisher. Preparation aids in eliminating danger, so that you can take effective action in the event of an accident.

In the event of a vehicle fire, remain calm and take effective action to



put the fire out, reducing loss as much as possible:

- a. Pay attention to the fire premonitions, such as abnormal noise, foreign odours. If you detect any premonition, stop the engine and your vehicle immediately and take positive remedial action.

- b. Call fire reporting line at once while contacting BYD service shops and insurance agency.

Tips
To prevent property loss in the event of an accident, it is recommended to purchase "spontaneous combustion insurance".



Chapter 4

Emergency Treatment

If the Car Cannot Start Up.....	4-2
If Engine Stalls during Driving	4-4
If the Car Overheats	4-4
If the Vehicle has to be Towed	4-6



If the Car Cannot Start Up

(a) Simple Check

Before performing the following inspections, check if you can start the engine normally according to the instructions and procedures in Chapter 3 "How to Start Engine", and if there is sufficient fuel. Meanwhile, please check if the spare key can start the engine. If the engine can be started successfully, it is proved that the original key may be damaged. You need to let your BYD service station inspect your keys. If all keys do not function, the key or smart key system may be malfunctioning, please contact your BYD service station.

If Engine Cannot Rotate or Rotate Slowly

1. Check whether battery terminals are

tightened and cleaned properly.

2. If the battery terminals are normal, open the rear interior light. If the light cannot be turned on or is dim, it shows that the battery is weak. Start the engine by jump starting. Refer to the instructions "(3) Jump Starting".

If the interior light is on but the engine cannot start, please contact your BYD service station.

The starter can drive the engine rotating at normal speed, but the engine cannot run independently:

1. Restart Engine
2. If the engine cannot start up, there may be a fuel spill as a result of repeated starting. Please see "(b) Start Engine with Fuel Spill" for more details.
3. If the engine still fails to start,

please contact your BYD service station for adjustment or repair.

(b) Start Engine with Fuel Spill

If the engine fails to start, maybe there is fuel spill as a result of repeated starting.

In this case, depress the throttle pedal firmly while starting the vehicle, and hold the throttle pedal for about 5 seconds. Then release the pedal and move your foot away, and restart the engine after that.

If the engine still cannot start when performing above starting procedure for 5 seconds, please wait for a few minutes and try again.

If the engine still cannot be started, please contact your BYD service station for adjustment or repair.



Tips

Ensure the interval between two engine starts is longer than 1 minute. You may start the engine continuously 3 times at most. Otherwise, the starter and circuit system may be overheated.

(c) Jump Start

To prevent the vehicle and electrical attachments and persons from damage and injury due to battery explosion, sulphuric acid solution corrosion and combustion of electrical installations, it is strongly recommended to contact a BYD service station for help.

Tips

- The engine cannot be started by pushing or towing the BYD vehicle with an automatic transmission.
- Do not push or pull the vehicle to

start. Otherwise when the engine starts, there may be damage to the vehicle or a collision. It may also cause the three-way catalytic converter to overheat, which may lead to fire.

- If the battery power is run out, the current clock time and preset frequency in the audio system will be cancelled.
- The battery is dangerous, please refer to Chapter 7 to learn about the hazard of the battery.
- The battery contains corrosive sulphuric acid. While making a jump start, wear goggles and protect your skin, clothes, and the car from being sulphuric acid spillage.
- The charging battery must be 12 V. Before conducting a jump start, please make sure the

charging battery is applicable.

Procedures of Jump Start

1. If the charging battery is installed on another car, please make sure there is no contact between the two cars. Shut down all electrical devices.
2. If the engine of the vehicle charged with batteries is not started, then start and run the engine for a few minutes. Step lightly on the throttle pedal to keep the engine running at 2,000 rpm during a jump-start.
3. Connect wires in order of a, b, c, d:
 - a. Connect the clamp of anode (red) jump starting cable to anode terminal ("+") of the depleted battery.
 - b. Connect the other clamp of anode (red) jump starting cable to anode terminal ("+") of the charging battery.



- c. Connect the clamp of cathode (black) jump starting cable to cathode terminal ("-") of the charging battery.
- d. Connect the another clamp of cathode (black) starting cable to a grounded metal fixing point on the car with depleted battery.

Tips

When connecting, keep your body away from the battery and do not allow the connecting cable to get close to the engine components, otherwise, it may result in personal injury.

- 4. Start the engine in the normal way, and then step lightly on the throttle pedal to keep the engine running for several minutes at a speed of 2,000 rpm.
- 5. Disconnect the starting cable

carefully in the reversed order of connection: disconnect the cathode starting cable first, and then disconnect the anode starting cable.

If unsure about the cause of battery capacity loss, please contact a BYD service station to have the vehicle checked.

If Engine Stalls during Driving

- a. Slow down and drive the vehicle to a safe place.
- b. Turn on the hazard warning light switch.
- c. Try to start the engine again.

If the Car Overheats

If the engine coolant thermometer indicates overheating, or there is power loss, loud knocking, or bang, the engine may be overheated.

Please take actions as per the procedures below:

- a. Drive away from the heavy traffic road, park in a safe place, and turn on the hazard warning lights, then move the shift handle to the neutral position and apply the parking brake. Turn off the air conditioning if it is operating. Then, place the warning triangle in the direction of approaching vehicles according to traffic regulations.
- b. If there is coolant spouting out of the radiator or expansion tank, please switch off the engine. Open the bonnet after the steam clears. If no coolant is spouting, just keep the engine running and make sure the cooling fan is working; if not, please turn off the power switch.



Tips

To avoid personal injury, please keep the engine bonnet closed until there is no coolant coming out. The spouting of coolant means high pressure.

- c. Check if there is any coolant leakage under the radiator, hose and the bottom of vehicle.



WARNING

When the engine is running, please keep your hands and clothes away from the working fan & driving belt of the engine.

- d. If there is coolant leakage, please shut down the engine at once and contact a BYD service station for help.
- e. In case of no obvious leakage,

please check the coolant expansion tank. If it is dry, please add coolant to the tank until the level is between the maximum and minimum limit scale lines while the engine is running.

- f. When the coolant temperature drops to normal, recheck the coolant level in the tank again and add additional coolant if necessary. Obvious coolant level drop means leakage in the cooling system, please contact a BYD service station for examination.



WARNING

When the engine and radiator are under high temperature, do not remove the radiator cap as spouting high-temperature steam and liquid under pressure may cause serious personal injury.

When the car is stopped, do not use the air conditioner for long time, because the air conditioner will lead to high engine speed and cause accident or engine overheating, which may result in fire.

If the Vehicle has to be Towed

Contact a BYD service station if the vehicle has to be towed. Never tow with rope or chain by other vehicles as it is very dangerous.

There are three usual towing methods.

- a. Platform Lift Type - the vehicle will be loaded on a tow truck, which is the best towing method.
- b. Wheel Lift Type - the tow truck inserts two supporting arms under the bottom of the tyre (front or rear) to lift the wheels. The other two wheels are still on the ground.



c. In an emergency where a tow truck is not available, the vehicle may be towed using a towing hook. Remove the decorative cover on the front bumper. Take out the hook from the tool box and screw it into the fixing seat securely, then tow the vehicle with special towing cable.

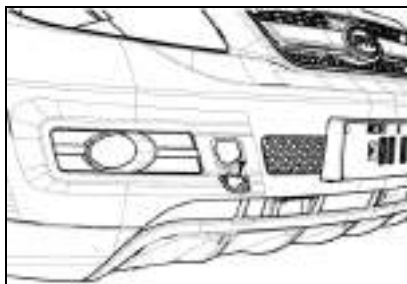

During emergency towing, the driver should sit inside steering the vehicle and operating the brake.

! WARNING

● If your vehicle cannot be towed by a platform truck, please adopt the wheel lift method for towing. If the vehicle is at fault or damaged and only the front wheels can be on the ground, please observe the following instructions:

● Manual transmission:

- Release the parking brake.
- Shift the transmission to the neutral position.
- Make sure the starting button is at the ACC position so as to keep the steering wheel unlocked.

Automatic transmission:

- Release the parking brake.
- Start the engine.

- Move the shift lever to the D position, then N position.
- Shut down the engine.
- Make sure the start button is at the ACC position so as to keep the steering wheel unlocked.

● Improper towing preparation may damage the transmission, please observe the procedures above. If gear shifting is impossible or the engine (automatic transmission) cannot be started, please adopt the towing method with front wheels lift.

● When adopting above method, the towing distance should not exceed 10 km, and the speed should be less than 30 km/h.

● If towing the vehicle with all wheels on the ground, it is necessary to use special designed towing cable and



specified towing hook. For the vehicle preparations, please see the procedures above. Make sure the start button is not at the OFF position so as to keep the steering wheel unlocked. Confirm that all the electrical accessories are all switched off to avoid battery discharging.

- If the steering wheel is locked, the steering system may be damaged. Before towing, make sure the start button is at the ACC position and the steering wheel moves smoothly.
- Lifting the vehicle from the bumper may result in serious damage. The bumper is not designed for supporting the vehicle weight.
- Towing the vehicle with all wheels on the ground and using the towing

hook is not recommended, it is recommended to contact a BYD service station for help.

Only use the specified towing hook and do not tow the rear part of the vehicle with all the wheels on the ground, otherwise the vehicle may be damaged.

- Take special care when towing the car. Please avoid sudden startup and unstable driving operation, which may exert great stress on the emergency towing hook, and towing cable/chain. The hook, towing cable/chain may crack, in which case there may be serious personal injury or damage to the car.



Chapter 5

Vehicle Exterior Maintenance

Tips on Maintenance of Paint Surface.....	5-2
Washing and Waxing	5-3
Inside Cleaning	5-5
Auto Air Freshener	5-7
Corrosion Prevention	5-7



Tips on Maintenance of Paint Surface

Pay attention to the following points in use and maintenance of the vehicle:

- a. Clean any dust from the car before, during and after using the car, which can reduce dust absorption by static.
- b. Wash the car after it has rained. Marks left by rain on the car body will shrink in size after it stops raining, which means acid materials in the rain will concentrate. Clean any marks as soon as possible to avoid harm to the paint surface caused by marks.
- c. Wash the car after the engine cools down. Do not wash the car in strong sunlight or in high temperatures, otherwise the detergent will form marks on the paint surface after

quick drying. If you wash the car by yourself, only use special-purpose detergent. Do not use strongly alkaline washing powder, soap water and detergent, which may wash away grease in the paint and speed up aging. When washing the car at a car wash, prevent the staff from using de-waxing detergent, or the paint may be damaged. When the car is used along seacoast or in a region with heavy pollution, you must wash the car daily.

- d. Only use a damp, clean and soft sponge or finishing cloth to wipe the car, and make sure there are no metal and sand particles in it. Do not use a dry cloth, sponge or towel in order to avoid scratching. When wiping, move the cloth gently along the running water, and do not move it in a circular motion or perpendicular to the running water.

- e. Marks of strongly corrosive substances, such as tar, bird droppings and insect remains, must be cleaned off immediately. Please use special purpose detergent. Do not use a knife or petrol to remove the mark, otherwise the paint surface may be damaged.
- f. Do not touch the paint with greasy hands, wipe the paint with a greasy cloth, or put any tools with grease on them or finishing cloths dipped in organic solvent on the car body, otherwise there may be a harmful chemical reaction.
- g. If there is no obvious scratching, do not paint it again so as to avoid colour non-matching and poor combination.
- h. Please park the vehicle in a garage or a well ventilated place if it will not be driven for a long period. Cover



the body with a special body cover in winter. For temporary parking, please stop the vehicle in a cool and shaded place.

- i. Prevent strong impacts, knocks or scratching to the paint film. If the paint has a scratch, is sinking or peeling off, please repair immediately, please contact a BYD service station for repair.
- j. Use carbon detergent to clean glossy metal parts, and apply wax regularly for protection.
- k. Use quality detergent for cleaning of trim, and do not use excessive force when waxing to prevent the base layer from becoming exposed when the paint is penetrated.
- l. Please wax the vehicle regularly (once per season), contact a BYD

service station to recover the body paint gloss.

Washing and Waxing

Cleaning

In the cases below, the paint may peel off and corrosion can occur in the vehicle body and parts. Please clean the vehicle immediately.

- a. Driving along the seacoast.
- b. Driving on the road covered with anti-freezer.
- c. Stuck with coal tar, resin, bird manure, and insect remains.
- d. Driving in an area with heavy smoke, coal ash, dust, iron scurf, or chemical substances.
- e. The car is obviously covered with dust and slurry.

Manual cleaning method

Tips

- Clean the vehicle in a shaded place when the body does not feel hot.
- Please protect your hands while cleaning the underside of the floor or chassis.

- a. Use hose pipe to wash away loose dirt, slush and saline-alkali at the bottom of the vehicle and in the recessed areas of the wheels.
- b. Use special detergent to wash the vehicle, following the manufacturer's instructions when mixing the detergent with water. Dip a soft cloth into the detergent to wipe the vehicle gently, and use soap water and clean water to remove the dirt.
- c. Flush with running water thoroughly, otherwise when soap water dries it will leave marks. Use clean water to flush each part of the vehicle after washing in the summer.



d. To avoid leaving water marks, please wipe dry with a clean soft towel. Do not wipe or press too hard, or the paint surface may be damaged.

Decorative parts on wheels: the decorative parts can easily be damaged by organic substances. If any organic substance spills onto the decorative parts, please wash away with clean water and check if the parts are damaged.

Tips

Do not install plastic decorative pieces which have been seriously damaged on wheels, or they may drop off the wheel while driving and thus lead to an accident.

Wheels: Wash only with neutral soap water or neutral detergent.

Bumper: due to the relative soft frontage, please take special care

when cleaning the bumper. Do not scrub with abrasive detergents in order to prevent scratching the bumper.

Asphalt from the road: wash it using turpentine or detergent marked as non-harmful to painted surfaces.



WARNING

Do not use organic substances (petrol, kerosene, volatile oil, or strong solvents) which may be toxic or cause damage.

Auto Car Washing

You can wash your car at an automatic car wash station. Note however that some types of brushes, unfiltered water, and the wash process adopted by the machine may damage the painted

surface. Damage to the painted surface will reduce its duration and gloss, particularly for dark coloured cars. Usually the staff from car wash will tell you which washing process is suitable for your car.

Waxing

Polishing and waxing is recommended to maintain the original beauty of the vehicle. Apply the wax once a month or if the vehicle surface does not resist water well.

- a. Before waxing, please wash and dry the vehicle body even if you use the mixture of detergent and wax.
- b. Please use quality polish and car wax. When the polishing coat has been weathered seriously, please use the cleaning polish which is



separated from the car wax. Follow the instructions and precautions from the manufacturer. The chrome plated surface also needs polishing and waxing.

- c. Wax the vehicle again when water does not bead and remains on the surface in large patches.



WARNING

When the car is placed in a workshop with high temperatures for repainting, please remove the plastic bumper from the car, or the heat may damage the bumper.

Inside Cleaning

Tips

Do not allow the water to flow onto the floor while cleaning the vehicle;

otherwise water may enter the audio devices or other electric appliances on or under the carpet (mat), which may result in malfunction of the devices and corrosion of the vehicle body.

Carpet

Please use quality foam detergent to clean the carpet.

First use the dust collector to absorb the dust. Several kinds of foam detergents are applicable: some are contained in aerosol cans, and some are powders or liquids, which must be mixed with water to generate foam. Use a sponge or brush dipped in foam to wash the carpet by moving in a circular motion.

Do not use water in order to keep the carpet dry. Please read and follow the instructions from the detergent

manufacturer.

Seat Belts

The seat belt can be washed with neutral soap water or warm water.

Please use a sponge or soft cloth to clean it. Check if the seat belt has excessive wear, tears or cuts.

Tips

- The seat belt must not be cleaned with colouring agent or bleach, or its strength will be weakened.
- Do not use the seat belt until it is dry.

Windows

The windows may be cleaned with any household window cleaner.



Tips
<p>The heating wire of rear window defroster and lead of the aerial is fixed to the interior of the rear window glass. Strong wiping or wiping up and down, may cause ruptures. Therefore, when wiping the rear window, you should wipe it lightly and wipe from left to right.</p>

Instrument panel, console panel and switches

Tips
<ul style="list-style-type: none">● Do not use organic substances (kerosene, alcohol, petrol etc.) or alkaline or acidic solutions. These chemicals may corrupt the interior device surfaces.● Before using detergent or polish, first please make sure they do not include the substances mentioned

<p>above.</p> <ul style="list-style-type: none">● If you use a new type of liquid car freshener, do not spill the liquid onto the vehicle's interior surfaces. It may contain the ingredients mentioned above.
--

Leather Trim inside the Car

For leather trimming, you can use neutral detergent intended for woolen fabrics to clean them.

Remove dirt using a piece of soft cloth dampened with 5% solution of neutral detergent for wool. Then, thoroughly wipe off all traces of detergent with a piece of clean damp cloth. Allow the leather to dry in a ventilated shaded area.

Tips
<ul style="list-style-type: none">● Don't wash leather with organic substances at all, like volatile oil, alcohol, petrol, or acid or alkaline solution, etc, as they will cause leather to fade.● A nylon brush or synthetic fibre cloth etc will scratch and damage the good texture on the leather surface.● Dirty decorative leather pieces will cause mildew. Especially, keep the decorative pieces clean and protected from oil stains.● Exposure to prolonged periods of sunlight will cause the leather surface to harden or shrink. Therefore, the car should be parked in a cool and shaded place, especially in the summer.● During hot summer periods, as the temperature inside the car rises



easily, objects made from plastics or wax-included materials, may stick to leather in the high-temperature environment.

It is recommended to have your vehicle cleaned by a BYD service station.

Auto Air Freshener

Since the chemical compositions in some liquid air fresheners may result in broken or faded interior devices, please use a solid air freshener or deodorant.

If a liquid air freshener is used, make sure it is securely fixed to avoid spillage whilst driving.

Corrosion Prevention

Generally speaking, there are two reasons for vehicle corrosion:

- a. The moisture accumulates in the hole of body. The mud which accumulates in the clearance and holes of the vehicle bottom easily accumulates moisture and causes the parts to corrode more easily.
- b. Scaling off protective layer and paint of body surface and vehicle bottom.

Performing simple periodic maintenance is helpful to avoid vehicle corrosion.

Immediately repair flaking paint or scratch.

Check and wash the door as well as drain hole under the body.

Check the humidity of floor covering. The carpet and floor cushion will keep the humidity for a long time, especially in winter.

Wash the bottom of the body using a high pressure spray gun. It is particularly important for vehicles that drive on salted roads in winter. It is also a good method to use in areas where the climate is wet and often has a sea breeze.

Check and repair the anti-dust layer of the bottom of the vehicle regularly.



Chapter 6

Maintenance Instructions

Maintenance.....	6-2
Does Your Car need Repairing.....	6-3
Maintenance Program.....	6-4



Maintenance

Scheduled maintenance is very important

BYD Auto Company strongly recommends that users protect BYD S6 cars by following the maintenance program below, because scheduled maintenance serves the following purposes:

- a. Saves fuel
- b. Extends its operating life
- c. Enjoy your driving
- d. Drive safely and stably
- e. Conform to regulations on maintenance
- f. Conform to governmental regulations

Tips

Please refer to BYD S6

"Maintenance & Repair Manual" and turn to BYD service station regularly for car maintenance.
--

Stated maintenance record

Please fill all stated maintenance items into the schedule at BYD service station and keep all receipts safe. To make sure your vehicle runs optimally, follow the maintenance schedule.

Where can you get maintenance service?

It is recommended to keep your vehicle maintained at your local BYD service station. BYD technicians are all well-trained professionals. They will get the latest service information, such as proceedings about technique, maintenance and internal training

program of BYD service station, in order to provide better and more professional maintenance service for your car.

BYD service stations have spent a large amount of money on special tools and maintenance equipment for BYD cars, which helps to provide better complete maintenance tasks as well as reduce expenses, and provide quicker and better service for you. BYD service stations can perform all the maintenance programs for your car – reliably and economically.

Which maintenance items can be completed by driver himself?

Some simple maintenance tasks can be performed by a driver with some mechanical knowledge and basic auto-repairing tools. For instruction details, see Chapter 7. Naturally, you



can get all maintenance items at your BYD service station.

Notes: special tools and professional skills are required for part of maintenance operation. These items must be maintained by qualified technicians from a BYD service station. They can keep a record of maintenance for your car, which will be very helpful when you need maintenance service.

Does Your Car need Repairing?

Pay attention to changes in vehicle performance and sound, as well as visual signs for necessary repair. Some important conditions are shown as below:

a. Engine hunting or instable, obvious decrease in power, abnormal engine noise;

- b. The car is leaking underneath (air conditioning water drops are normal);
- c. Abnormal exhaust sound;
- d. Flat tyre; excessive noise made by tyres while cornering; uneven tyre wear;
- e. The vehicle leans to one side while braking or driving in a straight line on level ground;
- f. Abnormal noises related to movement of suspension system;
- g. Loss of brake effectiveness or spongy feeling when braking;
- h. Engine coolant temperature stays higher than normal continually;
- i. Engine malfunction light comes on (after vehicle starting).

If you notice any of these; please contact a BYD service station at once.



Maintenance Program

Maintenance Intervals	Reading on odometer or months, subject to what comes first																				
	×1,000 km	3	8	13	18	23	28	33	38	43	48	53	58	63	68	73	78	83	88	93	98
Maintenance Items	Months	First maintenance	6	9	12	15	18	21	24	27	30	33	36	39	42	45	48	51	54	57	60
Engine and transmission																					
1. Check for cracks, chips, wear on the multi-wedge belt and adjust its tension		I		I		I		I		R		I		I		I		I		I	
2. Replace the timing belt of engine (timing chain)	483QB engine	Check every 20,000 km; replace every 80,000 km; shorten the cycle according to condition																			
	488QA engine	Check every 20,000 km; replace every 80,000 km; shorten the cycle according to condition																			
	4G69 engine	Check every 20,000 km; replace every 100,000 km; shorten the cycle according to condition																			
3. Check if any damage on the ignition cable		I		I		I		I		I		I		I		I		I		I	
4. Check and replace the spark plug	Common spark plug (general using conditions)	Replace every 30,000 km																			
	Iridium spark	Replace every 80,000 km																			



	plug (general using conditions)																	
	Rigorous using conditions	Shorten cycle according to condition																
5. Check the crankcase ventilation system (PVC valve and ventilation hose)		I		I		I		I		I		I		I		I		I
6. Check if the cooling water pipe is damaged and confirm if the pipe joint is locked tightly		I		I		I		I		I		I		I		I		I
7. Check the engine coolant level in the over flow pot		I		I		I		I		I		I		I		I		I
8. Replace the engine coolant		Replace every 2 years or 40,000 km.																
9. Replace the air filter element	General using conditions	Clean every 2000 km; replace every 15,000 km																
	Rigorous using conditions	Shorten cycle according to condition																
10. Replace engine oil	General using conditions	R: Replace every 5,000 km or 6 months																
	Rigorous	R: every 3,000 km																



BYD AUTO S6, S6A, S6K Owner's Manual

	using conditions																
11. Replace the engine oil filter	General using conditions	R: Replace every 5,000 km or 6 months															
	Rigorous using conditions	R: every 3,000 km															
12. Check battery		I		I		I		I		I		I		I		I	
13. Check the engine idle speed		I		I		I		I		I		I		I		I	
14. Check the ignition timing		I				I				I				I			I
15. Check and adjust the valve gap		I		I		I		I		I		I		I		I	
16. Check the joint of exhaust pipe for gas leak		I		I		I		I		I		I		I		I	I
17 Throttle control cable		I		I		I		I		I		I		I		I	I
18. Throttle Body		Clean every 10,000 km															
19. Injection nozzle		I				I				I				I			I
20. Check the oxygen sensor		I		I		I		I		I		I		I		I	
21. Check the three-way catalytic converter		I		I		I		I		I		I		I		I	
22. Fuel filter		R: Replace every 10,000 km or 6 months															
23. Fuel tank cover, fuel pipe and joint		I				I				I				I			I
24. Activated carbon canister		I		I		I		I		I		I		I		I	



BYD AUTO S6, S6A, S6K Owner's Manual

36. Front and rear suspension	I		I		I		I		I		I		I		I		I		I	
37. Tyre and inflation pressure	I	I	I	I	I	I	I	I	I	I	I	I	I	I	I	I	I	I	I	I
38. Check the front and rear wheel alignment	I		I		I		I		I		I		I		I		I		I	
39. Check if the wheel bearing has end play	I		I		I		I		I		I		I		I		I		I	
40. Check clutch function and adjust pedal travel	I		I		I		I		I		I		I		I		I		I	
41. Clutch fluid	I	I	I	I	I	I	I	R	I	I	I	I	I	I	I	I	I	I	I	I
42. Clutch pipes and hoses	I		I		I		I		I		I		I		I		I		I	
43. Cooling or heating system	I		I		I		I		I		I		I		I		I		I	
44. Air filter of air conditioner	I		R		R		R		R		R		R		R		R		R	
45. Air conditioner refrigerant	I		I		I		I		I		I		I		I		I		I	
46. Check SRS	I		I		I		I		I		I		I		I		I		I	
47. Inspect the vehicle body damage conditions	Every year																			

Remarks: a. Symbol meaning in the schedule

I = Check, adjust or replace if necessary; R = Replace.

b. Depending on the dirt level of the petrol engine, early replacement may be required.

"Serious condition" refers to:

(1) The vehicle is driving in dusty area, or the vehicle is in salty surroundings.



- (2) Frequent driving on bumpy roads, slopes, water-accumulated roads or mountain paths.
- (3) Driving in cold areas.
- (4) Frequently keeping engine idling for a long time or the vehicle frequently drives on short trips.
- (5) Use the brakes frequently and often operate sudden brakes.
- (6) Use it as a taxi.
- (7) At 32 or above, the driving time in heavy traffic area is 50% of the gross time or more.
- (8) At 30 ℃ or above, the driving time at 120 km/h or above is 50% of the gross time or more.
- (9) Frequent driving under overloaded conditions.



Chapter 7

Self-maintenance

Precautions on Self-maintenance	7-2
Open Engine Bonnet.....	7-3
Engine Oil.....	7-4
Cooling System	7-4
Windscreen Washer	7-5
Wiper Blade.....	7-6
Transmission Fluid	7-7
Brake Fluid and Clutch Fluid	7-7
Power Steering Fluid	7-7
Three-Way Catalytic Converter	7-8
Air Filter Element.....	7-8
Fuel Filter	7-9
Engine Bonnet Lock	7-9
Battery.....	7-9
Air Conditioning System	7-11
Driving Belt.....	7-11
Tyre	7-11
Lamps	7-14
Lamp Mist.....	7-14
Vehicle Storage.....	7-15



Precautions on Self-maintenance

In case of self maintenance, you must follow the correct procedures in this section.

This Chapter only explains maintenance operations which can easily be carried out by yourself. However, some items must still be performed at a BYD service station.

During operation, you must pay special attention to avoiding accidental injuries. You are required to follow the special preventive measures below.

Tips

- When the engine is running, you must keep your body, clothes and tools away from the running fans and drive belt of the engine, and remove items such as rings,

watches and neckties.

- Immediately after driving, some components in the engine compartment will be very hot, so observe caution and do not touch them.
- If the engine is hot, do not remove the radiator cap to prevent burning yourself.
- Do not leave inflammable, such as paper or rags, in the engine compartment.
- Be sure that the power is off if you work near the electric cooling fan or radiator grille. With the power on, the electric cooling fan will automatically start to run if the engine coolant temperature is high or the air conditioning is turned on.
- Do not smoke for fear of causing a fire around the fuel tank or the battery.

- Be sure to handle the battery with special care, as it contains corrosive sulphuric acid.
- Do not go under your vehicle with only the body jack supporting it. Always use automotive jack stands or other solid supports if you have to work under your vehicle.
- Use goggles whenever you work on or under your vehicle to prevent injury.
- Since the brake fluid is harmful to eyes and paint surface, be careful when refilling. If the brake fluid comes into contact with your skin, rinse with soap water. If the brake fluid comes into contact with your eyes, wash your eyes at once, and seek medical advice immediately.
- Window cleaner, steering fluid and brake fluid are flammable, keep them away from sparks and naked

flames.

- The battery and ignition coils bear high current or high voltage. Protect their terminals to avoid shorting.
- If the coolant or brake fluid overflows, rinse with water to avoid damaging the components or paint finish.
- Do not drop anything into the spark plug hole.
- You can only use the specified spark plug. Using another spark plug may damage the engine or generate electromagnetic interference.
- Do not refill too much power steering fluid, or it may overflow when starting the vehicle.
- Do not drive with the air filter removed, otherwise it may cause excessive engine wear due to dust being drawn into the cylinders and causing backfire in the engine

compartment.

- Note: do not scratch the glass by the wiper bracket.

Open Engine Bonnet

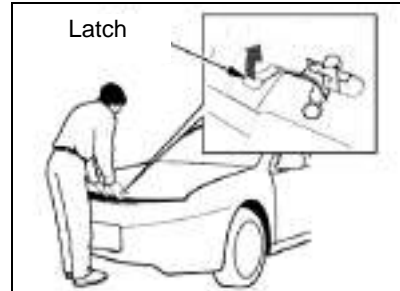
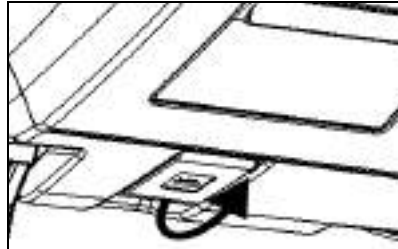

WARNING

- Before driving, be sure that the bonnet is closed and securely locked. Otherwise, the bonnet may open unexpectedly while driving and an accident may occur.



Engine oil

Engine oil is a kind of Consumable, which is very important to ensure the engine runs normally. Therefore, check the engine oil level regularly.

The consumption of engine oil is determined by driving, weather and road conditions. For a new engine, the oil consumption may be more.

Make sure to park the car on level ground, switch off the engine and wait for 3 minutes, then check the engine oil level.

If the oil level is near or lower than the low oil scale line, you must go to a BYD service station to add the appropriate amount of engine oil.

Recommended engine oil

Engine oil is a major contributor to your engine's performance and service life. Therefore, always use high-quality and detergent engine oil. For your vehicle, it is recommended to use the same grade engine oil or above.

API grade: SG or above

SAE: Choose the appropriate oil type for local climate”



WARNING

- Do not splash engine oil on parts of the car.
- Check the oil level on the oil dipstick once again after engine oil refilling. Avoid overfilling, or the engine could be damaged.
- Engine oil, engine components and exhaust system may be very

hot and lead to burns. Be careful and wear protective clothes when operating in the engine compartment.

- Prolonged and repeated contact with used engine oil may cause skin irritation. If your skin comes into contact with this kind of engine oil, wash it with soap and clean water.

Cooling System

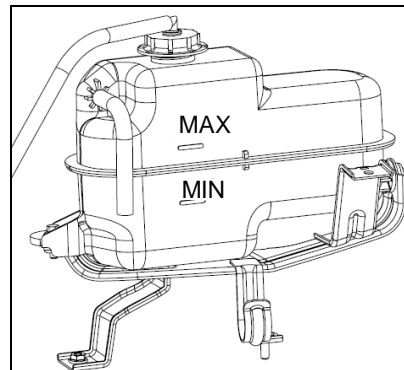



If the coolant level in the coolant reservoir is at or below the (MIN) scale, fill coolant to the (MAX) scale. Note that coolant of different brands and types cannot be mixed.

Inspect the cooling system for leaks. If the reservoir is completely empty, you should also check the coolant level in the radiator.

Never add any rust inhibitor or other additives to the cooling system, since the additives may not be compatible with the coolant or engine components.

**WARNING**

To avoid burning, do not remove the radiator cap when the engine is hot.

Windscreen Washer

Check the level in the windscreen washer reservoir at least once a month during normal using. In poor weather conditions, if you use the washer frequently, check the level in the windscreen washer reservoir when adding fuel.

The windscreen washer reservoir is located in the engine compartment behind the right headlight.

Check the reservoir's level by removing the cap and looking at the level gauge attached to the cap.

Fill the reservoir with a good-quality windscreen washer fluid. This can increase the cleaning capability, and prevent freezing in cold weather.

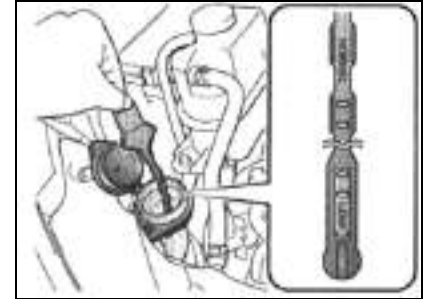

When you refill the reservoir, clean the edges of the windscreen wiper blades with windscreen washer fluid on a clean cloth. This will help to keep the blade edges in good condition.

**WARNING**

- Do not fill the windscreen washer reservoir with engine antifreeze or a vinegar/water solution. Antifreeze can damage the vehicle's paint, while a vinegar/water solution can damage



the windscreen washer motor.

- It is recommended to only use the windscreen washer fluid which is available from BYD service stations.

Wiper Blade

The blade strips made of synthetic rubber, are wearing parts. The using environment of the car and the habits might cause damage to the blade, so in order to ensure the life of the blade and the driving safety, please note the following.

1. Do not scrape the ice from the windshield surface with the blade; use a special ice scraper instead;
2. Do not scrape dirty, oily or waxed windshield surface;
3. Keep the windshield surface clean, and do not scrape the dust, sand, insects and foreign matter on the windshield surface;

4. During washing and body paint maintenance, it is not necessary to wax the windshield. The wax layer will reflect light in poor lighting, which will affect the sight and traffic safety. Rinse with purified water after washing the blade, and use specialized glass-wax cleaning agent to remove the wax layer on the windshield;

5. Do not rinse the blade with water gun directly when washing the car to prevent damage to the blade due to high water pressure.

Lift the wiper arm before cleaning the windshield; the specific methods of operation are as follows:

1. Turn off the car power;
2. Grasp the upper end of the wiper arm with the thumb and other fingers, and lift the wiper arm and blade assembly carefully.

Tips

- Regularly clean the windshield and wiper blade (once every one or two weeks).
- It is also recommended to wipe periodically even if it does not rain (once every one or two days).
- The windshield must remain fully wet when scraping the windshield with the blade (if it doesn't rain, spray the windshield with washing liquid first).
- Use special windshield cleaner to clean the windshield.
- If soil or insect's body adheres to the windshield, wipe with a rag timely.
- If the windshield has pits knocked by gravel, service or replace timely.
- Replace the wiper blade regularly (every six months).

Transmission Fluid

Checking, changing and refilling transmission fluid requires professional skill and knowledge, so please contact a BYD service station to perform these operations.

Brake Fluid and Clutch Fluid

Check the fluid level in the fluid reservoir monthly. The two types of fluid are in the same reservoir.

Replace the brake fluid according to recommended driving time and mileage in the periodical maintenance schedule.

Make sure to use BYD original brake fluid DOT4. The other types of brake fluid are not compatible with your vehicle's braking system. The brake system and clutch system should use the same type of brake fluid.

Brake System

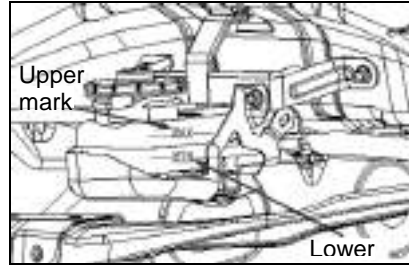

The fluid level should be between the lower (MIN) and upper (MAX) marks on the side of fluid reservoir. If the level is at or below the (MIN) mark, check the braking system. Check the braking system for leakage and brake discs for abrasion.

Power Steering Fluid

Check the fluid level in the power steering fluid reservoir monthly; this task should be performed after the

engine has cooled down. Look over the side of reservoir, the fluid level should be between the upper level and lower level. If it is below the lower level, refill the power steering fluid so the fluid level is up to the upper level.

Drop in power steering fluid level means that the power steering system may be leaking. Check the fluid level frequently and check this system as soon as possible.

Tips

- Make sure to only use BYD specified power steering fluid. Use of other types of power steering fluid will damage the power steering system.
- Refill the fluid slowly and carefully and do overflow. Clean up any spilled fluid immediately as it may damage the



components in the engine compartment.

- Please contact BYD service station if you have any doubt about checking fluid level or filling fluid in gearbox.
- Do not turn the steering wheel to the left or right end for a long period. Otherwise, it may damage the power steering pump.

Three-way Catalytic Converter

The three-way catalytic converter contains precious metals which are catalysts and accelerate the chemical reaction to purify exhaust gases, however, the metal hasn't been affected. Three-way catalytic converter has a positive effect on the HC, CO and NOx. To replace it, BYD

original parts must be used.

To cause the chemical reaction, the three-way catalytic converter must work at high temperatures, it may combust surrounding inflammables. Therefore, park your vehicle at a location far away from combustible objects such as dry grass and leaves. In the event of failure, the three-way catalytic converter will cause air pollution, and engine efficiency will be reduced. Please protect it according to the following rules.

- a. Keep using unleaded petrol. Even if it contains a little lead, it will also pollute the catalytic metal and cause failure.
- b. Keep the engine running normally.
- c. If your vehicle misfires, backfires, stalls or develops another abnormal symptom, check and repair it immediately.



WARNING

When the engine is running, stay away and keep inflammable material away from the exhaust pipe. The hot gas from the exhaust pipe may cause injury or fire.

Air Filter Element

Clean and replace the air filter element according to recommended driving time and mileage in the periodical maintenance schedule.

The air filter element is installed in the air filter case on the driver side of engine compartment.

Clean

Intake compression air into air filter element through the opposite direction. If you can't obtain the compression air, please let a BYD service station deal with it.

Fuel Filter

Replace the fuel filter according to recommended driving time and mileage in the periodical maintenance schedule.

If you find the fuel is polluted, the fuel filter will clog quickly, so it is recommended to replace the fuel filter every 10,000 km or every 6 months. Please go to a BYD service station to replace the fuel filter. If the fuel pipeline is not attached properly, fuel may spill out and lead to danger due to pipeline internal pressure.

If you have ever used one or more barrels of impure fuel, you should replace the fuel filter earlier. If you find the filter is clogged by dirt, you should invite a BYD service station to check or replace the fuel filter.

Engine Bonnet Lock

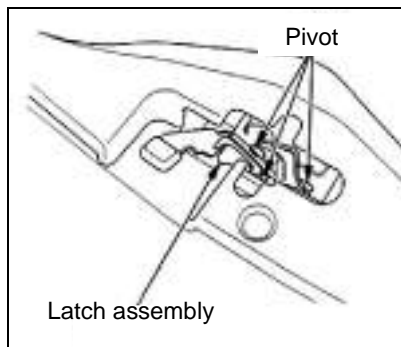

Use mild detergent to clean the engine bonnet lock, then wipe on multipurpose lubricating oil. You

should contact a BYD service station to handle it.



WARNING

Make sure that the engine bonnet lock is locked before driving.

Battery

Check the battery once per month. You should check the colour of the viewport window as well as for any terminal corrosion.

Check the extent of battery terminal corrosion (white or yellow powder). To remove it, you should apply sodium bicarbonate to the surface of the terminals, the terminal will produce air bubbles and gradually turn brown. When the bubbles disappear, clean using clean water, and dry with cloth



or paper. Finally apply grease to the surface of the terminals to avoid further corrosion.



WARNING

- Precautions on Battery
- The battery may produce inflammable and explosive hydrogen. When using tools, prevent the battery from generating sparks. Do not smoke or ignite anything near the battery.
- Prevent electrolyte from touching eye, skin or clothing.
- Do not drink electrolyte by mistake.
- When working near the battery, you must wear goggles. If electrolyte enters the eyes, seek medical advice immediately.

- Keep children away from the battery.
- If electrolyte comes into contact with the skin, immediately wash the affected area thoroughly with sodium bicarbonate. If you feel burning or pain, seek medical advice immediately.
- When electrolyte is splashed on your clothes, it may penetrate and touch the skin. Please take off the clothes with electrolyte immediately, if necessary, treat it as per the previous method.

To connect the battery with other chargers, disconnect the anode and cathode to prevent the electrical system from damage



WARNING

- Charging the battery without disconnecting the cables on it may seriously damage ECUs on the car. Remove the battery cables before connecting the battery to charger.
- If the battery power is run out, the current clock time and preset frequency in the audio system will be cancelled. You need to reset them.

Tips

- Do not use the electrical devices for a prolonged period of time when the engine stops, such as the audio system, navigation system (if equipped), AC blower, light system and so on. It may make the battery discharge, and



then it cannot start the engine, and even lead to permanent damage to the battery.

- Before leaving the car, make sure the doors are closed and all electric appliances are turned off.

Air Conditioning System

The air conditioning system is a closed system, and any maintenance must be performed by a BYD service station. To keep it working effectively, you can perform the following operations. Regularly check the engine radiator and A/C condenser. Remove leaves, insects and dust attached to their surfaces. These foreign substances will block the airflow and reduce the cooling effect. Clean them with a low pressure spray gun or soft brush.

Tips

- The condenser plates and radiator fins can bend easily. Only use a low pressure spray gun or soft brush to wash.
- Please run the air conditioner at least once a week and ten minutes each time during cold seasons, when driving the vehicle at a constant speed and normal engine temperature, to circulate the lubricant in the coolant.
- If the cooling effect is not as good as before, please contact a BYD service station to maintain it.

Driving Belt

Check the driving belt status, and check every belt's edge for cracking or abrasion.
Mitsubishi 4G69 engine's automatic

tension regulator can adjust the tension of the driving belt. The needle on the regulator should be in appropriate range. Examine it according to recommended driving time and mileage in the periodical maintenance schedule.

Tyre

To drive your vehicle safely, it should be equipped with tyres of proper type and size, and keep adequate tread and correct tyre pressure.

Tyre Inflation

Keeping the tyres properly inflated gives the best possible manoeuvrability, ride comfort and tread service life. Insufficient inflation of tyres causes uneven wear, affects manoeuvrability and fuel economy and is more likely to cause the tyres to



fail due to overheating. If over-inflated, the ride may be more harsh, and it would be easier to cause damage from road hazards, as well as cause uneven wear.

For the recommended tyre pressures, please refer to the placard on the driver's door frame for correct pressures when the tyres are cold.

Inspection

Every time you check the tyre pressure, examine the tyres for damage, foreign objects and abrasion as well.

- a. Replace the tyre if you find damage and bulges on the tyre tread or sides.
- b. There are cuts, splits or cracks on the tyre sides. Replace the tyre if its fabric or cord is exposed.
- c. Replace if the tread is worn

excessively.

Tips

- Maintain the correct tyre pressure in case of the following conditions:
 - 1) Low tyre pressure (insufficient air filling)
 - 2) Excessive wear
 - 3) Abnormal wear
 - 4) Hard steering
 - 5) Air leakage due to overheating of tyres
 - 6) Deteriorated sealability at the edge of tyre.
 - 7) Deformation of wheel and/or detachment of tyre and wheel
 - 8) High Tyre Pressure (excessive air filling)

9) Difficulty in operation

10) Excessive wear of centre of tyre tread

Tread wear marks

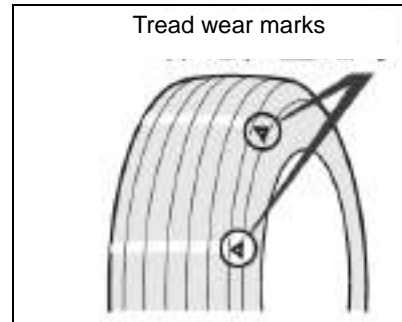

The tyres have wear marks moulded into the tread. When the tread wears down, you will see a wide band across the tread. This means that there is less than 1.6 mm of tread left on the tyre. As for this kind of tyre, it may give very little adhesive force on wet roads. Replace the tyre if you see

three or more tread wear marks.

Maintenance

In addition to properly inflating, correct wheel alignment could also decrease the tyre wear. If you find a tyre is worn unevenly, contact a BYD service station to check the wheel alignment.

The tyre has been balanced at the factory. If you feel a constant vibration while driving, please contact a BYD service station to check the tyres. If any tyre ever has been repaired or replaced, make sure to re-balance the tyre.

Tyre Rotation

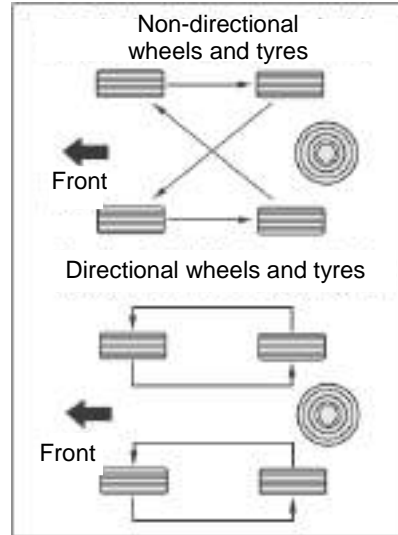

To extend the tyre service life and make it wear more evenly, change the position of tyres every 10,000 km. You should move the tyres to the positions shown above when performing each

rotation.

The figure above shows how to change the vehicle's tyre position.

WARNING

- Do not mix radial, bias-belted or bias-ply tyres.
- Do not use tyre sizes other than those recommended by manufacturers.
- Do not use tyres on BYD S6 if you do not know how they were used previously.

Chains

Snow chains are only used for emergencies or in special areas. Install the snow chains on the front wheels. Please pay special attention when driving your vehicle with snow



chains on slippery roads, such as those covered with ice or snow. Since some snow chains may damage the tyres, wheels, suspensions and vehicle body, choose chains with small teeth in order to allow sufficient gaps between tyre and other parts in the wheel well. Look through and read parts assembly graph and other instructions of chain manufacturer carefully. Before purchase and installation, please consult a BYD service station. After installation is completed, drive on icy and snowy roads below 30 km/h. To reduce the abrasion of tyres and chains as far as possible, please avoid driving with the tyre installed chains on roads which are not covered with ice and snow.

Tips

- The driving speed should not be higher than 30 km/h or the speed

specified by chain manufacturer.

- Drive carefully with tyre chains installed and avoid protrusion, holes and sharp turns on the road, which may jolt the car.
- When tyre chain is installed, avoid sharp turn or braking with wheels locked, which may pose adverse effect to car operability.
- When tyre chains are installed, slow the car down before turning to prevent losing control of the car.

Lamps

The headlights have been aligned before delivery. If the vehicle is heavily loaded frequently, the headlights may need to be aligned again. Please go to a BYD service station to complete this task.

Hold the bulb steel socket to replace.

Do not touch the glass portion of the bulb with bare skin or hard objects.

Lamp Mist

After heavy rain or cleaning, the combination lights, tail lights or turn signals of exterior rear-view mirrors may have mist. This is similar with the phenomenon that one side of the window condensates during rain, and does not mean that your car has a fault.

The lamps have relatively closed and small space and the temperature is high after lit (mask and mirror may be deformed easily), and thus need heat dissipation. In order to meet the dissipation requirements after lit, the lamps have vents in the lamp shell to generate convection heat with the surrounding environment. The greater the temperature difference, the more active the convection is. In the



convection process, the moisture in the air will inevitably be brought inside the lamp. Due to the solar radiation, convection, and bulb heating, the lamp is not a space of constant temperature, so that moisture in the air condenses into mist or water droplets easily on the lamp surface with low temperature. This heat convection is a natural phenomenon.

Tips

- If the inside of the headlamps and the inside of turn signals in the exterior rear-view mirrors have mist, the air humidity may be high or the temperature difference between the car and its surroundings is great. In this case, please turn on the headlights or turn signals when driving, and the mist will disappear after a short period of

time.

- If water accumulates in the lamps, please drive the car to a BYD service station for repairs.



WARNING

When the headlight halogen bulbs are on, they become very hot. Grease, sweat or scratches on the glass will result in bulb breakage due to overheating.

Vehicle Storage

To park the vehicle for a long period (over one month), prepare as follows. These preparations may prevent the vehicle from deteriorating and make it easy to start it again. If possible, park it indoors.

- a. Please refill fuel.
- b. Replace the engine oil and filter.

- c. Clean and dry the vehicle body thoroughly.
- d. Clear the interior and make sure that the carpet and floor mat is completely dry.
- e. Release the parking handle. Apply reverse gear (manual transmission) or parking gear (automatic transmission).
- f. To park your vehicle for a long time, support it with jack stands to clear it from the ground.
- g. Open a window (if it is parked indoors).
- h. Disconnect the battery cathode cable.
- i. Raise the front wiper arm with a towel or cloth to prevent it touching the windscreen.
- j. To prevent sticking, spray silicone ketene lubricant on the weather sealing positions of all doors, and apply wax to the connecting



positions of door sealing strips.

- k. Cover the body with a ventilated cotton cover, as a plastic cloth will damage the body paint because it may accumulate moisture.
- l. If possible, start and run the engine for a moment once per month.

If your vehicle is parked for more than a year, please go to a BYD service station to perform overall maintenance.