

Owner's Manual
for Vehicle



Z4 roadster 2.5i Z4 roadster 3.0i

Congratulations, and thank you for choosing a BMW.

Thorough familiarity with your vehicle will provide you with enhanced control and security when you drive it. Therefore, we have one request:

Please take the time to read this Owner's Manual and familiarize yourself with the information that we have compiled for you before starting off in your new BMW. The manual contains important data and instructions intended to assist you in obtaining maximum satisfaction from your BMW's unique array of advanced technical features. It also contains information on vehicle maintenance designed to enhance operating safety while simultaneously helping you to maintain your BMW's value throughout an extended service life. For additional information refer to the supplemental manuals.

This Owner's Manual should be considered a permanent part of this vehicle. It should stay with the vehicle when sold to provide the next owner with important operating, safety and maintenance information.

We wish you an enjoyable driving experience.

BMW AG

Contents

Notes

- 6 About this Owner's Manual
- 6 Symbols used
- 6 Symbol on vehicle parts
- 6 Your individual vehicle
- 6 Status at time of printing
- 7 For your own safety
- 7 Service and warranty
- 8 Reporting safety defects

Overview

- 12 Cockpit
- 13 Instrument cluster
- 14 Indicator and warning lamps

Opening and closing

- 18 Keys
- 18 Central locking system
- 18 Remote control
- 20 Door lock
- 20 Interior
- 21 Luggage compartment lid
- 22 Luggage compartment
- 22 Electric power windows
- 23 Manual convertible top
- 24 Fully automatic convertible top
- 26 Wind deflector
- 27 Alarm system

Adjustments

- 29 Safe seating position
- 29 Seats
- 30 Seat memory
- 31 Seat heating
- 31 Safety belts
- 32 Steering wheel
- 32 Mirrors
- 33 Airbags
- 34 Transporting children safely
- 37 Vehicle Memory, Key Memory

Driving

- 38 Ignition lock
- 38 Engine
- 39 Parking brake
- 40 Manual transmission
- 40 Automatic transmission with Steptronic
- 42 Electric Power Steering EPS
- 42 Drivelogic
- 42 Turn signal indicators/Headlamp flasher
- 43 Washer/wiper system and rain sensor
- 44 Cruise control

Lamps

- 45 Parking lamps/Low beams
- 46 High beams/Standing lamps
- 46 Instrument lighting
- 46 Fog lamps
- 46 Interior lamps

Everything under control

- 47 Odometer
- 47 Tachometer
- 47 Fuel gauge
- 47 Coolant temperature gauge
- 48 Service interval display
- 48 Outside temperature
- 48 Clock
- 49 Computer

Technology for safety and driving convenience

- 51 Dynamic Stability Control DSC
- 52 Brake Force Display
- 53 Antilock Brake System ABS
- 53 Flat Tire Monitor

Controlling the climate for pleasant driving

- 55 Air conditioning
- 57 Automatic climate control

Interior conveniences

- 60 Glove compartment
- 60 Storage compartments
- 61 Beverage holder
- 61 Preparations for the cellular phone
- 61 Ashtray

Special operating instructions

- 64 Break-in procedures
- 65 Driving notes
- 65 Brake system
- 66 Cargo loading
- 67 Hardtop preparation

Refueling

- 70 Fuel filler door
- 70 Fuel specifications

Wheels and tires

- 71 Tire inflation pressure
- 73 Tire condition
- 73 Tire replacement
- 74 Wheel and tire combinations
- 75 Run Flat tires
- 76 Winter tires
- 76 Snow chains

In the engine compartment

- 77 Hood
- 78 Engine compartment
- 79 Washer fluids for washer systems
- 79 Engine oil
- 80 Coolant
- 81 Brake fluid

Maintenance

- 82 The BMW Maintenance System
- 82 Care

Laws and regulations

- 83 California Proposition 65 warning
- 83 OBD interface socket

Replacement procedures

- 84 Onboard tool kit
- 84 Windshield wiper blades
- 84 Lamps and bulbs
- 87 Changing a wheel
- 87 Battery

Giving and receiving assistance

- 89 Warning triangle
- 89 First-aid kit
- 89 Jump-starting
- 90 Towing and tow-starting the vehicle

Technical data

- 94 Engine data
- 94 Weights
- 95 Dimensions
- 96 Capacities

Everything from A-Z

- 97 Index

Notes

About this Owner's Manual

We have made every effort to ensure that you are able to find what you need in this Owner's Manual as quickly as possible. The fastest way to find certain topics is by using the detailed index at the end. If you wish to gain an initial overview of your vehicle, you will find what you are looking for in the first chapter.

Should you wish to sell your BMW at some time in the future, please remember to pass the Owner's Manual on to the new owner. The manual represents an important component of the vehicle.

If you have additional questions, your BMW center will be glad to advise you.

Symbols used

 Indicates precautions that must be followed precisely in order to avoid the possibility of personal injury and serious damage to the vehicle.

 Contains information that will assist you in gaining the optimum benefit from your vehicle and enable you to care more effectively for your vehicle.

 Refers to measures that can be taken to help protect the environment.

◀ Marks the end of a specific item of information.

* Indicates special equipment, country-specific equipment and optional extras.

 Identifies systems or components which can be activated or adapted to suit an individual driver's requirements – Vehicle Memory, Key Memory. Refer to page 37. Activation and adjustments on some of these systems can be performed at your BMW center.

Symbol on vehicle parts

 Indicates that you should consult the relevant section of this Owner's Manual for information on a particular part or assembly.

Your individual vehicle

On buying your BMW, you have decided in favor of a model with individualized equipment and features. This Owner's Manual describes all models and equipment that BMW offers within the same group.

We hope you will understand that equipment and features are included which you might not have chosen for your vehicle. Any differences can easily be identified since all optional accessories and special equipment are marked with an asterisk *.

If your BMW features equipment not described in this Owner's Manual – a car radio or telephone, for instance – supplementary Owner's Manuals are enclosed. We ask that you read these manuals as well.

Status at time of printing

BMW pursues a policy of continuous, ongoing development that is conceived to ensure that our vehicles continue to embody the highest quality and safety standards combined with advanced, state-of-the-art technology. For this reason, the features described in this Owner's Manual could differ from those on your vehicle. Nor can errors and omissions be entirely ruled out. You are therefore asked to appreciate that no claims can be entertained on the basis of the data, illustrations or descriptions in this manual.

For your own safety



Use unleaded gasoline only. Fuels containing up to and including 10% ethanol or other oxygenates with up to 2.8% oxygen by weight – i.e. 15% MTBE or 3% methanol plus an equivalent amount of co-solvent – will not void the applicable warranties respecting defects in materials or workmanship. Field experience has indicated significant differences in fuel quality – i.e. volatility, composition, additives, etc. – among gasolines offered for sale in the United States and Canada. The use of poor quality fuels may result in drivability, starting and stalling problems especially under certain environmental conditions, such as high ambient temperature and high altitude.

Should you encounter driveability problems that you suspect could be related to the fuel you are using, we recommend that you respond by switching to a recognized high-quality brand.

Failure to comply with these recommendations may result in unscheduled maintenance.

Follow the relevant safety rules when you are handling gasoline. ◀

Important safety information!



For your own safety, use parts and accessories approved by BMW.

When you purchase accessories tested and approved by BMW and Original BMW Parts, you simultaneously acquire the assurance that they have been thoroughly tested by BMW to ensure optimum performance when installed on your vehicle.

BMW warrants these parts to be free from defects in material and workmanship.

BMW will not accept any liability for damage resulting from installation of parts and accessories not approved by BMW.

BMW cannot test every product made by other manufacturers to verify if it can be used on a BMW safely and without risk to either the vehicle, its operation, or its occupants.

Original BMW Parts, BMW Accessories and other products approved by BMW, together with professional advice on using these items, are available from all BMW retailers.

Installation and operation of non-BMW approved accessories such as alarms, radios, amplifiers, radar detectors, wheels, suspension components, brake dust shields, telephones – including operation of any portable cellular phone from within the vehicle without using an externally mounted antenna – or transceiver equipment – e.g. C.B., walkie-talkie, ham radio or similar – may cause extensive damage to the vehicle, compromise its safety, interfere with the vehicle's electrical system or affect the validity of the BMW Limited Warranty. See your BMW center for additional information.

Do not use key or remote control to lock doors or luggage compartment with anyone inside the car. Refer to the Owner's Manual for more details. ◀



Maintenance, replacement or repair of the emission control devices and systems may be performed by any automotive repair establishment or individual using any certified automotive part. ◀

Service and warranty

This manual is supplemented by a Service and Warranty Information Booklet for US models or a Warranty and Service Guide Booklet for Canadian models.

We recommend that you read this publication thoroughly.

Your BMW is covered by the following warranties:

- ▷ New Vehicle Limited Warranty
- ▷ Rust Perforation Limited Warranty
- ▷ Federal Emissions System Defect Warranty
- ▷ Federal Emissions Performance Warranty
- ▷ California Emission Control System Limited Warranty.

Detailed information about these warranties is listed in the Service and Warranty Information Booklet for US models or in the Warranty and Service Guide Booklet for Canadian models.

Reporting safety defects

The following only applies to vehicles owned and operated in the US.

If you believe that your vehicle has a defect which could cause a crash or could cause injury or death, you should immediately inform the National Highway Traffic Safety Administration – NHTSA – in addition to notifying BMW of North America, LLC, P.O. Box 1227, Westwood, New Jersey 07675-1227, Telephone toll-free 1-800-831-1117.

If NHTSA receives similar complaints, it may open an investigation, and if it finds that a safety defect exists in a group of vehicles, it may order a recall and remedy campaign. However, NHTSA cannot become involved in individual problems between you, your retailer, or BMW of North America, LLC.

To contact NHTSA, you may either call the Auto Safety Hotline toll-free at 1-800-424-9393 or 366-0123 in Washington, D.C. area, or write to: NHTSA, U.S. Department of Transportation, Washington, D.C. 20590. You can also obtain other information about motor vehicle safety from the Hotline.





At a glance

The overviews of buttons, switches and displays presented in this chapter will help you find your way around your vehicle. You will also be familiarized with the concepts behind the operation of the features available to you.

Overview

Cockpit

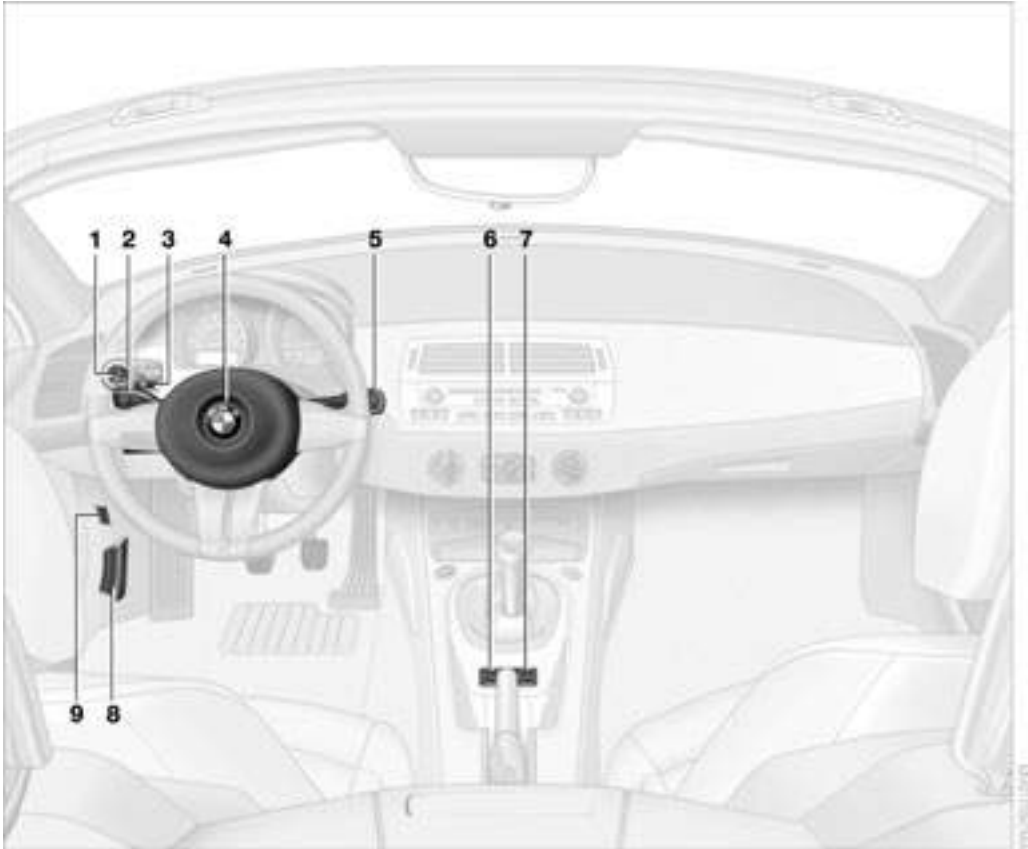

- | | |
|--|---|
| 1 Parking lamps/Low beams 45 | 4 Horn |
| 2 ▷ Turn signal indicators 42 | 5 Washer/wiper system/Rain sensor 43 |
| ▷ Standing lamps 46 | 6 Hazard warning flashers |
| ▷ High beams 46 | 7 Central locking system 20 |
| ▷ Headlamp flasher 42 | 8 Engine compartment release 77 |
| ▷ Computer 49 | 9 Luggage compartment lid release 21 |
| 3 Fog lamps 46 | |

Instrument cluster

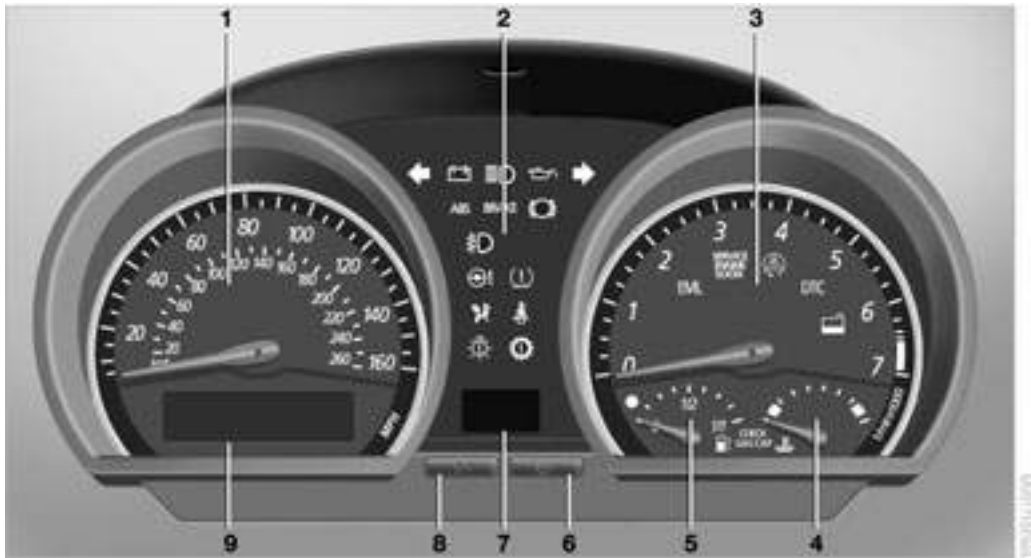

- 1 Speedometer
- 2 Indicator and warning lamps 14
- 3 Tachometer 47
- 4 Engine coolant temperature gauge 47
- 5 Fuel gauge 47
- 6 Button for
 - ▷ Time 48
 - ▷ Service interval display 48
- 7 Selector lever and program display for automatic transmission 41
- 8 Button for
 - ▷ Trip odometer, reset to zero 47
 - ▷ Setting time 48
- 9 Display for
 - ▷ Trip odometer/Odometer 47
 - ▷ Clock 48
 - ▷ Service interval 48
 - ▷ Computer 48

Indicator and warning lamps

Technology that monitors itself

Indicator and warning lamps that are identified by ● are tested for proper functioning whenever the ignition key is turned. They each light up once for different periods of time.

If a fault should occur in one of these systems, the corresponding lamp does not go out after the engine is started or it lights up again while the vehicle is moving. The indicated pages provide information on what measures to take.



Please fasten safety belts ● 31



Airbags ● 33



Battery charge current ● 87



Engine oil pressure/Engine oil level/Engine oil sensor ● 79



Parking brake/Chassis control system/Dynamic Brake Control/Brake fluid ● 39/ 51/ 52/ 81



Brake warning lamp for Canadian models



Antilock Brake System ABS/Chassis control system ● 53/ 51



Antilock Brake System ABS/Chassis control system for Canadian models



Dynamic Stability Control DSC ● 51



Dynamic Traction Control DTC ● 51



Flat Tire Monitor ● 53



Automatic transmission ● 41



Brake pads ● 66



Add coolant 80



Check Gas Cap ●



Service engine soon ● 83



Service engine soon ● warning lamp for Canadian models.



Defective bulbs 45



Turn signal indicators 42



Fog lamps 46



Headlamp flasher/High beams 42/ 46



Electric Power Steering EPS ● 42



Engine electronics ●

Malfunction in the engine electronics. You can continue to drive with reduced engine output or engine speed. Please have the system inspected by your BMW center.

Colors

The indicator and warning lamps can light up in various colors and combinations.

The following section explains the significance of the individual colors as well as how you should respond when they appear.

- ▷ Red:
Stop the vehicle immediately
or
an important reminder
- ▷ Yellow:
Have the system inspected as soon as possible
or
for your information
- ▷ Green:
For your information
- ▷ Blue:
For your information.



The background of the page is a blurred, dark blue-tinted image of a car's interior. It shows the dashboard, steering wheel, and center console, but the details are out of focus. The overall aesthetic is clean and modern.

Controls

This chapter provides you with the information you need for complete control over your vehicle. It describes all features used for driving and for ensuring your safety and comfort.

Opening and closing

Keys



The key set

- 1 Master keys with remote control – determine the functions of the Key Memory, refer to page 37.
You can mark individual keys for subsequent identification by applying the colored decals that you received when accepting delivery of your vehicle
 -  There is an extended-life battery in every master key that is charged automatically in the ignition lock as you drive.
For this reason, if you have a master key with remote control that is otherwise not used, use that key approximately once a year while driving for an extended period to charge the battery. ◀
- 2 Spare key for storage in a safe place, such as in your wallet.
This key does no open the lock of the luggage compartment lid – useful for valet parking, for example.
This key is not intended for constant use

Central locking system

The concept

The central locking system is ready for operation whenever the driver's door is

closed. The system simultaneously engages and releases the locks on the

- ▷ doors
- ▷ luggage compartment lid
- ▷ fuel filler door
- ▷ storage compartment between the backrests
- ▷ opened manual convertible top.

The central locking system can be operated

- ▷ from outside using the remote control or via the driver's door lock
- ▷ from inside via the central locking system button.

If it is operated from inside, the fuel filler door will not be locked. Refer to page 20.

The anti-theft system is automatically activated whenever you activate the central locking system from outside the vehicle. It prevents the doors from being unlocked with the lock buttons or release handles. The alarm system is also armed.

The central locking system unlocks automatically in the event of an accident. In addition, the hazard warning flashers and interior lamps come on.

Remote control

The concept

The remote control provides two additional functions for central locking.

- ▷ Switching on interior lamps. Refer to page 19.
With this function, you can also search for the vehicle when parked in an underground garage, for instance
- ▷ Opening the luggage compartment lid separately. Refer to page 19. The luggage compartment lid will open slightly, regardless of whether it was locked or unlocked.

Whenever you unlock or lock the vehicle, you simultaneously deactivate/activate the anti-theft system, disarm/arm the alarm system and switch the interior lamps on/off.

 You can have a signal set to confirm that the vehicle's locks have engaged securely. ◀

 Since persons or animals in the vehicle could lock the doors from the inside, always take the vehicle keys with you so that the vehicle can be opened again from the outside at any time. ◀

 If it is no longer possible to lock the vehicle via the remote control, the battery is discharged. Use this key while driving for an extended period in order to recharge the battery. In the event of a system malfunction, please contact your BMW center. You can also obtain replacement keys there. ◀



- 1 To unlock
- 2 To lock and secure, activate interior lamps, disarm tilt alarm sensor and interior motion sensor
- 3 To open the luggage compartment

To unlock



1. Press the button to unlock the driver's door and the fuel filler door
2. Press the button a second time to disengage all vehicle locks.

To lock and secure



Press the button.

To switch on the interior lamps



With the vehicle locked:
Press the button.

To deactivate the tilt alarm* and interior motion sensors*



Press the button a second time immediately after locking.
For additional information, refer to page 28.

To open the luggage compartment



Press the button.

The luggage compartment lid will open slightly, regardless of whether it was locked or unlocked.

 Before and after a trip, be sure that the luggage compartment lid has not been opened unintentionally. ◀

Panic mode – triggering alarm



By pressing the button for 2 to 5 seconds, the alarm can be sounded in the event of danger. The alarm is turned off by pressing button 1 again – for unlocking.

External systems

External systems or devices may cause local interference in the functions of the remote control.

Should this occur, you can still open and close the vehicle using the master key in either the door or luggage compartment locks.

For US owners only

The transmitter and receiver units comply with part 15 of the FCC – Federal Communications Commission – regulations. Operation is governed by the following:

FCC ID: LX8EWS
 LX8FZVS
 LX8FZVE

Compliance statement:

This device complies with part 15 of the FCC Rules. Operation is subject to the following two conditions:

- ▷ This device may not cause harmful interference, and
- ▷ this device must accept any interference received, including interference that may cause undesired operation.

 Any unauthorized modifications to these devices could void the user's authority to operate the equipment. ◀

Door lock



One turn of the key in the driver's door lock to unlock the driver's door only and the fuel gas door.

Turn the key a second time to disengage all other vehicle locks.

 You can have a signal set to confirm that the vehicle's locks have engaged securely. ◀

Convenience operation

You can also operate the power windows and the fully automatic convertible top via the door lock.

- ▷ To open:
With the door closed, hold the key in the "Unlock" position
- ▷ To close:
With the door closed, hold the key in the "Lock" position.

 Watch the closing process carefully and be sure that no one is trapped by the closing motion. Releasing the key stops the operation. ◀

Manual operation

In the event of an electrical malfunction

Turn the key all the way to the left or right to unlock/lock the driver's door.

Interior



You can use this button to control the central locking system whenever the doors are closed. The doors and luggage compartment lid are unlocked or locked only. The anti-theft system is not activated.

If only the driver's door was unlocked from the outside and you press the button, then, with the driver's door still open, the luggage compartment lid and the fuel gas door will unlock, too. If the driver's door is closed, it will be locked.

 If you desire, the central locking system can be activated automatically as soon as you begin to drive. This can be adjusted to be key-specific. ◀

To unlock and open

- ▷ Either unlock the doors together with the button for the central locking system and then pull each of the release handles above the armrests or
- ▷ pull the release handle for each door twice: the initial pull unlocks the door, and the second one opens it.

To lock

- ▷ Either use the central locking button to lock all doors at once or
- ▷ press the individual door lock buttons down.
 - ▷ To prevent the driver from being inadvertently locked out of the vehicle, the driver's door lock button will not engage as long as the door is open. ◀

 Since persons or animals in the vehicle could lock the doors from the inside, always take the vehicle keys with you so that the vehicle can be opened again from the outside at any time. ◀

Luggage compartment lid

To open from the outside

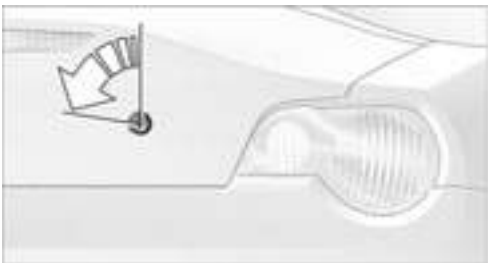

Turn the master key to the left as far as it will go. The luggage compartment lid will open slightly.

If the alarm system is armed, opening the luggage compartment with the key will trigger an alarm; refer also to page 27.

To open from the inside





If the luggage compartment lid has not been locked separately, you can open it with this button in the footwell on the driver's side when the vehicle is stationary.

To close



The handle recess in the interior trim panel of the luggage compartment lid makes it easier to pull the lid down.

 To avoid injuries, be sure that the travel path of the luggage compartment lid is clear when it is closed, following the same precautions as with all closing procedures. ◀

 Operate the vehicle only when the luggage compartment lid is closed, since exhaust fumes could penetrate into the interior of the vehicle. Should it be absolutely necessary to operate the vehicle with the luggage compartment lid open and with the convertible top closed:

- ▷ Close all windows
- ▷ Increase the air supply from the air conditioner or automatic climate control to a high level. Refer to page 55 or 57. ◀

Luggage compartment

Emergency release



This lever releases the luggage compartment lid from inside the luggage compartment.

To enlarge the luggage compartment



The luggage compartment can be enlarged when the convertible top is closed.

Simultaneously turn the handles on both sides of the luggage compartment to the right past the resistance point.

The convertible top compartment panel is raised.

Before opening the convertible top: Turn the handles to the left and fold the convertible top compartment panel downward.

 Before opening the convertible top, make sure that the convertible top compartment panel has been folded down in the luggage compartment to avoid any possible damage. ◀

Electric power windows



The illustration shows the power window switches in the trim of the passenger door.

To open and close the windows

Ignition key in position **1** or higher

- ▷ Press the switch until you feel resistance: the window continues to move downward as long as you continue to press the switch
- ▷ Press the switch briefly past the pressure point: the window moves automatically. Pressing the switch again stops the opening cycle.

You can close the windows in the same manner by pulling the switch.

The window on the passenger side does not move automatically.

After the ignition has been switched off: You can still use the electric power windows for up to 15 minutes, as long as no one opens any of the doors.

 When leaving the vehicle, always remove the ignition key from the lock and remember to close the doors to prevent children from operating the power windows and injuring themselves, etc. ◀

For convenience operation via the door lock, refer to page [20](#).

Manual convertible top

The fabric top offers perfect protection against the weather and it can be opened easily and quickly by one person alone.

Here are a few tips so that you get the most out of your Z4 roadster:

- ▷ It is advisable to close the convertible top when the vehicle is parked. The closed convertible top not only protects the passenger compartment from unforeseeable damage from the weather, but also provides a certain degree of theft protection
- ▷ In addition, only keep valuables in the locked luggage compartment, even with the convertible top closed
- ▷ When the convertible top is open, the central locking system also locks the release button for the convertible top. The convertible top cannot be operated. This provides better theft protection for valuables stored in the luggage compartment
- ▷ Never mount a roof-mounted luggage rack system on the convertible top.

To open the convertible top

 Operate the convertible top only when the vehicle is stationary. Never store the convertible top for longer than one day while it is wet to avoid permanent damage from moisture. ◀

 Before opening the convertible top, make sure that the convertible top compartment panel in the luggage compartment is lowered to avoid any possible damage; refer to page 22. ◀

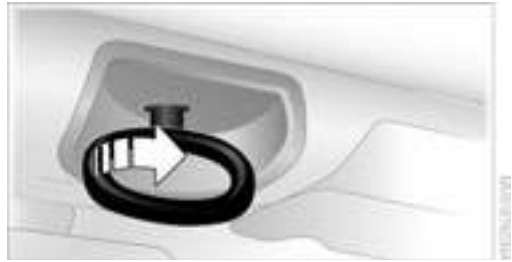

1. Flip the handle out and turn it to the end stop



2. Open the convertible top and push it toward the rear of the vehicle



3. Gently swing the convertible top downward and press until it engages audibly.

To close the convertible top



1. Press button; see arrow **1**
The convertible top is released and moves up slightly; see arrow **2**
2. Holding on to the handle, pull the convertible top forward onto the windshield frame
3. Lock the convertible top by turning the handle until you hear the convertible top engage.

 At higher speeds, the ensuing vacuum in the passenger compartment can cause the convertible top to begin fluttering. Increase the air supply so that a low pressure draft does not occur in the vehicle. ◀

Fully automatic convertible top*

The fully automatic convertible top combines assured protection against the elements with simple and easy handling.

Here are a few tips so that you get the most out of your roadster:

- ▷ it is advisable to close the convertible top when the vehicle is parked. The closed convertible top not only protects the passenger compartment from unforeseeable damage from the weather, but also provides a certain degree of theft protection. In addition, only keep valuables in the locked luggage compartment, even with the convertible top closed.
- ▷ Never mount a roof-mounted luggage rack system on the convertible top.
- ▷ To prevent damage, do not operate the convertible top at temperatures below 14 °F / -10 °C.

 Never store the convertible top while it is wet to avoid permanent damage from moisture. ◀

 Driving when the opening or closing process has not been completed can cause vehicle damage or personal injury. Do not lay objects on the convertible top, since they could fall off when the convert-

ible top is operated and cause damage or injuries.

Do not reach into the convertible top mechanism during opening and closing. Keep children away from the moving parts of the convertible top during operation. ◀

 If possible, only operate the convertible top with the vehicle stopped, as otherwise the process may be interrupted. If you set the convertible top in motion with the vehicle stationary and then have to start suddenly – for instance, at a traffic light – you can still complete the operation by driving as slowly as possible and again pressing and maintaining pressure on the button. ◀

 At higher speeds, the ensuing vacuum in the passenger compartment can cause the convertible top to begin fluttering. Increase the air supply so that a low pressure draft does not occur in the vehicle. ◀

To open and close



1 To close

2 To open

 If at all possible, only operate the convertible top if the engine is running. This saves unnecessary battery wear. Before closing the convertible top, remove any objects from the windshield frame that could keep the convertible top from closing properly. ◀

Ignition key in position **1** or higher.
With the vehicle standing.

1. Read and comply with the preceding safety precautions
2. Make sure that the convertible top compartment panel in the luggage compartment is lowered; refer to page 22. Otherwise the convertible top cannot be opened
3. Ensure that the luggage compartment lid is closed
4. Press and hold the corresponding button for convertible top operation.

If the convertible top should halt right before the closing phase is completed, press against the front part of the convertible top frame from the outside to help the closing process along. Keep pressing the button while doing so until the top starts up again on its own.

Indicator lamps

- ▷ The red indicator lamp will light up while the convertible top is in motion. It goes out as soon as the opening or closing operation has been completed
- ▷ If the red indicator lamp flashes after the button has been released, then the opening or closing operation has not yet been completed.
The sequence can be continued in the desired direction by pressing this button
- ▷ If the yellow indicator lamp lights up continuously with the button pressed, then the convertible top compartment panel is raised and the convertible top cannot be moved.

The side windows will lower slightly when you press the button for operating the convertible top.

After the opening or closing operation, the side windows will go back up if you keep the button pressed for more than 2 seconds after the indicator lamp has gone out.

The automatic sequence will be interrupted immediately if you release the button that operates the top. The sequence can be

continued in the desired direction by pressing this button.

 If the convertible top operation has been interrupted, do not close the side windows using the power window buttons. Otherwise the side windows may not close properly against the rubber seal of the convertible top. ◀

 After the convertible top has been stored for an extended period of time in the convertible top compartment – e.g. in the winter months because the hardtop was being used – you may have to support the convertible top by hand when closing it for the first time. ◀

If the opening or closing procedure has been interrupted due to an electrical malfunction, the convertible top will remain in that position for 15 minutes. The procedure can be resumed in the desired direction by pressing the button. After that, the convertible top can be moved again and, if it is an emergency situation, you may have to help the top along manually. This can also be done in ignition key position **0**.

Convenience operation from the driver's door lock

Refer to page 20.

To close manually in the event of an electrical malfunction

To release the convertible top



1. Pull out the handle in the luggage compartment as far as it will go
2. Turn the handle by 90° until it engages

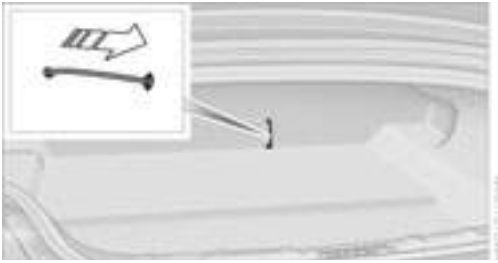

3. Pull on the cord in the rear luggage compartment panel.
The storage compartment between the backrests unlocks; refer also to page 60



4. Press button; see arrow 1
The convertible top is released and moves up slightly; see arrow 2



5. Grab the convertible top at its frame and pull it up to the windshield frame
6. Use a screwdriver to lift out the cover panel in the center of the front convertible top frame

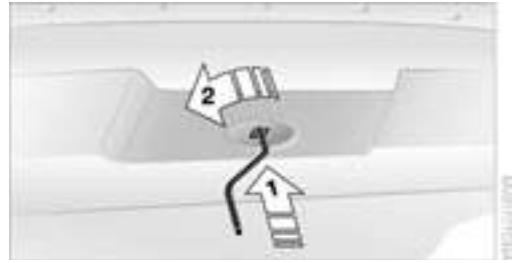

7. Insert the Allen wrench into the hex slot
8. Pull the convertible top frame down as far as possible
9. Continue turning the Allen wrench to the left until the front convertible top frame has locked onto the windshield frame.

Wind deflector*

With the convertible top open, the wind deflector keeps air movement in the passenger compartment to a minimum, thus providing you with a pleasant drive, even at higher speeds.

Because of its slim dimensions, it can easily be stored in a storage compartment in the luggage compartment lid.



The illustration shows the wind deflector guide and the wind deflector panel on the passenger side.

Installation

Insert the wind deflector in the guides provided on the rollover bars.

The wind deflector panels inserted in the rollover bars cannot be removed.

Clothes hooks

Located on the wind deflector panel in the rollover bars.



Do not hang heavy objects on the hooks. If you do so, personal injury could result during braking or evasive maneuvers, for example. ◀

Alarm system*

The concept

The vehicle alarm system responds:

- ▷ When a door, the hood or the luggage compartment lid is opened
- ▷ When attempts are made to start the vehicle
- ▷ To movement inside the vehicle – interior motion sensor
- ▷ To alterations in the vehicle tilt, e.g. as would occur during attempts to steal the wheels or tow the vehicle
- ▷ To interruption of battery voltage.

The alarm produced by the system in the event of unauthorized vehicle entry and attempted theft depends on the country version:

- ▷ Sounding of an acoustical alarm for 30 seconds
- ▷ Activation of the hazard warning flashers for approx. five minutes.

Arming and disarming the alarm system

When the vehicle is locked or unlocked either via the driver's door lock or with the remote control, the alarm system is simultaneously armed or disarmed.

The hazard warning flashers blink once when the alarm system has been properly armed.



You can have different acknowledgment signals set to confirm arming and disarming. ◀



You can open the luggage compartment lid when the system is armed by pressing the remote control button. Refer to page 19. When it is closed, the lid is once again secured.



Manual operation of the luggage compartment lid triggers the alarm. Refer to page 21. ◀

To cancel an alarm:



Press the button on the remote control, refer to page 18, or turn the ignition key to position 1. Refer to page 38.

Indicator lamp displays



- ▷ The indicator lamp beneath the interior mirror flashes continuously: The system is armed
- ▷ The indicator lamp flashes when it is being armed:
A door, the hood or luggage compartment lid is not completely closed. Even if you do not close the area causing the alert, the remaining areas are secured and the indicator lamp flashes continuously after 10 seconds.
However, the interior motion sensor is not activated

- ▷ If the indicator lamp goes out as soon as the system is disarmed:
No manipulation or attempted intrusions have been detected in the period since the system was armed
- ▷ If the indicator lamp flashes for 10 seconds when the system is being disarmed:
An attempted entry has been detected in the period since the system was armed.

After an alarm has been triggered, the indicator lamp will flash continuously.

Interior motion sensor*

The system monitors the footwells and the seating areas of the driver and passenger.

-  Deactivate the interior motion sensor – refer to Avoiding unintentional alarms – if children or animals are to remain in the vehicle. ◀

Avoiding unintentional alarms

The tilt alarm sensor and interior motion sensor can be deactivated at the same time. You can do this to prevent a false alarm from being triggered, for instance in garages with elevator ramps or when the vehicle is transported by train.

Lock the vehicle twice = arm the system:



Press the button on the remote control twice in succession,

or

lock the vehicle twice with the key. Refer to page 20.

The indicator lamp lights up briefly and then flashes continuously. The tilt alarm sensor and the interior motion sensor are deactivated as long as the system is armed.

Adjustments

Safe seating position

For relaxed and fatigue-free driving you should select a seating position that reflects your personal requirements. The correct seating position combines with safety belts and airbags to enhance occupant safety in the event of an accident. To ensure that the vehicle's safety systems provide you with optimal protection, we request that you direct your careful attention to the following section.

For supplementary information on transporting children, refer to page 34.

Sitting safely with airbags

 Always maintain an adequate distance between yourself and the airbags.

Always hold the steering wheel by its rim with hands at the 9 and 3 o'clock positions, to minimize the risk of injuries to your hands or arms in the event of airbag deployment. Never allow any objects, individuals or animals to obstruct the areas between passengers and airbags. Never use the front airbag's cover as a storage tray or support for objects of any kind. Never allow front passengers to rest their feet or legs on the airbag cover. ◀

For airbag locations and additional information on airbags, refer to page 33.

Sitting safely with safety belts

 Never allow more than one person to wear a single safety belt. Never allow infants or small children to ride in a passenger's lap. Avoid twisting the belt while routing it firmly across the pelvis and shoulder, wear it as snugly against your body as possible. Do not allow the belt to rest against hard or fragile objects. Do not route the belt across your neck, or run it across sharp edges. Be sure that the belt does not become caught or jammed. Avoid wearing bulky clothing and pull on the lap belt peri-

odically to retension it over your shoulders. In the event of a frontal impact, a loose lap belt could slide over your hips, leading to abdominal injury. In addition, the safety belt's restraint effectiveness is reduced if the belt is worn loosely. Expectant mothers should always wear their safety belts, taking care to position the lap belt against the lower hips, where it will not exert pressure against the abdominal area. ◀

For information on using the safety belts, refer to page 31.

Seats

Before adjusting your seat, always observe the following precautions

 Never try to adjust your seat while operating the vehicle. The seat could respond with an unexpected movement, and the ensuing loss of vehicle control could result in an accident. Never ride with the backrest inclined to an extreme angle – especially important for the front passenger to remember. If you do so, there is a risk that you will slide under the safety belt in the event of an accident, thus reducing the protection provided by the safety belt. ◀

Seat adjustment

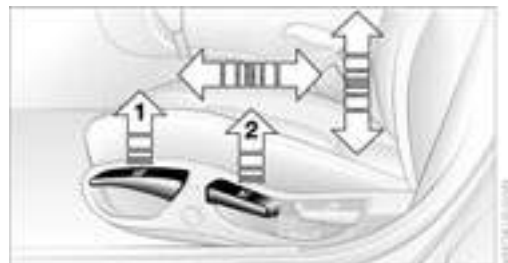

1 Backward/forward

Pull lever 1 and slide the seat into the desired position.

After releasing the lever, move the seat backwards or forwards slightly to ensure that the latch engages securely

2 Height

Pull lever **2** and apply weight to or remove weight from the seat as required



3 Backrest

Pull lever **3** and apply weight to or remove weight from the backrest as required.

Head restraints



Adjustments

Height: pull or push.

In order to move to the lowest positions, press button **1**.

 Adjust the head restraint so that its center is approximately at the height of your ears. Otherwise, there is a higher risk of injury to the cervical vertebra in the event of an accident. ◀

Removal

Pull the head restraint upward until it stops.

Press button **1** and remove the head restraint.

Installation

Insert the head restraint into the guides.

Power seat adjustment



- 1 Tilt angle
- 2 Backward/forward adjustment
- 3 Height
- 4 Backrest angle

The head restraints are adjusted manually. Refer to preceding section.

 Read and comply with the adjustment instructions on page 29. Failure to do so can result in diminished personal safety. ◀

Seat memory*



You can store and recall three different driver's seat positions.

To store

1. Ignition key position **1** or **2**
2. Adjust seat to desired position
3. Press the **MEMORY** button: the indicator lamp in the button lights up

4. Press memory button **1**, **2** or **3**, as desired. The indicator lamp goes out.

To select a stored setting

 Do not select a memory position while the vehicle is moving. If you do so, there is a risk of accident due to unexpected seat movement. ◀

Ignition key position **1**:

- ▷ Briefly press memory button **1**, **2** or **3**, as desired.
Movement stops immediately when one of the seat adjustment or memory buttons is operated during the adjustment process.

With the driver's door closed and the ignition key either removed or in position **0** or **2**:

- ▷ Press and hold the desired memory button – **1**, **2** or **3** – until the adjustment process is completed.

 If you press the **MEMORY** button accidentally: press the button again; the indicator lamp goes out. ◀

 You can have your vehicle adjusted in such a way that your personal settings are automatically set for the seat positions when you unlock the vehicle with your personal remote control. ◀

 If you make use of this method of adjustment, be sure that the space behind the driver's seat is unobstructed before unlocking the vehicle. If you fail to do so, objects behind the seat could be damaged by a rearward movement of the seat. ◀

Seat heating*



The seat cushion and backrest can be heated with the ignition key in position **2**. You can call up different heating modes by repeatedly pressing the buttons.

The seat heating can also be switched off from the higher heating modes: Press the button and hold it slightly longer.

Safety belts



Always fasten your safety belt before starting off. As supplemental restraint devices, the airbags are designed to enhance the effectiveness of the safety belts, and not to replace them.

To close

Make sure you hear the lock engage in the belt buckle.

 Please fasten safety belts warning lamp:
Lights up for several seconds.
An acoustic signal will sound at the same time.

To unlock the safety belt

1. Press the red button in the belt buckle
2. Hold the belt
3. Guide the belt back into its reel.

 If the safety belt system has been stressed as a result of an accident or if it has been damaged in any other way: have the safety belt mechanism, including the safety belt tensioners and any child-restraint systems, replaced by your BMW center. In addition, have your BMW center inspect the safety belt anchors. Otherwise, the system cannot be guaranteed to provide the required protection in the event of an accident. ◀

Steering wheel

Adjustments

 Never attempt to adjust the steering wheel while driving the vehicle. It could respond with unexpected movement, posing a potential accident hazard. ◀



1. Push the locking lever downward
2. Adjust the steering column's reach and rake to suit your seat position
3. Pull the lever back in.

Mirrors

To adjust exterior mirrors



- 1 Switch for 4-way adjustment
- 2 Selection switch for changing between mirrors
- 3 Button* for folding mirrors in and out

Fold the mirrors in and out by pressing the button repeatedly. This can be useful in car washes or narrow streets, for example, or for repositioning mirrors that have been folded forward.

 The mirror can be folded in at driving speeds of up to 6.2 mph / 30 km/h. ◀

To adjust manually

The mirrors can also be adjusted manually: Press on the edges of the lens.

Electric defrosting*

Both mirrors are automatically heated in ignition key position 2.

Interior rearview mirror



To reduce the glare from vehicles behind you when driving at night, turn the rotary knob.

For vehicles without an alarm system:
Tilt the small lever forward.

Interior and exterior mirrors with automatic dimming feature*

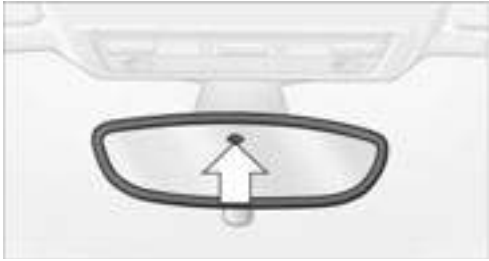

This mirror automatically dims through an infinitely variable range and switches automatically to its clear, undimmed mode whenever you engage reverse gear or place the selector lever in position R.

To ensure that the mirror continues to operate properly, keep the two photocells clean and unobstructed. One photocell is positioned in the mirror's lens, see arrow, while the other is slightly offset on the opposite side of the mirror. Do not obstruct the area between the interior rearview mirror and the windshield; do not apply stickers to the area of the windshield in front of the mirror.

Airbags

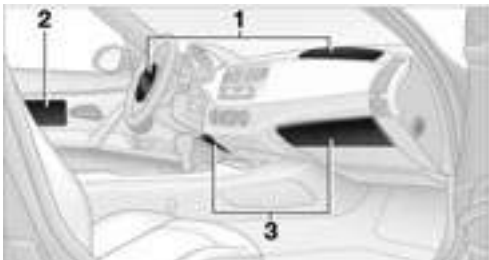

- 1 Front airbags for driver and passenger
- 2 Side airbags for driver and passenger
- 3 Knee airbags for driver and passenger

Protective effect

The front airbags help protect the driver and passenger in the event of a head-on collision where the protection provided by the safety belt alone would not be adequate. The side airbags help provide protection in the event of a collision from the side. Each of the side airbags is designed to help support the seat occupant's upper body. The knee airbags help provide additional protection in the event of a head-on collision.

 Do not remove or exchange the floor mat on the passenger side. It is a component of the safety system. ◀

For information on the correct seating position, refer to page 29.

Indicator lamp

 The indicator lamp in the instrument cluster shows the airbag system's operational readiness when the ignition key is in position 1 or higher.

System operational:

- ▷ The indicator lamp comes on briefly when the ignition key is in position 1 or higher.

System malfunction:

- ▷ The indicator lamp fails to go out after the engine has been started, or it comes on again during normal driving.

 BMW recommends that you respond to any malfunctions in the system by immediately having it inspected at your BMW center; otherwise the airbag could fail to respond in an accident that would normally trigger airbag deployment. ◀

 For your safety, comply with the following instructions for the airbags. If you do not, the airbags may not be able to provide their full protection. All passengers in the vehicle should be aware of and comply with this information:

The airbags are supplemental restraint devices designed to provide additional protection; they are not a substitute for safety belts. Wear your safety belt at all times. The airbags are intentionally not trig-

gered in every type of collision, e.g. in the event of minor accidents, certain vehicle roll-over situations or collisions from the rear. In these instances, the safety belt provides sufficient protection.

Adjust your seat to a position that provides maximum distance between you and the steering wheel and the instrument panel while still allowing comfortable and safe access to all vehicle controls.

To minimize the risk of sustaining hand and arm injuries, always hold the steering wheel on the rim with the hands at or near the 9 and 3 o'clock positions. Do not place your hands on the center pad.

Never allow any objects to obstruct the area between the airbags and an occupant. Do not use the cover panel above the passenger side airbags as a storage area. Never allow front passengers to lean against or rest their feet or legs on the airbag cover panel.

Do not apply adhesive materials to the cover panels of the airbags, cover them or modify them in any other way.

Never install a rear-facing child-restraint system in the passenger seat of this vehicle, unless the passenger airbags have been turned off and the indicator lamp in the center console indicates that the passenger airbags are deactivated.

If you transport children, carefully read and comply with the instructions in the following section.

Be sure that child-restraints are mounted correctly and as far as possible towards the rear and in the lowest position. ◀

Even when all these guidelines are observed, there is still a small residual risk of injuries resulting from contact with deploying airbags in isolated instances.

The ignition and inflation noise from the airbags may induce a mild temporary hearing loss in sensitive individuals.

Transporting children safely

Deactivating/reactivating passenger airbags



The passenger airbags must be deactivated before using a rear-facing child-restraint system on the passenger seat, refer also to page 36 for explanation. BMW also recommends that the passenger airbags be deactivated if a child is transported in a front-facing child-restraint system, regardless of the age of the child. If you transport a child in the passenger seat – not an infant in a rear-facing seat – who is properly seated and seat-belted at all times, the potential benefits of airbags deploying in an accident generally outweigh the risks of the child being injured by the force of a deploying airbag.

Therefore, you should deactivate the passenger airbags only if you find it difficult to ensure that the child will remain properly seated and seat-belted at all times.

Always position the passenger seat as far back as possible and at the lowest level. The above warning and recommendations are compatible with regulations established by the National Highway Traffic Safety Administration – NHTSA – permitting the deactivation of front passenger airbags by means of an on-off switch for members of certain "at risk" groups.

Specifically, the 'at risk' groups are:

- ▷ Infants in rear-facing infant seats
- ▷ Persons with certain medical conditions
- ▷ Children aged 12 and under in the front passenger seat.

NHTSA provides this information via their website – www.nhtsa.dot.gov – or via their Auto Safety Hotline toll-free at 1-800-424-9393 or 366-0123 in Washington, D.C. area. ◀

The concept

Passenger airbags can be deactivated/reactivated with the vehicle ignition key. The key switch is located on the outer passenger's side of the instrument panel.

The passenger airbags can only be deactivated or reactivated with the vehicle standing still, ignition off and the passenger door open.

Deactivation



Deactivation of the passenger airbags system deactivates the passenger front, knee and side airbag. The airbags on the driver side remain active.

Using the vehicle ignition key, turn the key switch to the "OFF" position. Note, the passenger airbags will remain deactivated with the switch in this position.

 As soon as the reason for the deactivation of the passenger airbags no longer exists, you must reactivate these airbags so that they can deploy in an accident within their normal deployment range. ◀

Reactivating

Using the vehicle ignition key, turn the key switch to the "ON" position.

All airbags in the vehicle are activated and will be triggered under appropriate conditions.

Passenger airbags lamp



The system checks that the airbag system is functioning properly when the ignition key is turned, and the indicator lamp in the central console lights up for several seconds.

- ▶ The indicator lamp lights up continuously when the passenger airbags are deactivated
- ▶ If the passenger airbags are activated, it goes out after several seconds.

 At all times, occupants should sit comfortably upright and be properly restrained – infants and small children in appropriate child-restraint systems; larger children and adults using the safety belts. Please note that the word "Airbag" imprinted on the door trim panel indicates the airbag's location. ◀

Seat position for children



This is the correct way a larger child no longer using a child-restraint system should sit wearing the safety belt, when the airbag system is activated.

LATCH child-restraint mounting system*

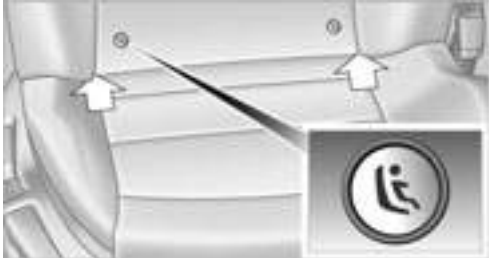

LATCH: Lower Anchors and Tethers for Children

The anchorage points for the LATCH child-restraint system are located at the positions indicated by the arrows.

For Canadian models only:

The position of the anchorage points is indicated by a label on the seat; refer to detail in illustration.

Carefully slide the brackets through the gaps in the upholstery at the indicated locations, see arrows.

 To mount the LATCH child-restraint system, please follow the manufacturer's operating and safety precautions. ◀



Commercially available child seats complying with the legal standard are designed to be secured with a seat belt or with the seat belt portion of a combination lap/shoulder belt.

Improperly or inadequately installed child-restraint systems can increase the risk of injury to children. Always read and follow the instructions that come with the system.

 Before installing any child-restraint device or child seat, please read the following:

Never install a rear-facing child-restraint system in the passenger seat of this vehicle, unless the passenger airbags have been turned off and the indicator lamp in the center console indicates that the passenger airbags are deactivated.

Your vehicle is equipped with an airbag restraint system for the passenger. Because the backrest on any rear-facing child-restraint system – of the kind designed for infants under 1 year and 20 lbs/9 kg – would be within the airbag's deployment range, you must deactivate the passenger's airbags, as the impact of the airbags against the child-restraint's backrest could lead to serious or fatal injuries, if the airbags are not deactivated.

For a child – not an infant –, certain precautions should be taken. Position the passenger seat as far back as possible and at the lowest level. This important precaution is intended to maximize the distance between the airbags and the child. Younger children should be secured in an appropriate forward-facing child-restraint system that has first been properly secured. Older children should be tightly secured with a safety belt, sitting with their back against the vehicle seat back.

Always ensure that all occupants – of all ages – remain properly and securely restrained at all times. ◀

Securing the child-restraint system

The front passenger's safety belt can be locked for mounting and securing a child-restraint system.

A label with the appropriate instructions for this is located in the immediate vicinity of the buckle latch of the safety belt.

Vehicle Memory, Key Memory



How the system functions

You have probably frequently wished that you could configure individual functions of your vehicle to reflect your own personal requirements. In engineering your vehicle, BMW has incorporated a number of options for personal adjustment that can be programmed into your vehicle at your BMW center.

The available configuration data fall into two categories, according to whether their primary orientation is the vehicle – Vehicle Memory, or the individual – Key Memory. You can have up to four different basic settings adjusted for four different persons. The only requirement is that each person uses his or her own remote control key.

When your vehicle is unlocked with the remote control, the vehicle recognizes the individual user by means of a data exchange with the key, and makes adjustments accordingly.

Colored decals were provided with the keys to help you distinguish between the different personal remote control keys.

What the system can do

You can learn about the entire array of features this system offers at your BMW center. A few examples follow below:

Examples for Vehicle Memory:

- ▷ Various signals as acknowledgement when locking or unlocking your vehicle: refer to pages 18, 19

- ▷ Activation/deactivation of the "Follow-me-home" function: refer to page 45
- ▷ Activation/deactivation of daytime driving lamps: refer to page 45
- ▷ Setting the units of measurement for the temperature and distance traveled in the instrument cluster display.

Examples for Key Memory:

- ▷ Locking of the vehicle when you start off: refer to page 20
- ▷ Automatic adjustment of the driver's seat position to the personal programmed settings when the vehicle is unlocked: refer to page 30.



You will see this symbol throughout the Owner's Manual. It is to remind you at appropriate places of the settings that are available to you. ◀

Driving

Ignition lock

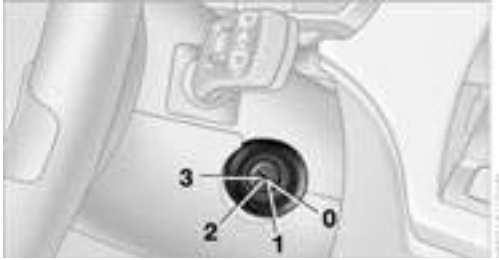

- 0 Steering locked
- 1 Steering unlocked
- 2 Ignition switched on
- 3 Engine started

Steering locked

This is the only position in which the ignition key can be inserted or removed.

After removing the key, turn the steering wheel slightly to the left or right until the lock engages.

If the key is not removed, an acoustic signal sounds when the driver's door is opened.

Once the ignition has been switched off – ignition key in position **0** or removed – the radio functions are still available for approx. 20 minutes. Turn the radio back on to use it.

 Vehicles with automatic transmission: do not move the selector lever from position P until the engine is running – ignition key in position **2**.

In order to turn the key back to position **0** or to remove it, move the selector level into position P first – Interlock. ◀

Steering unlocked

You will often find that it is easier to turn the ignition key from position **0** to **1** if you move the steering wheel slightly to help disengage the detent.

Individual electrical equipment and accessories are available for use.

Engine

Do not allow the engine to warm up while the vehicle is stationary. Instead, begin driving immediately at a moderate engine speed.

Engine idle speed is controlled by the engine computer system. Increased speeds at start-up are normal and should decrease as the engine warms up. If engine speed does not decrease, service is required.

To prevent the battery from discharging, always deactivate electrical devices that are not in use. Switch the Ignition off when the vehicle is not being driven.

 Do not allow the engine to run in enclosed spaces. The exhaust gases contain carbon monoxide, an odorless and colorless, but highly toxic gas. Breathing the exhaust gases poses an extreme health risk, and can lead to unconsciousness and death.

Do not leave the vehicle unattended with the engine running. An unattended vehicle with a running engine poses a safety hazard.

When driving, standing at idle and parking the vehicle, take care to avoid contact between the hot exhaust system and flammable materials – e.g. hay, leaves, grass, etc. Such contact could lead to a fire, resulting in serious personal injury and property damage. ◀

Starting the engine

Do not press the accelerator pedal while starting the engine.

 Vehicles with manual transmission: Step on the clutch when starting the vehicle. A lockout prevents the engine from starting if the clutch is not depressed. ◀

 Do not actuate the starter for too short a time, but do not actuate it for more than approx. 20 seconds. Release

the ignition key immediately when the engine starts. ◀

 Extended starting attempts, characterized by excessively frequent or long periods with the starter engaged, can damage the catalytic converter. ◀

If the engine fails to start on the first attempt – if it is very hot or cold, for instance:

- ▷ Press the accelerator pedal halfway down.

Cold starts at very low temperatures – starting at approx. +5 °F / -15 °C

- ▷ Press the accelerator pedal halfway down while engaging the starter
- ▷ On the first start attempt, engage the starter for a longer period – approx. 10 seconds.

Manual transmission

1. Engage the parking brake
2. Gearshift lever in idling position
3. Depress clutch pedal
4. Start the engine.

Automatic transmission

1. Depress footbrake
2. Place selector lever in position P or N
3. Start the engine.

 Before leaving the vehicle with the engine running, place the selector lever in position P and pull the parking brake.

Do not leave the vehicle unattended with the engine running. An unattended vehicle with a running engine poses a safety hazard. ◀

Switching off the engine

 Do not remove the ignition key while the vehicle is still moving. If you did so, the steering lock would engage when the steering wheel is turned.

When you leave the vehicle, always remove the ignition key and engage the steering lock. Always engage the parking brake when parking on downhill roads. ◀

Manual transmission

Turn the ignition key to position **1** or **0**.

Automatic transmission

Place the selector lever in position P and turn the ignition key to position **1** or **0**.

Parking brake

The parking brake is designed primarily to prevent the vehicle from rolling when parked. It operates against the rear wheels.

 The brake warning lamp lights up when the parking brake is engaged; if you start driving, an acoustic signal is heard as well.

 Brake warning lamp for Canadian models

To engage

The detent engages automatically and the indicator lamp in the instrument cluster comes on when the ignition key is in position **2**.





To release

Pull up slightly on the lever, press the button and lower the lever.

 If, in exceptional circumstances, it should be necessary to engage the parking brake while the vehicle is in motion, do not pull it with excessive pressure. Keep your thumb pressed against the release button while carefully pulling up the lever. Excessive pressure can lead to overbraking and loss of traction – fishtailing – at the rear axle.

The brake lamps do not come on when the parking brake is engaged. ◀

 Vehicles with manual transmission: Always engage the parking brake when parking on slopes and inclined surfaces, since shifting into 1st gear or reverse may not provide adequate resistance to rolling. Vehicles with automatic transmission: place the selector lever in position P. ◀

 To avoid corrosion and one-sided braking, apply the parking brake lightly from time to time when coasting to a standstill – at a traffic signal, for example – provided that it is safe to do so. ◀

Manual transmission

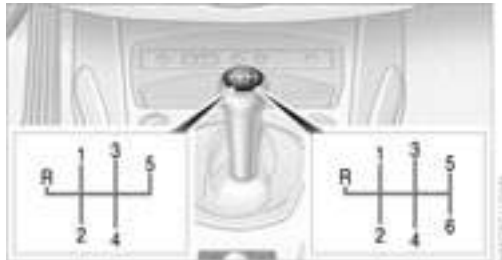

6-gear transmission*

When shifting into 5th or 6th gear, it is important to press the gear shift lever to the right to avoid accidentally engaging 3rd or 4th gear.

Reverse

Select reverse only when the vehicle is stationary. Press the gearshift lever to the left to overcome the resistance.

As you do this, the backup lamps will turn on automatically when the ignition key is in position 2.

 Do not hold the vehicle in place on slopes by slipping or "riding" the clutch. Use the parking brake instead, otherwise, the ensuing friction to the clutch plates will cause a great deal of wear and tear on the clutch. ◀

Automatic transmission with Steptronic*

You can drive as with a normal automatic transmission. In addition, you can also shift manually.

When you move the selector lever from the D position to the left into the M/S range, the performance-oriented shift programs of the automatic transmission are engaged. As soon as you briefly tap the selector lever in the "+" or "-" direction, Steptronic changes the gear. The manual mode is engaged. When you wish to use the automatic transmission mode again, move the selector lever to the right to position D.

Selector lever positions



P R N D M/S + -

Engine started

The engine can only be started in selector lever positions P – Park – or N – Neutral.

Range selection

A detent prevents inadvertent shifting into selector lever positions R and P. To disengage the detent, press the button on the front of the selector lever button, see arrow.

 While the vehicle is stationary and before shifting out of P or N, depress the footbrake in order to disengage the selector lever's lock mechanism – Shift-lock.

Hold the footbrake down until starting off. The vehicle will otherwise "creep" when a drive position is engaged. ◀



If you leave the vehicle with the engine running, move the selector lever to the P position and apply the parking brake. If you fail to do this, the vehicle could move.

Do not leave the vehicle unattended with the engine running. An unattended vehicle with a running engine poses a safety hazard. ◀

P Park

Select reverse only when the vehicle is stationary. The transmission locks to prevent the rear wheels from turning.

R Reverse

Select reverse only when the vehicle is stationary.

N Neutral – idling

Select only when stopping for an extended period.

D Drive – automatic shift program

This position is designed for driving under all normal operating conditions. All forward gears are available.

Kickdown

In the kickdown mode, you achieve maximum acceleration in position D. Depress the accelerator pedal past the increased resistance point at the full-throttle position.

M/S Manual mode and Sport program



When you change from D to M/S, the Sport program is activated. This is indicated in

the gear indicator by SD. The M/S mode is recommended for performance-oriented driving.

With the first brief touch, the automatic transmission shifts from the Sport program to the manual mode.

When you tap the selector lever in the "+" direction, the transmission shifts up. When the lever is tapped in the "-" direction, the transmission shifts down. M1 to M5 appear in the gear indicator.

The Adaptive Transmission Control ATC executes upshifts or downshifts only when the new gear will provide a suitable combination of engine and road speed, i.e. ATC will not execute downshifts if the engine speed is too high. The desired gear will appear briefly in the instrument cluster, followed by the actual gear.



If you are driving in the manual mode and wish to accelerate rapidly – to pass another vehicle, for example – shift down manually or with the kickdown function. ◀

Shifting from M/S to selector lever positions P, R and N is possible only by going through position D.

Available indicators



P R N D SD M1 M2 M3 M4 M5

Electronic transmission control module



If the indicator lamp comes on, there is a malfunction in the transmission system.

All of the selector lever positions can continue to be engaged; in the forward drive

positions, however, the vehicle will be operating in the fourth gear only. If this happens, avoid extreme engine loads and consult the nearest BMW center.

 Never work in the engine compartment when a drive gear – forward or reverse – is engaged. If you do so, the vehicle could move. ◀

For towing, tow-starting and jump-starting: refer to the information beginning on page 89.

Electric Power Steering EPS

The concept

The electric power steering is a direct, sporting steering system that is speed-sensitive.

Power support is reduced with an increase in driving speed.

Indicator lamp

 Electric Power Steering
The indicator lamp stays lit:
The system has malfunctioned or is faulty.

Please have the system inspected by the nearest BMW center.

Steering remains operational.

Drivelogic*



The Drivelogic feature lets you select between the standard and sport program. The sport program is recommended for performance-oriented driving.

Activating Drivelogic

Press the SPORT button.
The LED in the key lights up.

 The sport program of the automatic transmission is enabled by activating the Drivelogic system. Thus, the selector lever does not have to be shifted from D to M/S; refer also to page 41.

The electric power steering switches from standard mode to sport mode. Power support is reduced for a more sporting driving style. ◀

Turn signal indicators/ Headlamp flasher

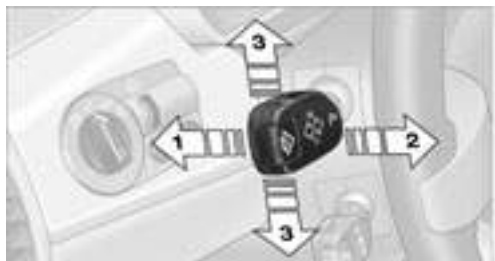

- 1 High beams – blue indicator lamp
- 2 Headlamp flasher – blue indicator lamp
- 3 Turn signal indicator – green indicator lamps accompanied by a periodic clicking sound from the relay

To signal briefly

Press the lever up to but not beyond the detent. It then returns to the center position when released.

 If the flashing indicator lamp and the clicking from the relay are both faster than normal, one of the turn signal indicators has failed. ◀

Washer/wiper system and rain sensor*



- 0 Wipers retracted
- 1 Intermittent operation or rain sensor
- 2 Normal wiper speed
- 3 Fast wiper speed
- 4 Brief wipe
- 5 Rotary dial for control of the wipe interval or the sensitivity of the rain sensor

Intermittent operation

Not on vehicles with rain sensor.

You can set the wipe interval over four stages with rotary dial 5.

In addition, the wipe interval is varied automatically depending on road speed.

Rain sensor

The rain sensor is positioned on the windshield, directly behind the interior rearview mirror.

To activate the rain sensor:

- ▷ With the ignition key in position 1 or higher, move the lever to position 1. The wipers travel once across the windshield, regardless of the weather.

You can leave the lever permanently in position 1. With the ignition key in position 1 or higher, it is then only necessary to activate the rain sensor. To do this

- ▷ turn rotary dial 5 briefly.

To adjust the sensitivity of the rain sensor: turn rotary dial 5.

To deactivate the rain sensor: return lever to position 0.

 Turn the rain sensor off in automatic car washes. Failure to do so could result in damage caused by undesired wiper activation. ◀

Normal wiper speed

When the vehicle is stationary, the wipers automatically switch to intermittent wipe – not on vehicles with rain sensor.

Fast wiper speed

When the vehicle is stationary, the wipers operate at normal speed – not on vehicles with rain sensor.

Cleaning windshield and headlamps*



- 0 Wipers retracted
- 1 Cleaning windshield and headlamps*

 Do not use the washers if there is any danger that the fluid will freeze on the windshield, otherwise vision could be obscured. For this reason, use an anti-freeze agent. Refer to page 79.

Do not use the washers when the reservoir is empty. Otherwise damage to the washer pump could result. ◀

Cleaning the windshield

The system sprays washer fluid against the windshield and activates the wipers for a brief period.

Cleaning the headlamps

When the vehicle's lighting system is switched on, the headlamps are cleaned at reasonable intervals.

Windshield washer nozzles

The windshield washer nozzles are heated automatically* when the ignition key is in position 2.

Cruise control*



- 1 To maintain and store speed/to accelerate
- 2 To decelerate
- 3 To recall the stored setting
- 4 To deactivate the system

To store and maintain speed or to accelerate

You can maintain and store any desired vehicle speed above approx. 20 mph / 30 km/h.

Press the lever briefly in direction **1**:
The system maintains and stores the current vehicle speed. Every time you tap the lever, the speed increases by approx. 0.6 mph / 1 km/h.

Hold the lever in position **1**:
The vehicle accelerates without pressure on the accelerator pedal. As soon as you release the lever, the system stores and maintains the current speed.

 If, on a downhill grade, the engine braking effect is not sufficient, the controlled speed can be exceeded. Speed can drop on uphill grades if the engine output is insufficient. ◀

To decelerate

Press the lever briefly in direction **2**:
When the cruise control is active, vehicle

speed is reduced by approx. 0.6 mph / 1 km/h every time you tap the button.

Hold the lever in position **2**:

With the cruise control active, the system automatically reduces the throttle opening to slow the vehicle. As soon as you release the lever, the system stores and maintains the current speed.

To recall the stored setting

Press the lever briefly in direction **3**:
The vehicle accelerates to and maintains the last speed stored.

To deactivate the system

Press the lever briefly in direction **4**:
The cruise control is deactivated immediately.

Cruise control is also deactivated when the ignition key is turned to position **0**.

In addition, the system is automatically deactivated in response to the following conditions:

- ▷ When you apply the brakes
- ▷ When you depress the clutch or move the automatic selector lever from D to N
- ▷ If you exceed or fall below the preset speed for an extended period – by depressing the accelerator, for example.

The stored speed is cleared in all three cases.

Lamps

Parking lamps/Low beams



Parking lamps

 The front, rear and side vehicle lighting is switched on. You can use the parking lamps to signal the position of the vehicle when it is parked. For information on lighting on one side of the vehicle for parking, which is available as an additional feature, refer to page 46.

Low beams

 When you switch off the ignition with the low beam headlamps on, only the parking lamps will remain on.

Follow me home lamps:

When you activate the headlamp flasher after parking the vehicle and switching off the lights, the low beams will come on for a brief period.

 You can also have this function activated/deactivated if you wish. ◀

Defective bulbs

 The defective bulb indicator lamp lights up:
At least one bulb of the vehicle's exterior lighting has failed.

For replacing bulbs: refer to page 84.

LIGHTS ON warning

Whenever you open the driver's door after having turned the ignition key to position 0, you will hear an acoustic signal for a few

seconds to remind you that the lamps have not been switched off.

Daytime driving lamps*

If you wish, the light switch can be left in the second position. When the ignition is switched off, the external lighting is also switched off.

 You can have the activation settings for the daytime driving lamps programmed on your vehicle. ◀

Automatic headlamp control*

 When the switch is set to this position, the system automatically switches the low beams on and off in response to changes in ambient light – in tunnels, at dusk, etc. – as well as to rain and snow.

 The vehicle's external lights remain on constantly when you switch on the front fog lamps after the headlights have come on automatically. ◀

 Automatic headlamp control cannot serve as a substitute for the driver's judgement in determining when the vehicle lights should be switched on. For example, the sensors are not able to detect fog. To avoid safety risks, you should respond to these kinds of low-visibility situations by switching the headlights on manually. ◀

 You can have the sensitivity of your vehicle's automatic headlamp control adjusted. ◀

High beams/Standing lamps

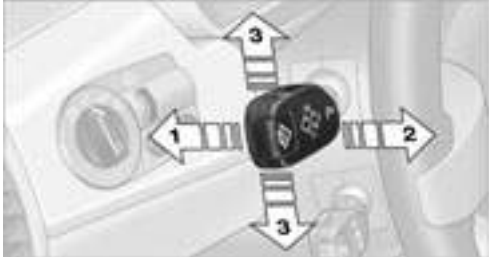

- 1 High beams – blue indicator lamp
- 2 Headlamp flasher – blue indicator lamp
- 3 Standing lamps

Left or right standing lamps*

As an additional feature, you can illuminate your vehicle on either side for parking:

With the ignition key in position **0**, push the lever in the appropriate turn-signal direction. The lever engages in the turn signal position.

Instrument lighting



Turn the rotary dial to adjust the illumination intensity.

Fog lamps



Fog lamps*



A green indicator lamp comes on in the instrument cluster to indicate that the front fog lamps are on.



If the automatic headlamp control is on, the low beams will automatically come on whenever you activate the front fog lamps. ◀

Interior lamps



The interior lamps operate automatically.

To switch the interior lamps on and off manually

Press button **1** briefly.

If you would like the interior lamps to remain off all the time, press and hold the button for approx. 3 seconds.

Press the button briefly to revert to normal operation.

Reading lamps*

Switch on and off with button **2** adjacent to each lamp.

Everything under control

Odometer



- 1 Odometer
- 2 Trip odometer

Odometer

With the ignition key in position **0**, you can activate the displays shown in the illustration by pressing the button – see arrow – in the instrument cluster.

Trip odometer

To set to zero

Ignition key position **1**

Keep the button pressed until the trip odometer counter is set to zero.

Tachometer



Never allow the engine to operate with the needle in the red overspeed sector of the gauge.

To protect the engine, the fuel supply is interrupted when you approach this sector.

Fuel gauge



Once indicator lamp **1** stays on continuously, there are still approx. 2 gallons / 8 liters of fuel in the fuel tank.

Tank capacity: approx. 14.5 gallons / 55 liters.

If the tilt of the vehicle varies – when you are driving in mountainous areas, for example – the needle may fluctuate slightly.

 Fill the fuel tank well before it is empty. Driving to the last drop of fuel can prevent the engine from operating properly and result in damage. ◀

When you switch on the ignition, the indicator lamp comes on briefly to indicate an operational check.

Coolant temperature gauge



Blue

The engine is still cold. Drive at moderate engine and vehicle speeds.

Between the blue and red zones

Normal operating range. The needle may rise as far as the edge of the red sector during normal operation.

Red

When you switch on the ignition, warning lamp **1** comes on briefly to indicate an operational check.

Comes on while driving:

The engine has overheated. Switch off the engine immediately and allow it to cool down.

For checking the coolant level, refer to page **80**.

Service interval display



Remaining distance to next service

The displays shown in the illustration appear for a few seconds when the ignition key is in position **1** or after the engine is started.

The next service due appears with the message OIL SERVICE or INSPECTION, together with the distance remaining in miles – in kilometers in Canada – before the next scheduled service.

The computer bases its calculations of the remaining distance on the preceding driving style.

A flashing message and a "-" in front of the number mean that the service interval has already been exceeded by the distance shown on the display. Please contact your BMW center for an appointment.

Outside temperature



If the vehicle is not equipped with a computer, the display in the instrument cluster always shows the outside temperature.

Clock

If you wish to have a permanent time display, you can have it appear in the car radio display, refer to the Owner's Manual for Radio.

You can set the clock and the time display in the car radio as follows.

To adjust



Ignition key in position **1** or higher:

Hours

1. Keep button **2** pressed for several seconds until the hours are displayed and the colon flashes
2. Press button **1** repeatedly until the required hour is set

Minutes

3. Press button **2** to switch to the minutes display

- Press button **1** repeatedly until the required minutes are set
- Press button **2** to confirm the settings.

The set time of day is transferred to the car radio display or appears in the instrument cluster display.

Display mode

In ignition key position **0**:
Press button **1**.

The time of day is displayed for several seconds.

Computer*

Mode selection



With the ignition key in position **1** or higher, you can use the button in the turn signal lever to retrieve information from the computer for display in the instrument cluster. Every time you press the button briefly in the direction of the steering column, a new function is called up for display.

The displays appear in the following order: time of day, outside temperature, average fuel consumption, cruising range, average vehicle speed.

With the ignition key in position **1** or higher, the last active setting is displayed.

Outside temperature



To change the units of measure – °C/°F

While the temperature display is active, keep the button in the turn signal lever pressed until the display changes.

Ice warning

If the outside temperature drops to approx. 37 °F/+3 °C, the computer automatically switches to the outside temperature display.

In addition, a signal sounds and the display flashes for a brief period.

Clock



Setting the 12-hour or 24-hour mode*

If the vehicle is equipped with a computer, you can have the time displayed in either a 12-hour or 24-hour mode.

While the time display is active, press the computer button in the turn signal lever until the display changes.

Average fuel consumption



If you continue to press the button on the turn signal lever, the average fuel consumption last displayed is recalculated from that point in time.

Any time spent when the vehicle is stationary and the engine shut off is ignored in the calculation.

Cruising range

The computer bases its calculations of the cruising range on the preceding driving style and on the remaining fuel in the tank.

Average speed

If you continue to press the button on the turn signal lever, the average fuel consumption last displayed is recalculated from that point in time.

Technology for safety and driving convenience

Dynamic Stability Control DSC

The concept

DSC maintains vehicle stability, even in critical driving situations.

The DSC is operational every time you start the engine.



 For additional details on the system and the various functions, please refer to the "Technology" brochure. ◀

Indicator lamps

The indicator lamps in the instrument cluster go out shortly after you switch on the ignition.

 Dynamic Stability Control DSC indicator lamp flashes:
The system is active and governs drive torque and braking intervention. The indicator lamp stays lit: Dynamic Stability Control DSC and Dynamic Traction Control DTC have been switched off via the button.

 Dynamic Traction Control DTC indicator lamp lights up permanently: DTC has been deactivated via the DSC button.

 Dynamic Stability Control DSC indicator lamp flashes:
 Dynamic Traction Control DTC indicator lamp lights up permanently: DTC is actively regulating drive torque and braking intervention.

 Interventions to increase stability are being performed to a limited degree only. ◀



The Dynamic Stability Control DSC indicator lamp and yellow brake warning lamp for Dynamic Brake Control DBC light up continuously: Dynamic Stability Control DSC, Dynamic Traction Control DTC and Dynamic Brake Control DBC are malfunctioning. Have the system repaired at your BMW center.



Indicator and warning lamps for Canadian models.

 The vehicle remains completely operational without the DSC, DTC and DBC functions. ◀

In the event of a malfunction, please see your BMW center.



If the brake warning lamp comes on together with the yellow indicator lamps for the Antilock Brake System ABS and the Dynamic Stability Control DSC:
 The entire ABS and DSC control system has failed. Continue driving cautiously and defensively. Avoid hard brake applications. Please have the system checked by your BMW center as soon as possible.



ABS and DSC indicator and warning lamps for Canadian models.

 For more information on the various systems, refer to the "Technology" brochure. ◀

Switching off DSC/Activating DTC



Press the DSC button briefly. The DTC indicator lamp comes on and stays on.

DSC has been switched off; DTC is in ready mode.

In the following exceptional circumstances, it may be effective to activate the DTC for a short period:

- ▷ When rocking the vehicle or starting off in deep snow or on loose surfaces
- ▷ When driving on snow-covered grades, in deep snow, or on a snow-covered surface that has been packed down from being driven on
- ▷ When driving with snow chains.

The gain in traction is achieved by a reduction in stabilizing intervention.

Switching off DSC and DTC

Hold the DSC switch down for at least 3 seconds. The DSC indicator lamp stays lit.

In this case, no interventions to increase stability and traction for the engine and brakes are carried out.

 To maintain vehicle stability, drive with the DSC switched on whenever possible. ◀

Reactivating DSC and DTC

Press the button again.
The indicator lamp goes out.

 The laws of physics cannot be repealed with DSC. It will always be

the driver's responsibility to drive in a manner that matches road conditions. We therefore urge you to avoid using the additional safety margin of the system as an excuse for taking risks. Stabilizing intervention is only performed to a limited degree when the DTC is activated.

Do not make any modifications to the DSC system. Allow only authorized technicians to perform service procedures on the DSC. ◀

Dynamic Brake Control DBC

If you step on the brake rapidly, this system automatically produces maximum braking force boost and thus helps to achieve the shortest possible braking distance during panic stops. All of the benefits of the ABS system are exploited under these circumstances.

Do not reduce the pressure on the brake pedal for the duration of the brake application. When the brake pedal is released, the DBC is deactivated.

For more information on the system, refer to the "Technology" brochure.

Brake Force Display

The Brake Force Display indicates to the road user behind you how hard you are braking.

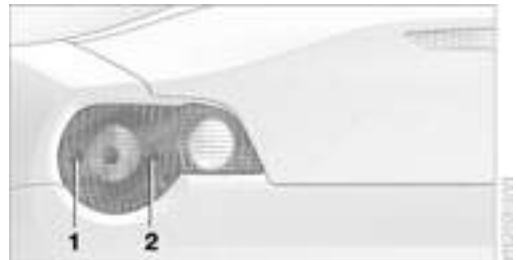

The display has two levels:

- ▷ Normal braking:
Brake lamp **1 lights up** on both sides of the vehicle together with the center brake lamp.

- ▷ Forceful braking and braking with ABS: Brake lamps **1** and **2** light up on both vehicle sides together with the center brake lamp.

Antilock Brake System ABS

The concept

ABS keeps the wheels from locking during braking, thereby enhancing active driving safety.

Malfunction



If the yellow indicator lamps for the Antilock Brake System ABS come on together with the brake warning lamp and the indicator lamp for the Dynamic Stability Control DSC:

The entire ABS and DSC control system has failed. Continue driving cautiously and defensively. Avoid hard brake applications. Please have the system checked by your BMW center as soon as possible.



ABS and DSC indicator and warning lamps for Canadian models.



Braking with ABS

If you are in a situation which requires full braking, you will exploit the full benefits of the ABS system if you apply maximum brake pressure – panic stop.

Pulsation at the brake pedal combines with sounds from the hydraulic circuits to indicate to the driver that ABS is in its active mode.

Flat Tire Monitor

The concept

The tire pressure is determined using the signals of the ABS sensors. The system provides an alert whenever the tire pressure of one tire drops relative to that of another.

Prerequisites

In order for the system to "learn" the correct tire inflation pressures, please do the following:

- ▷ Check the inflation pressure in all tires
- ▷ Compare to the inflation pressure table – refer to page 72 – and correct if necessary
- ▷ Initialize the system.



Check the tire pressures regularly and correct if necessary. Refer to page 71. ◀

Indicator lamp

In the event of a flat tire



The indicator lamp lights up red; in addition, an acoustic signal is sounded:

Respond immediately by carefully reducing vehicle speed to under 50 mph / 80 km/h. Avoid hard brake applications and steering maneuvers.



If your vehicle is equipped with Run Flat tires, note the information on page 75. ◀



The Flat Tire Monitor cannot alert you to severe and sudden tire damage caused by external factors. Another factor which the Flat Tire Monitor does not recognize is the even and very gradual pressure loss that takes place in all tires over an extended period of time. ◀

System malfunction



The indicator lamp lights up yellow: There is a malfunction or fault in the Flat Tire Monitor.

In the event of this, please contact your BMW center.

Initializing the system



Initialize the system only when the inflation pressure has been corrected or modified, e.g. if a tire was changed.

1. Turn ignition key to position **2**. Do not start the engine
2. Press the button long enough for the yellow indicator lamp in the instrument cluster to light up for a few seconds
3. Start the engine.

After a few minutes' driving time, the Flat Tire Monitor stores the current inflation pressure in the tires as the target value to be monitored.

The Flat Tire Monitor automatically functions when the ignition key is in position **2** and thus operates whenever the vehicle is being driven.

False alarms



Do not initialize the system when snow chains are in use. When driving with snow chains, false alarms can occur or a drop in inflation pressure may go undetected. ◀



The following situations may lead to false alarms or to delays in the detection of inflation pressure drop:

- ▷ Driving on snowy or slippery roads
- ▷ Driving in a sporty manner – slipping drive wheels, high lateral acceleration. ◀

Controlling the climate for pleasant driving

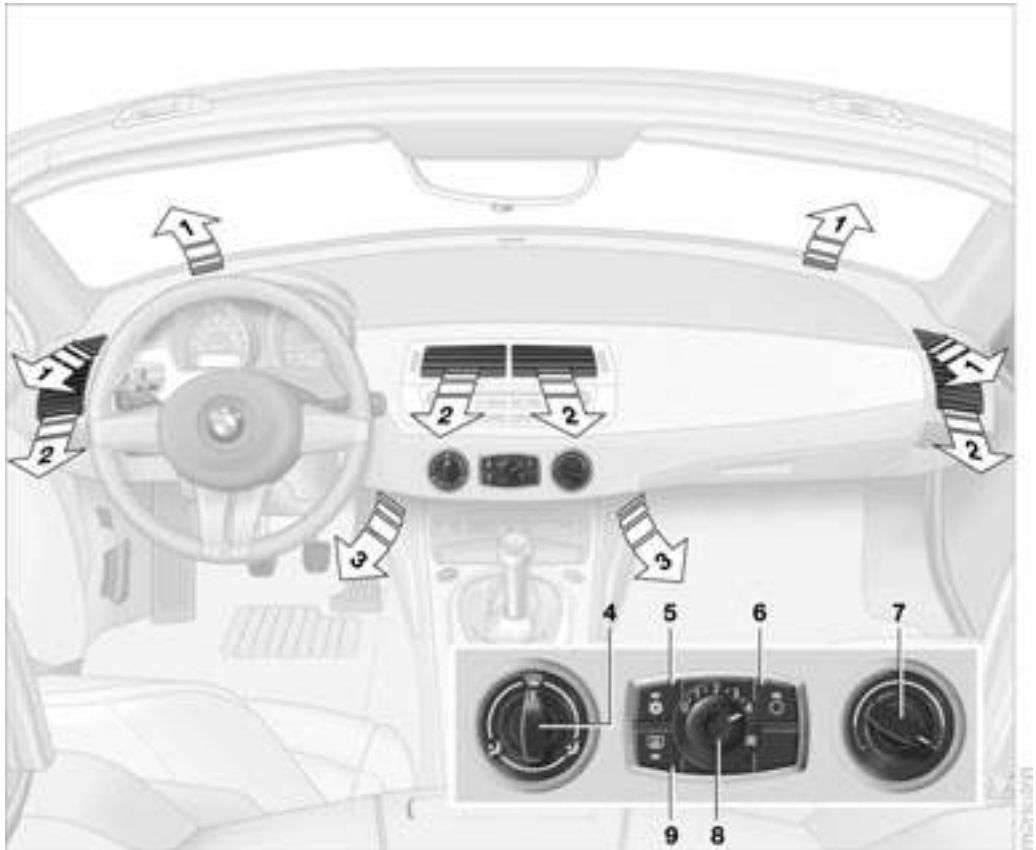

Air conditioning



- | | | | |
|---|--|---|--------------------------------------|
| 1 | Air onto the windshield and the side windows | 6 | Outside-air/recirculated-air mode 56 |
| 2 | Air for the upper body area 56 | 7 | Temperature adjustment 56 |
| 3 | Air for the footwell | 8 | Air supply/blower 56 |
| 4 | Air distribution 56 | 9 | Rear window defroster 56 |
| 5 | Air conditioning 56 | | |

Air distribution



You can direct airflow onto the windows , toward the upper body  and into the footwell . All intermediate settings are possible.

Air supply/blower



You can set the blower to 8 different levels. Both heating and ventilation become more effective as the air supply rate is increased.

Temperature



In order to increase the temperature of the passenger compartment, turn to the right – red zone.

Air conditioning



The air is cooled and dehumidified and – depending on the temperature setting – rewarmed. Depending on the weather, the windshield may fog over briefly when the engine is started.

 Condensation forms during operation of the air conditioning system, which then exits under the vehicle. Traces of condensed water on the ground underneath the vehicle are thus normal. ◀

Outside-air/recirculated-air mode



If there are unpleasant odors in the outside air, you can temporarily block the supply of incoming air. The system then recirculates the air currently within the vehicle.

 If the windows fog over in the recirculated air mode, switch this mode off and increase the air supply as required. ◀

Rear window defroster



The indicator lamp lights up when the rear window defroster is active. The rear window defroster switches off automatically.

Ventilation



You can adjust the blower controls for the upper body area to obtain the optimum airflow rates and directions for your personal requirements:

- 1 Rotary dials for opening and closing the vents at any setting desired
- 2 Lever for adjusting airflow direction

Particle filter

The built-in particle filter removes dust and pollen from the incoming air and in the recirculated air mode. Your BMW center will replace this filter during the regularly scheduled maintenance. A substantial reduction in airflow indicates that the filter needs to be replaced earlier.

To defrost windows and remove condensation



- 1 Turn the rotary control to 
- 2 Turn the rotary blower control for the air supply completely to the right
- 3 Turn the rotary temperature control completely to the right
- 4 To defrost the rear window, switch on the rear window defroster

Automatic climate control*

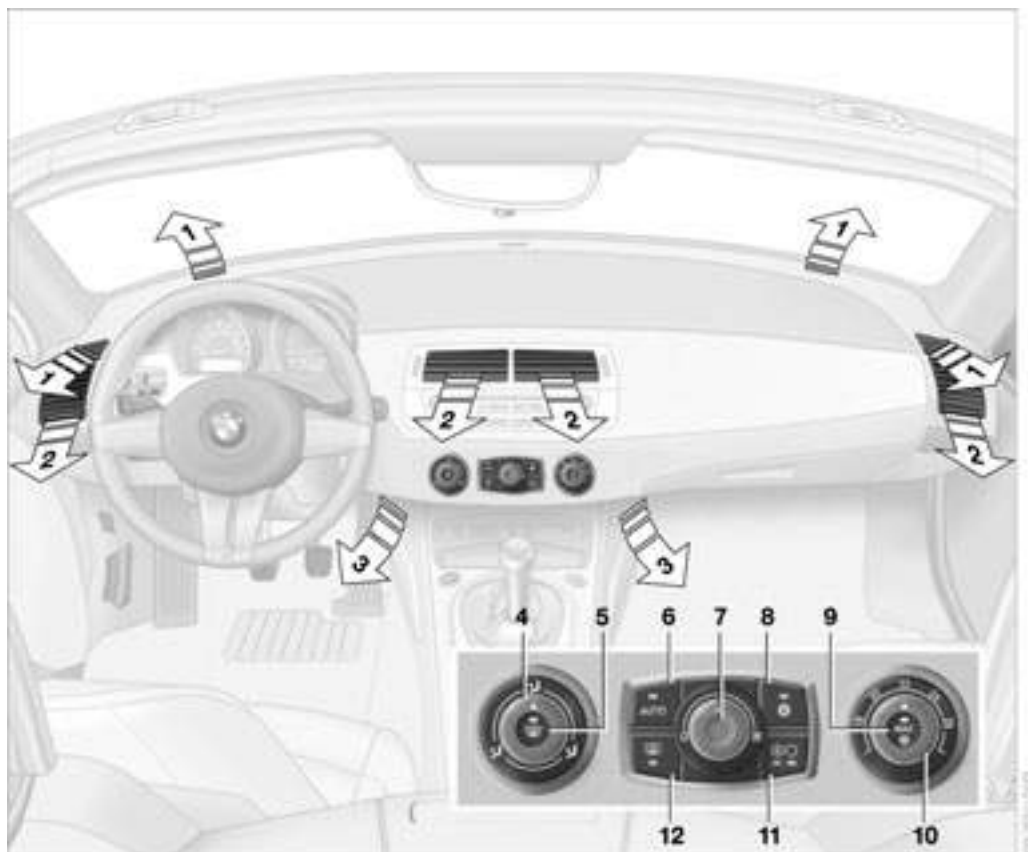

- 1 Air onto the windshield and the side windows
- 2 Air for the upper body area 59
- 3 Air for the footwell
- 4 Individual air distribution 58
- 5 Defrost windows and remove condensation 58
- 6 Automatic air distribution and air supply 58
- 7 Air supply/blower 58
- 8 Air conditioning 56
- 9 Maximum cooling 58
- 10 Temperature 58
- 11 Outside air/Automatic recirculated air control AUC/recirculated air mode 58
- 12 Rear window defroster 59

Tips for pleasant driving

Use the automatic system – switch on with AUTO button **6**. Select the desired interior temperature.

Detailed setting options are described for you below.



Automatic air distribution and supply



The AUTO program assumes the adjustment of the air distribution and air supply for you and in addition adapts the temperature to external influences – summer, winter – to meet preferences you can specify.

Individual air distribution



You can also direct air flow onto the windows , toward the upper body  and into the footwell  as you require. The arrow lights up. The automatic air supply remains unchanged. All intermediate settings are possible. By pressing the AUTO button, you can reactivate the air distribution.

Temperature



The interior temperature that appears on the display panel is a general figure intended for reference purposes. When you start the vehicle, the system ensures that the selected temperature is reached as quickly as possible. It then maintains this temperature, regardless of the season.

Air supply/blower



You can set the blower through an infinitely variable range of speeds. This shuts off the automatic air supply. The arrow lights up. The automatic air distribution remains unchanged. You can reactivate the automatic air supply by pressing the AUTO button.

When you turn the rotary control toward zero: the blower, heating and air conditioner are switched off, and the air supply is

stopped. You can reactivate the system by turning the control toward the right again.

To defrost windows and remove condensation



This program quickly removes ice and condensation from the windshield and the side windows.

Maximum cooling



This program gives you maximum cooling within a short period of time.

The temperature is set to the lowest possible value. The system switches into the recirculated air mode and air flows at maximum blower speed from the air outlets only. Therefore, the air outlets must always be open when you select this program.

Air conditioning



The air is cooled and dehumidified and – depending on the temperature setting – rewarmed.

Depending on the weather, the windshield may fog over briefly when the engine is started.

The air conditioning system is automatically switched on when you use the AUTO program.



Condensation forms during operation of the air conditioning system, which then exits under the vehicle. Traces of condensed water on the ground underneath the vehicle are thus normal. ◀

Outside air/Automatic recirculated air control AUC/recirculated air mode



You can respond to unpleasant external odors or pollutants by temporarily stopping the flow of outside air. The system then recirculates the air currently within the vehicle.

By repeatedly pressing the button, you can select one of three different operating modes.

- ▷ Indicator lamps off: outside air flows into the vehicle
- ▷ Left-hand indicator lamp on – AUC mode: the system detects pollutants in the outside air and responds by deactivating the outside airflow as required. The system then recirculates the air currently within the vehicle. Depending on air quality requirements, the system automatically switches between outside air supply and recirculation of the air already within the vehicle
- ▷ Right-hand indicator lamp on: the flow of outside air is permanently blocked. The system recirculates the air already within the vehicle.



If the windows fog over in the recirculated air mode, switch this mode off and increase the air supply as required. ◀

Rear window defroster



The indicator lamp lights up when the rear window defroster is active. The rear window defroster switches off automatically.

Ventilation

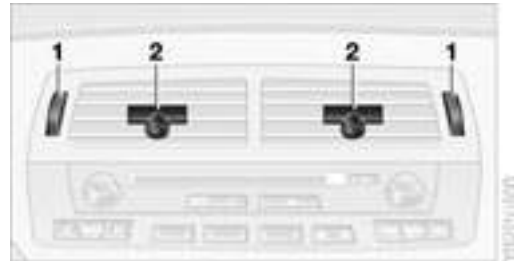

You can adjust the blower controls for the upper body area to obtain the optimum air-flow rates and directions for your personal requirements:

- 1 Rotary dials for opening and closing the vents at any setting desired
- 2 Lever for adjusting airflow direction

Microfilter/activated-charcoal filter

The built-in microfilter removes dust and pollen from the incoming air. The activated-charcoal filter provides additional protection by filtering gaseous pollutants from the outside air. Your BMW center will replace this combined filter as a standard part of your scheduled maintenance. A substantial reduction in airflow indicates that the filter needs to be replaced earlier.

Interior conveniences

Glove compartment

To open



Press the two push buttons together.

To close

Swing the door up.

 To prevent injury in the event of an accident, close the glove compartment immediately after use. ◀

Storage compartments

Storage compartment between backrests



To open

1. Press button; see arrow **1**
2. Swing the cover downward.

To close

Swing the door up.

Locking/unlocking

The storage compartment between the backrests is automatically locked and unlocked with the central locking system.

Releasing manually

In the event of an electrical malfunction of the central locking system, you can manually unlock the storage compartment between the seats.

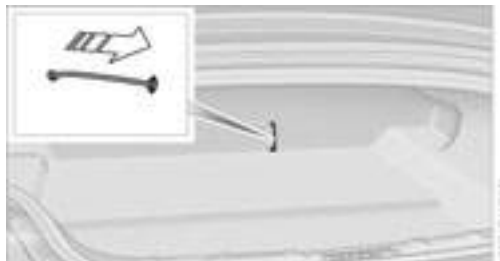

1. Pull on the cord in the rear luggage compartment panel.
The storage compartment between the seats unlocks
2. Press button; see arrow **1**.

Other compartments and nets*

You will find additional storage compartments in the front doors and in the center console.

Depending on the particular version, the vehicle may also be equipped with two storage compartments behind the seats.

A net* is located on the passenger side along the center console.

Beverage holder

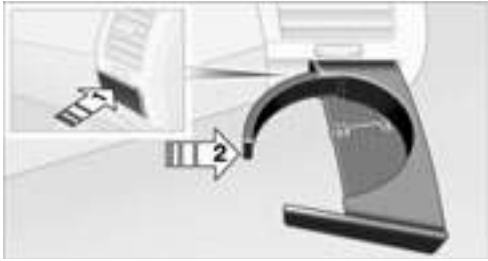

Beverage holders are located on each side beneath the air outlets.

1. Press the trim piece beneath the air outlets; see arrow 1
2. Place the beverage can into the holder
3. Adjust the holder to fit the size of the beverage can; see arrow 2.

Preparations for the cellular phone*

Hands-free system



In vehicles that are wired for a telephone*, the cover of the hands-free microphone is located in the headliner close to the interior lamps.

For further information on the cellular phone, refer to the Owner's Manual for the telephone.

Ashtray*

To empty



1. Open cover
2. Pull out ashtray 1.

Cigarette lighter

Press in lighter 2. As soon as the lighter springs back out, it can be removed.

⚠ Hold or touch the hot cigarette lighter by the knob only. Holding or touching it in other areas could result in burns. The cigarette lighter remains operational even when the ignition key has been removed. For this reason, children should never be left in the vehicle unattended. ◀

Cigarette lighter socket

This can be used for attaching power supplies for flashlights, car vacuum cleaners and other similar appliances up to a rating of approx. 200 watts at 12 volts.

⚠ Do not damage the socket by inserting plugs of a different shape or size. ◀



Driving tips

"Driving tips" provides you with information you will require in certain driving situations and when using special operating modes.

Special operating instructions

Break-in procedures

To ensure that your vehicle provides maximum economy throughout a long service life, we request that you observe the following:

Engine and differential

Up to 1,250 miles / 2,000 km:

Drive at varying engine and road speeds, but do not exceed the following engine or road speed:

4,500/min or 100 mph / 160 km/h:

Obey your local and state maximum speed limits.

Refrain from using full throttle and avoid pressing the accelerator beyond the kick-down point.

After you have driven 1,250 miles / 2,000 km, you can gradually increase the engine or road speeds.

You should also comply with these break-in procedures if the engine or differential is replaced later in the course of the vehicle's service life.

Tires

Due to technical factors associated with their manufacture, tires do not achieve their full traction potential until an initial break-in period has elapsed. You should therefore drive with extra caution during the first 200 miles / 300 km.

Obey your local and state maximum speed limits.

 When the vehicle is operated on wet or slushy roads, a wedge of water may form between the tire and the road surface. This phenomenon is referred to as hydroplaning and can lead to partial or complete loss of traction, vehicle control and braking effectiveness. Reduce your speed on wet roads. ◀

Brake system

Approx. 300 miles / 500 km must elapse before the brake pads and rotors achieve their optimal surface and wear pattern.

To break in the separate parking brake drums, apply the parking brake lightly when coasting to a standstill – at a traffic signal, for instance; use caution to avoid posing a danger to other road users.

To avoid corrosion, repeat this procedure from time to time.

The brake lamps do not come on when the parking brake is set.

 Vacuum for the brake system servo unit on your BMW is available only when the engine is running. When you move the car with the engine off – e.g., by towing – substantially higher levels of pedal force will be required to brake the vehicle. ◀

Clutch

The clutch will achieve its optimal functionality after approx. 300 miles / 500 km. Shift gears carefully during the break-in period.

Driving notes

Parking the vehicle

Condensation forms in the air conditioner system during operation, which then exits under the vehicle. Traces of condensed water on the ground underneath the vehicle are thus normal.

Brakes

 Do not drive with your foot resting on the brake pedal. Even light but consistent pedal pressure can lead to high temperatures, brake wear and possibly even brake failure.

Hydroplaning

 When driving on wet or slushy roads, reduce vehicle speed. If you do not, a wedge of water may form between the tires and the road surface. This phenomenon can lead to partial or complete loss of traction, vehicle control and braking effectiveness. ◀

Driving through water

 Do not drive through water on the road if it is deeper than 1 ft / 30 cm, and then only at walking speed. Otherwise, the vehicle's engine, the electrical systems and the transmission may be damaged. ◀

High temperatures

 High temperatures occur with every vehicle equipped with a catalytic converter. Heat shields are installed adjacent to some sections of the exhaust system. Never remove these shields; do not apply undercoating to their surfaces. When driving, standing at idle and parking the vehicle, take care to avoid contact between the hot exhaust system and flammable materials – e.g. hay, leaves, grass, etc. Such contact could lead to a fire, resulting in serious personal injury and property damage. ◀

Brake system



The brake warning lamp lights up although the parking brake is not engaged: check the brake fluid level. It is very important that you follow the instructions on page 81 before driving on.

Disc brakes

Corrosion

Limited vehicle use, extended periods with the vehicle parked or in storage, and operating conditions in which braking is restricted to gentle, low-pressure applications will all increase the tendency for corrosion to form on the rotors and contamination to accumulate on the brake pads. This occurs because the minimal pressure which must be exerted by the pads to clean the rotors by brake applications is not reached.

If the brake rotors are corroded, they will tend to respond to braking with a pulsating effect which even extended application will fail to cure.

Wet roads

When driving in heavy rain and on wet roads, it is useful to apply light pressure to the brake pedal every few miles. Watch traffic conditions to ensure that this maneuver does not endanger other road users. The heat generated in this process helps dry the pads and rotors to ensure that your brake system will respond with undiminished efficiency when you need it.

Inclines

Extended or steep mountain descents should be driven in the gear or drive position in which only minimal periodic brake application is required. This helps avoid placing excessive loads on the brake system. Observe the maximum allowable engine speed when doing so; refer to page 47.



Do not coast with the clutch depressed or with the transmission or selector lever in Neutral. Do not coast with

the engine switched off. Otherwise the engine provides no braking effect and there is no power-assist for braking or steering when the engine is off. ◀

Brake pads



The yellow indicator lamp for the brake pads lights up:

Have the condition of the brake pads inspected. ◀



For your own safety: use brake pads which the manufacturer has approved for your specific vehicle model. The manufacturer cannot evaluate non-approved brake pads to determine if they are suitable for use, and therefore cannot ensure the operating safety of the vehicle in the event of their use. ◀

Cargo loading

Stowing cargo



▷ Load heavy cargo as far forward as possible – directly behind the luggage compartment partition – and as low as possible

▷ Cover sharp edges and corners.



With the convertible top closed, you can increase the space in your luggage compartment. Refer to page 22.

We recommend that you always fold the convertible top compartment panel down as soon as you have removed your cargo from the luggage compartment. This way, you can be sure that you can always operate the convertible top at any time.

Conversely, when the convertible top is closed, raise the convertible top compart-

ment panel before stowing your cargo in the luggage compartment to avoid any damage to the convertible top compartment or your load. ◀

If you stow cargo behind the seats of your BMW Z4 roadster:

- ▷ Only stow light objects such as clothing, etc.
- ▷ Do not pile objects higher than the top edge of the backrests.



To avoid damaging the rear of the backrest or the rear interior trim panel, do not stow heavy cargo or cargo with sharp edges and corners behind the seats.

In addition, large and bulky cargo stowed behind the seats may prevent the backrest from engaging properly. Ensure that the backrest is securely locked by moving the seat forward if necessary. Refer to page 29. ◀



Always position and secure the load correctly. If you do not, it can endanger the passengers during braking or evasive maneuvers.



Do not exceed the approved gross vehicle weight or the specified maximum axle loads. Refer to page 94. Otherwise the vehicle's operating safety is no longer assured and you are in violation of the law. Do not stow heavy or hard objects in the passenger compartment without first securing them. Otherwise they would be thrown around during braking and evasive maneuvers and would endanger the occupants. ◀

Hardtop preparation*



Pull covers off; see arrow **1**.

The brackets for attaching the hardtop are located underneath the covers; see arrow **2**.

-  For instructions on how to install the hardtop, please read the accompanying assembly information. ◀
-  The hardtop is available from your BMW center as a special option. ◀





Mobility

To ensure that you stay mobile, the following chapter provides you with important information on fuels and fluids, tires and wheels, maintenance procedures and steps to take in the event of a breakdown.

Refueling

Fuel filler door



1. Open fuel filler door
2. Turn the filler cap in a counter-clockwise direction
3. Place the filler cap in the bracket on the filler door.

Releasing manually

If an electrical malfunction occurs, you can unlock the fuel filler door manually.



1. Remove the covers of the tail lamps by turning the lock to the right; refer also to page 87
2. Pull the luggage compartment trim panel slightly toward the interior. The green button with the fuel pump symbol is revealed
3. Undo the adhesive strip and pull off
4. Pull on the knob
Fuel filler cap is released.

Fuel gas cap

Close the gas cap carefully after refueling until a "click" is heard. While

closing, be sure not to squeeze the strap which is fastened to the cap. A loose or missing cap will activate the "Check gas cap" lamp. ◀



Check gas cap

This indicator lamp comes on when the fuel gas cap is loose or missing. Close the gas cap tightly as described above.

Tank capacity: approx. 14.5 gallons / 55 liters, of which approx. 2.1 gallons / 8 liters are reserve capacity.

Simple and environmentally friendly



When handling fuels, comply with all of the applicable safety precautions posted at the service station. ◀

When refueling, insert the filler nozzle completely into the filler pipe. Pulling the nozzle out of the pipe during refueling

- ▷ results in premature shutoff
- ▷ and will reduce the effect of the vapor recovery system on the pump.

The fuel tank is full when the filler nozzle shuts off the first time.



Fill the fuel tank before it is completely empty. Driving to the last drop of fuel can prevent the engine from operating properly and result in damage. ◀

Fuel specifications

The engine uses lead-free gasoline only.

Required fuel:

- ▷ Premium Unleaded Gasoline, min. 91 AKI.
AKI = Anti Knock Index.



Do not use leaded fuels. The use of leaded fuels will cause permanent damage to the system's oxygen sensor and the catalytic converter. ◀

Wheels and tires

Tire inflation pressure

Information for your safety

The factory-approved Run Flat tires are matched to the vehicle and have been selected to provide optimum safety and driving comfort.

It is not merely the tire's service life, but also driving comfort and – above all else – driving safety that depend on the condition of the tires and the maintenance of the specified tire pressure.

Incorrect tire inflation pressure is a frequent cause of tire damage. It also significantly influences the roadholding ability of your BMW.

 Check tire inflation pressures regularly – at least every two weeks and before every extended journey. If this is not done, incorrect tire pressures can cause driving instability or tire damage, ultimately resulting in accidents. ◀

Checking tire pressures



The specified inflation pressures are provided on a sticker attached to the B-pillar and are visible when the driver's door is open.

All pressures are specified in the units usually used in your country – psi and kilopascal – for tires at ambient temperatures; also refer to the following tire inflation pressure table.

 Reinitialize the Flat Tire Monitor after correcting the tire inflation pressure. Refer to page 53.

Comply with tire approval specifications

The inflation pressures in the table apply to BMW-approved tire sizes and tire brands. Your BMW center will be glad to supply this information. Other tire brands may require a higher inflation pressure, which may impair handling and vehicle response.

Z4 roadster 2.5i

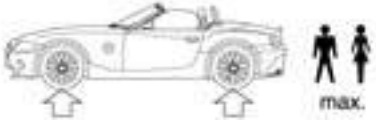
Tires	Pressure specifications in psi/kPa	
Tires		
All pressure specifications in the table are indicated in psi/kilopascal with cold tires – cold = ambient temperature		
225/50 R 16	30/210	33/230
225/45 R 17		
225/40 R 18	30/210	–
245/40 R 17	–	33/230
255/35 R 18		
All winter tires	30/210	33/230

Z4 roadster 3.0i

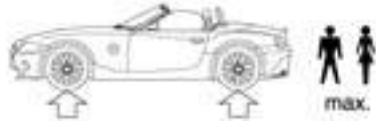
Tires	Pressure specifications in psi/kPa	
Tires		
All pressure specifications in the table are indicated in psi/kilopascal with cold tires – cold = ambient temperature		
225/45 R 17	33/230	36/250
225/40 R 18	33/230	–
245/40 R 17	–	36/250
255/35 R 18		
All winter tires	33/230	36/250

Tire condition

Tire tread – Tire damage



Inspect your tires frequently for tread wear, signs of damage and for foreign objects lodged in the tread. Check the tread depth.

Tread depth should not be allowed to go below $\frac{1}{8}$ in / 3 mm, even though in Europe, for example, the legally specified minimum tread depth is only $\frac{1}{16}$ in / 1.6 mm.

Tread wear indicators in the tread-groove base – see arrow – are distributed around the wheel circumference and are labeled on the tire sidewall as TWI – Tread Wear Indicator. At a tread depth of $\frac{1}{16}$ in / 1.6 mm, the indicators signal that the legally permissible wear limit has been reached.

 Avoid overloading the vehicle so that the permitted load on the tires is not exceeded. Overloading can cause overheating and damage inside the tires. The ultimate result can assume the form of a sudden air loss.

Unusual vibrations encountered during normal vehicle operation can indicate tire failure or some other vehicle malfunction. This type of problem can be caused by contact with curbs, etc. This is also true for irregularities in the vehicle's handling characteristics, such as a pronounced tendency to pull to the left or right. Should this occur, respond by immediately reducing your speed. Proceed carefully to the nearest BMW center or professional tire center, or have the vehicle towed there to have it and its wheels or tires inspected.

Tire damage – up to and including sudden

and complete air loss – can pose an extreme hazard for both vehicle occupants and other road users. ◀

Tire replacement

To maintain good handling and vehicle response, use tires of a single tread configuration from a single manufacturer.

 BMW advises against using retreaded tires as this could negatively affect driving safety. This is due to possible variations in casing structures and, in some cases, to their extreme age, factors which can lead to a decrease in their durability. ◀

Tire age

The date on which the tire was manufactured is indicated by the code on the sidewall:

DOT ... 3602 indicates that the tire was manufactured in week 36 of the year 2002.

BMW recommends the replacement of all tires every 6 years at the latest, even if a tire usage of 10 years is possible.

Run Flat tires

 When replacing tires, always use Run Flat tires since a spare wheel is not provided to replace a flat tire.

Run Flat tires are labeled on the sidewall with a circular symbol containing the letters RSC. Refer to page 75. ◀

DOT quality grades

Tread wear
Traction AA A B C
Temperature A B C

 All passenger car tires must conform to Federal Safety Requirements in addition to these grades. ◀

Tread wear

The tread wear grade is a comparative rating based on the wear rate of the tire when tested under controlled conditions on a specified government test course.

For example, a tire graded 150 would wear

one and one-half (1 ½) times as well on the government course as a tire graded 100. The relative performance of tires depends upon the actual conditions of their use, however, and may depart significantly from the norm due to variations in driving habits, service practices and differences in road characteristics and climate.

Traction

The traction grades, from highest to lowest, are AA, A, B and C.

Those grades represent the tire's ability to stop on wet pavement as measured under controlled conditions on specified government test surfaces of asphalt and concrete. A tire marked C may have poor traction performance.

 The traction grade assigned to this tire is based on straight-ahead braking traction tests, and does not include acceleration, cornering, hydroplaning, or peak traction characteristics. ◀

Temperature

The temperature grades are A – the highest – B, and C, representing the tire's resistance to the generation of heat and its ability to dissipate heat when tested under controlled conditions on a specified indoor laboratory test wheel.

Sustained high temperature can cause the material of the tire to degenerate and reduce tire life, and excessive temperature can lead to sudden tire failure. The grade C corresponds to a level of performance which all passenger car tires must meet under the Federal Motor Vehicle Safety Standard No. 109. Grades B and A represent higher levels of performance on the laboratory test wheel than the minimum required by law.

 The temperature grade for this tire is established for a tire that is properly inflated and not overloaded. Excessive speed, under-inflation, or excessive loading, either separately or in combination, can cause heat buildup and possible tire failure. ◀

Uniform Tire Quality Grading

Quality grades can be found where applicable on the tire sidewall between tread shoulder and maximum section width. For example:

Tread wear 200 Traction AA
Temperature A

Wheel and tire combinations

The right choice

 Use wheels and tires approved by BMW for your particular vehicle. Variations in factors such as manufacturing tolerances mean that even wheels and tires with identical official size ratings could actually have dimensions different from the approved units. These differences could lead to body contact, and with it the risk of severe accidents. If non-approved wheels and tires are used, BMW cannot evaluate their suitability, and therefore cannot be held liable for driving safety. ◀

BMW tests certain tire brands for each tire size, classifies them as road-safe and approves them. Consult your BMW center for more information. Observe any country-specific regulations, e.g. on making a corresponding entry in the vehicle documents.

 The correct wheel and tire combination affects different systems such as ABS, DSC, DTC and DBC. The function of these systems is impaired if improper wheel and tire combinations are used. For this reason, use tires of the same brand and tread configuration. In the event of a flat tire, for example, remount the approved wheel and tire combination as soon as possible. ◀

Run Flat tires



Run Flat tires are labeled on the sidewall with a circular symbol containing the letters RSC.

Run Flat tires consist of self-supporting tires and special rims. The tire reinforcement ensures that the tire retains some residual safety in the event of pressure drop and driving remains possible to a restricted degree.

 Because the sides of the Run Flat tires are reinforced, a drop in inflation pressure usually cannot be detected from the outside. ◀

Flat tire

 The red warning lamp in the instrument cluster lights up when a tire has failed. In addition, an acoustic signal is heard. Refer to pages 14, 53.

1. Reduce vehicle speed carefully to under 50 mph / 80 km/h. Avoid hard brake applications and steering maneuvers
2. Do not exceed 50 mph / 80 km/h again
3. Find out which tire has been damaged; to do so, check the tire inflation pressure of all four tires at the earliest opportunity. Refer to page 71
4. Correct the tire inflation pressure if you wish to continue driving and if it is safe to do so. Refer to the following section
5. Have the damaged tires changed by your BMW center.

 BMW recommends that you consult your BMW center if you wish to

replace the tires of your BMW, or change from summer to winter tires or vice versa. Your BMW center knows how to work with Run Flat tires and is equipped with the necessary special tools. ◀

 For safety reasons, do not have Run Flat tires repaired.

When replacing tires or changing from summer to winter tires – or vice versa – use Run Flat tires only since a spare tire will not be available in the event of a flat tire. ◀

Driving with a damaged tire

When using Run Flat tires, you can continue driving cautiously at a maximum speed of 50 mph / 80 km/h, depending on the cargo load and the extent of tire damage.

You can estimate the distance you can continue driving on the basis of the following values:

- ▷ Tire inflation pressure of 0 psi / 0 kPa: approx. 100 miles / 150 km
- ▷ Tire inflation pressure of 7–15 psi 50–100 kPa: approx. 300 miles / 500 km
- ▷ Tire inflation pressure greater than 15 psi / 100 kPa: approx. 600 miles / 1,000 km.

 Drive cautiously and do not exceed a speed of 50 mph / 80 km/h. In the event of pressure loss, changes in handling characteristics – such as reduced stability when braking, increased stopping distance, and altered steering response – may occur. ◀

Winter tires

Choosing the right tire

BMW recommends Run Flat winter tires – M+S – for operation under inclement winter driving conditions. While all-season tires with the M+S identification mark do indeed possess better winter traction than summer tires that have the H, V, W, Y and ZR speed ratings, they generally do not provide the same levels of performance as true winter tires.

In the interests of sure tracking and safe steering response, mount winter tires which are made by the same manufacturer and which have the same tread configuration on all four wheels.

Your BMW is equipped with Run Flat tires. Please consult your BMW center if you wish to replace the tires of your BMW or change from summer to winter tires, or vice versa.

 When replacing tires or changing from summer to winter tires – or vice versa – use only Run Flat tires since a spare tire will not be available in the event of a flat tire. ◀

Comply with recommended speed

 Never exceed the maximum speed for which the winter tires are rated. Unprofessional attempts by laymen to service tires can lead to damage and accidents.

Have this work performed by skilled professionals only. Any BMW center has the required technical knowledge and the proper equipment and will be happy to assist you. ◀

Tire condition, tire pressure

Once the tire wears to below $\frac{3}{16}$ in / 4 mm, winter tires display a perceptible decrease in their ability to cope with winter driving conditions, and should be replaced in the interest of safety.

Comply with the specified tire inflation pressures – and be sure to have the wheel and tire assemblies balanced every time you change the tires.

Storage

Store tires in a cool, dry place, protecting them against light whenever possible. Protect the tires from contact with oil, grease and fuel.

Snow chains*

Only certain types of snow chains have been tested by BMW, classified as road-safe and approved. Consult your BMW center for more information. BMW recommends using only approved fine-link snow chains.

Their use is only permitted in pairs on the winter tires on the rear wheels. Comply with all manufacturer's safety precautions when mounting the chains.

You cannot mount snow chains on the following tires:

245/40 R 17

255/35 R 18

 Do not exceed a speed of 30 mph / 50 km/h when using snow chains. ◀

 Do not initialize the Flat Tire Monitor after snow chains have been mounted.

When driving with snow chains, it may be useful to deactivate the DSC briefly. Refer to page 51. ◀

In the engine compartment

Hood

To release the hood



Pull the lever located under the left-hand side of the instrument panel.

 Do not work on your vehicle without the appropriate skills to do so. Failure to work in an informed, professional manner when servicing components and materials constitutes a safety hazard for vehicle occupants and other road users. If you are not familiar with the guidelines, please have the operations performed by a BMW center. ◀

To open



1. Reach under the engine hood
2. Push the release handle up
3. Open the hood.

To close

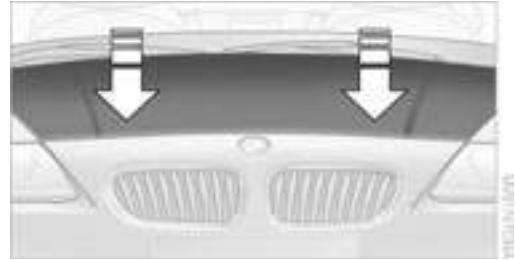

Allow the hood to fall from a low height and push on both sides so that it audibly engages.

 To avoid injuries, be sure that the travel path of the hood is clear when it is closed, as with all closing procedures. If you notice while driving that the hood is not completely closed, stop immediately and close it securely. ◀

Engine compartment

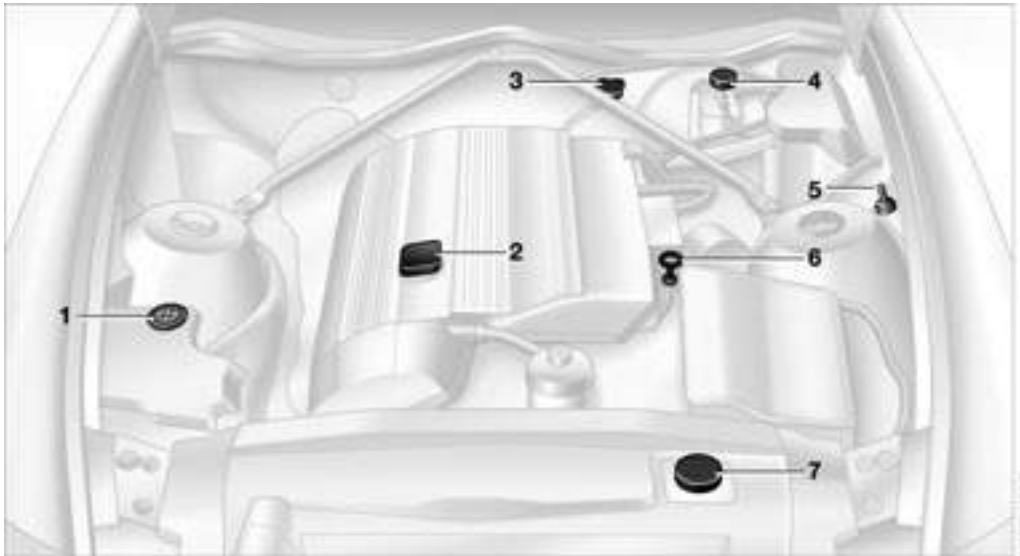

- | | | | | | |
|---|---|----|---|------------------------------------|----|
| 1 | Reservoir for headlamp and windshield washer system | 79 | 4 | Reservoir for brake fluid | 81 |
| 2 | Engine oil filler neck | 80 | 5 | Chassis ground - negative terminal | |
| 3 | Auxiliary terminal for jump-starting | 89 | 6 | Engine oil dipstick | 79 |
| | | | 7 | Coolant expansion tank | 80 |

Washer fluids for washer systems

Headlamp* and windshield washer system



Capacity of windshield washer system: approx. 3.2 US quarts / 3 liters.

Capacity when equipped with headlamp washer system: approx. 5.3 US quarts / 5 liters.

Fill with water and – if required – with an antifreeze agent according to the manufacturer's recommendations.

 We recommend that you mix the washer fluid before adding it to the reservoir. ◀

 Antifreeze agent for the washer systems is flammable. For this reason, keep it away from sources of flame and store it only in its original container. Store it so that it is inaccessible to children. Comply with the instructions on the containers. ◀

Engine oil

Engine oil pressure

 The red engine oil warning lamp lights up: Stop the vehicle immediately and switch off the engine. Check the engine oil level and top off as required. If the oil level is correct, please contact the nearest BMW center.

 Do not continue driving, as the engine could sustain serious damage from inadequate lubrication. ◀

Engine oil level



The yellow engine oil indicator lamp lights up while driving: The oil level is at the absolute minimum; refill as soon as possible. Do not drive more than approx. 30 miles / 50 km until you do.



The yellow engine oil indicator lamp lights up after the engine is switched off: add engine oil at the earliest opportunity, when you stop to refuel.

Engine oil sensor



The yellow engine oil indicator lamp lights up within 20 seconds after the engine is started: The oil level sensor is defective. Please have it checked by a BMW center.

Checking the oil level



1. Park the vehicle on a level surface
2. Switch the engine off after it has reached normal operating temperature
3. After approx. 5 minutes, pull the dipstick out and wipe it off with a clean lint-free cloth, paper towel, or similar material
4. Carefully push the dipstick all the way into the guide tube and pull it out again
5. The oil level should be between the two marks on the dipstick
6. Return the dipstick to the guide tube, inserting it as far as it will go.

As with fuel economy, oil consumption is directly influenced by your driving style and vehicle operating conditions.

The oil volume between the two marks on the dipstick corresponds to approx. 1.1 US quarts / 1 liter. Do not fill beyond the upper mark on the dipstick. Excess oil will damage the engine.

Adding engine oil



While you should wait until the level has dropped to just above the lower mark before adding oil, you should never allow the oil level to fall below this mark.

 BMW engines are designed to operate without oil additives; the use of additives could even lead to damage in some cases. This also applies to manual and automatic transmissions and to the differential. ◀

 Continuous exposure to used oil has caused cancer in laboratory tests. For this reason, thoroughly wash any areas of skin that come into contact with oil using soap and water.

Always store oils, grease and similar materials so that they are inaccessible to children. Comply with warning labels and the information on the containers. ◀

 Comply with the applicable environmental laws regulating the disposal of used oil. ◀

Approved engine oils

The quality of the engine oil is extremely important for the function and life of an engine. Based on extensive testing, BMW has approved certain grades of engine oil. Use approved "BMW High Performance Synthetic Oil".

If you are unable to obtain an approved BMW High Performance Synthetic Oil, you

may use small volumes of other synthetic oils for topping up between oil changes. Use only oils with the specification API SH or higher.

 Ask your BMW center for details concerning the specific BMW High Performance Synthetic Oil or synthetic oils that have been approved. ◀

You can also call BMW of North America toll-free at 1-800-831-1117 or visit this website: www.bmwusa.com to obtain this information.

Coolant

 The yellow coolant indicator lamp lights up:
The coolant level is too low: top up as soon as possible.

 Do not add coolant to the cooling system when the engine is hot. If you do, escaping coolant can cause burns. Antifreeze and anti-corrosion agents are hazardous to health. You should always store them in their original containers and in a location inaccessible to children. Antifreeze and anti-corrosion agents are flammable. For this reason, do not spill them on hot engine parts. They could ignite and cause burns. Comply with the instructions on the containers. ◀

Checking the coolant level



Correct coolant level when the engine is cold – at approx. 68 °F / 20 °C:

1. Open the cap of the expansion tank by turning it slightly counterclockwise to

allow accumulated pressure to escape, then open completely

2. The coolant level is correct when the upper end of the red float is at least even with the upper edge of the filler neck but no more than $\frac{3}{4}$ in / 2 cm above it, that is, up to the second mark on the float. Refer also to the schematic diagram next to the filler neck
3. If necessary, add coolant. Slowly add coolant until the correct level is reached – do not overfill.

 Comply with the applicable environmental laws regulating the disposal of extended-duty antifreeze with corrosion inhibitor. ◀

Brake fluid

Indicator lamp



 The brake warning lamp lights up red when the parking brake is not engaged: the brake fluid level is too low, refer to page 65.

 Brake warning lamp for Canadian models

Brake fluid, refilling

Brake fluid loss may result in extended brake pedal travel. If this occurs, also refer to the notes on page 65.

 Brake fluid is hygroscopic, that is, it absorbs moisture from the air over time.

In order to ensure the brake system's safety and reliability, have the brake fluid

changed every two years by a BMW center. Refer also to page 48 and the Service Manual.

Brake fluid is toxic and damages the vehicle's paint. You should always store it in the closed original container and in a location inaccessible to children.

Do not spill the fluid and do not fill the brake fluid reservoir beyond the MAX mark. The brake fluid could ignite upon contact with hot engine parts and cause serious burns. ◀

 Comply with the applicable environmental laws regulating the disposal of brake fluid. ◀

Brake fluid level

Low brake fluid level in the reservoir combined with extended pedal travel may indicate a defect in one of the brake system's hydraulic circuits.

 BMW recommends that you proceed to the nearest BMW center. Higher brake application pressure may be necessary under these conditions, and braking distances may be significantly longer. Please remember to adapt your driving style accordingly. ◀

Maintenance

The BMW Maintenance System

The BMW Maintenance System has been designed as a reliable means of providing maximum driving and operating safety – and as cost-effectively for you as possible.

Please keep in mind that regular maintenance is not only necessary for the safety of your vehicle, but also plays a significant role in maintaining the resale value of your vehicle.

Service interval display



While conventional systems rely on distance traveled alone to determine when a service is due, the BMW Maintenance System has taken the actual conditions under which the vehicle is operated into consideration for years, because miles can be traveled in many different ways:

From a maintenance point of view, 62,000 miles / 100,000 km accumulated in short-distance urban driving are not the equivalent of the same distance covered at moderate speeds in long-distance highway travel.

The BMW Maintenance System includes the Engine Oil Service and Inspections I and II.

Determining the maintenance intervals based on the actual loads on the vehicle covers every kind of operating situation. Minimal use drivers, who drive fewer than 6,200 miles / 10,000 km per year, should nevertheless have the oil changed at least

every 2 years since engine oil deteriorates over time, regardless of use.

Service and Warranty Information Booklet for US models/Warranty and Service Guide Booklet for Canadian models

For detailed information on required maintenance items and the work involved, please refer to the Service and Warranty Information Booklet for US models or to the Warranty and Service Guide Booklet for Canadian models.

Depending on operating conditions, it may be advisable to have the body checked for damage from rocks or gravel as a precaution against corrosion.

 BMW recommends that you have your BMW center perform the maintenance and repair.

Check that the maintenance work is recorded in the Service Manual. These entries will serve as proof that the vehicle has received regular maintenance. ◀

Care

Interesting facts about the care of your vehicle are found in the Caring for your vehicle brochure.

Laws and regulations

California Proposition 65 warning

California laws require us to state the following warning:

 Engine exhaust, some of its constituents, and certain vehicle components contain or emit chemicals known to the State of California to cause cancer and birth defects and reproductive harm. In addition, certain fluids contained in vehicles and certain products of component wear contain or emit chemicals known to the State of California to cause cancer and birth defects or other reproductive harm. Battery posts, terminals and related accessories contain lead and lead compounds. Wash your hands after handling. Used engine oil contains chemicals that have caused cancer in laboratory animals. Always protect your skin by washing thoroughly with soap and water. ◀

OBD interface socket



The Onboard Diagnostic OBD interface socket is located on the left of the driver's side behind a specially marked cover located beneath the instrument panel. The cover has the letters OBD on it.

This interface makes it possible to access data on emissions – related components using special equipment.



If the Service Engine Soon indicator lamp comes on either continuously or intermittently, this indicates a fault in the emissions-related electronic systems. Although the vehicle remains operational, you should have the systems checked by your BMW center at the earliest possible opportunity.

The illuminated indicator informs you of the need for service, not that you need to stop the vehicle. However, the systems should be checked by your BMW center at the next opportunity.

If the indicator blinks or flashes, this indicates a high level of engine misfire. Reduce speed and contact the nearest BMW center immediately. Severe engine misfiring over even a short period of time can seriously damage emission control system components, especially the catalytic converter.



Service Engine Soon warning lamp for Canadian models.



If the fuel filler cap is not on tight enough, the OBD system can detect leaking vapor and the indicator will light up. If the fuel filler cap is then tightened, the indicator will usually go out after a short period of time. ◀

Replacement procedures

Onboard tool kit



The onboard tool kit is stored in a tool pouch. It is located in the luggage compartment beneath the floor panel.

Windshield wiper blades



1. Fold the wiper arm completely out from the windshield
2. Position the wiper blade at an angle and pull the release spring, see arrow
3. Fold the wiper blade down and unhook it toward the windshield
4. Pull the wiper blade past the wiper arm toward the top
5. Insert a new wiper blade and apply pressure until you hear it engage.

Lamps and bulbs

The lamps and bulbs make essential contributions to the safety of your vehicle. Therefore, comply fully with the following instructions during bulb replacement. If you are not familiar with the procedures, BMW recommends that you have your BMW center carry out the work.

 Do not touch the glass portion of a new bulb with your bare hands since even small amounts of impurities burn into the surface and reduce the service life of the bulb. Use a clean cloth, paper napkin or a similar material, or hold the bulb by its metallic base. ◀

A replacement bulb set is available from your BMW center.

 Before working on the electrical system, switch off the electrical accessory you are working on or disconnect the cable from the negative terminal of the battery. Failure to observe this precaution could result in short circuits.

To prevent injuries and damage, always comply with any instructions provided by the bulb manufacturer. ◀

Accessing the headlamps



To gain access to the headlamp covers, turn the front wheels in the required direction.



1. Open the caps with a suitable object – coin or screwdriver
2. Flip open the headlamp cover.

Removing the protective cover



1. Pull the wire clamp out straight, see arrow 1



2. Fold the wire clamp down past the catches; see arrows
3. Flip the protective cover open and remove.

Reinstalling the protective cover

⚠ Reinstall the protective cover carefully. If the protective cover is not on tight, the headlamp installation could be damaged. ◀

1. Insert the protective cover into the guides
2. Check that the protective cover is positioned correctly
3. Press the wire clamp past both catches; see arrow.

Low beams and high beams



Left side of engine compartment:

- 1 Low beams
- 2 High beams

H7 bulb, 55 watts

⚠ The H7 bulb is pressurized. Therefore, wear safety glasses and protective gloves. Failure to comply with these precautions could result in physical injury if the bulb is damaged. ◀

1. Turn the bulb holder to the left and pull out
2. Remove and replace the bulb
3. Install in the reverse order.

▶ When cleaning the headlamps, please observe the instructions in the Caring for your vehicle brochure. ◀

Xenon lamps*

The service life of these bulbs is very long and the probability of a failure is very low, provided that they are not switched on and off an unusual number of times. If one of these bulbs should nevertheless fail, it is possible to continue driving with great cau-

tion using the fog lamps, provided traffic laws in your area do not prohibit this.

⚠ Because of the extremely high voltages involved, any work on the xenon lighting system, including bulb-changing, should be carried out by technically qualified personnel only. Otherwise, there is a risk of fatal injury. ◀

Front turn signal indicators

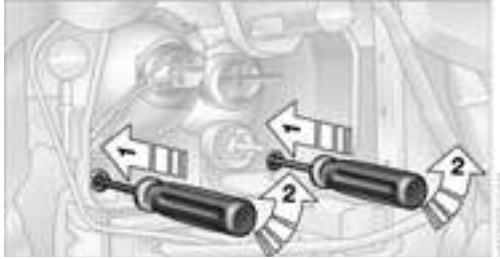

21 watt bulb

1. Insert a screwdriver into the appropriate opening; see arrows **1**
2. Turn the screwdriver to the left; see arrows **2**



3. Use the screwdriver to pull out the entire bulb holder
4. Replace the bulb; see arrow
5. Install in the reverse order.

Side turn signal indicators



5 watt bulb

1. Turn the lamp to the left and remove
2. Apply gentle pressure to the bulb while turning it to the left to remove
3. Install in the reverse order.

Tail lamps

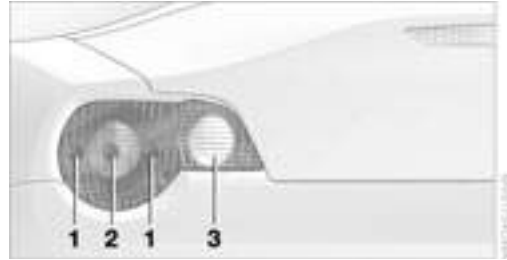

Tail lamps (**1**): 21/4 watt bulbs
Remaining bulbs: 21 watt

- 1** Tail lamp/brake lamp, red
- 2** Turn signal indicator, yellow
- 3** Backup lamp, white



On the right-hand side of the luggage compartment:

1. Remove the cover by turning the lock to the right; refer to the detail in the illustration
2. Applying light pressure, turn the bulb to the left. Remove and exchange the bulb
3. Reinstall the cover.

Center high-mount brake lamp



The LED strip is in the luggage compartment lid.

Please contact a BMW center in case of a malfunction.

License plate lamps



5 watt bulb

1. Push out the lamp with a suitable object and remove it
2. Replace the bulb.
Snap the lamp back into place.

Changing a wheel

Run Flat tires

Your BMW is equipped with Run Flat tires. Therefore, the wheel no longer has to be changed immediately in the event of a loss in inflation pressure.

Run Flat tires are labeled on the sidewall with a circular symbol containing the letters RSC. Refer to page 75.

BMW recommends that you consult your BMW center if you wish to replace the tires of your BMW, or change from summer to winter tires or vice versa.

Your BMW center knows how to work with Run Flat tires and is equipped with the necessary special tools.

 When replacing tires or changing from summer to winter tires – or vice versa – use only Run Flat tires since a spare tire will not be available in the event of a flat tire. ◀

Jacking points

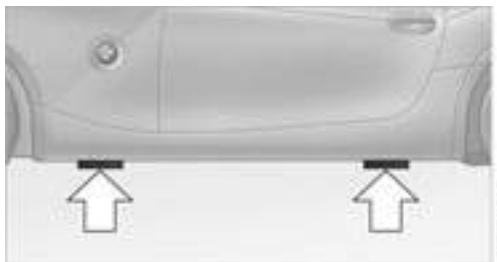

The jacking points are located at the positions indicated in the illustration.

 Your BMW center can provide you with a suitable jack. ◀

Battery

Maintenance

The battery is completely maintenance-free. This means that the original electrolyte will normally last for the service life of the battery under moderate climatic conditions.

 Please consult your BMW center whenever you have any questions concerning the battery. Since the battery is absolutely maintenance-free, the following statements are for your information only. ◀

 Do not disconnect the battery cables when the engine is running. Disconnecting the battery cables when the engine is running will cause a voltage surge which will damage the vehicle's onboard electronics. ◀

Indicator lamp

 The indicator lamp for the battery charge current lights up: The battery is no longer being charged. The alternator drive belt is defective or there is a malfunction in the charging circuit of the alternator. Please contact the nearest BMW center.

 If the drive belt is defective, pull over and switch off the engine immediately to prevent overheating and serious engine damage.

If the onboard supply voltage drops to a very low level, increased steering effort may also be necessary. ◀

Charging the battery

Charge the battery in the vehicle only when the engine is not running. Use the terminals provided in the engine compartment. For information on connections, refer to Jump-Starting on page 89.

Battery disposal

 Return used batteries to a recycling point or to your BMW center. Maintain the battery in an upright position for transport and storage. Secure the battery against tilting when transporting. ◀

Fuses



You will find the fuses and information on their respective allocation behind the glove compartment.

1. Press the lock on the left; see arrow 1
2. Press the lock on the right; see arrow 2
3. Swing the glove compartment down.

Spare fuses and plastic tweezers for grasping the fuses are found in the onboard tool kit; refer to page 84.

 Do not attempt to repair a burned fuse or replace it with a fuse having a different color or amperage rating. To do this could cause a fire in the vehicle as a result of circuit overload. ◀

Giving and receiving assistance

Warning triangle*



The warning triangle is stored in the rear luggage compartment panel.

Pull the ends of the rubber bands upward and out of the fasteners; see arrow.

 Always observe all legal regulations requiring a warning triangle to be carried in the vehicle. ◀

First-aid kit*



The first-aid kit is located beneath the passenger seat.

To open

Pull the handle and fold the cover downward.

To close

Fold the cover up and press into the catch.

 Some of the articles in the first-aid kit have a limited period of use before expiration. For this reason, check the expi-

ration dates of each of the items regularly, and replace any whose expiration dates have passed. You can acquire replacements in any drugstore or pharmacy. Always observe all legal regulations requiring a first-aid kit to be carried in the vehicle. ◀

Jump-starting

When your battery is discharged you can use two jumper cables to start your vehicle with power from the battery in a second vehicle. You can also use the same method to help start another vehicle. Always use jumper cables with fully insulated handles on the terminal clamps.

 Do not touch components carrying current on a running engine. Contact with these components can cause fatal injury. Carefully observe the following instructions to avoid personal injury and/or damage to one or both vehicles. ◀

 Never use spray starter fluids to start the engine. ◀

Preparations for jump-starting the vehicle

1. Check that the battery on the other vehicle is also rated at 12 volts, and that the capacities – in Ah – of the two batteries are roughly comparable. This information is provided on the top of the battery casing
2. Turn off the engine of the support vehicle
3. Switch off all electrical accessories in both vehicles
 - ▷ Do not disconnect the battery from your vehicle's electrical system
 - ▷ Make absolutely certain that there is no contact between the bodywork of the two vehicles – short circuit hazard.

4. Start the engine on the support vehicle and allow it to run
5. Open the cover of the BMW jump-start support terminal by pulling on the tab; see arrow.



Connect jumper cable

 Always adhere to this sequence when connecting jumper cables, even when jump-starting other vehicles. Failure to observe this procedure can lead to sparks and pose a danger of personal injury. ◀

1. With the + jumper cable, connect the positive terminal of the drained battery and the positive terminal of the support battery
2. With the – jumper cable, connect the negative terminals of both vehicles. Your BMW is equipped with a special nut for this purpose, refer to Engine compartment on page 78.

To do so:

- ▷ Attach one cable clamp to the negative battery terminal or to a suitable ground on the engine or body work of the support vehicle
- ▷ Attach the second cable clamp to the negative battery terminal or to a suitable ground on the engine or body work of the vehicle to be jump-started.

Jump-starting the vehicle

1. Let the engine of the support vehicle run for several minutes at a slightly elevated engine idle speed
2. Start the engine of the other vehicle as usual
 - ▷ If the first start attempt is not successful, wait a few minutes before another attempt in order to allow the discharged battery to recharge.
3. Let the engines run for several minutes
4. Then disconnect the jumper cables in reverse sequence.

 Depending on the cause of the fault, have the battery checked and recharged at a BMW center. ◀

Towing and tow-starting the vehicle

Towing eyelet

The screw-in towing eyelet is stored in the onboard tool kit; be sure that it remains in the vehicle at all times. This eyelet is designed for installation in the tow sockets located at the front and rear of the vehicle, and is intended for towing on paved road surfaces only.

Access to towing socket



Front:

Press out the cover panel with a screwdriver inserted in the recess at the top.



Rear:

Press out the cover panel with a screwdriver inserted in the recess at the top.

 Make sure the towing eyelet is firmly screwed all the way in, otherwise the thread could be damaged.

Do not tow the vehicle by any components of the chassis or suspension, or lash them down in any way. If you do, the components could be damaged, possibly leading to accidents.

If the engine is off, increased effort will be required to steer the vehicle since power support will not be available. ◀

Towing with a commercial tow truck



- ▷ Do not tow with sling-type equipment
- ▷ Use wheel lift or flatbed equipment
- ▷ Please comply with applicable state towing laws.

 Never allow passengers to ride in a towed vehicle for any reason.

Never attach tie-down hooks, chains, straps or tow hooks to tie rods, control arms or any other part of the vehicle suspension, as severe damage to these components will occur, leading to possible accidents. ◀



Reference

This chapter will help you find the desired information as quickly as possible. It contains the Technical data section as well as the manual's index.

Technical data

Engine data

		Z4 roadster 2.5i	Z4 roadster 3.0i
Displacement	cu in/cm ³	152.1/2,494	181.7/2,979
Number of cylinders		6	6
Maximum power output at engine speed	hp/kW rpm	184/141 6,000	225/170 5,900
Maximum torque at engine speed	lb ft/Nm rpm	181/245 3,500	222/300 3,500
Compression ratio	ε	10.5	10.2
Stroke	in/mm	2.95/75	3.53/89.6
Bore	in/mm	3.31/84	3.31/84
Fuel-injection system	Digital electronic engine-management system DME		

Weights

		Z4 roadster 2.5i	Z4 roadster 3.0i
Curb weight			
with manual transmission	lbs/kg	2,932/1,330	2,998/1,360
with automatic transmission	lbs/kg	2,998/1,360	3,042/1,380
Approved gross vehicle weight			
with manual transmission	lbs/kg	3,483/1,580	3,549/1,610
with automatic transmission	lbs/kg	3,549/1,610	3,593/1,630
Approved front axle load	lbs/kg	1,720/780	1,742/790
Approved rear axle load	lbs/kg	1,841/835	1,863/845
Luggage compartment capacity	cu ft/l	8.5/240	8.5/240
with the convertible top compartment raised	cu ft/l	9.2/260	9.3/260

Never exceed either the approved axle loads or the approved gross vehicle weight.

Dimensions

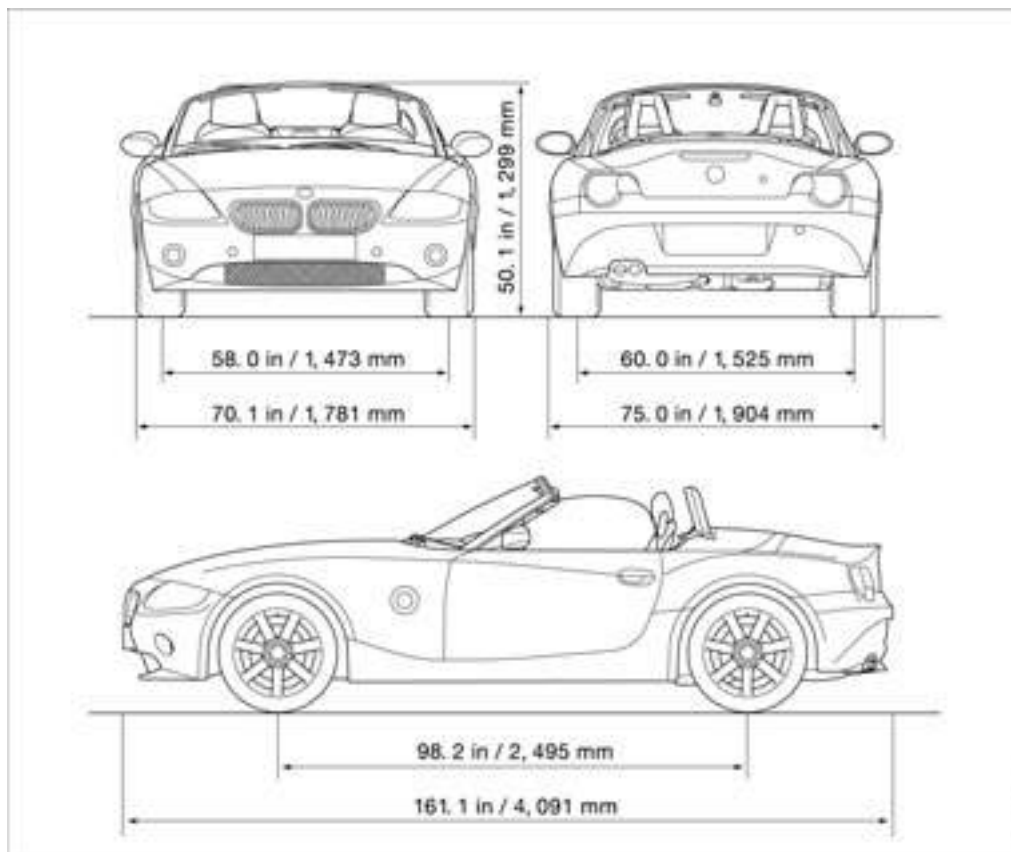

Smallest turning circle \varnothing 32 ft 2 in / 9.8 m.

Capacities

			Notes
Fuel tank	gal./liters	approx. 14.5/55	Fuel specifications: page 70
Reserve	gal./liters	approx. 2.1/8	
Windshield washer reservoir	quarts/liters	approx. 3.2/3	For details: page 79
Headlamp washer reservoir	quarts/liters	approx. 5.3/5	For details: page 79
Cooling system including heating circuit	quarts/liters	9.3/8.8 for manual transmission 9.5/9.0 for automatic transmission	For details: page 80
Engine with oil filter renewal	quarts/liters	6.9/6.5	For details: page 80
Manual transmission, automatic transmission and differential		–	Lifetime lubricant, no oil change required

Everything from A-Z

Index

A

- ABS Antilock Brake System 53
 - indicator lamp 14
- Accessories 7
- Activated-charcoal filter 59
- Air conditioning 55, 56
 - air distribution 56
 - air supply 56
 - automatic climate control 58
 - defrosting windows and removing condensation 56
 - outside-air mode 56
 - rear window defroster 56
 - recirculated-air mode 56
 - temperature 56
- Air distribution
 - air conditioning 56
 - automatic climate control 58
- Air outlets 56, 59
- Air pressure 71
 - checking 71
- Air supply
 - air conditioning 56
 - automatic climate control 58
- Airbags 33
 - activation/deactivation 34
 - indicator lamp 14, 33
 - passenger airbags lamp 35
- Alarm system 27
 - arming/disarming 27
 - indicator lamp 27
 - tilt alarm sensor 28
 - triggering 19
- All-season tires, refer to Winter tires 76
- Antifreeze
 - coolant 81
 - washer fluid 79
- Antilock Brake System ABS
 - indicator lamp 14
- Anti-theft alarm system, refer to Alarm system 27
- Approved axle load 94
- Approved gross vehicle weight 94
- Ashtray 61
- AUC Automatic recirculated air control 58
- Automatic
 - air distribution 58
 - air supply 58
 - cruise control 44
 - lamp control 45
- Automatic car wash, refer to the Caring for your vehicle brochure
- Automatic climate control 57, 58
 - air conditioning 58
 - air distribution 58
 - air supply 58
 - Automatic recirculated air control AUC 58
 - defrosting windows and removing condensation 58
 - maximum cooling 58
 - outside air 58
 - rear window defroster 59
 - recirculated air mode 58
 - temperature 58
- Automatic transmission
 - with Steptronic 40
 - display 41
 - electronic transmission control 41
 - indicator lamp 14
 - manual mode 41
 - selector lever position 40
 - sport program 41
- Automatic windshield washer 44

- Average fuel consumption 50
- Average speed 50
- Axle load, approved 94

B

- Backrest, refer to Seats 30
- Backup lamps 40
 - bulb replacement 86
- Bandages 89
- Battery 87
- Battery charge current
 - indicator lamp 14, 88
- Belt tensioner, refer to Safety belts 31
- Belts 31
- Beverage holder 61
- Blinker, refer to Turn signal indicators 42
- Blower
 - air conditioning 56
 - automatic climate control 58
- BMW High Performance synthetic oils 80
- BMW Maintenance System 82
- Bore 94
- Brake fluid 81
 - indicator lamp 14, 81
 - refilling 81
- Brake Force Display 52
- Brake hydraulic system 65
- Brake hydraulics
 - indicator lamp 14
- Brake lamps
 - bulb replacement 86
 - indicator lamp, defective bulb 14
- Brake pads 66
 - indicator lamp 14

- Brake system 65
 - brake fluid level 81
 - brake pads 66
 - break-in procedures 64
 - disc brakes 65
- Brakes
 - driving notes 65
- Break-in procedures 64
 - brake system 64
 - clutch 64
 - differential 64
 - engine 64
 - tires 64
- Bulb
 - defective 45
 - replacement 84

C

- California Proposition 65
 - warning 83
- Can holder 61
- Capacities 94, 96
 - luggage compartment 22, 94
- Car battery 87
- Car radio, refer to the Owner's Manual for Radio
- Car wash, refer to the Caring for your vehicle brochure
- Cargo loading 66
- Cassette player operation, refer to the Owner's Manual for Radio
- Catalytic converter, refer to High temperatures 65
- CD player operation, refer to the Owner's Manual for Radio
- Cellular phone
 - preparation 61
- Cellular phone, refer to the separate Owner's Manual
- Center high-mount brake lamp 87
- Central locking system 18
 - button 20
 - interior 20
- Charge indicator lamp 14, 88

- Check gas cap 70
 - indicator lamp 14
- Child seat 34
- Child-restraint mounting system (LATCH) 36
- Child-restraint systems 34
- Cigarette lighter 61
- Cleaning the headlamps 43
- Cleaning the windshield 43
- Clock
 - 12/24-hour mode 49
 - adjusting, refer also to the radio or onboard computer Owner's Manual
- Clothes hooks 27
- Cluster 13
- Clutch
 - break-in procedure 64
- Cockpit 12
- Code, refer to the Owner's Manual for Radio
- Combination switch, refer to Turn signal indicators/Headlamp flasher 42
- Compartments 60
- Compression ratio 94
- Computer 49
 - average fuel consumption 50
 - average speed 50
 - clock, 12/24-hour mode 49
 - cruising range 50
 - outside temperature 49
- Condensation
 - removing from windows 56, 58
- Configuring adjustments, refer to Vehicle Memory, Key Memory 37
- Consumption 50
- Convenience operation
 - convertible top 20
 - windows 20
- Convertible top 23
 - convenience operation 20
 - electrical fault 25
 - emergency operation 25
 - malfunction 25
 - manual operation 23
 - mechanical 23

- Convertible top compartment panel 22
- Coolant 80, 96
 - indicator lamp 14
- Coolant thermometer 47
- Cooling system 96
- Cooling, maximum 58
- Copyright 4, 6
- Cruise control 44
- Cruising range 50
- Cup holder, refer to Beverage holder 61
- Curb weight 94
- Cylinders 94

D

- Data 94
 - engine 94
 - filling capacities 96
 - weights 94
- Daytime driving lamps 45
- DBC Dynamic Brake Control 52
- Defects 8
- Deflector for wind 26
- Defrost setting 56, 58
- Defroster, rear window
 - air conditioning 56
 - automatic climate control 59
- Defrosting
 - windows 56, 58
- Differential
 - break-in procedures 64
- Digital clock
- Dimensions 95
- Dimming mirror 33
- Dipstick, engine oil 79
- Disc brakes 65
- Displacement 94
- Displays, refer to Instrument cluster 13
- Door lock 20
- Door lock buttons 21
- Doors
 - emergency operation 20
 - locking 19
 - unlocking 19
- DOT quality grades 73
- Drivelogic 42

Driving lamps
– indicator lamp, defective bulb 14
Driving notes 65
DSC Dynamic Stability Control 51
– indicator lamp 14
DTC Dynamic Traction Control 51
– indicator lamp 14
Dynamic Brake Control DBC 52
– indicator lamp 14
Dynamic Stability Control DSC 51
– indicator lamp 14
Dynamic Traction Control DTC 51
– indicator lamp 14

E

Electric Power Steering EPS 42
– indicator lamp 15
Electric power windows 22
Electrical convertible top 25
Electrical fault
– convertible top 25
– door lock 20
– fuel filler door 70
– storage compartment 60
Emergency operation
– convertible top 25
– doors 20
– fuel filler door 70
– storage compartment 60
Emergency release
– from inside luggage compartment 22
Engine 38
– break-in procedures 64
– starting 38
– switching off 39
Engine compartment 78
Engine coolant 96
– refilling 81

Engine oil 79
– capacity 96
– quality 80
– refilling 79
Engine oil consumption 79
Engine oil level 79
– checking 79
Engine oil pressure 79
– indicator lamp 14
Engine oil sensor 79
– indicator lamp 14
Engine oil types 80
Engine output 94
Engine speed 94
EPS Electric Power Steering 42
ESP, refer to DSC 51
Exhaust system, refer to High temperatures 65
Exterior mirrors 32
– automatic dimming feature 33
Eyelet for tow-starting and towing 90

F

False alarm 28
Fault
– storage compartment 60
First-aid kit 89
Flat tire 73, 75
Flat Tire Monitor 53
– indicator lamp 14, 53
Fog lamps 46
– indicator lamp 14
Footbrake, refer to Driving notes 65
Front airbags 33
Fuel consumption 50
– display 47
Fuel filler door 70
– unlocking in case of electrical fault 70
Fuel gas cap 70
Fuel gauge 47
Fuel specifications 70, 94
Fuel tank capacity 96
Fuses 88

G

Gasoline gauge, refer to Fuel gauge 47
Gasoline specifications, refer to Fuel specifications 70
Glove compartment 60
Gross vehicle weight, approved 94
Guide Booklet, Warranty and Service 82

H

Handbrake 39
Hands-free system 61
Hardtop preparation 67
Hardtop, refer to the separate Owner's Manual
Hazard warning flashers 12
Hazard warning triangle 89
Head restraints 30
Headlamp flasher 42, 46
Headlamp washer system 79, 96
Headlamps 84
– access 84
– high beam 42
Heated seats 31
Heavy loads 66
Height 95
High beams 42, 46
– bulb replacement 85
– indicator lamp 14
High temperatures 65
Hood 77
Hood release 77
Hydraulic brake assistant, refer to DBC
Hydroplaning 65

I

Ignition lock 38
Imprint 4, 6
Indicator and warning lamps 14

- Indicator lamps
 - airbag 33
 - alarm system 27
 - brake fluid 81
 - engine temperature 47
 - flat tire 75
 - Flat Tire Monitor 53
 - reserve tank 47
- Inflation pressure 71
 - monitor 53
- INSPECTION 48
- Instrument cluster 13
- Instrument lighting 46
- Instrument panel 12
- Interior
 - central locking system 20
- Interior lamps 19, 46
 - remote control 19
- Interior mirror
 - automatic dimming feature 33
- Interior motion sensor 19
 - deactivating 28
- Interior rearview mirror 32
- Interlock 38
- Intermittent operation, windshield wipers 43

J

- Jack 87
 - jacking points 87
- Jets, refer to Ventilation 56, 59
- Jump-starting 89

K

- Key Memory 37
- Keys 18
 - spare 18
 - with remote control 18
- Knee airbags 33

L

- Lamp
 - passenger airbags 35
- Lamp control 45
- Lamp replacement 84

- Lamps
 - backup lamp 86
 - brake lamp 86
 - bulb replacement 84
 - center high-mount brake lamp 87
 - daytime driving lamps 45
 - defective bulbs 45
 - fog lamps 46
 - headlamp flasher 46
 - headlamps 84
 - high beams 46, 85
 - indicator lamp, defective bulb 14
 - instrument lighting 46
 - interior lamps 46
 - lamp replacement 84
 - license plate lamps 87
 - LIGHTS ON warning 45
 - low beams 45, 85
 - low beams, automatic 45
 - parking lamps 45
 - reading lamps 46
 - rear lamp 86
 - standing lamps 46
 - turn signal indicators 86
 - xenon lamps 85
- LATCH child-restraint mounting system 36
- Length 95
- License plate lamps
 - bulb replacement 87
- Light switch 45
- Lighter 61
- LIGHTS ON warning 45
- Loads, securing 66
- Lock
 - door 20
- Locking 19
- Longlife oils 80
- Low beams 45
 - automatic 45
 - bulb replacement 85
 - indicator lamp, defective bulb 14
- Luggage
 - compartment 22, 94
 - capacity 94
 - enlarging 22
 - remote control 19

- Luggage compartment lid 21
 - emergency release from luggage compartment's interior 22
 - opening from the inside 21
 - opening from the outside 21
 - opening/closing 21
 - remote control 19

M

- M+S tires 76
- Maintenance system 82
- Malfunction
 - door lock 20
 - fuel filler door 70
 - remote control 19
 - storage compartment 60
- Malfunction of electrical accessory 88
- Manual convertible top 23
- Manual operation
 - door lock 20
 - electrical convertible top 25
 - fuel filler door 70
 - storage compartment 60
- Manual transmission 40
- Master key 18
- Maximum cooling 58
- MC operation, refer to the Owner's Manual for Radio
- MD operation, refer to the Owner's Manual for Radio
- Mechanical convertible top 23
- Mechanical seat 29
- Memory
 - seats 30
- Memory, refer to Key Memory, Vehicle Memory 37
- Microfilter 59
- Microphone, cellular phone 61
- Mirrors 32
 - heating 32
- Modifications, technical 7

N

Navigation system, refer to the separate Owner's Manual

Nets 60

O

OBD socket 83

Odometer 47

Oil 79

– additives 80

– capacity 96

– quality 80

Oil change interval, refer to the Service and Warranty Information Booklet for US models/Warranty and Service Guide Booklet for Canadian models

Oil consumption 79

Oil dipstick 79

Oil filter change 96

Oil level 79

– checking 79

– indicator lamp 14

Oil pressure 79

– indicator lamp 14

Oil sensor 79

– indicator lamp 14

OIL SERVICE 48

Oil types 80

Onboard computer, refer to Computer or to the separate Owner's Manual for Onboard Computer

Onboard tool kit 84

Operating elements 12

Outlets, refer to

Ventilation 56, 59

Output 94

Outside air mode

– air conditioning 56

Outside temperature display 48

– changing units 49

– in computer 49

P

Paintwork, refer to the Car- ing for your vehicle brochure

Panel lighting 46

Panic mode 19

Parking brake 39

– indicator lamp 14

Parking lamps 45

Particle filter

– automatic climate control 56

Passenger airbags

– activation/deactivation 34

Pollen, refer to

– Microfilter/activated- charcoal filter 59

– Particle filter 56

Power seat 30

Power steering, electric 42

Power windows 22

Preparations for the cellular phone 61

Pressure monitor, tires 53

Pressure, tires 71

R

Radiator 96

Radio, refer to the Owner's Manual for Radio

Rain sensor 43

Reading lamps 46

Rear lamps 86

– bulb replacement 86

Rear window defroster

– air conditioning 56

– automatic climate control 59

Rearview mirror 32

Recirculated air mode

– air conditioning 56

– automatic climate control 58

Refueling 70

Remote control 18

– interior motion sensor 19

– luggage compartment lid 19

– malfunction 19

Remote control keys 18

Replacement key 18

Replacement of tires 73

Reserve tank indicator lamp 47

Restraint systems 34

Reverse 40

Run Flat tires 73, 75, 87

– flat tire 75

S

Safety belts 31

Safety defects 8

Seat adjustment

– storing 30

Seat heating 31

Seat memory 30

Seats 29

– adjustment, mechanical 29

– adjustment, power 30

Securing loads 66

Securing, locking the vehicle 19

Selector lever

– automatic transmission 40

– position, automatic transmission 40

Service 48

Service and warranty 7

Service and Warranty Infor- mation Booklet 82

Service Engine Soon 83

– indicator lamp 14

Service interval display 48, 82

Shiftlock 40

Side airbags 33

Snow chains 76

Socket

– for Onboard

Diagnostics 83

– refer to Cigarette lighter socket 61

Spare fuses 88

Spare key 18

Special oils 80

Speed control, refer to Cruise control 44

Speedometer 13
 Sport program
 – automatic transmission with Steptronic 41
 – Drivelogic 42
 Standing lamps, refer to
 Parking lamps 45, 46
 Starting problems 89
 Starting the engine 38
 Steering lock 38
 Steering wheel
 – adjusting 32
 Steptronic 40
 Storage compartments 60
 – electrical fault 60
 – opening manually 60
 Storage nets 60
 Storage, tires 76
 Storing the vehicle, refer to the Caring for your vehicle brochure
 Stroke 94
 Switching gears, refer to
 Automatic transmission with Steptronic 40
 Symbols 6
 Synthetic oils 80

T

Tachometer 47
 Tail lamps
 – bulb replacement 86
 – indicator lamp, defective bulb 14
 Tank capacity 96
 Technical data 94
 – engine 94
 – weight 94
 Technical modifications 7
 Telephone preparation 61
 Telephone, refer to the Owner's Manual for the telephone
 Temperature
 – air conditioning 56
 – automatic climate control 58
 – tires 74

Temperature display
 – engine coolant 47
 – outside temperature 48
 – outside temperature in computer 49
 Third brake lamp 87
 Tilt alarm sensor 19, 28
 – deactivating 28
 – remote control 19
 Tire change 87
 Tire damage 73
 Tire inflation pressure 71
 – checking 71
 Tire pressure monitor 53
 Tires
 – age 73
 – approval 71
 – break-in procedures 64
 – condition 73
 – damage 73
 – DOT quality grades 73
 – flat tire 75
 – inflation pressure 71
 – M+S tires 76
 – replacement 73
 – Run Flat tires 73, 75, 87
 – temperature 74
 – traction 74
 – tread 73
 – tread wear 73
 – Uniform Tire Quality Grading 74
 – wheel-tire combination 74
 – winter tires 76
 Tool kit, refer to Onboard tool kit 84
 Torque 94
 Towing 90
 Towing eyelet 90
 Tow-starting 90
 Track width 95
 Traction 74
 Transmission, refer to
 Automatic transmission with Steptronic 40
 Transporting children safely 34
 Tread depth, tires 73
 Tread wear 73
 Tread wear indicator 73

Trip odometer 47
 Trunk lid, refer to Luggage compartment lid 21, 22
 Trunk, refer to Luggage compartment 22
 Turn signal indicators 42
 – bulb replacement 86
 – indicator lamps 14
 Turning circle 95

U

Undercoating, refer to the Caring for your vehicle brochure
 Uniform Tire Quality Grading 74
 Unintentional alarm 28
 Unlocking the vehicle 19
 Used batteries, refer to
 Battery disposal 88

V

Vacuum cleaner, refer to
 Cigarette lighter socket 61
 Vehicle
 – battery 87
 – break-in procedures 64
 – data 94
 Vehicle Memory 37
 Vehicle storage, refer to the Caring for your vehicle brochure
 Vehicle vacuum cleaner, refer to Cigarette lighter socket 61
 Ventilation 56, 59
 Vents, refer to
 Ventilation 56, 59

W

Warning and indicator lamps 14
 Warning triangle 89
 Warranty and service 7
 Warranty and Service Guide Booklet 82

Washer fluids
– refilling 79
Washer reservoir 79, 96
– filling 79
Washer/wiper system 43
Washing fluids 96
Water on roads
– flooding 65
Wear indicator in tires 73
Weights 94
Wheel change 87
Wheel wrench 87
Wheelbase 95
Wheels and tires 74
Width 95
Wind deflector 26
Window condensation
– removing 56, 58
Windows
– convenience operation 20
– defrosting and removing
condensation 56, 58
– power windows 22
Windshield washer
nozzles 44
Windshield washer
reservoir 79
– filling 96
Windshield wipers 43
– cleaning windshield 43
– intermittent operation 43
– rain sensor 43
– replacing 84
Winter tires 76
– changing 87
– condition 76
– pressure 76
– storage 76
Wipers
– replacing 84
Work in the engine
compartment 77

X

Xenon lamps 85

Refueling

So that you have important specifications available to you when you stop to refuel, we recommend that you fill out this table with the data that apply to your vehicle. Consult the index for individual specifications.

Fuel

Designation

Please enter your preferred fuel here.

Engine oil

Quality

The oil volume between the two marks on the oil dipstick corresponds to approx. 1.1 US quarts / 1 liter.

Tire inflation pressures

	Summer tires Front	Rear	Winter tires Front	Rear
Up to 2 persons				

More about BMW

bmwusa.com



The Ultimate
Driving Machine