

SUBARU 

IMPREZA[®]

OUTBACK' &

SPORT



2000 OWNER'S MANUAL

Always wear your seatbelt.

How to use this owner's manual

■ Using your Owner's manual

Before you operate your vehicle, carefully read this manual. To protect yourself and extend the service life of your vehicle, follow the instructions in this manual. Failure to observe these instructions may result in serious injury and damage to your vehicle.

This manual is composed of thirteen chapters. Each chapter begins with a brief table of contents, so you can usually tell at a glance if that chapter contains the information you want.

Chapter 1: Doors and Locks

This chapter informs you how to operate the keys, locks and windows.

Chapter 2: Seat, seat belt and SRS airbag

This chapter informs you how to use the seat and seat belt and contains precautions for the SRS airbag.

Chapter 3: Instruments and controls

This chapter informs you about the operation of instrument panel indicators and how to use the instruments and other switches.

Chapter 4: Climate Control

This chapter informs you how to operate the climate control.

Chapter 5: Audio

This chapter informs you how to operate your audio system.

Chapter 6: Interior equipment

This chapter informs you how to operate interior equipment.

Chapter 7: Starting and operating

This chapter informs you how to start and operate your SUBARU.

Chapter 8: In case of emergency

This chapter informs you what to do if you have a problem while driving, such as a flat tire or engine overheating.

Chapter 9: Appearance care

This chapter informs you how to keep your SUBARU looking good.

Chapter 10: Maintenance and service

This chapter informs you how to keep your SUBARU running properly.

Chapter 11: Specifications

This chapter informs you about dimension and capacities of your SUBARU.

Chapter 12: Consumer information and Reporting safety defects

This chapter informs you about Uniform tire quality grading standards and Reporting safety defects.

Chapter 13: Index

This is an alphabetical listing of all that's in this manual. You can use it to quickly find something you want to read.

■ Safety warnings

You will find a number of WARNINGS, CAUTIONs and NOTEs in this manual.

These safety warnings alert you to potential hazards that could result in injury to you or others.

Please read these safety warnings as well as all other portions of this manual carefully in order to gain a better understanding of how to use your SUBARU vehicle safely.



WARNING

A WARNING indicates a situation in which serious injury or death could result if the warning is ignored.



CAUTION

A CAUTION indicates a situation in which injury or damage to your vehicle, or both, could result if the caution is ignored.

NOTE

A NOTE gives information or suggestions how to make better use of your vehicle.

■ Safety symbol



You will find a circle with a slash through it in this manual. This symbol means "Do not", "Do not do this", or "Do not let this happen", depending upon the context.

Safety precautions when driving

SEAT BELT AND SRS AIRBAG



WARNING

- All persons in the vehicle should fasten their seat belts **BEFORE** the vehicle starts to move. Otherwise, the possibility of serious injury becomes greater in the event of a sudden stop or accident.
- To obtain maximum protection in the event of an accident, the driver and all passengers in the vehicle should always wear seat belts when the vehicle is moving. The SRS (Supplemental Restraint System) airbag does not do away with the need to fasten seat belts. In combination with the seat belts, it offers the best combined protection in case of a serious accident. Not wearing a seat belt increases the chance of severe injury or death in a crash even when the car has the SRS airbag.
- The SRS airbags deploy with considerable speed and force. Occupants who are out of proper position when the SRS airbag

deploys could suffer very serious injuries. Because the SRS airbag needs enough space for deployment, the driver should always sit upright and well back in the seat as far from the steering wheel as practical while still maintaining full vehicle control and the front passenger should move the seat as far back as possible and sit upright and well back in the seat.

Carefully read the sections "Seat belts and SRS airbag" in chapter 2 of this owner's manual for instructions and precautions concerning the seat belt system and SRS airbag system.

CHILD SAFETY



WARNING

- **Never hold a child on your lap or in your arms while the vehicle is moving. The passenger cannot protect the child from injury in a collision, because the child will be caught between the passenger and objects inside the vehicle.**
- **While riding in the vehicle, infants and small children should always be placed in the REAR seat in an infant or child restraint system which is appropriate for the child's age, height and weight. If a child is too big for a child restraint system, the child should sit in the REAR seat and be restrained using the seat belts. According to accident statistics, children are safer when properly restrained in the rear seating positions than in the front seating positions. Never allow a child to stand up or kneel on the seat.**
- **Put children aged 12 and under in the REAR seat properly restrained at all times in a child restraint device or in a seat belt. The SRS airbag deploys with considerable speed and force and can injure or even kill children, especially if they are 12 years of age and under and are not restrained or improperly restrained. Because children are lighter and weaker than adults, their risk being injured from deployment is greater.**
- **NEVER INSTALL A REARWARD FACING CHILD SEAT IN THE FRONT SEAT. DOING SO RISKS SERIOUS INJURY OR DEATH TO**

– CONTINUED –

THE CHILD BY PLACING THE CHILD'S HEAD TOO CLOSE TO THE SRS AIRBAG.

- Always use the child safety locks whenever a child rides in the rear seat. Serious injury could result if a child accidentally opened the door and fell out. Refer to the "Door locks" section in chapter 1.
- Always lock the passenger's windows using the lock switch when children are riding in the vehicle. Failure to follow this procedure could result in injury to a child operating the power window. Refer to the "Power windows" section in chapter 1.
- Never leave unattended children in the vehicle. They could accidentally injure themselves or others through inadvertent operation of the vehicle. Also, on hot or sunny days, temperature in a closed vehicle could quickly become high enough to cause severe or possibly fatal injuries to them.

Carefully read the sections "Child restraint systems", "SRS airbag" and "Seat belts" in chapter 2 of this owner's manual for instructions and precautions concerning the child restraint system, seat belt system and SRS airbag system.

ENGINE EXHAUST GAS (CARBON MONOXIDE)

 **WARNING**

- Never inhale engine exhaust gas. Engine exhaust gas contains carbon monoxide, a colorless and odorless gas which is dangerous, or even lethal, if inhaled.
- Always properly maintain the engine exhaust system to prevent engine exhaust gas from entering the vehicle.
- Never run the engine in a closed space, such as a garage, except for the brief time needed to drive the vehicle in or out of it.
- Avoid remaining in a parked vehicle for a lengthy time while the engine is running. If that is unavoidable, then use the ventilation fan to force fresh air into the vehicle.
- Always keep the front ventilator inlet grille free from snow, leaves or other obstructions to ensure that the ventilation system always works properly.

- If at any time you suspect that exhaust fumes are entering the vehicle, have the problem checked and corrected as soon as possible. If you must drive under these conditions, drive only with all windows fully open.
- Keep the trunk lid or rear gate closed while driving to prevent exhaust gas from entering the vehicle.

DRINKING AND DRIVING



WARNING

Drinking and then driving is very dangerous. Alcohol in the bloodstream delays your reaction and impairs your perception, judgment and attentiveness. If you drive after drinking – even if you drink just a little – it will increase the risk of being involved in a serious or fatal accident, injuring or killing yourself, your passengers and others. In addition, if you are injured in the accident, alcohol may increase the severity of that injury.

Please don't drink and drive.

Drunken driving is one of the most frequent causes of accidents. Since alcohol affects all people differently, you may have consumed too much alcohol to drive safely even if the level of alcohol in your blood is below the legal limit. The safest thing you can do is never drink and drive. However if you have no choice but to drive, stop drinking and sober up completely before getting behind the wheel.

DRUGS AND DRIVING



WARNING

There are some drugs (over the counter and prescription) that can delay your reaction time and impair your perception, judgment and attentiveness. If you drive after taking them, it may increase your, your passengers' and other persons' risk of being involved in a serious or fatal accident.

– CONTINUED –

If you are taking any drugs, check with your doctor or pharmacist or read the literature that accompanies the medication to determine if the drug you are taking can impair your driving ability. Do not drive after taking any medications that can make you drowsy or otherwise affect your ability to safely operate a motor vehicle. If you have a medical condition that requires you to take drugs, please consult with your doctor.

Never drive if you are under the influence of any illicit mind-altering drugs. For your own health and well-being, we urge you not to take illegal drugs in the first place and to seek treatment if you are addicted to those drugs.

DRIVING WHEN TIRED OR SLEEPY



WARNING

When you are tired or sleepy, your reaction will be delayed and your perception, judgment and attentiveness will be impaired. If you drive when tired or sleepy, your, your passengers' and other persons' chances of being involved in a serious accident may increase.

Please do not continue to drive but instead find a safe place to rest if you are tired or sleepy. On long trips, you should make periodic rest stops to refresh yourself before continuing on your journey. When possible, you should share the driving with others.

CAR PHONES AND DRIVING



CAUTION

A driver's use of a car phone can be distracting and if special care is not taken, can lead to an accident. If you use a car phone while driving, make an extra effort to pay attention to the road and to traffic at all times. If you can safely do so, it is best to pull off to the side of the road before using your car phone.

MODIFICATION OF YOUR VEHICLE



CAUTION

Your vehicle should not be modified. Modification could affect its performance, safety or durability, and may even violate governmental regulations. In addition, damage or performance problems resulting from modification may not be covered under warranties.

DRIVING WITH PETS

Unrestrained pets can interfere with your driving and distract your attention from driving. In a collision or sudden stop, unrestrained pets or cages can be thrown around inside the vehicle and hurt you or your passengers. Besides, the pets can be hurt under these situations. It is also for their own safety that pets should be properly restrained in your vehicle. Restrain a pet with a special traveling harness which can be secured to the rear seat with a seat belt or use a pet carrier which can be secured to the rear seat by routing a seat belt through the carrier's handle. Never restrain pets or pet carriers in the front passenger's seat. For further information, consult your veterinarian, local animal protection society or pet shop.

Table of contents

<i>Doors and locks</i>	1
<i>Seat, seatbelt and SRS airbag</i>	2
<i>Instruments and controls</i>	3
<i>Climate control</i>	4
<i>Audio</i>	5
<i>Interior equipment</i>	6
<i>Starting and operating</i>	7
<i>In case of emergency</i>	8
<i>Appearance care</i>	9
<i>Maintenance and service</i>	10
<i>Specifications</i>	11
<i>Consumer information and Reporting safety defects</i>	12
<i>Index</i>	13

A	
ABS (Anti-Lock Brake System) (if equipped)	7-34
ABS warning light (for vehicles with ABS)	3-8
Accessory power socket	6-7
Adjusting the shoulder belt anchor height	2-16
Air cleaner element	10-16
Air conditioner operation	4-8
Air filtration system (if equipped)	4-11
Aluminum wheels (if equipped)	10-44
AM/FM stereo radio with cassette player (if equipped)	5-3
Antenna	5-2
Ashtray	6-10
AT OIL TEMPerature warning light (for AT vehicles)	3-9
Automatic Locking Retractor (ALR) function (except driver's and 2-point type seatbelt)	2-13
Automatic transmission	7-19
Automatic transmission fluid	10-20

B	
Battery	10-29
Brake booster	10-29
Brake fluid	10-26
Brake pedal	10-34
Brake system	7-33
Brake system warning light	3-6
Braking	7-32
Braking tips	7-32
Bulb chart	11-8

C	
Capacities	11-3
Cargo anchorage eyelets (if equipped)	6-27
Cassette player operation	5-9
Catalytic converter	7-8
Center console	6-3
Charge warning light	3-6

CHECK ENGINE warning light/Malfunction indicator lamp	3-7
Child restraint systems	2-20
Child safety locks	1-7
Cigarette lighter (if equipped)	6-9
Cleaning aluminum wheels	9-5
Cleaning the interior	9-6
Clock	3-11
Clock function	5-11
Clutch fluid (2.5 liter MT models)	10-28
Clutch pedal (Manual transmission vehicles)	10-36
Coat hook	6-12
Coin tray	6-5
Cooling system	10-12
Corrosion protection	7-46, 9-4
Cruise control (if equipped)	7-28
Cup holder	6-6

D

Dashboard storage compartment	6-5
Dimensions	11-2
Disc brake pad wear warning indicators	7-34
Dome/Rear map reading light (if equipped)	6-13, 10-58
Door locks	1-3
Door open warning lights	3-10
Drive belts	10-18
Driving in foreign countries	7-10
Driving tips for AWD vehicles	7-37

E

Electrical system	11-3
Emergency Locking Retractor (ELR) function (except 2-point type seatbelt)	2-12
Engine	11-2
Engine compartment overview	10-6
Engine coolant	10-13
Engine exhaust gas (Carbon monoxide)	7-7

Engine hood	1-30
Engine oil	10-7
Engine overheating	8-2
Exterior care	9-2

F

Fastening the seatbelt	2-13
Flat tires	8-6
FM reception	5-2
Fog light (if equipped)	10-50
Fog light switch (if equipped)	3-16
Fold down rear seat - Wagon and OUTBACK SPORT	2-8
Front differential gear oil (Automatic transmission vehicles)	10-22
Front seats	2-2
Front turn signal light	10-53
Front-wheel drive warning light (for AWD AT vehicles)	3-10
Fuel economy hints	7-9
Fuel filler door and cap	1-28
Fuel gauge	3-3
Fuel requirements	7-4
Fuses	10-44
Fuses and circuits	11-5

G

Gauge pack (if equipped)	6-16
Gauges	3-2
Glove compartment	6-3
GVWR and GAWR (Gross Vehicle Weight Rating and Gross Axle Weight Rating)	7-48

H

Hazard warning flasher	3-11, 8-2
Headlight	10-49
Heater operation	4-4
Heating and air conditioning	4-3
High beam indicator	3-10

Horn	3-22
I	
If the sunroof can not be closed	1-33
Ignition switch	7-11
Illumination brightness control	3-15
Inside mirror	3-22
Installation of accessories	5-12, 10-48
Installing carrying attachments on the cross bars	1-35
Interior light	6-12
Interior light, spot light	10-57
J	
Jump starting	8-4
K	
Key interlock release (AT vehicles only)	7-13
Keyless entry system (if equipped)	1-8
Key number	1-2
Key reminder chime	7-13
Keys	1-2
L	
License plate light	10-57
Light control switch	3-12
Loading your vehicle	7-47
Low fuel warning light	3-10
Luggage cover (Wagon only)	6-25
M	
Main fuse and fusible link	10-47
Maintenance precautions	10-3
Maintenance schedule	10-3
Maintenance tools	6-28
Manual transmission	7-16
Manual transmission oil	10-19

Master, submaster and valet key	1-2
Maximum load limits	11-2
Mirrors	3-22

N

New vehicle break-in driving - the first 1,000 miles (1,600 km)	7-3
---	-----

O

Odometer/Trip meter	3-2
Off road driving	7-38
Oil pressure warning light	3-6
Operating tips for heater and air conditioner	4-9
Outside mirrors	3-23

P

Parking brake stroke	10-38
Parking light	10-52
Parking light switch	3-15
Parking your vehicle	7-30
Periodic inspections	7-10
Power door locking switches (if equipped)	1-6
Power steering	7-27
Power steering fluid	10-25
Power windows (if equipped)	1-22
Precautions against vehicle modification	2-38
Preparing to drive	7-10

R

Radio	5-2
Radio operation	5-3
Rear combination lights	10-55
Rear differential gear oil	10-23
Rear gate (Wagon)	1-27
Rear seat access (Coupe)	2-6
Rear seats	2-7
Rear viscous limited slip differential (For RS models)	7-26

Rear window defogger switch	3-21
Rear window wiper and washer switch (if equipped)	3-20
Replacement of brake pad and lining	10-37
Replacement of windshield wiper blades	10-32
Replacing bulbs	10-49
Reporting safety defects (USA)	12-4
Rocking the vehicle	7-46
Roof rack (if equipped)	1-34

S

Seatbelt guide (Coupe)	2-17
Seatbelt maintenance	2-19
Seatbelts	2-11
Seatbelt safety tips	2-11
Seatbelt warning light and chime	2-13, 3-5
Security system (if equipped)	1-12
Selector lever	7-20
Shift lock release	7-24
Shopping bag hook (Wagon only)	6-27
Side turn signal light	10-54
Snow tires	7-45
Spark plugs	10-17
Specifications	11-2
Speedometer	3-2
Spotlight (if equipped)	6-15
SRS airbag (Supplemental Restraint System airbag)	2-26
SRS airbag operation	2-31
SRS airbag system monitors	2-36
SRS airbag system servicing	2-37
SRS airbag system warning light	3-5
Starting the engine	7-14
State emission testing (U.S. only)	7-6
Steering	7-26
Stopping the engine	7-16
Storage compartment	6-2
Sunroof (if equipped)	1-31

Sun visors	6-2
------------------	-----

T

Tachometer (if equipped)	3-3
Temperature A, B, C	12-3
Temperature gauge	3-4
Temporary spare tire	8-11
Tilt steering wheel	7-26
Tire chains	7-45
Tire changing tools	8-13
Tire pressure	10-39
Tire rotation	10-40
Tires	11-4
Tires and wheels	10-39
Top strap anchors	2-24
Towing	8-14
Towing eyelets	8-17
Traction A, B, C	12-2
Trailer hitches	7-51
Trailer towing	7-49
Treadwear	12-2
Trunk lid (Sedan and Coupe)	1-25
Turn signal indicator lights	3-10
Turn signal lever	3-14

U

Unfastening the seatbelt	2-18
Uniform tire quality grading standards	12-2

V

Vanity mirror (if equipped)	6-2
Vehicle capacity weight	7-48
Vehicle identification	11-9
Vehicle with driver's and front passenger's SRS airbags and lap/shoulder restraint	2-26
Ventilator	4-2

W

Warning and indicator lights	3-5
Washing	9-2
Waxing and polishing	9-3
When luggage is put on the slats	1-34
Windows	1-22
Windshield washer fluid	10-31
Windshield wipers and washer switches	3-18
Winter driving	7-41
Wiper and washer	3-16

This manual describes the following vehicle types.

Coupe

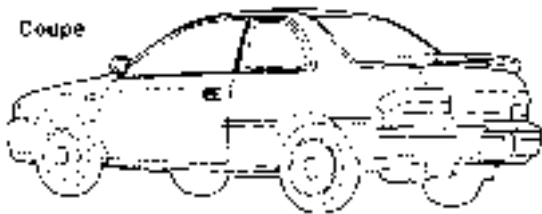

HGF001AB

Sedan



HGF002AB

Wagon



HGF003AB

OUTBACK SPORT

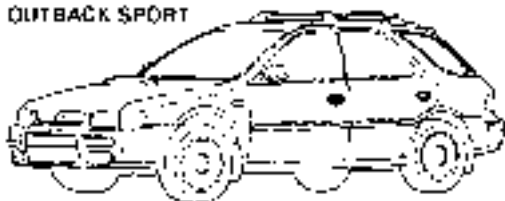

HGF004AB

Warranties

▼ Warranties for U.S.A.

All SUBARU vehicles distributed by Subaru of America, Inc. and sold at retail by an authorized SUBARU dealer in the United States come with the following warranties:

- SUBARU Limited Warranty
- Emission Control Systems Warranty
- Emissions Performance Warranty

All warranty information, including details of coverage and exclusions, is in the "Warranty and Maintenance Booklet". Please read these warranties carefully.

▼ Warranties for Canada

All SUBARU vehicles distributed by Subaru Canada, Inc. and sold at retail by an authorized SUBARU dealer in Canada come with the following warranties:

- SUBARU Limited Warranty
- Anti-Corrosion Warranty
- Emission Control Warranty

All warranty information, including details of coverage and exclusions, is in the Warranty and Service Booklet. Please read these warranties carefully.

Doors and locks

Keys	1-2
<i>Master, submaster and valet key</i>	1-2
<i>Key number</i>	1-2
Door locks	1-3
<i>Power door locking switches (if equipped)</i>	1-6
<i>Child safety locks</i>	1-7
Keyless entry system (if equipped)	1-8
Security system (if equipped)	1-12
Windows	1-22
<i>Power windows (if equipped)</i>	1-22
<i>Trunk lid (Sedan and Coupe)</i>	1-25
<i>Rear gate (Wagon)</i>	1-27
<i>Fuel filler door and cap</i>	1-28
<i>Engine hood</i>	1-30
<i>Sunroof (if equipped)</i>	1-31
<i>If the sunroof can not be closed</i>	1-33
<i>Roof rack (if equipped)</i>	1-34
<i>When luggage is put on the slats</i>	1-34
<i>Installing carrying attachments on the cross bars</i>	1-35

Keys

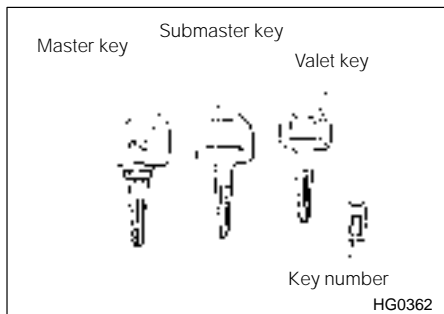

■ Master, submaster and valet key

Three types of keys are provided for your vehicle. Master key, submaster key and valet key.

The master key and submaster key fit all locks on your vehicle.

- Ignition switch
- Doors
- Trunk or Rear gate
- Glove compartment

The valet key fits only the ignition switch and door locks. You can keep the trunk and glove compartment locked when you leave your vehicle and valet key at a parking facility.

■ Key number

The key number is stamped on the metal plate attached to the key. Write down the key number and keep it in another safe place, not in the vehicle. This number is needed to make a replacement key if you lose your key or lock it inside the vehicle.

Door locks

▼ Locking and unlocking from the outside

▽ For Vehicles with power door locking switches

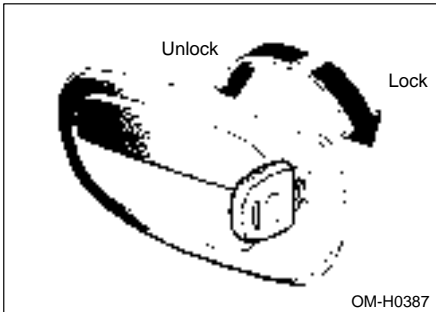

To lock the door from the outside with the key, turn the key toward the rear. To unlock the door, turn the key toward the front.

Lift the outside door handle to open an unlocked door.

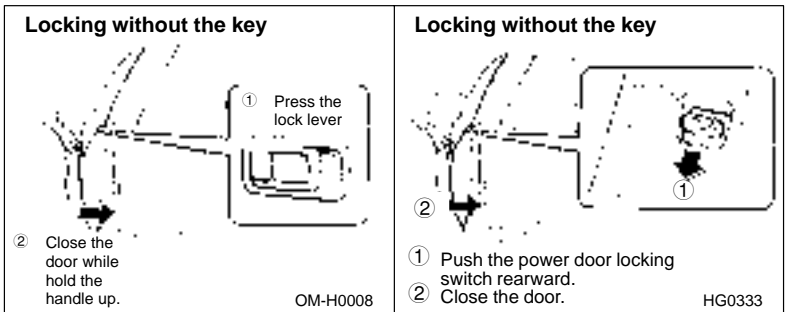

To lock the door from the outside without the key, press the end of the lock lever down on the door and then close the door.

To lock the door from the outside using the power door locking switch, push the switch rearward ("LOCK" side) and then close the door. In this case, all closed doors and the rear gate (for wagon and OUT-

– CONTINUED –

BACK SPORT) are locked at the same time.

Always make sure that all doors and the rear gate (for wagon and OUTBACK SPORT) are locked before leaving your vehicle.

NOTE

Make sure that you do not leave the key inside the vehicle before locking the doors from the outside without the key.

▽ For vehicles without power door locking switches

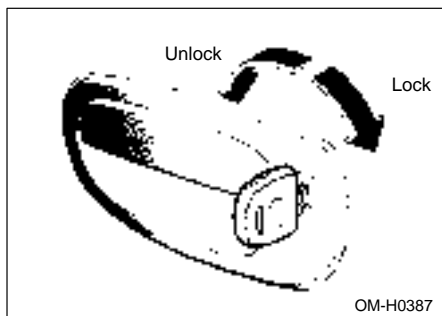

To lock the door from the outside with the key, turn the key toward the rear. To unlock the door, turn the key toward the front.

Lift the outside door handle to open an unlocked door.

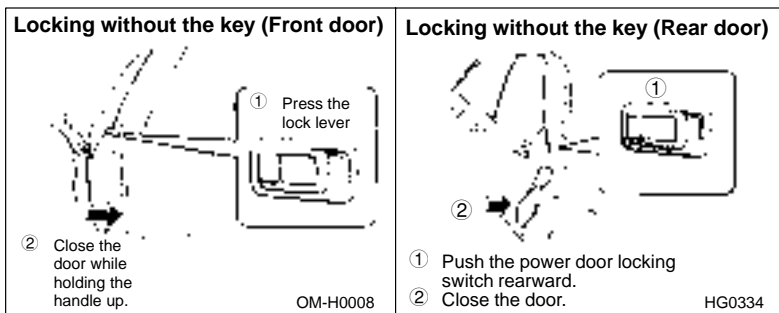

To lock the **front door** from the outside without the key, press the end of the lock lever down on the door and hold the outside door handle

up while closing the door.

To lock the **rear door** from the outside without the key, press the end of the lock lever down on the door and then close the door.

Always make sure that all doors and the rear gate (for wagon and OUTBACK SPORT) are locked before leaving your vehicle.

NOTE

Make sure that you do not leave the key inside the vehicle before locking the doors from the outside without the key.

▼ Locking and unlocking from the inside

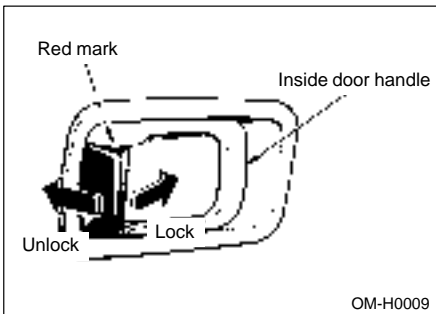

To lock the door from the inside, press the end of the lock lever down.

To unlock the door from the inside, pull the front end of the lock lever.

The red mark on the lock lever appears when the door is unlocked.

Pull the inside door handle to open an unlocked door.

Always make sure that all doors and the rear gate (for wagon and OUTBACK SPORT) are closed before starting to drive.

■ Power door locking switches (if equipped)

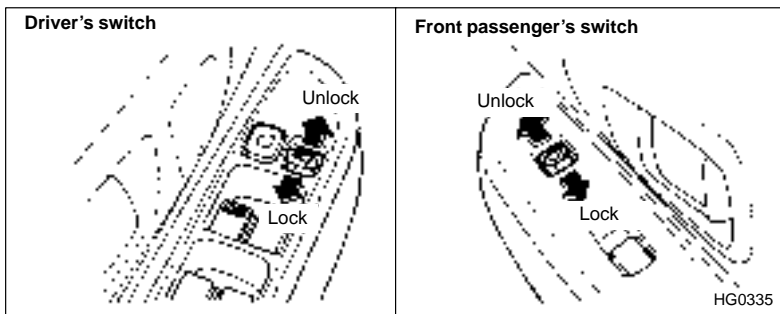

All doors and the rear gate can be locked and unlocked by the power door locking switches located at the driver's side and the front passenger's side doors.

To lock the doors, push the switch rearward.

To unlock the doors, push the switch forward.

When you close the doors after you set the door locks, the doors remain locked.

NOTE

Make sure that you do not leave the key inside the vehicle before locking the doors from the outside using power door locking switches.

■ Child safety locks

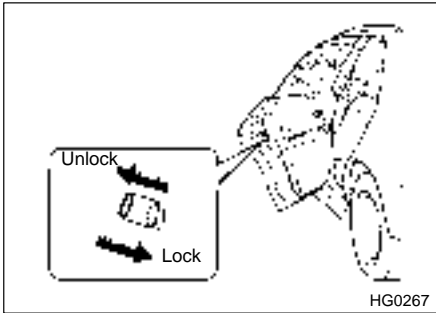

WARNING

Always use the child safety lock whenever a child rides in the rear seat. Serious injury could result if a child accidentally opened the door and fell out.

Each rear door has a child safety lock that prevents the doors from being opened even if the inside door handle is pulled.

When the child safety lock lever is in the lock position, the door cannot be opened from inside regardless of the position of the inner door handle lock lever. The door can only be opened from the outside.

Keyless entry system (if equipped)



CAUTION

- **Do not expose the transmitter to severe shocks, such as those experienced as a result of dropping or throwing.**
- **Do not take the transmitter apart except when replacing the battery.**
- **Do not get the transmitter wet. If it gets wet, wipe it dry with a cloth immediately.**

This device complies with Part 15 of the FCC Rules. Operation is subject to the following two conditions: (1) This device may not cause harmful interference, and (2) this device must accept any interference received, including interference that may cause undesired operation.

Changes or modifications not expressly approved by the party responsible for compliance could void the user's authority to operate the equipment.

The keyless entry system has the following functions.

- Locking and unlocking the doors (and rear gate on the wagon and OUTBACK SPORT) without a key
- Arming and disarming the security system (if your vehicle is equipped with an optional security system). See the next section "Security system (if equipped)" for detailed information.

The receiver inside your vehicle's keyless entry system and the remote control transmitters are designed together to have an average operating range of 25 to 50 feet (8 to 15 meters) during ideal conditions. Although at times you may experience range greater than that, there may be occasions when range is less than normal. Atmospheric conditions or interference from other RF-emitting devices can effectively reduce transmitter range.

▼ System operation

Keyless entry functions do not operate when vehicle ignition is "ON".



▽ Locking the doors

Press the "LOCK" button to lock all doors (and the rear gate on the wagon and OUTBACK SPORT). The parking lights will flash one time.

▽ Unlocking the doors

To unlock the driver's door only, press and release the "UNLOCK" button.

To unlock all doors (and the rear gate on the wagon and OUTBACK SPORT), press and hold the "UNLOCK" button.

The parking lights will flash one time.

The vehicle's interior (courtesy) light will illuminate for 60 seconds or until vehicle is started.

NOTE

1. Parking lights will flash when the vehicle's battery is disconnected and reconnected.

To stop lights from flashing, either:

- Press remote transmitter "UNLOCK" button once.
- Turn the ignition switch to the "ON" position and press programming button for one second (see location below).

2. The vehicle's interior (courtesy) light and door open warning light (DOOR AJAR indicator) will illuminate for 60 seconds when the ignition is turned off, or until the doors are locked with the

– CONTINUED –

remote transmitter.

3. The instrument panel lights will flash when the parking lights flash.

4. Your SUBARU Keyless Entry System is equipped with two remote transmitters.

▼ Programming button location

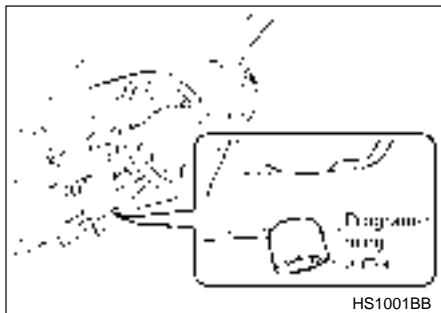

The Programming Button is located under the driver's side dash beneath the diagnostic connector.

▼ Adding or deleting remote transmitters

Up to four (4) transmitters can be programmed to your keyless entry system.

NOTE

Make sure no one else is operating another keyless entry or security system within range of your vehicle when you are programming remote transmitters. Another transmitter code could be inadvertently "learned" by your system, allowing someone unauthorized access to your vehicle.

▽ To program an additional transmitter

1. Open the driver's door.
2. Turn the vehicle ignition to the "ON" position.
3. Press and hold the Programming button in.
 - After approximately 15 seconds, the door locks will cycle 3 times.

This indicates that the system is in the Transmitter Programming Mode. **Do not release the Programming button.**

4. Press the "LOCK" button on the new transmitter. The door locks will cycle once.
5. Repeat step 4 for any additional transmitters.
6. Exit the Transmitter Program Mode by releasing the Programming button and turning the vehicle ignition off. Test all remote transmitters to ensure that they work properly.

▽ **To delete a lost or stolen transmitter**

1. Follow step 1 to 3 as described above.
2. Re-program the remaining transmitters as described in step 4.
 - If there is only one remaining transmitter, perform step 4 **four times**.
 - If there are two remaining transmitters, perform step 4 **twice** for each transmitter.

▼ **System maintenance**

Your keyless entry system does not require any specific maintenance except for occasionally changing the transmitter battery. The 12-volt battery in the remote transmitter should last approximately one year, depending on usage. When the battery begins to weaken, you will notice a decrease in range, or the distance from your vehicle that the remote transmitter will operate.

▽ **To change the remote transmitter battery**



CAUTION

Do not let dust, oil or water get on or in the transmitter when replacing the battery.

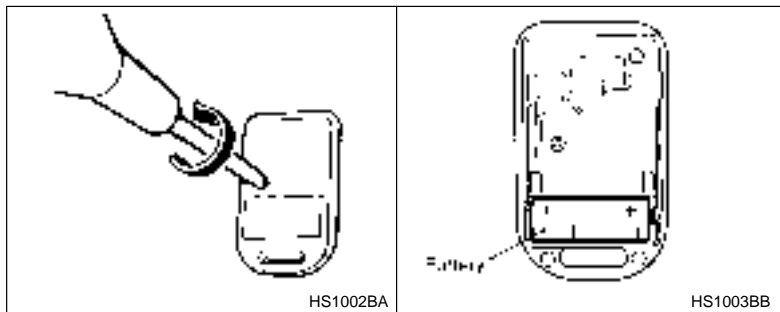

1. Remove the phillips screw on the back of the remote transmitter case. Use a small coin to separate the case halves and expose the battery.
2. Remove the old battery and replace with type GP-23A or equivalent.
3. Close the transmitter case and replace the screw.

Security system (if equipped)

▼ How the security system protects your vehicle

▽ Starter interrupt

The vehicle's starter is disabled when the system is armed with your remote transmitter.

▽ Passive starter interrupt (if selected)

The vehicle starter is automatically disabled one minute after the ignition is turned off, **even if the system has not been armed with your remote transmitter**. (This option may be activated by your SUBARU dealer for an additional charge.)

NOTE

If the Passive Starter Interrupt Option is enabled on your system, pay special attention to the "Starter interrupt" section.

▽ All entrances protected

Opening any door or entrance protected by the security system triggers the alarm's 125 db siren and flashes the vehicle's parking lights.

▽ Shock Sensor

The shock sensor detects any impact to the vehicle. Light impact will cause the siren to emit a warning "chirp"; heavier blows will trigger the alarm. (Shock sensor sensitivity has been preset, but may be adjusted by your SUBARU dealer.)

▽ Personal protection (Panic) feature

Pressing both buttons on the remote transmitter activates the Panic feature, sounding the siren and flashing the vehicle's parking lights.

▽ Interior status indicator

The bright-red warning light provides a visual deterrent to a would-be thief.

▽ Emergency override button

Ensures that you will be able to disarm your alarm system and start your vehicle if your remote transmitter is lost or broken. See "The emergency override/programming button" Section.

▼ Security system components

▽ The remote transmitter

The remote transmitter controls the features and options of the security system.

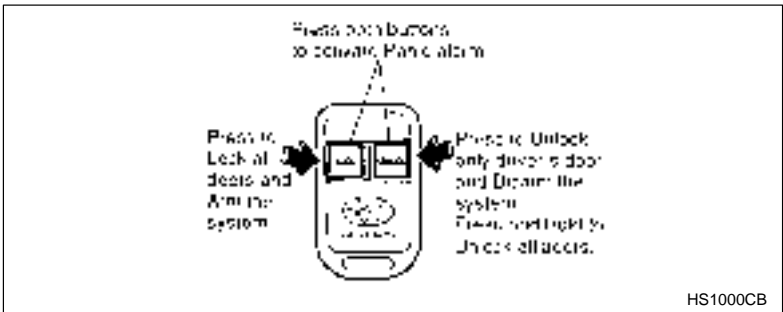

– CONTINUED –

The security system can be programmed to operate with one to four remote transmitters. Each transmitter is powered by an internal 12-volt alkaline battery.

▽ **The status indicator/Valet button**

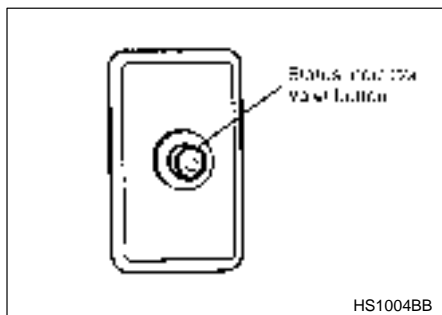

The Status Indicator is a high intensity warning light, located on the dash to the left of the steering wheel. The Status Indicator displays a visual indication of the security system's status while creating a powerful theft deterrent.

LED status

Off: System is disarmed.

Double-Flash: System is in valet mode.

Steady Flash: System is armed.

Fast Flash: System has been triggered.

On: System is in pre-arm state (and will arm when all doors are closed).

▽ **The valet button (built into the status indicator)**

The Valet Button is used to engage **Valet Mode** (see "Valet mode" Section). In Valet Mode, the security system will not arm, through the siren will chirp and keyless entry features will function when the security system is disarmed.

▽ The emergency override/programming button

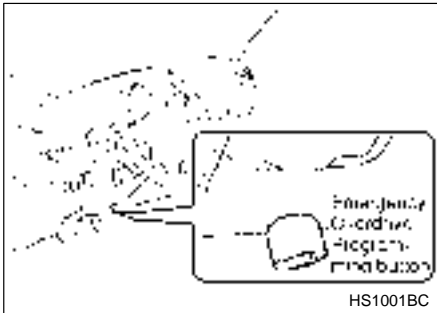

The Emergency Override/Programming button is used to disarm the alarm system in case of a lost or broken transmitter. It is also used in conjunction with the transmitter and vehicle ignition to program additional transmitters.

The Emergency Override Button is located under the driver's side dash beneath the diagnostic connector.

▼ Security system operation

IMPORTANT

Security System and Keyless Entry Features Do Not Operate when the Vehicle Ignition is on.

▽ Arming the system

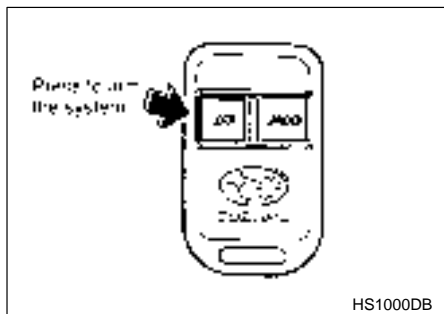

To arm the system, close all doors, then press the "LOCK" button. The siren will "chirp" twice and the parking lights will flash twice, indicating the system is armed.

The doors will also lock at this time. The status indicator will blink steadily, once per second.

If the siren chirps and/or the parking lights flash only **once**, this indicates that the system is in **pre-arm mode**. The system has detected that a protected entrance is not secured. In pre-arm mode, the status indicator stays on and does not blink. Check to see that all vehicle entrances are closed securely. Once all entrances are secured, the system will chirp/flash again, and the status indicator will blink steadily. The system is now fully armed.

▽ **Disarming the system**



To disarm the system, press and release the “UNLOCK” button. The siren will chirp and parking lights will flash **once**. The driver’s door will unlock at this time, and the vehicle interior (dome) light will turn on for 60 seconds, or until the vehicle is started.

If the siren chirps and parking lights flash **four times**, the system was triggered in your absence. Refer to the “**Trip identification**” section in this manual.

▽ **The alarm cycle**

If your alarm system is triggered, the siren will sound and the parking lights will flash for 60 seconds. After this duration, the system will check to see if an entrance was left open. If so, the alarm will continue to sound. If not, the system will re-arm.

▽ Personal protection alarm (Panic)



Pressing both buttons together on the remote transmitter activates the Panic feature, sounding the siren and flashing the parking lights. Panic is designed to bring attention to the vehicle and surrounding area. Press either button on the transmitter to turn off the Panic alarm.

▽ Disarming the security system in the event of a lost or broken transmitter



If your remote transmitter fails to operate, the system can be disarmed using the Emergency Override/Programming button. Follow the procedure below:

1. Enter the vehicle. The alarm will sound when the door is opened.
2. Insert the ignition key and turn to the "ON" position.

3. Press the Emergency Override/Programming button. The system will disarm.

▽ **Valet mode**

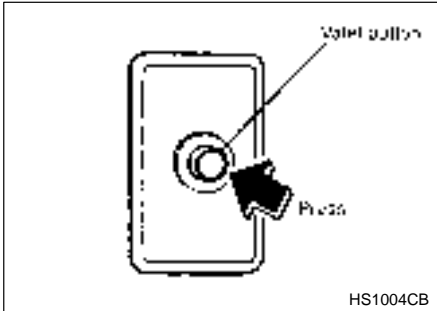

Valet Mode prevents the security system from arming, yet allows all keyless entry and convenience features to function normally.

The valet button is built into the status indicator, located on the dash to the left of the steering wheel.

To engage Valet Mode:

- With the system disarmed and the vehicle ignition off, press the Status Indicator/Valet Button.
- The status indicator will begin to emit a quick double-flash pattern. This indicates that the system is in Valet Mode.
- To exit Valet Mode, press the Status Indicator/Valet Button again. The status indicator will turn off, indicating the system is in normal operating mode.

▽ **Trip identification**

If the siren chirps **four times** when you disarm your security system, this indicates that the system was triggered in your absence. Before turning the ignition on, perform the following operation to determine the protected zone that triggered the system.

- Open the vehicle door and press the Emergency Override/Programming button.

– CONTINUED –

-
- The siren will emit a number of chirps. Refer to the chart (below) to identify the violated zone.

Chirps	Triggered Zone
1	Shock Sensor
2	Ignition turned on
4	Door or Rear gate

▽ **Starter interrupt**

Starter interrupt is an automatic procedure. The starter is disabled any time the system is armed, or if the **Passive** starter interrupt feature is enabled and the passive arm time is expired. The vehicle also will not start if power is disconnected from the alarm module.

How starter interrupt works

The alarm system interrupts the signal from the ignition key to the vehicle's starter when Starter interrupt is activated. If you attempt to start the vehicle, the dash indicator will turn on as usual, but the starter will not "crank", or turn over.

Passive starter interrupt

If the **Passive** Starter Interrupt option has been activated by your SUBARU dealer, the starter will be automatically disabled one minute after you turn off the vehicle ignition, whether or not you arm the security system with your remote transmitter.

Possible situations with starter interrupt or *Passive* starter interrupt

*If the **Passive Starter Interrupt** Option is enabled on your Security System:*

- If you leave the vehicle for a short amount of time, to refuel or go to the car wash for example, always engage the Valet Mode before exiting your vehicle. If you forget to engage Valet Mode, the **Passive** Starter Interrupt will engage and the vehicle will not start when you return. To **enable the vehicle to start, simply press "UNLOCK" on**

your remote transmitter, or turn the vehicle ignition to the “ON” position and press the Emergency Override/programming button in and release.

- If your remote transmitter is lost or broken and the **Passive** Starter Interrupt has automatically engaged, enter the vehicle, turn the ignition to the “ON” position, and press the Emergency Override/programming button. This will enable the vehicle to start.

Whether or Not the Passive Starter Interrupt Option is Activated:

- In the unlikely event of an alarm system malfunction, your vehicle may not start. To enable the vehicle to start, **press and hold the Emergency Override/programming button, and attempt to start the vehicle while holding the button in.**

▼ System maintenance

Your security system does not require any specific maintenance except for occasionally changing the transmitter battery. However, it is suggested that the system be armed and all protected zones be checked about once a month to make sure that they trigger an alarm cycle.

To change the remote transmitter battery, refer to “System maintenance” section under the heading of “Keyless entry system”.

▼ Trouble shooting guide

▽ **If you experience any of the following situations...**

- **Your remote transmitter is lost or broken and your alarm system is armed.**
- **You attempt to start your vehicle after pressing “UNLOCK” on your remote transmitter and it does not “crank”.**

Perform the following procedure:

- 1. Use your keys to enter the vehicle. (Depending on your situation, the alarm may sound when you open the door.)**
- 2. Insert your key into the ignition and turn to the “ON” position.**
- 3. Press and release the Emergency Override Button. The alarm system will disarm and you will be able to start your vehicle.**
- 4. If your vehicle still will not start, press and HOLD the Emergency Override Button in while attempting to start your vehicle.**

Windows

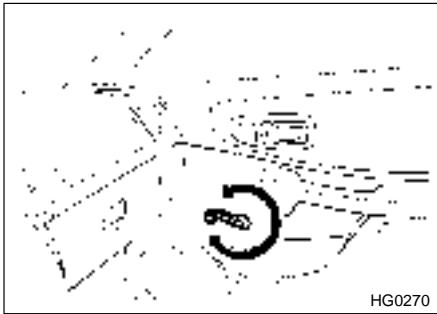

Turn the handle to open or close the window.

Power windows (if equipped)



WARNING

- When operating power windows, be extremely careful to prevent anyone's fingers or head from being caught in the window.
- Always lock the passenger's windows using the lock switch when children are riding in the vehicle.
- Before leaving the vehicle, always remove the key from the ignition switch for safety and never allow an unattended child to remain in the vehicle. Failure to follow this procedure could result in injury to a child operating the power window.

The power windows operate only when the ignition switch is in the "ON" position.

▼ Power window switch cluster (driver's side)

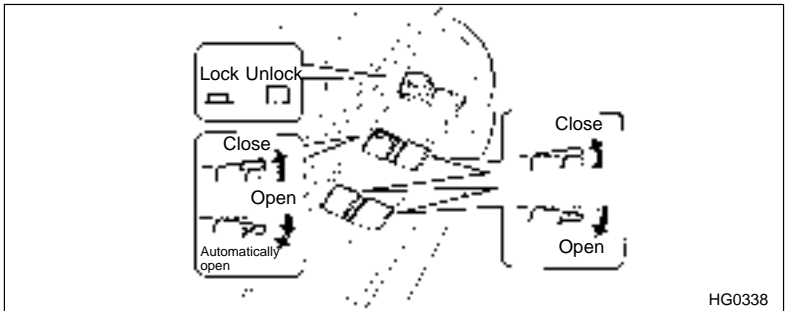
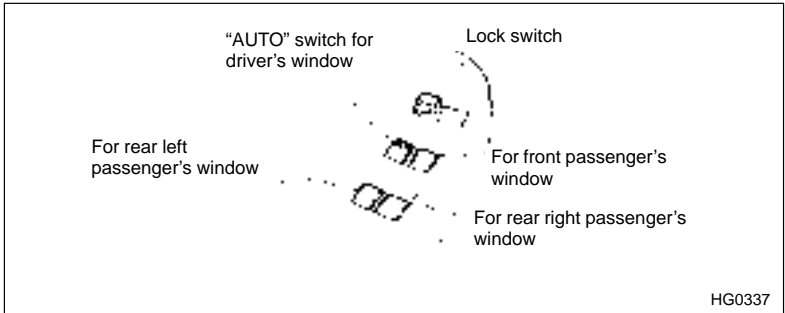

All door windows can be controlled by the power window switch cluster at the driver side door.

▽ To open or close the driver's window

AUTO switch: This switch has two functions.

Push the switch down until it clicks and release it, and the window will fully open. To stop the window halfway, pull the switch up slightly.

Push the switch down lightly and hold it. The window will open as long as the switch is held.

Pull the switch up lightly and hold it. The window will close as long as the switch is held.

– CONTINUED –

▽ To open or close the passengers' windows

To open the passengers' windows, push the appropriate switch down and hold it until the window reaches the desired position. To close the window, pull the switch up and hold it until it reaches the desired position.

▽ To lock the passengers' windows

To lock the passengers' windows, push the lock switch. When the lock switch is in the "LOCK" position, the passengers' windows cannot be opened or closed.

▼ Passenger's switches

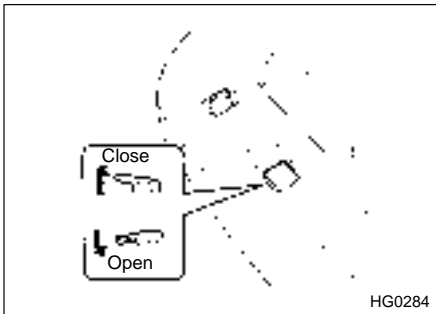

To open the window, push the switch down and hold it until the window reaches the desired position. To close the window, pull the switch up and hold it until the window reaches the desired position.

When the lock switch on the power window switch cluster, located on the driver's side door, is in the "LOCK" position, the front passenger's window cannot be operated with the front passenger's switch.

Trunk lid (Sedan and Coupe)



WARNING

- To prevent dangerous exhaust gas from entering the vehicle, always keep the trunk lid closed while driving.
- Help prevent young children from locking themselves in the trunk. When leaving the vehicle, either close all windows and lock all doors or cancel the inside trunk lid release. Also make certain that the trunk is closed.

▼ To open and close the trunk lid from outside

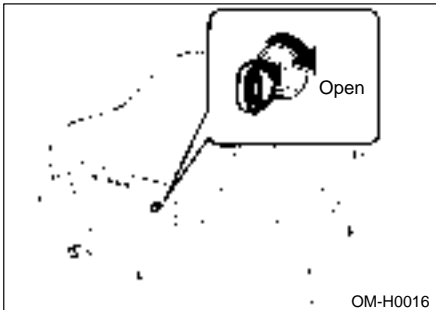

To open the trunk lid from outside, insert the key in the keyhole and turn it clockwise. To close the trunk lid, lightly press the trunk lid down until the latch engages.

▼ **To open the trunk lid from inside (vehicle with trunk lid release lever)**

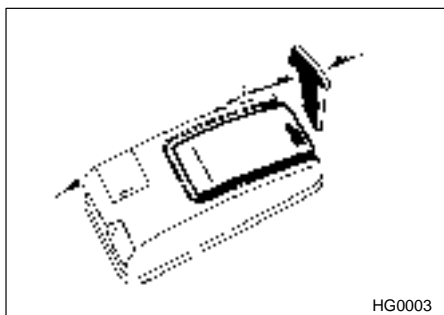

Pull the trunk lid release lever upward.

▽ **To cancel the trunk lid release**

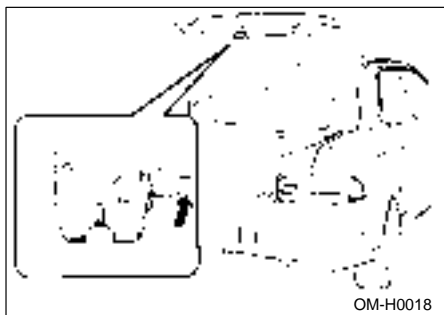

The inside trunk lid release can be cancelled to help prevent unauthorized entry into the trunk. To cancel the trunk lid release, set the lid release cancel lever (located on the inside of the trunk lid, mounted to the trunk lid latch) to the "CANCEL" position. When this lock is in the "CANCEL" position, the trunk can be opened only with the key.

Rear gate (Wagon)



WARNING

To prevent dangerous exhaust gas from entering the vehicle, always keep the rear gate closed while driving.

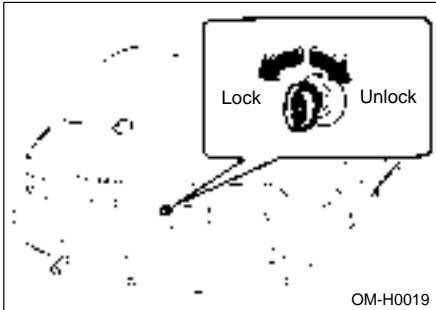

To unlock the rear gate, insert the key in the keyhole and turn it clockwise. To lock the rear gate, insert the key in the keyhole and turn it counterclockwise. If your vehicle is equipped with power door locks, the rear gate can also be locked and unlocked through use of the power door lock system. Refer to the "Power door locking switches" section in this chapter.

To open the rear gate, first unlock the rear gate lock then pull the outside handle up. To close the rear gate, lower it slowly and push down firmly until the latch engages.

Fuel filler door and cap

WARNING

- Gasoline vapor is highly flammable. Before refueling, always first stop the engine and make sure that there are no lighted cigarettes, open flames or electrical sparks in the adjacent area.
- When opening the cap, do not remove the cap quickly. Fuel may be under pressure and spray out of the fuel filler neck especially in hot weather, which may cause injury.

CAUTION

Never add any cleaning agents to the fuel tank. The addition of a cleaning agent may cause damage to the fuel system.

For choosing the right fuel for your SUBARU, refer to the “Fuel requirements” section located in chapter 7.

To open and close the fuel filler door



To open the fuel filler door, pull it outward. After refueling, be sure to close the fuel filler door completely.

▼ Fuel filler cap



CAUTION

- Make sure that the cap is tightened until it clicks to prevent fuel spillage in the event of an accident.
- Always use a genuine SUBARU fuel filler cap. If you use the wrong cap, it may not fit or have proper venting, and your fuel tank and emission control system might be damaged.

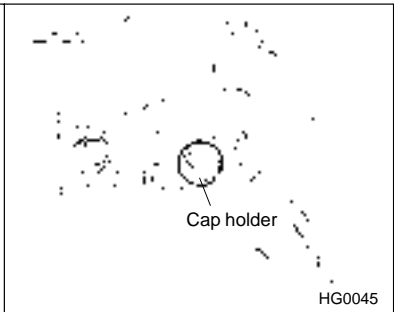
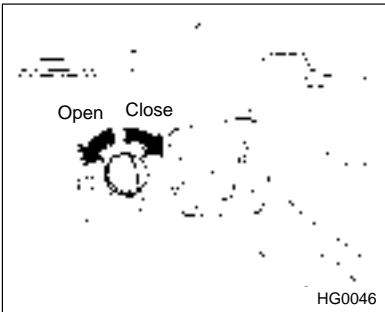

To take off the fuel filler cap, turn it slowly counterclockwise and remove the cap. While refueling, hang the cap on the cap holder inside the fuel lid.

To put the cap back on, turn it clockwise until you hear a clicking noise.

NOTE

If the fuel filler cap is not tightened until it clicks, the CHECK ENGINE warning light may come on. Refer to the “Warning and indicator lights” section located in chapter 3.

▼ Refueling

After the fuel filler nozzle has automatically stopped, do not add any more fuel.

If you spill any fuel on the painted surface, rinse it off immediately. Otherwise, the painted surface could be damaged. Such damage is not covered under the SUBARU Limited Warranty.

Engine hood

WARNING

Always check that the hood is properly locked before you start driving. If it is not, it might fly open while the vehicle is moving and block your view, which may cause an accident and serious bodily injury.

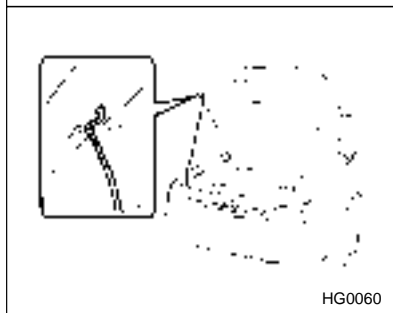
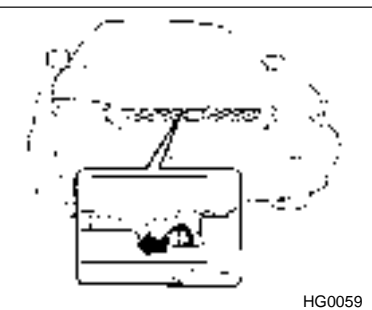
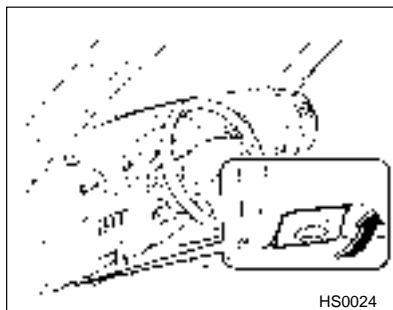

To open the hood:

1. Pull the hood release knob under the instrument panel.
2. Release the secondary hood release located under the front of the engine hood by moving the lever toward the left. Lift up the hood, release the hood prop from its retainer and put the end of the hood prop into the slot in the hood.

To close the hood:

1. Lift the hood slightly and remove the hood prop from the slot in the hood and return the prop to its retainer.
2. Lower the hood until it approaches about 6 in. (15 cm) from the closed position and let it drop.
3. After closing the hood, be sure the hood is securely locked.

If this does not close the hood, release it from a slightly higher position. Do not push the hood forcibly to close it. It could deform the metal.

Sunroof (if equipped)



WARNING

- **Never let anyone's hands, arms, head or any objects protrude from the sunroof.**
- **Before closing the sunroof, make sure that no one's hands, arms, head or other objects will be accidentally caught in the sunroof.**



CAUTION

- **Do not sit on the edge of the open sunroof.**
- **Do not operate the sunroof if falling snow or extremely cold conditions have caused it to freeze shut.**

The sunroof operates only when the ignition switch is in the "ON" position.



▼ To open the sunroof

Push the rear side of the switch marked "▲", and the sunroof will tilt up.

Release the switch once and push it again to slide the sunroof open.

After washing the vehicle or after there is rain, wipe away any water on the roof prior to opening the sunroof to prevent water drops from falling into the passenger compartment.

▼ To close the sunroof

Push the front side of the switch marked "▼", and the sunroof will close. The sunroof will stop halfway if you continue to press on the switch. Release the switch once and push it again to close the sunroof completely.

Release the switch after the sunroof has closed completely or has tilted up. Pushing the switch continuously may cause damage to the sunroof.

■ If the sunroof can not be closed

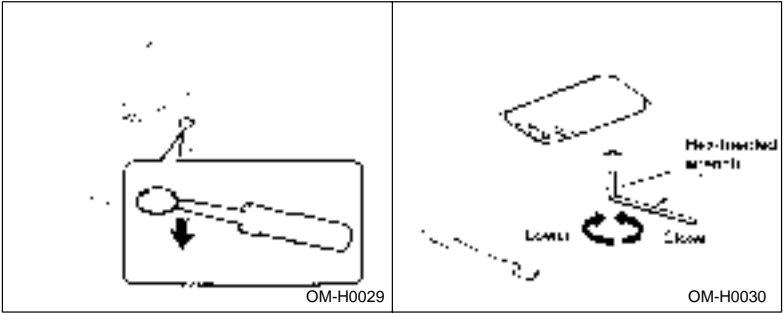

If the sunroof can not be closed with the sunroof switch, you can close the roof manually.

1. Take out the hex-headed wrench and screwdriver from the tool bag.
2. Remove the plug on the roof trim by inserting the end of the regular screwdriver between the roof and plug and prying it off.
3. Insert the wrench in the end of the motor shaft.
 - To lower the sunroof, turn the wrench clockwise.
 - To close the sunroof, turn the wrench counterclockwise.

Have your vehicle checked by an authorized SUBARU dealer.

Roof rack (if equipped)

CAUTION

When using the roof rack, make sure that the total carrying capacity of the roof rack and luggage does not exceed the maximum load limit. Overloading may cause damage to the vehicle and create a safety hazard.

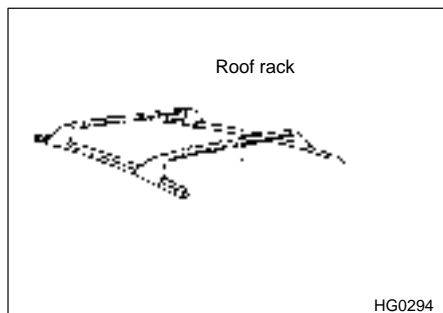

When you carry cargo on the roof using the roof rack, never exceed the maximum load limit explained below. In addition, be careful that your vehicle does not exceed the Gross Vehicle Weight Rating (GVWR) and front and rear Gross Axle Weight Rating (GAWR). See the "Loading your vehicle" section in chapter 7 for information on loading cargo into or onto your vehicle.

■ When luggage is put on the slats

When putting any luggage on the slats, make sure the total weight of the luggage on the slats does not exceed **40 lb. (18 kg)**. Overloading may cause damage to the roof and create a safety hazard. Place the heaviest load at the bottom, nearest the roof, and evenly distribute the luggage. Always secure the luggage with straps, ropes or nets.

■ Installing carrying attachments on the cross bars

When installing any carrying attachment such as a bike carrier, ski carrier, canoe carrier, etc. on the cross bars, follow the manufacturer's instructions and make sure that the attachment is securely fixed to the cross bars. Use only attachments designed specifically for the cross-bars. A set of the cross bars is designed to carry loads (cargo and attachment) of not more than **100 lb. (45 kg)**. Before operating the vehicle, make sure that the cargo is properly secured on the attachment.

NOTE

Remember that the vehicle's center of gravity is altered with the weight of the load on the roof, thus affecting the driving characteristics.

Drive carefully. Avoid rapid starts, hard cornering and abrupt stops. Crosswind effects will be increased.

Seat, seat belt and SRS airbag

Front seats	2-2
<i>Rear seat access (Coupe)</i>	2-6
Rear seats	2-7
<i>Fold down rear seat — Wagon and OUTBACK SPORT</i>	2-8
Seatbelts	2-11
<i>Seatbelt safety tips</i>	2-11
<i>Emergency Locking Retractor (ELR) function (except 2-point type seatbelt)</i>	2-12
<i>Automatic Locking Retractor (ALR) function (except driver's and 2-point type seatbelt)</i>	2-13
<i>Seatbelt warning light and chime</i>	2-13
<i>Fastening the seatbelt</i>	2-13
<i>Adjusting the shoulder belt anchor height</i>	2-16
<i>Seatbelt guide (Coupe)</i>	2-17
<i>Unfastening the seatbelt</i>	2-18
<i>Seatbelt maintenance</i>	2-19
Child restraint systems	2-20
<i>Top strap anchors</i>	2-24
SRS airbag (Supplemental Restraint System airbag)	2-26
<i>Vehicle with driver's and front passenger's SRS airbags and lap/shoulder restraint</i>	2-26
<i>SRS airbag operation</i>	2-31
<i>SRS airbag system monitors</i>	2-36
<i>SRS airbag system servicing</i>	2-37
<i>Precautions against vehicle modification</i>	2-38

Front seats



WARNING

- Never adjust the seat while driving to avoid the possibility of loss of vehicle control and of personal injury.
- Never drive the vehicle with the head restraints removed because they are designed to reduce the risk of serious neck injury in the event that the vehicle is struck from the rear.
- Before adjusting the seat, make sure the hands and feet of rear seat passengers are clear of the adjusting mechanism.
- Seat belts provide maximum restraint when the occupant sits well back and upright in the seat. To reduce the risk of sliding under the seat belt in a collision, the front seatbacks should be always used in the upright position while the vehicle is running. If the front seatbacks are not used in the upright position in a collision, the risk of sliding under the lap belt and of the lap belt sliding up over the abdomen will increase, and both can result in serious internal injury or death.
- Do not put cushions or any other materials between occupants and seatbacks or seat cushions. If you do so, the risk of sliding under the lap belt and of the lap belt sliding up over the abdomen will increase, and both can result in serious internal injury or death.
- The SRS airbags deploy with considerable speed and force. Occupants who are out of proper position when the SRS airbag deploys could suffer very serious injuries. Because the SRS airbag needs enough space for deployment, the driver should always sit upright and well back in the seat as far from the steering wheel as practical while still maintaining full vehicle control and the front passenger should move the seat as far back as possible and sit upright and well back in the seat.
- Put children aged 12 and under in the rear seat properly restrained at all times. The SRS airbag deploys with considerable speed and force and can injure or even kill children, especially if they are 12 years of age and under and are not restrained or improperly restrained. Because children are lighter and weaker than

adults, their risk of being injured from deployment is greater. For that reason, we strongly recommend that ALL children (including those in child seats and those that have outgrown child restraint devices) sit in the REAR seat properly restrained at all times in a child restraint device or in a seat belt, whichever is appropriate for the child's age, height and weight.

Secure ALL types of child restraint devices (including forward facing child seat) in the REAR seats at all times.

NEVER INSTALL A REARWARD FACING CHILD SEAT IN THE FRONT SEAT. DOING SO RISKS SERIOUS INJURY OR DEATH TO THE CHILD BY PLACING THE CHILD'S HEAD TOO CLOSE TO THE SRS AIRBAG.

According to accident statistics, children are safer when properly restrained in the rear seating positions than in the front seating positions. For instructions and precautions concerning child restraint systems, see the "Child restraint systems" section in this chapter.

Adjust the seatback to upright position. Sit well back and upright.



Move the seat as far from the steering wheel as practical.

HS0233

Adjust the seatback to upright position. Sit well back and upright.

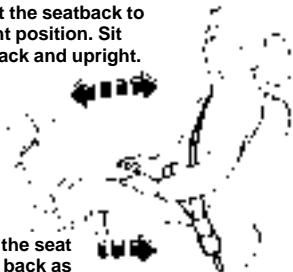

Move the seat as far back as possible.

HS0234

Put children in the rear seat properly restrained at all times.



HG0356

 Do not recline the seatback while vehicle is moving.



HS0247

▼ Fore and aft adjustment



OM-H0031

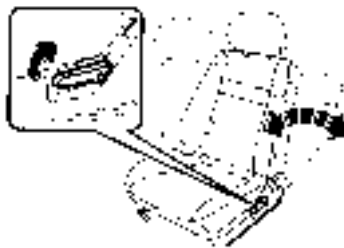

OM-H0032

Pull the lever upward and slide the seat to the desired position. Then release the lever and move the seat back and forth to make sure that it is securely locked into place.

▼ Reclining the seatback

Pull the reclining lever up and adjust the seatback to the desired position. Then release the lever and make sure the seatback is securely locked into place.

▼ Head restraint adjustment

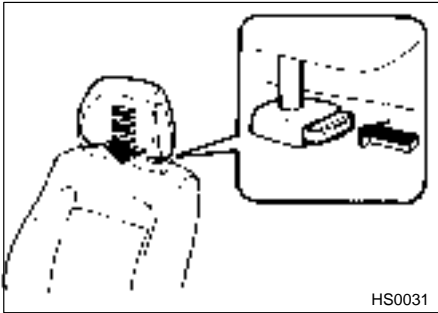

To raise the head restraint, pull it up. To lower it, push the head restraint down while depressing the release button on the top of the seatback.

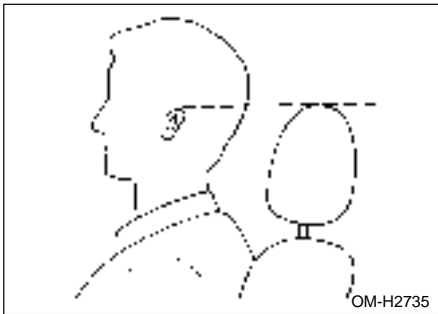

The best position for the head restraint is just above or level with the top of the ears.

■ Rear seat access (Coupe)

CAUTION

- Never operate the reclining pedal with your fingers or with bare feet. Doing so could result in injury to your fingers or toes.
- Never allow children to operate the reclining pedal or lever. Their fingers or feet could be caught in the reclining mechanism, which may result in injury.

For access to the rear seat, pull up the reclining lever at the right side of the passenger's seat cushion. The seat back will recline forward fully, allowing you to access to the rear seat.

For egress from the rear seat, depress the reclining pedal at the back of the passenger's seat cushion. The seat back will recline forward fully, allowing you room to exit.

Raise the seat back until it locks after access to or egress from the rear seat and make sure that the seat back is locked in position by moving the top of it fore and aft.

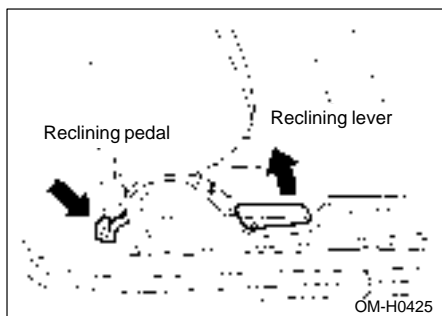

Rear seats



WARNING

- Seat belts provide maximum restraint when the occupant sits well back and upright in the seat. Do not put cushions or any other materials between occupants and seatbacks or seat cushions. If you do so, the risk of sliding under the lap belt and of the lap belt sliding up over the abdomen will increase, and both can result in serious internal injury or death.
- Never allow passengers to ride on the folded rear seatback, in the cargo area. Doing so may result in serious injury or death.
- Never stack luggage or other cargo higher than the top of the seatback because it could tumble forward and injure passengers in the event of a sudden stop or accident.
- Secure skis and other lengthy items properly to prevent them from shooting forward and causing serious injury during a sudden stop, a sudden steering or a rapid acceleration.

Sit well back and upright.



HG0339

■ Fold down rear seat — Wagon and OUTBACK SPORT

WARNING

- After returning the rear seat to its original position, be certain to place all of the seat belts and the tab attached to the seat cushion above the seat cushion. And make certain that the shoulder belts are fully visible.
- Never permit anyone to ride in the cargo area.

▼ Folding down the seatback

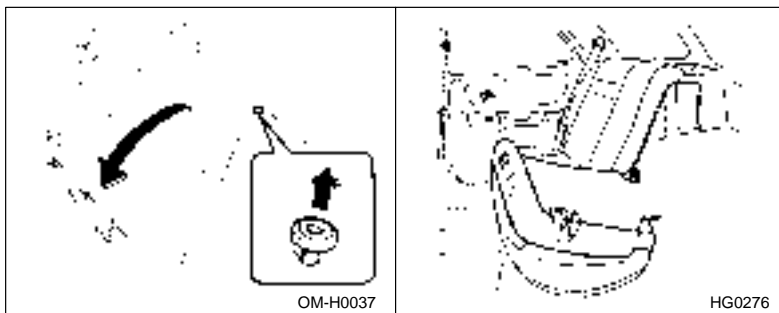

Unlock the seatback by pulling the release knob and then fold the seatback down.

▼ Folding down the seat cushion and seatback

1. Move the front seat forward.
2. Store the seat belts in the seat belt pocket to prevent them falling below the cushion.

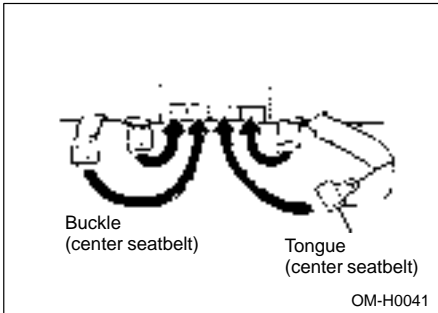

3. Raise the seat cushion by pulling up the tab.

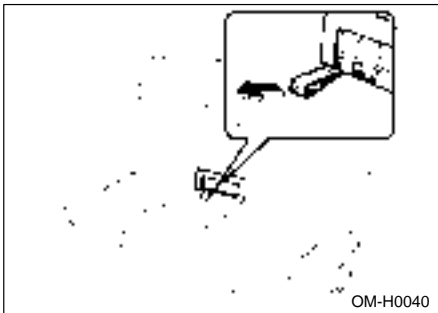

4. Unlock the seatback by pulling the release knob and fold the seat-back down. Confirm that the pin located at the bottom of the seat cushion is inserted into the slot at the top of the seatback.

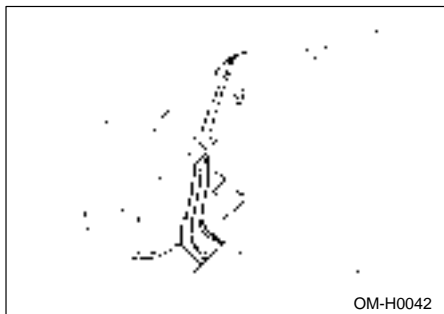

To return the rear seat to its original position, raise the seatback and seat cushion until they lock into place and make sure that they are securely locked.

Make sure that the rear seat belts are not under the seat cushion or seatback.

Seatbelts

■ Seatbelt safety tips



WARNING

- All persons in the vehicle should fasten their seatbelts **BEFORE** the vehicle starts to move. Otherwise, the possibility of serious injury becomes greater in the event of a sudden stop or accident.
- All belts should fit snugly in order to provide full restraint. Loose fitting belts are not as effective in preventing or reducing injury.
- Each seatbelt is designed to support only one person. Never use a single belt for two or more persons — even children. Otherwise, in an accident, serious injury or death could result.
- Replace all seatbelt assemblies including retractors and attaching hardware worn by occupants of a vehicle that has been in a serious accident. The entire assembly should be replaced even if damage is not obvious.
- Put children aged 12 and under in the rear seat properly restrained at all times. The SRS airbag deploys with considerable speed and force and can injure or even kill children, especially if they are 12 years of age and under and are not restrained or improperly restrained. Because children are lighter and weaker than adults, their risk of being injured from deployment is greater. For that reason, we strongly recommend that **ALL** children (including those in child seats and those that have outgrown child restraint devices) sit in the **REAR** seat properly restrained at all times in a child restraint device or in a seatbelt, whichever is appropriate for the child's height and weight.

Secure **ALL** types of child restraint devices (including forward facing child seats) in the **REAR** seats at all times.

NEVER INSTALL A REARWARD FACING CHILD SEAT IN THE FRONT SEAT. DOING SO RISKS SERIOUS INJURY OR DEATH TO THE CHILD BY PLACING THE CHILD'S HEAD TOO CLOSE TO THE SRS AIRBAG.

– CONTINUED –

According to accident statistics, children are safer when properly restrained in the rear seating positions than in the front seating positions. For instructions and precautions concerning the child restraint system, see the “Child restraint systems” section in this chapter.

▼ Infants or small children

Use a child restraint system that is suitable for your vehicle. See information on “Child restraint systems” in this chapter.

▼ Children

If a child is too big for a child restraint system, the child should sit in the rear seat and be restrained using the seatbelts. According to accident statistics, children are safer when properly restrained in the rear seating positions than in the front seating positions. Never allow a child to stand up or kneel on the seat.

If the shoulder portion of the belt crosses the face or neck, move the child closer to the belt buckle to help provide a good shoulder belt fit. Care must be taken to securely place the lap belt as low as possible on the hips and not on the child's waist. If the shoulder portion of the belt cannot be properly positioned, a child restraint system should be used. Never place the shoulder belt under the child's arm or behind the child's back.

▼ Expectant mothers

Expectant mothers also need to use the seatbelts. They should consult their doctor for specific recommendations. The lap belt should be worn securely and as low as possible over the hips, not over the waist.

■ Emergency Locking Retractor (ELR) function (except 2-point type seatbelt)

The emergency locking retractor allows normal body movement but the retractor locks automatically during a sudden stop, impact or if you pull the belt very quickly out of the retractor.

■ Automatic Locking Retractor (ALR) function (except driver's and 2-point type seatbelt)

When securing a child restraint system on the passengers' seats, the seatbelt must be changed over to the Automatic Locking Retractor (ALR) mode.

When the child restraint system is removed, make sure that the retractor operates as an Emergency Locking Retractor (ELR).

For instructions on how to convert the retractor to the ALR mode and restore it to the ELR mode, see the "Child restraint systems" section in this chapter.

■ Seatbelt warning light and chime



Your vehicle is equipped with a seatbelt warning device at the driver's seat.

This device causes the seatbelt warning light on the instrument panel to light up for about six seconds when the ignition switch is turned to the "ON" position to remind the driver to wear the seatbelt. If the driver's seatbelt is not fastened, a warning chime sounds at the same time.

■ Fastening the seatbelt



WARNING

- **Never use a belt that is twisted or reversed. In an accident, this can increase the risk or severity of injury.**
- **Keep the lap belt as low as possible on your hips. In a collision, this spreads the force of the lap belt over stronger hip bones instead of across the weaker abdomen.**
- **Seatbelts provide maximum restraint when the occupant sits well back and upright in the seat. To reduce the risk of sliding under the seatbelt in a collision, the front seatbacks should be always used in the upright position while the vehicle is running. If the front seatbacks are not used in the upright position in a collision, the risk of sliding under the lap belt and of the lap belt sliding up over the abdomen will increase, and both can result in se-**

rious internal injury or death.

- Do not put cushions or any other materials between occupants and seatbacks or seat cushions. If you do so, the risk of sliding under the lap belt and of lap belt sliding up over the abdomen will increase, and both can result in serious internal injury or death.

Always wear the seatbelts correctly.



Adjust the seatback to upright position. Sit well back and upright.

HS0230



Never place the shoulder belt under the arm or behind the back.

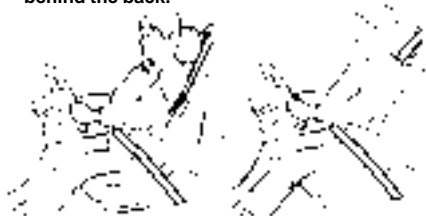

HS0231

Always wear the seat belt correctly. Sit well back and upright.

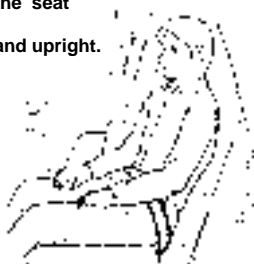

HG0358



CAUTION

Metallic parts of the seatbelt can become very hot in a vehicle that has been closed up in sunny weather; they could burn an occupant. Do not touch such hot parts until they cool.

▼ 3-point type seatbelt (Combination lap/shoulder belts)



WARNING

Never place the shoulder belt under the arm or behind the back. If an accident occurs, this can increase the risk or severity of injury.

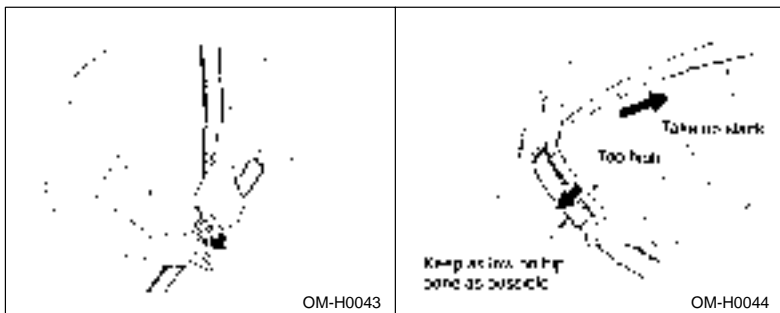

1. Adjust the seat position:

Driver's seat: Adjust the seatback to the upright position. Move the seatback as far from the steering wheel as practical while still maintaining full vehicle control.

Front passenger's seat: Adjust the seatback to the upright position. Move the seat as far back as possible.

2. Sit well back in the seat.

3. Pick up the tongue plate and pull the belt out slowly. Do not let it get twisted. If the belt stops before reaching the buckle, return the belt slightly and pull it out more slowly. If the belt still cannot be unlocked, let the belt retract slightly after giving a strong pull on it, then pull it out slowly again.

4. Insert the tongue plate into the buckle until you hear a click.

5. To make the lap part tight, pull up on the shoulder belt. And place the lap belt as low as possible on your hips, not on your waist.

▼ 2-point type seatbelt (lap only belts)

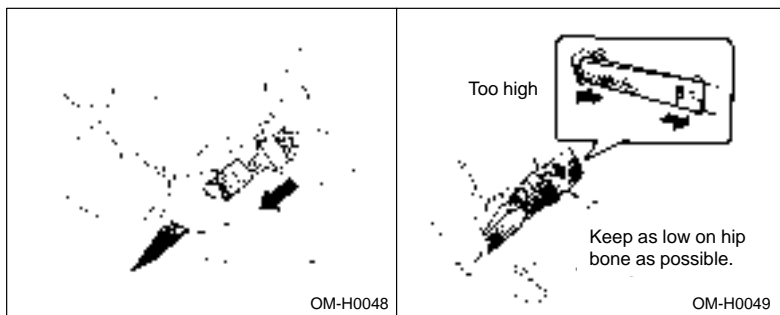

1. Sit well back in the seat and pick up the tongue plate marked "CENTER". Be careful not to twist the belt.
2. Insert the tongue plate into the buckle marked "CENTER" until you hear a click. The tongue plate marked "CENTER" can be fastened only into the buckle marked "CENTER". If the belt is not long enough for you, hold the tongue plate at a right angle to the belt and pull the belt to extend.
3. To make the belt tight, pull up on the belt. And place the lap belt as low as possible on your hips, not your waist.

■ Adjusting the shoulder belt anchor height



WARNING

When wearing the front seatbelts, make sure the shoulder portion of the webbing does not pass over your neck. If it does, adjust the seatbelt anchor to a lower position. Placing the shoulder belt over the neck may result in neck injury during sudden braking or in a collision.

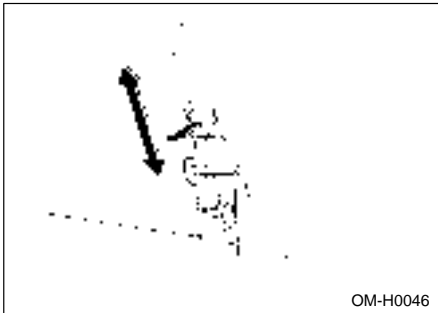

The shoulder belt anchor height should be adjusted to the position best suited for you.

To adjust the anchor height, pull the release knob and move the anchor to the desired position.

Always adjust the anchor height so that the shoulder belt passes over the middle of the shoulder without touching the neck.

■ Seatbelt guide (Coupe)



WARNING

The seatbelt guide must be in its fully raised position when the seatbelt is worn.

Otherwise, the seatbelt will be less effective in prevailing injury in an accident.

Before fastening the seatbelt, raise the belt guide until it stops so that the seatbelt can be easily handled. For easy access to or egress from the rear seat, lower the guide to the storing position.

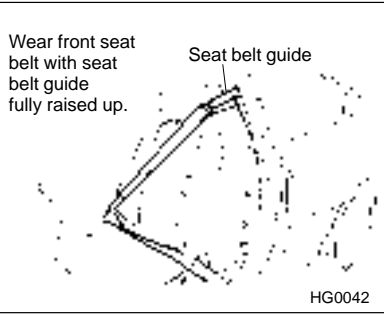
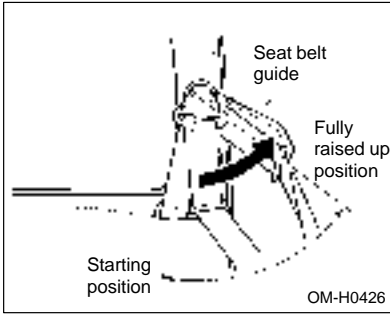

■ Unfastening the seatbelt

▼ 3-point type seatbelt (Combination lap/shoulder belts)

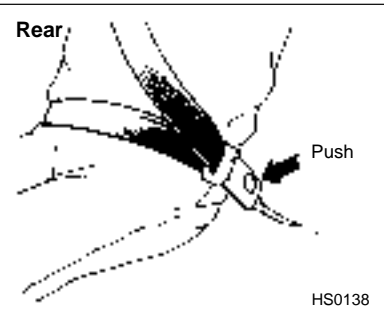
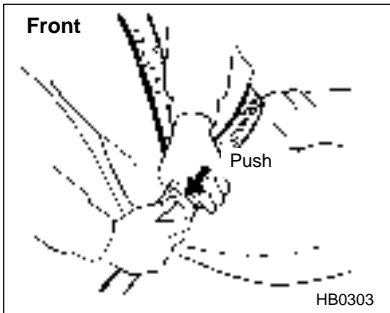

Push the button on the buckle.

Before closing the door, make sure that the belts are retracted properly to avoid catching the belt webbing in the door.

▼ 2-point type seatbelt (lap only belts)

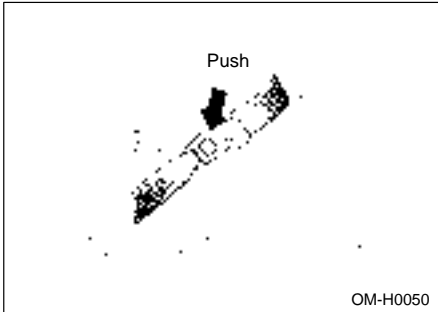

Push the release button on the buckle.

NOTE

When the seatbelt is not in use, store the seatbelt in the seatbelt pocket to prevent it from being damaged.

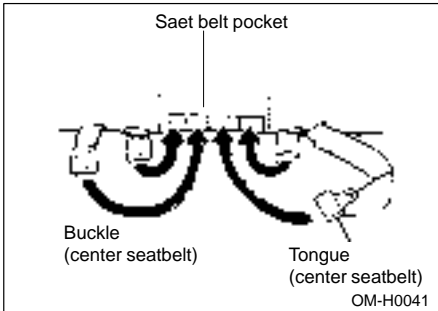

■ **Seatbelt maintenance**



CAUTION

- Keep the belts free of polishes, oils, chemicals and particularly battery acid.
- Never attempt to make modifications or changes that will prevent the seatbelt from operating properly.

– CONTINUED –

To clean the seatbelts, use a mild soap and lukewarm water. Never bleach or dye the belts because this could seriously affect their strength.

Inspect the seatbelts and attachments including the webbing and all hardware periodically for cracks, cuts, gashes, tears, damage, loose bolts or worn areas. Replace the seatbelts even if only minor damage is found.

Child restraint systems



WARNING

- **Never let a passenger hold a child on his or her lap while the vehicle is moving. The passenger cannot protect the child from injury in a collision, because the child will be caught between the passenger and objects inside the vehicle. Additionally, holding a child in your lap or arms in the front seat exposes that child to another serious danger. Since the SRS airbag deploys with considerable speed and force, the child could be injured or even killed.**
- **Put children aged 12 and under in the rear seat properly restrained at all times. The SRS airbag deploys with considerable speed and force and can injure or even kill children, especially if they are 12 years of age and under and are not restrained or improperly restrained. Because children are lighter and weaker than adults, their risk of being injured from deployment is greater. For that reason, be sure to secure ALL types of child restraint devices (including forward facing child seats) in the REAR seats at all times. You should choose a restraint device which is appropriate for the child's age, height and weight. According to accident statistics, children are safer when properly restrained in the rear seating positions than in the front seating positions.**
- **SINCE YOUR VEHICLE IS EQUIPPED WITH A PASSENGER'S SRS AIRBAG, DO NOT INSTALL A REARWARD FACING CHILD SEAT IN THE FRONT PASSENGER'S SEAT. DOING SO RISKS SERIOUS INJURY OR DEATH TO THE CHILD BY PLACING THE CHILD'S HEAD TOO CLOSE TO THE SRS AIRBAG.**

- Children should be properly restrained in the rear seat at all times. Never allow a child to stand up, or to kneel on the front passenger's seat. The SRS airbag deploys with considerable force and can injure or even kill the child.

- ⚠ Never hold a child on your lap or in your arms in the front passenger's seat or any other seat.



HS0229

- Secure child restraint devices in the REAR seats at all times.



OM-H0051

- ⚠ Never install rearward facing child seat in the front passenger's seat.



HS0042

- ⚠ Never allow a child to stand up, or to kneel on the front passenger's seat or any other seat.



HS0228

⚠ WARNING

- Child restraint systems and seat belts can become hot in a vehicle that has been closed up in sunny weather; they could burn a small child. Check the child restraint system before you place a child in it.
- Do not leave an unsecured child restraint system in your vehicle. Unsecured child restraint systems can be thrown around inside of the vehicle in a sudden stop, turn or accident; it can strike and injure vehicle occupants as well as result in serious injuries or death to the child.

– CONTINUED –

Infants and small children should always be placed in an infant or child restraint system in the rear seat while riding in the vehicle. You should use an infant or child restraint system that meets Federal Motor Vehicle Safety Standards or Canada Motor Vehicle Safety Standards, is compatible with your vehicle and is appropriate for the child's age and size. All child restraint systems are designed to be secured in the vehicle seats by lap belts or the lap portion of a lap/shoulder belt.

Children could be endangered in an accident if their child restraints are not properly secured in the vehicle. When installing the child restraint system, carefully follow the manufacturer's instructions.

According to accident statistics, children are safer when properly restrained in the rear seating positions than in the front seating positions. These statistics also indicate that the safest position for a child restraint system is the center of the rear seat.

All U.S. states and Canadian provinces require that infants and small children be restrained in an approved child restraint system at all times while the vehicle is moving.

▼ Installing child restraint systems in the 2-point type seat belt position (Rear center seating position)

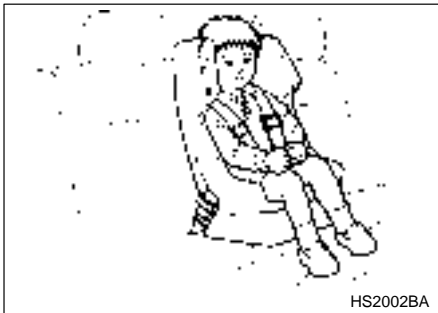

1. Set the child restraint system in the center seating position.
2. Run the 2-point type seat belt through or around the child restraint system following the instructions provided by its manufacturer.
3. Insert the tongue plate into the buckle.

4. Tighten the seat belt.
5. Before having a child sit in the child restraint system, move it back and forth to check if it is firmly secured. Sometimes a child restraint can be more firmly secured by pushing it down into the seat cushion and then tightening the seatbelt.

If the child restraint system requires a top strap, latch the hook onto the top strap anchor and tighten the top strap.

▼ Installing child restraint systems in the 3-point type seat belt position

NOTE

When the child restraint system is no longer in use, remove it and restore the ELR function of the retractor. That function is restored by allowing the seat belt to retract fully.

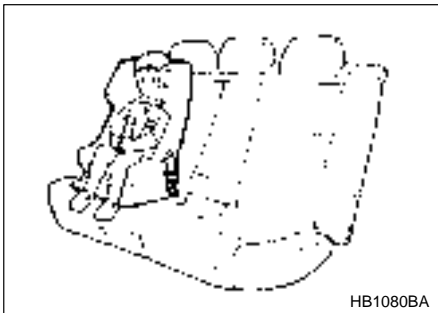

1. Set the child restraint system in the seating position.
2. Run the lap and shoulder belts through or around the child restraint system following the instructions provided by its manufacturer. If the shoulder belt goes in front of the child's face or neck, put it behind the child restraint system.
3. Insert the tongue plate into the buckle.
4. Take up the slack in the lap belt.
5. Pull out the seat belt fully from the retractor to change the retractor over from the Emergency Locking Retractor(ELR) to the Automatic Locking Retractor (ALR) function. Then, allow the belt to rewind into

– CONTINUED –

the retractor. As the belt is rewinding, clicks will be heard which indicate the retractor functions as ALR.

6. Before having a child sit in the child restraint system, move it back and forth to check if it is firmly secured. Sometimes a child restraint can be more firmly secured by pushing it down into the seat cushion and then tightening the seat belt.

7. Pull at the shoulder portion of the belt to confirm that it cannot be pulled out (ALR properly functioning).

If the child restraint system requires a top strap, latch the hook onto the top strap anchor and tighten the top strap.

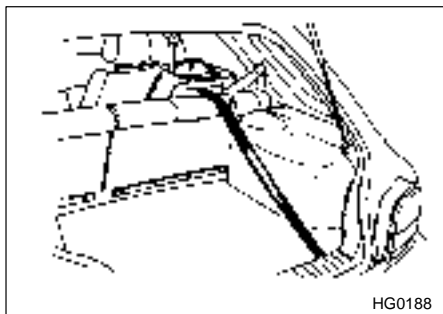

■ Top strap anchors

▼ Anchorage location

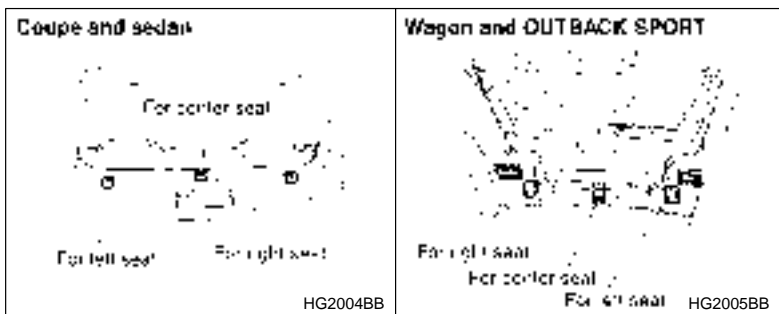

Three anchor brackets, i.e., ones for the right, center and left positions, are already installed on the rear parcel shelf (on coupe and sedan) or on the back wall of the cargo area (on station wagon and OUTBACK SPORT).

▼ To hook the top strap

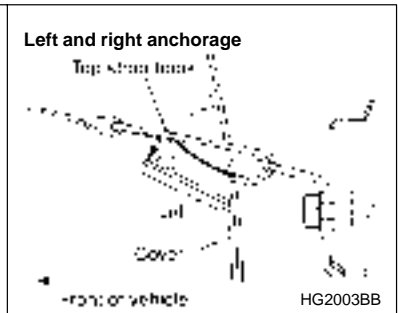
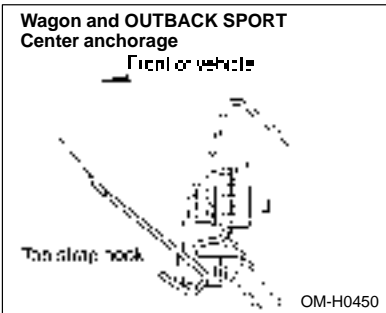
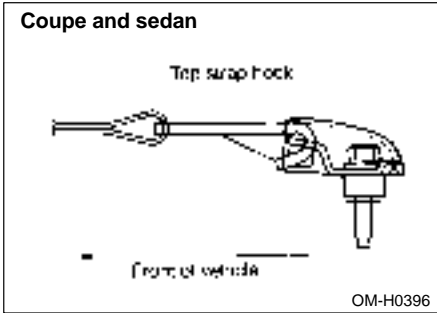

Fasten the top strap hook of the child restraint to the appropriate anchor bracket.

Tighten the top strap securely.

***SRS airbag (Supplemental Restraint System airbag)**

*SRS: This stands for supplemental restraint system. This name is used because the airbag system supplements the vehicle's seatbelts.

■ Vehicle with driver's and front passenger's SRS airbags and lap/shoulder restraint



WARNING

- To obtain maximum protection in the event of an accident, the driver and all passengers in the vehicle should always wear seatbelts when the vehicle is moving. The SRS airbag is designed only as a supplement to the primary protection provided by the seatbelt. It does not do away with the need to fasten seatbelts. In combination with the seatbelts, it offers the best combined protection in case of a serious accident.

Not wearing a seatbelt increases the chance of severe injury or death in a crash even when the car has the SRS airbag.

For instructions and precautions concerning the seatbelt system, see the "Seatbelts" sections in this chapter.

- Do not sit or lean unnecessarily close to the SRS airbag. Because the SRS airbag deploys with considerable speed – faster than the blink of an eye – and force to protect in high speed collisions, the force of an airbag can injure an occupant whose body is too close to SRS airbag.

It is also important to wear your seatbelt to help avoid injuries that can result when the SRS airbag contacts an occupant not in proper position such as one thrown forward during pre-accident braking.

Even when properly positioned, there remains a possibility that an occupant may suffer minor injury such as abrasions and bruises to the face or arms because of the SRS airbag deployment force.

- Do not place any objects over or near the SRS airbag cover or between you and the SRS airbag. If the SRS airbag deploys, those objects could interfere with its proper operation and could be propelled inside the car and cause injury.
- The SRS airbags deploy with considerable speed and force. Occupants who are out of proper position when the SRS airbag deploys could suffer very serious injuries. Because the SRS airbag needs enough space for deployment, the driver should always sit upright and well back in the seat as far from the steering wheel as practical while still maintaining full vehicle control and the front passenger should move the seat as far back as possible and sit upright and well back in the seat.

Adjust the seatback to upright position. Sit well back and upright.



Move the seat as far from the steering wheel as practical.

HS0233

Adjust the seatback to upright position. Sit well back and upright.



Move the seat as far back as possible.

HB0290

WARNING

- Put children aged 12 and under in the rear seat properly restrained at all times. The SRS airbag deploys with considerable speed and force and can injure or even kill children, especially if they are 12 years of age and under and are not restrained or improperly restrained. Because children are lighter and weaker than adults, their risk of being injured from deployment is greater. For that reason, we strongly recommend that ALL children (including those in child seats and those that have outgrown child restraint devices) sit in the REAR seat properly restrained at all times in a child restraint device or in a seatbelt, whichever is ap-

– CONTINUED –

appropriate for the child's age, height and weight.

Secure ALL types of child restraint devices (including forward facing child seats) in the REAR seats at all times.

According to accident statistics, children are safer when properly restrained in the rear seating positions than in the front seating positions.

For instructions and precautions concerning the child restraint system, see the "Child restraint systems" section in this chapter.

- NEVER INSTALL A REARWARD FACING CHILD SEAT IN THE FRONT SEAT. DOING SO RISKS SERIOUS INJURY OR DEATH TO THE CHILD BY PLACING THE CHILD'S HEAD TOO CLOSE TO THE SRS AIRBAG.

- Never allow a child to stand up, or to kneel on the front passenger's seat, or never hold a child on your lap or in your arms. The SRS airbag deploys with considerable force and can injure or even kill the child.

Put children in the REAR seat properly restrained at all times.

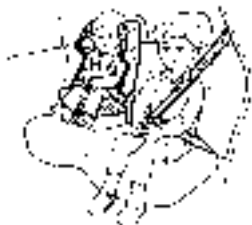

HB0291



Never install rearward facing child seat in the front passenger's seat.



HB0306



Never allow a child to stand up, or to kneel on the front passenger's seat



HB0307



Never hold a child on your lap or in your arms.



HB0308



WARNING

- Do not put any objects over the steering wheel pad and dashboard. If the SRS airbag deploys, those objects could interfere with its proper operation and could be propelled inside the vehicle and cause injury.
- Do not attach accessories to the windshield, or fit an extra-wide mirror over the rear view mirror. If the SRS airbag deploys, those objects could become projectiles that could seriously injure vehicle occupants.



Do not put any objects over the steering wheel pad and dashboard



HS0244



Do not attach accessories to the windshield, or fit an extra-wide mirror over the rear view mirror.



HS0245

 **CAUTION**

- **When the SRS airbag deploys, some smoke will be released. This smoke could cause breathing problems for people with a history of asthma or other breathing trouble. If you or your passengers have breathing problems after SRS airbag deploys, get fresh air promptly.**
- **A deploying SRS airbag releases hot gas. Occupants could get burnt if they come into direct contact with the hot gas.**

The supplemental restraint system (SRS) consists of two airbags (driver's and front passenger's SRS airbags).

These SRS airbags are designed only as a supplement to the primary protection provided by the seatbelt.

The driver's SRS airbag is stowed in the center portion of the steering wheel. The passenger's SRS airbag is stowed near the top of the dashboard under an "SRS AIRBAG" mark.

In a moderate to severe frontal collision, the driver's and front passenger's SRS airbags deploy and supplement the seatbelts by reducing the impact on the driver's and front passenger's head and chest.

NOTE

When you sell your vehicle, we urge you to explain to the buyer that it is equipped with SRS airbags by alerting him to the applicable section in this owner's manual.

▼ Components

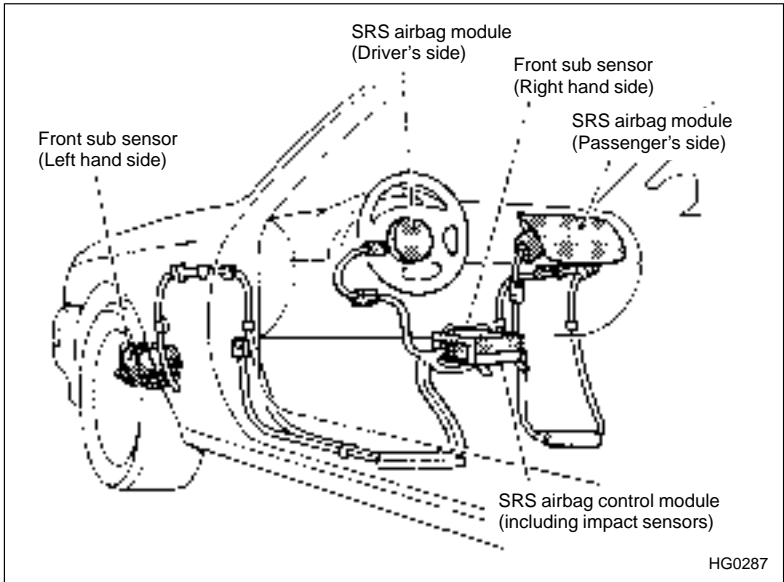

■ SRS airbag operation



CAUTION

Do not touch the SRS airbag system components around the steering wheel and dashboard with bare hands right after deployment. Doing so can cause burns because the components can be very hot as a result of deployment.

SRS airbags
deploy as soon as
a collision occurs.

After deployment,
SRS airbags start
to deflate immedi-
ately so that the
driver's vision is not
obstructed.

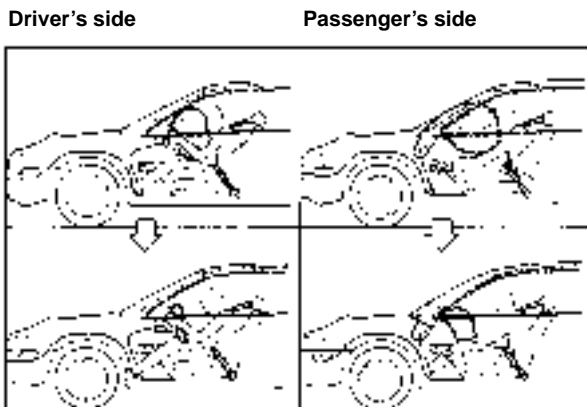

OM-H0384

The SRS airbag can function only when the ignition switch is in the "ON" position.

If the front sub sensors inside the both front fenders and the impact sensors in the airbag control module detect a certain predetermined amount of force during a frontal collision, the control module sends signals to the airbag modules instructing them to inflate the SRS airbags. Then both airbag modules produce gas, which instantly inflates driver's and passenger's SRS airbags. After the deployment, the SRS airbags immediately start to deflate so that the driver's vision is not obstructed. The time required from detecting impact to the deflating SRS airbag after deployment is shorter than the blink of eye.

The front passenger's SRS airbag deploys together with driver's SRS airbag even when no one occupies the front passenger's seat.

Although it is highly unlikely that the SRS airbag would activate in a non-accident situation, should it occur, the SRS airbag will deflate quickly, not obscuring vision and will not interfere with the driver's ability to maintain control of the vehicle.

When the SRS airbag deploys, a sudden, fairly loud inflation noise will be heard and some smoke will be released. These occurrences are

normal result of the deployment. This smoke does not indicate a fire in the vehicle.

The SRS airbag is designed to deploy in the event of an accident involving a moderate to severe frontal collision. It is basically not designed to deploy in lesser frontal impacts because the necessary protection can be achieved by the seatbelt alone. Also, it is basically not designed to deploy in side or rear impacts or in roll-over accidents because deployment of the SRS airbag would not help the occupant in those situations.

The SRS airbag is designed to function on a one-time-only basis.

SRS airbag deployment depends on the level of force experienced in the passenger compartment during a collision. That level differs from one type of collision to another, and it may have no bearing on the visible damage done to the vehicle itself.

▽ **Examples of accident in which the SRS airbag will most likely deploy.**

A head-on collision against a thick concrete wall at a vehicle speed of 12 to 19 mph (20 to 30 km/h) activates the SRS airbag. The SRS airbag will also be activated when the vehicle is exposed to a frontal impact similar in fashion and magnitude to the above-mentioned collision.

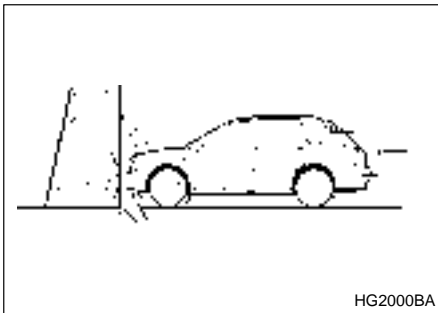

▽ **Examples of the types of accidents in which it is possible that the SRS airbag will deploy.**

The SRS airbag may be activated when the vehicle sustains a hard impact in the undercarriage area from the road surface (such as when the vehicle plunges into a deep ditch, is severely bumped or knocked hard against an obstacle on the road such as a curb).

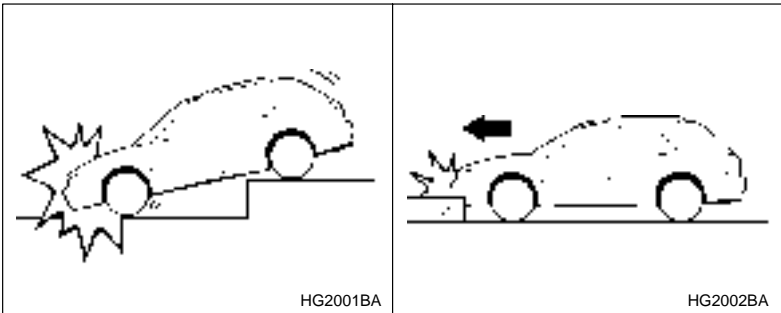

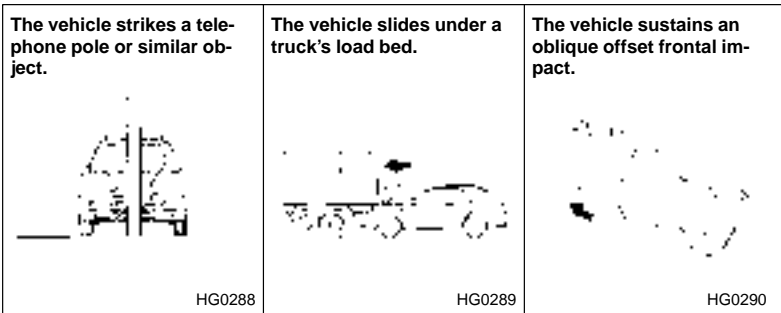

▽ **Examples of the types of accidents in which the SRS airbag is unlikely to deploy.**

There are many types of collisions which might not necessarily require SRS airbag deployment. If the vehicle strikes an object, such as a telephone pole or sign pole, or if it slides under a truck's load bed, or if it sustains an oblique offset frontal impact, the SRS airbag may not deploy depending on the level of accident forces involved.

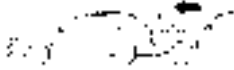

▽ **Examples of the types of accidents in which the SRS airbag will basically not deploy.**

The SRS airbag is basically not designed to deploy if the vehicle is struck from side or from behind, or if it rolls onto its side or roof, or if it is involved in a low-speed frontal collision.

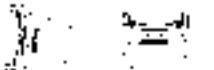
<p>The vehicle is struck from behind.</p>  <p>HG0291</p>	<p>The vehicle is struck from the side.</p>  <p>HG0292</p>	<p>The vehicle rolls onto its side or roof.</p>  <p>HG0293</p>
--	--	--

In an accident where the vehicle is impacted more than once, the SRS airbag deploys only once on the first impact.

Example: In the case of a double collision, first with another vehicle, then against a concrete wall in immediate succession, the SRS airbag is activated on the first impact but not on the second.

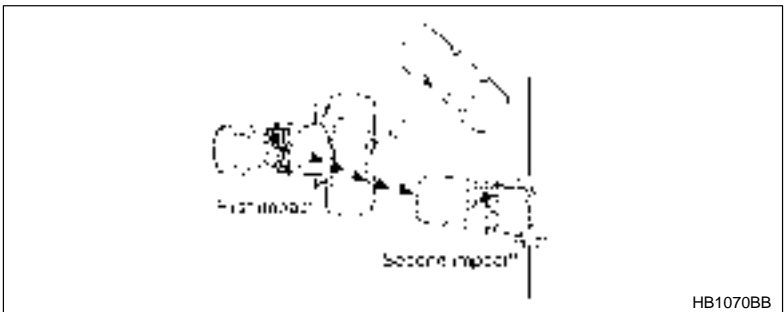

■ SRS airbag system monitors

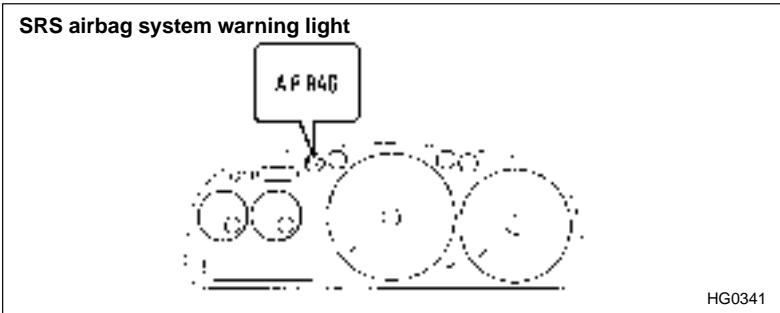

A diagnostic system continually monitors the readiness of the SRS airbag system while the vehicle is being driven. The SRS airbag system warning light "AIRBAG" will show normal system operation by lighting for about 6 seconds when the ignition key is turned to the "ON" position.

The following components are monitored by the indicator:

- Front sub sensor (Right hand side)
- Front sub sensor (Left hand side)
- Airbag control module (including impact sensors)
- Airbag module (Driver's side)
- Airbag module (Passenger's side)
- All related wiring

In the event of a malfunction indicated by any of following, the vehicle should be taken promptly to your nearest SUBARU dealer to have the system checked. Unless checked and repaired, the SRS airbags will not function reliably:

- Flashing or flickering of the indicator light.
- No illumination of the warning light when the ignition switch is first turned to the "ON" position.
- Continuous illumination of the warning light.
- Illumination of the warning light while driving.

■ SRS airbag system servicing



WARNING

- When discarding an airbag module or scrapping the entire car damaged by a collision, consult your SUBARU dealer.
- The SRS airbag has no user-serviceable parts. Do not use electrical test equipment on any circuit related to the SRS airbag system. For required servicing of the SRS airbag, see your nearest SUBARU dealer. Tampering with or disconnecting the system's wiring could result in accidental inflation of the SRS airbag or could make the system inoperative, which may result in serious injury. The wiring harnesses of the SRS airbag system are covered with yellow insulation and the system connectors are yellow for easy identification.



CAUTION

If you need service or repair in areas listed below, we recommend that you have an authorized SUBARU dealer perform the work. The SRS airbag control module, impact sensors and airbag modules are stored in these areas.

- Under the center console
- Inside each front fender
- Steering wheel and column and nearby areas
- Top of the dashboard on front passenger's side and nearby areas

In the event that the SRS airbag is deployed, replacement of the system should be performed only by an authorized SUBARU dealer. When the components of the SRS airbag system are replaced, use only genuine SUBARU parts.

To ensure their long-term reliability, the SRS airbags must be inspected by a SUBARU dealer ten years after the date of manufacture, which is shown on the certification label attached to the driver's door.

NOTE

In the following cases, contact your SUBARU dealer as soon as possible.

- The front part of the vehicle was involved in an accident in which the SRS airbags did not deploy.
- The pad section of the steering wheel or front passenger's airbag cover is scratched, cracked, or otherwise damaged.

■ Precautions against vehicle modification



WARNING

• To avoid accidental activation of the system or rendering the system inoperative, which may result in serious injury, no modifications should be made to any components or wiring of the SRS airbag system.

This includes following modifications:

- Installation of custom steering wheel
- Attachment of additional trim materials to the dashboard
- Installation of additional electrical/electronic equipment such as a mobile two-way radio on or near the SRS airbag system components and/or wiring is not advisable. This could interfere with proper operation of the SRS airbag system.



CAUTION

Do not perform any of the following modifications. Such modifications can interfere with proper operation of the SRS airbag system.

- Attachment of any equipment (brush bar, winches, snow plow, skid plate, etc.) other than SUBARU genuine accessory parts to the front end
- Modification of the suspension system or front end structure
- Installation of a tire of different size and construction from the original tires listed on the tire placard attached to the door jamb

Always consult your SUBARU dealer if you want to install any accessory parts to your vehicle.

Instruments and controls

Gauges	3-2
Speedometer	3-2
Odometer/Trip meter	3-2
Tachometer (if equipped)	3-3
Fuel gauge	3-3
Temperature gauge	3-4
Warning and indicator lights	3-5
Seat belt warning light and chime	3-5
SRS airbag system warning light	3-5
Charge warning light	3-6
Oil pressure warning light	3-6
Brake system warning light	3-6
CHECK ENGINE warning light/Malfunction indicator lamp	3-7
ABS warning light (for vehicles with ABS)	3-8
AT OIL TEMPerature warning light (for AT vehicles)	3-9
Door open warning lights	3-10
Front-wheel drive warning light (for AWD AT vehicles)	3-10
Turn signal indicator lights	3-10
High beam indicator	3-10
Low fuel warning light	3-10
Clock	3-11
Hazard warning flasher	3-11
Light control switch	3-12
Turn signal lever	3-14
Illumination brightness control	3-15
Parking light switch	3-15
Fog light switch (if equipped)	3-16
Wiper and washer	3-16
Windshield wipers and washer switches	3-18
Rear window wiper and washer switch (if equipped)	3-20
Rear window defogger switch	3-21
Horn	3-22
Mirrors	3-22
Inside mirror	3-22
Outside mirrors	3-23

Gauges

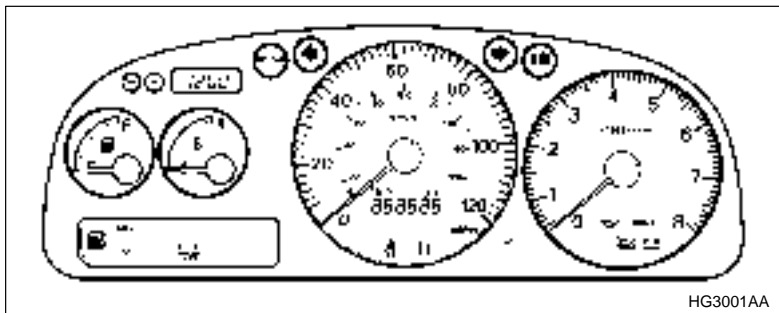

■ Speedometer

The speedometer shows the vehicle speed.

■ Odometer/Trip meter

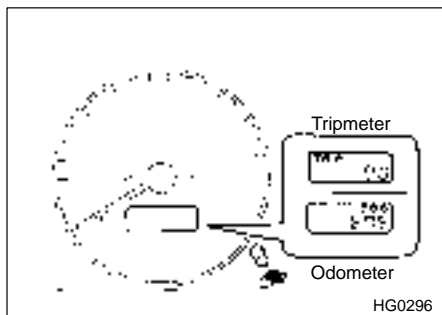

This meter displays the odometer and trip meter when the ignition switch is in the "ON" position.

To change the mode indication, briefly push the knob.

The odometer shows the total distance that the vehicle has been driven.

The trip meter shows the distance that the vehicle has been driven since you last set it to zero.

To set the trip meter to zero, select the indication of the trip meter by

pushing the knob and keep the knob pushed for more than 2 seconds.

NOTE

If the connection between the combination meter and battery is broken for any reason such as vehicle maintenance or fuse replacement, the data recorded on the trip meter will be lost.

■ Tachometer (if equipped)



CAUTION

Do not operate the engine with the pointer of the tachometer in the red zone. In this range, fuel injection will be cut by the engine control module to protect the engine from overrevving. The engine will resume running normally after the engine speed is reduced below the red zone.

The tachometer shows the engine speed in thousands of revolutions per minute.

■ Fuel gauge

The fuel gauge shows the approximate amount of fuel remaining in the tank.

The gauge does not return to "E" even though the ignition switch is in the "ACC" or "LOCK" position.

The gauge may move slightly during braking, turning or acceleration due to fuel movement in the tank.

■ Temperature gauge

CAUTION

If the pointer exceeds the normal operating range, safely stop the vehicle as soon as possible.

See “In case of emergency” in this manual.

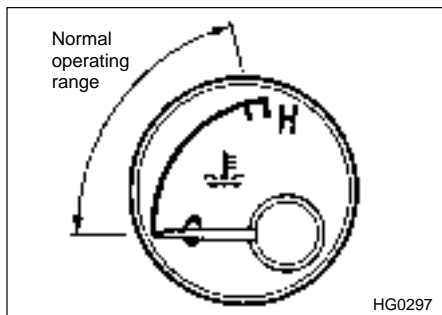

The temperature gauge shows engine coolant temperature when the ignition switch is in the “ON” position.

The coolant temperature will vary in accordance with the outside temperature and driving conditions.

We recommend that you drive moderately until the pointer of the temperature gauge reaches near the middle of the range. Engine operation is optimum with the engine coolant at this temperature range and high revving operation when the engine is not warmed up enough should be avoided.

Warning and indicator lights

Several of the warning and indicator lights come on momentarily and then go out when the ignition switch is initially turned to the "ON" position. This permits checking the operation of the bulbs.

Apply the parking brake and turn the ignition switch to the "ON" position. The following lights come on:

- Seat belt warning light
- SRS airbag system warning light
- Charge warning light
- Oil pressure warning light
- Brake system warning light
- CHECK ENGINE warning light/Malfunction indicator lamp
- ABS warning light (if equipped)
- AT OIL TEMPerature warning light (if equipped)

If any lights fail to come on, it indicates a burned-out bulb or a malfunction of the corresponding system.

Consult your authorized SUBARU dealer for repair.

■ Seat belt warning light and chime



When the ignition switch is turned to the "ON" position, the seat belt warning light will come on and the reminder chime will sound to remind driver to fasten the seat belt.

The seat belt warning light will remain on for about six seconds and turn off automatically after six seconds.

The seat belt reminder chime will turn off when the driver's side seat belt is buckled or it will turn off automatically after six seconds.

■ SRS airbag system warning light

AIRBAG

When the ignition switch is turned to the "ON" position, the SRS airbag warning light will come on for about six seconds and go out. This shows the SRS airbag is in normal operation.

If this light comes on while driving or does not go out after the engine starts, it may indicate that the SRS airbag system is not working properly. Contact your nearest SUBARU dealer immediately.

– **CONTINUED** –

■ Charge warning light



If this light comes on when the engine is running, it may indicate that the charging system is not working properly.

If the light comes on while driving or does not go out after the engine starts, stop the engine at the first safe opportunity and check the alternator belt. If the belt is loose, broken or if the belt is in good condition but the light remains on, contact your nearest SUBARU dealer immediately.

■ Oil pressure warning light



CAUTION

Do not operate the engine with the oil pressure warning light on. This may cause serious engine damage.

If this light comes on when the engine is running, it may indicate that the engine oil pressure is low and the lubricating system is not working properly.

If the light comes on while driving or does not go out after the engine starts, stop the engine at the first safe opportunity and check the engine oil level. If the oil level is low, add oil immediately. If the engine oil is at the proper level but the light remains on, contact your nearest SUBARU dealer immediately.

■ Brake system warning light



WARNING

- **Driving with the brake system warning light on is dangerous. This indicates your brake system may not be working properly. If the light remains on, have the brakes inspected by a SUBARU dealer immediately.**
- **If at all in doubt about whether the brakes are operating properly, do not drive the vehicle. Have your vehicle towed to the nearest SUBARU dealer for repair.**

This light has the following two functions:

▼ **Parking brake warning**

The light comes on with the parking brake applied while the ignition switch is in the "ON" position. It goes out when the parking brake is fully released.

▼ **Brake fluid level warning**

This light comes on when the brake fluid level drops to near the "MIN" level of the brake fluid reservoir with the ignition switch in the "ON" position and with the parking brake fully released.

If the brake system warning light should come on while driving with the parking brake lever fully released, it could be an indication of leaking of brake fluid or worn brake pads. In such a case, have your vehicle checked by a SUBARU dealer immediately.

■ **CHECK ENGINE warning light/
Malfunction indicator lamp**

**CHECK
ENGINE**



CAUTION

If the CHECK ENGINE light comes on while you are driving, have your vehicle checked/repared by your SUBARU dealer as soon as possible. Continued vehicle operation without having the emission control system checked and repaired as necessary could cause serious damage, which may not be covered by your vehicle's warranty.

If this light comes on steadily or blinks while the engine is running, it may indicate that there is a problem or potential problem somewhere in the emission control system.

▼ **If the light comes on steadily:**

If the light comes on steadily while driving or does not go out after the engine starts, an emission control system malfunction has been detected.

You should have your vehicle checked by an authorized SUBARU dealer immediately.

– CONTINUED –

NOTE

This light also comes on when the fuel filler cap is not tightened until it clicks. If you have recently refueled your vehicle, the cause of the CHECK ENGINE warning light/malfunction indicator lamp coming on could be a loose or missing fuel filler cap. Remove the cap and retighten it until it clicks. Make sure nothing is interfering with the sealing of the cap. Tightening the cap will not make the CHECK ENGINE warning light turn off immediately. It may take several driving trips. If the light does not go out, take your vehicle to your authorized SUBARU dealer immediately.

▼ If the light is blinking:

If the light is blinking while driving, an engine misfire condition has been detected which may damage the emission control system.

To prevent serious damage to the emission control system, you should do the following:

- Reduce vehicle speed.
- Avoid hard acceleration.
- Avoid steep uphill grades.
- Reduce the amount of cargo, if possible.
- Stop towing a trailer as soon as possible.

The CHECK ENGINE warning light may stop blinking and come on steadily after several driving trips. You should have your vehicle checked by an authorized SUBARU dealer immediately.

■ ABS warning light (for vehicles with ABS) (U.S.) (Canada)

The ABS warning light comes on when the ignition switch is turned to the "ON" position and goes out after about two seconds.

This is an indication that the ABS system is working properly.

If the warning light behaves as follows, the ABS system may not work properly.

- The warning light does not come on when the ignition switch is turned to the "ON" position.
- The warning light comes on when the ignition switch is turned to the "ON" position, but it does not go out even when the vehicle speed

exceeds approximately 8 mph (12 km/h).

- The warning light comes on during driving.

When the warning light is on, the ABS function shuts down; however, the conventional brake system continues to operate normally. If this occurs, have the ABS system repaired at the first available opportunity by your SUBARU dealer.

NOTE

If the warning light behavior is as shown below, the ABS system may be considered normal.

- **The warning light comes on right after the engine is started but goes out immediately, remaining off.**
- **The warning light remains on after the engine has been started, but it goes out when the vehicle speed reaches about 8 mph (12 km/h).**
- **The warning light comes on during driving, but it goes out immediately and remains off.**

When driving with an insufficient battery voltage such as when the engine is jump started, the ABS warning light may come on. This is due to the low battery voltage and does not indicate a malfunction. When the battery becomes fully charged, the light will go out.

■ AT OIL TEMPerature warning light (for AT vehicles)

**AT OIL
TEMP**

This light comes on when the ignition switch is turned to the "ON" position and goes out after about two seconds. If this light comes on when the engine is running, it may indicate that the automatic transmission fluid temperature is too hot.

Even if the light comes on while driving, it is unnecessary to stop the vehicle. But avoid driving up steep grades or driving in stop and go traffic.

▼ Automatic transmission control system warning

If the light flashes after the engine starts, it may indicate that the automatic transmission control system is not working properly. Contact your nearest SUBARU dealer for service immediately.

– CONTINUED –

■ Door open warning lights



The door open warning light comes on if any door or the rear gate (for wagon and OUTBACK SPORT) is not fully closed.

Always make sure this light is out before you start to drive.

■ Front-wheel drive warning light (for AWD AT vehicles)



This light comes on when All Wheel Drive is disengaged and the drive mechanism is switched to Front Wheel Drive for maintenance or similar purposes.

■ Turn signal indicator lights



These lights show the operation of the turn signal or lane change signal. If the indicator lights do not blink or blink rapidly, the turn signal bulb may be burned out. Replace the bulb as soon as possible. Refer to "Replacing bulbs" section in chapter 10.

■ High beam indicator



This light shows that the headlights are in the high beam mode. This indicator light also comes on when operating headlight flasher.

■ Low fuel warning light



The low fuel warning light comes on when the tank is nearly empty (about 2.3 U.S. gal., 9.0 liters, 1.9 Imp. gal.). It only operates when the ignition switch is in the "ON" position.

NOTE

This light does not go out unless the tank is replenished up to an internal fuel quantity of about 3.6 U.S. gal. (14 liters, 3.0 Imp. gal.).

Clock

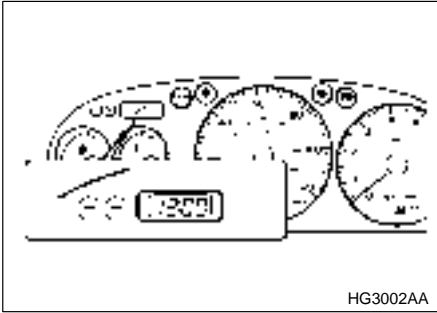

The clock displays the time when the ignition switch is in the “ACC” or “ON” positions.

▼ Setting the clock

Each time the “+” button is pressed, the clock gains 1 minute. By holding the button depressed, the clock can be put forward continuously. Pressing the “-” button puts the clock rearward.

Hazard warning flasher

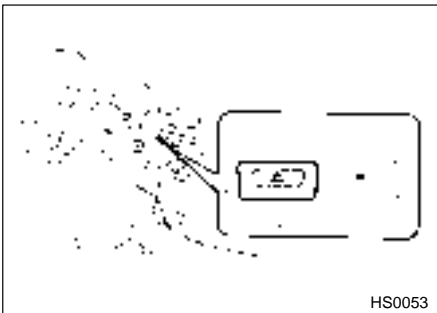

The hazard warning flasher is used to warn other drivers when you have to park your vehicle under emergency conditions. The hazard warning

– CONTINUED –

flasher works with the ignition switch in any position.

When you have to park your vehicle under emergency conditions, pull off the road safely and park away from the traffic if it is possible.

To turn on the hazard warning flasher, push the hazard warning button on the instrument panel. To turn off the flasher, push the button again.

NOTE

When the hazard warning flasher is on, the turn signals do not work.

Light control switch



WARNING

To prevent battery discharge resulting from accidentally leaving your lights on when your vehicle is parked, the light switch operates only when the ignition switch is in the "ON" position. In any other position, the vehicle's lights will be out.

If you park vehicle on a roadside at night, use the hazard warning flasher to alert the other drivers.

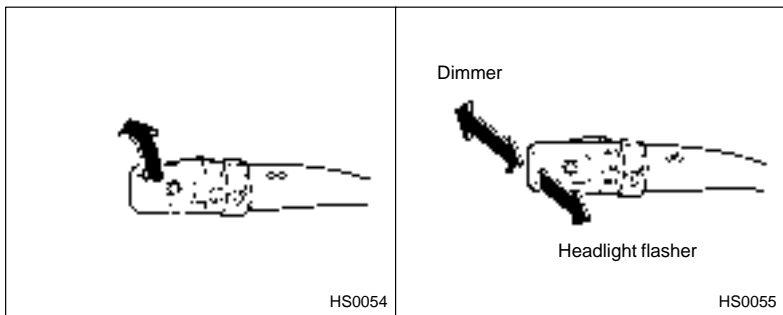

The light switch operates only when the ignition switch is in the "ON" position.

▼ Headlights

To turn on the headlights, turn the knob on the end of the turn signal

lever.

 first position

Parking lights, instrument panel illumination, tail lights, side marker lights and license plate light are on.

 second position

Headlights, parking lights, instrument panel illumination, tail lights, side marker lights and license plate light are on.

▼ High/low beam change (dimmer)

To change from low beam to high beam, push the turn signal lever forward. When the headlights are on high beam, the high beam indicator light “a ” on the instrument panel is also on.

To switch back to low beam, pull the lever back to the detent position.

▼ Headlight flasher



CAUTION

Do not hold the lever in the flashing position for more than just a few seconds.

To flash the headlights, pull the lever toward you and then release it. The high beam will stay on for as long as you hold the lever. The headlight flasher works even though the lighting switch is in the “OFF” position.

When the headlights are on high beam, the high beam indicator light “a ” on the instrument panel also comes on.

▼ Daytime running light system (for CANADA models)



WARNING

The tail lights, parking lights, and side marker lights are not turned on by the daytime running light system. The light switch must always be turned to the “a ” position when it is dark outside.

The low beam headlights will automatically come on at reduced brightness when the engine has started, under the following conditions:

- The parking brake is fully released.
- The automatic transmission selector lever is set at other than the "P" position.
- The light switch is in the "OFF" position.

Turn signal lever

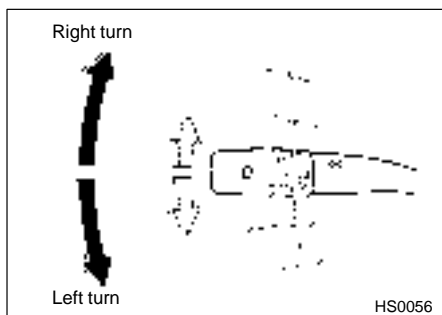

To activate the right turn signal, push the turn signal lever up. To activate the left turn signal, push the turn signal lever down. When the turn is finished, the lever will return automatically. If the lever does not return after cornering, return the lever to the neutral position by hand.

To signal a lane change, push the turn signal lever up or down slightly and hold it during the lane change. The turn signal indicator lights will flash in the direction of the turn or lane change. The lever will return automatically to the neutral position when you release it.

Illumination brightness control

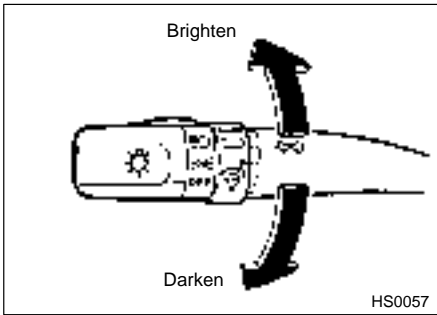

When the lighting switch is in the "p" or "a" position, you can adjust brightness of the instrument panel illumination for better visibility.

To brighten, turn the control dial counterclockwise.

To darken, turn the control dial clockwise.

Parking light switch



The parking light switch operates regardless of the ignition switch position.

By pushing the front end of this switch, following lights will come on.

- parking lights

- CONTINUED -

-
- front and rear side marker lights
 - tail lights
 - license plate lights

To turn off, push the rear end of the parking light switch.

Avoid leaving these lights on for a long time because that will run down the battery.

Fog light switch (if equipped)

The fog lights operate only when the headlights are on low beam.

Push the switch to turn the fog lights on. To turn them off, push the switch again.

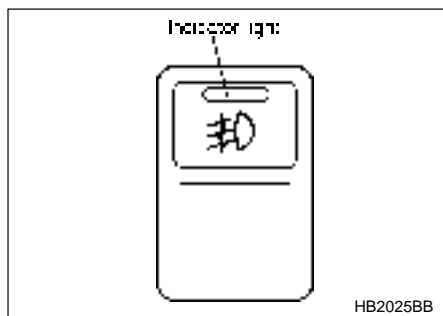

Wiper and washer



WARNING

In freezing weather, do not use the windshield washer until the windshield is sufficiently warmed by the defroster.

Otherwise the washer fluid can freeze on the windshield, blocking your view.



CAUTION

- Do not operate the washer continuously for more than ten seconds, or when the washer fluid tank is empty. This may cause overheating of the washer motor. Check the washer fluid level frequently, such as at fuel stops.
 - Do not operate the wipers when the windshield or rear window is dry. This may scratch the glass, damage the wiper blades and cause the wiper motor to burn out. Before operating the wiper on a dry windshield or rear window, always use the windshield washer.
 - In freezing weather, be sure that the wiper blades are not frozen to the windshield or rear window before switching on the wipers. Attempting to operate the wiper with the blades frozen to the window glass could cause not only the wiper blades to be damaged but also the wiper motor to burn out. If the wiper blade is frozen to the window glass, be sure to operate the defroster or rear window defogger before turning on the wiper.
 - If the wipers stop during operation because of ice or some other obstruction on the window, the wiper motor could burn out even if the wiper switch is turned off. If this occurs, promptly stop the vehicle in a safe place, turn the ignition switch to the “LOCK” position and clean the window glass to allow proper wiper operation.
 - Use clean water if windshield washer fluid is unavailable. In areas where water freezes in winter, use SUBARU Windshield Washer Fluid or the equivalent. (See “Windshield washer fluid” section in chapter 10.)
- Also, when driving the vehicle when there are freezing temperatures, use non-freezing type wiper blades.
- Do not clean the wiper blades with gasoline or a solvent, such as paint thinner or benzene. This will cause deterioration of the wiper blades.

NOTE

- The wiper operates only when the ignition switch is in the “ON” or “ACC” position.
- Clean your wiper blades and window glass periodically with a washer solution to prevent streaking, and to remove accumulations of road salt or road film. Keep the washer button depressed at least for 1 second so that washer solution will be sprinkled all over the windshield or rear window.
- Grease, wax, insects or other material on the windshield or the wiper blades results in jerky wiper operation and streaking on the glass. If you cannot remove those streaks after operating the washer or if the wiper operation is jerky, clean the outer surface of the windshield or rear window and the wiper blades using a sponge or soft cloth with a neutral detergent or mild-abrasive cleaner. After cleaning, rinse the window glass and wiper blades with clean water. The glass is clean if no beads form on the glass when you rinse with water.
- If you cannot eliminate the streaking even after following this procedure, replace the wiper blades with new ones. Refer to the “Wiper blade replacement” section (chapter 10) for replacement instructions.

■ Windshield wiper and washer switches

▼ Windshield wipers

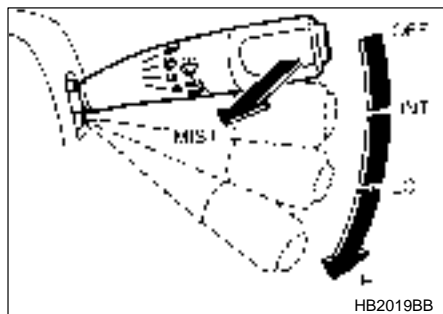

To turn the wipers on, push the wiper control lever down.

 : Intermittent

LO : Low speed

HI : High speed

To turn the wipers off, return the lever to the "OFF" position.

▼ **Mist (for a single wipe)**

For a single wipe of the wipers, pull the lever toward you. The wipers operate until you release the lever.

▼ **Washer**

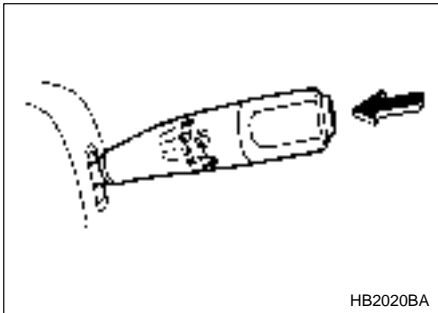

To wash the windshield, push the washer button at the end of the wiper control lever. The washer fluid sprays until you release the washer button. The wipers operate while you push the button.

■ Rear window wiper and washer switch (if equipped)

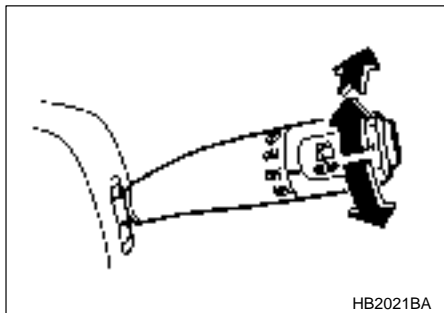

▼ Rear wiper

To turn the rear wiper on, turn the knob on the end of the wiper control lever to the "ON" position.

To turn the wiper off, return the knob on the end of the lever to the "OFF" position.

▼ Washer

To wash the rear window while the rear wiper is operating, turn the knob on the end of the wiper control lever counterclockwise to the "☐" position. The washer fluid sprays until you release the knob.

To wash the rear window when the rear wiper is not in use, turn the knob on the end of the wiper control lever clockwise to the "☐" position. The washer fluid sprays and the wiper operates until you release the knob.

Rear window defogger switch



CAUTION

- Do not use sharp instruments or window cleaner containing abrasives to clean the inner surface of the rear window. They may damage the conductors printed on the window.
- To prevent the battery from being discharged, do not operate the defogger continuously for any longer than necessary.

The rear window defogger operates only when the ignition switch is in the "ON" position.

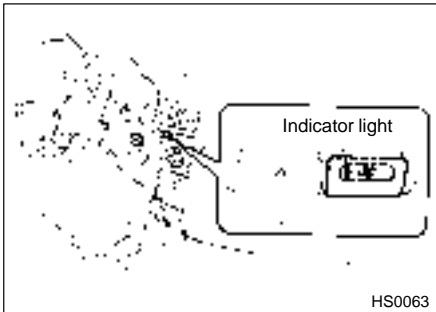

To turn on the defogger, push the switch. To turn it off, push the switch again.

The indicator light located on the switch lights up while the rear window defogger is operating.

The defogger will automatically shut off after about 15 minutes. If the window clears before that time, push the switch to turn it off. It also turns off when the ignition switch is turned to the "ACC" or "LOCK" position. If defrosting or defogging is desired when you restart your vehicle, you have to push the switch to turn it on again.

Horn

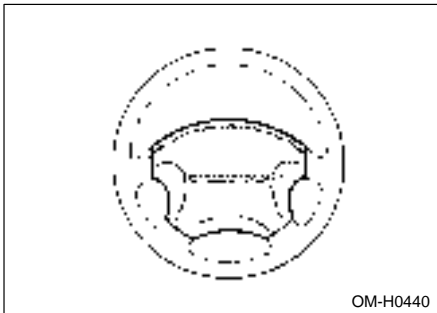

To sound the horn, push the horn pad.

Mirrors

Always check that the inside and outside mirrors are properly adjusted before you start driving.

■ Inside mirror



The inside mirror has a day and night position. Pull the tab at the bottom of the mirror toward you for the night position. Push it away for the day position. The night position reduces glare from headlights.

■ Outside mirrors



WARNING

Objects look smaller in a convex mirror (passenger side) and farther away than when viewed in a flat mirror. Do not use the convex mirror to judge the distances of vehicles behind you when changing lanes. Use the inside mirror (or glance backwards) to determine the actual size and distance of objects that you view in the convex mirror.

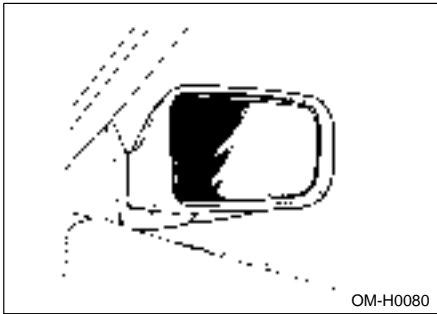

▼ Adjusting mirrors

To adjust the mirrors by hand, push where indicated by the arrows.

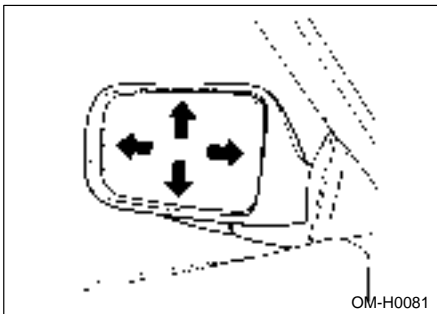

▼ Remote control mirror switch (if equipped)

The remote control mirrors operate only when the ignition switch is in the "ON" or "ACC" position.

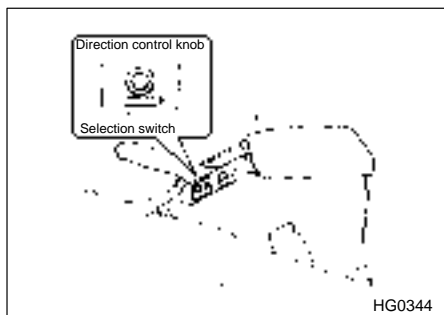

1. Press either end of the selection switch; "L" for the left and "R" for the right.
2. Move the direction control knob in the direction you want to move the mirror.
3. Return the selection switch to the neutral position to prevent unintentional operation.

The mirrors can also be adjusted manually.

Climate control

<i>Ventilator</i>	4-2
<i>Heating and air conditioning</i>	4-3
<i>Heater operation</i>	4-4
<i>Air conditioner operation</i>	4-8
<i>Operating tips for heater and air conditioner</i>	4-9
<i>Air filtration system (if equipped)</i>	4-11

Ventilator

Move the thumb-wheel up and down or right and left to adjust the air flow direction

Open



Close

Move the thumb-wheel up and down or right and left to adjust the air flow direction

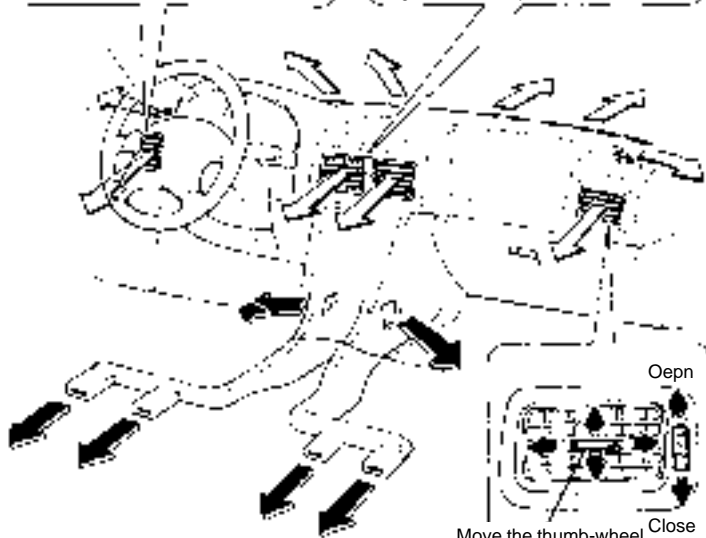

Open

Close

Move the thumb-wheel up and down or right and left to adjust the air flow direction



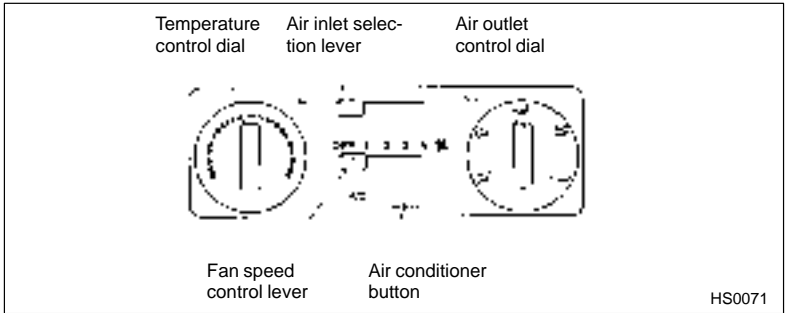

HS0070

Heating and air conditioning



▼ Air outlet control dial

This dial has the following five positions:

-  : Air flows through the instrument panel outlets.
-  : Air flows through the instrument panel outlets and the foot outlets.
-  : Air flows through the foot outlets and some through the windshield defroster outlets.
-  : Air flows through the windshield defroster outlets and foot outlets.
-  : Air flows through the windshield defroster outlets.

▼ Temperature control dial

This dial regulates the hot air flow from the heater over a range from the blue area (cool) to red area (warm).



▼ Fan speed control lever

The fan operates only when the ignition switch is turned to the "ON" position. The fan speed control lever is used to select four fan speeds.

▼ Air inlet selection lever



WARNING

Continued operation in the “” position may fog up the windows. Switch to the “” position as soon as the outside dusty condition clears.



: Interior air is recirculated inside the passenger compartment.



: Outside air is drawn into the passenger compartment.

▼ Air conditioner button (if equipped)

The air conditioner operates only when the engine is running.

Push the air conditioner button while the fan is in operation to turn on the air conditioner. The indicator light will come on.



Push it again to turn off the air conditioner.

■ Heater operation

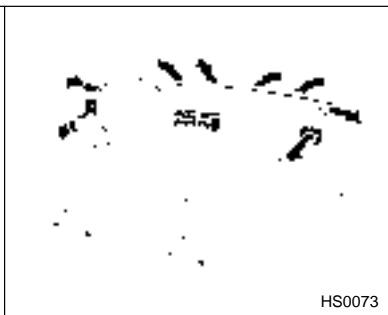
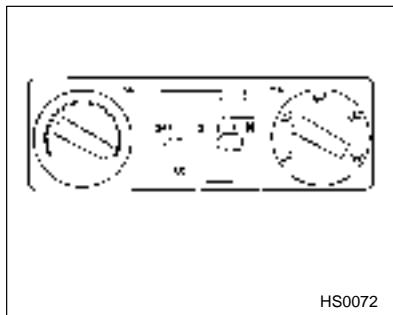
▼ Defrosting or defogging the windshield



To direct warm air to the windshield and front door windows:

1. Set the air inlet selection lever to the “” position.
2. Set the air outlet control dial to the “” position.
3. Turn the temperature control dial all the way right.
4. Set the fan speed control lever to the highest speed.

Warm air also comes out from the right and left air outlets. To stop warm air flow from these outlets, turn the corresponding thumb-wheel to the "☒" position.

▼ Heating and defrosting



To direct warm air toward the floor and the windshield:



1. Set the air inlet selection lever to the "☒" position.
2. Set the air outlet control dial to the "☒" position.
3. Set the temperature control dial to the most comfortable level.
4. Set the fan speed control lever to the desired speed.

Warm air also comes out from the right and left air outlets. To stop warm air flow from these outlets, turn the corresponding thumb-wheel to the "☒" position.

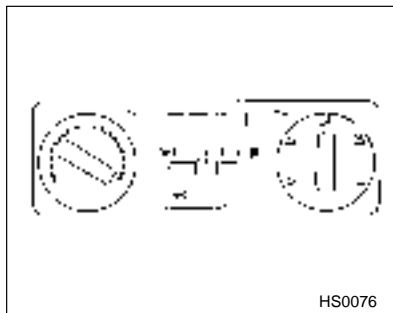
▼ Heating



To direct warm air toward the floor:

1. Set the air inlet selection lever to the "  " position
2. Set the air outlet control dial to the "  " position.
3. Set the temperature control dial to the most comfortable level.
4. Set the fan speed control lever to the desired speed.

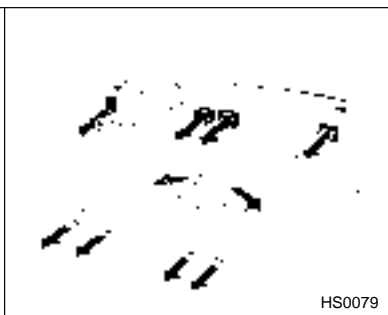
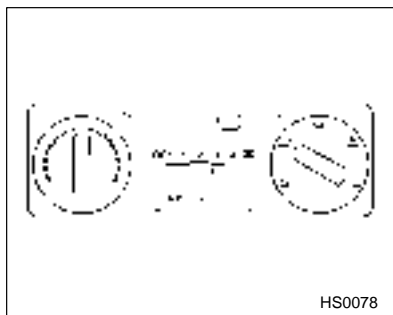

Warm air also comes out from the right and left air outlets. To stop warm air flow from these outlets, turn the corresponding thumb-wheel to the "  " position.

▼ Bi-level heating



This setting allows you to direct air of different temperatures from the instrument panel and outlets. The air from the foot outlets is slightly

warmer than from the instrument panel outlet.



1. Set the air inlet selection lever to the "  " position.
2. Set the air outlet control dial to the "  " position.
3. Set the temperature control dial to the desired temperature level.
4. Set the fan speed control lever to the desired speed.

Setting the temperature control dial fully turned to the red area or blue area decreases the temperature difference between the air from the instrument panel outlets and the air from the foot outlets.

▼ Ventilation



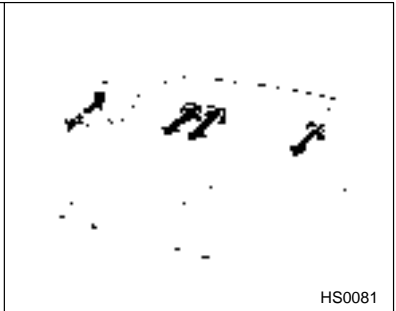
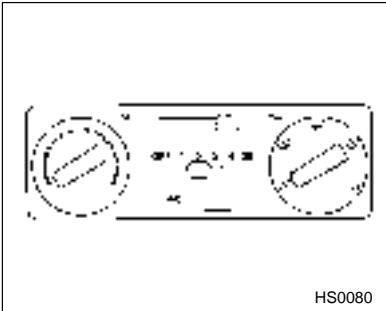

WARNING

Continued operation in the "  " position may fog up the windows. Switch to the "  " position as soon as the outside dusty condition clears.



To force outside air through the instrument panel outlets:

1. Set the air inlet selection lever to the "  " position.
2. Set the air outlet control dial to the "  " position.
3. Set the temperature control dial all the way left.
4. Set the fan speed control lever to the desired speed.



When driving on a dusty road, set the air inlet control lever to the "  " position.

■ Air conditioner operation

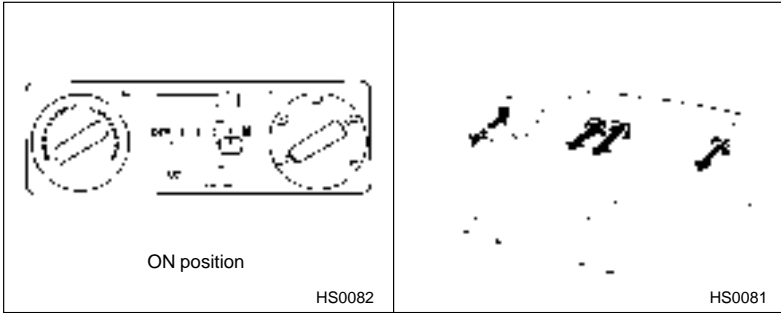
▼ Cooling or dehumidifying



For cooling and dehumidification of the passenger compartment, air flows through the instrument panel outlets:

1. Set the air inlet selection lever to the " " position.
2. Set the air outlet control dial to the " " position.
3. Push the air conditioner button on.
4. Set the temperature control dial to the blue area.
5. Set the fan speed control lever at the highest speed.

▼ Defrosting or defogging



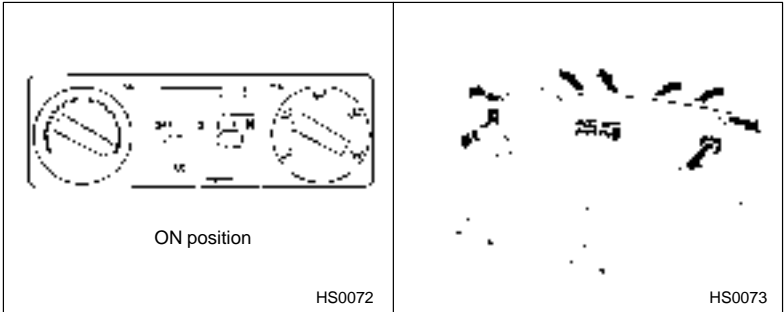

CAUTION

The air conditioner compressor will not cycle on automatically when set the air outlet control dial to the " " position. In order to take advantage of the air conditioning system's ability to dehumidify the air in the passenger compartment, it is also necessary to depress the air conditioner button.



To direct warm air to the windshield and front door windows:

1. Set the air inlet selection lever to the "  " position.
2. Set the air outlet control dial to the "  " position.
3. Push the air conditioner button on.
4. Set the temperature control dial to the red area.
5. Set the fan speed control lever at the highest speed.

Operating tips for heater and air conditioner

▼ Cleaning ventilator grille

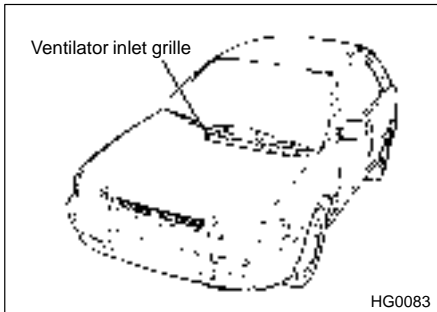

Always keep the front ventilator inlet grille free of snow, leaves, or other obstructions to ensure efficient heating and defrosting. Since the condenser is located in front of the radiator, this area should be kept

– CONTINUED –

clean because cooling performance is impaired by any accumulation of insects and leaves on the condenser.

▼ **Efficient cooling after parking in direct sunlight**

After parking in direct sunlight, drive with the windows open for a few minutes to allow outside air to circulate into the heated interior. This results in quicker cooling by the air conditioner. Keep the windows closed during the operation of the air conditioner for maximum cooling efficiency.

▼ **Lubrication oil circulation in the refrigerant circuit**

Operate the air conditioner compressor at a low engine speed (at idle or low driving speeds) a few minutes each month during the off-season to circulate its oil.

▼ **Checking air conditioning system before summer season**

Check the air conditioner unit for refrigerant leaks, hose conditions, and proper operation each spring. This check is best performed by your SUBARU dealer.

▼ **Cooling and dehumidifying in high humidity and low temperature weather condition**

Under certain weather conditions (high relative humidity, low temperatures, etc.) a small amount of water vapor emission from the air outlets may be noticed during cooling or dehumidifying. This condition is normal and does not indicate any problem with the air conditioning system.

▼ **Air conditioner compressor shut-off when engine is heavily loaded**

To improve acceleration and gas mileage, the air conditioner compressor is designed to temporarily shut off during air conditioner operation whenever the accelerator is fully depressed. Such as during rapid acceleration or when driving on a steep upgrade.

▼ **Refrigerant for your climate control system**

Your air conditioner uses ozone friendly refrigerant HFC134a. Therefore, the method of adding, changing or checking the refrigerant is different from the method for CFC12 (freon). Consult your SUBARU

dealer for service. Repairs needed as a result of using the wrong refrigerant are not covered under warranty.

Air filtration system (if equipped)

If your vehicle's air conditioning system is equipped with a optional air filtration system, replace the filter element according to the replacement schedule shown below. This schedule should be followed to maintain the filter's dust collection ability. Under extremely dusty conditions, the filter should be replaced more frequently. Since the filter element is a viscous type, it is unnecessary to clean or wash the element. It is recommended that you have your filter checked or replaced by your SUBARU dealer. For replacement, use only a genuine SUBARU air filter kit.

Replacement schedule:

Every 12 months or 7,500 miles (12,000 km) whichever comes first

NOTE

The filter can influence the air conditioning, heating and defroster performance.

▼ Replacement procedure

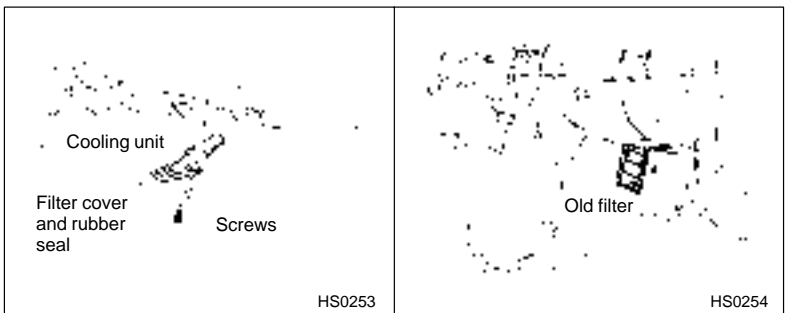

1. Remove the filter cover by removing the two (2) screws.
2. Remove the old filter.

– CONTINUED –

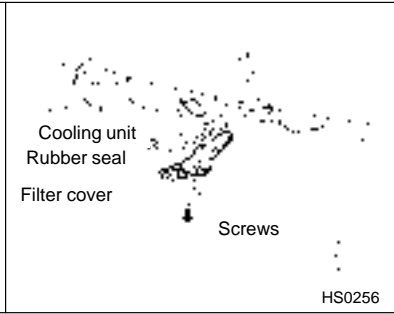
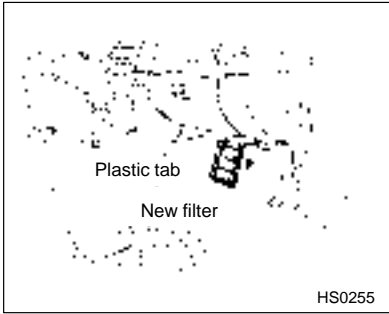

3. Insert a new filter with the plastic tab facing forward.
4. Install rubber seal on the duct opening.



CAUTION

Make certain that the rubber seal is evenly seated on the duct opening.

5. Install the filter cover and secure with two (2) screws.

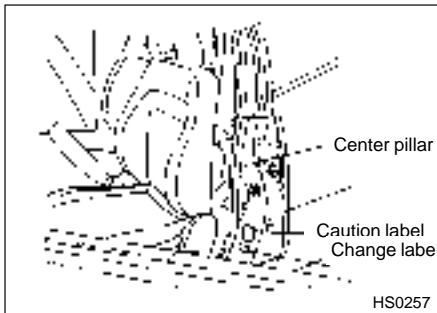

6. Fill out information on the small label supplied with the filter kit.
7. Attach small and large labels on the lower part of the center pillar.

Audio

Radio	5-2
Antenna	5-2
FM reception	5-2
AM/FM stereo radio with cassette player (if equipped)	5-3
Radio operation	5-3
Cassette player operation	5-9
Clock function	5-11
Installation of accessories	5-12

Radio

■ Antenna

Before listening to the radio, extend the antenna to its full length for better reception and reproduction quality.

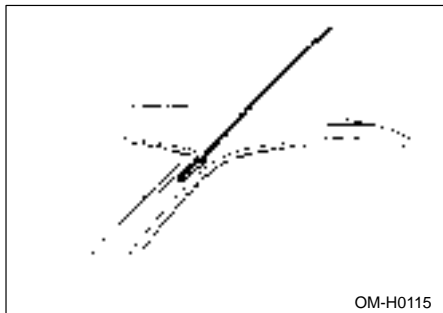

■ FM reception

Although FM is normally static free, reception can be affected by the surrounding area, atmospheric conditions, station strength and transmitter distance. Buildings or other obstructions may cause momentary static, flutter or station interference. If reception continues to be unsatisfactory, switch to a stronger station.

AM/FM stereo radio with cassette player (if equipped)

The radio will operate only when the ignition switch is in the "ACC" or "ON" positions.

Radio operation

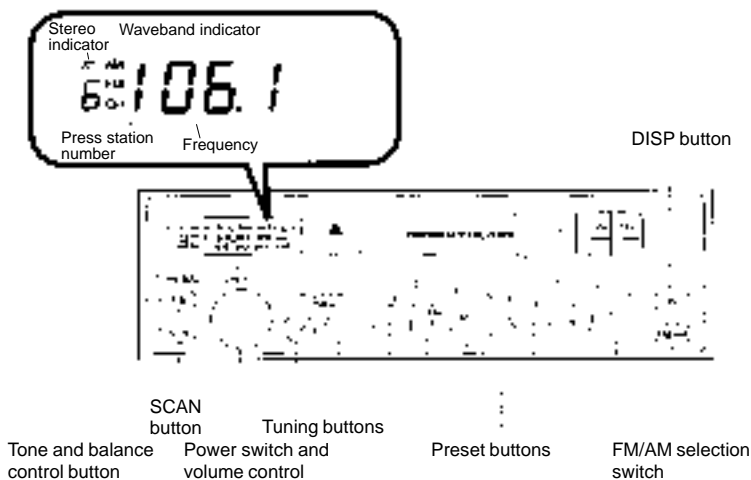

HG0084

■ Power switch and volume control (ON/VOL)

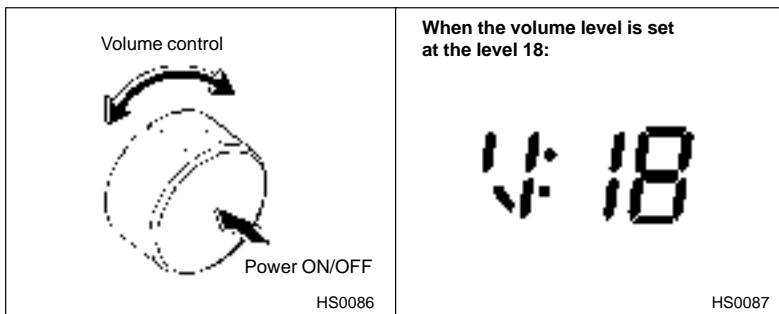

The knob is used for both power (on/off) and volume control. The radio is turned on and off by pushing the knob and the volume is controlled by turning the knob.

The volume control has total of 34 volume levels (V: 0 for minimum, V: 33 for maximum).

■ Tone and balance control (TONE/BAL)

The volume control knob normally function as volume control. This knob becomes a control for Bass, Treble, Fader or Balance when you select the appropriate tone and balance control mode.



The "T/B" (Tone and balance) button is used for selecting the following control modes:

- Bass (low note) control
- Treble (high note) control
- Fader control (Volume balance control between front and rear speakers)
- Balance control (Volume balance control between right and left speakers)

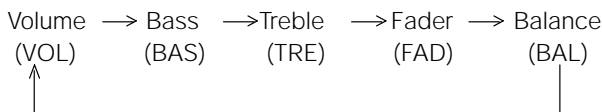
To change control modes: Each brief press of the "T/B" button changes control modes in the following sequence starting from volume control mode. (When the radio is first turned on, the control mode is in the volume control.)



▼ Bass control

<p>Bass volume control indication</p>  <p>HG0085</p>	<p>When the bass volume level is set at the level +6</p>  <p>HG0086</p>
--	---

Select the Bass control mode by pressing the "T/B" button. In the bass control mode, the display shows the indication as shown.

The bass control has total of 13 volume levels (B: -6 for minimum, 0 for middle, B: +6 for maximum). Choose desired bass volume level by turning the volume control knob. The control function returns to volume control mode after about 5 seconds.

▼ Treble control

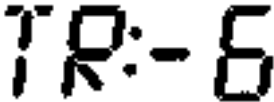
<p>Treble volume control indication</p>  <p>HG0087</p>	<p>When the treble volume level is set at the level -6</p>  <p>HG0088</p>
--	---

Select the Treble control mode by pressing the "T/B" button. In the treble control mode, the display shows the indication as shown.

The treble control has total of 13 volume levels (TR: -6 for minimum, 0 for middle, TR: +6 for maximum). Choose desired treble volume level by turning the volume control knob. The control function returns to volume control mode after about 5 seconds.

▼ Fader control

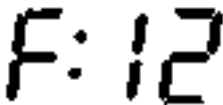
<p>Fader control indication</p>  <p>HG0089</p>	<p>When the fader setting is at the F12 (front maximum and rear minimum)</p>  <p>HG0090</p>
--	---

Select the Fader control mode by pressing the "T/B" button. In the fader control mode, the display shows the indication as shown.

The fader control has total of 25 settings (F: 12 for front maximum and rear minimum, 0 for neutral, R: 12 for front minimum and rear maximum). Choose desired setting by turning the volume control knob. The control function returns to volume control mode after about 5 seconds.

▼ Balance control

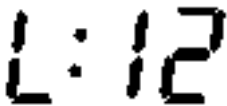
<p>Balance control indication</p>  <p style="text-align: right;">HG0091</p>	<p>When the balance setting is at the L12 (left side maximum and right side minimum)</p>  <p style="text-align: right;">HG0092</p>
---	--

Select the Balance control mode by pressing the "T/B" button. In the balance control mode, the display shows the indication as shown.

The balance control has total of 25 settings (L: 12 for left side maximum and right side minimum, 0 for neutral, R: 12 for left side minimum and right side maximum). Choose desired setting by turning the volume control knob. The control function returns to volume control mode after about 5 seconds.

■ FM/AM selection switch

Use this switch to select either FM or AM reception. The display indicates which one is currently selected.

■ Stereo indicator

The stereo indicator "ST" will come on when an FM stereo broadcast is received.

■ Manual tuning (TUNING)

Press the tuning button marked "∧" to increase the tuning frequency and press the tuning button marked "∨" to decrease it.

Each time the button is pressed, the frequency changes by 10 KHz in the AM mode and by 0.2 MHz in the FM mode.

Constant pressure on the button causes a continuous change in the frequency.

– CONTINUED –

■ Automatic tuning (SCN)

Press the "SCN" button to change the radio to the SCAN mode. In this mode, the radio scans through the radio band until a station is found. The radio will stop at the station for five seconds while displaying the frequency, after which scanning will continue until the entire band has been scanned from the low end to the high end.

Press the "SCN" button again to cancel the SCAN mode and to stop on any displayed frequency.

When the "SCN" button is pressed for automatic tuning, stations are scanned in the direction of low frequencies to high frequencies only. Automatic tuning may not function properly if the station reception is weakened by distance from the station or proximity to tall buildings and hills.

■ Selecting preset stations

Presetting a station with a preset button allows you to select that station in a single operation. Up to six AM and FM stations each may be preset.

■ How to preset stations

1. Press the FM/AM selection switch to select either FM or AM reception.
2. Press the "SCN" button or tune the radio manually until the desired station frequency is displayed.
3. Press one of the preset buttons for **at least two seconds** to store the frequency. The frequency of the station will flash once on the display at this time. If the button is pressed for less than two seconds, the preceding selection will remain in memory.

NOTE

If the connection between the radio and battery is broken for any reason such as vehicle maintenance or radio removal, all stations stored in the preset buttons are cleared. If this occurs, it is necessary to reset the preset buttons.

Cassette player operation

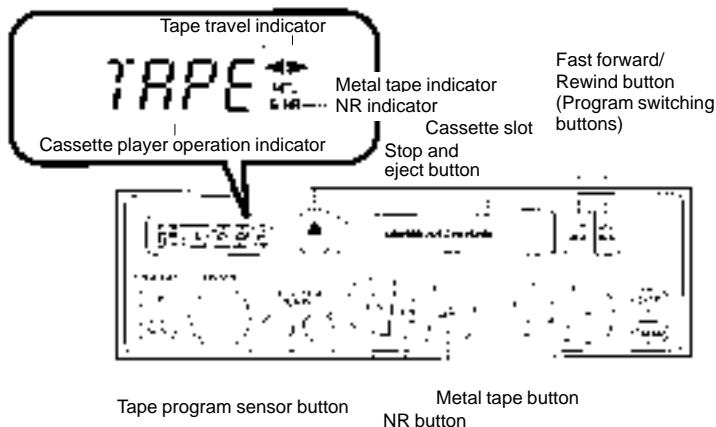

HG0093

NOTE

- Only use good quality cassettes (cassettes longer than C-90 are not recommended).
- Put cassettes back in their boxes immediately after use to protect them from dust and dirt and to prevent the tape from unwinding.
- Never expose cassettes to heat, direct sunlight or moisture.
- Clean the tape head (once or twice a month) using a *wet-type cleaning cassette*.

■ Cassette slot

Insert a cassette with the exposed tape side facing to the right. After insertion, playback starts.

■ Tape travel indicators

These indicate the direction the cassette tape is moving.

- ▶ : indicates that the top side of the cassette is being played back.
- ◀ : indicates that the bottom side of the cassette is being played back.

– CONTINUED –

■ Program switching buttons (PROG)

When the program switching buttons ("◀◀" and "▶▶" buttons) are pressed at the same time during playback, the tape travel indicators will switch and the player will begin playing back the opposite side of the tape. The same mechanism is automatically activated when the end of the tape is reached. This allows the opposite side of the tape to play, providing continuous playback.

■ Fast-forward button

To fast-forward the tape, press the "◀◀" or "▶▶" button in the same direction to the tape travel indicator. To stop fast-forwarding, lightly press the opposite side of the "◀◀" or "▶▶" button.

■ Rewind button

To rewind the tape, press the "◀◀" or "▶▶" button in the opposite direction to the tape travel indicator. To stop rewinding, lightly press the opposite side of the "◀◀" or "▶▶" button.

■ Stop and eject button (▲)

When "▲" button is pressed, play back stops and the cassette tape is ejected.

Before the ignition switch turn to the "OFF" position, eject the tape from the player. Always make certain that you remove the cassette tape.

■ Tape program sensor button (TPS)

Press "TPS" button during playback to return to the beginning of the current selection or to skip to the beginning of the next selection. To use this function, press the "TPS" button to turn on the "TPS" indicator. If the fast-forward button (FF) is then pressed, the player advances the tape to the beginning of the next selection and starts playing it. If the rewind button (REW) is pressed instead, the player rewinds the tape to the beginning of the current selection and starts replaying it. The "TPS" function may not operate properly under the following conditions:

- When the recording level is low.
- When there are long pauses in the middle of a selection.

- When the tape contains verbal material such as conversations.
- When the blanks between selections are shorter than five seconds.
- When there are no blanks between selections (live concerts, etc.).

■ Dolby NR button (BNR)

Press "BNR" button when playing tapes recorded using the Dolby NR system*. The "BNR" indicator will light up and high-frequency noise on the tape will be reduced for clearer sound reproduction.

* Noise reduction system manufactured under license from Dolby Laboratories Licensing Corporation. "Dolby" and the double-D Symbol are trade marks of Dolby Laboratories Licensing Corporation.

■ Metal tape button (MTL)

Press the "MTL" button when playing a metal or CrO₂ tape.

■ Clock function

The radio has a built-in clock function that displays the time when the ignition switch is turned either to "ACC" or "ON".



Tuning buttons

HG0094

■ Display mode

You can select either the time display mode or function display mode by pressing the "DISP/CLK" button when the ignition switch is either "ACC"

– CONTINUED –

or "ON" position.

▼ Time display mode

When the time display mode is selected, the time display takes priority of the function display. The time is shown on the display whenever the ignition switch is "ACC" or "ON" position.

When the radio is turned on or the station is changed during the time display mode, the time display is replaced by the frequency display. However, after the frequency has been displayed for five seconds, it is replaced by the time display again.

▼ Function display mode

When the function display mode is selected, the time is not shown on the display. The display indicates the current function only.

When the radio is turned off during the function display mode, the back-up light on the display goes out.

■ Setting the time

1. Turn the ignition switch to "ACC" or "ON".
2. **To adjust hour:** Press the "DISP" button and the "TUNING" button indicated with "v" together to advance the hours in one-hour increments. Keeping the buttons pressed advances the hours quickly.
3. **To adjust minute:** Press the "DISP" button and the "TUNING" button indicated with "^" together to advance the minutes in one-minute increments. Keeping the buttons pressed advances the minutes quickly.

NOTE

If the connection between the radio and battery is broken for any reason such as vehicle maintenance or radio removal, the time setting will be cleared. If this occurs, it is necessary to reset the time.

Installation of accessories

Always consult your SUBARU dealer before installing a citizen band radio or other transmitting device in your vehicle. Such devices may cause the electronic control system to malfunction if they are incorrectly installed or if they are not suited for the vehicle.

Interior equipment

Sun visors	6-2
Vanity mirror (if equipped)	6-2
Storage compartment	6-2
Glove compartment	6-3
Center console	6-3
Dashboard storage compartment	6-5
Coin tray	6-5
Cup holder	6-6
Accessory power socket	6-7
Cigarette lighter (if equipped)	6-9
Ashtray	6-10
Coat hook	6-12
Interior light	6-12
Dome/Rear map reading light (if equipped)	6-13
Spotlight (if equipped)	6-15
Gauge pack (if equipped)	6-16
Luggage cover (Wagon only)	6-25
Shopping bag hook (Wagon only)	6-27
Cargo anchorage eyelets (if equipped)	6-27
Maintenance tools	6-28

Sun visors

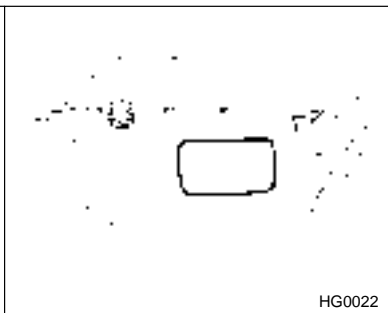
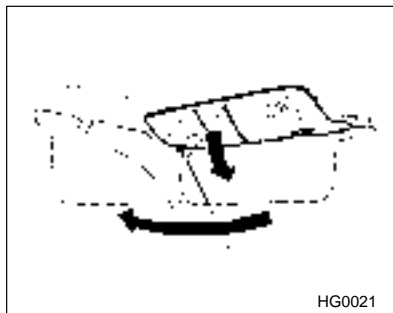

To block out glare, swing down the visors. To use the sun visor at a side window, swing it down and move it sideways.

■ Vanity mirror (if equipped)

To use the vanity mirror, swing down the passenger side visor.

Storage compartment



CAUTION

- Always keep the storage compartment closed while driving to reduce the risk of injury in the event of sudden stops or an accident.
- Do not store spray cans, containers with flammable or corrosive liquids or any other dangerous items in the storage compartment.

■ Glove compartment

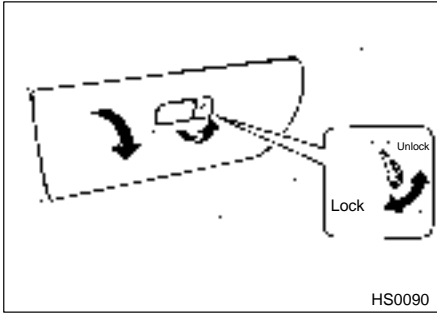

To open the glove compartment, pull the handle. To close it, push the lid firmly upward.

To lock the glove compartment, insert the master key and turn it clockwise. To unlock it, insert the masterkey and turn it counterclockwise.

■ Center console

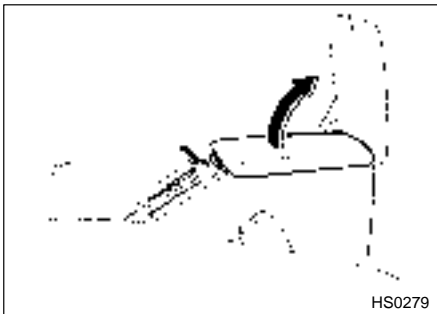

To open the lid, pull up the lock release.

▼ Lid tray

 **WARNING**

Objects must not be placed on the lid tray while the vehicle is moving. In the event of sudden braking, sudden steering, or a collision, objects on the lid tray could be thrown toward the vehicle's occupants and could cause injuries.

 **CAUTION**

If drinks are placed on the tray, take care to prevent them from spilling. Spilled liquids, if hot, could burn passengers and liquids of any kind could damage the vehicle's interior trim and/or electrical equipment.

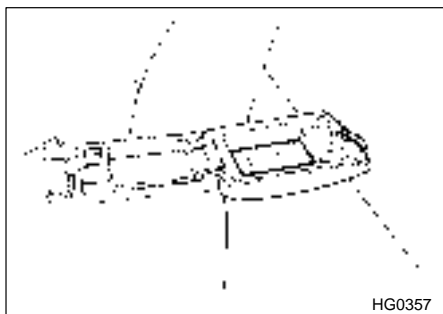

When the lid of the center console is fully opened, it can be used as a tray on which small objects can be placed.

■ Dashboard storage compartment

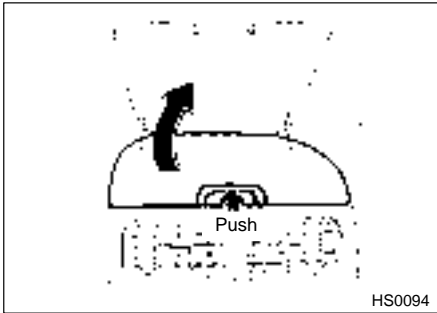

To open the dashboard compartment, push the button and pull up on the lid. Be sure to close the compartment fully before driving.

■ Coin tray

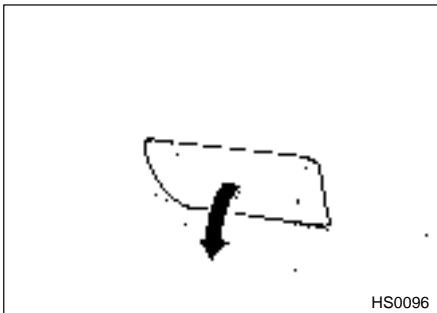

To open the coin tray, pull the upper edge of the lid.

Cup holder

CAUTION

- When not in use, always keep the holder stored while driving to reduce the risk of injury in the event of a sudden stop or an accident.
- Do not pick up a cup from the cup holder or put a cup in the holder while you are driving, as this may distract you and lead to an accident.
- Take care to avoid spills. Beverages, if hot, might burn you or your passengers. Spilled beverages may also damage upholstery, carpets or audio equipment.

▼ Driver's cup holder

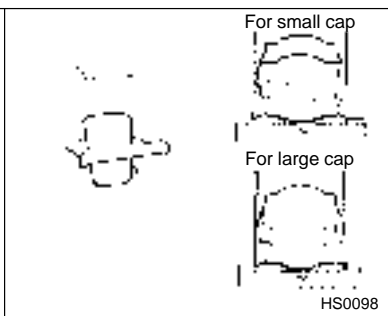
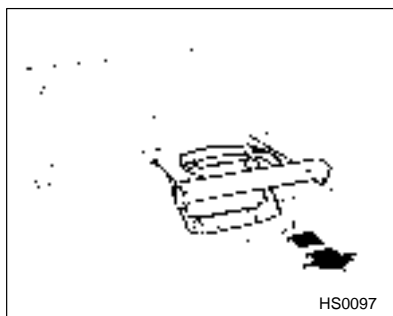

To use the cup holder, pull it out to the first click stop. If you want to use a larger cup, pull it out farther until it stops.

▼ Front passenger's cup holder

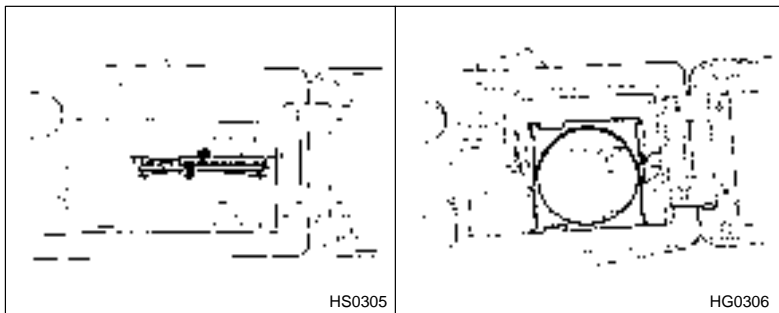

The front passenger's cup holder is built in the center console. To use the cup holder, open the lid of the console and open the holder. When not in use, fold the holder and close the lid.

Accessory power socket

▼ Electrical power socket located on the lower part of the instrument panel



CAUTION

The electrical power socket located on the lower part of the instrument panel is designed to use only a SUBARU genuine cigarette lighter plug. Do not use non-genuine cigarette lighter plugs or any "plug-in" type electrical accessories in the socket. Doing so may cause a short-circuit and overheating, resulting in a fire. Refer to the "Cigarette lighter" section in this chapter.

▼ Accessory power socket in the luggage compartment (if equipped)



CAUTION

- Do not attempt to use a cigarette lighter in the accessory power socket.

– CONTINUED –

- Do not place any foreign objects, especially metal ones such as coins or aluminum foil, into the accessory power socket. That could cause a short circuit. Always put the cap on the accessory power socket when it is not in use.
- Use only electrical appliances which are designed for 12V DC and which consume less than 120W. Overloading the accessory power socket can cause a short circuit. Do not use double adapters or more than one electrical appliance.
- If the plug on your electric appliance is either too loose or too tight for the accessory power socket, this can result in a poor contact or cause the plug to get stuck. Only use plugs that fit properly in the accessory power socket.
- Use of an electric appliance in the accessory power socket for a long period of time while the engine is not running can cause battery discharge.

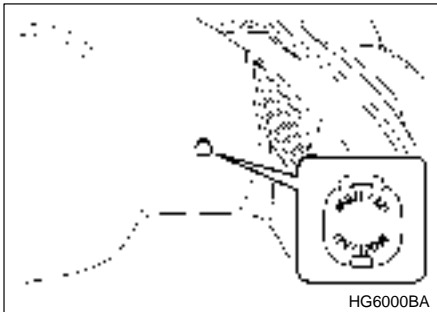

The accessory power socket is located on the right side of the luggage compartment.

Electrical power (12V DC) from the battery is on tap at the socket when the ignition switch is either in the "ACC" or "ON" position.

You can use an in-car use electrical appliance by connecting it to the socket.

Cigarette lighter (if equipped)



CAUTION

The electrical power socket located on the lower part of the instrument panel is designed to use only a SUBARU genuine cigarette lighter plug. Do not use non-genuine cigarette lighter plugs or any “plug-in” type electrical accessories in the socket. Doing so may cause a short-circuit and overheating, resulting in a fire.

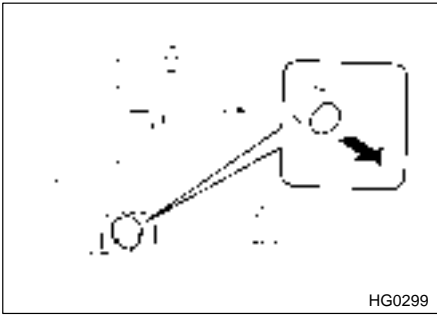

The electrical power socket located on the lower part of the instrument panel can only be used as cigarette lighter socket. A cigarette lighter plug is an optional accessory. It is available from your SUBARU dealer. If smoking is not desired, always put the cap on the socket to prevent any foreign object from entering it.

▼ Cigarette lighter (if equipped)



WARNING

To avoid being burned, never grasp the lighter by the end with the heating element. Doing so could result in injury and could also damage the heating element.



CAUTION

Do not hold the lighter pushed in, because it will overheat.

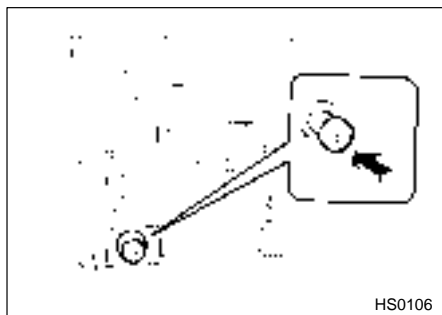

The cigarette lighter operates only when the ignition switch is in the "ON" and "ACC" positions.

To use the cigarette lighter, push in the knob and wait a few moments. It will automatically spring up when ready for use.

Ashtray



CAUTION

Do not use ashtrays as waste receptacles or leave a lighted cigarette in an ashtray. This could cause a fire.

▼ Front ashtray

Fully close the ashtray after using it to help reduce residual smoke.

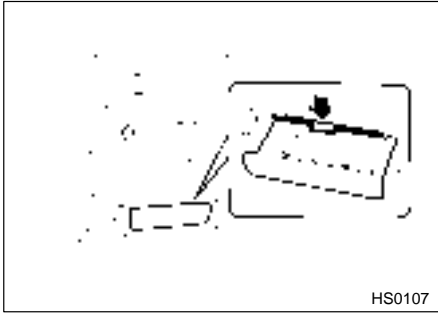

To open the ashtray, pull the lid out.

To remove the ashtray for cleaning, open it and pull it out while pushing the inner plate down.

▼ Rear ashtray

The ashtray is located at the back of the center console for use by rear seat passengers.

To open the ashtray, pull the upper edge of the lid. Fully close the ashtray after using it to help reduce residual smoke.

To remove the ashtray for cleaning, open it and pull it out while pushing the inner plate down.

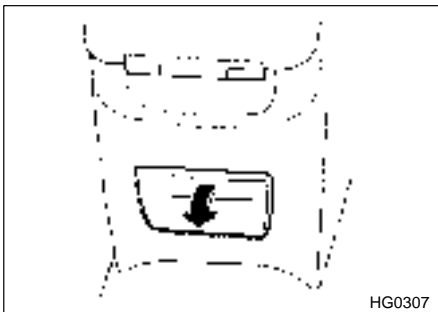

Coat hook

CAUTION

Never hang anything on the coat hook that might obstruct the driver's view or that could cause injury in sudden stops or in a collision. And do not hang items on the coat hook that weigh 2.2 lb (1 kg) or more.

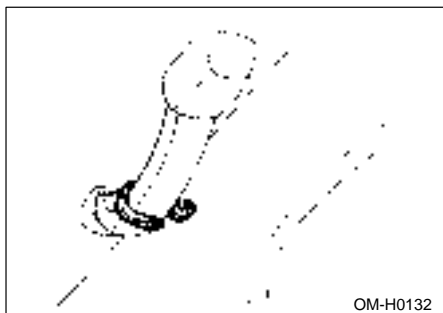

Interior light

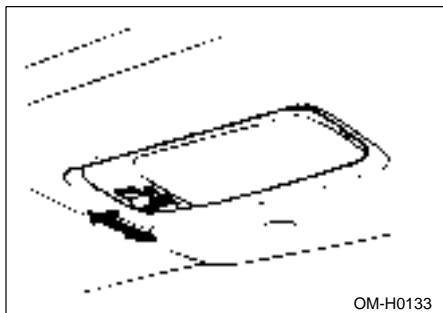

The interior light switch has three positions:
ON: The light stays on continuously.

Middle position: The light comes on only when any door is opened.

OFF: The light stays off.

When leaving your vehicle, make sure the light is turned off to avoid battery discharge.

Dome/Rear map reading light (if equipped)



CAUTION

- Do not use excessive force or sharp objects to activate the switches.
- Do not spray cleaner directly on the dome light lens or the switches.
- Remove the lens and use a damp cloth to clean the switch surfaces.

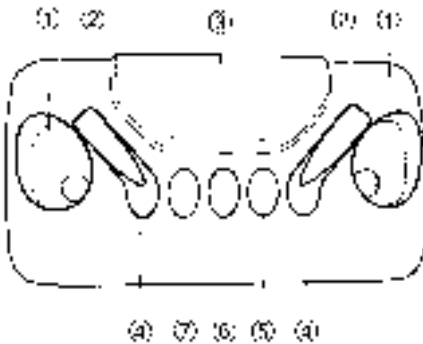

HB6012BB

- | | |
|---------------------------|---------------|
| ① Map light | ⑤ OFF switch |
| ② MAP light dimmer switch | ⑥ DOOR switch |
| ③ Main dome light | ⑦ ON switch |
| ④ MAP light ON/OFF switch | |

– CONTINUED –

▼ Dome light

ON mode: Pressing the "ON" switch ⑦ will turn on main dome light.

DOOR mode: Pressing the "DOOR" switch ⑥ will allow all three lights to fully illuminate when door is opened and then fade out once door is closed.

OFF mode: Pressing the "OFF" switch ⑤ will prevent all lights from illuminating when the door is opened.

▼ Rear map reading light

▽ Turn ON or OFF

Press the "MAP ON/OFF" switch ④ once to turn on the map light at full intensity. Press a second time to turn it off.

▽ Map light dimming

This area ② will vary the intensity of the map light depending on which dimming zone area is pressed.

NOTE

- **The switch color will change to indicate position setting. *Green* indicates current switch while the other switches will be *Red*. (Map light switches will be *Yellow* regardless of setting).**
- **Switch indicator lights will shut off when not in use, but will come back on when any switches are touched.**
- **The light assembly is equipped with a time delayed-off feature. The lights will remain on for a few seconds after all vehicle doors are closed.**
- **If a map light is in use and the door is opened, the map light will maintain its current setting even after the door is closed.**
- **The light assembly is equipped with a 1 hour *sleep mode* timer that will turn off any light that may be accidentally left on. Touching any switch will *reactivate the unit* and allow for continued operation.**

Spotlight (if equipped)

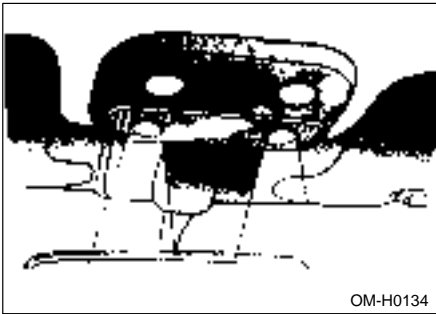

To turn on the spotlight, push the switch. To turn it off, push the switch again.

When leaving the vehicle, make sure the light is turned off to avoid battery discharge.

Gauge pack (if equipped)



CAUTION

Never attempt to adjust any instrument settings while driving. Doing so may lead to an accident.

The gauge pack displays following information.

- Compass direction
- Barometric pressure
- Altitude
- Outside temperature

▼ Display

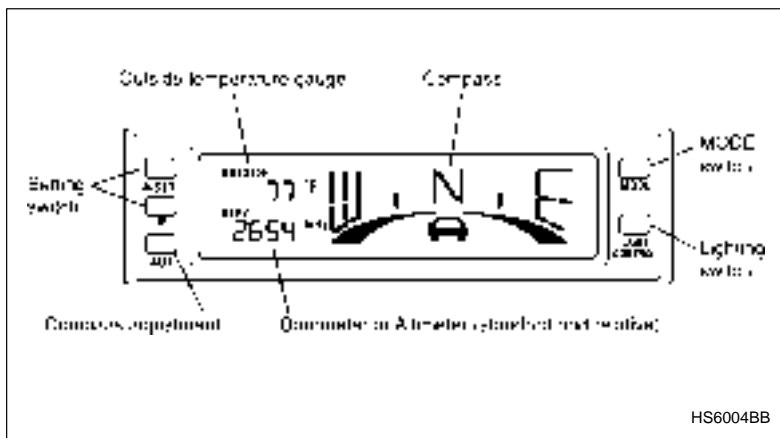

- The display operates when the ignition switch is in the "ACC" or "ON" position.
- The display brightness can be adjusted by pressing the "LIGHT CONTROL" button repeatedly to change from dim to bright to off.

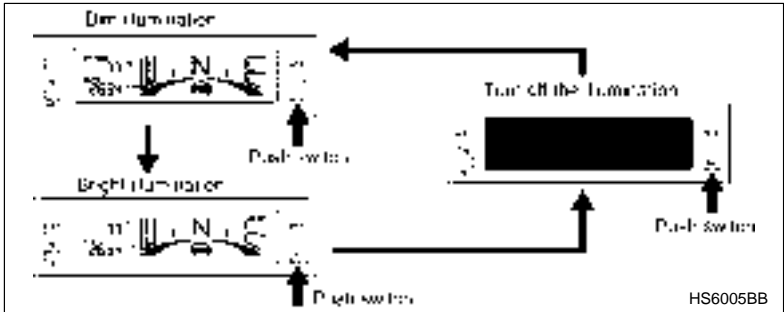

▼ Measurement unit selection (Default setting is English units)

The following procedure is required to select measurement units other than English.

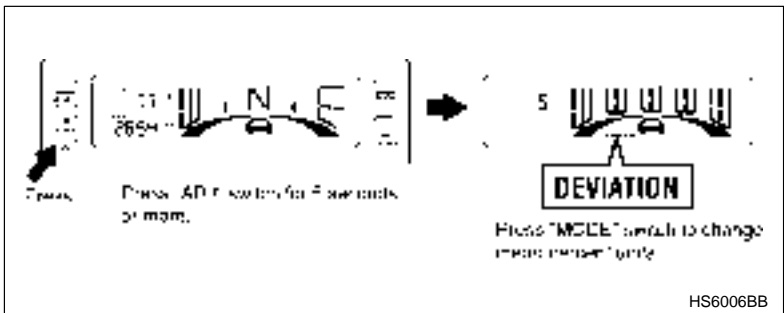

1. Turn on the ignition switch to the "ACC" position and the display shows the default English measurement units.
2. Depress the "ADJ" switch for 5 seconds or more and the display will show "DEVIATION" together with the "5" and "W".

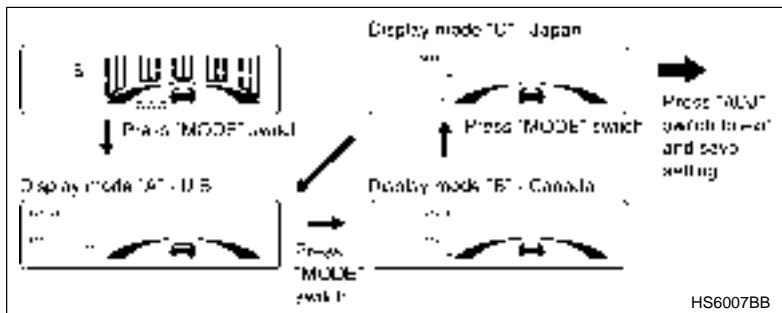

3. Change the measurement units by pressing the "MODE" switch until the proper mode appears.
4. Press the "ADJ" switch to save your selection.

NOTE

- If the setting is not completed in 30 seconds, the display will return to the initial mode.
- When the battery is disconnected, you may have to perform this operation again to reset to the desired units.

▼ Compass

The compass displays eight (8) directions.

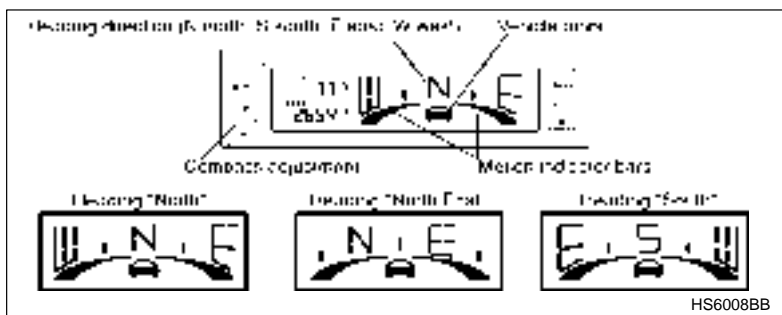

NOTE

The compass may be affected by interference in the magnetic field. (For example natural and artificial causes like tunnels, subways, sub-stations, railways, and so forth may affect compass operation.)

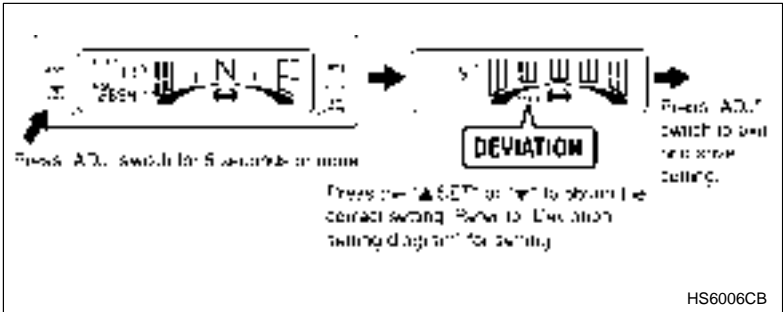
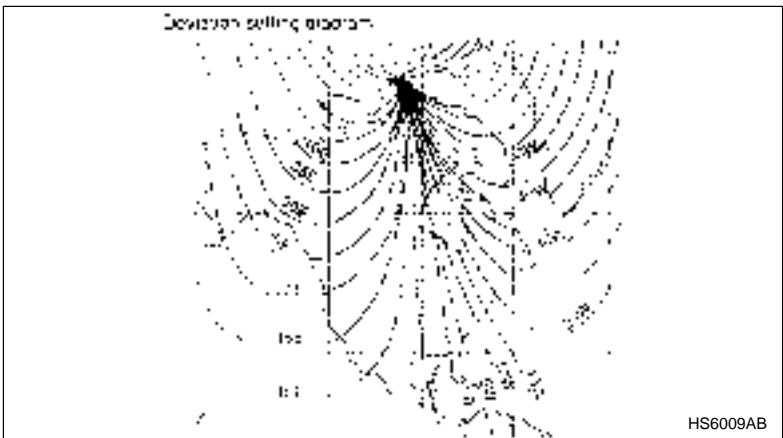
▽ **Compass setting****1. Deviation setting**

Depending on your location, the following adjustment is required due to the difference between magnetic and geographic North. Refer to

– CONTINUED –

the map shown above for the setting most appropriate for your location.

- 1) Press the "ADJ" switch for 5 seconds or more.
- 2) Press the "▲SET" or "▼" to obtain the correct setting.
"▲SET": "0" & "W", "5" & "E", "10" & "E", ...
"▼": "10" & "W" → "15" & "W", ...
- 3) Press the "ADJ" switch again to save the setting and return the system to the original display.

2. Direction setting

If the vehicle icon is blinking at any time, the following adjustment is required to recalibrate the compass.

NOTE

This will happen due to the magnetic field interference as described previously.

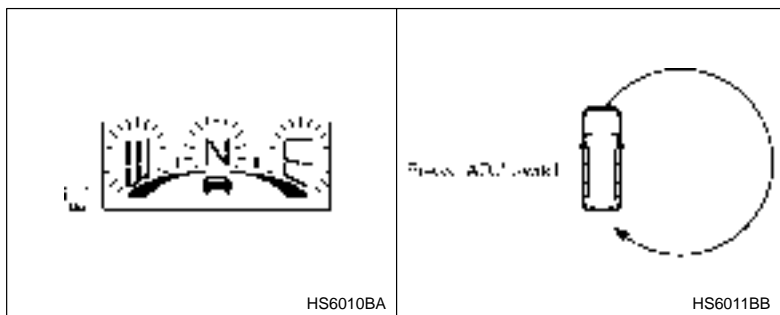

- 1) Press the "ADJ" switch for the compass setting mode.

NOTE

- **The compass starts blinking in this mode.**
- **This mode can be canceled by pressing the "ADJ" switch again.**

- 2) Make certain that it is safe to do so and then drive the vehicle in a circle until the compass stops blinking. You may have to complete more than one circle to perform this calibration.

NOTE

- When setting is completed, all blinking disappears.
- The setting mode is automatically cancelled if the “ADJ” switch is pressed in the middle of setting or if the setting is not completed within 2 minutes.

The motion indicator bars move in two patterns according to the vehicle speed.

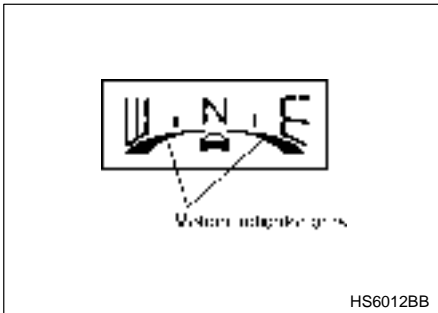

1. 1.8 mile/h (2.8 km/h) of vehicle speed ... 1 second interval bar motion.
2. 12.5 mile/h (20 km/h) or more of vehicle speed ... 0.5 second interval bar motion.

NOTE

- When the vehicle stops, the motion indicator bars will return to their original position.
- When the vehicle is driven in reverse, the motion bars move in the same pattern as when driving forward.

▼ Barometer

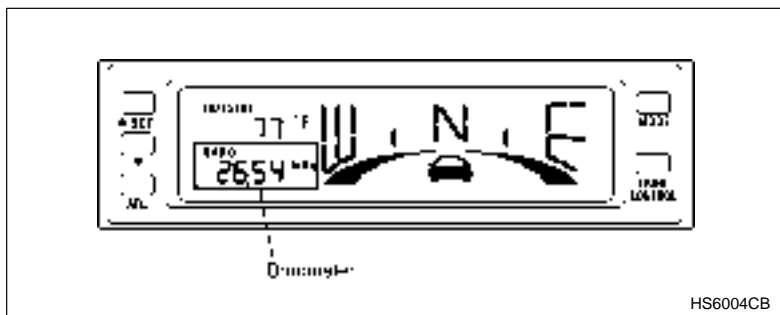

The display indicates atmospheric pressure in the passenger compartment.

Range: 21.26 to 30.86 inHg or 720 to 1045 hpa

NOTE

- The reading may change during air-conditioner operation, door window operation, driving in a tunnel, and so forth.
- All barometric readings reported in local weather reports are corrected to a sea-level reading regardless of altitude. The Gauge Pack displays true local air pressure and hence may differ significantly from local weather reports (especially at higher altitudes). The barometer is not adjustable.
- Since air pressure changes with altitude, the barometric reading will vary when the vehicle is moving up or down an incline. For accurate barometric trending, the vehicle should be stationary.

▼ Altimeter

The altimeter has two modes, Standard elevation mode and Relative elevation mode.

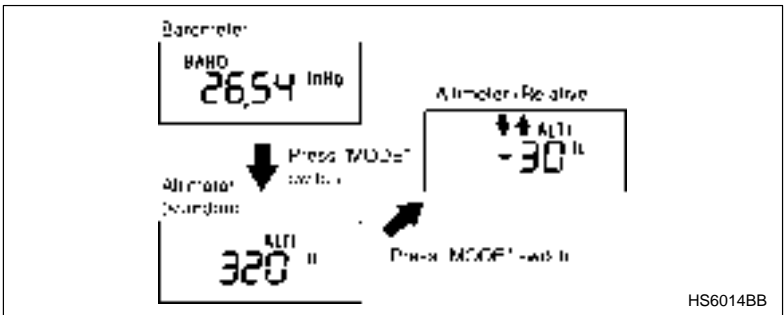
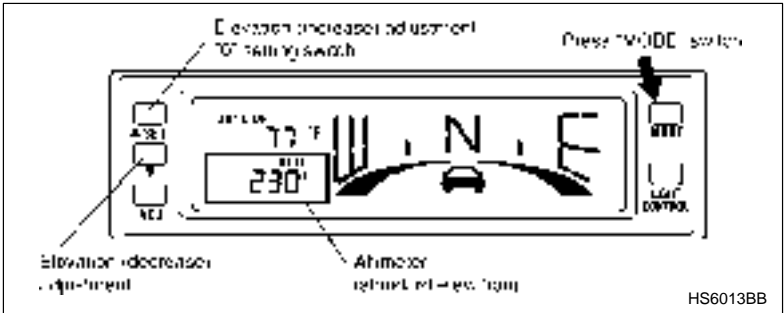

▽ Standard elevation mode

The "MODE" switch changes the barometer to the standard elevation mode of the altimeter.

The altimeter indicates the "sea level" elevation.

Range: -660 to 9200 ft (-200 to 2800 m) at a pitch of 20 ft or 10 m in metric measurement units.

Adjustment: In order to get a precise elevation, manually correct the altimeter when the current elevation is known.

“▲SET”: 20 ft increase or 10 m increase in metric measurement units.

“▼”: 20 ft decrease or 10 m decrease in metric measurement units.

NOTE

- The indication may change during air-conditioner operation, door window operation, driving in a tunnel, and so forth.
- Adjustable elevation is ± 780 ft (± 300 m).
- To cancel the adjustment and return to the default altimeter reading, press the “▲SET” and “▼” switch together for 1 second or more.

▽ Relative elevation mode

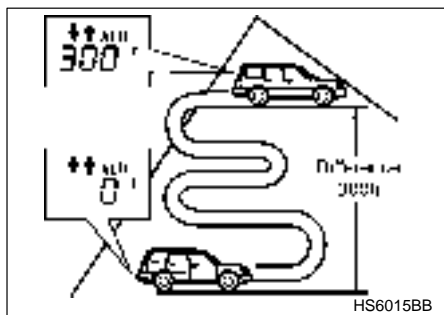

The altimeter indicates the relative elevation.

1. The “MODE” switch changes the standard elevation mode to the relative elevation mode.
2. Press the “▲SET” switch for the “0” ft (“0 m”) setting.
3. The display shows the current elevation relative to the starting elevation.

Range: up to 9800 ft (3000 m) at a pitch of 20 ft (5 m)

▼ Outside temperature gauge

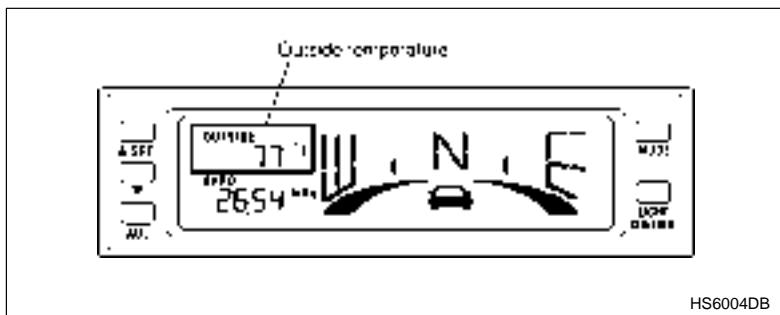

The indication shows the outside temperature.

NOTE

Indication range: -40°F to 140°F (-40°C to 60°C)

If the temperature is beyond the range, the maximum number is shown.

Luggage cover (Wagon only)



WARNING

Do not place anything on the extended cover. Putting excessive weight on the extended cover can break it and an object on the cover could tumble forward in the event of a sudden stop or collision. This could cause serious injury.



CAUTION

Be careful not to scratch the rear gate stay when using the luggage cover.
The scratch on the stay could cause the rear gate to incomplete opening.

The luggage cover is provided for covering the cargo area and to pro-

– CONTINUED –

protect its contents from direct sunlight. This cover is detachable to make room for additional cargo.

▼ **Using the cover**

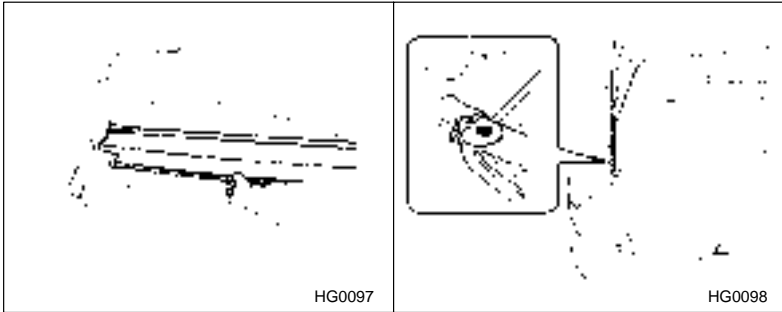

To extend the cover, pull the end of the cover out of the cover housing, then insert its hooks into the catches as shown. To rewind it, unhook it from the catches and it will rewind automatically. You should hold on to the cover and guide it back into the cover housing while it is rewinding.

▼ **To remove the cover housing**

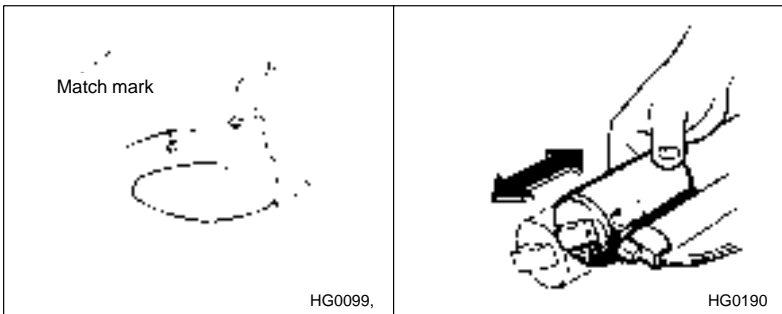

1. Rewind the cover.
2. Pull either sleeve on the end of the cover housing to shorten its length.

3. Take it off the retainer.
4. Store the cover housing in the cargo area.

▼ **To install the cover housing**

1. Pull either sleeve on the end of the cover housing to shorten the cover's length.
2. Insert the projections located on the both ends of the sleeve into the recesses of the retainers.

Shopping bag hook (Wagon only)

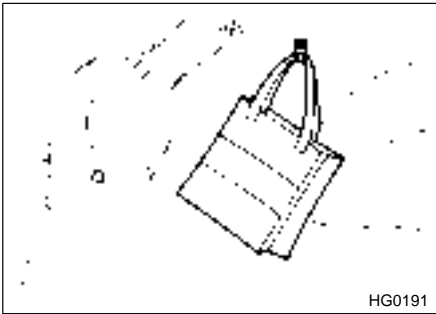

The shopping bag hook is attached to the left side of the cargo area. You can hook a light shopping bag or something similar on it.

Cargo anchorage eyelets (if equipped)



CAUTION

The cargo anchorage eyelets are designed only for securing light cargo. Never try to secure the cargo which weights more than the load capacity of the anchorage eyelets. The maximum load capacity is about 44 lbs (20 kg) per eyelet.

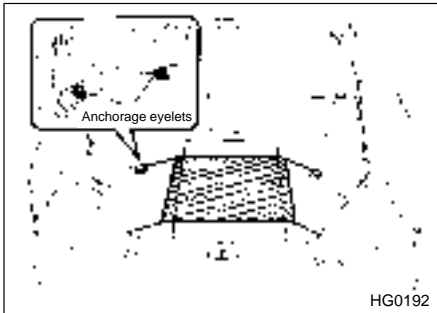

The cargo area is equipped with four anchorage eyelets so that cargo can be secured with a luggage net or ropes.

When using the anchorage eyelets, raise them up from under the cutouts of the luggage compartment mat. When not in use, put the eyelets down into the storing recesses.

Maintenance tools

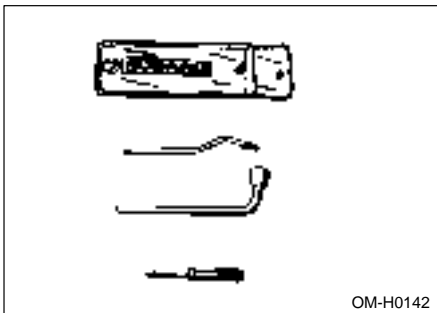

Your vehicle is equipped with the following maintenance tools:

- Screwdriver

- Wheel nut wrench

- Wheel cover remover (for vehicles equipped with wheel covers)

Starting and operating

New vehicle break-in driving – the first 1,000 miles (1,600 km)	7-3
Fuel requirements	7-4
State emission testing (U.S. only)	7-6
Engine exhaust gas (Carbon monoxide)	7-7
Catalytic converter	7-8
Fuel economy hints	7-9
Preparing to drive	7-10
Driving in foreign countries	7-10
Periodic inspections	7-10
Ignition switch	7-11
Key reminder chime	7-13
Key interlock release (AT vehicles only)	7-13
Starting the engine	7-14
Stopping the engine	7-16
Manual transmission	7-16
Automatic transmission	7-19
Selector lever	7-20
Shift lock release	7-24
Rear viscous limited slip differential (For RS models)	7-26
Steering	7-26
Tilt steering wheel	7-26
Power steering	7-27
Cruise control (if equipped)	7-28
Parking your vehicle	7-30
Braking	7-32
Braking tips	7-32
Brake system	7-33
Disc brake pad wear warning indicators	7-34
ABS (Anti-Lock Brake System) (if equipped)	7-34
Driving tips for AWD vehicles	7-37
Off road driving	7-38
Winter driving	7-41
Snow tires	7-45
Tire chains	7-45
Rocking the vehicle	7-46

<i>Corrosion protection</i>	7-46
Loading your vehicle	7-47
<i>Vehicle capacity weight</i>	7-48
<i>GVWR and GAWR (Gross Vehicle Weight Rating and Gross Axle Weight Rating)</i>	7-48
Trailer towing	7-49
<i>Trailer hitches</i>	7-51

New vehicle break-in driving – the first 1,000 miles (1,600 km)

The performance and long life of your vehicle are dependent on how you handle and care for your vehicle while it is new. Follow these instructions during the first 1,000 miles (1,600 km):

- Do not race the engine.

▼ Break-in engine speed limit

- Vehicle with tachometer

Never exceed 4,000 rpm engine speed except for brief acceleration in an emergency.

- Vehicle without tachometer (for manual transmission)

Do not exceed the speed limits below for each gear position except for brief acceleration in an emergency.

mph (km/h)			
1st	2nd	3rd	4th
20 (30)	30 (50)	50 (80)	65 (105)

- Vehicles without tachometer (for automatic transmission)

Try to drive at moderate speeds while accelerating and braking smoothly. Proper gears are selected automatically according to the driving conditions.

- Do not drive at one constant engine or vehicle speed for a long time, either fast or slow.
- Avoid starting suddenly and rapid acceleration, except in an emergency.
- Avoid hard braking, except in an emergency.

The same break-in procedures should be applied to a newly-installed or overhauled engine or when brake pads or brake linings are replaced with new ones.

Fuel requirements

▼ Fuel octane rating

Your engine is designed to use only unleaded gasoline with an octane rating of 87 AKI or higher. This octane rating is the average of the Research Octane and Motor Octane numbers and is commonly referred to as the Anti Knock Index (AKI).

Using a gasoline with a lower octane rating can cause persistent and heavy knocking, which can damage the engine. Do not be concerned if your vehicle sometimes knocks lightly when you drive up a hill or when you accelerate. See your dealer or a qualified service technician if you use a gasoline with the specified octane rating and your vehicle knocks heavily or persistently.

▼ Unleaded gasoline

The neck of the fuel filler pipe is designed to accept only an unleaded gasoline filler nozzle. Under no circumstances should leaded gasoline be used because it will damage the emission control system and may impair driveability and fuel economy.

▼ Gasoline for California-certified LEV

If your vehicle is a California-certified Low Emission Vehicle (LEV) as indicated on the underhood tune-up label, it is designed to optimize engine and emission control system performance with gasoline that meets California low sulfur specifications. Your vehicle will operate on gasoline meeting Federal specifications.

▼ Gasoline for cleaner air



CAUTION

Do not let fuel spill on the exterior surfaces of the vehicle. Fuels containing alcohol may cause paint damage, which is not covered under the SUBARU Limited Warranty.

Your use of gasoline with detergent additives will help prevent deposits from forming in your engine and fuel system. This helps keep your engine in tune and your emission control system working properly.

and is a way of doing your part for cleaner air. If you continuously use a high quality fuel with the proper detergent and other additives, you should never need to add any fuel system cleaning agents to your fuel tank.

Many gasolines are now blended with materials called oxygenates. Use of these fuels can also help keep the air cleaner. SUBARU approves the use of oxygenated blend fuels, such as MTBE (Methyl Tertiary Butyl Ether) or ethanol (ethyl or grain alcohol). The blended fuels should contain no more than 15% MTBE or 10% ethanol for the proper operation of your SUBARU.

In addition, some gasoline suppliers are now producing reformulated gasolines, which are designed to reduce vehicle emissions. SUBARU approves the use of reformulated gasoline.

If you are not sure what the fuel contains, you should ask your service station operators if their gasolines contain detergents and oxygenates and if they have been reformulated to reduce vehicle emissions.

As additional guidance, only use fuels suited for your vehicle as explained below.

- Fuel should be unleaded and have an octane rating no lower than that specified in this manual.
- Methanol (methyl or wood alcohol) is sometimes mixed with unleaded gasoline. Methanol can be used in your vehicle **ONLY** if it does not exceed 5% of the fuel mixture **AND** if it is accompanied by sufficient quantities of the proper cosolvents and corrosion inhibitors required to prevent damage to the fuel system. Do not use fuel containing methanol **EXCEPT** under these conditions.
- If undesirable driveability problems are experienced and you suspect they may be fuel related, try a different brand of gasoline before seeking service at your SUBARU dealer.
- Fuel system damage or driveability problems which result from the use of improper fuel are not covered under the SUBARU Limited Warranty.

State emission testing (U.S. only)

WARNING

Testing of an All Wheel drive vehicle must **NEVER** be performed on a single two-wheel dynamometer. Attempting to do so will result in uncontrolled vehicle movement and may cause an accident or injuries to persons nearby.

CAUTION

Resultant vehicle damage due to improper testing is not covered under the SUBARU Limited Warranty and is the responsibility of the state inspection program or its contractors or licensees.

At state inspection time, remember to tell your inspection or service station in advance not to place your SUBARU AWD vehicle on a two-wheel dynamometer. Otherwise, serious transmission damage will result.

Some states have started using dynamometers in their state inspection programs in order to meet their obligation under federal law to implement stricter vehicle emission standards to reduce air pollution from cars. A dynamometer is a treadmill or roller-like testing device that allows your car's wheels to turn while the car remains in one place. Depending on the severity of a state's air pollution problems, the states must adopt either a "basic" or "enhanced" vehicle emission inspection test. Normally, a portion of the basic emission test consists of an emission inspector inserting an analyzer probe into the exhaust pipe of an idling vehicle for a short period of time. States with more severe air pollution problems are required to adopt an enhanced vehicle emission test. This test simulates actual driving conditions on a dynamometer and permits more accurate measurement of tailpipe emitted pollution than the basic emission test.

The U.S. Environmental Protection Agency (EPA) and states using two-wheel dynamometers in their emission testing programs have

EXEMPTED SUBARU AWD vehicles from the portion of the testing program that involves a two-wheel dynamometer.

There are some states that use four-wheel dynamometers in their testing programs. When properly used, that equipment will not damage an AWD SUBARU vehicle.

Under no circumstances should the rear wheels be jacked off the ground, nor should the driveshaft be disconnected for state emission testing.

Engine exhaust gas (Carbon monoxide)



WARNING

- **Never inhale engine exhaust gas. Engine exhaust gas contains carbon monoxide, a colorless and odorless gas which is dangerous, or even lethal, if inhaled.**
- **Always properly maintain the engine exhaust system to prevent engine exhaust gas from entering the vehicle.**
- **Never run the engine in a closed space, such as a garage, except for the brief time needed to drive the vehicle in or out of it.**
- **Avoid remaining in a parked vehicle for a lengthy time while the engine is running. If that is unavoidable, then use the ventilation fan to force fresh air into the vehicle.**
- **Always keep the front ventilator inlet grille free from snow, leaves or other obstructions to ensure that the ventilation system always works properly.**
- **If at any time you suspect that exhaust fumes are entering the vehicle, have the problem checked and corrected as soon as possible. If you must drive under these conditions, drive only with all windows fully open.**
- **Keep the trunk lid or rear gate closed while driving to prevent exhaust gas from entering the vehicle.**

NOTE

Due to the expansion and contraction of the metals used in the manufacture of the exhaust system, you may hear a crackling sound coming from the exhaust system for a short time after the engine has been shut off. This sound is normal.

Catalytic converter

WARNING

- Avoid fire hazards. Do not drive or park the vehicle anywhere near flammable materials (e.g. grass, paper, rags or leaves), because the catalytic converter operates at very high temperatures.
- Keep everyone and flammable materials away from the exhaust pipe while the engine is running. The exhaust gas is very hot.

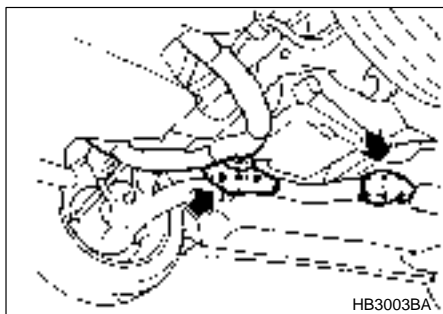

The catalytic converter is installed in the exhaust system. It serves as a catalyst to reduce HC, CO and NO_x in exhaust gases, thus providing cleaner exhaust.

To avoid damage to the catalytic converter:

- Use only unleaded fuel. Even a small amount of leaded fuel will damage the catalytic converter.
- Never start the engine by pushing or pulling the vehicle.

- Avoid racing the engine.
- Never turn off the ignition switch while the vehicle is moving.
- Keep your engine tuned-up. If you feel the engine running rough (mis-firing, backfiring or incomplete combustion), have your vehicle checked and repaired by an authorized SUBARU dealer.
- Do not apply undercoating or rust prevention treatment to the heat shield of catalytic converter and the exhaust system

Fuel economy hints

The following suggestions will help to save your fuel.

- Select the proper gear position for the speed and road conditions.
- Avoid sudden acceleration or deceleration. Always accelerate gently until you reach the desired speed. Then try to maintain that speed for as long as possible.
- Do not pump the accelerator and avoid racing the engine.
- Avoid unnecessary engine idling.
- Keep the engine properly tuned.
- Keep the tires inflated to the correct pressure shown on the tire placard, which is located under the door latch on the driver's side. Low pressure will increase tire wear and fuel consumption.
- Use the air conditioner only when necessary.
- Keep the front and rear wheels in proper alignment.
- Avoid carrying unnecessary luggage or cargo.

Preparing to drive

You should perform the following checks and adjustments every day before you start driving.

1. Check that all windows, mirrors, and lights are clean and unobstructed.
2. Check the appearance and condition of the tires. Also check tires for proper inflation.
3. Look under the vehicle for any sign of leaks.
4. Check that the hood, trunk and rear gate are fully closed.
5. Check the adjustment of the seat.
6. Check the adjustment of the inside and outside mirrors.
7. Fasten your seat belt. Check that your passengers have fastened their seat belts.
8. Check the operation of the warning and indicator lights when the ignition switch is turned to the "ON" position.
9. Check the gauges, indicator and warning lights after starting the engine.

NOTE

Engine oil, engine coolant, brake fluid, washer fluid and other fluid levels should be checked daily, weekly or at fuel stops.

Driving in foreign countries

When planning to use your vehicle in another country:

- Confirm the availability of the correct fuel. (Refer to the "Fuel requirement" section in this chapter.)
- Comply with all regulations and requirements of each country.

Periodic inspections

To keep your vehicle in the best condition at all times, always have the recommended maintenance services listed in the maintenance schedule in the "Warranty and Maintenance Booklet" performed at the specified time or mileage intervals.

Ignition switch



WARNING

Never turn the ignition switch to “LOCK” while the vehicle is being driven or towed because that will lock the steering wheel, preventing steering control. And when the engine is turned off, it takes a much greater effort than usual to steer.

The ignition switch has four positions: LOCK, ACC, ON and START.

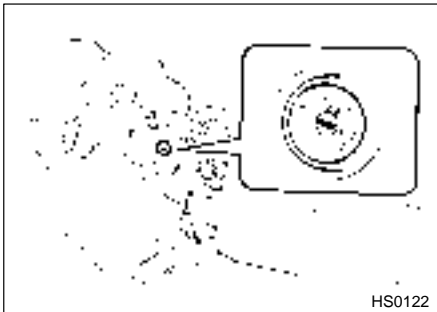

▼ LOCK

The key can only be inserted or removed in this position. The ignition switch will lock the steering wheel when you remove the key.

If turning the key is difficult, turn the steering wheel slightly to the right and left as you turn the key.

▽ Automatic transmission vehicles

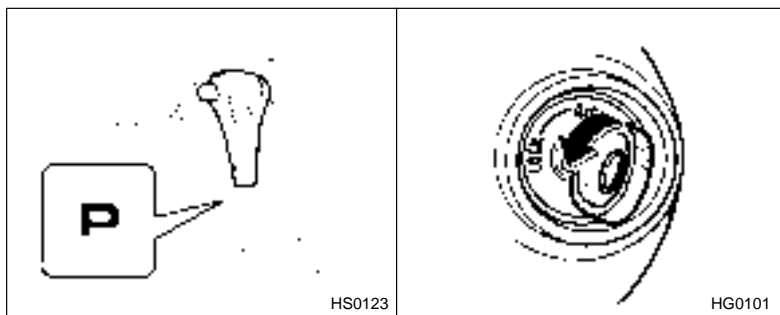

The key can be turned from "ACC" to "LOCK" only when the selector lever is in the "P" position.

▽ Manual transmission vehicles

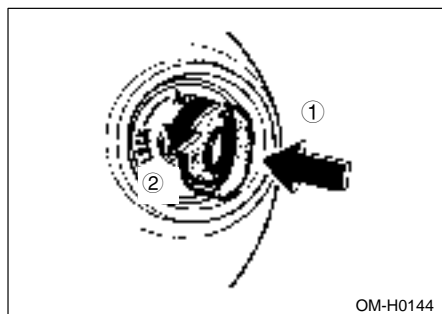

The key can be turned from "ACC" to "LOCK" only when the key is pushed in while turning it.

▼ ACC

In this position the electrical accessories (radio, accessory socket, etc.) can be used.

▼ ON

This is the normal operating position after the engine is started.

▼ START

**CAUTION**

Do not turn the ignition switch to the "START" position while the engine is running.

The engine is started in this position. The starter cranks the engine to start it. When the key is released (after the engine has started), the key automatically returns to the "ON" position.

■ Key reminder chime

The reminder chime sounds when the driver's door opens and the key is in the "LOCK" or "ACC" positions. The chime stops when the key is removed from the ignition switch.

■ Key interlock release (AT vehicles only)

If the key can not be turned to the "LOCK" position even when the selector lever is in the "P" position:

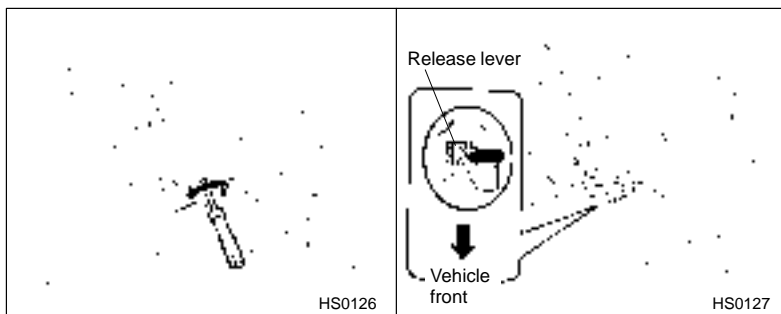

1. Take out the screwdriver from the tool bag.
2. Remove three screws securing the undercover of the steering column.
3. Remove the undercover of the steering column.
4. Turn the ignition key while pressing the key interlock release lever.

Take your vehicle to the nearest SUBARU dealer immediately to have the key interlock system repaired.

Starting the engine

CAUTION

Do not operate the starter motor continuously for more than ten seconds. If the engine fails to start after operating the starter for five to ten seconds, wait for ten seconds or more before trying again.

▼ Manual transmission vehicles

1. Apply the parking brake.
2. Turn off unnecessary lights and accessories.
3. Press the clutch pedal to the floor and shift the shift lever into neutral. Hold the clutch pedal to the floor while starting the engine. The starter motor will only operate when the clutch pedal is pressed fully to the floor.
4. Turn the ignition switch to the "ON" position and check the operation of the warning and indicator lights. Refer to "Warning and indicator lights" section (chapter 3).
5. Turn the ignition switch to the "START" position without depressing the accelerator pedal. Release the key immediately after the engine has started.

If the engine does not start within ten seconds, wait a while and then turn the ignition switch to the "START" position again while depressing the accelerator pedal half way down.

6. Confirm that all warning and indicator lights have gone off after the engine has started. The fuel injection system automatically lowers the idle speed as the engine warms up.

▼ Automatic transmission vehicles

CAUTION

If you restart the engine while the vehicle is moving, shift the selector lever into the "N" position. Do not attempt to place the selector lever of a moving vehicle into the "P" position.

1. Apply the parking brake.
2. Turn off unnecessary lights and accessories.
3. Shift the selector lever to the "P" or "N" position (preferably "P" position).

The starter will only operate when the select lever is at the "P" or "N" position.

4. Turn the ignition switch to the "ON" position and check the operation of the warning and indicator lights. Refer to "Warning and indicator lights" section (chapter 3).
5. Turn the ignition switch to the "START" position **without depressing the accelerator pedal**. Release the key immediately after the engine has started.

If the engine does not start within ten seconds, wait a while and then turn the ignition switch to the "START" position again while depressing the accelerator pedal half way down.

6. Confirm that all warning and indicator lights have gone out after the engine has started. The fuel injection system automatically lowers the idle speed as the engine warms up.

While the engine is warming up, make sure that the selector lever is at the "P" or "N" position and that the parking brake is applied.

▼ **During cold weather below -4°F (-20°C)**

If the engine is difficult to start using the normal method (without depressing the accelerator pedal), turn the ignition switch to the "START" position while slightly depressing the accelerator pedal.

▼ **Flooded engine**

If the engine does not start, it may be flooded (excessive fuel in the engine).

In case of a flooded engine, turn the starter motor for five seconds with the accelerator pedal fully depressed. Repeat this two or three times until the engine starts. Release the ignition switch and accelerator pedal as soon as the engine starts.

Stopping the engine

WARNING

Do not stop the engine when the vehicle is moving. This will cause loss of power to the power steering and the brake booster, making steering and braking more difficult. It could also result in accidental activation of the “LOCK” position on the ignition switch, causing the steering wheel to lock.

The ignition switch should be turned off only when the engine is idling.

Manual transmission

WARNING

Do not drive the vehicle with the clutch disengaged (i.e., when the clutch pedal is depressed) or with the shift lever in the neutral position. Engine braking has no effect in either of these conditions and the risk of an accident is consequently increased.

CAUTION

Shift into reverse **ONLY** when the vehicle has completely stopped. It may cause damage to the transmission to try shifting into reverse when the vehicle is moving.

The manual transmission is a fully synchromeshed 5-forward and 1-reverse speed transmission.



The shift pattern is shown on the shift lever knob. When shifting from 5th gear to reverse gear, first return the shift lever to neutral position then shift into the reverse gear.

To change gears, fully depress the clutch pedal, move the shift lever, and gradually let the pedal up.

If it is difficult to shift into gear, put the transmission in neutral, release the clutch pedal momentarily, and then try again.

▼ Shifting speeds

▽ Recommended shifting speeds

The best compromise between fuel economy and vehicle performance during normal driving is ensured by shifting up at the speeds listed in the following table.

Shift up	mph (km/h)
1st to 2nd	15 (24)
2nd to 3rd	25 (40)
3rd to 4th	40 (65)
4th to 5th	45 (73)

▽ Maximum allowable speeds

WARNING

When shifting down a gear, ensure that the vehicle is not travelling at a speed exceeding the Maximum Allowable Speed for the gear which is about to be selected. Failure to observe this precaution can lead to engine over-revving and this in turn can result in engine damage.

In addition, sudden application of engine brakes when the vehicle is travelling on a slippery surface can lead to wheel locking; as a consequence, control of the vehicle may be lost and the risk of an accident increased.

The following table shows the maximum speeds that are possible with each different gear.

Never exceed the speed limit below for each gear position except for brief acceleration in an emergency. The tachometer's needle (if so equipped) will enter the red area if these speeds are exceeded. Failure to observe this precaution can lead to excessive engine wear and poor fuel economy.

		mph (km/h)	
Vehicle type \ Gear	2.2 liter models		2.5 liter RS models
	except OUTBACK SPORT	OUTBACK SPORT	
1st	29 (46)	29 (47)	28 (45)
2nd	48 (77)	49 (79)	47 (76)
3rd	70 (113)	71 (115)	68 (110)

▼ Driving tips

Do not drive with your foot resting on the clutch pedal and do not use the clutch to hold your vehicle at a standstill on an upgrade. Either of those actions may cause clutch damage.

Do not drive with your hand resting on the shift lever. This may cause wear on the transmission components.

When it is necessary to reduce vehicle speed due to slow traffic, turning corners, or driving up steep hills, downshift to a lower gear before the engine starts to labor.

On steep downgrades, downshift the transmission to 4th, 3rd or 2nd gear as necessary; this helps to maintain a safe speed and to extend brake pad life.

In this way, the engine provides a braking effect. Remember, if you “ride” (over use) the brakes while descending a hill, they may over-heat and not work properly.

Automatic transmission



WARNING

Do not shift from the “P” or “N” position into the “D”, “3”, “2”, “1” or “R” position while depressing the accelerator pedal. This may cause the vehicle to jump forward or backward.



CAUTION

- **Shift into the “P” or “R” position only after the vehicle is completely stopped. Shifting while the vehicle is moving may cause damage to the transmission.**
- **Do not race the engine for more than five seconds in any position except the “N” or “P” position when the brake is set or the tires are on blocks. This may cause the automatic transmission fluid to overheat.**
- **Avoid shifting from one of the forward driving positions into the “R” position or vice versa until the vehicle has completely stopped. Such shifting may cause damage to the transmission.**

The automatic transmission is electronically controlled with 4-forward speeds and 1-reverse speed.

NOTE

Immediately after a disconnected battery is reconnected or ATF (automatic transmission fluid) is replaced, you may feel that the automatic transmission operation is somewhat unusual.

This results from erasure or invalidation of data the on-board computer has collected and stored in memory to allow the transmission to shift at the most appropriate times for the current condition of your vehicle. Optimized shifting will be restored as the vehicle continues to be driven for a while.

■ Selector lever

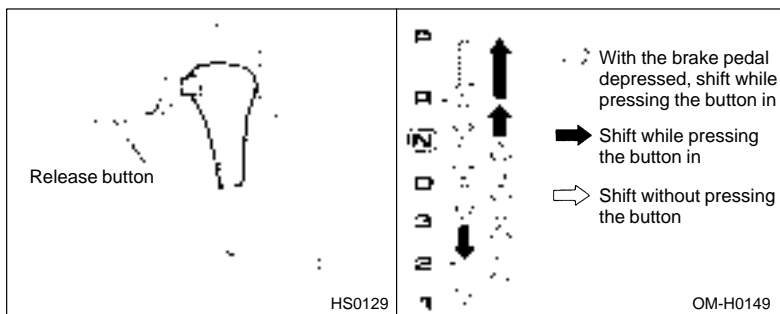

The selector lever has seven positions.

The release button must be pushed to select the "P", "R", or "2" positions.

▼ P (Park)

This position is for parking the vehicle and starting the engine.

In this position, the transmission is mechanically locked to prevent the vehicle from rolling freely.

When you park the vehicle, first set the parking brake fully, then shift into the "P" position. Do not hold the vehicle with only the transmission.

A shift interlock function is employed in the automatic transmission system to ensure safe starting of the vehicle.

To shift the selector lever from the "P" to the any other position, you have to depress the brake pedal fully then push the release button on the selector lever when the ignition switch is in the "ON" position. This prevents the vehicle from lurching when it is started.

If the shift lever does not move from the "P" position with the brake pedal depressed and the release button pushed in when the ignition switch is in the "ON" position, refer to the "Shift lock release" section in this chapter.

▼ R (Reverse)

This position is for backing the vehicle.

To shift from the "N" to "R" position, first stop the vehicle completely then move the lever to the "R" position while pushing the release button.

▼ N (Neutral)



WARNING

Do not drive the vehicle with the selector lever in the "N" (neutral) position. Engine braking has no effect in this condition and the risk of an accident is consequently increased.

This position is for restarting a stalled engine.

In this position the wheels and transmission are not locked. In this position, the transmission is neutral; the vehicle will roll freely, even on the slightest incline unless the parking brake or foot brake is on.

Avoid coasting with the transmission neutral. During coasting, the engine braking does not act.

▼ D (Drive)

This position is for normal driving.

The transmission automatically shifts into a suitable gear from 1st to 4th according to the vehicle speed and the acceleration you require.

When more acceleration is required in this position, press the accelerator pedal fully to the floor and hold that position. The transmission will automatically downshift to 3rd, 2nd or 1st gear. When you release

– CONTINUED –

the pedal, the transmission will return to the original gear position.

▽ **While climbing a grade**

When driving up a hill, undesired upshift to 4th gear is prevented from taking place when the accelerator is released. This minimizes the chance of subsequent downshifting to a lower gear when accelerating again. This prevents repeated upshifting and downshifting resulting in a smoother operation of the vehicle.

NOTE

The transmission may downshift to 2nd or 1st gear, depending on the way the accelerator pedal is pressed to accelerate the vehicle again.

▽ **While going down a hill**

When descending a steep hill, depressing the brake pedal will cause the transmission to downshift to 3rd gear, thus applying engine braking. Reacceleration for a short time will cause the transmission to upshift normally.

NOTE

In some cases, depressing the brake pedal on a downhill grade does not result in an automatic downshift to 3rd gear. This can happen when the automatic transmission fluid temperature is very low, for example, during driving shortly after the vehicle has been parked for an extended period of time. When the ATF temperature has risen to a certain level, automatic downshift normally takes place. In the meantime, downshift manually for engine braking as required.

Also, downshifting when braking downhill will not occur at speeds above approximately 50 mph (80 km/h).

▼ **3 (Third)**

This position is for using engine braking when going down a hill or for climbing a grade.

The transmission automatically shifts into a suitable gear from 1st to 3rd according to the vehicle speed and the acceleration you require.

When more acceleration is required in this position, press the accelerator pedal fully to the floor and hold that position. The transmission will automatically downshift to 2nd or 1st gear. When you release the pedal, the transmission will return to the original gear position.

▼ **2 (Second)**

To shift from the “3” position, push the release button.

This position is for using engine braking when going down a hill or for climbing a steep grade.

In this position, the transmission holds in the 2nd gear.

Use this position when starting off from a standstill on slippery road surfaces such as mud or snow. It will ensure greater traction.

▼ **1 (First)**

This position is for driving up or down very steep grades, or driving through mud or sand, or on slippery surfaces. In this position, the transmission holds in the 1st gear.

▼ **Maximum speeds**



WARNING

When shifting down a gear, ensure that the vehicle is not travelling at a speed exceeding the Maximum Allowable Speed for the gear which is about to be selected. Failure to observe this precaution can lead to engine over-revving and this in turn can result in engine damage.

In addition, sudden application of engine brakes when the vehicle is travelling on a slippery surface can lead to wheel locking; as a consequence, control of the vehicle may be lost and the risk of an accident increased.

The following tables show the maximum speeds that are possible with each different gear. The tachometer's (if so equipped) needle will enter the red area if these speeds are exceeded.

When shifting down a gear, it is important to confirm that the current vehicle speed is not in excess of the Maximum Allowable Speed of

– CONTINUED –

the gear which is about to be selected.

Exceeding the Maximum Allowable Speeds will result in over-revving of the engine. In addition a powerful engine brake will engage and control of the vehicle may be lost.

				mph (km/h)
Gear	Vehicle type	2.2 liter models		2.5 liter RS models
		except OUTBACK SPORTS	OUTBACK SPORTS	
1st		35 (56)	35 (56)	30 (49)
2nd		62 (100)	63 (102)	57 (91)
3rd		96 (155)	98 (157)	91 (147)

NOTE

- **In order to prevent over-revving during acceleration of the vehicle, the transmission will automatically shift to the next highest gear if the Maximum Allowable Speed for the current gear is exceeded.**
- **Similarly, in order to prevent over-revving during deceleration of the vehicle, the transmission will remain in the current gear if the speed of the vehicle is in excess of the Maximum Allowable Speed for the gear to which the selector lever has been moved.**

▼ Driving tips

- Always apply the foot or parking brake when the vehicle is stopped in the "D", "3", "2", "1", or "R" position.
- Always set the parking brake when parking your vehicle. Do not hold the vehicle with only the transmission.
- Do not keep the vehicle in a stationary position on an uphill grade by using the "D", "3", "2" or "1" position. Use the brake instead.

■ Shift lock release

If the selector lever does not move from the "P" position with the brake pedal depressed and the release button pushed in and the ignition switch in the "ON" position, perform the following steps:

To override the shift lock:

1. Set the parking brake and stop the engine.

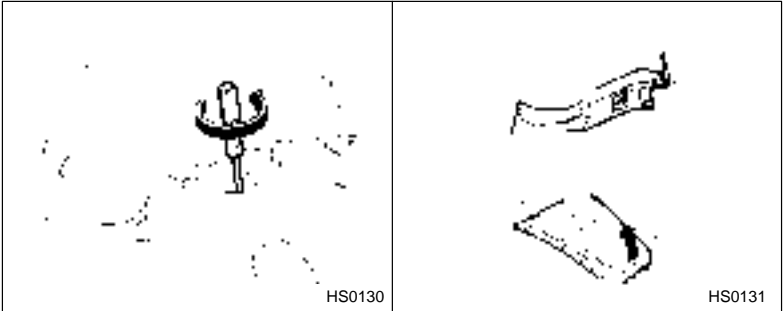

2. Take out the screwdriver from the tool bag.
3. Open the center console and remove two screws securing the parking brake lever cover.
4. Remove the parking brake lever cover by pulling up on the cover's rear end.
5. Raise the rear end of the selector lever cover.

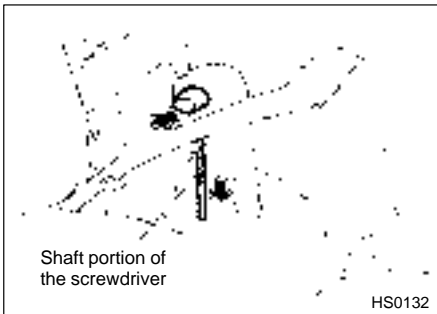

6. Draw the shaft portion of the screwdriver from the grip and then insert the shaft into the hole.
7. Push down on the shaft while pushing the release button and move the selector lever from the "P" to the "N" position.
8. Remove the shaft from the hole. Depress the brake pedal and start the engine.

Take your vehicle to the nearest SUBARU dealer immediately to have the system repaired.

Rear viscous limited slip differential (For RS models)

CAUTION

- Never start the engine while a tire on one side is jacked up, as the vehicle may move.
- If one rear tire is spinning in mud, avoid continued spinning at high speed as this could adversely affect the LSD.
- If a different size rear tire is temporarily used (as in an emergency), it will adversely affect the LSD. Always replace it with a regular size tire as soon as possible.

The LSD provides optimum distribution of power according to the difference in revolutions between the right and left rear wheels that may be caused by certain driving conditions, thereby improving driving stability on snow-covered, muddy or other slippery roads.

Steering

■ Tilt steering wheel

WARNING

Do not adjust the steering wheel tilt position while driving. This may cause loss of vehicle control and result in personal injury.

▼ Tilt adjustment

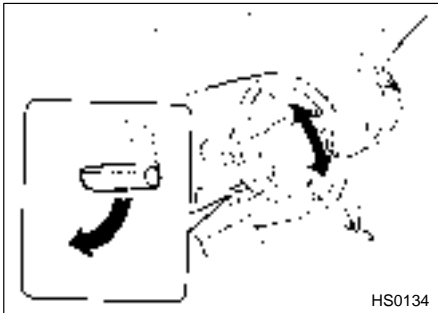

1. Adjust the seat position. Refer to "Front seat" section (chapter 2).
2. Pull the tilt lock lever down.
3. Move the steering wheel to the desired level.
4. Push the lever up to lock the steering wheel in place.
5. Make sure that the steering wheel is securely locked by moving it up and down.

■ Power steering



CAUTION

Do not hold the steering wheel at the fully locked position left or right for more than five seconds. This may damage the power steering pump.

The power steering system operates only when the engine is running. If you lose power steering assist because the engine stops or the system fails to function, you can steer but it will take much more effort.

Cruise control (if equipped)

WARNING

Do not use the cruise control under any of the following conditions. This may cause loss of vehicle control:

- driving up or down a steep grade
- driving on slippery or winding roads
- driving in heavy traffic

Cruise control enables you to maintain a constant vehicle speed without holding your foot on the accelerator pedal and it is operative when the vehicle speed is 25 mph (40 km/h) or more.

Make sure the main switch is turned "OFF" when the cruise control is not in use to avoid unintentionally setting the cruise control.

▼ To set cruise control

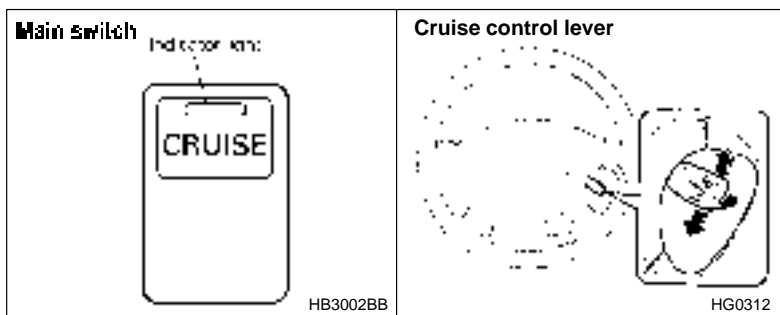

1. Push the "CRUISE" main switch.
2. Depress the accelerator pedal until the vehicle reaches to the desired speed.
3. Push the control lever downward in the "SET, COAST" direction and release it. Then release the accelerator pedal.
The vehicle will maintain the desired speed.

Vehicle speed can be temporarily increased while driving with the cruise control activated. Simply depress the accelerator pedal to ac-

celerate the vehicle. When the accelerator pedal is released, the vehicle will return to and maintain the previous cruising speed.

▼ **To temporarily cancel the cruise control**

There are four ways to cancel the cruise control temporarily:

- Depress the brake pedal.
- Pull the control lever in the "CANCEL" direction.
- Depress the clutch pedal (manual transmission vehicles only).
- Shift the selector lever into the "N" position (automatic transmission vehicles only).

To resume the cruise control after it has been temporarily canceled and with vehicle speed of 25 mph (40 km/h) or more, push the control lever upward in the "ACCEL, RESUME" direction to return to the original cruising speed automatically.

▼ **To turn off the cruise control**

There are two ways to turn off the cruise control:

- Push the main switch again.
- Turn the ignition switch to the "ACC" position (but only when the vehicle is completely stopped).

▼ **To change the cruising speed**

▽ **To increase the speed**

1. Push the control lever upward in the "ACCEL, RESUME" direction and hold it until the vehicle reaches the desired speed.

The control lever can be used for increasing the cruising speed slightly. Pressing the control lever upward in the "ACCEL, RESUME" direction increases the vehicle speed about 1 mph (1.6 km/h). Press the control lever repeatedly until the desired speed is reached.

OR

1. Depress the accelerator pedal to accelerate the vehicle to the desired speed.
2. Push the control lever downward in the "SET, COAST" direction once. Now the desired speed is set and the vehicle will keep running at that speed without depressing the accelerator pedal.

▽ To decrease the speed

1. Push the control lever downward in the "SET, COAST" direction and hold it until the vehicle reaches the desired speed.

The control lever can be used for decreasing the cruising speed slightly. Pressing the control lever downward in the "SET, COAST" direction decreases the vehicle speed about 1 mph (1.6 km/h). Press the control lever repeatedly until the desired speed is reached.

OR

1. Depress the brake pedal to release cruise control temporarily.
2. When the speed decreases to the desired speed, press the control lever downward in the "SET, COAST" direction once. Now the desired speed is set and the vehicle will keep running at that speed without depressing the accelerator pedal.

Parking your vehicle



WARNING

- **Never leave unattended children or pets in the vehicle. They could accidentally injure themselves or others through inadvertent operation of the vehicle. Also, on hot or sunny days, the temperature in a closed vehicle could quickly become high enough to cause severe or possibly fatal injuries to them.**
- **Do not park the vehicle over flammable materials such as dry grass, waste paper or rags, as they may burn easily if they come near hot engine or exhaust system parts.**
- **Always stop the engine if you take a nap in the vehicle. If engine exhaust gas enters the passenger compartment, occupants in the vehicle could die from carbon monoxide (CO) contained in the exhaust gas.**

**CAUTION**

Never drive while the parking brake is set because this will cause unnecessary wear on the brake linings. Before starting to drive, always make sure that the parking brake has been fully released.

To set the parking brake, press the brake pedal firmly and hold it down while fully pulling up the parking brake lever.

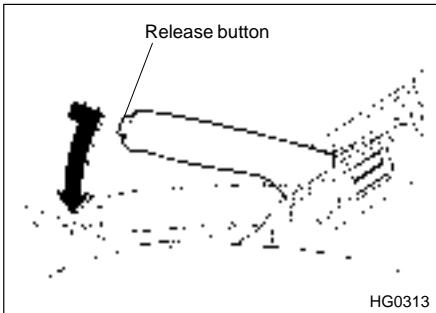

To release the parking brake, pull the lever up slightly, press the release button, then lower the lever while keeping the button pressed.

When the parking brake is set while the engine is running, the parking brake warning light comes on. After starting the vehicle, be sure that the warning light has gone out before the vehicle is driven. Refer to the "Warning and indicator lights" section (chapter 3).

When parking your vehicle, always set the parking brake firmly and put the shift lever in the "1" (1st) for an upgrade or "R" (Reverse) for a down grade for manual transmission vehicles, or in the "P" (Park) position for automatic transmission vehicles.

Always set the parking brake firmly when parking your vehicle. Never rely on the transmission alone to hold the vehicle.

For better parking brake power, depress the brake pedal firmly while setting the parking brake (Drum brake only).

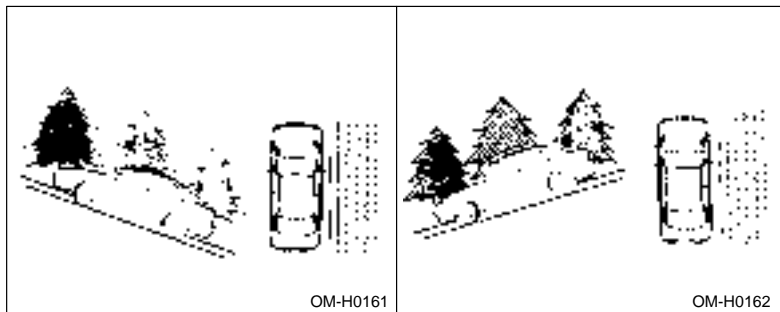

When parking on a hill, always turn the steering wheel. When the vehicle is headed up the hill, the front wheels should be turned away from the curb. When facing down hill, the front wheels should be turned into the curb.

Braking

■ Braking tips



WARNING

Never rest your foot on the brake pedal while driving. This can cause dangerous overheating of the brakes and needless wear on the brake pads and linings.

▼ **When the brakes get wet**

When driving in rain, in puddle or after washing the vehicle, the brakes may get wet. As a result, brake stopping distance will be longer. To dry the brakes, drive the vehicle at a safe speed while lightly depressing the brake pedal to heat up the brakes.

▼ **Use of engine braking**

Remember to make use of engine braking in addition to foot braking. When descending a grade, if only the foot brake is used, the brakes may start working improperly because of brake fluid overheating, caused by overheated brake pads. To help prevent this, shift into a

lower gear to get stronger engine braking.

▼ **Braking when a tire is punctured**

Do not depress the brake pedal suddenly when a tire is punctured. This could cause a loss of control of the vehicle. Keep driving straight ahead while gradually reducing speed. Then slowly pull off the road to a safe place.

■ **Brake system**

▼ **Two separate circuits**

Your vehicle has two separate circuit brake systems. Each circuit works diagonally across the vehicle. If one circuit of the brake system should fail, the other half of the system still works. If one circuit fails, the brake pedal will go down much closer to the floor than usual and you will need to press it down much harder. And a much longer distance will be needed to stop the vehicle.

▼ **Brake booster**

The brake booster uses engine manifold vacuum to assist braking force. Do not turn off the engine while driving because that will turn off the brake booster, resulting in poor braking power.

The brakes will continue to work even when the brake booster completely stops functioning. If this happens, however, you will have to push the pedal much harder than normal and the braking distance will increase.

■ Disc brake pad wear warning indicators

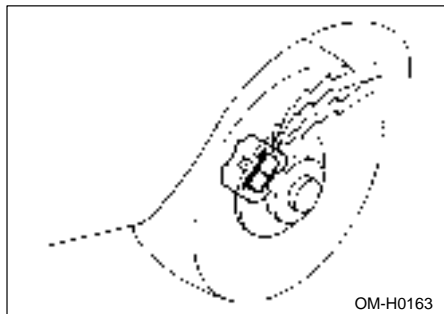

The disc brake pad wear warning indicators on the disc brakes give a warning noise when the brake pads are worn.

If a squeaking or scraping noise is heard from the disc brakes while braking, immediately have your vehicle checked by your SUBARU dealer.

ABS (Anti-Lock Brake System) (if equipped)



WARNING

Always use the utmost care in driving – overconfidence because you are driving with an ABS equipped vehicle could easily lead to a serious accident.



CAUTION

- The ABS system does not always decrease stopping distance. You should always maintain a safe following distance from other vehicles.
- When driving on badly surfaced roads, gravel roads, icy roads, or over deep newly fallen snow, stopping distances may be longer for a vehicle with the ABS system than one without. When driving under these conditions, therefore, reduce your speed and

leave ample distance from other vehicles.

- **When you feel the ABS system operating, you should maintain constant brake pedal pressure. Do not pump the brake pedal since doing so may defeat the operation of the ABS system.**

The ABS system prevents the lock-up of wheels which may occur during sudden braking or braking on slippery road surfaces. This helps prevent the loss of steering control and directional stability caused by wheel lock-up.

When the ABS system is operating, you may hear a chattering noise or feel a slight vibration in the brake pedal. This is normal when the ABS operates.

The ABS system will not operate when the vehicle speed is below approximately 6 mph (10 km/h).

▼ **ABS system self-checking**

You may feel a slight shock in the brake pedal and hear the operating sound of ABS from the engine compartment just after the vehicle is started. This is caused by an automatic functional test of the ABS system being carried out and does not indicate any abnormal condition.

▼ **ABS warning light**

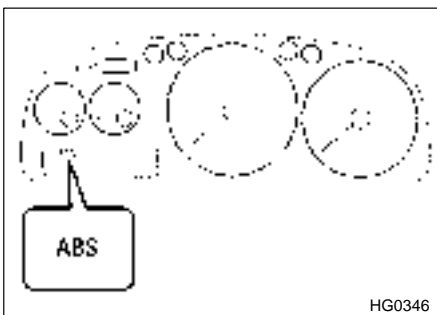

The ABS warning light comes on when the ignition switch is turned to the "ON" position and goes out after about two seconds.

This is an indication that the ABS system is working properly.

– CONTINUED–

If the warning light behaves as follows, the ABS system may not be working properly.

- The warning light does not come on when the ignition switch is turned to the "ON" position.
- The warning light comes on when the ignition switch is turned to the "ON" position, but it does not go out even when the vehicle speed exceeds approximately 8mph (12km/h).
- The warning light comes on during driving.

When the warning light is on, the ABS function shuts down; however, the conventional brake system continues to operate normally. If this occurs, have the ABS system repaired at the first available opportunity by your SUBARU dealer.

NOTE

If the warning light behavior is as described below, the ABS system may be considered normal.

- **The warning light comes on right after the engine is started but goes out immediately, remaining off.**
- **The warning light remains on after the engine has been started, but it goes out when the vehicle speed reaches about 8 mph (12 km/h).**
- **The warning light comes on during driving, but it goes out immediately and remains off.**

When driving with an insufficient battery voltage such as when the engine is jump started, the ABS warning light may come on. This is due to the low battery voltage and does not indicate a malfunction. When the battery becomes fully charged, the light will go out.

Driving tips for AWD vehicles



WARNING

- Always maintain a safe driving speed according to the road and weather conditions in order to avoid having an accident on a sharp turn, during sudden braking or under other similar conditions.
- Always use the utmost care in driving – overconfidence because you are driving an all wheel drive vehicle could easily lead to a serious accident.

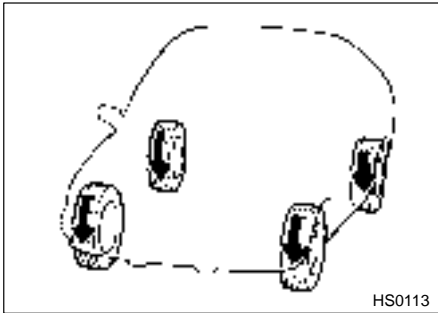

All wheel drive distributes the engine power to all four wheels. AWD vehicles provide better traction when driving on slippery, wet or snow-covered roads and when moving out of mud, dirt and sand. By shifting power between the front and rear wheels, SUBARU AWD can also provide added traction during acceleration and added engine braking force during deceleration.

Therefore, your SUBARU AWD vehicle may handle differently than an ordinary two wheel drive vehicle and it contains some features unique to AWD. For safety purposes as well as to avoid damaging the AWD system, you should keep the following tips in mind:

- An AWD vehicle is better able to climb steeper roads under snowy or slippery conditions than a two wheel drive vehicle. There is little differ-

– CONTINUED –

ence in handling, however, during extremely sharp turns or sudden braking. Therefore, when driving down a slope or turning corners, be sure to reduce your speed and maintain an ample distance from other vehicles.

- When replacing a tire, make sure you use only the same size, circumference, construction, brand, and load range as the original tires listed on the tire placard. Using other sizes, circumference or construction may result in severe mechanical damage to the drive train of your vehicle and may affect ride, handling, braking, speedometer/odometer calibration, and clearance between the body and tires. It also may be dangerous and lead to loss of vehicle control.
- If you use a temporary spare tire to replace a flat tire, be sure to use the original temporary spare tire stored in the vehicle. Using other sizes may result in severe mechanical damage to the drive train of your vehicle.
- Always check the cold tire pressure before starting to drive. The recommended tire pressure is provided on the tire placard, which is located under the door latch on the driver's side.
- Tire chains should always be placed on the front wheels only.
- There are some precautions that you must observe when towing your vehicle. For detail information, see the "Towing" section in chapter 8.

Off road driving



WARNING

- **Always maintain a safe driving speed according to the road and weather conditions in order to avoid having an accident on a sharp turn, during sudden braking or under other similar conditions.**
- **Always use the utmost care in driving – overconfidence because you are driving an all wheel drive vehicle could easily lead to a serious accident.**

▼ All AWD models except OUTBACK SPORT

Your AWD vehicle is neither a conventional off-road vehicle nor an all terrain vehicle. It is a passenger car designed primarily for on-road

use. The AWD feature gives it some limited off-road capabilities in situation in which driving surfaces a relatively level, obstruction-free and otherwise similar to on-road driving conditions. Operating it under other than those conditions could subject the vehicle to excessive stress which might result in damage not eligible for repair under warranty. If you do take your SUBARU off road, you should review the common sense precautions in the next section (applicable to the OUTBACK) for general guidance. But please keep in mind that your vehicle's off-road capabilities are more limited than those of the OUTBACK.

Never attempt to drive through pools and puddles, or roads flooded with water. Water entering the engine air intake or the exhaust pipe or water splashing onto electrical parts may damage your vehicle and may cause it to stall.

▼ **OUTBACK SPORT**

Because of the AWD feature and higher ground clearance, your Subaru can be driven on ordinary roads or off-road. But please keep in mind that an AWD Subaru is a passenger car and is neither a conventional off-road vehicle nor an all-terrain vehicle. If you do take your Subaru off-road, certain common sense precautions such as the following should be taken:

- Make certain that you and all of your passengers are wearing seat belts.
- Carry some emergency equipment, such as a towing rope or chain, a shovel, wheel blocks, first aid kit and portable phone or citizens band radio.
- Drive carefully. Do not take unnecessary risks by driving in dangerous areas or over rough terrain.
- Slow down and employ extra caution at all times. When driving off-road, you will not have the benefit of marked traffic lanes, banked curves, traffic signs and the like.
- Do not drive across steep slopes. Instead, drive either straight up or straight down the slopes. A vehicle can much more easily tip over sideways than it can end over end. Avoid driving straight up or down slopes that are too steep.
- Avoid sharp turning maneuvers, especially at higher speeds.

– **CONTINUED**–

-
- Do not grip the inside or spokes of the steering wheel. A bad bump could jerk the wheel and injure your hands. Instead drive with your fingers and thumbs on the outside of the rim.
 - If driving through water, such as when crossing shallow streams, first check the depth of the water and the bottom of the stream bed for firmness and ensure that the bed of the stream is flat. Drive slowly and completely through the stream. The water should be shallow enough that it does not reach the vehicle's undercarriage. Water entering the engine air intake or the exhaust pipe or water splashing onto electrical parts may damage your vehicle and may cause it to stall. Never attempt to drive through rushing water; regardless of its depth, it can wash away the ground from under your tires, resulting in possible loss of traction and even vehicle rollover.
 - Always check your brakes for effectiveness immediately after driving in sand, mud or water. Do this by driving slowly and stepping on the brake pedal. Repeat that process several times to dry out the brake discs and brake pads.
 - Do not drive or park over or near flammable materials such as dry grass or fallen leaves, as they may burn easily. The exhaust system is very hot while engine is running and right after the engine stops. This could create a fire hazard.
 - After driving through tall grass, mud, rock, sand, rivers, etc., check that there is no grass, bush, paper, rags, stones, sand, etc. adhering to or trapped on the underbody. Clear off any such matter from the underbody. If the vehicle is used with these materials trapped or adhering to the underbody, a mechanical breakdown or fire could occur.
 - Secure all cargo carried inside the vehicle and make certain that it is not piled higher than the seatbacks. During sudden stops or jolts, unsecured cargo could be thrown around in the vehicle and cause injury. Do not pile heavy loads on the roof. Those loads raise the vehicle's center of gravity and make it more prone to tip over.
 - If you must rock the vehicle to free it from sand or mud, depress the accelerator pedal slightly and move the selector lever back and forth between "D" and "R" repeatedly. Do not race the engine. For the best possible traction, avoid spinning the wheels when trying to free the vehicle.

When the road surface is extremely slippery, you can obtain better traction by starting the vehicle with the transmission in 2nd than 1st (both for MT and AT).

- Never equip your vehicle with tires larger than those specified in this manual.
- Frequent driving of an AWD vehicle under hard-driving conditions such as rough roads or off roads will necessitate more frequent replacement of engine oil, brake fluid and transmission oil than that specified in the maintenance schedule described in the “Warranty and Maintenance Booklet”.

Remember that damage done to your Subaru while operating it off-road and not using common sense precautions such as those listed above is not eligible for warranty coverage.

Winter driving

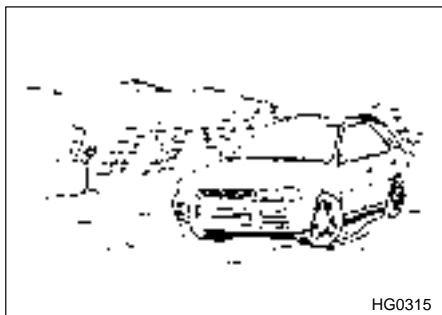

▼ Operation during cold weather

Carry some emergency equipment, such as tire chains, a window scraper, a bag of sand, flares, a small shovel, and jumper cables.

Check the battery and cables. Cold temperatures reduce battery capacity. The battery must be in good condition to provide enough power for cold winter starts.

Use an engine oil of proper grade and viscosity for cold weather.

– CONTINUED –

Heavy summer oil will cause harder starting.

Keep the door locks from freezing by squirting them with deicer or glycerin.

Forcing a frozen door open may damage or separate the rubber weather strips around the door. If the door is frozen, use hot water to melt the ice, and afterwards thoroughly wipe the water away.

Use a windshield washer fluid that contains an antifreeze solution. Do not use engine antifreeze or other substitutes because they may damage the paint of the vehicle.

▽ **Before driving your vehicle**

Before entering the vehicle, remove any snow or ice from your shoes because that could make the pedals slippery and dangerous.

While warming up the vehicle before driving, check that the accelerator pedal, brake pedal, and all other controls operate smoothly.

Clear away ice and snow that has accumulated under the fenders to avoid making steering difficult. During severe winter driving, stop when and where it is safe to do so and check under the fenders periodically.

▽ **During cold weather below -4°F (-20°C)**

If the engine is difficult to start using the normal method (without depressing the accelerator pedal), turn the ignition switch to the "START" position while slightly depressing the accelerator pedal.

▽ **Parking in cold weather**



WARNING

Snow can trap dangerous exhaust gases under your vehicle. Keep snow clear of the exhaust pipe and from around your vehicle if you park the vehicle in snow with the engine running.

Do not use the parking brake when parking for long periods in cold weather since it could freeze in that position. Instead, observe the following:

1. Place the shift lever in "1" or "R" for manual transmission vehicles, and in "P" for automatic transmission vehicles.
2. Use tire stops under the tires to prevent the vehicle from moving.

When the vehicle is parked in snow or when it snows, raise the wiper blades off the glass to prevent damage to them.

When the vehicle has been left parked after use on roads heavily covered with snow, or has been left parked during a snowstorm, icing may develop on the brake system, which could cause poor braking action. Check for snow or ice buildup on the suspension, disc brakes and brake hoses underneath the vehicle.

If there is caked snow or ice, remove it, being careful not to damage the disc brakes and brake hoses and ABS harness.

▽ Refueling in cold weather

To help prevent moisture from forming in the fuel system and the risk of its freezing, use of an antifreeze additive in the fuel tank is recommended during cold weather.

Use only additives that are specifically designed for this purpose. When an antifreeze additive is used, its effect lasts longer if the tank is refilled whenever the fuel level reaches half empty.

If your SUBARU is not going to be used for an extended period, it is best to have the fuel tank filled to capacity.

▼ Driving on snowy and icy roads



WARNING

Do not use the cruise control on slippery roads such as snowy or icy roads. This may cause loss of vehicle control.

To prevent skidding and slipping, avoid sudden braking, abrupt acceleration, high-speed driving, and sharp turning when driving on snowy or icy roads.

Always maintain ample distance between your vehicle and the vehicle ahead of you to avoid the need for sudden braking.

To supplement the foot brake, use the engine brake effectively to control the vehicle speed. (Shift into a lower gear when necessary.)

– CONTINUED–

Avoid shifting down abruptly. Such behavior can cause the wheel to lock, possibly leading to loss of vehicle control.

Avoid locking the front wheels because that can lead to a loss of steering control. When braking with a vehicle not equipped with an Anti-Lock Brake System (ABS), press the brake pedal repeatedly at short intervals to prevent the wheels from locking. Then apply the brakes softly to bring the vehicle to a stop.

An ABS enhances your vehicle's braking performance on snowy and icy roads. Refer to the "ABS (Anti-Lock Brake System)" in this chapter for information on braking on slippery surfaces in ABS equipped vehicle.

▽ **Wiper operation when snowing**

Before driving in cold weather, make sure the wiper blades are not frozen to the windshield or rear window. If the wiper blades are frozen to the windshield or rear window, use the defroster with the airflow control dial in the " " position and the temperature control dial turned fully to the right until the wiper blades are completely thawed out. To thaw out the rear wiper blade, use the rear window defogger.

When driving in snow, if frozen snow starts to stick on the surface of the windshield despite wiper operation, use the defroster with the airflow control dial in " " and the temperature control dial turned fully to the right. After the windshield gets warmed enough to melt the frozen snow on it, wash it away using the windshield washer.

Snow stuck on the wiper arm prevents the wiper from working effectively. If snow is stuck on the wiper arm, pull off the road to a safe place, then remove it. If you stop the car at the side of the road, use the hazard warning flasher to alert other drivers.

We recommend use of non-freezing type wiper blades during the seasons you could have snow and sub-zero temperature.

■ Snow tires



WARNING

- When replacing a tire, make sure you use only the same size, circumference, construction, brand, and load range as the original tires listed on the tire placard. Using other sizes, circumferences or construction may result in severe mechanical damage to the drive train of your vehicle and may affect ride, handling, braking, speedometer/odometer calibration, and clearance between the body and tires. It also may be dangerous and lead to loss of vehicle control.
- Do not use a combination of radial, belted bias or bias tires since it may cause dangerous handling characteristics and lead to an accident.

Your vehicle is equipped with “all season tires” which are designed to provide an adequate measure of traction, handling and braking performance in year-round driving. In winter, it may be possible to enhance performance through use of tires designed specifically for winter driving conditions.

If you choose to install winter tires on your vehicle, be sure to use the same tire size, construction, circumference, brand, and load range as the original tires. The recommended tire sizes and pressure are provided on the tire label, which can be found on the driver's side door jamb under the latch.

Remember to drive with care at all times regardless of the type of tires on your vehicle.

■ Tire chains



CAUTION

Tire chains cannot be fitted with P205/60R15 tires for OUTBACK and P205/55R16 tires for RS because of lack of clearance between the tire and body.

Driving on snowy grades or icy roads may require the use of tire chains, in which case put the chains on the front wheels only. Use only SAE class S type chains that are of the correct size for your tires so as not to damage the vehicle body or suspension.

When driving with tire chains, drive at speeds below 19 mph (30 km/h).

When a temporary spare tire is on a front wheel, replace the temporary spare tire with the rear tire on the same side of the vehicle, and then fit chains on the front tires.

Always use the utmost care when driving with tire chains — overconfidence because you are driving with tire chains could easily lead to a serious accident.

■ **Rocking the vehicle**

If you must rock the vehicle to free it from snow, sand, or mud, depress the accelerator pedal slightly and move the selector lever back and forth between “D” and “R” repeatedly. Do not race the engine. For the best possible traction, avoid spinning the wheels when trying to free the vehicle.

When the road surface is extremely slippery, you can obtain better traction by starting the vehicle with the transmission in 2nd than 1st (both for MT and AT).

Refer to the “Automatic transmission” section in this chapter for information on holding the transmission in 2nd position.

■ **Corrosion protection**

Refer to the “Corrosion protection” section (chapter 9).

Loading your vehicle



WARNING

- Never allow passengers to ride on the folded rear seatback in the trunk or in the cargo area. Doing so may result in serious injury.
- Never stack luggage or other cargo higher than the top of the seatback because it could tumble forward and injure passengers in the event of a sudden stop or accident. Keep luggage or cargo low, as close to the floor as possible.
- When you carry something inside the vehicle, secure it whenever you can to prevent it from being thrown around inside the vehicle during sudden stops, sharp turns or in an accident.
- Do not pile heavy loads on the roof. These loads raise the vehicle's center of gravity and make it more prone to tip over.
- Secure skis and other lengthy items properly to prevent them from shooting forward and causing serious injury during a sudden stop.
- Never exceed the maximum load limit. If you do, some parts on your vehicle can break, or it can change the way your vehicle handles. This could result in loss of control and cause personal injury. Also, overloading can shorten the life of your vehicle.
- Do not place anything on the rear shelf behind the rear seatback (for sedan and coupe) or the extended luggage cover (for wagon and OUTBACK SPORT). Such items could tumble forward in the event of a sudden stop or a collision. This could cause serious injury.



CAUTION

Do not carry spray cans, containers with flammable or corrosive liquids or any other dangerous items inside the vehicle.

NOTE

For better fuel economy, do not carry unneeded cargo.

– CONTINUED–

■ Vehicle capacity weight

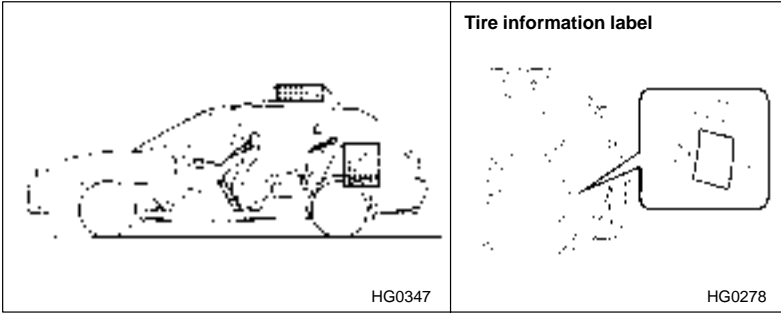

The load capacity of your vehicle is determined by weight, not by available cargo space. The maximum load you can carry in your vehicle is shown as the Vehicle Capacity Weight on the tire information label attached to the driver's side door jamb. It includes the total weight of driver and all passengers and their belongings, any optional equipment such as a trailer hitch, roof rack or bike carrier, etc., and the tongue load of a trailer.

■ GVWR and GAWR (Gross Vehicle Weight Rating and Gross Axle Weight Rating)

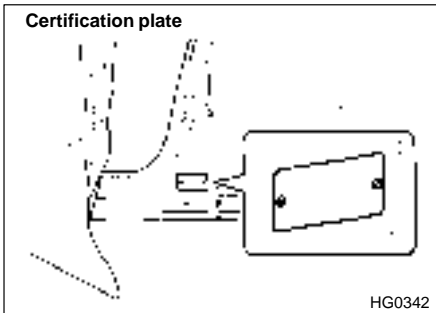

The certification plate attached to the driver's side door jamb shows GVWR (Gross Vehicle Weight Rating) and GAWR (Gross Axle Weight

Rating).

The GVW (Gross Vehicle Weight) must never exceed the GVWR. GVW is the combined total of weight of the vehicle, fuel, driver, all passengers, luggage, any optional equipment and trailer tongue load. Therefore, the GVW changes depending on the situation. The GVWR equals Curb Weight (actual weight of your vehicle – including standard equipment, fluids, emergency tools and spare tire assembly) plus the vehicle capacity weight.

In addition, the total weight applied to each axle (GAW) must never exceed the GAWR. The front and rear GAWs can be adjusted by relocating luggage inside the vehicle.

Even if the total weight of your luggage is lower than the vehicle capacity weight, either front or rear GAW may exceed the GAWR, depending on the distribution of the luggage.

If you carry heavy loads in the vehicle, you should confirm that GVW and front and rear GAWs are within the GVWR and GAWR by putting your vehicle on a vehicle scale, found at a commercial weighing station.

Do not use replacement tires with a lower load range than the originals because they may lower the GVWR and GAWR limitations. Replacement tires with a higher load range than the originals do not increase the GVWR and GAWR limitations.

Trailer towing

Your car is designed and intended to be used primarily as a passenger-carrying vehicle. Towing a trailer puts additional loads on your car's engine, drive train, brakes, tires and suspension and has an adverse effect on fuel economy.

If you do decide to tow a trailer, your safety and satisfaction depend upon proper use of correct equipment and cautious operation of your vehicle. Seek the advice of a professional trailer and/or hitch supplier to assist you in purchasing a hitch and other necessary towing equipment appropriate for your vehicle. In addition, be sure to follow the instructions on correct installation and use provided by the trailer and other towing

– CONTINUED–

equipment manufacturers.

SUBARU assumes no responsibility for injuries or vehicle damage that result from trailer towing equipment, or from any errors or omissions in the instructions accompanying such equipment or for your failure to follow the proper instructions.

▼ Warranties and maintenance

SUBARU warranties do not apply to vehicle damage or malfunction caused by trailer towing. If you use your vehicle to tow a trailer, more frequent maintenance will be required due to the additional load.

Under no circumstances should a trailer be towed with a new vehicle or a vehicle with any new power train component (engine, transmission, differential, wheel bearings, etc.) for the first 1,000 miles (1,600 km) of driving.

▼ Maximum load limits



CAUTION

Never exceed the maximum load limits explained below. Exceeding the maximum load limits could cause personal injury and/or vehicle damage.

The total trailer weight (trailer weight plus its cargo weight) with brakes must never exceed 1,500 lbs (681 kg).

The Gross Vehicle Weight (i.e., the combined weight of vehicle, driver, passengers, luggage, trailer hitch, trailer tongue load and any other optional equipment installed on your vehicle) must never exceed the Gross Vehicle Weight Rating (GVWR). GVWR is shown on the certification plate located on the left center pillar of your vehicle.

The total weight applied to each axle must never exceed the Gross Axle Weight Rating (GAWR). The front and rear GAWR are also shown on the certification plate.

The maximum trailer tongue load must never exceed 150 lbs. (68 kg). The tongue load can be adjusted by proper distribution of the load in the trailer. Never load the trailer with more weight in the back than the front; approximately 60 percent of the trailer load should be in the

front and approximately 40 percent in the rear. Also, distribute the load as evenly as possible on both the left and right sides.

To check both GVWR and GAWR and to confirm that the total weight and weight distribution are within safe driving limits, you should have your vehicle and trailer weighed at a commercial weighing station.

Be sure that all cargo is firmly secured to prevent a change in weight distribution while driving.

■ Trailer hitches



WARNING

Never drill the frame or under-body of your vehicle to install a commercial trailer hitch. If you do, dangerous exhaust gas, water or mud may enter the passenger compartment through the drilled hole. Exhaust gas contains carbon monoxide, a colorless and odorless gas which is dangerous, or even lethal, if inhaled. Also, drilling the frame or under-body of your vehicle could cause deterioration of strength of your vehicle and cause corrosion around the drilled hole.



CAUTION

- **Do not modify the vehicle exhaust system, brake system, or other system when installing a hitch or other trailer towing equipment.**
- **Adequate size trailer brakes are required when the trailer and its cargo exceed 700 lbs (318 kg) total weight.**

Choose a proper hitch for your vehicle and trailer. SUBARU does not offer accessory trailer hitches. Consult with a professional hitch supplier to assist you in choosing an appropriate hitch for your vehicle. Be sure to follow all of the hitch manufacturer's instructions for installation and use.

▼ Trailer lights



CAUTION

Direct splicing or other improper connection may damage your vehicle's electrical system and cause a malfunction of your vehicle lighting system.

Consult your authorized SUBARU dealer concerning the connection of wires for trailer lights. Check for correct operation of the turn signals and brake lights and parking lights each time you hitch up.

▼ Side mirrors

After hitching a trailer to your vehicle, check that the standard side mirrors provide a good rearward field of view without significant blind spots. If significant blind spots occur with the vehicle's standard side mirrors, use towing mirrors that conform with Federal, state/province and/or other applicable regulations.

▼ Tires



WARNING

Never tow a trailer when the temporary spare tire is used. The temporary spare tire is not designed to sustain the towing load. Use of the temporary spare tire when towing can result in failure of the spare tire and/or less stability of the vehicle and may lead to an accident.

Make sure that all the tires on your vehicle are properly inflated to the pressure specified on the tire placard located on the left center pillar of your vehicle.

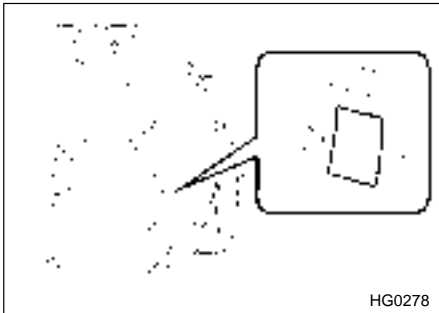

Trailer tire condition, size, load rating and proper inflation pressure should be in accordance with the trailer and tire manufacturer's specifications.

In the event your vehicle gets a flat tire when towing a trailer, ask a commercial road service to repair the flat tire.

If you carry a regular size spare tire in your vehicle or trailer as a precaution against getting a flat tire, be sure that the spare tire is firmly secured.

▼ Trailer towing tips

When towing a trailer, steering, stability, stopping distance and braking performance will vary from normal operation. For safety's sake, you should employ extra caution when towing a trailer and you should never speed.

You should also keep the following tips in mind:

Sufficient time should be taken to learn the "feel" of the vehicle/trailer combination before starting out on a trip. In an area free of traffic, practice turning, stopping and backing up.

You should allow for considerably more stopping distance when towing a trailer. Avoid sudden braking because it may result in skidding or jackknifing and loss of control.

Avoid abrupt starts and sudden accelerations. If your vehicle has a manual transmission, always start out in 1st gear and release the

– CONTINUED –

clutch at moderate engine rpm.

Avoid uneven steering, sharp turns and rapid lane changes.

Slow down before turning. Make a longer than normal turning radius because the trailer wheels will be closer than the vehicle wheels to the inside of the turn. In a tight turn, the trailer could hit your vehicle.

Crosswinds will adversely affect the handling of your vehicle and trailer, causing sway. Crosswinds can be due to weather conditions or the passing of large trucks or buses. If swaying occurs, firmly grip the steering wheel and immediately slow down gradually.

When passing other vehicles, considerable distance is required because of the added weight and length caused by attaching a trailer to your vehicle.

Before going down a steep hill, slow down and shift into low gear in order to utilize the engine braking effect and prevent overheating of your vehicle's brakes. Do not make sudden downshifts.

When going uphill on hot days, turn off your air conditioner to reduce the possibility of engine overheating caused by the added load of the trailer.

Pay attention to your water temperature gauge.

If your vehicle has an automatic transmission, avoid using the accelerator pedal to stay stationary on an uphill slope instead of using the parking brake or foot brake. This may cause the transmission fluid to overheat.

Always block the wheels under both vehicle and trailer when parking. Apply the parking brake firmly. You should not park on a hill or slope. But if parking on a hill or slope cannot be avoided, you should take the following steps:

1. Apply the brakes and hold the pedal down.
2. Have someone place wheel blocks under both the vehicle and trailer wheels.
3. When the wheel blocks are in place, release the regular brakes slowly until the blocks absorb the load.

4. Apply the regular brakes and then apply the parking brake; slowly release the regular brakes.
5. Shift into 1st or reverse gear (manual transmission) or "P" (automatic transmission) and shut off the engine.

If the ABS warning light illuminates while the vehicle is in motion, stop towing the trailer and have repairs carried out immediately by the nearest SUBARU dealer.

In case of emergency

<i>Hazard warning flasher</i>	8-2
<i>Engine overheating</i>	8-2
<i>Jump starting</i>	8-4
<i>Flat tires</i>	8-6
<i>Temporary spare tire</i>	8-11
<i>Tire changing tools</i>	8-13
<i>Towing</i>	8-14
<i>Towing eyelets</i>	8-17

Hazard warning flasher

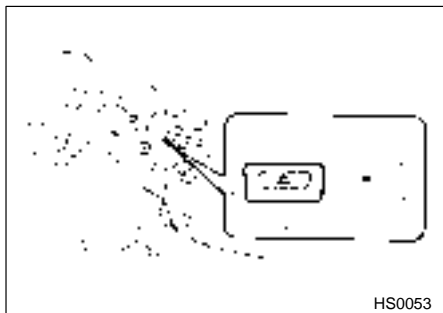

Day or night, if your vehicle becomes a traffic hazard, use the hazard warning flasher. Avoid stopping on the road. It is best to safely pull off the road if a problem occurs. The hazard warning flasher can be activated regardless of the ignition switch position.

Turn on the hazard warning by pushing the hazard warning flasher switch. Turn it off by pushing the switch again.

NOTE

When the hazard warning flasher is on, the turn signals do not work.

Engine overheating



WARNING

Never attempt to remove the radiator cap until the engine has been shut off and has fully cooled down. When the engine is hot, the coolant is under pressure. Removing the cap while the engine is still hot could release a spray of boiling hot coolant, which could burn you very seriously.

If the engine overheats, safely pull off the road and stop the vehicle in a safe place.

▼ **If steam is coming from the engine compartment**

Turn the engine off and get everyone away from the vehicle until it cools down.

▼ **If no steam is coming from the engine compartment**

1. Keep the engine running at idling speed.

2. Open the hood to ventilate the engine compartment.

Confirm that the cooling fan is turning. If the fan is not turning, immediately turn the engine off and contact your authorized SUBARU dealer for repair.

3. After the engine coolant temperature has dropped, turn off the engine.

If the temperature gauge stays at the overheated zone, turn the engine off.

4. After the engine has fully cooled down, check the coolant level in the reserve tank.

If the coolant level is below the "MIN" mark, add coolant up to the "MAX" mark.

5. If there is no coolant in the reserve tank, add coolant to the reserve tank. Then remove the radiator cap and fill the radiator with coolant.

If you remove the radiator cap from a hot radiator, first wrap a thick cloth around the radiator cap, then turn the cap counterclockwise slowly without pressing down until it stops. Release the pressure from the radiator. After the pressure has been fully released, remove the cap by pressing down and turning it.

Jump starting

WARNING

- Battery fluid is **SULFURIC ACID**. Do not let it come in contact with the eyes, skin, clothing or the vehicle.

If battery fluid gets on you, thoroughly flush the exposed area with water immediately. Get medical help if the fluid has entered your eyes.

If battery fluid is accidentally swallowed, immediately drink a large amount of milk or water, and obtain immediate medical help.

Keep everyone including children away from the battery.

- The gas generated by a battery explodes if a flame or spark is brought near it. Do not smoke or light a match while jump starting.
- Never attempt jump starting if the discharged battery is frozen. It could cause the battery to burst or explode.
- Whenever working on or around a battery, always wear suitable eye protectors, and remove metal objects such as rings, bands or other metal jewelry.
- Be sure the jumper cables and clamps on them do not have loose or missing insulation.

Do not jump start unless cables in suitable condition are available.

- A running engine can be dangerous. Keep your fingers, hands, clothing, hair and tools away from the cooling fan, belts and any other moving engine parts. Removing rings, watches and ties is advisable.

CAUTION

The battery used for boosting must be 12V. Do not jump start unless you are sure that the booster battery is correct.

When your vehicle does not start due to a run down (discharged) battery, the vehicle may be jump started by connecting your battery to another battery (called the booster battery) with jumper cables.

Jump starting is dangerous if it done incorrectly. If you are unsure about the proper procedure for jump starting, consult a competent mechanic.

▼ **How to jump start**

1. Make sure the booster battery is 12 volts and the negative terminal is grounded.
2. If the booster battery is in another vehicle, do not let the two vehicles touch.
3. Turn off all unnecessary lights and accessories.
4. Connect the jumper cables exactly in the sequence illustrated.

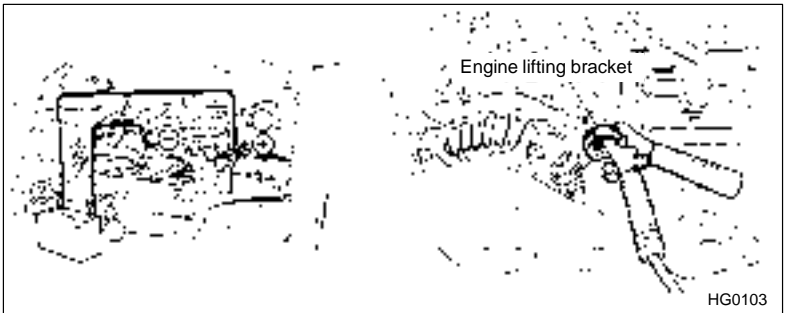

- ① Connect one jumper cable to the positive (+) terminal on the discharged battery.
- ② Connect the other end of the jumper cable to the positive (+) terminal of the booster battery.
- ③ Connect one end of the other cable to the negative (-) terminal of the booster battery.
- ④ Connect the other end of the cable to the engine lifting bracket.

Make sure that the cables are not near any moving parts and that the cable clamps are not in contact with any other metal.

5. Start the engine of the vehicle with the booster battery and run it at

– **CONTINUED** –

moderate speed. Then start the engine of the vehicle that has the discharged battery.

6. When finished, carefully disconnect the cables in exactly the reverse order.

Flat tires



WARNING

- **Do not jack up the vehicle on an incline or a loose road surface. The jack can come out of the jacking point or sink into the ground and this can result in a severe accident.**
- **Use only the jack provided with your vehicle. The jack supplied with the vehicle is designed only for changing a tire. Never get under the vehicle while supporting the vehicle with this jack.**
- **Always turn the engine off before raising the flat tire off the ground using the jack. Never swing or push the vehicle supported with the jack. The jack can come out of the jacking point due to a jolt and this can result in a severe accident.**
- **Do not use oil or grease on the wheel studs or nuts when the spare tire is installed. This could cause the nuts to become loose and lead to an accident.**
- **Never place a tire or tire changing tools in the passenger compartment after changing wheels. In a sudden stop or collisions, loose equipment could strike occupants and cause injury. Store the tire and all tools in the proper place.**

If you have a flat tire while driving, never brake suddenly; keep driving straight ahead while gradually reducing speed. Then slowly pull off the road to a safe place.

1. Park on a hard, level surface, whenever possible, then stop the engine.
2. Set the parking brake securely and shift a manual transmission vehicle in reverse or an automatic transmission vehicle in the "P" (Park) position.

3. Turn on the hazard warning flasher and have everyone get out of the vehicle.
4. Put wheel blocks at the front and rear of the tire diagonally opposite the flat tire.

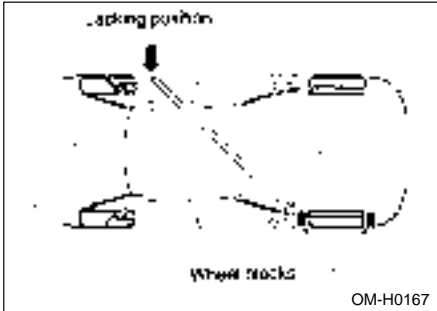

5. Take out the spare tire, jack, and wheel nut wrench. See the "Tire changing tools" in this chapter.
6. Remove the wheel covers.

Locking type wheel cover: Grasp the wheel cover with both hands by the spokes and twist sharply in a **counterclockwise** direction until you feel the detente release. Now the wheel cover is free from the retention ring.

Regular type wheel cover: Insert the wheel cover remover into the notch provided in the wheel cover, and pry it off.

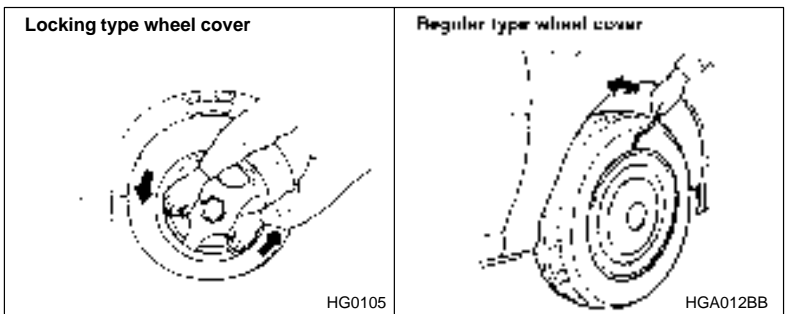

7. Loosen the wheel nuts using the wheel nut wrench but do not remove the nuts.

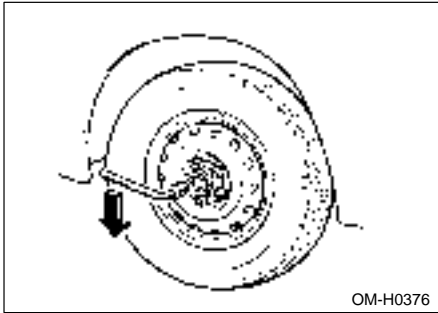

8. Place the jack under the side sill at the front or rear jack-up point closest to the flat tire.
Turn the jackscrew by hand until the jack head engages firmly into the jack-up point.

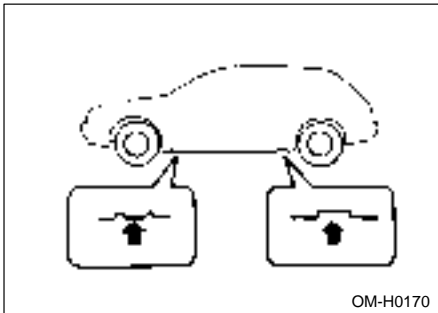

9. Insert the jack handle into the jackscrew, and turn the handle clockwise until the tire clears the ground. Do not raise the vehicle higher than necessary.

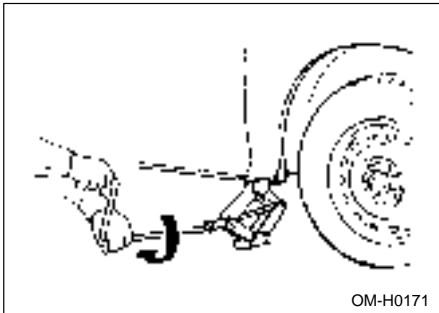

10. Remove the wheel nuts and the flat tire.

11. Before putting the spare tire on, clean the mounting surface of the wheel and hub with a cloth.

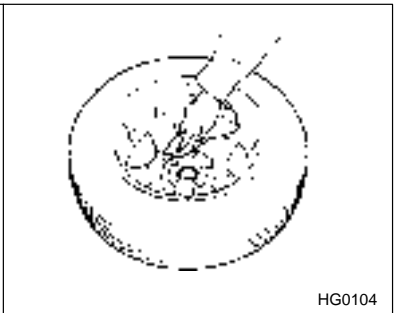
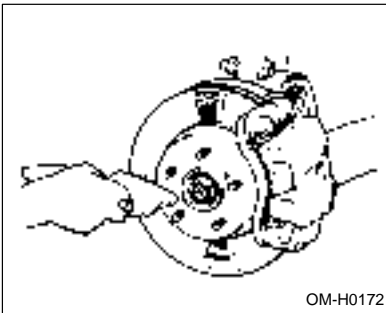

12. Put on the spare tire. Replace the wheel nuts. Tighten them by hand.

13. Turn the jack handle counterclockwise to lower the vehicle.

14. Use the wheel nut wrench to securely tighten the wheel nuts to the specified torque, following the tightening order in the illustration.

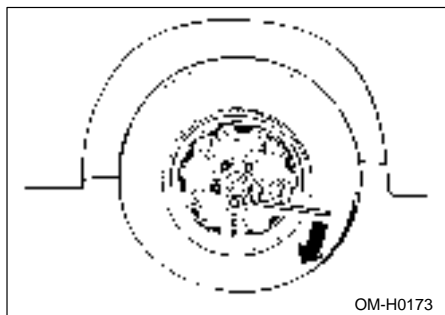

The torque for tightening the nuts is 58 to 72 ft-lb (78 to 98 N-m, 8 to 10 kg-m). This torque is equivalent to applying about 88 to 110 lbs (40 to 50 kg) at the top of the wheel nut wrench. Never use your foot on the wheel nut wrench or a pipe extension on the wrench because you may exceed the specified torque. Have the wheel nut torque checked at the nearest automotive service facility.

15. Store the flat tire in the compact spare tire compartment.

When storing a conventional tire, put the spacer upside down and tighten the attaching bolt firmly.

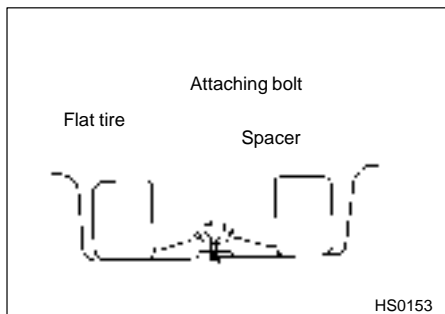

Also store the jack and wheel nut wrench in their storage locations. See "Tire changing tools" in this section.

■ Temporary spare tire



WARNING

Never tow a trailer when the temporary spare tire is used. The temporary spare tire is not designed to sustain the towing load. Use of the temporary spare tire when towing can result in failure of the spare tire and/or less stability of the vehicle and may lead to an accident.



CAUTION

Never use any temporary spare tire other than the original. Using other sizes may result in severe mechanical damage to the drive train of your vehicle.

Your vehicle has a temporary spare tire. This tire is smaller and lighter than a conventional tire and is designed for emergency use only. Remove the temporary spare tire and re-install the conventional tire as soon as possible because the spare tire is designed only for temporary use.

Check the inflation pressure of the temporary spare tire at **60 psi (420 kPa, 4.2 kg/cm²)** periodically to keep the tire ready for use.

When using the temporary spare tire, note the following:

- Do not exceed 50 mph (80 km/h).
- Do not put a tire chain on the temporary spare tire. Because of the smaller tire size, a tire chain will not fit properly .
- Do not use two or more temporary spare tires at the same time.
- Do not drive over obstacles. This tire has a smaller diameter, so road clearance is reduced.
- When the wear indicator appears on the tread, replace the tire.

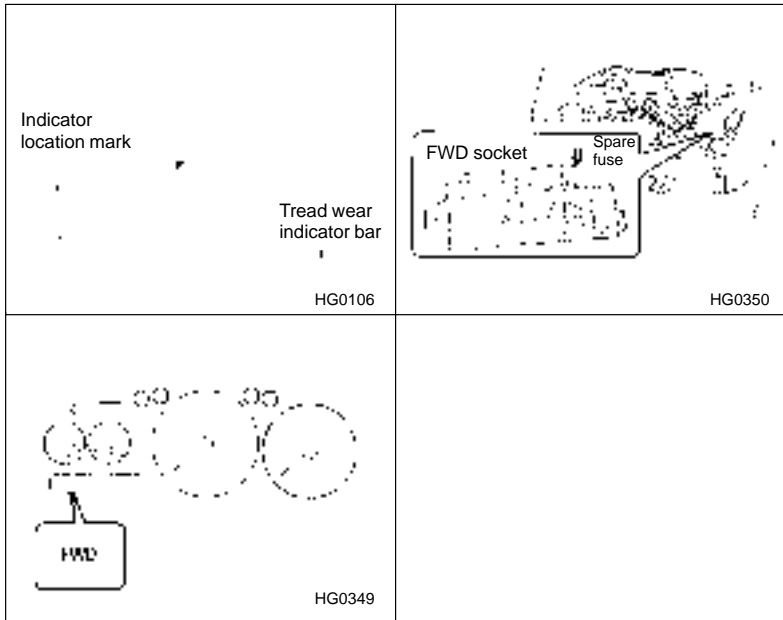

- **(If your vehicle is AWD with automatic transmission) Before driving your vehicle with the temporary spare tire, put a spare fuse inside the FWD connector in the main fuse box located in the engine compartment and confirm that the Front-wheel drive warning light comes on. The all wheel drive capability of the vehicle has now deactivated. After re-installing the conventional tire, remove the spare fuse from the FWD connector in order to reactivate all wheel drive.**

■ Tire changing tools

▼ Spare tire

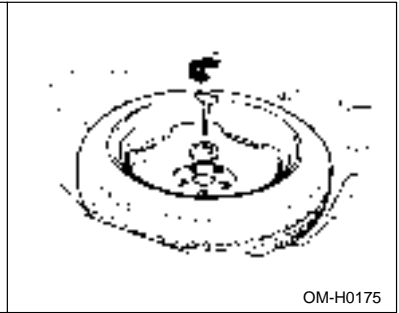
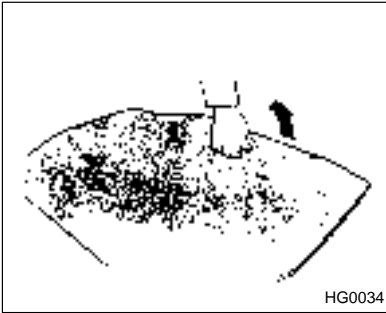

The spare tire is stored under the floor of the trunk or the cargo area. To remove the spare tire, first remove the spare tire cover, turn the attaching bolt counterclockwise, then take the spare tire out.

▼ Jack and jack handle

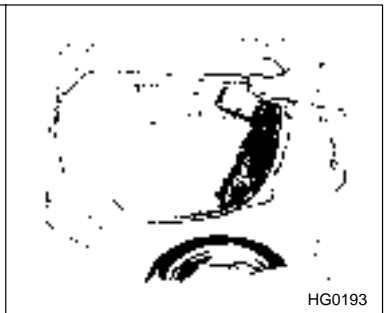

The jack is stored on the left side of the trunk or cargo area.

To take out the jack, first pull the tab on the trim cover down to open the cover, turn the jackscrew counterclockwise to loosen it, then remove the jack.

The jack handle is stored under the spare tire cover.

Towing

If towing is necessary, it is best done by your SUBARU dealer or a commercial towing service. Observe the following procedures for safety.

▼ Transporting your vehicle using a flat-bed truck

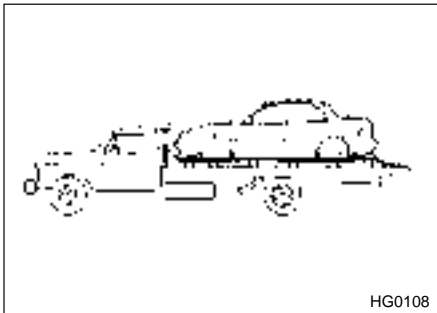

This is the best way to transport your vehicle. Use the following procedures to ensure safe transportation.

1. Shift the selector lever into the "P" position for automatic transmission vehicles or "1st" for manual transmission vehicles.
2. Pull up the parking brake lever firmly.
3. Secure the vehicle onto the carrier properly with safety chains. Each safety chain should be equally tightened and care must be taken not to pull the chains so tightly that the suspension bottoms out.

▼ Towing with the front wheels raised off the ground



WARNING

Never tow manual transmission AWD vehicles with the front wheels raised off the ground while the rear wheels are on the ground. This will cause the vehicle to spin away due to the operation or deterioration of the viscous coupling.



CAUTION

When transmission failure occurs, transport your vehicle on a flat-bed truck.



1. Check the transmission and differential oil levels and add oil to bring it to the upper level if necessary.
2. Release the parking brake and put the transmission in neutral.
3. The ignition switch should be in the "ACC" position while the vehicle is being towed.
4. Take up slack in the towline slowly to prevent damage to the vehicle.

▼ Towing with all wheels on the ground



WARNING

- **Never turn the ignition switch to the "LOCK" position while the vehicle is being towed because the steering wheel and the direction of the wheels will be locked.**
- **Remember that the brake booster and power steering do not function when the engine is not running. Because the engine is turned off, it will take greater effort to operate the brake pedal and steering wheel.**

CAUTION

- If transmission failure occurs, transport your vehicle on a flat-bed truck.
- For AWD vehicles or FWD vehicles with automatic transmission, the traveling speed must be limited to less than 20 mph (30 km/h) and the traveling distance to less than 31 miles (50 km). For greater speeds and distances, transport your vehicle on a flat-bed truck.
- For OUTBACK models, be sure to use a flexible cable for towing purpose and wrap the towing cable with cloth to prevent damage to the bumper.

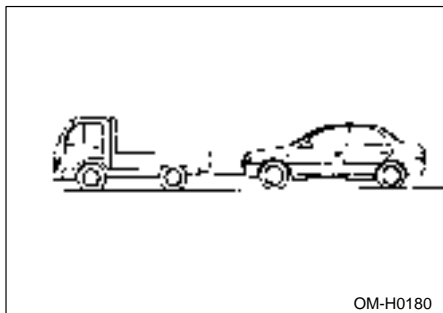

We do not recommend this method of towing. Use this method only when towing service by a SUBARU dealer or a commercial towing service is not available.

1. Check the transmission and differential oil levels and add oil to bring it to the upper level if necessary.
2. Release the parking brake and put the transmission in neutral.
3. The ignition switch should be in the "ACC" position while the vehicle is being towed.
4. Take up slack in the towline slowly to prevent damage to the vehicle.

■ Towing eyelets



CAUTION

- Never use the tie-down eyelet closest to the muffler under the vehicle for towing purposes.
- Do not apply excessive lateral load to the towing eyelets.

Towing eyelets



Towing and tie-down eyelets

HG0110



Towing eyelet

HG0197

Never use tie-down eyelet
for towing purposes.



HG0111

The towing eyelets should be used only in an emergency (e.g., to free a stuck vehicle from mud, sand or snow).

Appearance care

Exterior care	9-2
Washing	9-2
Waxing and polishing	9-3
Corrosion protection	9-4
Cleaning aluminum wheels	9-5
Cleaning the interior	9-6

Exterior care

■ Washing



CAUTION

- **When washing the vehicle, the brakes may get wet. As a result, the brake stopping distance will be longer. To dry the brakes, drive the vehicle at a safe speed while lightly pressing the brake pedal to heat up the brakes.**
- **Do not wash the engine compartment and areas adjacent to it. If water enters electrical parts or the power steering fluid reservoir, it will cause engine trouble or faulty power steering respectively.**

The best way to preserve your vehicle's beauty is frequent washing. Wash the vehicle at least once a month to avoid contamination by road grime.

Wash dirt off with a wet sponge and plenty of lukewarm or cold water. Do not wash the vehicle with hot water and in direct sunlight.

Salt, chemicals, insects, tar, soot and bird droppings should be washed off by using a light detergent, as required. If you use a light detergent, make certain that it is a neutral detergent. Do not use strong soap or chemical detergents. All cleaning agents should be promptly flushed from the surface and not allowed to dry there. Rinse the vehicle thoroughly with plenty of lukewarm water. Wipe the remaining water off with a chamois or soft cloth.

NOTE

When having your vehicle washed in an automatic car wash, make sure beforehand that the car wash is of suitable type. If the vehicle is equipped with a rear spoiler, it may be damaged by the brush, etc.

▼ Washing the underbody

Chemicals, salts, and gravel used for deicing road surfaces are extremely corrosive, accelerating the corrosion of underbody components, such as the exhaust system, fuel and brake lines, brake

cables, floor pan and fenders, and suspension.

Thoroughly flush the underbody and inside of the fenders with lukewarm or cold water at frequent intervals to reduce the harmful effects of such agents.

▼ Using a warm water washer

- Keep a good distance of 12 inches (30 cm) or more between the washer nozzle and the vehicle.
- Do not wash the same area continuously.
- If a stain will not come out easily, wash by hand. Some warm water washers are of the high temperature, high pressure type and they can damage or deform the resin parts such as mouldings, or cause water to leak into the vehicle.

■ Waxing and polishing

Always wash and dry the vehicle before waxing and polishing.

Use a good quality polish and wax and apply them according to the manufacturer's instructions. Wax or polish when the painted surface is cool.

Be sure to polish and wax the chrome trim, as well as the painted surfaces. Loss of wax on a painted surface leads to loss of the original luster and also quickens the deterioration of the surface. It is recommended that a coat of wax be applied at least once a month, or whenever the surface no longer repels water.

If the appearance of the paint has diminished to the point where the luster or tone cannot be recovered, lightly polish the surface with a fine-grained compound. Never polish just the affected area, but include the surrounding area as well. Always polish in only one direction. A No. 2000 grain compound is recommended. Never use a coarse-grained compound. Coarser grained compounds have a smaller grain-size number and could damage the paint. After polishing with a compound, coat with wax to restore the original luster. Frequent polishing with a compound or an incorrect polishing technique will result in removing the paint layer and exposing the undercoat. When in doubt, it is always best to contact your SUBARU dealer or an auto paint specialist.

Corrosion protection

Your SUBARU has been designed and built to resist corrosion. Special materials and protective finishes have been used on most parts of the vehicle to help maintain fine appearance, strength, and reliable operation.

▼ Most common causes of corrosion

The most common causes of corrosion are:

1. The accumulation of moisture retaining dirt and debris in body panel sections, cavities, and other areas.
2. Damage to paint and other protective coatings caused by gravel and stone chips or minor accidents.

Corrosion is accelerated on the vehicle when:

1. It is exposed to road salt or dust control chemicals, or used in coastal areas where there is more salt in the air, or in areas where there is considerable industrial pollution.
2. It is driven in areas of high humidity, especially when temperatures range just above freezing.
3. Dampness in certain parts of the vehicle remains for a long time, even though other parts of the vehicle may be dry.
4. High temperatures will cause corrosion to parts of the vehicle which cannot dry quickly due to lack of proper ventilation.

▼ To help prevent corrosion

Wash the vehicle frequently. If you drive on salted roads in the winter or if you live in a coastal area, you should flush the underbody with fresh water frequently.

After the winter has ended, it is recommended that the underbody be given a very thorough washing.

Before the beginning of winter, check the condition of underbody components, such as the exhaust system, fuel and brake lines, brake cables, suspension, steering system, floor pan, and fenders. If any of them are found to be rusted, they should be given an appropriate rust prevention treatment or should be replaced. Contact your SUBARU

dealer to perform this kind of maintenance and treatment if you need assistance.

Repair chips and scratches in the paint as soon as you find them.

Check the interior of the vehicle for water and dirt accumulation under the floor mats because that could cause corrosion. Occasionally check under the mats to make sure the area is dry.

Keep your garage dry. Do not park your vehicle in a damp, poorly ventilated garage. In such a garage, corrosion can be caused by dampness. If you wash the vehicle in the garage or put the vehicle into the garage when wet or covered with snow, that can cause dampness.

If your vehicle is operated in cold weather and/or in areas where road salts and other corrosive materials are used, the door hinges and locks, trunk lid lock, and hood latch should be inspected and lubricated periodically.

Cleaning aluminum wheels

- Promptly wipe the aluminum wheels clean of any kind of grime or agent. If dirt is left on too long, it may be difficult to clean off.
- Do not use soap containing grit to clean the wheels. Be sure to use a neutral cleaning agent, and later rinse thoroughly with water. Do not clean the wheels with a stiff brush or expose them to a high-speed washing device.
- Clean the vehicle (including the aluminum wheels) with water as soon as possible when it has been splashed with sea water, exposed to sea breezes, or driven on roads treated with salt or other agents.

Cleaning the interior

Use a vacuum cleaner to get rid of the dust and dirt. Wipe the vinyl areas with a clean, damp cloth.

▼ Seat fabric

Remove loose dirt, dust or debris with a vacuum cleaner. If the dirt is caked on the fabric or hard to remove with a vacuum cleaner, use a soft brush then vacuum it.

Wipe the fabric surface with a tightly wrung cloth and dry the seat fabric thoroughly. If the fabric is still dirty, wipe using a solution of mild soap and lukewarm water then dry thoroughly.

If the stain does not come out, try a commercially-available fabric cleaner. Use the cleaner on a hidden place and make sure it does not affect the fabric adversely. Use the cleaner according to its instruction.

▼ Synthetic leather upholstery

The synthetic leather material used on the SUBARU may be cleaned using mild soap or detergent and water, after first vacuuming or brushing away loose dirt. Allow the soap to soak in for a few minutes and wipe off with a clean, damp cloth. Commercial foam-type cleaners suitable for synthetic leather materials may be used when necessary.

NOTE

Strong cleaning agents such as solvents, paint thinners, window cleaner or gasoline must never be used on leather or synthetic interior materials.

Maintenance and service

<i>Maintenance schedule</i>	10-3
<i>Maintenance precautions</i>	10-3
<i>Engine compartment overview</i>	10-6
<i>Engine oil</i>	10-7
<i>Cooling system</i>	10-12
<i>Engine coolant</i>	10-13
<i>Air cleaner element</i>	10-16
<i>Spark plugs</i>	10-17
<i>Drive belts</i>	10-18
<i>Manual transmission oil</i>	10-19
<i>Automatic transmission fluid</i>	10-20
<i>Front differential gear oil (Automatic transmission vehicles)</i>	10-22
<i>Rear differential gear oil</i>	10-23
<i>Power steering fluid</i>	10-25
<i>Brake fluid</i>	10-26
<i>Clutch fluid (2.5 liter MT models)</i>	10-28
<i>Brake booster</i>	10-29
<i>Battery</i>	10-29
<i>Windshield washer fluid</i>	10-31
<i>Replacement of windshield wiper blades</i>	10-32
<i>Brake pedal</i>	10-34
<i>Clutch pedal (Manual transmission vehicles)</i>	10-36
<i>Replacement of brake pad and lining</i>	10-37
<i>Parking brake stroke</i>	10-38
<i>Tires and wheels</i>	10-39
<i>Tire pressure</i>	10-39
<i>Tire rotation</i>	10-40
<i>Aluminum wheels (if equipped)</i>	10-44
<i>Fuses</i>	10-44
<i>Main fuse and fusible link</i>	10-47
<i>Installation of accessories</i>	10-48
<i>Replacing bulbs</i>	10-49
<i>Headlight</i>	10-49

Fog light (if equipped)	10-50
Parking light	10-52
Front turn signal light	10-53
Side turn signal light	10-54
Rear combination lights	10-55
License plate light	10-57
Interior light, spot light	10-57
Dome/Rear map reading lights (if equipped)	10-58

Maintenance schedule

The scheduled maintenance items required to be serviced at regular intervals are shown in the “Warranty and Maintenance Booklet”.

For details of your maintenance schedule, read the separate “Warranty and Maintenance Booklet”.

Maintenance precautions

When maintenance and service are required, it is recommended that all work be done by an authorized SUBARU dealer.

If you perform maintenance and service by yourself, you should familiarize yourself with the information provided in this section on general maintenance and service for your SUBARU.

Incorrect or incomplete service could cause improper or unsafe vehicle operation. Any problems caused by improper maintenance and service performed by you are not eligible for warranty coverage.



WARNING

- **Testing of a Full-Time All-Wheel Drive vehicle must NEVER be performed on a single two-wheel dynamometer or similar apparatus nor should you install FWD fuse in the engine compartment. Attempting to do so will result in transmission damage and in uncontrolled vehicle movement and may cause an accident or injuries to persons nearby.**
- **Always select a safe area when performing maintenance on your vehicle.**
- **Always be very careful to avoid injury when working on the vehicle. Remember that some of the materials in the vehicle may be hazardous if improperly used or handled, for example, battery acid.**
- **Your vehicle should only be serviced by persons fully competent to do so. Serious personal injury may result to persons not experienced in servicing vehicles.**

-
- Always use the proper tools and make certain that they are well maintained.
 - Never get under the vehicle supported only by jack. Always use a safety stands to support the vehicle.
 - Never keep the engine running in a poorly ventilated area, such as a garage or other closed areas.
 - Do not smoke or allow open flames around the fuel or battery. This will cause a fire.
 - Wear adequate eye protection to guard against getting oil or other fluids in your eyes. If something does get in your eyes, thoroughly wash it out with clean water.
 - Because the fuel system is under pressure, replacement of the fuel filter should be performed only by your SUBARU dealer.
 - The SRS airbag has no user-serviceable parts. Tampering with or disconnecting the system's wiring could result in accidental inflation of the airbag or could make the system inoperative, which may result in serious injury. The wiring harnesses of the SRS airbag system are covered with yellow insulation and the connectors of the system are yellow, for easy identification. Do not use electrical test equipment on any circuit related to the SRS airbag system. For required servicing of the SRS airbag, see your nearest SUBARU dealer.

■ Before checking or servicing in the engine compartment

- Always stop the engine and set the parking brake firmly to prevent the vehicle from moving.
- Always let the engine cool down. Engine parts become very hot when the engine is running and remain hot for some time after the engine is stopped.
- Do not spill engine oil, engine coolant, brake fluid or any other fluid on hot engine components. This may cause a fire.
- Always remove the key from the ignition switch. When the ignition switch is in the "ON" position, the cooling fan may operate suddenly even when the engine is stopped.

■ When you do checking or servicing in the engine compartment while the engine is running

A running engine can be dangerous. Keep your fingers, hands, clothing, hair and tools away from the cooling fan, belts and any other moving engine parts. Removing rings, watches and ties is advisable.

Engine compartment overview

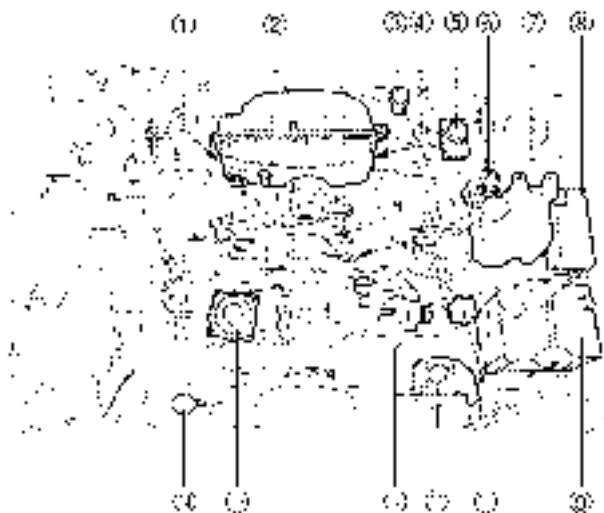

HGA017BB

- | | |
|--|---|
| ① Manual transmission oil level gauge (MT) (page 10-19) or Differential gear oil level gauge (AT) (page 10-22) | ⑦ Windshield washer tank (page 10-31) |
| ② Air cleaner element (page 10-16) | ⑧ Fuse box (page 10-44) |
| ③ Clutch fluid reservoir (page 10-28) | ⑨ Battery (page 10-29) |
| ④ Automatic transmission fluid level gauge (page 10-20) | ⑩ Engine oil filler cap (page 10-7) |
| ⑤ Brake fluid reservoir (page 10-26) | ⑪ Engine coolant reservoir (page 10-13) |
| ⑥ Fuel filter | ⑫ Engine oil level gauge (page 10-7) |
| | ⑬ Power steering fluid reservoir (page 10-25) |
| | ⑭ Radiator cap (page 10-13) |

Engine oil

▼ Checking the oil level

Check the engine oil level at each fuel stop.

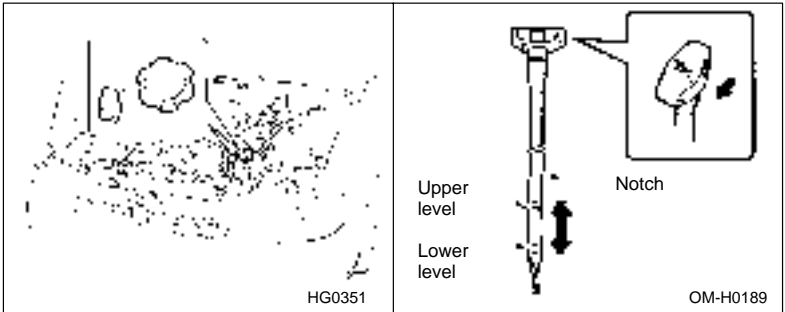

1. Park the vehicle on a level surface and stop the engine.
2. Pull out the dipstick, wipe it clean, and insert it again.
3. Be sure the dipstick is correctly inserted until it stops with the graphic symbol  on its top appearing as shown in the illustration.
4. Pull out the dipstick again and check the oil level on it. If it is below the lower level, add oil to bring the level up to the upper level.



CAUTION

Use only engine oil with the recommended grade and viscosity.

If you check the oil level just after stopping the engine, wait a few minutes for the oil to drain back into the oil pan before checking the level.

Just after driving or while the engine is warm, the engine oil level reading may be in a range between the upper level and the notch mark. This is caused by thermal expansion of the engine oil.

To prevent overfilling the engine oil, do not add any additional oil above the upper level when the engine is cold.

– CONTINUED –

▼ Changing the oil and oil filter

Change the oil and oil filter according to the maintenance schedule in the "Warranty and Maintenance Booklet".

The engine oil and oil filter must be changed more frequently than listed in the maintenance schedule when driving on dusty roads, when short trips are frequently made, when towing a trailer or when driving in extremely cold weather.

1. Warm up the engine by letting the engine idle for about 10 minutes to ease draining the engine oil.
2. Park the vehicle on a level surface and stop the engine.
3. Remove the oil filler cap.

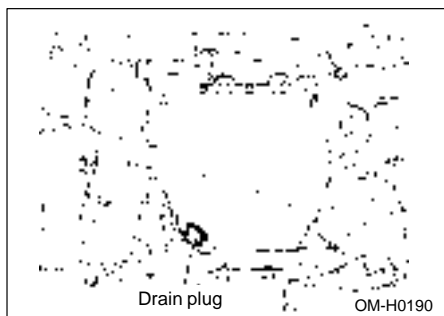

4. Drain out the engine oil by removing the drain plug while the engine is still warm. The used oil should be drained into an appropriate container and disposed of properly.



WARNING

Be careful not to burn yourself with hot engine oil.

5. Wipe the seating surface of the drain plug with a clean cloth and tighten it securely with a new sealing washer after the oil has completely drained out.

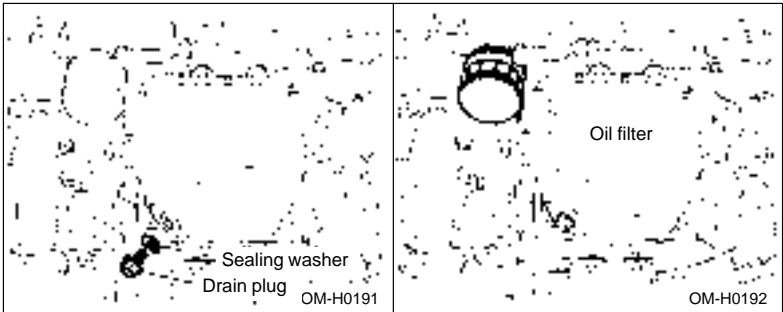

6. Remove the oil filter with an oil filter wrench.
7. Before installing a new oil filter, apply a thin coat of engine oil to the seal.
8. Clean the rubber seal seating area of the lower crank case and install the oil filter by hand turning. Be careful not to twist or damage the seal.
9. Tighten it approximately two-thirds of a turn after the seal makes contact with underside of the crank case.



CAUTION

Never over tighten the oil filter because that can result in an oil leak.

10. Pour the specified amount of engine oil through the filler neck.

Oil capacity: 4.2 US qt (4.0 liters, 3.5 Imp qt)

11. Start the engine and make sure that no oil leaks appear around the filter's rubber seal.
12. Run the engine until it reaches the normal operating temperature. Then stop the engine and wait a few minutes to allow the oil drain back. Check the oil level again and if necessary, add more engine oil.

– CONTINUED –

▼ Recommended grade and viscosity



CAUTION

Use only engine oil with the recommended grade and viscosity.

Oil grade: API classification SJ or SH with the words “ENERGY CONSERVING II” (if you cannot obtain the oil with SJ or SH grade, you may use SG grade oil.) or the new API mark (Starburst mark) displayed on the container.

API Service label

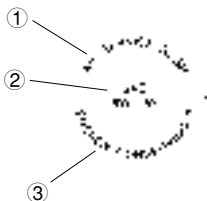

New API Certification Mark (Starburst Mark)



- ① Indicates the oil quality by API designations
- ② Indicates the SAE oil viscosity grade
- ③ Indicates that the oil has fuel saving capabilities

In choosing an oil, you want the proper quality and viscosity, as well as one that will add to fuel economy. The following table lists the recommended viscosities and applicable temperatures.

When adding oil, different brands may be used together as long as they are the same API classification and SAE viscosity as those recommended by SUBARU.

Engine oil viscosity (thickness) affects fuel economy. Oils of lower viscosity provide better fuel economy. However, in hot weather, oil of higher viscosity is required to properly lubricate the engine.

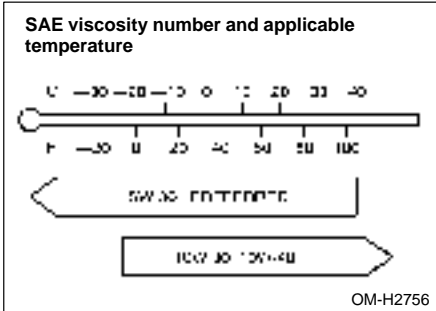

▼ **Recommended grade and viscosity under severe driving conditions**

If the vehicle is used in desert areas, in areas with very high temperatures, or used for heavy-duty applications such as towing a trailer, use of oil with the following grade and viscosities is recommended.

API classification: SJ or SH

SAE viscosity No.: 30, 40, 10W-50, 20W-40, 20W-50

Cooling system



WARNING

Never attempt to remove the radiator cap until the engine has been shut off and has cooled down completely. Since the coolant is under pressure, you may suffer serious burns from a spray of boiling hot coolant when the cap is removed.



CAUTION

- The cooling system has been filled at the factory with a high quality, corrosion-inhibiting, year-around coolant which provides protection against freezing down to -33°F (-36°C). For adding, use genuine SUBARU coolant or an equivalent: a mixture of 50% soft water and 50% ethylene-glycol basis coolant. Use of improper coolants may result in corrosion in the cooling system. It is important to maintain protection against freezing and corrosion, even if freezing temperatures are not expected. Never mix different kinds of coolant.
- Do not splash the engine coolant over painted parts. The alcohol contained in the engine coolant may damage the paint surface.

▼ Hose and connections

Your vehicle employs an electric cooling fan which is thermostatically controlled to operate when the engine coolant reaches a specific temperature.

If the radiator cooling fan does not operate even when the engine coolant temperature gauge exceeds the normal operating range, the cooling fan circuit may be defective. Check the fuse and replace it if necessary. If the fuse is not blown, have the cooling system checked by your SUBARU dealer.

If frequent addition of coolant is necessary, there may be a leak in the engine cooling system. It is recommended that the cooling system and connections be checked for leaks, damage, or looseness.

■ Engine coolant

▼ Checking the coolant level

Check the coolant level at each fuel stop.

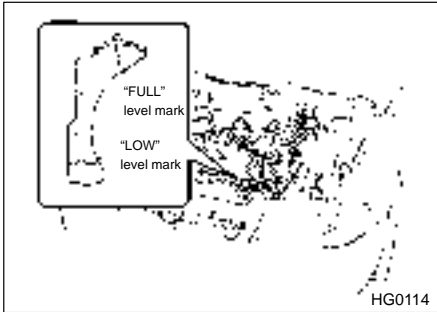

1. Check the coolant level on the outside of the reservoir while the engine is cool.
2. If the level is close to or lower than the "LOW" level mark, add coolant up to the "FULL" level mark. If the reserve tank is empty, remove the radiator cap and refill as required.

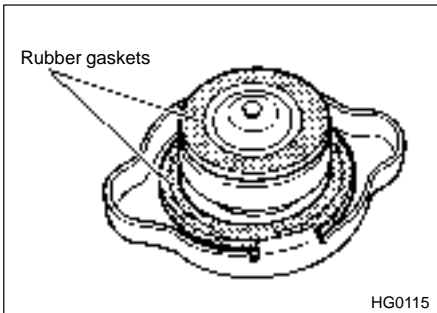

3. After refilling the reserve tank and the radiator, reinstall the caps and check that the rubber gaskets inside the radiator cap are in the proper position.

– CONTINUED –

▼ Changing the coolant

WARNING

Never attempt to remove the radiator cap until the engine has been shut off and has cooled down completely. Since the coolant is under pressure, you may suffer serious burns from a spray of boiling hot coolant when the cap is removed.

Change the engine coolant in the following procedures according to the maintenance schedule in the “Warranty and Maintenance Booklet”.

1. Place a proper container under the drain plug and loosen the drain plug.

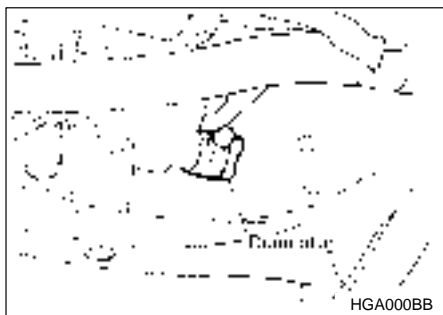

2. Loosen the radiator cap to drain the coolant from the radiator. Then drain the coolant from the reserve tank. Tighten the drain plug securely.

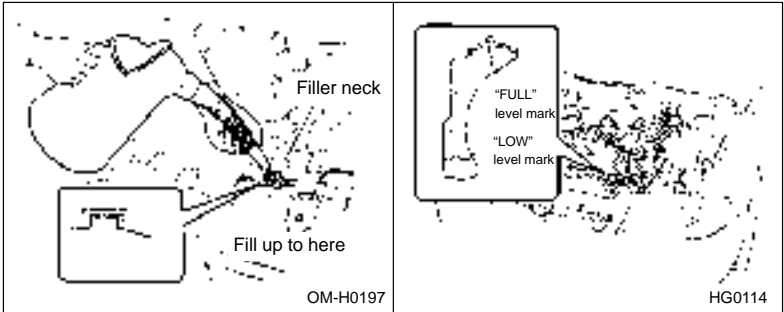

3. Slowly pour the coolant and fill to the radiator filler neck and to the reserve tank's "FULL" level mark. Do not pour the coolant too quickly, as this may lead to insufficient air bleeding and trapped air in the system.

Coolant capacity: 6.2 US qt (5.8 liters, 5.2 Imp qt)

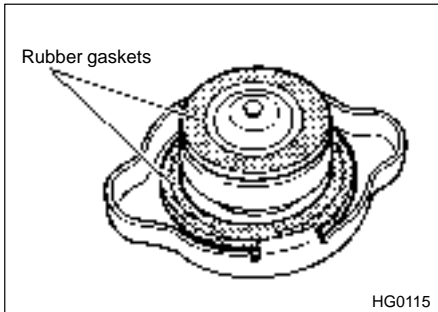

4. Put the radiator cap back on and tighten firmly. At this time, make sure that the rubber gaskets in the radiator cap are correctly in place.
5. Start and run the engine for more than five minutes at 2,000 to 3,000 rpm.
6. Stop the engine and wait until the coolant cools down (122 to 140°F [50 to 60 °C]). If there is any loss of coolant, add coolant to the radiator's filler neck and to the reserve tank's "FULL" level.

– CONTINUED –

7. Put the radiator cap and reservoir cap back on and tighten firmly.

Air cleaner element



WARNING

Do not operate the engine with the air cleaner element removed. The air cleaner element not only filters intake air but also stops flames if the engine backfires. If the air cleaner element is not installed when the engine backfires, you could be burned.

The air cleaner element functions as a filter screen. When the element is perforated or removed, engine wear will be excessive and engine life shortened.

The air cleaner element is a viscous type. It is unnecessary to clean or wash the element.

▼ Replacing the air cleaner element

Replace the air cleaner element according to the maintenance schedule in the "Warranty and Maintenance Booklet". Under extremely dusty conditions, replace it more frequently. It is recommended that you always use genuine SUBARU parts.

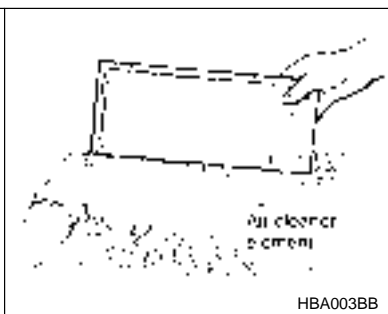
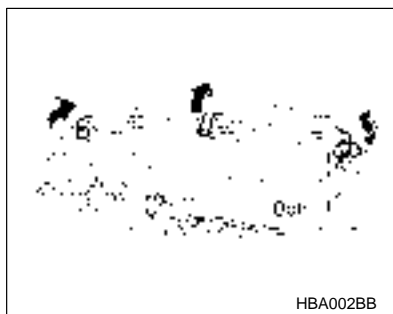

1. Remove the bolt securing the rear air cleaner element case.
2. Unsnap the three clamps holding the rear air cleaner element

case.

3. Separate the rear air cleaner element case from the front air cleaner element case and remove the air cleaner element.
4. Clean the inside of the front and rear air cleaner element cases with a damp cloth and install a new air cleaner element.
5. Insert the four projections on the rear air cleaner element case into the slits on the front air cleaner element case and snap the three clamps on the rear air cleaner element case and then tighten the bolt.

Spark plugs



CAUTION

- **When disconnecting the spark plug cables, always grasp the spark plug cap, not the cables.**
- **Make sure the cables are replaced in the correct order.**

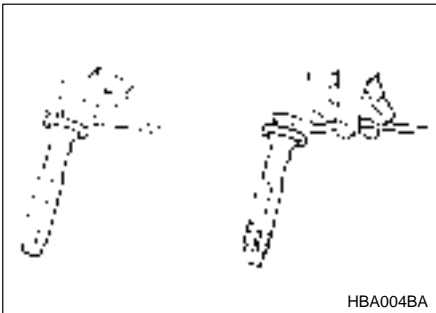

It may be difficult to replace the spark plugs. It is recommended that you have the spark plugs replaced by your SUBARU dealer.

The spark plugs should be replaced according to the maintenance schedule in the "Warranty and Maintenance Booklet".

▼ Recommended spark plugs

NGK	CHAMPION	NIPPONDENSO
BKR6E-11	RC10YC4 RC8YC4	K20PR-U11

Drive belts

The alternator, power steering pump, and air conditioner compressor depend on drive belts. Satisfactory performance requires that belt tension be correct.

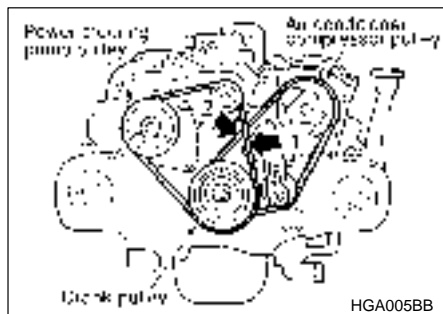

in. (mm)

	Deflection	
	New belt	Used belt
①	0.28 — 0.35 (7.0 — 9.0)	0.35 — 0.43 (9.0 — 11.0)
②	0.30 — 0.33 (7.5 — 8.5)	0.35 — 0.40 (9.0 — 10.0)

To check belt tension, place a straightedge (ruler) across two adjacent pulleys and apply a force of 98 N (22 lb, 10 kg) midway between the

pulleys by using a spring scale. Belt deflection should be the amount specified. If a belt is loose, cracked, or worn, contact your SUBARU dealer.

Manual transmission oil

▼ Checking the oil level

Check the oil level monthly.

1. Park the vehicle on a level surface and stop the engine.

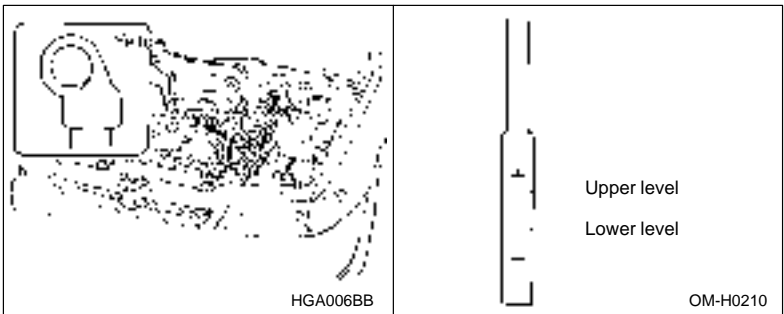

2. Pull out the dipstick, wipe it clean, and insert it again.
3. Pull out the dipstick again and check the oil level on it. If it is below the lower level, add oil through the dipstick hole to bring the level up to the upper level.

▼ Recommended grade and viscosity

Each oil manufacturer has its own base oils and additives. Never use different brands together.

Oil grade: API classification GL-5

SAE viscosity No. and Applicable Temperature

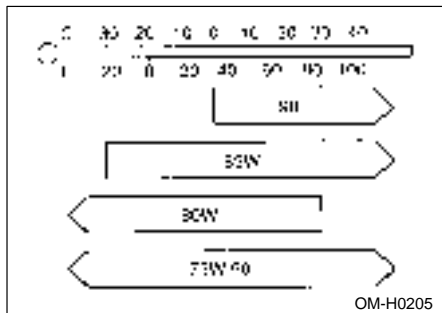

Automatic transmission fluid

▼ Checking the fluid level

The automatic transmission fluid expands largely as its temperature rises; the fluid level differs according to fluid temperature. Therefore, there are two different scales for checking the level of hot fluid and cold fluid on the dipstick.

Though the fluid level can be checked without warming up the fluid on the "COLD" side, we recommend checking the fluid level when the fluid is at operating temperature.

▽ Checking the fluid level when the fluid is hot

Check the fluid level monthly.

1. Drive the vehicle several miles to raise the temperature of the transmission fluid up to normal operating temperature; 140 to 176°F (60 to 80 °C) is normal.
2. Park the vehicle on a level surface and set the parking brake.
3. First shift the selector lever in each position. Then shift it in the "P" position, and run the engine at idling speed.

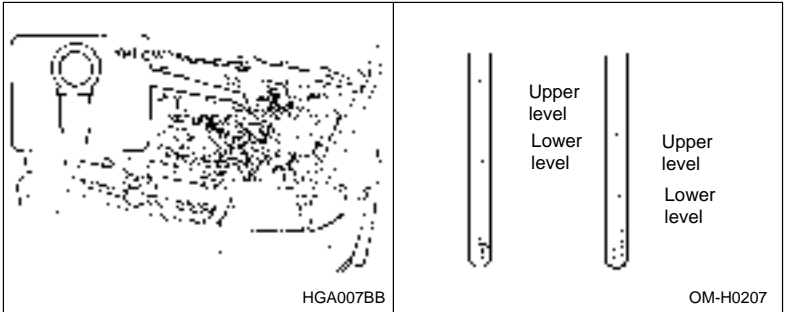

4. Pull out the dipstick and check the fluid level on the gauge. If it is below the lower level on the "HOT" range, add the recommended automatic transmission fluid up to the upper level.

▽ **Checking the fluid level when the fluid is cold**

When the fluid level has to be checked without time to warm up the automatic transmission, check to see that the fluid level is between the lower level and upper level on the "COLD" range. If it is below that range, add fluid up to the upper level. Be careful not to overfill.

▼ **Recommended fluid**

"Dexron II" or "Dexron III" Type Automatic Transmission Fluid

Front differential gear oil (Automatic transmission vehicles)

▼ Checking the oil level

Check the differential oil level monthly.

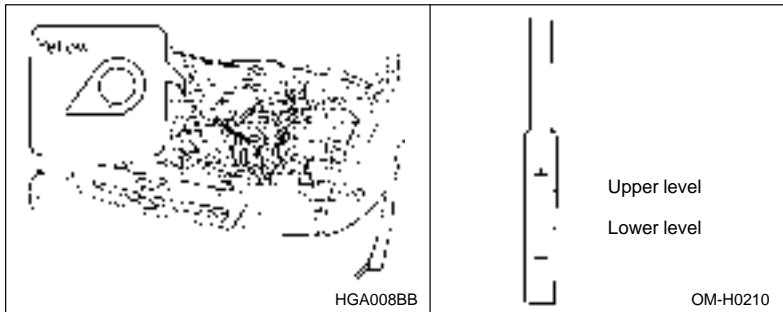

1. Park the vehicle on a level surface and stop the engine.
2. Pull out the dipstick, wipe it clean, and insert it again.
3. Pull out the dipstick again and check the oil level on it. If it is below the lower level, add oil to bring the level up to the upper level.

▼ Recommended grade and viscosity

Each oil manufacturer has its own base oils and additives. Never use different brands together.

Oil grade: API classification GL-5

SAE viscosity No. and Applicable Temperature

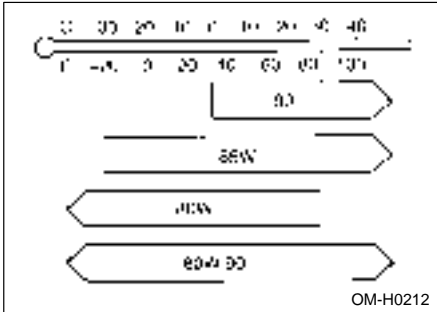

Rear differential gear oil

▼ Checking the oil level



CAUTION

If the vehicle requires frequent refilling, there may be an oil leak. If you suspect a problem, have the vehicle checked at your SUBARU dealer.

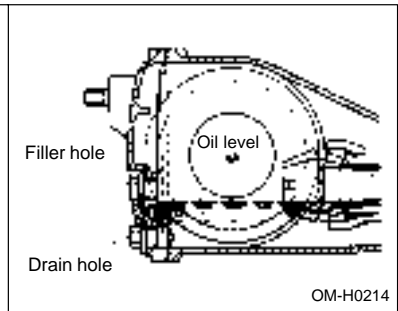
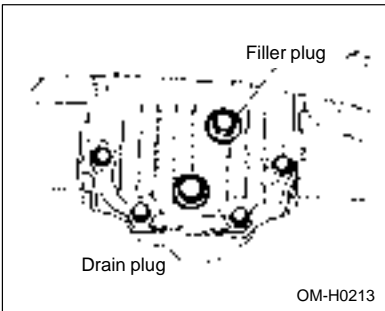

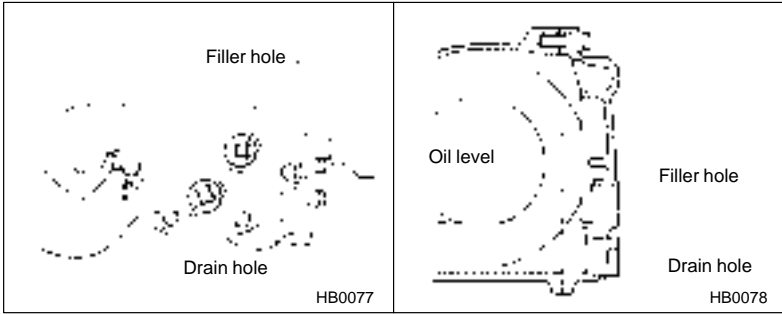

Remove the plug from the filler hole and check the oil level. The oil level should be kept even with the bottom of the filler hole. If the oil level is below the bottom edge of the hole, add oil through the filler hole to raise the level.

▼ Recommended grade and viscosity

Each oil manufacturer has its own base oils and additives. Never use different brands together.

Oil grade: API classification GL-5

SAE viscosity No. and Applicable Temperature

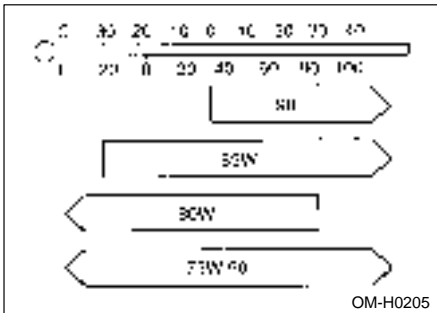

Power steering fluid

The power steering fluid expands greatly as its temperature rises; the fluid level differs according to fluid temperature. Therefore, the dipstick has two different checking ranges for hot and cold fluids.

▼ Checking the fluid level when the fluid is hot



WARNING

Be careful not to burn yourself because the fluid may be hot.



CAUTION

- When power steering fluid is being added, use only clean fluid, and be careful not to allow any dirt into the tank. And never use different brands together.
- Avoid spilling fluid when adding it in the tank.

Check the power steering fluid level monthly.

1. Drive the vehicle several miles to raise the temperature of the power steering fluid up to normal operating temperature, about 140°F (60°C).
2. Park the vehicle on a level surface, and stop the engine.
3. Turn the reservoir cap counterclockwise to remove the fluid level dipstick, wipe the dipstick clean, and reinsert it.

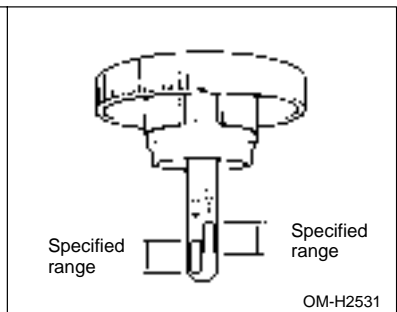
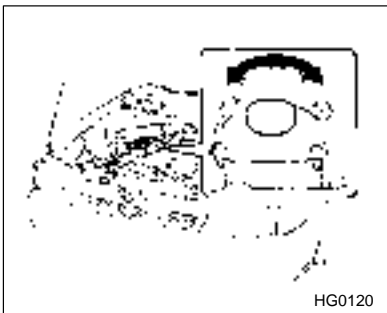

– CONTINUED –

4. Remove the dipstick again and check the fluid level on it. If it is below the lower level of the "HOT" range, add the recommended steering fluid up to the specified range of the dipstick.

If the fluid level is extreme low, it may indicate possible leakage. Consult your SUBARU dealer for inspection.

▼ **Checking the fluid level when the fluid is cold**

When the fluid level has to be checked without warming up the power steering system (approximately 70°F [21°C]), read the fluid level on the "COLD" range.

▼ **Recommended fluid**

"Dexron II, Dexron II E or Dexron III" Type Automatic Transmission Fluid

Brake fluid

▼ **Checking the fluid level**



WARNING

- **Never let brake fluid contact your eyes because brake fluid can be harmful to your eyes. If brake fluid gets in your eyes, immediately flush them thoroughly with clean water. For safety, when performing this work, wearing eye protection is advisable.**
- **Brake fluid absorbs moisture from the air. Any absorbed moisture can cause a dangerous loss of braking performance.**
- **If the vehicle requires frequent refilling, there may be a leak. If you suspect a problem, have the vehicle checked at your SUBARU dealer.**



CAUTION

- Never use different brands of brake fluid together.
- When adding brake fluid, be careful not to allow any dirt into the reservoir.
- Never splash the brake fluid over painted surfaces or rubber parts. Alcohol contained in the brake fluid may damage them.

Check the fluid level monthly.

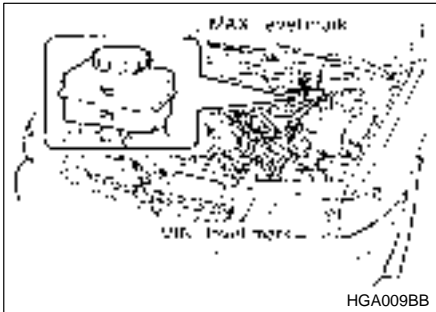

Check the fluid level on the outside of the reservoir. If the level is below "MIN", add the recommended brake fluid to "MAX".

Use only brake fluid from a sealed container.

▼ Recommended brake fluid

FMVSS No. 116, fresh DOT 3 or 4 brake fluid

Clutch fluid (2.5 liter MT models)

WARNING

Never let clutch fluid contact your eyes because clutch fluid can be harmful to your eyes. If clutch fluid gets in your eyes, immediately flush them thoroughly with clean water. For safety, when performing this work, wearing eye protection is advisable.

CAUTION

- Clutch fluid absorbs moisture from the air. Any absorbed moisture can cause improper clutch operation.
- If the vehicle requires frequent refilling, there may be a leak. If you suspect a problem, have the vehicle checked at your SUBARU dealer.
- Never use different brands of clutch fluid together.
- When clutch fluid is added, be careful not to allow any dirt into the tank.

Check the fluid level on the outside of the reservoir. If the level is below "MIN" level mark, add the recommended clutch fluid to "MAX" level mark. Use only clutch fluid from a sealed container.

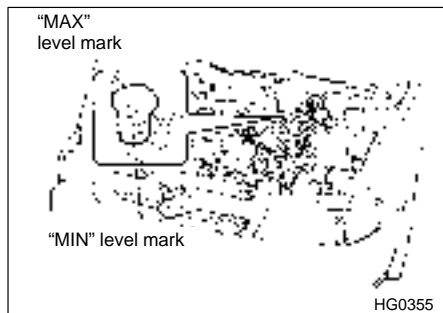

▼ **Recommended clutch fluid**

FMVSS No. 116, fresh DOT 3 or 4 brake fluid

Brake booster

If the brake booster does not operate as described below, have it checked by your SUBARU dealer.

1. With the engine off, depress the brake pedal several times, applying the same pedal force each time. The distance the pedal travels should not vary.
2. With the brake pedal depressed, start the engine. The pedal should move slightly down to the floor.
3. With the brake pedal depressed, stop the engine and keep the pedal pressed for 30 seconds. The pedal height should not change.
4. Start the engine again and run for about one minute then turn it off. Depress the brake pedal several times to check the brake booster. Brake booster operates properly if the pedal stroke decreases with each depression.

Battery



WARNING

- **Before beginning work on or near any battery, be sure to extinguish all cigarettes, matches, and lighters. Never expose a battery to an open flame or electric sparks. Batteries give off a gas which is highly flammable and explosive.**
- **For safety, in case an explosion does occur, wear eye protection or shield your eyes when working near any battery. Never lean over a battery.**
- **Do not let battery fluid contact eyes, skin, fabrics, or paint because battery fluid is a corrosive acid. If battery fluid gets on your skin or in your eyes, immediately flush the area with water thoroughly. Seek medical help immediately if acid has entered the**

– CONTINUED –

eyes.

- To lessen the risk of sparks, remove rings, metal watchbands, and other metal jewelry. Never allow metal tools to contact the positive battery terminal and anything connected to it **WHILE** you are at the same time in contact with any other metallic portion of the vehicle because a short circuit will result.
- Keep everyone including children away from the battery.
- Charge the battery in a well-ventilated area.



CAUTION

Never use more than 10 amperes when charging the battery because it will shorten battery life.

▼ Checking the fluid level

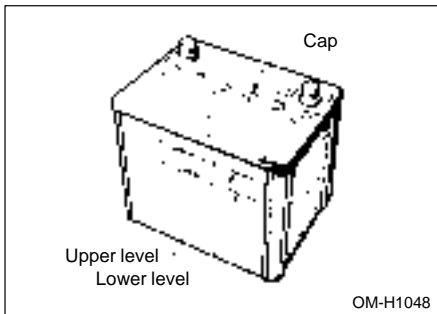

It is unnecessary to periodically check the battery fluid level or periodically refill with distilled water.

However, if the battery fluid level is below the lower level, remove the cap. Fill to the upper level with distilled water.

Windshield washer fluid



CAUTION

Never use engine coolant as washer fluid because it could cause paint damage.

Check the level of the washer fluid at each fuel stop. If the level is low, fill the fluid up to the neck of the reservoir.

Use windshield washer fluid. If windshield washer fluid is unavailable use clean water.

In areas where water freezes in winter, use an anti-freeze type windshield washer fluid. SUBARU Windshield Washer Fluid contains 58.5% methyl alcohol and 41.5% surfactant, by volume. Its freezing temperature varies according to how much it is diluted, as indicated below.

Washer Fluid Concentration	Freezing Temperature
30%	10.4°F(-12°C)
50%	-4 °F(-20°C)
100%	-49°F(-45°C)

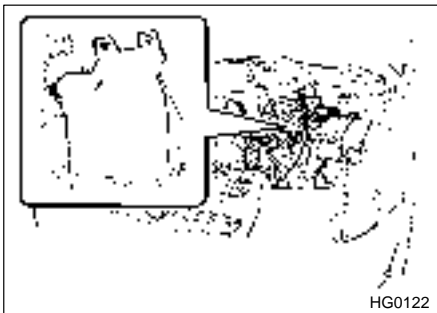

HG0122

Replacement of windshield wiper blades

Grease, wax, insects, or other materials on the windshield or the wiper blade results in jerky wiper operation and streaking on the glass. If you cannot remove those streaks after operating the windshield washer or if the wiper operation is jerky, clean the outer surface of the windshield (or rear window) and the wiper blades using a sponge or soft cloth with a neutral detergent or mild-abrasive cleaner. After cleaning, rinse the windshield and wiper blades with clean water. The windshield is clean if beads do not form when you rinse the windshield with water.



CAUTION

Do not clean the wiper blades with gasoline or a solvent, such as paint thinner or benzene. This will cause deterioration of the wiper blades.

If you cannot eliminate the streaking ever after following this method, replace the wiper blades using the following procedures:

1. Raise the wiper arm off the windshield.
2. Remove the wiper blade assembly by holding its pivot area and pushing it in the direction shown by the arrow while depressing the wiper blade stopper.

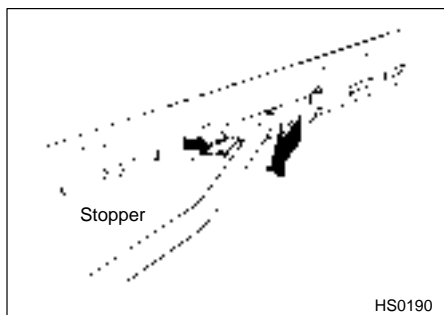

3. Grasp the locked end of the blade rubber assembly and pull it firmly until the stoppers on the rubber are free of the metal support.

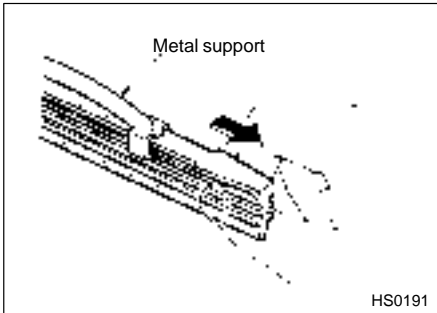

4. If the new blade rubber is not provided with two metal spines, remove the metal spines from the old blade rubber and install them in the new blade rubber.

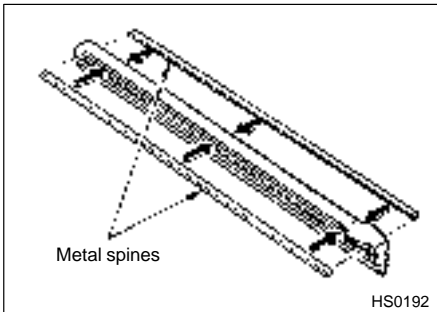

5. Align the claws of the metal support with the grooves in the rubber and slide the blade rubber assembly into the metal support until it locks. Be sure to position the claws at the end of the metal support between the stoppers on the rubber as shown. If the rubber is not retained properly, the wiper blade may scratch the windshield.



6. Install the wiper blade assembly to the wiper arm. Make sure that it locks in place.
7. Lower the wiper arm.

Brake pedal

Check the brake pedal free play and reserve distance according to the maintenance schedule in the "Warranty and Maintenance Booklet".

▼ Checking the brake pedal free play

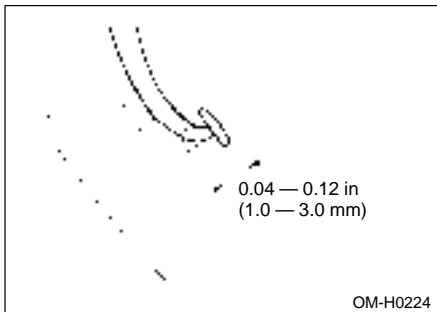

Stop the engine and firmly depress the brake pedal several times. Lightly press the brake pedal down with one finger to check the free play with a force of less than 10 N (2 lb., 1 kg). If the free play is not within proper specification, contact your

SUBARU dealer.

▼ **Checking the brake pedal reserve distance**



Depress the pedal with a force of approximately 294 N (66 lb., 30 kg) and measure the distance between the upper surface of the pedal pad and the floor.

When the measurement is smaller than the specification, or when the pedal does not operate smoothly, contact with your SUBARU dealer.

Clutch pedal (Manual transmission vehicles)

Check the clutch pedal free play and reserve distance according to the maintenance schedule in the "Warranty and Maintenance Booklet".

▼ Checking the clutch function

Check the clutch engagement and disengagement.

1. With the engine idling, check that there are no abnormal noises when the clutch pedal is depressed, and that shifting into 1st or reverse feels smooth.
2. Start the vehicle by releasing the pedal slowly to check that the engine and transmission smoothly couple without any sign of slippage.

▼ Checking the clutch pedal free play

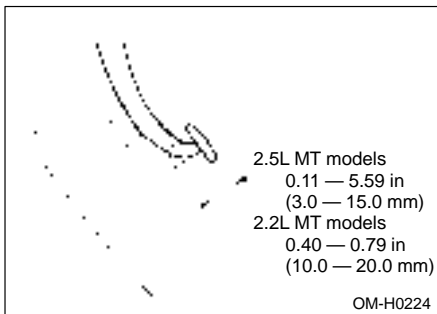

Lightly press the clutch pedal down with your finger until you feel resistance, and check the free play.

If the free play is not within proper specification, contact your SUBARU dealer.

Replacement of brake pad and lining



CAUTION

If you continue to drive despite the scraping noise from the audible brake pad wear indicator, it will result in the need for costly brake rotor repair or replacement.

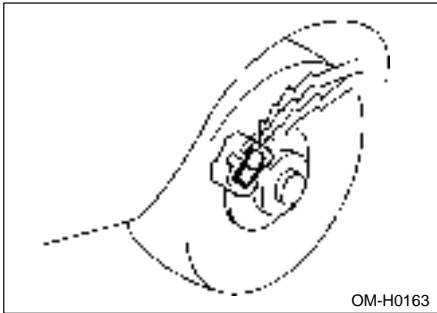

The front disc brake has an audible wear indicator on the brake pads. For RS models, the right side rear disc brake also has a audible wear indicator. If the brake pads wear close to their service limit, the wear indicator makes a very audible scraping noise when the brake pedal is applied.

If you hear this scraping noise each time you apply the brake pedal, have the brake pads serviced by your SUBARU dealer as soon as possible.

▼ **Breaking-in of new brake pads and linings**

When replacing the brake pad or lining, use only genuine SUBARU parts. After replacement, the new parts must be broken in as follows:

▽ **Brake pad and lining**

While maintaining a speed of 30 to 40 mph (50 to 65 km/h), step on the brake pedal lightly. Repeat this five or more times.

▽ Parking brake lining



WARNING

A safe location and situation should be selected for break-in driving.



CAUTION

Pulling the parking brake lever too forcefully may cause the rear wheels to lock. To avoid this, be certain to pull the lever up slowly and gently.

1. Drive the vehicle at a speed of about 22 mph (35 km/h).
2. With the parking brake release button pushed in, pull the parking brake lever SLOWLY and GENTLY. (Pulling with a force of approximately 147 N [15 Kg, 33 lb].)
3. Drive the vehicle for about 220 yards (200 meters) in this condition.
4. Wait 5 to 10 minutes for the parking brake to cool down. Repeat this procedure.
5. Check the parking brake stroke. If the parking brake stroke is out of the specified range, adjust it by turning the adjusting nut located on the parking brake lever.

Parking brake stroke: 7 — 8 notches / 196 N (20 kg, 44 lb.)

Parking brake stroke

Check the parking brake stroke according to the maintenance schedule in the "Warranty and Maintenance Booklet". When the parking brake is properly adjusted, braking power is fully applied by pulling the lever up seven to eight notches gently but firmly (about 196 N, 44 lb., 20 kg). If the parking brake lever stroke is not within the specified range, have the brake system checked and adjusted at your SUBARU dealer.

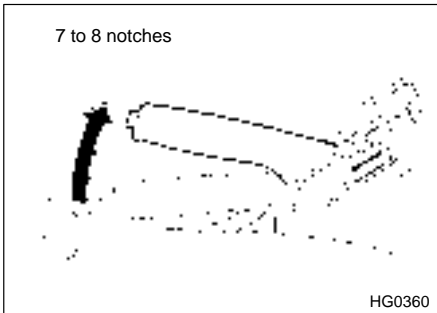

Tires and wheels



WARNING

- When replacing a tire, make sure you use only the same size, circumference, construction brand, and load range as the original tires listed on the tire placard. Using other sizes, circumferences or construction may result in severe mechanical damage to the drive train of your vehicle and may affect ride, handling, braking, speedometer/odometer calibration, and clearance between the body and tires. It also may be dangerous and lead to loss of vehicle control.
- Do not use a combination of radial, belted bias or bias tires since it may cause dangerous handling characteristics and lead to an accident.
- Do not let air out of warm tires to adjust pressure. Doing so will result in low tire pressure.

The tires should be checked frequently for proper tire pressure, wear, and cuts.

■ Tire pressure

For the best balance between fuel economy, tire life, ride comfort, and handling, tire pressure should be maintained in accordance with speci-

– CONTINUED –

cations. Check the tire pressure when the tires are cold. Cold means that the vehicle has been parked for three hours or has been driven less than 1 mile (1.6 km).

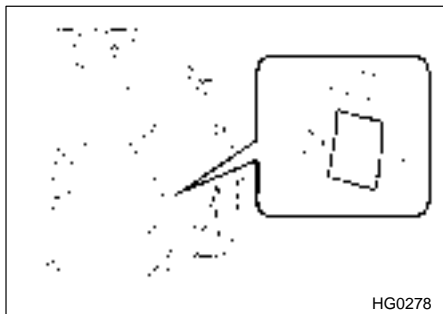

The recommended tire pressure and sizes are provided on the tire placard, which is located under the door latch on the driver's side.

■ Tire rotation

Tire wear will vary with each wheel. To increase the life of tires and keep wear uniform, it is best to rotate them every 7,500 miles (12,000 km).

When rotating tires, replace any unevenly worn or damaged tire. After rotating the tires, adjust tire pressure and be sure to check wheel nut tightness.

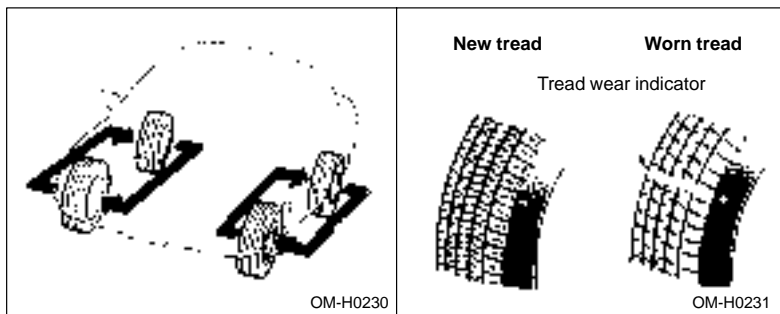

A tire should be replaced when the tread wear indicator appears as a

solid band across the tread. The indicators appear when the remaining tread has been worn to 0.063 in (1.6 mm) or less.

▼ **Wheel covers (Locking type wheel covers)**

▽ **Removing the wheel cover**



CAUTION

If it becomes necessary to remove the wheel cover, **NEVER** use a screwdriver or other prying tool. Doing so will severely damage or destroy the wheel cover.



Grasp the wheel cover with both hands by the spokes and twist sharply in a **counterclockwise** direction until you feel the detent release. Now the wheel cover is free from the retention ring.

▽ **Installing the wheel cover**

1. Install the wheel cover on the retention ring, aligning the valve stem with the valve stem area and fitting the lock pins on the wheel cover with the lock springs in the retention ring.

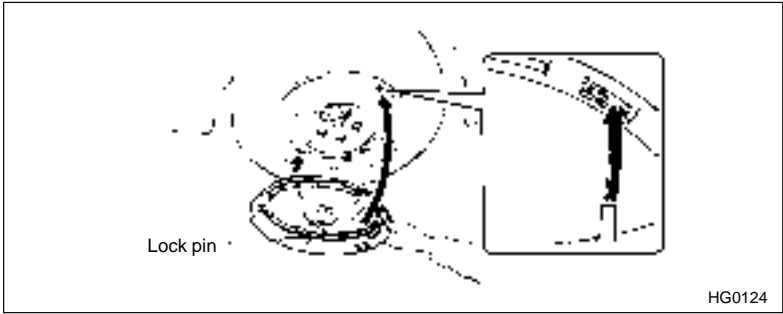

2. Grasp the wheel cover with both hands by the spokes and twist sharply in a **clockwise** direction until you feel the detent locking. After twisting the wheel cover, make sure the wheel cover is locked securely by lightly turning the wheel cover right and left.

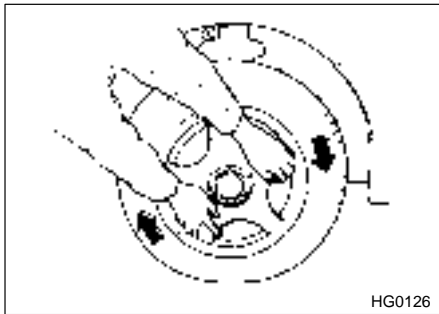

NOTE

When any of the wheels is removed and replaced for tire rotation or to change a flat tire, always check the tightness of the wheel nuts after driving approximately 600 miles (1,000 km). If any nut is loose, tighten it to the specified torque.

▼ **Wheel covers (Regular type wheel covers)**

▽ **Removing the wheel cover**

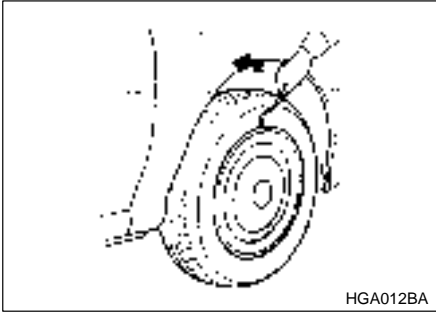

Insert the wheel cover remover into the notch provided, and pry the wheel cover off.

▽ **Installing the wheel cover**

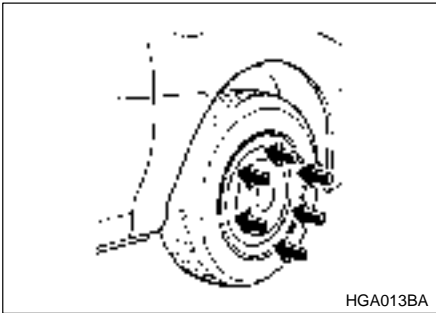

Align the valve with the valve hole in the cover, then fit the cover on the wheel by tapping your hand evenly around the circumference of the cover.

NOTE

When any of the wheels is removed and replaced for tire rotation or to change a flat tire, always check the tightness of the wheel nuts after driving approximately 600 miles (1,000 km). If any nut is loose, tighten it to the specified torque.

Aluminum wheels (if equipped)

Aluminum wheels can be scratched and damaged easily. Handle them carefully to maintain their appearance, performance, and safety.

- When any of the wheels is removed and replaced for tire rotation or to change a flat, always check the tightness of the wheel nuts after driving approximately 600 miles (1,000 km). If any nut is loose, tighten it to the specified torque.
- Never apply oil to the threaded parts, wheel nuts, or tapered surface of the wheel.
- Never let the wheel rub against sharp protrusions or curbs.
- Be sure to fit tire chains on uniformly and completely around the tire, otherwise the chains may scratch the wheel.
- When wheel nuts, balance weights, or the center cap are replaced, be sure to replace them with genuine SUBARU parts designed for aluminum wheels.

Fuses

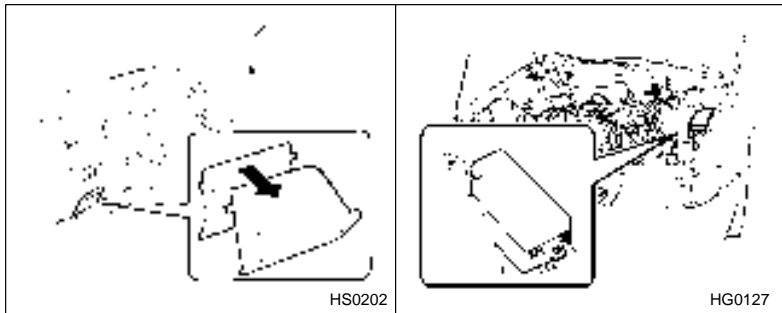

The fuses are designed to melt during an overload to prevent damage to the wiring harness and electrical equipment. The fuses are located in two fuse boxes.

If any lights, accessories or other electrical controls do not operate, inspect the corresponding fuse. If a fuse has blown, replace it.

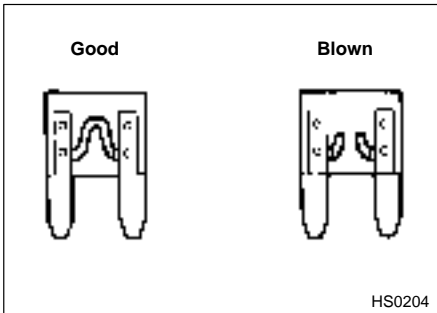

CAUTION

Never replace a fuse with one having a higher rating or with material other than a fuse because serious damage or a fire could result.

▼ Fuse box (behind the coin tray)

1. Turn the ignition switch to the "LOCK" position and turn off all electrical accessories.

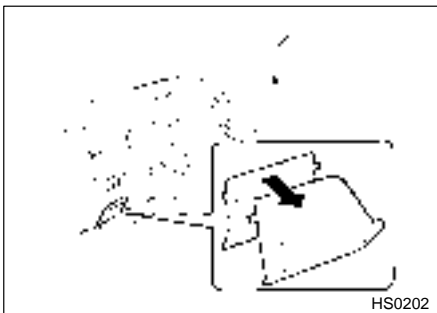

2. Open the coin tray and pull it horizontally to remove it.
3. Determine which fuse may be blown. The back side of the coin tray and the "Fuse and circuits" section in chapter 11 in this manual show the circuit for each fuse.

– CONTINUED –

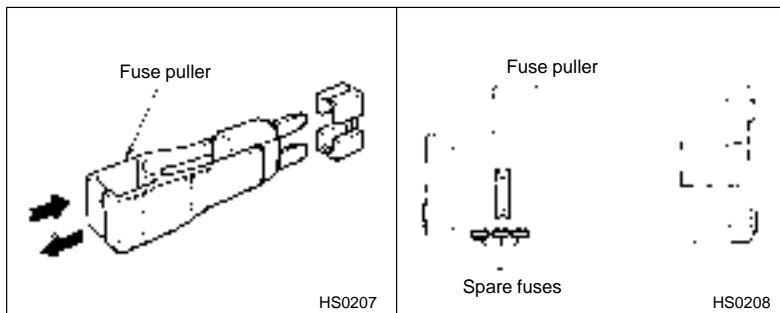

4. Pull out the fuse with the fuse puller. The fuse puller is stored in the main fuse box cover in the engine compartment.
5. Inspect the fuse. If it has blown, replace it with a spare fuse of the same rating. The spare fuses are stored in the main fuse box cover in the engine compartment.
6. If the same fuse blows again, this indicates that its system has a problem. Contact your SUBARU dealer for repairs.

▼ Main fuse box (in the engine compartment)

1. Turn the ignition switch to the "LOCK" position and turn off all electrical accessories.
2. Open the engine hood.
3. Remove the main fuse box cover.
4. Determine which fuse may be blown. The fuse box cover and "Fuse and circuits" section in chapter 11 in this manual show the circuit for each fuse.

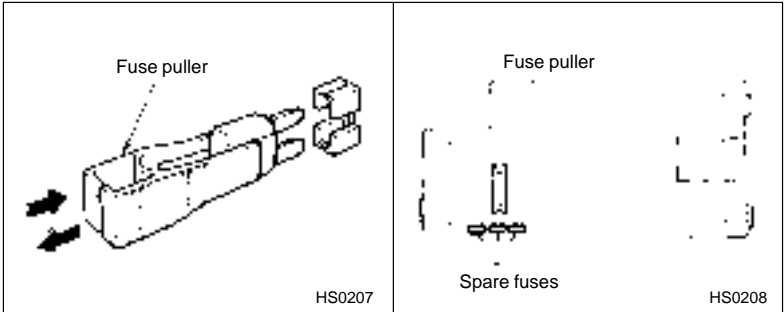

5. Pull out the fuse with the fuse puller provided in the main fuse box cover.
6. Inspect the fuse. If it has blown, replace it with a spare fuse of the same rating. The spare fuses are stored in the main fuse box cover in the engine compartment.
7. If the same fuse blows again, this indicates that its system has a problem. Contact your SUBARU dealer for repairs.

Main fuse and fusible link

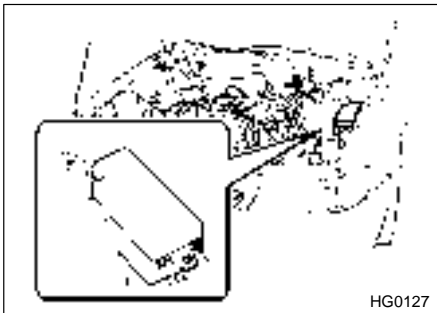

The main fuses and fusible link are designed to melt during an overload to prevent damage to the wiring harness and electrical equipment. Check the main fuses and fusible link if any electrical component fails to

– CONTINUED –

operate (except the starter motor) and other fuses are good. A melted main fuse or fusible link must be replaced. Use only replacements with the same specified rating as the melted main fuse or fusible link. If a main fuse or fusible link blows after it is replaced, have the electrical system checked by your nearest SUBARU dealer.

Installation of accessories

Always consult your SUBARU dealer before installing fog lights or any other electrical equipment in your vehicle. Such accessories may cause the electronic system to malfunction if they are incorrectly installed or if they are not suited for the vehicle.

Replacing bulbs

■ Headlight



CAUTION

Halogen headlight bulbs become very hot while in use. If you touch the bulb surface with bare hands or greasy gloves, finger prints or grease on the bulb surface develop into hot spots, causing the bulb to break. If there are finger prints or grease on the bulb surface, wipe them away with a soft cloth moistened with alcohol.

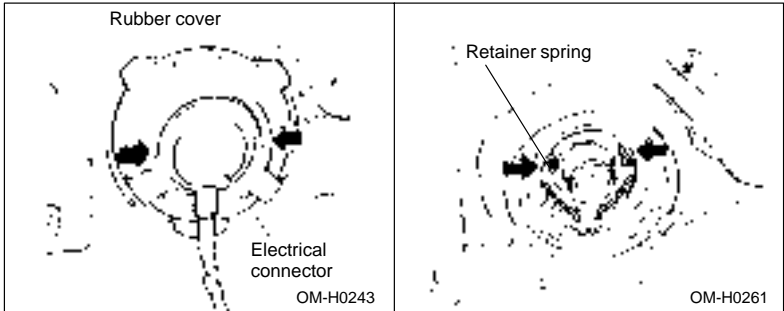

1. Disconnect the electrical connector, then remove the rubber cover.
2. Remove the retainer spring.
3. Replace the bulb, then set the retainer spring securely.
4. Install the rubber cover with the top mark facing up, then reconnect the electrical connector.

– CONTINUED –

■ Fog light (if equipped)

CAUTION

Halogen light bulbs become very hot while in use. If you touch the bulb surface with bare hands or greasy gloves, finger prints or grease on the bulb surface develop into hot spots, causing the bulb to break. If there are finger prints or grease on the bulb surface, wipe them away with a soft cloth moistened with alcohol.

▼ Type A

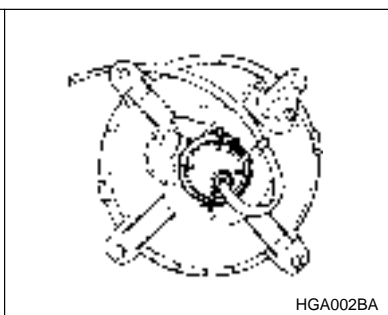
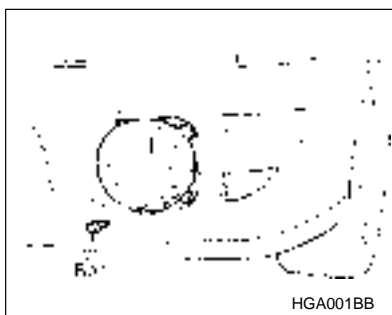

1. Remove the front fog light assembly by removing the three bolts.
2. Disconnect the connector.
3. Remove the front fog light case cap by turning it counterclockwise.

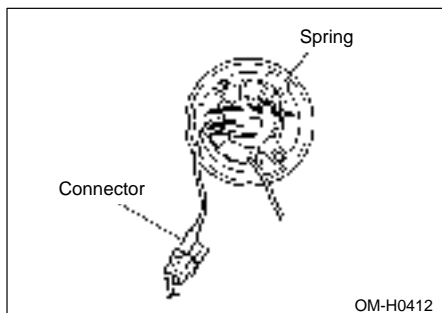

4. Disconnect the connector behind the case cap.
5. Release the retainer spring.
6. Replace the bulb with a new one. Then reconnect the connectors and reinstall the removed parts in the reverse order of removal.

▼ Type B

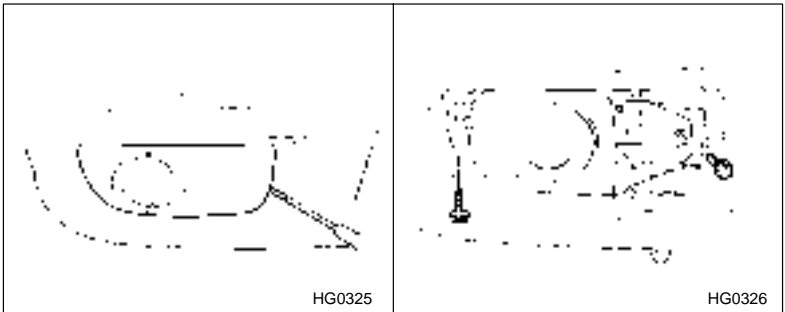

1. Remove the front fog light cover.
2. Remove the front fog light assembly by removing the two bolts.
3. Disconnect the connector.
4. Remove the front fog light case cap by turning it counterclockwise.

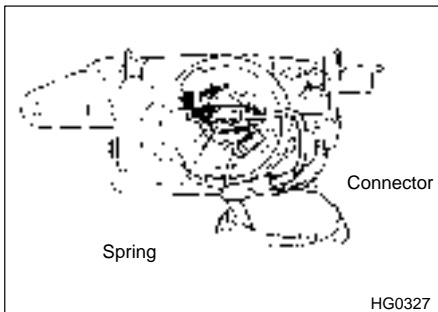

5. Disconnect the connector behind the case cap.
6. Release the retainer spring.
7. Replace the bulb with a new one. Then reconnect the connectors and reinstall the removed parts in the reverse order of removal.

– CONTINUED –

■ Parking light

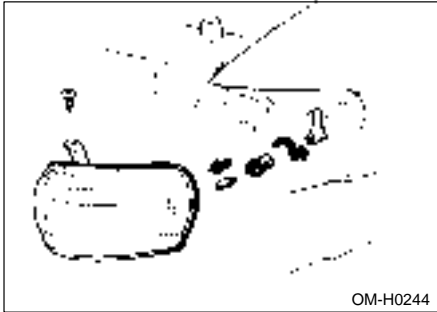

1. Remove the parking light assembly mounting screw located at the top of the headlight assembly using the phillips screwdriver.
2. Move the parking light assembly forward until it pops out from the fender.
3. Remove the bulb holder from the parking light assembly by turning it counterclockwise.
4. Pull the bulb out of the socket. Install a new bulb.
5. Set the bulb holder into the parking light assembly and turn it clockwise until it locks.
6. Set the parking light assembly into the fender. Tighten the mounting screw.

■ Front turn signal light

▼ Type A

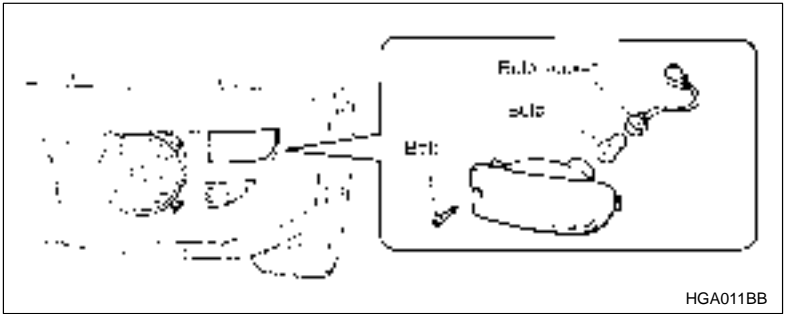

1. Remove the bolt securing the front turn signal light assembly.
2. Remove the front turn signal light assembly from the front bumper and remove the bulb socket by turning it counterclockwise.
3. Remove the bulb from the socket by pushing it in and turning clockwise, then install a new bulb.
4. Install the removed parts in the reverse order of removal.

▼ Type B

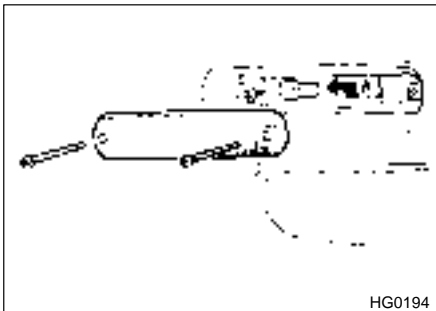

1. Remove the front turn signal light assembly mounting screws using the phillips screwdriver.
2. Remove the lens from the front turn signal light assembly.

– CONTINUED –

-
3. Remove the bulb from the socket by pushing it in and turning counterclockwise. Install a new bulb.
 4. Reinstall the lens to the front turn signal light assembly and tighten the mounting screws.

■ Side turn signal light

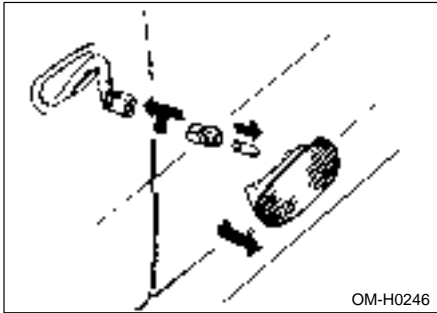

1. Pull the left side of the turn signal light assembly while moving it forward in relation to the vehicle.
2. Remove the bulb holder from the side turn signal light assembly by turning it counterclockwise.
3. Pull the bulb out of the socket. Install a new bulb.
4. Set the bulb holder into the side turn signal light assembly and turn it clockwise until it locks.
5. Reinstall the side turn signal light assembly on the side of the front fender.

■ Rear combination lights

▼ Sedan and Coupe



HG0241



OM-H0446

1. Remove the spare tire cover.
2. Remove the clip from the rear trunk trim with a regular screw driver.
3. Remove the nut securing the rear trunk trim.

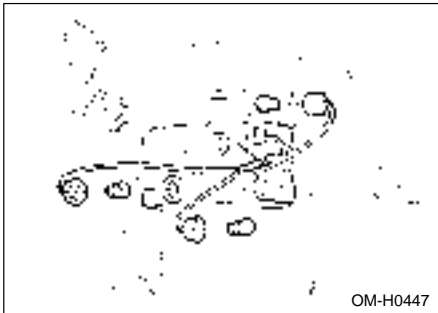

OM-H0447

4. Open the rear portion of the side trunk trim panel.
5. Remove the bulb holder from the rear combination light assembly by turning it counterclockwise.
6. Remove the bulb from the socket by pushing it and turning counterclockwise. Install a new bulb.
7. Set the bulb holder into the rear combination light assembly and turn it clockwise until it locks.
8. Secure the rear trunk trim panel with the nut and the clips.

– **CONTINUED** –

▼ Wagon

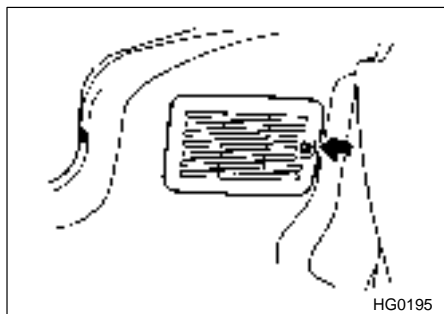

1. Unlatch the rear combination light cover by pulling the knob. Open the cover up.

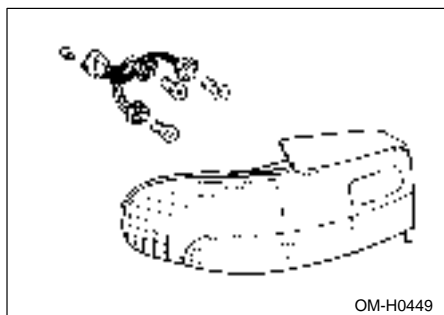

2. Remove the bulb holder from the rear combination light assembly by turning it counterclockwise.
3. Remove the bulb from the socket by pushing it and turning counterclockwise. Install a new bulb.
4. Set the bulb holder into the rear combination light assembly and turn it clockwise until it locks.
5. Close the cover and latch the lock.

■ License plate light

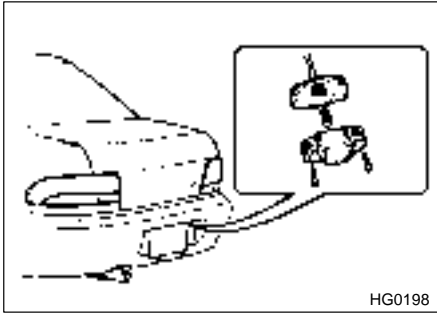

1. Remove the mounting screws using a phillips screwdriver.
2. Remove the cover and lens.
3. Pull the bulb out of the socket. Install a new bulb.
4. Reinstall the lens and cover.
5. Tighten the mounting screws.

■ Interior light, spot light

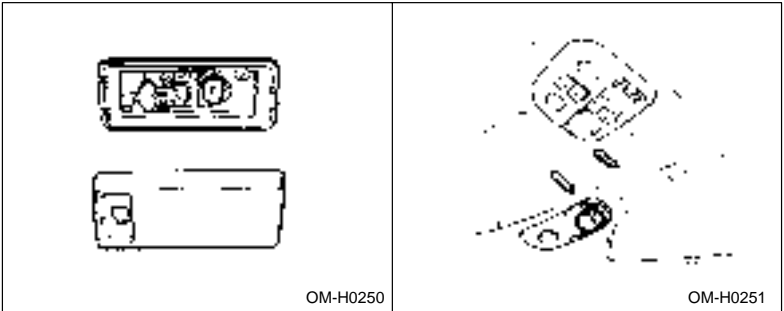

1. Remove the lens by prying the edge of the lens with a regular screwdriver.
2. Pull the bulb out of the socket. Install a new bulb.
3. Reinstall the lens.

– CONTINUED –

■ Dome/Rear map reading lights (if equipped)

CAUTION

- While sitting in the vehicle, be sure to touch the metal frame of the vehicle to allow all static electricity to be discharged prior to replacing bulbs.
- Always use recommended replacement bulbs.

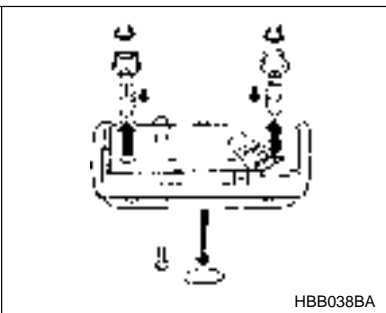
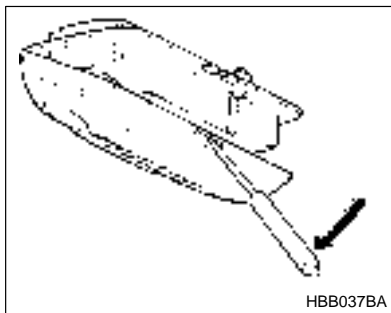

1. Remove the dome light lens as follows:

Insert a small flat-tipped screwdriver into the center slot in the front edge of the lens and lever the lens downward in such a way that it may be bowed and disengaged from the mounting tabs.

2. To replace the dome light bulb (center bulb): remove the dome light by pulling it out of its retainer clips, then insert a new bulb into the retain-er clips.

3. To replace the map light bulbs: use a Phillips head screwdriver to re-move the two mounting screws located on either side of the lamp assem-bly. Pull the assembly downward out of the headliner. At this time, use care not to touch the circuit board.

4. Remove the necessary bulb socket from the circuit board by grasping it on the backside of the lamp assembly and twisting counterclockwise to disengage.

5. Pull the bulb out of the socket. Install a new bulb by pushing it into the socket.

6. Reinstall the socket in the circuit board. Then, fit the lamp assembly back into the headliner.
7. Reinstall the lens in the reverse order of removal.

Specifications

Specifications	11-2
Dimensions	11-2
Maximum load limits	11-2
Engine	11-2
Electrical system	11-3
Capacities	11-3
Tires	11-4
Fuses and circuits	11-5
Bulb chart	11-8
Vehicle identification	11-9

Specifications

These specifications are subject to change without notice.

■ Dimensions

Overall length	172.2 in. (4,375 mm)
Overall width	67.1 in. (1,705 mm)
Overall height	56.3 in. (1,430 mm)* ¹
	55.5 in. (1,410 mm)
Ground clearance	6.5 in. (165 mm)* ¹
	5.7 in. (145 mm)
Front tread	57.5 in. (1,460 mm),
	57.9 in. (1,470 mm)* ²
Rear tread	57.1 in. (1,450 mm),
	57.5 in. (1,460 mm)* ²
Wheelbase	99.2 in. (2,520 mm)

*1: OUTBACK

*2: RS

■ Maximum load limits

Gross vehicle weight rating	See the certification label attached
Gross axle weight rating	to the driver's door jamb.

■ Engine

2500 cc

Engine model	EJ251
Engine type	Horizontally opposed, liquid cooled 4 cylinder, 4 stroke gasoline engine
Engine displacement	149.9 cu in (2,457 cc)
Bore	3.92 in. (99.5 mm)
Stroke	3.11 in. (79.0 mm)
Compression ratio	10.0 : 1
Firing order	1 – 3 – 2 – 4

2200 cc	
Engine model	EJ222
Engine type	Horizontally opposed, liquid cooled 4 cylinder, 4 stroke gasoline engine
Engine displacement	135.0 cu in (2,212 cc)
Bore	3.81 in. (96.9 mm)
Stroke	2.95 in. (75.0 mm)
Compression ratio	10.0 : 1
Firing order	1 — 3 — 2 — 4

■ Electrical system

Battery	
Type	MT: 55D23L, AT: 75D23L
Reserve capacity	MT: 99 min., AT: 118 min.
Cold cranking ampere	MT: 356 amp., AT: 520 amp.
Alternator	12V - 75A
Spark plugs	BKR6E-11 (NGK) RC10YC4, RC8YC4 (CHAMPION) K20PR-U11 (NIPPONDENSO)
Spark plug gap	0.039 to 0.043 in. (1.0 to 1.1 mm)

■ Capacities

2.5 Liter models	
Fuel tank	15.9 US gal (60 liter, 13.2 Imp gal)
Engine oil	4.2 US qt (4.0 liter, 3.5 Imp qt)
Transmission oil	3.7 US qt (3.5 liter, 3.1 Imp qt)
Automatic transmission fluid	9.8 US qt (9.3 liter, 8.2 Imp qt)
AT differential gear oil	1.3 US qt (1.2 liter, 1.1 Imp qt)
AWD rear differential gear oil	0.8 US qt (0.8 liter, 0.7 Imp qt)
Power steering fluid	0.7 US qt (0.7 liter, 0.6 Imp qt)
Engine coolant	6.2 US qt (5.8 liter, 5.2 Imp qt)
2.2 Liter models	
Fuel tank	15.9 US gal (60 liter, 13.2 Imp gal)
Engine oil	4.2 US qt (4.0 liter, 3.5 Imp qt)

— CONTINUED —

Transmission oil (AWD)	3.7 US qt (3.5 liter, 3.1 Imp qt)
Automatic transmission fluid	8.9 US qt (8.4 liter, 7.4 Imp qt)
AT differential gear oil	1.3 US qt (1.2 liter, 1.1 Imp qt)
AWD rear differential gear oil	0.8 US qt (0.8 liter, 0.7 Imp qt)
Power steering fluid	0.7 US qt (0.7 liter, 0.6 Imp qt)
Engine coolant	6.2 US qt (5.8 liter, 5.2 Imp qt)

■ Tires

Type		Steel belted radial, Tubeless
Size	Front and rear	P195/60R15 P205/60R15* ³ P205/55R16* ²
	Spare	T135/70D16
Pressure	Front	32 psi (2.2 kg/cm ² , 220 kpa)
	Rear	29 psi (2.0 kg/cm ² , 200 kpa)
	Spare	60 psi (4.2 kg/cm ² , 420 kpa)
Wheel size	Front and rear	16 x 7JJ* ² 15 x 6JJ
	Spare	16 x 4T
Wheel alignment		
Toe	Front	0 ± 0.12 in. (0 ± 3 mm)
	Rear	0 ± 0.12 in. (0 ± 3 mm)
Camber	Front	-0°* ⁴ , -0°25'* ⁵
	Rear	-0°55', -1°10'* ²

*²: RS

*³: OUTBACK

*⁴: 2.2 liter

*⁵: 2.5 liter

Fuses and circuits

▼ Fuse panel located behind the coin tray

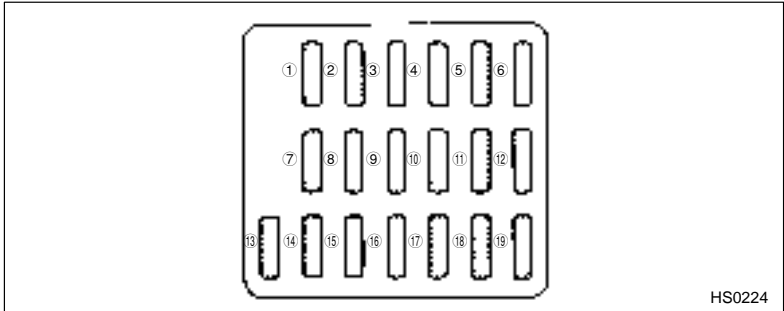

Fuse panel	Fuse rating	Circuit
1	15A	● Heater fan
2	15A	● Heater fan
3	Empty	
4	20A	<ul style="list-style-type: none"> ● Front accessory power socket ● Cigarette lighter ● Remote controlled rear view mirrors
5	10A	<ul style="list-style-type: none"> ● Tail light ● Parking light
6	15A	● SRS airbag
7	15A	● Fog light
8	20A	● ABS solenoid
9	15A	<ul style="list-style-type: none"> ● Radio ● Clock

– CONTINUED –

Fuse panel	Fuse rating	Circuit
10	Empty	
11	15A	<ul style="list-style-type: none"> ● Engine ignition system ● SRS airbag
12	10A	<ul style="list-style-type: none"> ● Illumination brightness control
13	Empty	
14	15A	<ul style="list-style-type: none"> ● AT shift lock unit ● ABS control ● Cruise control
15	20A	<ul style="list-style-type: none"> ● Windshield wiper and washer ● Rear window wiper and washer
16	20A	<ul style="list-style-type: none"> ● Brake light
17	15A	<ul style="list-style-type: none"> ● Air conditioner
18	15A	<ul style="list-style-type: none"> ● Backup light ● Turn light ● SRS airbag system warning light
19	20A	<ul style="list-style-type: none"> ● Rear accessory power socket ● Seat heater

▼ Fuse panel located in the engine compartment

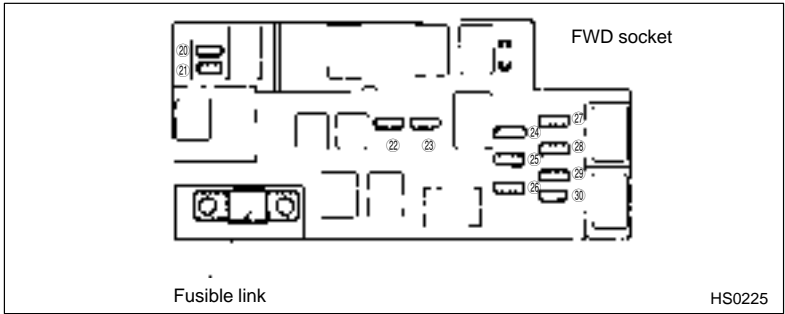

Fuse panel	Fuse rating	Circuit
20	20A	● Radiator cooling fan (Main)
21	20A	● Radiator cooling fan (Sub)
22	20A	● Rear window defogger
23	15A	● Hazard warning flasher ● Horn
24	15A	● Power door lock
25	10A	● Automatic transmission control unit
26	10A	● Alternator
27	15A	● Headlight (right side)
28	15A	● Headlight (left side)
29	20A	● Lighting switch
30	15A	● Clock ● Interior light

Bulb chart

Description	Wattage	Bulb No.
Headlight	12V-60/55W	HB2 (H4)
Front turn signal	12V-27W	1156
Side marker/Parking	12V-3.8W	194
Side turn signal	12V-3.8W	194
Rear combination light		
Brake/tail and Marker	12V-27/8W	1157
Turn signal	12V-27W	1156
Back-up	12V-27W	1156
High mount stop light (Sedan)	12V-18W	921
High mount stop light (Wagon)	12V-13W	912
License plate light	12V-3.8W	194
Interior light	12V-8W	—
Fog light	12V-55W	H3
Dome light/Rear map reading lights (if equipped)		
Dome light (room light)	12V-8W	—
Rear map reading lights	12V-3.8W	194

Vehicle identification

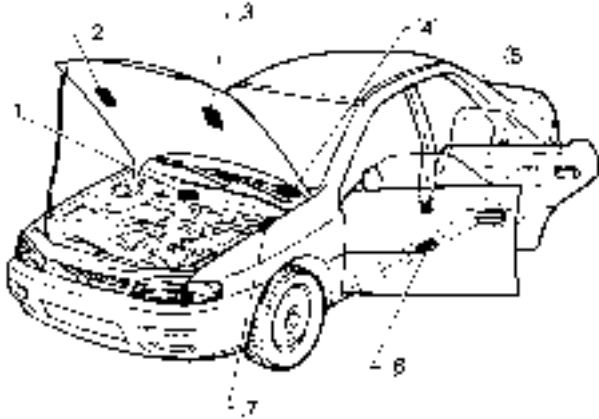

HG0196

- ① Chassis number
- ② Emission control label
- ③ Vacuum hose piping label
- ④ Vehicle identification number plate
- ⑤ Tire placard
- ⑥ Certification plate
- ⑦ Model number plate

Consumer information and Reporting safety defects

Uniform tire quality grading standards	12-2
Treadwear	12-2
Traction A, B, C	12-2
Temperature A, B, C	12-3
Reporting safety defects (USA)	12-4

For U.S.A.

The following information has been compiled according to Code of Federal Regulations "Title 49, Part 575".

Uniform tire quality grading standards

This information indicates the relative performance of passenger car tires in the area of treadwear, traction, and temperature resistance. This is to aid the consumer in making an informed choice in the purchase of tires. These grades are molded in the sidewall of the tire and can be interpreted by referring to the following information:

■ Treadwear

The treadwear grade is a comparative rating based on the wear rate of the tire when tested under controlled conditions on a specified government test course.

For example, a tire graded 150 would wear one and one-half (1-1/2) times as well on the government course as a tire graded 100. The relative performance of tires depends upon the actual conditions of their use, however, and may depart significantly from the norm due to variations in driving habits, service practices and differences in road characteristics and climate.

■ Traction A, B, C

The traction grades, from highest to lowest, are A, B and C, and they represent a tire's ability to stop on wet pavement as measured under controlled conditions on specified government test surfaces of asphalt and concrete. A tire marked C may have poor traction performance.



WARNING

The traction grade assigned to a tire is based on braking (straight-ahead) traction tests and does not include cornering (turning) traction.

■ Temperature A, B, C

The temperature grades are A (highest), B and C, representing the tire's resistance to generation of heat and its ability to dissipate heat when tested under controlled conditions on a specified indoor laboratory test wheel. Sustained high temperature can cause the material of the tire to degenerate and reduce tire life, and excessive temperature can lead to sudden tire failure. Grade C corresponds to a level of performance which all passenger car tires must meet under the Federal Motor Vehicle Safety Standards No. 109. Grades B and A represent higher levels of performance on the laboratory test wheel than the minimum required by law.



WARNING

The temperature grade for a tire is established for one that is properly inflated and not overloaded. Excessive speed, under inflation or excessive loading, either separately or in combination, can cause heat buildup and possible tire failure.

Reporting safety defects (USA)

If you believe that your vehicle has a defect which could cause a crash or could cause injury or death, you should immediately inform the National Highway Traffic Safety Administration (NHTSA) in addition to notifying Subaru of America, Inc.

If NHTSA receives similar complaints, it may open an investigation, and if it finds that a safety defect exists in a group of vehicles, it may order a recall and remedy campaign. However, NHTSA cannot become involved in individual problems between you, your dealer, or Subaru of America, Inc. To contact NHTSA, you may either call the Auto Safety Hotline toll-free at 1-800-424-9393 (or 366-0123 in the Washington D.C. area) or write to: NHTSA, U.S. Department of Transportation, Washington, D.C. 20590. You can also obtain other information about motor vehicle safety from the Hotline.