

Audi Q7 - Electrical System

Self-Study Programme 364

The Audi Q7 stands for 100% premium-quality electronics!

There has been an enormous increase of the number of electronic control units over the past few years. The majority of innovations made are only possible thanks to increasingly sophisticated electronics. Without this development, many of the in-car comfort features which today are taken for granted would not be viable. To keep pace with the increasing complexity of new vehicles, continuous learning is essential. The Self-Study Programmes by AUDI are an efficient advanced learning tool as they enable you keep abreast of technical developments.

To be able to offer customers with this diversity of functions and equipment options, a multiplicity of different electronic control units are required in the Audi Q7. The control units do not work separately as independent nodes, rather they are interconnected via efficient bus systems. Depending on the quantity of data to be exchanged, the MOST bus, an optical data bus, a CAN bus or a LIN bus is utilised. Data is also exchanged across the various bus systems. A separate control unit provides the interface between the various systems. Each control unit is therefore supplied efficiently with the information and vehicle operating variables which it requires for optimal functioning.

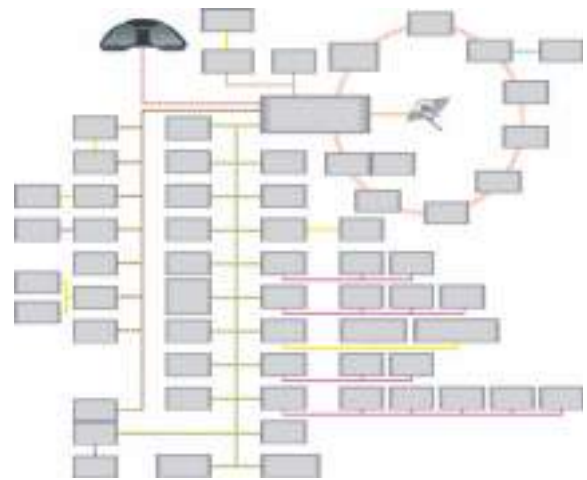

364_006

Self-Study Programme 364 introduces you to the network topology of the Audi Q7, and provides you with an overview of the positions in the vehicle in which electrical components are located. In addition to obtaining service-related information on the control units, you will learn the installation location of each control unit and become familiar with its tasks. You quickly and efficiently gain an insight into the electronics in the Audi Q7.



364_029

Contents

Overview 4

Fuses and relays	4
Installation overview - control units.....	6
Networking	8

Control units 10

Data bus diagnostic interface J533	10
Control unit with display in dash panel insert J285	11
Onboard power supply control unit J519	13
Battery and energy management	15
Battery	23
Alternator.....	25
Front exterior light.....	29
Rear exterior light	30
Onboard power supply control unit 2 J520	32
Entry and start authorisation control unit J518.....	33
Door control units	38
Seat adjustment control units on driver and front passenger sides	
J136 and J521	39
Convenience system central control unit J393	42
Convenience system central control unit 2 J773	45
open sky system	48
Trailer detector control unit J345	54
Rear lid control unit J605 and rear lid control unit 2 J756.....	58

This self-study programme teaches the design and function of new vehicle models, new automotive components or new technologies.

The self-study programme is not a workshop manual!
All values given are intended as a guideline only, and refer to the software variant valid at the time of publication of the SSP.

Please refer to the relevant Service Literature for current inspection, adjustment and repair instructions.

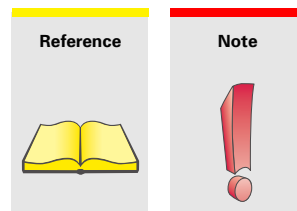

Overview

Fuses and relays

The fuse and electric boxes

Fuse and relay carriers can be found in the following locations in the new Audi Q7:

- Dash panel, left and right adjacent the A-post
- Engine compartment, rear left
- Onboard power supply control unit
- Electronics box under the left seat
- Luggage compartment, right

For details of fuse and relay assignments, please refer to the current service literature.



361_094

Installation overview - control units

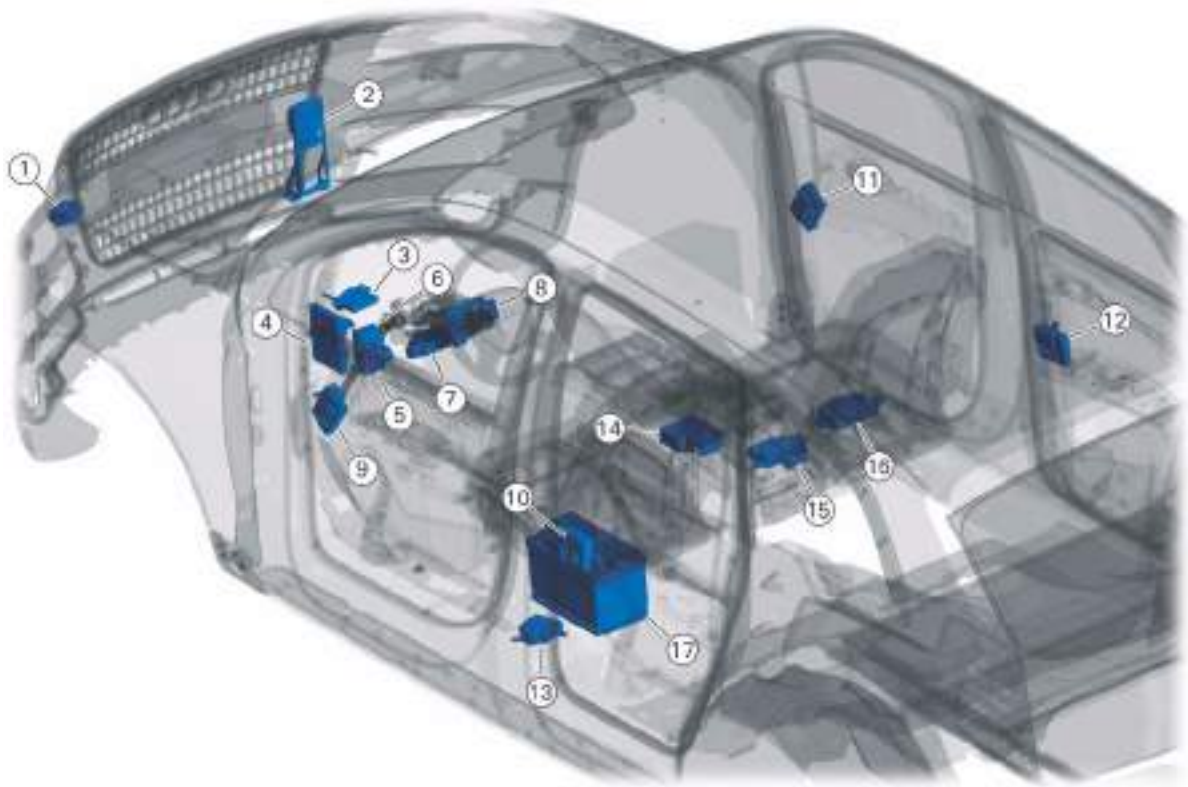

364_004

Legend

- 1 Garage door operation control unit J530
- 2 Adaptive cruise control unit J428
- 3 Data bus diagnostic interface J533
- 4 Onboard power supply control unit J519
- 5 Headlight range control, control unit J431
- 6 Tyre pressure monitor control unit J502
- 7 Entry and start authorisation control unit J518
- 8 Steering column electronics control unit J527
- 9 Driver door control unit J386
- 10 Rear left door control unit J388
- 11 Front passenger door control unit J387
- 12 Rear right door control unit J389
- 13 Energy management control unit J644
- 14 Airbag control unit J234
- 15 Onboard power supply control unit 2 J520
- 16 Seat adjustment control unit with memory, front passenger J521
- 17 Battery A

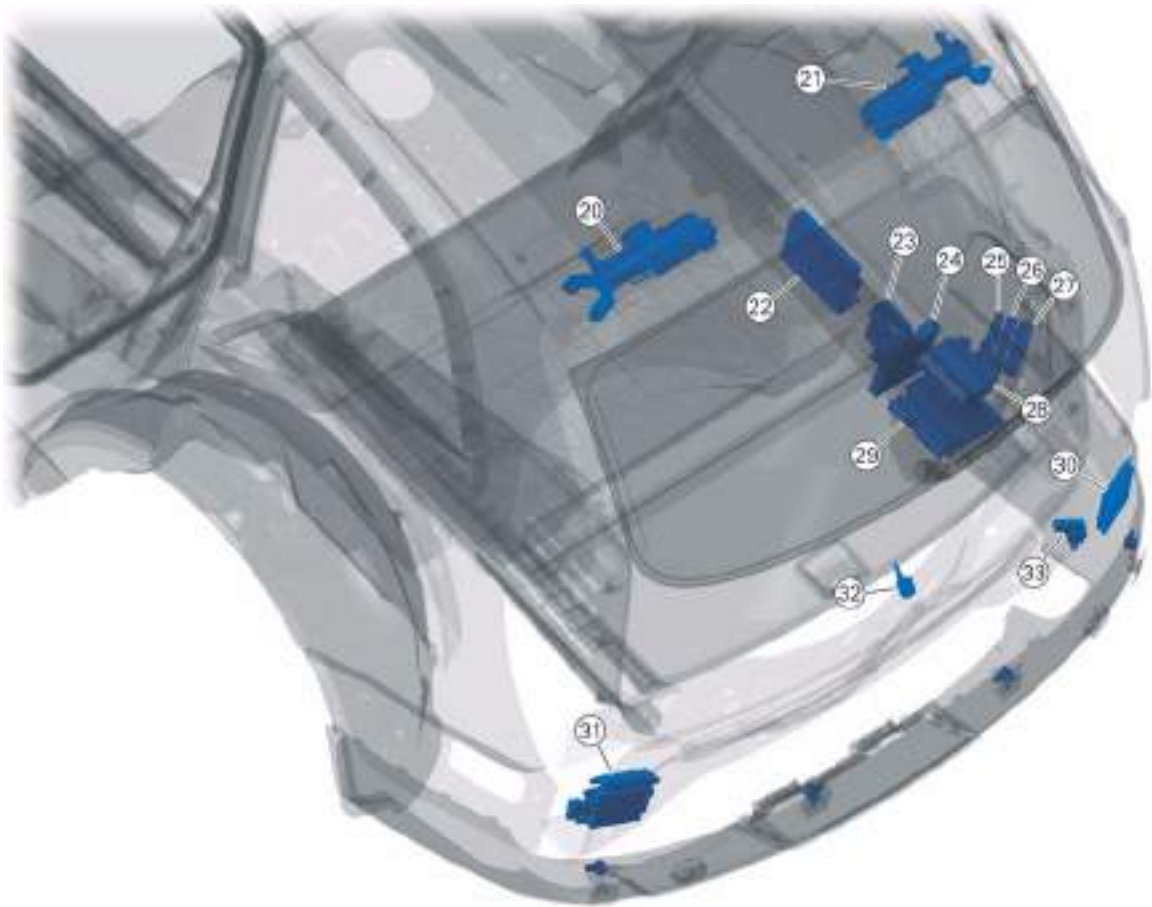

364_005

Legend

- 20 Tailgate control unit J605
- 21 Tailgate control unit 2 J756
- 22 Reversing camera system control unit J772
- 23 Convenience system central control unit 2 J773
- 24 Convenience system central control unit J393
- 25 Additional heater control unit J364
- 26 Aerial reader unit for entry authorisation for keyless entry system J723
- 27 Parking aid control unit J446
- 28 Trailer detector control unit J345
- 29 Adaptive suspension control unit J197
- 30 Lane Change Assist control unit J769
- 31 Lane Change Assist control unit 2 J770
- 32 Reversing camera R189
- 33 Radio controlled clock receiver J489

Overview

Networking

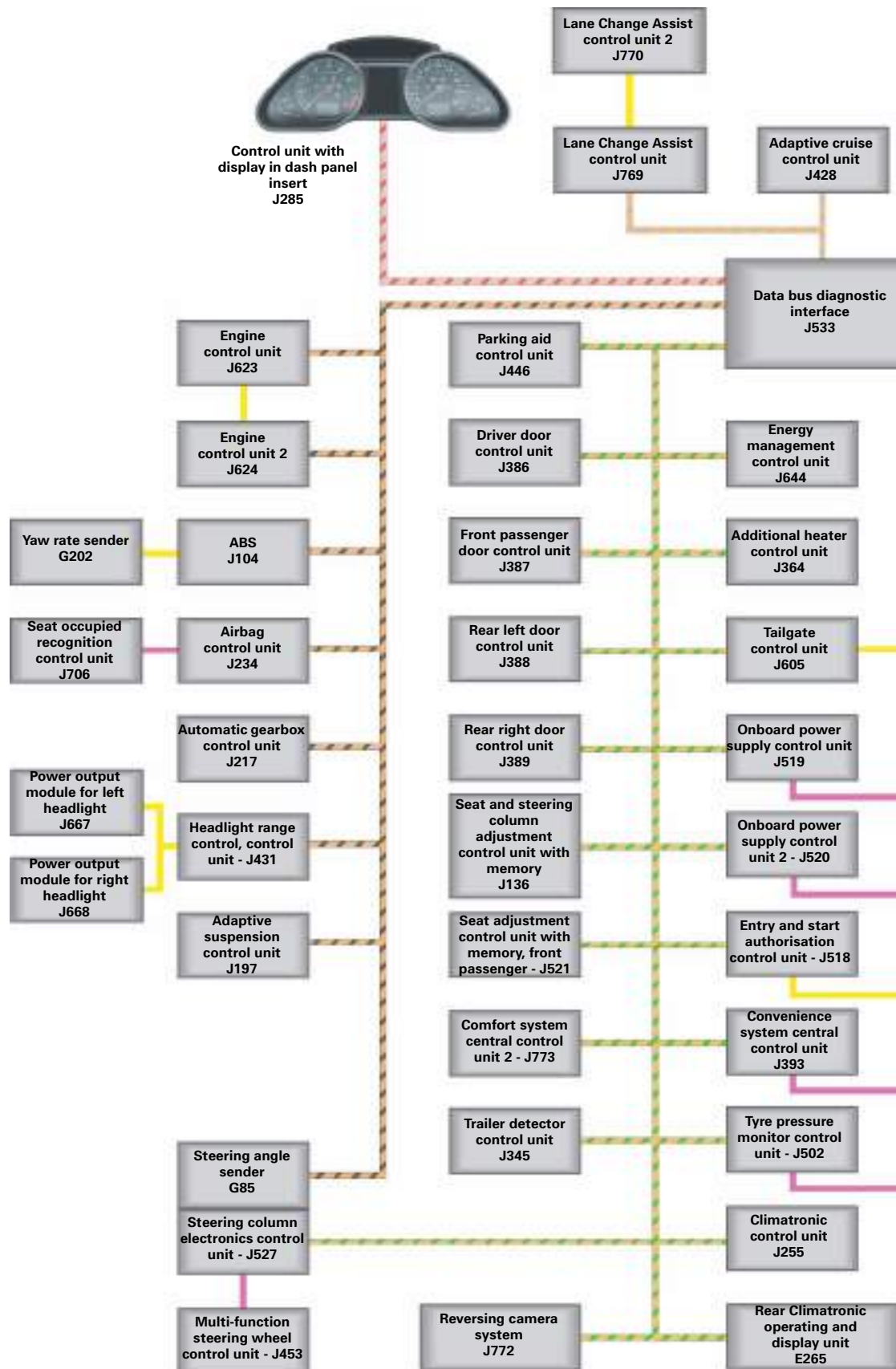

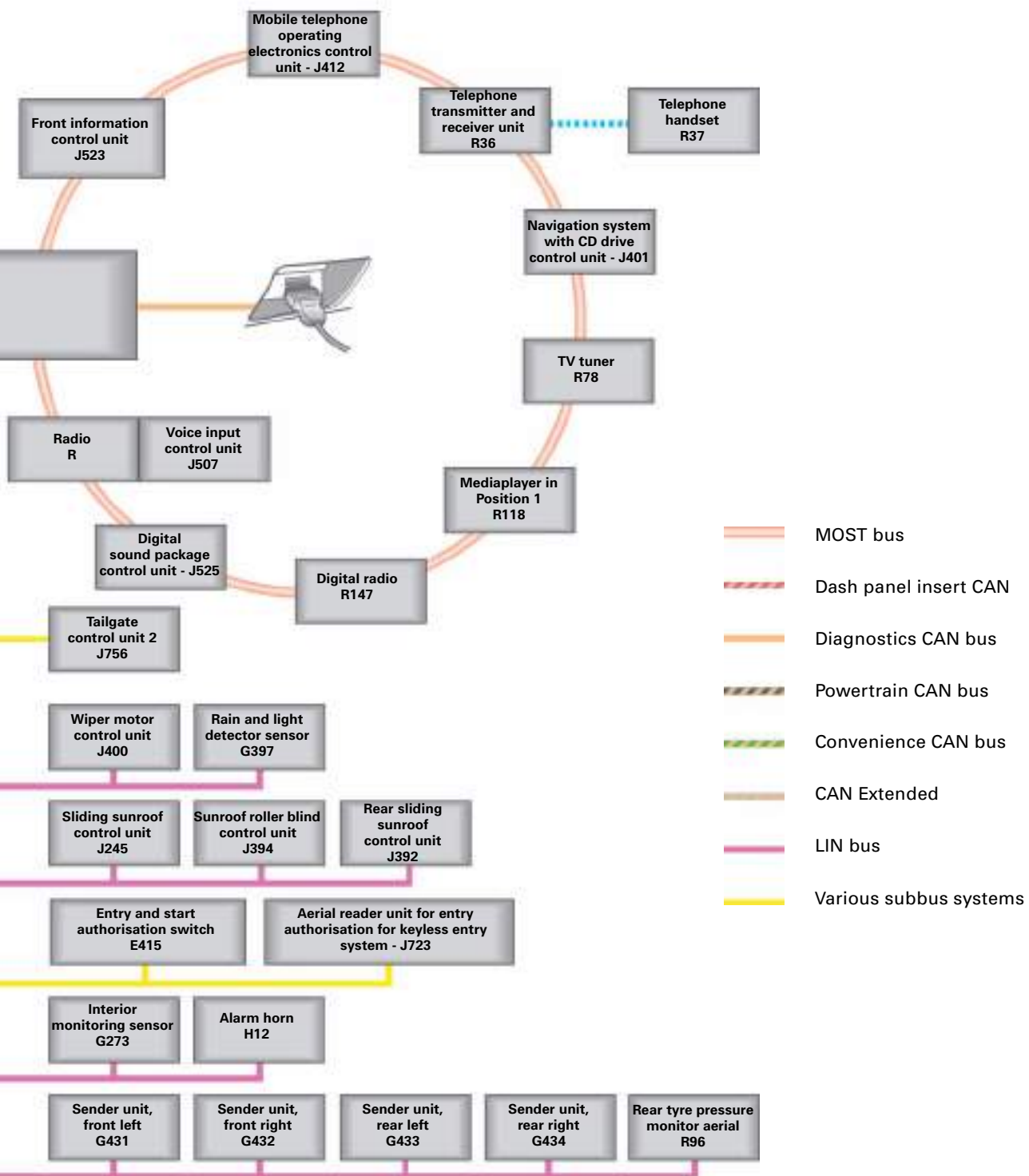

Control units

Data bus diagnostic interface J533

Modifications to Audi A6 '05

The data bus diagnostic interface of the Audi Q7 now has more powerful hardware and a new processor. This was necessary due to the increasing number of messages which are required to be routed between the various bus systems. No functional modifications were made to the diagnostic interface of the Audi A6 '05. The diagnostic interface with new hardware is also be introduced in the Audi A8 '03 and A6 '05 at a later date.

Master functions

- Terminal 15 - powertrain CAN bus run-on
- Sleep and wake-up of the data bus systems
- Optical fibre break diagnostics of the MOST-Bus
- Installation list

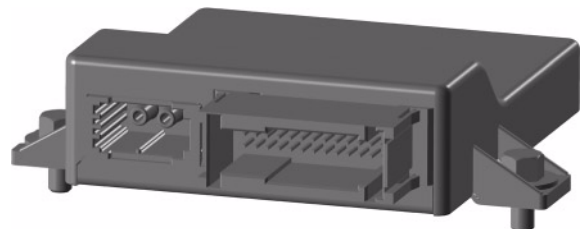

364_007

Variants

The data bus diagnostic interface is available in two variants for the Audi Q7. The part numbers differ from one another only in respect of the index. The difference between the two variants is the availability of a CAN Extended connection. This connection is required if ACC or Lane Change Assist is installed in the vehicle.

Installation location

The data bus diagnostic interface J533 is located on the left behind the dash panel insert and is attached to a mounting bracket.



364_008

Control unit with display in dash panel insert J285



364_009

Modifications to Audi A6 '05

The control unit with display in dash panel insert J285 is already known from the Audi A6 '05. It was adapted functionally to the new features of the Audi Q7.

Unlike the Audi A6 '05, the Audi Q7 does not have an electro-mechanical parking brake; it is equipped with a foot-operated mechanical handbrake. A switch, which is read by the control unit with display in dash panel insert J285, is attached to the operating lever. When the switch is actuated, earth is connected and the corresponding warning lamp is activated in the dash panel insert.

A new feature in the dash panel insert is the air spring suspension level indicator. This indicator is activated in the centre display as soon as an automatic level change is performed. This is the case, for example, if the system exits "lift" mode because a speed threshold has been exceeded; the suspension height will then be lowered.

The level indicator can, however, be activated continuously by the driver by clicking the onboard computer to the corresponding level with the Reset key.

A further new feature was implemented in the onboard computer. The driver has the option of displaying the vehicle's current speed digitally. This is done by setting the onboard computer setting the onboard computer to the corresponding level with the Reset key. On this level, the onboard computer variables can still be retrieved in the case of a colour dash panel insert. The two diagrams show the vehicle speed display in a colour dash panel insert and in a monochrome dash panel insert.



364_010



364_011

Control units

Inputs

- Oil pressure switch
- Oil temperature and oil level sensor
- Radio controlled clock signal
- Brake pad/lining wear indicator wire
- Fuel tank sender 1 and fuel tank sender 2
- Washer fluid shortage indicator switch
- Brake fluid shortage indicator switch
- Handbrake applied recognition switch
- Ambient temperature sensor
- Auto Check button
- Terminal 30
- Terminal 31

Outputs

- Radio controlled clock voltage supply
- Terminal 58d (display illumination)
- Terminal 58s (switch illumination)

Variants

The Audi Q7 comes with three different dash panel insert variants. A monochrome dash panel insert is standard equipment, but a dash panel insert with colour display is also available. In the case of the dash panel insert with colour display, a distinction must be made between vehicle with or without ACC function.

Inputs and outputs

- CAN bus lines of the dash panel insert CAN
- Wake-up line between diagnostic interface and dash panel insert for mutual wake-up at "terminal 15 OFF"



Onboard power supply control unit J519

The onboard power supply control unit J519 known from the Audi A6 '05 and A8 '03 is employed in the Audi Q7.

Various additional functions were implemented for use in the Audi Q7.

Installation location

The onboard power supply control unit J519 is installed in the cockpit at the front left on the control unit holder adjacent the steering column.

Variants

Compared to the new Audi A6 '05, only the Midline and Highline variants are installed in the Audi Q7. This is necessary because a rear window wiper is always installed in the Audi Q7. In the Midline variant or higher, the onboard power supply control unit drives the windscreen and rear window washer pump V59. The Highline variant is required in combination with the electrical steering column adjustment.

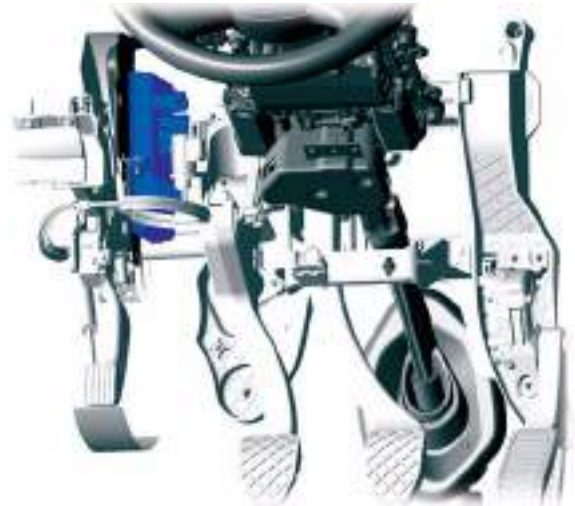

364_013

Reference



For further information about the onboard power supply control unit, please refer to Self-Study Programmes SSP 287, SSP 288 and SSP 326.

Control units

Master functions

- Exterior light control
- Coming home / leaving home
- LIN master for J400 - wiper motor control unit
- LIN master for G397 - rain and light detector sensor

Substitute master function

In case of failure of the convenience system central control unit J393, the onboard power supply control unit J519 acts as the substitute master. It sends flash information via the CAN bus.

Other functions

- Voltage-encoded read-in of the rotary light switch
- Activation of the side lights warning lamp in the rotary light switch
- Electrical steering column adjustment
- Activation of the driver and front passenger footlights. The type of lighting, LED or conventional bulb can be encoded in the onboard power supply control unit.
- Activation of the shift gate lighting
- Activation of the daytime driving lights
- Activation of the front and side turn signals
- Activation of the signal horn
- Activation of the windscreen and rear window washer pump V59
- Activation of the headlight washer system
- Activation of the rear window wiper motor V12
- Steering column adjustment memory
- Easy entry steering column adjustment

Emergency functions

If a fault is found in the rotary light switch or an open circuit in the wire to the rotary light switch, the onboard power supply control unit automatically activates the light continuously.

If a fault has occurred in the light control, the light is activated continuously by the onboard power supply control unit J519.

Battery and energy management

The energy management control unit J644 is identical to the control unit already known from the A6 '05 and A8 '03.

Installation location

The energy management control unit J644 is installed below the left-hand seat adjacent the battery case.

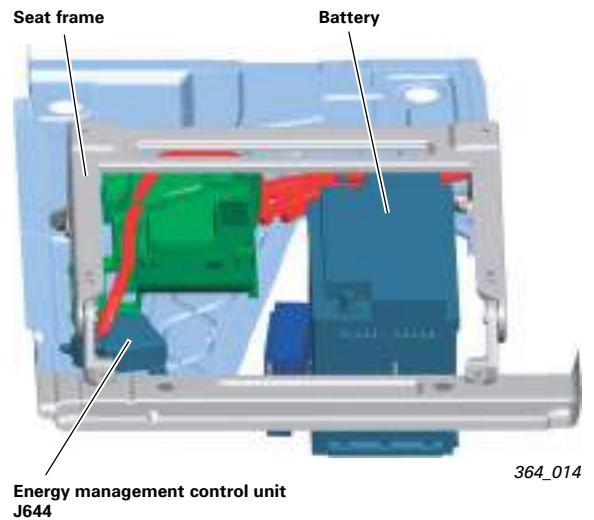

Reference



For further information about the energy management system, please refer to Self-Study Programmes SSP 287 and SSP 326.

Express static current measurement

A so-called express static current measurement can be made in the Guided Fault Finding mode or the Guided Functions mode under "61 - Battery control - Static current measurement using J644 - energy management control unit". The energy management system measures the actual static current in approx. 15 minutes. If the static current is too high, a faultfinding program can be started directly from this program.

Control units

Evaluating history data

The history data contains recorded information about the onboard power supply.

Reference



For further information, please refer to Self-Study Programme SSP 326.

Data records

The data can be read out in Guided Fault Finding mode or the Guided Functions mode under "61 - Battery control".

The following data records are available:

- Static voltage history
- Static current history
- Critical energy balance
- Power-down level history
- Battery change history
- Energy balance of the previous 5 trips
- Energy balance of the previous 5 standstill periods
- Date/clock time programming in the dash panel insert

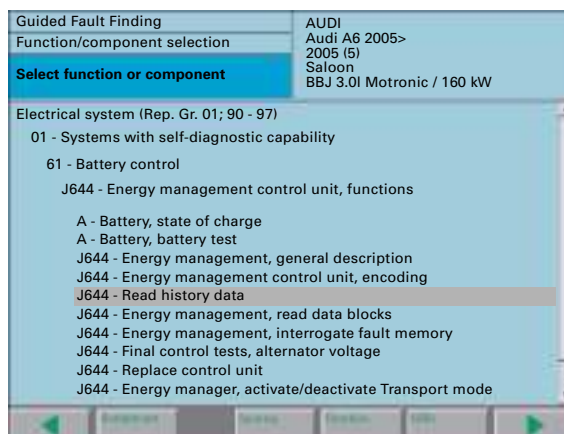

326_123

Structure of the data records

Static voltage history

In the static voltage history, it is possible to read out the following battery voltages:

- 12.5 V
- 12.2 V
- 11.5 V

The previous 4 entries, or "time stamps", are displayed.

Display on tester

Static voltage < 12.5 V : 46 hours
 Static voltage < 12.2 V : 18 hours
 Static voltage < 11.5 V : 9 hours

Display of the complete voltage undershoot for each voltage threshold

Static voltage history (raw data) =

2005-06-28, 10:12:00 * 0005 * 001 **
 2005-06-14, 12:45:00 * 0001 * 001 **
 2005-05-24, 10:26:00 * 0004 * 001 **
 2005-05-17, 11:08:00 * 0002 * 001 * 00046 ***

Previous four values for static voltage < 12.5 V
 The most recent value is listed first

2005-06-24, 11:12:00 * 0004 * 001 **
 2005-05-16, 10:36:00 * 0002 * 001 **
 2005-04-20, 12:56:00 * 0003 * 001 **
 2005-04-12, 16:03:00 * 0002 * 001 * 00018 ***

The previous four values for static voltage < 12.2 V
 The most recent value is listed first

2005-06-28, 10:12:00 * 0002 * 001 **
 2005-06-17, 18:49:00 * 0003 * 001 **
 2005-05-20, 11:16:00 * 0001 * 001 **
 2005-04-22, 13:18:00 * 0001 * 001 * 00009 ***

Previous four values for static voltage < 11.5 V
 The most recent value is listed first

Structure of the data record

2005-06-28 , 10:12:00 * 005 * 001 * 0012 **

2005-06-28	Date: year, month, day	Time stamp
10:12:00	Time: hours, minutes, seconds	
005	Time in hours which the actual voltage is below the set voltage, e.g. 12.5 V	
001	Battery number	
0012	Total time in hours which the actual voltage is below the set value. Only specified for fourth value. The total may be larger than the total of the previous 4 entries, because all deviations below the voltage threshold are counted for the battery which is fitted.	

Prolonged deviations below 12.2 V and 11.5 V are particularly critical.

If the battery voltage is below these threshold values, the battery will not be able to regenerate. This can result in damage to the battery after a lengthy standstill period.

If lengthy deviations below 12.2 V and 11.5 V are ascertained, the battery must be tested.

The data are recorded under the following test conditions :

- Terminal 15 OFF for at least 2 hours
- Convenience CAN bus in Sleep mode
- Power consumption less than 100 mA

Control units

Static current history

The previous 10 entries can be read out in the static current history.

Display on tester

An excessively high static current was measured for a total period of 136 hours.

Static current history =

2005-06-27, 11:14:00 * 0001 hours 00.60 A, static current
2005-06-20, 13:36:00 * 0001 hours 00.70 A, static current
2005-06-18, 19:19:00 * 0004 hours 01.00 A, static current
2005-06-10, 14:12:00 * 0002 hours 00.60 A, static current
2005-05-30, 11:47:00 * 0003 hours 00.70 A, static current
2005-05-29, 12:03:00 * 0002 hours 01.20 A, static current
2005-05-21, 10:59:00 * 0005 hours 00.80 A, static current
2005-05-14, 16:52:00 * 0001 hours 01.00 A, static current
2005-04-20, 11:28:00 * 0004 hours 00.60 A, static current
2005-04-18, 10:07:00 * 0002 hours 00.70 A, static current

The previous 10 entries are displayed.

An excessively high static current was measured for a total period of 136 hours.

Total duration with excessively high static current. The total may be larger than the total of the previous 10 entries, because all are counted for the battery which is fitted. This entry is not required for the analysis. The evaluation of the previous 10 entries is important.

2005-06-27	, 11:14:00	* 00 hours	00, 60 A, static current
2005-06-27		Date: year, month, day	Time stamp
11:14:00		Time: hours, minutes, seconds	
00 hours		Time in hours which the actual voltage is below the set voltage, e.g. 12.5 V	
00, 60 A, static current		Battery number	

The evaluation of prolonged deviations above the static current is important. If 0 or 1 is displayed for the duration the deviation above the set value, this means that the duration of the deviation above the set value was less than or equal to one hour. Such entries can be disregarded because they are caused, among other things, by the "TP memory function". If the value 0 is displayed for the static current, these are short current peaks which can be disregarded.

High static currents can be caused by:

- the customer - if electrical consumers such as power supplies or vehicle fridges are connected to the cigarette lighter supplied via terminal 30.
- the vehicle - in the event of a fault.

If the vehicle is required to have a high static current due to an awake bus system, no entry is made in the history data under "Static current history" due to non-compliance with the test conditions (convenience CAN bus must be in Sleep mode).

Test conditions are:

- Terminal 15 OFF for at least 2 hours
- Convenience CAN bus in Sleep mode
- Power consumption greater than 50 mA

The 50 mA current threshold consists of the following components:

- 25 mA max. permissible static current
- 25 mA for possible charging of the anti-theft alarm sounder

When a test is made using express static current measurement, 70 mA is output as the maximum permissible static current. The difference can be attributed to an additional tolerance of 20 mA.

Critical energy balance

This data record is only written if the vehicle is in an energy critical state (breakdown risk). The data record is written if the energy management control unit recognises the condition "vehicle cannot be started". The most recent data record is displayed at all times.

Display on tester

This data record is only written if the vehicle is in an energy critical state (breakdown risk).

00.05 A, mean static current
19.75 A, mean total current
-10.73 A, current at time of history data entry
17 %, battery state of charge
03 Mohms, internal resistance of the battery
+0118 Ah, energy throughput
-00067 Ah, energy balance
009624 km, mileage
2005-06-13, 23:24:47 time and date
Hazard warning OFF Light status
Side lights OFF
Low beam headlight OFF
Fog light OFF
Main beam OFF
07.1 hours, terminal 15 ON Vehicle status
07.1 hours, data bus awake
007.1 hours, previous standstill period
00 number of data bus ON/OFF cycles
01 number of terminal 15 ON/OFF cycles
01 number of breakdown entries in history database
002 number of fitted (replaced) batteries in vehicle

The data record is output together with the information in alphanumeric text. This simplifies evaluation.

Display on tester if no danger of breakdown risk existed

No entry exists. The vehicle is not in an energy critical state.

The "mean total current" is the value of "Engine OFF" up to the "limit of startability". It therefore gives the average electrical current until an entry was made.

The "current up to time of history data entry" gives the electrical current at the moment of entry or at the moment of breakdown risk recognition.

The "battery state of charge" is recorded at the moment of triggering.

The "battery internal resistance" is recorded at the moment of triggering. The battery should internal resistance of less than approx. 10 Mohms at all times. If the internal resistance is greater than this, the battery should be checked. Please note that the internal resistance increases rapidly after the state of charge drops to 15-20 %. In the case of a fully discharged battery, values up to 99 Mohms may be indicated.

With regard to the energy throughput, it should be considered that a battery can deliver approx. 60 x of its rated capacitance over its useful life.

The energy balance is the battery's "account". If more current flows away from the battery than to the battery, the value is negative. If the battery is fully charged, a 0 is displayed as the energy balance. As this value is produced by current integration only, it loses significance with increasing battery age.

From the status of the lights and the vehicle, it can be ascertained whether an electrical consumer or the ignition was "on" at the moment of recording, i.e. at the time of breakdown risk.

The "number of breakdown entries" indicates how often the energy management control unit has ascertained an energy-critical balance which could lead to starting problems.

Generally, the history data must be read out rapidly in cases of complaint. If a new "breakdown risk" is triggered by frequent ignition on/off cycles or short manoeuvres, the previous critical energy balance data will be overwritten by the new data. This means that the data at the time of complaint is overwritten and therefore lost, which, in turn, can complicate the problem handling process.

Control units

Power-down level history

The data on the previous 15 power-down levels is entered into the power-down level history.

Display on tester

Interpreting the data in the power-down level history:

Example: 2*2*-12.50*30*2003-10-31-10:10:25*0-0-0-0-0*06.5**

2 = power-down level 2 was set
2 = reason for triggering of power-down level (2 = low battery charge)
-12.50 = mean total discharge current in A during the set power-down level
30 = battery state of batches (SOC = state of charge)
2003-10-31 = date
10:10:25 = time
0 = hazard warning lights OFF (1 = hazard warning lights ON)
0 = parking lights OFF (1 = parking lights ON)
0 = side lights OFF (1 = side lights ON)
0 = low beam headlights OFF (1 = low beam headlights ON)
0 = fog lights OFF (1 = fog lights ON)
0 = main beam OFF (1 = main beam ON)
06.5 = terminal 15 "on" time in hours (engine was OFF during this period)

Power-down level history =

2*0*-04.57*77*2005-06-23, 14:02:19*0-0-0-0-0*03.1**
.
.
5*2*-10.76*21*2005-06-11. 10:38:45*0-0-0-0-0*06.7**

The previous 15 entries are displayed.

The data record is output together with the information in alphanumeric text. This simplifies evaluation.

Reasons for triggering

0 = electrical current related
1 = battery charge too low and/or battery internal resistance too high and/or capacitance loss Qv too high
2 = starting-critical battery voltage at present discharge current
3 = 1 and 2 simultaneously
4 = state of charge < 30%
5 = 1 and 4 simultaneously
6 = 2 and 4 simultaneously
7 = 1, 2 and 4 simultaneously

Power-down levels are also registered in the fault memory. The difference to the history data is that the initial activation of a power-down level is recorded in the fault memory in the new Audi A6 '05 and A8 '03. In the Audi Q7, only the note "Energy management system active" is entered when any power-down level is set. The most recent value is always output in the history data.

Battery change history

The data from the previous 3 battery changes is stored in the battery change history. The entry in the history data is made when the battery energy management system is encoded. Therefore, it is very important that the energy management control unit J644 only be encoded when a new battery has actually been fitted. Encoding deletes all history data. In this case, it will not be possible to perform, among other things, a reliable battery test using the VAS 5051, because this test utilises the history data. Likewise, it will be very difficult for Audi AG to comment upon queries submitted through DISS, because the history data is no longer available or is falsified.

Display on tester

The battery change history contains no more than 3 lines of data.

An evaluation of the data produced the following results:

Original battery serial number:
1401270070

2005-06-24, 12:03:17 time and date of removal of the battery.
-00050 Ah, energy balance of the removed battery
-240 Ah, energy throughput of the removed battery

Additional data

The following information can be read out with the "Additional data" button:

- Energy balance of the previous 5 trips
- Energy balance of the previous 5 standstill periods
- Time programming in the dash panel insert

Energy balance of the previous 5 trips

The energy balance and the duration of the previous 5 trips are recorded.

Display on tester

Energy balance of the previous 5 trips =

+003.5 Ah, energy balance, trip duration in hours 000.7
+010.3 Ah, energy balance, trip duration in hours 002.3
+008.2 Ah, energy balance, trip duration in hours 001.2
+003.5 Ah, energy balance, trip duration in hours 000.5
+001.3 Ah, energy balance, trip duration in hours 001.2

Negative energy balances mean that the battery was discharged during the trip!

Causes:

- driving short distances
- many electrical consumers
- low battery charge

In Audi vehicles, the alternators are always designed in such a way that discharge of the battery while driving can only occur in very unfavourable operating situations. This means that the alternator must be tested for proper function if the energy balance is negative for a prolonged period of time.

Control units

Energy balance of the previous 5 standstill periods

The energy balance and the duration of the previous 5 standstill periods are recorded.

Display on tester

- 007.1 Ah, energy balance, standstill period in hours: 034.0
- 009.5 Ah, energy balance, standstill period in hours: 063.6
- 000.4 Ah, energy balance, standstill period in hours: 001.2
- 002.1 Ah, energy balance, standstill period in hours: 003.7
- 010.3 Ah, energy balance, standstill period in hours: 004.3

A negative energy balance means that a number of electrical consumers were still active after the engine was shut off.

This data is very useful if there is no data in the static current history. It is possible to ascertain whether the battery was loaded or discharged after the engine was shut off.

Data for date/time programming in the dash panel insert

Display on tester

Data for date/time programming in the dash panel insert:

The data record indicates when, and how often the date/time display in the dash panel insert was changed. In addition, it is possible to check whether the time has been set correctly in vehicles without a radio-controlled clock.

Number of date/time resets in the dash panel insert: 15

Each successive line consists of a time stamp pair. The first time stamp of the pair shows the time in the dash panel insert prior to the reset. The second time stamp shows the adjusted time after the reset.

Causes of a reset are:

- 1st cause: battery was disconnected
- 2nd cause: low battery voltage

2005-06-29, 16:12:00*2005-06-30, 13:00:00
2005-05-01, 13:09:20*2005-05-01, 16:30:00
2005-04-03, 10:22:14*2005-04-03, 12:13:00
2005-02-11, 11:34:00*2005-02-13, 14:05:00
2005-02-01, 12:54:00*2005-02-01, 13:30:00

This data can be used to validate the time of reset. The most recent value is always found on the top line in the history data. The energy management control unit J644 always writes the time and date along with the current value. The time and date are made available by the dash panel insert on the data bus system. If the time and date settings are incorrect, an old date will possibly be written along with a new entry.

Battery

The battery is located below the left-hand seat in order to save space. Direct access to the battery is not necessary for charging and checking the state of charge of the battery.

There are two slave start connectors in the engine compartment for charging and external power supply.

The battery state is checked using the energy management control unit J644.

If it is necessary to replace and check the battery acid level (e.g. during routine service work), the seat can be easily folded up after undoing two screws.

The following batteries are used:

- 80 Ah / 380 A
- 95 Ah / 450 A
- 110 Ah / 520 A

The choice of battery depends on:

- Engine
- Equipment
- Country

Battery test

A battery test can be performed using the energy management control unit J644. This test can be started in the Guided Fault Finding mode or the Guided Functions mode under "61-Battery control - A-Battery, test".

The energy management control unit calculates from various measured values and the history data the state of the battery and displays the following as a possible result:

- Battery OK
- Charge battery
- Replace battery

In the case of the Audi Q7, it is no longer necessary to test the battery using battery tester VAS 5097A.

The advantages of this new test method are:

- It is not necessary to charge the battery prior to the test.
- It is not necessary to disconnect the battery from the onboard power supply.
- It is not necessary to remove the battery.

The battery acid level can be checked visually in the usual way.

Control units

Battery replacement

When the vehicle battery is replaced, the energy management control unit J644 must be encoded. This is necessary to adapt the new battery (size, manufacturer, new condition) to the energy management system. Only then will the energy management system function with maximum efficiency and precision.

The energy management control unit J644 may only be encoded after a battery is replaced. Otherwise, faults will be produced in the vehicle due to incorrect assessment of the battery state and loss of important history data, which is required, among other things for testing the battery with the VAS tester.

Trickle charge

To conserve battery power in showroom vehicles and vehicles in the workshop, a VAS 5095A, VAS 5900 or VAS 5903 charger must be connected to the designated slave start connector in the engine compartment on the left-hand side. This will prevent exhaustive discharging of the battery.



Slave start connector
Positive

Slave start connector
Negative

364_016

Disconnecting the vehicle battery

To disconnect the earth wire of the vehicle battery, it is not necessary to fold up the seat. The battery's earth wire of the battery can, when necessary, be disconnected at the earth connector in front of the left-hand seat.



Cover in front of left-hand seat

364_017



Earth connector

364_018

Alternator

Functional principle of the alternator regulator

The current output of the alternator depends on the excitation voltage, and hence the excitation current. Transistor T connects the voltage applied to B+ to the excitation winding at a frequency of approximately 150 Hz. The resultant excitation current I_{Exc} or I_{Exc_eff} , from 0 A to max. 8 A, is directly proportional to alternator current output.

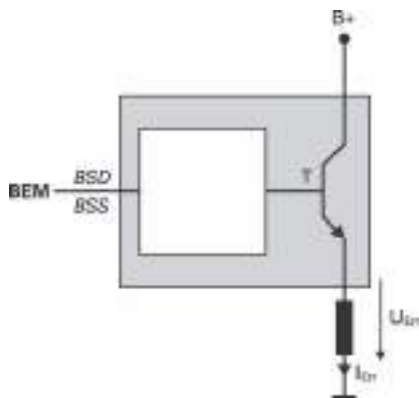

364_056

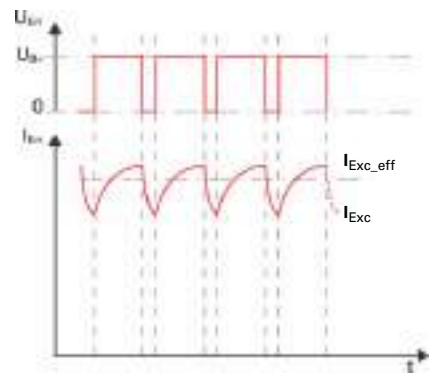

$$U_{Err} = U_{Exc}$$

$$I_{Err} = I_{Exc}$$

364_057

Alternator characteristic

The diagram gives a qualitative overview of the relationship between speed and current output under full alternator load, i.e. the characteristic curve gives the maximum possible current output for each speed.

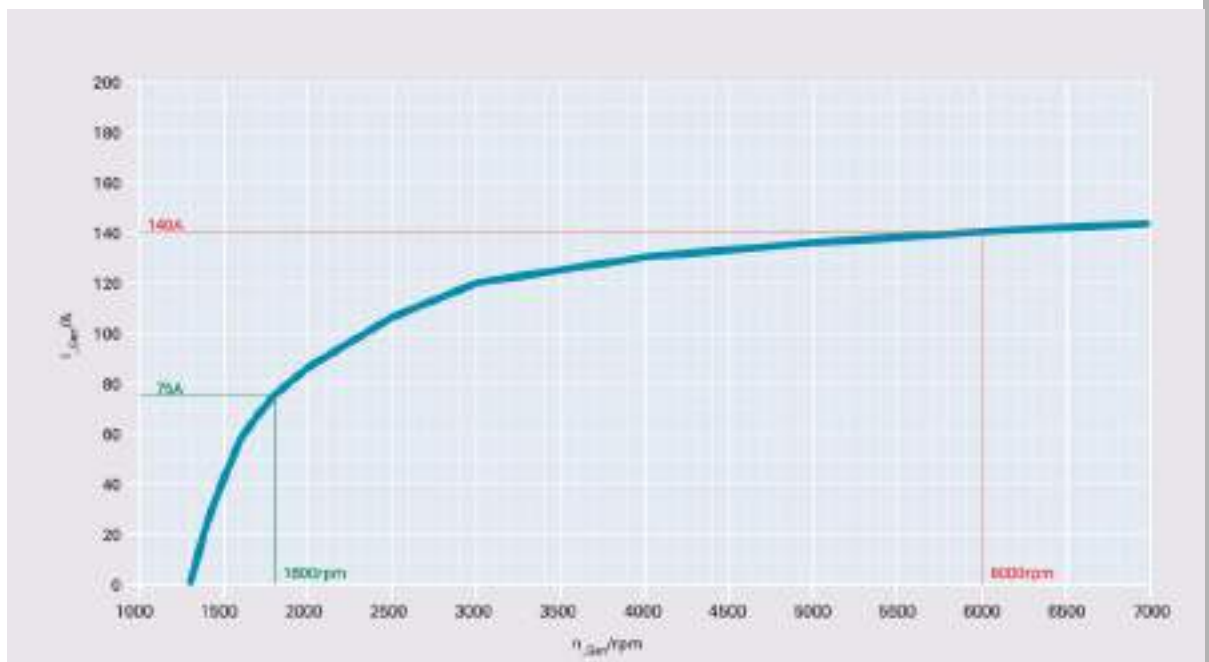

364_061

Control units

Close attention is normally given to two operating points. This is firstly the point at 1800 rpm (equivalent to idling speed, green marks) and, secondly, the setpoint at 6000 rpm (red mark). In the case of an 140 A alternator, for example, this value always refers to the setpoint at 6000 rpm. Some nameplates display values such as 75-140 A. The first value denotes the maximum possible current output at 1800 rpm, i.e. 75 A, and the second value corresponds to the setpoint (140 A at 6000 rpm).



Notes

- The characteristic data always refers to operation at room temperature.
- In this context, "speed" means alternator speed, and not the engine speed.

The following alternators are used in the Audi Q7:

Manufacturer	Alternator data	Alternator type	I_max @ 1800 rpm	I_max @ 6000 rpm
Valeo	100-150 A	TG16	100A	150A
Valeo	105-180 A	TG17	105A	180A
Hitachi	140-210 A	HTC 190A	140A	210A

Alternator warning lamp

The warning lamp indicates a fault in the alternator or a malfunction in the vehicle electrical system.

The alternator sends status messages to the energy management control unit J644 via the bit-synchronous interface. These status messages are the basis for the activation of the warning lamp.

The information for activating the warning lamp is sent to the convenience CAN bus by the energy management control unit J644 and relayed to the dash panel insert CAN bus via the data bus diagnostic interface (gateway) J533. The control unit with display in dash panel insert J285 reads this information from the dash panel insert CAN and activates the warning lamp.

The warning lamp is activated if any of the following faults occur:

- The engine is running and a mechanical fault is present in the alternator for at least 10 seconds.
- An electrical fault is present in the alternator or at the bit-synchronous interface for at least 10 seconds.

Both faults trigger entries into the energy management control unit J644.

The warning lamp is not activated:

- No communication between the energy management control unit J644 and the control unit with display in dash panel insert J285.

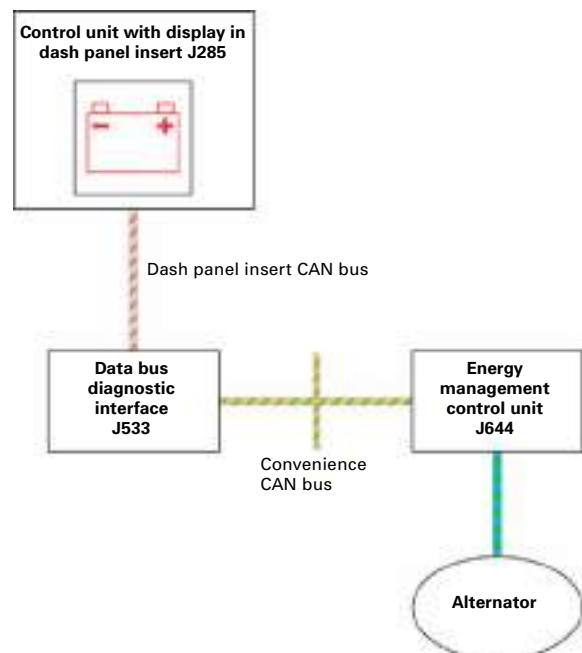

364_059

The alternator or the regulator in the alternator can send 3 fault messages via the bit-synchronous interface to the energy management control unit:

- Mechanical faults
- Electrical fault
- High-temperature fault



Note

Important! If the regulator is faulty, it is possible that the alternator warning lamp is not being activated. This is the case if a fault in the regulator is preventing information from being sent to the bit-synchronous interface. As a result, the energy management control unit J644 does not receive any information on the activation of the warning lamp.

Alternator test

The following tests are necessary for diagnosis of the regulator:

- Rated voltage
- Undervoltage
- Overvoltage

Voltages are ideally measured directly at the alternator connected to B+. If it is not possible to gain access to the measuring point, the voltage can also be measured at the slave start connectors.

Rated voltage

The alternator regulator must supply at least 14.3 V.

Undervoltage

The alternator voltage should not be less than 13 V. 13 V are still allowable at low speed and when electrical consumers are active.

Overvoltage

The alternator voltage must not exceed 15.5 V at high speed and when few electrical consumers are active.

The following are indications of a faulty diode in the alternator:

- Alternator makes loud noise.
- Very high ripple content when measuring harmonic content with the DSO.

Front exterior light

Layout of the front lights

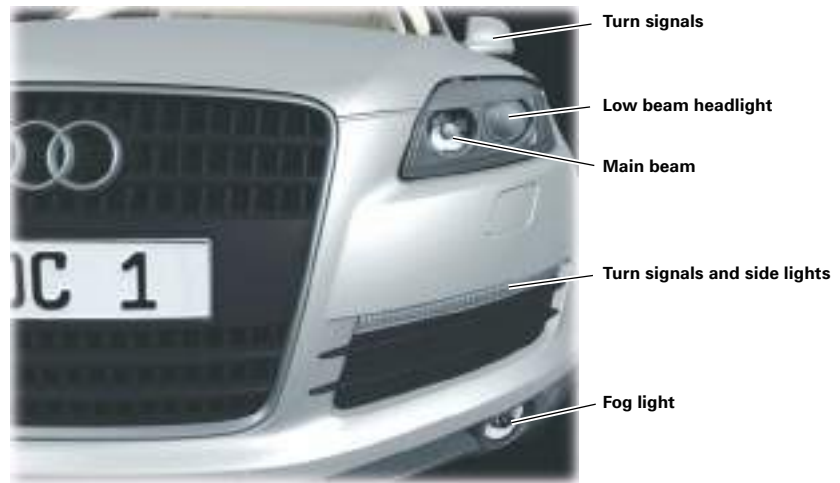

364_020

Slide system for the headlights

By using a slide system, it is possible to remove the headlight without dismantling the bumper. This makes it easier to replace bulbs in the service workshop.

For further information on replacing bulbs, please refer to the Audi Q7 Owner's Manual.



364_062

Unlocking



364_063

The headlight can be pulled out to the front after unlocking and disconnecting the electrical wiring. Please follow the instructions in the current workshop manual.

Replacing the bulbs

Almost all bulbs can be replaced using the vehicle's tool kit.

For further information on replacing bulbs, please refer to the Audi Q7 Owner's Manual.

The following cannot be replaced by the customer:
Xenon lamps, turn signal lamps in the mirrors, high-level brake light.



364_064

Control units

Rear exterior light

Layout of the rear lights

The main rear lights are integrated in the tailgate. Due to the fact that the rear lights also swing upward when the tailgate is opened, additional fixed rear lights are required in the bumper. When the tailgate is opened, the system changes over to the additional rear lights. The brake/tail lights, two for each side of the vehicle and the turn signals, are integrated in the rear lights. The additional brake/tail lights and the additional turn signals are integrated in the additional rear lights in the bumper. The reversing lights and the rear fog lights are also integrated in the bumper.

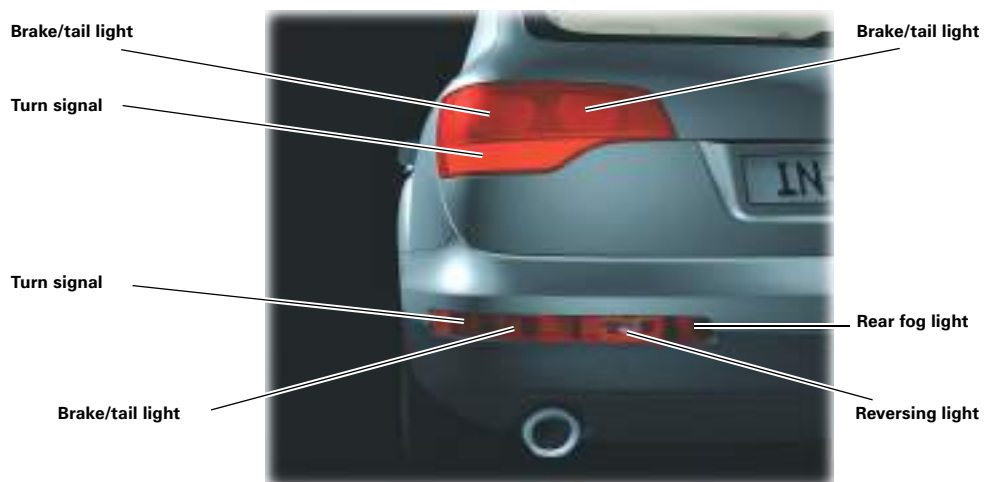

364_021

Variants

The rear lights are available in country-specific variants:

- ECE (e.g. Europe)
- SAE (e.g. North America)

Activation of the rear lights

Activation by convenience system central control unit J393

- Brake lights
- Tail light
- Turn signals

Activation by convenience system central control unit 2 J773

- Rear fog light
- Reversing light
- Side brand (North America)

Switch-over of the rear lights

Switch-over when opening the tailgate

When the tailgate is opened, the brake/tail lights and the turn signals are switched over from the rear lights in the tailgate to the additional rear lights in the bumper. The bulbs in the rear lights in the tailgate are then switched off. If the tailgate is closed again, the system switches back to the rear lights in the tailgate. The additional rear lights in the bumper are again deactivated.

Switch-over in case of failure of lamps

In the case of failure of the turn signal on one side of the vehicle or failure of both lamps for the combined tail lights/brake lights, the system switches over asymmetrically to the lights in the bumper. This means that the system switches over only to the faulty side of the vehicle. If an asymmetric switch-over is made, this is indicated in the dash panel insert. In the case of a switch-over due to the failure of the main rear lights to the additional rear lights in the bumper, the next attempt to switch on the rear lights in the tailgate is made in conjunction with the next terminal 15 cycle.



364_022

Rear light switch-over sequence

The convenience system central control unit J393 receives sensor information from the convenience system central control unit 2 J773 for switching over the lights when opening the tailgate. Tailgate closed sender 1 G525 and tailgate closed sender 2 G526 are connected to the convenience system central control unit 2 J773. If the convenience system central control unit 2 J773 receives the information "tailgate open", this information will be relayed to the convenience system central control unit J393 via the convenience CAN bus. The convenience system central control unit J393 thereupon switches over from the rear light in the tailgate to the additional rear lights in the bumper. You will find information on senders G525 and G526 in the section on convenience system central control unit 2 J773 in this self-study programme. The convenience system central control unit is equipped with a cold and hot lamp monitoring system. This enables it to detect the failure of the brake/tail lights and turn signals. If the failure of a lamp is detected on one side of the vehicle, the system, switches over to the additional rear light.

Replacing the lamps

All lamps can be replaced using the vehicle's tool kit. The lamps can be accessed through 4 covers in the tailgate.

Control units

Onboard power supply control unit 2 J520

Modifications to the Audi A6 '05

The onboard power supply control unit 2 was adopted from the Audi A6 '05. The installation location of the control unit is new.

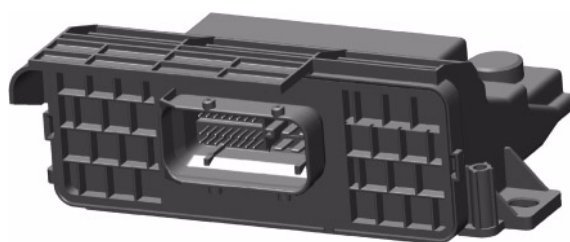

364_023

Functions

- Reading in the glove box button E316
- Activation of the glove box release motor V327
- Activation of the servotronic solenoid valve N119
- Provides the information on road speed signal, convenience opening and convenience locking to the sliding sunroof via one discrete line
- Transfers the measured values from the tilt-angle sensor integrated in the control unit to the CAN bus

Variants

There are two variants of the onboard power supply control unit 2 J520.

The basis variant has the functions of the glove box release and activates the servotronic solenoid valve.

The Highline variant additionally has the functions of the sliding sunroof and a tilt sensor in the control unit. The measured values of the tilt sensor are required for the anti-theft alarm system.

Installation location

Onboard power supply control unit 2 is, as shown in the illustration, located below the right-hand front seat.



364_024

Entry and start authorisation control unit J518

- with aerial reader unit for entry authorisation for keyless entry system J723
- Entry and start authorisation switch E415 and
- Entry and start authorisation button E408

Changes to the Audi A6 '05

The entry and start authorisation system has basically been adopted from the Audi A6 '05. The following changes have been made compared to the Audi A6 '05:

The installation location of the aerial reader unit for entry authorisation for keyless entry system J723 was changed.

In the Audi Q7 it is located at the rear right. The exact installation location is shown in the relevant section.

System overview

Three components of the entry and start authorisation system communicate with each other via a local single-wire bus.

These are:

- the entry and start authorisation control unit J518
- the entry and start authorisation switch E415 and
- the aerial reader unit for entry authorisation for keyless entry system J723 (is only installed in combination with Advanced Key)

The entry and start authorisation control unit J518 is the system master and represents the interface externally. The entry and start authorisation control unit J518 is a convenience CAN bus user.

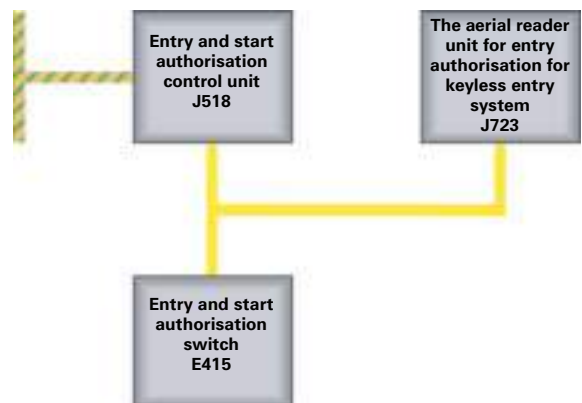

364_025

Control units

Variants

Depending on the vehicle's target market and the vehicle equipment specification, a variety of demands are placed on the entry and start authorisation system. The resulting type diversity is covered only by different variants of the entry and start authorisation switch E415. The switch variant is determined by the following vehicle characteristics:

- with or without Advanced Key
- with automatic or manual gearbox (due to ignition key withdrawal lock)
- radio frequency of the ignition key (315 MHz, 433 MHz or 868 MHz)

The entry and start authorisation control unit J518 as well as the aerial reader unit for entry authorisation for keyless entry system J723 are available in one variant only.

Reference



The entry and start authorisation system is described in SSP 326 - Audi A6 '05 Electrical System.

Tasks of the entry and start authorisation control unit J518

- Represents the system bus connection externally. Is a convenience CAN bus user
- Communicates with the other components of the entry and start authorisation system via a local single-wire bus
- Reads the position of the ignition key in the entry and start authorisation switch E415 via 2 discrete lines and the single-wire bus
- Reads the position of the entry and start authorisation button E408 (is only installed in combination with Advanced Key)
- Activates the terminal relay for terminal 15 and for terminal 75x
- Requests the engine control unit to start the engine
- Activates the steering column locking and unlocking motor
- Queries the automatic gearbox control unit J217 to determine whether the selector lever is currently engaged in the P or N position.
- Enables "vehicle opening"
- Is the diagnostic interface for all components of the entry and start authorisation system
- Acts as the master for the immobiliser IV vehicle function



364_026

The entry and start authorisation control unit and the steering column form a single unit, as in the Audi A6 '05. The control unit is attached to the steering column by tear-off screws, and cannot be replaced separately. If it is necessary to replace the entry and start authorisation control unit, the steering column must also be replaced.

Tasks of the entry and start authorisation switch E415

The entry and start authorisation switch E415 is not mechanically encoded. This switch can, therefore, be turned with any A6 key. Key recognition is electronic only.



364_027

- Evaluating the key position in the ignition switch with 4 microswitches
- Transferring the current ignition key position via single-wire bus and via 2 discrete lines to the entry and start authorisation control unit
- For safety reasons, the entry and start authorisation switch has an additional disconnect for the power supply to the steering column lock (to prevent automatic locking)
- Reading the gear selector position P switch F305 (only in vehicles with automatic gearbox)
- Controlling the integrated ignition key withdrawal lock
- Reading the entry and start authorisation button E408 (only in vehicles with Advanced Key)
- Reading the signal from the central locking and anti-theft alarm system aerial R47
- Relaying data received from the remote control key to the entry and start authorisation control unit
- Reading the signal from brake light switch F (only in vehicles with Advanced Key)
- Transmitting power via a reader coil to the inserted ignition key so that it can send its key ID
- Transmitting the received key ID via the single-wire bus to the entry and start authorisation control unit J518
- Communicating with the other components of the entry and start authorisation system via a local single-wire bus

Tasks of the aerial reader unit for entry authorisation for keyless entry system J723

(The aerial reader unit for entry authorisation for keyless entry system J723 is only available in combination with the optional Advanced Key)

- Evaluating the signals from the four proximity sensors in the doors
- Activating the aerials for entry and start authorisation R134 - R138
- Communicating with the other components of the entry and start authorisation system via a local single-wire bus

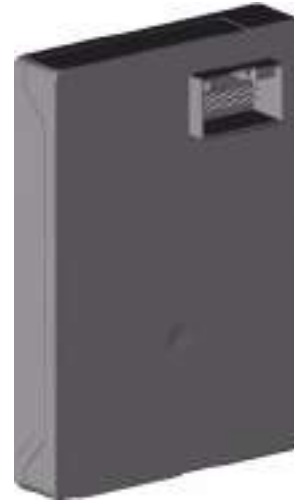

364_028

Aerial reader unit for entry authorisation for keyless entry system J723



Installation location of the aerial reader unit for entry authorisation for keyless entry system J723

364_029

Tasks of the entry and start authorisation button E408

(The button is only installed in combination with the optional Advanced Key)

- For security reasons, the current position of the entry and start authorisation button is provided to both the control unit and to the entry and start authorisation.

Reference



The functions of the entry and start authorisation switch are described in SSP 326 - Audi A6 '05 Electrical System.

Control units

Door control units

- J386 Driver door control unit
- J387 Front passenger door control unit
- J388 Rear left door control unit
- J389 Rear right door control unit

Changes to the Audi A6 '05

The door control units for the Audi Q7 have been adopted from the Audi A6 '05. This means that the control unit and the window lifter motor are again installed as separate units.

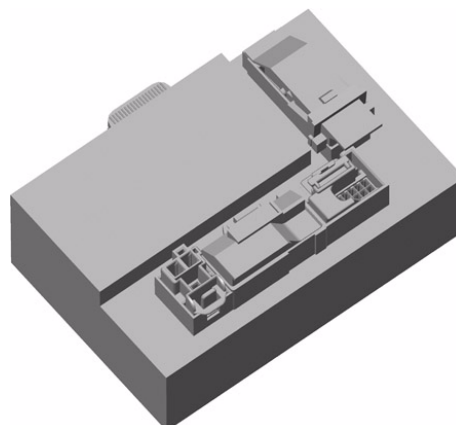

364_030

Substitute master functions

In case of failure of the convenience system central control unit J393, the driver door control unit acts as a substitute master for the central locking system. In this case, opening by remote control and the Advanced Key functions are not available. The vehicle must be opened and closed mechanically. In this case, the other door control units evaluate the information from the driver door control unit directly.

Variants

The door control unit for the Audi Q7 is available in two variants - a Min variant and a Max variant.

The Max variant is required if the vehicle has any of the following functions:

- Advanced Key
- Ambient lighting
- Outside lights
- Seat memory
- Exterior mirror fold-back
- Auto-dimming exterior mirror
- Electrical child lock

Installation locations of the control unit and the window lifter motor



364_031

Driver and front passenger seat adjustment control units

J136 Seat and steering column adjustment control unit with memory with memory function

J521 Seat adjustment control unit with memory, front passenger

Changes to Audi A6 05

The seat adjustment control unit and memory has, apart from a few minor modifications, been adopted from the Audi A6 '05.

The control unit can be installed both as a J136 on the driver's side and as a J521 on the front passenger side. The control unit recognises its installation location automatically based on the voltage level present at one of its terminal pins. This method is known as pin encoding.



364_032

Stored settings

The following settings are stored by when the Save button on the driver side memory block is pressed or when the vehicle is locked with the remote control key:

- Current position of the left and right exterior mirrors
- Current driver seat settings
- Current steering column position (if electrical steering column adjustment is installed)

The following setting is stored when the Save button on the driver side memory block is pressed:

- Current front passenger seat settings

The driver side control unit J136 can store six different settings. Two settings can be stored with the Save buttons, the other four with different remote control keys.

However, only two different settings can be stored with the Save buttons for the front passenger side control unit; it is not possible to store any settings with the remote control key.

The basic prerequisite for all memory operations is that the memory block ON/OFF switch is set to "ON". The position of this switch is read by software from the driver door control unit J386 and transferred to the CAN bus. However, the switch position is also transmitted via hardware line through the driver door control unit and relayed from here to the seat control unit. Here, the hardware line prevents the activation of output modules for motor activation or disables active output modules.

Control units

Functions

Electrical manual adjustment

In the case of seats with electrical adjustment and memory functions, the manual adjustment switches located in the seat are read by the seat adjustment control unit. The control unit, in turn, drives the 4 adjusting motors and adjusts the seat to the desired position.

In the case of seats with electrical adjustment without memory function, no control unit is used. The 4 adjusting motors are controlled directly by the manual adjustment switch.

Only terminal 30 is required for adjusting the seats. If a power-down level of the energy management control unit is set, seat adjustment will not be possible or, if so, only to a limited degree.

Saving settings and adjusting the seats using the programming buttons

The settings described above can be saved by pressing the SET button and then pressing one of the two memory location buttons. The SET function remains enabled until the red function indicator LED in the button goes off. An acoustic signal is given as feedback when a setting has been saved successfully. Again, the prerequisite is that the memory block ON/OFF switch is set to "ON".

Saved settings can be retrieved as follows:

- If the driver door is open and "terminal 15 = OFF", the mirrors, driver seat and steering column or front passenger seat can be adjusted to the pre-configured positions by pressing briefly one of the two Save buttons.
- If the driver door is closed or "terminal 15 = ON", the Save button must be held pressed until the adjustment procedure is completed. The adjustment procedure can be interrupted by releasing the Save button.

Saving settings and memory adjustment using a remote control key

The current mirror, driver seat and steering column positions can be saved to a remote control key as follows:

- The settings are saved after closing the driver door and locking the vehicle with the remote control key.
- After unlocking the vehicle with the remote control key and opening the driver's door, the mirror, driver seat and steering column are adjusted to the positions saved to the remote control key. The front passenger seat does not have this function.

However, the function described above will only work properly if two basic requirements are met:

- The menu item "Remote Control Key" must be set to "ON" in the MMI Car Menu under "Systems", "Seat Settings", "Driver Seat".
- The memory block ON/OFF switch must be set to "ON".

Saving settings and memory adjustment with Advanced Key

The memory adjustment procedure with Advanced Key is identical to the memory adjustment procedure with the remote control key.
The only difference is that the vehicle is locked and unlocked with the Advanced Key function.

Circuit diagram of the seat memory

Memory operating unit, driver seat E97

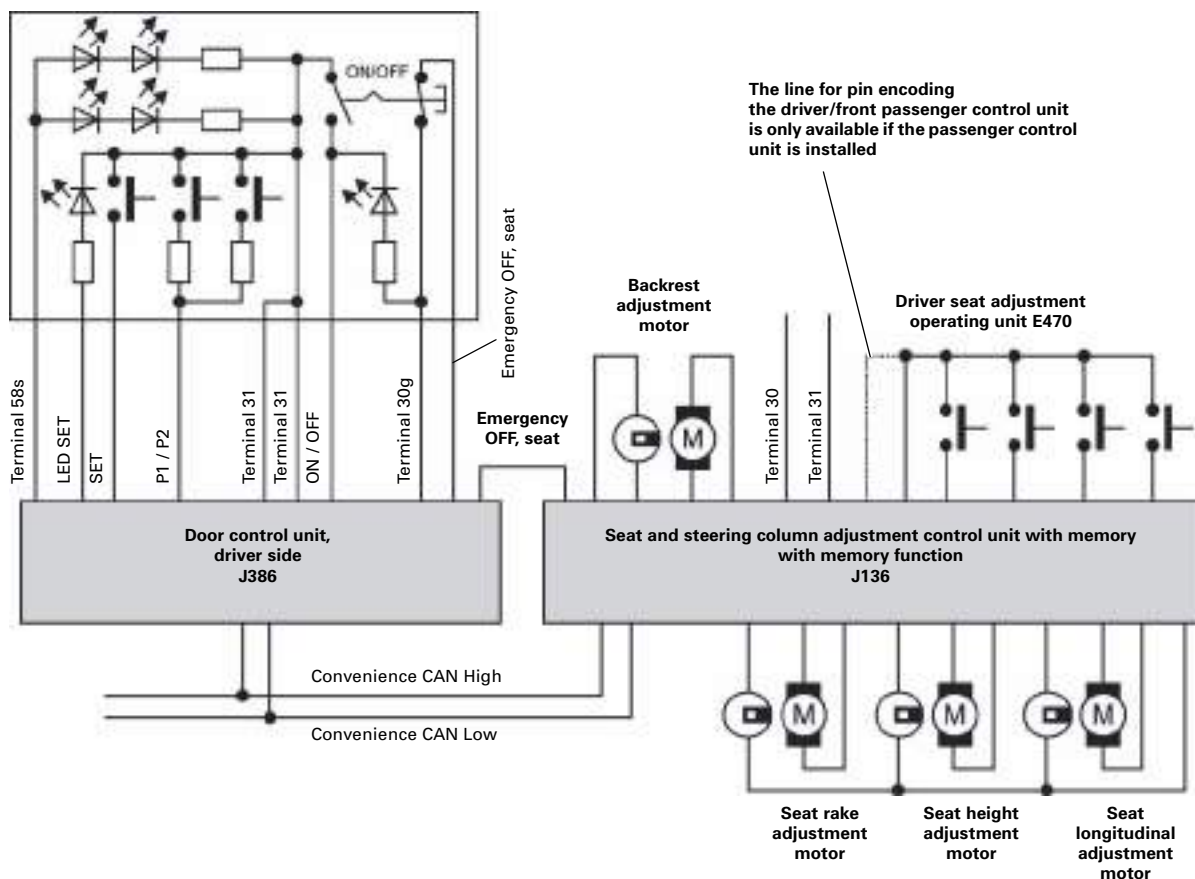

364_033

Reference



For further information, please refer to Self-Study Programme SSP 326.

Convenience system central control unit J393

Changes to Audi A6 '05

The convenience system central control unit J393 is based on the control unit in the Audi A6 '05.

The following modifications have resulted:

Due to the introduction of a second convenience system control unit (convenience system central control unit 2 J773), several functions and outputs have been omitted from the convenience system central control unit J393. These are listed in the following.

The pins which become available on the control unit are now used for activating the additional lamps because turn signals, brake and tail lights are installed both in the tailgate and in the bumper. This redundancy was necessary because the lights in the tailgate are not sufficiently visible to traffic following on behind when the tailgate is open.

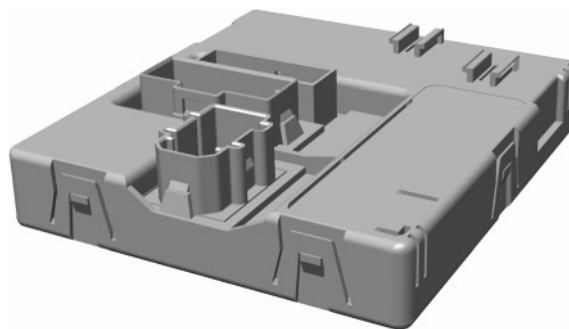

364_034

Master functions

- Turn signal master
- Central locking master
- Interior lighting master
- LIN master for the LIN bus users alarm horn H12 and interior monitoring sensor G273

Variants

The convenience system central control unit J393 comes in 2 variants for the Audi Q7: a basic variant and a Highline variant.

The Highline variant differs from the basic variant in that it has two additional functions:

- Activation of the rear footwell lights
- Tailgate power latching control

Outputs

- Brake and tail lights in bumper, left
- Brake and tail lights in bumper, outside left
- Brake and tail lights in bumper, inside left
- Turn signal in bumper, left
- Turn signal in tailgate, left
- Brake and tail lights in bumper, right
- Brake and tail lights in bumper, outside right
- Brake and tail lights in bumper, inside right
- Turn signal in bumper, right
- Turn signal in tailgate, right
- Centre brake light
- License plate light
- Boot light
- Footwell lights, rear left
- Footwell lights, rear right
- Fuel tank cap release motor
- Rear window defroster relay
- Supply cables in the power latching motor
- Tailgate lock unlocking motor
- Wake-up signal for the adaptive suspension control unit J197 (if a vehicle door has been opened)
- Wake-up signal for the engine control unit

Bidirectional lines

- High and Low CAN bus lines of the convenience CAN bus
- LIN bus line to alarm horn H12 and interior monitoring sensor G273

Inputs

- Microswitch for power latching system position information
- Brake light switch
- Softtouch in the tailgate
- Glass break detector for anti-theft alarm system (left and right side windows and rear window)
- Crash signal from airbag control unit
- Flashing light as confirmation of successful programming of the multipurpose garage door opener
- "Brake light on" is requested by the ABS control unit J104 due to an ACC braking operation
- Tailgate closed microswitch

Control units

Inputs and outputs on the convenience system central control unit 2 J773

- Sidemarker, left
- Sidemarker, right
- Rear fog light, left
- Rear fog light, right
- Reversing light, left
- Reversing light, right
- Interior lights
- LIN bus line to panorama sunroof

Installation location

The convenience system central control unit J393 is located at the rear right in the vehicle.

It is installed in an upright position and attached to a control unit bracket. The convenience system central control unit 2 J773 is located adjacent the convenience system central control unit on the left and is attached to the same bracket.



364_035

Convenience system central control unit 2 J773

The convenience system central control unit 2 J773 is a new control unit and will be used for the first time in the Audi Q7.

Tasks

The convenience system central control unit 2 J773 has the following tasks:

- Evaluating the tailgate closed sender for rear lights switch-over
- Activating the cargo space light or the light for the 3rd seat row (depending on whether 3 or 5 rear seats are fitted)
- Activating the reversing lights in the bumper
- Activating the rear fog lights in the bumper
- Activating the sidemarkers (North America)
- LIN master for the open sky system

Installation location

The convenience system central control unit 2 J773 is installed in the cargo space on the right below the load floor.



364_036

Variants

Min variant

- Standard equipment
- Solid roof
- 3 rear seats

Max variant

- Luxury-level equipment
- open sky system
- 5 rear seats (3rd seat row)

Master functions

The convenience system central control unit 2 J773 is the LIN master for the open sky system. As the LIN master, the control unit is responsible for the functioning and the diagnostics of the open sky system.

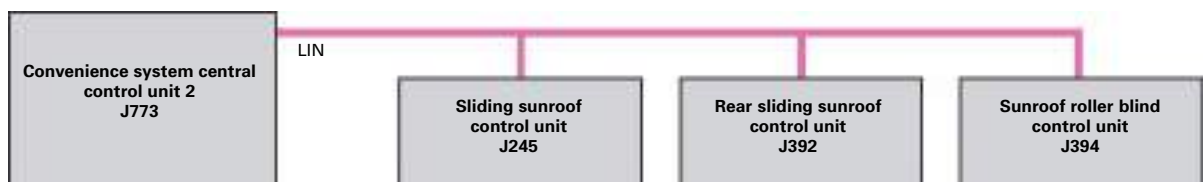

364_058

Control units

Function diagram

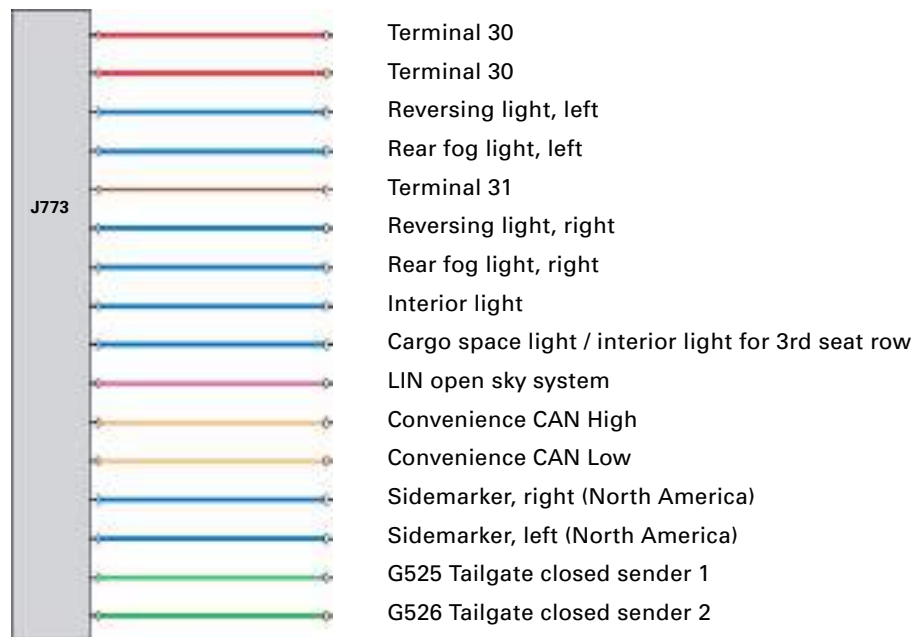

364_037

Evaluating the tailgate closed sender

The two switches G525 tailgate closed sender 1 and G526 tailgate closed sender 2 are read by the convenience system central control unit 2 J773.

The control unit provides the position of the two switches on the convenience CAN bus.

The convenience system central control unit J393 reads the switch information from the convenience CAN bus and activates the rear lights accordingly.

Position of the switches G525 and G526 "tailgate closed":

- The convenience system central control unit J393 activates the brake/tail lights and the turn signals in the main rear lights in the tailgate.
- The brake/tail lights and turn signals in the additional rear lights in the bumper are not activated.

Position of switches G525 and G526 "tailgate open":

- The convenience system central control unit J393 activates the brake/tail lights and the turn signals in the bumper.
- The brake/tail lights and the turn signals in the tailgate are not activated.

Legend

TS	Turn signal
BT	Brake/tail light
RL	Reversing light
RF	Rear fog light

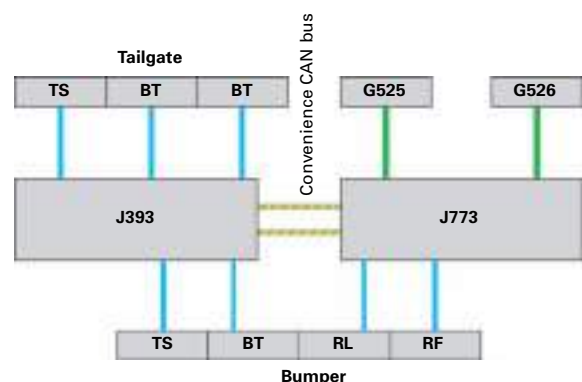

364_060

Emergency function

In the event of a fault in switches G525 and G526, the system switches over from the main rear lights in the tailgate to the additional rear lights in the bumper. This action is not indicated in the dash panel insert.

In this case, a new attempt to switch on the main rear lights in the tailgate is not made until the next ignition OFF/ON cycle.

Fault memory entries

The number of fault memory entries for the lights has been reduced. Only one fault memory entry is made per light assembly. Thus, only four fault memory entries are needed to cover the complete rear lighting. From the environmental data of the corresponding fault memory entry it can be determined which lamp in a light assembly is faulty.

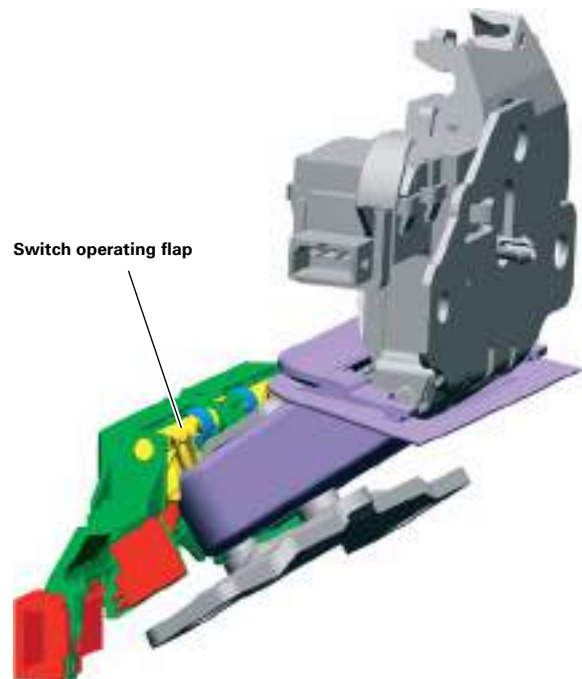

364_038

Data blocks

The convenience system central control unit 2 J773 provides data blocks for the following functions:

- Onboard power supply
- Additional rear lights in the bumpers
- Interior light
- open sky system
- LIN communication
- Tailgate recognition

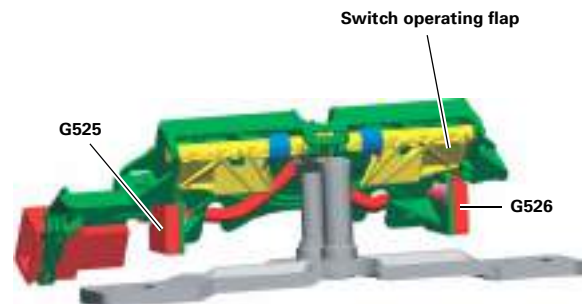

364_039

Final control test

The convenience system central control unit 2 J773 provides final control tests for the following functions:

- Additional rear lights
- Sidemarkers
- Interior lighting
- open sky system

Encoding

The convenience system central control unit 2 J773 provides codings for the following functions:

- Vehicle type
- open sky system
- Interior light
- Country
- Convenience opening of open sky roof
- Convenience opening of roll-up sun screen
- Convenience closing of roll-up sun screen

Control units

open sky system

Design

The open sky system is a 3-section panoramic glass sunroof. It extends back to the 3rd seat row. The front glass section tilts up and opens electrically. The rear glass section opens electrically. The panoramic sunroof has a full-area sunshade system. The sunshade operates electrically for the front two glass sections and manually and for the rear glass section.

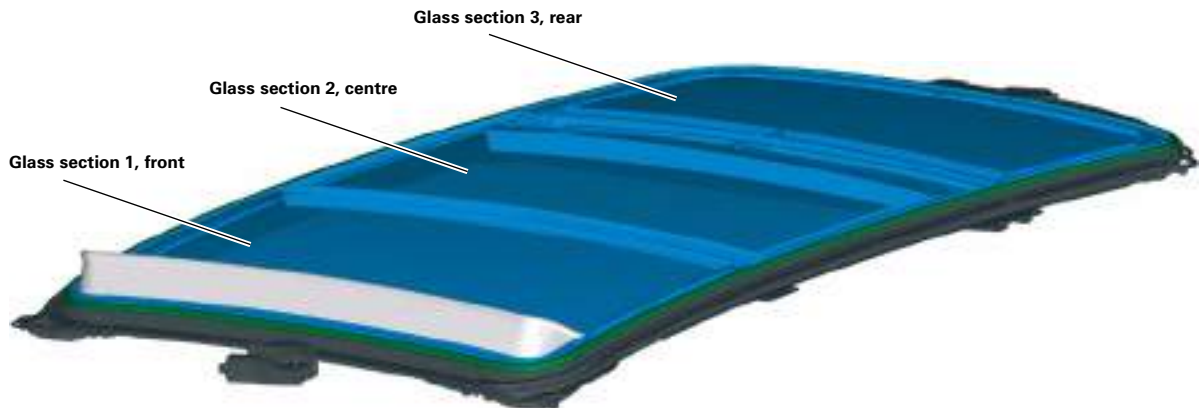

364_041

Functions

- Glass section 1, front: open and tilt up
- Glass section 2, centre: fixed
- Glass section 3, rear: tilt up

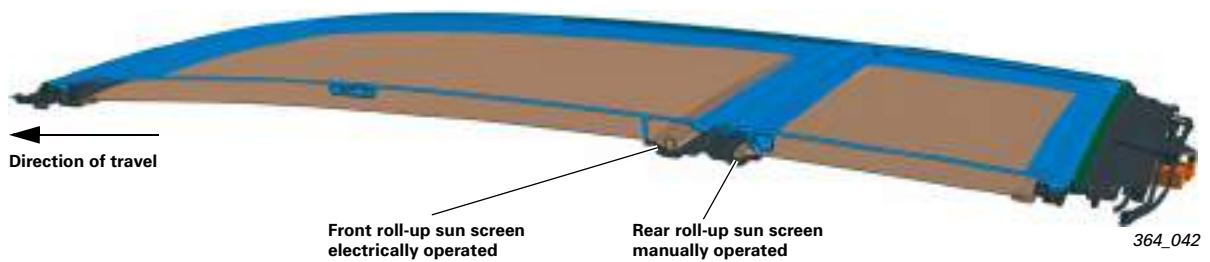

364_042

Glass sunroofs 1 and 3 tilted up



364_043

Glass sunroof 1 slid open and glass sunroof 3 tilted up



364_044

Control units

Sunblind

The three glass sections have sunshades for protection against direct sunlight. The front sunshades for glass sections 1 and 2 are operated electrically. The rear sunshade for glass section 3 can be operated manually.

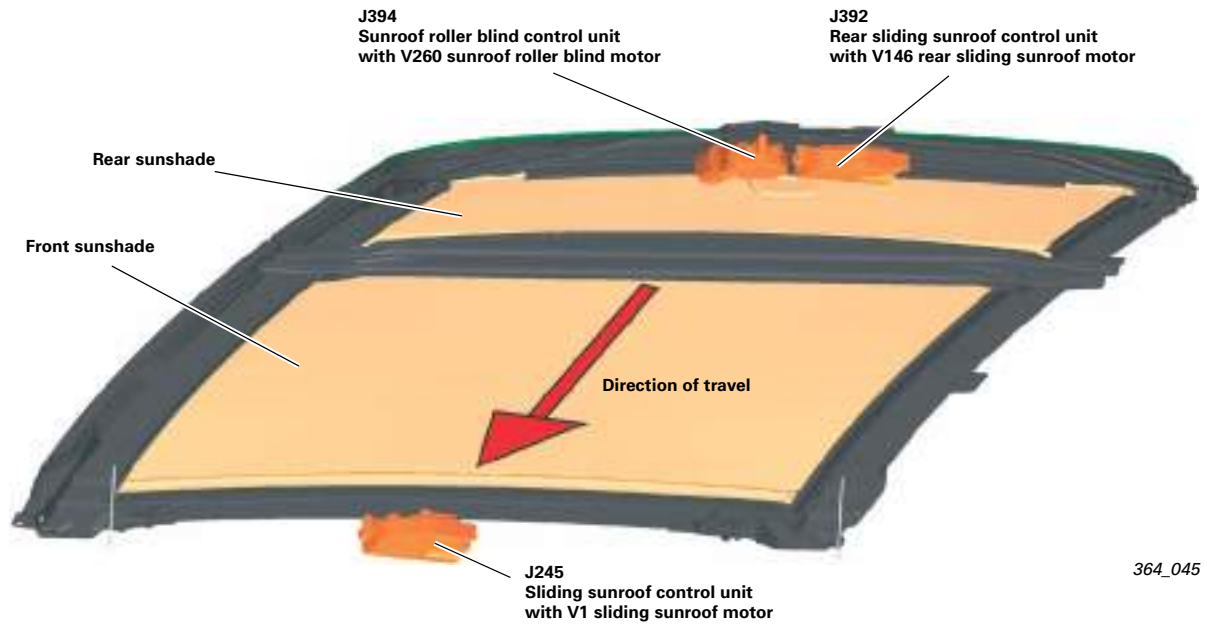

Operation

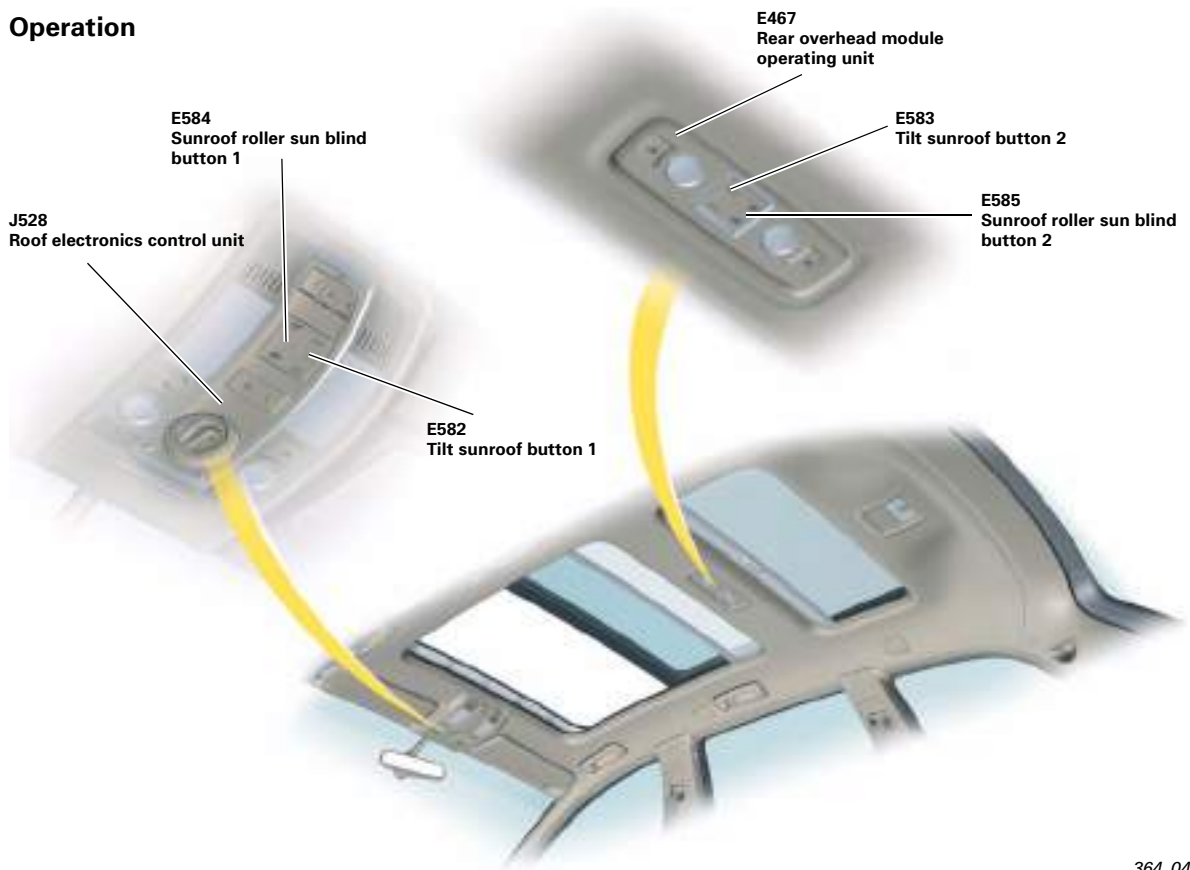

Glass section 1 can be operated using the rotary switch for the sliding sunroof in the front overhead module. Glass section 3 can be operated using the tilt sunroof button 1 E582 in the front overhead module and tilt sunroof button 2 E583 in the rear overhead module operating unit E467. Automatic opening/closing mode is activated by briefly pressing the button. Manual opening/closing mode is activated by holding the button down.

The front roof section can be tilted up by pressing the rotary switch. To be able to do this, the rotary switch must be in the 0 position. To close the tilted-open roof section, the rotary switch must be pulled down. The front roll-up sun screen can be operated with sunroof roller sun blind button 1 E584 and sunroof roller sun blind button 2 E585. Briefly pressing the button activates automatic opening/closing mode and holding the button down activates the manual opening/closing mode.

Tilt sunroof button 2 E583 and the sunroof roller sun blind button 2 E585, which are located in the rear overhead module operating unit E582, can be deactivated using the child lock. For further operating instructions, please refer to the Audi Q7 Owner's Manual.

Function diagram

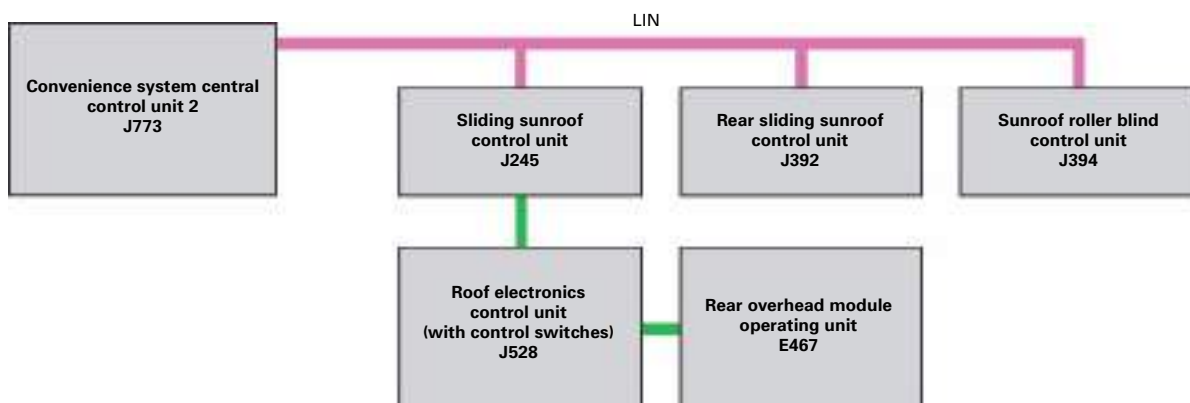

364_055

Control units

Initialisation

The initialisation for the open sky system's motors will be lost if the power supply to the motors or control units is disconnected when the convenience CAN bus is awake. For instance, the initialisation for motor V1 will be lost if the convenience CAN bus is not in Sleep mode and the power supply to this motor is disconnected.

Information on handling a lost initialisation

J245 Sliding sunroof control unit with V1 sliding sunroof motor:

- Roof section 1 can no longer be moved in the "OPEN" direction with the rotary switch. Manual closing can only be initiated by pulling the button down. A teach-in cycle is performed directly after the manual closing cycle.

J392 Rear sliding sunroof control unit with V146 rear sliding sunroof motor:

- The red LED in the tilt sunroof button 1 E582 is lit continuously at "term. 15 ON". Only a manual closing cycle can be performed with the "CLOSE" button. A teach-in cycle is started directly after the manual closing cycle.

J394 Sunroof roller blind control unit with V260 sunroof roller blind motor:

- The sunroof roller blind cannot be moved in the "OPEN" direction. Only a manual closing cycle can be performed with the "CLOSE" button. A teach-in cycle is performed directly after the manual closing cycle.

Performing the initialisation and teach-in cycle

Info

The drive motors initialise themselves in the sliding sunroof or roller sun blind "closed" position. The teach-in cycle is performed automatically directly after the initialisation is completed. During the teach-in cycle the drive motors are adapted to the vehicle-specific mechanism, and the set-up is saved. During the teach-in cycle, the switch must not be released since the teach-in cycle will otherwise become invalid and the drive motor will again become reset to default.

Note

The anti-pinch protection feature is not active during the teach-in cycle.

Procedure in case of drive motors which have been reset to default

Hold the switch for the relevant motor, e.g. tilt sunroof button 1 E582 for V146, rear sliding sunroof motor, manually in the "Close" position until the roof section - in this case it is roof section 3 - closes completely, reopens completely and closes again.

If the roof section or the roller sun blind is already closed at the start of the initialisation, the relevant motor opens the roof slightly and recloses it again completely.

During the teach-in cycle for cover 1 and during roller sun blind operation, the roof opens 200 mm and closes again completely.

If the control switch is released during an initialisation procedure, the initialisation will not be accepted.

If the "close" button is pressed for longer than 10 sec. while the roof or roller sun blind is closed, the respective drive motor will be reset to default and the teach-in cycle will start immediately.

Procedure in case of standardised drive motors

The teach-in cycle can only be initiated in the "closed" position.

If the "close" button is pressed for longer than 10 sec. while the roof or roller sun blind is closed, the respective drive motor will be reset to default and the teach-in cycle will start immediately.

Deactivation of control switches

If a switch is pressed for longer than 60 seconds, it will be deactivated in the direction it is set. If the switch is pressed for longer than 60 seconds in "OPEN" direction, the "OPEN" function will be deactivated. The deactivation can be cancelled by means of an ignition OFF/ON cycle.

Anti-pinch protection feature

All 3 motors have an anti-pinch protection feature which is enabled over the full closing distance of the window.

Emergency closing

If the anti-pinch protection feature for a motor is activated, the corresponding roof section or roller sun blind can be closed using an emergency function. To be able to do this, the relevant switch must be pressed manually and held down within 5 seconds after the reversing cycle starts. The corresponding roof section or roller sun blind will then close manually without the anti-pinch protection feature.

Control units

Trailer detector control unit J345

In addition to activating the trailer lights, the trailer detector control unit J345 controls the electric swivelling tow attachment.

The electric swivelling tow attachment known from group vehicles can also be retrofitted. In this case, it is installed as a unit behind the bumper.

Installation location

The trailer detector control unit J345 is installed in the cargo space on the right under the load floor.



364_049

Tasks

- Controlling the electric swivelling tow attachment
- Monitoring the "clutch engaged" position
- Coupled trailer detection
- Activating the trailer's rear lights
- Switching "Terminal 30 trailer" OFF when a power-down is activated by the energy management control unit J644.

Electric swivelling tow attachment

The electric swivelling tow attachment consists of an electro-mechanical swivel unit, which swivels the tow attachment ball head together with the trailer socket U10. The tow attachment ball head is first swivelled down together with the socket, and then swivelled back into its end position.

The electric swivelling tow attachment is actuated by means of a rocker in the luggage compartment on the right.

The trailer detector control unit J345 is responsible for activation, status indication and diagnostics. The electric swivelling tow attachment is installed as a unit behind the bumper cover.



364_050

Variants

The following tow attachments are available for the Audi Q7:

- Mechanical tow attachment, removable tow attachment ball head
- Electric tow attachment, electric swivelling tow attachment ball head

Operation

The electric swivelling tow attachment can be swivelled out manually or automatically. The operating unit consists of a rocker in the right side trim in the luggage compartment. The rocker has a red locating light and a yellow function light. For further operating instructions, please refer to the Audi Q7 Owner's Manual.

The swivelling tow attachment ball head can only be extended or retracted under the following conditions:

- Vehicle must be stationary
- Tailgate must be open
- No trailer attached



364_051

Control units

Mode of operation

The swivel-out operation is executed by the hinged tow attachment ball head motor V317 and monitored by the trailer detector control unit J345. If the tow attachment comes collides with an obstacle while swivelling out, the swivel-out operation is stopped. To detect collisions, the control unit monitors the power consumption of the hinged tow attachment ball head motor V317. The swivel-out operation can be continued by pressing the button continuously.

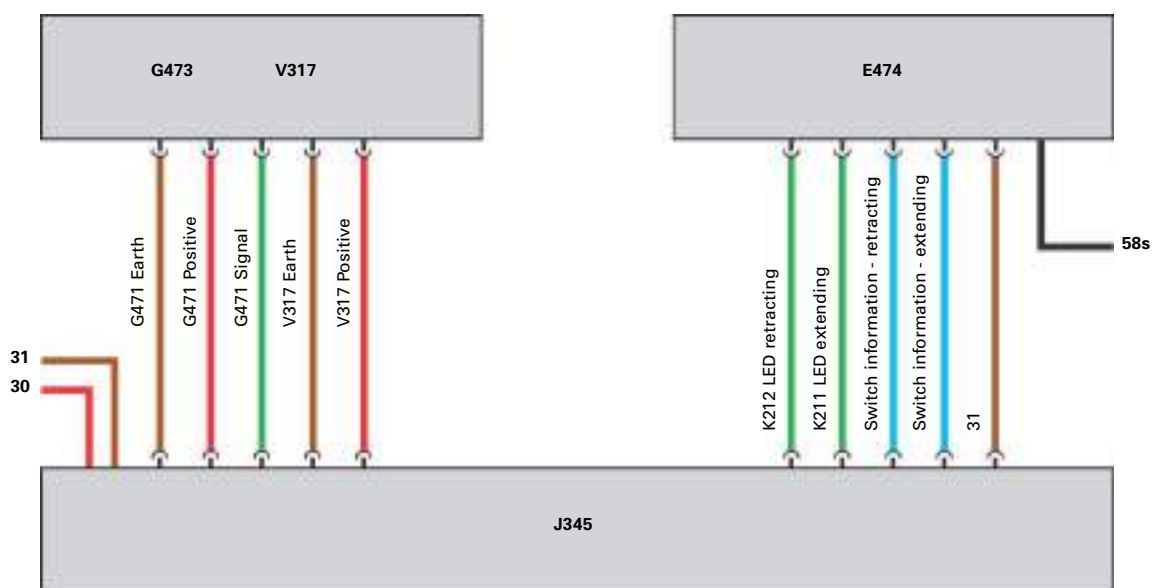

364_052

Legend

- E474 Electric hinged tow attachment coupling button
- G473 Trailer coupling motor Hall sender
- J345 Trailer detection control unit
- K211 Extending tow ball coupling warning lamp
- K212 Retracting tow ball coupling warning lamp
- L76 Button illumination (via 58s)
- V317 Hinged tow attachment ball head motor

"ON" conditions

The swivelling tow attachment ball head can only be extended or retracted under the following conditions:

- Vehicle must be stationary
- Tailgate must be open
- Button E474 must be operated
- No trailer attached

"OFF" conditions

The swivelling movement may be stopped under the following conditions:

- Anti-pinch protection
- By altering the supply voltage, i.e. if the supply voltage is less than 9 V or more than 15 V, the swivel-out operation will be stopped
- By changing an "ON" condition
- Attaching a trailer
- Vehicle road speed greater than 6 kph

Initialisation

The electric swivelling tow attachment must be initialised after the following conditions occur:

- Fault memory entry "mechanical fault", "implausible signal" or "electrical fault in electrical circuit"
- After a terminal 30 Reset (e.g. disconnecting the battery) if the tow attachment was not in its end position
- After replacing the electric swivelling tow attachment
- After replacing the trailer detector control unit J345

During the initialisation procedure, the system "learns" the two limit stops or the swivel distance.

The electric swivelling tow attachment ball head must complete a single swivel cycle in at least one direction without interruption. The initialisation is complete at the most recent after a full swivel-in/swivel-out cycle has been completed.

To initialise the system, the control button for the relevant direction of movement must be pressed until the tow attachment ball head reaches the limit stop.

Alternatively, the initialisation can be performed with the diagnostic tester using the Final Control Diagnosis function.

An initialisation is only possible under the following conditions:

- The trailer detector control unit J345 has not detected an attached trailer
- Vehicle road speed less than 6 kph
- Supply voltage between 9 and 15 V
- Tailgate open

Tailgate control unit J605 and tailgate control unit 2 J756



364_053

Changes to Audi A6 '05

The tailgate control units and drives J605 and J756 have been adopted from the Audi A6 Avant. The software was adapted to the Audi Q7 tailgate, which, for example, has a different opening angle than the Audi A6 Avant tailgate. The tailgate control operating concept is identical to that described in SSP 344.

The tailgate control system

The tailgate control unit J605 communicates with tailgate control unit 2 J756 via a single-wire bus manufactured by systems supplier Valeo.

The tailgate control unit J605 is a convenience CAN bus user and can be addressed under the address word 6D with the diagnostic tester. The tailgate control unit 2 J756 cannot be addressed separately with the diagnostic tester; it transmits its diagnostic information to the tailgate control unit J605.

The tailgate drives and the tailgate control unit form a unit. They have a single part number. The tailgate control unit J605 is always installed on the left-hand side and is the master control unit, while tailgate control unit 2 J756 is located on the right-hand side and acts as the slave control unit.

Installation locations of the tailgate drives

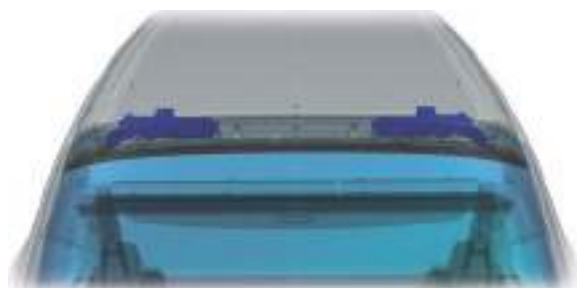

364_054

Reference

For further information, please refer to Self-Study Programme SSP 344.



Self-Study Programmes on the Audi Q7

SSP 287 - Audi A8 '03 Electrical Components

- Bus Topology
- Control units

Order number: 000.2811.07.20



SSP 288 - Audi A8 '03 Distributed Functions

- Bus Topology
- Distributed Functions

Order number: 000.2811.08.20



SSP 344 - The New Audi A6 Avant '05

- Body
- Occupant Protection
- Engine
- Running Gear
- Electrical System
- Infotainment
- Convenience Electronics

Order number: A05.5S00.13.20



SSP 326 Audi A6 '05 Electrical System

- Networking
- Bus Topologies
- Convenience Electronics
- Infotainment

Order number: A04.5S00.09.20



SSP 375 Audi Q7 - New Driver Assist Systems

- Lane Change Assist (LCA)
- Optical Parking System (OPS)
- Rear-View Camera

Order number: A05.5S00.21.20



All rights reserved.
Technical specifications
subject to change without
notice.

Copyright
AUDI AG
I/VK-35
Service.training@audi.de
Fax +49-841/89-36367

AUDI AG
D-85045 Ingolstadt
Technical status: 10/05

Printed in Germany
A05.5S00.17.20