

# Owner's Manual

2023 INTEGRA

## California Proposition 65 Warning

**⚠ WARNING:** Operating, servicing and maintaining a passenger vehicle or off-highway motor vehicle can expose you to chemicals including engine exhaust, carbon monoxide, phthalates, and lead, which are known to the State of California to cause cancer and birth defects or other reproductive harm. To minimize exposure, avoid breathing exhaust, do not idle the engine except as necessary, service your vehicle in a well-ventilated area and wear gloves or wash your hands frequently when servicing your vehicle. For more information go to [www.P65Warnings.ca.gov/passenger-vehicle](http://www.P65Warnings.ca.gov/passenger-vehicle).

### **Event Data Recorders**

**This vehicle is equipped with an event data recorder (EDR).** The main purpose of an EDR is to record, in certain crash or near crash-like situations, such as an air bag deployment or hitting a road obstacle, data that will assist in understanding how a vehicle's systems performed. **The EDR is designed to record data related to vehicle dynamics and safety systems for a short period of time, typically 30 seconds or less. The EDR in this vehicle is designed to record such data as:**

- **How various systems in your vehicle were operating;**
- **Whether or not the driver and passenger safety belts were buckled/fastened;**
- **How far (if at all) the driver was depressing the accelerator and/or brake pedal; and,**
- **How fast the vehicle was traveling.**

These data can help provide a better understanding of the circumstances in which crashes and injuries occur. NOTE: EDR data are recorded by your vehicle only if a non-trivial crash situation occurs; no data are recorded by the EDR under normal driving conditions and no personal data (e.g., name, gender, age, and crash location) are recorded. However, other parties, such as law enforcement, could combine the EDR data with the type of personally identifying data routinely acquired during a crash investigation.

To read data recorded by an EDR, special equipment is required, and access to the vehicle or the EDR is needed. In addition to the vehicle manufacturer, other parties, such as law enforcement, that have the special equipment, can read the information if they have access to the vehicle or the EDR.

The data belongs to the vehicle owner and may not be accessed by anyone else except as legally required or with the permission of the vehicle owner.

## **Service Diagnostic Recorders**

This vehicle is equipped with service-related devices that record information about powertrain performance. The data can be used to verify emissions law requirements and/or help technicians diagnose and solve service problems. It may also be combined with data from other sources for research purposes, but it remains confidential. Some diagnostic and maintenance information is uploaded to Acura upon vehicle start up.

## **California Perchlorate Contamination Prevention Act**

The airbags, seat belt tensioners, and CR type batteries in this vehicle may contain perchlorate materials - special handling may apply. See [www.dtsc.ca.gov/hazardouswaste/perchlorate/](http://www.dtsc.ca.gov/hazardouswaste/perchlorate/)

As you read this manual, you will find information that is preceded by a **NOTICE** symbol. This information is intended to help you avoid damage to your vehicle, other property, or the environment.

## **Software End User License Agreement**

Your vehicle comes equipped with software, which is governed by the End User License Agreement in this Owner's Manual, and which contains a binding arbitration clause. Please refer to the End User License Agreement for the terms and conditions governing your use of the installed software, as well as the applications, services, functions, and content provided through the software. Your use of the installed software will serve as your consent to the terms and conditions of the End User License Agreement. You may opt out within 30 days of your initial use of the Software by sending a signed, written notice to Acura at American Honda Motor Co., Inc., Acura Client Relations, Mail Stop CHI-4, 1919 Torrance Blvd., Torrance, CA 90501-2746.

## **Privacy Notice**

This vehicle may share location and usage information. To manage this setting, visit [www.acuralink.com/vehicle-data-choices](http://www.acuralink.com/vehicle-data-choices).

**To learn more about how we collect and use Personal Information, please read our Privacy Policy, accessible at [www.acura.com](http://www.acura.com).**

## System Updates Terms and Conditions\*

### General

Your vehicle has an application that allows your 9-in. Color Touchscreen to automatically search for Acura software updates that are specific to your 9-in. Color Touchscreen and its connected devices (initially every one (1) week via Wi-Fi or every four (4) weeks via Telematics Control Unit (TCU)\*, queries may occur more or less frequently due to internet outages, retries, direct user action, WAP push from the server or a change in query policy on the Honda servers). This application periodically transmits to our servers a limited amount of vehicle and device information (Vehicle Identification Number (VIN), the Model Type (MT) Identification Number, Hardware and Software Part Number, Serial Number, Software Version, preferred language, Internet Protocol (IP) address, Transaction Log (alert or update viewing, update download and installation, software status), etc.). When the application finds an update from the server, the application initially asks permission to download and install the update. Where available, in your settings menu you may elect to automatically download and install these updates or you may elect to manually update the system.

When your 9-in. Color Touchscreen searches our servers for updates or alerts, we will automatically provide you with the opportunity to update your devices or transmit the update or alert directly to your 9-in. Color Touchscreen. We will also maintain on our servers a log of the updates or alerts that are installed.

### Your Personal Data

Should the aforementioned information transmitted to Honda constitute personal information in your region, please note that this information will be treated in strict accordance with the rules and regulations outlined in this notice as well as applicable data protection law.

\* Not available on all models

The terms of our privacy policy are incorporated into these terms by reference and your use of system updates will be subject to the privacy policy. Our privacy policy sets out information about how we and any named third parties will process any personal data we collect from you or that you provide to us, via the application.

For further details, see Acura's connected product privacy policy at:

U.S.: [www.acura.com](http://www.acura.com)

Canada: [www.honda.ca/privacy/vehicledata](http://www.honda.ca/privacy/vehicledata)

Honda collects, uses and stores your personal data for the reasons set out below:

- to deliver the system updates and related services to you;
- to allow us to improve and optimize the system updates products and services;
- to respond to user questions and complaints; and for internal record keeping.
- where necessary for Honda's legitimate interests, as listed below, and where our interests are not overridden by your data protection rights.

Protecting our legitimate business interests and legal rights includes, but is not limited to, use in connection with compliance, regulatory, auditing, legal claims (including disclosure of such information in connection with legal process or litigation) and other ethics and compliance reporting requirements.

Honda will also convert personal data into anonymous data and use it (normally on an aggregated statistical basis) for uses such as market research and analysis, to improve the system updates, to analyze trends, and to assess the success of software update releases. Aggregated personal information does not personally identify you or any other user of the system updates.

Honda may share this data with Honda's worldwide support organization or affiliated Honda companies or other third parties engaged by Honda for the purposes of rendering support services in connection with system support.



## A Few Words About Safety

---

Your safety, and the safety of others, is very important. And operating this vehicle safely is an important responsibility.

To help you make informed decisions about safety, we have provided operating procedures and other information on labels and in this manual. This information alerts you to potential hazards that could hurt you or others.

Of course, it is not practical or possible to warn you about all the hazards associated with operating or maintaining your vehicle. You must use your own good judgment.

You will find this important safety information in a variety of forms, including:

- **Safety Labels** - on the vehicle.
- **Safety Messages** - preceded by a safety alert symbol  and one of three signal words: **DANGER**, **WARNING**, or **CAUTION**. These signal words mean:

 **DANGER**

You **WILL** be **KILLED** or **SERIOUSLY HURT** if you don't follow instructions.

 **WARNING**

You **CAN** be **KILLED** or **SERIOUSLY HURT** if you don't follow instructions.

 **CAUTION**

You **CAN** be **HURT** if you don't follow instructions.

- **Safety Headings** - such as Important Safety Precautions.
- **Safety Section** - such as Safe Driving.
- **Instructions** - how to use this vehicle correctly and safely.

This entire book is filled with important safety information - please read it carefully.

This owner's manual should be considered a permanent part of the vehicle and should remain with the vehicle when it is sold.

This owner's manual covers all models of your vehicle. You may find descriptions of equipment and features that are not on your particular model.

Images throughout this owner's manual (including the front cover) represent features and equipment that are available on some, but not all, models. Your particular model may not have some of these features.

This owner's manual is for vehicles sold in the United States and Canada.

The information and specifications included in this publication were in effect at the time of approval for printing. Honda Motor Co., Ltd. reserves the right, however, to discontinue or change specifications or design at any time without notice and without incurring any obligation.

#### ➤ **Safe Driving P. 35**

For Safe Driving P. 36      Seat Belts P. 40      Airbags P. 49

#### ➤ **Instrument Panel P. 83**

Indicators P. 84      Gauges and Displays P. 104

#### ➤ **Controls P. 141**

Clock P. 142      Locking and Unlocking the Doors P. 144  
Operating the Switches Around the Steering Wheel P. 172  
Interior Convenience Items P. 201

#### ➤ **Features P. 225**

Audio System P. 226      Audio System Basic Operation P. 234, 259  
Customized Features P. 351, 359

#### ➤ **Driving P. 423**

Before Driving P. 424      Towing a Trailer P. 429  
Multi-View Rear Camera P. 606      Refueling P. 608

#### ➤ **Maintenance P. 613**

Before Performing Maintenance P. 614      Maintenance Minder™ P. 617  
Checking and Maintaining Wiper Blades P. 639  
Climate Control System Maintenance P. 655

#### ➤ **Handling the Unexpected P. 665**

Tools P. 666      If a Tire Goes Flat P. 667  
Shift Lever Does Not Move P. 696      Overheating P. 697  
If You Cannot Unlock the Fuel Fill Door P. 712

#### ➤ **Information P. 715**

Specifications P. 716      Identification Numbers P. 718  
Warranty Coverages P. 723      Authorized Manuals P. 726

# Contents

Child Safety P. 68

Exhaust Gas Hazard P. 81

Safety Labels P. 82

Hatch P. 162

Security System P. 165

Windows P. 168

Moonroof P. 171

Mirrors P. 189

Seats P. 191

Climate Control System P. 218

Audio Error Messages P. 328

General Information on the Audio System P. 330

*Bluetooth*® HandsFreeLink® P. 383, 403

When Driving P. 430

AcuraWatch™ P. 478

Braking P. 584

Parking Your Vehicle P. 596

Fuel Economy and CO<sub>2</sub> Emissions P. 611

Turbo Engine Vehicle P. 612

Maintenance Under the Hood P. 625

Replacing Light Bulbs P. 637

Checking and Maintaining Tires P. 641

Battery P. 651

Remote Transmitter Care P. 653

Cleaning P. 656

Accessories and Modifications P. 662

Engine Does Not Start P. 689

If the Battery Is Dead P. 694

Indicator, Coming On/Blinking P. 699

Fuses P. 705

Emergency Towing P. 711

If You Cannot Open the Hatch P. 713

Refueling P. 714

Devices that Emit Radio Waves P. 719

Reporting Safety Defects P. 720

Emissions Testing P. 721

Client Service Information P. 727

Open Source Licenses P. 728

Quick Reference Guide P. 6

Safe Driving P. 35

Instrument Panel P. 83

Controls P. 141

Features P. 225

Driving P. 423

Maintenance P. 613

Handling the Unexpected P. 665

Information P. 715

Index P. 729

# Visual Index

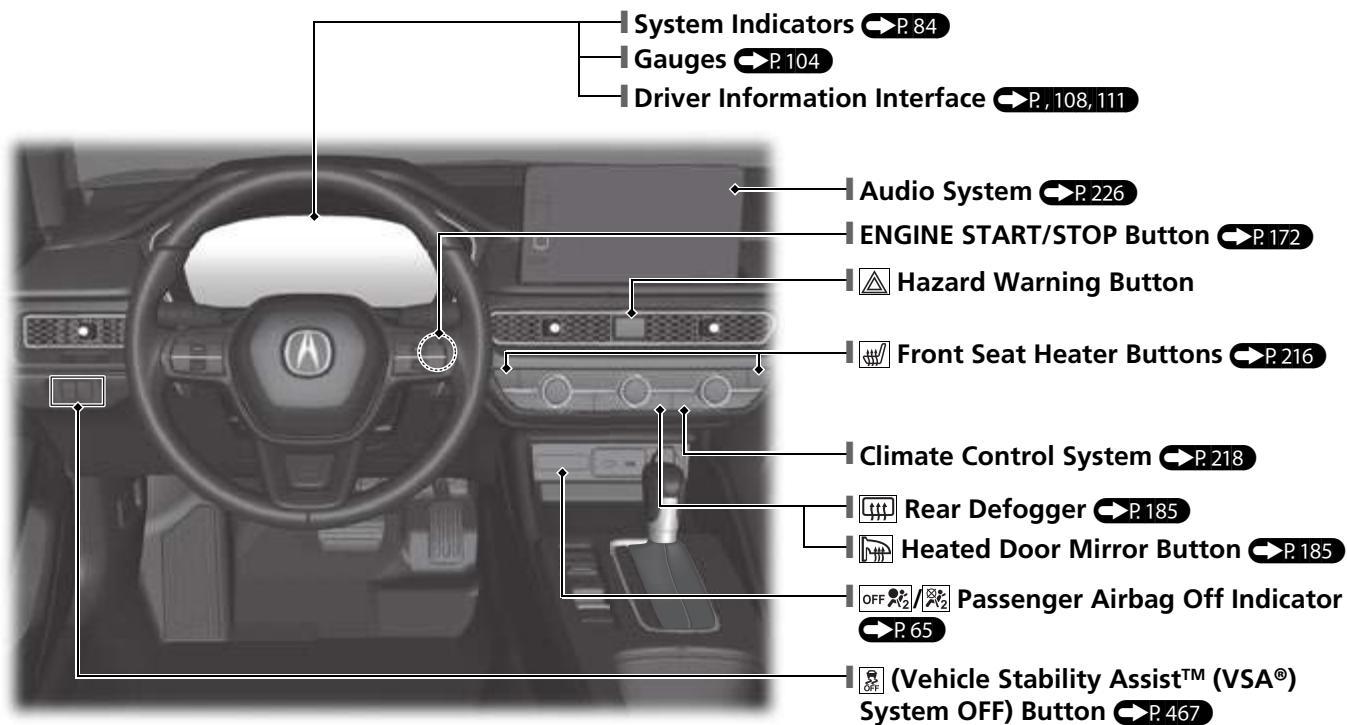

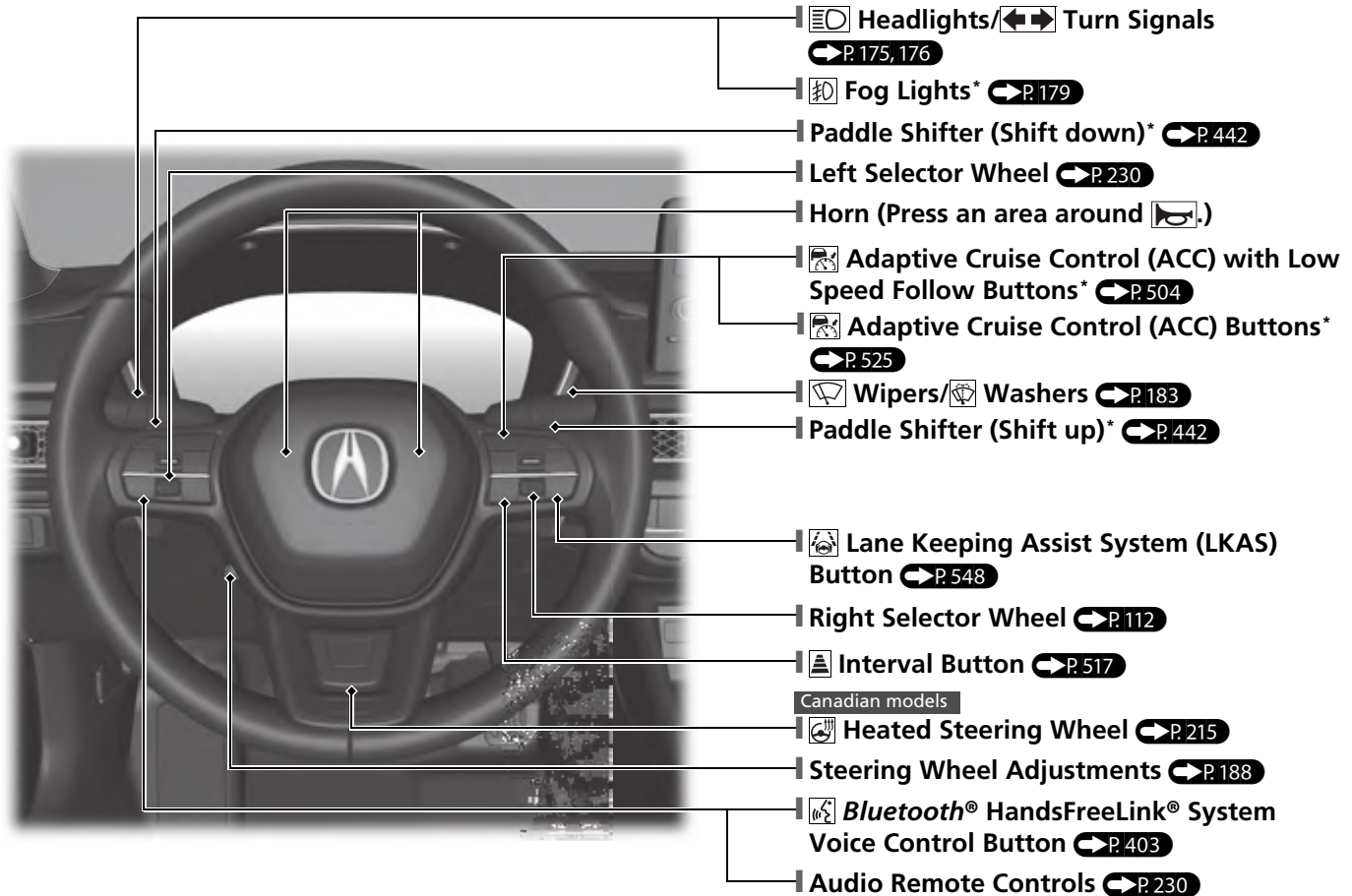

\* Not available on all models

# Visual Index

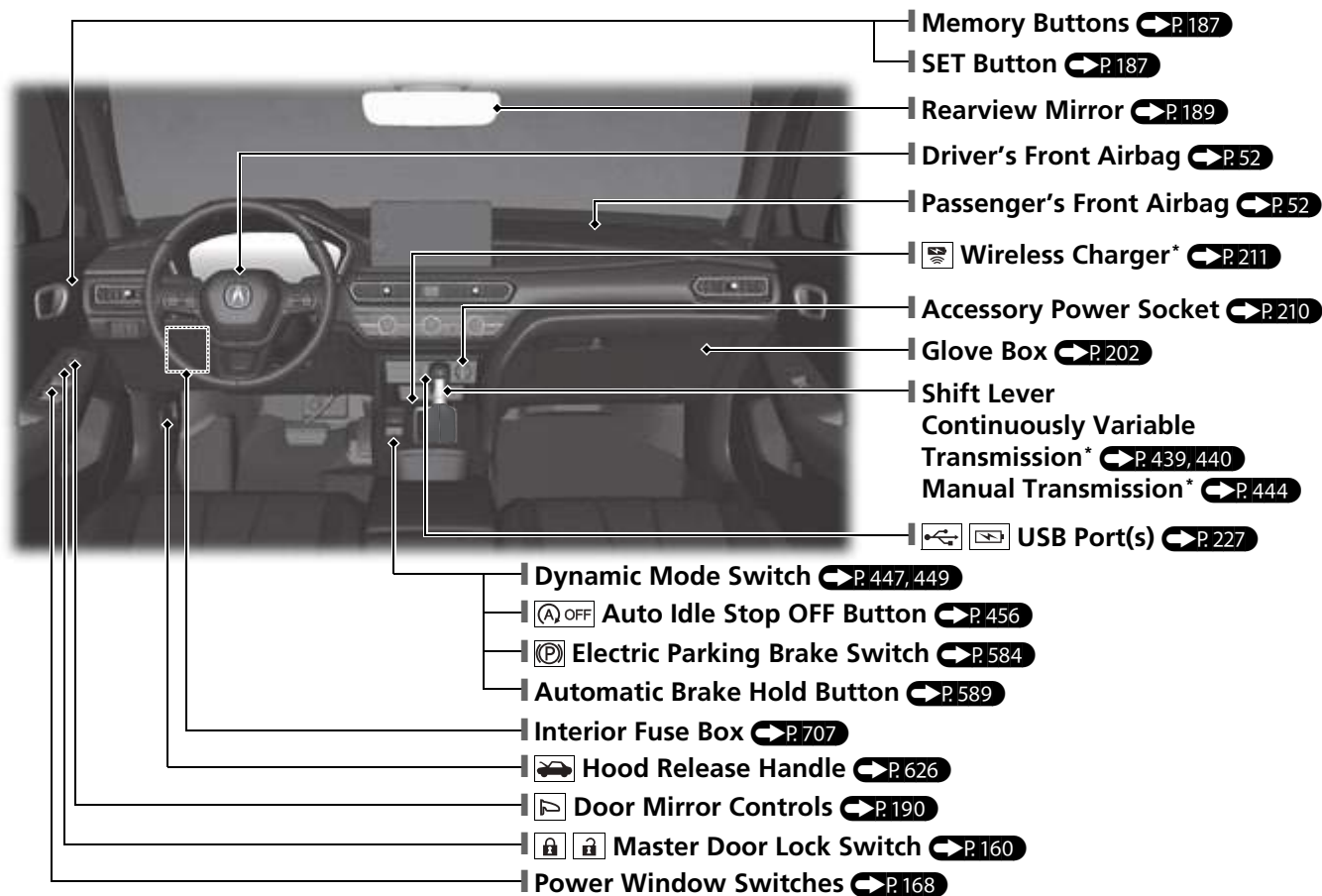

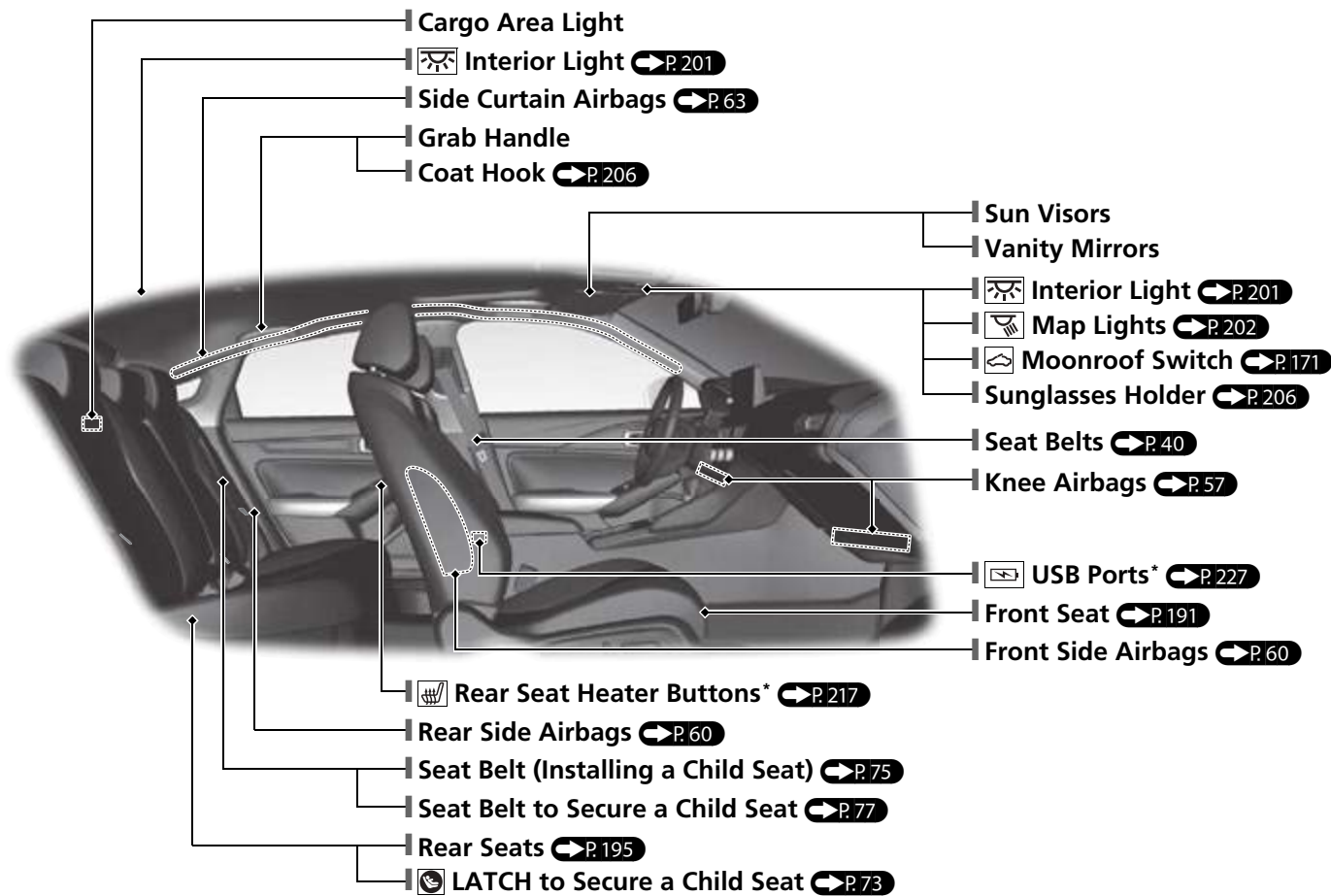



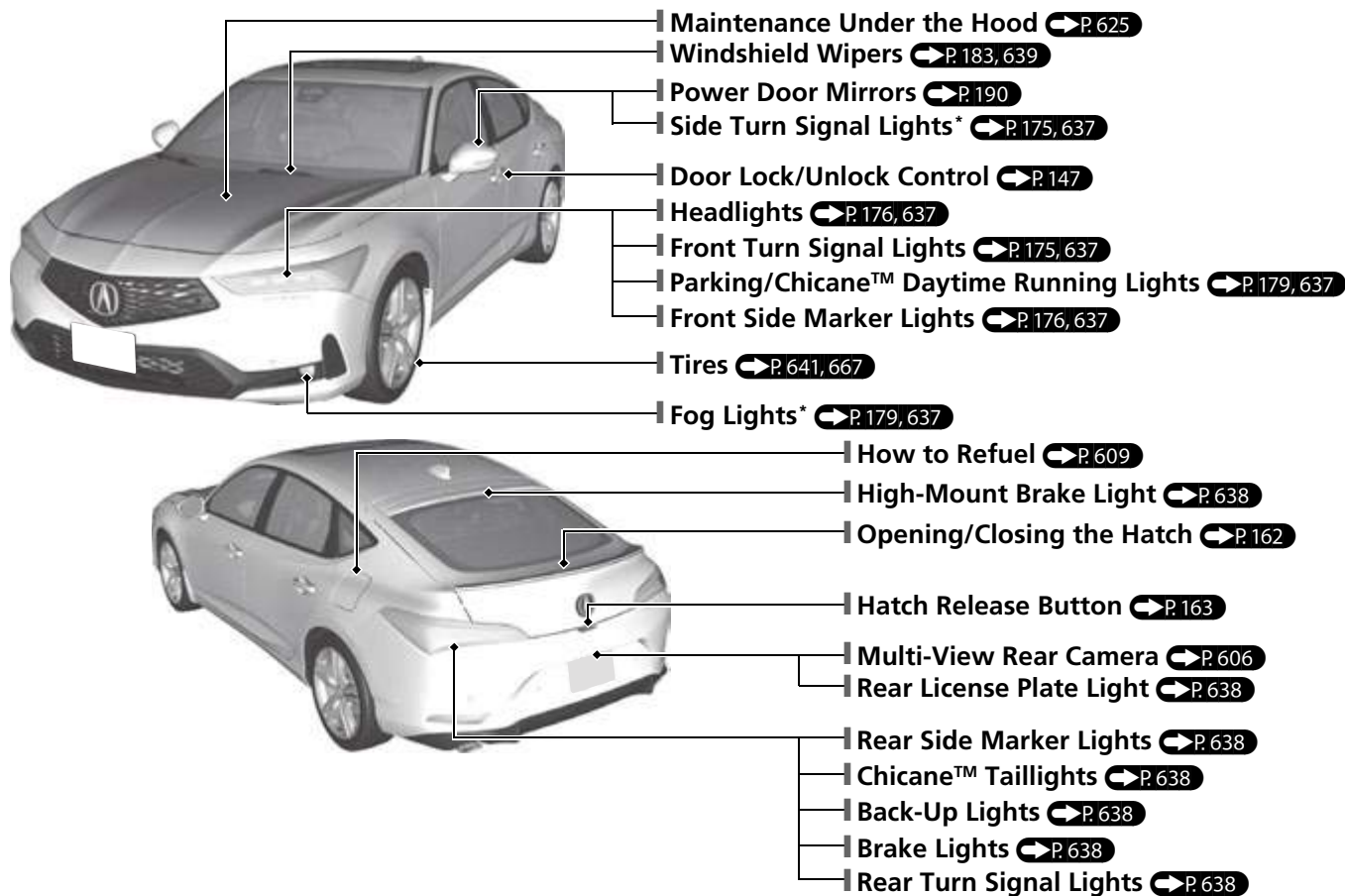







# Visual Index





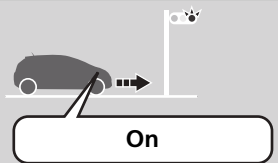

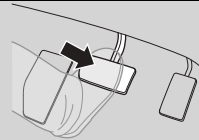
# Auto Idle Stop Function

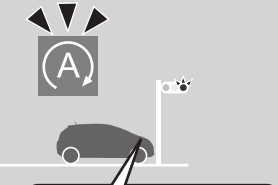
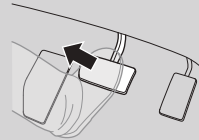
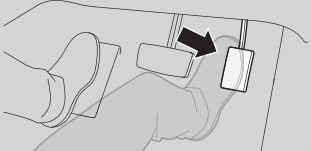
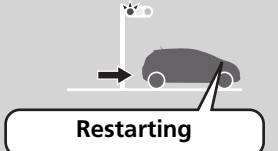
To improve fuel economy, the engine stops and then restarts as detailed below. When Auto Idle Stop is on, the Auto Idle Stop indicator (green) comes on. P. 455, 461

At	Continuously variable transmission		Engine status
Deceleration  	<b>Automatic Brake Hold Off</b>  	<b>Automatic Brake Hold On</b>    Depress the brake pedal.	 <b>On</b>
Stop  	 Keep the brake pedal depressed.	 *1 *2 With the automatic brake hold system activated, you can release the brake pedal when the (A) indicator (green) comes on.	 <b>Off</b>
Start-up	 Release the brake pedal.	 With the automatic brake hold system activated, depress the accelerator pedal.	 <b>Restarting</b>

\*1:U.S. models

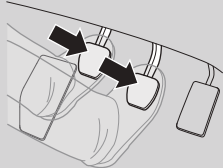
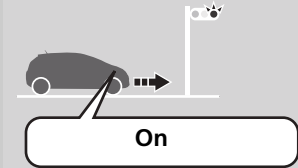
\*2:Canada models

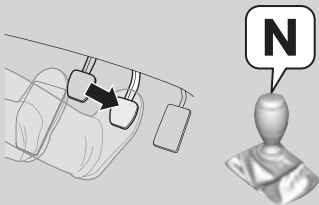
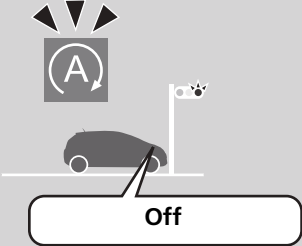
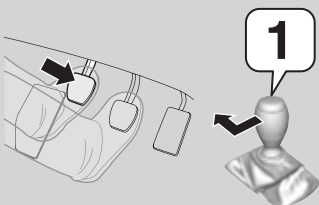
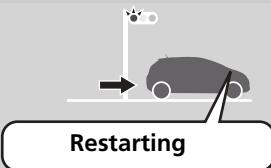
At	Manual transmission	Engine status
Deceleration  	<ol style="list-style-type: none"> <li>1. Depress the brake pedal.</li> <li>2. Fully depress the clutch pedal.</li> </ol> 	
Stop  	<ul style="list-style-type: none"> <li>● Continue to depress the brake pedal.</li> <li>● Move the shift lever to <b>N</b>.</li> <li>● Release the clutch pedal.</li> </ul> 	
Start-up	<ol style="list-style-type: none"> <li>1. Depress the clutch pedal fully again.</li> <li>2. Move the shift lever to <b>1</b>.</li> <li>3. Depress the accelerator pedal to resume driving.</li> </ol> 	

# Safe Driving P.35

## Airbags P.49

- Your vehicle is fitted with airbags to help protect you and your passengers during a moderate-to-severe collision.

## Child Safety P.68

- All children 12 and younger should be seated in the rear seat.
- Smaller children should be properly restrained in a forward-facing child seat.
- Infants must be properly restrained in a rear-facing child seat.

## Exhaust Gas Hazard P.81

- Your vehicle emits dangerous exhaust gases that contain carbon monoxide. Do not run the engine in confined spaces where carbon monoxide gas can accumulate.

## Seat Belts P.40

- Fasten your seat belt and sit upright well back in the seat.
- Check that your passengers are wearing their seat belts correctly.

## Before Driving Checklist P.39

- Before driving, check that the front seats, head restraints, steering wheel, and mirrors have been properly adjusted.

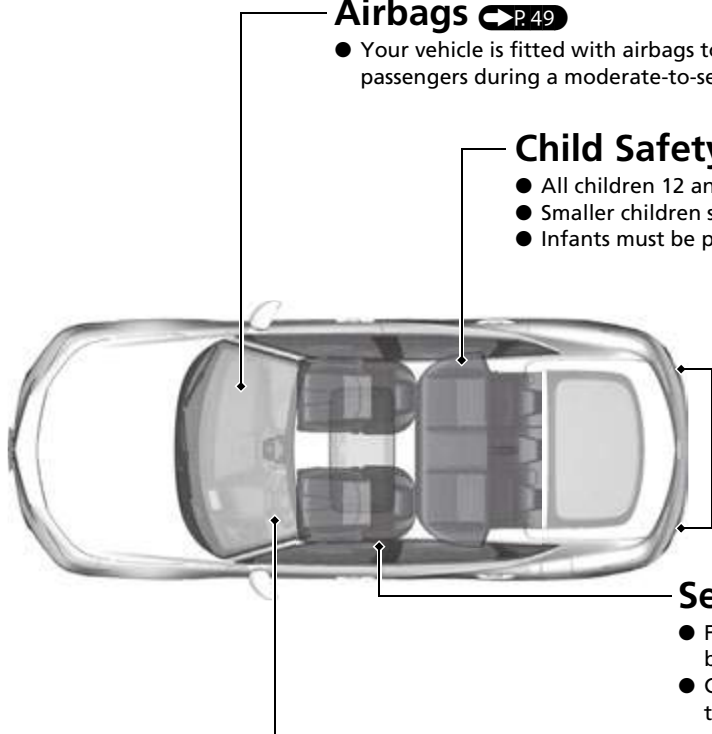

Fasten your lap belt as low as possible.

# Instrument Panel [↔ P.83](#)

Indicators [↔ P.84](#) / Gauges [↔ P.104](#) / Driver Information Interface [↔ P.108, 111](#) / Head-Up Display\* [↔ P.135](#)



Head-Up Display\*

Tachometer [↔ P.105](#)

Traffic Sign Recognition System [↔ P.106](#)

Driver Information Interface (Left Side Area) [↔ P.108](#)

Speedometer [↔ P.104](#)

Driver Information Interface (Right Side Area) [↔ P.111](#)

Temperature Gauge [↔ P.105](#)

Fuel Gauge [↔ P.105](#)



Outside Temperature [↔ P.106](#)

Odometer [↔ P.105](#)

Shift Position Indicator\*/Transmission System Indicator\* [↔ P.89, 90](#)

M (7-speed manual shift mode) Indicator/Shift Indicator\* [↔ P.89](#)



# Controls P.141

## Clock P.142

Models with 7-in. Color Touchscreen



MENU Button

- 1 Press the **MENU** button.
- 2 Select **Clock Settings**.
- 3 Select **Automatic Time**, then select **OFF**.
- 4 Select **Set Time**.
- 5 Select **12H/24H** to change 12 or 24 hour clock.
- 6 Select  or .
- 7 Select **Set** to set the time.

Models with 9-in. Color Touchscreen



### To adjust date



### To adjust time



- 1 Press the  button.
- 2 Select **General Settings**.
- 3 Select **System**.
- 4 Select **Date & Time**.
- 5 Select **Set Date & Time**.
- 6 Select **Automatic Date & Time**, then select **OFF**.

- 7 Select **Set Date** or **Set Time**.
- 8 Select  or .
- 9 Select **Save** to set the date or time.

The audio system receives signals from GPS satellites, updating the clock automatically.

## ENGINE START/STOP Button P.172

Press the button to change the vehicle's power mode.



## Turn Signals P.175

Turn Signal Control Lever

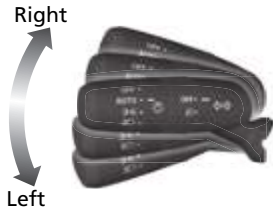

## Lights P.176

Light Control Switches

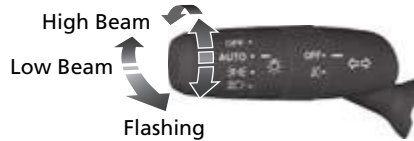





## Wipers and Washers

 P.183

Wiper/Washer Control Lever

Adjustment Ring\*

- : Low sensitivity\*<sup>1</sup>
- : Lower speed, fewer sweeps\*<sup>2</sup>
- : High sensitivity\*<sup>1</sup>
- : Higher speed, more sweeps\*<sup>2</sup>

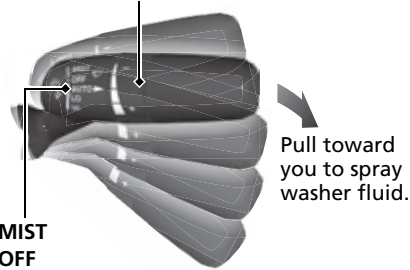

**MIST  
OFF**

**AUTO**\*<sup>1</sup>: Wiper speed varies automatically

**INT**\*<sup>2</sup>: Low speed with intermittent

**LO**: Low speed wipe

**HI**: High speed wipe

\*1: Models with automatic intermittent wipers

\*2: Models with manual intermittent operation

**Models with automatic intermittent wipers**

**AUTO** should always be turned **OFF** before the following situations in order to prevent severe damage to the wiper system:

- Cleaning the windshield
- Driving through a car wash
- No rain present

## Steering Wheel P.188

- To adjust, push the adjustment lever down, adjust to the desired position, then lock the lever back in place.

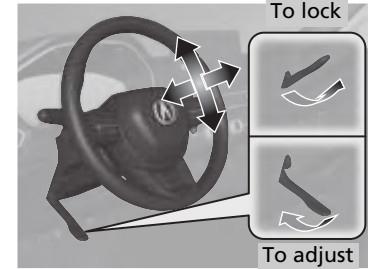

## Unlocking the Front Doors from the Inside

 P.159

- Pull either front door inner handle to unlock and open it at the same time.

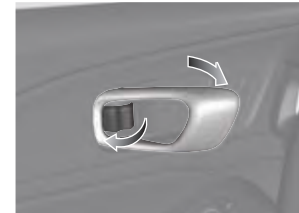

## Hatch P.162

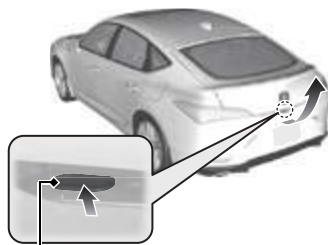

Hatch Release Button

- Press the hatch release button to unlock and open the hatch when you carry the keyless remote.

## Power Door Mirrors

 P.190

- With the power mode in ON, move the selector switch to L or R.
- Push the appropriate edge of the adjustment switch to adjust the mirror.

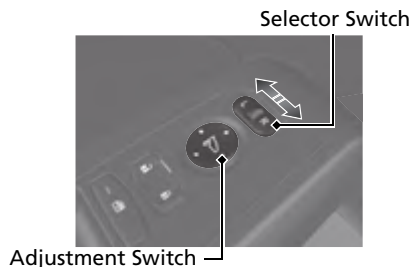

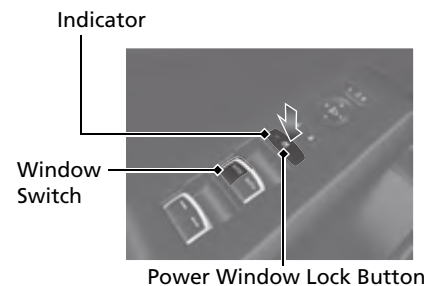

## Power Windows P.168

- With the power mode in ON, open and close the power windows.
- If the power window lock button is in the off position, each passenger's window can be opened and closed with its own switch.
- If the power window lock button is in the on position (indicator on), each passenger's window switch is disabled.



# Climate Control System P.218

- Press the **AUTO** button to activate the climate control system.
- Press the  button to turn the system on or off.
- Press the  button to defrost the windshield.

## Models with SYNC button

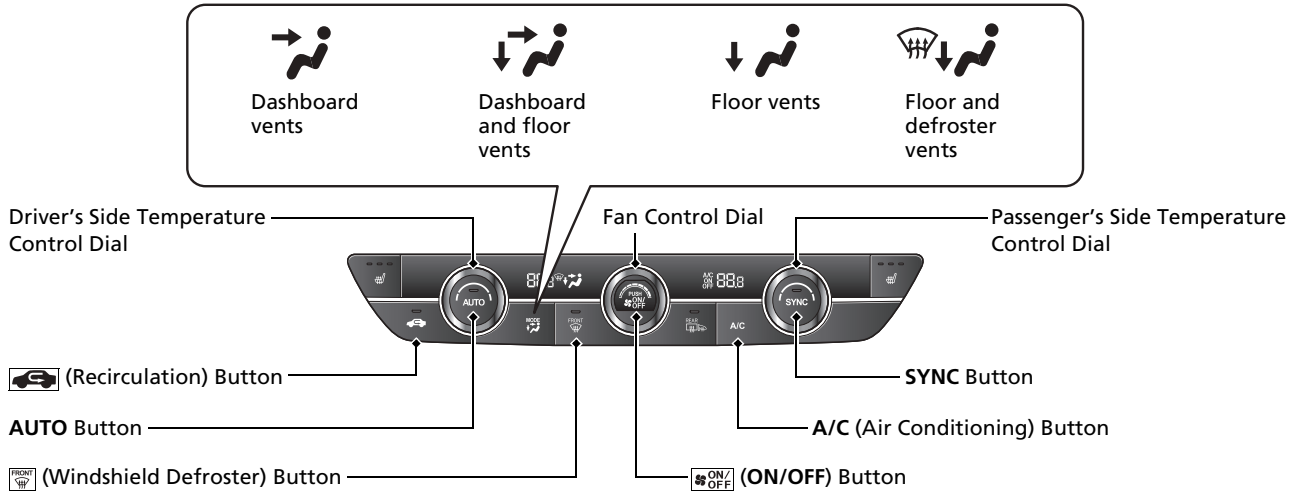



Models without SYNC button

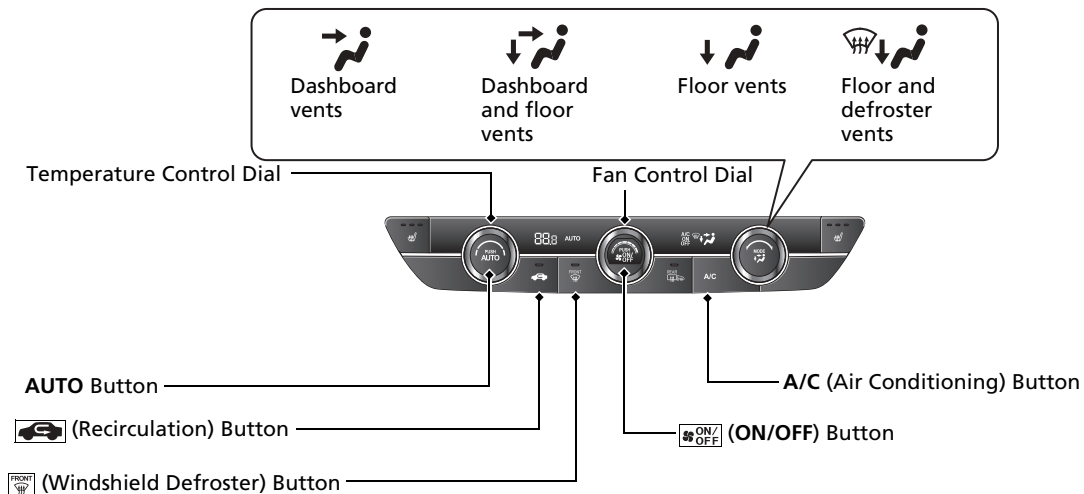

# Features P.225

## Audio Remote Controls

 P.230

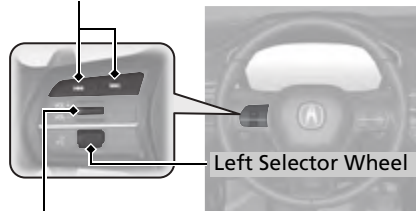

Models with 7-in. Color Touchscreen

 (Seek/Skip) Buttons







**VOL+**/**VOL-** (Volume) Switch



- **VOL+**/**VOL-** (Volume) Switch  
Press to adjust the volume up/down.

-  /  (Seek/Skip) Buttons

Radio:

Press  /  to change the preset radio station. Press and hold  /  to change the strong station.

iPod, USB flash drive, *Bluetooth*® Audio, or Smartphone Connection:

Press  /  to skip to the beginning of the next song or return to the beginning of the current song.

USB flash drive or *Bluetooth*® Audio:

Press and hold  /  to change a folder/group.

- Left Selector Wheel  
Roll up or down: To cycle through the modes, roll up or down and then press the left selector wheel:

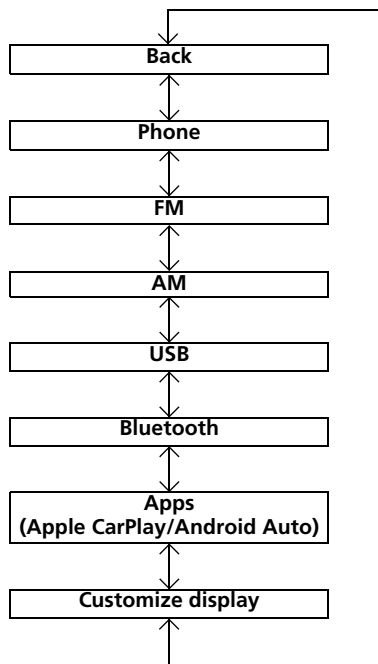

Models with 9-in. Color Touchscreen

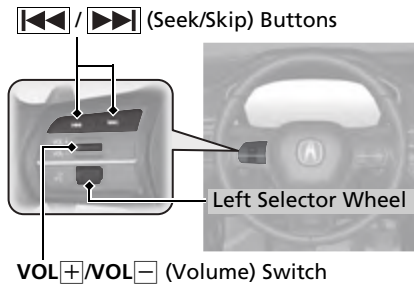

- **VOL+ / VOL-** (Volume) Switch  
Press to adjust the volume up/down.
- **Seek/Skip Buttons**  
Radio:  
Press **Seek/Skip Buttons** to change the preset radio station. Press and hold **Seek/Skip Buttons** to change the strong station.  
iPod, USB flash drive, *Bluetooth*® Audio, or Smartphone Connection:  
Press **Seek/Skip Buttons** to skip to the beginning of the next song or return to the beginning of the current song.  
USB flash drive:  
Press and hold **Seek/Skip Buttons** to change a folder.

- **Left Selector Wheel**  
Roll up or down: To cycle through the modes, roll up or down and then press the left selector wheel:

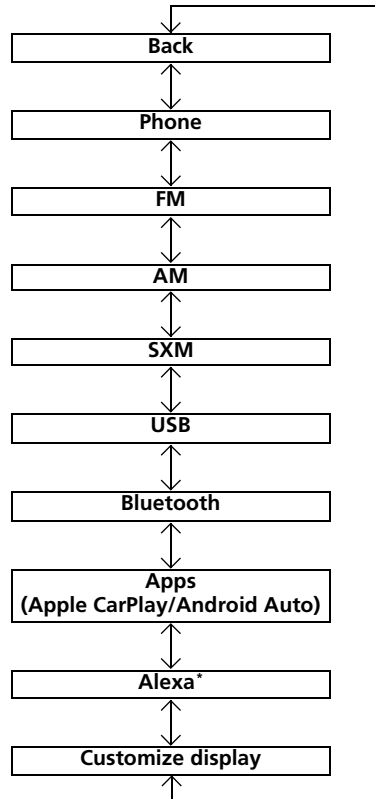

# Audio System P. 226

Models with 7-in. Color Touchscreen  P. 234

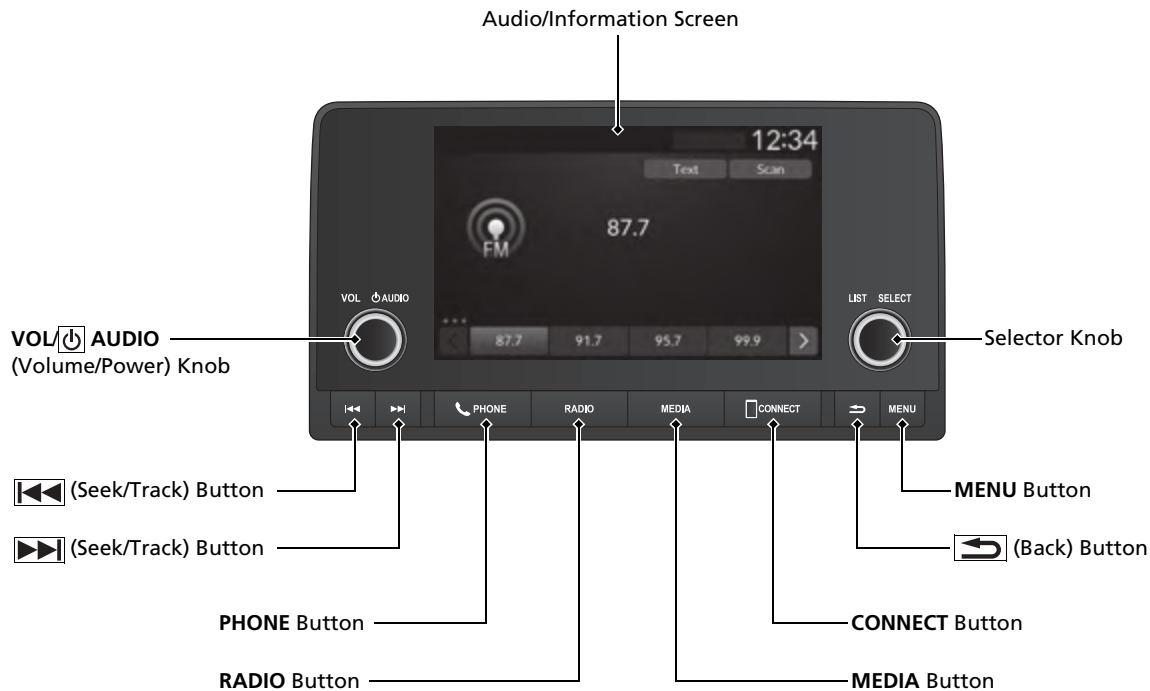



# Driving P. 423

## Manual Transmission\* P. 444

### Continuously Variable Transmission\*

 P. 439, 440

- Shift to **P** and depress the brake pedal when starting the engine.
- **Shifting**

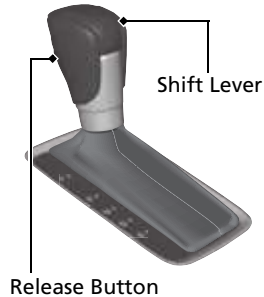
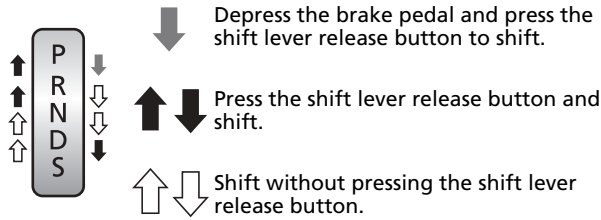

- P Park**  
Used when parking or starting the engine.
- R Reverse**  
Used when reversing.
- N Neutral**  
Transmission is not locked.
- D Drive**  
Used:
  - For normal driving.
  - When temporarily driving in the 7-speed manual shift mode.
- S Drive (S)**  
Used:
  - For better acceleration.
  - To increase engine braking.
  - When going up or down hills.

## 7-Speed Manual Shift Mode P. 442

- Allows you to manually shift the transmission up or down without removing your hands from the steering wheel.

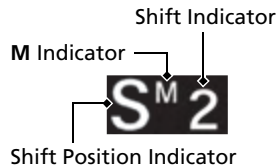

Shift Down  Paddle Shifter

Shift Up  Paddle Shifter

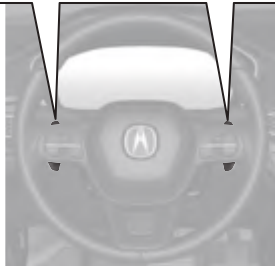

### When the transmission is in

- Pulling a paddle shifter changes the mode from continuously variable transmission to 7-speed manual shift mode.
- The **M** indicator and the selected speed number are displayed in the shift indicator.

### When the transmission is in

- Pulling a paddle shifter temporarily changes the mode from continuously variable transmission to 7-speed manual shift mode. The selected speed number is displayed in the shift indicator.

## VSA® On and Off P.467

- The Vehicle Stability Assist™ (VSA®) system helps stabilize the vehicle during cornering and helps maintain traction while accelerating on loose or slippery road surfaces.
- VSA® comes on automatically every time you start the engine.
- To partially disable or fully restore VSA® function, press and hold the  (VSA® OFF) button until you hear a beep.

## CMBS™ On and Off

 P.485

- When a possible frontal collision is likely unavoidable, the CMBS™ can help you to reduce the vehicle speed and the severity of the collision.
- The CMBS™ is turned on every time you start the engine.
- To turn the CMBS™ on or off, use the safety support of the driver information interface.

## Tire Pressure Monitoring System (TPMS) with Tire Fill Assist P.470

- The TPMS monitors tire pressure.
- The TPMS is turned on automatically every time you start the engine.
- TPMS fill assist provides audible and visual guidance during tire pressure adjustment.

## Refueling P.608

**Fuel recommendation:** Unleaded premium gasoline, pump octane number 91 or higher

**Fuel tank capacity:** 12.39 US gal (46.9 L)

- 1** Unlock the driver's door.
- 2** Press the area indicated by the arrow to release the fuel fill door. You will hear a click.
- 3** After filling, wait about five seconds before removing the filler nozzle.

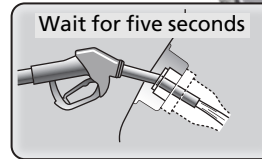



# AcuraWatch™

➔ P. 478

## Models with Low Speed Braking Control

AcuraWatch™ is a driver support system which employs the use of two distinctly different kinds of sensors: the sonar sensors located in the front and rear bumpers, and the front grille, and a front wide view camera mounted to the interior side of the windshield, behind the rearview mirror.

## Models without Low Speed Braking Control

AcuraWatch™ is a driver support system which employs the use of a front wide view camera mounted to the interior side of the windshield, behind the rearview mirror.

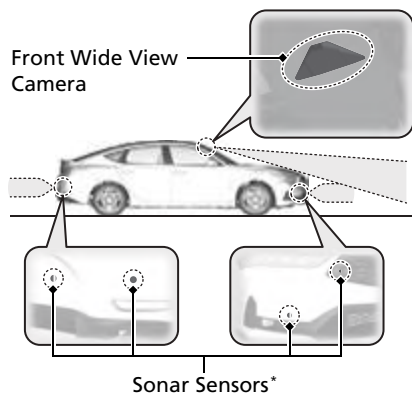

## Collision Mitigation Braking System™ (CMBS™)

➔ P. 481

The system can assist you when it determines there is a possibility of your vehicle colliding with a vehicle (including motorcycles) ahead from behind, an oncoming vehicle in front, a pedestrian, or someone riding a bicycle (moving bicycle). The CMBS™ is designed to alert you when the potential for a collision is determined, as well as assist in reducing speed, avoiding collisions, and reducing collision severity.

## Low Speed Braking Control\*

➔ P. 493

### Continuously variable transmission models with parking sensor system

Using sonar sensors located on the front and rear bumpers, and the front grille, this system detects if there is danger of a potential collision with a wall or other obstacle during normal driving or when the accelerator pedal is depressed with too much force. The system then assists in avoiding collisions and reducing damage from impact through assistive braking and/or assistive driving power suppression.

## Low Speed Braking Control\*

➔ P. 499

### Manual transmission models

Using sonar sensors located on the front and rear bumpers and the front grille, this system detects if there is danger of a potential collision with a wall or other obstacle during normal driving. The system then assists in avoiding collisions and reducing damage from impact through assistive braking.

## Adaptive Cruise Control (ACC) with Low Speed Follow\*

➔ P. 504

Helps maintain a constant vehicle speed and a set following-interval behind a vehicle detected ahead of yours and, if the detected vehicle comes to a stop, can decelerate and stop your vehicle, without you having to keep your foot on the brake or the accelerator.

## Adaptive Cruise Control (ACC)\* P.525

Helps maintain a constant vehicle speed and a set following-interval behind a vehicle detected ahead of yours, without you having to keep your foot on the brake or the accelerator.

## Lane Keeping Assist System (LKAS) P.545

Provides steering input to help keep the vehicle in the middle of a detected lane and provides tactile and visual alerts if the vehicle is detected drifting out of its lane.

## Traffic Jam Assist\* P.557

The traffic jam assist system uses a camera mounted to the upper portion of the windshield to detect and monitor left and right white (or yellow) traffic lane lines. Based on inputs from the camera, the system can apply steering torque to keep your vehicle in the center of the detected lane.

## Road Departure Mitigation System P.566

Alerts and helps assist you when the system detects a possibility of your vehicle crossing over detected lane markings, or approaching the outer edge of the pavement (into grass or gravel border) or a detected oncoming vehicle.

## Traffic Sign Recognition System P.574

Reminds you of road sign information, such as the current speed limit your vehicle has just passed through, showing it on the gauge and the head-up display\*.

# Maintenance P. 613

## Under the Hood P. 625

- Check engine oil, engine coolant, and windshield washer fluid. Add when necessary.
- Check brake/clutch\* fluid.
- Check the battery condition monthly.

- 1** Pull the hood release handle under the driver's side lower corner of the dashboard.

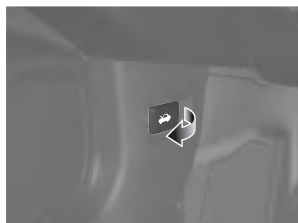

- 2** Locate the hood latch lever, push it to the side, and then raise the hood. Once you have raised the hood slightly, you can release the lever.



- 3** When finished, close the hood and make sure it is firmly locked in place.

## Wiper Blades P. 639

- Replace blades if they leave streaks across the windshield or become noisy.



## Tires P. 641

- Inspect tires and wheels regularly.
- Check tire pressures regularly.
- Install snow tires for winter driving.

## Lights P. 637

- Inspect all lights regularly.

# Handling the Unexpected P.665

## Flat Tire P.667

- Models with tire repair kit

Park in a safe location and repair the flat tire using the temporary tire repair kit.

- Models with optional spare tire

Park in a safe location and replace the flat tire with the compact spare tire in the cargo area.



## Indicators Come On

-  P.699

- Identify the indicator and consult the owner's manual.



## Engine Won't Start

-  P.689

- If the battery is dead, jump start using a booster battery.



## Blown Fuse P.705

- Check for a blown fuse if an electrical device does not operate.

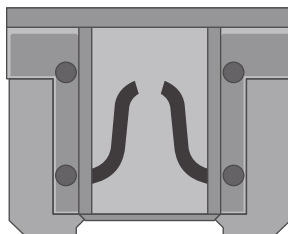

## Overheating P.697

- Park in a safe location. If you do not see steam under the hood, open the hood, and let the engine cool down.



## Emergency Towing

-  P.711

- Call a professional towing service if you need to tow your vehicle.



# What to Do If

**Q** Manual transmission models  
The power mode does not change from VEHICLE OFF (LOCK) to ACCESSORY.  
Why?

**A**

- The steering wheel may be locked.
- Move the steering wheel left and right after pressing the **ENGINE START/STOP** button.



**Q** Continuously variable transmission models  
The power mode does not change from ACCESSORY to VEHICLE OFF (LOCK).  
Why?

**A** The shift lever should be moved to **P**.



**Q** Why does the brake pedal pulsate slightly when applying the brakes?

**A** This can occur when the ABS activates and does not indicate a problem. Apply firm, steady pressure on the brake pedal. Never pump the brake pedal.

➤ Anti-lock Brake System (ABS) ➔ P.594

**Q** The rear door cannot be opened from inside the vehicle. Why?

**A** Check if the childproof lock is in the lock position. If so, open the rear door with the outside door handle. To cancel this function, slide the lever up to the unlock position.

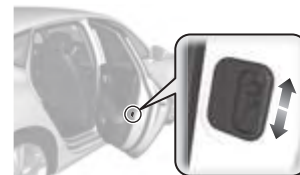

**Q** Why do the doors lock after I unlocked the doors?

**A** If you do not open the doors within 30 seconds, the doors are relocked automatically for security.

**Q** Why does the beeper sound when I open the driver's door?

**A** The beeper sounds when:

- The power mode is in ACCESSORY.
- The exterior lights are left on.
- The Auto Idle Stop is in operation.

**Q** Why does a beeper sound when I walk away from the vehicle after I close the door?

**A** The beeper sounds if you move outside the walk away auto lock operating range before the door completely closes.

Locking the doors and hatch (Walk away auto lock®) P.150

---

**Q** Why does the beeper sound when I start driving?

**A** The beeper sounds when the driver and/or any passengers are not wearing their seat belts.

---

**Q** Pressing the electric parking brake switch does not release the parking brake. Why?

**A** Press the electric parking brake switch with the brake pedal depressed.

---

**Q** I'm seeing an amber indicator of a tire with an exclamation point. What is that?

**A** The Tire Pressure Monitoring System (TPMS) needs attention.  
☒ Tire Pressure Monitoring System (TPMS) with Tire Fill Assist ➔ P.470

---

**Q** Depressing the accelerator pedal does not release the parking brake automatically. Why?

**A**

- Fasten the driver's seat belt.
- Check if the transmission is in **P**\* or **N**. If so, select any other position.



**Why do I hear a screeching sound when I apply the brake pedal?**



The brake pads may need to be replaced. Have your vehicle inspected by a dealer.

---



**Unleaded gasoline with a Pump Octane Number (PON) of 91 or higher is recommended. Is it possible to use unleaded gasoline with a Pump Octane Number (PON) of 87 or lower on this vehicle?**



Use of a lower octane gasoline can cause occasional metallic knocking noise in the engine and will result in decreased engine performance.  
Use of a gasoline with a pump octane less than 87 can lead to engine damage.

---



# Safe Driving

You can find many safety recommendations throughout this chapter, and throughout this manual.

## **For Safe Driving**

Important Safety Precautions.....	36
Your Vehicle's Safety Features.....	38
Safety Checklist .....	39

## **Seat Belts**

About Your Seat Belts.....	40
Fastening a Seat Belt.....	45
Seat Belt Inspection.....	48

## **Airbags**

Airbag System Components.....	49
Types of Airbags .....	52
Front Airbags (SRS) .....	52
Knee Airbags .....	57
Side Airbags.....	60
Side Curtain Airbags .....	63
Airbag System Indicators.....	64
Airbag Care .....	67

## **Child Safety**

Protecting Child Passengers .....	68
Safety of Infants and Small Children....	70
Safety of Larger Children .....	79

## **Exhaust Gas Hazard**

Carbon Monoxide Gas.....	81
--------------------------	----

## **Safety Labels**

Label Locations.....	82
----------------------	----

The following pages explain your vehicle's safety features and how to use them properly. The safety precautions below are ones that we consider to be among the most important.

## Important Safety Precautions

### ■ Always wear your seat belt

A seat belt is your best protection in all types of collisions. Airbags are designed to supplement seat belts, not replace them. So even though your vehicle is equipped with airbags, make sure you and your passengers always wear your seat belts, and wear them properly.

### ■ Restrain all children

Children ages 12 and under should ride properly restrained in a back seat, not the front seat. Infants and small children should be restrained in a child seat. Larger children should use a booster seat and a lap/shoulder seat belt until they can use the belt properly without a booster seat.

### ■ Be aware of airbag hazards

While airbags can save lives, they can cause serious or fatal injuries to occupants who sit too close to them, or are not properly restrained. Infants, young children, and short adults are at the greatest risk. Be sure to follow all instructions and warnings in this manual.

### ■ Don't drink and drive

Alcohol and driving don't mix. Even one drink can reduce your ability to respond to changing conditions, and your reaction time gets worse with every additional drink. So don't drink and drive, and don't let your friends drink and drive, either.

### ▣ Important Safety Precautions

Some states, provinces and territories prohibit the use of cell phones other than hands-free devices by the driver while driving.

**■ Pay appropriate attention to the task of driving safely**

Engaging in cell phone conversation or other activities that keep you from paying close attention to the road, other vehicles, and pedestrians could lead to a crash. Remember, situations can change quickly, and only you can decide when it is safe to divert some attention away from driving.

**■ Control your speed**

Excessive speed is a major factor in crash injuries and deaths. Generally, the higher the speed, the greater the risk, but serious injuries can also occur at lower speeds. Never drive faster than is safe for current conditions, regardless of the maximum speed posted.

**■ Keep your vehicle in safe condition**

Having a tire blowout or a mechanical failure can be extremely hazardous. To reduce the possibility of such problems, check your tire pressures and condition frequently, and perform all regularly scheduled maintenance.

**■ Do not leave children unattended in the vehicle**

Children, pets, and people needing assistance left unattended in the vehicle may be injured if they activate one or more of the vehicle controls. They may also cause the vehicle to move, resulting in a crash in which they and/or another person(s) can be injured or killed. Also, depending on the ambient temperature, the temperature of the interior may reach extreme levels, which can result in harm or death. Even if the climate control system is on, never leave them in the vehicle unattended as the climate control system can shut off at any time.

## Your Vehicle's Safety Features

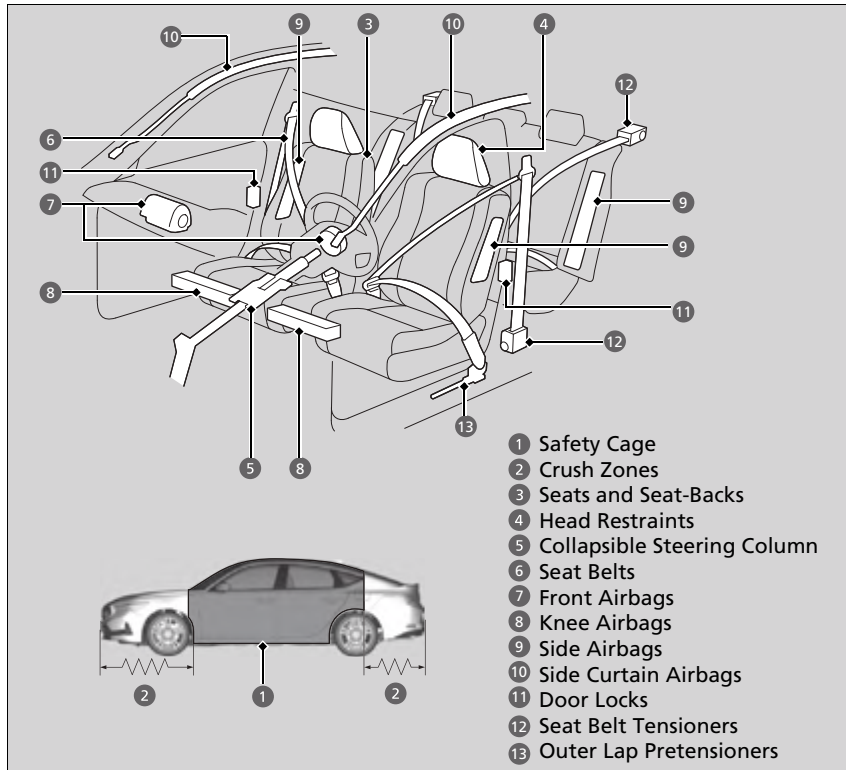

The following checklist will help you take an active role in protecting yourself and your passengers.

### ► Your Vehicle's Safety Features

Your vehicle is equipped with many features that work together to help protect you and your passengers during a crash.

Some features do not require any action on your part. These include a strong steel framework that forms a safety cage around the passenger compartment, front and rear crush zones, a collapsible steering column, and tensioners that tighten the front and outer rear seat belts in a sufficient crash.

However, you and your passengers cannot take full advantage of these features unless you remain seated in the correct position and always wear your seat belts. In fact, some safety features can contribute to injuries if they are not used properly.

## Safety Checklist

For the safety of you and your passengers, make a habit of checking these items each time before you drive.

- After everyone has entered the vehicle, be sure all doors and the hatch are closed and locked. Locking the doors and the hatch helps prevent an occupant from being ejected and an outsider from unexpectedly opening a door or the hatch.
  - **Locking/Unlocking the Doors from the Inside** P. 158
- Adjust your seat to a position suitable for driving. Be sure the front seats are adjusted as far to the rear as possible while allowing the driver to control the vehicle. Sitting too close to a front airbag can result in serious or fatal injury in a crash.
  - **Seats** P. 191
- Adjust head restraints to the proper position. Head restraints are most effective when the center of the head restraint aligns with the center of your head. Taller persons should adjust their head restraint to the highest position.
  - **Adjusting the Front Head Restraint Positions** P. 198
- Always wear your seat belt, and make sure you wear it properly. Confirm that any passengers are properly belted as well.
  - **Fastening a Seat Belt** P. 45
- Protect children by using seat belts or child seats according to a child's age, height, and weight.
  - **Child Safety** P. 68

### ☒ Safety Checklist

If the door and/or hatch open message appears on the driver information interface, a door and/or the hatch is not completely closed. Close all doors and the hatch tightly until the message disappears.

➤ **Driver Information Interface (Right Side Area)** P. 111

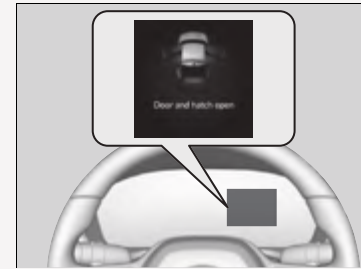

## About Your Seat Belts

Seat belts are the single most effective safety device because they keep you connected to the vehicle so that you can take advantage of many built-in safety features. They also help keep you from being thrown against the inside of the vehicle, against any passengers, or out of the vehicle. When worn properly, seat belts also keep your body properly positioned in a crash so that you can take full advantage of the additional protection provided by the airbags.

In addition, seat belts help protect you in almost every type of crash, including:

- frontal impacts
- side impacts
- rear impacts
- rollovers

### ■ Lap/shoulder seat belts

All five seating positions are equipped with lap/shoulder seat belts with emergency locking retractors. In normal driving, the retractor lets you move freely while keeping some tension on the belt. During a collision or sudden stop, the retractor locks to restrain your body.

The front passenger's and rear seat belts also have a lockable retractor for use with child seats.

➤ **Installing a Child Seat with a Lap/Shoulder Seat Belt** P. 75

### ➤ About Your Seat Belts

## **WARNING**

**Not wearing a seat belt properly increases the chance of serious injury or death in a crash, even though your vehicle has airbags.**

**Be sure you and your passengers always wear seat belts and wear them properly.**

If you extend the seat belt too quickly, it will lock in place. If this happens, slightly retract the seat belt, then extend it slowly.

Seat belts cannot completely protect you in every crash. But in most cases, seat belts can reduce your risk of serious injury.

Most states and all Canadian provinces and territories require you to wear seat belts.

## ■ Proper use of seat belts

Follow these guidelines for proper use:

- All occupants should sit upright, well back in the seat, and remain in that position for the duration of the trip. Slouching and leaning reduce the effectiveness of the belt and can increase the chance of serious injury in a crash.
- Never place the shoulder part of a lap/shoulder seat belt under your arm or behind your back. This could cause very serious injuries in a crash.
- Two people should never use the same seat belt. If they do, they could be very seriously injured in a crash.
- Do not put any accessories on the seat belts. Devices intended to improve comfort or reposition the shoulder part of a seat belt can reduce the protective capability and increase the chance of serious injury in a crash.

### ⌘ About Your Seat Belts

If a passenger moves around and extends the seat belt, the lockable retractor may activate. If this happens, release the retractor by unfastening the seat belt and allow the belt to retract completely. Then, refasten the belt.

*Continued*

## ■ Seat Belt Reminder



### ■ Front seats

The seat belt system includes an indicator on the instrument panel to remind the driver or a front passenger or both to fasten their seat belts.

If you set the power mode to ON and a seat belt is not fastened, a beeper will sound, and the indicator will blink. After a few seconds, the beeper will stop and the indicator will come on and remain illuminated until the seat belt is fastened.

The beeper will periodically sound and the indicator will blink while the vehicle is moving until the seat belt is fastened.

### ☞ Seat Belt Reminder

The indicator will also come on if a front passenger does not fasten their seat belt within six seconds after the power mode is set to ON.

When no one is sitting in the front passenger's seat, the indicator will not come on and the beeper will not sound.

The indicator also may not come on and the beeper may not sound when the occupant is not heavy enough to trigger the weight sensor. Such occupants (e.g., infants and smaller children) should be moved to the rear seat as a deploying front airbag likely will injure or kill them.

☞ **Protecting Child Passengers** P. 68





### ■ Rear seats

Your vehicle monitors rear seat belt use. The driver information interface notifies you if any of the rear seat belts are unfastened after they were previously fastened.

In order to encourage the driver to evaluate rear seat belt usage, the display appears when:

- Any of the rear passenger seat belts are unfastened when the power mode is set to ON.
- A rear door is opened and then closed.
- Any of the rear passengers fasten or unfasten their seat belt.

The seat belt reminder indicator blinks and the beeper sounds if any rear passenger seat belts are unfastened while driving.

### ▣ Seat Belt Reminder

The system will not detect a passenger in the rear seats who has not fastened the seat belt. The driver should check the status of the rear passengers' seat belts at the start of each trip and each time a passenger is seated in the rear seats, using the driver information interface as an aid. An alert will sound if a passenger in the rear seats unfastens the seat belt while the vehicle is in motion or if motion resumes while the graphic is red.

The driver information interface uses colors to aid the driver in checking the status of the passengers.

For the rear seating positions:

- Green indicates the seat belt is fastened.
- An unfastened gray graphic indicates the seat belt has not been fastened recently.
- An unfastened red graphic indicates the seat belt was unfastened recently.

The system does not monitor harnesses that are part of a child seat, nor the anchors of the LATCH system. While the system can inform you that a seat belt is fastened, it cannot determine whether a child seat is properly installed or used.

▣ **Protecting Child Passengers** P. 68

## ■ Automatic Seat Belt Tensioners

The front seats and the outer rear seats are equipped with automatic seat belt tensioners to enhance safety.

The tensioners automatically tighten the front seat belts and the outer rear seat belts during a moderate-to-severe frontal collision, sometimes even if the collision is not severe enough to inflate the front airbags or the knee airbags.

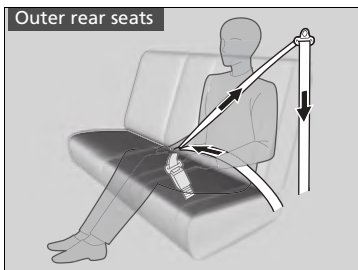
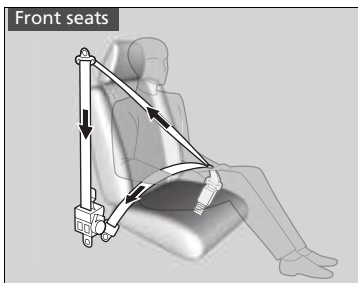

## ▶▶ Automatic Seat Belt Tensioners

The seat belt tensioners can only operate once. If a tensioner is activated, the SRS indicator will come on. Have a dealer replace the tensioner and thoroughly inspect the seat belt system as it may not offer protection in a subsequent crash.

During a moderate-to-severe side impact, the tensioner on both sides of the vehicle also activates.

## Fastening a Seat Belt

After adjusting a front seat to the proper position, and while sitting upright and well back in the seat:

➤ **Seats** P. 191

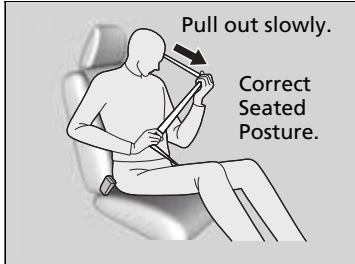

1. Pull the seat belt out slowly.

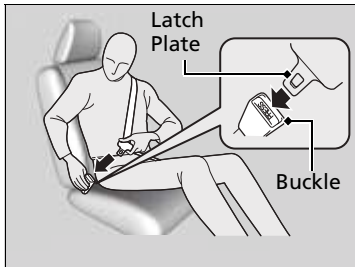

2. Insert the latch plate into the buckle, then tug on the belt to make sure the buckle is secure.

▶ Make sure that the belt is not twisted or caught on anything.

### Fastening a Seat Belt

No one should sit in a seat with an inoperative seat belt or one that does not appear to be working correctly. Using a seat belt that is not working properly may not protect the occupant in a crash. Have a dealer check the belt as soon as possible.

Never insert any foreign objects into the buckle or retractor mechanism.

If the seat belt appears to be locked in a fully retracted position, firmly pull out on the shoulder belt once, then push it back in.

Then, smoothly pull it out of the retractor and fasten. If you are unable to release the seat belt from a fully retracted position, do not allow anyone to sit in the seat, and take your vehicle to a dealer for repair.

➤ **About Your Seat Belts** P. 40

➤ **Seat Belt Inspection** P. 48



3. Position the lap part of the belt as low as possible across your hips, then pull up on the shoulder part of the belt so the lap part fits snugly. This lets your strong pelvic bones take the force of a crash and reduces the chance of internal injuries.
4. If necessary, pull up on the belt again to remove any slack, then check that the belt rests across the center of your chest and over your shoulder. This spreads the forces of a crash over the strongest bones in your upper body.

▶▶ Fastening a Seat Belt

**⚠ WARNING**

Improperly positioning the seat belts can cause serious injury or death in a crash.

**Make sure all seat belts are properly positioned before driving.**

To release the belt, push the red **PRESS** button and then guide the belt by hand until it has retracted completely. When exiting the vehicle, be sure the belt is properly stowed so that it will not get caught in the closing door.

▶▶ Adjusting the Shoulder Anchor

The shoulder anchor height can be adjusted to four levels. If the belt contacts your neck, lower the height one level at a time.

After an adjustment, make sure that the shoulder anchor position is secure.

**■ Adjusting the Shoulder Anchor**

The front seats have adjustable shoulder anchors to accommodate taller and shorter occupants.

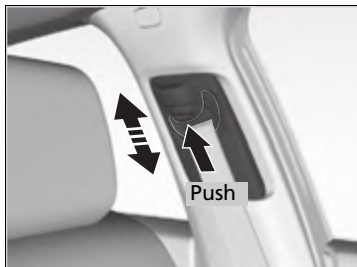

1. Move the anchor up and down while holding the release button.
2. Position the anchor so that the belt rests across the center of your chest and over your shoulder.

## Advice for Pregnant Women

If you are pregnant, the best way to protect yourself and your unborn child when driving or riding in a vehicle is to always wear a seat belt and keep the lap part of the belt as low as possible across the hips.

Wear the shoulder belt across the chest avoiding the abdomen.



Wear the lap part of the belt as low as possible across the hips.

## Advice for Pregnant Women

Each time you have a checkup, ask your doctor if it is okay for you to drive.

To reduce the risk of injuries to both you and your unborn child that can be caused by an inflating front airbag:

- When driving, sit upright and adjust the seat as far back as possible while allowing full control of the vehicle.
- When sitting in the front passenger's seat, adjust the seat as far back as possible.

## Seat Belt Inspection

Regularly check the condition of your seat belts as follows:

- Pull each belt out fully, and look for frays, cuts, burns, and wear.
- Check that the latch plates and buckles work smoothly, and the belts retract easily.
  - ▶ If a belt does not retract easily, cleaning the belt may correct the problem. Only use a mild soap and warm water. Do not use bleach or cleaning solvents. Make sure the belt is completely dry before allowing it to retract.

Any belt that is not in good condition or working properly will not provide proper protection and should be replaced as soon as possible.

A belt that has been worn during a crash may not provide the same level of protection in a subsequent crash. Have your seat belts inspected by a dealer after any collision.

### ▶▶ Seat Belt Inspection

#### **WARNING**

**Not checking or maintaining seat belts can result in serious injury or death if the seat belts do not work properly when needed.**

**Check your seat belts regularly and have any problem corrected as soon as possible.**

## Airbag System Components

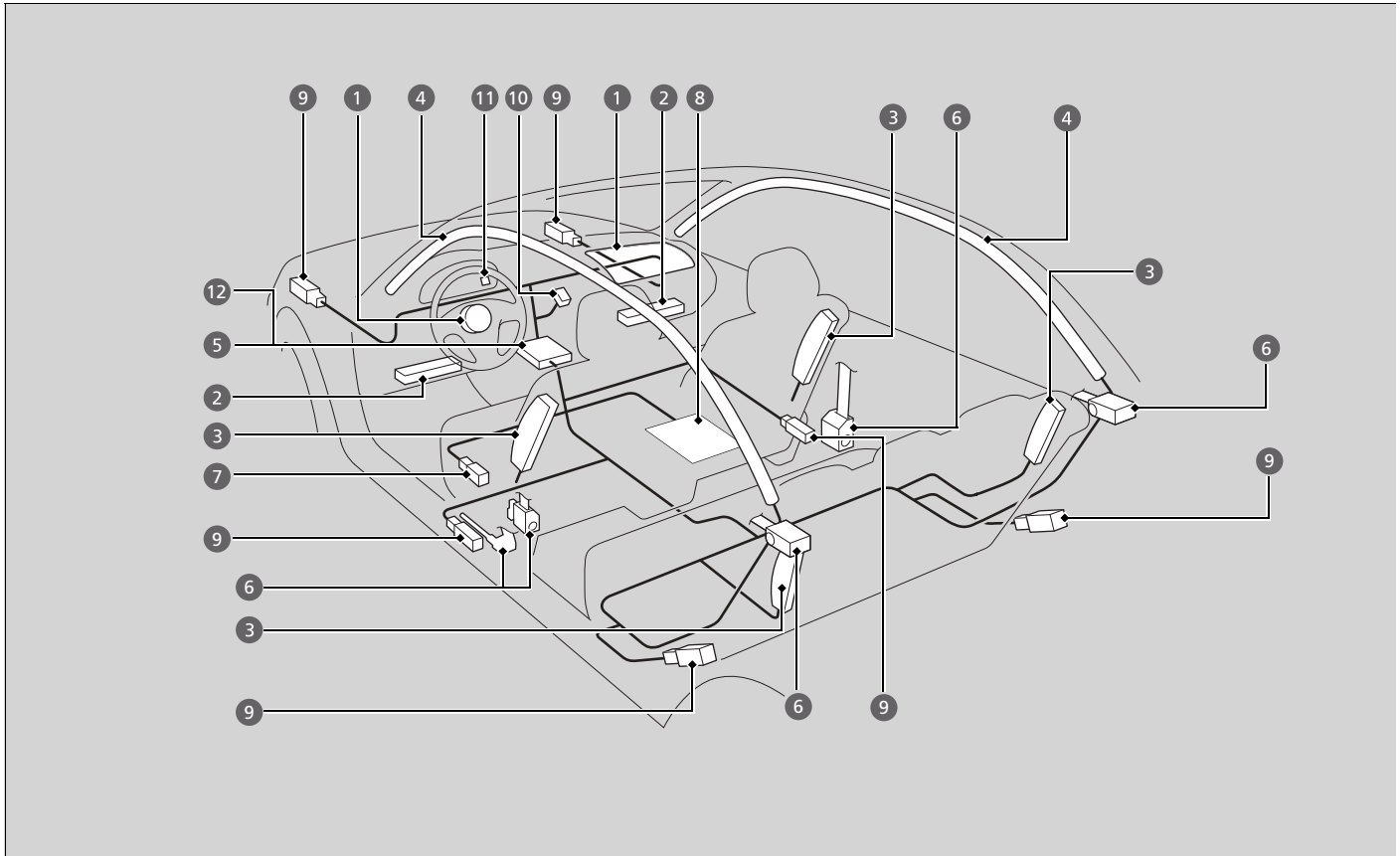

The front, driver's knee, front passenger's knee, side, and side curtain airbags are deployed according to the direction and severity of impact. Both side curtain airbags are deployed in a rollover. The airbag system includes:

- 1 Two SRS (Supplemental Restraint System) front airbags. The driver's airbag is stored in the center of the steering wheel; the front passenger's airbag is stored in the dashboard. Both are marked **SRS AIRBAG**.
- 2 Two knee airbags. The driver's knee airbag is stored under the steering column; the front passenger's knee airbag is stored under the glove box. Both are marked **SRS AIRBAG**.
- 3 Four side airbags, one for the driver, one for the front passenger and two for the rear outboard seating positions. The front airbags are stored in the outer edges of the seat-backs and the rear airbags are stored next to the outer rear seating positions. All are marked **SIDE AIRBAG**.
- 4 Two side curtain airbags, one for each side of the vehicle. The airbags are stored in the ceiling, above the side windows. The front and rear pillars are marked **SIDE CURTAIN AIRBAG**.
- 5 An electronic control unit that, when the power mode is in ON, continually monitors information about the various impact sensors, seat and buckle sensors, rollover sensor, airbag activators, seat belt tensioners, and other vehicle information. During a crash event the unit can record such information.
- 6 Seat belt tensioners for the front seats and outer rear seats. In addition, the driver's and front passenger's seat belt buckles incorporate sensors that detect whether or not the belts are fastened.
- 7 Driver's seat position sensor. This sensor detects the driver's seat slide position to help determine the optimal deployment of the driver's airbag.
- 8 Weight sensors in the front passenger's seat. The sensors are used for occupant classification to activate or deactivate the front passenger's airbag.
- 9 Impact sensors that can detect a moderate-to-severe front or side impact.
- 10 An indicator on the center console that alerts you that the front passenger's front airbag has been turned off.
- 11 An indicator on the instrument panel that alerts you to a possible problem with your airbag system or seat belt tensioners.
- 12 A rollover sensor that can detect if your vehicle is about to roll over and signal the control unit to deploy both side curtain airbags.



## ■ Important Facts About Your Airbags

Airbags can pose serious hazards. To do their job, airbags must inflate with tremendous force. So, while airbags help save lives, they can cause burns, bruises, and other minor injuries, sometimes even fatal ones if occupants are not wearing their seat belts properly and sitting correctly.

**What you should do:** Always wear your seat belt properly and sit upright and as far back from the steering wheel as possible while allowing full control of the vehicle. A front passenger should move their seat as far back from the dashboard as possible.

Remember, however, that no safety system can prevent all injuries or deaths that can occur in a severe crash, even when seat belts are properly worn and the airbags deploy.

**Do not place hard or sharp objects between yourself and a front airbag.**

Carrying hard or sharp objects on your lap, or driving with a pipe or other sharp object in your mouth, can result in injuries if your front airbag inflates.

**Do not attach or place objects on the front, driver's knee and front passenger's knee airbag covers.** Objects on the covers marked **SRS AIRBAG** could interfere with the proper operation of the airbags or be propelled inside the vehicle and hurt someone if the airbags inflate.

## ▣ Important Facts About Your Airbags

Do not attempt to deactivate your airbags. Together, airbags and seat belts provide the best protection.

When driving, keep hands and arms out of the deployment path of the front airbag by holding each side of the steering wheel. Do not cross an arm over the airbag cover.

## Types of Airbags

Your vehicle is equipped with four types of airbags:

- **Front airbags:** Airbags in front of the driver's and front passenger's seats.
- **Knee airbags:** Airbags under the steering column and under the glove box.
- **Side airbags:** Airbags in the driver's and front passenger's outer seat-backs and next to the outer rear seating positions.
- **Side curtain airbags:** Airbags above the side windows.

Each is discussed in the following pages.

## Front Airbags (SRS)

The front SRS airbags inflate in a moderate-to-severe frontal collision to help protect the head and chest of the driver and/or front passenger.

**SRS** (Supplemental Restraint System) indicates that the airbags are designed to supplement seat belts, not replace them. Seat belts are the occupant's primary restraint system.

### Housing Locations

The front airbags are housed in the center of the steering wheel for the driver, and in the dashboard for the front passenger. Both airbags are marked **SRS AIRBAG**.

### Types of Airbags

The airbags can inflate whenever the power mode is in ON.

After an airbag inflates in a crash, you may see a small amount of smoke. This is from the combustion process of the inflator material and is not harmful. People with respiratory problems may experience some temporary discomfort. If this occurs, get out of the vehicle as soon as it is safe to do so.

### Front Airbags (SRS)

During a frontal crash severe enough to cause one or both front airbags to deploy, the airbags can inflate at different rates, depending on the severity of the crash, whether or not the seat belts are latched, and/or other factors. Frontal airbags are designed to supplement the seat belts to help reduce the likelihood of head and chest injuries in frontal crashes.

## ■ Operation

Front airbags are designed to inflate during moderate-to-severe frontal collisions. When the vehicle decelerates suddenly, the sensors send information to the control unit which signals one or both front airbags to inflate.

A frontal collision can be either head-on or angled between two vehicles, or when a vehicle crashes into a stationary object, such as a concrete wall.

## ■ How the Front Airbags Work

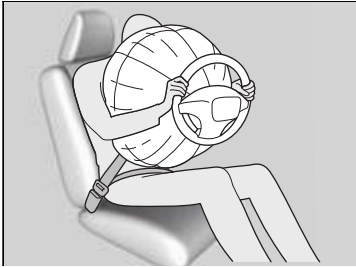

While your seat belt restrains your torso, the front airbag provides supplemental protection for your head and chest.

The front airbags deflate immediately so that they won't interfere with the driver's visibility or the ability to steer or operate other controls.

The total time for inflation and deflation is so fast that most occupants are not aware that the airbags deployed until they see them lying in front of them.

## ▣ How the Front Airbags Work

Although the driver's and front passenger's airbags normally inflate within a split second of each other, it is possible for only one airbag to deploy. This can happen if the severity of a collision is at the margin, or threshold, that determines whether or not the airbags will deploy. In such cases, the seat belt will provide sufficient protection, and the supplemental protection offered by the airbag would be minimal.

### ■ When front airbags should not deploy

**Minor frontal crashes:** Front airbags were designed to supplement seat belts and help save lives, not to prevent minor scrapes, or even broken bones that might occur during a less than moderate-to-severe frontal crash.

**Side impacts:** Front airbags can provide protection when a sudden deceleration causes a driver or front passenger to move toward the front of the vehicle. Side airbags and side curtain airbags have been specifically designed to help reduce the severity of injuries that can occur during a moderate-to-severe side impact which can cause the driver or passenger to move toward the side of the vehicle.

**Rear impacts:** Head restraints and seat belts are your best protection during a rear impact. Front airbags cannot provide any significant protection and are not designed to deploy in such collisions.

**Rollovers:** In a rollover, your best form of protection is a seat belt or, if your vehicle is equipped with a rollover sensor, both a seat belt and a side curtain airbag. Front airbags, however, are not designed to deploy in a rollover as they would provide little if any protection.

### ■ When front airbags deploy with little or no visible damage

Because the airbag system senses sudden deceleration, a strong impact to the vehicle framework or suspension might cause one or more of the airbags to deploy. Examples include running into a curb, the edge of a hole, or other low fixed object that causes a sudden deceleration in the vehicle chassis. Since the impact is underneath the vehicle, damage may not be readily apparent.

### ■ When front airbags may not deploy, even though exterior damage appears severe

Since crushable body parts absorb crash energy during an impact, the amount of visible damage does not always indicate proper airbag operation. In fact, some collisions can result in severe damage but no airbag deployment because the airbags would not have been needed or would not have provided protection even if they had deployed.

## Advanced Airbags

The airbags have advanced features to help reduce the likelihood of airbag related injuries to smaller occupants.

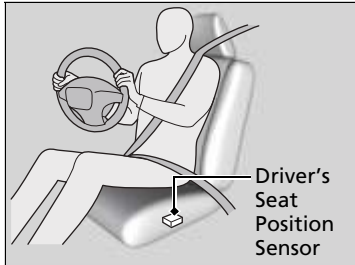

The driver's advanced airbag system includes a seat position sensor.

Based on information from this sensor and the severity of the impact, the advanced airbag system determines the optimal deployment of the driver's airbag.

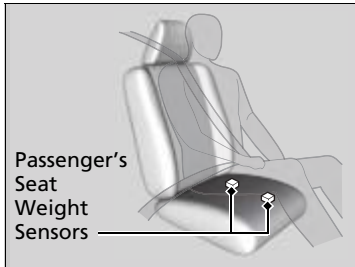

The front passenger's advanced airbag system has weight sensors. The sensors are used for occupant classification to activate or deactivate the front passenger's airbag.

For adult size occupants, the system will automatically activate the front passenger's airbag. If a small adult sits in the front passenger seat and the system does not recognize him/her as an adult, see

▶ **Passenger Airbag Off Indicator** P. 65

## Advanced Airbags

If there is a problem with the driver's seat position sensor or the passenger's seat weight sensors, the SRS indicator will come on, and in the event of a crash, the airbag will deploy (regardless of the driver's seating position or passenger's occupant classification) with a force corresponding to the severity of the impact.

### ▶ Supplemental Restraint System (SRS) Indicator P. 64

For the advanced front airbags to work properly, confirm that:

- The occupant is sitting in an upright position, wearing the seat belt properly and the seat-back is not excessively reclined.
- The occupant is not leaning against the door or center console.
- The occupant's feet are placed on the floor in front of them.
- There are no objects hanging from the front passenger's seat.
- Only small, lightweight objects are in the seat-back pocket.
- The steering wheel and passenger's side dashboard are not obstructed by any object.
- No liquid has been spilled on or under the seat.

We advise against allowing a child age 12 or under to ride in the front passenger's seat. However, if you do allow a small child or infant to ride in the front passenger's seat, the system is designed to automatically deactivate the front passenger's airbag. Do not let a small child or infant ride in the front passenger's seat if the airbag does not automatically deactivate.

#### Advanced Airbags

- There is no child seat or other object pressing against the rear of the seat or seat-back.
- There is no rear passenger pushing or pulling on the back of the front passenger's seat.
- There are no objects placed under or beside the front passenger's seat. Improperly positioned objects can interfere with the advanced airbag sensors.
- The head restraint is not contacting the roof.
  - **Passenger Airbag Off Indicator** P. 65
- The floor mat behind the front passenger's seat is set in the correct position evenly on the floor. An improperly placed mat can interfere with the advanced airbag sensors.
  - **Floor Mats** P. 657

## Knee Airbags

The knee SRS airbags inflate in a moderate-to-severe frontal collision to help keep the driver and/or front passenger in the proper position and to help maximize the benefit provided by the vehicle's other safety features.

**SRS** (Supplemental Restraint System) indicates that the airbag is designed to supplement seat belts, not replace them. Seat belts are the occupant's primary restraint system.

### Housing Locations

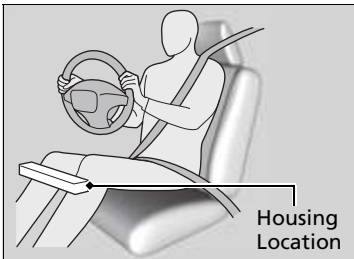

The knee airbag for the driver and the one for the front passenger are housed under the steering column and the glove box respectively.

Both are marked **SRS AIRBAG**.



### ⊗ Knee Airbags

Do not attach accessories on or near a knee airbag as they can interfere with the proper operation of the airbag, or even hurt someone if the airbag inflates.

The driver and front passenger should not store any items under the seat or behind their feet. The items can interfere with proper airbag deployment in the event of a moderate to severe frontal collision and may result in inadequate protection.

## ■ Operation

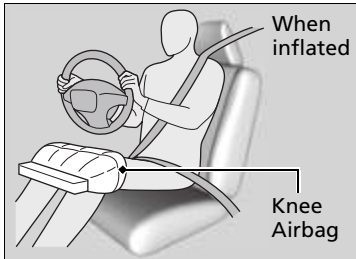

The driver's and front passenger's knee airbag deploy at the same time as the driver's and front passenger's airbag, respectively.

Even if the collision is not severe enough to deploy the front airbags, the knee airbags may inflate alone.



**■ When knee airbags deploy with little or no visible damage**

Because the airbag system senses sudden deceleration, a strong impact to the vehicle framework or suspension might cause one or more of the airbags to deploy. Examples include running into a curb, the edge of a hole, or other low fixed objects that cause a sudden deceleration in the vehicle chassis. Since the impact is underneath the vehicle, damage may not be readily apparent.

**■ When knee airbags may not deploy, even though exterior damage appears severe**

Since crushable body parts absorb crash energy during an impact, the amount of visible damage does not always indicate proper airbag operation. In fact, some collisions can result in severe damage but no airbag deployment because the airbags would not have been needed or would not have provided protection even if they had deployed.

## Side Airbags

The side airbags help protect the torso and pelvis of the driver, front passenger, or an outer rear seat occupant during a moderate-to-severe side impact.

### Housing Locations

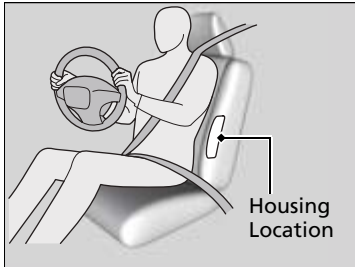

The side airbags are housed in the outside edge of the driver's and passenger's seat-backs and next to the outer rear seating positions.

Each are marked **SIDE AIRBAG**.



### Side Airbags

Make sure you and your front seat and rear outboard passengers always sit upright. Leaning into the path of a side airbag can prevent the airbag from deploying properly and increases the risk of serious injury.

Do not attach accessories on or near the side airbags. They can interfere with the proper operation of the airbags, or hurt someone if an airbag inflates.

Do not cover or replace the front seat-back covers without consulting a dealer. Improperly replacing or covering front seat-back covers can prevent your side airbags from properly deploying during a side impact.

## ■ Operation

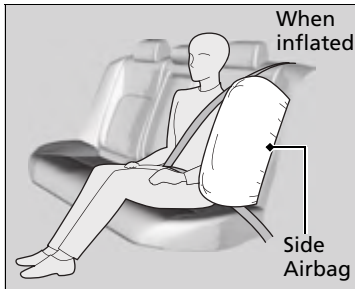
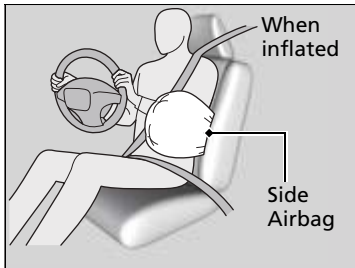

When the sensors detect a moderate-to-severe side impact, the control unit signals the side airbag on the impact side to immediately inflate.

■ **When a side airbag deploys with little or no visible damage**

Because the airbag system senses sudden acceleration, a strong impact to the side of the vehicle's framework can cause a side airbag to deploy. In such cases, there may be little or no damage, but the side impact sensors detected a severe enough impact to deploy the airbag.

■ **When a side airbag may not deploy, even though visible damage appears severe**

It is possible for a side airbag not to deploy during an impact that results in apparently severe damage. This can occur when the point of impact was toward the far front or rear of the vehicle, or when the vehicle's crushable body parts absorbed most of the crash energy. In either case, the side airbag would not have been needed nor provided protection even if it had deployed.

## Side Curtain Airbags

The side curtain airbags help protect the heads of the driver and passengers in the outer seating positions during a moderate-to-severe side impact. The side curtain airbags equipped in this vehicle are also designed to help reduce the likelihood of partial and complete ejection of vehicle occupants through side windows in crashes, particularly rollover crashes.

### ■ Housing Locations

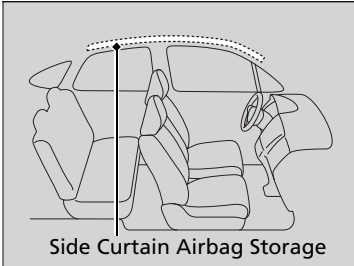

The side curtain airbags are located in the ceiling above the side windows on both sides of the vehicle.

### ■ Operation

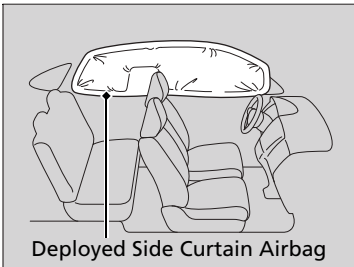

The side curtain airbag is designed to deploy in a rollover or a moderate-to-severe side impact.

### ▣ Side Curtain Airbags

To get the best protection from the side curtain airbags, occupants should wear their seat belts properly and sit upright and well back in their seats.

Do not attach any objects to the side windows or roof pillars as they can interfere with the proper operation of the side curtain airbags.

If the impact is on the passenger's side, the passenger's side curtain airbag deploys even if there are no occupants on that side of the vehicle.

If the SRS control unit senses that your vehicle is about to rollover, it immediately deploys both side curtain airbags and activates the seat belt tensioners for the front seats and outer rear seats.

■ **When side curtain airbags deploy in a frontal collision**

One or both side curtain airbags may also inflate in a moderate-to-severe angled frontal collision.

## Airbag System Indicators

If a problem occurs in the airbag system, the SRS indicator will come on and a message appears on the driver information interface.

### ■ Supplemental Restraint System (SRS) Indicator



■ **When the power mode is set to ON**

The indicator comes on for a few seconds, then goes off. This tells you the system is working properly.

If the indicator comes on at any other time, or does not come on at all, have the system checked by a dealer as soon as possible. If you don't, your airbags and seat belt tensioners may not work properly when they are needed.

⊗ Supplemental Restraint System (SRS) Indicator

**⚠ WARNING**

Ignoring the SRS indicator can result in serious injury or death if the airbag systems or tensioners do not work properly.

Have your vehicle checked by a dealer as soon as possible if the SRS indicator alerts you to a possible problem.

## Passenger Airbag Off Indicator

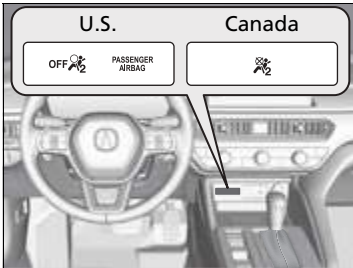

### When the passenger airbag off indicator comes on

The indicator comes on to alert you that the passenger's airbag has been turned off.

This occurs if the seat is empty or when the weight sensors determine that a small child or infant is on the passenger seat.

Children age 12 or under should always ride properly restrained in a back seat.

➤ **Child Safety** P. 68

If the indicator is on, in the event of a crash the passenger's airbag will not deploy. The passenger's knee airbag will not deploy, either.

### Passenger Airbag Off Indicator

To ensure the passenger is detected properly, confirm that:

- The occupant is sitting in an upright position, wearing the seat belt properly and the seat-back is not excessively reclined.
- The occupant is not leaning against the door or center console.
- The occupant's feet are placed on the floor in front of them.
- There are no objects hanging from the front passenger's seat.
- Only small, lightweight objects are in the seat-back pocket.
- No liquid has been spilled on or under the seat.
- There is no child seat or other object pressing against the rear of the seat or seat-back.
- There is no rear passenger pushing or pulling on the back of the front passenger's seat.
- There are no objects placed under or beside the front passenger's seat. Improperly positioned objects can interfere with the advanced airbag sensors.
- The floor mat behind the front passenger's seat is set in the correct position evenly on the floor. An improperly placed mat can interfere with the advanced airbag sensors.
- The head restraint is not contacting the roof.

#### ✘ Passenger Airbag Off Indicator

The passenger airbag off indicator may come on and go off periodically if the total weight on the seat is near the airbag cutoff threshold. For a small adult, depending on physique and posture, the system may not recognize him/her as an adult and thus deactivate the passenger's airbag.

If this occurs, please confirm that the conditions set forth in the above bullet points on the previous page are met.

If the above conditions are met and the indicator is still on, then with the transmission in park, set the power mode to OFF and back to ON.

Have your vehicle checked by a dealer as soon as possible if:

- All of the above conditions are met, and the indicator comes on with an adult seated in the front passenger seat.
- The seat is empty and the indicator is off.

Do not allow an adult passenger to ride in the front seat when the indicator is on.



## Airbag Care

You do not need to, and should not, perform any maintenance on or replace any airbag system components yourself. However, you should have your vehicle inspected by a dealer in the following situations:

### ■ When the airbags have deployed

If an airbag has inflated, the control unit and other related parts must be replaced. Similarly, once an automatic seat belt tensioner has been activated, it must be replaced.

### ■ When the vehicle has been in a moderate-to-severe collision

Even if the airbags did not inflate, have your dealer inspect the following: the driver's seat position sensor, weight sensors in the passenger's seat, seat belt tensioners for the front seats and outer rear seats, and each seat belt that was worn during the crash.

### ■ Do not remove or modify a front seat without consulting a dealer

This would likely disable or affect the proper operation of the driver's seat position sensor or the weight sensors in the passenger's seat. If it is necessary to remove or modify a front seat to accommodate a person with disabilities, contact an Acura dealer, or for U.S. vehicles, Acura Client Relations at 1-800-382-2238 and for Canadian vehicles, Acura Client Services at 1-888-9-ACURA-9.

#### ✘ Airbag Care

We recommend against the use of salvaged airbag system components, including the airbag, tensioners, sensors, and control unit.

## Protecting Child Passengers

Each year, many children are injured or killed in vehicle crashes because they are either unrestrained or not properly restrained. In fact, vehicle crashes are the number one cause of death of children ages 12 and under.

To reduce the number of child deaths and injuries, every state, Canadian province and territory requires that infants and children be properly restrained when they ride in a vehicle.

**Children should sit properly restrained in a rear seat.** This is because:



- An inflating front airbag can injure or kill a child sitting in the front seat.
- A child in the front seat is more likely to interfere with the driver's ability to safely control the vehicle.
- Statistics show that children of all sizes and ages are safer when they are properly restrained in a rear seat.

### Protecting Child Passengers

#### **WARNING**

**Children who are unrestrained or improperly restrained can be seriously injured or killed in a crash.**

**Any child too small for a seat belt should be properly restrained in a child seat. A larger child should be properly restrained with a seat belt, using a booster seat if necessary.**

The National Highway Traffic Safety Administration and Transport Canada recommend that all children ages 12 and under be properly restrained in a rear seat. Some states or provinces/territories have laws restricting where children may ride.

- Never hold a child on your lap because it is impossible to protect them in the event of a collision.
- Never put a seat belt over yourself and a child. During a crash, the belt would likely press deep into the child and cause serious or fatal injuries.
- Never let two children use the same seat belt. Both children could be very seriously injured in a crash.
- Any child who is too small to wear a seat belt correctly must be restrained in an approved child seat that is properly secured to the vehicle using either the seat belt or the lower anchors of the LATCH system.
- Do not allow children to operate the doors, windows, or seat adjustments.
- Do not leave children in the vehicle unattended, especially in hot weather when the inside of the vehicle can get hot enough to kill them. They could also activate vehicle controls causing it to move unexpectedly.

#### ▶▶ Protecting Child Passengers

### **⚠ WARNING**

Allowing a child to play with a seat belt or wrap one around their neck can result in serious injury or death.

**Instruct children not to play with any seat belt and make sure any unused seat belt a child can reach is buckled, fully retracted, and locked.**

To deactivate a lockable retractor, release the buckle and allow the seat belt to wind up all the way.

To remind you of the passenger's front airbag hazards and child safety, your vehicle has warning labels on the dashboard (U.S. models) and on the front visors. Please read and follow the instructions on these labels.

▶▶ **Safety Labels** P. 82

## Safety of Infants and Small Children

### ■ Protecting Infants

An infant must be properly restrained in a rear-facing child seat until the infant reaches the seat manufacturer's weight or height limit for the seat.

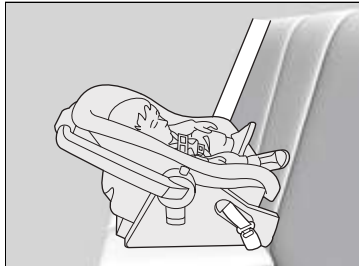

#### ■ Positioning a rear-facing child seat

Child seats must be placed and secured in a rear seating position.

When properly installed, a rear-facing child seat may prevent the driver or a front passenger from moving their seat all the way back, or from locking their seat-back in the desired position. Make sure that there is no contact between the child seat and the seat in front of it.

It can also interfere with proper operation of the passenger's advanced front airbag system.

➤ **Airbags** P. 49

If this occurs, we recommend that you install the child seat directly behind the front passenger's seat, move the seat as far forward as needed, and leave it unoccupied. Or, you may wish to get a smaller rear-facing child seat.

### ⌘ Protecting Infants

## ⚠ WARNING

Placing a rear-facing child seat in the front seat can result in serious injury or death during a crash.

Always place a rear-facing child seat in the rear seat, not the front.

Experts recommend use of a rear-facing seat for a child so long as the child's height and weight are appropriate for a rear-facing seat.

Infants should never be seated in a forward-facing position.

Always refer to the child seat manufacturer's instructions before installation.

Do not allow a front seat to rest against a child seat installed in a rear seating position. The weight sensor in the front seat may not correctly detect the actual weight of the occupant.

## ■ Protecting Smaller Children

If a child has exceeded the weight and height limitations of a rear-facing child seat, the child should be properly restrained in a firmly secured forward-facing child seat until they exceed the weight and height limitations for the forward-facing child seat.



### ■ Forward-facing child seat placement

We strongly recommend placing a forward-facing child seat in a rear seating position.

Placing a forward-facing child seat in the front seat can be hazardous, even with advanced front airbags that automatically turn the passenger's front airbag off. A rear seat is the safest place for a child.

## ▣ Protecting Smaller Children

### ▲ WARNING

Placing a forward-facing child seat in the front seat can result in serious injury or death if the front airbag inflates.

If you must place a forward-facing child seat in front, move the vehicle seat as far back as possible, and properly restrain the child.

Educate yourself about the laws and regulations regarding child seat use where you are driving, and follow the child seat manufacturer's instructions.

## ■ Selecting a Child Seat

Most child seats are LATCH-compatible (Lower Anchors and Tethers for Children). Some have a rigid-type connector while others have a flexible-type connector. Both are equally easy to use. Some existing and previously owned child seats can only be installed using the seat belt. Whichever type you choose, follow the child seat manufacturer's use and care instructions including recommended expiration dates as well as the instructions in this manual. Proper installation is key to maximizing your child's safety.

In seating positions and vehicles not equipped with LATCH, a LATCH-compatible child seat can be installed using the seat belt and a top tether for added security. This is because all child seats are required to be designed so that they can be secured with a lap belt or the lap part of a lap/shoulder belt. In addition, the child seat manufacturer may advise that a seat belt be used to attach a LATCH-compatible seat once a child reaches a specified weight. Please read the child seat owner's manual for proper installation instructions.

### ■ Important consideration when selecting a child seat

Make sure the child seat meets the following three requirements:

- The child seat is the correct type and size for the child.
- The child seat is the correct type for the seating position.
- The child seat is compliant with Federal Motor Vehicle Safety Standard 213 or Canadian Motor Vehicle Safety Standard 213.

## ▶▶ Selecting a Child Seat

Installation of a LATCH-compatible child seat is simple.

LATCH-compatible child seats have been developed to simplify the installation process and reduce the likelihood of injuries caused by incorrect installation.

## Installing a LATCH-Compatible Child Seat

A LATCH-compatible child seat can be installed in either of the two outer rear seats. A child seat is attached to the lower anchors with either the rigid or flexible type of connectors.

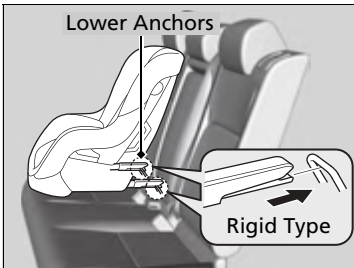
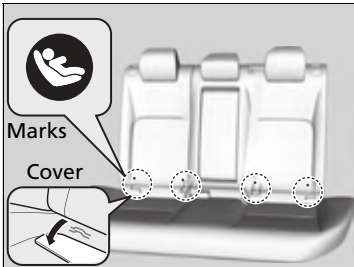

1. Locate the anchor marks affixed to the base of the seat cushion.
2. Pull out the anchor covers under the marks to expose the lower anchors.
3. Place the child seat on the vehicle seat, then attach the child seat to the lower anchors according to the instructions that came with the child seat.
  - ▶ When installing the child seat, make sure that the lower anchors are not obstructed by the seat belt or any other object.

## Installing a LATCH-Compatible Child Seat

### ⚠ WARNING

**Never attach two child seats to the same anchor. In a collision, one anchor may not be strong enough to hold two child seat attachments and may break, causing serious injury or death.**

For your child's safety, when using a child seat installed using the LATCH system, make sure that the child seat is properly secured to the vehicle. A child seat that is not properly secured will not adequately protect a child in a crash and may cause injury to the child or other vehicle occupants.

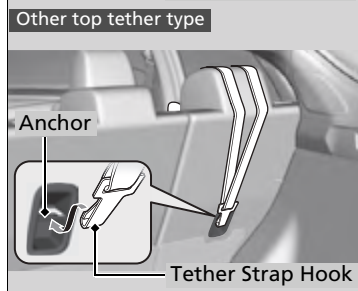
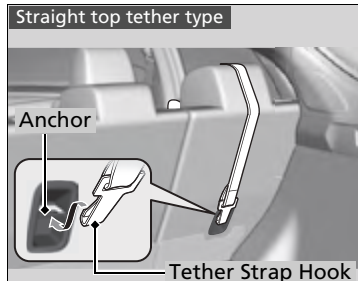
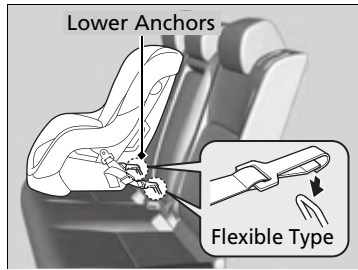

4. Remove the cargo area cover.  
 ➤ **Cargo Area Cover** P. 209
5. Route the tether strap over the top of the head restraint.  
 Make sure the strap is not twisted.
6. Secure the tether strap hook to the anchor.
7. Tighten the tether strap as instructed by the child seat manufacturer.
8. Make sure the child seat is firmly secured by rocking it forward and back and side to side; little movement should be felt.
9. Make sure any unused seat belt that a child can reach is buckled, the lockable retractor is activated, and the belt is fully retracted and locked.

► Installing a LATCH-Compatible Child Seat

**⚠ WARNING**

Using the outer rear seats' inner anchors to secure a LATCH-compatible child seat in the center seating position may result in failure of the child seat, causing injury or death.

Only use the outer rear seats' inner anchors to install a child seat in the center seating position if the manufacturer's instructions expressly permit.

**Installing a LATCH-compatible child seat in the rear center seat**

Each outer rear seat is equipped with a pair of lower anchors which are used to secure a LATCH-compatible child seat. The rear center seat, however, is not equipped with anchors of any kind.

The inner and outer anchors are spaced apart at a standard distance of 11 inches (280 mm). The distance between the two inner anchors is 15 inches (380 mm). LATCH-compatible restraint systems that are fitted with rigid-type attachments cannot be installed in the rear center seat. However, a system fitted with flexible-type attachments can be installed in the center seat, provided that the manufacturer's instructions for that system permit the use of the inner anchors with the stated spacing.

Before seating a child, make sure that the system is properly attached to both the lower anchors and tether anchors.



## ■ Installing a Child Seat with a Lap/Shoulder Seat Belt

A child seat can be installed with a lap/shoulder belt in any rear seat or, if absolutely necessary, the front passenger seat.

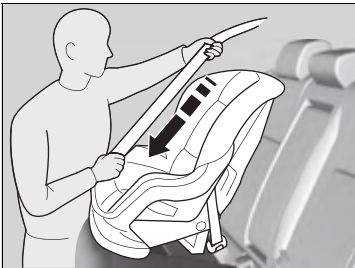
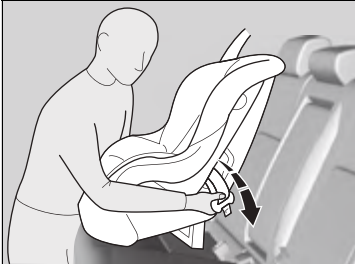

1. Place the child seat on the vehicle seat.
2. Route the seat belt through the child seat according to the seat manufacturer's instructions, and insert the latch plate into the buckle.
  - Insert the latch plate fully until it clicks.
3. Slowly pull the shoulder part of the belt all the way out until it stops. This activates the lockable retractor.
4. Let the seat belt retract a few inches and check that the retractor has switched modes by pulling on the webbing. It should not pull out again until it is reset by removing the latch plate from the buckle.
  - If you are able to pull the shoulder belt out, the lockable retractor is not activated. Slowly pull the seat belt all the way out, and repeat steps 3 – 4.

## ▣ Installing a Child Seat with a Lap/Shoulder Seat Belt

A child seat that is not properly secured will not adequately protect a child in a crash and may cause injury to the child or other vehicle occupants.

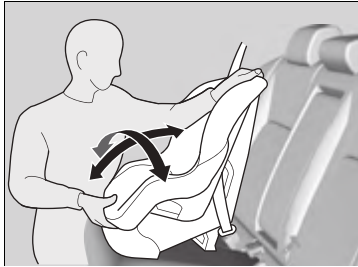
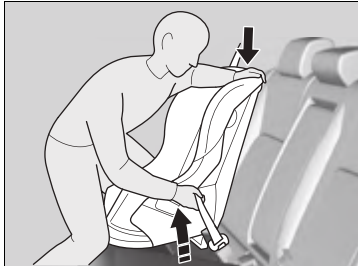

**5.** Grab the shoulder part of the seat belt near the buckle, and pull up to remove any slack from the lap part of the belt.

▶ When doing this, place your weight on the child seat and push it into the vehicle seat.

**6.** Make sure the child seat is firmly secured by rocking it forward and back and side to side; less than one inch of movement should occur near the seat belt.

**7.** Make sure any unused seat belt that a child can reach is buckled, the lockable retractor is activated, and the belt is fully retracted and locked.

▶▶ Installing a Child Seat with a Lap/Shoulder Seat Belt

To deactivate a lockable retractor, release the buckle and allow the seat belt to wind up all the way.

## ■ Adding Security with a Tether

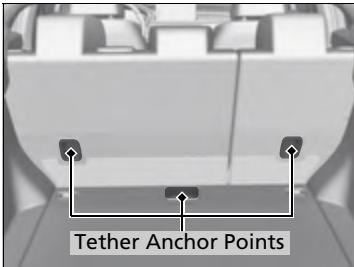

A tether anchor point is provided behind each rear seating position.

If you have a child seat that comes with a tether but can be installed with a seat belt, the tether may be used for additional security.

Straight top tether type in outer position

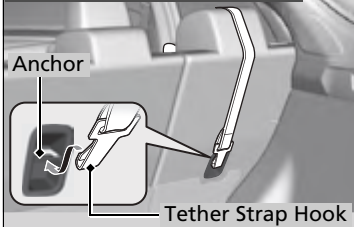

Other top tether type in outer position

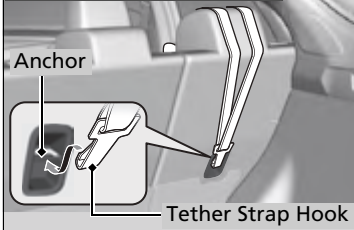

### ■ Using an outer anchor

1. Remove the cargo area cover.
  - ▶ **Cargo Area Cover** P. 209
2. Locate the appropriate tether anchor point.
3. Route the tether strap over the top of the head restraint. Make sure the strap is not twisted.
4. Secure the tether strap hook to the anchor.
5. Tighten the tether strap as instructed by the child seat manufacturer.

### ▶▶ Adding Security with a Tether

Always use a tether for forward-facing child seats whether using the seat belt or lower anchors.

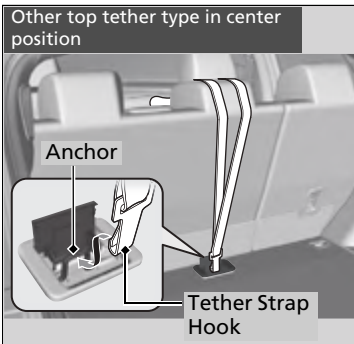
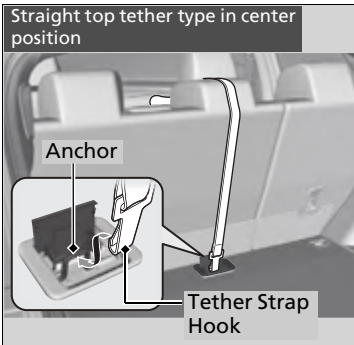

### ■ Using the center anchor

1. Remove the cargo area cover.  
    ❑ **Cargo Area Cover** P. 209
2. Locate the appropriate tether anchor point and lift the cover.
3. Route the tether strap over the top of the head restraint. Make sure the strap is not twisted.
4. Secure the tether strap hook to the anchor.
5. Tighten the tether strap as instructed by the child seat manufacturer.

## Safety of Larger Children

### ■ Protecting Larger Children

The following pages give instructions on how to check proper seat belt fit, what kind of booster seat to use if one is needed, and important precautions for a child who must sit in front.

### ■ Checking Seat Belt Fit

When a child is too big for a child seat, secure the child in a rear seat using the lap/shoulder seat belt. Have the child sit upright and all the way back, then answer the following questions.



#### ■ Checklist

- Do the child's knees bend comfortably over the edge of the seat?
- Does the shoulder belt cross between the child's neck and arm?
- Is the lap part of the seat belt as low as possible, touching the child's thighs?
- Will the child be able to stay seated like this for the whole trip?

If you answer yes to all these questions, the child is ready to wear the lap/shoulder seat belt correctly. If you answer no to any question, the child needs to ride on a booster seat until the seat belt fits properly without a booster seat.

### ☒ Safety of Larger Children

## ⚠ WARNING

Allowing a child age 12 or under to sit in front can result in injury or death if the passenger's front airbag inflates.

If a larger child must ride in front, move the vehicle seat as far to the rear as possible, have the child sit up properly and wear the seat belt properly, using a booster seat if needed.

## ■ Booster Seats



If a lap/shoulder seat belt cannot be used properly, position the child in a booster seat in the rear seat. For the child's safety, check that the child meets the booster seat manufacturer's recommendations.

## ▣ Booster Seats

When installing a booster seat, make sure to read the instructions that came with it, and install the seat accordingly.

There are high- and low-type booster seats. Choose a booster seat that allows the child to wear the seat belt correctly.

Some U.S. states, and Canadian provinces and territories require children to use a booster seat until they reach a given age or weight (e.g., 6 years or 60 lbs). Be sure to check current laws in the state or province, or territory where you intend to drive.

## ■ Protecting Larger Children - Final Checks

Your vehicle has a rear seat where children can be properly restrained. If you ever have to carry a group of children, and a child must ride in front:

- Make sure you read and fully understand the instructions and safety information in this manual.
- Move the front passenger seat as far back as possible.
- Have the child sit upright and well back in the seat.
- Check that the seat belt is properly positioned so that the child is secure in the seat.

## ■ Monitoring child passengers

We strongly recommend that you keep an eye on child passengers. Even older, more mature children sometimes need to be reminded to fasten their seat belts and sit up properly.

## Carbon Monoxide Gas

The engine exhaust from this vehicle contains carbon monoxide, a colorless, odorless, and highly toxic gas. As long as you properly maintain your vehicle, carbon monoxide gas will not get into the interior.

### ■ Have the exhaust system inspected for leaks whenever

- The exhaust system is making an unusual noise.
- The exhaust system may have been damaged.
- The vehicle is raised for an oil change.

When you operate a vehicle with the hatch open, airflow can pull exhaust gas into the interior and create a hazardous condition. If you must drive with the hatch open, open all the windows and set the climate control system as shown below.

1. Select the fresh air mode.
2. Select the  mode.
3. Set the fan speed to high.
4. Set the temperature control to a comfortable setting.

Adjust the climate control system in the same manner if you sit in your parked vehicle with the engine running.

### ☒ Carbon Monoxide Gas

## ⚠ WARNING

Carbon monoxide gas is toxic.

Breathing it can cause unconsciousness and even kill you.

Avoid any enclosed areas or activities that expose you to carbon monoxide.

An enclosed area such as a garage can quickly fill up with carbon monoxide gas. Do not run the engine with the garage door closed. Even when the garage door is open, drive out of the garage immediately after starting the engine.

## Label Locations

These labels are in the locations shown. They warn you of potential hazards that can cause serious injury or death. Read these labels carefully.

If a label comes off or becomes hard to read (except for the U.S. dashboard label which may be removed by the owner), contact a dealer for a replacement.

### Sun Visor

**U.S. models**

**WARNING**

**EVEN WITH ADVANCED AIR BAGS**

- Do not lean back or recline in the air bag.
- The back of the seat should be upright.
- Do not install rearward-facing child seats in any front passenger seat position.
- Always use proper tie-up technique about air bags.

**Canadian models**

WARNING	ATTENTION
<p>To avoid serious injury in all types of crashes, you must always wear your safety belt.</p> <ul style="list-style-type: none"> <li>Do not install rearward-facing child seats in any front passenger seat position.</li> <li>Do not sit or lean unnecessarily close to the air bag.</li> <li>Do not place any objects over the air bag or between the air bag and yourself.</li> <li>See the owner's manual for further information and explanations.</li> </ul>	<p><b>Pour éviter des blessures graves</b></p> <p>Pour profiter d'une protection maximale lors d'une collision boucliez toujours votre ceinture de sécurité.</p> <ul style="list-style-type: none"> <li>N'installez jamais un siège pour enfants faisant face à l'arrière sur le siège du passager avant.</li> <li>Ne vous appuyez pas et ne vous assoyez pas près du coussin gonflable.</li> <li>Ne déposez aucun objet sur le coussin gonflable ou entre le coussin gonflable et vous.</li> <li>Lisez le guide utilisateur pour de plus amples renseignements.</li> </ul>

### Dashboard

**U.S. models only**

This Vehicle is Equipped with Advanced Air Bags

Even with Advanced Air Bags:

- Do not lean back or recline in the air bag.
- The back of the seat should be upright.
- Do not install rearward-facing child seats in any front passenger seat position.
- Always use proper tie-up technique about air bags.

### Air Conditioner System

**U.S. models**

**WARNING**

Flammable Refrigerant

CAUTION SYSTEM CONTAINS REFRIGERANT R-1234yf UNDER HIGH PRESSURE.

TO BE SERVICED ONLY BY QUALIFIED PERSONNEL. Follow Instructions in the service manual.

**AIR CONDITIONER SYSTEM REFRIGERANT: R-1234yf (SAE J639 J2842 J2845)**

REC. CHARGE: MAX 0.485kg MIN 0.435kg

OIL TYPE: RB100EV-01 OIL (POE)

T39 Honda Motor Co., Ltd.

**Canadian models**

**R-1234yf**

### Radiator Cap

**DANGER WARNING**

危險 危險

NEVER OPEN WHEN HOT. Hot coolant will scald you. N'ouvrez pas quand chaud. Neht bít hbitem motor ořnén.

熱い液体が沸騰して危険です。高温時、絶対に開かない。

108kPa



# Instrument Panel

















This chapter describes the buttons, indicators, and gauges that are used while driving.



























<b>Indicators</b> .....	84
<b>Gauges and Displays</b>	
Gauges .....	104
Driver Information Interface (Left Side Area) .....	108
Driver Information Interface (Right Side Area) .....	111
Head-Up Display* .....	135

\* Not available on all models

Indicators come on/blink depending on the condition of the vehicle. Messages may display on the driver information interface at the same time. Please take the appropriate action outlined in the message, such as contacting a dealer.



<p><b>BRAKE</b> *1 U.S.  *1 Canada</p>	<p>Parking Brake and Brake System Indicator (Red) → P. 86</p>	<p> *1</p>	<p>Malfunction Indicator Lamp → P. 89</p>	<p> *1</p>	<p>Anti-lock Brake System (ABS) Indicator → P. 91</p>
<p><b>BRAKE SYSTEM</b> *1 U.S.  *1 Canada</p>	<p>Parking Brake and Brake System Indicator (Amber) → P. 88</p>	<p> *1</p>	<p>Charging System Indicator → P. 89</p>	<p> *1</p>	<p>Supplemental Restraint System Indicator → P. 91</p>
<p> *1</p>	<p>Automatic Brake Hold System Indicator → P. 88</p>	<p> *1</p>	<p>Shift Position Indicator* → P. 89</p>	<p> *1</p>	<p>Electric Power Steering (EPS) System Indicator → P. 91</p>
<p> *1 U.S.  *1 Canada</p>	<p>Automatic Brake Hold Indicator → P. 88</p>	<p> *1</p>	<p>M (7-speed manual shift mode) Indicator/Shift Indicator* → P. 89</p>	<p> *1</p>	<p>Vehicle Stability Assist™ (VSA®) System Indicator → P. 92</p>
		<p> *1</p>	<p>Transmission System Indicator* → P. 90</p>	<p> *1</p>	<p>Seat Belt Reminder Indicator → P. 90</p>
		<p> *1</p>	<p>Low Fuel Indicator → P. 91</p>	<p> *1</p>	<p>Vehicle Stability Assist™ (VSA®) OFF Indicator → P. 92</p>



\*1: When you set the power mode to ON, these indicators come on to indicate that system checks are being performed. They go off a few seconds later or after the engine has started. If an indicator does not come on or turn off, there may be a malfunction in the corresponding system. To resolve the issue, follow the instructions in the owner's manual.



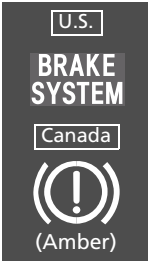

 *1	Low Tire Pressure/TPMS Indicator	→ P. 92	 <b>COMFORT</b>	<b>COMFORT</b> Mode Indicator	→ P. 94		Immobilizer System Indicator	→ P. 95
	Turn Signal and Hazard Warning Indicators	→ P. 93	 <b>SPORT</b>	<b>SPORT</b> Mode Indicator	→ P. 94		Security System Alarm Indicator	→ P. 95
	Lights On Indicator	→ P. 93	 <b>INDIVIDUAL</b>	<b>INDIVIDUAL</b> Mode Indicator*	→ P. 94	 *1	Adaptive Cruise Control (ACC) with Low Speed Follow* Indicator (Amber)	→ P. 98
	High Beam Indicator	→ P. 93		Cruise Mode Indicator (White/Green)	→ P. 99	 *1	Adaptive Cruise Control (ACC) with Low Speed Follow* Indicator (White/Green)	→ P. 98
 *1	Auto High-Beam Indicator	→ P. 93		Adaptive Cruise Control (ACC) with Low Speed Follow* Interval Indicator	→ P. 99	 *1	Lane Keeping Assist System (LKAS) Indicator (Amber)	→ P. 99
	Fog Light Indicator*	→ P. 93		Auto Idle Stop <b>OFF</b> Indicator	→ P. 96	 *1	Lane Keeping Assist System (LKAS) Indicator (White/Green)	→ P. 99
	System Message Indicator	→ P. 94		Auto Idle Stop Suspend Indicator	→ P. 97	 *1	Safety Support Indicator (Amber)	→ P. 100
 <b>NORMAL</b>	<b>NORMAL</b> Mode Indicator	→ P. 94		Auto Idle Stop System Indicator (Amber)	→ P. 96	 *1	Safety Support Indicator (Green/Gray)	→ P. 103

\*1: When you set the power mode to ON, these indicators come on to indicate that system checks are being performed. They go off a few seconds later or after the engine has started. If an indicator does not come on or turn off, there may be a malfunction in the corresponding system. To resolve the issue, follow the instructions in the owner's manual.



Indicator	Name	On/Blinking	Explanation
 <p>The indicator symbol consists of a rectangular box divided into two horizontal sections. The top section contains the text 'U.S.' and the word 'BRAKE' in large, bold, capital letters. The bottom section contains the text 'Canada' and a circular warning symbol (an exclamation mark inside a circle) with '(Red)' written below it.</p>	<p>Parking Brake and Brake System Indicator (Red)</p>	<ul style="list-style-type: none"> <li>• Comes on when the parking brake is applied, and goes off when it is released.</li> <li>• Comes on when the brake fluid level is low.</li> </ul>	<ul style="list-style-type: none"> <li>• The beeper sounds and the indicator comes on if you drive with the parking brake applied.</li> <li>• Comes on for about 30 seconds when you apply the electric parking brake while the power mode is in ACCESSORY or VEHICLE OFF, then goes off.</li> <li>• Stays on for about 30 seconds when you set the power mode to VEHICLE OFF while the electric parking brake is applied, then goes off.</li> <li>• <b>Comes on while driving</b> - Make sure the parking brake is released. Stop in a safe place and check the brake fluid level.             <ul style="list-style-type: none"> <li>➤ <b>What to do when the indicator comes on while driving</b> P. 701</li> </ul> </li> </ul>

Indicator	Name	On/Blinking	Explanation
<div style="text-align: center;">  <p>U.S.</p> <p><b>BRAKE</b></p> </div> <div style="text-align: center; margin-top: 10px;">  <p>Canada</p> <p>(Red)</p> </div>	<p>Parking Brake and Brake System Indicator (Red)</p>	<ul style="list-style-type: none"> <li>Comes on if there is a problem with the brake system.</li> </ul>	<p><b>Continuously variable transmission models</b></p> <ul style="list-style-type: none"> <li><b>Comes on along with the Parking Brake and Brake System Indicator (amber)</b> - Immediately stop in a safe place. Contact a dealer for repair. The brake pedal becomes harder to operate. Depress the pedal further than you normally do. <ul style="list-style-type: none"> <li>➤ <b>If the Brake System Indicator (Red) Comes On or Blinks at the Same Time When the Brake System Indicator (Amber) Comes On</b> P. 703</li> </ul> </li> </ul> <p><b>All models</b></p> <ul style="list-style-type: none"> <li><b>Comes on along with the ABS indicator</b> - Have your vehicle checked by a dealer. <ul style="list-style-type: none"> <li>➤ <b>If the Brake System Indicator (Red) Comes On or Blinks</b> P. 701</li> </ul> </li> <li><b>Blinks and the Parking Brake and Brake System Indicator (amber) comes on at the same time</b> - There is a problem with the electric parking brake system. The parking brake may not be set. Avoid using the parking brake and have your vehicle checked by a dealer immediately. <ul style="list-style-type: none"> <li>➤ <b>If the Brake System Indicator (Red) Comes On or Blinks at the Same Time When the Brake System Indicator (Amber) Comes On</b> P. 703</li> </ul> </li> </ul>





Indicator	Name	On/Blinking	Explanation
	Parking Brake and Brake System Indicator (Amber)	<ul style="list-style-type: none"> <li>Comes on if there is a problem with a system related to braking other than the conventional brake system.</li> </ul>	<ul style="list-style-type: none"> <li><b>Comes on while driving</b> - Have your vehicle checked by a dealer.</li> <li>With this indicator on, your vehicle still has normal braking ability.</li> </ul>
		<ul style="list-style-type: none"> <li>Comes on if there is a problem with the electric parking brake system and/or the automatic brake hold system.</li> </ul>	<ul style="list-style-type: none"> <li><b>Stays on constantly</b> - Avoid using the parking brake and have your vehicle checked by a dealer immediately.</li> </ul>
	Automatic Brake Hold System Indicator	<ul style="list-style-type: none"> <li>Comes on when the automatic brake hold system is on.</li> </ul>	<p>➤ <b>Automatic Brake Hold</b> P. 589</p>
	Automatic Brake Hold Indicator	<ul style="list-style-type: none"> <li>Comes on when the automatic brake hold is activated.</li> </ul>	<p>➤ <b>Automatic Brake Hold</b> P. 589</p>



Indicator	Name	On/Blinking	Explanation
	Malfunction Indicator Lamp	<ul style="list-style-type: none"> <li>• After you have set the power mode to ON, the vehicle performs system checks. However, if the readiness codes have not been set by that time, this indicator will blink five times and then go off.</li> <li>• Comes on if there is a problem with the emissions control systems.</li> <li>• Blinks when a misfire in the engine's cylinders is detected.</li> </ul>	<ul style="list-style-type: none"> <li>• Readiness codes are part of the on-board diagnostics for the emissions control systems.                             <ul style="list-style-type: none"> <li>► <b>Testing of Readiness Codes</b> P. 721</li> </ul> </li> <li>► <b>If the Malfunction Indicator Lamp Comes On or Blinks</b> P. 700</li> </ul>
	Charging System Indicator	<ul style="list-style-type: none"> <li>• Comes on when there is a problem with the charging system.</li> </ul>	<ul style="list-style-type: none"> <li>• Stop in a safe place and contact a dealer immediately.                             <ul style="list-style-type: none"> <li>► <b>Checking the Battery</b> P. 651</li> <li>► <b>If the Charging System Indicator Comes On</b> P. 700</li> </ul> </li> </ul>
	Shift Position Indicator*	<ul style="list-style-type: none"> <li>• Indicates the current shift position.</li> </ul>	<ul style="list-style-type: none"> <li>► <b>Shifting</b> P. 440</li> </ul>
	M (7-speed manual shift mode) Indicator/Shift Indicator*	<ul style="list-style-type: none"> <li>• Comes on when the 7-speed manual shift mode is applied.</li> </ul>	<ul style="list-style-type: none"> <li>► <b>7-Speed Manual Shift Mode</b> P. 442</li> </ul>





\* Not available on all models

Indicator	Name	On/Blinking	Explanation
	Transmission System Indicator*	<ul style="list-style-type: none"> <li>• Blinks if the transmission system has a problem.</li> </ul>	<ul style="list-style-type: none"> <li>• Have your vehicle checked by a dealer immediately.</li> </ul>
	Seat Belt Reminder Indicator	<ul style="list-style-type: none"> <li>• Blinks and the beeper sounds for a few seconds if you are not wearing a seat belt when you set the power mode to ON, then the indicator comes on.</li> <li>• If the front passenger is not wearing a seat belt, the indicator comes on a few seconds later.</li> <li>• Comes on for a while when the rear seat belt is unfastened while the power mode in ON.</li> <li>• Blinks while driving if you and/or any passenger has not fastened a seat belt. The beeper sounds and the indicator blinks at regular intervals.</li> </ul>	<ul style="list-style-type: none"> <li>• The beeper stops and the indicator goes off when you and the passengers fasten their seat belts.</li> <li>• <b>Stays on after you and/or the passengers have fastened the seat belt(s)</b> - A detection error may have occurred in the sensor. Have your vehicle checked by a dealer.                             <ul style="list-style-type: none"> <li>➤ <b>Seat Belt Reminder</b> P. 42</li> </ul> </li> </ul>







Indicator	Name	On/Blinking	Explanation
	Low Fuel Indicator	<ul style="list-style-type: none"> <li>• Comes on when the fuel reserve is running low (approximately 1.8 U.S. gal/7.0 Liter left).</li> <li>• Blinks if there is a problem with the fuel gauge.</li> </ul>	<ul style="list-style-type: none"> <li>• <b>Comes on</b> - Refuel your vehicle as soon as possible.</li> <li>• Have your vehicle checked by a dealer.</li> </ul>
	Anti-lock Brake System (ABS) Indicator	<ul style="list-style-type: none"> <li>• Comes on if there is a problem with the ABS.</li> </ul>	<ul style="list-style-type: none"> <li>• <b>Stays on constantly</b> - Have your vehicle checked by a dealer. With this indicator on, your vehicle still has normal braking ability but no anti-lock function.  <b>➤ Anti-lock Brake System (ABS) P. 594</b></li> </ul>
	Supplemental Restraint System Indicator	<ul style="list-style-type: none"> <li>• Comes on if a problem with any of the following is detected: <ul style="list-style-type: none"> <li>- Supplemental Restraint System</li> <li>- Side airbag system</li> <li>- Side curtain airbag system</li> <li>- Seat belt tensioner</li> </ul> </li> </ul>	<ul style="list-style-type: none"> <li>• <b>Stays on constantly</b> - Have your vehicle checked by a dealer.</li> </ul>
	Electric Power Steering (EPS) System Indicator	<ul style="list-style-type: none"> <li>• Comes on if there is a problem with the EPS system.</li> </ul>	<ul style="list-style-type: none"> <li>• <b>Stays on constantly</b> - Have your vehicle checked by a dealer.</li> <li>• <b>Do not drive displays on the driver information interface</b> - Immediately stop in a safe place and contact a dealer.  <b>➤ If the Electric Power Steering (EPS) System Indicator Comes On P. 702</b></li> </ul>



Indicator	Name	On/Blinking	Explanation
	Vehicle Stability Assist™ (VSA®) System Indicator	<ul style="list-style-type: none"> <li>• Blinks when VSA® is active.</li> </ul>	—
		<ul style="list-style-type: none"> <li>• Comes on if there is a problem with the VSA® system, brake assist system, hill start assist system, starting assist brake function*, or agile handling assist.</li> </ul>	<ul style="list-style-type: none"> <li>• <b>Stays on constantly</b> - Have your vehicle checked by a dealer.                             <ul style="list-style-type: none"> <li>▣ <b>Vehicle Stability Assist™ (VSA®), aka Electronic Stability Control (ESC), System</b> P. 466</li> </ul> </li> </ul>
	Vehicle Stability Assist™ (VSA®) <b>OFF</b> Indicator	<ul style="list-style-type: none"> <li>• Comes on when you partially disable VSA®.</li> </ul>	<ul style="list-style-type: none"> <li>▣ <b>VSA® On and Off</b> P. 467</li> </ul>
	Low Tire Pressure/TPMS Indicator	<ul style="list-style-type: none"> <li>• Comes on if the tire pressure of any of the tires becomes low.</li> </ul>	<ul style="list-style-type: none"> <li>• <b>Comes on while driving</b> - Stop in a safe place, check tire pressures, and inflate the tire(s) if necessary.</li> </ul>
		<ul style="list-style-type: none"> <li>• Blinks for about one minute, and then stays on if there is a problem with the TPMS with Tire Fill Assist, or when a compact spare tire* is temporarily installed.</li> </ul>	<ul style="list-style-type: none"> <li>• <b>Blinks and remains on</b> - Have your vehicle checked by a dealer. If the vehicle is fitted with a compact spare tire*, get your regular tire repaired or replaced and put back on your vehicle as soon as you can.</li> </ul>

Indicator	Name	On/Blinking	Explanation
	Turn Signal and Hazard Warning Indicators	<ul style="list-style-type: none"> <li>• Blinks when you operate the turn signal lever.</li> <li>• Blinks along with all turn signals when you press the hazard warning button.</li> </ul>	<ul style="list-style-type: none"> <li>• <b>Does not blink or blinks rapidly</b> - Have your vehicle checked by a dealer.</li> </ul>
	Lights On Indicator	<ul style="list-style-type: none"> <li>• Comes on when the parking, tail, and other external lights are on.</li> </ul>	<ul style="list-style-type: none"> <li>➤ <b>Light Switches</b> P. 176</li> </ul>
	High Beam Indicator	<ul style="list-style-type: none"> <li>• Comes on when the high beam headlights are on.</li> </ul>	—
	Auto High-Beam Indicator	<ul style="list-style-type: none"> <li>• Comes on when all the operating conditions of the auto high-beam are met.</li> </ul>	<ul style="list-style-type: none"> <li>➤ <b>Auto High-Beam</b> P. 180</li> </ul>
	Fog Light Indicator*	<ul style="list-style-type: none"> <li>• Comes on when the fog lights are on.</li> </ul>	<ul style="list-style-type: none"> <li>➤ <b>Fog Lights*</b> P. 179</li> </ul>

\* Not available on all models

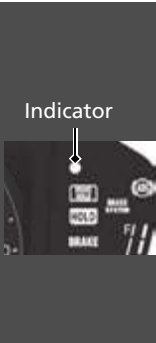
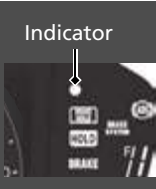

Indicator	Name	On/Blinking	Explanation
	System Message Indicator	<ul style="list-style-type: none"> <li>Comes on along with a beep when a problem is detected. A system message on the driver information interface appears at the same time.</li> </ul>	<ul style="list-style-type: none"> <li>While the indicator is on, roll the right selector wheel to see the message again.                             <ul style="list-style-type: none"> <li>➤ <b>Switching the Display</b> P. 112</li> </ul> </li> <li>Refer to the Indicators information in this chapter when a system message appears on the driver information interface. Respond to the message accordingly.</li> <li>The driver information interface will not return to the normal screen unless the warning is canceled, or the right selector wheel is rolled.</li> </ul>
	<b>NORMAL</b> Mode Indicator	<ul style="list-style-type: none"> <li>Comes on when you set the dynamic mode to <b>NORMAL</b>.</li> </ul>	<ul style="list-style-type: none"> <li>➤ <b>Acura Integrated Dynamics System</b> P. 449</li> </ul>
	<b>COMFORT</b> Mode Indicator	<ul style="list-style-type: none"> <li>Comes on when you set the dynamic mode to <b>COMFORT</b>.</li> </ul>	<ul style="list-style-type: none"> <li>➤ <b>Acura Integrated Dynamics System</b> P. 449</li> </ul>
	<b>SPORT</b> Mode Indicator	<ul style="list-style-type: none"> <li>Comes on when you set the dynamic mode to <b>SPORT</b>.</li> </ul>	<ul style="list-style-type: none"> <li>➤ <b>Acura Integrated Dynamics System</b> P. 449</li> </ul>
	<b>INDIVIDUAL</b> Mode Indicator*	<ul style="list-style-type: none"> <li>Comes on when you set the <b>INDIVIDUAL</b> mode.</li> </ul>	<ul style="list-style-type: none"> <li>➤ <b>Acura Integrated Dynamics System</b> P. 449</li> </ul>

Indicator	Name	On/Blinking	Explanation
 <p>Indicator</p>	<p>Immobilizer System Indicator</p>	<ul style="list-style-type: none"> <li>Blinks if the immobilizer system cannot recognize the key information.</li> </ul>	<ul style="list-style-type: none"> <li><b>Blinks</b> - You cannot start the engine. Set the power mode to VEHICLE OFF, then select the ON mode again.                             <ul style="list-style-type: none"> <li><b>Canadian models</b> Depress and hold the brake pedal before setting the power mode to ON.</li> </ul> </li> <li><b>Repeatedly blinks</b> - The system may be malfunctioning. Have your vehicle checked by a dealer.</li> <li>Do not attempt to alter this system or add other devices to it. Electrical problems can occur.</li> </ul>
 <p>Indicator</p>	<p>Security System Alarm Indicator</p>	<ul style="list-style-type: none"> <li>Blinks when the security system alarm has been set.</li> </ul>	<p>➤ <b>Security System Alarm</b> P. 165</p>





Indicator	Name	On/Blinking	Explanation
	Auto Idle Stop <b>OFF</b> Indicator	<ul style="list-style-type: none"> <li>Comes on when the Auto Idle Stop system has been turned off by the Auto Idle Stop <b>OFF</b> button.</li> </ul>	<ul style="list-style-type: none"> <li>➤ <b>Auto Idle Stop System ON/OFF</b> P. 456, 462</li> </ul>
	Auto Idle Stop System Indicator (Amber)	<ul style="list-style-type: none"> <li>Blinks if there is a problem with the Auto Idle Stop system.</li> </ul>	<ul style="list-style-type: none"> <li>• <b>Blinks</b> - Have your vehicle checked by a dealer.</li> </ul>
	Auto Idle Stop Indicator (Green)	<ul style="list-style-type: none"> <li>Comes on when Auto Idle Stop is in operation. The engine automatically shuts off.</li> </ul>	<ul style="list-style-type: none"> <li>➤ <b>Auto Idle Stop</b> P. 455, 461</li> </ul>

Indicator	Name	On/Blinking	Explanation
	Auto Idle Stop Suspend Indicator	<ul style="list-style-type: none"> <li>Comes on while Auto Idle Stop is temporarily suspended in the following situations.</li> </ul>	—
		<p><b>Continuously variable transmission models</b></p> <ul style="list-style-type: none"> <li>Brake pedal is not fully pressed</li> </ul>	<ul style="list-style-type: none"> <li>Depress the brake pedal firmly.</li> </ul>
		<p><b>Continuously variable transmission models</b></p> <ul style="list-style-type: none"> <li>The transmission is in a position other than <b>D</b></li> </ul>	<p>➤ <b>Auto Idle Stop</b> P. 455</p>
		<ul style="list-style-type: none"> <li>System charging is prioritized</li> </ul>	<p>➤ <b>Auto Idle Stop</b> P. 455, 461</p>
		<ul style="list-style-type: none"> <li>Climate control system is prioritized</li> </ul>	
		<ul style="list-style-type: none"> <li>Engine coolant temperature is not in operating range</li> </ul>	<p>➤ <b>Auto Idle Stop</b> P. 455, 461</p> <p>➤ <b>Customizing the INDIVIDUAL Settings</b> P. 453</p>
		<ul style="list-style-type: none"> <li>The Integrated Dynamics System mode is in <b>SPORT</b> or <b>INDIVIDUAL*</b> mode (when the Auto Idle Stop setting is set to <b>Disable</b>).</li> </ul>	
		<ul style="list-style-type: none"> <li>The battery temperature is too low.</li> <li>Auto Idle Stop does not activate for some reason.</li> </ul>	<p>➤ <b>Auto Idle Stop</b> P. 455, 461</p>
—	<ul style="list-style-type: none"> <li>If you press and hold the Auto Idle Stop <b>OFF</b> button, you can select whether to display the status messages or not.</li> </ul>		

\* Not available on all models

Indicator	Name	On/Blinking	Explanation
	Adaptive Cruise Control (ACC) with Low Speed Follow* Indicator (Amber)	<ul style="list-style-type: none"> <li>• Comes on if there is a problem with ACC with Low Speed Follow*.</li> <li>• Comes on if the ACC with Low Speed Follow* is deactivated temporarily after the battery has been disconnected, then re-connected.</li> <li>• Indicator may come on temporarily when the Maximum Load Limit is exceeded.</li> <li>• ACC with Low Speed Follow* has been automatically canceled.</li> </ul>	<ul style="list-style-type: none"> <li>• <b>Comes on while driving</b> - Have your vehicle checked by a dealer.</li> <li>• Drive a short distance at more than 12 mph (20 km/h). The indicator should go off. If it does not, have your vehicle checked by a dealer.</li> <li>• Make sure the total load is within the Maximum Load Limit.                             <ul style="list-style-type: none"> <li>➤ <b>Maximum Load Limit</b> P. 427</li> </ul> </li> <li>• <b>Stays on constantly</b> - Have your vehicle checked by a dealer.</li> </ul>
	Adaptive Cruise Control (ACC) with Low Speed Follow* Indicator (White/Green)	<ul style="list-style-type: none"> <li>• Lights up in white when you press the .</li> <li>• Lights up in green when you press the up or down the <b>RES/+ / SET/-</b> switch.</li> </ul>	<ul style="list-style-type: none"> <li>➤ <b>Adaptive Cruise Control (ACC) with Low Speed Follow*</b> P. 504</li> <li>➤ <b>Adaptive Cruise Control (ACC)*</b> P. 525</li> </ul>





Indicator	Name	On/Blinking	Explanation
	Lane Keeping Assist System (LKAS) Indicator (Amber)	<ul style="list-style-type: none"> <li>Comes on if there is a problem with the LKAS.</li> <li>Indicator may come on temporarily when the Maximum Load Limit is exceeded.</li> </ul>	<ul style="list-style-type: none"> <li><b>Stays on constantly</b> - Have your vehicle checked by a dealer.</li> <li>Make sure the total load is within the Maximum Load Limit.                             <ul style="list-style-type: none"> <li>➤ <b>Maximum Load Limit</b> P. 427</li> </ul> </li> <li><b>Stays on constantly</b> - Have your vehicle checked by a dealer.</li> </ul>
	Lane Keeping Assist System (LKAS) Indicator (White/Green)	<ul style="list-style-type: none"> <li>Lights up in white when you press the LKAS button.</li> <li>Lights up in green when the LKAS is in operation.</li> </ul>	<ul style="list-style-type: none"> <li>➤ <b>Lane Keeping Assist System (LKAS)</b> P. 545</li> </ul>
	Cruise Mode Indicator (White/Green)	<ul style="list-style-type: none"> <li>Lights up in white when you change to cruise mode.</li> <li>Lights up in green when you have set a speed for cruise control.</li> </ul>	<ul style="list-style-type: none"> <li>➤ <b>To Switch ACC with Low Speed Follow to Cruise Control</b> P. 522</li> <li>➤ <b>To Switch ACC to Cruise Control</b> P. 542</li> </ul>
	Adaptive Cruise Control (ACC) with Low Speed Follow* Interval Indicator	<ul style="list-style-type: none"> <li>Comes on when Adaptive Cruise Control (ACC) with Low Speed Follow* indicator comes on.</li> </ul>	<ul style="list-style-type: none"> <li>Each time you press the interval button, the following interval (the interval behind a vehicle detected ahead of you) setting cycles through extra long, long, middle, and short following intervals.                             <ul style="list-style-type: none"> <li>➤ <b>To Set or Change Following-interval</b> P. 517, 537</li> </ul> </li> </ul>

\* Not available on all models

Indicator	Name	On/Blinking	Explanation
	Safety Support Indicator (Amber)	<ul style="list-style-type: none"> <li>• Comes on if there is a problem with Road Departure Mitigation system, CMBS™, Low Speed Braking Control*, or blind spot information system.</li> </ul>	<ul style="list-style-type: none"> <li>• <b>Stays on constantly</b> - Have your vehicle checked by a dealer.</li> </ul>
		<p><b>Models with parking sensor system</b></p> <ul style="list-style-type: none"> <li>• Comes on if there is a problem with the parking sensor.</li> </ul>	<ul style="list-style-type: none"> <li>• Check if the area around the sensor(s) is covered with mud, ice, snow, etc. if the indicator stays on even after you clean the area, have the system checked by a dealer.</li> </ul>
		<ul style="list-style-type: none"> <li>• Indicator may come on temporarily when the Maximum Load Limit is exceeded.</li> </ul>	<ul style="list-style-type: none"> <li>• Make sure the total load is within the Maximum Load Limit.  <span style="font-size: small;">▶ <b>Maximum Load Limit</b> P. 427</span></li> <li>• <b>Stays on constantly</b> - Have your vehicle checked by a dealer.</li> </ul>
		<ul style="list-style-type: none"> <li>• Comes on if the Road Departure Mitigation system, CMBS™ and Low Speed Braking Control* are deactivated temporarily after the battery has been disconnected and then re-connected.</li> </ul>	<ul style="list-style-type: none"> <li>• Drive a short distance at more than 12 mph (20 km/h). The indicator should go off. If it does not, have your vehicle checked by a dealer.</li> </ul>

Indicator	Name	On/Blinking	Explanation
	<p>Safety Support Indicator (Amber)</p>	<ul style="list-style-type: none"> <li>Comes on when the Road Departure Mitigation system and/or CMBS™ shuts itself off.</li> </ul>	<ul style="list-style-type: none"> <li><b>Stays on</b> - The temperature inside the camera is too high. Use the climate control system to cool down the camera. The system activates when the temperature inside the camera cools down.                             <ul style="list-style-type: none"> <li>Front Wide View Camera P. 581</li> </ul> </li> <li><b>Stays on</b> - The area around the camera is blocked by dirt, mud, etc. Stop your vehicle in a safe place and wipe the debris off with a soft cloth.</li> <li>Have your vehicle checked by a dealer if the indicator and message are still displayed even after you have cleaned the area around the camera.                             <ul style="list-style-type: none"> <li>Front Wide View Camera P. 581</li> </ul> </li> <li>It may come on when the ambient conditions are dark, such as when driving in a tunnel, or at night, dawn, or dusk.</li> </ul>

Indicator	Name	On/Blinking	Explanation
	<p>Safety Support Indicator (Amber)</p>	<p><b>Models with Low Speed Braking Control</b></p> <ul style="list-style-type: none"> <li>• Comes on when mud, snow, or ice accumulates in the vicinity of the sonar sensor.</li> </ul>	<ul style="list-style-type: none"> <li>• Remove the obstacle in the vicinity of the sonar sensor.                             <ul style="list-style-type: none"> <li>➤ <b>Low Speed Braking Control</b>* P. 493, 499</li> </ul> </li> </ul>
<ul style="list-style-type: none"> <li>• Comes on when mud, snow, or ice accumulates in the vicinity of the blind spot information system sensor.</li> <li>• Comes on when the temperature of the blind spot information system sensor is high.</li> </ul>		<ul style="list-style-type: none"> <li>• <b>Comes on while driving</b> - Something may be interfering with the blind spot information system sensor. Check the vicinity of the blind spot information system sensor and remove any obstacles.</li> <li>• The system will return to normal when the temperature cools down.                             <ul style="list-style-type: none"> <li>➤ <b>Blind Spot Information System</b> P. 474</li> </ul> </li> </ul>	

Indicator	Name	On/Blinking	Explanation
	<p>Safety Support Indicator (Green/Gray)</p>	<ul style="list-style-type: none"> <li>• Lights up in green when Road Departure Mitigation system, CMBS™, Low Speed Braking Control*, blind spot information system and parking sensor system* are on.</li> <li>• Lights up in green and gray when Road Departure Mitigation system, CMBS™, Low Speed Braking Control*, blind spot information system, parking sensor system* or any two, three or four of these systems are off.</li> <li>• Lights up in gray when Road Departure Mitigation system, CMBS™, Low Speed Braking Control*, blind spot information system and parking sensor system* are off.</li> </ul>	<ul style="list-style-type: none"> <li>➤ <b>Road Departure Mitigation System</b> P. 566</li> <li>➤ <b>Blind Spot Information System</b> P. 474</li> <li>➤ <b>Low Speed Braking Control*</b> P. 493, 499</li> <li>➤ <b>Collision Mitigation Braking System™ (CMBS™)</b> P. 481</li> <li>➤ <b>Parking Sensor System*</b> P. 598</li> </ul>

\* Not available on all models

## Gauges

Gauges include the speedometer, fuel gauge, and other related indicators. They are displayed when the power mode is in ON.

### Speedometer

Displays your driving speed in mph or km/h.

### Speedometer

You can set the speedometer and the displayed measurements to read in either km/h or mph.

➔ **Speed/Distance Units** P. 123

Models with 7-in. Color Touchscreen

➔ **Vehicle Settings\*** P. 126

Models with 9-in. Color Touchscreen

➔ **Customized Features** P. 359

#### U.S. models

If you change the unit from miles and mph to km and km/h, the current vehicle speed in mph appears next to the digital speedometer.

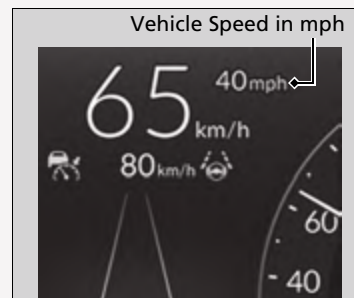

## ■ Tachometer

Shows the number of engine revolutions per minute.

## ■ Fuel Gauge

Displays the amount of fuel left in the fuel tank.

## ■ Temperature Gauge

Displays the temperature of the engine coolant.

## ■ Odometer

Shows the total number of miles or kilometers that your vehicle has accumulated.

### ⌘ Fuel Gauge

#### NOTICE

You should refuel when the reading approaches **E**. Running out of fuel can cause the engine to misfire, damaging the catalytic converter.

The actual amount of remaining fuel may differ from the fuel gauge reading.

### ⌘ Temperature Gauge

#### NOTICE

Driving with the temperature gauge reading in the upper zone can cause serious engine damage. Pull safely to the side of the road and allow engine temperature to return to normal.

➤ **Overheating** P. 697

## ■ Outside Temperature

Shows the outside temperature in Fahrenheit (U.S.) or Celsius (Canada).

### ■ Adjusting the outside temperature display

Adjust the temperature reading by up to  $\pm 5^{\circ}\text{F}$  or  $\pm 3^{\circ}\text{C}$  if the temperature reading seems incorrect.

## ■ Traffic Sign Recognition System

Shows certain detected traffic signs while driving.

The indicator blinks when the maximum speed of the traffic sign detected by the Traffic Sign Recognition System is exceeded.

➤ **Traffic Sign Recognition System** P. 574

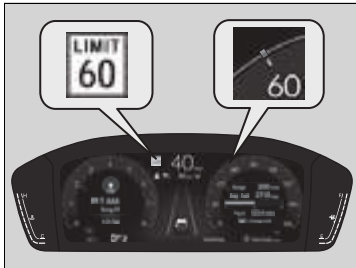

## ➤ Outside Temperature

The temperature sensor is in the front bumper. Road heat and exhaust from another vehicle can affect the temperature reading when your vehicle speed is less than 19 mph (30 km/h).

It may take several minutes for the display to be updated after the temperature reading has stabilized.

You can adjust the temperature reading.

Models with 7-in. Color Touchscreen

➤ **Vehicle Settings\*** P. 126

Models with 9-in. Color Touchscreen

➤ **Customized Features** P. 359



## ■ Current Mode for ACC with Low Speed Follow\*, the LKAS, and Traffic Jam Assist\*

Shows the current mode for ACC with Low Speed Follow\*, LKAS, and Traffic Jam Assist\*.

- ▶ **Adaptive Cruise Control (ACC) with Low Speed Follow\*** P. 504
- ▶ **Adaptive Cruise Control (ACC)\*** P. 525
- ▶ **Lane Keeping Assist System (LKAS)** P. 545
- ▶ **Traffic Jam Assist\*** P. 557

## ▣ Current Mode for ACC with Low Speed Follow\*, the LKAS, and Traffic Jam Assist\*

When you set speed for ACC with Low Speed Follow\* or cruise control, a set speed mark will be displayed on the speedometer.

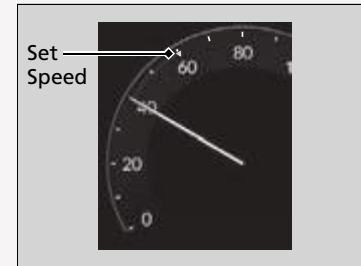

## Driver Information Interface (Left Side Area)

Shows the current mode for audio and phone information, etc.

▶ **Audio Remote Controls** P. 230

▶ **Bluetooth® HandsFreeLink®** P. 383, 403

### ■ Clock

Shows the clock.

### ▶ Clock

You can adjust the time manually and change the clock display to show the 12 hour clock or 24 hour clock.

▶ **Clock** P. 142

You can choose whether the clock is displayed on the driver information interface.

▶ **Customize Display** P. 109

## ■ Customize Display

### ■ Arrange audio source on the left side area

You can choose which sources to display on the audio source screen.

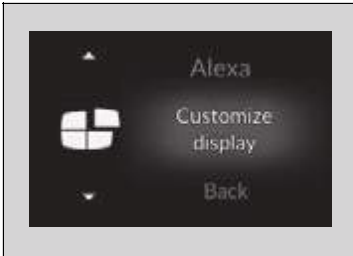

1. Roll the left selector wheel until **Customize display** is selected, then press the left selector wheel.

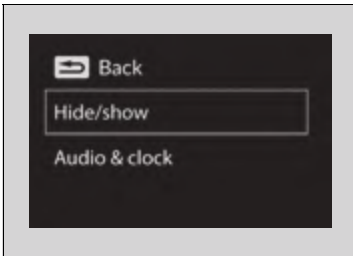

2. Roll the left selector wheel to scroll to select **Hide/show**, then press the left selector wheel.

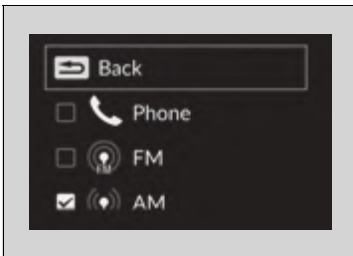

3. Roll the left selector wheel to scroll between audio sources, then press the left selector wheel to check or uncheck them.

## » Customize Display

### Continuously variable transmission models

When you customize settings, shift to **P**.

### Manual transmission models

When you customize settings, set the parking brake.

*Continued*

### ■ Turn the displaying on the left side area on and off

You can select whether the current audio information and clock appear on the left side area.



1. Roll the left selector wheel until **Customize display** is selected, then press the left selector wheel.

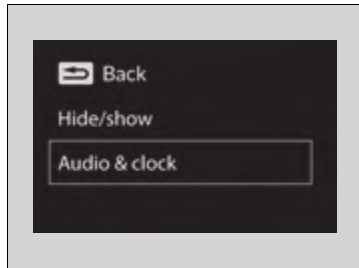

2. Roll the left selector wheel to scroll to select **Audio & clock**, then press the left selector wheel.

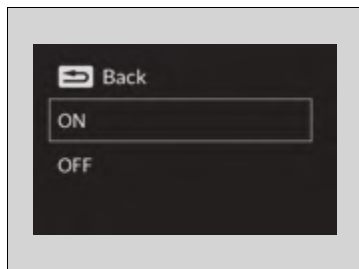

3. Roll the left selector wheel to scroll to select your desired settings, then press the left selector wheel.

## Driver Information Interface (Right Side Area)

---

The driver information interface shows information such as the estimated travelable distance and fuel economy of the vehicle. It also displays messages such as warnings and other helpful information.

When a warning message displays, please check the message and contact a dealer and have the vehicle inspected if necessary. Please refer to the pages below if the

**Engine oil pressure low** or **Engine temperature too hot** message is displayed.

➤ **If the Engine oil pressure low Warning Appears** P. 699

➤ **Overheating** P. 697

## ■ Switching the Display

Roll the right selector wheel to view different types of content.

### ☞ Switching the Display

You can add or delete the meter contents.

☞ **Gauge Display Settings** P. 125

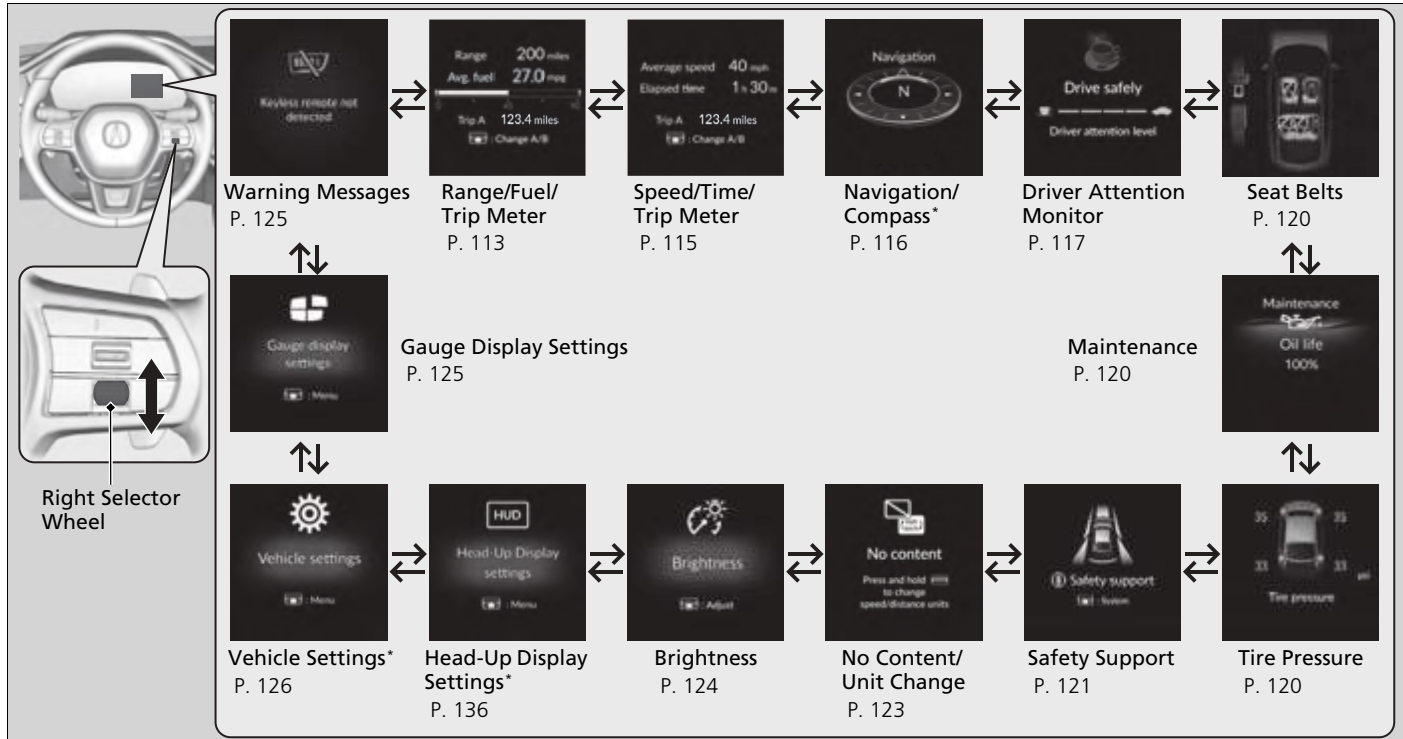

## Range/Fuel/Trip Meter

Press the right selector wheel to switch between trip meter A and trip meter B.

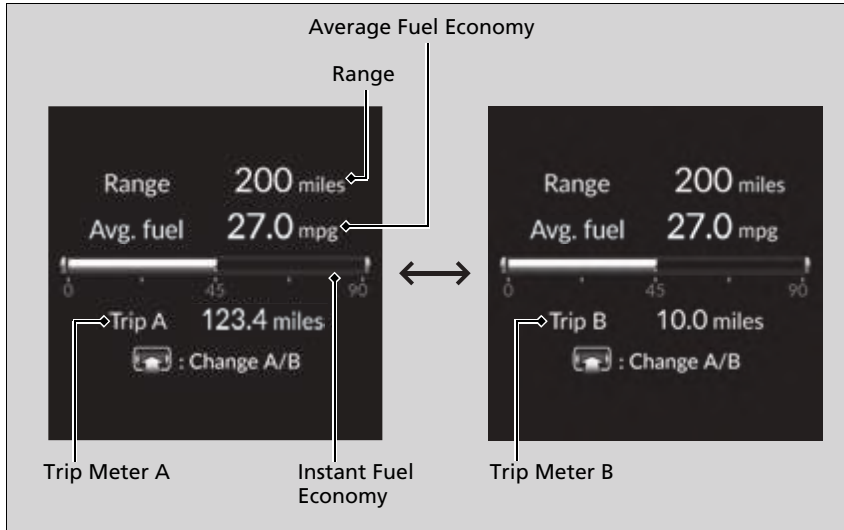

### ■ Trip meter

Shows the total number of miles or kilometers driven since the last reset. Meters A and B can be used to measure two separate trips.

### Resetting a trip meter

To reset the trip meter, display it, press and hold the right selector wheel and then select **Reset**.

- ▶ The trip meter is reset to 0.0.

*Continued*

### ■ Average fuel economy

Shows the estimated average fuel economy of each trip meter in mpg or l/100 km. The display is updated at set intervals. When a trip meter is reset, the average fuel economy is also reset.

### ■ Instant fuel economy

Shows the instant fuel economy as a bar graph in mpg or l/100 km.

### ■ Range

Shows the estimated distance you can travel on the remaining fuel. This estimated distance is based on the vehicle's current fuel economy.

#### ⌘ Average fuel economy

You can change when to reset the average fuel economy.

Models with 7-in. Color Touchscreen

➔ **Vehicle Settings**\* P. 126

Models with 9-in. Color Touchscreen

➔ **Customized Features** P. 359

#### ⌘ Range

The driving range displayed is only an estimate and may differ to the actual distance the vehicle can travel.



## Speed/Time/Trip Meter

Press the right selector wheel to switch between trip meter A and trip meter B.

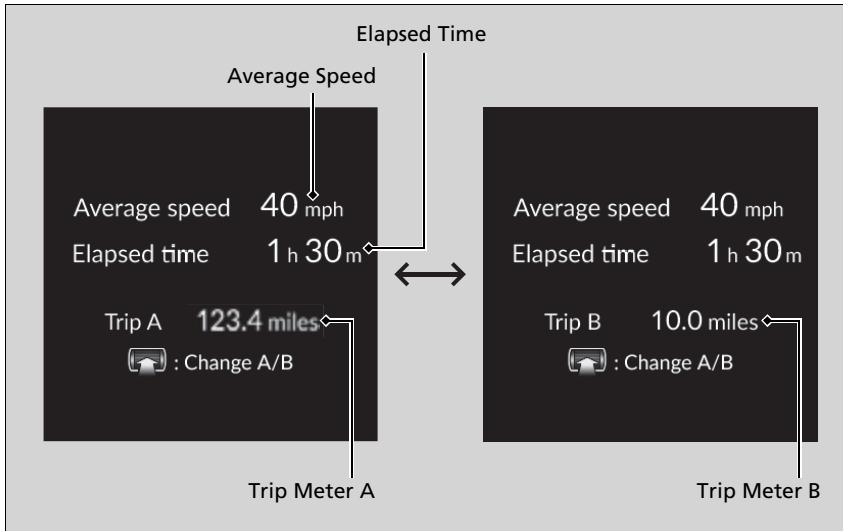

## ■ Trip meter

➔ **Trip meter** P. 113

## ■ Elapsed time

Shows the time elapsed since Trip A or Trip B was reset.

## ■ Average speed

Shows the average speed in mph or km/h since Trip A or Trip B was reset.

## ⌘ Elapsed time

You can change when to reset the elapsed time.

Models with 7-in. Color Touchscreen

➔ **Vehicle Settings**\* P. 126

Models with 9-in. Color Touchscreen

➔ **Customized Features** P. 359

## ⌘ Average speed

You can change when to reset the average speed.

Models with 7-in. Color Touchscreen

➔ **Vehicle Settings**\* P. 126

Models with 9-in. Color Touchscreen

➔ **Customized Features** P. 359

## ⌘ Navigation\*

You can select whether to have the turn-by-turn display come on or not during the route guidance.

➔ **Customized Features** P. 359

Turn-by-turn directions may not be available for all apps.

## ■ Navigation\*

### ■ Compass

Shows the compass screen.

### ■ Turn-by-Turn Directions

When driving guidance is provided by the Apple CarPlay or Android Auto, turn-by-turn directions to your destination appear.

➔ **Apple CarPlay** P. 315

➔ **Android Auto™** P. 322

## ■ Driver Attention Monitor

The Driver Attention Monitor analyzes steering inputs to determine if the vehicle is being driven in a manner consistent with drowsy or inattentive driving. If it determines that the vehicle is being driven in such a manner, it will display the degree of the driver's attention on the driver information interface.

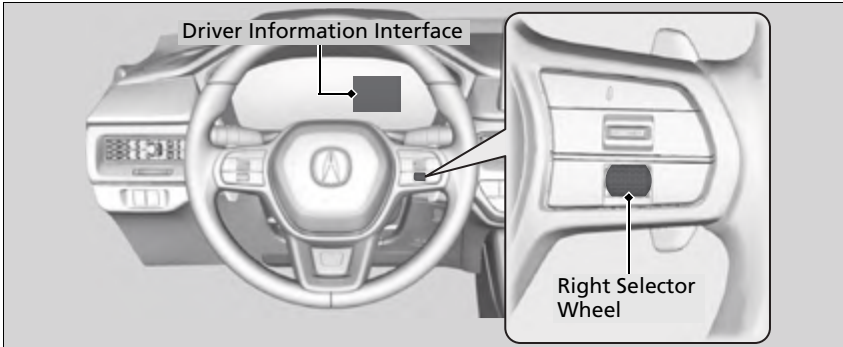

When you select Driver Attention Monitor on the driver information interface, bars on it light up in white to indicate the degree of the driver's attention.

➤ **Switching the Display** P. 112

## ⌘ Driver Attention Monitor

The Driver Attention Monitor cannot always detect if the driver is tired or inattentive. Regardless of the system's feedback, if you are feeling tired, stop in a safe location and rest for as long as needed.



If two bars light up, the **Driver attention level low** message will appear.

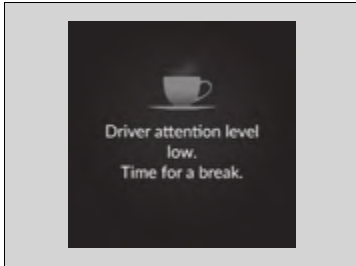

If one bar lights up, the **Driver attention level low. Time for a break.** message will appear, a beep will sound, and the steering wheel will vibrate.

If this message appears, stop in a safe location and rest for as long as needed.

The message will disappear when the right selector wheel is rolled or when the system has determined that the driver is driving normally.

If the driver does not take a break and the monitor continues to detect that the driver is very tired, the message will appear again after approximately 15 minutes, accompanied by a beep and steering wheel vibrations.

The message does not appear when the traveling time is 30 minutes or less.

■ **The Driver Attention Monitor resets when:**

- The engine is turned off.
- The driver unfastens the seat belt and opens the door while the vehicle is stopped.

■ **For the Driver Attention Monitor to function:**

- The vehicle must be traveling above 25 mph (40 km/h).
- The electric power steering (EPS) system indicator must be off.

■ **Depending on driving conditions or other factors, the Driver Attention Monitor may not function in the following circumstances:**

- The steering assist function of the Lane Keeping Assist System (LKAS) is active.
  - **Lane Keeping Assist System (LKAS)** P. 545
- The condition of the road is poor, e.g. the surface is unpaved or bumpy.
- It is windy.
- The driver is frequently operating the vehicle in an assertive manner such as changing lanes or accelerating.

■ **Customizing**

You can change the Driver Attention Monitor settings. Select **Tactile and audible alert\*1/Tactile And Audible Alert\*2**, **Tactile alert\*1/Tactile Alert\*2**, or **OFF**.

Models with 7-in. Color Touchscreen

➤ **Vehicle Settings\*** P. 126

Models with 9-in. Color Touchscreen

➤ **Customized Features** P. 359

\*1: Models with 7-in. Color Touchscreen

\*2: Models with 9-in. Color Touchscreen

\* Not available on all models

⌘ For the Driver Attention Monitor to function:

The bars on the driver information interface remain grayed out unless the Driver Attention Monitor is functioning.

## ■ Seat Belts

Appears, under specified conditions, when seat belts are latched or unlatched.

➤ **Seat Belt Reminder** P. 42

## ■ Maintenance

Shows the remaining oil life and Maintenance Minder™.

➤ **Maintenance Minder™** P. 617

## ■ Tire Pressure Monitor

Shows each tire's pressure.

➤ **Tire Pressure Monitoring System (TPMS) with Tire Fill Assist** P. 470

---

### ➤ Tire Pressure Monitor

Tire pressure status is displayed via green and amber icons.

The icons turn amber if tire pressure is too low, or if there is a problem with the system. "--" is displayed if there is a problem.

## Safety Support

Indicates the status of the Road Departure Mitigation system, CMBS™, Low Speed Braking Control\*, blind spot information system and parking sensor system\* such as On, Off, or Failure, by color and letters.

The following colors indicate the status of any of the above mentioned systems:

- Green: The system is on.
- Gray: The system is off.
- Amber: There is a problem with the system.

### » Safety Support

If a system is indicated by the color amber, have your vehicle checked by a dealer immediately.

To turn on or off each system, first press the right selector wheel to switch displays. From the next display you can select which system to turn on or off.

- **Road Departure Mitigation System** P. 566
- **Blind Spot Information System** P. 474
- **Low Speed Braking Control\*** P. 493, 499
- **Collision Mitigation Braking System™ (CMBS™)** P. 481
- **Parking Sensor System\*** P. 598

You can also confirm the status of each function by the color of the safety support indicator.

- **Safety Support Indicator (Amber)** P. 100
- **Safety Support Indicator (Green/Gray)** P. 103

### Models with Low Speed Braking Control

Even when the Low Speed Braking Control icon is green, if the **Rear Sensor Setting** is turned off, the brake assist will not operate when reversing.

- **Customized Features** P. 359

Even when the Parking Sensor System icon is green, if the **Rear Sensor Setting** is turned off, the rear parking sensor will not operate when reversing.

- **Customized Features** P. 359

Area Info for Road Departure Mitigation System



Road Departure Mitigation System Icon and Status Info

Area Info for Blind Spot Information System

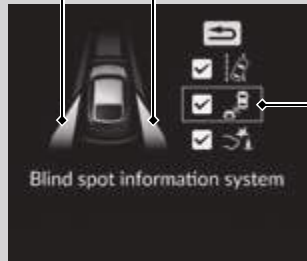

Blind Spot Information System Icon and Status Info

Area Info for Low Speed Braking Control\*



Low Speed Braking Control Icon and Status Info\*

Area Info for Parking Sensor System\*



Parking Sensor System Icon and Status Info\*

Area Info for CMBS™

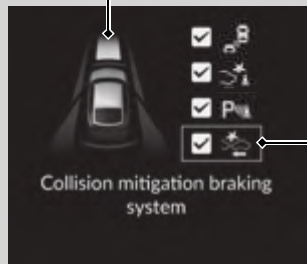

CMBS™ Icon and Status Info



## Speed/Distance Units

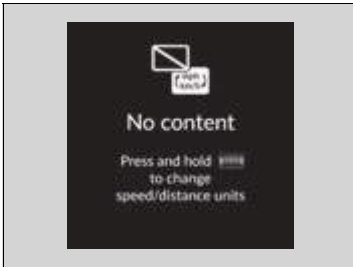

Enables you to show another unit on the driver information interface, head-up display\* and set the displayed measurements to read in either miles and mph or km and km/h.

Press and hold the right selector wheel when you select the No Content/Unit Change screen on the driver information interface. Each time you do this, the unit will change from miles and mph to km and km/h or vice versa. After this, a confirmation screen will appear for a few seconds.

\* Not available on all models

## ■ Brightness

Display the adjustment for instrument panel brightness.

When the power mode is in ON, you can use the right selector wheel to adjust instrument panel brightness.

**Brighten:** Roll the right selector wheel up.

**Dim:** Roll the right selector wheel down.

Press the right selector wheel to exit.

## ☒ Brightness

The brightness of the gauge is automatically adjusted depending on the ambient brightness.

- The brightness dims when the ambient light is dark.
- The brightness brightens when the ambient light is bright.

You can change the setting even when the ambient lighting is bright, but the brightness of the gauge won't change.

## ■ Gauge Display Settings

### ■ Arrange content on the right side area

You can choose which contents to display on the right side area.

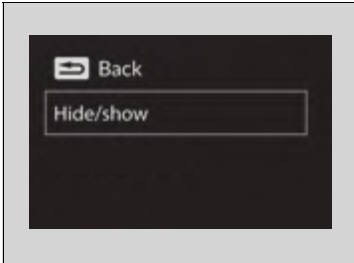

1. Press the right selector wheel when you select the **Gauge display settings** on the driver information interface.
2. Roll the right selector wheel to scroll to select **Hide/show**, then press the right selector wheel.

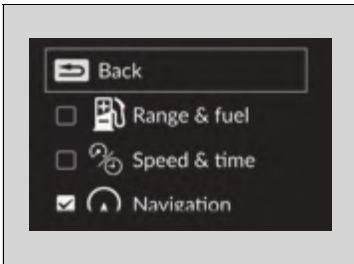

3. Roll the right selector wheel to scroll between contents, then press the right selector wheel to check or uncheck them.

## ■ Warnings

You can check if there are any active warning messages.

### ▶▶ Arrange content on the right side area

Contents that are gray cannot be removed from the right side area.

#### Continuously variable transmission models

When you customize settings, shift to **P**.

#### Manual transmission models

When you customize settings, set the parking brake.

### ▶▶ Warnings

If there are multiple warnings, you can roll the right selector wheel to see other warnings.

## ■ Vehicle Settings\*

Use the driver information interface to customize certain features.

### ■ How to customize

Roll the right selector wheel to scroll to select  screen while the power mode is in ON, the vehicle is at a complete stop, and the shift position is in **P**. Then, press the right selector wheel.

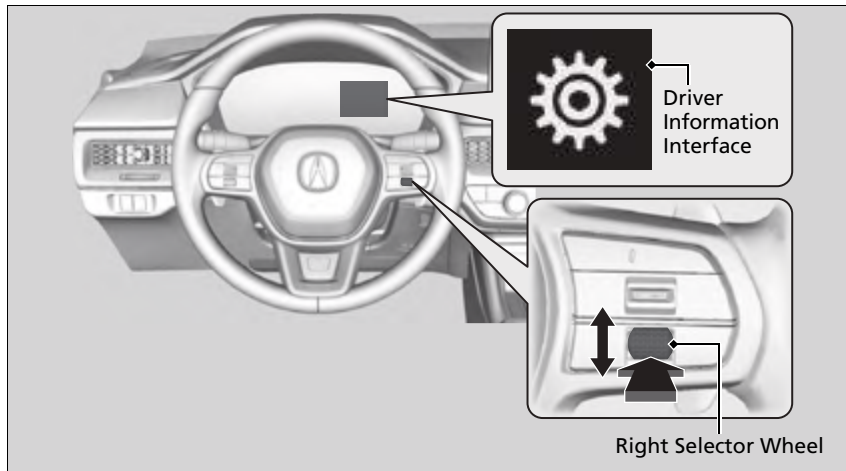

## ⌘ Vehicle Settings\*

To customize other features, roll the right selector wheel.

- **List of customizable options** P. 127
- **Example of customization settings** P. 133

When you customize settings, shift to **P**.

■ List of customizable options

Setup Group	Customizable Features	Description	Selectable Settings
<b>Driver assist system setup</b>	<b>Forward collision warning distance</b>	Changes the distance at which CMBS™ alerts.	<b>Long/Normal*<sup>1</sup>/Short</b>
	<b>ACC forward vehicle detect beep</b>	Causes the system to beep when a vehicle is detected or when the vehicle is out of ACC with Low Speed Follow range.	<b>ON/OFF*<sup>1</sup></b>
	<b>Road departure mitigation setting</b>	Changes the setting for the Road Departure Mitigation system.	<b>Narrow/Normal*<sup>1</sup>/Wide/Warning only</b>
	<b>Lane keeping assist suspend beep</b>	Causes the system to beep when the LKAS is suspended.	<b>ON/OFF*<sup>1</sup></b>
	<b>Blind spot information</b>	Changes the setting for the blind spot information.	<b>Audible and visual alert*<sup>1</sup>/Visual alert</b>

\*1:Default Setting

Setup Group	Customizable Features	Description	Selectable Settings
<b>Driver assist system setup</b>	<b>Traffic sign recognition system display setting</b>	Turns the traffic sign recognition system on and off.	<b>ON<sup>*1</sup>/OFF</b>
	<b>Traffic sign recognition system exceeding speed warning</b>	Turns the traffic sign recognition system over speed warning on and off.	<b>ON<sup>*1</sup>/OFF</b>
	<b>Speed limit warning threshold setting</b>	Changes the setting speed the traffic sign recognition system over speed warning is activated.	<b>Speed limit<sup>*1</sup>/ Speed limit+3mph/ Speed limit+5mph/ Speed limit+10mph</b> (When mph is selected)  <b>Speed limit<sup>*1</sup>/ Speed limit+5km/h/ Speed limit+10km/h/ Speed limit+15km/h</b> (When km/h is selected)
	<b>Driver attention monitor</b>	Changes the setting for the driver attention monitor.	<b>Tactile and audible alert<sup>*1</sup>/ Tactile alert/OFF</b>

\*1:Default Setting

Setup Group	Customizable Features	Description	Selectable Settings
<b>Meter setup</b>	<b>Language selection</b>	Changes the displayed language.	<b>English<sup>*1</sup>/Français/ Español</b>
	<b>Adjust outside temp. display</b>	Adjusts the temperature reading by a few degrees.	<b>-5°F ~ ±0°F<sup>*1</sup> ~ +5°F</b> (U.S.) <b>-3°C ~ ±0°C<sup>*1</sup> ~ +3°C</b> (Canada)
	<b>"Trip A" reset timing</b>	Changes the setting of how to reset trip meter A, average fuel economy A, average speed A, and elapsed time A.	<b>When fully refueled/ IGN OFF/Manually reset<sup>*1</sup></b>
	<b>"Trip B" reset timing</b>	Changes the setting of how to reset trip meter B, average fuel economy B, average speed B, and elapsed time B.	<b>When fully refueled/ IGN OFF/Manually reset<sup>*1</sup></b>
	<b>Adjust alarm volume</b>	Changes the alarm volume, such as buzzers, warnings, turn signal sound, and so on.	<b>High/Mid<sup>*1</sup>/Low</b>
	<b>Rear seat reminder</b>	Turns the Rear Seat Reminder feature on and off.	<b>ON<sup>*1</sup>/OFF</b>
	<b>Speed/distance units</b>	Selects the speed/distance units.	<b>km/h·km/mph·miles<sup>*1</sup></b> (U.S.) <b>km/h·km<sup>*1</sup>/mph·miles</b> (Canada)

\*1:Default Setting

Setup Group	Customizable Features	Description	Selectable Settings
<b>Keyless access setup</b>	<b>Door unlock mode</b>	Changes which doors unlock when you grab the driver's door handle.	<b>Driver door only*<sup>1</sup>/All doors</b>
	<b>Keyless access light flash</b>	Causes some exterior lights to flash when you unlock/lock the doors.	<b>ON*<sup>1</sup>/OFF</b>
	<b>Keyless access beep</b>	Causes the beeper to sound when you unlock/lock the doors.	<b>ON*<sup>1</sup>/OFF</b>
	<b>Remote start system ON/OFF*</b>	Turns the remote engine start feature on and off.	<b>ON*<sup>1</sup>/OFF</b>
<b>Lighting setup</b>	<b>Auto high-beam</b>	Turns the auto high-beam on and off.	<b>ON*<sup>1</sup>/OFF</b>
	<b>Interior light dimming time</b>	Changes the length of time the interior lights stay on after you close the doors.	<b>60sec/30sec*<sup>1</sup>/15sec</b>
	<b>Headlight auto off timer</b>	Changes the length of time the exterior lights stay on after you close the driver's door.	<b>60sec/30sec/15sec*<sup>1</sup>/0sec</b>
	<b>Auto light sensitivity*</b>	Changes the timing for the headlights to come on.	<b>Max/High/Mid*<sup>1</sup>/Low/Min</b>
	<b>Auto headlight ON with wiper ON</b>	Changes the settings for the wiper operation when the headlights automatically come on while the headlight switch is in the <b>AUTO</b> position.	<b>ON*<sup>1</sup>/OFF</b>

\*1:Default Setting



Setup Group	Customizable Features	Description	Selectable Settings
<b>Door setup</b>	<b>Auto door lock</b>	Changes the setting for when the doors and the hatch automatically lock.	<b>With vehicle speed*<sup>1</sup>/Shift from P/OFF</b>
	<b>Auto door unlock</b>	Changes the setting for when the doors and the hatch automatically unlock.	<b>All doors when driver's door opens*<sup>1</sup>/All doors when shifted to Park/All doors when ignition switched OFF/OFF</b>
	<b>Walk away auto lock</b>	Changes the settings for the automatic locking the doors when you walk away from the vehicle while carrying the keyless remote.	<b>ON/OFF*<sup>1</sup></b>
	<b>Keyless lock answer back</b>	LOCK/UNLOCK- The exterior lights flash. LOCK (2nd push)- The beeper sounds.	<b>ON*<sup>1</sup>/OFF</b>
	<b>Keyless remote power window control</b>	Turns remote window control using the keyless remote on and off.	<b>ON*<sup>1</sup>/OFF</b>
	<b>Lockout prevention</b>	Changes the settings for the lockout protection function.	<b>ON*<sup>1</sup>/OFF</b>
	<b>Lock presetting</b>	Changes the settings for the lock presetting function.	<b>ON*<sup>1</sup>/OFF</b>

\* 1:Default Setting

Setup Group	Customizable Features	Description	Selectable Settings
<b>Maintenance reset</b>	—	Resets the Maintenance Minder™ display when you have performed the maintenance service.	(Selects Reset Items)
<b>Default all</b>	—	Cancels customized changes you have made or restores them to their default setting.	<b>Cancel/Set</b>

\*1:Default Setting

### ■ Example of customization settings

The steps for changing the “Trip A” reset timing setting to **When fully refueled** are shown below. The default setting for “Trip A” reset timing is **Manually reset**.

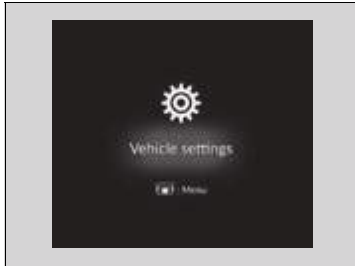

1. Roll the right selector wheel to select **Vehicle settings**, then press the right selector wheel.

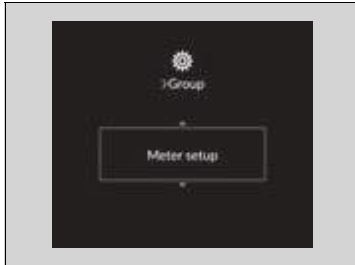

2. Roll the right selector wheel until **Meter setup** appears on the display.
3. Press the right selector wheel.

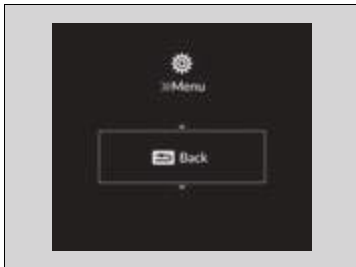
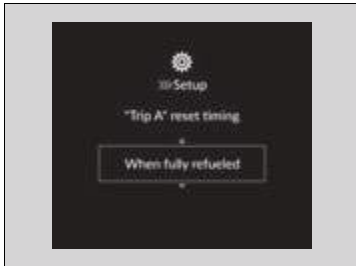
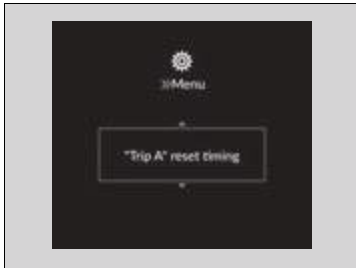

4. Roll the right selector wheel until **"Trip A" reset timing** appears on the display, then press the right selector wheel.
  - ▶ The display switches to the customization setup screen, where you can select **When fully refueled, IGN OFF, Manually reset,** or **Back**.
  
5. Roll the right selector wheel and select **When fully refueled**, then press the right selector wheel.
  - ▶ The **Selected** appears, then the display returns to the customization menu screen.
  
6. Press the right selector wheel after **Back** appears on the display.
7. Repeat Step 6 until you return to the normal screen.

## Head-Up Display\*

Shows the current mode for ACC with Low Speed Follow\*, LKAS, and Traffic Jam Assist\*, traffic sign recognition system, or turn-by-turn directions along with the vehicle speed. You can choose which item to be displayed using the driver information interface. They are displayed when the power mode is in ON.

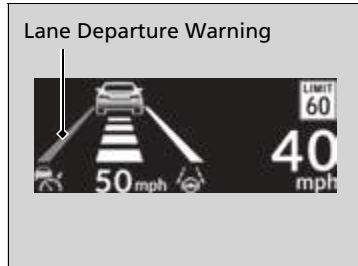

The display also shows the following warnings.

- **Lane Departure Warning:** When your vehicle is too close to the traffic lane lines, the lane departure warning appears.
  - **Lane Keeping Assist System (LKAS)**  
P. 545
- **Head-up Warning Lights:** Flash when the **BRAKE** message appears on the driver information interface.
  - **Collision Mitigation Braking System™ (CMBST™)** P. 481
  - **Low Speed Braking Control**  
P. 493, 499
  - **Adaptive Cruise Control (ACC) with Low Speed Follow\*** P. 504
  - **Adaptive Cruise Control (ACC)\*** P. 525

\* Not available on all models

## ■ Head-Up Display Settings

Shows the display for changing the head-up display settings on the driver information interface.

Roll the right selector wheel to scroll to select **Head-Up Display settings**, then press the right selector wheel.

➤ **Switching the Display** P. 112

## ☒ Head-Up Display Settings

### HUD content

➤ **To change head-up display content** P. 137

### HUD brightness

➤ **Adjusting the head-up display brightness**  
P. 138

### HUD height

➤ **Adjusting the head-up display height**  
P. 138

■ **To change head-up display content**

1. Roll the right selector wheel to scroll to select **HUD content**, then press the right selector wheel.
2. Roll the right selector wheel to scroll to select desired item, then press the right selector wheel.
  - **Speedometer**
    - ▶ Speedometer P. 139
  - **Navigation**
    - ▶ Navigation P. 139
  - **Driver assist**
    - ▶ Current Mode for ACC with Low Speed Follow\*, LKAS, and Traffic Jam Assist\* P. 139
  - **OFF**

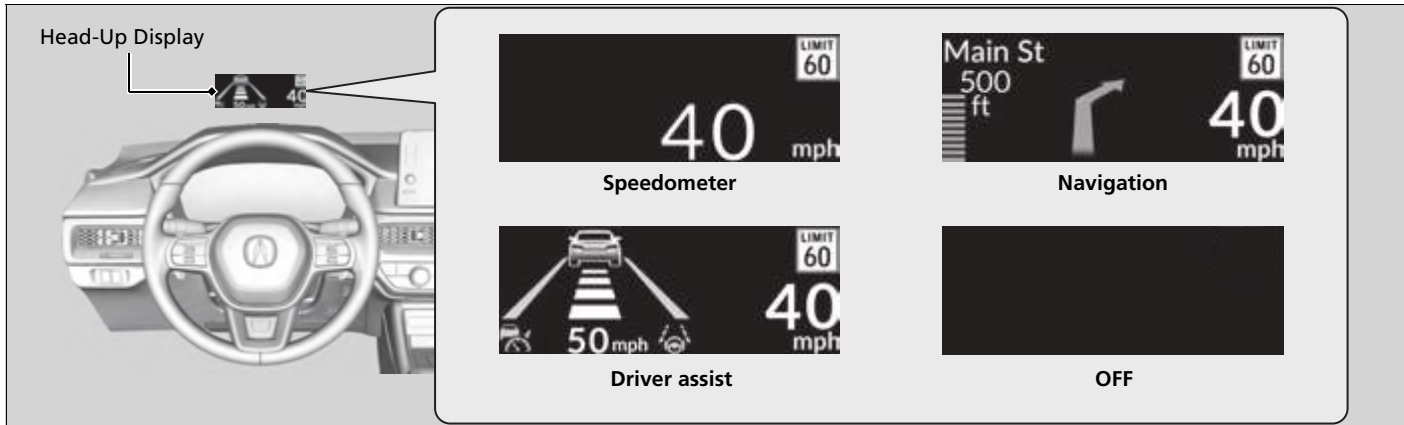

\* Not available on all models

### ■ Adjusting the head-up display brightness

Roll the right selector wheel to scroll to select **HUD brightness**, then press the right selector wheel.

**Brighten:** Roll the right selector wheel up.

**Dim:** Roll the right selector wheel down.

Press the right selector wheel to exit.

### ■ Adjusting the head-up display height

Roll the right selector wheel to scroll to select **HUD height**, then press the right selector wheel.

**Raise the head-up display:** Roll the right selector wheel up.

**Lower the head-up display:** Roll the right selector wheel down.

Press the right selector wheel to exit.

### ▣ Adjusting the head-up display height

When you unlock and open the driver's door with a remote transmitter or keyless access system, the head-up display adjusts automatically to one of the two preset positions.



## ■ Speedometer

Shows your driving speed in mph or km/h.

## ■ Current Mode for ACC with Low Speed Follow\*, LKAS, and Traffic Jam Assist\*

Shows the current mode for ACC with Low Speed Follow\*, LKAS, and Traffic Jam Assist\*.

- **Adaptive Cruise Control (ACC) with Low Speed Follow\*** P. 504
- **Adaptive Cruise Control (ACC)\*** P. 525
- **Lane Keeping Assist System (LKAS)** P. 545
- **Traffic Jam Assist\*** P. 557

## ■ Navigation

### ■ Compass

Shows the compass screen.

### ■ Turn-by-Turn Directions

When driving guidance is provided by the Android Auto or Apple CarPlay, turn-by-turn directions to your destination appear.

- **Android Auto™** P. 322
- **Apple CarPlay** P. 315

## ■ Traffic Sign Recognition System

Shows the traffic sign recognition system.

The indicator blinks when the maximum speed of the traffic sign detected by the Traffic Sign Recognition System is exceeded.

- **Traffic Sign Recognition System** P. 574

\* Not available on all models

## ⌘ Speedometer

Switch between mph and km/h by using the driver information interface or the customized features on the audio/information screen.

- **Speed/Distance Units** P. 123
- **Customized Features** P. 359

## ⌘ Navigation

You can select whether the turn-by-turn display comes on during the route guidance.

- **Customized Features** P. 359

Turn-by-turn directions may not be available for all apps.

This page intentionally left blank.

# Controls

This chapter explains how to operate the various controls necessary for driving.

<b>Clock</b> .....	142
<b>Locking and Unlocking the Doors</b>	
Key .....	144
Low Keyless Remote Signal Strength .....	146
Locking/Unlocking the Doors from the Outside .....	147
Locking/Unlocking the Doors from the Inside .....	158
Childproof Door Locks .....	160
Auto Door Locking/Unlocking .....	161
<b>Hatch</b> .....	162
<b>Security System</b>	
Immobilizer System .....	165

Security System Alarm.....	165
<b>Windows</b> .....	168
<b>Moonroof</b> .....	171
<b>Operating the Switches Around the Steering Wheel</b>	
ENGINE START/STOP Button.....	172
Turn Signals.....	175
Light Switches.....	176
Fog Lights* .....	179
Chicane™ Daytime Running Lights... ..	179
Auto High-Beam .....	180
Wipers and Washers .....	183

Rear Defogger/Heated Door Mirror Button .....	185
Driving Position Memory System *.....	186
Adjusting the Steering Wheel .....	188
<b>Mirrors</b>	
Interior Rearview Mirror .....	189
Power Door Mirrors .....	190
<b>Seats</b> .....	191
<b>Interior Convenience Items</b> .....	201
<b>Climate Control System</b>	
Using Automatic Climate Control ....	218
Automatic Climate Control Sensors.....	223

\* Not available on all models

## Adjusting the Clock

You can adjust the time in the clock display with the power mode in ON.

### ■ Adjusting the Time

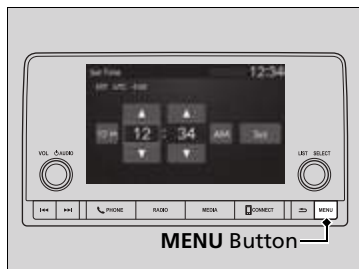

#### Models with 7-in. Color Touchscreen

1. Press the **MENU** button.
2. Select **Clock Settings**.
3. Select **Automatic Time**, then select **OFF**.
4. Select **Set Time**.
5. Select **12H/24H** to change 12 or 24 hour clock.
6. Select ▲ or ▼.
7. Select **Set** to set the time.

#### ▶▶ Adjusting the Clock

The clock is automatically updated through the audio system.

#### Models with 7-in. Color Touchscreen

You can also select and enter with the **LIST / SELECT** (List / Selector) knob instead of the touch panel.



**Models with 9-in. Color Touchscreen**

1. Press the button.
2. Select **General Settings**.
3. Select **System**.
4. Select **Date & Time**.
5. Select **Set Date & Time**.
6. Select **Automatic Date & Time**, then select **OFF**.

**To adjust date:**

7. Select **Set Date**.
8. Select or .
9. Select **Save** to set the date.

**To adjust time:**

7. Select **Set Time**.
8. Select or .
9. Select **Save** to set the time.

**Adjusting the Clock**

**Models with 9-in. Color Touchscreen**

You can also adjust the clock by touching the clock displayed on the header area of the audio/information screen, **Clock** displayed on the home screen, or **All Apps**.

1. Touch the clock on the screen.  
The clock screen of the face-type appears.
2. Select **Settings**.
3. Select **Date & Time**.
4. Select **Set Date & Time**.
5. Select **Automatic Date & Time**, then select **OFF**.
6. Select **Set Date** or **Set Time**.
7. Adjusting the dates, hours and minutes by selecting or .
8. Select **Save** to set the time.

You can customize the clock display to show the 12 hour clock or 24 hour clock.

**Customized Features** P. 359

You can customize the date display to **MM/DD/YYYY**, **DD/MM/YYYY** or **YYYY/MM/DD**.

**Customized Features** P. 359

## Key

This vehicle comes with the following keys:

Models without remote engine starter



Models with remote engine starter



Use the keys to start and stop the engine, and lock and unlock all the doors, hatch, and fuel fill door.

### Key

All the keys have an immobilizer system. The immobilizer system helps to protect against vehicle theft.

➤ **Immobilizer System** P. 165

Follow the advice below to prevent damage to the keys:

- Do not leave the keys in direct sunlight, or in locations with high temperature or high humidity.
- Do not drop the keys or set heavy objects on them.
- Keep the keys away from liquids, dust and sand.
- Do not take the keys apart except for replacing the battery.

If the circuits in the keys are damaged, the engine may not start, and the remote transmitter may not work.

If the keys do not work properly, have them inspected by a dealer.

### Models with remote engine starter

You can remotely start the engine using the remote engine start.

➤ **Remote Engine Start\*** P. 432

## ■ Built-in Key

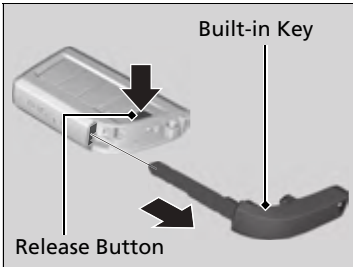

The built-in key can be used to unlock the doors when the keyless remote battery becomes weak and the power door unlock operation is disabled.

To remove the built-in key, push the release button and then pull out the key. To reinstall the built-in key, push the built-in key into the keyless remote until it clicks.

## ■ Key Number Tag

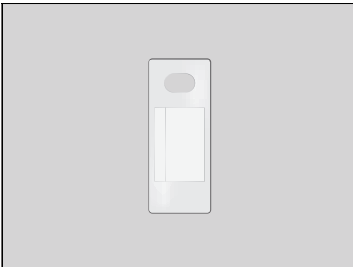

Contains a number that you will need if you purchase a replacement key.

## ☒ Key Number Tag

Keep the key number tag separate from the key in a safe place outside of your vehicle. If you wish to purchase an additional key, contact a dealer.

If you lose your key and you cannot start the engine, contact a dealer.

## Low Keyless Remote Signal Strength

The vehicle transmits radio waves to locate the keyless remote to start the engine, lock and unlock all the doors, hatch and the fuel fill door.

In the following cases, starting the engine, locking/unlocking the doors, hatch and fuel fill door may be inhibited or operation may be unstable:

- Strong radio waves are being transmitted by nearby equipment.
- You are carrying the keyless remote together with telecommunications equipment, laptop computers, cell phones, or wireless devices.
- A metallic object is touching or covering the keyless remote.

### ⓘ Low Keyless Remote Signal Strength

Communication between the keyless remote and the vehicle consumes the keyless remote's battery. Battery life is about two years, but this varies depending on regularity of use. The battery is consumed whenever the keyless remote is receiving strong radio waves. Avoid placing it near electrical appliances such as televisions and personal computers.



## Locking/Unlocking the Doors from the Outside

### ■ Using the Keyless Access System

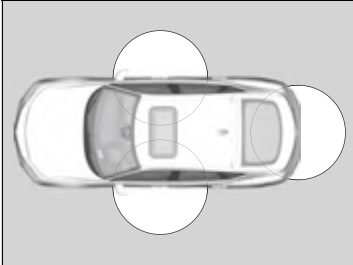

When you carry the keyless remote, you can lock/unlock the doors, fuel fill door and hatch. You can lock/unlock the doors, fuel fill door and hatch within a radius of about 32 inches (80 cm) of the outside door handle or hatch release button.

### ☒ Locking/Unlocking the Doors from the Outside

If the interior light switch is in the door activated position, the interior lights come on when you unlock the doors and hatch.

No doors opened: The lights fade out after 30 seconds.  
Doors and hatch relocked: The lights go off immediately.

☒ **Interior Lights** P. 201

### ☒ Using the Keyless Access System

If you do not open a door or the hatch within 30 seconds of unlocking the vehicle with the keyless access system, the doors and hatch will automatically relock.

You can lock or unlock doors using the keyless access system only when the power mode is in VEHICLE OFF.

The keyless access system will not lock the vehicle when a door is open.

### ■ Locking the doors and hatch

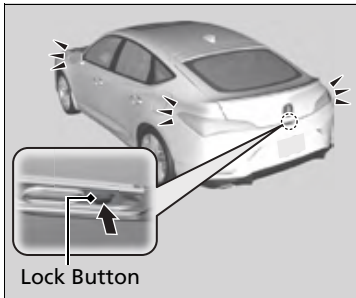
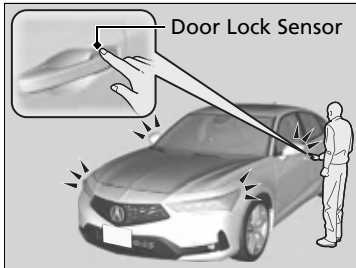

Touch the door lock sensor on the front door or press the lock button on the hatch.

- ▶ All the doors and hatch lock and the security system sets.
- ▶ Some exterior lights flash once and the beeper sounds once.

## ■ Unlocking the doors and hatch

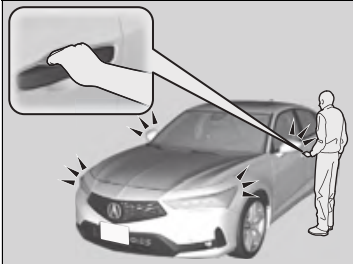

Grab the driver's door handle:

- ▶ The driver's door and fuel fill door unlock.
- ▶ Some exterior lights flash twice and the beeper sounds twice.

Grab the front passenger's door handle:

- ▶ All the doors and hatch unlock.
- ▶ Some exterior lights flash twice and the beeper sounds twice.

Press and hold the hatch release button:

- ▶ The hatch unlocks.
- ▶ Some exterior lights flash twice and the beeper sounds twice.

▶ **Opening/Closing the Hatch** P. 163

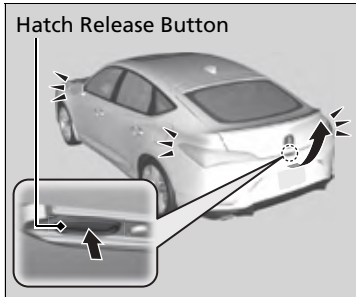

## ▣ Using the Keyless Access System

- Do not leave the keyless remote in the vehicle when you get out. Carry it with you.
  - Even if you are not carrying the keyless remote, you can lock/unlock the doors and hatch while someone else with the remote is within range.
  - The door may be unlocked if the door handle is covered with water in heavy rain or in a car wash if the keyless remote is within range.
  - If you grip a front door handle or touch the front door lock sensor wearing gloves, the door sensor may be slow to respond or may not respond by unlocking or locking the doors.
  - After locking the door, you have up to 2 seconds during which you can pull the door handle to confirm whether the door is locked. If you need to unlock the door immediately after locking it, wait at least 2 seconds before gripping the handle, otherwise the door will not unlock.
  - The door might not open if you pull it immediately after gripping the door handle. Grip the handle again and confirm that the door is unlocked before pulling the handle.
  - Even within the 32 inches (80 cm) radius, you may not be able to lock/unlock the doors and hatch with the keyless remote if it is above or below the outside handle.
  - The keyless remote may not operate if it is too close to the door, door glass and hatch.
- The light flash, beep and door unlock mode settings can be customized using the audio/information screen or driver information interface.

▶ **Vehicle Settings\*** P. 126

▶ **Customized Features** P. 359

\* Not available on all models

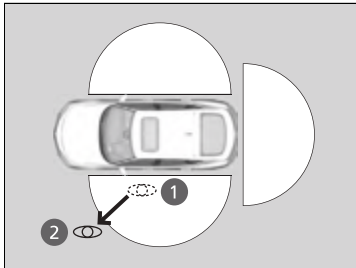
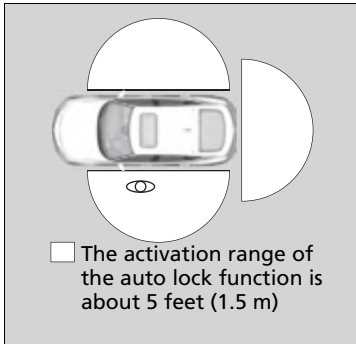

### ■ Locking the doors and hatch (Walk away auto lock®)

When you walk away from the vehicle with all doors and hatch closed while carrying the keyless remote, the doors will automatically lock.

The auto lock function activates when all doors and hatch are closed, and the keyless remote is within about 5 feet (1.5 m) radius of the outside door handle or hatch release button.

Exit vehicle while carrying keyless remote and close door(s) and hatch.

1. While within about 5 feet (1.5 m) radius of the vehicle.

▶ The beeper sounds; the auto lock function will be activated.

2. Carry the keyless remote beyond about 5 feet (1.5 m) from the vehicle and remain outside this range for 2 or more seconds.

▶ Some exterior lights flash; the beeper sounds; all doors and hatch will then lock.

### ▶▶ Locking the doors and hatch (Walk away auto lock®)

The auto lock function is set to OFF as the factory default setting. The auto lock function can be set to ON using the audio/information screen or driver information interface.

If you set the auto lock function to ON using the audio/information screen or driver information interface, only the remote transmitter that was used to unlock the driver's door prior to the setting change can activate auto lock.

▶ **Vehicle Settings\*** P. 126

▶ **Customized Features** P. 359

After the auto lock function has been activated, when you stay within the locking/unlocking operation range, the indicator on the keyless remote will continue to flash until the doors are locked.

When you stay beside the vehicle within the operation range, the doors will automatically lock approximately 30 seconds after the auto lock function activating beeper sounds.

When you open a door after the auto lock function activating beeper sounds, the auto lock function will be canceled.

Under the following circumstances, the auto-lock function will not activate:

- The keyless remote is inside the vehicle.
- ▶ The beeper will not sound.
- The keyless remote is taken out of its operational range before all the doors are closed.
- ▶ The beeper will sound.

To temporarily deactivate the function:

1. Set the power mode to OFF.
2. Open the driver's door.
3. Using the master door lock switch, operate the lock as follows:  
Lock → Unlock → Lock → Unlock.  
▶ The beeper sounds, and the function is deactivated.

To restore the function:

- Set the power mode to ON.
- Lock the vehicle without using the auto lock function.
- With the keyless remote on you, move out of the auto lock function operation range.
- Open any door.

#### ⌘ Locking the doors and hatch (Walk away auto lock®)

The auto lock function does not operate when any of the following conditions are met.

- The keyless remote is inside the vehicle.
- A door or the hood is not closed.
- The power mode is set to any mode other than OFF.
- The keyless remote is not located within a radius of about 5 feet (1.5 m) from the vehicle when you get out of the vehicle and close the doors.

#### **Auto lock function operation stop beeper**

After the auto lock function has been activated, the auto lock operation stop beeper sounds for approximately two seconds in the following cases.

- The keyless remote is put inside the vehicle through a window.
- You are located too close to the vehicle.
- The keyless remote is put inside the hatch.

If the warning beeper sounds, check that you are carrying the keyless remote. Then, open/close a door and confirm the auto lock activation beeper sounds once.

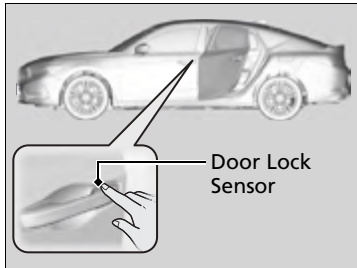

### ■ Locking the doors (lock presetting)

The vehicle will automatically lock after you lock the doors in advance then close the doors.

Activate lock presetting after closing the driver's door.

1. Touch the door lock sensor.
  - ▶ Alert sounds and lock presetting is activated.
2. Close all the doors.
  - ▶ Some exterior lights flash and a beeper sounds when vehicle locks.

Make sure the doors are locked before moving away from the vehicle.

### ▣ Locking the doors (lock presetting)

You can also activate lock presetting by pressing the lock button on the keyless remote.

Lock presetting will be reset if a door is opened before the vehicle has locked completely.

Before locking a door, make sure that the key is not inside the vehicle.

You can turn this function on and off.

▣ **Vehicle Settings**\* P. 126

▣ **Customized Features** P. 359

## ■ Using the Remote Transmitter

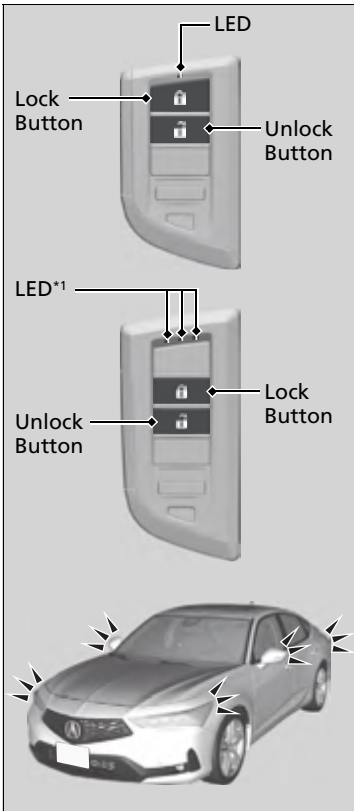

### ■ Locking the doors and hatch

Press the lock button.

#### Once:

- ▶ Some exterior lights flash, all the doors, hatch, and fuel fill door lock, and the security system sets.

#### Twice (within five seconds after the first push):

- ▶ Some exterior lights flash, the beeper sounds, and verifies the security system is set.

### ■ Unlocking the doors and hatch

Press the unlock button.

#### Once:

- ▶ Some exterior lights flash twice, and the driver's door and fuel fill door unlock.

#### Twice:

- ▶ The remaining doors and hatch unlock.

\*1: Checking Door Lock Status\* P. 154

\* Not available on all models

## ☒ Using the Remote Transmitter

If you do not open a door or the hatch within 30 seconds of unlocking the vehicle with the remote transmitter, the doors and hatch will automatically relock.

You can lock or unlock doors using the remote transmitter only when the power mode is in VEHICLE OFF.

The remote transmitter uses low-power signals, so the operating range may vary depending on the surroundings.

The remote will not lock the vehicle when a door is open.

If the distance at which the remote transmitter works varies, the battery is probably low. If the LED does not come on when you press a button, the battery is dead.

☒ **Replacing the Remote Battery** P. 653

Continued

### ■ Checking Door Lock Status\*

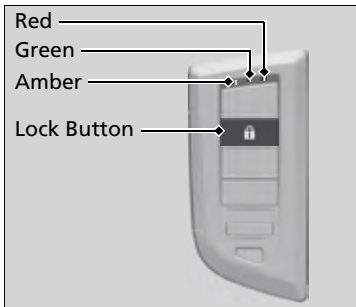

You can remotely check if your vehicle's doors are all locked or any are unlocked using the keyless remote from extended distances.

Press the lock button, the Amber (LEFT) LED blinks once. After three seconds, one of the following feedback will come:

- Green (center) comes on: Acknowledges that the doors are locked.
- Red (right) comes on: Acknowledges that doors are not locked, or any door is not completely closed.
- Red (right) blinks three times: The remote does not receive the door lock status from the vehicle.

### ☒ Checking Door Lock Status\*

Operate the remote in an open space. If there are buildings or other obstacles between your vehicle and the remote, the remote may not work even within the operable range. However, the range required for unlocking the hatch and all the doors as well as activating the panic function is the same as that required for operating the standard keyless remote.

When checking the door lock status, you can also start or stop the engine.

☒ **Remote Engine Start\*** P. 432



## ■ Unlocking the Doors Using a Key

If the unlock button of the keyless remote does not work, use the built-in key instead. The keyhole is on the back of the door handle.

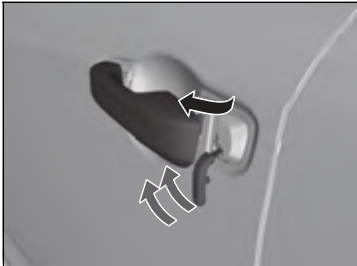

Insert the built-in key into the key cylinder from below the handle and then turn it.

## ☒ Unlocking the Doors Using a Key

When unlocking, the driver's door and fuel fill door unlock first. Turn the key a second time within a few seconds to unlock the remaining doors and the hatch.

If the lock button of the keyless remote does not work, refer to the following.

➤ **Locking a Door Without Using a Key** P. 156

*Continued*

## ■ Locking a Door Without Using a Key

If you do not have the key on you, or if for some reason you cannot lock a door using the key, you can lock the door without it.

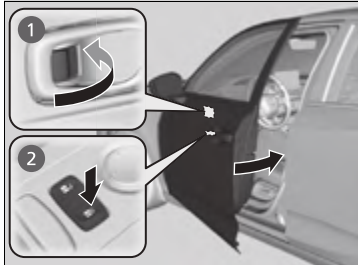

### ■ Locking the front door

Push the lock tab forward ① or push the master door lock switch in the lock direction ②, and close the door.

### ■ Locking the rear doors

Push the lock tab forward and close the door.

## ☒ Locking a Door Without Using a Key

When you lock the driver's door, all the other doors, hatch and fuel fill door lock at the same time.

Before locking a door, make sure that the key is not inside the vehicle.

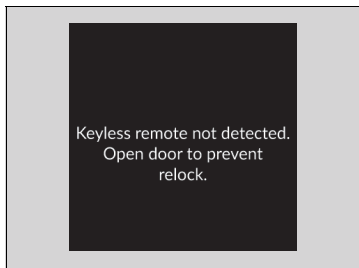

### ■ Lockout protection function

If the vehicle cannot detect the keyless remote, lockout protection activates.

- ▶ A beeper sounds, some exterior lights flash, the doors unlock, and a message appears on the driver information interface.
- ▶ This allows you to open a door in case the keyless remote is still inside the vehicle.

If you do not open a door, all doors relock after 15 seconds.

To avoid non-detection, make sure to keep the keyless remote away from cell phones and other devices that may cause signal interference.

### ▶ Locking a Door Without Using a Key

You can change the lockout protection operation setting.

▶ **Vehicle Settings\*** P. 126

▶ **Customized Features** P. 359

\* Not available on all models

## Locking/Unlocking the Doors from the Inside

### ■ Using the Lock Tab

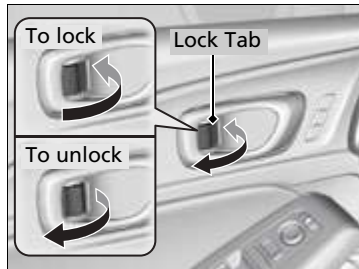

#### ■ Locking a door

Push the lock tab forward.

#### ■ Unlocking a door

Pull the lock tab rearward.

### ☒ Using the Lock Tab

When you lock the door using the lock tab on the driver's door, all of the other doors, hatch and fuel fill door lock at the same time.

When you unlock the door using the lock tab on the driver's door, only the driver's door and fuel fill door will unlock.

## ■ Unlocking Using the Front Door Inner Handle

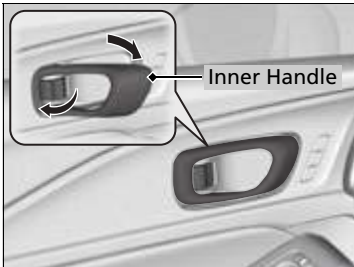

Pull the front door inner handle.

- ▶ The door unlocks and opens in one motion.

Unlocking and opening the driver's door from the inner handle unlocks all the other doors.

To avoid all the doors unlocking, use the lock tab on the driver's door to unlock, then lock again before opening the door.

- ▶ This setting works for one time only.

If you do not want all the doors to be unlocked all the time, customize the **Auto Door Unlock**<sup>\*1</sup>/**Auto door unlock**<sup>\*2</sup> setting to **OFF** using the driver information interface or audio/information screen.

▣ **Vehicle Settings**\* P. 126

▣ **Customized Features** P. 359

## ▣ Unlocking Using the Front Door Inner Handle

The front door inner handles are designed to allow front seat occupants to open the door in one motion. However, this feature requires that front seat occupants never pull a front door inner handle while the vehicle is in motion.

Children should always ride in a rear seat where childproof door locks are provided.

▣ **Childproof Door Locks** P. 160

\*1: Models with 9-in. Color Touchscreen

\*2: Models with 7-in. Color Touchscreen

\* Not available on all models

### ■ Using the Master Door Lock Switch

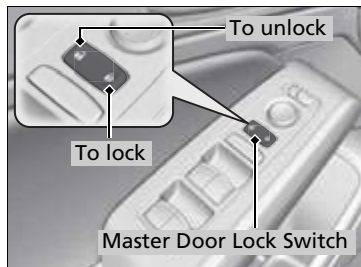

Press the master door lock switch in as shown to lock or unlock all doors, hatch and fuel fill door.

### Childproof Door Locks

The childproof door locks prevent the rear doors from being opened from the inside regardless of the position of the lock tab.

### ■ Setting the Childproof Door Locks

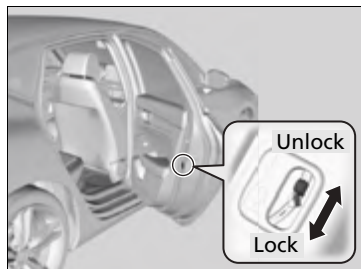

Slide the lever in the rear door to the lock position, and close the door.

#### ■ When opening the door

Open the door using the outside door handle.

### ☒ Using the Master Door Lock Switch

When you lock/unlock either of the front doors using the master lock switch, all the other doors, hatch and fuel fill door lock/unlock at the same time.

### ☒ Childproof Door Locks

To open the door from the inside when the childproof door lock is on, put the lock tab in the unlock position, lower the rear window, put your hand out of the window, and pull the outside door handle.

## Auto Door Locking/Unlocking

Your vehicle locks or unlocks all doors automatically when a certain condition is met.

### ■ Auto Door Locking

#### ■ Drive lock mode

All doors and the hatch lock when the vehicle's speed reaches about 10 mph (15 km/h).

### ■ Auto Door Unlocking

#### ■ Driver's door open mode

All doors and the hatch unlock when the driver's door is opened.

#### ☒ Auto Door Locking/Unlocking

You can turn off or change to another auto door locking/unlocking setting using the driver information interface or audio/information screen.

☒ **Vehicle Settings**\* P. 126

☒ **Customized Features** P. 359

\* Not available on all models

## Precautions for Opening/Closing the Hatch

Always make sure individuals and objects are clear of the hatch before opening or closing it.

- Open the hatch all the way.
  - ▶ If it is not fully opened, the hatch may begin to close under its own weight.
- Be careful when it is windy. The wind may cause the hatch to close.

Keep the hatch closed while driving to:

- ▶ Avoid possible damage.
- ▶ Prevent exhaust gas from leaking into the vehicle.
  - ☒ **Carbon Monoxide Gas** P. 81

### ☒ Precautions for Opening/Closing the Hatch

#### **WARNING**

**Anyone caught in the path of a hatch that is being opened or closed can be seriously injured.**

**Make sure that all people are clear of the hatch before opening or closing it.**

Be careful not to hit your head on the hatch or to put your hands between the hatch and the cargo area when closing the hatch.

When you are storing or picking up luggage from the cargo area while the engine is idling, do not stand in front of the exhaust pipe. You may get burned.

Do not allow any passenger in the cargo space. They may get hurt during hard braking, a sudden acceleration, or a crash.



## Opening/Closing the Hatch

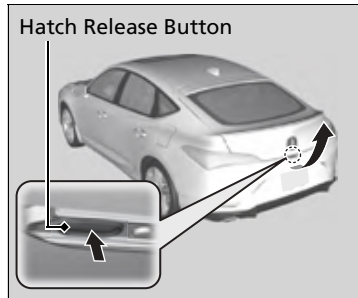

When all the doors are unlocked or press the hatch unlock button on the remote transmitter, the hatch is unlocked. Press the hatch release button and lift open the hatch.

If you are carrying the keyless remote, you do not have to unlock the hatch before opening it.

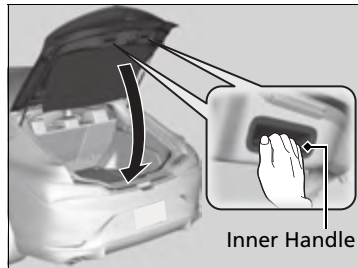

To close the hatch, grab the inner handle, pull the hatch down, and push it closed from outside.

If you close the hatch when the driver's door is locked, the hatch locks automatically.

- ▶ Some exterior lights flash.

### Opening/Closing the Hatch

- Do not leave the keyless remote in the vehicle when you get out. Carry it with you.
- Even if you are not carrying the keyless remote, you can unlock the hatch while someone else with the remote is within range.
- Do not leave the keyless remote inside the cargo area and close the hatch when all the doors are locked. The beeper sounds and the hatch cannot be locked.

### ■ Using the Remote Transmitter

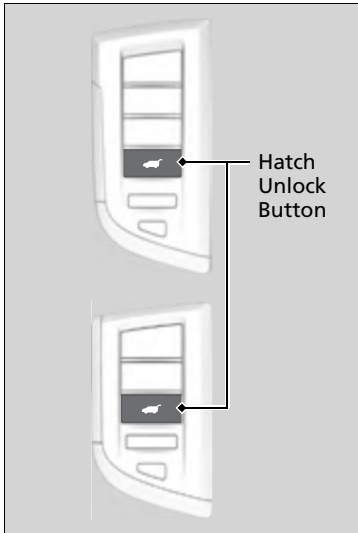

Press the hatch unlock button to unlock the hatch.

### ▣ Using the Remote Transmitter

If you have unlocked and opened the hatch using the remote transmitter, when closing, the hatch locks automatically.

## Immobilizer System

This system prevents a key that has not been pre-registered from starting the engine.

Pay attention to the following when pressing the **ENGINE START/STOP** button:

- Do not allow objects that emit strong radio waves near the **ENGINE START/STOP** button.
- Make sure the key is not covered by or touching a metal object.
- Do not bring a key from another vehicle's immobilizer system near the **ENGINE START/STOP** button.
- Do not put the key near magnetic items. Electronic devices, such as televisions and audio systems emit strong magnetic fields. Note that even a key chain can become magnetic.

## Security System Alarm

The security system alarm activates when the hatch, hood or doors are forcibly opened. The alarm does not activate if the hatch or doors are opened with the key, remote transmitter or keyless access system.

However, the alarm activates if a door is opened with the key and then the transmission is taken out of **P** (continuously variable transmission models) or the hood is opened before the power mode is set to ON.

### Immobilizer System

#### NOTICE

Leaving the key in the vehicle can result in theft or accidental movement of the vehicle. Always take the key with you whenever you leave the vehicle unattended.

Do not alter the system or add other devices to it. Doing so may damage the system and make your vehicle inoperable.

#### Canadian models

Apply and hold the brake pedal before turning the vehicle on the first time after the battery has been disconnected.

### Security System Alarm

Do not alter the system or add other devices to it. Doing so may damage the system and make your vehicle inoperable.

The security system alarm continues for a maximum of two minutes until the security system alarm deactivates.

### ■ When the security system alarm activates

The horn sounds intermittently, and some exterior lights flash.

### ■ To deactivate the security system alarm

Unlock the vehicle using the key, remote transmitter or keyless access system, or set the power mode to ON. The system, along with the horn and flashing lights, is deactivated.

### ■ Setting the security system alarm

The security system alarm automatically sets when the following conditions have been met:

- The power mode is set to VEHICLE OFF.
- The hood is closed.
- All doors and hatch are locked from outside with the remote transmitter or keyless access system.

### ■ When the security system alarm sets

The security system alarm indicator in the instrument panel blinks and the blinking interval changes after about 15 seconds.

### ■ To cancel the security system alarm

The security system alarm is canceled when the vehicle is unlocked using the remote transmitter or keyless access system, or when the power mode is set to ON. The security system alarm indicator goes off at the same time.

#### » Security System Alarm

Do not set the security system alarm when someone is in the vehicle or a window is open. The system can accidentally activate when:

- Unlocking the door with the lock tab.
- Opening the hood with the hood release.

#### Continuously variable transmission models

- Taking the transmission out of **P**.

If the battery goes dead after you have set the security system alarm, the security alarm may go off once the battery is recharged or replaced.

If this occurs, deactivate the security system alarm by unlocking a door using the key, remote transmitter or keyless access system.

## ■ Panic Mode

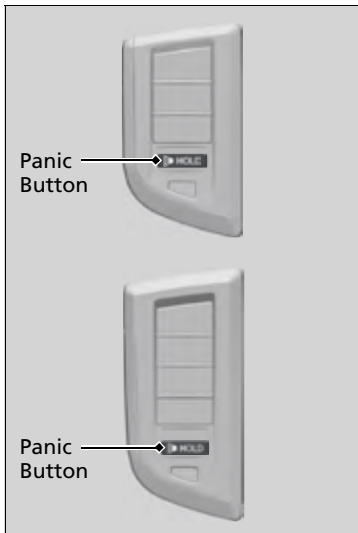

### ■ The panic button on the remote transmitter

If you press the panic button for approximately one second, the following will occur for about 30 seconds:

- The horn sounds.
- Some exterior lights flash.

### ■ Canceling panic mode

- Press any button on the remote transmitter.
- Set the power mode to ON.

## Opening/Closing the Power Windows

The power windows can be opened and closed when the power mode is in ON, using the switches on the doors.

The driver's side switches can be used to open and close all the windows. The power window lock button on the driver's side must be switched off (indicator off) to open and close the windows from anywhere other than the driver's seat.

When the power window lock button is pressed, the indicator comes on and you can only operate the driver's window. Turn the power window lock button on if a child is in the vehicle.

### Opening/Closing the Windows with Auto-Open/Close Function

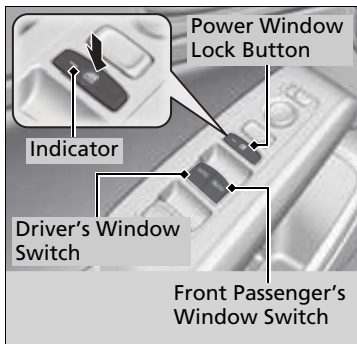

#### Manual operation

**To open:** Push the switch down lightly, and hold it until the desired position is reached.

**To close:** Pull the switch up lightly, and hold it until the desired position is reached.

#### Automatic operation

**To open:** Push the switch down firmly.

**To close:** Pull the switch up firmly.

The window opens or closes completely. To stop the window at any time, push or pull the switch briefly.

### Opening/Closing the Power Windows

#### **WARNING**

**Closing a power window on someone's hands or fingers can cause serious injury.**

**Make sure your passengers are away from the windows before closing them.**

The power windows can be operated for up to 10 minutes after you set the power mode to VEHICLE OFF.

Opening either front door cancels this function.

#### Auto Reverse

If a power window senses resistance when closing automatically, it will stop closing and reverse direction.

The driver's window auto reverse function is disabled when you continuously pull up the switch.

The auto reverse function stops sensing when the window is almost closed to ensure that it fully closes.

## ■ Opening/Closing the Windows without Auto-Open/Close Function

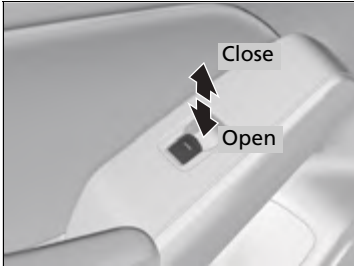

**To open:** Push the switch down.

**To close:** Pull the switch up.

Release the switch when the window reaches the desired position.

## ■ Opening the Windows with the Remote

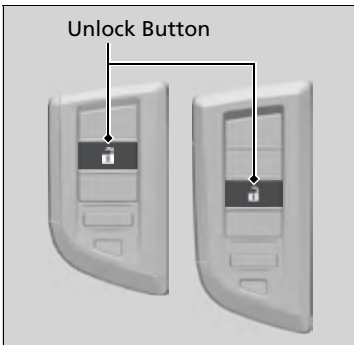

**To open:** Press the unlock button, and then within 10 seconds, press it again and hold it.

If the windows stop midway, repeat the procedure.

### ☒ Opening/Closing the Power Windows

While driving with any of the windows open, you may hear a booming, throbbing, or helicopter-type noise or pressure. This is called wind buffeting. This is a normal occurrence that can be minimized.

If you hear a wind buffeting noise with any of the windows open, lower all of the other windows slightly or open the moonroof.

### ☒ Opening the Windows with the Remote

If you open the windows with the remote, the moonroof will open automatically along with them.

You can turn off or on to open the windows with the keyless remote setting using the driver information interface or audio/information screen.

➤ **Vehicle Settings**\* P. 126

➤ **Customized Features** P. 359

\* Not available on all models

## ■ Opening the Windows with the Key

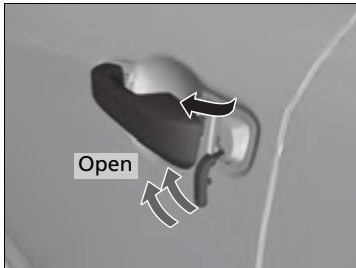

Pull and hold the outer handle. Insert the key into the key cylinder completely from below the handle.

**To open:** Unlock the driver's door with the key. Within 10 seconds of returning the key to the central position, turn the key in the unlock direction and hold it there.

Release the key to stop the windows at the desired position. If you want further adjustment, repeat the same operation.

## ☒ Opening the Windows with the Key

If you open the windows with the key, the moonroof will open automatically along with them.



## Opening/Closing the Moonroof

You can operate the moonroof when the power mode is in ON. Use the switch in the front of the ceiling to open and close the moonroof.

### Using the Moonroof Switch

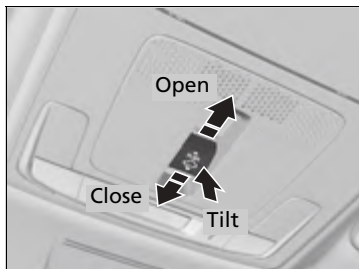

#### Automatic operation

**To open:** Pull the switch back firmly.

**To close:** Push the switch forward firmly.

The moonroof automatically opens or closes all the way. To stop the moonroof midway, pull or push the switch briefly.

#### Manual operation

**To open:** Pull the switch back lightly, and hold it until the desired position is reached.

**To close:** Push the switch forward lightly, and hold it until the desired position is reached.

#### Tilting the moonroof up

**To tilt:** Push on the center of the moonroof switch.

**To close:** Push the switch forward firmly, then release.

### Opening/Closing the Moonroof

#### ⚠ WARNING

Opening or closing the moonroof on someone's hands or fingers can cause serious injury.

Make sure all hands and fingers are clear of the moonroof before opening or closing it.

#### NOTICE

Opening the moonroof in below freezing temperature or when it is covered with snow or ice can damage the moonroof panel or motor.

The moonroof can be operated for up to 10 minutes after you set the power mode to VEHICLE OFF. Opening either front door cancels this function.

When resistance is detected, the auto reverse function causes the moonroof to change directions, then stop. Auto reverse stops sensing when the moonroof is almost closed to ensure that it fully closes. Make sure that all objects, including fingers, are clear of the moonroof.

You can use the remote transmitter or the key to operate the moonroof.

➤ **Opening the Windows with the Remote**  
P. 169

➤ **Opening the Windows with the Key** P. 170

## ENGINE START/STOP Button

### ■ Changing the Power Mode

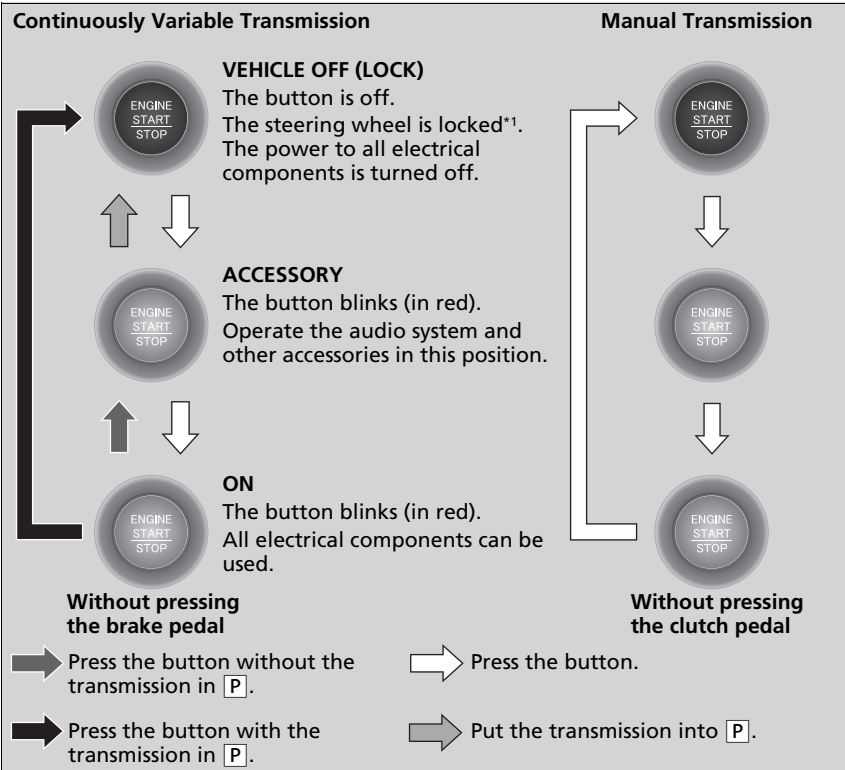

\*1:Manual transmission models

### ▣ ENGINE START/STOP Button

#### ENGINE START/STOP Button Operating Range

You can start the engine when the keyless remote is inside the vehicle.

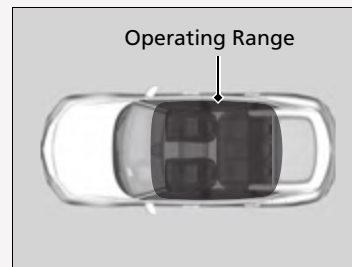

The engine may also start if the keyless remote is close to the door or window, even if it is outside the vehicle.

ON mode:

The **ENGINE START/STOP** button is on (in red), if the engine is running.

If the battery of the keyless remote is getting low, the engine may not start when you push the **ENGINE START/STOP** button. If the engine does not start, refer to the following link.

▣ **If the Keyless Remote Battery is Weak**

P. 691

## Automatic Power Off

If you leave the vehicle for 30 to 60 minutes with the transmission in **P** (continuously variable transmission) and the power mode in ACCESSORY, the vehicle automatically goes into the mode similar to VEHICLE OFF (LOCK) to avoid draining the battery.

### Manual transmission models

When in this mode:

The steering wheel does not lock. You cannot lock or unlock doors with the remote transmitter or the keyless access system. Press the **ENGINE START/STOP** button twice to switch the mode to VEHICLE OFF (LOCK).

## Power Mode Reminder

If you open the driver's door when the power mode is in ACCESSORY, a warning beep sounds.

## ENGINE START/STOP Button

### Manual transmission models

If the power mode does not change from VEHICLE OFF to ACCESSORY, press the **ENGINE START/STOP** button while moving the steering wheel left and right. The steering wheel will unlock, allowing the mode to change.

Do not leave the power mode in ACCESSORY or ON when you get out.

## ■ Keyless Remote Reminder

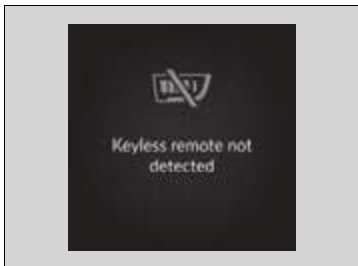

When the power mode is set to any mode other than OFF and you remove the keyless remote from the vehicle and shut the door, an alarm will sound. If the alarm continues to sound, place the keyless remote in another location.

### ■ When the power mode is in ACCESSORY

The alarm will sound from outside the vehicle.

### ■ When the power mode is in ON

An alarm will sound both inside and outside the vehicle. In addition, a warning indicator will appear on the instrument panel.

## ☒ Keyless Remote Reminder

When the keyless remote is within the system's operational range, and all the doors are closed, the warning function cancels.

If the keyless remote is taken out of the vehicle after the engine has been started, you can no longer change the **ENGINE START/STOP** button mode or restart the engine. Always make sure if the keyless remote is in your vehicle when you operate the **ENGINE START/STOP** button.

Removing the keyless remote from the vehicle through a window does not activate the warning buzzer.

Do not put the keyless remote on the dashboard or in the glove box. It may cause the warning buzzer to go off. Under some other conditions that can prevent the vehicle from locating the keyless remote, the warning buzzer may also go off even if the keyless remote is within the system's operational range.

## Turn Signals

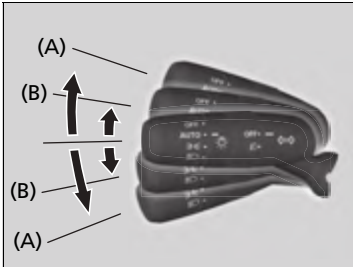

The turn signals can be used when the power mode is in ON.

### ■ (A): Turn signal

Push the lever up or down based on the direction you want to turn, and the turn signal will blink.

### ■ (B): One-touch turn signal

When you lightly push the lever up or down and release it, the turn signal will blink 3 times.

- ▶ If you lightly push the lever in the opposite direction while it is blinking, the blinking will stop.

### ☒ Turn Signals

The turn signal indicator on the instrument panel will blink when the external turn signal blinks.

#### ☒ Turn Signal and Hazard Warning Indicators

P. 93

## Light Switches

### Manual Operation

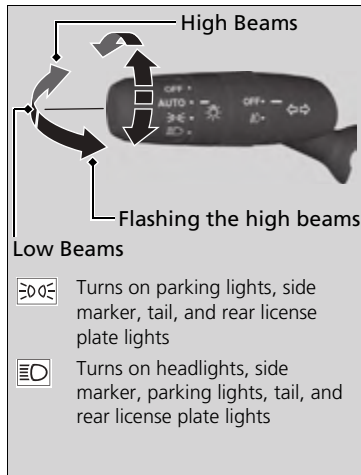

Rotating the light switch turns the lights on and off, regardless of the power mode setting.

#### High beams

Push the lever forward until you hear a click.

#### Low beams

When in high beams, pull the lever back to return to low beams.

#### Flashing the high beams

Pull the lever back, and release it.

#### Lights off

Turn the lever to **OFF** either when:

- The shift lever is in **P** (continuously variable transmission).
- The parking brake is applied.

To turn the lights on again, turn the lever to **OFF** to cancel the lights off mode. Even if you do not cancel the lights off mode, the lights come on automatically when:

- The transmission is taken out of **P** (continuously variable transmission) and the parking brake is released.
- The vehicle starts to move.

### Light Switches

If you leave the power mode in VEHICLE OFF while the lights are on, a chime sounds when the driver's door is opened.

When the lights are on, the lights on indicator in the instrument panel will be on.

#### Lights On Indicator P. 93

Do not leave the lights on when the engine is off because it will cause the battery to discharge.

If you sense that the level of the headlights is abnormal, have the vehicle inspected by a dealer.

## Automatic Operation (automatic lighting control)



Automatic lighting control can be used when the power mode is in ON.

When the light switch is in **AUTO**, the headlights and other exterior lights will switch on and off automatically depending on the ambient brightness.

The headlights come on when you unlock a door in dark areas with the headlight switch in **AUTO**.

- ▶ Once you lock the door, the headlights will go off.

## Automatic Operation (automatic lighting control)

We recommend that you turn on the lights manually when driving at night, in a dense fog, or in dark areas such as long tunnels or parking facilities.

The light sensor is in the location shown below. Do not cover this light sensor with anything; otherwise, the automatic lighting system may not work properly.

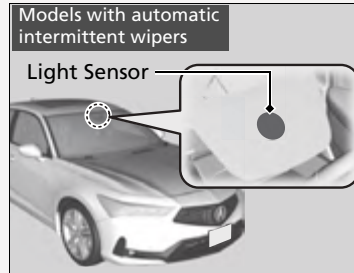
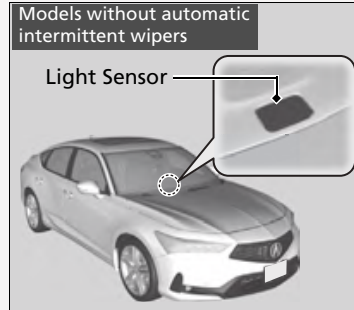

### ■ Headlight Integration with Wipers

The headlights automatically come on when the wipers are used several times within a certain number of intervals with the headlight switch in **AUTO**. The headlights automatically go off a few minutes later if the wipers are stopped.

### ■ Automatic Lighting Off Feature

The headlights, all other exterior lights, and the instrument panel lights turn off 15 seconds after you set the power mode to VEHICLE OFF, and close the driver's door.

If you set the power mode to VEHICLE OFF with the headlight switch on, but do not open the door, the lights turn off after 10 minutes (3 minutes, if the switch is in the **AUTO** position).

The lights turn on again when you unlock or open the driver's door. If you unlock the door, but do not open it within 15 seconds, the lights go off. If you open the driver's door, you will hear a reminder chime alerting you that the lights are on.

#### ⌘ Automatic Operation (automatic lighting control)

##### U.S. models

You can adjust the auto light sensitivity as follows:

Setting	The exterior lights come on when the ambient light is at
Max	 Bright
High	
Mid	
Low	
Min	

➤ **Vehicle Settings**\* P. 126

➤ **Customized Features** P. 359

#### ⌘ Headlight Integration with Wipers

This feature activates while the headlights are off in **AUTO**.

The instrument panel brightness does not change when the headlights come on.

At dark ambient light levels, the automatic lighting control feature turns on the headlights, regardless of the number of wiper sweeps.

#### ⌘ Automatic Lighting Off Feature

You can change the headlight auto off timer setting.

➤ **Vehicle Settings**\* P. 126

➤ **Customized Features** P. 359



## Fog Lights\*

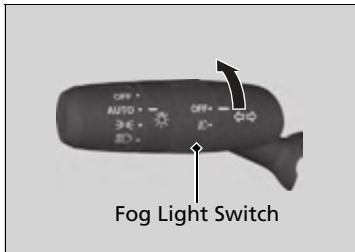

When the low beam headlights are on, turn the fog light switch on to use the fog lights.

## Chicane™ Daytime Running Lights

The parking/daytime running lights come on when the following conditions have been met:

- The power mode is in ON.
- The headlight switch is **AUTO** or .
- The parking brake is released.

The lights remain on even if you set the parking brake. Setting the power mode to VEHICLE OFF will turn off the daytime running lights.

The daytime running lights are off once the headlight switch is turned on, or when the headlight switch is in **AUTO** and it is getting darker outside.

\* Not available on all models

## Auto High-Beam

The front wide view camera detects the light sources ahead of the vehicle such as the lights of a preceding or oncoming vehicle, or street lights. When you are driving at night, the system automatically switches the headlights between low beam and high beam depending on the situation.

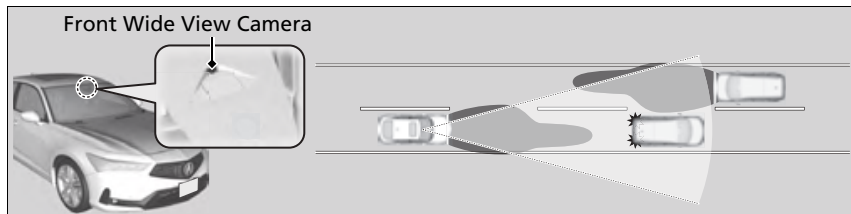

### How to Use the Auto High-Beam

When all of the following conditions have been met, the auto high-beam indicator comes on and the auto high-beam is activated.

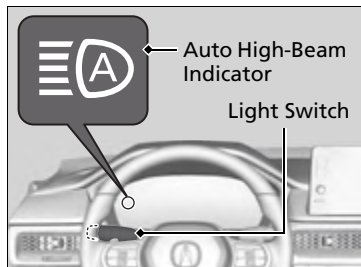

- The power mode is in ON.
- The light switch is in **AUTO**.
- The lever is in the low beam position.
- The headlights have been automatically activated.
- It is dark outside the vehicle.

If the auto high-beam indicator does not come on even when all the conditions have been met, carry out the following procedure and the indicator will come on.

- Pull the lever toward you for flashing the high beams then release it while driving.

### Auto High-Beam

The auto high-beam system does not always operate in every situation. This system is just for assisting the driver. Always observe your surroundings and switch the headlights between high beam and low beam manually if necessary.

If you find the timing of beam changes inconvenient for driving, change the headlight beams manually.

The range and the distance at which the camera can recognize varies depending on conditions surrounding your vehicle.

Regarding the handling of the camera mounted to the inside of the windshield, refer to the following.

#### Front Wide View Camera P. 581

For the auto high-beam to work properly:

- Do not place an object that reflects light on the dashboard.
- Keep the windshield around the camera clean.
- When cleaning the windshield, be careful not to apply the windshield cleanser to the camera lens.
- Do not attach an object, sticker or film to the area around the camera.
- Do not touch the camera lens.

If the camera receives a strong impact, or repairing of the area near the camera is required, consult a dealer.

## ■ Automatic switching between high-beam and low-beam

When auto high-beam is active, the headlights switch between high beam and low beam based on the following conditions.

### Switching to high beam:

All of the following conditions must be met before the high beams turn on.

- Your vehicle speed is 25 mph (40 km/h) or more.
- There are no preceding or oncoming vehicle with headlights or taillights turned on.
- There are few street lights on the road ahead.



### Switching to low beam:

One of the following conditions must be met before the low beams turn on.

- Your vehicle speed is 15 mph (24 km/h) or less.
- There is a preceding or oncoming vehicle with headlights or taillights turned on.
- There are many street lights on the road ahead.

### How to Use the Auto High-Beam

In the following cases, the auto high-beam system may not switch the headlights properly or the switching timing may be changed. In case of the automatic switching operation does not fit for your driving habits, please switch the headlights manually.

- The brightness of the lights from the preceding or oncoming vehicle is intense or poor.
- Visibility is poor due to the weather (rain, snow, fog, windshield frost, etc.).
- Surrounding light sources, such as street lights, electric billboards and traffic lights are illuminating the road ahead.
- The brightness level of the road ahead constantly changes.
- The road is bumpy or has many curves.
- A vehicle suddenly appears in front of you, or a vehicle in front of you is not in the preceding or oncoming direction.
- Your vehicle is tilted with a heavy load in the rear.
- A traffic sign, mirror, or other reflective object ahead is reflecting strong light toward the vehicle.
- The oncoming vehicle frequently disappears under roadside trees or behind median barriers.
- The preceding or oncoming vehicle is a motorcycle, bicycle, mobility scooter, or other small vehicle.

The auto high-beam system keeps the headlight low beam when:

- Windshield wipers are operating at a high speed.
- The camera has detected a dense fog.

## ■ Manual switching between high-beam and low-beam

If you want to manually switch the headlights between high beam and low beam, follow either of the procedures below. Note that when you do this, the auto high-beam indicator will turn off and the auto high-beam will be deactivated.

### Using the lever:

Pull the lever toward you for flashing the high beams then release it within about one second while driving.

- ▶ To reactivate the auto high-beam, pull the lever toward you for flashing the high beams then release it while driving. The auto high-beam indicator will come on.

### Using the light switch:

Turn the light switch to .

- ▶ To reactivate the auto high-beam, turn the light switch to **AUTO** when the lever is in the low beam position, the auto high-beam indicator will come on.

### ▶▶ How to Use the Auto High-Beam

#### How to turn off the Auto High-Beam System

You can turn the auto high-beam system on and off.

▶ Models with 7-in. Color Touchscreen

▶ **Vehicle Settings**\* P. 126

▶ Models with 9-in. Color Touchscreen

▶ **Customized Features** P. 359

If the **Some driver assist systems cannot operate:**

**Camera temperature too high** message appears:

- Use the climate control system to cool down the interior and, if necessary, also use defroster mode with the airflow directed toward the camera.
- Start driving the vehicle to lower the windshield temperature, which cools down the area around the camera.

If the **Some driver assist systems cannot operate:**

**Clean front windshield or poor viewing**

**conditions.** message appears:

- Park your vehicle in a safe place, and clean the windshield. If the message does not disappear after you have cleaned the windshield and driven for a while, have your vehicle checked by a dealer.

## Wipers and Washers

### ■ Windshield Wiper/Washer

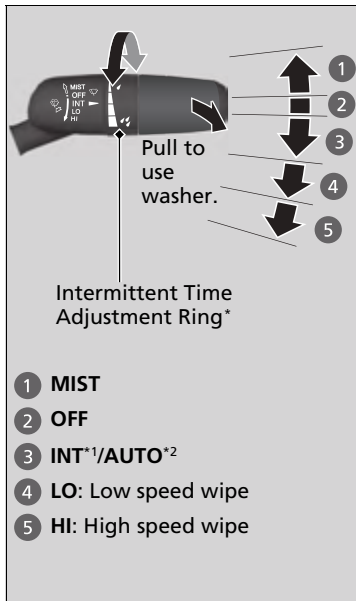

The windshield wipers and washers can be used when the power mode is in ON.

#### ■ MIST

The wipers run at high speed until you release the lever.

#### ■ Wiper switch (OFF, INT\*<sup>1</sup>/AUTO\*<sup>2</sup>, LO, HI)

Move the lever up or down to change the wiper settings.

#### ■ Adjusting wiper operation\*

Turn the adjustment ring to adjust the wiper operation.



Lower speed, fewer sweeps

Higher speed, more sweeps

#### ■ Washer

Sprays while you pull the lever toward you. When you release the lever for more than one second, the spray stops, the wipers sweep two or three more times to clear the windshield, then stop.

\*1: Models with manual intermittent operation

\*2: Models with automatic intermittent operation

\* Not available on all models

### ▶ Wipers and Washers

#### NOTICE

Do not use the wipers when the windshield is dry. The windshield will get scratched, or the rubber blades will get damaged.

#### NOTICE

Turn the washers off if no washer fluid comes out. The pump may get damaged.

#### NOTICE

In cold weather, the blades may freeze to the windshield. Operating the wipers in this condition may damage the wipers. Use the defogger to warm the windshield, then turn the wipers on.

#### Models with intermittent time adjustment ring

If the vehicle speeds up while the wipers are operating intermittently, the length of the wipe interval shortens. When the vehicle speeds up, the wiper operation's shortest delay setting (🔍) and the **LO** setting become the same.

The wiper motor may stop motor operation temporarily to prevent an overload. Wiper operation will return to normal within a few minutes.

If the wiper stops operating due to any obstacle such as the buildup of snow, park the vehicle in a safe place. Rotate the wiper switch to **OFF**, and set the power mode to ACCESSORY or VEHICLE OFF, then remove the obstacle.

## ■ Automatic Intermittent Wipers\*

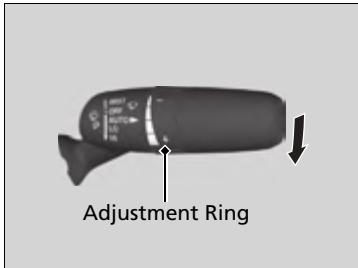

When you push the lever down to **AUTO**, the windshield wipers sweep once, and go into the automatic mode.

The wipers operate intermittently, at low speed, or at high speed and stop in accordance with the amount of rainfall the rainfall sensor detects.

### ■ Auto sensitivity adjustment

When the wiper function is set to **AUTO**, you can adjust the sensitivity of the rainfall sensor (using the adjustment ring) so that wipers will operate in accordance with your preference.

### Sensor sensitivity

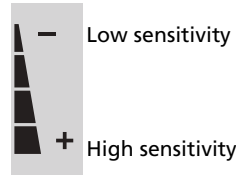

## ▶▶ Automatic Intermittent Wipers\*

The rainfall sensor is in the location shown below.

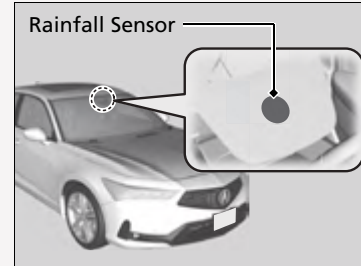

### NOTICE

**AUTO** should always be turned OFF before the following situations in order to prevent severe damage to the wiper system:

- Cleaning the windshield
- Driving through a car wash
- No rain present

## Rear Defogger/Heated Door Mirror Button

Press the rear defogger and heated door mirror button to defog the rear window and mirrors\* when the power mode is in ON.

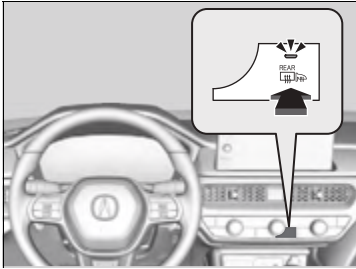

The rear defogger and heated door mirror automatically switch off after 10-30 minutes depending on the outside temperature. However, if the outside temperature is 32°F (0°C) or below, it does not automatically switch off.

### ⌘ Rear Defogger/Heated Door Mirror Button

This system consumes a lot of power, so turn it off when the window has been defogged. Also, do not use the system for a long time while the engine is idling. This may weaken the battery, making it difficult to start the engine.

When the power mode is set to ON and the outside temperature is below 41°F (5°C), the heated door mirror may automatically activate for 10 minutes.

\* Not available on all models

## Driving Position Memory System\*

You can store two driver's seat positions (except for power lumbar) with the driving position memory system.

When you unlock and open the driver's door with a keyless remote, or keyless access system, the seat adjusts to retracted positions of one of the two preset positions automatically.

The seat will move to the stored position when you set the power mode to ACCESSORY.

- **DRIVER 1** transmitter is linked to memory button 1.
- **DRIVER 2** transmitter is linked to memory button 2.



The driver's seat moves rearward depending on the set seating position once you

- Stop the vehicle.
- Put the transmission in **P** (continuously variable transmission).
- Turn the engine off.
- Open the driver's door.

Once the power mode is in the ACCESSORY position, the driver's seat moves forward to the **DRIVER 1** or **2** preset position.

### ▶▶ Driving Position Memory System\*

Using the audio/information screen, you can disable the automatic seat adjustment function.

▶ **Customized Features** P. 359

The driver's seat easy exit feature can be turned ON/OFF.

▶ **Customized Features** P. 359

### System Operation

The system will not operate if:

- Either memory button is pressed while the seat is in motion.
- The seat positions are adjusted while in operation.
- Either of the memorized positions is set fully to the rear.

The system may not recognize a key if:

- The key is in close proximity to a cell phone or other wireless device.
- Both keys are in the vehicle at the same time.
- The Driving Position Memory System is disabled in customized features.
- Opening driver's door without fully grabbing door handle.



## ■ Storing a Position in Memory

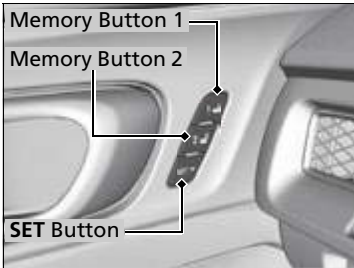

1. Set the power mode to ON. Adjust the driver's seat to the desired position.
2. Press the **SET** button.
  - ▶ The memory button indicator lights will come on.
3. Press the memory button **1** or **2** within five seconds of pressing the **SET** button.
  - ▶ Once the seat position has been memorized, you will hear the double-beep.

## ■ Recalling the Stored Position

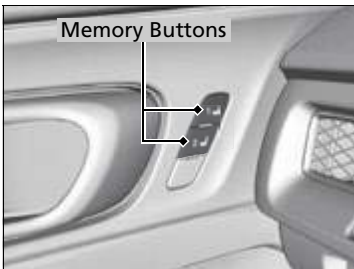

### Continuously variable transmission models

1. Put the transmission into **P**.
2. Press a memory button (**1** or **2**).

### Manual transmission models

1. Apply the parking brake.
2. Press a memory button (**1** or **2**).

The seat will automatically move to the memorized position.

### ⌘ Storing a Position in Memory

After you press the **SET** button, the storing operation will be canceled when:

- You do not press the memory button within five seconds.
- You readjust the seat position before the double-beep.
- You set the power mode to any position except ON.

### ⌘ Recalling the Stored Position

The seat will stop moving if you:

- Press the **SET** button or memory button **1** or **2**.
- Adjust the seat position.
- Put the transmission into a position other than **P** (continuously variable transmission).
- Release the parking brake (manual transmission).

## Adjusting the Steering Wheel

The steering wheel height and distance from your body can be adjusted so that you can comfortably grip the steering wheel in an appropriate driving posture.

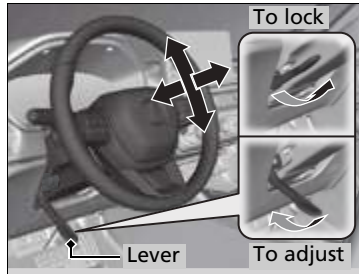

1. While the vehicle is stopped, push the steering wheel adjustment lever down.
  - ▶ The steering wheel adjustment lever is under the steering column.
2. Move the steering wheel up or down, and in or out.
  - ▶ Make sure you can see the instrument panel gauges and indicators.
3. Pull the steering wheel adjustment lever up to lock the steering wheel in position.
  - ▶ After adjusting the position, make sure you have securely locked the steering wheel in place by trying to move it up, down, in, and out.

### Adjusting the Steering Wheel

#### **WARNING**

Adjusting the steering wheel position while driving may cause you to lose control of the vehicle and be seriously injured in a crash.



Adjust the steering wheel only when the vehicle is stopped.

## Interior Rearview Mirror

Adjust the angle of the rearview mirror when you are sitting in the correct driving position.

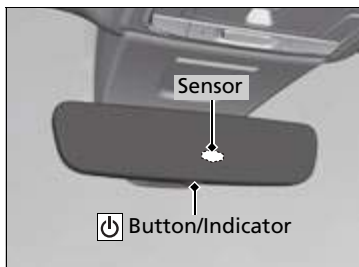
### Automatic Dimming Rearview Mirror



When you are driving after dark, the automatic dimming rearview mirror reduces the glare from headlights behind you. Press the  button to turn this function on and off. When activated, the  indicator comes on.

#### Mirrors

Keep the inside and outside mirrors clean and adjusted for best visibility.

Adjust the mirrors before you start driving.

➤ **Front Seats** P. 191

#### Automatic Dimming Rearview Mirror

The auto dimming function cancels when the transmission is in **R**.

## Power Door Mirrors

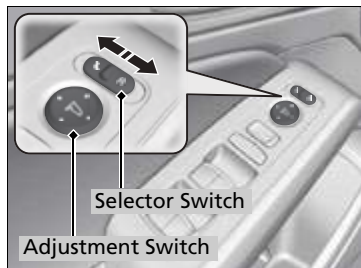

You can adjust the door mirrors when the power mode is in ON.

### ■ Mirror position adjustment

**L/R selector switch:** Select the left or right mirror. After adjusting the mirror, return the switch to the center position.

**Mirror position adjustment switch:** Press the switch left, right, up, or down to move the mirror.

### ■ Reverse Tilt Door Mirror\*

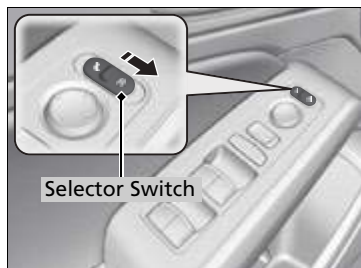

If activated, the passenger side door mirror automatically tilts downward when you put the transmission into **R**; this improves close-in visibility on the passenger side of the vehicle when backing up. The mirror automatically returns to its original position when you take the transmission out of **R**.

To activate this feature, set the power mode to ON and slide the selector switch to the passenger side.

## Front Seats

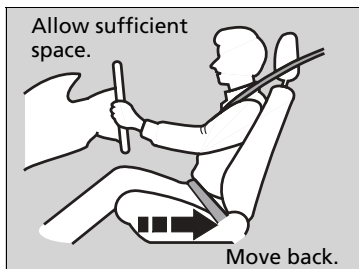

Adjust the driver's seat as far back as possible while allowing you to maintain full control of the vehicle. You should be able to sit upright, well back in the seat and be able to adequately press the pedals without leaning forward, and grip the steering wheel comfortably. The passenger's seat should be adjusted in a similar manner, so that it is as far back from the front airbag in the dashboard as possible.

### ■ Adjusting the Seat Positions

#### ■ Adjusting the front power seat(s)\*



\* Not available on all models

Continued

#### ▣ Seats

Always make seat adjustments before driving.

#### ▣ Front Seats

### **⚠ WARNING**

**Sitting too close to a front airbag can result in serious injury or death if the front airbags inflate.**

Always sit as far back from the front airbags as possible while maintaining control of the vehicle.

The National Highway Traffic Safety Administration and Transport Canada recommend that drivers allow at least 10 inches (25 cm) between the center of the steering wheel and the chest.

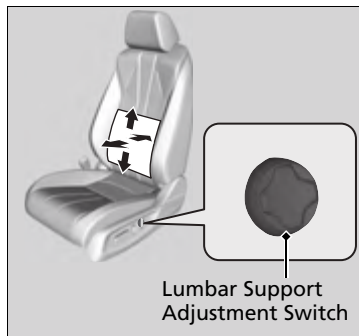

■ **Lumbar Support Adjustment Switch\***

**Press the top:** To move the lumbar support up.

**Press the bottom:** To move the lumbar support down.

**Press the front:** To increase the entire lumbar support.

**Press the rear:** To decrease the entire lumbar support.

■ **Adjusting the front manual seat\***

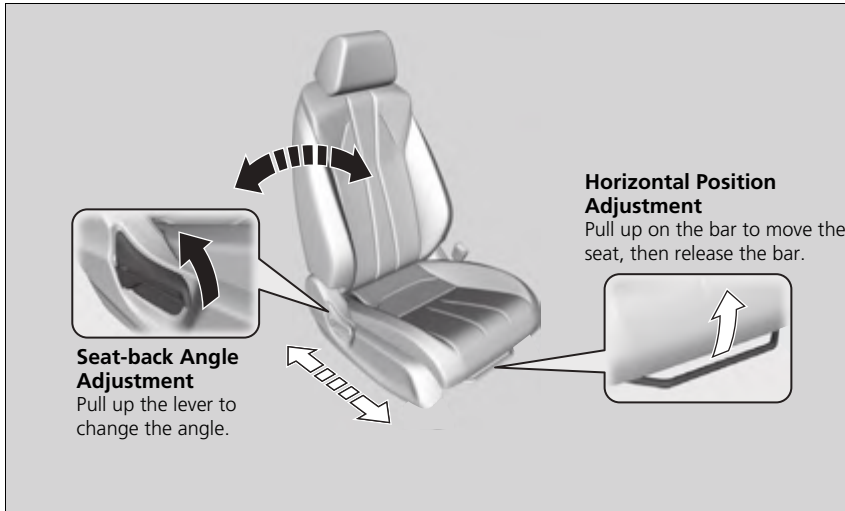

▣ **Adjusting the front manual seat\***

Once a seat is adjusted correctly, rock it back and forth to make sure it is locked in position.

\* Not available on all models

*Continued*

## ■ Adjusting the Seat-Backs

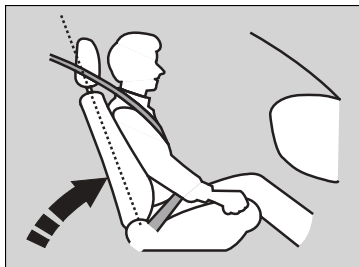

Adjust the driver's seat-back to a comfortable, upright position, leaving ample space between your chest and the airbag cover in the center of the steering wheel.

The front seat passenger should also adjust their seat-back to a comfortable, upright position.

Reclining a seat-back so that the shoulder part of the belt no longer rests against the occupant's chest reduces the protective capability of the belt. It also increases the chance of sliding under the belt in a crash and being seriously injured. The farther a seat-back is reclined, the greater the risk of injury.

## ► Adjusting the Seat-Backs

### **⚠ WARNING**

**Reclining the seat-back too far can result in serious injury or death in a crash.**

**Adjust the seat-back to an upright position, and sit well back in the seat.**

Do not put a cushion, or other object, between the seat-back and your back.

Doing so may interfere with proper seat belt or airbag operation.

If you cannot get far enough away from the steering wheel and still reach the controls, we recommend that you investigate whether some type of adaptive equipment may help.



## Rear Seats

### Folding Down the Rear Seats

The rear seats can be folded down separately to allow for additional storage space. Pull the release lever and fold down the seat-back.

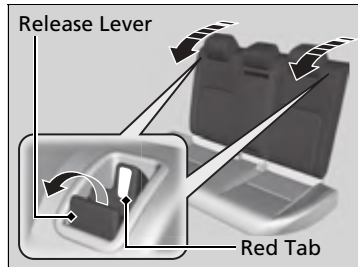

### Folding Down the Rear Seats

The rear seat-back(s) can be folded down to accommodate bulkier items in the cargo area.

To lock a seat-back upright, push it backwards until it locks, so that the red tabs in the release lever go down.

When returning the seat-back to its original position, push it firmly back.

Make sure that the folded seat-back does not press against the front passenger seat, as this can cause the weight sensors in the front passenger seat to work improperly.

▶ **Passenger Airbag Off Indicator** P. 65

**Make sure all items in the cargo area or items extending to the rear seats are properly secured. Loose items can fly forward if you have to brake hard.**

The front seat(s) must be far enough forward so they do not interfere with the rear seats as they fold down.

## ■ Rear Seat Reminder

This feature alerts you to the possible presence of passengers or items in the rear seats before you exit the vehicle. It activates when the power mode is set to VEHICLE OFF if the rear doors were opened shortly before or after the power mode was set to ON.

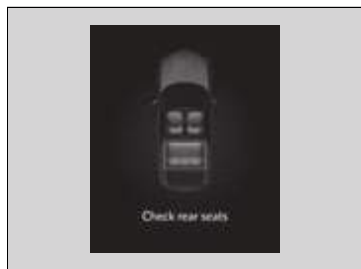

A reminder appears on the driver information interface and an alert will sound when the power mode is set to VEHICLE OFF.

## ▣ Rear Seat Reminder

When the power mode is set to VEHICLE OFF, the reminder comes on briefly, then the function is deactivated.

The reminder will not work if the power mode has not been set to ON within 10 minutes of operating the rear doors.

The system does not detect passengers in the rear seats. Instead, it can detect when a rear door is opened and closed, indicating that there may be something in the rear seats.

You can turn off the notification setting.

- ▣ **Vehicle Settings\*** P. 126
- ▣ **Customized Features** P. 359

## Maintain a Proper Sitting Position

After all occupants have adjusted their seats and head restraints\*, and put on their seat belts, it is very important that they continue to sit upright, well back in their seats, with their feet on the floor, until the vehicle is safely parked and the engine is off.

Sitting improperly can increase the chance of injury during a crash. For example, if an occupant slouches, lies down, turns sideways, sits forward, leans forward or sideways, or puts one or both feet up, the chance of injury during a crash is greatly increased.

In addition, an occupant who is out of position in the front seat can be seriously or fatally injured in a crash by striking interior parts of the vehicle or being struck by an inflating front airbag.

### ▶▶ Maintain a Proper Sitting Position

#### **⚠ WARNING**

**Sitting improperly or out of position can result in serious injury or death in a crash.**

**Always sit upright, well back in the seat, with your feet on the floor.**

\* Not available on all models

## Head Restraints

Your vehicle is equipped with head restraints in all seating positions.

### ■ Adjusting the Front Head Restraint Positions

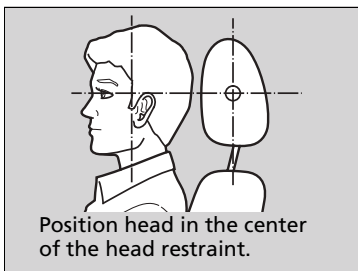

Head restraints are most effective for protection against whiplash and other rear-impact crash injuries when the center of the back of the occupant's head rests against the center of the restraint. The tops of the occupant's ears should be level with the center height of the restraint.

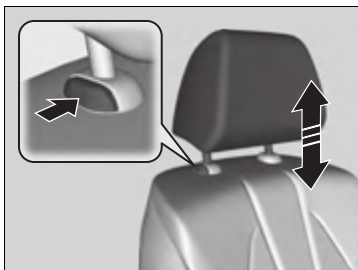

**To raise the head restraint:**

Pull it upward.

**To lower the head restraint:**

Push it down while pressing the release button.

### ⓘ Adjusting the Front Head Restraint Positions

#### **⚠ WARNING**

**Improperly positioning head restraints reduces their effectiveness and increases the likelihood of serious injury in a crash.**

**Make sure head restraints are in place and positioned properly before driving.**

In order for the head restraint system to work properly:

- Do not hang any items on the head restraints, or from the restraint legs.
- Do not place any objects between an occupant and the seat-back.
- Install each restraint in its proper location.

## ■ Removing and Reinstalling the Front Head Restraints

Head restraints can be removed for cleaning or repair.

### To remove a head restraint:

Pull the restraint up as far as it will go. Then, push the release button and pull the restraint up and out.

### To reinstall a head restraint:

Insert the legs back in place, then adjust the head restraint to an appropriate height while pressing the release button. Pull up on the restraint to make sure it is locked in position.

## ▣ Removing and Reinstalling the Front Head Restraints

### ⚠ WARNING

Failure to reinstall or correctly reinstall, the head restraints can result in severe injury during a crash.

Always replace the head restraints before driving.

## Armrest

### ■ Using the Front Seat Armrest



The console lid can be used as an armrest.

### ■ Using the Rear Seat Armrest\*



Pull down the armrest in the center backrest.

## Interior Lights

### Interior Light Switches

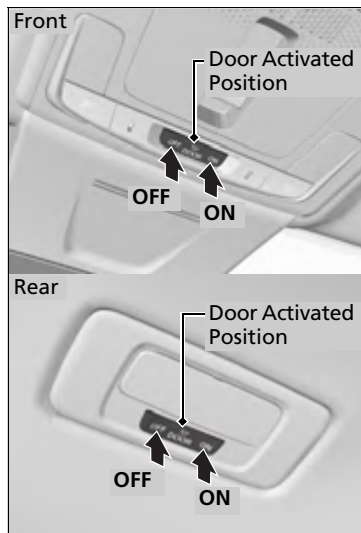

#### ■ ON

The interior lights come on regardless of whether the doors are open or closed.

#### ■ Door activated

The interior lights come on in the following situations:

- When any doors are opened.
- You unlock the driver's door.
- When the power mode is set to VEHICLE OFF.

#### ■ OFF

The interior lights remain off regardless of whether the doors are open or closed.

### Interior Light Switches

In the door activated position, the interior lights fade out and go off about 30 seconds after the doors are closed.

The lights go off after about 30 seconds in the following situations:

- When you unlock the driver's door but do not open it.
- When you set the power mode to VEHICLE OFF but do not open a door.

You can change the interior lights dimming time.

➤ **Vehicle Settings**\* P. 126

➤ **Customized Features** P. 359

The interior lights go off immediately in the following situations:

- When you lock the driver's door.
- When you close the driver's door in ACCESSORY mode.
- When you set the power mode to ON.

To avoid draining the battery, do not leave the interior light on for an extended length of time when the engine is off.

If you leave any of the doors open in VEHICLE OFF mode, the interior lights go off after about 15 minutes.

\* Not available on all models

### ■ Map Light Switches

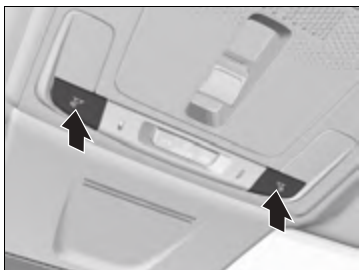

The map lights can be turned on and off by pressing the switches.

### ⌘ Map Light Switches

When the front interior light switch is in the door activated position and any door is open, the map light will not go off when you press the switches.

## Storage Items

### ■ Glove Box

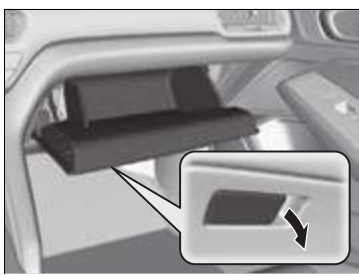

Pull the handle to open the glove box.

### ⌘ Glove Box

## **⚠ WARNING**

An open glove box can cause serious injury to your passenger in a crash, even if the passenger is wearing the seat belt.

Always keep the glove box closed while driving.



## ■ Console Compartment



Pull the handle to open the console compartment.

## ■ Beverage Holders



■ **Front seat beverage holders**  
Are located in the console between the front seats.

■ **Rear seat beverage holders\***  
Fold the armrest down to use the rear seat beverage holders.

## ☞ Beverage Holders

### NOTICE

Spilled liquids damage the upholstery, carpeting, and electrical components in the interior.

Be careful when you are using the beverage holders. Hot liquid can scald you.

Front seat



Rear seat



### ■ Door beverage holders

Are located on the both of front and rear door side pockets.

### ■ Coat Hook



There is a coat hook on the rear left grab handle.

### ☒ Coat Hook

The coat hook is not designed for large or heavy items.

### ■ Sunglasses Holder

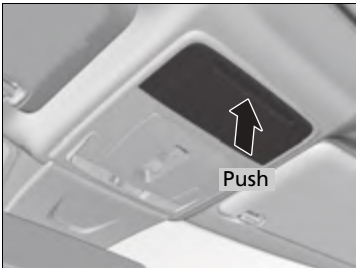

To open the sunglasses holder, push and release the indent. To close, push it again until it latches.

You can store eyeglasses and other small items in this holder.

### ☒ Sunglasses Holder

Keep the holder closed while driving except when accessing stored items.

## ■ Tie-down Anchors

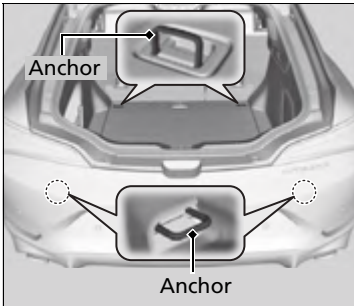

The tie-down anchors on the cargo area floor can be used to install a net for securing items.

## ☒ Tie-down Anchors

Do not let anyone access items in the cargo area while driving. Loose items can cause injury if you have to brake hard.

## ■ Under-Floor Storage Area

Pull the strap and open the lid.

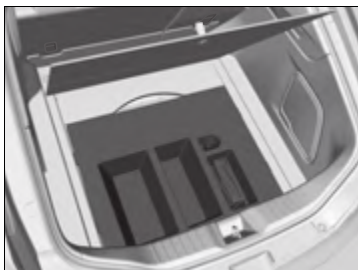
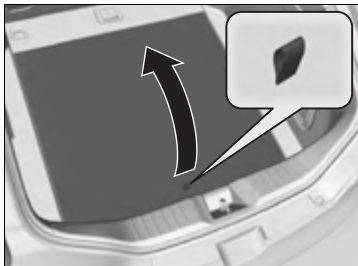

## ■ Cargo Area Cover

The cargo area cover can be used to cover the cargo space.

### ■ To remove the cargo area cover

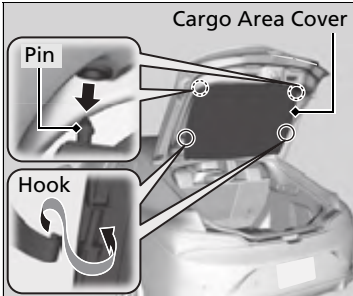

1. Open the hatch.
2. Release the cargo area cover from the hook of each side.
3. Remove the cargo area cover by carefully pulling out the pins on the lower edge of cargo area cover.

Reverse this procedure to install the cargo area cover.

### ☒ Cargo Area Cover

Do not access parcels in the cargo area while driving. This may cause injury if you have to brake hard.

Do not stack objects higher than the top of the seat in the cargo area. They could block your view and be thrown about the vehicle during a sudden stop.

To prevent cargo area cover damage:

- Do not place items on the cargo area cover.
- Do not put weight on the cargo area cover.

## Other Interior Convenience Items

### ■ Accessory Power Socket

The accessory power socket can be used when the power mode is in ACCESSORY or ON.



### ■ Console panel

Open the cover to use it.

### »» Accessory Power Socket

#### NOTICE

Do not insert an automotive type cigarette lighter element. This can overheat the accessory power socket.

The accessory power socket is designed to supply power for 12-volt DC accessories that are rated 180 watts (15 amps) or less.

To prevent battery drain, only use the accessory power socket with the engine running.

When the accessory power socket is not in use, close the cover to prevent any small foreign objects from getting into the accessory power socket.



## ■ Wireless Charger\*

To use the wireless charger, the power mode must be in ACCESSORY or ON. Charge any devices compatible with Qi wireless charging on the area indicated by the  mark as follows:

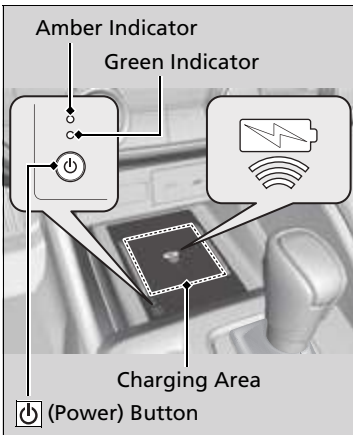

1. To turn the system on and off, press and hold the  (power) button.
  - When the system is activated, the green indicator light comes on.
2. Place the device you want to charge on the charging area.
  - The system will automatically start charging the device and the amber indicator light will come on.
  - Make sure that the device is compatible with the system and placed with the chargeable side in the center of the charging area.
3. When charging is completed, the green indicator light will come on.
  - Depending on the device, the amber indicator light will stay on.

## ▣ Wireless Charger\*

### RF Radiation Exposure Statement:

This equipment complies with FCC RF Radiation exposure limits set forth for an uncontrolled environment.

This device and its antenna must not be co-located or operating in conjunction with any other antenna or transmitter.

In order to use safely:

- Remove any metal objects from the charge pad before charging a device.
- Do not open the charger case.
- Do not use the charger if it malfunctions. Contact your dealer.

If the charger interferes with radio communications, attempt to correct the interference:

- Press and hold the switch on the charger for a few seconds to turn off the charger.

**■ When charging does not start**

Perform one of the solutions in the following table.

Indicator		Cause	Solution
Green & Amber	Blinking simultaneously	There is an obstacle(s) between the charging area and the device.	Remove the obstacle(s).
		The device is not within the charging area.	Pick up and reset the device to the center of the charging area where  is located.
		The temperature of the wireless charger pad increases.	Temporarily suspend charging the device. Wait for the temperature to drop and attempt to charge the device again.
Amber	Blinking	The wireless charger is faulty.	Contact a dealer for repairs.

Controls

Wireless Charger\*

**⚠ CAUTION**

Metal objects between the charge pad and the device to be charged will get hot and can burn you.

- Always remove foreign objects from the charge pad before charging the device.
- Be sure the surface is clear of dust and other debris before charging.
- Do not spill liquids (i. e. water, drinks, etc.) on the charger and the device.
- Do not use oil, grease, alcohol, benzine or thinner for cleaning the charge pad.
- Do not cover the system with towels, clothing, or other objects while charging etc.
- Avoid spraying aerosols which may come in contact with the charge pad surface.

This system consumes a lot of power. Do not use the system for a long time when the engine is not running. This may weaken the battery, making it difficult to start the engine.

When using the wireless charger, check the user's manual that came with the compatible device you want to charge.

**Wireless Charger\***

The wireless charger can support up to 15 W, but the charging rate varies based on the device and other conditions.

**NOTICE**

Do not place any magnetic recording media or precision machines within the charging area while charging.

The data on your cards such as credit cards can be lost because of the magnetic effect. Also, precision machines such as watches can be affected.

“Qi” and  marks are the registered trademarks owned by Wireless Power Consortium (WPC).

In the following cases, charging may stop or not start:

- The device is already fully charged.
- The temperature of the device is extremely high while charging.
- You are at a place that emits strong electromagnetic waves or noises, such as a TV station, electric power plant, or gas station.
- The device has a cover, case or accessories which are not compatible with wireless charging.

A device may not charge if the size or shape of its chargeable side is not appropriate for use with the charging area.

Not all devices are compatible with the system.

\* Not available on all models

#### Wireless Charger\*

During the charging phase, it is normal for the charging area and device to heat up.

Charging may be briefly interrupted when:

- All the doors and the hatch are closed
  - to avoid interference with the proper functioning of the keyless access system.
- The position of the device is altered.

Do not charge more than one device at a time on a charging area.

If the device becomes too hot and its battery protection function activates, it may charge extremely slowly or no longer charge. The temperature at which the battery protection function activates depends on the device.

Canadian models

## ■ Heated Steering Wheel

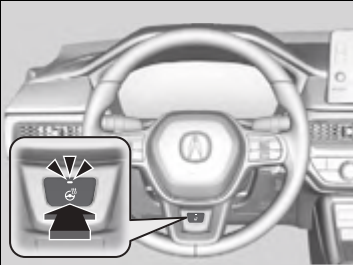

The power mode must be in ON to use the heated steering wheel.

Press the button on the lower side of the steering wheel.

When a comfortable temperature is reached, press the button again to turn it off.

The heated steering wheel is turned off every time you start the engine, even if you turned it on the last time you drove the vehicle.

## ▣ Heated Steering Wheel

Do not use the heated steering wheel continuously when the engine is off. Under such conditions, the battery may be weakened, making the engine difficult to start.

## ■ Front Seat Heaters

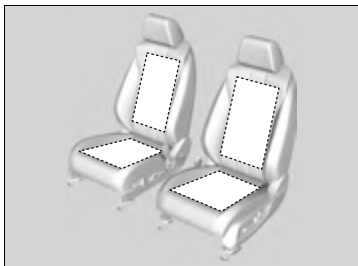

The seat heaters can be used when the power mode is in ON.

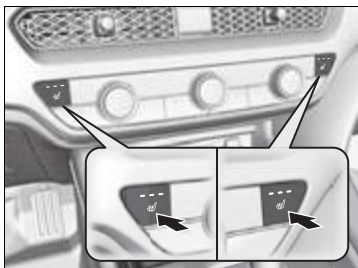

Press the seat heater button:

Once - The HI setting (three indicators on)

Twice - The MID setting (two indicators on)

Three times - The LO setting (one indicator on)

Four times - The OFF setting (no indicators on)

When the power mode is turned on after it is turned off, the previous setting is maintained.

## ▣ Front Seat Heaters

### **⚠ WARNING**

Heat induced burns are possible when using seat heaters.

Persons with a diminished ability to sense temperature (e.g., persons with diabetes, lowerlimb nerve damage, or paralysis) or with sensitive skin should not use seat heaters.

Do not use the seat heaters even in LO when the engine is off. Under such conditions, the battery may be weakened, making the engine difficult to start.

After a certain period of time, the strength setting for the front seat heaters will automatically be reduced by one level at a time until the front seat heaters shuts off. The elapsed time varies according to the interior environment.

Canadian models

## Rear Seat Heaters



The seat heaters can be used when the power mode is in ON.

There is no heater in the rear center seating position.

Press the seat heater button:

Once - The HI setting (three indicators on)

Twice - The MID setting (two indicators on)

Three times - The LO setting (one indicator on)

Four times - The OFF setting (no indicators on)

►► Rear Seat Heaters

### **⚠ WARNING**

Heat induced burns are possible when using seat heaters.

Persons with a diminished ability to sense temperature (e.g., persons with diabetes, lowerlimb nerve damage, or paralysis) or with sensitive skin should not use seat heaters.

Do not use the seat heaters even in LO when the engine is off. Under such conditions, the battery may be weakened, making the engine difficult to start.

After a certain period of time, the strength setting for the rear seat heaters will automatically be reduced by one level at a time until the rear seat heaters shuts off. The elapsed time varies according to the interior environment.

## Using Automatic Climate Control

The automatic climate control system maintains the interior temperature you select. The system also selects the proper mix of heated or cooled air that raises or lowers the interior temperature to your preference as quickly as possible.

### Models with SYNC button

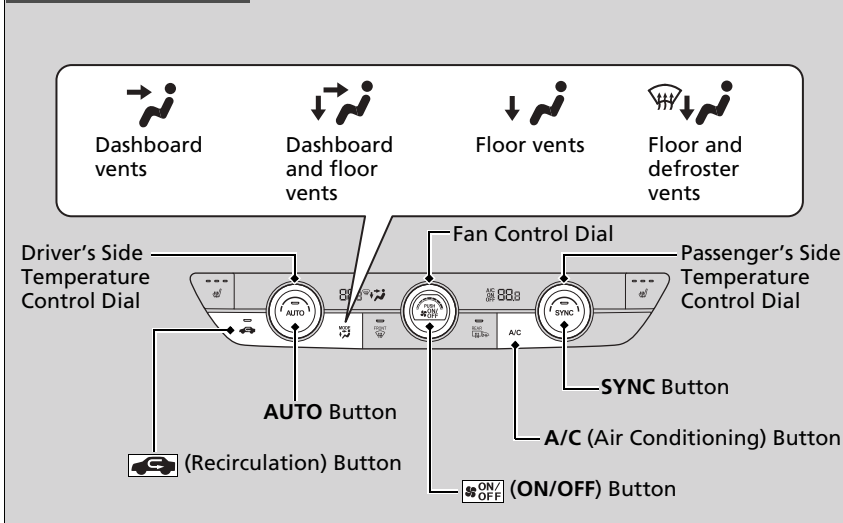

Use the system when the engine is running.

1. Press the **AUTO** button.
2. Adjust the interior temperature using the driver's side or passenger's side temperature control dial.
3. Press the  (**ON/OFF**) button to cancel.

### Using Automatic Climate Control

If any buttons are pressed while using the climate control system in auto, the function of the button that was pressed will take priority.

The auto button indicator\*/**AUTO** indicator\* will go off, but functions unrelated to the button that were pressed will be controlled automatically.

During idle-stops, air-conditioning is suspended, and only the blower remains active. If you do not want air-conditioning suspended, press the Auto Idle Stop **OFF** button to cancel idle-stop.

To prevent cold air from blowing in from outside, the fan may not start immediately when the **AUTO** button is pressed.

If the interior is very warm, you can cool it down more rapidly by partially opening the windows, turning the system on auto, and setting the temperature to low. Change the fresh air mode to recirculation mode until the temperature cools down.

When you set the temperature to the lower or upper limit, **Lo** or **Hi** is displayed.



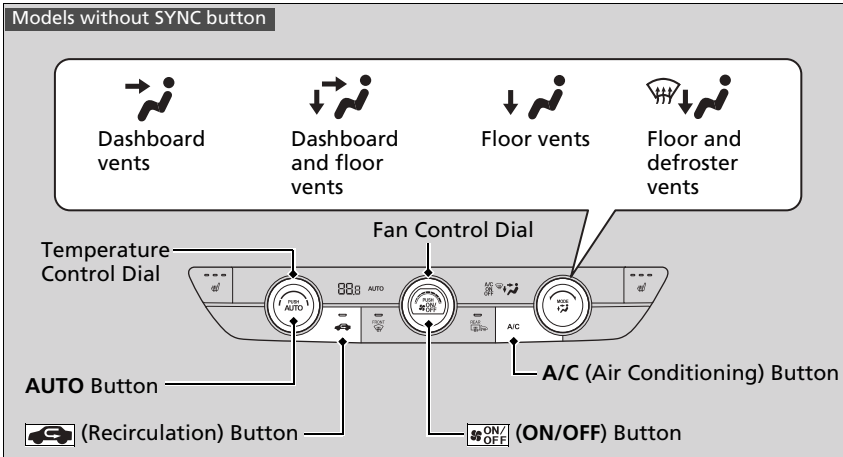

Use the system when the engine is running.

1. Press the **AUTO** button.
2. Adjust the interior temperature using the temperature control dial.
3. Press the (**ON/OFF**) button to cancel.

### ■ Switching between the recirculation and fresh air modes

Press the (recirculation) button and switch the mode depending on environmental conditions.

Recirculation mode (indicator on): Recirculates air from the vehicle's interior through the system.

Fresh air mode (indicator off): Maintains outside ventilation. Keep the system in fresh air mode in normal situations.

### ►► Using Automatic Climate Control

Pressing the button switches the climate control system between on and off. When turned on, the system returns to your last selection.

## Defrosting the Windshield and Windows

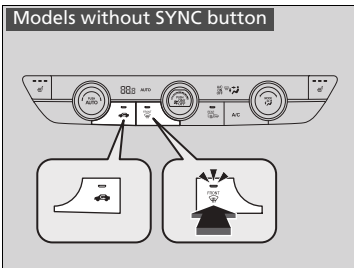
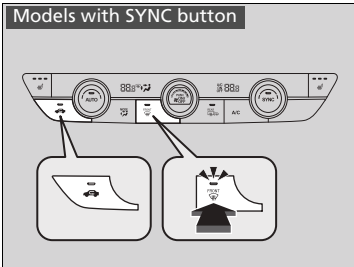

Pressing the  (windshield defroster) button turns the air conditioning system on and automatically switches the system to fresh air mode.

Press the  button again to turn off, the system returns to the previous settings.

### Defrosting the Windshield and Windows

**For your safety, make sure you have a clear view through all the windows before driving.**

Do not set the temperature near the upper or lower limit.

When cold air hits the windshield, the outside of the windshield may fog up.

If you press the  button during Auto Idle Stop, the engine restarts automatically.

#### Manual transmission models

To defog during the Auto Idle Stop, restart the engine as follows.

1. Make sure the shift lever is in **N**.
2. Press the  button.

■ To rapidly defrost the windows

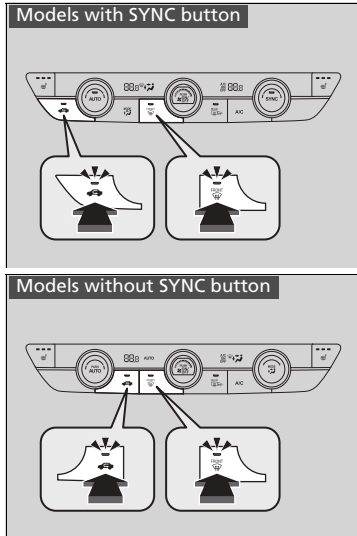

1. Press the  button.
2. Press the  button.

☒ To rapidly defrost the windows

After defrosting the windows, switch over to fresh air mode. If you keep the system in recirculation mode, the windows may fog up from humidity. This impedes visibility.

## ■ Synchronization Mode\*

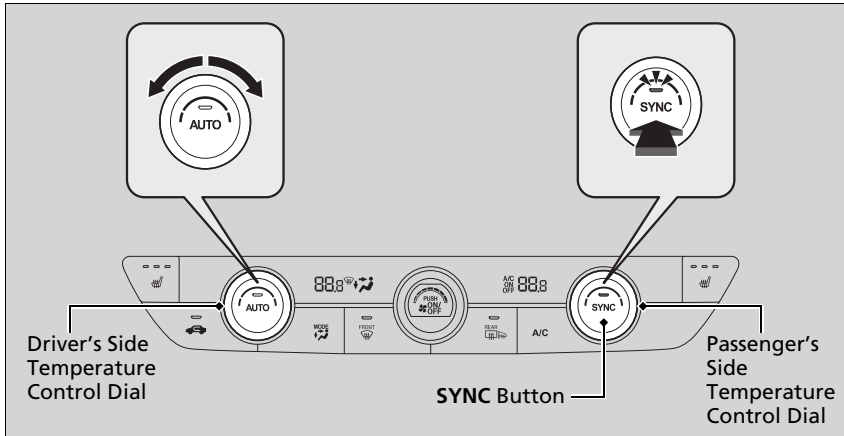

You can set the temperature synchronously for the driver's side and the passenger's side in synchronization mode.

1. Press the **SYNC** button.
  - The system switches to synchronization mode.
2. Adjust the temperature using the driver's side temperature control dial.

Press the **SYNC** button or adjust the interior temperature using the passenger's side temperature control dial to return to dual mode.

## ☒ Synchronization Mode\*

When the system is in dual mode, the driver's side temperature and the passenger's side temperature can be set separately.

When you press the  button, the system changes to synchronization mode.

## Automatic Climate Control Sensors

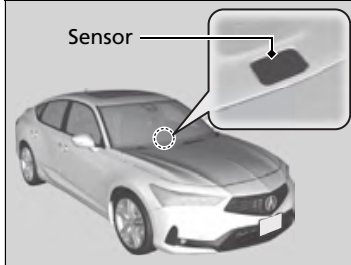

Sensor

The automatic climate control system is equipped with sensors. Do not cover or spill any liquid on them.

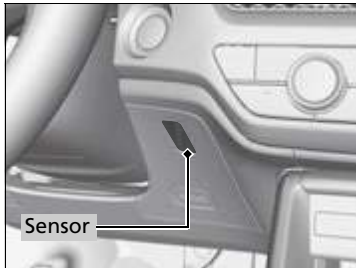

Sensor

This page intentionally left blank.

# Features

This chapter describes how to operate technology features.

## **Audio System**

About Your Audio System ..... 226

USB Port(s)..... 227

Audio System Theft Protection ..... 229

Audio Remote Controls ..... 230

**Audio System Basic Operation** ..... 234, 259

**Audio Error Messages** ..... 328

## **General Information on the Audio**

**System** ..... 330

**Customized Features** ..... 351, 359

**Bluetooth® HandsFreeLink®** ..... 383, 403

## About Your Audio System

The audio system features AM/FM radio and SiriusXM® Radio service\*. It can also play USB flash drives, iPod, iPhone and *Bluetooth*® devices.

You can operate the audio system from the buttons and switches on the panel, the remote controls on the steering wheel, or the icons on the touchscreen interface.

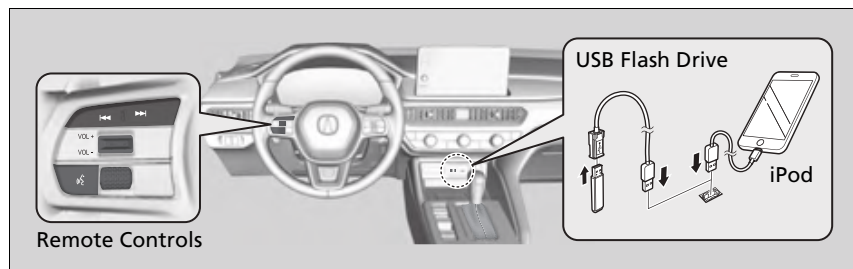

### About Your Audio System

SiriusXM® Radio\* is available on a subscription basis only. For more information on SiriusXM® Radio\*, contact a dealer.

#### General Information on the Audio System P. 330

SiriusXM® Radio\* is available in the United States and Canada, except Hawaii, Alaska, and Puerto Rico.

SiriusXM®\* is a registered trademark of SiriusXM Radio, Inc.

State or local laws may prohibit the operation of handheld electronic devices while operating a vehicle.



## USB Port(s)

### On the front panel

#### Models with 7-in. Color Touchscreen



#### Models with 9-in. Color Touchscreen



### ■ On the front panel

The USB port (2.5A) is for charging devices, playing audio files, and connecting compatible phones with Apple CarPlay or Android Auto.

- ▶ To prevent any potential issues, be sure to use an Apple MFi Certified Lightning Connector for Apple CarPlay, and for Android Auto, the USB cables should be certified by USB-IF to be compliant with USB 2.0 Standard.

### ■ On the front panel \*

The USB port (3.0A) is only for charging devices.

- ▶ You cannot play music even if you have connected music players to it.

### ⌘ USB Port(s)

- Do not leave the iPod or USB flash drive in the vehicle. Direct sunlight and high temperatures may damage it.
- We recommend that you use a USB cable if you are attaching a USB flash drive to the USB port.
- Do not connect the iPod or USB flash drive using a hub.
- Do not use a device such as a card reader or hard disk drive, as the device or your files may be damaged.
- We recommend backing up your data before using the device in your vehicle.
- Displayed messages may vary depending on the device model and software version.

### USB charge

The USB port can supply up to 2.5A/3.0A of power. It does not output 2.5A/3.0A unless requested by the device.

For amperage details, read the operating manual of the device that needs to be charged.

Under certain conditions, a device connected to the port may generate noise to the radio station you are listening to.

\* Not available on all models

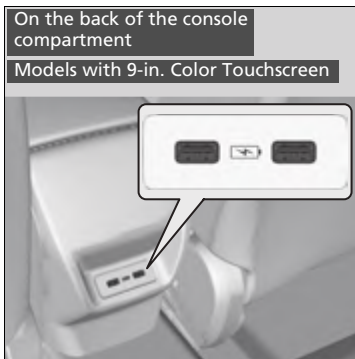

■ **On the back of the console compartment\***

The USB ports (2.5A) are only for charging devices.

- ▶ You cannot play music even if you have connected music players to them.

## Audio System Theft Protection

---

The audio system is disabled when it is disconnected from the power source, such as when the battery is disconnected or goes dead. In certain conditions, the system may display a code entry screen. If this occurs, reactivate the audio system.

### ■ Reactivating the audio system

1. Set the power mode to ON.
2. Turn on the audio system.
3. Press and hold the **VOL/⏻** **AUDIO** (Volume/Power) knob for more than two seconds.
  - ▶ The audio system is reactivated when the audio control unit establishes a connection with the vehicle control unit. If the control unit fails to recognize the audio unit, you must go to a dealer and have the audio unit checked.

## Audio Remote Controls

### Models with 7-in. Color Touchscreen

Allow you to operate the audio system while driving. The information is shown on the driver information interface.

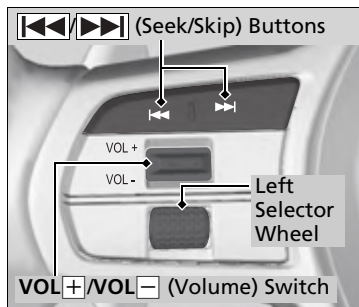

### VOL+ / VOL- (Volume) Switch

**Press Up:** To increase the volume.

**Press Down:** To decrease the volume.

### ⏪ / ⏩ (Seek/Skip) Buttons

- When listening to the radio
  - Press** ⏩: To select the next preset radio station.
  - Press** ⏪: To select the previous preset radio station.
  - Press and hold** ⏩: To select the next strong station.
  - Press and hold** ⏪: To select the previous strong station.
- When listening to an iPod, USB flash drive, *Bluetooth*® Audio, or Smartphone Connection
  - Press** ⏩: To skip to the next song.
  - Press** ⏪: To go back to the beginning of the current or previous song.
- When listening to a USB flash drive or *Bluetooth*® Audio
  - Press and hold** ⏩: To skip to the next folder/group.
  - Press and hold** ⏪: To go back to the previous folder/group.

### ▶▶ Audio Remote Controls

Some modes appear only when an appropriate device or medium is used.

Depending on the *Bluetooth*® device you connect, some functions may not be available.

## Left Selector Wheel

### Roll up or down:

To cycle through the modes, roll up or down and then press the left selector wheel:

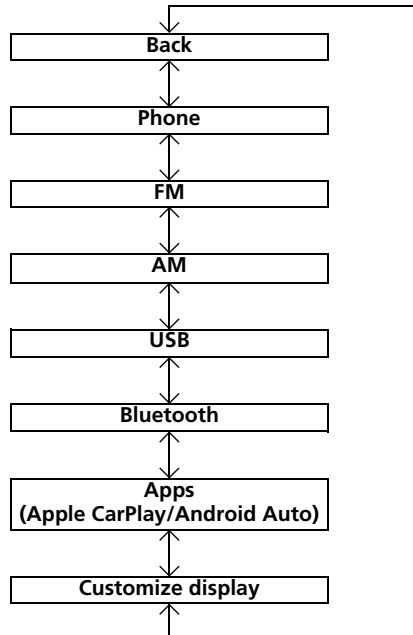

**Models with 9-in. Color Touchscreen**

Allow you to operate the audio system while driving. The information is shown on the driver information interface.

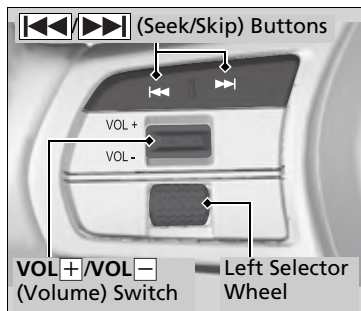

**VOL +/VOL - (Volume) Switch**

**Press Up:** To increase the volume.

**Press Down:** To decrease the volume.

**⏮️/⏭️ (Seek/Skip) Buttons**

- When listening to the radio
  - Press** ⏭️: To select the next preset radio station.
  - Press** ⏮️: To select the previous preset radio station.
  - Press and hold** ⏭️: To select the next strong station.
  - Press and hold** ⏮️: To select the previous strong station.
- When listening to an iPod, USB flash drive, *Bluetooth*® Audio, or Smartphone Connection
  - Press** ⏭️: To skip to the next song.
  - Press** ⏮️: To go back to the beginning of the current or previous song.
- When listening to a USB flash drive
  - Press and hold** ⏭️: To skip to the next folder.
  - Press and hold** ⏮️: To go back to the previous folder.

## Left Selector Wheel

### Roll up or down:

To cycle through the modes, roll up or down and then press the left selector wheel:

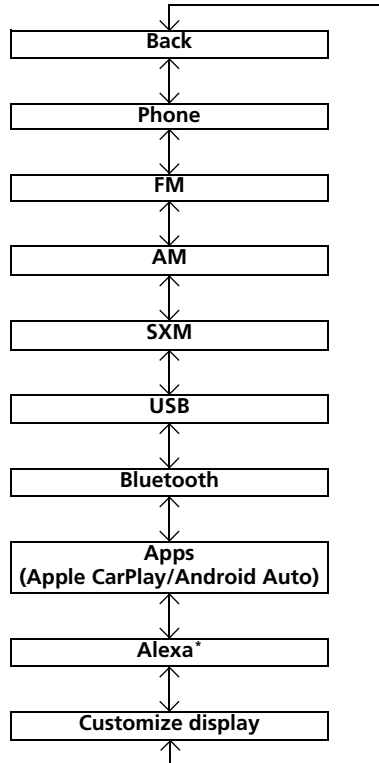

\* Not available on all models

## Models with 7-in. Color Touchscreen

To use the audio system, the power mode must be in ACCESSORY or ON.

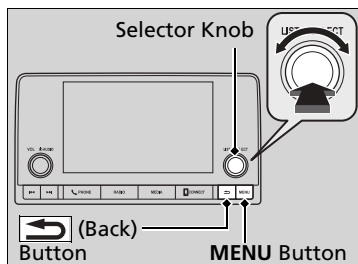

Use the selector knob or **MENU** button to access some audio functions.

Press  to switch between the normal and extended display for some functions.

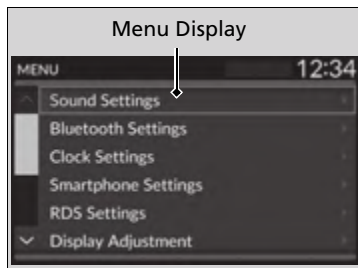

**Selector knob:** Rotate left or right to scroll through the available choices. Press  to set your selection.

**MENU button:** Press to display the menu screen.

 **(Back) button:** Press to go back to the previous display.





## Audio System Basic Operation

These indications are used to show how to operate the selector knob.

Rotate  to select.

Press  to enter.

### Menu Items

-  **Adjust Clock** P. 142
-  **Adjusting the Sound** P. 235
-  **Display Setup** P. 236
-  **Customized Features** P. 351

Press the buttons on the steering wheel to change any audio setting.

-  **Audio Remote Controls** P. 230

### Touchscreen operation

- Use simple gestures - including touching, swiping and scrolling - to operate certain audio functions.
- Some items may be grayed out during driving to reduce the potential for distraction.
- You can select them when the vehicle is stopped.
- Wearing gloves may limit or prevent touchscreen response.

You can change the touchscreen sensitivity setting.

-  **Customized Features** P. 351



## Adjusting the Sound

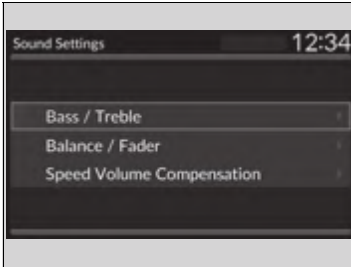

1. Select an audio source.
2. Press the **MENU** button.
3. Select **Sound Settings**.

Select an item from the following choices:

- **Bass / Treble:** Bass, Midrange, Treble
- **Balance / Fader:** Balance, Fader
- **Speed Volume Compensation:** Set the amount of volume increase.



### Adjusting the Sound

The **Speed Volume Compensation** adjusts the volume level based on the vehicle speed. As you go faster, audio volume increases. As you slow down, audio volume decreases.

## Display Setup

You can set the screen brightness separately for Day and Night modes.

### ■ Changing the Screen Brightness

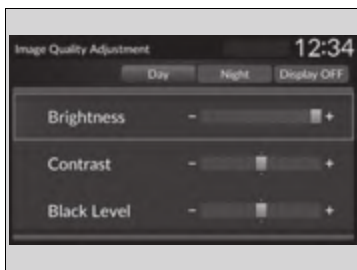

1. Press the **MENU** button.
2. Select **Display Adjustment**.
3. Select **Day** or **Night**.
4. Select the setting you want.

### ☒ Changing the Screen Brightness

You can change the **Contrast** and **Black Level** settings in the same manner.

You can adjust the settings by sliding or tapping on the bar.

## Playing AM/FM Radio

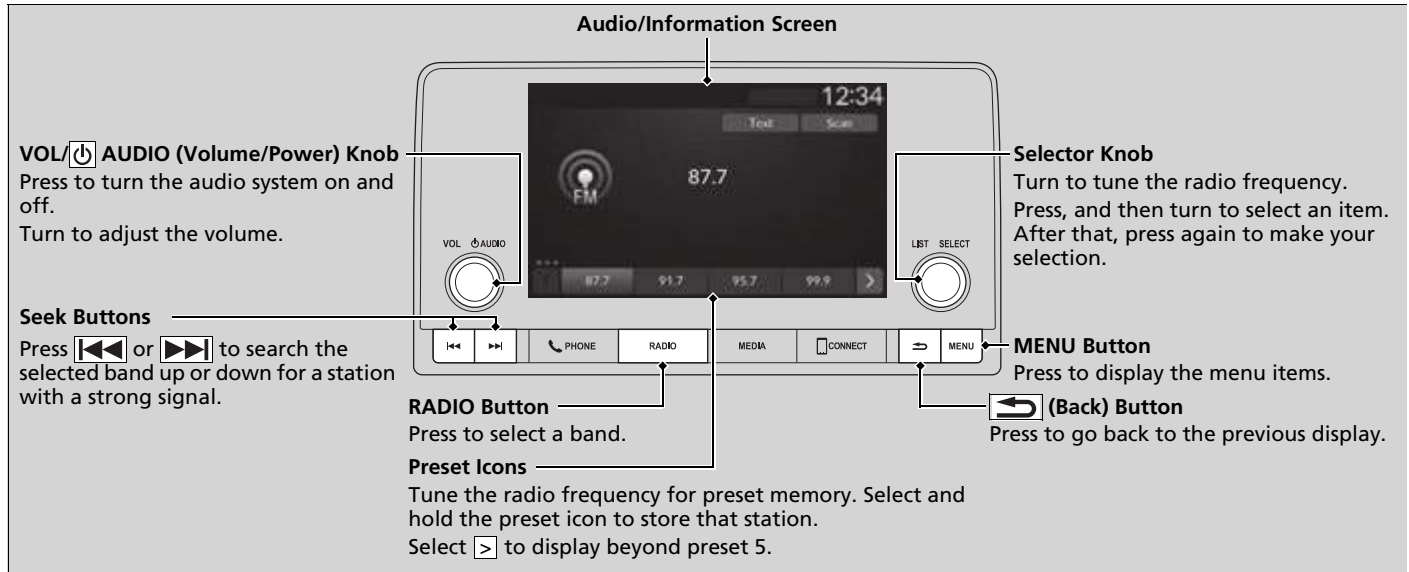

## ■ Radio Data System (RDS)

Provides text data information related to your selected RDS capable FM station.

### ■ To find an RDS station from Station List

1. Press  while listening to an FM station.
2. Select the station.

### ■ Update List

Updates your available station list at any time.

1. Press  while listening to an FM station.
2. Select **Refresh**.

### ■ Radio text

Displays the radio text information of the selected RDS station.

1. Select **Text**.

### ■ Scan

Samples each of the strongest stations on the selected band for 10 seconds.

1. Select **Scan**.

To turn off scan, select **Stop** or press the  button.

## ▶▶ Playing AM/FM Radio

Stereo reproduction in AM is not available.

You can store 12 AM stations and 12 FM stations into the preset memory.

Switching the Audio Mode  
Roll the left selector wheel.

 **Audio Remote Controls** P. 230

## ▶▶ Radio Data System (RDS)

When you select an RDS-capable FM station, the RDS automatically turns on, and the station name is displayed under the frequency. However, when the signals of that station become weak, the station name disappears.

## Playing an iPod

Using your USB connector, connect the iPod to the USB port, then select the iPod mode.

 **USB Port(s)** P. 227

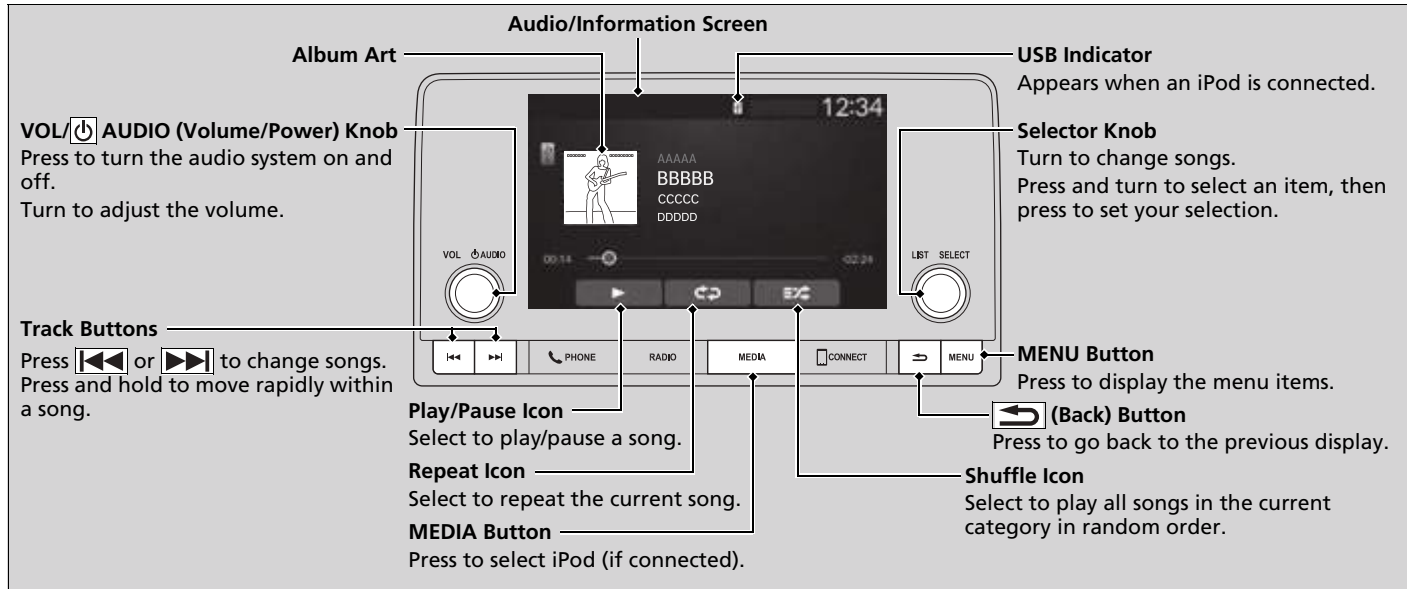

## ■ How to Select a Song from the iPod Music List

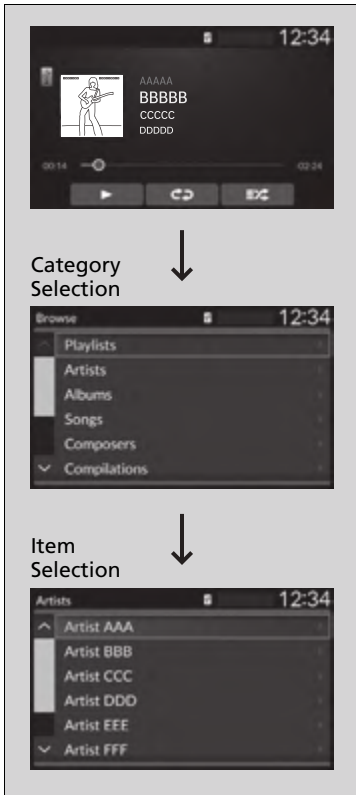

1. Press  to display the iPod music list.

2. Select a category.

3. Select an item.

▶ Select an item repeatedly until a desired item you want to listen is displayed.

## ▶▶ Playing an iPod

Available operating functions vary on models or versions. Some functions may not be available on the vehicle's audio system.

If there is a problem, you may see an error message on the audio/information screen.

 **iPod/USB Flash Drive** P. 328

## How to Select a Play Mode

You can select repeat and shuffle modes when playing a song.

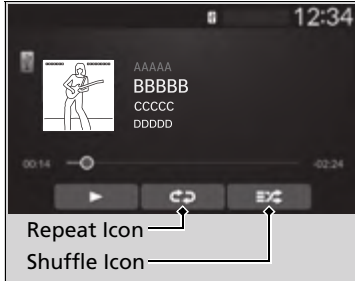

### Shuffle/Repeat

Select shuffle or repeat icon repeatedly until a desired mode.

### To turn off a play mode

Select the mode you want to turn off.

## How to Select a Play Mode

Play Mode Menu Items

### Shuffle



**Shuffle off:** Shuffle mode to off.



**Shuffle All Songs:** Plays all available songs in a selected list in random order.

### Repeat



**Repeat off:** Repeat mode to off.



**Repeat all:** Repeats the all songs.



**Repeat Song:** Repeats the current song.

## Playing a USB Flash Drive

Your audio system reads and plays sound files on a USB flash drive in either MP3, WMA, AAC<sup>\*1</sup>, FLAC, or WAV format.

Connect your USB flash drive to the USB port, then press the **MEDIA** button.

➤ **USB Port(s)** P. 227

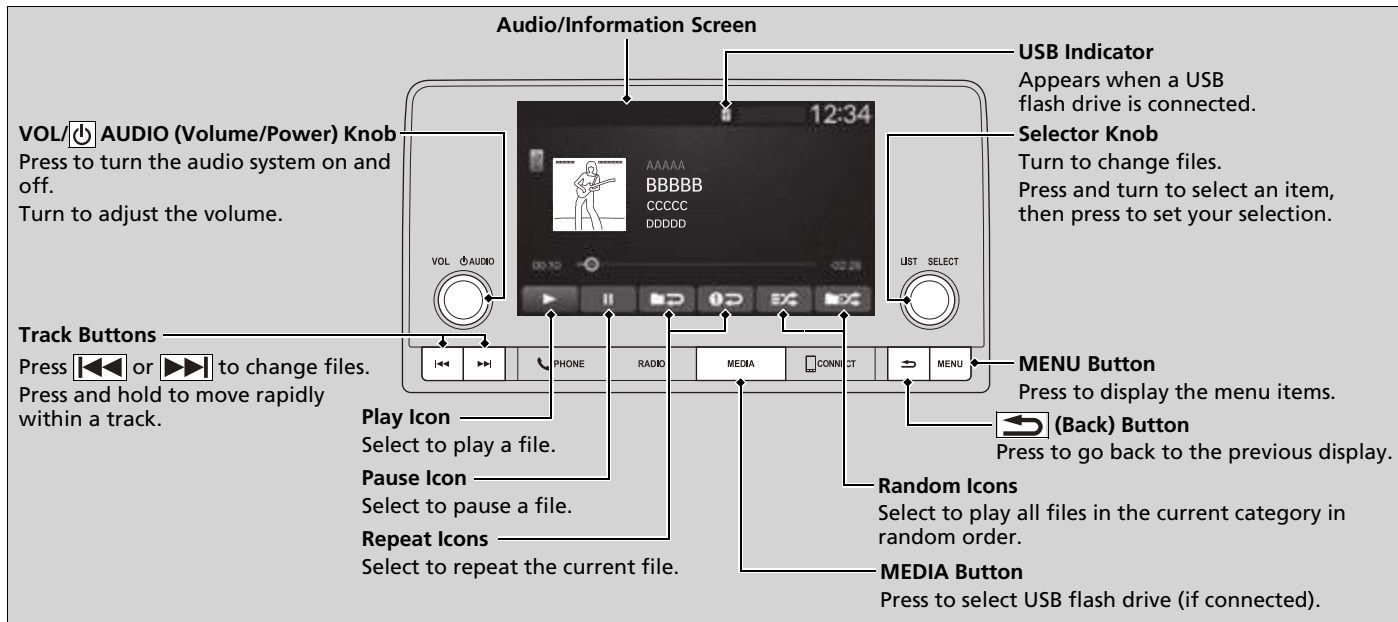

\*1: Only AAC format files recorded with iTunes are playable on this unit.



## How to Select a File from a Folder

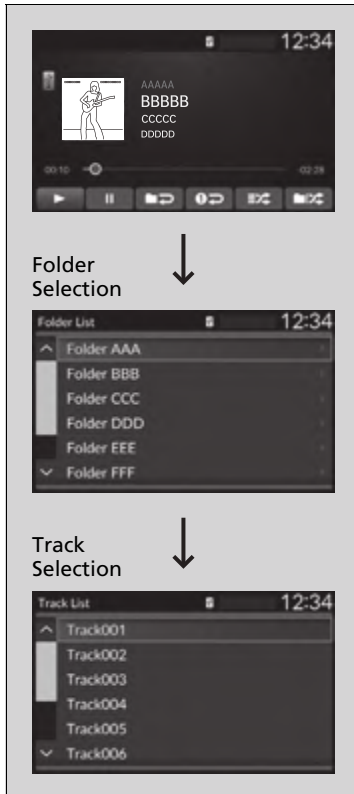

1. Press  to display a folder list.

2. Select a folder.

3. Select a file.

### ▶▶▶ Playing a USB Flash Drive

Use the recommended USB flash drives.

▶ **General Information on the Audio System**  
P. 330

Files in WMA format protected by digital rights management (DRM) cannot be played.

The audio system displays **Unplayable File**, and then skips to the next file.

If there is a problem, you may see an error message on the audio/information screen.

▶ **iPod/USB Flash Drive** P. 328

## ■ How to Select a Play Mode

You can select repeat and random modes when playing a file.

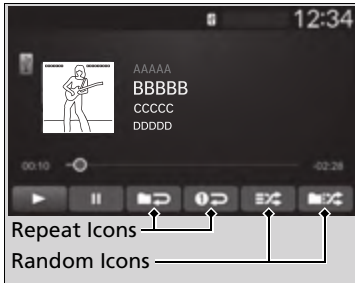

### ■ Random/Repeat

Select random or repeat icon.

### ■ To turn off a play mode

Select the mode you want to turn off.

## ▶▶ How to Select a Play Mode

Play Mode Menu Items

### Random

 **Random All Tracks:** Plays all files in random order.

 **Random in Folder:** Plays all files in the current folder in random order.

### Repeat

 **Repeat track:** Repeats the current file.

 **Repeat folder:** Repeats all files in the current folder.

## Playing *Bluetooth*® Audio

Your audio system allows you to listen to music from your *Bluetooth*-compatible phone.

This function is available when the phone is paired and connected to the vehicle's *Bluetooth*® HandsFreeLink® (HFL) system.

☛ **Phone Setup** P. 388

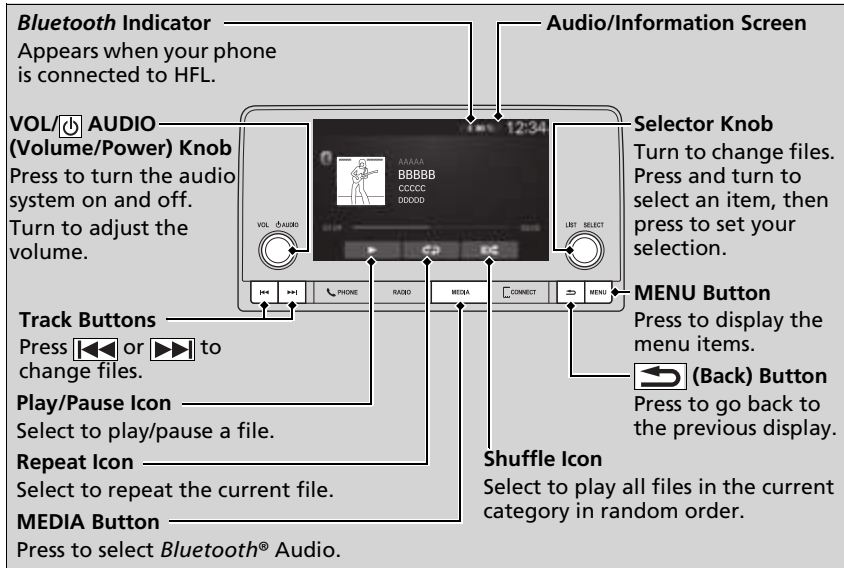

### ▶▶ Playing *Bluetooth*® Audio

Not all *Bluetooth*-enabled phones with streaming audio capabilities are compatible with the system.

For a list of compatible phones:

- U.S.: Visit [www.handsfreelink.com/Acura](http://www.handsfreelink.com/Acura), or call 1-888-528-7876.
- Canada: For more information on smartphone compatibility, call 1-855-490-7351.

In some states, it may be illegal to perform some data device functions while driving.

Only one phone can be used with HFL at a time. When there are more than two paired phones in the vehicle, the system automatically connects to the prioritized phone. You can assign priority to a phone in the **Bluetooth Settings** menu.

☛ **HFL Menus** P. 386

To change the searched phone manually, select **Go to Device List**.

In some cases, the name of the artist, album, or track may not appear correctly.

Some functions may not be available on some devices.

If a phone is currently connected via Apple CarPlay or Android Auto, *Bluetooth*® Audio from that phone is unavailable. However, a second previously paired phone can stream *Bluetooth*® Audio by selecting **Audio** from the *Bluetooth*® device list.

☛ **Phone Setup** P. 388

Continued

## ■ To Play *Bluetooth*® Audio Files

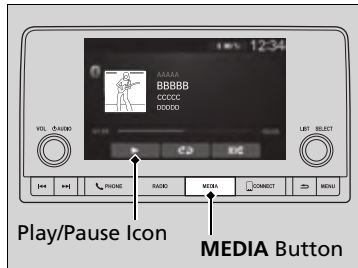

1. Make sure that your phone is paired and connected to HFL.
2. Press the **MEDIA** button until the *Bluetooth*® Audio Source is selected.

If the phone is not recognized, another HFL-compatible phone, which is not compatible for *Bluetooth*® Audio, may already be connected.

### ■ To play or pause a file

Select the play/pause icon.

## ▶▶ To Play *Bluetooth*® Audio Files

To play the audio files, you may need to operate your phone. If so, follow the phone maker's operating instructions.

The pause function may not be available on some phones.

If any audio device is connected to the USB port, you may need to press the **MEDIA** button repeatedly to select the *Bluetooth*® Audio system.

Switching to another mode pauses the music playing from your phone.

Check the volume setting of your phone if the audio volume is too loud or soft.

## How to Select a Song from the Music Search List

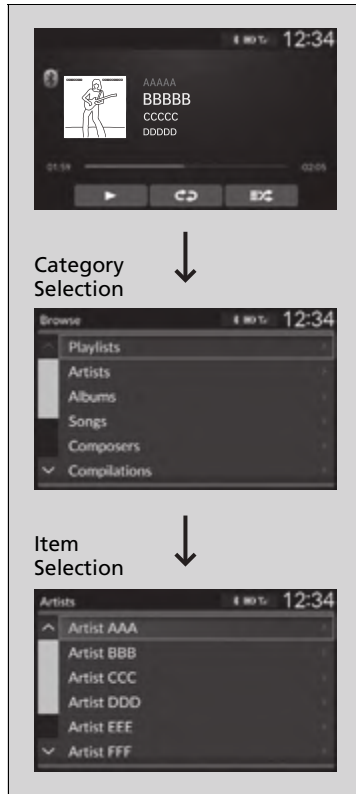

1. Press  to display the music search list.

2. Select a category.

3. Select an item.

▶ Select an item repeatedly until a desired item you want to listen to is displayed.

### How to Select a Song from the Music Search List

Depending on the *Bluetooth*® device you connect, some or all of the categories may not be displayed.

## ■ How to Select a Play Mode

You can select repeat and shuffle modes when playing a song.

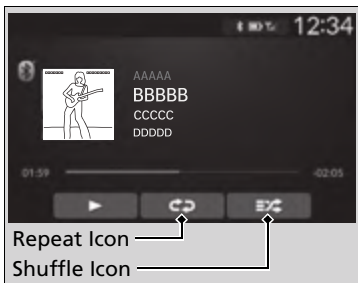

### ■ Shuffle/Repeat

Select shuffle or repeat icon repeatedly until a desired mode.



### ■ To turn off a play mode

Select the mode you want to turn off.



## ▶▶ How to Select a Play Mode

Play Mode Menu Items

### Shuffle

-  **Shuffle off:** Shuffle mode to off.
-  **Shuffle Albums:** Plays all available albums in a selected list in random order.
-  **Shuffle All Songs:** Plays all available songs in a selected list in random order.

### Repeat

-  **Repeat off:** Repeat mode to off.
-  **Repeat all:** Repeats the all songs.
-  **Repeat Song:** Repeats the current song.

Depending on the *Bluetooth*® device you connect, some or all of the functions may not be displayed.

## Siri Eyes Free

You can talk to Siri using the  (Talk) button on the steering wheel when your iPhone is paired to the *Bluetooth*® HandsFreeLink® (HFL) system.

 **Phone Setup** P. 388

### ■ Using Siri Eyes Free

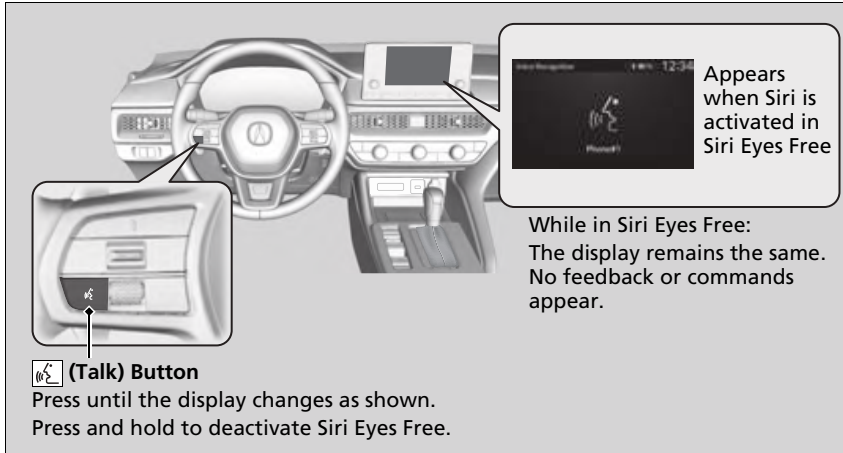

#### Siri Eyes Free

Check Apple Inc. website for features available for Siri.

We recommend against using Siri other than in Siri Eyes Free mode while operating a vehicle.

#### Using Siri Eyes Free

Some commands work only on specific phone features or apps.

## Smartphone Voice Recognition

You can use Smartphone Voice Recognition using the  (Talk) button on the steering wheel when your Android phone is paired to the *Bluetooth*<sup>®</sup> HandsFreeLink<sup>®</sup> (HFL) system.

➤ **Phone Setup** P. 388

### Using Smartphone Voice Recognition

#### Using Smartphone Voice Recognition

Depending on your Android phone, you may need to operate your phone.

Some commands work only on specific phone features or apps.



The diagram shows the car's interior, focusing on the steering wheel and the center console. A callout box points to the Talk button on the steering wheel, which is a square button with a microphone icon. Another callout box points to the center console display, which shows a smartphone interface with a microphone icon and the text "Smartphone Voice Recognition is activated".

** (Talk) Button**  
Press to activate Smartphone Voice Recognition.  
Press and hold to deactivate Smartphone Voice Recognition.

Appears when Smartphone Voice Recognition is activated

While in Smartphone Voice Recognition:  
The display remains the same.  
No feedback or commands appear.



# Apple CarPlay

If you connect an Apple CarPlay-compatible iPhone to the system via the front USB, you can use the audio/information screen, instead of the iPhone display, to make a phone call, listen to music, view maps (navigation), and access messages.

📄 **USB Port(s)** P. 227

## ■ Apple CarPlay Menu

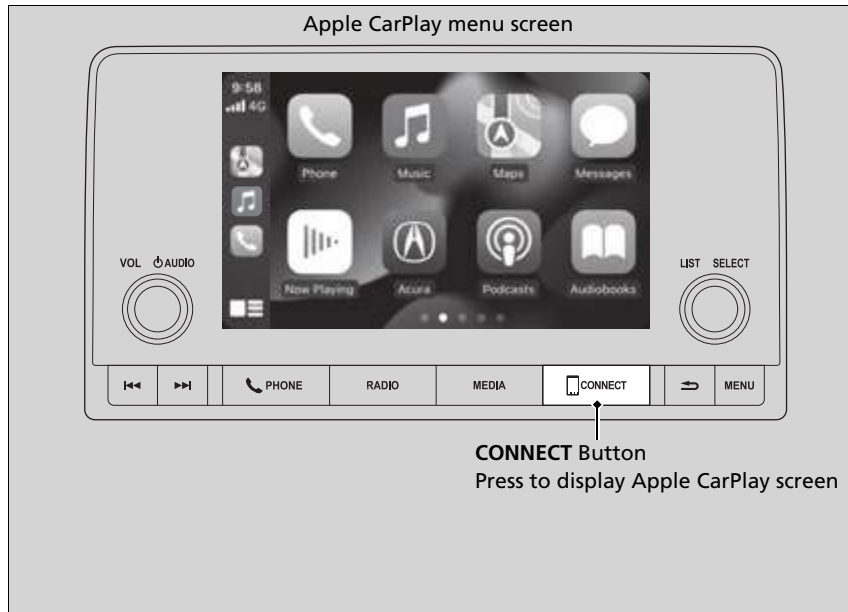

### 📄 Apple CarPlay

Only iPhone 5 or newer versions with iOS 8.4 or later are compatible with Apple CarPlay.

We recommend using the latest OS.

Park in a safe place before connecting your iPhone to Apple CarPlay and when launching any compatible apps.

To directly access the Apple CarPlay phone function, press the **PHONE** button. While connected to Apple CarPlay, calls are only made through Apple CarPlay. If you want to make a call with HandsFreeLink, turn Apple CarPlay OFF or detach the USB cable from your iPhone.



📄 **Setting Up Apple CarPlay** P. 253

When your iPhone is connected to Apple CarPlay, it is not possible to use the *Bluetooth*® Audio or *Bluetooth*® HandsFreeLink®. However, other previously paired phones can stream audio via *Bluetooth*® while Apple CarPlay is connected.

📄 **Phone Setup** P. 388

Apple CarPlay and Android Auto cannot run at the same time.

For details on countries and regions where Apple CarPlay is available, as well as information pertaining to function, refer to the Apple homepage.

- **Phone**  
Access the contact list, make phone calls, or listen to voicemail.
- **Messages**  
Check and reply to text messages, or have messages read to you.
- **Music**  
Play music stored on your iPhone.
- **Maps**  
Display Apple Maps and use the navigation function just as you would on your iPhone.
- **Acura**  
Select the **Acura** icon to go back to the home screen.
-   
Go back to the Apple CarPlay Dashboard screen.
-   
Go back to the Apple CarPlay menu screen.

#### Apple CarPlay

##### **Apple CarPlay Operating Requirements & Limitations**

Apple CarPlay requires a compatible iPhone with an active cellular connection and data plan. Your carrier's rate plans will apply.

Changes in operating systems, hardware, software, and other technology integral to providing Apple CarPlay functionality, as well as new or revised governmental regulations, may result in a decrease or cessation of Apple CarPlay functionality and services. Acura cannot and does not provide any warranty or guarantee of future Apple CarPlay performance or functionality.

It is possible to use 3rd party apps if they are compatible with Apple CarPlay. Refer to the Apple homepage for information on compatible apps.

To adjust the ring tone volume, the guidance volume of the navigation or Siri, or the audio volume, turn the **VOL/🔊 AUDIO** (Volume/Power) knob while the sound you want to adjust is playing.

## ■ Setting Up Apple CarPlay

After you have connected your iPhone to the system via the front USB, use the following procedure to set up Apple CarPlay. Use of Apple CarPlay will result in the transmission of certain user and vehicle information (such as vehicle location, speed, and status) to your iPhone to enhance the Apple CarPlay experience. You will need to consent to the sharing of this information on the audio/information screen.

## ■ Enabling Apple CarPlay

### ■ Connecting Apple CarPlay Using the USB Cable to the USB Port

1. Connect the iPhone to the USB port using the USB cable.

➤ **USB Port(s)** P. 227

▶ The confirmation screen will be displayed.

2. Select **Yes**.

▶ If you do not want to connect Apple CarPlay, select **No**.

You may change the consent settings under the **Smartphone Settings** menu.

### ☒ Setting Up Apple CarPlay

Only initialize Apple CarPlay when you are safely parked.

When Apple CarPlay first detects your iPhone, you will need to set up your iPhone. Refer to the instruction manual that came with your iPhone.

You can use the following procedure to disconnect or delete the devices connecting Apple CarPlay:

Press the **MENU** button →

Select Smartphone Settings → Apple CarPlay

→ Select device

### Use of user and vehicle information

The use and handling of user and vehicle information transmitted to/from your iPhone by Apple CarPlay is governed by the Apple iOS terms and conditions and Apple's Privacy Policy.

## ■ Operating Apple CarPlay with Siri

Press the  (Talk) button to activate Siri.

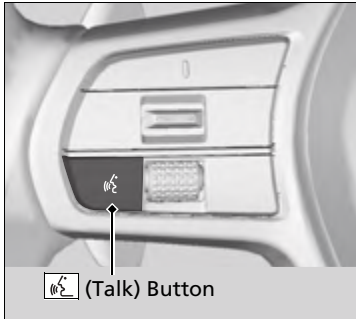

### (Talk) Button:

Press to activate Siri.

Press again to deactivate Siri.

## ▶▶ Operating Apple CarPlay with Siri

Below are examples of questions and commands for Siri:

- What movies are playing today?
- Call dad at work.
- What song is this?
- How's the weather tomorrow?
- Read my latest email.

For more information, please visit [www.apple.com/ios/siri](http://www.apple.com/ios/siri).

To adjust the guidance volume of Siri, turn the **VOL/**  **AUDIO** (Volume/Power) knob while Siri is activated.

## Android Auto™

When you connect an Android phone to the audio system via the USB port, Android Auto is automatically initiated. When connected via Android Auto, you can use the audio/information screen to access the Phone, Google Maps (Navigation), and Google Now functions. When you first use Android Auto, a tutorial will appear on the screen.

We recommend that you complete this tutorial while safely parked before using Android Auto.

➤ **USB Port(s)** P. 227

➤ **Auto Pairing Connection** P. 257

### Android Auto™

Android Auto is a trademark of Google LLC.

We recommend that you update Android OS to the latest version when using Android Auto.

*Bluetooth* A2DP cannot be used while your phone is connected to Android Auto.

To use Android Auto on a smartphone with Android 9.0 (Pie) or earlier, you need to download the Android Auto app from Google Play to your smartphone.

Park in a safe place before connecting your Android phone to Android Auto and when launching any compatible apps.

To use Android Auto, connect the USB cable to the USB port.

➤ **USB Port(s)** P. 227

When your Android phone is connected to Android Auto, it is not possible to use the *Bluetooth*® Audio. However, other previously paired phones can stream audio via *Bluetooth*® while Android Auto is connected.

➤ **Phone Setup** P. 388

Apple CarPlay and Android Auto cannot run at the same time.

## ■ Android Auto Menu

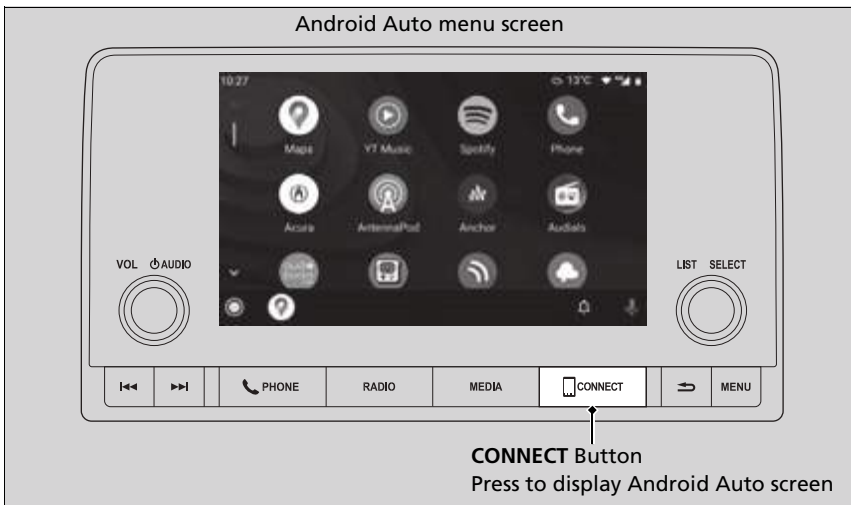

- **Maps**  
Display Google Maps and use the navigation function just as you would with your Android phone. When the vehicle is in motion, it is not possible to make keyboard entries. Stop the vehicle in a safe location to undertake a search or provide other inputs.
- **Phone**  
Make and receive phone calls as well as listen to voicemail.
- **Acura**  
Select the **Acura** icon to go back to the home screen.

## ▣ Android Auto™

For details on countries and regions where Android Auto is available, as well as information pertaining to function, refer to the Android Auto homepage.

Screens may differ depending on the version of the Android Auto app you are using.



### Android Auto Operating Requirements & Limitations

Android Auto requires a compatible Android phone with an active mobile connection and data plan. Your carrier's rate plans will apply.

Changes in operating systems, hardware, software, and other technology integral to providing Android Auto functionality, as well as new or revised governmental regulations, may result in a decrease or cessation of Android Auto functionality and services. Acura cannot and does not provide any warranty or guarantee of future Android Auto performance or functionality.

It is possible to use 3rd party apps if they are compatible with Android Auto. Refer to the Android Auto homepage for information on compatible apps.

To adjust the ring tone volume, the guidance volume of the navigation or voice recognition, or the audio volume, turn the **VOL**  **AUDIO** (Volume/Power) knob while the sound you want to adjust is playing.

-  Operate Android Auto with your voice.
-  You can check Android notifications.
-  (Android Auto Home)  
Display useful information organized by Android Auto into simple cards that appear just when they're needed.

## Auto Pairing Connection

When you connect an Android phone to the unit via the USB port, Android Auto is automatically initiated.

## Enabling Android Auto

To enable Android Auto after connecting an Android phone to the system, select **Yes** on the screen.

You may change the consent settings under the **Smartphone Settings** menu.

### ☒ Enabling Android Auto

Only initialize Android Auto when you are safely parked. When Android Auto first detects your phone, you will need to set up your phone so that auto pairing is possible. Refer to the instruction manual that came with your phone.

You can use the following procedure to disconnect or delete the devices connecting Android Auto after you have completed the initial setup:

Press the **MENU** button →  
Select Smartphone Settings → Android Auto →  
Select device

### Use of user and vehicle information

The use and handling of user and vehicle information transmitted to/from your phone by Android Auto is governed by the Google's Privacy Policy.

## ■ Operating Android Auto with Voice Recognition

Press the  (Talk) button to operate Android Auto with your voice.

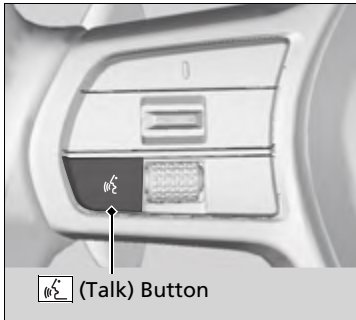

### (Talk) Button:

Press to operate Android Auto with your voice.  
Press again to deactivate voice recognition.

## ▶▶ Operating Android Auto with Voice Recognition

Below are examples of commands you can give with voice recognition:

- Reply to text.
- Call my wife.
- Navigate to Acura.
- Play my music.
- Send a text message to my wife.
- Call flower shop.

For more information, please refer to the Android Auto homepage.

You can also activate the voice recognition function by selecting the  icon in the lower-right corner of the screen.

To adjust the guidance volume of voice recognition, turn the **VOL**  **AUDIO** (Volume/Power) knob while the guidance is playing.



# Audio System Basic Operation

## Models with 9-in. Color Touchscreen

To use the audio system function, the power mode must be in ACCESSORY or ON.

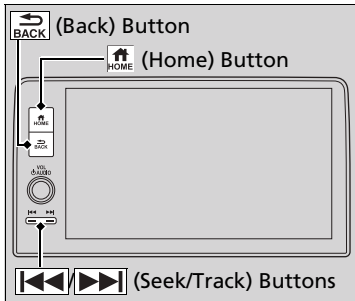

 **(Home) button:** Press to go to the home screen.

### **Using the audio/information screen**

P. 261

 **(Back) button:** Press to go back to the previous screen.

 **(Seek/Track) buttons:** Press to change station, channel, song or file.

## Start Up

The 9-in. Color Touchscreen starts automatically when you set the power mode to ACCESSORY or ON. At start-up, the following screen about the data upload will be displayed.



Select **OK**.

- ▶ If you want to change the settings for data upload, select **Data Sharing**, then select the ON/OFF settings on the **Data Sharing Setting** screen.
- ▶ If you do not select **OK**, the system will automatically be switched the home screen after a certain period of time.
- ▶ If there is no registered device, select **OK** and the *Bluetooth*® pairing screen will be displayed.
- ▶ If you check the box with **Do not show this again**, this screen will not be displayed.

### ■ To pair a cell phone (when there is no phone paired to the system)

1. Make sure your phone is in search or discoverable mode.
2. Select **Acura Integra** from your phone.
  - ▶ If you want to pair a phone from this 9-in. Color Touchscreen, select **Search for Devices**, and then select your phone when it appears on the list.



### ▶▶ Start Up

#### Data Sharing Setting

**ON:** Available the data communication.

**OFF:** Not available the data communication.

## Audio/Information Screen

Displays the audio status and wallpaper. From this display, you can go to various setup options.

### Switching the Display

#### Using the audio/information screen



Press the  button to go to the home screen.

Select the following icons on the home screen or after selecting  **All Apps**.

#### Phone

Displays the HFL information.

 **Bluetooth® HandsFreeLink®** P. 403

#### FM/AM/SiriusXM/USB/Bluetooth Audio

Displays information for each audio format.

#### Using the audio/information screen

##### Touchscreen operation

- Use simple gestures - including touching, swiping and scrolling - to operate certain audio functions.
- Some items may be grayed out during driving to reduce the potential for distraction.
- You can select them when the vehicle is stopped.
- Wearing gloves may limit or prevent touchscreen response.

You can change the touchscreen sensitivity setting.

 **Customized Features** P. 359

### ■ General Settings

Enters the customizing menu screen.

➤ **Customized Features** P. 359

### ■ Wi-Fi Hotspot

Displays the Wi-Fi Hotspot screen.

➤ **AT&T Hotspot** P. 314

### ■ AcuraLink®

Displays the AcuraLink screen.

➤ **AcuraLink®** P. 305

### ■ Apple CarPlay/Android Auto

Displays the Apple CarPlay or Android Auto.

➤ **Apple CarPlay** P. 315

➤ **Android Auto™** P. 322

### ■ Vehicle Settings

Displays the vehicle settings screen.

➤ **Customized Features** P. 359

## ■ Trip Computer

Displays the trip computer information.

- **Current Drive** tab: Displays the current trip information.
- **Trip A/Trip B** tab: Displays information for the current and three previous drives.

The information is stored every time you reset Trip A/B.

To reset the Trip A/B, select **Settings**, then select **Delete Trip History**.

To change the setting of how to reset Trip A/B, select **Settings**, then select **“Trip A” Reset Timing** or **“Trip B” Reset Timing**.

## ■ System Updates

Updates the software version of the audio system.

📖 **System Updates** P. 272

## ■ Clock

Displays the clock.

## ■ Compass

Displays the compass screen.

## ■ Smart Shortcuts

Displays the **Smart Shortcuts** screen.

📖 **Smart Shortcuts** P. 309

## ■ Display Mode

Displays the brightness bar.

## ■ Alexa\*

Displays the **Alexa** screen.

📖 **Alexa Built-In\*** P. 280

\* Not available on all models

*Continued*

## Wallpaper Setup

You can change, store, and delete the wallpaper on the audio/information screen.

### Import wallpaper

You can import up to 11 images, one at a time, for wallpaper from a USB flash drive.

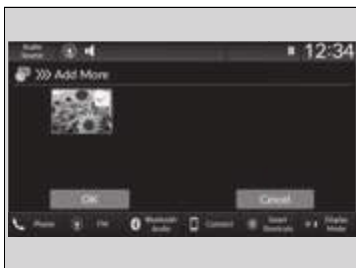

1. Connect the USB flash drive to the USB port.

▶ **USB Port(s)** P. 227

2. Press the **HOME** button.
3. Select **Clock**.
4. Select **Settings**.
5. Select **Clock Faces**.
6. Select **Add More**.
  - ▶ The image of the pictures stored in the USB flash drive are displayed on the list.
7. Select a desired picture to import.
  - ▶ Multiple pictures can be selected at the same time.
8. Select **OK**.
  - ▶ The selected pictures are displayed.
9. Select **Transfer**.
  - ▶ It will return to the clock wallpaper setting screen.

### Wallpaper Setup

The wallpaper you set up on **Clock Faces** cannot be displayed on the driver information interface.

- When importing wallpaper files, the image must be in the USB flash drive's root directory. Images in a folder cannot be imported.
- The file name must be less than 64 bytes.
- The file format of the image that can be imported is BMP (bmp) or JPEG (jpg).
- The individual file size limit is 10 MB.
- The maximum image size is 4,096 × 2,304 pixels. If the image size is less than 1,280 × 720 pixels, the image is displayed in the middle of the screen with the extra area appearing in black.
- If the USB flash drive does not have any pictures, the **No files detected** message appears.

**■ Select wallpaper**

1. Press the  button.
2. Select **Clock**.
3. Select **Settings**.
4. Select **Clock Faces**.
5. Select a desired picture to set.
  - ▶ The preview is displayed on the screen.
6. Select **Save**.
  - ▶ The clock screen which the wallpaper has been set is displayed.

**■ To view wallpaper once it is set**

1. Press the  button.
2. Select **Clock**.

**■ Delete wallpaper**

1. Press the  button.
2. Select **Clock**.
3. Select **Settings**.
4. Select **Clock Faces**.
5. Select **Delete Photos**.
6. Select a desired picture to delete.
  - ▶ Multiple pictures can be selected at the same time.
7. Select **OK**.
  - ▶ The selected pictures are displayed.
8. Select **Delete**.
  - ▶ It will return to the clock wallpaper setting screen.

**Wallpaper Setup**

You cannot delete the initial imported wallpapers.

## ■ Home Screen

### ■ To move to the next screen

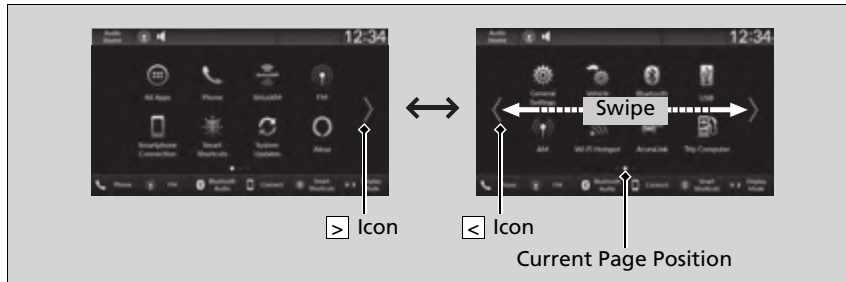

Selecting < or >, or swiping the screen left or right changes to the next screen.

## ▶ Home Screen

The home screen can add up to 6 pages.

Press the  button to go directly back to the first page of the home screen from any page.



## ■ To add app icons on the home screen

App icons can be added on the home screen.



1. Press the  button.
2. Select **All Apps**.
3. Select the box checked on the desired apps.

## ☒ To add app icons on the home screen

Pre-installed apps may not start up normally. If this occurs, you need to reset the system.

➤ **Defaulting All the Settings** P. 382

If you perform **Factory Data Reset**, it may reset all the settings to their factory default.

➤ **Defaulting All the Settings** P. 382

In case those apps still do not start up normally even after **Factory Data Reset**, contact your dealer.

### ■ To move icons on the home screen

You can change location on the home screen.

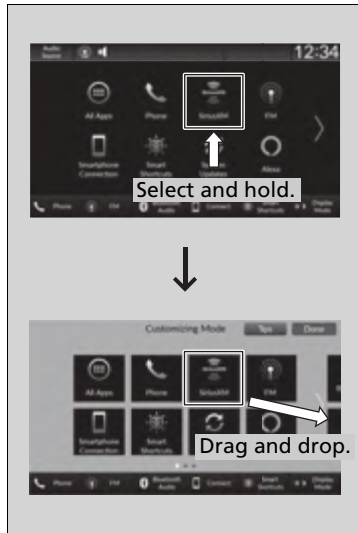

1. Press the  button.
2. Select and hold an icon.
  - ▶ The screen switches to the customization screen.
3. Drag and drop the icon to where you want it to be.
4. Select **Done**.
  - ▶ The screen will return to the home screen.

### ▶▶ To move icons on the home screen

Select **Tips** to show tips. To hide them, select it again.

## ■ To remove icons on the home screen

You can delete the icons on the home screen.

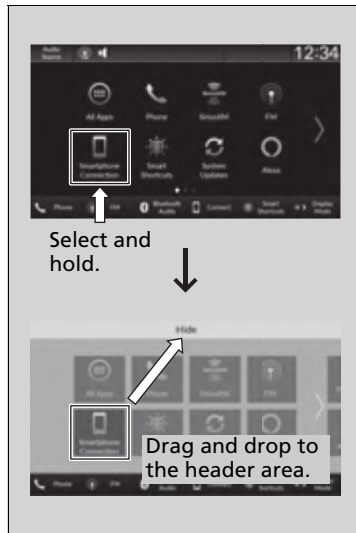

1. Press the  button.
2. Select and hold an icon.
  - ▶ The screen switches to the customization screen.
3. Drag and drop the icon you want to remove to the header area.
  - ▶ The icon is removed from the home screen.
4. Select **Done**.
  - ▶ The screen will return to the home screen.

## ⌘ To remove icons on the home screen

You cannot delete the **All Apps** icon.

Apps will not be deleted by deleting the icon on the home screen.

Select **Tips** to show tips. To hide them, select it again.

### ■ To shortcut icons on the home screen

You can store up to six icons on the bottom of the home screen.

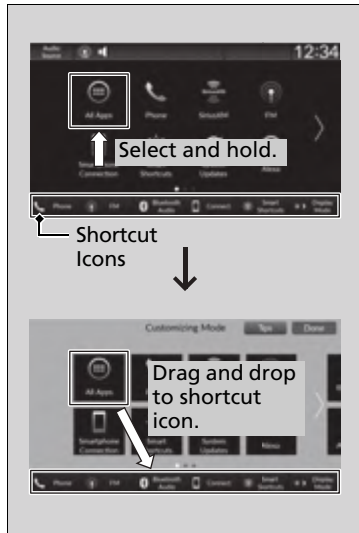



1. Press the **HOME** button.
2. Select and hold an icon.
  - ▶ The screen switches to the customization screen.
3. Drag and drop the icon you want to store to the bottom of the home screen.
  - ▶ The icon is shortcut.
4. Select **Done**.
  - ▶ The screen will return to the home screen.

### ▶▶ To shortcut icons on the home screen

Select **Tips** to show tips. To hide them, select it again.

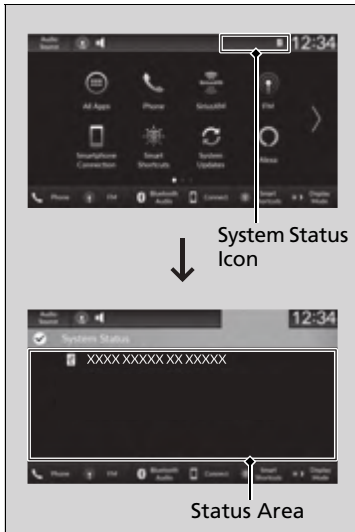
## Status Area



1. Select the system status icon.
  - ▶ The status area appears.
2. Select an item to see the details.
3. Press the  button or select the system status icon to close the area.

## System Updates

The audio system's firmware can be updated with a Wi-Fi connection, or with a USB device.

### How to Update

When the audio system update is available, the notification is shown on the status area. Use the following procedure to update the system.

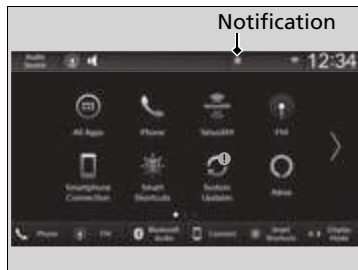

1. Press the **HOME** button.
2. Select **System Updates**.
  - ▶ If **System Updates** is not displayed on the home screen, select **All Apps**.
  - ▶ The system will check for updates.
  - ▶ If the update icon is appeared on the home screen, select the status icon.
- ▶ **Status Area** P. 271
3. Select **Download**.
  - ▶ A notification appears on the screen if need to user acceptance for download.
4. Select **Install Now** or **Install While Vehicle Off**.
  - ▶ A notification appears on the screen if the update is successful.

### How to Update

You can update the system via Wi-Fi, but cannot use the captive portal that require login or agreement the terms of use on the browser.

Your download will be canceled if:

- Your Wi-Fi connection is severed.
- You stop the engine when the battery is low on power.

Your download will recommence the next time a Wi-Fi connection is established.

For the battery protection, **Install While Vehicle Off** cannot be selected when the battery is low on power. If you want to install the updated data, recharge the battery or select **Install Now**.

## System Updates Settings

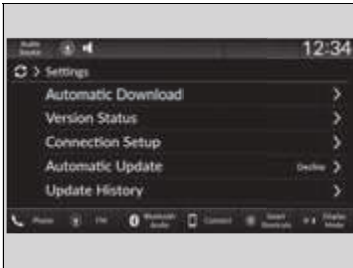



The following settings can be set.

- **Automatic Download**
- **Version Status**
- **Connection Setup**
- **Automatic Update\***
- **Update History**



### Automatic download settings

Use the following procedure to change to the automatic download setting.

1. Press the  button.
2. Select **System Updates**.
  - ▶ If **System Updates** is not displayed on the home screen, select  **All Apps**.
3. Select **Settings**.
4. Select **Automatic Download**.
5. Select the access point, then select **Allow**.
  - ▶ If you do not want to system update automatically, select **Block**.

### View a version and update status

Use the following procedure to confirm the version and update status.



1. Press the  button.
2. Select **System Updates**.
  - ▶ If **System Updates** is not displayed on the home screen, select  **All Apps**.
3. Select **Settings**.
4. Select **Version Status**.

\* Not available on all models

*Continued*



### ■ Connection setup

Use the following procedure to connect to the Internet via a Wi-Fi network.

1. Press the  button.
2. Select **System Updates**.
  - ▶ If **System Updates** is not displayed on the home screen, select  **All Apps**.
3. Select **Settings**.
4. Select **Connection Setup**.
5. Select **OK**.
6. Select **Change Mode**.
7. Select **Network**.
  - ▶ If the vehicle's Wi-Fi is turned off, select **OFF**.



### ■ Automatic update settings\*

Use the following procedure to change to the automatic update setting.

1. Press the  button.
2. Select **System Updates**.
  - ▶ If **System Updates** is not displayed on the home screen, select  **All Apps**.
3. Select **Settings**.
4. Select **Automatic Update**.
5. Select **Accept**.
  - ▶ If you do not want to system update automatically, select **Decline**.

### ■ View the update history

Use the following procedure to confirm the update history.



1. Press the  button.
2. Select **System Updates**.
  - ▶ If **System Updates** is not displayed on the home screen, select  **All Apps**.
3. Select **Settings**.
4. Select **Update History**.

\* Not available on all models





## ■ How to Update Wirelessly

### ■ Wireless connection mode setup



1. Press the  button.
2. Select **System Updates**.
  - ▶ If **System Updates** is not displayed on the home screen, select  **All Apps**.
3. Select **Settings**.
4. Select **Connection Setup**.
5. Select **OK**.
6. Select **Change Mode**.
7. Select **Network**.
  - ▶ It will return to the network list.
8. Select an access point from the network list.
  - ▶ If the audio system requires a password, enter a password.
9. Select **Connect**.

### ■ How to update



1. Press the  button.
2. Select **System Updates**.
  - ▶ If **System Updates** is not displayed on the home screen, select  **All Apps**.
3. Select **via Wireless**.
4. Select **Download**.
  - ▶ A notification appears on the screen if need to user acceptance for download.
5. Select **Install Now** or **Install While Vehicle Off**.
  - ▶ A notification appears on the screen if the update is successful.

## ■ How to Update with a USB Device

### ■ Download the update files from the server

1. Press the  button.
2. Select **System Updates**.
  - ▶ If **System Updates** is not displayed on the home screen, select  **All Apps**.
3. Select **Other Methods**.
4. Select **Via USB**.
  - ▶ A notification appears on the screen.
5. Connect a USB device into the USB port.
  - ▶ The inventory data is copied into the USB device.
    - ▶  **USB Port(s)** P. 227
6. Remove the USB device from the USB port.
7. Connect the USB device into your computer, and then download the update files.
  - ▶ Follow the link to download the required software update files. Refer to <https://usb.acura.com/> for instructions.

### ■ Update the audio system

1. Press the  button.
2. Select **System Updates**.
3. Select **Other Methods**.
4. Select **Via USB**.
  - ▶ A notification appears on the screen.
5. Connect the USB device with the update files into the USB port.
  - ▶ A notification appears on the screen.
    - ▶  **USB Port(s)** P. 227
6. Select **Install Now**.
  - ▶ A notification appears on the screen if the update is successful.

### ▶▶ How to Update with a USB Device

A USB device with a minimum of 8 GB of free space or more is recommended.

Be sure to delete any previous inventory or update files from the USB before starting the USB update process.

## Adjusting the Sound

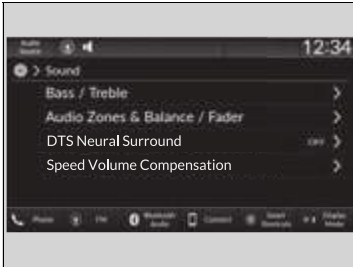

1. Press the button.
2. Select an audio source icon.
3. Select **Sound**.

Select an item from the following choices:

- **Bass / Treble:** Treble, Midrange, Bass
- **Audio Zones & Balance / Fader:** Driver Only, Front Only, Rear Only, Full Vehicle, Balance, Fader
- **DTS Neural Surround:** DTS Neural Surround™
- **Speed Volume Compensation:** Set the amount of volume increase.



### Adjusting the Sound

The **Speed Volume Compensation** adjusts the volume level based on the vehicle speed. As you go faster, audio volume increases. As you slow down, audio volume decreases.

You can also adjust the sound by the following procedure.

1. Press the button.
2. Select **General Settings**.
3. Select **Sound**.

#### Audio Zones & Balance / Fader

You can change where the sound comes from by selecting one of the speaker options below:

- **Full Vehicle:** All the speakers emit sound.
- **Driver Only:** Only the speaker by the driver's seat emits sound.
- **Front Only:** Only the front speakers emit sound.
- **Rear Only:** Only the rear speakers emit sound.

To reset each setting for **Bass / Treble**, **Audio Zones & Balance / Fader**, and **Speed Volume Compensation**, select **Default** on each setting screen.

## Display Setup

You can set the screen brightness.

### ■ Switching Display Mode Manually



Select **Display Mode**.

- ▶ The brightness bar is displayed for a few seconds.
- ▶ Select or to adjust the brightness.
- ▶ Select **Display OFF** to turn off the screen. To turn on the screen, press the or button.

### »» Display Setup

You can adjust the screen brightness by sliding or tapping on the brightness bar.

You can also change the screen brightness on the following procedures.

1. Press the button.
2. Select **General Settings**.
3. Select **Display**.
4. Select the setting you want.

To reset the settings, select **Default**.



## ■ Selecting an Audio Source

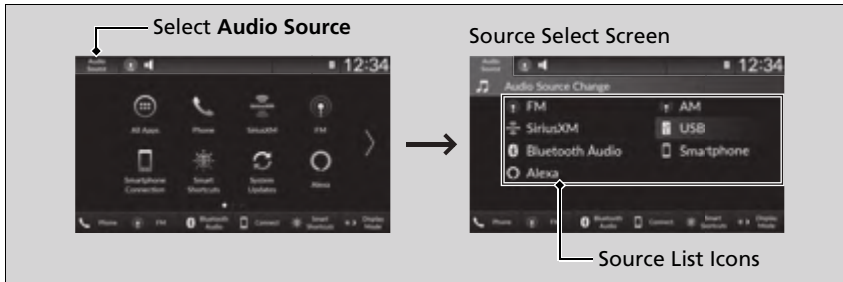

Select **Audio Source** on the header area, then select an icon on the source list to switch the audio source.

## ■ Limitations for Manual Operation

Certain manual functions are disabled or inoperable while the vehicle is in motion. You cannot select a grayed-out option until the vehicle is stopped.

## Alexa Built-In\*

You can talk to Amazon Alexa through the audio system. With Alexa, you can:

- Stream music
- Check the weather
- Answer questions
- Control smart home devices
- And more with supported Alexa skills

### Using Alexa

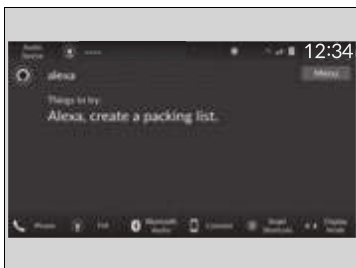

Once you sign into Alexa in the vehicle, you can use Alexa without opening the app.

You can trigger Alexa by doing any of the following:

- Say the wake word “*Alexa*” from anywhere in the audio system.
- Press the  (Talk) button on the steering wheel.
- Select the **Alexa** icon from inside the app.

### ▶▶ Alexa Built-In\*

#### Support Resources

For more information or client support:

- Call Acura Client Relations at 1-800-382-2238.
- Go to <https://www.amazon.com/alexa/support>.

### ▶▶ Using Alexa

#### Troubleshooting Tips:

- Make sure you are connected to Alexa via either Wi-Fi Network or AT&T Vehicle Data Plan.
- If using an AT&T Vehicle Data Plan, confirm that your subscription is active.
- Make sure you are logged into your Amazon account.
- If Alexa Built-in is using your phone's Wi-Fi Network, connecting CarPlay/Android Auto by wireless will disable Alexa Built-In. To enable Alexa Built-In and Carplay or Android Auto at the same time, connect your phone with an Apple or Android OEM cable.

#### Deleting Your Alexa Settings from the Vehicle

For your privacy and security, if you transfer the vehicle to a third party, reset all vehicle settings to default and delete all personal data. Also, remove the vehicle from the list of devices in your phone's Alexa app.

▶▶ **Defaulting All the Settings** P. 382

## Playing AM/FM Radio

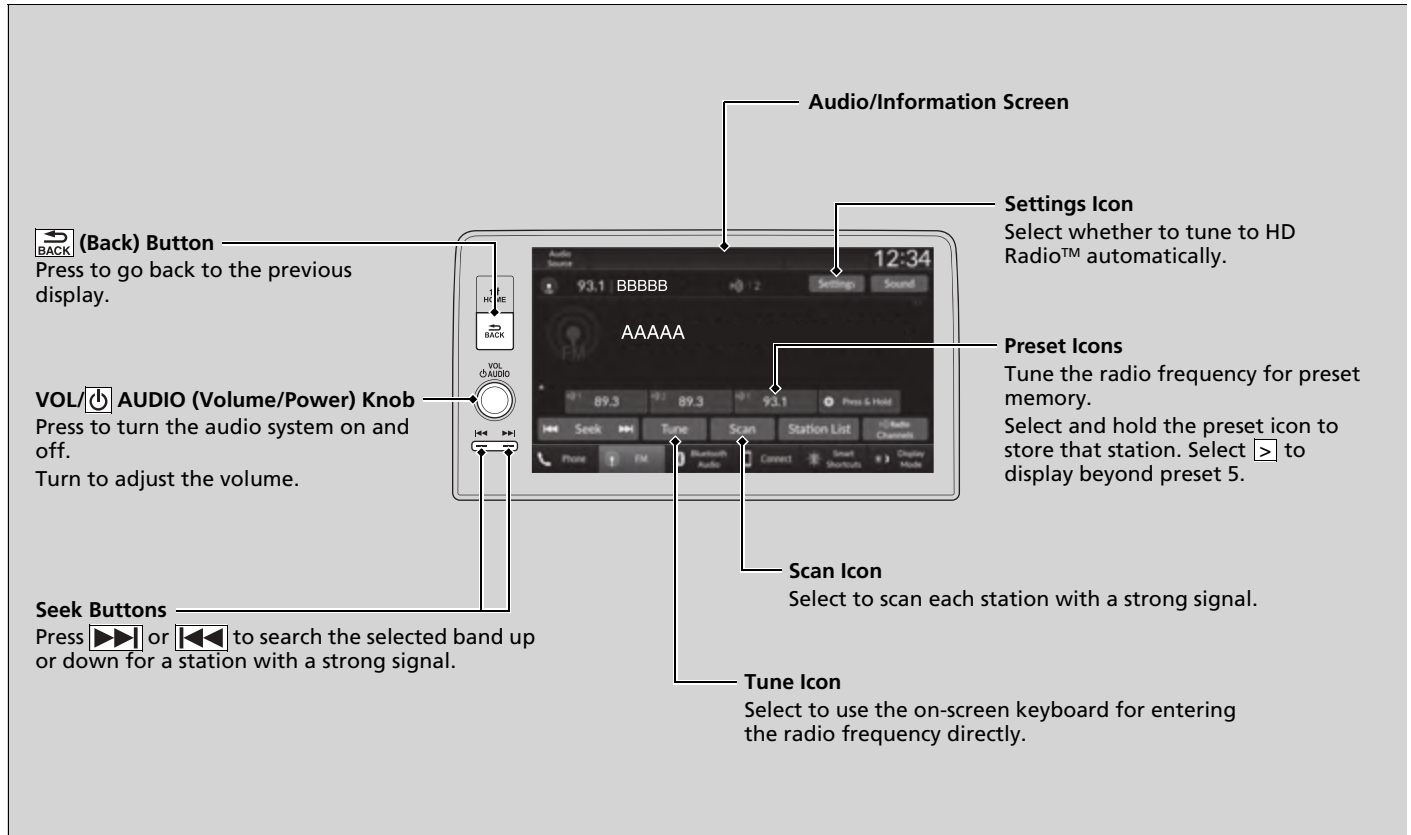

## ■ Preset Memory

To store a station:

1. Tune to the selected station.
2. Select and hold the preset icon to store that station.
  - ▶ Selecting **Press & Hold** can be set a new preset station.

## ■ Station List

Lists the strongest stations on the selected band.

1. Select **Station List** to display a list.
2. Select the station.

### ■ Manual update

Updates your available station list at any time.

1. Select **Station List** to display a list.
2. Select **Refresh**.

## ▶▶ Preset Memory

The **ST** indicator appears on the display indicating stereo FM broadcasts.

Stereo reproduction in AM is not available.

Switching the Audio Mode

Roll the left selector wheel or select **Audio Source** on the screen.

▶▶ **Audio Remote Controls** P. 230

You can store 12 AM/FM stations into preset memory.

HD Radio Technology manufactured under license from iBiquity Digital Corporation. U.S. and Foreign Patents. For patents see <http://dts.com/patents>. HD Radio, Artist Experience, and the HD, HD Radio, and "ARC" logos are registered trademarks or trademarks of iBiquity Digital Corporation in the United States and/or other countries.





## ■ Scan

Samples each of the strongest stations on the selected band for 10 seconds. To turn off scan, select **Stop** or press the  button.

## ■ HD Subchannel

Displays the subchannel list when an HD Radio™ station is selected while listening to an FM station.

1. Select **HD Radio Channels**.
2. Select the channel number.

## ■ Radio Data System (RDS)

Provides text data information related to your selected RDS-capable FM station.

### ■ To find an RDS station from Station List

1. Select **Station List** to display a list while listening to an FM station.
2. Select the station.

### ■ Manual update

Updates your available station list at any time.

1. Select **Station List** to display a list while listening to an FM station.
2. Select **Refresh**.

### ▣ Radio Data System (RDS)

When you select an RDS-capable FM station, the RDS automatically turns on, and the frequency display changes to the station name. However, when the signals of that station become weak, the display changes from the station name to the frequency.

## ■ AM/FM Settings

Change the AM/FM settings.

1. Select **Settings**.
2. Select an option.
  - **HD Radio:** Automatically choose a digital or an analog channel, or listen to analog only.
  - **Artwork:** Turns the artwork display on and off.

## Playing SiriusXM® Radio

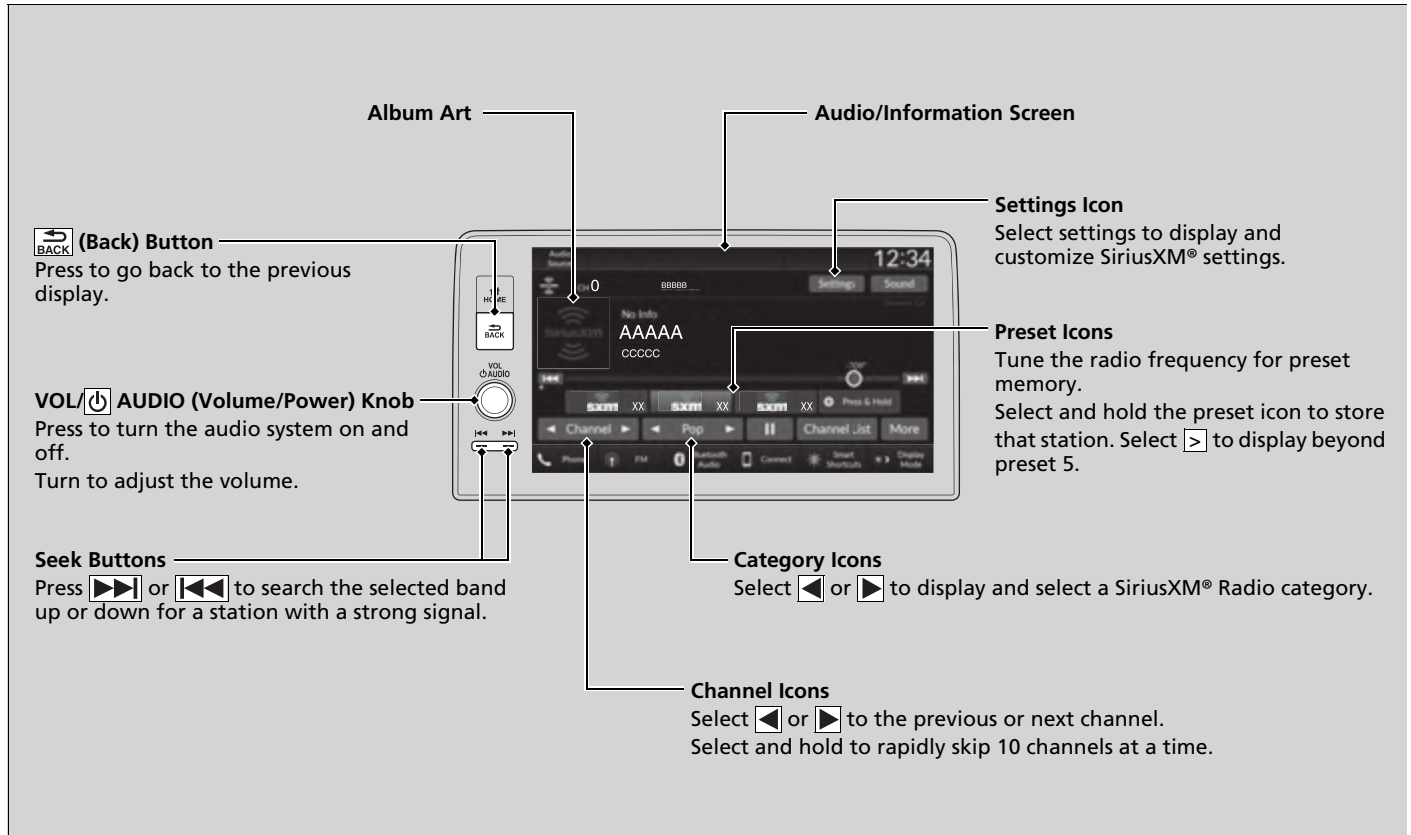

**BACK (Back) Button**  
Press to go back to the previous display.

**VOL/AUDIO (Volume/Power) Knob**  
Press to turn the audio system on and off.  
Turn to adjust the volume.

**Seek Buttons**  
Press **▶▶** or **◀◀** to search the selected band up or down for a station with a strong signal.

**Album Art**

**Audio/Information Screen**

**Settings Icon**  
Select settings to display and customize SiriusXM® settings.

**Preset Icons**  
Tune the radio frequency for preset memory.  
Select and hold the preset icon to store that station. Select **>** to display beyond preset 5.

**Category Icons**  
Select **◀** or **▶** to display and select a SiriusXM® Radio category.

**Channel Icons**  
Select **◀** or **▶** to the previous or next channel.  
Select and hold to rapidly skip 10 channels at a time.

## ■ To Change the Tune Mode

1. Select **Settings**.
2. Select **Tune Mode**.
3. Select **Channel** or **Category**.

### ▶▶ Playing SiriusXM® Radio

In the channel mode, all available channels are selectable. In the category mode, you can select a channel within a category (Jazz, Rock, Classical, etc.).

There may be instances when SiriusXM® Radio does not broadcast all the data fields (artist name, title). This does not indicate a problem with your audio system.

SiriusXM® Radio stations load in ascending order, which can take about a minute. Once they have loaded you will be able to scroll up or down to make your selections.

Switching the Audio Mode

Roll the left selector wheel or select **Audio Source** on the screen.

▶▶ **Audio Remote Controls** P. 230

#### **Tune Start:**

When you change to a preset channel, a song being played on that channel restarts from the beginning with this function. This can be turned on or off by the following procedure.

1. Select **Settings**.
2. Select **Tune Start**.
3. Select **ON** or **OFF**.

To change a category, select **Category** icons, or select **More** and then select **Category List**.

## ■ Preset Memory

To store a channel:

1. Tune to the selected channel.
2. Select and hold the preset icon to store that channel.
  - ▶ Selecting **Press & Hold** can be set a new preset channel.

## ■ Multi-channel preset (for music channels only)

You can store up to 10 of your preferred music channels per preset.



1. Tune a station.
2. Select and hold the preset number you want to add a music channel.
3. Select **Add to TuneMix** or **Create TuneMix**.
  - ▶ A message appears if there are no available presets.

## ▶▶ Playing SiriusXM® Radio

You can store 12 SiriusXM® channels into the preset memory.

## ▶▶ Multi-channel preset (for music channels only)

### **TuneMix:**

The multi-channel preset function can be turned on or off by the following procedure.

1. Select **Settings**.
2. Select **TuneMix**.
3. Select **ON** or **OFF**.

When you want to replace the channel, select

### **Replace Preset.**

If you want to delete a channel, select **Edit TuneMix**, and then select the channel you want to delete.

## ■ Listening to Featured Channels

Suggested channel listing received from SiriusXM® can be displayed and selected.

1. Select **More**.
2. Select **Category List**.
3. Select **Featured Favorites**.
4. Select the featured favorite list title you want to listen to.
  - ▶ The selected channel list of the title is displayed.
5. Select the channel.

## ▶▶ Listening to Featured Channels



Up to 10 featured channels by SiriusXM® can be displayed.

To switch the sorting method, select **Number** or **Name** on the upper right of the screen.

Select **Keypad** to use the on-screen keyboard for entering the channel number directly.

## ■ Replay Function

The system can record up to the last 60 minutes of your currently tuned channel's broadcast, as well as the last 30 minutes of your preset channel's broadcast, starting from the moment you turn the vehicle on. If you tuned to a preset channel, the system records up to 60 minutes of a broadcast instead of up to 30 minutes. You can rewind and replay the last 30 or 60 minutes of a broadcast.

Move the position you want to replay by selecting  or .

To play or pause on playback mode, select the play/pause icon.

## ■ Returning to real-time broadcast

Select and hold .

## ▶▶ Replay Function

The system starts storing broadcast in memory when the power mode is turned ON. You can go back to the program from that point.

You can no longer replay any program once the power mode is turned off as it erases memory. You can check how long the program has been stored in memory from the audio/information screen.

After 30 or 60 minutes of recording the system will automatically start deleting the oldest data.

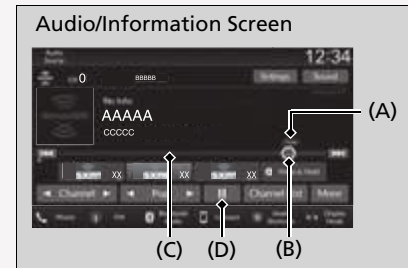

(A): Shows how much time the replayed segment is behind the real-time broadcast

(B): Replayed segment

(C): Length stored in memory

(D): Play/Pause icon

When you listen a multi-channel preset while at the playback mode, the replayed segment is not displayed.

Continued

## ■ Live Sports Alert

While listening to other channels, you can receive sports alerts such as scores from the games of your favorite teams.

### ■ To set up a favorite team

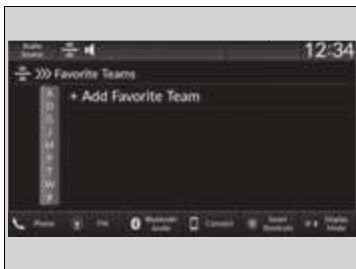

1. Select **Settings**.
2. Select **Sports Notifications Setup**.
3. Select **Favorite Teams**.
4. Select **+ Add Favorite Team**.
5. Select a team.

### ■ To set up an alert message

1. Select **Settings**.
2. Select **Sports Notifications Setup**.
3. Select **Notifications**.
4. Select **Game Notifications** or **SportsFlash Game Play Notifications**.
5. Select **Notifications**.
6. Select **ON**.
7. Select a favorite team.

### ■ Receiving a sports alert

1. A pop-up appears and notifies you of a sports alert.
  2. Select **Listen**.
    - ▶ You can use the same items as the playback mode pop-up screen.
      - ▶ **Replay Function** P. 289
- To go back to the previous screen, select ⊗.

## ⊗ Live Sports Alert

The Pop-up appears and notifies you of a sports alert function.



## ■ Traffic and Weather Information

You can receive traffic and weather information.

### ■ To set up a traffic & weather information

1. Select **Settings**.
2. Select **Traffic & Weather Now Setup**.
3. Select **Selected City**.
4. Select the region.
  - ▶ When you do not want to receive the information, select **No Market Selected**.

### ■ Listening a traffic and weather information

1. Select the status icon.
2. Select the traffic and weather information.
  - ▶ Play mode can also use the any items same as playback mode.
    - ▶ **Replay Function** P. 289

To go back to the previous screen, select ⊗.

### ☒ Traffic and Weather Information

When traffic and weather information is received, a notification is displayed in the header area.

▶ **Status Area** P. 271

Traffic & Weather Now are registered trademarks of SiriusXM® Radio, Inc.

## ■ Channel Schedule

You can view a channel schedule or receive an alert when your favorite program is about to start.

### ■ To view a channel schedule

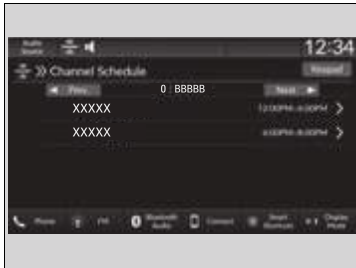

1. Select **More**.
2. Select **Channel Schedule**.

### ■ To set up an alert message

1. Select **More**.
2. Select **Channel Schedule**.
3. Select a program.
4. Select **Set Program Alert**.
5. Select **Just Once** or **Every Time**.

## ☒ Channel Schedule

Select **Keypad** to use the on-screen keyboard for entering the channel number directly.

## ☒ To set up an alert message

The Pop-up appears and notifies you of an alert function.

Selecting **Just Once** disables the alert feature next time you turn the power mode to ON.

If you want to delete the alert, select **Remove Alert**.

To enable an alert message, change settings for the alert function.

☒ **To enable the alert function** P. 293

## Manage Program Alert

You can change settings for the alert function.

### To enable the alert function

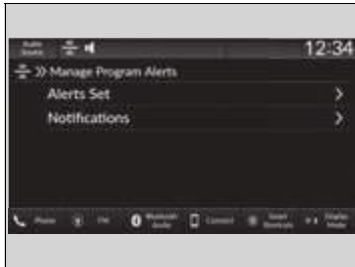

1. Select **Settings**.
2. Select **Manage Program Alerts**.
3. Select **Notifications**.
4. Select **ON** or **OFF**.

### To remove an alert

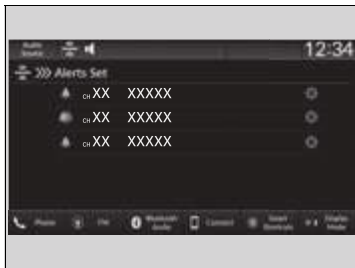

1. Select **Settings**.
2. Select **Manage Program Alerts**.
3. Select **Alerts Set**.
4. Select  on the alert you want to delete.

## ■ Scan

Sample each channel on the selected mode for 10 seconds.

1. Select **More**.
2. Select **Scan**.

You can change a scan mode by the following procedure.

1. Select **Settings**.
2. Select **Scan Mode**.
3. Select **Channel** or **Preset**.

To turn off scan, select **Stop**.

## ☞ Scan

The “Scan Songs in Presets” function is based on TuneScan™ technology of SiriusXM®.

The “Featured Channels” function is based on Featured Favorites™ technology of SiriusXM®.

TuneScan™ and Featured Favorites™ are registered trademarks of SiriusXM® Radio, Inc.

## ■ SiriusXM® Settings

Change the SiriusXM® settings.

1. Select **Settings**.
2. Select an option.
  - **TuneMix:** Turns multiple channel mix preset on and off.
  - **Tune Mode:** Choose whether to group by category or channel number when changing channels.
    - **To Change the Tune Mode** P. 286
  - **Scan Mode:** Select the scan mode from all channels or presets.
    - **Scan** P. 294
  - **Tune Start:** Start the currently playing song at the beginning when you switch to a music channel preset.
    - **Tune Start:** P. 286
  - **Sports Notifications Setup:** Set to receive sports alerts such as scores from your favorite teams.
    - **Live Sports Alert** P. 290
  - **Traffic & Weather Now Setup:** Set to receive traffic and weather information.
    - **Traffic and Weather Information** P. 291
  - **Manage Program Alerts:** Change settings for the alert function.
    - **Manage Program Alert** P. 293

## Playing an iPod

Using your USB connector, connect the iPod to the USB port (2.5A), then select the iPod mode.

➤ **USB Port(s)** P. 227

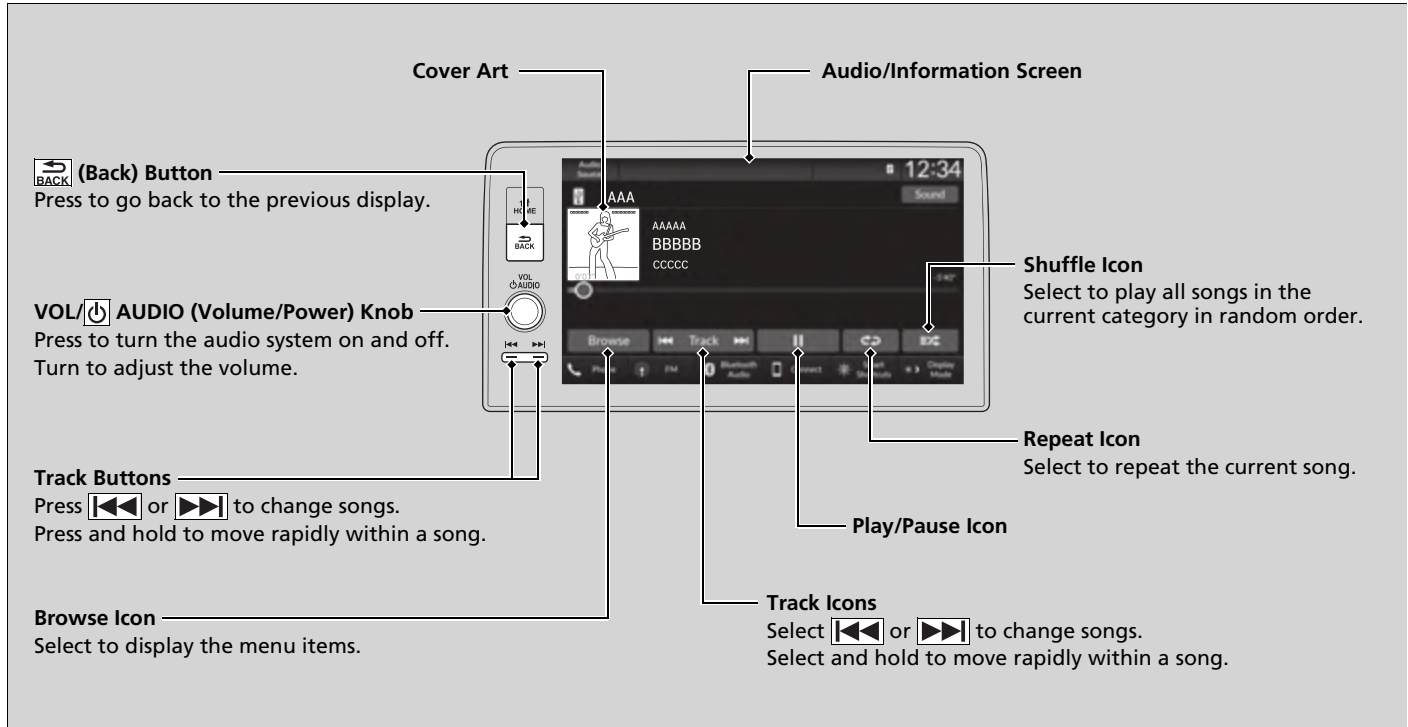

## How to Select a Song from the Music Search List

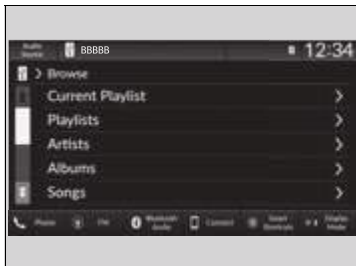

1. Select **Browse**.
2. Select a search category (e.g., Artists, Albums, etc.).
3. Continue making selections until you find the song of your choice.

## ▶▶ Playing an iPod

Available operating functions vary on models or versions. Some functions may not be available on the vehicle's audio system.

If there is a problem, you may see an error message on the audio/information screen.

▶ **iPod/USB Flash Drive** P. 328

If you operate the music app on your iPhone/iPod while the phone is connected to the audio system, you may no longer be able to operate the same app on the audio/information screen. Reconnect the device if necessary.

If an iPhone or a smartphone is connected via Apple CarPlay or Android Auto, the iPod/USB source will be unavailable and audio files on the phone will be playable only within Apple CarPlay or Android Auto.

Continued

## ■ How to Select a Play Mode

You can select shuffle and repeat modes when playing a file.

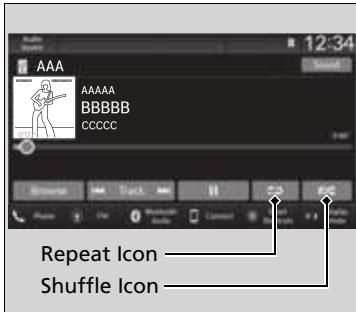

### ■ Shuffle/Repeat

Select shuffle or repeat icon repeatedly until a desired mode.

### ■ To turn off a play mode

Select the mode you want to turn off.

## ▶▶ How to Select a Play Mode

Play Mode Menu Items

### Shuffle



**Shuffle off:** Shuffle mode to off.



**Shuffle All Songs:** Plays all available songs in a selected list in random order.

### Repeat



**Repeat off:** Repeat mode to off.



**Repeat Song:** Repeats the current song.



**Repeat all:** Repeats the all songs.



## Playing a USB Flash Drive

Your audio system reads and plays sound on a USB flash drive in either MP3, WMA, AAC\*1, FLAC, or WAV format.

Connect your USB flash drive to the USB port (2.5A), then select the USB mode.

📄 **USB Port(s)** P. 227

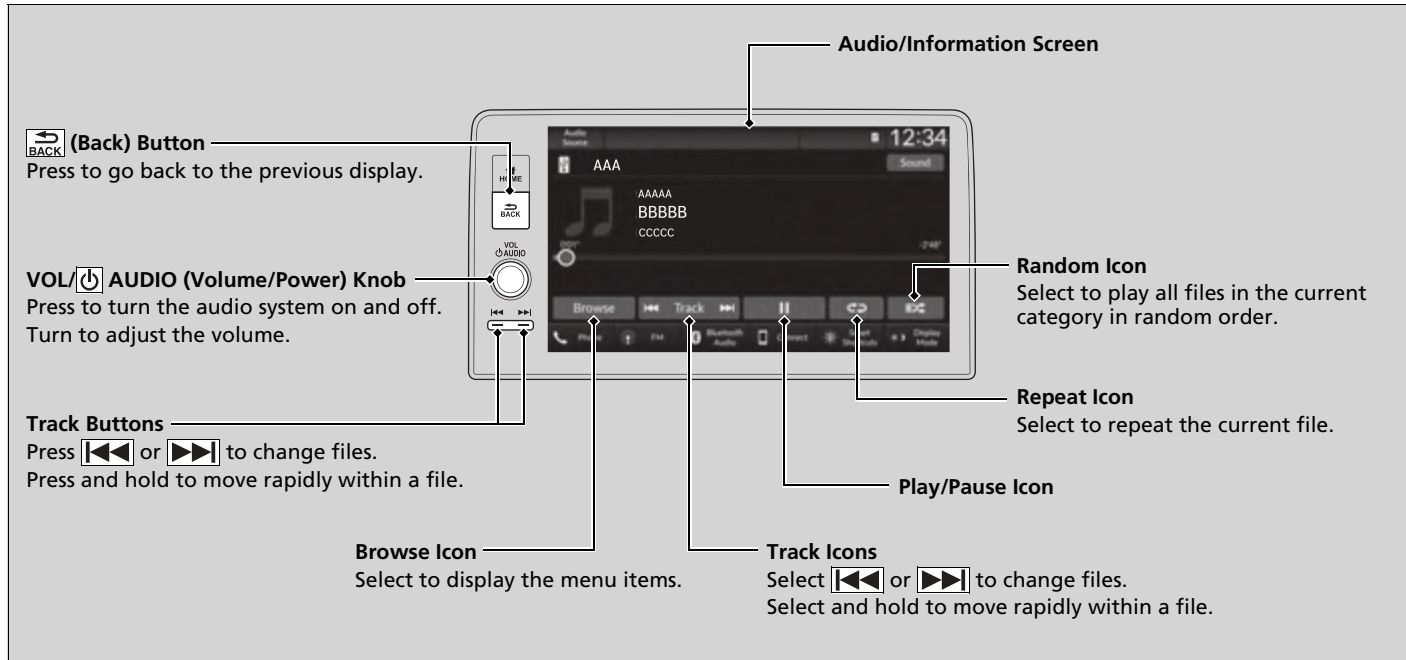

\*1: Only AAC format files recorded with iTunes are playable on this unit.

## How to Select a File from the Music Search List

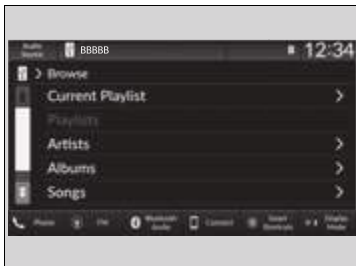

1. Select **Browse**.
2. Select a search category (e.g., Artists, Albums, etc.).
3. Continue making selections until you find the song of your choice.

## ▶▶ Playing a USB Flash Drive

Use the recommended USB flash drives.

▶ **General Information on the Audio System**  
P. 330

WMA files protected by digital rights management (DRM) cannot be played.

The audio system displays **Unplayable File**, then skips to the next file.

If there is a problem, you may see an error message on the audio/information screen.

▶ **iPod/USB Flash Drive** P. 328

## How to Select a Play Mode

You can select repeat, and random modes when playing a file.

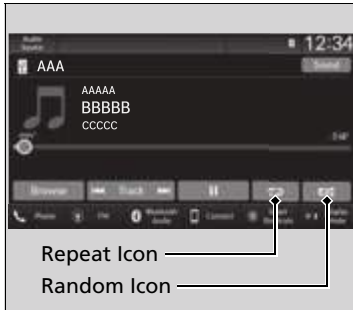

### Random/Repeat

Select random or repeat icon repeatedly until a desired mode.

### To turn off a play mode

Select the mode you want to turn off.

## How to Select a Play Mode

Play Mode Menu Items

### Random



**Random off:** Random mode to off.



**Random All Tracks:** Plays all files in random order.



**Random in Folder:** Plays all files in the current folder in random order.

### Repeat



**Repeat off:** Repeat mode to off.



**Repeat track:** Repeats the current file.



**Repeat folder:** Repeats all files in the current folder.

## Playing *Bluetooth*® Audio

Your audio system allows you to listen to music from your *Bluetooth*-compatible phone.

This function is available when the phone is paired and connected to the vehicle's *Bluetooth*® HandsFreeLink® (HFL) system.

📄 **Phone Setup** P. 408

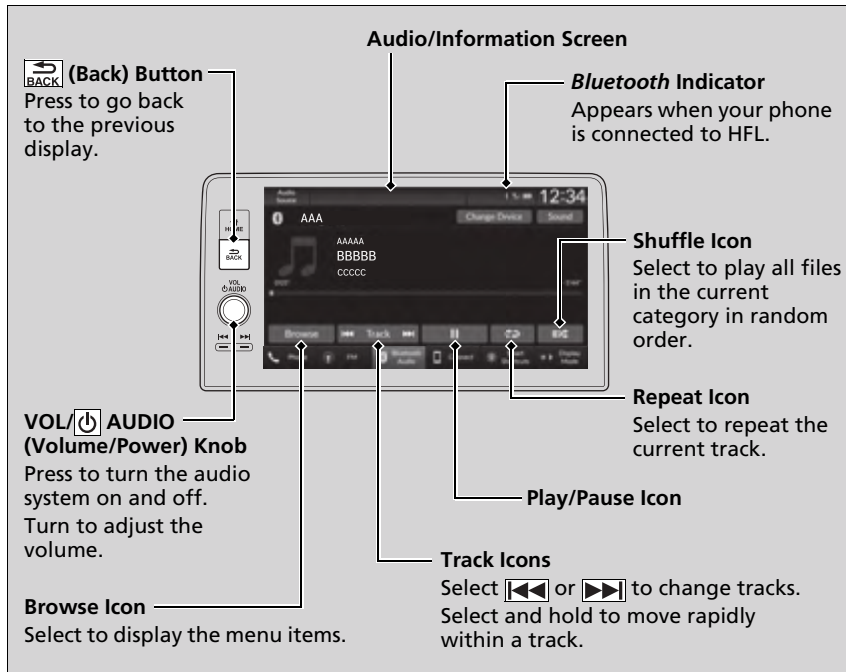

### ▶▶ Playing *Bluetooth*® Audio

Not all *Bluetooth*-enabled phones with streaming audio capabilities are compatible with the system. For a list of compatible phones:

- U.S.: Visit [www.handsfreelink.com/Acura](http://www.handsfreelink.com/Acura), or call 1-888-528-7876.
- Canada: For more information on smartphone compatibility, call 1-855-490-7351.

It may be illegal to perform some data device functions while driving.

Only one phone can be used with HFL at a time. When there are more than two paired phones in the vehicle, the system automatically connects to the prioritized phone. You can assign priority to a phone in the *Bluetooth*® device list.

📄 **Phone Setup** P. 408

The connected phone for *Bluetooth*® Audio can be different.

If more than one phone is paired to the HFL system, there may be a delay before the system begins to play.

In some cases, the name of the artist, album, or track may not appear correctly.

Some functions may not be available on some devices.

If a phone is currently connected via Apple CarPlay or Android Auto, *Bluetooth*® Audio from that phone is unavailable. However, a second previously paired phone can stream *Bluetooth*® Audio by selecting  from the *Bluetooth*® device list.

📄 **Phone Setup** P. 408

## ■ To Play *Bluetooth*® Audio Files



1. Make sure that your phone is paired and connected to the system.

➤ **Phone Setup** P. 408

2. Select the *Bluetooth*® Audio mode.

If the phone is not recognized, another HFL-compatible phone, which is not compatible for *Bluetooth*® Audio, may already be connected.

## ■ To play or pause a file

Select the play/pause icon.

## ■ Searching for Music

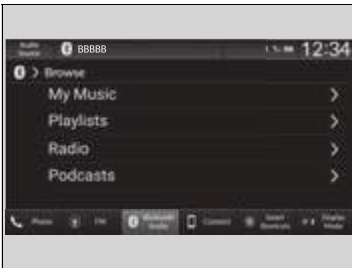

1. Select **Browse**.

2. Select a search category (e.g., Albums).

3. Select an item.

▶ The selection begins playing.

## ☒ To Play *Bluetooth*® Audio Files

To play the audio files, you may need to operate your phone. If so, follow the phone maker's operating instructions.

Switching to another mode pauses the music playing from your phone.

You can change the connected phone by selecting **Change Device**.

➤ **Phone Setup** P. 408

## ☒ Searching for Music

Depending on the *Bluetooth*® device you connect, some or all of the lists may not be displayed.

## ■ How to Select a Play Mode

You can select shuffle and repeat modes when playing a file.

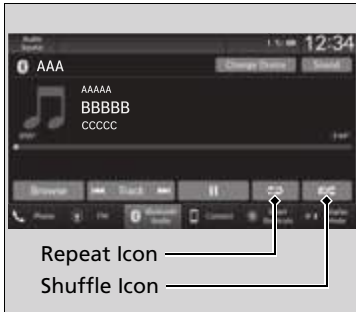

### ■ Shuffle/Repeat

Select shuffle or repeat icon repeatedly until a desired mode.



### ■ To turn off a play mode

Select the mode you want to turn off.





## ▶▶ How to Select a Play Mode

Play Mode Menu Items

### Shuffle

-  **Shuffle off:** Shuffle mode to off.
-  **Shuffle All Songs:** Plays all available songs in a selected list in random order.

### Repeat

-  **Repeat off:** Repeat mode to off.
-  **Repeat Song:** Repeats the current song.
-  **Repeat Group:** Repeats the current group.
-  **Repeat all:** Repeats the all songs.

Depending on the *Bluetooth*® device you connect, some or all of the functions may not be displayed.

## AcuraLink®

AcuraLink® connects you to the latest information from Acura. You can connect your phone wirelessly through Wi-Fi or *Bluetooth®*.

➤ **Wi-Fi Connection** P. 312

➤ **Phone Setup** P. 408

### ■ AcuraLink® Menu



#### ■ Connect

Displays the connection status of the vehicle.

#### ■ Help & Support

Displays tips for vehicle usage, and get support via road side or customer service center.

#### ■ Message

Displays helpful and important information from Acura.

### ▶▶ AcuraLink®

The AcuraLink® connect app is compatible with most iPhone and Android phones.

Some cell phone carriers charge for tethering and smartphone data use. Check your phone's data subscription package.

If there is an active connection to Apple CarPlay or Android Auto, AcuraLink® can only be connected through Wi-Fi.

## ■ To Set Up to Connect AcuraLink® Service

Use the following procedure to connect to AcuraLink® service.

### ■ To enable the AcuraLink® service



1. Press the  button.
2. Select **General Settings**.
3. Select **System**.
4. Select **Data Sharing Setting**.
5. Select **ON**.

### ■ To link with AcuraLink®



You can see the connection guide screen after launching AcuraLink® when there is no connection to a network. If you do not need this guide, select check-box and select **OK**.



## ■ Vehicle Information and Message from Acura Tips

You can check the messages that are received quickly in the shortcut operation.

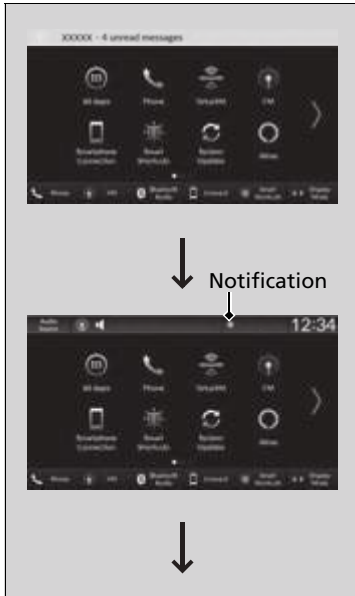

1. A notification appears and notifies you of a new message on the header area.

2. A notification icon is continuously displayed in the header area until the new message is read.



3. Select the system status icon to see the messages.

4. Select a new message to open.

## Smart Shortcuts

By observing and learning driver behaviors, patterns, and preferences, the system anticipates driver actions and presents on-screen suggestions to help perform desired actions quicker and with fewer steps.

- The app will suggest actions based on what it learns you do often, and occasionally make recommendations based on your learned preferences.
- The system will take some time to learn. The more you interact with the system, the more suggestion you will see, and the more accurate they will become.
- Suggestions will automatically refresh periodically to provide updated content for each profile.
- You can also provide feedback on whether a suggestion is helpful by pressing and holding on it. This can help the app grow smarter over time.





- To change the notifications behavior for Smart Shortcuts:
  1. Select **Options** on the **Smart Shortcuts** screen.
  2. Select **Suggestion Settings**.
  3. Select an option.
- All data used for Smart Shortcuts can be erased by a **Factory Data Reset**.
  - **Defaulting All the Settings** P. 382

### Smart Shortcuts

The app also supports different profiles for each user, with customized learning for each profile. The app will also learn to associate a profile to a user over time based on key fob and connected phone data.

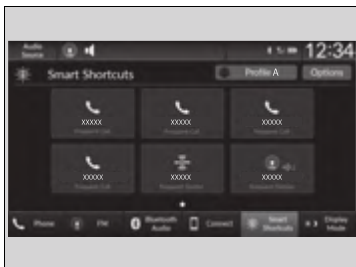
## How to Use



1. Press the  button.
2. Select **Smart Shortcuts**.
3. Select a shortcut to take the action suggested.

- **Call Suggestions:** When selected, a call to the contact or number suggested will be placed and shown. Based on your calling patterns, contacts will be suggested for you to call.
  - ▶ Connect your smartphone through *Bluetooth*® to get contact suggestions.
  - ▶ Call suggestions will not be displayed when you are connected to Apple Carplay.

## How to Use

You can change the profile by selecting  on the top of the **Smart Shortcuts** screen.

You can customize the following items by selecting **Options** on the top of the **Smart Shortcuts** screen.

- **Profiles:** Create, change, and manage profiles.
- **View App Walkthrough:** View the Smart Shortcuts walkthrough.
- **Suggestion Settings:** Change where suggestions can appear.

### To create a profile:

1. Select **Options** on the **Smart Shortcuts** screen.
  2. Select **Profiles**.
  3. Select **Manage Profiles**.
  4. Select **+ Add New Profile**.
  5. Enter name for your profile.
  6. Select **Done**.
- ▶ A new profile has been created and the Smart App will automatically switch to that profile.

### To change a profile:

1. Select **Options** on the **Smart Shortcuts** screen.
  2. Select **Profiles**.
  3. Select **Change Current Profile**.
  4. Select a profile from the list.
- ▶ The change to the selected profile has been made.

- **Radio Suggestions:** When selected, the corresponding radio app (FM, AM, or SiriusXM®) will open and it will start playing the station.
  - ▶ From radio apps you can receive:
    - FM, AM, SiriusXM®: Most frequently listened stations you may like to play next.
    - FM, SiriusXM®: Genre-based suggestions.
  - ▶ Considerations:
    - FM suggestions will appear only when they are within range, according to your vehicle's tuner signal.
    - SiriusXM® suggestions will be available as long as there is an active account in the vehicle.

## Wi-Fi Connection

This vehicle is equipped with Wi-Fi connectivity. You can connect to an external Wi-Fi hotspot or communication device.

### Wi-Fi Connection

Wi-Fi and Wi-Fi Direct are registered trademarks of Wi-Fi Alliance®.



### Connect the vehicle to a Wi-Fi hotspot

You cannot go through the setting procedure while the vehicle is moving. Park in a safe place to set the audio system in Wi-Fi mode.



Some cell phone carriers charge for tethering and smartphone data use. Check your phone's data subscription package.

Check your phone manual to find out if the phone has Wi-Fi connectivity.

You can confirm whether Wi-Fi connection is on or off with the  icon on the system status area. Transmission speed and others will not be displayed on this screen.

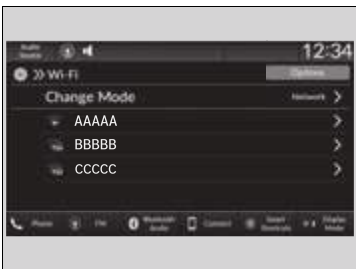
### Connect the vehicle to a Wi-Fi hotspot



1. Press the  button.
2. Select **General Settings**.
3. Select **Connections**.
4. Select **Wi-Fi**.
5. Select **OK**.
6. Select **Change Mode**.
7. Select **Network**.
  - ▶ If the data sharing settings is to **OFF**, the message will be displayed on the screen. You need to change to **ON**.
    - ▶  **Customized Features** P. 359
  - ▶ If you want to turn off the Wi-Fi mode, select **OFF**.



8. Select the access point you want to connect to the system.
  - ▶ To add a new network or select the saved networks, select **Options**.
  - ▶ If **Options** is selected, **Add Network** and **Saved Networks** can be registered.

## AT&T Hotspot

If you have subscribed to AT&T hotspot services, your vehicle will provide data to connect your mobile devices to the Internet. You can use the AT&T Hotspot app to turn on/off vehicle data and monitor data usage left on your subscription.

### AT&T Hotspot

To use AT&T Hotspot services, your vehicle must be subscribed to a data plan. If your vehicle is not subscribed to a data plan, you can visit [www.att.com/acura](http://www.att.com/acura) to add vehicle data services.

Hotspot username and password can be changed in the **Settings** of the AT&T Hotspot app. **Settings** cannot be accessed while driving. Park in a safe place to adjust Hotspot settings.

Alternatively, you can use your mobile hotspot to connect the vehicle and other mobile devices to the Internet.

➔ **Wi-Fi Connection** P. 312

### AT&T Hotspot Menu



#### 1 Hotspot Enable

Turn on/off AT&T Hotspot.

#### 2 Data Usage Bar

Check the current status of your data plan. This Usage Bar will show your current plan and how much data remains on your plan. Subscription plans for AT&T Hotspot can be added/modified at [www.att.com/acura](http://www.att.com/acura).

#### 3 Plan Info

Shows your current AT&T subscription plan for the vehicle.

#### 4 Settings

Shows the current username and password for vehicle Hotspot. **Settings** can be changed while the vehicle is not in motion.

#### 5 Help



## Apple CarPlay

If you connect an Apple CarPlay-compatible iPhone to the system via the 2.5A USB port or wirelessly, you can use the audio/information screen, instead of the iPhone display, to make a phone call, listen to music, view maps (navigation), and access messages.

📌 **USB Port(s)** P. 227

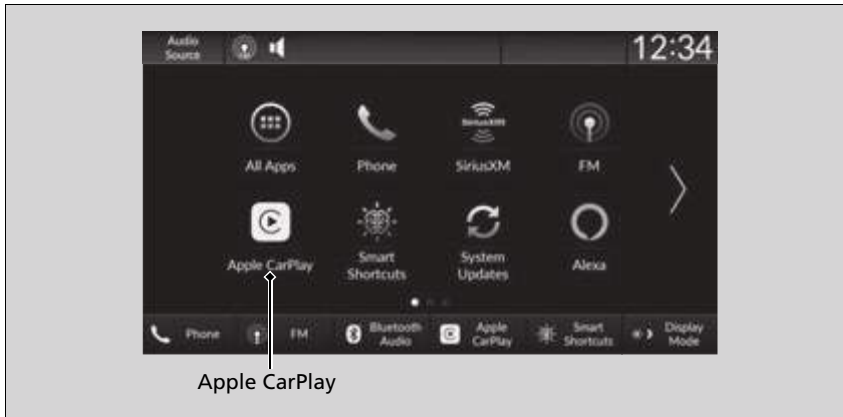

### 📌 Apple CarPlay

We recommend that you update iOS to the latest version when using Apple CarPlay.

Park in a safe place before connecting your iPhone to Apple CarPlay and when launching any compatible apps.

While connected to Apple CarPlay, calls are only made through Apple CarPlay. If you want to make a call with the HandsFreeLink® (HFL) system, turn Apple CarPlay off.

📌 **Setting Up Apple CarPlay** P. 317

When your iPhone is connected to Apple CarPlay, it is not possible to use the *Bluetooth*® Audio or *Bluetooth*® HandsFreeLink®. However, other previously paired phones can stream audio via *Bluetooth*® while Apple CarPlay is connected.



📌 **Phone Setup** P. 408

Apple CarPlay and Android Auto cannot run at the same time.

For details on countries and regions where Apple CarPlay is available, as well as information pertaining to function, refer to the Apple homepage.

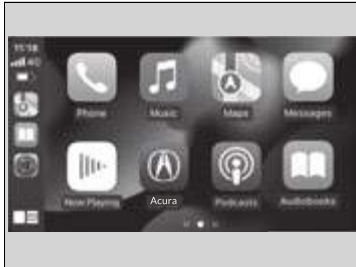
## ■ Apple CarPlay Menu



- **Phone**  
Access the contact list, make phone calls, or listen to voicemail.
- **Messages**  
Check and reply to text messages, or have messages read to you.
- **Music**  
Play music stored on your iPhone.
- **Maps**  
Display Apple Maps and use the navigation function just as you would on your iPhone.
- **Acura**  
Select the **Acura** icon to go back to the home screen.
-   
Go back to the Apple CarPlay Dashboard screen.
-   
Go back to the Apple CarPlay menu screen.

## ▶▶ Apple CarPlay

### Apple CarPlay Operating Requirements & Limitations

Apple CarPlay requires a compatible iPhone with an active cellular connection and data plan. Your carrier's rate plans will apply.

Changes in operating systems, hardware, software, and other technology integral to providing Apple CarPlay functionality, as well as new or revised governmental regulations, may result in a decrease or cessation of Apple CarPlay functionality and services. Acura cannot and does not provide any warranty or guarantee of future Apple CarPlay performance or functionality.

It is possible to use 3rd party apps if they are compatible with Apple CarPlay. Refer to the Apple homepage for information on compatible apps.

## Setting Up Apple CarPlay

After you have connected your iPhone to the system via the 2.5A USB port or wirelessly, use the following procedure to set up Apple CarPlay. Use of Apple CarPlay will result in the transmission of certain user and vehicle information (such as vehicle location, speed, and status) to your iPhone to enhance the Apple CarPlay experience. You will need to consent to the sharing of this information on the audio/information screen.

## Connecting Apple CarPlay Using the USB Cable to the USB Port

1. Connect the iPhone to the 2.5A USB port using the USB cable.

📄 **USB Port(s)** P. 227

▶ The confirmation screen will be displayed.

2. Select **Yes**.

▶ If you do not want to connect Apple CarPlay, select **No**.

You may change the consent settings under the **Smartphone Connection** settings menu.

## Setting Up Apple CarPlay

Only initialize Apple CarPlay when you are safely parked.

When Apple CarPlay first detects your iPhone, you will need to set up your iPhone. Refer to the instruction manual that came with your iPhone.

You can use the following procedure to disconnect or delete the devices connecting Apple CarPlay:



Press the  button → Select General Settings → Smartphone Connection → Apple CarPlay → Select device

### Use of user and vehicle information



The use and handling of user and vehicle information transmitted to/from your iPhone by Apple CarPlay is governed by the Apple iOS terms and conditions and Apple's Privacy Policy.

## ■ Connect Apple CarPlay Wirelessly

### ■ Connect Apple CarPlay wirelessly on the home screen

1. Press the  button.
2. Select **Smartphone Connection**.
3. Select **+ Connect New Device**.
4. Pair the iPhone to the vehicle's *Bluetooth*® HandsFreeLink® (HFL) system.  
 **Phone Setup** P. 408
5. Select **Yes**.
  - ▶ If your iPhone asks to accept for connecting Apple CarPlay, accept for connection. A confirmation message for AcuraLink Assist appears.
6. Select **Yes** or **No**.

### ■ Connect Apple CarPlay wirelessly on the Apple CarPlay device list

1. Press the  button.
2. Select **General Settings**.
3. Select **Smartphone Connection**.
4. Select **Apple CarPlay**.
5. Select **+ Connect New Device**.
6. Pair the iPhone to the vehicle's *Bluetooth*® HandsFreeLink® (HFL) system.  
 **Phone Setup** P. 408
7. Select **Yes**.
  - ▶ If your iPhone asks to accept for connecting Apple CarPlay, accept for connection. A confirmation message for AcuraLink Assist appears.
8. Select **Yes** or **No**.

### ■ Connect Apple CarPlay wirelessly on the *Bluetooth*® device list

1. Press the  button.
2. Select **General Settings**.
3. Select **Connections**.
4. Select **Bluetooth**.
5. Select **+ Connect New Device**.
6. Pair the iPhone to the vehicle's *Bluetooth*® HandsFreeLink® (HFL) system.  
▶ **Phone Setup** P. 408
7. Check the box on **Apple CarPlay**.  
▶ If you select **Apple CarPlay**, you cannot select **Audio** and **Phone**.
8. Select **Connect**.
9. Select **Yes**.  
▶ If your iPhone asks to accept for connecting Apple CarPlay, accept for connection. A confirmation message for AcuraLink Assist appears.
10. Select **Yes** or **No**.

### ■ Connect Apple CarPlay wirelessly with the steering wheel

1. Press and hold the  (Talk) button on the steering wheel.
2. Pair the iPhone to the vehicle's *Bluetooth*® HandsFreeLink® (HFL) system.  
▶ **Phone Setup** P. 408
3. Check the box on **Apple CarPlay**.  
▶ If you select **Apple CarPlay**, you cannot select **Audio** and **Phone**.
4. Select **Connect**.
5. Select **Yes**.  
▶ If your iPhone asks to accept for connecting Apple CarPlay, accept for connection. A confirmation message for AcuraLink Assist appears.
6. Select **Yes** or **No**.

■ **Connect Apple CarPlay wirelessly at start-up (when there is no phone paired to the system)**

1. Set the power mode to ACCESSORY or ON.
2. Select **OK**.
  - ▶ If there is no registered device, the *Bluetooth*® pairing screen will be displayed.
  - ▶ If you check the box with **Do not show this again**, this screen will not be displayed.
3. Pair the iPhone to the vehicle's *Bluetooth*® HandsFreeLink® (HFL) system.
  - 📖 **Phone Setup** P. 408
4. Check the box on **Apple CarPlay**.
  - ▶ If you select **Apple CarPlay**, you cannot select **Audio** and **Phone**.
5. Select **Connect**.
6. Select **Yes**.
  - ▶ If your iPhone asks to accept for connecting Apple CarPlay, accept for connection. A confirmation message for AcuraLink Assist appears.
7. Select **Yes** or **No**.

## ■ Operating Apple CarPlay with Siri

Press and hold the  (Talk) button to activate Siri.

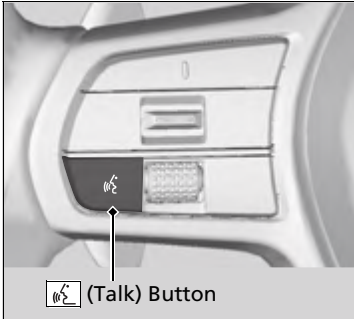

### (Talk) Button:

Press and hold to activate Siri.

Press again to deactivate Siri.

Press and release to activate standard voice recognition system.

## ▣ Operating Apple CarPlay with Siri

Below are examples of questions and commands for Siri:

- What movies are playing today?
- Call dad at work.
- What song is this?
- How's the weather tomorrow?
- Read my latest email.

For more information, please visit [www.apple.com/ios/siri](http://www.apple.com/ios/siri).

## Android Auto™

When you connect an Android phone to the audio system via the USB port or wirelessly, Android Auto is automatically initiated. When connected via Android Auto, you can use the audio/information screen to access the Phone, Google Maps (Navigation), and Google Now functions. When you first use Android Auto, a tutorial will appear on the screen.

We recommend that you complete this tutorial while safely parked before using Android Auto.

➤ **USB Port(s)** P. 227

➤ **Auto Pairing Connection** P. 324

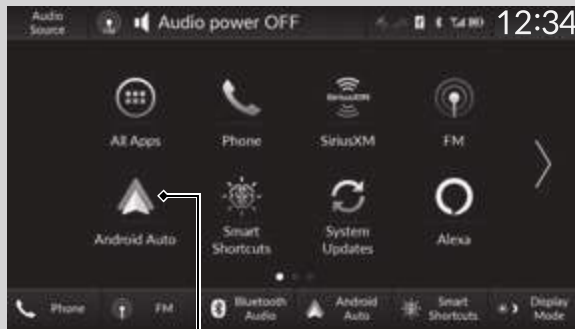

Android Auto

### Android Auto™

Android Auto is a trademark of Google LLC.

We recommend that you update Android OS to the latest version when using Android Auto.

*Bluetooth* A2DP cannot be used while your phone is connected to Android Auto.

To use Android Auto on a smartphone with Android 9.0 (Pie) or earlier, you need to download the Android Auto app from Google Play to your smartphone.

Park in a safe place before connecting your Android phone to Android Auto and when launching any compatible apps.

When your Android phone is connected to Android Auto, it is not possible to use the *Bluetooth*® Audio. However, other previously paired phones can stream audio via *Bluetooth*® while Android Auto is connected.



➤ **Phone Setup** P. 408

Apple CarPlay and Android Auto cannot run at the same time.



## Android Auto Menu



- **Maps**  
Display Google Maps and use the navigation function just as you would with your Android phone. When the vehicle is in motion, it is not possible to make keyboard entries. Stop the vehicle in a safe location to undertake a search or provide other inputs.
- **Phone**  
Make and receive phone calls as well as listen to voicemail.
- **Acura**  
Select the **Acura** icon to go back to the home screen.
-   
Operate Android Auto with your voice.
-   
You can check Android notifications.
-  (Android Auto Home)  
Display useful information organized by Android Auto into simple cards that appear just when they're needed.

## Android Auto™

For details on countries and regions where Android Auto is available, as well as information pertaining to function, refer to the Android Auto homepage.

Screens may differ depending on the version of the Android Auto app you are using.

### Android Auto Operating Requirements & Limitations

Android Auto requires a compatible Android phone with an active mobile connection and data plan. Your carrier's rate plans will apply.

Changes in operating systems, hardware, software, and other technology integral to providing Android Auto functionality, as well as new or revised governmental regulations, may result in a decrease or cessation of Android Auto functionality and services. Acura cannot and does not provide any warranty or guarantee of future Android Auto performance or functionality.

It is possible to use 3rd party apps if they are compatible with Android Auto. Refer to the Android Auto homepage for information on compatible apps.

## ■ Auto Pairing Connection

When you connect an Android phone to the unit via the USB port or wirelessly, Android Auto is automatically initiated.

## ■ Connecting Android Auto Using the USB Cable to the USB Port

1. Connect the Android phone to the USB port using the USB cable.
  - 📖 **USB Port(s)** P. 227
  - ▶ The confirmation screen will be displayed.
2. Select **Yes**.
  - ▶ If you do not want to connect Android Auto, select **No**.

You may change the consent settings under the **Smartphone Connection** settings menu.

## ■ Connect Android Auto Wirelessly

### ■ Connect Android Auto wirelessly on the home screen

1. Press the  button.
2. Select **Smartphone Connection**.
3. Select **+ Connect New Device**.
4. Pair the Android phone to the vehicle's *Bluetooth*® HandsFreeLink® (HFL) system.
  - 📖 **Phone Setup** P. 408
5. Select **Yes**.
  - ▶ If your Android phone asks to accept for connecting Android Auto, accept for connection. A confirmation message for AcuraLink Assist appears.
6. Select **Yes** or **No**.

## ☒ Connecting Android Auto Using the USB Cable to the USB Port

Only initialize Android Auto when you are safely parked. When Android Auto first detects your phone, you will need to set up your phone so that auto pairing is possible. Refer to the instruction manual that came with your phone.



You can use the following procedure to disconnect or delete the devices connecting Android Auto after you have completed the initial setup:

Select **General Settings** →  
**Smartphone Connection** → **Android Auto** →  
**Select device**



### Use of user and vehicle information

The use and handling of user and vehicle information transmitted to/from your phone by Android Auto is governed by the Google's Privacy Policy.

### ■ Connect Android Auto wirelessly on the Android Auto device list

1. Press the  button.
2. Select **General Settings**.
3. Select **Smartphone Connection**.
4. Select **Android Auto**.
5. Select **+ Connect New Device**.
6. Pair the Android phone to the vehicle's *Bluetooth*® HandsFreeLink® (HFL) system.  
 **Phone Setup** P. 408
7. Select **Yes**.
  - ▶ If your Android phone asks to accept for connecting Android Auto, accept for connection. A confirmation message for AcuraLink Assist appears.
8. Select **Yes** or **No**.

### ■ Connect Android Auto wirelessly on the *Bluetooth*® device list

1. Press the  button.
2. Select **General Settings**.
3. Select **Connections**.
4. Select **Bluetooth**.
5. Select **+ Connect New Device**.
6. Pair the Android phone to the vehicle's *Bluetooth*® HandsFreeLink® (HFL) system.  
 **Phone Setup** P. 408
7. Check the box on **Android Auto**.
  - ▶ If you select **Android Auto**, you cannot select **Audio** and **Phone**.
8. Select **Connect**.
9. Select **Yes**.
  - ▶ If your Android phone asks to accept for connecting Android Auto, accept for connection. A confirmation message for AcuraLink Assist appears.
10. Select **Yes** or **No**.

### ■ Connect Android Auto wirelessly with the steering wheel

1. Press and hold the  (Talk) button on the steering wheel.
2. Pair the Android phone to the vehicle's *Bluetooth*® HandsFreeLink® (HFL) system.
  - 📄 **Phone Setup** P. 408
3. Check the box on **Android Auto**.
  - ▶ If you select **Android Auto**, you cannot select **Audio** and **Phone**.
4. Select **Connect**.
5. Select **Yes**.
  - ▶ If your Android phone asks to accept for connecting Android Auto, accept for connection. A confirmation message for AcuraLink Assist appears.
6. Select **Yes** or **No**.

### ■ Connect Android Auto wirelessly at start-up (when there is no phone paired to the system)

1. Set the power mode to ACCESSORY or ON.
2. Select **OK**.
  - ▶ If there is no registered device, the *Bluetooth*® pairing screen will be displayed.
  - ▶ If you check the box with **Do not show this again**, this screen will not be displayed.
3. Pair the Android phone to the vehicle's *Bluetooth*® HandsFreeLink® (HFL) system.
  - 📄 **Phone Setup** P. 408
4. Check the box on **Android Auto**.
  - ▶ If you select **Android Auto**, you cannot select **Audio** and **Phone**.
5. Select **Connect**.
6. Select **Yes**.
  - ▶ If your Android phone asks to accept for connecting Android Auto, accept for connection. A confirmation message for AcuraLink Assist appears.
7. Select **Yes** or **No**.

## ■ Operating Android Auto with Voice Recognition

Press and hold the  (Talk) button to operate Android Auto with your voice.

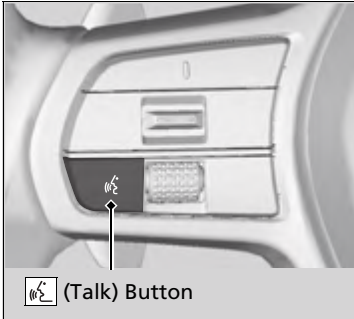

### (Talk) Button:

Press and hold to operate Android Auto with your voice.

Press and release to activate standard voice recognition system.

## ☒ Operating Android Auto with Voice Recognition

Below are examples of commands you can give with voice recognition:

- Reply to text.
- Call my wife.
- Navigate to Acura.
- Play my music.
- Send a text message to my wife.
- Call flower shop.

For more information, please refer to the Android Auto homepage.

You can also activate the voice recognition function by selecting the  icon in the lower-right corner of the screen.

## iPod/USB Flash Drive

If an error occurs while playing an iPod or USB flash drive, you may see the following error messages. If you cannot clear the error message, contact a dealer.

Error Message	Solution
<b>Bad USB Device</b> Please check owners manual <sup>*1</sup>	Appears when an incompatible device is connected. Disconnect the device. Then, turn the audio system off and turn it on again. Do not reconnect the device that caused the error.
<b>Connect Retry</b> <sup>*1, *2</sup>	Appears when the system does not acknowledge the iPod. Reconnect the iPod.
<b>Unplayable File</b> <sup>*1, *2</sup>	Appears when the files in the USB flash drive are copyright protected or an unsupported format. This error message appears for about a few seconds, then plays the next file.
<b>No Data</b> <sup>*1, *2</sup>	<b>iPod</b> Appears when the iPod is empty. <b>USB flash drive</b> Appears when the USB flash drive is empty or there are no MP3, WMA, AAC, FLAC, or WAV files in the USB flash drive. <b>iPod and USB flash drive</b> Check that compatible files are stored on the device.
<b>Unsupported</b> <sup>*1, *2</sup>	Appears when an unsupported device is connected. If it appears when a supported device is connected, reconnect the device.

\*1:Models with 7-in. Color Touchscreen

\*2:Models with 9-in. Color Touchscreen

Error Message	Solution
<b>Device No Response</b> <sup>*1, *2</sup>	Appears when the system does not communicate with a connected device. If it appears when a device is connected, contact your place of device purchase.
<b>USB hub not supported</b> <sup>*1, *2</sup>	Appears when only a HUB is connected. If it appears, connect a USB flash drive to the HUB.
<b>A charging error has occurred with the connected USB device. When safe please check the compatibility of the device and USB cable and try again.</b> <sup>*1, *2</sup>	Appears when an incompatible device is connected. Disconnect the device. Then, turn the audio system off and turn it on again. Do not reconnect the device that caused the error.

\*1: Models with 7-in. Color Touchscreen

\*2: Models with 9-in. Color Touchscreen

## SiriusXM® Radio Service\*

### ■ Subscribing to SiriusXM® Radio

1. You need your radio ID ready before registering for subscription. To see the ID on the screen, select **Channel 0**.
2. Have your radio ID ready, and either call or visit the SiriusXM® website to subscribe.

### ■ Receiving SiriusXM® Radio

Switch to the SiriusXM® mode by using the audio remote controls on the steering wheel, or through the audio/information screen, and stay in this mode for about 30 minutes until the service is activated. Make sure your vehicle is in an open area with good reception.

### ■ SiriusXM® Radio Display Messages

**Channel \*\*\*\* is not subscribed. Call SiriusXM to subscribe.\*1**

You are not subscribed to the channel selected.

**Subscription Updated:**

SiriusXM® radio is receiving information update from the network.

**Channel Not Available:**

No such channel exists, or the artist or title information is unavailable.

**No Signal:**

The signal is too weak in the current location.

**Check Tuner:**

There is a problem with the SiriusXM® tuner. Contact a dealer.

**Antenna Disconnected, Antenna Shorted:**

There is a problem with the SiriusXM® antenna. Contact a dealer.

\*1 : \*\*\*\*part is variable characters, and will change depending upon the channel selected.

\* Not available on all models

### ☒ Subscribing to SiriusXM® Radio

Contact Information for SiriusXM® Radio:

- U.S.: SiriusXM® Radio at [www.siriusxm.com/subscribe-now](http://www.siriusxm.com/subscribe-now), or 1-866-635-2349
- Canada: SiriusXM® Canada at [www.siriusxm.ca/subscribe-now](http://www.siriusxm.ca/subscribe-now), or 1-877-209-0079

### ☒ Receiving SiriusXM® Radio

The SiriusXM® satellites are in orbit over the equator; therefore, objects south of the vehicle may cause satellite reception interruptions. Satellite signals are more likely to be blocked by tall buildings and mountains the farther north you travel from the equator.

You may experience reception problems under the following circumstances:

- In a location with an obstruction to the south of your vehicle.
- In tunnels
- On the lower level of a multi-tiered road
- Large items carried on the roof rack



## Compatible iPod, iPhone, and USB Flash Drives

### iPod and iPhone Model Compatibility

#### Models with 7-in. Color Touchscreen

##### Model

Made for iPod touch (6th to 7th generation) released between 2015 and 2019

Made for iPhone 5s/iPhone 6/iPhone 6 Plus/iPhone 6s/iPhone 6s Plus/iPhone SE/iPhone 7/iPhone 7 Plus/iPhone 8/iPhone 8 Plus/iPhone X/iPhone XS/iPhone XS Max/iPhone XR/iPhone 11/iPhone 11 Pro/iPhone 11 Pro Max/iPhone SE (2nd generation)

#### Models with 9-in. Color Touchscreen

##### Model

Made for iPod touch (5th to 6th generation) released between 2012 and 2015

Made for iPhone 4s/iPhone 5/iPhone 5s/iPhone 5c/iPhone 6/iPhone 6 Plus/iPhone 6s/iPhone 6s Plus/iPhone SE/iPhone 7/iPhone 7 Plus/iPhone 8/iPhone 8 Plus/iPhone X/iPhone XS/iPhone XS Max/iPhone XR/iPhone 11/iPhone 11 Pro/iPhone 11 Pro Max

### USB Flash Drives

- A USB flash drive of 256 MB or higher is recommended.
- Some digital audio players may not be compatible.
- Some USB flash drives (e.g., a device with security lockout) may not work.
- Some software files may not allow for audio play or text data display.
- Some versions of MP3, WMA, AAC, FLAC, or WAV formats may be unsupported.

\*1: Models with 9-in. Color Touchscreen

\*2: Models with 7-in. Color Touchscreen

### iPod and iPhone Model Compatibility

This system may not work with all software versions of these devices.

The Lightning connector works with iPhone 5<sup>\*1</sup>, iPhone 5s, iPhone 5c<sup>\*1</sup>, iPhone 6, iPhone 6 Plus, iPhone 6s, iPhone 6s Plus, iPhone SE, iPhone 7, iPhone 7 Plus, iPhone 8, iPhone 8 Plus, iPhone X, iPhone XS, iPhone XS Max, iPhone XR, iPhone 11, iPhone 11 Pro, iPhone 11 Pro Max, iPhone SE (2nd generation)<sup>\*2</sup>, iPod touch (5th<sup>\*1</sup>, 6th, 7th<sup>\*2</sup> generation).

The 30-pin connector works with iPhone 4s<sup>\*1</sup>.

USB works with iPhone 4s<sup>\*1</sup>, iPhone 5<sup>\*1</sup>, iPhone 5s, iPhone 5c<sup>\*1</sup>, iPhone 6, iPhone 6 Plus, iPhone 6s, iPhone 6s Plus, iPhone SE, iPhone 7, iPhone 7 Plus, iPhone 8, iPhone 8 Plus, iPhone X, iPhone XS, iPhone XS Max, iPhone XR, iPhone 11, iPhone 11 Pro, iPhone 11 Pro Max, iPhone SE (2nd generation)<sup>\*2</sup>, iPod touch (5th<sup>\*1</sup>, 6th, 7th<sup>\*2</sup> generation).

### USB Flash Drives

Files on the USB flash drive are played in their stored order. This order may be different from the order displayed on your PC or device.

## Honda App License Agreement

### ■ END USER LICENSE AGREEMENT

PLEASE CAREFULLY READ THIS END USER LICENSE AGREEMENT (THIS “AGREEMENT”) WHICH GOVERNS YOUR USE OF THE SOFTWARE INSTALLED ON YOUR HONDA OR ACURA VEHICLE (YOUR “VEHICLE”) AS WELL AS THE APPLICATIONS, SERVICES, FUNCTIONS, AND CONTENT PROVIDED THROUGH THE SOFTWARE (COLLECTIVELY, THE “SERVICES”). YOUR USE OF THE SOFTWARE OR SERVICES WILL SERVE AS YOUR CONSENT TO THE TERMS OF THIS AGREEMENT. THE SOFTWARE IS OWNED (OR LICENSED), PROVIDED, AND/OR OPERATED BY AMERICAN HONDA MOTOR CO. INC., (“HONDA,” “US,” “WE,” OR “OUR”), WITH ITS BUSINESS ADDRESS AT 1919 TORRANCE BLVD., TORRANCE, CA 90501. REFERENCE TO “HONDA” IN THIS AGREEMENT INCLUDES HONDA’S PARENT COMPANY AND ITS AFFILIATES AND DESIGNATED AGENTS. THE SERVICES ARE OWNED (OR LICENSED), PROVIDED, AND/OR OPERATED BY HONDA OR A THIRD-PARTY SERVICE PROVIDER (A “PROVIDER”). REFERENCE TO A “PROVIDER” IN THIS AGREEMENT INCLUDES SUCH PROVIDER’S PARENT COMPANY, AFFILIATES, AND DESIGNATED AGENTS.

**A. Description of the Software.** The SOFTWARE includes the software, firmware and the like, installed and executing on your VEHICLE during manufacture, and thereafter updated from time to time by HONDA, you or an authorized HONDA dealer (a “DEALER”). The SOFTWARE allows you to access and use a variety of SERVICES, including but not limited to: (a) HONDA applications, services, and content provided through the SOFTWARE (together, “HONDA SERVICES”); and (b) PROVIDER applications, services, and content provided through the SOFTWARE (together, “PROVIDER SERVICES”), each of which may provide access to various information, media, content, and services.

#### **B. SOFTWARE Licensing and Intellectual Property.**

**1. SOFTWARE.** This AGREEMENT grants you a non-exclusive, limited, and revocable license to use the SOFTWARE and SERVICES solely (a) as installed on your VEHICLE by HONDA, (b) as updated on your Vehicle by HONDA, you (but only as and when directed by HONDA), or a DEALER and (c) as permitted under the terms of this AGREEMENT.

**2. HONDA Services.** The SOFTWARE may provide you with access to various HONDA SERVICES. Installation, activation, or use of HONDA SERVICES may require your consent to additional terms, conditions, and privacy policies applicable to those HONDA SERVICES (the “HONDA TERMS”). You acknowledge and agree that any collection, use, sharing of data generated by your VEHICLE or your use of your VEHICLE, and your use of the HONDA SERVICES shall be subject to this AGREEMENT and any additional HONDA TERMS that may be specifically applicable to such HONDA SERVICES or data generation. The HONDA SERVICES may collect, use, and share such data while you are using the SOFTWARE.

**3. Open-Source Software.** The SOFTWARE and SERVICES may incorporate software licensed to HONDA under free or open-source licenses which govern HONDA's distribution and your use of such software. HONDA and the third-party authors, licensors, and distributors of such software disclaim all warranties and all liability arising from any and all use or distribution of the software. To the extent such software is provided under terms that differ from the applicable free or open-source licenses, those terms are offered by HONDA alone. Additional information regarding free and open-source software incorporated in the SOFTWARE and SERVICES is available in this manual or within the SOFTWARE.

**4. Provider Services.** The SOFTWARE may provide you with access to various PROVIDER SERVICES. Installation or use of such PROVIDER SERVICES may require your consent to additional terms, conditions, and privacy policies of the applicable PROVIDER (the "PROVIDER TERMS"). This AGREEMENT restricts the manner in which you can install and use PROVIDER SERVICES but does not grant you a license or permission to use such PROVIDER SERVICES. Your permission to use PROVIDER SERVICES is limited and subject to any license grants, conditions, and limitations included in the PROVIDER TERMS. You acknowledge that any collection, use, sharing of your information, targeted advertising practices by PROVIDERS, and your use of the PROVIDER SERVICES shall be subject to both this AGREEMENT and any applicable PROVIDER TERMS. The PROVIDER SERVICES may collect, use, and share such information while you are using the SOFTWARE.

**5. License Limitations and Restrictions on Use.**

(a) Limited License. You understand and agree that the SOFTWARE and SERVICES are licensed, not sold, to you solely for use in accordance with this AGREEMENT and any applicable PROVIDER TERMS, and any documentation for the VEHICLE made available to you by HONDA (any "DOCUMENTATION"). HONDA and its licensors reserve all rights in the SOFTWARE and HONDA SERVICES not expressly granted to you under this AGREEMENT. PROVIDERS and their licensors reserve all rights in the PROVIDER SERVICES not expressly granted to you under the applicable PROVIDER TERMS.

(b) Restrictions on Use. The licenses granted under this AGREEMENT do not permit you to use the SOFTWARE or SERVICES on a device other than your VEHICLE. As a condition of using the SOFTWARE and SERVICES, you agree that you may not and will not:

- (1) copy, download, distribute, modify, publish, sell, rent, lease, lend, license, sublicense, reuse, or create derivative works of the SOFTWARE or SERVICES or any of the content or other material within the SOFTWARE or SERVICES, including without limitation, HONDA or PROVIDER names, logos, or any other trademarks of HONDA or PROVIDERS or used in association with the SOFTWARE or any SERVICES, except as required to use the SOFTWARE or SERVICES in accordance with this AGREEMENT, any applicable PROVIDER TERMS, and the DOCUMENTATION;
- (2) access or use the SOFTWARE or SERVICES in any manner intended to damage or impair the operation of the SOFTWARE or SERVICES or interfere with anyone else's use and enjoyment of the SOFTWARE or SERVICES;
- (3) access or attempt to access any system or server on which the SOFTWARE or SERVICES is hosted or modify or alter the SOFTWARE or SERVICES in any way;
- (4) use the SOFTWARE or SERVICES for any unlawful purpose, or in violation of any third party rights;
- (5) use the SOFTWARE or SERVICES in violation of any applicable traffic regulations, rules or laws, including but not limited to any driver distraction laws, rules or regulations;
- (6) violate the terms of this AGREEMENT, any HONDA TERMS, any PROVIDER TERMS or other applicable third-party terms, conditions, and privacy policies; or
- (7) reverse engineer, decompile, disassemble, attempt to derive the source code of, nor permit others to reverse engineer, decompile, or disassemble, or attempt to derive the source code of the SOFTWARE or SERVICES, except and only to the extent that such activity is expressly permitted (a) by applicable law notwithstanding this limitation or (b) the terms of applicable free or opensource software licenses.

**6. Intellectual Property Rights.** All title and intellectual property rights in and to the SOFTWARE and SERVICES, the accompanying DOCUMENTATION, and all copies of the SOFTWARE or SERVICES are owned by HONDA, PROVIDERS, or their suppliers or licensors. This AGREEMENT does not grant you any rights in connection with any trademarks or service marks of HONDA, PROVIDERS, or their licensors, affiliates, or suppliers.

**7. Export Restrictions:** You acknowledge that the SOFTWARE and SERVICES are subject to U.S., European Union, and other export jurisdictions. You agree to comply with all applicable international and national laws that apply to the SOFTWARE and SERVICES, including the U.S. Export Administration Regulations, as well as end-user, end-use, and destination restrictions issued by the U.S. and other governments.

### **C. SOFTWARE Operation**

- 1. HONDA reserves the right to suspend or terminate your access to and use of the SOFTWARE or SERVICES if you are found to be in violation of this AGREEMENT or as reasonably deemed necessary by HONDA.**
- 2. Eligibility/Registration/Activation.** The SOFTWARE is intended for and available to individuals who (a) are of legal age of majority in their jurisdiction of residence (and at least 18 years of age), or are younger than 18 years of age and possess a valid driver's license issued by their jurisdiction of residence, and (b) own or have permissive access to a compatible VEHICLE. We do not knowingly collect any information, including personal information, from children under 13. If we learn or are notified that we have collected personal information of a child under 13, we will immediately take steps to delete such information.
- 3. Use of PROVIDER SERVICES through the SOFTWARE.** Certain PROVIDER SERVICES made available through the SOFTWARE may require that you register or otherwise have an account with the PROVIDER and agree to PROVIDER TERMS. Any use of any of such PROVIDER SERVICES within the SOFTWARE is subject to this AGREEMENT and the applicable PROVIDER TERMS. HONDA does not exercise control over such PROVIDER SERVICES and is not responsible or liable for the availability, security, or content of such PROVIDER SERVICES, and the inclusion of any PROVIDER SERVICES does not imply a referral from, the approval of, or the endorsement by HONDA of such PROVIDER SERVICES. HONDA is not responsible or liable, directly or indirectly, for any damage relating to or resulting from your use of the PROVIDER SERVICES.
- 4. Links to Third Party Sites:** The SOFTWARE may provide you with the ability to access third-party sites and content through the use of the SOFTWARE or SERVICES. The third-party sites and content are not under the control of HONDA. HONDA is not responsible or liable, directly or indirectly, for such third-party websites and their content or for any damage relating to or resulting from your access or use of such websites and content.

**5. Unauthorized Use and Abuse.** You are responsible for ensuring your (and any authorized third parties') use of the SOFTWARE and SERVICES remains in compliance with this AGREEMENT and all other applicable HONDA TERMS and PROVIDER TERMS. You acknowledge and agree that any use of the SOFTWARE or SERVICES occurring through your VEHICLE will be deemed your actions and that HONDA and PROVIDERS may rely upon such actions. You agree to immediately notify us if you suspect fraudulent or abusive activity involving the SOFTWARE or SERVICES. If you so notify us or if we otherwise suspect fraudulent or abusive activity, you agree to cooperate with us in any fraud investigation and to use any fraud prevention measures we prescribe. Your failure to immediately notify us or cooperate to use such measures will result in your liability for all fraudulent usage or abusive activity associated with your VEHICLE.

**6. SOFTWARE Updates.** The SOFTWARE and SERVICES may be updated when your VEHICLE is serviced by a DEALER or remotely, over-the-air, by HONDA from time to time; such updates may occur with or without further notice or your future consent. The SOFTWARE may be updated at HONDA's discretion and for any purpose including, without limitation, to patch or otherwise improve the SOFTWARE or SERVICES functionality, security, or stability. All updates to the SOFTWARE and SERVICES are subject to this AGREEMENT and any other applicable HONDA TERMS and PROVIDER TERMS.

**7. Uninstalling, Removing, and Replacing the SOFTWARE.** Replacing SOFTWARE or HONDA SERVICES with software or firmware not provided and installed by HONDA or a DEALER will render all representations and warranties for the SOFTWARE, HONDA SERVICES, and VEHICLE functionality reliant upon the SOFTWARE or HONDA SERVICES null and void.

#### **D. SOFTWARE Operational Notices and Warnings**

**1. Vehicle Geolocation Information.** You acknowledge that your VEHICLE may be equipped with certain traffic and map features. The traffic feature will automatically collect and transmit, through GPS technology, your Vehicle's current location (longitude and latitude), travel direction and speed ("VEHICLE GEOLOCATION INFORMATION") to HONDA and PROVIDERS. The VEHICLE GEOLOCATION INFORMATION is used by HONDA and PROVIDERS to provide traffic and navigation-related information to you, but may also be used to provide other SERVICES or offers to you. HONDA will not use such VEHICLE GEOLOCATION INFORMATION for its own marketing efforts, or provide such information to unaffiliated third parties for their own purposes, without your express consent.

**2. Potential Map Inaccuracy and Route Safety.** Maps used by this system may be inaccurate because of changes in roads, traffic controls, routing, or driving conditions. Always use good judgment and common sense when following suggested routes. Do not follow the route suggestions if doing so would result in an unsafe or illegal driving maneuver, if you would be placed in an unsafe situation, or if you would be directed into an area that you consider unsafe. Do not rely on any navigation features included in the system to route you to emergency services. Not all emergency services such as police, fire stations, hospitals, or clinics are likely to be contained in the map database for such navigation features. Ask local authorities or an emergency services operator for such locations and routes. The driver is ultimately responsible for the safe operation of the vehicle and therefore, must evaluate whether it is safe to follow the suggested directions. Any navigation features are provided only as an aid. Make your driving decisions based on your observations of local conditions and existing traffic regulations. Navigation features are not a substitute for your personal judgment. Any route suggestions made by the SOFTWARE or SERVICES should never replace any local traffic regulations or your personal judgment or knowledge of safe driving practices.

**3. Speech Recognition:** You acknowledge and understand that HONDA and PROVIDERS may record, retain, and use voices commands when you use the speech recognition components of the SOFTWARE or SERVICES. You and all VEHICLE operators and passengers (a) consent to the recording and retention of voice commands in support of providing speech recognition components and (b) release HONDA and PROVIDERS from all claims, liabilities, and losses that may result from any use of such recorded voice commands. Recognition errors are inherent in speech recognition. It is your responsibility to monitor any speech recognition functions included in the system and address any errors. Neither HONDA nor PROVIDERS will be liable for any damages arising out of errors in the speech recognition process.

**4. Distraction Hazards.** Navigation features may require manual (non-verbal) input or setup. Attempting to perform such set-up or insert data while driving can seriously distract your attention and could cause a crash or other serious consequences; the ability to undertake such interactions may also be limited by state or local law, which laws you are responsible to know and follow. Even occasional short scans of the screen may be hazardous if your attention has been diverted away from your driving at a critical time. Pull over and stop the vehicle in a safe and legal manner before attempting to access a function of the system requiring prolonged attention. Do not raise the volume excessively. Keep the volume at a level where you can still hear outside traffic and emergency signals while driving. Driving while unable to hear these sounds could result in a crash.

## E. Information Collection and Storage

**1. Information Collection, Use, Transmission and Storage of Data. Consent to Use of Data:** You agree that HONDA and PROVIDERS may collect and use your information gathered in any manner as part of product support services related to the SOFTWARE or related services. HONDA may share such information with third parties, including, without limitation, PROVIDERS, third party software and services suppliers, their affiliates and/or their designated agents, solely to improve their products or to provide services or technologies to you. HONDA, third party software and systems suppliers, their affiliates and/or their designated agent may disclose this information to others, but not in a form that personally identifies you.

**2. Information Storage.** Depending on the type of multimedia system you have in your VEHICLE, certain information may be stored for ease of use of the SOFTWARE including, without limitation, search history, location history in certain applications, previous and saved destinations, map locations within certain applications, and device numbers and contact information.

(a) Vehicle Health Information. Your VEHICLE may remotely transmit information regarding the status and health of your VEHICLE (“VEHICLE INFORMATION”) to HONDA without notification to you. VEHICLE INFORMATION may contain VEHICLE maintenance and malfunction status that is derived from VEHICLE diagnostic data and includes, but is not limited to, status of powered doors and windows, battery life data, battery charging data, VEHICLE speed, coolant temperature, air compressor revolution, output power, warning codes, diagnostic trouble codes, fuel injection volume, and engine rotations per minute. VEHICLE HEALTH INFORMATION may be used by HONDA for research and development, to deliver HONDA SERVICES and information to you, and to contact you, and is retained only for a period of time necessary to fulfill these goals.

(b) VEHICLE Geolocation Data (non-navigation/map based). If you opt-in to geolocation-based SERVICES, your vehicle’s geolocation data (latitude and longitude) will be automatically sent from your VEHICLE to HONDA and PROVIDERS.

(c) You understand that the inputting or uploading of information to your VEHICLE’s multimedia system or the SOFTWARE or SERVICES is at your own risk and that HONDA is not responsible for unauthorized access to or use of any personal or other information. All information uploaded to the SOFTWARE and SERVICES may be stored on your VEHICLES’s multimedia system and you understand that the security and safety of your VEHICLE’s multimedia system is your sole responsibility.



**F. NO WARRANTY.** You understand and agree that your use of the SOFTWARE and SERVICES are solely at your own risk and that you will be solely responsible for any damage to your VEHICLE's multimedia system or any other equipment or any loss of data that may result from your use of the SOFTWARE or SERVICES. THE SOFTWARE AND SERVICES ARE PROVIDED ON AN "AS IS" AND "AS AVAILABLE" BASIS WITHOUT ANY WARRANTY OF ANY KIND, EXPRESSED, IMPLIED OR STATUTORY. WE SPECIFICALLY DISCLAIM ANY IMPLIED WARRANTIES OF MERCHANTABILITY, FITNESS FOR A PARTICULAR PURPOSE, AND NON-INFRINGEMENT. HONDA makes no warranties that the SOFTWARE or SERVICES will meet your requirements, or that the SOFTWARE or SERVICES will be uninterrupted, timely, secure, non-infringing or error free. You understand and agree that you are responsible for any and all charges, costs or expenses associated with your use of the SOFTWARE or SERVICES. Advice or information, whether oral or written, obtained by you from us or through the SOFTWARE or SERVICES are provided for informational purposes only and will not create any warranty not expressly made herein. You should not rely on any such information or advice. We assume no liability or responsibility for any errors or omissions in the SOFTWARE or SERVICES. We do not make any warranty or representation that your use of the material displayed on, or obtained through, the SOFTWARE or SERVICES is non-infringing of any rights of any third party. Any decision or action taken by you on the basis of information or content provided via the application is at your sole discretion and risk. HONDA and PROVIDERS are not responsible or liable for any such decision, or for the accuracy, completeness, usefulness, or availability of any content or information displayed, transmitted, or otherwise made available via the SOFTWARE or SERVICES. To the extent jurisdictions do not allow the exclusion of certain warranties, some of the above exclusions may not apply to you.

**G. LIMITATIONS ON LIABILITY.** You and HONDA are each waiving important rights.

**1. Limitations on YOUR liability.** HONDA cannot recover from you any consequential, indirect, incidental, or special damages, or attorney's fees in connection with your use of the SOFTWARE or HONDA SERVICES. HONDA WAIVES TO THE FULLEST EXTENT ALLOWED BY LAW ANY CLAIM FOR DAMAGES OTHER THAN DIRECT, COMPENSATORY DAMAGES AS LIMITED IN THIS AGREEMENT.

**2. Limitation on HONDA and PROVIDER liability.** Neither HONDA nor PROVIDERS will be liable to you or any other party for consequential, indirect, incidental, special, or punitive damages (including without limitation lost profits) in connection with your use of the SOFTWARE or SERVICES, even if HONDA or PROVIDERS are aware of the possibility of such damages. These limitations apply to all claims, including, without limitation, claims in contract and tort (such as negligence, product liability and strict liability). To the extent that a jurisdiction does not permit the exclusion or limitation of liability as set forth herein our liability is limited to the maximum extent permitted by law in such states. If HONDA or PROVIDERS are found liable to you for any reason, you agree that the aggregate liability of all these parties to you for any claim is limited to ten U.S. dollars (US \$10.00). Neither HONDA nor any PROVIDER would have agreed to provide the SOFTWARE or SERVICES to you if you did not agree to this limitation. This amount is the sole and exclusive liability of HONDA and PROVIDERS to you, and is payable as liquidated damages and not as a penalty. Except where prohibited by law, you may not bring any claim against HONDA or any third-party beneficiary more than two (2) years after the claim arises. We do not have any liability for SOFTWARE or SERVICES interruptions of any length.

(a) **Release of HONDA and PROVIDERS** For yourself and anyone else claiming under you, you agree to release and discharge HONDA, PROVIDERS, their respective officers, directors, and employees, and each third-party beneficiary from all claims, liabilities and losses in connection with the SOFTWARE or SERVICES, including, but not limited to claims for personal injury or property damage arising from the total or partial failure of performance of the SOFTWARE or SERVICES, even if caused by or based upon the negligence, gross negligence, strict products liability, Deceptive Trade Practices Act violations, bad faith, or breach of warranty of us or the malfunction of the SOFTWARE or SOFTWARE SERVICES. YOU AGREE TO WAIVE TO THE FULLEST EXTENT ALLOWED BY LAW, ANY CLAIM FOR DAMAGES OTHER THAN DIRECT, COMPENSATORY DAMAGES AS LIMITED IN THIS AGREEMENT. YOU HEREBY RELEASE AND DISCHARGE HONDA AND ITS LICENSORS AND CONTRACTORS (INCLUDING ANY THIRD PARTIES PROVIDING ALL OR PART OF THE SOFTWARE OR SERVICES) FROM AND AGAINST ANY CLAIMS, DAMAGES, EXPENSES AND LIABILITY ARISING FROM OR RELATED TO ANY INJURIES, DAMAGES, OR LOSSES TO ANY PERSON (INCLUDING DEATH) OR PROPERTY OF ANY KIND RESULTING IN WHOLE OR PART, DIRECTLY OR INDIRECTLY, FROM YOUR USE OF THE SOFTWARE OR SERVICES.

**H. Survival.** You agree that the limitations of liability and indemnities in this AGREEMENT will survive even after the AGREEMENT has ended. These limitations of liability apply not only to you, but to anyone using the SOFTWARE or SERVICES via your VEHICLE, to anyone making a claim on your behalf, and to any claims made by your family, employees, customers, or others arising out of or relating to your VEHICLE, the SOFTWARE, or SERVICES.

**I. Availability/Interruption.** The SOFTWARE and certain SERVICES are made available through your VEHICLE's compatible multimedia system when the VEHICLE is turned on. Certain SERVICES may be available only through your compatible mobile device when it is within the operating range of the VEHICLE and a wireless carrier. The availability of the SOFTWARE and SERVICES may be subject to transmission limitation or interruption, including but not limited to technical obsolescence or sunset of the hardware, software or firmware, inside of or external to the Vehicle, required for data transmission or receipt. HONDA does not guarantee that the SOFTWARE, SERVICES, or any portion thereof will be available at all times or in all areas. You acknowledge and agree that HONDA is not responsible for performance degradation, interruption or delays. You acknowledge that HONDA shall not be liable to you if the SOFTWARE or SERVICES in a given location are not available. If the SOFTWARE or SERVICES are not available within your intended location, you agree that your sole remedy shall be to cease using the SOFTWARE and SERVICES.

**J. PRODUCT SUPPORT:** Product support for the SOFTWARE is provided by HONDA. For product support, please refer to HONDA instructions provided in the DOCUMENTATION. Should you have any questions concerning this AGREEMENT, or if you desire to contact HONDA for any other reason, please refer to the HONDA contact information provided in the DOCUMENTATION.

**K. Termination and Transfer.**

**1. Termination.** This AGREEMENT is effective until terminated by you or US. WE may terminate this AGREEMENT for any or no reason, and with or without notice to you. Your rights under this AGREEMENT will terminate automatically without notice from US if you fail to comply with any term of this AGREEMENT. Upon termination of this AGREEMENT, you shall cease all use of the SOFTWARE and SERVICES.

**2. Transfer:** You may permanently transfer your rights under this AGREEMENT only as part of a sale or transfer of the VEHICLE, provided you retain no copies, you transfer all of the SOFTWARE and HONDA SERVICES (including all component parts, the media and printed materials, and any upgrades), and the recipient agrees to the terms of this AGREEMENT. You agree to notify HONDA upon the sale or transfer of the VEHICLE. To contact HONDA, please refer to the HONDA contact information provided in the DOCUMENTATION.

**L. Changes to the SOFTWARE or SERVICES.** WE may change, modify, or update the SOFTWARE or SERVICES from time to time. Unless explicitly stated otherwise, any new features or services that augment or enhance the SOFTWARE or SERVICES in the future shall respectively be considered part of the SOFTWARE or SERVICES and subject to this AGREEMENT. WE reserve the right at any time and from time to time to interrupt, restrict, modify, suspend, discontinue, temporarily or permanently, the SOFTWARE or SERVICES (or any portion thereof), with or without notice to you, and you agree that HONDA shall not be liable to you or to any third party for any modification, suspension or discontinuance of the SOFTWARE or SERVICES.

**M. ARBITRATION:**

PLEASE READ THIS ARBITRATION PROVISION CAREFULLY TO UNDERSTAND YOUR RIGHTS. YOU AGREE THAT ANY CLAIM THAT YOU MAY HAVE IN THE FUTURE MUST BE RESOLVED THROUGH BINDING ARBITRATION. YOU WAIVE THE RIGHT TO HAVE YOUR DISPUTE HEARD IN COURT AND WAIVE THE RIGHT TO BRING CLASS CLAIMS. YOU UNDERSTAND THAT DISCOVERY AND APPEAL RIGHTS ARE MORE LIMITED IN ARBITRATION.

Arbitration is a method of resolving a claim, dispute or controversy without filing a lawsuit. By agreeing to arbitrate, the right to go to court is waived and instead claims, disputes or controversies are submitted to binding arbitration. This provision sets forth the terms and conditions of our agreement. YOU and HONDA agree and acknowledge that this Agreement affects interstate commerce and the Federal Arbitration Act ("FAA") applies. By using the Software, Vehicle, or Services, YOU elect to have disputes resolved by arbitration. YOU, HONDA or any involved third party may pursue a Claim. "Claim" means any dispute between YOU, HONDA, or any involved third party relating to your use of the Software, the Vehicle, or the Services, this Agreement, or our relationship, including any representations, omissions or warranties. "Claim" does not include personal injury or wrongful death claims. YOU or HONDA may seek remedies in small claims court or provisional judicial remedies without arbitrating. In addition, notwithstanding anything herein to the contrary, YOU or HONDA may seek equitable relief in a court of competent jurisdiction.

YOU or HONDA may select arbitration with American Arbitration Association, JAMS or National Arbitration and Mediation. Contact these sponsors for their rules. The hearing will be in the federal district where YOU reside. If agreed, it may be by telephone or written submissions. Filing and arbitrator fees to be paid per the sponsor rules. You may contact the sponsor for a fee waiver. If no fee waivers, HONDA will pay filing and arbitrator fees up to \$5,000, unless law requires more. Each party is responsible for other fees. Arbitrator may award costs or fees to prevailing party, if permitted by law. HONDA will not seek fees, unless the claims are frivolous.

Arbitrator shall be an attorney or current or retired judge familiar with automotive or consumer software. The arbitrator shall follow substantive law, statute of limitations and decide all issues relating to the interpretation, construction, enforceability and applicability of this provision. The arbitrator may order relief permitted by law. This provision is governed and enforceable by the FAA. An award shall include a written opinion and be final, subject to appeal by the FAA.

This provision survives termination of this Agreement or relationship, bankruptcy, assignment or transfer. If part of this provision is unenforceable, the remainder remains in effect. If unenforceability allows arbitration as a class action, then this provision is entirely unenforceable. YOU may opt out within 30 days of your initial use of the Software by sending a signed, written notice to HONDA at Honda Financial Services, P.O. Box 165007, Irving, TX 75016. HONDA reserves the right to make changes to this provision after providing written notice and an opportunity to opt out.

**N. Miscellaneous:** You may not assign this AGREEMENT without HONDA's prior written consent. This AGREEMENT and any additional HONDA TERMS and PROVIDER TERMS represents the entire agreement between you and US. HONDA may amend the terms of this AGREEMENT by providing you with notices of such updated terms. If you do not consent to be bound by the updated terms, your sole remedy will be to cease using the SOFTWARE and SERVICES. If any part of this AGREEMENT is found invalid, void, or unenforceable, the balance of the AGREEMENT will remain valid and enforceable according to its terms. To the fullest extent permitted by law, and except as explicitly provided otherwise, this AGREEMENT and any disputes arising out of or relating to it will be governed by the laws of the State of California, except that California laws concerning choice of law or conflicts shall not apply if they would cause the substantive law of another jurisdiction to apply. Notwithstanding the foregoing, Section M shall be governed by the Federal Arbitration Act and the laws of the State of California, as applicable, as set forth therein. The failure to enforce any term of this AGREEMENT on one occasion shall not prevent enforcement on any other occasion or the enforcement of any other term. Headings and captions shall not be considered included for purposes of interpretation or application hereof, but are for convenience only.

## Legal Information on Apple CarPlay/Android Auto

---

### ■ OWNER'S MANUAL LICENSE/LIABILITY STATEMENTS

USE OF APPLE CARPLAY IS SUBJECT TO YOUR AGREEMENT TO THE CARPLAY TERMS OF USE, WHICH ARE INCLUDED AS PART OF THE APPLE iOS TERMS OF USE. IN SUMMARY, THE CARPLAY TERMS OF USE DISCLAIM APPLE AND ITS SERVICE PROVIDERS' LIABILITY IF THE SERVICES FAIL TO PERFORM CORRECTLY OR ARE DISCONTINUED, STRICTLY LIMIT APPLE AND ITS SERVICE PROVIDERS' OTHER LIABILITIES, DESCRIBE THE KINDS OF USER INFORMATION (INCLUDING, FOR EXAMPLE, VEHICLE LOCATION, VEHICLE SPEED, AND VEHICLE STATUS) BEING GATHERED AND STORED BY APPLE AND ITS SERVICE PROVIDERS, AND DISCLOSE CERTAIN POSSIBLE RISKS ASSOCIATED WITH THE USE OF CARPLAY, INCLUDING THE POTENTIAL FOR DRIVER DISTRACTION. SEE APPLE'S PRIVACY POLICY FOR DETAILS REGARDING APPLE'S USE AND HANDLING OF DATA UPLOADED BY CARPLAY.

USE OF ANDROID AUTO IS SUBJECT TO YOUR AGREEMENT TO THE ANDROID AUTO TERMS OF USE WHICH MUST BE AGREED TO WHEN THE ANDROID AUTO APPLICATION IS DOWNLOADED TO YOUR ANDROID PHONE. IN SUMMARY, THE ANDROID AUTO TERMS OF USE DISCLAIM GOOGLE AND ITS SERVICE PROVIDERS' LIABILITY IF THE SERVICES FAIL TO PERFORM CORRECTLY OR ARE DISCONTINUED, STRICTLY LIMIT GOOGLE AND ITS SERVICE PROVIDERS' OTHER LIABILITIES, DESCRIBE THE KINDS OF USER INFORMATION (INCLUDING, FOR EXAMPLE, VEHICLE LOCATION, VEHICLE SPEED, AND VEHICLE STATUS) BEING GATHERED AND STORED BY GOOGLE AND ITS SERVICE PROVIDERS, AND DISCLOSE CERTAIN POSSIBLE RISKS ASSOCIATED WITH THE USE OF ANDROID AUTO, INCLUDING THE POTENTIAL FOR DRIVER DISTRACTION. SEE GOOGLE'S PRIVACY POLICY FOR DETAILS REGARDING GOOGLE'S USE AND HANDLING OF DATA UPLOADED BY ANDROID AUTO.

## DISCLAIMER OF WARRANTIES; LIMITATION ON LIABILITY

YOU EXPRESSLY ACKNOWLEDGE AND AGREE THAT USE OF APPLE CARPLAY OR ANDROID AUTO (“THE APPLICATIONS”) IS AT YOUR SOLE RISK AND THAT THE ENTIRE RISK AS TO SATISFACTORY QUALITY, PERFORMANCE, ACCURACY AND EFFORT IS WITH YOU TO THE MAXIMUM EXTENT PERMITTED BY APPLICABLE LAW, AND THAT THE APPLICATIONS AND INFORMATION ON THE APPLICATIONS IS PROVIDED “AS IS” AND “AS AVAILABLE,” WITH ALL FAULTS AND WITHOUT WARRANTY OF ANY KIND, AND HONDA HEREBY DISCLAIMS ALL WARRANTIES AND CONDITIONS WITH RESPECT TO THE APPLICATIONS AND INFORMATION ON THE APPLICATIONS, EITHER EXPRESS, IMPLIED OR STATUTORY, INCLUDING, BUT NOT LIMITED TO, THE IMPLIED WARRANTIES AND/OR CONDITIONS OF MERCHANTABILITY, SATISFACTORY QUALITY, FITNESS FOR A PARTICULAR PURPOSE, ACCURACY, QUIET ENJOYMENT, AND NON-INFRINGEMENT OF THIRD PARTY RIGHTS. NO ORAL OR WRITTEN INFORMATION OR ADVICE GIVEN BY HONDA OR AN AUTHORIZED REPRESENTATIVE SHALL CREATE A WARRANTY. AS EXAMPLES, AND WITHOUT LIMITATION, HONDA DISCLAIMS ANY WARRANTY REGARDING THE ACCURACY OF DATA PROVIDED BY THE APPLICATIONS, SUCH AS THE ACCURACY OF DIRECTIONS, ESTIMATED TRAVEL TIME, SPEED LIMITS, ROAD CONDITIONS, NEWS, WEATHER, TRAFFIC, OR OTHER CONTENT PROVIDED BY APPLE, GOOGLE, THEIR AFFILIATES, OR THIRD PARTY PROVIDERS; HONDA DOES NOT GUARANTEE AGAINST LOSS OF APPLICATION DATA, WHICH MAY BE LOST AT ANY TIME; HONDA DOES NOT GUARANTEE THAT THE APPLICATIONS OR ANY SERVICES PROVIDED THROUGH THEM WILL BE PROVIDED AT ALL TIMES OR THAT ANY OR ALL SERVICES WILL BE AVAILABLE AT ANY PARTICULAR TIME OR LOCATION. FOR EXAMPLE, SERVICES MAY BE SUSPENDED OR INTERRUPTED WITHOUT NOTICE FOR REPAIR, MAINTENANCE, SECURITY FIXES, UPDATES, ETC., SERVICES MAY BE UNAVAILABLE IN YOUR AREA OR LOCATION, ETC. IN ADDITION, YOU UNDERSTAND THAT CHANGES IN THIRD PARTY TECHNOLOGY OR GOVERNMENT REGULATION MAY RENDER THE SERVICES AND/OR APPLICATIONS OBSOLETE AND/OR UNUSABLE.

TO THE EXTENT NOT PROHIBITED BY LAW, IN NO EVENT SHALL HONDA OR ITS AFFILIATES BE LIABLE FOR PERSONAL INJURY, OR ANY INCIDENTAL, SPECIAL, INDIRECT OR CONSEQUENTIAL DAMAGES WHATSOEVER, INCLUDING, WITHOUT LIMITATION, DAMAGES FOR LOSS OF PROFITS, CORRUPTION OR LOSS OF DATA, FAILURE TO TRANSMIT OR RECEIVE ANY DATA, BUSINESS INTERRUPTION OR ANY OTHER COMMERCIAL DAMAGES OR LOSSES, ARISING OUT OF OR RELATED TO THE APPLICATIONS OR YOUR USE OF OR INABILITY TO USE THE APPLICATIONS OR INFORMATION ON THE APPLICATIONS, HOWEVER CAUSED, REGARDLESS OF THE THEORY OF LIABILITY (CONTRACT, TORT OR OTHERWISE) AND EVEN IF HONDA WERE ADVISED OF THE POSSIBILITY OF SUCH DAMAGES. SOME STATES AND JURISDICTIONS DISALLOW THE EXCLUSION OR LIMITATION OF LIABILITY FOR DAMAGES, SO THESE LIMITATIONS AND EXCLUSIONS MAY NOT APPLY TO YOU. IN NO EVENT SHALL HONDA’S TOTAL LIABILITY TO YOU FOR ALL DAMAGES (OTHER THAN AS MAY BE REQUIRED BY APPLICABLE LAW IN CASES INVOLVING PERSONAL INJURY) EXCEED THE AMOUNT OF FIVE DOLLARS (\$5.00). THE FOREGOING LIMITATIONS WILL APPLY EVEN IF THE ABOVE STATED REMEDY FAILS OF ITS ESSENTIAL PURPOSE.

## About Open Source Licenses

---

To see the open source license information, follow these steps.

### Models with 7-in. Color Touchscreen

1. Press the **MENU** button.
2. Select **License**.

### Models with 9-in. Color Touchscreen

1. Press the  button.
2. Select **General Settings**.
3. Select **System**.
4. Select **About**.
5. Select **Legal Information**.
6. Select **License**.



## License Information

### ■ DTS Neural Surround

For DTS patents, see <http://patents.dts.com>. Manufactured under license from DTS Licensing Limited. DTS, the Symbol, & DTS and the Symbol together are registered trademarks, and DTS Neural Surround is a trademark of DTS, Inc. © DTS, Inc. All Rights Reserved.



### ■ Bluetooth

The *Bluetooth*® word mark and logos are registered trademarks owned by Bluetooth SIG, Inc. and any use of such marks by PANASONIC CORPORATION is under license. Other trademarks and trade names are those of their respective owners.

The *Bluetooth*® word mark and logos are registered trademarks owned by Bluetooth SIG, Inc. and any use of such marks by MITSUBISHI ELECTRIC is under license. Other trademarks and trade names are those of their respective owners.

<https://www.bluetooth.com/develop-with-bluetooth/marketing-branding/>



## ■ Windows Media

This product is protected by certain intellectual property rights of Microsoft. Use or distribution of such technology outside of this product is prohibited without a license from Microsoft.

## ■ Apple

“Made for iPod,” and “Made for iPhone,” mean that an electronic accessory has been designed to connect specifically to iPod, or iPhone, respectively, and has been certified by the developer to meet Apple performance standards. Apple is not responsible for the operation of this device or its compliance with safety and regulatory standards. Please note that the use of this accessory with iPod, or iPhone, may affect wireless performance.

Apple, the Apple Logo, iPhone, iPod touch are trademarks of Apple Inc., registered in the U.S. and other countries. Apple CarPlay, iPod, iPhone, iTunes, Siri and Lightning are trademarks of Apple Inc. App Store is a service mark of Apple Inc.



## MPEG

### Mpeg4 Visual

THIS PRODUCT IS LICENSED UNDER THE MPEG-4 VISUAL PATENT PORTFOLIO LICENSE FOR THE PERSONAL AND NON-COMMERCIAL USE OF A CONSUMER FOR (i) ENCODING VIDEO IN COMPLIANCE WITH THE MPEG-4 VISUAL STANDARD (“MPEG-4 VIDEO”) AND/OR (ii) DECODING MPEG-4 VIDEO THAT WAS ENCODED BY A CONSUMER ENGAGED IN A PERSONAL AND NONCOMMERCIAL ACTIVITY AND/OR WAS OBTAINED FROM A VIDEO PROVIDER LICENSED BY MPEG LA TO PROVIDE MPEG-4 VIDEO. NO LICENSE IS GRANTED OR SHALL BE IMPLIED FOR ANY OTHER USE. ADDITIONAL INFORMATION INCLUDING THAT RELATING TO PROMOTIONAL, INTERNAL AND COMMERCIAL USES AND LICENSING MAY BE OBTAINED FROM MPEG LA, LLC. SEE [HTTP://WWW.MPEGLA.COM](http://www.mpegla.com).

### VC-1

THIS PRODUCT IS LICENSED UNDER THE VC-1 PATENT PORTFOLIO LICENSE FOR THE PERSONAL AND NON-COMMERCIAL USE OF A CONSUMER TO (i) ENCODE VIDEO IN COMPLIANCE WITH THE VC-1 STANDARD (“VC-1 VIDEO”) AND/OR (ii) DECODE VC-1 VIDEO THAT WAS ENCODED BY A CONSUMER ENGAGED IN A PERSONAL AND NON-COMMERCIAL ACTIVITY AND/OR WAS OBTAINED FROM A VIDEO PROVIDER LICENSED TO PROVIDE VC-1 VIDEO. NO LICENSE IS GRANTED OR SHALL BE IMPLIED FOR ANY OTHER USE. ADDITIONAL INFORMATION MAY BE OBTAINED FROM MPEG LA, L.L.C. SEE [HTTP://WWW.MPEGLA.COM](http://www.mpegla.com).

#### AVC/H.264

THIS PRODUCT IS LICENSED UNDER THE AVC PATENT PORTFOLIO LICENSE FOR THE PERSONAL AND NONCOMMERCIAL USE OF A CONSUMER TO (i) ENCODE VIDEO IN COMPLIANCE WITH THE AVC STANDARD ("AVC VIDEO") AND/OR (ii) DECODE AVC VIDEO THAT WAS ENCODED BY A CONSUMER ENGAGED IN A PERSONAL AND NON-COMMERCIAL ACTIVITY AND/OR WAS OBTAINED FROM A VIDEO PROVIDER LICENSED TO PROVIDE AVC VIDEO. NO LICENSE IS GRANTED OR SHALL BE IMPLIED FOR ANY OTHER USE.

ADDITIONAL INFORMATION MAY BE OBTAINED FROM MPEG LA, L.L.C. SEE [HTTP://WWW.MPEGLA.COM](http://www.mpegla.com).

# Customized Features

## Models with 7-in. Color Touchscreen

Use the audio/information screen to customize certain features.

### How to Customize the Settings

While the vehicle is at a complete stop with the power mode in ON, press the **MENU** button. To customize the phone settings, press the **PHONE** button, then select **Settings**.

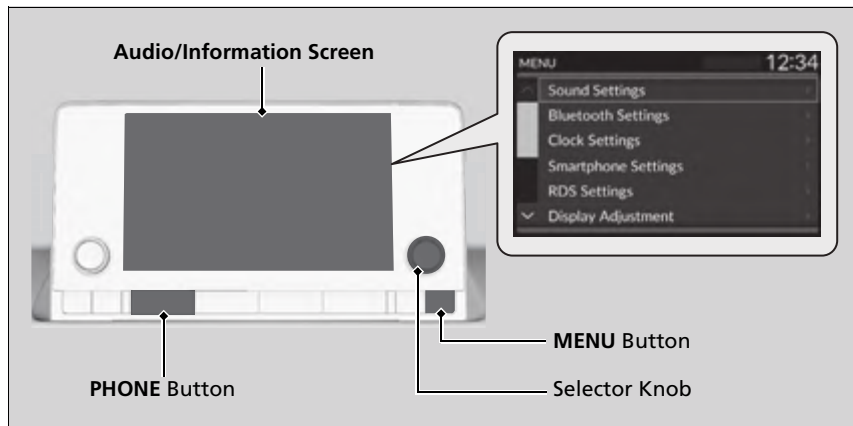

## Customized Features

When you customize settings:

- Make sure that the vehicle is at a complete stop.
- Shift to [P].

To customize features detail, refer to the following.

- **Customization Flow** P. 352
- **List of customizable options** P. 355

## ■ Customization Flow

Press the **MENU** button.

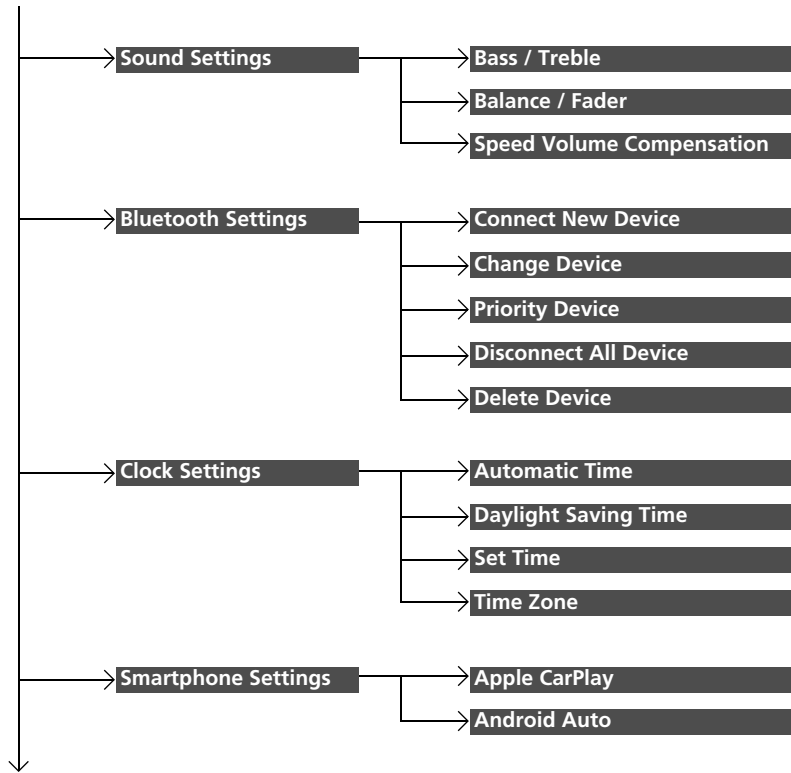

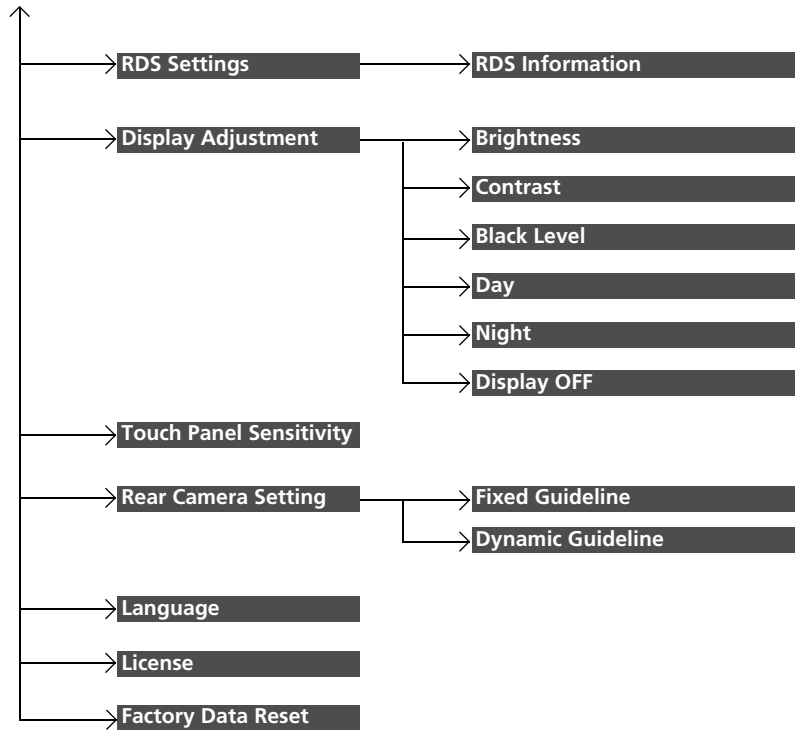

Press the **PHONE** button and select **Settings**.

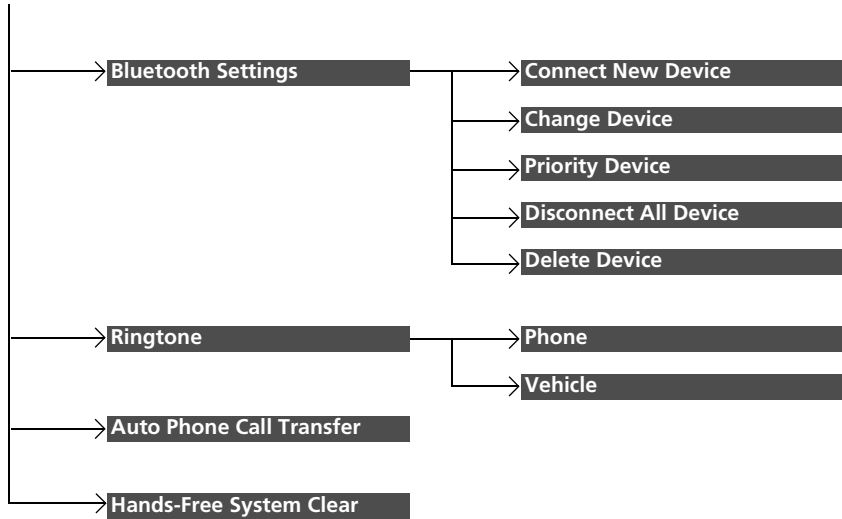



## ■ List of customizable options

Press the **MENU** button.

	Customizable Features	Description	Selectable Settings
Sound Settings	<b>Bass / Treble</b>	Adjusts the settings of the audio speakers' sound. ▶ <b>Adjusting the Sound</b> P. 235	—
	<b>Balance / Fader</b>		
	<b>Speed Volume Compensation</b>		
Bluetooth Settings	<b>Connect New Device</b>	Pairs a new phone to HFL. ▶ <b>Phone Setup</b> P. 388	—
	<b>Change Device</b>	Connects a paired phone. ▶ <b>Phone Setup</b> P. 388	—
	<b>Priority Device</b>	Sets a device as the priority device.	<b>ON*<sup>1</sup>/OFF</b>
	<b>Disconnect All Device</b>	Disconnects a paired phone from HFL.	—
	<b>Delete Device</b>	Deletes a paired phone.	—
Clock Settings	<b>Automatic Time</b>	Selects <b>ON</b> to have the GPS automatically adjust the clock. Select <b>OFF</b> to cancel this function.	<b>ON*<sup>1</sup>/OFF</b>
	<b>Daylight Saving Time</b>	Sets the clock to update based on daylight savings time.	<b>ON/OFF*<sup>1</sup></b>
	<b>Set Time</b>	Adjusts time. ▶ <b>Adjusting the Clock</b> P. 142	—
	<b>Time Zone</b>	Changes the time zone manually.	—
Smartphone Settings	<b>Apple CarPlay</b>	Sets up the Apple CarPlay connection.	—
	<b>Android Auto</b>	Sets up the Android Auto connection.	—
RDS Settings	<b>RDS Information</b>	Selects whether the RDS information comes on.	<b>ON*<sup>1</sup>/OFF</b>

\*1:Default Setting

Customizable Features	Description	Selectable Settings	
<b>Display Adjustment</b>	<b>Brightness</b>	Changes the brightness of the audio/information screen.	
	<b>Contrast</b>	Changes the contrast of the audio/information screen.	
	<b>Black Level</b>	Changes the black level of the audio/information screen.	
	<b>Day</b>	Changes between the daytime mode, nighttime mode and display off mode.	
	<b>Night</b>		
<b>Display OFF</b>			
<b>Touch Panel Sensitivity</b>	Sets the sensitivity of the touch panel screen.	<b>Normal*<sup>1</sup>/High</b>	
<b>Rear Camera Setting</b>	<b>Fixed Guideline</b>	Shows the guideline that does not move with the steering wheel. <input checked="" type="checkbox"/> <b>Multi-View Rear Camera</b> P. 606	<b>ON*<sup>1</sup>/OFF</b>
	<b>Dynamic Guideline</b>	Shows the guideline that moves with the steering wheel. <input checked="" type="checkbox"/> <b>Multi-View Rear Camera</b> P. 606	<b>ON*<sup>1</sup>/OFF</b>
	<b>Language</b>	Changes the display language.	<b>English*<sup>1</sup>/Español/Français</b>
<b>License</b>	Shows the legal information.	—	
<b>Factory Data Reset</b>	Resets all the settings to their factory default. <input checked="" type="checkbox"/> <b>Defaulting All the Settings</b> P. 358	—	

\*1:Default Setting

Press the **PHONE** button and select **Settings**.

Customizable Features	Description	Selectable Settings
<b>Bluetooth Settings</b>	<b>Connect New Device</b> Pairs a new phone to HFL. ☒ <b>Phone Setup</b> P. 388	—
	<b>Change Device</b> Connects a paired phone. ☒ <b>Phone Setup</b> P. 388	—
	<b>Priority Device</b> Sets a device as the priority device.	<b>ON*<sup>1</sup>/OFF</b>
	<b>Disconnect All Device</b> Disconnects a paired phone from HFL.	—
	<b>Delete Device</b> Deletes a paired phone.	—
<b>Ringtone</b>	Selects the ring tone.	<b>Phone*<sup>1</sup>/Vehicle</b>
<b>Auto Phone Call Transfer</b>	Sets calls to automatically transfer from your phone to HFL when you enter the vehicle.	<b>ON*<sup>1</sup>/OFF</b>
<b>Hands-Free System Clear</b>	Resets all customized items in the Phone Settings group as default.	—

\*1:Default Setting

## Defaulting All the Settings

---

Reset all the menu and customized settings as the factory defaults.

1. Press the **MENU** button.
2. Select **Factory Data Reset**.
  - A confirmation message appears on the screen.
3. Select **Yes** to reset the settings.
4. Select **Yes** again to reset the settings.
  - The system will reboot.

### ►► Defaulting All the Settings

---

When you transfer the vehicle to a third party, reset all settings to default and delete all personal data.

If you perform **Factory Data Reset**, it will reset the preinstalled apps to their factory default.

# Customized Features

## Models with 9-in. Color Touchscreen

Use the audio/information screen to customize certain features.

### How to Customize the General Settings

With the power mode in ON, press the  button, and then select **General Settings** and select a setting item.

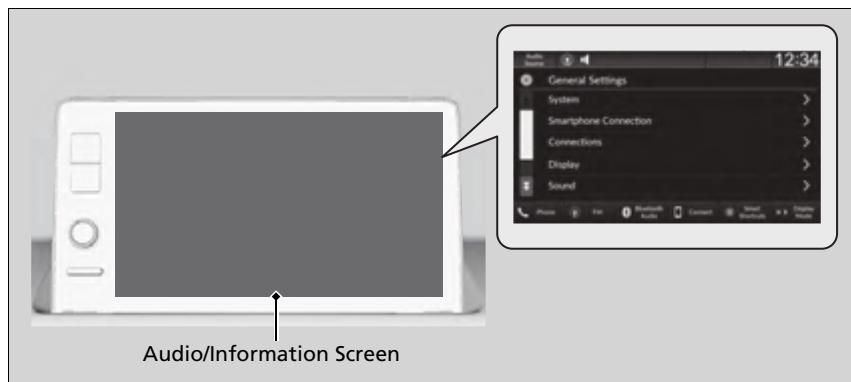

## Customized Features

When you customize settings:

- Make sure that the vehicle is at a complete stop.

### Continuously variable transmission models

- Shift to [P].

### Manual transmission models

- Set the parking brake.

To customize features detail, refer to the following.

- **Customization flow** P. 360
- **System** P. 364
- **Smartphone Connection** P. 367
- **Connections** P. 368
- **Display** P. 369
- **Sound** P. 369
- **Camera** P. 370

### ■ Customization flow

Press the  button.

Select **General Settings**.



Features

**System**

**Date & Time**

**Set Date & Time**

**Automatic Date & Time**

**Set Date**

**Set Time**

**Time Zone**

(Select time zone)

**Auto Daylight Saving Time**

**Date Format**

**Time Format**

**Language**

**Touch Panel Sensitivity**

**System Volumes**

**System Sounds**

**Text-to-Speech**

**Navigation Guidance**

**Phone Calls**

**Default**

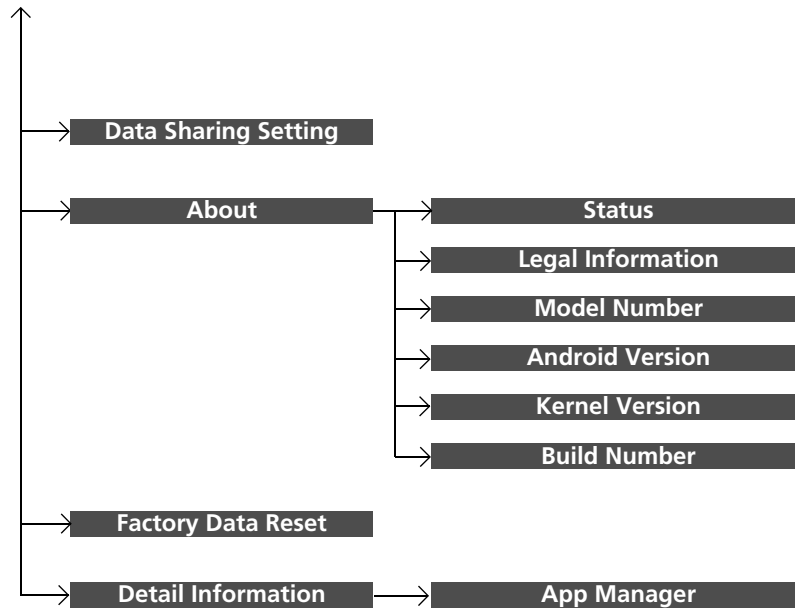

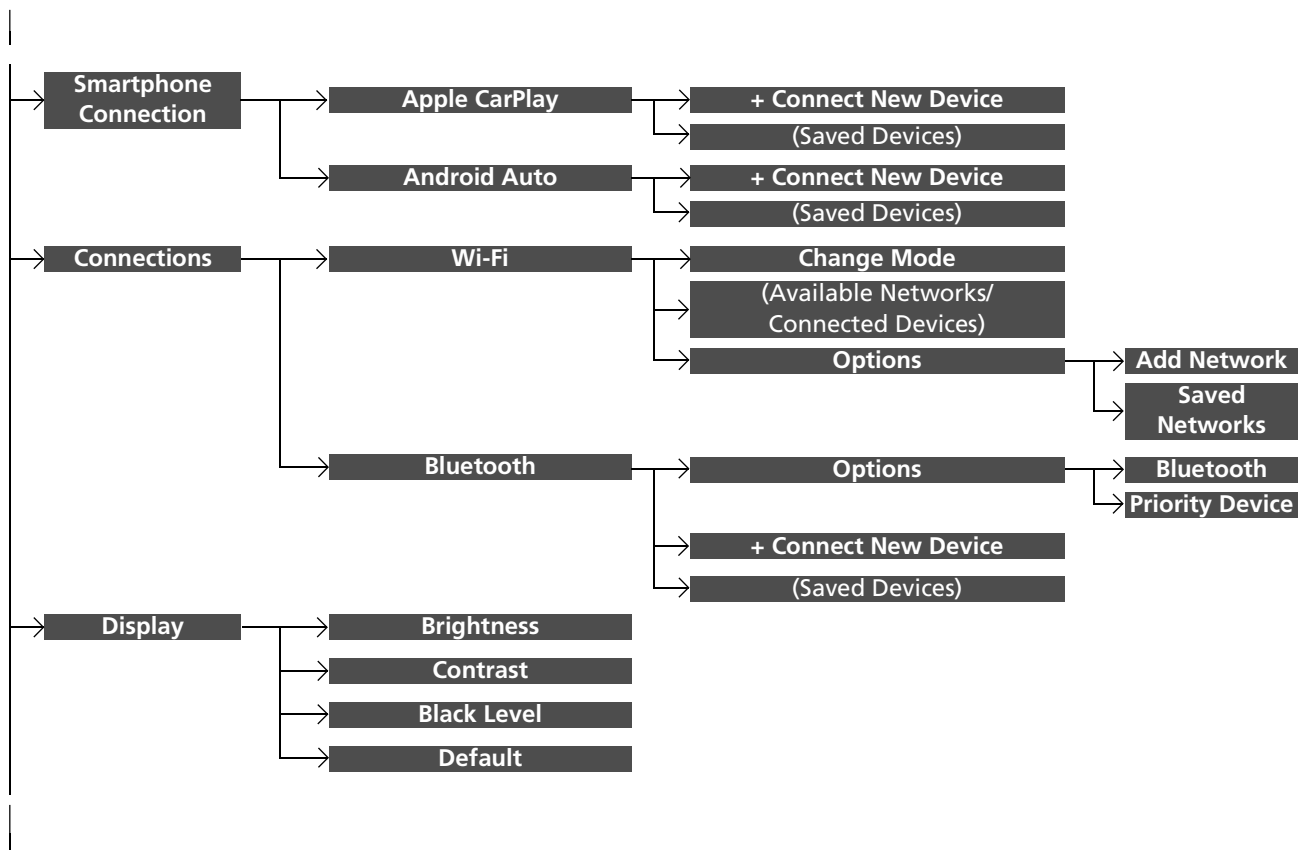



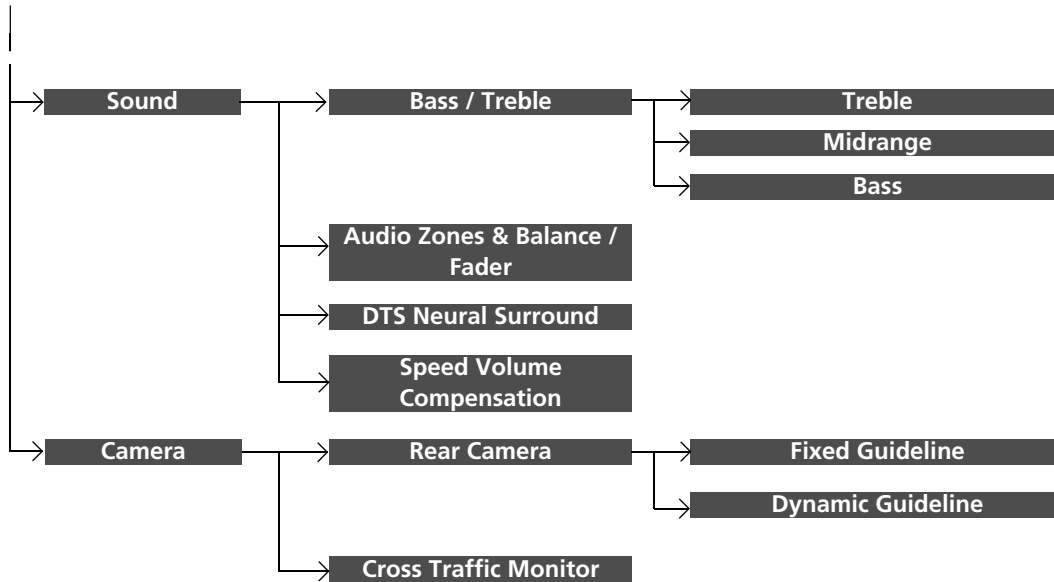

■ System

Customizable Features		Description	Selectable Settings	
Date & Time	<b>Automatic Date &amp; Time</b>	Selects <b>ON</b> to have the GPS automatically adjust the clock. Select <b>OFF</b> to cancel this function.	<b>ON<sup>*1</sup>/OFF</b>	
	<b>Set Date &amp; Time</b>	<b>Set Date</b>	Adjusts date. ▶ <b>Adjusting the Clock</b> P. 142	—
		<b>Set Time</b>	Adjusts time. ▶ <b>Adjusting the Clock</b> P. 142	—
	<b>Time Zone</b>	(Select time zone) Changes the time zone manually.	—	
	<b>Auto Daylight Saving Time</b>	Sets the clock to update based on daylight savings time.	<b>ON<sup>*1</sup>/OFF</b>	
	<b>Date Format</b>	Select a date format.	<b>MM/DD/YYYY<sup>*2</sup>/ DD/MM/YYYY<sup>*3</sup>/ YYYY/MM/DD</b>	
	<b>Time Format</b>	Select a time format.	<b>12H<sup>*1</sup>/24H</b>	

\*1:Default Setting

\*2:Default Setting for U.S. models

\*3:Default Setting for Canadian models

Customizable Features	Description	Selectable Settings
<b>Language</b>	Changes the driver information interface and audio/information screen language separately.	<b>English<sup>*1</sup>/Español/ Français</b>
<b>Touch Panel Sensitivity</b>	Sets the sensitivity of the touch panel screen.	<b>High/Normal<sup>*1</sup></b>
<b>System Volumes</b>	<b>System Sounds</b>	Sets the system sound volume level. —
	<b>Text-to-Speech</b>	Sets the text-to-speech volume level. —
	<b>Navigation Guidance</b>	Sets the navigation guidance volume level. —
	<b>Phone Calls</b>	Sets the phone call volume level. —
	<b>Default</b>	Resets all <b>System Volumes</b> settings to default values.
<b>Data Sharing Setting</b>	Turns the data sharing setting on and off. <input checked="" type="checkbox"/> <b>Start Up</b> P. 260	<b>ON<sup>*1</sup>/OFF</b>

\*1:Default Setting

Customizable Features		Description	Selectable Settings
<b>About</b>	<b>Status</b>	Displays the Android setting items.	—
	<b>Legal Information</b>		
	<b>Model Number</b>		
	<b>Android Version</b>		
	<b>Kernel Version</b>		
	<b>Build Number</b>		
<b>Factory Data Reset</b>		Resets all the settings to their factory default. <input checked="" type="checkbox"/> <b>Defaulting All the Settings</b> P. 382	<b>Continue/Cancel</b>
<b>Detail Information</b>	<b>App Manager</b>	Displays the Android system memory and apps information.	—

## ■ Smartphone Connection

Customizable Features		Description	Selectable Settings
<b>Apple CarPlay</b>	<b>+ Connect New Device</b>	Pairs a new phone to Apple CarPlay. ➤ <b>Phone Setup</b> P. 408	—
	(Saved Devices)	Connects, disconnects, or deletes a paired phone. ➤ <b>Phone Setup</b> P. 408	—
<b>Android Auto</b>	<b>+ Connect New Device</b>	Pairs a new phone to Android Auto. ➤ <b>Phone Setup</b> P. 408	—
	(Saved Devices)	Connects, disconnects, or deletes a paired phone. ➤ <b>Phone Setup</b> P. 408	—

■ Connections

	Customizable Features	Description	Selectable Settings	
Wi-Fi	<b>Change Mode</b>	Changes the Wi-Fi mode.	<b>Network<sup>*1</sup>/ Smartphone<sup>*2</sup>/OFF</b>	
	(Available Networks/Connected Devices)	Displays the available network(s) or current connected device(s).	—	
	<b>Options</b>	<b>Add Network</b>	Adds a new network to connect Wi-Fi.	—
		<b>Saved Networks</b>	Saves the connected network.	—
	<b>Setup</b>	<b>Network SSID</b>	Sets the network name.	—
		<b>Security</b>	Displays the network security.	—
		<b>Password</b>	Sets password for require entering password when connecting Wi-Fi device to the network.	—
		<b>Wi-Fi Band</b>	Displays the Wi-Fi band.	—
Bluetooth	<b>Options</b>	<b>Bluetooth</b>	Turns the <i>Bluetooth</i> ® on and off.	<b>ON<sup>*1</sup>/OFF</b>
		<b>Priority Device</b>	Displays the priority device.	—
	<b>+ Connect New Device</b>	Pairs a new phone to HFL. 📄 <b>Phone Setup</b> P. 408	—	
	(Saved Devices)	Connects, disconnects, or deletes a paired phone. 📄 <b>Phone Setup</b> P. 408	—	

\*1:Default Setting

\*2:Appears only when Apple CarPlay or Android Auto is connected wirelessly.

■ Display

Customizable Features	Description	Selectable Settings
<b>Brightness</b>	Changes the brightness of the audio/information screen.	—
<b>Contrast</b>	Changes the contrast of the audio/information screen.	—
<b>Black Level</b>	Changes the black level of the audio/information screen.	—
<b>Default</b>	Resets all customized settings for the brightness, contrast, and black level.	—

■ Sound

Customizable Features	Description	Selectable Settings
<b>Bass / Treble</b>	Adjusts the settings of the audio speakers' sound.  <b>Adjusting the Sound</b> P. 277	—
<b>Treble</b>		
<b>Midrange</b>		
<b>Bass</b>		
<b>Audio Zones &amp; Balance / Fader</b>		
<b>DTS Neural Surround</b>		
<b>Speed Volume Compensation</b>		

■ Camera

Customizable Features		Description	Selectable Settings
Rear Camera	<b>Fixed Guideline</b>	Shows the guideline that does not move with the steering wheel. ➤ <b>Multi-View Rear Camera</b> P. 606	<b>ON*1/OFF</b>
	<b>Dynamic Guideline</b>	Shows the guideline that moves with the steering wheel. ➤ <b>Multi-View Rear Camera</b> P. 606	<b>ON*1/OFF</b>
<b>Cross Traffic Monitor</b>		Shows arrows on the rear camera image to indicate vehicles approaching from the sides. ➤ <b>Cross Traffic Monitor</b> P. 602	<b>ON*1/OFF</b>

\*1:Default Setting



## ■ How to Customize the Vehicle Settings

With the power mode in ON, press the  button, and then select **Vehicle Settings** and select a setting item.

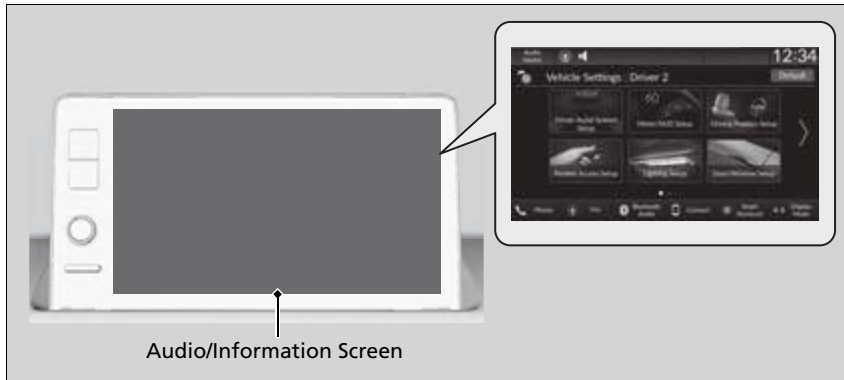

### ■ Customization flow

Press the  button.



Select **Vehicle Settings**.



#### Driver Assist System Setup

- Forward Collision Warning Distance
- Head-up Warning
- ACC Forward Vehicle Detect Beep
- Road Departure Mitigation Setting
- Lane Keeping Assist Suspend Beep
- Blind Spot Info
- Traffic Sign Recognition System Display Setting
- Traffic Sign Recognition System Speed Limit Warning
- Speed Limit Warning Threshold Setting
- Driver Attention Monitor
- Rev Match System\*
- Rear Sensor Setting

Features

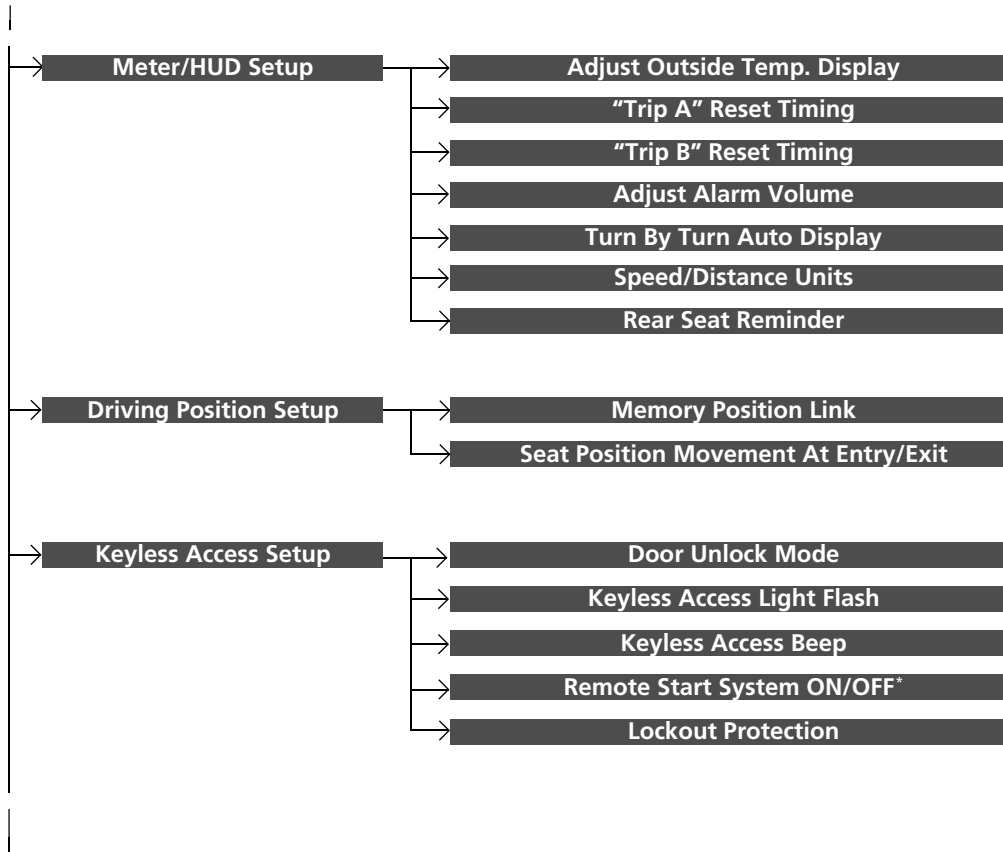

\* Not available on all models

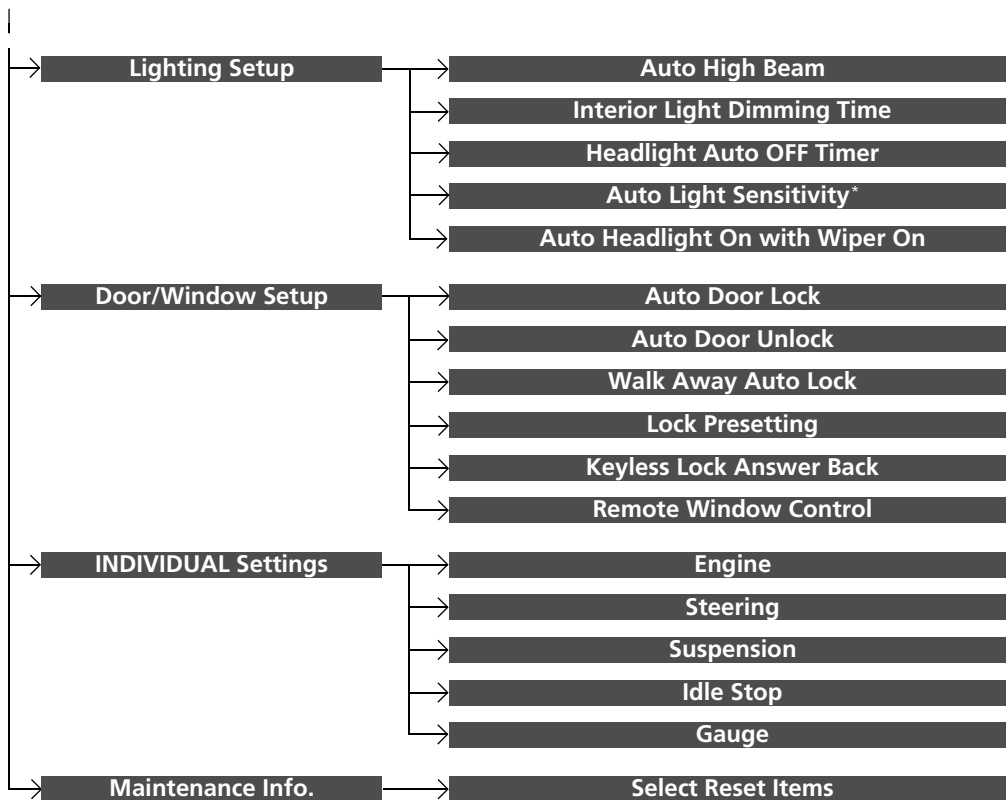

■ Driver Assist System Setup

Customizable Features	Description	Selectable Settings
<b>Forward Collision Warning Distance</b>	Selects distance for Forward Collision Warning audible and visual alerts. ▶ <b>Collision Mitigation Braking System™ (CMBS™)</b> P. 481	<b>Long/Normal*<sup>1</sup>/Short</b>
<b>Head-up Warning</b>	Turn On/Off warning light for head-up flash alert.	<b>ON*<sup>1</sup>/OFF</b>
<b>ACC Forward Vehicle Detect Beep</b>	Turns On/Off audible notification when vehicle has moved in/out of Adaptive Cruise Control with Low Speed Follow* range. ▶ <b>Adaptive Cruise Control (ACC) with Low Speed Follow*</b> P. 504 ▶ <b>Adaptive Cruise Control (ACC)*</b> P. 525	<b>ON/OFF*<sup>1</sup></b>
<b>Road Departure Mitigation Setting</b>	Selects operating mode of the Road Departure Mitigation system. ▶ <b>Road Departure Mitigation System</b> P. 566	<b>Narrow/Normal*<sup>1</sup>/Wide/Warning Only</b>
<b>Lane Keeping Assist Suspend Beep</b>	Selects On/Off the LKAS alert for not detecting road lines. ▶ <b>Lane Keeping Assist System (LKAS)</b> P. 545	<b>ON/OFF*<sup>1</sup></b>
<b>Blind Spot Info</b>	Selects On/Off the blind spot information system audible alert. ▶ <b>Blind Spot Information System</b> P. 474	<b>Audible And Visual Alert*<sup>1</sup>/Visual Alert</b>
<b>Traffic Sign Recognition System Display Setting</b>	Displays the traffic sign recognition system on instrument panel. ▶ <b>Traffic Sign Recognition System</b> P. 574	<b>Display*<sup>1</sup>/None</b>

\*1:Default Setting

\* Not available on all models

Customizable Features	Description	Selectable Settings
<b>Traffic Sign Recognition System Speed Limit Warning</b>	Enables over speed limit warning when speed limit is exceeded. ➤ <b>Traffic Sign Recognition System</b> P. 574	<b>ON*<sup>1</sup>/OFF</b>
<b>Speed Limit Warning Threshold Setting</b>	Select speed limit warning threshold based on personal preference. ➤ <b>Traffic Sign Recognition System</b> P. 574	<b>Speed Limit*<sup>1</sup>/ Speed Limit+3mph/ Speed Limit+5mph/ Speed Limit+10mph</b> (When mph is selected) <b>Speed Limit*<sup>1</sup>/ Speed Limit+5km/h/ Speed Limit+10km/h/ Speed Limit+15km/h</b> (When km/h is selected)
<b>Driver Attention Monitor</b>	Changes the setting for the driver attention monitor. ➤ <b>Driver Attention Monitor</b> P. 117	<b>OFF/Tactile Alert/Tactile And Audible Alert*<sup>1</sup></b>
<b>Rev Match System*</b>	Selects On/Off the rev match system. ➤ <b>Rev Match System</b> P. 445	<b>ON*<sup>1</sup>/OFF</b>
<b>Rear Sensor Setting</b>	Selects to turn ON or OFF the rear Parking Sensor. This selection will also affect the rear Low Speed Braking Control. ➤ <b>Parking Sensor System*</b> P. 598 ➤ <b>Low Speed Braking Control*</b> P. 493, 499	<b>ON*<sup>1</sup>/OFF</b>

\*1:Default Setting

## ■ Meter/HUD Setup

Customizable Features	Description	Selectable Settings
<b>Adjust Outside Temp. Display</b>	Selects to adjust outside temperature reading by a few degrees. <input checked="" type="checkbox"/> <b>Outside Temperature</b> P. 106	<b>-5°F ~ ±0°F*<sup>1</sup> ~ +5°F (U.S.)</b> <b>-3°C ~ ±0°C*<sup>1</sup> ~ +3°C (Canada)</b>
<b>“Trip A” Reset Timing</b>	Selects the timing to reset Trip A. <input checked="" type="checkbox"/> <b>Range/Fuel/Trip Meter</b> P. 113 <input checked="" type="checkbox"/> <b>Speed/Time/Trip Meter</b> P. 115	<b>When Fully Refueled/IGN OFF/Manually Reset*<sup>1</sup></b>
<b>“Trip B” Reset Timing</b>	Selects the timing to reset Trip B. <input checked="" type="checkbox"/> <b>Range/Fuel/Trip Meter</b> P. 113 <input checked="" type="checkbox"/> <b>Speed/Time/Trip Meter</b> P. 115	<b>When Fully Refueled/IGN OFF/Manually Reset*<sup>1</sup></b>
<b>Adjust Alarm Volume</b>	Changes volume level of all system warnings, door opening warning and indicator.	<b>High/Mid*<sup>1</sup>/Low</b>
<b>Turn By Turn Auto Display</b>	Turns on/off the pop-up information in the turn-by-turn navigation in the driver information interface. <input checked="" type="checkbox"/> <b>Turn-by-Turn Directions</b> P. 116	<b>ON*<sup>1</sup>/OFF</b>
<b>Speed/Distance Units</b>	Selects the speed/distance units. <input checked="" type="checkbox"/> <b>Speed/Distance Units</b> P. 123	<b>km/h · km/mph · miles*<sup>1</sup></b> <b>(U.S.)</b> <b>km/h · km*<sup>1</sup>/mph · miles</b> <b>(Canada)</b>
<b>Rear Seat Reminder</b>	Turns the Rear Seat Reminder feature on and off.	<b>ON*<sup>1</sup>/OFF</b>

\*1:Default Setting

■ **Driving Position Setup**

Customizable Features	Description	Selectable Settings
<b>Memory Position Link</b>	Turns the driving position memory system on and off.	<b>ON<sup>*1</sup>/OFF</b>
<b>Seat Position Movement At Entry/Exit</b>	Moves the seat rearward when you get in/get out of the vehicle. Changes the setting for this feature.	<b>ON<sup>*1</sup>/OFF</b>

\*1:Default Setting

■ **Keyless Access Setup**

Customizable Features	Description	Selectable Settings
<b>Door Unlock Mode</b>	Changes which doors unlock when you grab the driver's door handle.	<b>Driver Door Only<sup>*1</sup>/All Doors</b>
<b>Keyless Access Light Flash</b>	Causes some exterior lights to flash when you unlock/lock the doors.	<b>ON<sup>*1</sup>/OFF</b>
<b>Keyless Access Beep</b>	Causes the beeper to sound when you unlock/lock the doors.	<b>ON<sup>*1</sup>/OFF</b>
<b>Remote Start System ON/OFF<sup>*</sup></b>	Turns the remote engine start feature on and off.	<b>ON<sup>*1</sup>/OFF</b>
<b>Lockout Protection</b>	Changes the settings for the lockout protection function.	<b>ON<sup>*1</sup>/OFF</b>

\*1:Default Setting



■ Lighting Setup

Customizable Features	Description	Selectable Settings
<b>Auto High Beam</b>	Turns on/off auto high beam function.	<b>ON<sup>*1</sup>/OFF</b>
<b>Interior Light Dimming Time</b>	Selects the length of time the interior lights stay on after doors are closed. <input checked="" type="checkbox"/> <b>Interior Lights</b> P. 201	<b>60sec/30sec<sup>*1</sup>/15sec</b>
<b>Headlight Auto OFF Timer</b>	Selects the length of time the exterior lights stay on after you close the driver's door. <input checked="" type="checkbox"/> <b>Automatic Lighting Off Feature</b> P. 178	<b>60sec/30sec/15sec<sup>*1</sup>/0sec</b>
<b>Auto Light Sensitivity*</b>	Changes the timing for the headlights to come on.	<b>Min/Low/Mid<sup>*1</sup>/High/Max</b>
<b>Auto Headlight On with Wiper On</b>	Selects On/Off headlight function at wiper operation when the headlight is in <b>AUTO</b> setting. <input checked="" type="checkbox"/> <b>Headlight Integration with Wipers</b> P. 178	<b>ON<sup>*1</sup>/OFF</b>

\*1:Default Setting

\* Not available on all models

■ Door/Window Setup

Customizable Features	Description	Selectable Settings
<b>Auto Door Lock</b>	Changes the setting for the automatic locking feature.	Continuously variable transmission models <b>OFF/With Vehicle Speed<sup>*1</sup>/Shift From P</b> Manual transmission models <b>OFF/With Vehicle Speed<sup>*1</sup></b>
<b>Auto Door Unlock</b>	Changes the setting for when the doors unlock automatically.	Continuously variable transmission models <b>OFF/All Doors When Driver's Door Opens<sup>*1</sup>/All Doors When Shifted to Park/All Doors With IGN OFF</b> Manual transmission models <b>OFF/All Doors When Driver's Door Opens<sup>*1</sup>/All Doors With IGN OFF</b>
<b>Walk Away Auto Lock</b>	Changes the settings for the auto lock function when you walk away from the vehicle.	<b>ON/OFF<sup>*1</sup></b>
<b>Lock Presetting</b>	Changes the settings for the lock presetting function.	<b>ON<sup>*1</sup>/OFF</b>
<b>Keyless Lock Answer Back</b>	Turns on/off flash of exterior lights when doors are locked/unlocked by keyless remote.  <b>Using the Remote Transmitter</b> P. 153	<b>ON<sup>*1</sup>/OFF</b>
<b>Remote Window Control</b>	Turns the remote window control on and off.	<b>ON<sup>*1</sup>/OFF</b>

\*1: Default Setting

## ■ INDIVIDUAL Settings

Customizable Features	Description	Selectable Settings
<b>Engine</b>	Selects the responsiveness of the engine. <input checked="" type="checkbox"/> <b>Customizing the INDIVIDUAL Settings</b> P. 453	<b>COMFORT/NORMAL*<sup>1</sup>/SPORT</b>
<b>Steering</b>	Selects the level of steering effort. <input checked="" type="checkbox"/> <b>Customizing the INDIVIDUAL Settings</b> P. 453	<b>COMFORT/NORMAL*<sup>1</sup>/SPORT</b>
<b>Suspension</b>	Selects the firmness of the suspension. <input checked="" type="checkbox"/> <b>Customizing the INDIVIDUAL Settings</b> P. 453	<b>COMFORT/NORMAL*<sup>1</sup>/SPORT</b>
<b>Idle Stop</b>	Sets Auto Engine Idle Stop to be Enabled or Disabled. <input checked="" type="checkbox"/> <b>Customizing the INDIVIDUAL Settings</b> P. 453	<b>Enable*<sup>1</sup>/Disable</b>
<b>Gauge</b>	Selects the gauges to be displayed in the Driver Information Interface. <input checked="" type="checkbox"/> <b>Customizing the INDIVIDUAL Settings</b> P. 453	<b>COMFORT/NORMAL*<sup>1</sup>/SPORT</b>

\*1:Default Setting

## ■ Maintenance Info.

Customizable Features	Description	Selectable Settings
<b>Maintenance Info.</b>	Resets the maintenance information. <input checked="" type="checkbox"/> <b>Maintenance Minder™</b> P. 617	<b>Select Reset Items</b>

## Defaulting All the Settings

Reset all the menu and customized settings as the factory defaults.

### ■ Defaulting General Settings

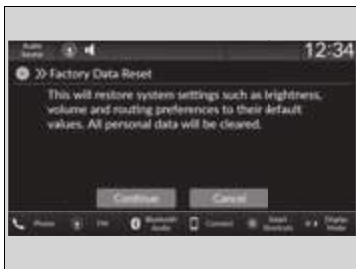

1. Press the  button.
2. Select **General Settings**.
3. Select **System**.
4. Select **Factory Data Reset**.
  - A confirmation message appears on the screen.
5. Select **Continue** to reset the settings.
6. Select **Continue** again to reset the settings.
  - The system will reboot.

### ■ Defaulting Vehicle Settings



1. Press the  button.
2. Select **Vehicle Settings**.
3. Select **Default**.
4. Select **Yes**.

### ►► Defaulting All the Settings

When you transfer the vehicle to a third party, reset all settings to default and delete all personal data.

If you perform **Factory Data Reset**, it will reset the preinstalled apps to their factory default.

If you perform **Factory Data Reset**, you cannot use the AcuraLink® because it becomes off line.

► **AcuraLink®** P. 305

## Models with 7-in. Color Touchscreen

Bluetooth® HandsFreeLink® (HFL) allows you to place and receive phone calls using your vehicle's audio system, without handling your cell phone.

## Using HFL

### HFL Buttons

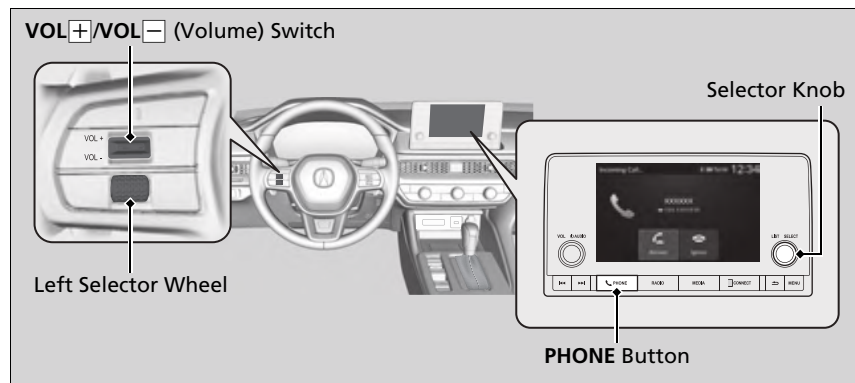

### Bluetooth® HandsFreeLink®

Place your phone where you can get good reception.

To use HFL, you need a *Bluetooth*-compatible cell phone. For a list of compatible phones, pairing procedures, and special feature capabilities:

- U.S.: Visit [www.handsfreelink.com/Acura](http://www.handsfreelink.com/Acura), or call 1-888-528-7876.
- Canada: For more information on smartphone compatibility, call 1-855-490-7351.

#### Voice control tips

- Aim the vents away from the ceiling and close the windows, as noise coming from them may interfere with the microphone.
- If the microphone picks up voices other than yours, the command may be misinterpreted.

State or local laws may prohibit the operation of handheld electronic devices while operating a vehicle.

Up to 20 favorite contacts can be stored. If there is no entry in the system, the pop-up notification appears on the screen.



➤ **Favorite Contacts** P. 396

Up to 20 call histories can be stored. If there is no call history, Call History is disabled.

**Left Selector Wheel:** While receiving a call, the incoming call screen is displayed on the driver information interface. You can pick up the call using the left selector wheel.

➤ **Receiving a Call** P. 401

**PHONE button:** Press to go directly to the **Phone** screen.

**Selector knob:** Rotate  to select an item on the screen, then press .

#### ▶▶ Bluetooth® HandsFreeLink®

##### *Bluetooth®* Wireless Technology

The *Bluetooth®* word mark and logos are registered trademarks owned by *Bluetooth* SIG, Inc., and any use of such marks by Honda Motor Co., Ltd., is under license. Other trademarks and trade names are those of their respective owners.

##### HFL Limitations

An incoming call on HFL will interrupt the audio system when it is playing. It will resume when the call is ended.

## ■ HFL Status Display

The audio/information screen notifies you when there is an incoming call.

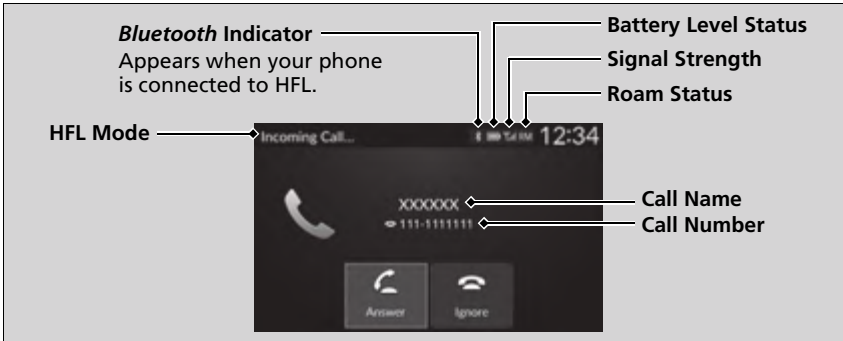

## ■ Limitations for Manual Operation

Certain manual functions are disabled or inoperable while the vehicle is in motion. You cannot select a grayed-out option until the vehicle is stopped.

## ▣ HFL Status Display

The information that appears on the audio/information screen varies between phone models.

## HFL Menu

The power mode must be in ACCESSORY or ON to use the system.

### HFL Menu

To use HFL, you must first pair your *Bluetooth*-compatible cell phone to the system while the vehicle is parked.

Some functions are limited while driving. A message appears on the screen when the vehicle is moving and the operation is canceled.

### PHONE button

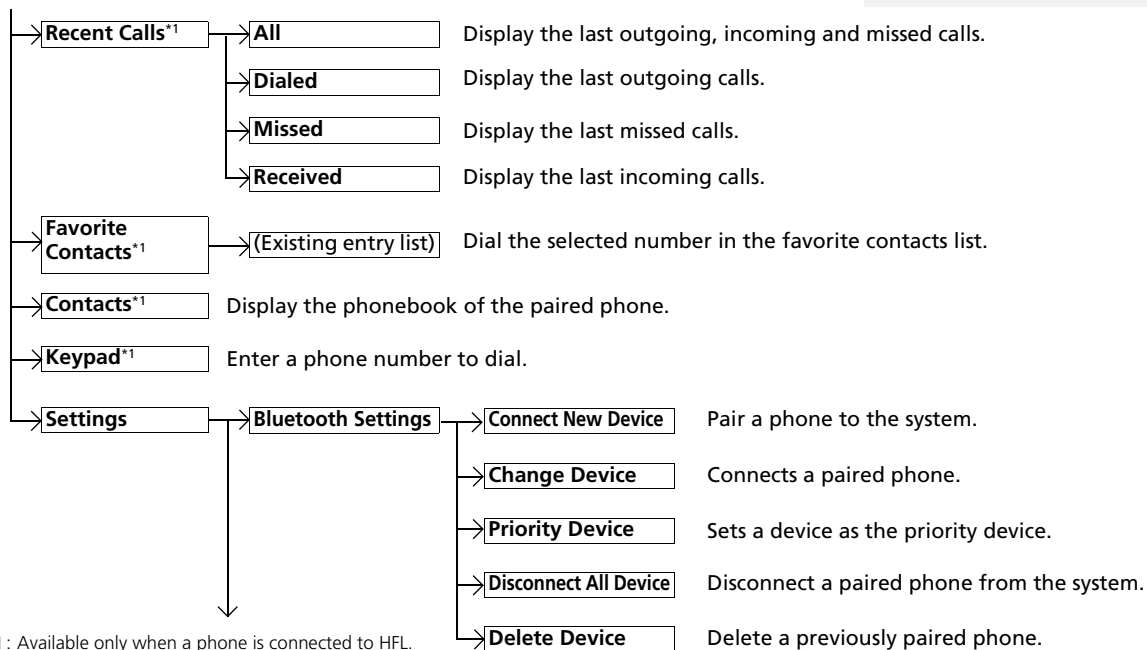

\*1: Available only when a phone is connected to HFL.



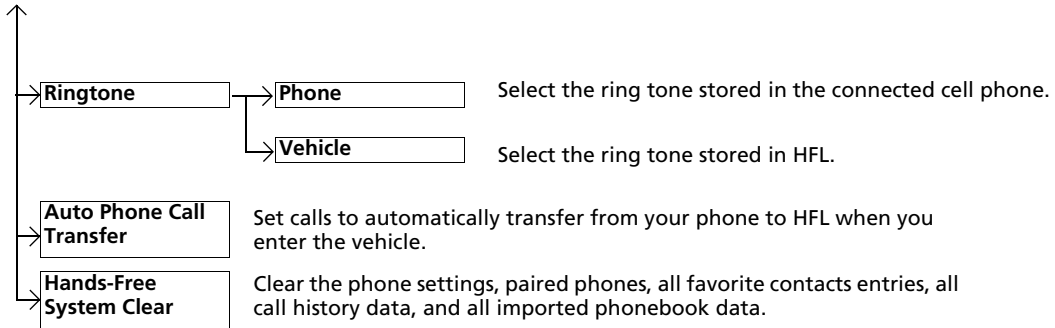

## Phone Setup

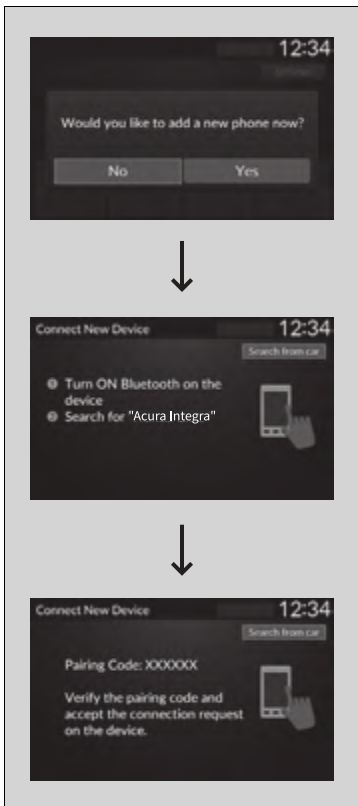

### ■ To pair a cell phone (No phone has been paired to the system)

1. Press the **PHONE** button.
2. Make sure your phone is in search or discoverable mode.
3. Select **Yes**.
  - ▶ The audio system will enter a waiting mode for pairing.
4. Select **Acura Integra** from your phone.
  - ▶ If you want to pair a phone from this audio system, select **Search from car** and follow the prompts. When your phone appears on the list, select it.
5. The system gives you a pairing code on the audio/information screen.
  - ▶ Confirm if the pairing code on the screen and your phone match. This may vary by phone.
6. A notification appears on the screen if pairing is successful.

## ☞ Phone Setup

Your *Bluetooth*-compatible phone must be paired to HFL before you can make and receive hands-free calls.

### Phone Pairing Tips:

- You cannot pair your phone while the vehicle is moving.
- Up to six phones can be paired.
- Your phone's battery may drain faster when it is connected to HFL.
- If your phone is not ready to be paired or is not paired within three minutes, the system will time out and return to the **Bluetooth Settings** screen.

Once you have paired a phone, you can see it displayed on the screen with one or two icons on the right side.

These icons indicate the following:

- : The phone is compatible with *Bluetooth*® Audio.
- : The phone can be used with HFL.

When pairing a phone from this audio system: If your phone doesn't appear on the audio/information screen, select **Search from phone** and search for *Bluetooth*® devices using your phone. From your phone, select **Acura Integra**.

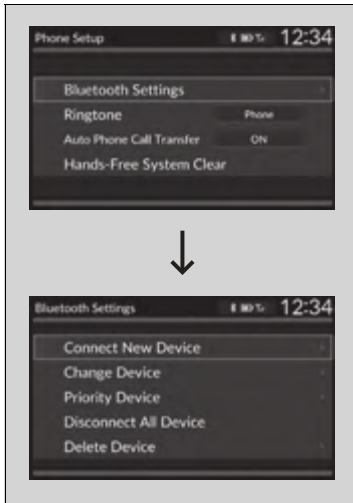

■ **To pair a cell phone (when a phone has already been paired to the system)**

1. Press the **PHONE** button.
  - ▶ If a prompt appears asking to connect to a phone, select **No** and proceed with step 2.
2. Select **Settings**.
3. Select **Bluetooth Settings**.
4. Select **Connect New Device**.
  - ▶ The audio system will enter a waiting mode for pairing.



5. Make sure your phone is in search or discoverable mode.
6. Select **Acura Integra** from your phone.
  - ▶ If you want to pair a phone from this audio system, select **Search from car** and follow the prompts. When your phone appears on the list, select it.
7. The system gives you a pairing code on the audio/information screen.
  - ▶ Confirm if the pairing code on the screen and your phone match. This may vary by phone.
8. A notification appears on the screen if pairing is successful.
  - ▶ You can prioritize a *Bluetooth*® device at the same time. Select **Yes** if you want to prioritize the device.



### ■ To change the currently paired phone

1. Press the **PHONE** button.
2. Select **Settings**.
3. Select **Bluetooth Settings**.
4. Select **Change Device**.
  - ▶ The screen changes to a device list.
5. Select a desired device name.
6. Select **Both**, **Audio**, or **Phone**.
  - ▶ When another device is connected to Android Auto and you select **Both** or **Phone**, a confirmation message appears. Select **Continue**.
  - ▶ HFL disconnects the connected phone and starts searching for another paired phone.

Continued



■ **To delete a paired phone**

1. Press the **PHONE** button.
2. Select **Settings**.
3. Select **Bluetooth Settings**.
4. Select **Delete Device**.
  - ▶ The screen changes to a device list.
5. Select a phone you want to delete.
6. A confirmation message appears on the screen. Select **Yes**.
  - ▶ When the device is connected to Android Auto, a confirmation message appears. Select **Yes**.

## Automatic Transferring

If pairing between your phone and the system is executed while you are on the phone, the call can be automatically transferred to HFL.

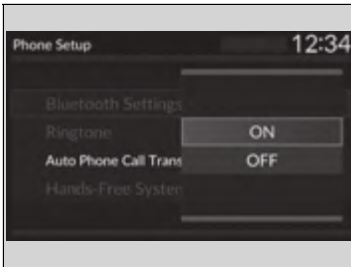

1. Press the **PHONE** button.
2. Select **Settings**.
3. Select **Auto Phone Call Transfer**.
4. Select **ON** or **OFF**.

## Ring Tone

You can change the ring tone setting.



1. Press the **PHONE** button.
2. Select **Settings**.
3. Select **Ringtone**.
4. Select **Phone** or **Vehicle**.

### Ring Tone

**Phone:** Depending on the make and model of the cell phone, the ring tone stored in the phone will sound if the phone is connected.

**Vehicle:** The fixed ring tone sounds from the speakers.

## ■ To Clear the System

Phone settings, paired phones, all favorite contacts entries, all call history data, and all imported phonebook data are erased.

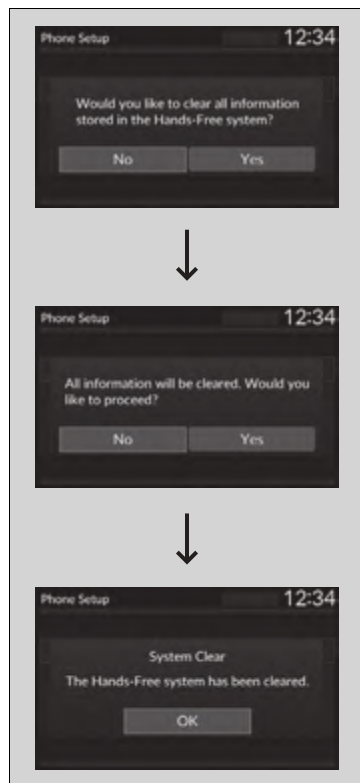

1. Press the **PHONE** button.
2. Select **Settings**.
3. Select **Hands-Free System Clear**.
4. Select **Yes**.
  
5. A confirmation message appears on the screen. Select **Yes**.
  
6. A notification appears on the screen. Select **OK**.



## Automatic Import of Cellular Phonebook and Call History

When your phone is paired, the contents of its phonebook and call history are automatically imported to HFL.

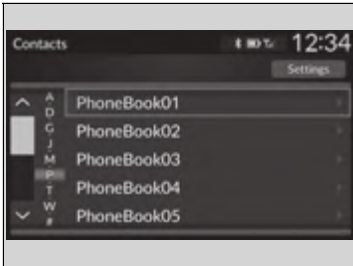

### Automatic Import of Cellular Phonebook and Call History

When you select a person from the list in the cellular phonebook, you can see up to five category icons. The icons indicate what types of numbers are stored for that name.

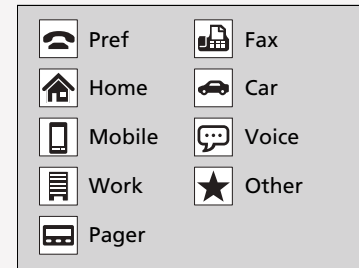

On some phones, it may not be possible to import the category icons to HFL.

The phonebook is updated after every connection. Call history is updated after every connection or call.

## Favorite Contacts

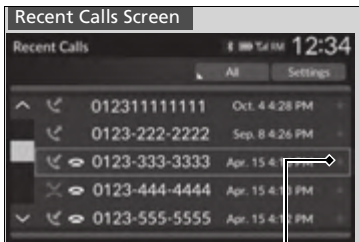

Star Icon

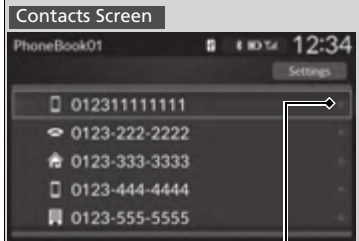

Star Icon

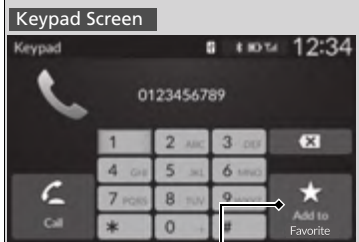

Add to Favorite

### ■ To add a favorite contacts

1. Press the **PHONE** button.
2. Select **Recent Calls**, **Contacts**, or **Keypad**.

On the Recent Calls or Contacts screen

3. Select the star icon.

On the Keypad screen

3. Select **Add to Favorite**.
  - ▶ A notification appears on the screen if the favorite contact is successfully stored.
  - ▶ To remove the favorite contact, select the star icon again.

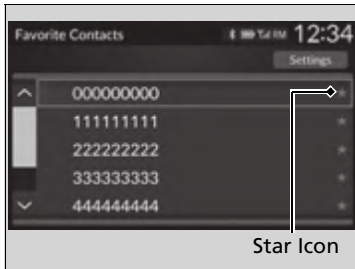

### ■ To delete a favorite contact

1. Press the **PHONE** button.
2. Select **Favorite Contacts**.
3. Select the star icon.
4. A confirmation message appears on the screen. Select **Yes**.

## ■ Making a Call

You can make calls by inputting any phone number, or by using the imported **Recent Calls**, **Favorite Contacts**, and **Contacts** entries.

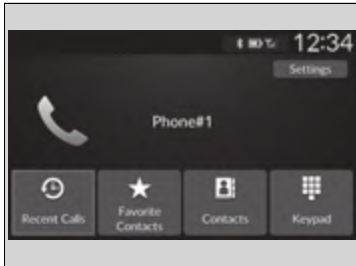

### ■ To make a call using the imported phonebook

When your phone is paired, the contents of its phonebook are automatically imported to HFL.

1. Press the **PHONE** button.
2. Select **Contacts**.
3. The phonebook is stored alphabetically. Select a name.
4. Select a number.
  - ▶ Dialing starts automatically.

## ▶▶ Making a Call

Once a call is connected, you can hear the voice of the person you are calling through the audio speakers.

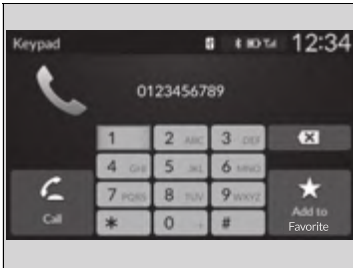

■ **To make a call using a phone number**

1. Press the **PHONE** button.
2. Select **Keypad**.
3. Select a number.
4. Select **Call**.
  - ▶ Dialing starts automatically.

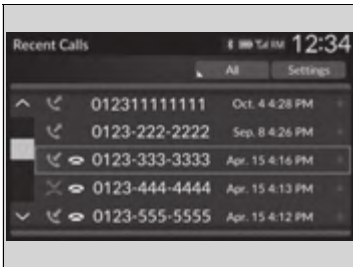

■ **To make a call using the call history**

Call history is stored by **All**, **Dialed**, **Missed**, or **Received**.

1. Press the **PHONE** button.
2. Select **Recent Calls**.
  - ▶ You can sort by **All**, **Dialed**, **Missed**, or **Received**. Select the icon on the upper right of the screen.
3. Select a number.
  - ▶ Dialing starts automatically.

☒ **To make a call using the call history**

The call history appears only when a phone is connected to HFL, and displays the last 20 dialed, received, or missed calls.

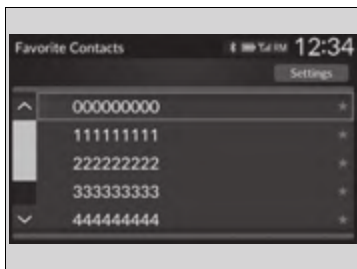

■ **To make a call using a favorite contact**

1. Press the **PHONE** button.
2. Select **Favorite Contacts**.
3. Select a number.
  - ▶ Dialing starts automatically.

## Receiving a Call

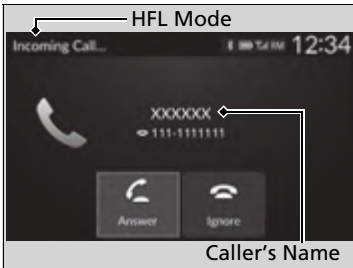

When there is an incoming call, an audible notification sounds and the **Incoming Call...** screen appears.

You can answer the call using the left selector wheel.

To pick the call, roll up or down to select **Answer** on the driver information interface and then press the left selector wheel.

- ▶ If you want to decline or end the call, select **Ignore** on the driver information interface using the left selector wheel.

## Receiving a Call

### Call Waiting

Select **Answer** using the left selector wheel to put the current call on hold to answer the incoming call. Select **Swap calls** using the left selector wheel to return to the current call.

Select **Ignore** using the left selector wheel to ignore the incoming call if you do not want to answer it.

Select **Hang Up** using the left selector wheel if you want to hang up the current call.

You can select the icons on the audio/information screen instead of the icons on the driver information interface.

## ■ Options During a Call

The following options are available during a call.

**Swap Calls:** Put the current call on hold to answer the incoming call.

**Mute:** Mute your voice.

**Use Handheld:** Transfer a call from HFL to your phone.

**Keypad:** Send numbers during a call. This is useful when you call a menu-driven phone system.

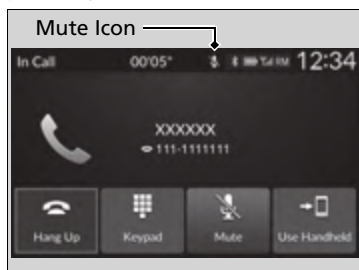

The available options are shown on the lower half of the screen.

Select the option.

- ▶ The mute icon appears when **Mute** is selected. Select **Mute** again to turn it off.

## ☞ Options During a Call

**Keypad:** Available on some phones.



## Models with 9-in. Color Touchscreen

Bluetooth® HandsFreeLink® (HFL) allows you to place and receive phone calls using your vehicle's audio system, without handling your cell phone.

## Using HFL

### HFL Buttons

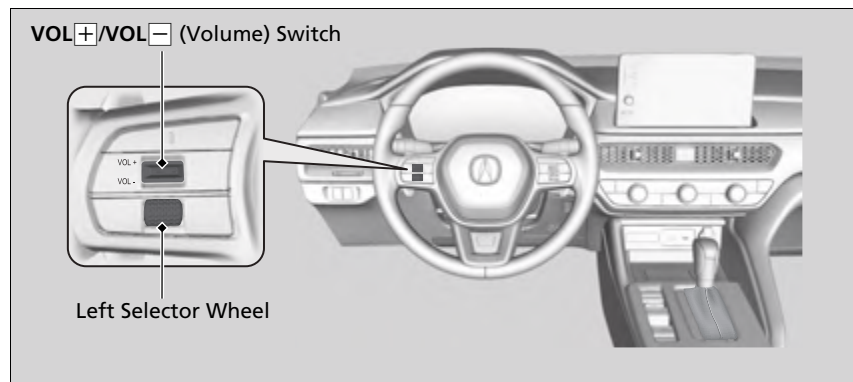

### Bluetooth® HandsFreeLink®

Place your phone where you can get good reception.

To use HFL, you need a *Bluetooth*-compatible cell phone. For a list of compatible phones, pairing procedures, and special feature capabilities:

- U.S.: Visit [www.handsfreelink.com/Acura](http://www.handsfreelink.com/Acura), or call 1-888-528-7876.
- Canada: For more information on smartphone compatibility, call 1-855-490-7351.

To use the system, the **Bluetooth** setting must be **ON**. If there is an active connection to Apple CarPlay, HFL is unavailable.

➤ **Customized Features** P. 359

Voice control tips

- Aim the vents away from the ceiling and close the windows, as noise coming from them may interfere with the microphone.
- If the microphone picks up voices other than yours, the command may be misinterpreted.
- To change the volume level, the volume level is able to change by the audio system's volume.

If there is no Favorite Contact entry in the system, the pop-up notification appears on the screen.

➤ **Favorite Contacts** P. 414

**Left Selector Wheel:** Roll up or down to select **Phone** on the driver information interface, and then press the left selector wheel.

While receiving a call, the incoming call screen is displayed on the driver information interface. You can pick up the call using the left selector wheel.

➤ **Receiving a Call** P. 418

To go to the phone screen:

1. Press the  button.
2. Select **Phone** to switch the display to the phone screen.

#### Bluetooth® HandsFreeLink®

##### *Bluetooth®* Wireless Technology

The *Bluetooth®* word mark and logos are registered trademarks owned by *Bluetooth* SIG, Inc., and any use of such marks by Honda Motor Co., Ltd., is under license. Other trademarks and trade names are those of their respective owners.

##### HFL Limitations

An incoming call on HFL will interrupt the audio system when it is playing. It will resume when the call is ended.

## ■ HFL Status Display

The audio/information screen notifies you when there is an incoming call.

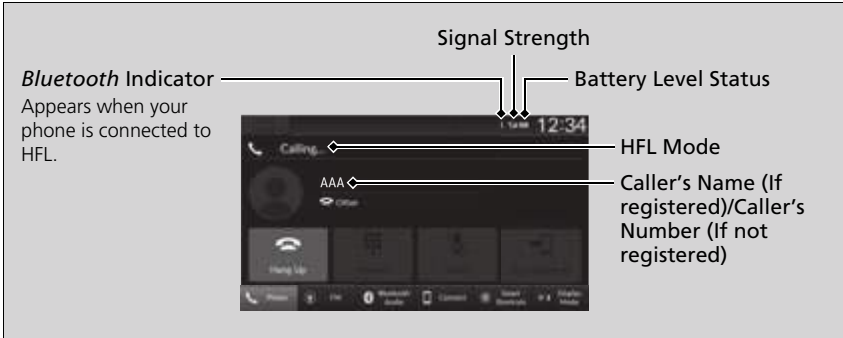

## ■ Limitations for Manual Operation

Certain manual functions are disabled or inoperable while the vehicle is in motion. You cannot select a grayed-out option until the vehicle is stopped.

## ▣ HFL Status Display

The information that appears on the audio/information screen varies between phone models.

## HFL Menus

The power mode must be in ACCESSORY or ON to use the system.

### ■ Phone settings screen

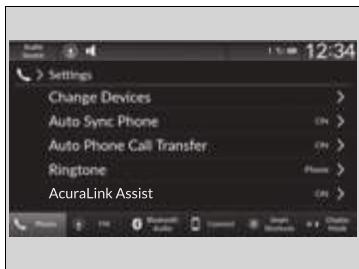

1. Press the  button.
2. Select **Phone**.
3. Select **Settings**.

### ☒ HFL Menus

To use HFL, you must first pair your *Bluetooth*-compatible cell phone to the system while the vehicle is parked.

Some functions are limited while driving.

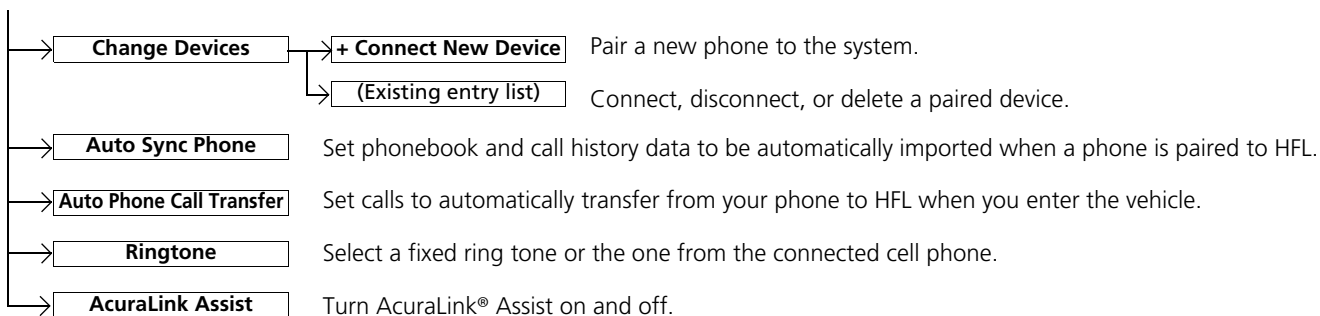

■ Phone menu screen



1. Press the  button.
2. Select **Phone**.

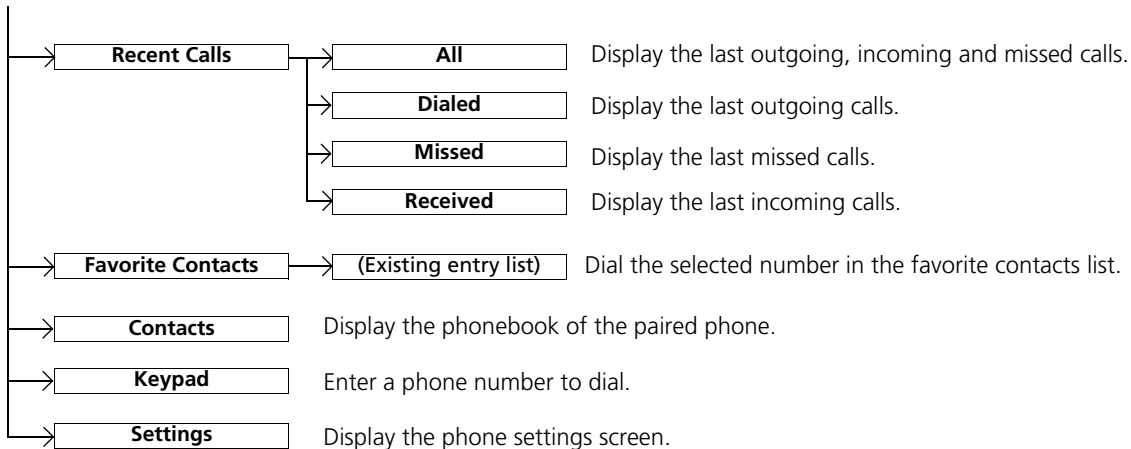

## ■ Phone Setup

### ■ Bluetooth® setup

You can turn *Bluetooth*® function on and off.

1. Press the  button.
2. Select **General Settings**.
3. Select **Connections**.
4. Select **Bluetooth**.
5. Select **Options**.
6. Select **Bluetooth**, then select **ON**.

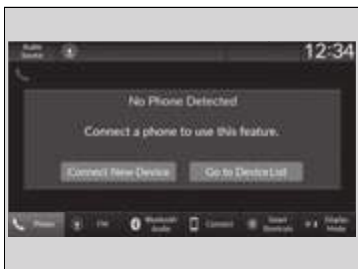

### ■ To pair a cell phone (when there is no phone paired to the system)

1. Select **Phone**.
2. Select **Connect New Device**.
3. Make sure your phone is in search or discoverable mode.
4. Select **Acura Integra** from your phone.
  - ▶ If you want to pair a phone from this audio system, select **Search for Devices**, and then select your phone when it appears on the list.
5. The system gives you a pairing code on the audio/information screen.
  - ▶ Confirm if the pairing code on the screen and your phone match. This may vary by phone.
6. Select desired functions and then select **Connect**.

## ☞ Phone Setup





Your *Bluetooth*-compatible phone must be paired to the system before you can make and receive hands-free calls.

### Phone Pairing Tips:

- You cannot pair your phone while the vehicle is moving.
- Up to six phones can be paired.
- Your phone's battery may drain faster when it is paired to the system.

Once you have paired a phone, you can see it displayed on the screen with one or more icons on the right side.

These icons indicate the following:







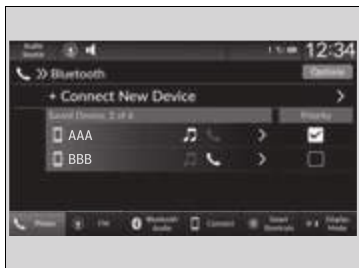



- : The phone is compatible with *Bluetooth*® Audio.
- : The phone can be used with HFL.
- : The phone is compatible with Apple CarPlay.
- : The phone is compatible with Android Auto.

If there is an active connection to Apple CarPlay or Android Auto, pairing of additional *Bluetooth*-compatible devices is unavailable.

7. A notification appears on the screen if pairing is successful.
8. Select **OK**.
  - ▶ A confirmation message for phone data collection appears.
9. Select **ON** or **OFF**.
  - ▶ A confirmation message for AcuraLink Assist appears.
10. Select **Yes** or **No**.



### ■ To change the currently paired phone

1. Go to the phone settings screen.
  - ▶ **Phone settings screen** P. 406
2. Select **Change Devices**.
3. Select a phone to connect.
  - ▶ HFL disconnects the connected phone and starts searching for another paired phone.
  - ▶ You can set the connected phone priority. Select the box checked on the phone you want to prioritize.
4. Select , ,  or .
- ▶  and  can be selected simultaneously, however, when  or  is selected,  and  cannot be selected.
5. Select **Apply**.

### ▶▶ To change the currently paired phone

If no other phones are found or paired when trying to switch to another phone, HFL will inform you that the original phone is connected again.

To pair other phones, select + **Connect New Device** from the **Bluetooth** screen.





### ■ To delete a paired phone

1. Go to the phone settings screen.  
    ▶ **Phone settings screen** P. 406
2. Select **Change Devices**.
3. Select a phone you want to delete.
4. Select **Options**.
5. Select **Delete Device**.
6. A confirmation message appears on the screen. Select **Delete**.

## ■ Ring Tone

You can change the ring tone setting.



1. Go to the phone settings screen.  
    ▶ **Phone settings screen** P. 406
2. Select **Ringtone**.
3. Select **Vehicle** or **Phone**.

## ■ Automatic Transferring

If you get into the vehicle while you are on the phone, the call can be automatically transferred to HFL.

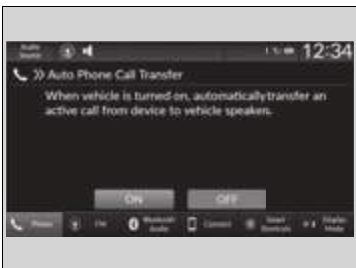

1. Go to the phone settings screen.  
    ▶ **Phone settings screen** P. 406
2. Select **Auto Phone Call Transfer**.
3. Select **ON** or **OFF**.

## ▶▶ Ring Tone

**Vehicle:** The fixed ring tone sounds from the speakers.

**Phone:** Depending on the make and model of the cell phone, the ring tone stored in the phone will sound if the phone is connected.

## Automatic Import of Cellular Phonebook and Call History



### ■ When Auto Sync Phone is set to On:

When your phone is paired, the contents of its phonebook and call history are automatically imported to the system.

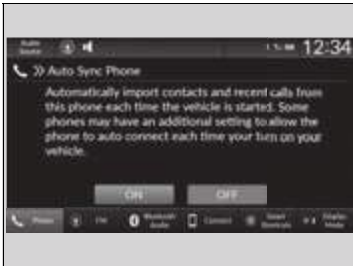

### ■ Changing the Auto Sync Phone setting

1. Go to the phone settings screen.
2. Select **Auto Sync Phone**.
3. Select **ON** or **OFF**.

➤ **Phone settings screen** P. 406

## Automatic Import of Cellular Phonebook and Call History

When you select a name from the list in the cellular phonebook, you can see a category icon. The icons indicate what types of numbers are stored for that name.

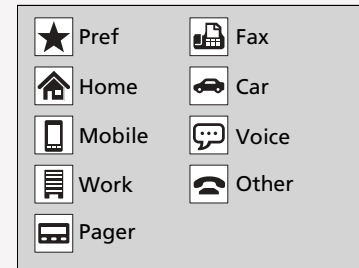

On some phones, it may not be possible to import the category icons to the system.

The phonebook is updated after every connection. Call history is updated after every connection or call.

## Favorite Contacts

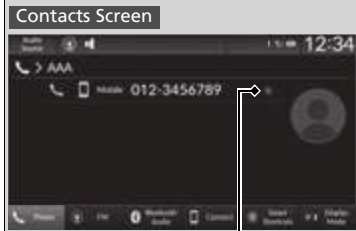

### ■ To add a favorite contacts

1. Select **Phone**.
2. Select **Recent Calls**, **Contacts**, or **Keypad**.

On the Recent Calls or Contacts screen

3. Select the star icon.

On the Keypad screen

3. Select **Add to Favorite Contacts**.
  - ▶ A notification appears on the screen if the favorite contact is successfully stored.
  - ▶ To remove the favorite contact, select the star icon again.



### ■ To edit a favorite contacts

1. Select **Phone**.
2. Select **Favorite Contacts**.
3. Select **Edit** on the favorite contacts entry you want to edit.
4. Select a setting you want.
5. Select **Done**.

### ■ To delete a favorite contacts

1. Select **Phone**.
2. Select **Favorite Contacts**.
3. Select **Edit** on the favorite contacts entry you want to delete.
4. Select **Remove**.
5. A confirmation message appears on the screen. Select **Yes**.

## ■ Making a Call

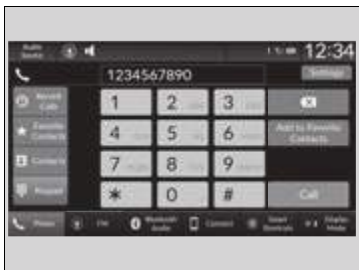

You can make calls by inputting any phone number, or by using the imported **Recent Calls**, **Favorite Contacts**, and **Contacts** entries.

### ■ To make a call using the imported phonebook

1. Select **Phone**.
2. Select **Contacts**.
3. Select a name.
  - ▶ You can sort by **First Name** or **Last Name**. Select the icon on the upper right of the screen.
4. Select a number.
  - ▶ Dialing starts automatically.

## ☞ Making a Call

Once a call is connected, you can hear the voice of the person you are calling through the audio speakers.

While there is an active connection with Apple CarPlay, phone calls cannot be made with HandsFreeLink® and are only made from Apple CarPlay.



■ **To make a call using a phone number**

1. Select **Phone**.
2. Select **Keypad**.
3. Select a number.
  - ▶ Use the keyboard on the touch screen for entering numbers.
4. Select **Call**.
  - ▶ Dialing starts automatically.

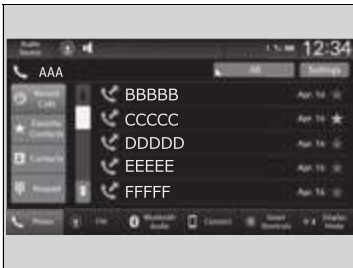

■ **To make a call using the Call History**

Call history is stored by **All**, **Dialed**, **Missed**, and **Received**.

1. Select **Phone**.
2. Select **Recent Calls**.
  - ▶ You can sort by **All**, **Dialed**, **Missed**, or **Received**. Select the icon on the upper right of the screen.
3. Select a number.
  - ▶ Dialing starts automatically.



■ **To make a call using a favorite contacts entry**

1. Select **Phone**.
2. Select **Favorite Contacts**.
  - ▶ You can change the order of favorite contacts entries by selecting **Reorder**.
3. Select a number.
  - ▶ Dialing starts automatically.

☒ **To make a call using the Call History**

The call history displays the last 20 all, dialed, missed, or received calls. (Appears only when a phone is connected to the system.)

Continued

## ■ Receiving a Call

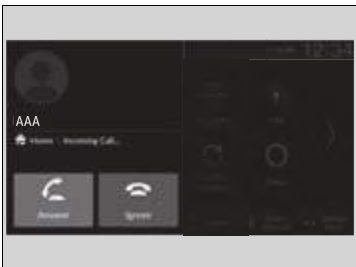

When there is an incoming call, an audible notification sounds (if activated) and the **Incoming Call...** screen appears.

You can answer the call using the left selector wheel.

To pick the call, roll up or down to select  (answer) on the driver information interface and then press the left selector wheel.

- ▶ If you want to decline or end the call, select  (ignore) on the driver information interface using the left selector wheel.

## ▣ Receiving a Call



### Call Waiting

Select  (answer) to put the current call on hold to answer the incoming call.

Select  using the left selector wheel to return to the current call.

Select  (ignore) to ignore the incoming call if you do not want to answer it.

Select  if you want to hang up the current call.

You can select the icons on the audio/information screen instead of the  and  on the driver information interface.



## Options During a Call

The following options are available during a call.

**Mute:** Mute your voice.

**Use Handheld:** Transfer a call from the system to your phone.

**Keypad:** Send numbers during a call. This is useful when you call a menu-driven phone system.



The available options are shown on the lower half of the screen.

Select the option.

- ▶ The mute icon appears when **Mute** is selected when the other source screen other than the phone screen is displayed. Select **Mute** again to turn it off.

## Options During a Call

**Keypad:** Available on some phones.

You can select the icons on the audio/information screen.

Models with 9-in. Color Touchscreen

## AcuraLink® Assist

### ■ In Case of Emergency

#### ■ Automatic collision notification

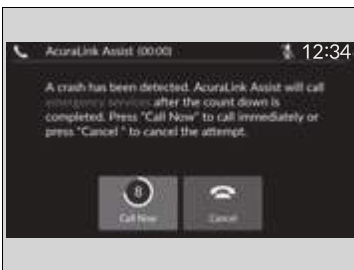

If your vehicle's airbags deploy or if the unit detects that the vehicle is severely impacted, your vehicle automatically will attempt to connect to an E911 operator through your connected cellular phone. If connected, information about your vehicle and its location can be sent to the operator\*1; you also can speak to the operator when connected.

**IMPORTANT:** For the vehicle equipped with AcuraLink Assist, owner activation constitutes authorization for Acura to collect information from your vehicle needed to provide the service. In a crash, AcuraLink Assist will attempt to notify emergency services but ACURA CANNOT GUARANTEE THAT SUCH NOTIFICATION WILL OCCUR.

Acura reserves the right to terminate AcuraLink Assist services at any time or for any reason, and in the future may not be able to provide services due to changes in, or obsolescence of, technology integral to the service or changes in governmental regulation.

\*1: Depending on your phone and its cellular coverage, your vehicle's location may not be sent to the operator.

### ☞ In Case of Emergency

Your vehicle may not be able to connect to the operator if its, or your cellular phone's, battery level is low, the line is disconnected, or you do not have adequate cellular coverage.

You cannot use this emergency service when:

- You travel outside your cellular provider's coverage areas.
- There is a problem with the connecting devices, such as the microphones or speakers, or your connected phone itself.

You cannot operate other phone-related functions using the screen while talking to the operator. Select **Hang Up** to terminate the connection to your vehicle.

### ☞ Automatic collision notification

If the unit fails to connect to the operator, it repeatedly tries until it succeeds.

## ■ To enable notification

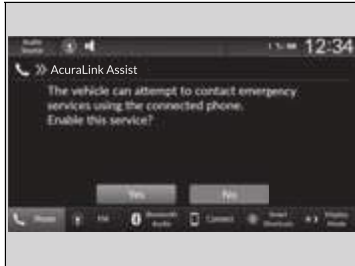

1. Go to the phone settings screen.
  - ▶ **Phone settings screen** P. 406
2. Select **AcuraLink Assist**.
3. Select **Yes** or **No**.

## ☒ To enable notification

Setting options:

- **Yes:** Notification is available.
- **No:** Disable the feature.

This page intentionally left blank.

# Driving



This chapter discusses driving and refueling.

<b>Before Driving</b> .....	424
<b>Towing a Trailer</b> .....	429
<b>When Driving</b>	
Starting the Engine .....	430
Precautions While Driving.....	438
Continuously Variable Transmission* ...	439
Shifting.....	440, 444
Acura Integrated Dynamics System ..	447, 449
Auto Idle Stop.....	455, 461
Vehicle Stability Assist™ (VSA®), aka Electronic Stability Control (ESC), System .....	466
Agile Handling Assist .....	468

Limited Slip Differential (LSD) .....	469
Tire Pressure Monitoring System (TPMS) with Tire Fill Assist .....	470
Tire Pressure Monitoring System (TPMS) - Required Federal Explanation .....	472
Blind Spot Information System .....	474
<b>AcuraWatch™</b> .....	478
Collision Mitigation Braking System™ (CMBS™) .....	481
Low Speed Braking Control* ....	493, 499
Adaptive Cruise Control (ACC) with Low Speed Follow* .....	504
Adaptive Cruise Control (ACC)* .....	525

Lane Keeping Assist System (LKAS)....	545
Traffic Jam Assist* .....	557
Road Departure Mitigation System... 566	
Traffic Sign Recognition System .....	574
Front Wide View Camera .....	581
Sonar Sensors* .....	583
<b>Braking</b> .....	584
<b>Parking Your Vehicle</b> .....	596
<b>Multi-View Rear Camera</b> .....	606
<b>Refueling</b> .....	608
<b>Fuel Economy and CO<sub>2</sub> Emissions</b> ....	611
<b>Turbo Engine Vehicle</b> .....	612

\* Not available on all models

## Driving Preparation

Check the following items before you start driving.

### Exterior Checks

- Make sure there are no obstructions on the windows, door mirrors, exterior lights, or other parts of the vehicle.
  - ▶ Remove any frost, snow, or ice.
  - ▶ Remove any snow on the roof, as this can slip down and obstruct your field of vision while driving. If frozen solid, remove ice once it has softened.
  - ▶ When removing ice from around the wheels, be sure not to damage the wheel or wheel components.
- Make sure the hood is securely closed.
  - ▶ If the hood opens while driving, your front view will be blocked.
- Make sure the tires are in good condition.
  - ▶ Check air pressures, and check for damage and excessive wear.
    - ✦ **Checking and Maintaining Tires** P. 641
- Make sure there are no people or objects behind or around the vehicle.
  - ▶ There are blind spots from the inside.

### Exterior Checks

#### NOTICE

When doors are frozen shut, use warm water around the door edges to melt any ice. Do not try to force them open, as this can damage the rubber trim around the doors. When done, wipe dry to avoid further freezing.

Do not pour warm water into the key cylinder. You will be unable to insert the key if the water freezes in the hole.

Heat from the engine and exhaust can ignite flammable materials left under the hood, causing a fire. If you've parked your vehicle for an extended period, inspect and remove any debris that may have collected, such as dried grass and leaves that have fallen or have been carried in for use as a nest by a small animal. Also, check under the hood for leftover flammable materials after you or someone else has performed maintenance on your vehicle.

## Interior Checks

- Store or secure all items on board properly.
  - ▶ Carrying too much cargo, or improperly storing it, can affect your vehicle's handling, stability, stopping distance, and tires, and make it unsafe.
    - **Maximum Load Limit** P. 427
- Do not pile items higher than the seat height.
  - ▶ They can block your view and may be thrown forward in the event of sudden braking.
- Do not place anything in the front seat footwells. Make sure to secure the floor mat.
  - ▶ An object or unsecured floor mat can interfere with your brake and accelerator pedal operation while driving.
- If you have any animals on board, do not let them move around in the vehicle.
  - ▶ They may interfere with driving and a crash could occur.
- Securely close and lock all doors and the hatch.
  - **Locking/Unlocking the Doors from the Inside** P. 158
- Adjust your seating position properly.
  - ▶ Adjust the front head restraint, too.
    - **Seats** P. 191
    - **Adjusting the Front Head Restraint Positions** P. 198
- Adjust the mirrors and steering wheel properly.
  - ▶ Adjust them while sitting in the proper driving position.
    - **Mirrors** P. 189
    - **Adjusting the Steering Wheel** P. 188

## Interior Checks

The headlight aim is set by the factory, and does not need to be adjusted. However, if you regularly carry heavy items in the cargo area, have the aiming readjusted at a dealer or by a qualified technician.

- Be sure items placed on the floor behind the front seats cannot roll under the seats.
  - ▶ They can interfere with the driver's ability to operate the pedals, the operation of the seats, or the operation of the sensors under the seats.
- Everyone in the vehicle must fasten their seat belt.
  - 📄 **Fastening a Seat Belt** P. 45
- Make sure that the indicators in the instrument panel come on when you start the vehicle, and go off soon after.
  - ▶ Always have a dealer check the vehicle if a problem is indicated.
    - 📄 **Indicators** P. 84



## Maximum Load Limit

The maximum load for your vehicle is 850 lbs (385 kg). See the Tire and Loading Information label attached to the driver's doorjamb.

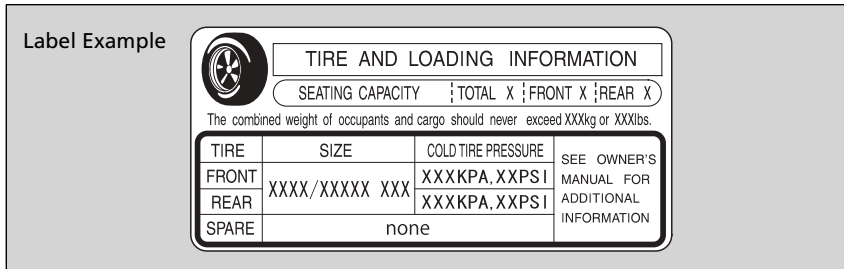

This figure includes the total weight of all occupants, cargo, and accessories, and the tongue load if you are towing a trailer.

Steps for Determining Correct Load Limit -

- (1) Locate the statement "The combined weight of occupants and cargo should never exceed XXX kg or XXX lbs." on your vehicle's placard.
- (2) Determine the combined weight of the driver and passengers that will be riding in your vehicle.
- (3) Subtract the combined weight of the driver and passengers from XXX kg or XXX lbs.
- (4) The resulting figure equals the available amount of cargo and luggage load capacity. For example, if the "XXX" amount equals 1,400 lbs. and there will be five 150 lb. passengers in your vehicle, the amount of available cargo and luggage load capacity is 650 lbs. (1,400 - 750 (5 x 150) = 650 lbs.)

Continued

### Maximum Load Limit

## ⚠ WARNING

Overloading or improper loading can affect handling and stability and cause a crash in which you can be hurt or killed.

Follow all load limits and other loading guidelines in this manual.

Gross Vehicle Weight Rating (GVWR):

The maximum allowable weight of the vehicle, all occupants, all accessories and all cargo.

➤ **Specifications** P. 716

Gross Axle Weight Rating (GAWR):

The maximum allowable weight of the vehicle axle.

➤ **Specifications** P. 716

- (5) Determine the combined weight of luggage and cargo being loaded on the vehicle. That weight may not safely exceed the available cargo and luggage load capacity calculated in step 4.
- (6) If your vehicle will be towing a trailer, load from your trailer will be transferred to your vehicle. Consult this manual to determine how this reduces the available cargo and luggage load capacity of your vehicle.

In addition, the total weight of the vehicle, all occupants, accessories, cargo, and trailer tongue load must not exceed the Gross Vehicle Weight Rating (GVWR) or the Gross Axle Weight Rating (GAWR). Both are on a label on the driver's doorjamb.

▶▶ Maximum Load Limit

Towing a Trailer:

See Towing a Trailer to determine whether your vehicle is designed to tow a trailer.

▶▶ **Towing a Trailer** P. 429

Load Limits Example

Example1



Max Load  
850 lbs  
(385 kg)



Passenger Weight  
150 lbs x 2 = 300 lbs  
(68 kg x 2 = 136 kg)



Cargo Weight  
550 lbs  
(249 kg)

Example2



Max Load  
850 lbs  
(385 kg)



Passenger Weight  
150 lbs x 5 = 750 lbs  
(68 kg x 5 = 340 kg)



Cargo Weight  
100 lbs  
(45 kg)

Your vehicle is not designed to tow a trailer. Attempting to do so can void your warranties.

### **Towing Behind a Motorhome**

---

Your vehicle is not designed to be towed behind a motor home. If your vehicle needs to be towed in an emergency, refer to the emergency towing information.

📄 **Emergency Towing** P. 711

## Starting the Engine

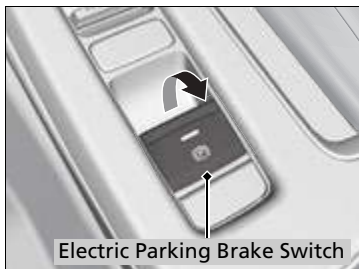

1. Make sure the parking brake is applied.
  - ▶ The parking brake and brake system indicator (red) comes on for 30 seconds when you pull up the electric parking brake switch.

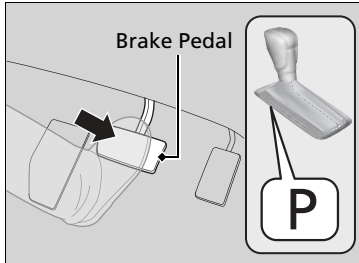

- Continuously variable transmission models**
2. Check that the transmission is in **P**, then depress the brake pedal.
    - ▶ Although it is possible to start the vehicle in **N**, it is safer to start it in **P**.

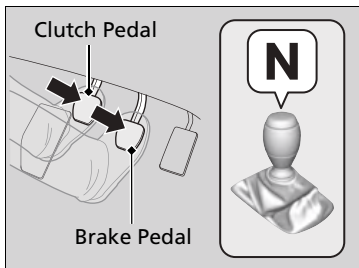

- Manual transmission models**
2. Check that the shift lever is in **N**. Then depress the brake pedal with your right foot, and the clutch pedal with your left foot.
    - ▶ The clutch pedal must be fully depressed to start the engine.

### Starting the Engine

Keep your foot firmly on the brake pedal when starting the engine.

The engine is harder to start in cold weather and in thinner air found at altitudes above 8,000 feet (2,400 meters).

When starting the engine in cold weather, turn off all electrical accessories such as the lights, climate control system, and rear defogger in order to reduce battery drain.

If you live in a region where winter is extremely cold, an engine block heater will improve starting and warming of the engine. Consult a dealer for details.

If the exhaust system sounds abnormal or you can smell exhaust gas inside the vehicle, have your vehicle checked by a dealer. There may be a problem with the engine or exhaust system.

Bring the keyless remote close to the **ENGINE START/STOP** button if the battery in the keyless remote is weak.

❏ **If the Keyless Remote Battery is Weak** P. 691

The engine may not start if the keyless remote is subjected to strong radio waves.

Do not hold the **ENGINE START/STOP** button to start the engine.

If the engine does not start, wait at least 30 seconds before starting the engine again.

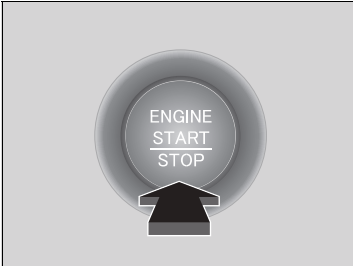
**All models**

3. Press the **ENGINE START/STOP** button without depressing the accelerator pedal.

**Starting the Engine**

The immobilizer system protects your vehicle from theft. If an improperly coded device is used, the engine's fuel system is disabled.

➤ **Immobilizer System** P. 165

*Continued*



## ■ Remote Engine Start\*

You can remotely start the engine using the two-way keyless remote from extended distances.

### ■ To start the engine

Amber LED: Blinks when any button is pressed.



Press the  button, then press and hold the  button.

- ▶ Continues to blink during a vehicle self check until the engine starts.

Green LED: Comes on while the engine is running.



Red LED: Blinks when the remote is out of the keyless system range.

- ▶ Go within the range, and try again.



## ▶▶ Remote Engine Start\*

### ⚠ WARNING

Carbon monoxide gas is toxic and can rapidly accumulate in closed or even partly enclosed areas.



Breathing it can cause unconsciousness and even kill you.

Never use the remote engine starter with the vehicle parked in a garage or other areas with limited ventilation.

The remote engine start may violate local laws. Before using the remote engine start, check your local laws.

If there are buildings and obstacles between your vehicle and the remote, the range will be reduced. This distance may vary by external electrical interference.

The engine runs for up to 10 minutes without you starting the vehicle.

To extend the run time for another 10 minutes during the first run, press the  button, then press and hold the  button.

- ▶ The amber LED blinks, then the green LED comes back on if a 10-minute extension request was transmitted successfully.

After pressing the  button, wait for the green LED to blink. This indicates that the all the doors and the hatch are locked.

⌘ Remote Engine Start\*

The engine may not start by the remote engine start if:

- You have disabled a remote engine start setting using the driver information interface.

**Models with 7-in. Color Touchscreen**

➔ **Vehicle Settings\*** P. 126

**Models with 9-in. Color Touchscreen**

➔ **Customized Features** P. 359

- The power mode is not in VEHICLE OFF.
- The transmission is in a position other than **P**.
- The hood is open, or any door or the hatch is unlocked.
- You have already used the remote twice to start the engine.
- Another registered keyless remote is in the vehicle.
- There is any antenna failure.
- The door is unlocked with the built-in key.
- The engine oil pressure is low.
- The engine coolant temperature is extremely high.
- The telematics unit\* malfunctions.
- The security system alarm is not set.
- The 12-volt battery temp is too low or the 12-volt battery charge is too low.

Before starting the engine, make sure to check the door lock status using the remote. When you press the  button, wait for the green LED to blink. If the red LED turns on, the doors and hatch did not lock, and the engine does not start.

\* Not available on all models

### ■ To stop the engine

Amber LED: Blinks when any button is pressed.



Press and hold the  button for one second.

Red LED: Comes on for one second to let you know that the engine has stopped.



Red LED: Blinks when the remote is out of the keyless system range. The engine will not stop.

▶ Go within the range, and try again.

### ⊞ Remote Engine Start \*

While the engine is running, the vehicle will automatically precondition inside the vehicle.

When it is warm outside:

- The climate control system is activated in recirculation mode.

When it is cold outside:

- The defroster is activated at a moderately warm temperature.
- The rear defogger, heated door mirrors, front seat heaters are activated.

⊞ **Rear Defogger/Heated Door Mirror Button** P. 185

⊞ **Front Seat Heaters** P. 216



## Starting to Drive

### Continuously variable transmission models

When the engine was started using the  button on the keyless remote

1. Depress and hold the brake pedal, then press the **ENGINE START/STOP** button.
- When the engine was started in any case
2. Keeping your right foot on the brake pedal, put the transmission into **[D]**. Select **[R]** when reversing.
  3. With the parking brake applied, release the brake pedal and gently depress the accelerator pedal.
    - ▶ Make sure the parking brake and brake system indicator (red) goes off.
      - **Parking Brake** P. 584

## Starting to Drive

### Manual transmission models

#### Engine Restart Function

If the engine stalls, fully depress the clutch pedal within three seconds. The engine may automatically restart under certain conditions. Otherwise, follow the standard procedure.

➤ **Starting the Engine** P. 430

### Continuously variable transmission models

When the engine was started using the  button on the keyless remote

The engine stops when the transmission is taken out of **[P]** before the **ENGINE START/STOP** button is pressed. Follow step 1 when starting to drive.

### All models

You can also release the parking brake by pressing the electric parking brake switch while depressing the brake pedal.

When facing downhill, you can start your vehicle more smoothly by manually releasing it with the electric parking brake switch than by releasing it with the accelerator pedal.

### ■ Hill start assist system

Hill start assist keeps the brake engaged briefly to help prevent the vehicle from rolling on inclines as you move your foot from the brake pedal to the accelerator.

#### Continuously variable transmission models

Put the transmission into **D** or **S** when facing uphill, or **R** when facing downhill, then release the brake pedal.

#### Manual transmission models

Depress the clutch pedal, and shift to one of the forward gears when facing uphill, or **R** when facing downhill, then release the brake pedal.

#### ⓘ Hill start assist system

Hill start assist may not prevent the vehicle from rolling downhill on a very steep or slippery slope, and will not operate on small inclines.

Hill start assist is not a replacement for the parking brake.

Hill start assist will operate even when VSA® is switched off.

## Stopping the Engine

You can turn the engine off when the vehicle is completely stopped.

### Continuously variable transmission models

1. Put the transmission into **P**.
2. Press the **ENGINE START/STOP** button.

### Manual transmission models

- If the transmission is in **N**, press the **ENGINE START/STOP** button.
- If the transmission is in any gear other than **N**, depress the clutch pedal, then press the **ENGINE START/STOP** button.

### Stopping the Engine

The power mode will automatically turn to VEHICLE OFF about 20 minutes after the following conditions have been met:

- A door has been opened, such as when leaving the vehicle.
- The driver's seat belt is not fastened.

### Continuously variable transmission models

- The transmission is in **P**.

### Manual transmission models

- The vehicle is completely stopped.

## Precautions While Driving

### ■ In Rain

Avoid driving in deep water and on flooded roads. This can damage the engine or driveline, or cause electrical component failure.

### ■ Other Precautions

If there is a strong impact with something under the vehicle, stop in a safe location. Check the underside of the vehicle for damage or any fluid leaks.

### » Precautions While Driving

#### Continuously variable transmission models

##### NOTICE

Do not operate the shift lever while pressing the accelerator pedal. You could damage the transmission.

##### NOTICE

If you repeatedly turn the steering wheel at an extremely low speed, or hold the steering wheel in the full left or right position for a while, the electric power steering (EPS) system heats up. The system goes into a protective mode, and limits its performance. The steering wheel becomes harder and harder to operate. Once the system cools down, the EPS system is restored.

Repeated operation under these conditions can eventually damage the system.

If the power mode is set to ACCESSORY while driving, the engine will shut down and all steering and brake power assist functions will stop, making it difficult to control the vehicle.

Do not select **[N]** while driving as you will lose engine braking (and acceleration) performance.

During the first 600 miles (1,000 km) of operation, avoid sudden acceleration or full throttle operation so as not to damage the engine or powertrain.

## Continuously Variable Transmission \*

### ■ Creeping

When the engine runs at higher idle speeds, the creeping force increases. Keep the brake pedal firmly depressed when stopped.

### ■ Kickdown

Quickly depressing the accelerator pedal while driving uphill may cause the transmission to drop to a lower ratio, unexpectedly increasing vehicle speed. Depress the accelerator pedal carefully, especially on slippery roads and curves.

\* Not available on all models

### ⌘ Precautions While Driving

Avoid hard braking for the first 200 miles (300 km) after purchasing your new vehicle or replacing the brake pads or rotors, to allow for proper break-in.

#### NOTICE

The following can damage the under spoiler:

- Parking the vehicle by a parking block
- Parallel parking along the road shoulder
- Driving towards the bottom of a hill
- Driving up or down to a different surface level (such as a road shoulder)
- Driving on a rutted or bumpy road
- Driving on a road with potholes

Continuously variable transmission models

## Shifting

Change the shift position in accordance with your driving needs.

### ■ Shift positions

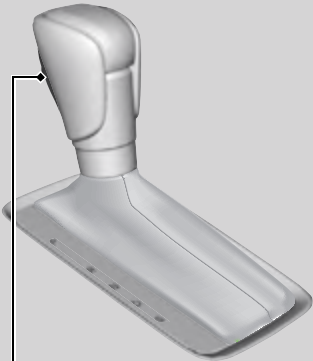

**P** **Park**  
Used when parking or starting the engine

**R** **Reverse**  
Used when reversing

**N** **Neutral**  
Transmission is not locked

**D** **Drive**  
Used:  
• For normal driving  
• When temporarily driving in the 7-speed manual shift mode

**S** **Drive (S)**  
Used:  
• For better acceleration  
• To increase engine braking  
• When going up or down hills  
• When driving in the 7-speed manual shift mode

Release Button

### ▶▶ Shifting

You cannot change the power mode from ON to VEHICLE OFF unless the shift position is in **P**.

The vehicle may move very slightly even in **N** while the engine is cold.

Depress the brake pedal firmly and, when necessary, apply the parking brake.

## Shift Operation

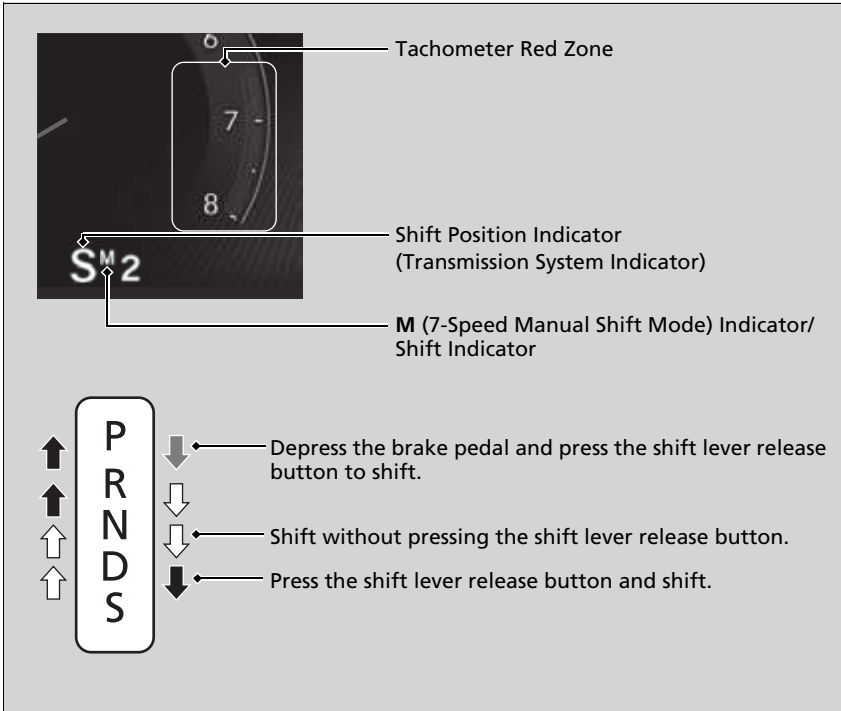

## Shift Operation

### NOTICE

When you change the shift position from **[D]** to **[R]** and vice versa, come to a complete stop and keep the brake pedal depressed. Operating the shift lever before the vehicle has come to a complete standstill can damage the transmission.

Use the shift position indicator to check the lever position before pulling away.

If the transmission system indicator blinks when driving, in any shift position, there is a problem with the transmission. Avoid sudden acceleration and have the transmission checked by a dealer as soon as possible.

The fuel supply may be cut off if you drive at engine speeds in or over the tachometer red zone (engine speed limit). If this happens, you may experience a slight jolt.

It may not be possible to operate the shift lever if the brake pedal is applied while the shift lever release button is held down. Depress the brake pedal first.

When shifting positions in extremely low temperatures (-22°F/-30°C), there may be a short delay before the shift position is displayed. Always confirm you are in the correct shift position before driving.

## ■ 7-Speed Manual Shift Mode

Use the paddle shifters to change between 1st and 7th speeds without releasing your hands from the steering wheel. The transmission switches to the 7-speed manual shift mode when you pull a paddle shifter while driving. This mode is useful when engine braking is needed.

### ■ When the transmission is in **[D]**:

The shift mode goes into the 7-speed manual shift mode temporarily, and the number is displayed in the shift indicator.

The 7-speed manual shift mode is canceled automatically if you drive at constant speed or accelerate, and the number in the shift indicator goes off.

You can cancel this mode by pulling the **[+]** paddle shifter for a few seconds.

The 7-speed manual shift mode is especially useful when reducing the vehicle speed temporarily before making a turn.

### ■ When the transmission is in **[S]**:

The shift mode goes into the 7-speed manual shift mode. The **M** indicator and the speed number are displayed in the shift indicator. As the vehicle speed slows down, the transmission automatically shifts down accordingly. When the vehicle comes to a stop, it automatically shifts down into 1st.

If the vehicle speed increases and the engine speed reaches near the tachometer red zone, the transmission automatically shifts up.

You can only pull away in 1st speed.

When canceling the 7-speed manual shift mode, move the shift position from **[S]** to **[D]** or pull the **[+]** paddle shifter for a few seconds. When the 7-speed manual shift mode is canceled, the **M** indicator and shift indicator will turn off.

## ⌘ 7-Speed Manual Shift Mode

In the 7-speed manual shift mode, the transmission shifts up or down by operating either paddle shifter under the following conditions:

Shift Up; The engine speed reaches the lowest threshold of the higher speed position.

Shift Down; The engine speed reaches the highest threshold of the lower speed position.

When the engine speed reaches near the tachometer red zone, the transmission shifts up automatically.

When the engine speed reaches the lowest threshold of the selected speed position, the transmission shifts down automatically.

Operating the paddle shifters on slippery surfaces may cause the tires to lock up. In this case, the 7-speed manual shift mode is canceled and goes back to the normal **[D]** driving mode.



## 7-Speed Manual Shift Mode Operation

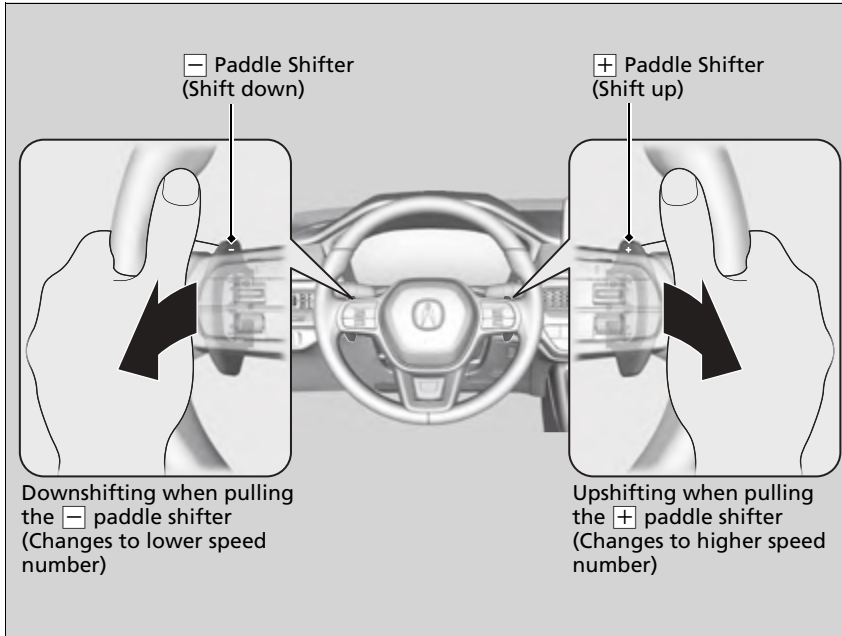

## 7-Speed Manual Shift Mode Operation

Each paddle shift operation makes a single speed change.

To change continuously, release the paddle shifter before pulling it again for the next speed.

The shift indicator blinks when you cannot shift up or down. It indicates that your vehicle speed is not in its allowable shifting range.

Slightly accelerate to shift up and decelerate to shift down while the indicator is blinking.

Manual transmission models

## Shifting

### Shift Lever Operation

Fully depress the clutch pedal to operate the shift lever and change gears, then slowly release the pedal.

Depress the clutch pedal, and pause for a few seconds before shifting into **[R]**, or shift into one of the forward gears for a moment. This stops the gears so they do not “grind.”

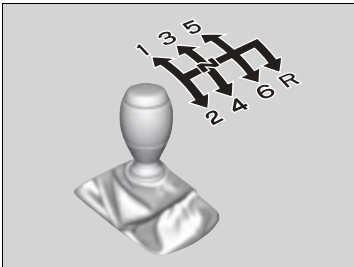

When you are not shifting, do not rest your foot on the clutch pedal. This can cause your clutch to wear out faster.

#### Shift Lever Operation

##### NOTICE

Do not shift to **[R]** before the vehicle comes to a complete stop. Shifting to **[R]** before stopping can damage the transmission.

##### NOTICE

Before downshifting, make sure the engine will not go into the tachometer red zone. Should this occur, it can severely damage your engine.

If you exceed the maximum speed for the gear you are in, the engine speed will enter into the tachometer red zone. When this happens, you may experience a slight jolt.

## ■ Rev Match System

Adjusts the engine's RPM to match the optimal speed of the gear that is about to be engaged.

🔧 **Acura Integrated Dynamics System** P. 449

### ■ Limitations

The rev match system will not activate under the following conditions:

- You are shifting into a lower gear, but the system has determined that the engine will over rev.
- You are shifting into 1st gear from a higher gear.
- Engine RPM is low and you are shifting into a lower gear in sequential order.
- The system has determined that the engine will be at idling speed after you have shifted into a higher gear.
- The clutch pedal is not fully depressed.

The rev match system may deactivate if the clutch pedal is fully depressed for a extended period of time.

### 🔧 Rev Match System

You can turn off the rev match system using the audio/information screen.

🔧 **Customized Features** P. 359

If you depress the accelerator pedal while changing gears, the system may give priority to inputs from the accelerator pedal depending on the amount of depression of the accelerator pedal.

If the message below appears, there may be a problem with the system. The rev match system may not operate, but you can perform regular gear shifting. Have the system checked by a dealer.

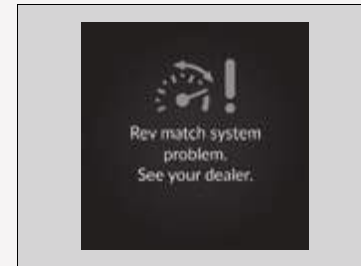

## ■ Reverse Lockout

The manual transmission has a lockout mechanism that stops you from accidentally shifting into **R** from a forward gear while the vehicle is moving above a certain speed.

If you cannot shift to **R** when the vehicle is stopped, do the following:

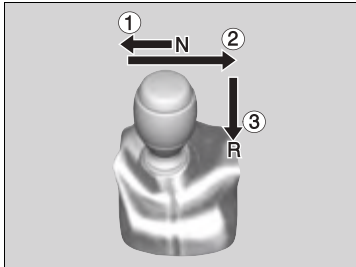

1. Depress the clutch pedal, move the shift lever all the way to the left, and shift to **R**.
2. If you still cannot shift into **R**, apply the parking brake, and set the power mode to ACCESSORY or VEHICLE OFF.
3. Depress the clutch pedal and shift into **R**.
4. Keep depressing the clutch pedal and start the engine.

## ⌘ Reverse Lockout

Have your vehicle checked by a dealer if you have to go through this procedure repeatedly.

Models with 7-in. Color Touchscreen

## Acura Integrated Dynamics System

Modifies the dynamic character of the vehicle. There are three modes to select from:

**COMFORT**, **NORMAL**, and **SPORT**.

Turn the **Dynamic Mode** switch to select **COMFORT**, **NORMAL** or **SPORT**. The mode you have selected appears on the driver information interface.

### Selecting the Dynamic Mode

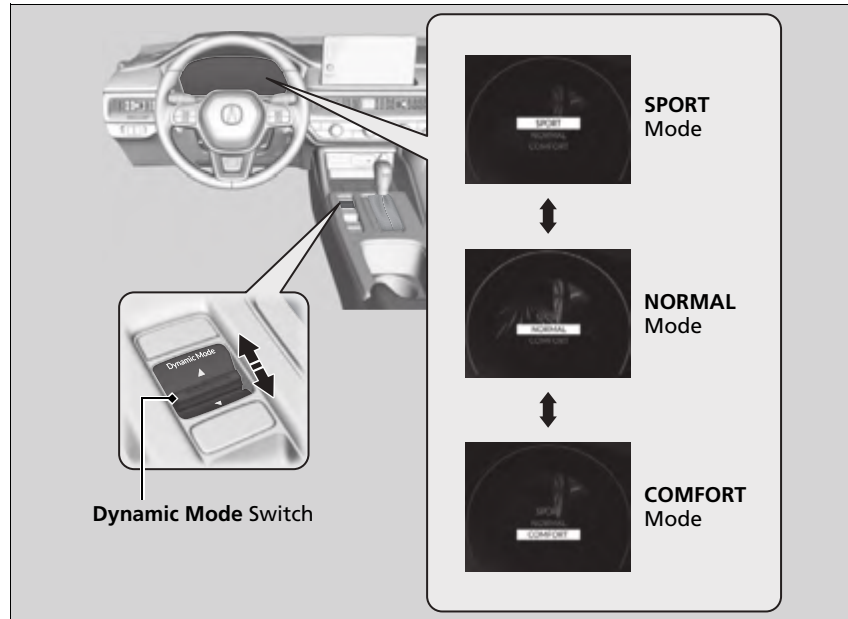

### ⊗ Acura Integrated Dynamics System

The mode may not be able to be changed when:

- The vehicle is turning
- The VSA® system is activating
- There is a problem with the engine, transmission, the brake system, the VSA®, or the EPS

■ **Mode descriptions**

Each mode has been crafted for different driving styles according to the following chart.

Mode	Function	Gauge Color
<b>COMFORT</b>	Maximizes driver comfort through decreased steering effort	Blue
<b>NORMAL</b>	Balanced response for everyday use	White
<b>SPORT</b>	Enhances vehicle response through increased steering effort, heightened throttle response, and modified active sound control When in <b>SPORT</b> , the Auto Idle Stop System will stay disabled regardless of the Auto Idle Stop <b>OFF</b> button  <b>Auto Idle Stop</b> P. 455	Red

■ **Next start-up mode**

The mode for the next start-up is saved according to the following chart. Each keyless remote has its own mode saved.

Last Dynamic Mode	Next Dynamic Mode
<b>COMFORT</b>	<b>COMFORT</b>
<b>NORMAL</b> or <b>SPORT</b>	<b>NORMAL</b>

Models with 9-in. Color Touchscreen

## Acura Integrated Dynamics System

Modifies the dynamic character of the vehicle. There are four modes to select from:

**COMFORT**, **NORMAL**, **SPORT**, and **INDIVIDUAL**.

Using the **Dynamic Mode** switch to select **COMFORT**, **NORMAL** or **SPORT**. Press the **INDIVIDUAL** button to select **INDIVIDUAL**. The mode you have selected appears on the audio/information screen.

### ⌘ Acura Integrated Dynamics System

The mode may not be able to be changed when:

- The vehicle is turning
- The VSA® system is activating
- There is a problem with the engine, transmission, the brake system, the VSA®, the EPS, or the Active Damper System

*Continued*

## ■ Selecting the Dynamic Mode

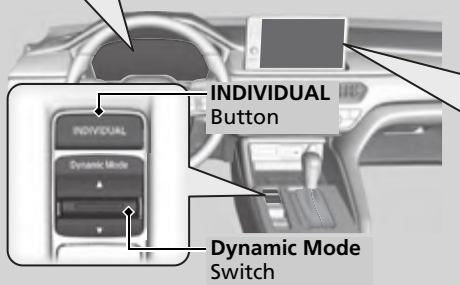
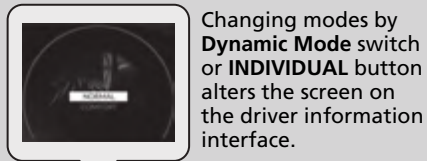

- ➔ Press the **BACK** or **HOME** button on the audio/information screen.
- ➔ **Audio System Basic Operation** P. 259
- ➔ Press the **INDIVIDUAL** button
- ➔ Press and hold the **INDIVIDUAL** button or select **Customize**
- ➔ **Customized Features** P. 359
- ➔ Press the **Dynamic Mode** switch up or down

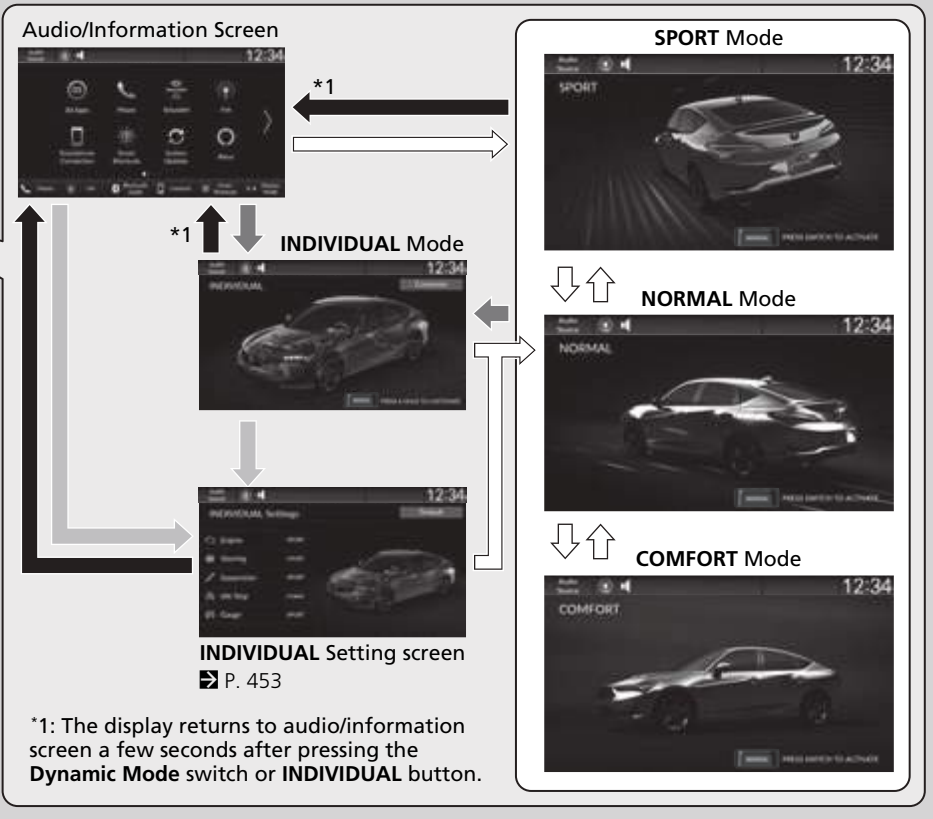



■ **Mode descriptions**

Each mode has been crafted for different driving styles according to the following chart.

Mode	Function	Gauge Color
<b>COMFORT</b>	Maximizes driver comfort through decreased steering effort and reduced ride firmness	Blue
<b>NORMAL</b>	Balanced response for everyday use	White
<b>SPORT</b>	Enhances vehicle response through increased steering effort, heightened throttle response, modified active sound control, and are more responsive ride and handling When in <b>SPORT</b> , the Auto Idle Stop System will stay disabled regardless of the Auto Idle Stop <b>OFF</b> button ➤ <b>Auto Idle Stop</b> P. 455, 461	Red
<b>INDIVIDUAL</b>	Each category can be customized separately to suit the driver's preference ➤ <b>Customizing the INDIVIDUAL Settings</b> P. 453	Blue, white, or red ➤ <b>Customizing the INDIVIDUAL Settings</b> P. 453

■ **Next start-up mode**

The mode for the next start-up is saved according to the following chart. Each keyless remote has its own mode saved.

Last Dynamic Mode	Next Dynamic Mode
<b>COMFORT</b>	<b>COMFORT</b>
<b>NORMAL</b> , or <b>SPORT</b>	<b>NORMAL</b>
<b>INDIVIDUAL</b> (via <b>COMFORT</b> )	<b>COMFORT</b>
<b>INDIVIDUAL</b> (via <b>NORMAL</b> , or <b>SPORT</b> )	<b>NORMAL</b>

## Customizing the INDIVIDUAL Settings

You can customize the **INDIVIDUAL** settings linked to your current keyless remote. Each keyless remote has its own settings.

1. Press and hold the **INDIVIDUAL** button or select **Customize** to enter **INDIVIDUAL** mode and open the **INDIVIDUAL** settings.

▶ You can also select from Customized Features on the 9-in. Color Touchscreen.

➤ **Selecting the Dynamic Mode** P. 450

➤ **Customized Features** P. 359

2. Select the setting category.

3. Select the desired setting.



Category	Description
<b>Engine</b>	Select <b>COMFORT</b> , <b>NORMAL</b> , or <b>SPORT</b> for the engine throttle response and transmission shift response
<b>Steering</b>	Select <b>COMFORT</b> , <b>NORMAL</b> , or <b>SPORT</b> for the steering effort
<b>Suspension</b>	Select <b>COMFORT</b> , <b>NORMAL</b> , or <b>SPORT</b> for the firmness of the suspension
<b>Idle Stop</b>	Set the Auto Idle Stop system to <b>Enable</b> or <b>Disable</b> . While <b>Idle Stop</b> is <b>Disable</b> in <b>INDIVIDUAL</b> mode, the Auto Idle Stop System will stay disabled regardless of the Auto Idle Stop <b>OFF</b> button  <b>Auto Idle Stop</b> P. 455, 461
<b>Gauge</b>	Set the gauge color. <b>COMFORT</b> for blue, <b>NORMAL</b> for white, and <b>SPORT</b> for red
<b>Default</b>	<b>Engine</b> , <b>Steering</b> , <b>Suspension</b> and <b>Gauge</b> is set to <b>Normal</b> , and <b>Idle Stop</b> is set to <b>Enable</b>

Continuously variable transmission models

## Auto Idle Stop

To help maximize fuel economy, the engine automatically stops when the vehicle comes to a stop, depending on environmental and vehicle operating conditions. The indicator (green) comes on at this time.

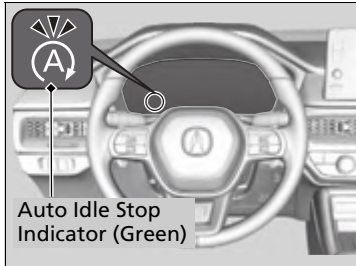

The environmental and vehicle conditions that impact Auto Idle Stop system operation are varied.

➤ **Auto Idle Stop Activates When:** P. 457

➤ **Auto Idle Stop may not activate when:**  
P. 458

The engine then restarts once the vehicle is about to move again, and the indicator (green) goes off.

➤ **The Engine Automatically Restarts When:**  
P. 459

The Auto Idle Stop suspend indicator comes on and a message appears on the gauge when the Auto Idle Stop system cannot be activated.

➤ **Indicators** P. 84

➤ **Auto Idle Stop System ON/OFF** P. 456

If the driver's door is opened while the indicator (green) comes on, a buzzer sounds to notify you that the Auto Idle Stop function is in operation.

A message associated with Auto Idle Stop appears on the driver information interface.

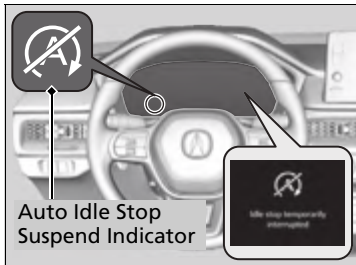

### Auto Idle Stop

The 12-volt battery installed in this vehicle is specifically designed for a model with Auto Idle Stop. Using a 12-volt battery other than this specified type may shorten the 12-volt battery life, and prevent Auto Idle Stop from activating. If you need to replace the 12-volt battery, make sure to select the specified type. Ask a dealer for more details.

## ■ Auto Idle Stop System ON/OFF

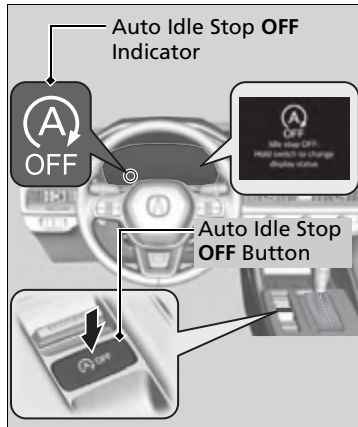

To turn the Auto Idle Stop system off, press this button. The Auto Idle Stop system stops.

- ▶ Auto Idle Stop system will stop, the indicator will come on and a message appears on the gauge.

The Auto Idle Stop system is turned on every time you start the engine, even if you turned it off the last time you drove the vehicle.

## ▶▶ Auto Idle Stop System ON/OFF

If you turn off the Auto Idle Stop system while it is activated, the engine will restart.

▶ **Auto Idle Stop Activates When:** P. 457

If you hold the Auto Idle Stop **OFF** button, you can disable idle stop messages.

▶ **Indicators** P. 84

## ■ Auto Idle Stop Activates When:

The vehicle stops with the transmission in **D** and the brake pedal depressed. When you put the transmission into **P** quickly with depressing the brake pedal, the Auto Idle Stop continues to operate, even if the brake pedal is released.

▶ If you depress the brake pedal, the engine may automatically restart.

## ■ Auto Idle Stop does not activate when:

- The Auto Idle Stop **OFF** button is pressed.
- The driver's seat belt is not fastened.
- The engine is not adequately warmed up or coolant temperature is high.
- The transmission fluid temperature is low or high.
- The vehicle comes to a stop again before the vehicle speed reaches 3 mph (5 km/h) after the engine starts.
- The vehicle is stopped on a steep incline.
- The transmission is in a position other than **D**.
- The engine is started with the hood open.
  - ▶ Turn off the engine. Close the hood before you restart the engine to activate Auto Idle Stop.
- The battery charge is low.
- The internal temperature of the battery is 41°F (5°C) or less.
- The climate control system is in use, and the outside temperature is below -4°F (-20°C) or over 104°F (40°C).
- The climate control system is in use, and the temperature is set to **Hi** or **Lo**.
-  is ON (indicator on).
- The Integrated Dynamics System mode is changed to **SPORT** mode.

### Models with **INDIVIDUAL** mode

- The Auto Idle Stop is set to off on **INDIVIDUAL** Setting screen.
  - ▶ **Customizing the INDIVIDUAL Settings** P. 453

## ⊠ Auto Idle Stop Activates When:

Do not open the hood while the Auto Idle Stop function is activated. If the hood is opened, the engine will not restart automatically. In this case, restart the engine with the **ENGINE START/STOP** button.

▶ **Starting the Engine** P. 430

When Adaptive Cruise Control (ACC) with Low Speed Follow is in operation, the vehicle stops without depressing the brake pedal and Auto Idle Stop may activate. In such cases, the engine may restart if you change the shift position other than **D**.

Pressing the **ENGINE START/STOP** button causes the engine to no longer restarts automatically. Follow the standard procedure to start the engine.

▶ **Starting the Engine** P. 430

■ **Auto Idle Stop may not activate when:**

- The vehicle is stopped by braking suddenly.
- The steering wheel is operated.
- The vehicle is repeatedly accelerated and decelerated at a low speed.
- The fan speed is high.
- The climate control system is in use, and there is a significant difference between the set temperature and the actual interior temperature.
- The climate control system is in use, and humidity in the interior is high.
- Altitude is high.



### ■ The Engine Automatically Restarts When:

- The brake pedal is released (without the automatic brake hold system activated).
- The accelerator pedal is depressed (with the automatic brake hold system activated).
  - **Automatic Brake Hold** P. 589

### ☒ The Engine Automatically Restarts When:

If you are using an electronic device during Auto Idle Stop, the device may temporarily be turned off when the engine restarts.

*Continued*

### ■ The engine restarts even if the brake pedal is depressed\*1 when:

- The Auto Idle Stop **OFF** button is pressed.
- The steering wheel is operated.
- The transmission is put into **R** or **S**, or when it is set from **N** to **D**.
  - ▶ If you put the transmission into **P** after the Auto Idle Stop activates, the Auto Idle Stop continues to operate. In this case, the engine restarts when you depress the brake pedal.
- The pressure on the brake pedal is reduced and the vehicle starts moving while stopped on an incline.
- The pressure on the brake pedal is repeatedly applied and released slightly during a stop.
- The battery charge becomes low.
- The accelerator pedal is depressed.
- The driver's seat belt is unlatched.
-  is ON (indicator on).
- The climate control system is in use, and the difference between the set temperature and actual interior temperature becomes significant.
- The climate control system is being used to dehumidify the interior.
- The vehicle ahead of you starts again when your vehicle stops automatically with Adaptive Cruise Control (ACC) with Low Speed Follow.
- The Integrated Dynamics System mode is changed to **SPORT** mode.

#### Models with **INDIVIDUAL** mode

- The Auto Idle Stop is set to off on **INDIVIDUAL** Setting screen.
  - ▶ **Customizing the INDIVIDUAL Settings** P. 453

### ■ Starting Assist Brake Function

Briefly keeps the brake applied after releasing the brake pedal to restart the engine. This can keep your vehicle from unexpectedly moving while on an incline.

#### ▶▶ The engine restarts even if the brake pedal is depressed\*1 when:

\*1: With the automatic brake hold system activated, you can release the brake pedal while Auto Idle Stop is in operation.

If the automatic brake hold system has been turned off, or if there is a problem with the system, the engine will restart automatically when you release the brake pedal.

▶ **Automatic Brake Hold** P. 589

## Manual transmission models

## Auto Idle Stop

To help maximize fuel economy, the engine automatically stops when the vehicle comes to a stop, depending on environmental and vehicle operating conditions. The indicator (green) comes on at this time.

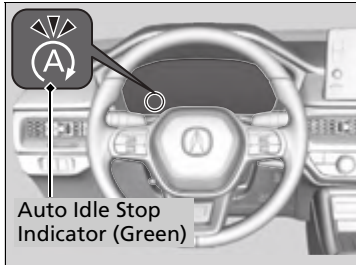

The environmental and vehicle conditions that impact Auto Idle Stop system operation are varied.

➤ **Auto Idle Stop Activates When:** P. 463

➤ **Auto Idle Stop may not activate when:**  
P. 464

The engine then restarts once the vehicle is about to move again when you depress the clutch pedal, and the indicator (green) goes off.

➤ **The Engine Automatically Restarts When:**  
P. 465

The Auto Idle Stop suspend indicator comes on and a message appears on the gauge when the Auto Idle Stop system cannot be activated.

➤ **Indicators** P. 84

➤ **Auto Idle Stop System ON/OFF** P. 462

If the driver's door is opened while the indicator (green) comes on, a buzzer sounds to notify you that the Auto Idle Stop function is in operation.

A message associated with Auto Idle Stop appears on the driver information interface.

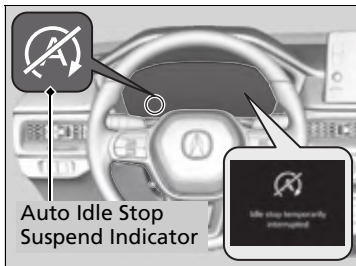

### Auto Idle Stop

The 12-volt battery installed in this vehicle is specifically designed for a model with Auto Idle Stop. Using a 12-volt battery other than this specified type may shorten the 12-volt battery life, and prevent Auto Idle Stop from activating. If you need to replace the 12-volt battery, make sure to select the specified type. Ask a dealer for more details.

## ■ Auto Idle Stop System ON/OFF

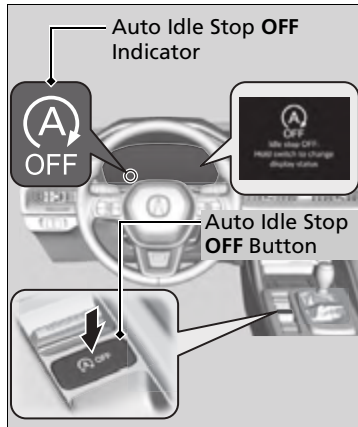

To turn the Auto Idle Stop system off, press this button. The Auto Idle Stop system stops.

- ▶ Auto Idle Stop system will stop, the indicator will come on and a message appears on the gauge.

The Auto Idle Stop system is turned on every time you start the engine, even if you turned it off the last time you drove the vehicle.

## ▶▶ Auto Idle Stop System ON/OFF

If you turn off the Auto Idle Stop system while it is activated, the engine will restart.

▶ **Auto Idle Stop Activates When:** P. 457

If you hold the Auto Idle Stop **OFF** button, you can disable idle stop messages.

▶ **Indicators** P. 84

## ■ Auto Idle Stop Activates When:

After the vehicle moves forward, stopping with the brake, the clutch pedal fully depressed, the shift lever in **[N]**, and then the clutch pedal is released.

### ■ Auto Idle Stop does not activate when:

- The Auto Idle Stop **OFF** button is pressed.
- The driver's seat belt is not fastened.
- The engine is not adequately warmed up or coolant temperature is high.
- The vehicle comes to a stop again before the vehicle speed reaches 2 mph (3 km/h) after the engine starts.
- The engine is started with the hood open.
  - ▶ Turn off the engine. Close the hood before you restart the engine to activate Auto Idle Stop.
- The battery charge is low.
- The internal temperature of the battery is 41°F (5°C) or less.
- The shift lever is in any position except **[N]**.
- The climate control system is in use, and the outside temperature is below -4°F (-20°C) or over 104°F (40°C).
- The climate control system is in use, and the temperature is set to **Hi** or **Lo**.
-  is ON (indicator on).
- The Integrated Dynamics System mode is changed to **SPORT** mode.
- The Auto Idle Stop is set to off on **INDIVIDUAL** Setting screen.
  - ▶ **Customizing the INDIVIDUAL Settings** P. 453

## ⊠ Auto Idle Stop Activates When:

Do not open the hood while the Auto Idle Stop function is activated. If the hood is opened, the engine will not restart automatically. In this case, restart the engine with the **ENGINE START/STOP** button.

▶ **Starting the Engine** P. 430

Pressing the **ENGINE START/STOP** button causes the engine to no longer restarts automatically. Follow the standard procedure to start the engine.

▶ **Starting the Engine** P. 430

■ **Auto Idle Stop may not activate when:**

- The steering wheel is operated.
- The fan speed is high.
- The climate control system is in use, and there is a significant difference between the set temperature and the actual interior temperature.
- The climate control system is in use, and humidity in the interior is high.
- Altitude is high.

## ■ The Engine Automatically Restarts When:

The clutch pedal is depressed.

### ■ The engine automatically restarts even if the clutch pedal is not depressed with the transmission in **[N]** when:

- The Auto Idle Stop **OFF** button is pressed.
- The pressure on the brake pedal is reduced and the vehicle starts moving while stopped on an incline.
- The steering wheel is operated.
- The pressure on the brake pedal is repeatedly applied and released slightly during a stop.
- The battery charge becomes low.
-  is ON (indicator on).
- The climate control system is in use, and the difference between the set temperature and actual interior temperature becomes significant.
- The climate control system is being used to dehumidify the interior.
- The Integrated Dynamics System mode is changed to **SPORT** mode.
- The Auto Idle Stop is set to off on **INDIVIDUAL** Setting screen.
  - **Customizing the INDIVIDUAL Settings** P. 453

### ⌘ The Engine Automatically Restarts When:

If you are using an electronic device during Auto Idle Stop, the device may temporarily be turned off when the engine restarts.

The engine does not restart automatically when there is a problem in the system. Follow the normal procedure to start the engine.

➤ **Starting the Engine** P. 430

The engine does not restart automatically when:

- The driver's seat belt is unlatched.
- The transmission is put into a position other than **[N]**. Put the transmission into **[N]** to restart the engine.

#### NOTICE

Auto Idle Stop system also comes with stall recovery. If you fully depress the clutch pedal after stalling the engine, the engine automatically restarts.

➤ **Starting to Drive** P. 435

When the system stops operating, follow the normal procedure to start the engine.

➤ **Starting the Engine** P. 430

## Vehicle Stability Assist™ (VSA®), aka Electronic Stability Control (ESC), System

VSA® helps stabilize the vehicle during cornering if the vehicle turns more or less than what was intended. It also assists in maintaining traction on slippery surfaces. It does so by regulating engine output and selectively applying the brakes.

### ■ VSA® Operation

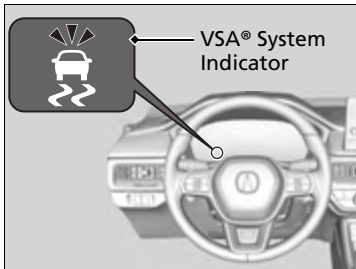

When VSA® activates, you may notice that the engine does not respond to the accelerator. You may also notice some noise from the hydraulic brake system. You will also see the indicator blink.

### ▣ Vehicle Stability Assist™ (VSA®), aka Electronic Stability Control (ESC), System

The VSA® may not function properly if tire type and size are mixed. Make sure to use the same size and type of tire, and the air pressures as specified.

When the VSA® system indicator comes on and stays on while driving, there may be a problem with the system. While this may not interfere with normal driving, have your vehicle checked by a dealer immediately.

The Vehicle Stability Assist™ (VSA®) system, Adaptive Cruise Control (ACC)\*, Adaptive Cruise Control (ACC) with Low Speed Follow\* and safety support indicators may come on in amber along with a message in the gauge when you set the power mode to ON after reconnecting the battery.

Drive a short distance at more than 12 mph (20 km/h). Each indicator should go off. If any do not, have your vehicle checked by a dealer.

VSA® cannot enhance stability in all driving situations and does not control the entire braking system. You still need to drive and corner at speeds appropriate for the conditions and always leave a sufficient margin of safety.

The main function of the VSA® system is generally known as Electronic Stability Control (ESC). The system also includes a traction control function.



## ■ VSA® On and Off

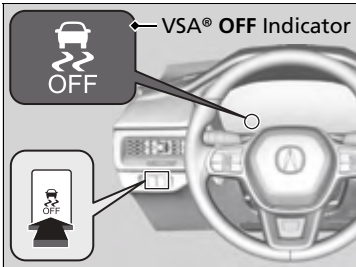

This button is on the driver side control panel. To partially disable VSA® functionality/features, press and hold it until you hear a beep.

Your vehicle will have normal braking and cornering ability, but traction control function will be less effective.

To restore VSA® functionality/features, press the  (VSA® **OFF**) button until you hear a beep.

VSA® is turned on every time you start the engine, even if you turned it off the last time you drove the vehicle.

## ▣ Vehicle Stability Assist™ (VSA®), aka Electronic Stability Control (ESC), System

In certain unusual conditions when your vehicle gets stuck in shallow mud or fresh snow, it may be easier to free it with the VSA® temporarily switched off.

When the  button is pressed, the traction control function becomes less effective. This allows for the wheels to spin more freely at low speed. You should only attempt to free your vehicle with the VSA® off if you are not able to free it when the VSA® is on.

Immediately after freeing your vehicle, be sure to switch VSA® on again. We do not recommend driving your vehicle with the VSA® system switched off.

You may hear a motor sound coming from the engine compartment while system checks are being performed immediately after starting the engine or while driving. This is normal.

## Agile Handling Assist

---

Lightly brakes the front wheels, as needed, when you turn the steering wheel, and helps support the vehicle's stability and performance during cornering.

### ⓘ Agile Handling Assist

The agile handling assist cannot enhance stability in all driving situations. You still need to drive and corner at speeds appropriate for the conditions and always leave a sufficient margin of safety.

When the VSA® system indicator comes on and stays on while driving, the agile handling assist does not activate.

You may hear a sound coming from the engine compartment while the agile handling assist is activated. This is normal.

Manual transmission models

## Limited Slip Differential (LSD)

### Limited Slip Differential (LSD)

LSD (limited slip differential) is a type of differential that delivers extra torque to the wheel or the wheels with the most traction to minimize wheel slip and maintain control of the vehicle.

#### ⌘ Limited Slip Differential (LSD)

##### NOTICE

Make sure both front tires of your vehicle are of the same brand and specified size, and have equal wear. Otherwise, the LSD may not function properly.

## Tire Pressure Monitoring System (TPMS) with Tire Fill Assist

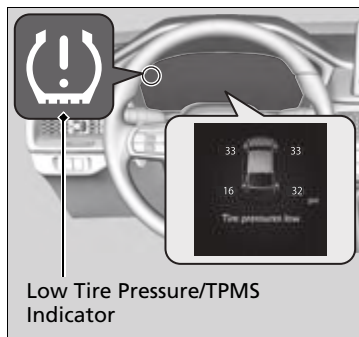

Monitors the tire pressure while you are driving. If your vehicle's tire pressure becomes significantly low, the low tire pressure/TPMS indicator comes on and a message appears on the driver information interface.

### ▶ Tire Pressure Monitoring System (TPMS) with Tire Fill Assist

Conditions such as low ambient temperature and altitude change directly affect tire pressure and can trigger the low tire pressure/TPMS indicator to come on.

#### ▶ If the Low Tire Pressure/TPMS Indicator Comes On or Blinks P. 704

Tire pressure checked and inflated in:

- Warm weather can become under-inflated in colder weather.
- Cold weather can become overinflated in warmer weather.

The low tire pressure/TPMS indicator will not come on as a result of overinflation.

Only use genuine TPMS specified wheels since your vehicle's wheels are equipped with the low tire pressure/TPMS sensor.

If you drive your vehicle without the genuine TPMS specified wheels, the low tire pressure/TPMS indicator blinks for one minutes and then stays on.

#### ▶ Tire and Wheel Replacement P. 647

The TPMS audibly and visually informs you of changes in tire pressure of the individual tire that you are adjusting using audible and visual indications.

If a change in tire pressure has been significant, the system beeps and the hazard lights flash continuously for five seconds when the specified tire pressure is reached. Stop filling the tire.

## ■ Tire Pressure Monitor



To select the tire pressure monitor, set the power mode to ON, and roll the right selector wheel until you see the tire pressure screen.

The pressure for each tire is displayed in psi.

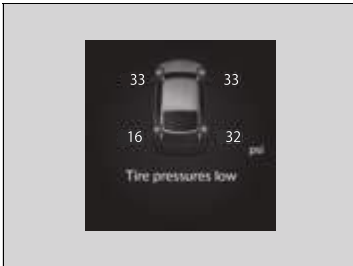

**Tire pressures low** is displayed when a tire has significantly low pressure. The specific tire is displayed on the screen.

## ☒ Tire Pressure Monitor

The pressure displayed on the driver information interface can be slightly different from the actual pressure as measured by a gauge. If there is a significant difference between the two values, or if the low tire pressure/TPMS indicator and the message on the driver information interface do not go off after you have inflated the tire to the specified pressure, have the system checked by a dealer.

**Tire pressure monitor system problem. Check tire pressure. See your dealer.** may appear if you drive with the compact spare tire\*, or there is a problem with the TPMS.

\* Not available on all models

## Tire Pressure Monitoring System (TPMS) - Required Federal Explanation

---

Each tire, including the spare (if provided), should be checked monthly when cold and inflated to the inflation pressure recommended by the vehicle manufacturer on the vehicle placard or tire inflation pressure label.

(If your vehicle has tires of a different size than the size indicated on the vehicle placard or tire inflation pressure label, you should determine the proper tire inflation pressure for those tires.)

As an added safety feature, your vehicle has been equipped with a tire pressure monitoring system (TPMS) that illuminates a low tire pressure telltale



when one or more of your tires is significantly under-inflated.

Accordingly, when the low tire pressure telltale illuminates, you should stop and check your tires as soon as possible, and inflate them to the proper pressure.

Driving on a significantly under-inflated tire causes the tire to overheat and can lead to tire failure. Under-inflation also reduces fuel efficiency and tire tread life, and may affect the vehicle's handling and stopping ability.

Please note that the TPMS is not a substitute for proper tire maintenance, and it is the driver's responsibility to maintain correct tire pressure, even if under-inflation has not reached the level to trigger illumination of the TPMS low tire pressure telltale.

Your vehicle has also been equipped with a TPMS malfunction indicator to indicate when the system is not operating properly. The TPMS malfunction indicator is combined with the low tire pressure telltale. When the system detects a malfunction, the telltale will flash for approximately one minute and then remain continuously illuminated. This sequence will continue upon subsequent vehicle start-ups as long as the malfunction exists.

When the malfunction indicator is illuminated, the system may not be able to detect or signal low tire pressure as intended.

TPMS malfunctions may occur for a variety of reasons, including the installation of replacement or alternate tires or wheels on the vehicle that prevent the TPMS from functioning properly.

Always check the TPMS malfunction telltale after replacing one or more tires or wheels on your vehicle to ensure that the replacement or alternate tires and wheels allow the TPMS to continue to function properly.

## Blind Spot Information System

When the system detects vehicles approaching from behind in adjacent lanes, the appropriate indicator comes on, providing assistance when you change lanes.

### ■ How the System works

The system activates when your vehicle is moving forward at about 20 mph (32 km/h) or above.

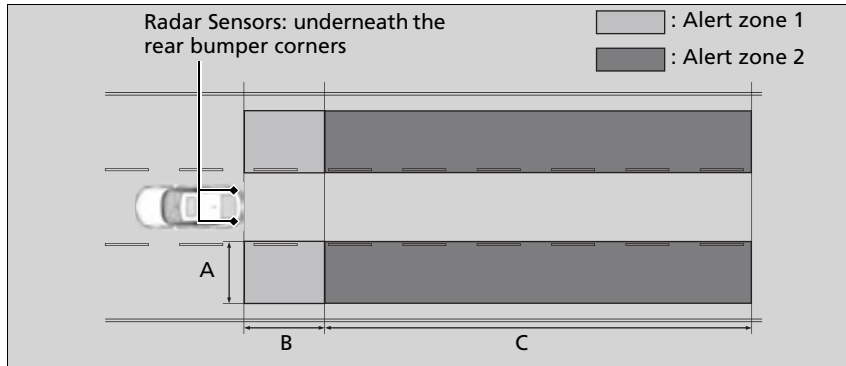

Alert zone range

A: Approx. 1.6 ~ 10 feet (0.5 ~ 3 meters) from vehicle side.

B: Approx. 10 feet (3 meters) from rear bumper.

C: Approx. 10 ~ 82 feet (3 ~ 25 meters) behind from rear bumper. (The faster the approaching vehicle, the further away it will be detected.)

The initially set alert zone is alert zone 1. Over time, after the vehicle has been driven on straight roads with traffic and roadside objects, the system will adapt and expand the alert zone (alert zone 1 and 2).

### ▶▶ Blind Spot Information System

#### Important Safety Reminder

Like all assistance systems, the blind spot information system has limitations. Always look in your mirrors, to either side of your vehicle, and behind you for other vehicles before changing lanes. Overreliance on the blind spot information system may result in a collision.

Have your vehicle checked by a dealer in the following situations:

- The rear bumper or area around the radar sensors is strongly impacted.
- The indicator does not come on even if a vehicle in the alert zone should have been detected.
- The rear bumper or any system components need to be repaired.

If the rear bumper or any system components are repaired, the system will revert to alert zone 1 only until it is able to adapt and expand to alert zone 1 and 2.



■ When the system detects a vehicle

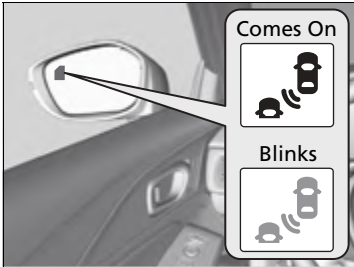

Blind spot information system alert indicator: Located on the outside rearview mirror on both sides.

**Comes on when:**

- A vehicle approaches you from behind to overtake you at a speed difference of no more than about 31 mph (50 km/h).
- You pass a vehicle at a speed difference of no more than about 12 mph (20 km/h).

**Blinks and a beeper sounds when:**

You use the turn signal lever to signal a turn in the direction of the detected vehicle while the blind spot information system alert indicator is on.

- ▶ The beeper sounds three times.

▶▶ Blind Spot Information System

For proper blind spot information system operation:

- Always keep the rear bumper and area around the radar sensors clean.
- Do not cover the rear bumper corner area with labels or stickers of any kind.

The system is for your convenience only. Even if an object is within the alert zone, the following situations may occur:

- The blind spot information system alert indicator does not come on and the message **Blind spot information system not available** appears on the driver information interface.
- The blind spot information system alert indicator may come on even with the message displayed.

## ■ Blind Spot Information System On and Off

You can turn the system on and off using the driver information interface.

➤ **Switching the Display** P. 112

➤ **Safety Support** P. 121

The blind spot information system will stay on the previously selected on (checked) or off (unchecked) setting each time you start the engine.

## ▶▶ Blind Spot Information System

You can change the settings for the blind spot information system.

Models with 7-in. Color Touchscreen

➤ **Vehicle Settings\*** P. 126

Models with 9-in. Color Touchscreen

➤ **Customized Features** P. 359

## Blind Spot Information System Conditions and Limitations

The blind spot information system alert indicator may not come on under the following conditions:

- There is a large speed difference between your vehicle and the vehicle in the adjacent lane.
- A vehicle is parked in a side lane.
- An object not detected by the radar sensors approaches or passes your vehicle.
- The vehicle driving in the adjacent lane is a motorcycle or other small vehicle.

The Blind Spot Information System may not operate correctly under the following conditions:

- Making a turn at an intersection.
- Objects (guard rails, poles, trees, etc.) are detected.
- An object that does not reflect radio waves well or a motorcycle, is in the alert zone.
- Driving on a curved road.
- A vehicle is moving from a far lane to the adjacent lane.
- The system picks up signal interference such as other radar sensors from another vehicle or strong radio wave transmitted from a facility nearby.
- The rear bumper or the area around the radar sensors is covered by dirt, mud, snow, ice, etc.
- The rear bumper or the area around the radar sensors has been damaged or deformed.
- In bad weather (heavy rain, snow, and fog).
- Making a short turn or driving on a bumpy road that slightly tilts the vehicle.
- An object such as a bicycle rack is attached to the rear of the vehicle.

## Models with Low Speed Braking Control

AcuraWatch™ is a driver support system which employs the use of two distinctly different kinds of sensors: the sonar sensors located in the front and rear bumpers, and the front grille, and a front wide view camera mounted to the interior side of the windshield, behind the rearview mirror.

## Models without Low Speed Braking Control

AcuraWatch™ is a driver support system which employs the use of a front wide view camera mounted to the interior side of the windshield, behind the rearview mirror.

AcuraWatch™ has the following functions.

### ■ The functions which do not require switch operations to activate

- Collision Mitigation Braking System™ (CMBS™) 📄 P. 481
- Low Speed Braking Control\* 📄 P. 493
- Low Speed Braking Control\* 📄 P. 499
- Road Departure Mitigation System 📄 P. 566
- Traffic Sign Recognition System 📄 P. 574

### ■ The functions which require switch operations to activate

- Adaptive Cruise Control (ACC) with Low Speed Follow\* 📄 P. 504
- Adaptive Cruise Control (ACC)\* 📄 P. 525
- Lane Keeping Assist System (LKAS) 📄 P. 545
- Traffic Jam Assist\* 📄 P. 557

**■ Operation Switches for the Adaptive Cruise Control (ACC) with Low Speed Follow\*/Adaptive Cruise Control (ACC)\*/Lane Keeping Assist System (LKAS)/Traffic Jam Assist\***

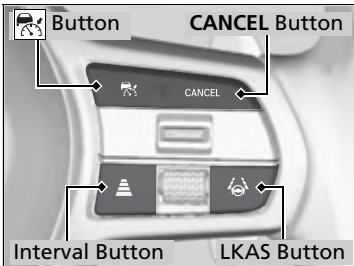

**■ Button**  
 Press to activate standby mode for ACC with Low Speed Follow\*/ACC\*.  
 Or press to cancel the system.

**■ LKAS Button**  
 Press to activate standby mode for LKAS and Traffic Jam Assist\*.  
 Or press to cancel these systems.

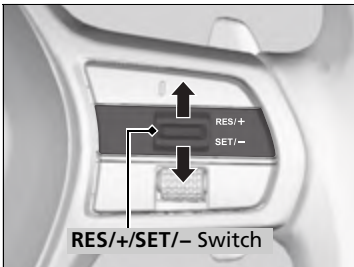

**■ CANCEL Button**  
 Press to cancel ACC with Low Speed Follow\*/ACC\*.

**■ Interval Button**  
 Press to change the ACC with Low Speed Follow\*/ACC\* following-interval.

**■ RES/+ / SET/- Switch**  
 Press the **RES/+ / SET/-** switch up to resume the ACC with Low Speed Follow\*/ACC\* or increase the vehicle speed. Press the **RES/+ / SET/-** switch down to set the ACC with Low Speed Follow\*/ACC\* or decrease the vehicle speed.

\* Not available on all models

Continued

## ■ Gauge Content

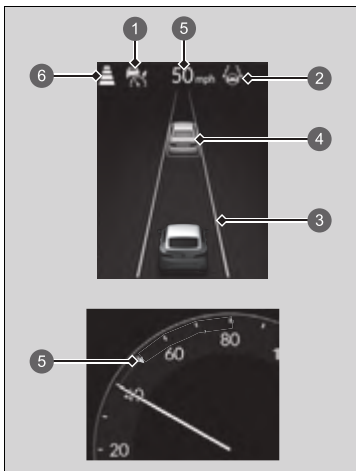

You can see the current state of Adaptive Cruise Control (ACC) with Low Speed Follow\*/Adaptive Cruise Control (ACC)\*, Lane Keeping Assist System (LKAS) and Traffic Jam Assist\*.

- ① Indicates that ACC with Low Speed Follow\*/ACC\* is ready to be activated.
  - Green: The system is on.
  - White: The system is standby.
  - Amber: There is a problem with the system.
- ② Indicates that LKAS or Traffic Jam Assist\* is ready to be activated.
  - Green: The system is on.
  - White: The system is standby.
  - Amber: There is a problem with the system.
- ③ Indicates that LKAS or Traffic Jam Assist\* is activated and whether or not traffic lane lines are detected.
  - Green lines: The system is on.
  - White lines: Traffic lane lines are detected.
  - Amber line: Lane departure is detected.
- ④ Indicates whether or not a vehicle is detected ahead.
  - Control target vehicle: White and outlined in green
  - Outside of control target vehicle: Gray
- ⑤ Indicates that ACC with Low Speed Follow\*/ACC\* shows the set vehicle speed.
- ⑥ Indicates that ACC with Low Speed Follow\*/ACC\* shows the set vehicle interval.

## ▶▶ Gauge Content

### Models with Head-up display

You can have the head-up display show you the current state of each function.

▶▶ **Head-Up Display**\* P. 135

## Collision Mitigation Braking System™ (CMBS™)

The system can assist you when it determines there is a possibility of your vehicle colliding with a vehicle (including motorcycles) ahead from behind, an oncoming vehicle in front, a pedestrian, or someone riding a bicycle (moving bicycle). The CMBS™ is designed to alert you when the potential for a collision is determined, as well as assist in reducing speed, avoiding collisions, and reducing collision severity.

### Collision Mitigation Braking System™ (CMBS™)

#### Important Safety Reminder

The CMBS™ is designed to reduce the severity of an unavoidable collision. It does not prevent collisions nor stop the vehicle automatically. It is still your responsibility to operate the brake pedal and steering wheel appropriately according to the driving conditions.

The CMBS™ may not activate or may not detect a vehicle in front of your vehicle under certain conditions:

➤ **CMBS™ Conditions and Limitations** P. 486

You can read about handling information for the camera equipped with this system.

➤ **Front Wide View Camera** P. 581

When the CMBS™ is activated, it will continue to operate even if the accelerator pedal is partially depressed. However, it will be canceled if the accelerator pedal is fully depressed.

#### Manual transmission models

When the CMBS™ activates, the engine may stop automatically. Start the engine by normal operation if the engine stops.

➤ **Starting the Engine** P. 430

## ■ How the system works

## ☒ How the system works

**When to use**

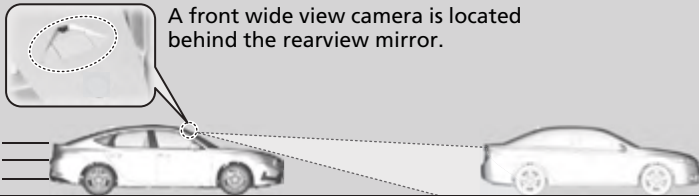

A front wide view camera is located behind the rearview mirror.

The system starts monitoring the roadway ahead when your vehicle speed is about 3 mph (5 km/h) or above and will search for a vehicle, pedestrian, or moving bicycle in front of you.

The CMBS™ activates when:

- The speed difference between your vehicle and a vehicle, pedestrian, or moving bicycle detected in front of you becomes about 3 mph (5 km/h) and over with a chance of a collision.
- Your vehicle drives at about 18 mph (30 km/h) or less and there is a chance of in frontal collision with a detected oncoming vehicle when you turn left at an intersection.
- Your vehicle speed is about 62 mph (100 km/h) or less and the system determines there is a chance of a collision with:
  - An oncoming or stationary vehicle detected in front of you.
  - A pedestrian or moving bicycle detected in front of you.

The camera in the CMBS™ is also designed to detect pedestrians.

However, this pedestrian detection feature may not activate or may not detect a pedestrian in front of your vehicle under certain conditions.

Refer to the ones indicating the pedestrian detection limitations from the list.

➤ **CMBS™ Conditions and Limitations** P. 486

The CMBS™ will be canceled when your vehicle stops or the system determines there no longer is the potential for a collision.

The CMBS™ may also be canceled when a driver operates the steering wheel and the brake or accelerator pedal to avoid a collision.



## ■ When the system activates

The system provides visual and audible alerts of a possible collision, and stops if the collision is avoided.

- ▶ Take appropriate action to prevent a collision (apply the brakes, change lanes, etc.)

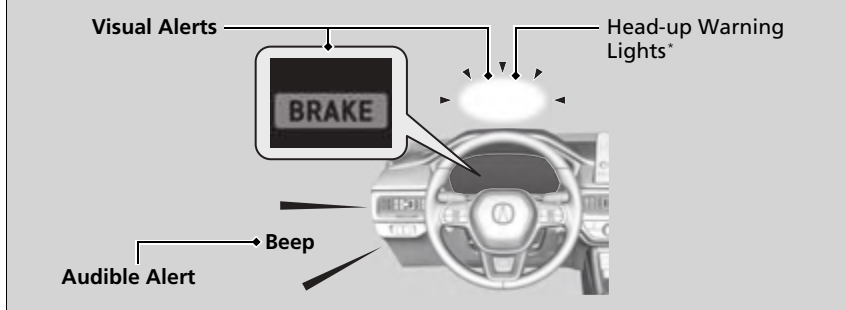

You can change the distance (**Long/Normal/Short**) between vehicles at which the system's earliest collision alert will come on.

Models with 7-in. Color Touchscreen

- **Vehicle Settings\*** P. 126

Models with 9-in. Color Touchscreen

- **Customized Features** P. 359

\* Not available on all models

Continued

## ▶▶ When the system activates

### Models with Head-up display

The head-up warning uses a lens located at the front end of the dashboard.

Do not cover the lens or spill any liquid on it.

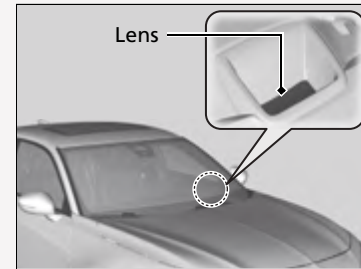

## ■ Collision Alert Stages

The system has three alert stages for a possible collision. However, depending on circumstances, the CMBS™ may not go through all of the stages before initiating the last stage.

Distance between vehicles		CMBS™		
		The sensors detect a vehicle	Audible & Visual WARNINGS	Braking
Stage one		There is a risk of a collision with the vehicle ahead of you.	When in <b>Long</b> , visual and audible alerts come on at a longer distance from a vehicle ahead than in <b>Normal</b> setting, and in <b>Short</b> , at a shorter distance than in <b>Normal</b> .	—
Stage two		The risk of a collision has increased, time to respond is reduced.	Visual and audible alerts.	Lightly applied
Stage three		The CMBS™ determines that a collision is unavoidable.		Forcefully applied

## ■ CMBS™ On and Off

You can turn the system on and off using the driver information interface.

☒ **Switching the Display** P. 112

☒ **Safety Support** P. 121

The CMBS™ is turned on every time you start the engine, even if you turned it off the last time you drove the vehicle.

## ☒ Collision Mitigation Braking System™ (CMBS™)

You cannot turn the CMBS™ off while driving.

The CMBS™ may automatically shut off, and the safety support indicator (amber) will come and stay on under certain conditions:

☒ **CMBS™ Conditions and Limitations** P. 486

The CMBS™ is not activated for about 15 seconds after the engine starts.

The Vehicle Stability Assist™ (VSA®) system, Adaptive Cruise Control (ACC)\*, Adaptive Cruise Control (ACC) with Low Speed Follow\* and safety support indicators may come on in amber along with a message in the gauge when you set the power mode to ON after reconnecting the battery.

Drive a short distance at more than 12 mph (20 km/h). Each indicator should go off. If any do not, have your vehicle checked by a dealer.

\* Not available on all models

## ■ CMBS™ Conditions and Limitations

The system may automatically shut off and the safety support indicator (amber) will come on under certain conditions. Some examples of these conditions are listed below. Other conditions may reduce some of the CMBS™ functions.

➤ **Front Wide View Camera** P. 581

### ■ Environmental conditions

- Driving in bad weather (rain, fog, snow, etc.).
- Sudden changes between light and dark, such as the entrance or exit of a tunnel or the shadows of trees, buildings, etc.
- Driving into low sunlight (e.g., at dawn or dusk).
- Strong light is reflected onto vehicles, pedestrians, moving bicycles, or road surfaces.
- Water is sprayed by or snow blown from a vehicle ahead.
- Driving at night or in a dark place such as a tunnel (due to low-light conditions, vehicles, pedestrians, or moving bicycles may not be illuminated).

### ■ Roadway conditions

- Driving on curvy, winding, undulating, or sloping roads.
- There is a film of water or puddles on the road surface.
- Driving on rutted roads (snowy or unpaved roads, etc.).
- Your vehicle is strongly shaken on uneven road surfaces.

## ⌘ CMBS™ Conditions and Limitations

Have your vehicle checked by a dealer if you find any unusual behavior of the system (e.g., the warning message appears too frequently).

**■ Vehicle conditions**

- The vehicle is tilted due to heavy load in the cargo area or rear seats.
- Tire chains are installed.
- Driving at night or in a dark place (e.g., a tunnel) with the headlights off.
- The front of the camera is covered by dirt, fog, rain, mud, wet snow, seals, accessories, stickers, or film on the windshield.
- There is residue on the windshield from the windshield wipers.
- When lighting is weak due to dirt covering the headlight lenses, or there is poor visibility in a dark place due to the headlights being improperly adjusted.
- An abnormal tire or wheel condition (incorrect sizes, varied sizes or construction, improperly inflated, compact spare tire\*, etc.).
- The suspension has been modified.

\* Not available on all models

■ **Examples of limitations on the correct detection of the camera due to the condition of the vehicle ahead of you, oncoming vehicles, pedestrians, or moving bicycles**

- The distance between your vehicle and the vehicle ahead of you, oncoming vehicle, pedestrian, or moving bicycle ahead of you is too short.
- The vehicle ahead of you, oncoming vehicle, pedestrian, or moving bicycle suddenly cuts in front of or jumps out in front of you.
- The bicycle is stopped.
- The oncoming vehicle or vehicle ahead of you is sideways.
- When the vehicle ahead of you, oncoming vehicle, pedestrian, or moving bicycle blends in with the background, preventing the system from recognizing them.
- When several pedestrians or bicycles are moving ahead of you in a group.
- When a pedestrian or moving bicycle crosses the road too quickly.
- A pedestrian or moving bicycle approaches from the opposite direction.
- The headlights of the vehicle ahead of you or oncoming vehicle are lit on one side or not lit on either side in a dark place.
- When part of a pedestrian (heads, limbs, etc.) is hidden by load.
- When a pedestrian is bent over or squatting, when their hands are raised, or they are running.
- When the pedestrian is shorter than about 3.3 feet (1 meter) or taller than about 6.6 feet (2 meters) in height.
- When the pedestrian is pushing a stroller or bicycle.

⊠ Collision Mitigation Braking System™ (CMBS™)

Make sure that all the tires are of the same specified size, type and brand, and that they are evenly worn. If you use tires of different sizes, types, brands, or degree of wear, the system may not work properly.

Do not modify the suspension. Altering the height of the vehicle may prevent the system from working properly.

**■ Examples of other limitations on detection or system operation**

- When the vehicle ahead of you is a small motorcycle, motorcycle with a sidecar, wheelchair, or other specially shaped vehicle.
- When a vehicle is lower in the rear than the front such as trucks that are not carrying a load, or a narrow vehicle.
- When the vehicle ahead of you, oncoming vehicle, pedestrian or moving bicycle is not in front of the vehicle.
- The speed difference between your vehicle and the vehicle ahead of you, oncoming vehicle, pedestrian or moving bicycle is significantly large.
- When the vehicle or moving bicycle in front of you slows suddenly.
- When the driver operates the brake pedal and steering wheel to avoid a collision.
- When you approach the vehicle ahead of you, oncoming vehicle, pedestrians or moving bicycles while accelerating rapidly or operating the steering wheel (except when turning left at an intersection. etc.)\*<sup>1</sup>
- When the moving bicycle is a child-sized bicycle, folding bicycle, three-wheeler or other bicycle with small tires, or a long bicycle like a tandem bicycle.
- When the camera cannot correctly identify the shape of the vehicle ahead of you, oncoming vehicle, pedestrian, or moving bicycle.
- When the minimum ground clearance of a vehicle ahead of you is extremely high.

\*1: When there is a possibility of a frontal collision with the oncoming vehicle while turning left, the CMBS™ is activated. However, it may not be activated if you suddenly turn the steering wheel.

*Continued*

### ■ Automatic shutoff

The CMBS™ may automatically shut itself off and the safety support indicator (amber) comes and stays on when:

- You drive off-road or on a mountain road, or curved and winding road for an extended period.
- Driving in bad weather (rain, fog, snow, etc.).
- Driving with the parking brake applied.
- The camera temperature gets too high.
- The front of the camera is covered by dirt, fog, rain, mud, wet snow, seals, accessories, stickers, or film on the windshield.
- An abnormal tire condition is detected (incorrect tire size, flat tire, etc.).

Once the conditions that caused the CMBS™ to shut off improve or are addressed (e.g., cleaning), the system comes back on.



## ■ With Little Chance of a Collision

Even if there is little chance of a collision, the CMBS™ may activate under the following conditions:

- Your vehicle approaches or passes another vehicle that is making a left or right turn.
- Your vehicle approaches another vehicle ahead of you and you change lanes to pass.
- Your vehicle approaches another vehicle at an intersection, etc.

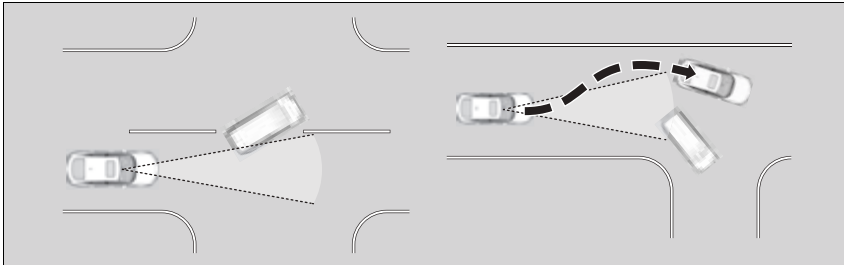

- When passing through a low or narrow gate at a speed well over the speed limit.
- When there are traffic signs or structures such as guard rails are beside the road along a curve.

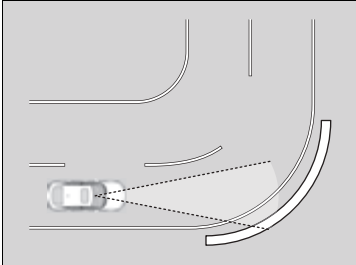

- When driving through curves, your vehicle comes to a point where the oncoming vehicle is right in front of you.

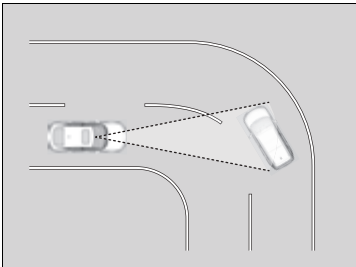

- When approaching stationary vehicles or walls, such as when parking.

## Low Speed Braking Control\*

### Continuously variable transmission models with parking sensor system

Using sonar sensors located on the front and rear bumpers, and the front grille, this system can detect if there is danger of a potential collision with a wall or other obstacle during normal driving or when the accelerator pedal is depressed with too much force. The system then assists in avoiding collisions and reducing damage from impact through assistive braking and/or assistive driving power suppression.

### ▶▶ Low Speed Braking Control\*

## WARNING

The Low Speed Braking Control System cannot avoid all collisions and may not reduce damage in each situation where the accelerator is mistakenly or aggressively pressed. Overreliance on the system may result in a collision with serious injury or death. Always check your surroundings, your shift position, and your pedal use. Driver remains responsible for safely operating the vehicle.

If the Low Speed Braking Control activates in a situation where you do not want automatic brake application (such as when the vehicle is between two railroad crossing gates), simply press the brake pedal to deactivate the system and then continue to drive as intended.

## ■ How the System Works

### ■ Assistive braking

Assistive braking provides a visual and audible alert when the vehicle is moving between approximately 1 and 6 mph (2 and 10 km/h) and there is the possibility of a collision with a detected wall or other obstacles, as well as providing assistance with braking.

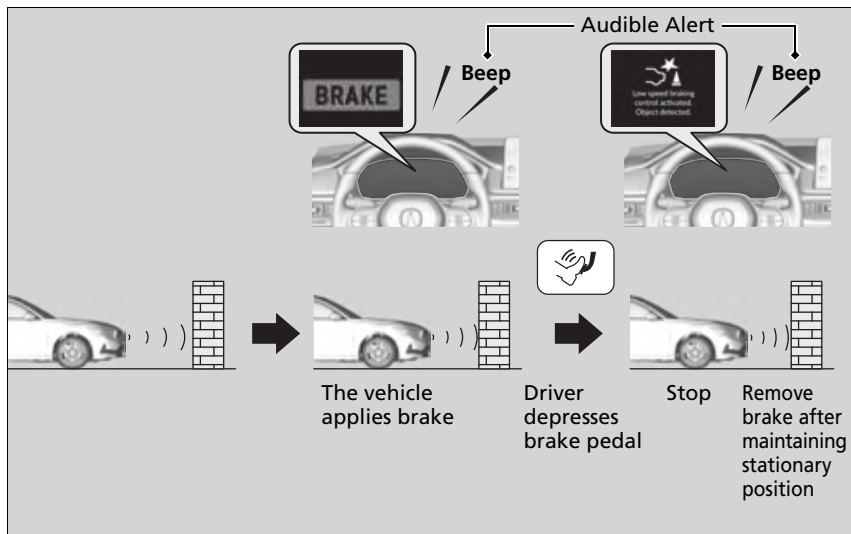

If the only rear sensors are turned off using the parking sensor system, the assistive braking is not working when reversing.

▶ **Customized Features** P. 359

## ▶▶ Low Speed Braking Control\*

For directions on the proper handling of the sonar sensors, please refer to the following page.

▶ **Sonar Sensors\*** P. 583

The vehicle will release the brake and start moving a few seconds after the system is activated. To keep the vehicle stopped, keep the brake pedal depressed or put the transmission into **P**.

In order to prevent the system from activating when not needed, always turn it off during vehicle maintenance, when loading on ships, trucks, and so on, or when using a chassis dynamometer, free rollers for inspection or when washing the car in conveyor type car wash machine.

### ■ Assistive driving power suppression

When the vehicle is stopped or moving at less than 6 mph (10 km/h) and there is an obstacle such as a wall detected near the front of or back of the vehicle, if the accelerator pedal is depressed more than necessary, the system will inform you with a visual and audible alert. At the same time, the system will prevent sudden forward or backwards movement by limiting the output of the engine, then assistive braking will activate when you get closer to the obstacle.

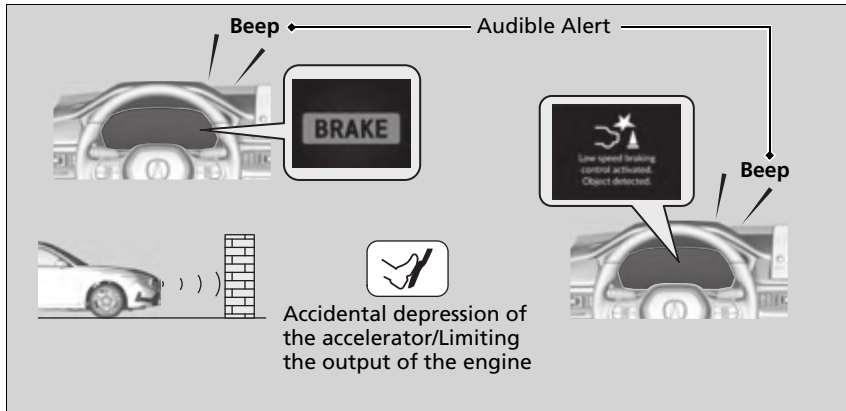

Assistive driving power suppression will not activate in the following situations.

When moving forward:

- When on a steep slope or the shift position is in **P**, **R**, or **N**.

When reversing:

- When on a steep slope or the shift position is in a position other than **R**.

If the only rear sensors are turned off using the parking sensor system, the assistive driving power suppression is not working when reversing.

🔧 **Customized Features** P. 359

## ■ System On and Off

You can turn the system on and off using the driver information interface.

➤ **Switching the Display** P. 112

➤ **Safety Support** P. 121

The system is turned on every time you start the engine, even if you turned it off the last time you drove the vehicle.

## ☒ System On and Off

The system may temporarily turn off after reconnecting the battery.

The system will automatically turn ON after the vehicle has been moving at over 12 mph (20 km/h) for some time.

If the system does not turn on, have your vehicle checked by a dealer.

## ■ Conditions for Cancellation

Conditions for assistive driving power suppression.

- When the accelerator is no longer depressed.
- When the accelerator is depressed for approximately four seconds.
- When the brake pedal is depressed.

Conditions for assistive braking cancellation.

- A certain amount of time has passed since activation.

## ■ Low Speed Braking Control System Conditions and Limitations

The system may not operate correctly in the following conditions:

### ■ Examples of obstacles the sonar sensor cannot detect

- Obstacles that do not reflect sound waves well, such as people, snow, cloth, sponges, etc.
- Thin obstacles such as fences, bicycles, sign posts, etc.
- Short or small obstacles.
- Obstacles immediately in front of the bumper.
- Moving objects or obstacles that suddenly enter the road.
- Obstacles that are not perpendicular to the ground.

### ☒ Conditions for Cancellation

After Low Speed Braking Control has activated once, it will not activate again for the same obstacle. They can be activated again after driving for a certain distance after last activation.

Low Speed Braking Control activates separately when moving forward and reversing. (For example, if it activates when moving forward, it can be activated again immediately if reversing.)

However, if assistive braking has been activated, in order to activate assistive driving power suppression again, it is necessary to drive for a certain distance to reset the system.

■ **Examples of situations where the sonar sensor cannot detect obstacles**

- The sonar sensor is dirty (covered by snow, water, mud, etc.).
- The vehicle is too hot or cold.
- The steering wheel is turned sharply when approaching the obstacle at an angle.

■ **Examples of other cases where the system may not work correctly**

- The vehicle is tilted due to heavy load or suspension modifications.
- An abnormal tire or wheel condition (incorrect sizes, varied sizes or construction, improperly inflated, compact spare tire, etc.).
- Bad weather conditions such as heavy rain, fog, snow, sandstorms, etc.
- The ambient temperature/humidity is too high or low.
- When going down a very steep slope.
- When close to other vehicles with sonar sensors or other objects that emit ultrasonic waves.

■ **Situations where the system may activate even without risk of a collision**

- When passing through short or narrow gates.
- When driving on uneven surfaces, grassy areas, or places with steps.
- When a sloped pillar or wall is protruding from a high position.
- When there are obstacles next to the road.
- When driving toward flags, curtains, tree branches, railroad crossing bars, etc.
- When driving on flooded roads.



## Low Speed Braking Control\*

### Manual transmission models

Using sonar sensors located on the front and rear bumpers, and the front grille, this system can detect if there is danger of a potential collision with a wall or other obstacle during normal driving. The system then assists in avoiding collisions and reducing damage from impact through assistive braking.

### ▶▶ Low Speed Braking Control\*

## WARNING

The Low Speed Braking Control System cannot avoid all collisions and may not reduce damage in each situation where the accelerator is mistakenly or aggressively pressed. Overreliance on the system may result in a collision with serious injury or death. Always check your surroundings, your shift position, and your pedal use. Driver remains responsible for safely operating the vehicle.

If the Low Speed Braking Control activates in a situation where you do not want automatic brake application (such as when the vehicle is between two railroad crossing gates), simply press the brake pedal to deactivate the system and then continue to drive as intended.

## ■ How the System Works

The Low Speed Braking Control provides a visual and audible alert when the vehicle is moving between approximately 1 and 6 mph (2 and 10 km/h) and there is the possibility of a collision with a detected wall or other obstacles, as well as providing assistance with braking.

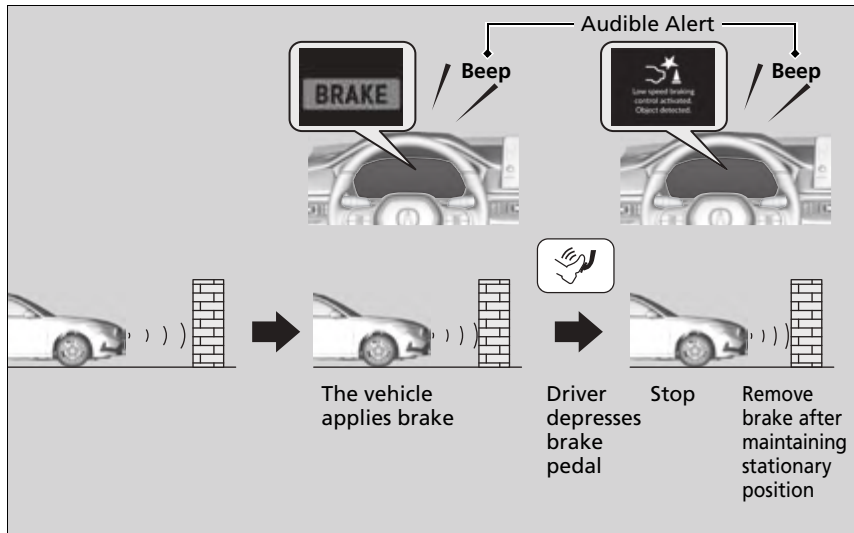

If the only rear sensors are turned off using the parking sensor system, the Low Speed Braking Control is not working when reversing.

▶ **Customized Features** P. 359

## ▶ Low Speed Braking Control\*

For directions on the proper handling of the sonar sensors, please refer to the following page.

▶ **Sonar Sensors\*** P. 583

The vehicle will release the brake a few seconds after the system is activated. Keep the brake pedal depressed.

When the system activates, the engine may stop automatically. Start the engine by normal operation if the engine stops.

▶ **Starting the Engine** P. 430

In order to prevent the system from activating when not needed, always turn it off during vehicle maintenance, when loading on ships, trucks, and so on, or when using a chassis dynamometer, free rollers for inspection or when washing the car in conveyor type car wash machine.

## ■ System On and Off

You can turn the system on and off using the driver information interface.

➤ **Switching the Display** P. 112

➤ **Safety Support** P. 121

The system is turned on every time you start the engine, even if you turned it off the last time you drove the vehicle.

## ☒ System On and Off

The system may temporarily turn off after reconnecting the battery.

The system will automatically turn ON after the vehicle has been moving at over 12 mph (20 km/h) for some time.

If the system does not turn on, have your vehicle checked by a dealer.

*Continued*

## ■ Conditions for Cancellation

A certain amount of time has passed since activation.

## ■ Low Speed Braking Control System Conditions and Limitations

The system may not operate correctly in the following conditions:

### ■ Examples of obstacles the sonar sensor cannot detect

- Obstacles that do not reflect sound waves well, such as people, snow, cloth, sponges, etc.
- Thin obstacles such as fences, bicycles, sign posts, etc.
- Short or small obstacles.
- Obstacles immediately in front of the bumper.
- Moving objects or obstacles that suddenly enter the road.
- Obstacles that are not perpendicular to the ground.

## ☒ Conditions for Cancellation

After Low Speed Braking Control has activated once, it will not activate again for the same obstacle. They can be activated again after driving for a certain distance after last activation.

Low Speed Braking Control activates separately when moving forward and reversing. (For example, if it activates when moving forward, it can be activated again immediately if reversing.)

**■ Examples of situations where the sonar sensor cannot detect obstacles**

- The sonar sensor is dirty (covered by snow, water, mud, etc.).
- The vehicle is too hot or cold.
- The steering wheel is turned sharply when approaching the obstacle at an angle.

**■ Examples of other cases where the system may not work correctly**

- The vehicle is tilted due to heavy load or suspension modifications.
- An abnormal tire or wheel condition (incorrect sizes, varied sizes or construction, improperly inflated, compact spare tire, etc.).
- Bad weather conditions such as heavy rain, fog, snow, sandstorms, etc.
- The ambient temperature/humidity is too high or low.
- When going down a very steep slope.
- When close to other vehicles with sonar sensors or other objects that emit ultrasonic waves.

**■ Situations where the system may activate even without risk of a collision**

- When passing through short or narrow gates.
- When driving on uneven surfaces, grassy areas, or places with steps.
- When a sloped pillar or wall is protruding from a high position.
- When there are obstacles next to the road.
- When driving toward flags, curtains, tree branches, railroad crossing bars, etc.
- When driving on flooded roads.

## Adaptive Cruise Control (ACC) with Low Speed Follow\*

Helps maintain a constant vehicle speed and a set following-interval behind a vehicle detected ahead of yours and, if the detected vehicle comes to a stop, can decelerate and stop your vehicle, without you having to keep your foot on the brake or the accelerator.

When ACC with Low Speed Follow slows your vehicle by applying the brakes, your vehicle's brake lights will illuminate.

### ⚠ Adaptive Cruise Control (ACC) with Low Speed Follow\*

#### ⚠ WARNING

Improper use of ACC with Low Speed Follow can lead to a crash.

Use ACC with Low Speed Follow only when driving on expressways or freeways and in good road and weather conditions.

#### ⚠ WARNING

ACC with Low Speed Follow has limited braking capability and may not stop your vehicle in time to avoid a collision with a vehicle that quickly stops in front of you.

Always be prepared to apply the brake pedal if the conditions require.

#### Important Reminder

As with any system, there are limits to ACC with Low Speed Follow. Use the brake pedal whenever necessary, and always keep a safe interval between your vehicle and other vehicles.

#### When to use



A front wide view camera is located behind the rearview mirror.



- Vehicle speed for ACC with Low Speed Follow: **A vehicle is detected ahead within ACC with Low Speed Follow range** – ACC with Low Speed Follow operates at speeds up to 90 mph (145 km/h).  
**No vehicle is detected within ACC with Low Speed Follow range** – ACC with Low Speed Follow operates at the speed of 25 mph (40 km/h) or above.
- Shift position for ACC with Low Speed Follow: In **D** or **S**.

## ■ How to activate the system

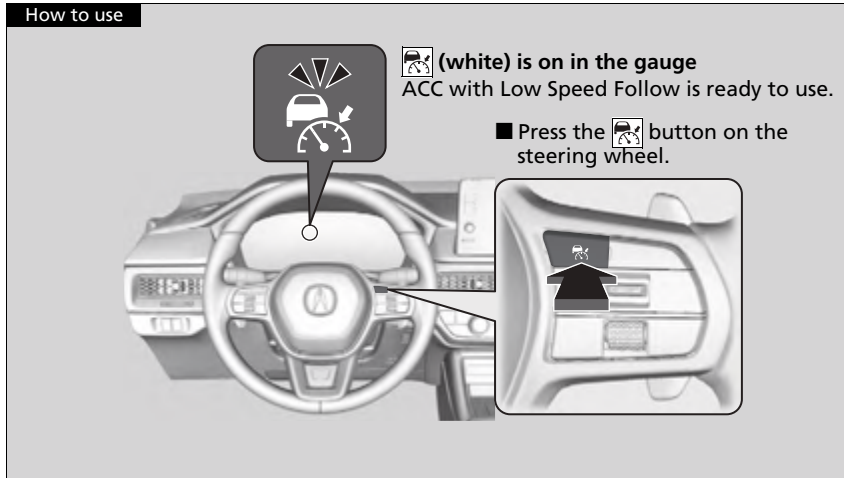

## ▣ Adaptive Cruise Control (ACC) with Low Speed Follow\*

You can read about handling information for the camera equipped with this system.

▣ **Front Wide View Camera** P. 581

ACC with Low Speed Follow may not work properly under certain conditions.

▣ **ACC with Low Speed Follow Conditions and Limitations** P. 512

When not using ACC with Low Speed Follow: Turn off adaptive cruise by pressing the button.

Do not use ACC with Low Speed Follow under the following conditions:

- On roads with frequent lane change or continuous stop and go traffic, ACC with Low Speed Follow cannot keep an appropriate distance between your vehicle and the vehicle ahead of you.
- On roads with sharp turns.
- On roads with toll collection facilities or other objects between lanes of traffic, or in parking areas, or facilities with drive through access.
- On roads with bad weather (rain, fog, snow, etc.), ACC with Low Speed Follow may not detect the distance between your vehicle and the vehicle ahead of you properly.
- On roads with slippery or icy surfaces. The wheels may spin out and your vehicle may lose the control on the condition.
- On roads with steep uphill or steep downhill slopes.
- On roads with undulating slopes.

\* Not available on all models

Continued

## ■ To Set the Vehicle Speed

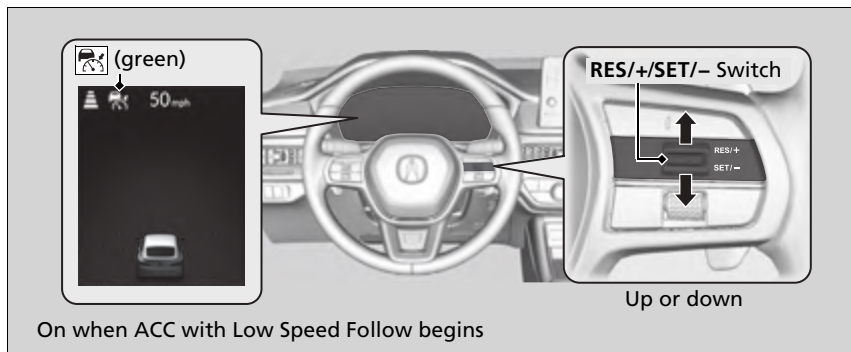

**When driving at about 25 mph (40 km/h) or above:** Take your foot off the pedal and press the **RES/+SET/-** switch up or down when you reach the desired speed. The moment you release the switch, the set speed is fixed, and ACC with Low Speed Follow begins.

**When driving slower than about 25 mph (40 km/h):** If the vehicle is moving and the brake pedal is not depressed, pressing the switch fixes the set speed to about 25 mph (40 km/h) regardless of current vehicle speed. If your vehicle is stationary, you can set the vehicle speed even with the brake pedal depressed.

## ▶▶ To Set the Vehicle Speed

The Vehicle Stability Assist™ (VSA®) system, Adaptive Cruise Control (ACC) with Low Speed Follow and safety support indicators may come on in amber along with a message in the gauge when you set the power mode to ON after reconnecting the battery. Drive a short distance at more than 12 mph (20 km/h). Each indicator should go off. If any do not, have your vehicle checked by a dealer.

You can switch the displayed set speed measurements on the driver information interface or audio/information screen\* between mph and km/h.

▶ **Speed/Distance Units** P. 123

Models with 7-in. Color Touchscreen

▶ **Vehicle Settings\*** P. 126

Models with 9-in. Color Touchscreen

▶ **Customized Features** P. 359



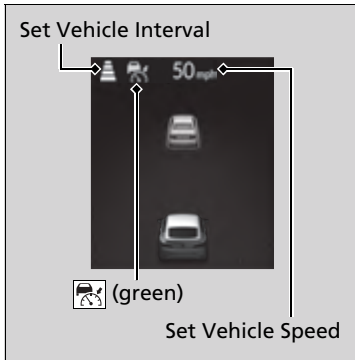

When ACC with Low Speed Follow starts operating, the vehicle icon, interval bars and set speed appear on the gauge.

When you use ACC with Low Speed Follow, Straight Driving Assist (a feature of the Electric Power Steering system) is activated. By enabling the steering system to automatically compensate for natural steering pull, Straight Driving Assist makes it easier for you to keep your vehicle in a straight line.

## ■ When in Operation

### ■ There is a vehicle ahead

ACC with Low Speed Follow monitors if a vehicle ahead of you enters the ACC with Low Speed Follow range. If a vehicle is detected doing so, the ACC with Low Speed Follow system maintains or decelerates your vehicle's set speed in order to keep the vehicle's set following-interval from the vehicle ahead.

➤ **To Set or Change Following-interval** P. 517

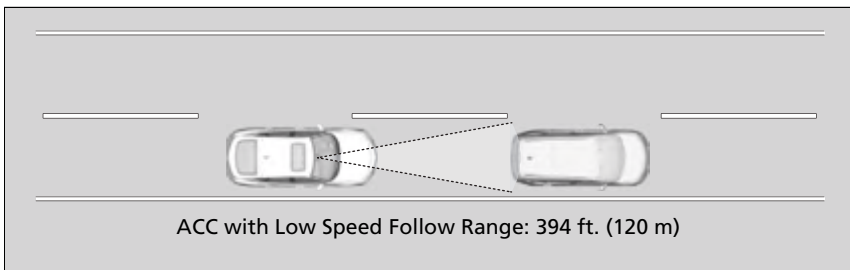

## ⌘ When in Operation

If the vehicle ahead of you slows down abruptly, or if another vehicle cuts in front of you, a beeper sounds, a message appears on the driver information interface, and the head-up warning lights\* flash.

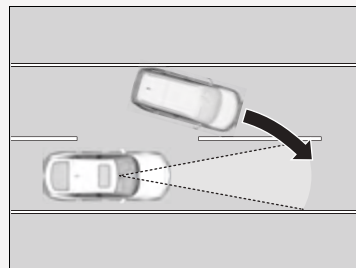

Depress the brake pedal, and keep an appropriate interval from the vehicle ahead.

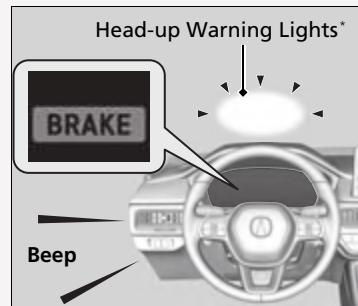

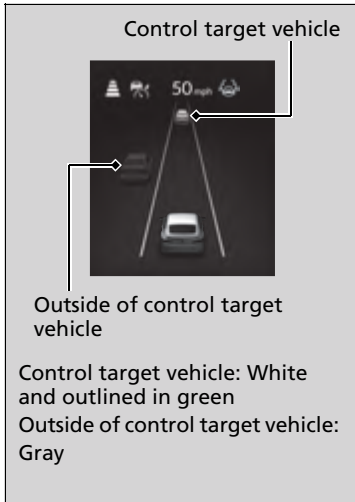

When a vehicle whose speed is slower than your set speed is detected in front of you, your vehicle starts to slow down.

▶▶ When in Operation

Even if the interval between your vehicle and the vehicle detected ahead is short, ACC with Low Speed Follow may start accelerating your vehicle under the following circumstances:

- The vehicle ahead of you is going at almost the same speed as, or faster than, your vehicle.
- A vehicle that cuts in front of you is going faster than your vehicle, gradually increasing the interval between the vehicles.

You can also set the system to beep when a vehicle in front of you comes in and goes out of the ACC with Low Speed Follow detecting range. A vehicle detect beep on and off can be selected.

▶▶ Models with 7-in. Color Touchscreen

▶▶ **Vehicle Settings**\* P. 126

▶▶ Models with 9-in. Color Touchscreen

▶▶ **Customized Features** P. 359

**Limitations**

You may need to use the brake to maintain a safe interval when using ACC with Low Speed Follow. Additionally, ACC with Low Speed Follow may not work properly under certain conditions.

▶▶ **ACC with Low Speed Follow Conditions and Limitations** P. 512

\* Not available on all models

Continued

### ■ There is no vehicle ahead

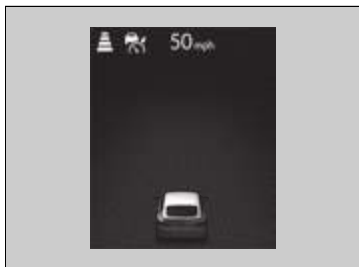

Your vehicle maintains the set speed without having to keep your foot on the brake or accelerator pedal.

If there previously was a vehicle detected ahead that kept your vehicle from traveling at the set speed, ACC with Low Speed Follow accelerates your vehicle to the set speed, and then maintains it.

On steep downhill during ACC with Low Speed Follow, it brakes to inhibit excessive acceleration for maintaining the set speed. However, the vehicle speed may become faster than the set speed.

### ■ When you depress the accelerator pedal

You can temporarily increase the vehicle speed. In this case, there is no audible or visual alert even if a vehicle is in the ACC with Low Speed Follow range.

ACC with Low Speed Follow stays on unless you cancel it. Once you release the accelerator pedal, the system resumes the set speed.

There are times when the vehicle speed will decrease when the accelerator pedal is lightly applied.

### ⌘ When in Operation

- ACC with Low Speed Follow may temporarily control the interval between your vehicle and the vehicle in adjacent lane or surroundings of your vehicle depending on the road conditions (e.g. curves) or vehicle conditions (e.g. operating the steering wheel or the vehicle location in the lane).

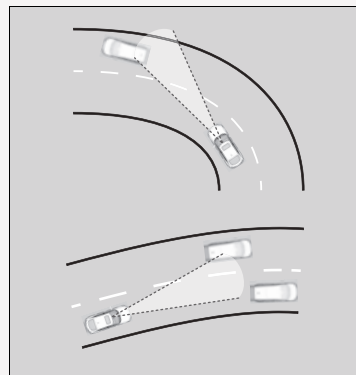

- When the vehicle ahead of you moves away, such as when entering an interchange or rest area, ACC with Low Speed Follow may continue to maintain the set following-interval for a short time.

■ **A vehicle detected ahead is within ACC with Low Speed Follow range and slows to a stop**

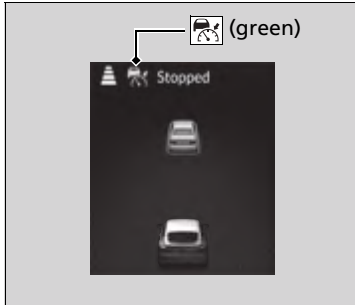

Your vehicle also stops, automatically. The **Stopped** message appears on the gauge. When the vehicle ahead of you starts again, the vehicle icon on the gauge blinks. If you press the **RES/+ / SET / -** switch up or down, or depress the accelerator pedal, ACC with Low Speed Follow operates again within the prior set speed.



If no vehicle is ahead of you before you resume driving, depress the accelerator pedal and ACC with Low Speed Follow will operate again within the prior set speed.

▶▶ When in Operation

**⚠ WARNING**

Exiting a vehicle that has been stopped while the ACC with Low Speed Follow system is operating can result in the vehicle moving without operator control.

A vehicle that moves without operator control can cause a crash, resulting in serious injury or death.

Never exit a vehicle when the vehicle is stopped by ACC with Low Speed Follow.

## ■ ACC with Low Speed Follow Conditions and Limitations

The system may automatically shut off under certain conditions. Some examples of these conditions are listed below. Other conditions may reduce some of the ACC with Low Speed Follow functions.

➤ **Front Wide View Camera** P. 581

### ■ Environmental conditions

- Driving in bad weather (rain, fog, snow, etc.).
- Sudden changes between light and dark, such as the entrance or exit of a tunnel or the shadows of trees, buildings, etc.
- Strong light is reflected onto vehicles or road surfaces.
- Water is sprayed by or snow blown from a vehicle ahead.
- Driving at night or in a dark place such as a tunnel (due to low-light conditions, the whole vehicle may not be illuminated).
- Driving into low sunlight (e.g., at dawn or dusk).

### ■ Roadway conditions

- Driving on curvy, winding, undulating, or sloping roads.

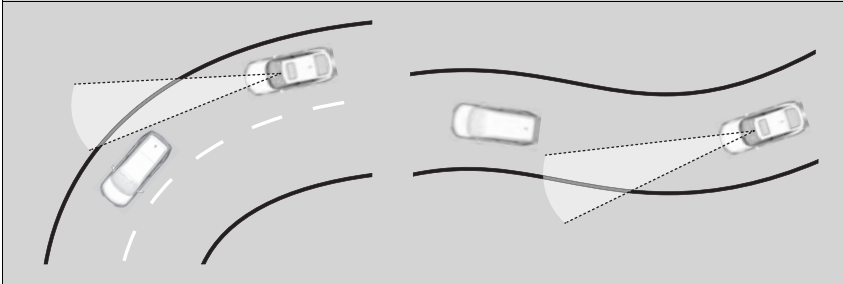

- Driving on rutted roads (snowy or unpaved roads, etc.).
- Puddles or a film of water is on the road surface.
- Your vehicle is strongly shaken on uneven road surfaces.

### ■ Vehicle conditions

- The vehicle is tilted due to heavy load in the cargo area or rear seats.
- Tire chains are installed.
- The front of the camera is covered by dirt, fog, rain, mud, wet snow, seals, accessories, stickers, or film of the windshield.
- Driving at night or in a dark place (e.g., a tunnel) with the headlights off.
- There is residue on the windshield from the windshield wipers.
- When lighting is weak due to dirt covering the headlight lenses, or there is poor visibility in a dark place due to the headlights being improperly adjusted.
- An abnormal tire or wheel condition (incorrect sizes, varied sizes or construction, improperly inflated, compact spare tire, etc.).
- The suspension has been modified.

Continued

■ **Examples of conditions under which the camera may not correctly detect the vehicle ahead of you**

- A vehicle suddenly crosses in front of you.
- The interval between your vehicle and the vehicle ahead of you is too short.
- When the vehicle ahead of you blends in with the background, preventing the system from recognizing it.
- The headlights of the vehicle ahead of you are lit on one side or not lit on either side in a dark place.



**■ Examples of conditions under which the system may not work properly**

- A vehicle ahead of you stops and the speed difference between your vehicle and the vehicle ahead of you is significantly large.
- When the vehicle ahead of you slows suddenly.
- When the vehicle ahead of you is a specially shaped vehicle.
- When a vehicle is lower in the rear than the front such as trucks that are not carrying a load, or a narrow vehicle.

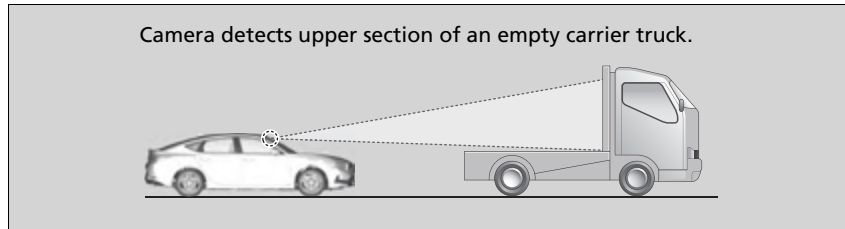

- When your vehicle or the vehicle ahead of you is driving on the edge of the lane.
- When the vehicle ahead of you is a narrow vehicle such as a motorcycle.
- When the minimum ground clearance of a vehicle ahead of you is extremely high.
- When the camera cannot correctly identify the shape of the vehicle ahead of you.

## ■ To Adjust the Vehicle Speed

Increase or decrease the vehicle speed using the **RES/+**/**SET/-** switch on the steering wheel.

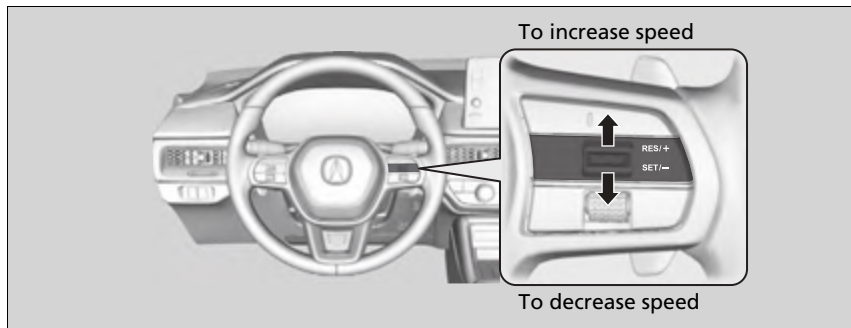

- Each time you press the **RES/+**/**SET/-** switch up or down, the vehicle speed is increased or decreased by about 1 mph or 1 km/h accordingly.
- If you keep the **RES/+**/**SET/-** switch pressed up or down, the vehicle speed increases or decreases by about 5 mph or 5 km/h accordingly.

## ▶▶ To Adjust the Vehicle Speed

If a vehicle detected ahead is going at a speed slower than your increased set speed, ACC with Low Speed Follow may not accelerate your vehicle. This is to maintain the set interval between your vehicle and the vehicle ahead.

When you depress the accelerator pedal and then press down and release the **RES/+**/**SET/-** switch, the current speed of the vehicle is set.



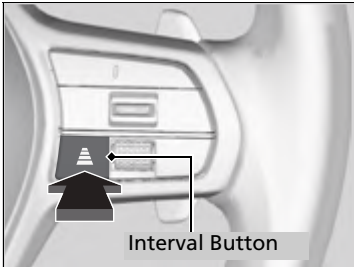

## ■ To Set or Change Following-interval



Press the Interval button to change the ACC with Low Speed Follow following-interval. Each time you press the button, the following-interval (the interval behind a vehicle detected ahead of you) setting cycles through furthest, far, mid, and nearest following-intervals.

Determine the most appropriate following-interval setting based on your specific driving conditions. Be sure to adhere to any following-interval requirements set by local regulation.

The higher your vehicle's following-speed is, the longer the nearest, mid, far or furthest following-interval becomes. See the following examples for your reference.





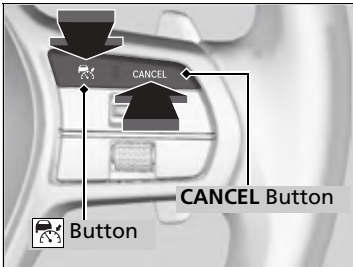

Following-interval		When the Set Speed is:	
		50 mph (80 km/h)	65 mph (104 km/h)
Nearest		82.7 feet 25.2 meters 1.1 sec	107.1 feet 32.6 meters 1.1 sec
Mid		113.4 feet 34.6 meters 1.6 sec	147.2 feet 44.9 meters 1.6 sec
Far		144.2 feet 44.0 meters 2.0 sec	187.3 feet 57.1 meters 2.0 sec
Furthest		175.9 feet 53.6 meters 2.4 sec	229.6 feet 70.0 meters 2.4 sec

When your vehicle stops automatically because a vehicle detected ahead of you has stopped, the interval between the two vehicles will vary based on the ACC with Low Speed Follow interval setting.

## ■ To Cancel



To cancel ACC with Low Speed Follow, do any of the following:

- Press the **CANCEL** button.
  - ▶ The  indicator (green) on the gauge changes to the  indicator (white).
- Press the  button.
  - ▶  indicator (green) goes off.
- Depress the brake pedal while the vehicle is moving forward.
  - ▶ The  indicator (green) on the gauge changes to the  indicator (white).

## ☒ To Cancel

Resuming the prior set speed: After you have canceled ACC with Low Speed Follow, you can activate the ACC with Low Speed Follow with the prior set speed displayed on the gauge (in gray) by pressing the **RES/+ / SET/-** switch up even if the vehicle is stopped.

When you turn the ACC with Low Speed Follow off by pressing the **CANCEL** button or depressing the brake pedal, the prior set speed is displayed on the gauge in gray.

When pressing the **RES/+ / SET/-** switch up, the ACC with Low Speed Follow is activated with displayed speed.

If the  indicator (white) is displayed and you press the **RES/+ / SET/-** switch up, but no prior set speed (in gray) is displayed, the speed will be set to your vehicle's current speed.



### ■ Automatic cancellation

The beeper sounds and a message appears on the driver information interface when ACC with Low Speed Follow is automatically canceled. Any of these conditions may cause the ACC with Low Speed Follow to automatically cancel:

- Bad weather (rain, fog, snow, etc.)
- The vehicle ahead of you cannot be detected.
- An abnormal tire condition is detected, or the tires are skidding.
- Driving on a mountainous road, or driving off road for extended periods.
- Abrupt steering wheel movement.
- When the ABS, VSA®, CMBS™, or Low Speed Braking Control\* is activated.
- When the VSA® system indicator comes on.
- When the vehicle is stopped on a very steep slope.
- When you manually apply the parking brake.
- Water is sprayed by or snow blown from a vehicle ahead.
- Driving into low sunlight (e.g., at dawn or dusk).
- When the detected vehicle within the ACC with Low Speed Follow range is too close to your vehicle.
- When accelerating rapidly.
- The front of the camera is covered by dirt, fog, rain, mud, wet snow, seals, accessories, stickers, or film on the windshield.
- The vehicle is loaded heavy load in the cargo area or rear seats.
- When passing through a dark place, such as tunnel.
- When the parking brake and brake system indicator (amber) comes on.
- The vehicle has repeatedly applied the brakes to maintain the set speed (for example, you are descending a long slope).
- When the system doesn't detect any driving actions from the driver for a certain amount of time while the LKAS is also activated.

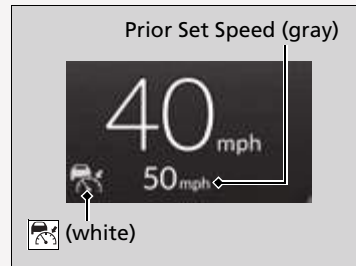
### ▶▶ To Cancel



The set speed cannot be set or resumed when ACC with Low Speed Follow has been turned off using the  button. Press the  button to activate the system, then set the desired speed.

The ACC with Low Speed Follow automatic cancellation can be also triggered by the following causes. In these cases, the parking brake will be automatically applied.

- The driver's seat belt is unfastened when the vehicle is stationary.
- The vehicle stops for more than 10 minutes.
- The engine is turned off.

## ■ To Switch ACC with Low Speed Follow to Cruise Control

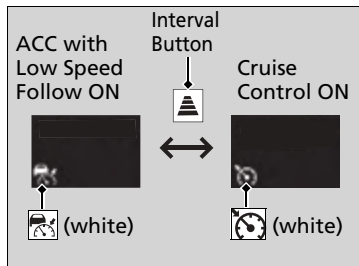

Press and hold the Interval button for one second. **Cruise mode selected** appears on the driver information interface for two seconds, and then the mode switches to Cruise.

The  indicator comes on.

- Green: The system is on.
- White: The system is standby.

To switch back to ACC with Low Speed Follow, press and hold the Interval button again for one second.

## ■ When to use

Desired speed in a range above roughly 25 mph (40 km/h).

## ■ To Set the Vehicle Speed

Take your foot off the pedal and press the **RES/+ / SET / -** switch up or down when you reach the desired speed.

The moment you release the **RES/+ / SET / -** switch, the set speed is fixed, and cruise control begins. The color of  indicator changes from white to green.

When you use cruise control, Straight Driving Assist (a feature of the Electric Power Steering system) is activated.

By enabling the steering system to automatically compensate for natural steering pull, Straight Driving Assist makes it easier for you to keep your vehicle in a straight line.

## ▶ To Switch ACC with Low Speed Follow to Cruise Control

Always be aware which mode you are in. When you are driving in Cruise mode, the system will not assist you to maintain a following-interval from a vehicle ahead of you.

You cannot switch ACC with Low Speed Follow to Cruise Control in the following situations:

- When the vehicle speed is set.
- When ACC with Low Speed Follow is not activated.

You can switch the displayed set speed measurements on the driver information interface or audio/information screen\* between mph and km/h.

▶ **Speed/Distance Units** P. 123

▶ **Models with 7-in. Color Touchscreen**

▶ **Vehicle Settings\*** P. 126

▶ **Models with 9-in. Color Touchscreen**

▶ **Customized Features** P. 359









## ■ To Adjust the Vehicle Speed

- Each time you press the **RES/+SET/-** switch up or down, the vehicle speed is increased or decreased by about 1 mph or 1 km/h accordingly.
- If you keep the **RES/+SET/-** switch pressed up or down, the vehicle speed increases or decreases by about 5 mph or 5 km/h accordingly.

## ■ To Cancel

To cancel cruise control, do any of the following:

- Press the **CANCEL** button.
  - ▶ The  indicator (green) on the gauge changes to the  indicator (white).
- Press the  button.
  - ▶ The  indicator (green) goes off.
- Depress the brake pedal.
  - ▶ The  indicator (green) on the gauge changes to the  indicator (white).

### ▶▶ To Cancel

Resuming the prior set speed: After you have canceled cruise control, you can activate the cruise control with the prior set speed displayed on the gauge (in gray) by pressing the **RES/+SET/-** switch up while driving at a speed of at least 25 mph (40 km/h) or more.

When you turn the cruise control off by pressing the **CANCEL** button or depressing the brake pedal, the prior set speed is displayed on the gauge in gray.

When pressing the **RES/+SET/-** switch up, the cruise control is activated with displayed speed.

If the  indicator (white) is displayed and you press the **RES/+SET/-** switch up, but no prior set speed (in gray) is displayed, the speed will be set to your vehicle's current speed.

▶▶ To Cancel

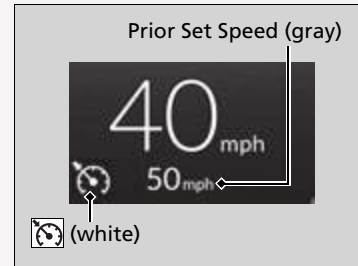

You cannot set or resume in the following situations:

- When vehicle speed is less than 25 mph (40 km/h)
- When cruise control is canceled by pressing the  button.

At vehicle speeds of 22 mph (35 km/h) or less, cruise control is canceled automatically.

## Adaptive Cruise Control (ACC)\*

Helps maintain a constant vehicle speed and a set following-interval behind a vehicle detected ahead of yours, without you having to keep your foot on the brake or the accelerator.

When ACC slows your vehicle by applying the brakes, your vehicle's brake lights will illuminate.

**When to use**

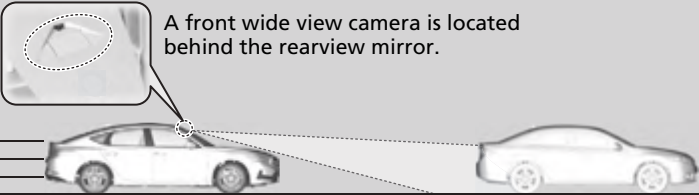

A front wide view camera is located behind the rearview mirror.

- Vehicle speed for adaptive cruise control: Desired speed in a range above roughly 25 mph (40 km/h).
- Shift position for ACC: In **2** or higher position.

### Adaptive Cruise Control (ACC)\*

#### **⚠ WARNING**

Improper use of ACC can lead to a crash.

Use ACC only when driving on expressways or freeways and in good road and weather conditions.

#### **⚠ WARNING**

ACC has limited braking capability. When your vehicle speed drops below 22 mph (35 km/h), ACC will automatically cancel and no longer will apply your vehicle's brakes.

Always be prepared to apply the brake pedal when conditions require.

#### **Important Reminder**

As with any system, there are limits to ACC. Use the brake pedal whenever necessary, and always keep a safe interval between your vehicle and other vehicles.

\* Not available on all models

## ■ How to activate the system

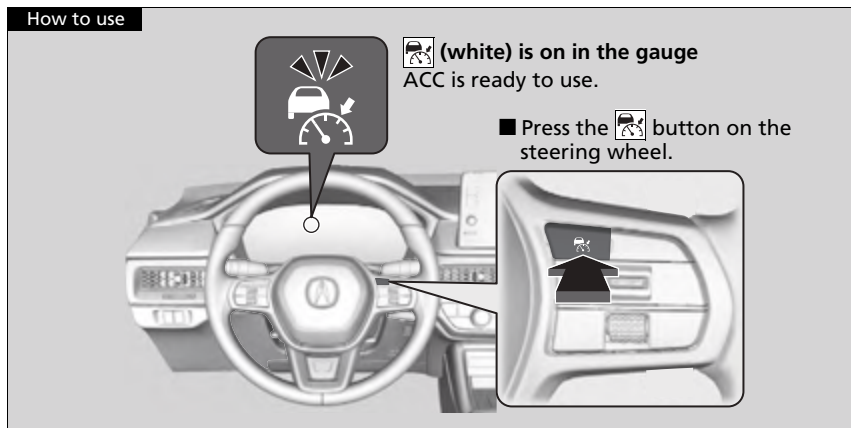

## ▶ Adaptive Cruise Control (ACC)\*

You can read about handling information for the camera equipped with this system.

▶ **Front Wide View Camera** P. 581

ACC may not work properly under certain conditions.

▶ **ACC Conditions and Limitations** P. 532

When the engine speed slows down, try to downshift.  
When the engine speed goes up, try to upshift.  
You can maintain the set speed if you change gear within five seconds.

When not using ACC: Turn off adaptive cruise by pressing the  button.

Do not use ACC under the following conditions:

- On roads with frequent lane change or continuous stop and go traffic, ACC cannot keep an appropriate distance between your vehicle and the vehicle ahead of you.
- On roads with sharp turns.
- On roads with toll collection facilities or other objects between lanes of traffic, or in parking areas, or facilities with drive through access.
- On roads with bad weather (rain, fog, snow, etc.), ACC may not detect the distance between your vehicle and the vehicle ahead of you properly.
- On roads with slippery or icy surfaces. The wheels may spin out and your vehicle may lose the control on the condition.
- On roads with steep uphill or steep downhill slopes.
- On roads with undulating slopes.

## ■ To Set the Vehicle Speed

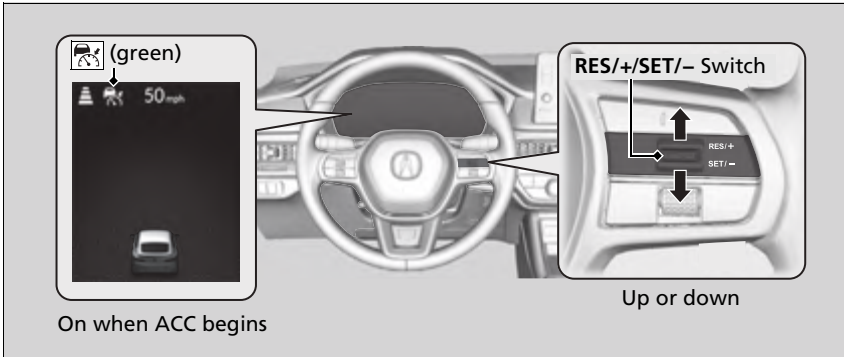

Take your foot off the pedal and press the **RES/+SET/-** switch up or down when you reach the desired speed. The moment you release the button, the set speed is fixed, and ACC begins.

When ACC starts operating, the vehicle icon, distance bars and set speed appear on the gauge.

## ☒ To Set the Vehicle Speed

The Vehicle Stability Assist™ (VSA®) system, Adaptive Cruise Control (ACC) and safety support indicators may come on in amber along with a message in the gauge when you set the power mode to ON after reconnecting the battery.

Drive a short distance at more than 12 mph (20 km/h). Each indicator should go off. If any do not, have your vehicle checked by a dealer.

You can switch the displayed set speed measurements on the driver information interface or audio/information screen between mph and km/h.

➤ **Speed/Distance Units** P. 123

➤ **Customized Features** P. 359

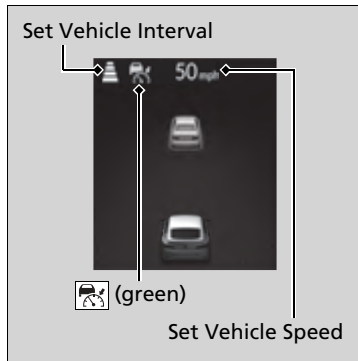

When you use ACC, Straight Driving Assist (a feature of the Electric Power Steering system) is activated.

By enabling the steering system to automatically compensate for natural steering pull, Straight Driving Assist makes it easier for you to keep your vehicle in a straight line.

## ■ When in Operation

### ■ There is a vehicle ahead

ACC monitors if a vehicle ahead of you enters the ACC range. If a vehicle is detected doing so, the ACC system maintains or decelerates your vehicle's set speed in order to keep the vehicle's set following-interval from the vehicle ahead.

🔧 **To Set or Change Following-interval** P. 537

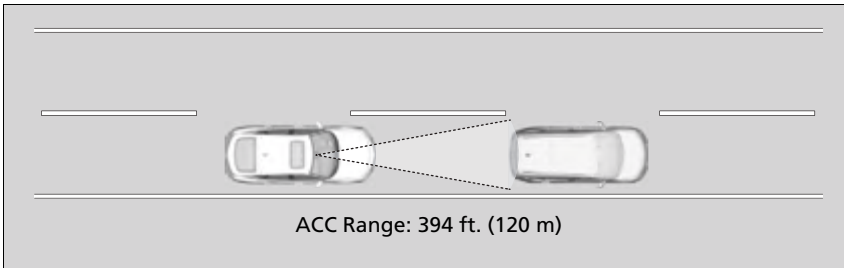

## 🔍 When in Operation

If the vehicle ahead of you slows down abruptly, or if another vehicle cuts in front of you, a beeper sounds, a message appears on the driver information interface, and the head-up warning lights flash.

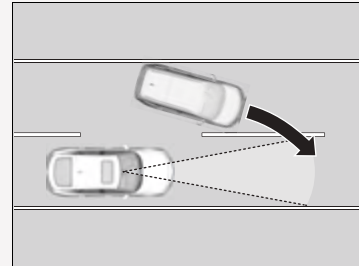

Depress the brake pedal, and keep an appropriate interval from the vehicle ahead.

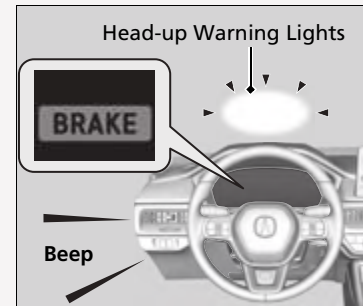

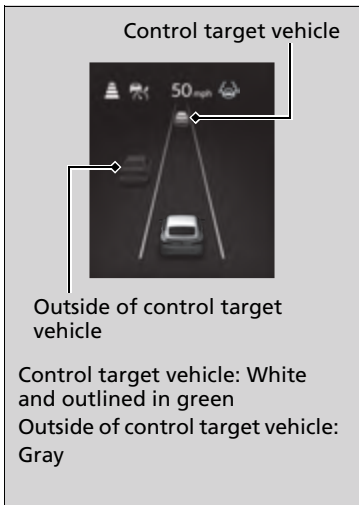

When a vehicle whose speed is slower than your set speed is detected in front of you, your vehicle starts to slow down.

🔗 When in Operation

Even if the interval between your vehicle and the vehicle detected ahead is short, ACC may start accelerating your vehicle under the following circumstances:

- The vehicle ahead of you is going at almost the same speed as, or faster than, your vehicle.
- A vehicle that cuts in front of you is going faster than your vehicle, gradually increasing the interval between the vehicles.

You can also set the system to beep when a vehicle in front of you comes in and goes out of the ACC detecting range. A vehicle detect beep on and off can be selected.

🔗 **Customized Features** P. 359

**Limitations**

You may need to use the brake to maintain a safe interval when using ACC. Additionally, ACC may not work properly under certain conditions.

🔗 **ACC Conditions and Limitations** P. 532



■ **There is no vehicle ahead**

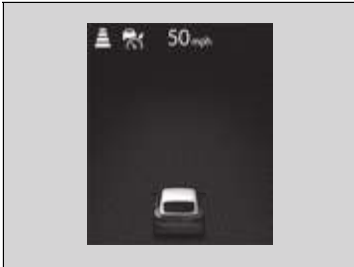

Your vehicle maintains the set speed without having to keep your foot on the brake or accelerator pedal.

If there previously was a vehicle detected ahead that kept your vehicle from traveling at the set speed, ACC accelerates your vehicle to the set speed, and then maintains it.

On steep downhill during ACC, it brakes to inhibit excessive acceleration for maintaining the set speed. However, the vehicle speed may become faster than the set speed.

■ **When you depress the accelerator pedal**

You can temporarily increase the vehicle speed. In this case, there is no audible or visual alert even if a vehicle is in the ACC range.

ACC stays on unless you cancel it. Once you release the accelerator pedal, the system resumes the set speed.

There are times when the vehicle speed will decrease when the accelerator pedal is lightly applied.

⌘ **When in Operation**

- ACC may temporarily control the interval between your vehicle and the vehicle in adjacent lane or surroundings of your vehicle depending on the road conditions (e.g. curves) or vehicle conditions (e.g. operating the steering wheel or the vehicle location in the lane).

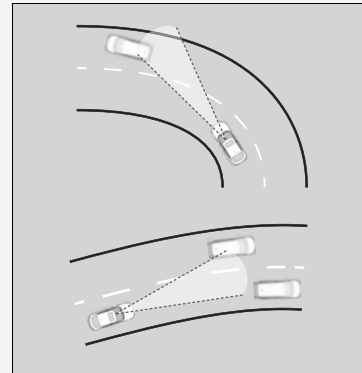

- When the vehicle ahead of you moves away, such as when entering an interchange or rest area, ACC may continue to maintain the set following-interval for a short time.

## ■ ACC Conditions and Limitations

The system may automatically shut off under certain conditions. Some examples of these conditions are listed below. Other conditions may reduce some of the ACC functions.

➤ **Front Wide View Camera** P. 581

### ■ Environmental conditions

- Driving in bad weather (rain, fog, snow, etc.).
- Sudden changes between light and dark, such as the entrance or exit of a tunnel or the shadows of trees, buildings, etc.
- Strong light is reflected onto vehicles or road surfaces.
- Water is sprayed by or snow blown from a vehicle ahead.
- Driving at night or in a dark place such as a tunnel (due to low-light conditions, the whole vehicle may not be illuminated).
- Driving into low sunlight (e.g., at dawn or dusk).

### ■ Roadway conditions

- Driving on curvy, winding, undulating, or sloping roads.

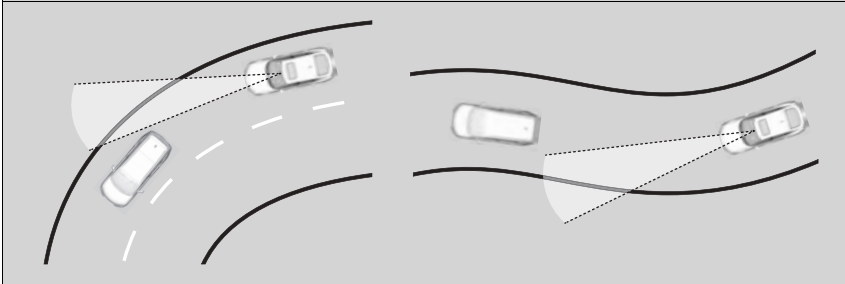

- Driving on rutted roads (snowy or unpaved roads, etc.).
- Puddles or a film of water is on the road surface.
- Your vehicle is strongly shaken on uneven road surfaces.

### ■ Vehicle conditions

- The vehicle is tilted due to heavy load in the cargo area or rear seats.
- Tire chains are installed.
- The front of the camera is covered by dirt, fog, rain, mud, wet snow, seals, accessories, stickers, or film of the windshield.
- Driving at night or in a dark place (e.g., a tunnel) with the headlights off.
- There is residue on the windshield from the windshield wipers.
- When lighting is weak due to dirt covering the headlight lenses, or there is poor visibility in a dark place due to the headlights being improperly adjusted.
- An abnormal tire or wheel condition (incorrect sizes, varied sizes or construction, improperly inflated, compact spare tire, etc.).
- The suspension has been modified.

*Continued*

■ **Examples of conditions under which the camera may not correctly detect the vehicle ahead of you**

- A vehicle suddenly crosses in front of you.
- The interval between your vehicle and the vehicle ahead of you is too short.
- When the vehicle ahead of you blends in with the background, preventing the system from recognizing it.
- The headlights of the vehicle ahead of you are lit on one side or not lit on either side in a dark place.

**■ Examples of conditions under which the system may not work properly**

- A vehicle ahead of you stops and the speed difference between your vehicle and the vehicle ahead of you is significantly large.
- When the vehicle ahead of you slows suddenly.
- When the vehicle ahead of you is a specially shaped vehicle.
- When a vehicle is lower in the rear than the front such as trucks that are not carrying a load, or a narrow vehicle.

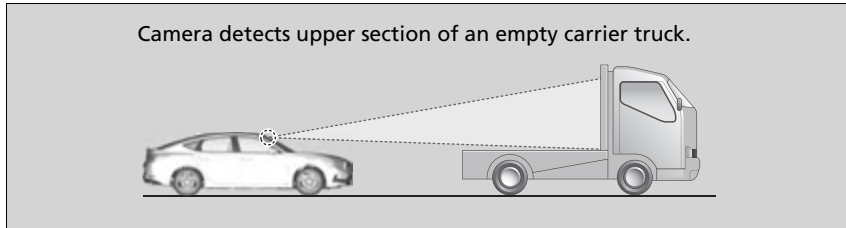

- When your vehicle or the vehicle ahead of you is driving on the edge of the lane.
- When the vehicle ahead of you is a narrow vehicle such as a motorcycle.
- When the minimum ground clearance of a vehicle ahead of you is extremely high.
- When the camera cannot correctly identify the shape of the vehicle ahead of you.

## ■ To Adjust the Vehicle Speed

Increase or decrease the vehicle speed using the **RES/+**/**SET/-** switch on the steering wheel.

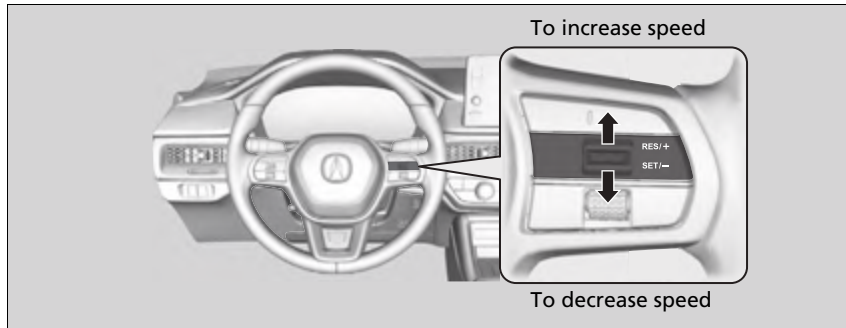

- Each time you press the **RES/+**/**SET/-** switch up or down, the vehicle speed is increased or decreased by about 1 mph or 1 km/h accordingly.
- If you keep the **RES/+**/**SET/-** switch pressed up or down, the vehicle speed increases or decreases by about 5 mph or 5 km/h accordingly.

## ▶▶ To Adjust the Vehicle Speed

If a vehicle detected ahead is going at a speed slower than your increased set speed, ACC may not accelerate your vehicle. This is to maintain the set interval between your vehicle and the vehicle ahead.

When you depress the accelerator pedal and then press down and release the **RES/+**/**SET/-** switch, the current speed of the vehicle is set.

## ■ To Set or Change Following-interval

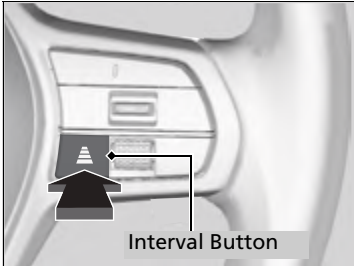





Press the Interval button to change the ACC following-interval.

Each time you press the button, the following-interval (the interval behind a vehicle detected ahead of you) setting cycles through furthest, far, mid, and nearest following-intervals.

Determine the most appropriate following-interval setting based on your specific driving conditions. Be sure to adhere to any following-interval requirements set by local regulation.

The higher your vehicle's following-speed is, the longer the nearest, mid, far or furthest following-interval becomes. See the following examples for your reference.

Following-interval		When the Set Speed is:	
		50 mph (80 km/h)	65 mph (104 km/h)
Nearest		82.7 feet 25.2 meters 1.1 sec	107.1 feet 32.6 meters 1.1 sec
Mid		113.4 feet 34.6 meters 1.6 sec	147.2 feet 44.9 meters 1.6 sec
Far		144.2 feet 44.0 meters 2.0 sec	187.3 feet 57.1 meters 2.0 sec
Furthest		175.9 feet 53.6 meters 2.4 sec	229.6 feet 70.0 meters 2.4 sec



## ■ To Cancel

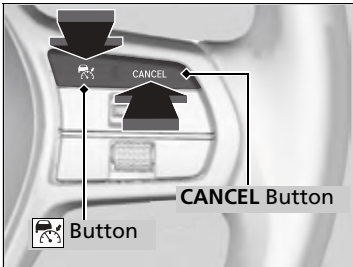

To cancel ACC, do any of the following:

- Press the **CANCEL** button.
  - ▶ The indicator (green) on the gauge changes to the indicator (white).
- Press the button.
  - ▶ indicator (green) goes off.
- Depress the brake pedal while the vehicle is moving forward.
  - ▶ The indicator (green) on the gauge changes to the indicator (white).
- Depress the clutch pedal for five seconds or more.
  - ▶ The indicator (green) on the gauge changes to the indicator (white).

## ☒ To Cancel

Resuming the prior set speed: After you have canceled ACC, you can activate the ACC with the prior set speed displayed on the gauge (in gray) by pressing the **RES/+SET/-** switch up. When you turn the ACC off by pressing the **CANCEL** button or depressing the brake pedal, the prior set speed is displayed on the gauge in gray. When pressing the **RES/+SET/-** switch up, the ACC is activated with displayed speed. If the indicator (white) is displayed and you press the **RES/+SET/-** switch up, but no prior set speed (in gray) is displayed, the speed will be set to your vehicle's current speed.



## ■ Automatic cancellation

The beeper sounds and a message appears on the driver information interface when ACC is automatically canceled. Any of these conditions may cause the ACC to automatically cancel:

- Bad weather (rain, fog, snow, etc.)
- The vehicle ahead of you cannot be detected.
- An abnormal tire condition is detected, or the tires are skidding.
- Driving on a mountainous road, or driving off road for extended periods.
- Abrupt steering wheel movement.
- When the ABS, VSA®, CMBS™, or Low Speed Braking Control is activated.
- When the VSA® system indicator comes on.
- When you manually apply the parking brake.
- When vehicle speed is less than 22 mph (35 km/h).
- Water is sprayed by or snow blown from a vehicle ahead.
- Driving into low sunlight (e.g., at dawn or dusk).
- When the detected vehicle within the ACC range is too close to your vehicle.
- When accelerating rapidly.
- The front of the camera is covered by dirt, fog, rain, mud, wet snow, seals, accessories, stickers, or film on the windshield.
- The engine is turned off.
- The vehicle is loaded heavy load in the cargo area or rear seats.
- When passing through a dark place, such as tunnel.
- When the parking brake and brake system indicator (amber) comes on.
- The vehicle has repeatedly applied the brakes to maintain the set speed (for example, you are descending a long slope).
- When the system doesn't detect any driving actions from the driver for a certain amount of time while the LKAS is also activated.

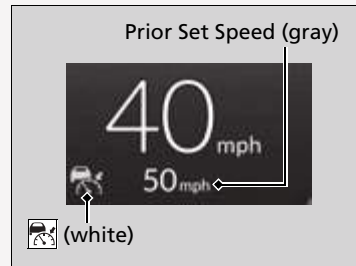
## ▶▶ To Cancel



The set speed cannot be set or resumed when ACC has been turned off using the  button. Press the  button to activate the system, then set the desired speed.

If the vehicle speed is less than 25 mph (40 km/h) you cannot resume.

- The engine speed goes into the tachometer red zone.
- The engine speed goes to below 1,000 rpm.
- You shift into neutral temporarily when shifting into a higher or lower gear.
- When the transmission is put into **N** without depressing the clutch pedal.

## ■ To Switch ACC to Cruise Control

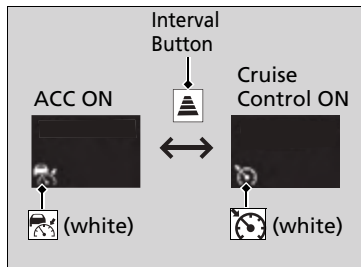

Press and hold the Interval button for one second. **Cruise mode selected** appears on the driver information interface for two seconds, and then the mode switches to Cruise.

The  indicator comes on.

- Green: The system is on.
- White: The system is standby.

To switch back to ACC, press and hold the Interval button again for one second.

### ■ When to use

Desired speed in a range above roughly 25 mph (40 km/h).

## ■ To Set the Vehicle Speed

Take your foot off the pedal and press the **RES/+ / SET / -** switch up or down when you reach the desired speed.

The moment you release the **RES/+ / SET / -** switch, the set speed is fixed, and cruise control begins. The color of  indicator changes from white to green.

When you use cruise control, Straight Driving Assist (a feature of the Electric Power Steering system) is activated.

By enabling the steering system to automatically compensate for natural steering pull, Straight Driving Assist makes it easier for you to keep your vehicle in a straight line.

## ▶▶ To Switch ACC to Cruise Control

Always be aware which mode you are in. When you are driving in Cruise mode, the system will not assist you to maintain a following-interval from a vehicle ahead of you.

You cannot switch ACC to Cruise Control in the following situations:

- When the vehicle speed is set.
- When ACC is not activated.

You can switch the displayed set speed measurements on the driver information interface or audio/information screen between mph and km/h.

▶▶ **Speed/Distance Units** P. 123









▶▶ **Customized Features** P. 359

## ■ To Adjust the Vehicle Speed

- Each time you press the **RES/+SET/-** switch up or down, the vehicle speed is increased or decreased by about 1 mph or 1 km/h accordingly.
- If you keep the **RES/+SET/-** switch pressed up or down, the vehicle speed increases or decreases by about 5 mph or 5 km/h accordingly.

## ■ To Cancel

To cancel cruise control, do any of the following:

- Press the **CANCEL** button.
  - ▶ The  indicator (green) on the gauge changes to the  indicator (white).
- Press the  button.
  - ▶ The  indicator (green) goes off.
- Depress the brake pedal.
  - ▶ The  indicator (green) on the gauge changes to the  indicator (white).
- Depress the clutch pedal for five seconds or more.
  - ▶ The  indicator (green) on the gauge changes to the  indicator (white).

## ▶▶ To Cancel



Resuming the prior set speed: After you have canceled cruise control, you can activate the cruise control with the prior set speed displayed on the gauge (in gray) by pressing the **RES/+SET/-** switch up while driving at a speed of at least 25 mph (40 km/h) or more.

When you turn the cruise control off by pressing the **CANCEL** button or depressing the brake pedal, the prior set speed is displayed on the gauge in gray.

When pressing the **RES/+SET/-** switch up, the cruise control is activated with displayed speed. If the  indicator (white) is displayed and you press the **RES/+SET/-** switch up, but no prior set speed (in gray) is displayed, the speed will be set to your vehicle's current speed.

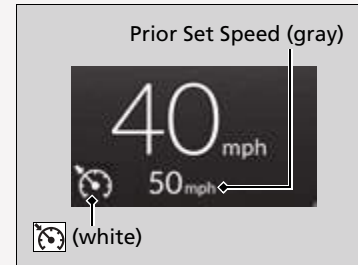
▶▶ To Cancel



The set speed cannot be set or resumed when ACC has been turned off using the  button. Press the  button to activate the system, then set the desired speed.

If the vehicle speed is less than 25 mph (40 km/h) you cannot resume.

## Lane Keeping Assist System (LKAS)

Provides steering input to help keep the vehicle in the middle of a detected lane and provides tactile and visual alerts if the vehicle is detected drifting out of its lane.

■ **Steering input assist**  
The system applies torque to the steering to keep the vehicle between the left and right lane lines. The applied torque becomes stronger as the vehicle gets closer to either of the lane lines.

■ **Front Wide View Camera**  
Monitors the lane lines

■ **Tactile and visual alerts**  
Rapid vibrations on the steering wheel and a warning display alert you that the vehicle is drifting out of a detected lane.

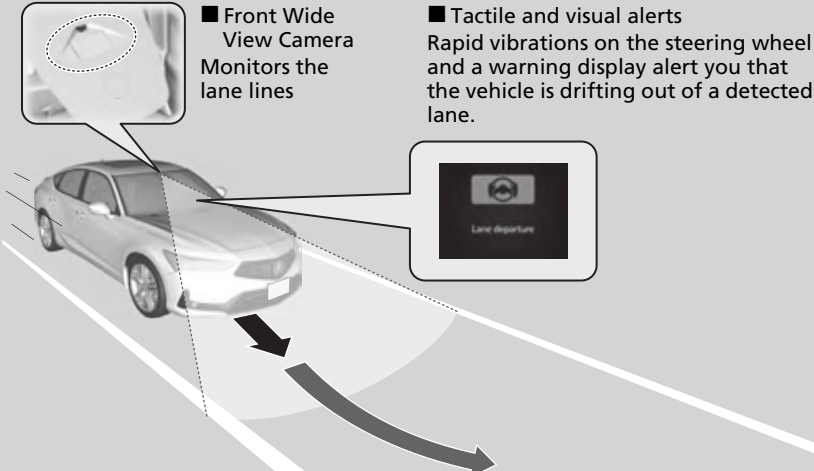

When you operate the turn signals to change lanes, the system is suspended, and resumes after the signals are off.  
If you make a lane change without operating the turn signals, the LKAS alerts activate, and torque is applied to the steering.

### ☒ Lane Keeping Assist System (LKAS)

#### Important Safety Reminders

The LKAS is for your convenience only. It is not an autonomous driving system and always requires driver attention and control. The system does not work if you take your hands off the steering wheel or fail to steer the vehicle.

The LKAS is convenient when it is used on expressways or freeways.

Do not place objects on the instrument panel. Objects may reflect on the windshield and prevent correct detection of the traffic lanes.

The LKAS only alerts you when lane drift is detected without a turn signal in use. The LKAS may not detect all lane markings or lane departures; accuracy will vary based on weather, speed, and lane marker condition.

It is always your responsibility to safely operate the vehicle and avoid collisions.

The LKAS may not work properly or may work improperly under the certain conditions:

☒ **LKAS Conditions and Limitations** P. 553

You can read about handling information for the camera equipped with this system.

☒ **Front Wide View Camera** P. 581

## ■ Lane Keep Support Function

Provides assistance to keep the vehicle in the center of the lane. When the vehicle nears a white or yellow line, steering force of the electric power steering will become stronger.

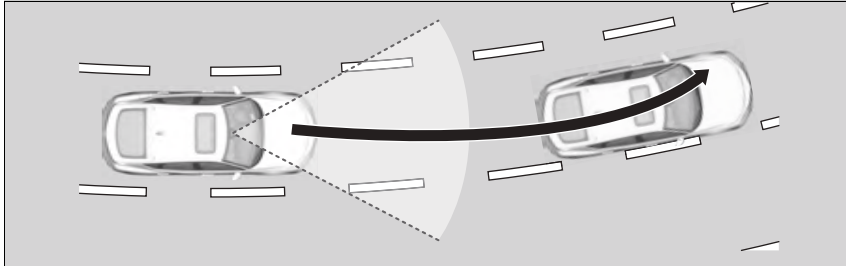

## ▣ Lane Keeping Assist System (LKAS)

When it fails to detect lanes, the system will temporarily be canceled. When a lane is detected, the system will recover automatically.

The LKAS may not function as designed while driving in frequent stop and go traffic, or on roads with sharp curves.



## ■ Lane Departure Warning Function

When the vehicle enters the warning area, the LKAS alerts you with slight steering wheel vibration as well as a warning display.

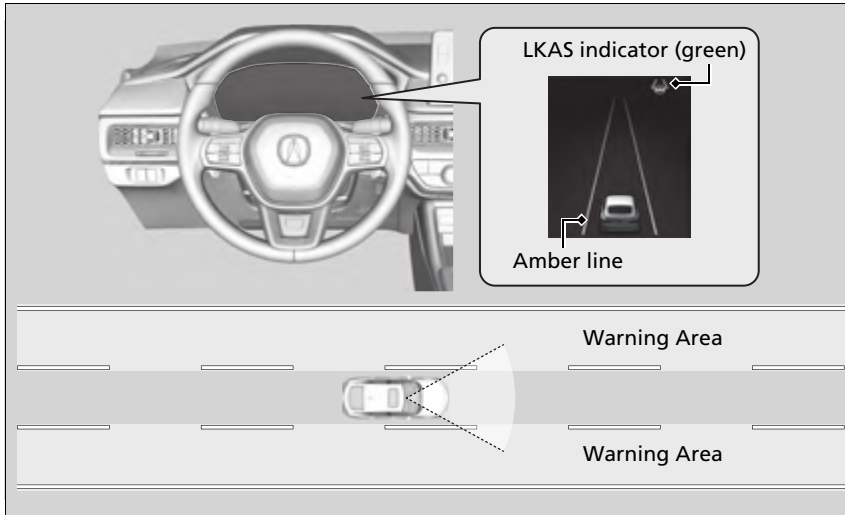

## ■ When the System can be Used

The system can be used when the following conditions are met.

- The lane in which you are driving has detectable lane markers on both sides, and your vehicle is in the center of the lane.
- The vehicle is traveling between about 45 and 90 mph (72 and 145 km/h).
- You are driving on a straight or slightly curved road.
- The turn signals are off.
- The brake pedal is not depressed.

## ■ How to activate the system

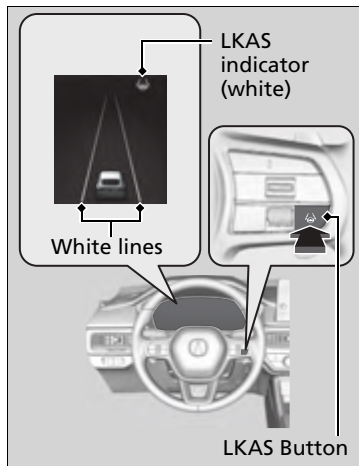

### 1. Press the LKAS button.

- ▶ LKAS indicator (white) appears on the gauge.  
The system is standby.
- ▶ If traffic lane lines are detected, white lines appear on the gauge.

## ⌘ When the System can be Used

If the vehicle drifts toward either left or right lane line due to the system applying torque, turn off the LKAS and have your vehicle checked by a dealer.

Be sure to keep the following below to activate the system properly;

- Always keep the windshield around the camera clean.
- When cleaning the windshield, be careful not to apply windshield cleanser to the camera lens.
- Do not touch the camera lens.
- Do not attach a sticker to the area around the camera.

If LKAS button is pressed when the system can be used, LKAS is on without standby.

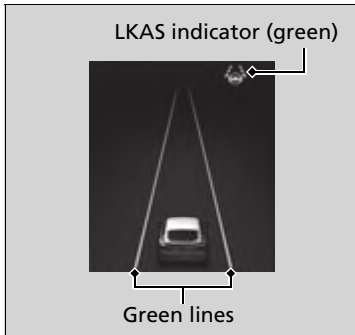

2. Keep your vehicle near the center of the lane while driving.
  - ▶ The LKAS indicator changes from white to green, and white lines change to green once the system starts operating after detecting the left and right lane markings.

## ■ To Cancel

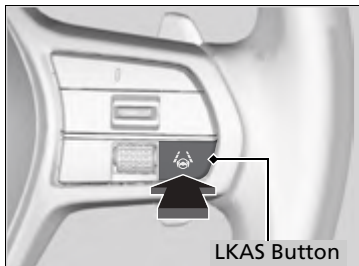

Press the LKAS button.

The LKAS is turned off every time you stop the engine, even if you turned it on the last time you drove the vehicle.

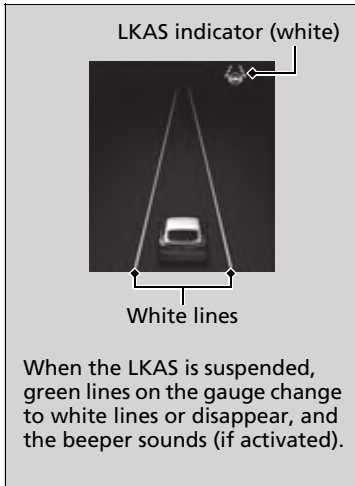

■ **The system operation is suspended if you:**

- Decrease the vehicle speed to about 40 mph (64 km/h) or less.
  - ▶ Increasing the vehicle speed to about 45 mph (72 km/h) or more resumes the LKAS.
- Depress the brake pedal.
  - ▶ The LKAS resumes and starts detecting the lane lines again once you release the brake pedal.
- Your vehicle is driving to the right or the left of the lane.

⌘ To Cancel

You can change the setting for the LKAS. LKAS suspended beep on and off can be selected.

Models with 7-in. Color Touchscreen

▶ **Vehicle Settings**\* P. 126

Models with 9-in. Color Touchscreen

▶ **Customized Features** P. 359

\* Not available on all models

Continued

■ **The LKAS may be automatically suspended when:**

- The system fails to detect lane lines.
  - The steering wheel is turned quickly.
  - You fail to steer the vehicle.
  - Driving through a sharp curve.
  - Driving at a speed in excess of approximately 94 mph (150 km/h).
- Once these conditions no longer exist, the LKAS automatically resumes.

■ **The LKAS may be automatically canceled when:**

In the following cases, traffic lane lines may disappear on the gauge, the beeper may sound, and the LKAS may automatically be canceled:

- The camera temperature gets extremely high.
- The camera behind the rearview mirror, or the area around the camera, including the windshield, gets dirty.
- The ABS or VSA® system engages.

## ■ LKAS Conditions and Limitations

The system may not detect lane markings and therefore may not keep the vehicle in the middle of the lane under certain conditions, including the following:

### ■ Environmental conditions

- There is little contrast between lane lines and the roadway surface.
- Driving in bad weather (rain, fog, snow, etc.).
- Driving on a snowy or wet roadway.
- Driving into low sunlight (e.g., at dawn or dusk).
- Shadows of adjacent objects (trees, buildings, guard rails, vehicles, etc.) are parallel to white (or yellow) lines.
- Sudden changes between light and dark, such as the entrance or exit of a tunnel or the shadows of trees, buildings, etc.
- Driving at night or in a dark place such as a tunnel (due to low-light conditions, lane lines or the road surface may not be illuminated).
- The distance between your vehicle and the vehicle ahead of you is too short, and lane lines and the road surface are not visible.
- Strong light is reflected onto the roadway.

### ■ Roadway conditions

- Driving on a road with temporary lane markings.
- Faint, multiple, or varied lane markings are visible on the roadway due to road repairs or old lane markings.

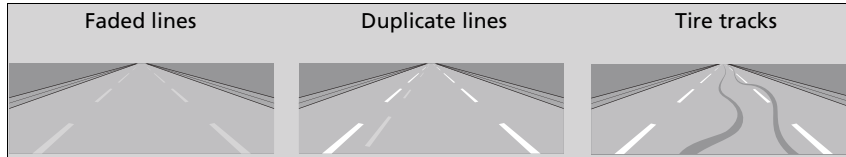

- The roadway has merging, split, or crossing lines, such as at an intersection or crosswalk.
- The lane markings are extremely narrow, wide, or changing.



- Part of the lane markings are hidden by an object, such as a vehicle.
- The road is hilly or the vehicle is approaching the crest of a hill.
- Your vehicle is strongly shaken on uneven road surfaces.



- When objects on the road (curb, guard rail, pylons, etc.) are recognized as white (or yellow) lines.
- Driving on rough or unpaved roads, or over bumpy surfaces.
- Driving on roads with double lane lines.
- Driving on snowy or slippery roads.
- The pavement is only partially visible due to snow or puddles on the road.
- There is a film of water or puddles on the road surface.
- White (or yellow) lines are not recognized correctly due to road conditions such as curves, twists, or hills.
- Driving on unpaved or rutted roads.
- Passing through an exit or an interchange.

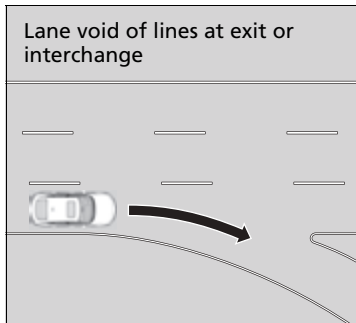

■ **Vehicle conditions**

- When lighting is weak due to dirt covering the headlight lenses, or there is poor visibility in a dark place due to the headlights being improperly adjusted.
- The front of the camera is covered by dirt, fog, rain, mud, wet snow, seals, accessories, stickers, or film on the windshield.
- Driving at night or in a dark place (e.g., a tunnel) with the headlights off.
- There is residue on the windshield from the windshield wipers.
- An abnormal tire or wheel condition (incorrect sizes, varied sizes or construction, improperly inflated, compact spare tire, etc.).
- The vehicle is tilted due to a heavy load in the cargo area or rear seats.
- The suspension has been modified.
- Tire chains are installed.

## Traffic Jam Assist\*

The Traffic Jam Assist system uses a camera mounted to the upper portion of the windshield to detect and monitor left and right white (or yellow) traffic lane lines. Based on inputs from the camera, the system can apply steering torque to keep your vehicle in the center of the detected lane.

### ■ How Traffic Jam Assist works

When you are in heavy traffic and Lane Keeping Assist System (LKAS) is active, the Traffic Jam Assist system, upon detecting the traffic lane lines, will apply steering torque to help keep your vehicle in the center of the lane.

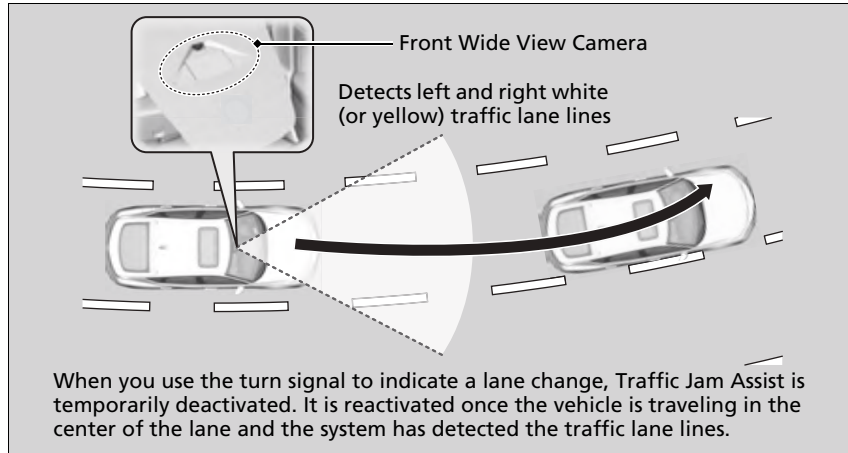

When the driver takes full control of the steering, the steering assist function is temporarily canceled.

The torque applied to the steering may not be noticeable when the driver has full control of the steering, or when the surface of the road is rough or uneven.

\* Not available on all models

*Continued*

### ☒ Traffic Jam Assist\*

#### Important Safety Reminders

Traffic Jam Assist is for your convenience only. It is not an autonomous driving system and always requires driver attention and control. The system does not work if you take your hands off the steering wheel or fail to steer the vehicle.

Traffic Jam Assist is convenient when it is used on expressways or freeways.

You can read about handling information for the camera equipped with this system.

☒ **Front Wide View Camera** P. 581

The Traffic Jam Assist only alerts you when lane drift is detected without a turn signal in use. The Traffic Jam Assist may not detect all lane markings or lane departures; accuracy will vary based on weather, speed, and lane marker condition. It is always your responsibility to safely operate the vehicle and avoid collisions.

Traffic Jam Assist may not work properly under certain conditions:

☒ **Traffic Jam Assist Conditions and Limitations** P. 562

## ■ Lane Departure Warning Function

When the vehicle enters the warning area, Traffic Jam Assist alerts you with an audible alert as well as a warning display.

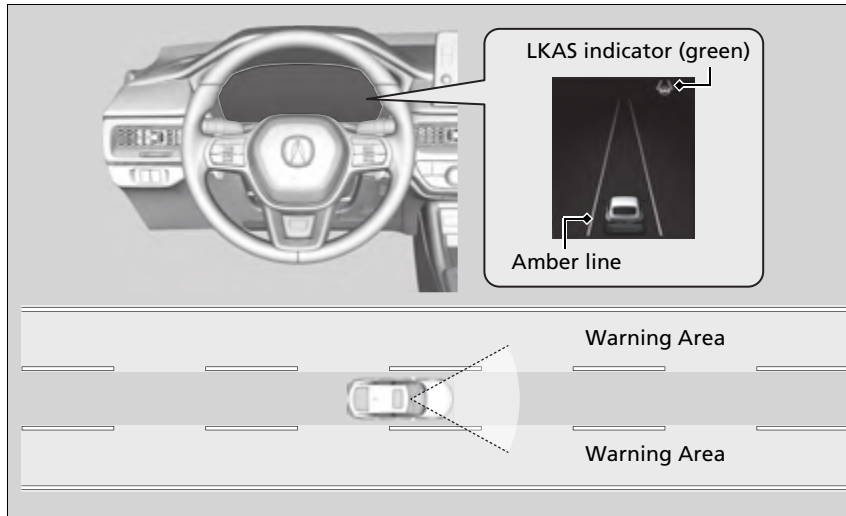

## Traffic Jam Assist Activation

Traffic Jam Assist is activated when all of the following conditions exist:

- LKAS is activated.
- The lane in which you are driving has detectable lane markers on both sides, and your vehicle is in the center of the lane.
- The vehicle is traveling between about 0 and 45mph (0 and 72km/h).
- You are driving on a straight or slightly curved road.
- The driver is gripping the steering wheel.
- The shift position is in **D** or **S**.

Do not use Traffic Jam Assist in any of the following situations:

- You are traveling on a road with sharp curves.
  - ▶ The system may not allow your vehicle to respond in a manner best suited for the road conditions.
- You are entering a toll booth, interchange, service area, or parking area.
- You are driving in adverse weather (rain, fog, snow, etc.).
- The surface of the road is slippery; for example, it is icy or covered with snow.
  - ▶ The tires may slip, causing you to lose control of the vehicle.

\* Not available on all models

*Continued*

### ▶▶ Traffic Jam Assist Activation

Refer to the following page for proper handling of the Lane Keeping Assist System (LKAS):

▶ **Lane Keeping Assist System (LKAS)** P. 545

Refer to the following page for steering buttons and displays:

▶ **Operation Switches for the Adaptive Cruise Control (ACC) with Low Speed Follow\*/Adaptive Cruise Control (ACC)\*/Lane Keeping Assist System (LKAS)/Traffic Jam Assist\*** P. 479

## ■ How Traffic Jam Assist Works

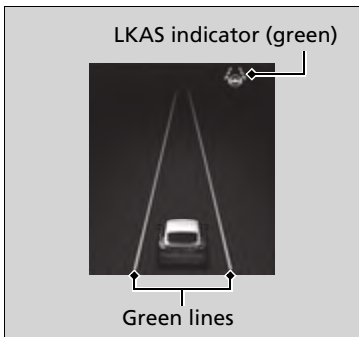

Keep your vehicle near the center of the lane while driving.

- ▶ The LKAS indicator changes from white to green, and white lines change to green once the system starts operating after detecting the left and right lane markings.

## ☒ How Traffic Jam Assist Works

If your vehicle veers too far to the right or the left of the white (or yellow) traffic lane lines while Traffic Jam Assist is active, deactivate Traffic Jam Assist and have your vehicle inspected by a dealer.

In some cases the system cannot properly detect the traffic lane lines and, as a result, will not provide steering assistance.

### ☒ Traffic Jam Assist Conditions and Limitations P. 562

If the driver takes their hands off the steering wheel or does not adequately maintain control of steering, the warning below will appear.



If the driver does not grip the steering wheel after the warning above has repeatedly appeared, a warning buzzer will sound and Traffic Jam Assist will be canceled.

## ■ Canceling Traffic Jam Assist

Press the LKAS button to cancel Traffic Jam Assist.

### ■ Traffic Jam Assist may be automatically suspended when:

The system is automatically temporarily canceled under the following circumstances.

- The system fails to detect lane lines.
- The steering wheel is turned sharply.
- You fail to steer the vehicle.
- You are driving through a sharp curve.
- The brake pedal is depressed.

Once these conditions no longer exist, Traffic Jam Assist automatically resumes.

### ■ Traffic Jam Assist may be automatically canceled when:

The traffic lane lines will disappear from the screen, the beeper may sound, and Traffic Jam Assist will be canceled under the following circumstances:

- The temperature of the camera is too high.
- The camera behind the rearview mirror, or the area around the camera, including the windshield, is dirty.

### ☒ Traffic Jam Assist may be automatically suspended when:

You are traveling over 45mph (72km/h).

- ▶ When the speed of the vehicle reaches 45mph (72km/h), Traffic Jam Assist is deactivated and LKAS is activated instead. Once the speed of the vehicle drops to under 40 mph (64 km/h), Traffic Jam Assist is reactivated.

*Continued*

## ■ Traffic Jam Assist Conditions and Limitations

The system may not detect lane markings and therefore may not keep the vehicle in the middle of the lane under certain conditions, including the following:

### ■ Environmental conditions

- There is little contrast between lane lines and the roadway surface.
- Driving in bad weather (rain, fog, snow, etc.).
- Driving on a snowy or wet roadway.
- Driving into low sunlight (e.g., at dawn or dusk).
- Shadows of adjacent objects (trees, buildings, guard rails, vehicles, etc.) are parallel to white (or yellow) lines.
- Sudden changes between light and dark, such as the entrance or exit of a tunnel or the shadows of trees, buildings, etc.
- Driving at night or in a dark place such as a tunnel (due to low-light conditions, lane lines or the road surface may not be illuminated).
- When the lane lines or road surface are not visible, such as when the distance to the vehicle in front of you is extremely short or when at an intersection.
- Strong light is reflected onto the roadway.



■ **Roadway conditions**

- Driving on a road with temporary lane markings.
- Faint, multiple, or varied lane markings are visible on the roadway due to road repairs or old lane markings.

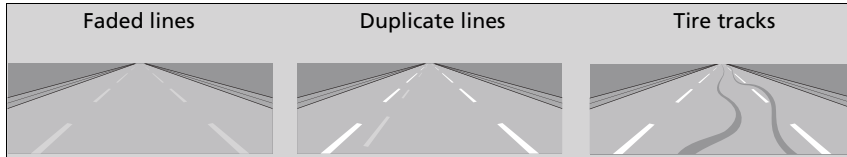

- The roadway has merging, split, or crossing lines, such as at an intersection or crosswalk.
- The lane markings are extremely narrow, wide, or changing.



- Part of the lane markings are hidden by an object, such as a vehicle.
- The road is hilly or the vehicle is approaching the crest of a hill.
- Your vehicle is strongly shaken on uneven road surfaces.

- When objects on the road (curb, guard rail, pylons, etc.) are recognized as white (or yellow) lines.
- Driving on rough or unpaved roads, or over bumpy surfaces.
- Driving on roads with double lane lines.
- Driving on snowy or slippery roads.
- The pavement is only partially visible due to snow or puddles on the road.
- There is a film of water or puddles on the road surface.
- White (or yellow) lines are not recognized correctly due to road conditions such as curves, twists, or hills.
- Driving on unpaved or rutted roads.
- Passing through an exit or an interchange.

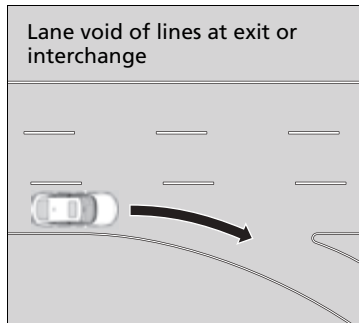

■ **Vehicle conditions**

- When lighting is weak due to dirt covering the headlight lenses, or there is poor visibility in a dark place due to the headlights being improperly adjusted.
- The front of the camera is covered by dirt, fog, rain, mud, wet snow, seals, accessories, stickers, or film on the windshield.
- Driving at night or in a dark place (e.g., a tunnel) with the headlights off.
- There is residue on the windshield from the windshield wipers.
- An abnormal tire or wheel condition (incorrect sizes, varied sizes or construction, improperly inflated, compact spare tire, etc.).
- The vehicle is tilted due to a heavy load in the cargo area or rear seats.
- The suspension has been modified.
- Tire chains are installed.

## Road Departure Mitigation System

Alerts and helps assist you when the system detects a possibility of your vehicle crossing over detected lane markings, or approaching the outer edge of the pavement (into grass or gravel border) or a detected oncoming vehicle.

### ⌘ Road Departure Mitigation System

#### **Important Safety Reminder**

Like all assistance systems, the Road Departure Mitigation system has limitations. Overreliance on the Road Departure Mitigation system may result in a collision. It is always your responsibility to keep the vehicle within your driving lane.

The Road Departure Mitigation system alerts you when the system detects that you are approaching the outer edge of the pavement (into grass or gravel border), an oncoming vehicle, or drifting into another lane without using a turn signal.

The Road Departure Mitigation system may not detect all lane markings or every instance of lane drift.

The Road Departure Mitigation system may not detect that you are approaching the outer edge of the pavement (bordered by grass or gravel) or an oncoming vehicle.

The Road Departure Mitigation system may not be able to assist you depending on weather, speed or road conditions.

The Road Departure Mitigation system is not activated for about 15 seconds after the engine starts.

You can read about handling information for the camera equipped with this system.

⌘ **Front Wide View Camera** P. 581

The Road Departure Mitigation system may not work properly or may work improperly under the certain conditions:

⌘ **Road Departure Mitigation system Conditions and Limitations** P. 570

## How the System Works

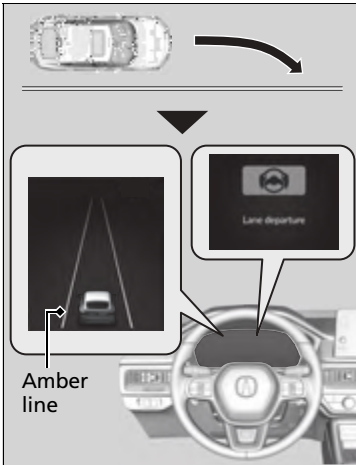

The front wide view camera behind the rearview mirror monitors left and right lane markings in white or yellow, the outer edge of the pavement (bordered by grass or gravel) or a detected oncoming vehicles.

If your vehicle approaches any detected lane markings, the outer edge of the pavement (bordered by grass or gravel) or a detected oncoming vehicles when the turn signals have not been engaged, the system activates.

- ▶ If the system cannot detect lane markings (in white or yellow), no assistance will be provided to avoid approaching oncoming vehicles. In addition to a visual alert, the system assists with steering and alerts you with rapid steering wheel vibrations to help you remain within the detected lane.

Models with 7-in. Color Touchscreen

▶ **Vehicle Settings**\* P. 126

Models with 9-in. Color Touchscreen

▶ **Customized Features** P. 359

As a visual alert, the **Lane departure** message appears on the driver information interface.

## ⌘ Road Departure Mitigation System

There are times when you may not notice the Road Departure Mitigation system functions due to your operation of the vehicle, or road surface conditions.

You can change the settings for the Road Departure Mitigation system.

If LKAS is off, the message below may appear if the system has determined that there is a possibility of your vehicle crossing over detected lane markings, the outer edge of the pavement (into a grass or gravel border) or oncoming vehicle.

Models with 7-in. Color Touchscreen

▶ **Vehicle Settings**\* P. 126

Models with 9-in. Color Touchscreen

▶ **Customized Features** P. 359



\* Not available on all models

The system cancels assisting operations when you turn the steering wheel to avoid crossing over detected lane markings or approaching the outer edge of the pavement (into grass or gravel border) or an oncoming vehicle.

If the system operates several times without detecting driver response, the system beeps to alert you.

### ■ How the System Activates

The system activates when all of the following conditions are met:

- The outer edge of the pavement is grass or gravel border.
- The vehicle is traveling between about 45 and 90 mph (72 and 145 km/h).
- The vehicle is on a straight or slightly curved road.
- The turn signals are off.
- The system makes a determination that the driver is not actively accelerating, braking, or steering.

### ▣ How the System Activates

The Road Departure Mitigation system may automatically shut off and the safety support indicator (amber) comes and stays on.

▣ **Indicators** P. 84

The Road Departure Mitigation system function can be impacted when the vehicle is:

- Driven on the inside edge of a curve, or outside of a lane.
- Driven in a narrow lane.

## Road Departure Mitigation system On and Off

You can turn the system on and off using the driver information interface.

➤ **Switching the Display** P. 112

➤ **Safety Support** P. 121

The Road Departure Mitigation system is in the previously selected on (checked) or off (unchecked) setting each time you start the engine.

### ⌘ Road Departure Mitigation system On and Off

When you have selected **Warning Only**, the system does not operate the steering wheel.

Models with 7-in. Color Touchscreen

➤ **Vehicle Settings**\* P. 126

Models with 9-in. Color Touchscreen

➤ **Customized Features** P. 359

The Vehicle Stability Assist™ (VSA®) system, Adaptive Cruise Control (ACC)\*, Adaptive Cruise Control (ACC) with Low Speed Follow\* and safety support indicators may come on in amber along with a message in the gauge when you set the power mode to ON after reconnecting the battery.

Drive a short distance at more than 12 mph (20 km/h). Each indicator should go off. If any do not, have your vehicle checked by a dealer.

## ■ Road Departure Mitigation system Conditions and Limitations

The system may not properly detect lane markings (in white or yellow), the outer edge of the pavement (into grass or gravel border) or an oncoming vehicle under certain conditions. Some examples of these conditions are listed below.

### ■ Environmental conditions

- There is little contrast between lane lines and the roadway surface.
- Driving in bad weather (rain, fog, snow, etc.).
- Driving on a snowy or wet roadway.
- Driving into low sunlight (e.g., at dawn or dusk).
- Shadows of adjacent objects (trees, buildings, guard rails, vehicles, etc.) are parallel to white (or yellow) lines.
- Sudden changes between light and dark, such as the entrance or exit of a tunnel or the shadows of trees, buildings, etc.
- Strong light is reflected onto the roadway.
- Driving at night or in a dark place such as a tunnel (due to low-light conditions, lane lines, the road surface, or oncoming vehicles may not be illuminated).
- The distance between your vehicle and the vehicle ahead of you is too short, and lane lines and the road surface are not visible.
- The outer edge of the road is bordered by objects, materials, etc. other than grass or gravel.



**■ Roadway conditions**

- Driving on a road with temporary lane markings.
- Faint, multiple, or varied lane markings are visible on the roadway due to road repairs or old lane markings.
- The roadway has merging, split, or crossing lines, such as at an intersection or crosswalk.
- The lane markings are extremely narrow, wide, or changing.
- Part of the lane markings are hidden by an object, such as a vehicle.
- The road is hilly or the vehicle is approaching the crest of a hill.
- Your vehicle is strongly shaken on uneven road surfaces.
- When objects on the road (curb, guard rail, pylons, etc.) are recognized as white (or yellow) lines.
- Driving on rough or unpaved roads, or over bumpy surfaces.
- Driving on roads with double lane lines.
- Driving on snowy or slippery roads.
- Passing through an exit or an interchange.
- The pavement is only partially visible due to snow or puddles on the road.
- Driving on unpaved or rutted roads.
- White (or yellow) lines are not recognized correctly due to road conditions such as curves, twists, or hills.

### ■ Vehicle conditions

- When lighting is weak due to dirt covering the headlight lenses, or there is poor visibility in a dark place due to the headlights being improperly adjusted.
- The front of the camera is covered by dirt, fog, rain, mud, wet snow, seals, accessories, stickers, or film on the windshield.
- Driving at night or in a dark place (e.g., a tunnel) with the headlights off.
- When the driver operates the brake pedal and steering wheel.
- There is residue on the windshield from the windshield wipers.
- An abnormal tire or wheel condition (incorrect sizes, varied sizes or construction, improperly inflated, compact spare tire, etc.).
- The vehicle is tilted due to heavy load in the cargo area or rear seats.
- Tire chains are installed.
- The suspension has been modified.

### ■ Examples of limitations on detection due to the condition of oncoming vehicles

- The oncoming vehicle or vehicle ahead of you is sideways.
- The oncoming vehicle jumps out in front of you.
- When the oncoming vehicle blends in with the background, preventing the system from recognizing it.
- The headlights of an oncoming vehicle are lit on one side or not lit on either side in a dark place.
- The distance between your vehicle and the oncoming vehicle is too short.
- Part of the oncoming vehicle is not visible due to the vehicle ahead of you.
- There are multiple oncoming lanes or turning lanes.
- The vehicle in the adjacent lane is parked or moving at an extremely slow speed.

■ **Examples of other limitations on detection or system operation**

- When the oncoming vehicle is specially-shaped.
- When the camera cannot correctly identify the shape of the oncoming vehicle.

■ **With Little Chance of a Collision**

The Road Departure Mitigation system may activate in the below conditions.

- When driving through curves, your vehicle comes to a point where an oncoming vehicle is right in front of you.

## Traffic Sign Recognition System

Reminds you of road sign information, such as the current speed limit your vehicle has just passed through, showing it on the gauge and the head-up display\*.

### ■ How the System Works

When the camera located behind the rearview mirror captures traffic signs while driving, the system displays the ones that are recognized as designated for your vehicle. The sign icon will be displayed until the vehicle reaches a predetermined time and distance.

If the system does not detect any traffic signs while you are driving, the sign icon will not be displayed.

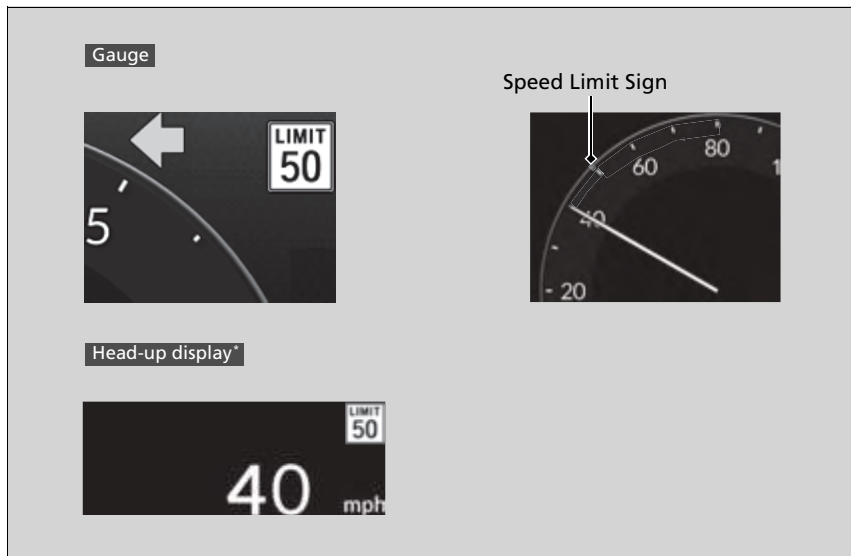

### ⌘ Traffic Sign Recognition System

Not all signs may be displayed, but any signs posted on roadsides should not be ignored. The system does not work on the designated traffic signs of all the countries you travel, nor in all situations. Do not rely too much on the system. Always drive at speeds appropriate for the road conditions.

Never apply a film or attach any objects to the windshield that could obstruct the camera's field of vision and cause the system to operate abnormally. Scratches, nicks, and other damage to the windshield within the camera's field of vision can cause the system to operate abnormally. If this occurs, we recommend that you replace the windshield with a genuine Acura replacement windshield. Making even minor repairs within the camera's field of vision or installing an aftermarket replacement windshield may also cause the system to operate abnormally. After replacing the windshield, have a dealer recalibrate the camera. Proper calibration of the camera is necessary for the system to operate properly.

The traffic sign recognition system is not activated for about 15 seconds after the engine starts.

You can read about handling information for the camera equipped with this system.

➡ **Front Wide View Camera** P. 581

The sign icon also may switch to another one, or disappear when:

- The end of speed limit or other designated limit is detected.
- You make a turn with a turn signal at an intersection.

☒ Traffic Sign Recognition System

You can turn the traffic sign recognition system on and off.

Models with 7-in. Color Touchscreen

➤ **Vehicle Settings\*** P. 126

Models with 9-in. Color Touchscreen

➤ **Customized Features** P. 359

To help reduce the likelihood that high interior temperatures will cause the camera's sensing system to shut off, when parking, find a shady area or face the front of the vehicle away from the sun. If you use a reflective sun shade, do not allow it to cover the camera housing.

Covering the camera can concentrate heat on it.

If your vehicle exceeds the detected speed limit, an icon representing the speed limit sign for the current area will blink in the display.

Models with 7-in. Color Touchscreen

➤ **Vehicle Settings\*** P. 126

Models with 9-in. Color Touchscreen

➤ **Customized Features** P. 359

\* Not available on all models

*Continued*

## ▶▶ Traffic Sign Recognition System

The system's ability to accurately notify the driver of the speed limit is dependent on certain conditions such as the units displayed on the traffic sign as well as the speed and direction of travel of the vehicle. In some cases, the system may display false warnings or other inaccurate information.

### ▶▶ **Traffic Sign Recognition System Conditions and Limitations** P. 577

The unit for speed limits (mph or km/h) varies from country to country. Just after entering a country whose unit differs to the one of the country from which you came, Traffic Sign Recognition System may not work correctly.

### ▶▶ **Speed/Distance Units** P. 123

Models with 7-in. Color Touchscreen

### ▶▶ **Vehicle Settings\*** P. 126

Models with 9-in. Color Touchscreen

### ▶▶ **Customized Features** P. 359

## ■ Traffic Sign Recognition System Conditions and Limitations

The traffic sign recognition system may not be able to recognize a traffic sign in the following cases.

### ■ Environmental conditions

- Driving into low sunlight (e.g., at dawn or dusk).
- Strong light is reflected onto the roadway.
- Driving at night, in dark areas such as long tunnels.
- Driving in bad weather (rain, fog, snow, etc.).
- Sudden changes between light and dark, such as the entrance or exit of a tunnel or the shadows of trees, buildings, etc.
- Water is sprayed by or snow blown from a vehicle ahead.

### ■ Roadway conditions

- Your vehicle is strongly shaken on uneven road surfaces.

### ■ Vehicle conditions

- When lighting is weak due to dirt covering the headlight lenses, or there is poor visibility in a dark place due to the headlights being improperly adjusted.
- The front of the camera is covered by dirt, fog, rain, mud, wet snow, seals, accessories, stickers, or film on the windshield.
- There is residue on the windshield from the windshield wipers.
- An abnormal tire or wheel condition (incorrect sizes, varied sizes or construction, improperly inflated, compact spare tire, etc.).
- The vehicle is tilted due to heavy load in the cargo area or rear seats.
- The suspension has been modified.
- Tire chains are installed.
- Driving at night or in a dark place (e.g., a tunnel) with the headlights off.

\* Not available on all models

### ⊠ Traffic Sign Recognition System Conditions and Limitations

When the traffic sign recognition system malfunctions,  appears on the gauge and the head-up display\*. If this message does not disappear, have your vehicle checked by a dealer.

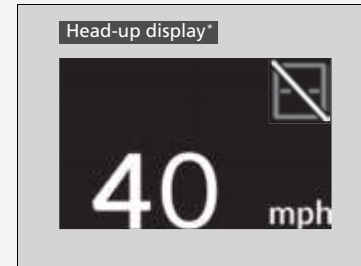

■ **The position or the condition of the traffic sign**

- The sign is in a place that makes it hard to find.
- The sign is located far away from your vehicle.
- The sign is located where it is hard for headlight beams to reach.
- The sign is on a corner or bend in the road.
- The sign is faded or bent.
- The sign is rotated or damaged signs.
- The sign is covered with mud, snow, or frost.
- Part of the sign is hidden by the trees, or is in the shadow of a vehicle or other object.
- Light (such as a streetlight) is reflected on the surface of the sign, or it is hidden in shadow.
- The sign is too bright or too dark (electric signs).
- Small signs (auxiliary signs, etc.).

■ **Other conditions**

- When you are driving at a high speed.



The traffic sign recognition system may not operate correctly, such as displaying signs that do not adhere to the actual regulations for the roadway or do not exist at all in the following cases.

- ▶ A speed limit sign may display at a higher or lower speed than the actual speed limit.
- There is a supplementary sign with further information such as weather, time, vehicle type, school zone, etc.
- Figures on the sign are hard to read (electric signs, numbers on the sign are blurred, etc.).
- The sign is in the vicinity of the lane you are driving in, even though it is not for the lane, such as a speed limit sign situated at an exit or an intersection between the side road and the main road.
- There are things that look similar in color or shape to recognized objects (similar sign, electric sign, signboard, structure, etc.).

## ■ Signs Displayed on the Gauge and Head-up Display\*

The speed limit sign icon is displayed on the screen.

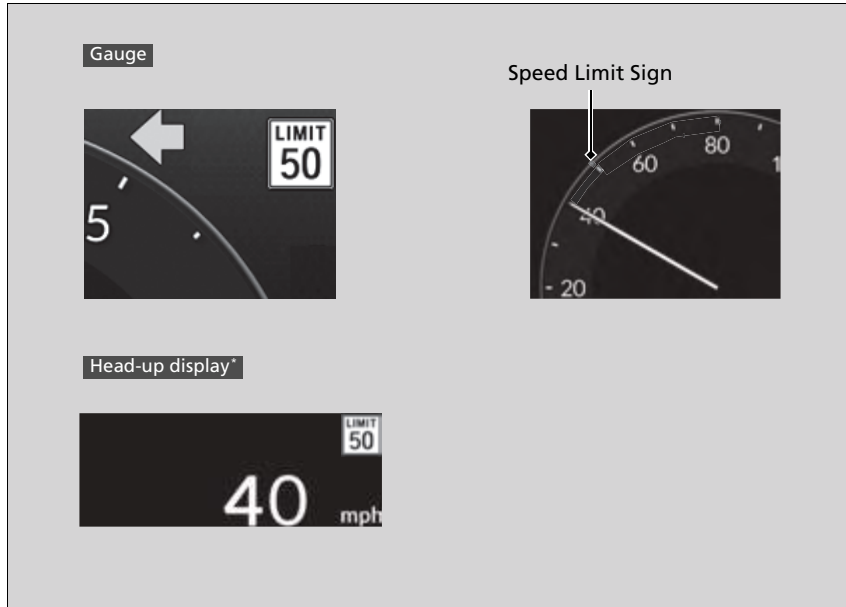

## Front Wide View Camera

The camera, used in systems such as Lane Keeping Assist System (LKAS), Road Departure Mitigation system, Adaptive Cruise Control (ACC) with Low Speed Follow\*, Adaptive Cruise Control (ACC)\*, Traffic Sign Recognition system, CMBS™, and Traffic Jam Assist\*, is designed to detect an object that triggers any of the systems to operate their functions.

### ■ Camera Location and Handling Tips

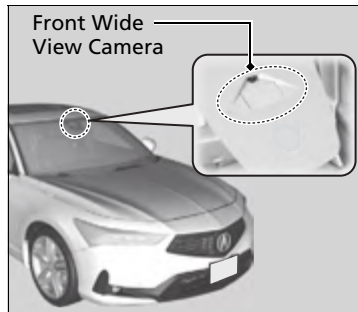

This camera is located behind the rearview mirror.

To help reduce the likelihood that high interior temperatures will cause the camera's sensing system to shut off, when parking, find a shady area or face the front of the vehicle away from the sun. If you use a reflective sun shade, do not allow it to cover the camera housing. Covering the camera can concentrate heat on it.

### ▣ Front Wide View Camera

Never apply a film or attach any objects to the windshield, the hood, or the front grille that could obstruct the camera's field of vision and cause the system to operate abnormally. Scratches, nicks, and other damage to the windshield within the camera's field of vision can cause the system to operate abnormally. If this occurs, we recommend that you replace the windshield with a genuine Acura replacement windshield. Making even minor repairs within the camera's field of vision or installing an aftermarket replacement windshield may also cause the system to operate abnormally. After replacing the windshield, have a dealer recalibrate the camera. Proper calibration of the camera is necessary for the system to operate properly.

Do not place an object on the top of the instrument panel. It may reflect onto the windshield and prevent the system from detecting lane lines properly.

Front Wide View Camera

If the  **Some driver assist systems cannot operate: Camera temperature too high** message appears:

- Use the climate control system to cool down the interior and, if necessary, also use defroster mode with the airflow directed towards the camera.
- Start driving the vehicle to lower the windshield temperature, which cools down the area around the camera.

If the  **Some driver assist systems cannot operate: Clean front windshield or poor viewing condition.** message appears:

- Park your vehicle in a safe place, and make sure the windshield is clean.  
Clean the windshield if it is dirty. If the message does not disappear after driven for a while, have your vehicle checked by a dealer.

# Sonar Sensors\*

## ■ Location and range of sensors

The sonar sensors are situated in the front and rear bumpers, and the front grille.

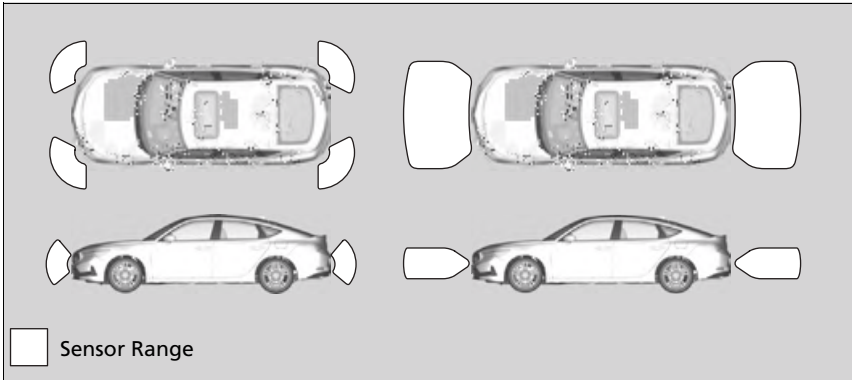
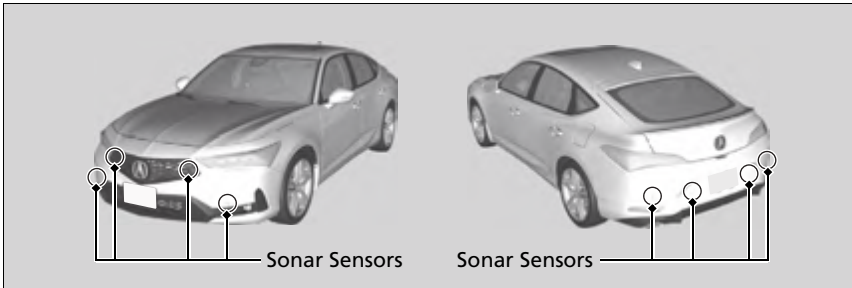

## ▣ Sonar Sensors\*

For the sonar sensors to work properly, do not:

- Place stickers or other objects on or around the sensors.
- Hit the area around the sensors.
- Attempt to take apart any sensor.
- Put any accessories on or around the sensors.

Consult with a dealer if:

- A sensor has been subjected to shock.
- Work needs to be done to the area around a sensor.

In the following cases, the sonar sensors may not work properly. Have your vehicle checked by a dealer.

- The front or rear bumper has made contact with a hill, parking block, curb, embankment, etc.
- The vehicle has been involved in frontal or rear collision.
- The vehicle has been driven through a deep puddle.

\* Not available on all models

## Brake System

### ■ Parking Brake

Use the parking brake to keep the vehicle stationary when parked. When the parking brake is applied, you can manually or automatically release it.

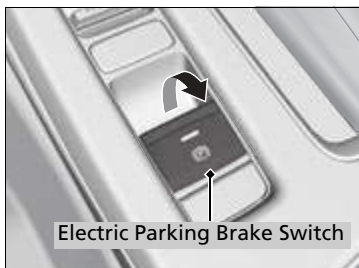

#### ■ To apply

The electric parking brake can be applied any time the vehicle has battery, no matter which position the power mode is in.

Pull the electric parking brake switch up gently and securely.

- ▶ The indicator in the switch comes on.
- ▶ The parking brake and brake system indicator (red) comes on.

#### ■ To release

The power mode must be in ON in order to release the electric parking brake.

1. Depress the brake pedal.
2. Press the electric parking brake switch.
  - ▶ The indicator in the switch goes off.
  - ▶ The parking brake and brake system indicator (red) goes off.

Manually releasing the parking brake using the switch helps your vehicle start slowly and smoothly when facing downhill on steep hills.

### ⊠ Parking Brake

You may hear the electric parking brake system motor operating from the rear wheel area when you apply or release the parking brake. This is normal.

The brake pedal may slightly move due to the electric parking brake system operation when you apply or release the parking brake. This is normal.

You cannot apply or release the parking brake if the battery goes dead.

➤ **If the Battery Is Dead** P. 694

**If you pull up and hold the electric parking brake switch while driving, the brakes on all four wheels are applied by the VSA® system until the vehicle comes to a stop. The electric parking brake then applies, and the switch should be released.**

Continuously variable transmission models

**Automatic parking brake feature operation**

If the automatic parking brake feature has been activated:

- The parking brake is applied automatically when you set the power mode to VEHICLE OFF.
- To confirm that the parking brake is applied, check if the parking brake and brake system indicator (red) is on.

➤ **Activating and deactivating the automatic parking brake feature** P. 587

**To release automatically**

Continuously variable transmission models

Depressing the accelerator pedal releases the parking brake.

Use the accelerator pedal to release the parking brake when you are starting the vehicle facing uphill, or in a traffic jam.

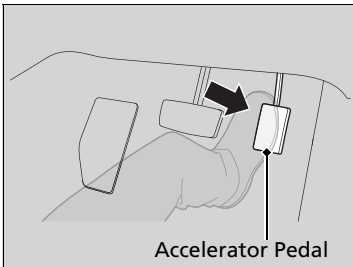

Gently depress the accelerator pedal.

When on a hill, it may require more accelerator input to release.

- ▶ The parking brake and brake system indicator (red) goes off.

You can release the parking brake automatically when:

- You are wearing the driver's seat belt.
- The engine is running.
- The transmission is not in **P** or **N**.

▶▶ Parking Brake

In the following situations, the parking brake automatically operates.

- When the vehicle stops with the automatic brake hold system activated for more than 10 minutes.
- When the driver's seat belt is unfastened while your vehicle is stopped and brake hold is applied.
- When the engine is turned off, except by Auto Idle Stop system, while brake hold system is applied.
- When there is a problem with the brake hold system while brake hold is applied.

Models with Adaptive Cruise Control (ACC) with Low Speed Follow

- When the vehicle stops more than 10 minutes while Adaptive Cruise Control (ACC) with Low Speed Follow is activated.
- When the driver's seat belt is unfastened while your vehicle is stopped automatically by ACC with Low Speed Follow.
- When the engine is turned off, except by Auto Idle Stop system, while ACC with Low Speed Follow is activated.

**Manual transmission models**

Depress the accelerator pedal while releasing the clutch pedal releases the parking brake.

Use the accelerator pedal to release the parking brake when you are starting the vehicle facing uphill, or in a traffic jam.

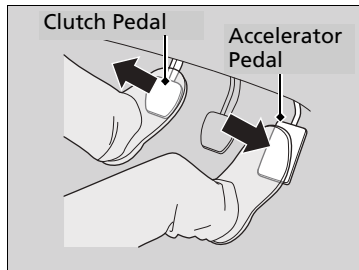

Gently depress the accelerator pedal and release the clutch pedal.

- The parking brake and brake system indicator (red) goes off.

The parking brake automatically releases as you depress the accelerator pedal when:

- You are wearing the driver's seat belt.
- The engine is running.
- The transmission is not in **N**.

**►► Parking Brake**

If the parking brake cannot be released automatically, release it manually.

When the vehicle is traveling uphill, the accelerator pedal may need to be pressed farther to automatically release the electric parking brake.

The parking brake cannot be released automatically while the following indicators are on:

- Malfunction indicator lamp
- Transmission system indicator\*

The parking brake may not be released automatically while the following indicators are on:

- Parking brake and brake system indicator (red)
- VSA® system indicator
- **ABS** indicator
- Supplemental restraint system indicator

**Manual transmission models**

The clutch pedal is fully depressed before gently depress the accelerator pedal and release the clutch pedal.



Continuously variable transmission models

**■ Activating and deactivating the automatic parking brake feature**

With the power mode is in ON, carry out the following steps to either activate or deactivate the automatic parking brake feature.

1. Put the transmission into **P**.
2. Without depressing the brake pedal, pull up and release the electric parking brake switch.
  - ▶ Check that the parking brake and brake system indicator (red) has come on.
3. Pull up and hold the electric parking brake switch. When you hear a beeping sound, release the switch and within 3 seconds pull up and hold the switch again.
4. When you hear a sound indicating that the procedure is completed, release the switch.
  - ▶ Two beeps indicates that the feature has been activated.
  - ▶ One beep indicates that the feature has been deactivated.
  - ▶ When you have completed activating the feature, the parking brake will remain applied after you turn off the engine.
  - ▶ To confirm that the parking brake is applied, check if the parking brake and brake system indicator (red) is on.

If you need to temporarily deactivate the feature while putting your vehicle through a conveyor type car wash, you can follow the procedure explained below.

1. Depress the brake pedal and bring the vehicle to a stop.
2. Set the power mode to VEHICLE OFF and then within 2 seconds push down the electric parking brake switch.
  - ▶ Activation and deactivation settings for the feature will not be affected.
  - ▶ Before temporarily deactivating the feature, make sure to first turn off both Adaptive Cruise Control (ACC) with Low Speed Follow and the automatic brake hold system.

⌘ Parking Brake

In cold climates, the parking brake may freeze in place if applied.

When parking the vehicle, chock the wheels and make sure the automatic parking brake feature is deactivated.

Also, when putting your vehicle through a conveyor-type car wash or when having your vehicle towed, deactivate the automatic parking brake feature and leave the parking brake released.

- To confirm that the parking brake is applied, check if the parking brake and brake system indicator (red) is on.

## ■ Foot Brake

Your vehicle is equipped with disc brakes at all four wheels. A vacuum power assist helps to reduce the effort needed on the brake pedal. The brake assist system increases the stopping force when you depress the brake pedal hard in an emergency situation. The anti-lock brake system (ABS) helps you retain steering control when braking very hard.

➤ **Brake Assist System** P. 595

➤ **Anti-lock Brake System (ABS)** P. 594

## ☒ Foot Brake

Check the brakes after driving through deep water, or if there is a buildup of road surface water. If necessary, dry the brakes by lightly depressing the pedal several times.

If you hear a continuous metallic friction sound when applying the brakes, this is caused by the brake wear indicator rubbing on the brake rotor and indicates that the brake pads need to be replaced. Have the vehicle checked by a dealer. If you hear only an occasional squeak or squeal when you initially apply the brake pedal, this may be normal and caused by high frequency vibration of the brake pads against the rotating brake disc.

Constantly using the brake pedal while going down a long hill builds up heat, which reduces the brake effectiveness. Apply engine braking by taking your foot off the accelerator pedal and downshifting to a lower gear/speed position. With manual transmission use a lower gear for greater engine braking.

Do not rest your foot on the brake pedal while driving, as it will lightly apply the brakes and cause them to lose effectiveness over time and reduce pad life. It will also confuse drivers behind you.

## Automatic Brake Hold

### Continuously variable transmission models

Keeps the brake applied after releasing the brake pedal until the accelerator pedal is pressed. You can use this system while the vehicle is temporarily stopped, like at traffic lights and in heavy traffic.

### Turning on the system

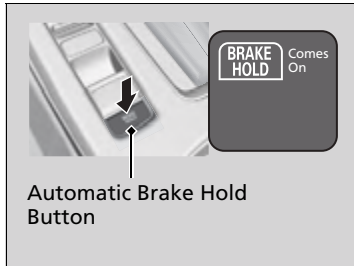

Fasten your seat belt properly, then start the engine. Press the automatic brake hold button.

- ▶ The automatic brake hold system indicator comes on. The system is turned on.

### Activating the system

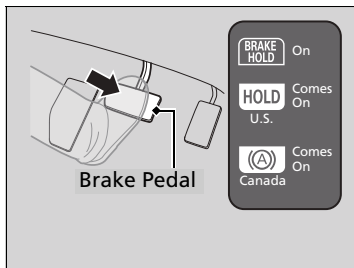

Depress the brake pedal to come to a complete stop. The transmission must not be in **P** or **R**.

- ▶ The automatic brake hold indicator comes on. Braking is kept for up to 10 minutes.
- ▶ Release the brake pedal after the automatic brake hold indicator comes on.

### Automatic Brake Hold

## ⚠ WARNING

Activating the automatic brake hold system on steep hills or slippery roads may still allow the vehicle to move if you remove your foot from the brake pedal.

If a vehicle unexpectedly moves, it may cause a crash resulting in serious injury or death.

Never activate the automatic brake hold system or rely on it to keep a vehicle from moving when stopped on a steep hill or slippery roads.

### Continuously variable transmission models

## ⚠ WARNING

Using the automatic brake hold system to park the vehicle may result in the vehicle unexpectedly moving.

If a vehicle moves unexpectedly, it may cause a crash, resulting in serious injury or death.

Never leave the vehicle when braking is temporarily kept by automatic brake hold and always park the vehicle by putting the transmission in **P** and applying the parking brake.

## ■ Canceling the system

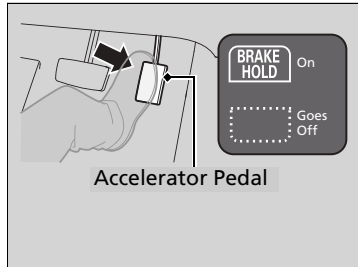

Depress the accelerator pedal while the transmission is in a position other than **P** or **N**. The system is canceled and the vehicle starts to move.

- ▶ The automatic brake hold indicator goes off. The system continues to be on.

## ⌘ Automatic Brake Hold

### ⚠ WARNING

When using the automatic brake hold, keep your foot on the brake pedal until the automatic brake hold indicator comes on. If the vehicle unexpectedly moves, it may cause a crash resulting in serious injury or death.

Release your foot from the brake pedal after the automatic brake hold indicator comes on.

While the system is activated, you can turn off the engine or park the vehicle through the same procedure as you normally do.

⚠ **When Stopped** P. 596

Whether the system is on, or the system is activated, the automatic brake hold turns off once the engine is off.

You may hear an operating noise if the vehicle moves while the automatic brake hold system is in operation.

#### Manual transmission models

The system turns off if the engine stalls while automatic brake hold is active or the system is on.

**Manual transmission models**

Keeps the brake applied after releasing the brake pedal until you shift into one of the gears other than **N** and:

- Release the clutch pedal on a level road or when facing downhill.
  - Release the clutch pedal and depress the accelerator pedal when facing uphill.
- You can use this system while the vehicle is temporarily stopped, like at traffic lights and in heavy traffic.

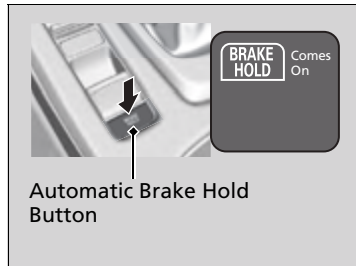
**Turning on the system**

Fasten your seat belt properly, then start the engine. Press the automatic brake hold button.

- ▶ The automatic brake hold system indicator comes on. The system is turned on.

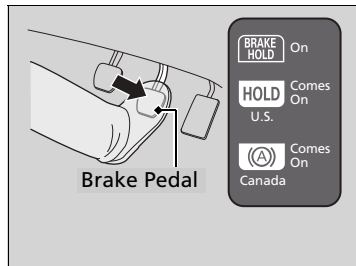
**Activating the system**

Depress the brake pedal to come to a complete stop.

- ▶ The automatic brake hold indicator comes on. Braking is kept for up to 10 minutes.
- ▶ Release the brake pedal after the automatic brake hold indicator comes on.

*Continued*

### ■ Canceling the system

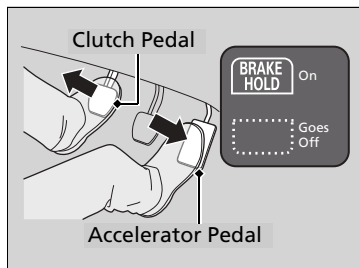

Shift into one of the gears other than **N** and:

- Release the clutch pedal on a level road or when facing downhill.
- Release the clutch pedal and depress the accelerator pedal when facing uphill. The system is canceled and the vehicle starts to move.
- The automatic brake hold indicator goes off. The system continues to be on.

### ■ The system automatically cancels when:

- You engage the parking brake.

#### Continuously variable transmission models

- You depress the brake pedal and put the transmission into **P** or **R**.

### ■ The system automatically cancels and the parking brake is applied when:

- Braking is kept for more than 10 minutes.
- The driver's seat belt is unfastened.
- The engine is turned off.
- There is a problem with automatic brake hold system.

#### Manual transmission models

- The engine stalls.

## ■ Turning off the automatic brake hold system

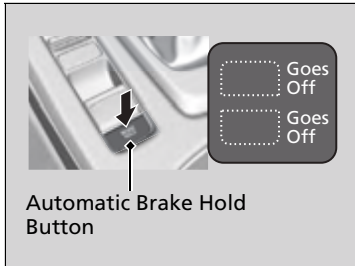

Only the automatic brake hold system indicator comes on:

- Press the automatic brake hold button.
  - ▶ The automatic brake hold system indicator goes off.

When the automatic brake hold indicator comes on at the same time:

- Press the automatic brake hold button with the brake pedal depressed.
  - ▶ The automatic brake hold system indicator and the automatic brake hold indicator go off.

## ☒ Turning off the automatic brake hold system

Make sure to turn off the automatic brake hold system before using an automated car wash.

## Anti-lock Brake System (ABS)

### ■ ABS

Helps prevent the wheels from locking up, and helps you retain steering control by pumping the brakes rapidly, much faster than you can.

The electronic brake distribution (EBD) system, which is part of the ABS, also balances the front-to-rear braking distribution according to vehicle loading.

You should never pump the brake pedal. Let the ABS work for you by always keeping firm, steady pressure on the brake pedal. This is sometimes referred to as “stomp and steer.”

### ■ ABS operation

The brake pedal may pulsate slightly when the ABS is working. Depress the brake pedal and keep holding the pedal firmly down. On dry pavement, you will need to press on the brake pedal very hard before the ABS activates. However, you may feel the ABS activate immediately if you are trying to stop on snow or ice.

ABS may activate when you depress the brake pedal when driving on:

- Wet or snow covered roads.
- Roads paved with stone.
- Roads with uneven surfaces, such as potholes, cracks, manholes, etc.

When the vehicle speed goes under 6 mph (10 km/h), the ABS stops.

### ► Anti-lock Brake System (ABS)

#### NOTICE

The ABS may not function correctly if you use a tire of the incorrect size or type.

If the **ABS** indicator comes on while driving, there may be a problem with the system. While normal braking will not be affected, there is a possibility that the ABS will not be operating. Have your vehicle checked by a dealer immediately.

The ABS is not designed for the purpose of reducing the time or distance it takes for a vehicle to stop: It is designed to limit brake lockup which can lead to skidding and loss of steering control.

In the following cases, your vehicle may need more distance to stop than a vehicle without the ABS:

- You are driving on rough or uneven road surfaces, such as gravel or snow.
- The tires are equipped with tire chains.

The following may be observed with the ABS system:

- Motor sounds coming from the engine compartment when the brakes are applied, or when system checks are being performed after the engine has been started and while the vehicle accelerates.
- Brake pedal and/or the vehicle body vibration when ABS activates.

These vibrations and sounds are normal to ABS systems and are no cause for concern.



## Brake Assist System

---

Designed to assist the driver by generating greater braking force when you depress the brake pedal hard during emergency braking.

### ■ Brake assist system operation

Press the brake pedal firmly for more powerful braking.

When brake assist operates, the pedal may wiggle slightly and an operating noise may be heard. This is normal. Keep holding the brake pedal firmly down.

## When Stopped

1. Depress the brake pedal firmly.
2. With the brake pedal depressed, pull up the electric parking brake switch slowly, but fully.

### Continuously variable transmission models

3. Change the shift position to **P**.
4. Turn off the engine.
  - ▶ The parking brake and brake system indicator (red) goes off in about 30 seconds.

### Manual transmission models

3. Move the shift lever to **N**.
4. Turn off the engine and move the shift lever to **R** or **1**.
  - ▶ The parking brake and brake system indicator (red) goes off in about 30 seconds.

### » Parking Your Vehicle

#### Continuously variable transmission models

## ⚠ WARNING

The vehicle can roll away if left unattended without confirming that Park is engaged.

A vehicle that rolls away could cause a crash resulting in serious injury or death.

Always keep your foot on the brake pedal until you have confirmed that **P** is shown on the shift position indicator.

### » When Stopped

#### Continuously variable transmission models

#### NOTICE

The following can damage the transmission:

- Depressing the accelerator and brake pedals simultaneously.
- Holding the vehicle in place when facing uphill by depressing the accelerator pedal.
- Putting the transmission into **P** before the vehicle stops completely.

Do not park your vehicle near flammable objects, such as dry grass, oil, or timber. Heat from the exhaust can cause a fire.

Always set the parking brake, in particular if you are parked on an incline.

⌘ When Stopped

In extremely cold temperatures, the parking brake may freeze up if applied. If such temperatures are expected, do not apply the parking brake but, if parking on a slope, either turn the front wheels so they will contact the curb if the vehicle rolls down the slope or block the wheels to keep the vehicle from moving. If you do not take either precaution, the vehicle may roll unexpectedly, leading to a crash.

## Parking Sensor System \*

The corner and center sensors monitor obstacles around your vehicle, and the beeper, driver information interface and audio/information screen let you know the approximate distance between your vehicle and the obstacle.

### ■ The sensor location and range

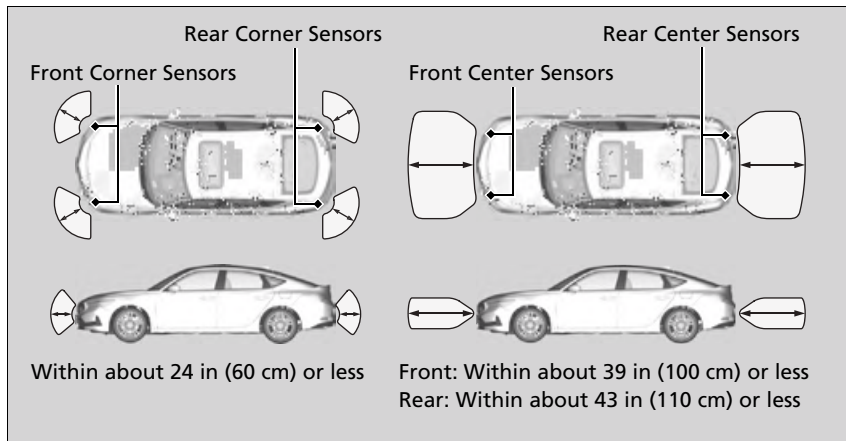

### ▣ Parking Sensor System \*

Even when the system is on, always confirm if there is no obstacle near your vehicle before parking.

The system may not work properly when:

- The sensors are covered with snow, ice, mud, or dirt.
- The vehicle has been out in hot or cold weather.
- There is something nearby that emits ultrasonic waves or high frequency sounds.
- Driving in bad weather (rain, fog, snow, etc.).
- Any accessories have been put on or around the sensors.

▶ If you put any accessories on or around the rear sensors, the system may activate if it detects these accessories as an obstacle. In this case, turn off the rear sensor.

▣ **Customized Features** P. 359

The system may not detect these obstacles:

- Thin or low objects.
- Sonic-absorptive materials, such as snow, cotton, or sponge.
- Objects directly under the bumper.

The system may falsely detect obstacles in the following situations:

- The vehicle is on uneven surface, such as grass, bumps, or a hill.
- When close to other vehicles with sonar sensors or other objects that emit ultrasonic waves.
- There is splashing water near the sensors due to heavy rains, etc.

## ■ Parking sensor system on and off

You can turn the system on and off using the driver information interface.

➤ **Switching the Display** P. 112

➤ **Safety Support** P. 121

The front corner, rear corner and rear center sensors start to detect an obstacle when the transmission is in **R**, and the vehicle speed is less than 5 mph (8 km/h).

The front corner and front center sensors start to detect an obstacle when the transmission is in any position other than **P**\* or **R**, and the vehicle speed is less than 5 mph (8 km/h).

### Manual transmission models

You also need to release the parking brake.

### ⌘ Parking Sensor System\*

Do not put any accessories on or around the sensors.

When you set the power mode to ON, the system will be in the previously selected condition.

You can turn the rear parking sensor system on and off using the audio/information screen.

➤ **Customized Features** P. 359

\* Not available on all models

## ■ Screen Operation

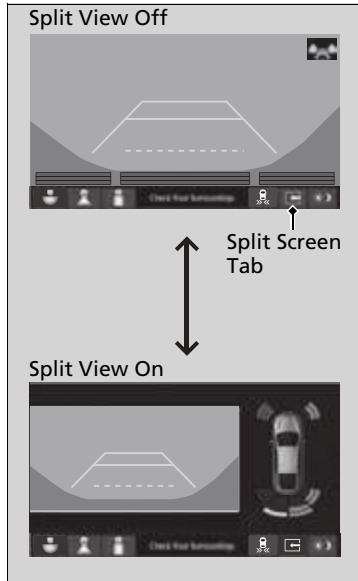





You can switch between split view off and split view on by touching the split screen tab.

## ☒ Screen Operation

The split screen tab disappears, and the split view returns to the last camera view mode under the following conditions:

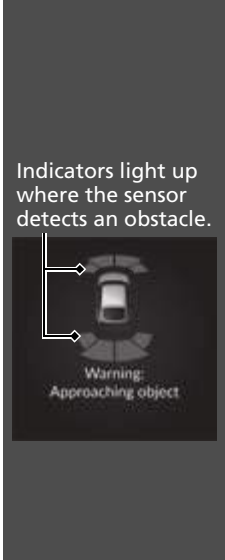
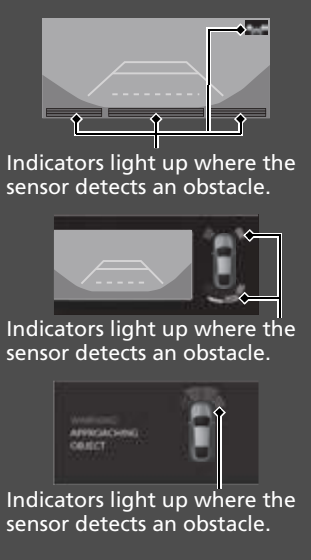
- If the parking sensor system is turned off.
- If there is a malfunction in the system.

■ When the distance between your vehicle and obstacles becomes shorter

Interval between beeps	Distance between the Bumper and Obstacle		Indicator	Driver information interface	Audio/Information Screen
	Corner Sensors	Center Sensors			
Moderate	—	Front: About 39-24 in (100-60 cm) Rear: About 43-24 in (110-60 cm)	Comes on*1/ Blinks*2 in Yellow*3	 <p>Indicators light up where the sensor detects an obstacle.</p> <p>Warning: Approaching object</p>	 <p>Indicators light up where the sensor detects an obstacle.</p>
Short	About 24-18 in (60-45 cm)	About 24-18 in (60-45 cm)	Comes on*1/ Blinks*2 in Amber		 <p>Indicators light up where the sensor detects an obstacle.</p>
Very short	About 18-14 in (45-35 cm)	About 18-14 in (45-35 cm)			 <p>Indicators light up where the sensor detects an obstacle.</p>
Continuous	About 14 in (35 cm) or less	About 14 in (35 cm) or less	Comes on*1/ Blinks*2 in Red		 <p>Indicators light up where the sensor detects an obstacle.</p>

\*1: On the driver information interface

\*2: On the audio/information screen

\*3: At this stage, only the center sensors detect obstacles.

To temporarily turn off the beeper, press the right selector wheel while it is sounding. Temporary OFF will be canceled when the shift position is switched or the vehicle speed reaches 14 km/h or higher.

## Cross Traffic Monitor

Monitors the rear corner areas using the radar sensors when reversing, and alerts you if a vehicle approaching from a rear corner is detected.

The system is convenient when you are backing out of a parking space.

### ⓘ Cross Traffic Monitor

#### CAUTION

Cross Traffic Monitor cannot detect all approaching vehicles and may not detect an approaching vehicle at all.

Failure to visually confirm that it is safe to back up the vehicle before doing so may result in a collision.

Do not solely rely on the system when reversing; always also use your mirrors, and look behind and to the sides of your vehicle before reversing.

#### Models with parking sensor system

The parking sensor system's alerting buzzer overrides the Cross Traffic Monitor buzzer when the sensors are detecting obstacles at the closest range.



## How the System Works

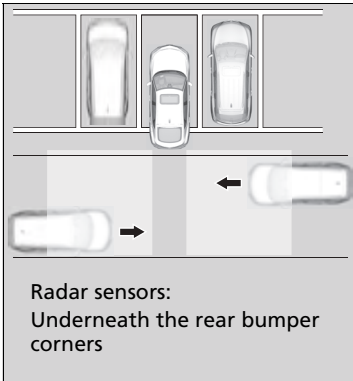

The system activates when:

- The power mode is in ON.
- The Cross Traffic Monitor is turned on.
  - ▶ **Cross Traffic Monitor On and Off** P. 605
- The transmission is in **R**.
- Your vehicle is moving at 3 mph (5 km/h) or lower.

When a vehicle is detected approaching from a rear corner, Cross Traffic Monitor alerts you with a buzzer and a displayed warning.

The system will not detect a vehicle that approaches from directly behind your vehicle, nor will it provide alerts about a detected vehicle when it moves directly behind your vehicle.

The system does not provide alerts for a vehicle that is moving away from your vehicle, and it may alert for pedestrians, bicycles, or stationary objects.

## ⊠ Cross Traffic Monitor

Cross Traffic Monitor may not detect or may delay alerting an approaching vehicle, or may alert without an approaching vehicle under the following conditions:

- An obstacle, such as another vehicle and a wall, near your vehicle's rear bumper, is blocking the radar sensor's scope.
- Your vehicle is moving at the speed of about 3 mph (5 km/h) or higher.
- A vehicle is approaching at the speed other than between about 6 mph (10 km/h) and 16 mph (25 km/h).
- The system picks up external interference such as other radar sensors from another vehicle or strong radio wave transmitted from a facility nearby.
- Either corner of the rear bumper is covered with snow, ice, mud or dirt.
- When there is bad weather.
- Your vehicle is on an incline.
- Your vehicle is tilted due to a heavy load in the rear.
- Your vehicle is reversing towards a wall, a pole, a vehicle, and so on.

The rear bumper or the sensors have been improperly repaired or the rear bumper has been deformed. Have your vehicle checked by a dealer.

For proper operation, always keep the rear bumper corner area clean.



Do not cover the rear bumper corner area with labels or stickers of any kind.

## ■ When the System Detects a Vehicle



An arrow icon appears on the side a vehicle is approaching on the audio/information screen.

## ▶▶ When the System Detects a Vehicle

If the  on the lower right changes to  in amber when the transmission is in **R**, mud, snow or ice, etc. may have accumulated in the vicinity of the sensor. The system is temporarily canceled. Check the bumper corners for any obstructions, and thoroughly clean the area if necessary.

If the  comes on when the transmission is in **R**, there may be a problem with the Cross Traffic Monitor system. Do not use the system and have your vehicle checked by a dealer.

If the display remains the same with the transmission in **R**, there may be a problem with the rear camera system and the Cross Traffic Monitor system. Do not use the system and have your vehicle checked by a dealer.

## ■ Cross Traffic Monitor On and Off

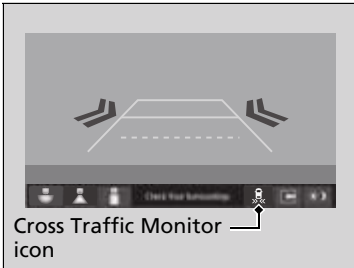

The system can be turned on and off on the audio/information screen by pressing the Cross Traffic Monitor icon.

You can also switch the system on and off from the customized feature on the audio/information screen.

▶ **Customized Features** P. 359

## About Your Multi-View Rear Camera

The audio/information screen can display your vehicle's rear view.

The display automatically changes to the rear view when the transmission is put into

**R**.

### Multi-View Rear Camera Display Area

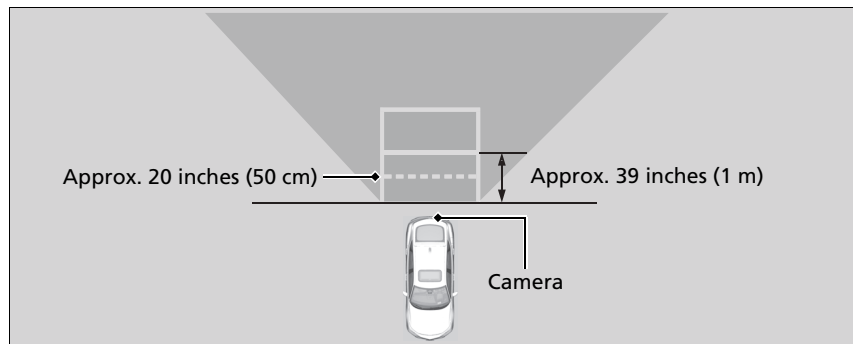

### About Your Multi-View Rear Camera

The rear camera view is restricted. You cannot see the corner ends of the bumper or what is underneath the bumper. Its unique lens also makes objects appear closer or farther than they actually are.

Visually confirm that it is safe to drive before backing up. Certain conditions (such as weather, lighting, and high temperatures) may also restrict the rear view. Do not rely on the rearview display which does not give you all information about conditions at the back of your vehicle.

The rear camera view is displayed prior to the audio/information screen.

If the camera lens is covered with dirt or moisture, use a soft, moist cloth to keep the lens clean and free of debris.

You can change the **Fixed Guideline** and **Dynamic Guideline** settings.

**Customized Features** P. 351, 359

#### Fixed Guideline

**ON:** Guidelines appear when you put the transmission into **R**.

**OFF:** Guidelines do not appear.

#### Dynamic Guideline

**ON:** Guidelines move according to the steering wheel direction.

**OFF:** Guidelines do not move.

You can view three different camera modes on the rearview display.  
Touch the appropriate icon to switch the mode.

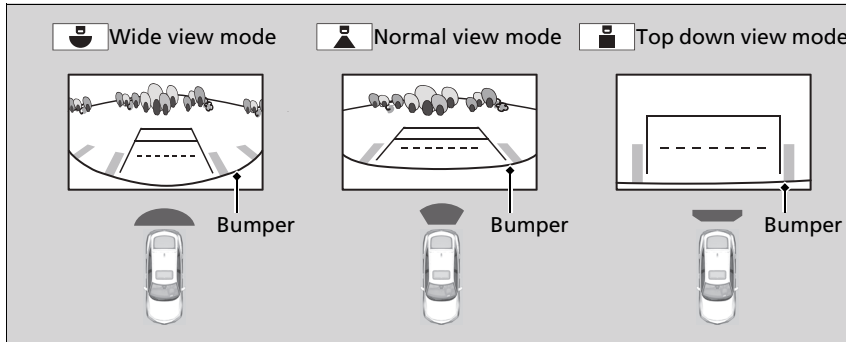

- If you were last using Wide view mode or Normal view mode, the same view mode will be activated the next time you put the transmission into **R**.
- If you were using Top down view mode before turning off the engine, the next time you set the power mode to ON and put the transmission into **R**, the view mode you were using just before using Top down view mode (Wide view mode or Normal view mode) will be activated.
- If you were using Top down view mode and 10 seconds elapsed after you took the transmission out of **R**, the view mode you were using just before selecting Top down view mode (Wide view mode or Normal view mode) will be activated the next time you put the transmission into **R**.

## Fuel Information

### ■ Fuel recommendation

#### Unleaded premium gasoline, pump octane number 91 or higher

Use of a lower octane gasoline can cause occasional metallic knocking noise in the engine and will result in decreased engine performance.

Use of a gasoline with a pump octane less than 87 can lead to engine damage.

### ■ Top tier detergent gasoline

Because the level of detergency and additives in gasoline vary in the market, Acura endorses the use of "TOP TIER Detergent Gasoline" where available to help maintain the performance and reliability of your vehicle. TOP TIER Detergent Gasoline meets a new gasoline standard jointly established by leading automotive manufacturers to meet the needs of today's advanced engines.

Qualifying gasoline retailers will, in most cases, identify their gasoline as having met "TOP TIER Detergent Gasoline" standards at the retail location. This fuel is guaranteed to contain the proper level of detergent additives and be free of metallic additives. The proper level of detergent additives, and absence of harmful metallic additives in gasoline, help avoid buildup of deposits in your engine and emission control system.

For further important fuel-related information for your vehicle, or on information on gasoline that does not contain MMT, visit Acura Owners at [owners.acura.com](http://owners.acura.com). In Canada, visit [www.acura.ca](http://www.acura.ca) for additional information on gasoline. For more information on top tier gasoline, visit [www.toptiergas.com](http://www.toptiergas.com).

### ■ Fuel tank capacity: 12.39 US gal (46.9 L)

### ⌘ Fuel Information

#### NOTICE

We recommend quality gasoline containing detergent additives that help prevent fuel system and engine deposits. In addition, in order to maintain good performance, fuel economy, and emissions control, we strongly recommend the use of gasoline that does NOT contain harmful manganese-based fuel additives such as MMT, if such gasoline is available.

Use of gasoline with these additives may adversely affect performance, and cause the malfunction indicator lamp on your instrument panel to come on. If this happens, contact a dealer for service.

Some gasoline today is blended with oxygenates such as ethanol. Your vehicle is designed to operate on oxygenated gasoline containing up to 15% ethanol by volume. Do not use gasoline containing methanol. If you notice any undesirable operating symptoms, try another service station or switch to another brand of gasoline.



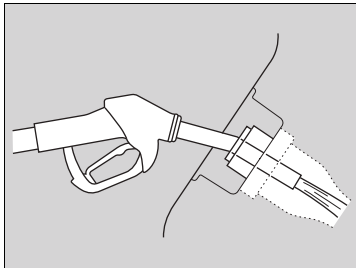

6. Place the end of the filler nozzle on the lower part of filler opening, then insert it slowly and fully.
  - ▶ Make sure that the end of the filler nozzle goes down along with the filler pipe.
  - ▶ Keep the filler nozzle level.
  - ▶ When the tank is full, the filler nozzle will click off automatically.
  - ▶ If you do not fill up the tank to full, always add a minimum of 1.2 US gal (5 L) of fuel.
  - ▶ After filling, wait about five seconds before removing the filler nozzle.
7. Shut the fuel fill door by hand.

#### How to Refuel

Use the lock tab or the master door lock switch to unlock the fuel fill door. The vehicle doors and fuel fill door automatically relock if the remote unlock function is used. This can be deactivated by briefly opening then closing the driver's door.

If the filler nozzle keeps turning off when the tank is not full, there may be a problem with the pump's fuel vapor recovery system. Try filling at another pump. If this does not fix the problem, consult a dealer.

The filler nozzle automatically stops to leave space in the fuel tank so that fuel does not overflow as a result of changes in air temperature.

Do not continue to add fuel after the filler nozzle has automatically stopped. Additional fuel can exceed the full tank capacity.

If you repeatedly fill the tank with less than the specified minimum amount of fuel, the malfunction indicator lamp may come on. If this happens, have your vehicle checked by a dealer.

If you have to refuel your vehicle from a portable container, use the funnel provided with your vehicle.

#### Refueling From a Portable Fuel Container

P. 714



## Improving Fuel Economy and Reducing CO<sub>2</sub> Emissions

Achieving fuel economy and reducing CO<sub>2</sub> emissions is dependent on several factors, including driving conditions, load weight, idling time, driving habits, and vehicle condition. Depending on these and other factors, you may not achieve the rated fuel economy of this vehicle.

### Maintenance and Fuel Economy

You can optimize your fuel economy with proper maintenance of your vehicle. Always maintain your vehicle in accordance with the messages displayed on the driver information interface.

- Use engine oil with the viscosity recommended.
  - **Recommended Engine Oil** P. 627
- Maintain the specified tire pressure.
- Do not load the vehicle with excess cargo.
- Keep your vehicle clean. A buildup of snow or mud on your vehicle's underside adds weight and increases wind resistance.

### Improving Fuel Economy and Reducing CO<sub>2</sub> Emissions

Direct calculation is the recommended method to determine actual fuel consumed while driving.



In Canada, posted fuel economy numbers are established following a simulated test. For more information on how this test is performed, please visit <https://www.nrcan.gc.ca> and search for “fuel consumption testing” in the search field at the top of the page.

## Handling Precautions

The turbocharger is a high-precision device to obtain greater horsepower by delivering a large volume of compressed air into the engine using a turbine driven by the engine's exhaust gas pressure.

- When the engine is cold just after starting, avoid revving the engine or sudden acceleration.
- Always replace the engine oil and engine oil filter according to the Maintenance Minder™. The turbine rotates at very high speeds over 100,000 rpm and its temperature reaches over 1,292°F (700°C). It is lubricated and cooled by engine oil. If you fail to replace the engine oil and filter at the scheduled distance or interval, deteriorated engine oil may cause failure such as sticking and abnormal noise of the turbine bearing.

### 🔧 Turbo Engine Vehicle

The scheduled maintenance intervals for replacing the filter is indicated on the driver information interface. Follow the information on replacement timing.

🔧 **Maintenance Minder™** P. 617

The **Engine temperature too hot. Do not drive. Allow engine to cool.** or **Engine temperature near limit. Avoid heavy acceleration and high speed.** message may appear on the driver information interface when you restart the engine after driving under high load conditions such as at high speed or in hilly terrain.

This is normal. The message goes off after you idle or drive the vehicle for about one minute.

The temperature gauge pointer is at the **H** mark when you restart the engine after driving under high load conditions such as at high speed or in hilly terrain. This is normal. The gauge goes down after you idle or drive the vehicle for about one minute.

# Maintenance

This chapter discusses basic maintenance.



## Before Performing Maintenance

Inspection and Maintenance .....	614
Safety When Performing Maintenance....	615
Parts and Fluids Used in Maintenance Service .....	616

## Maintenance Minder™ .....

## Maintenance Under the Hood

Maintenance Items Under the Hood ....	625
Opening the Hood .....	626
Recommended Engine Oil .....	627
Oil Check .....	628
Adding Engine Oil .....	629
Changing the Engine Oil and Oil Filter....	630

Engine Coolant .....	632
Transmission Fluid .....	634
Brake/Clutch * Fluid .....	635
Refilling Window Washer Fluid.....	636

## Replacing Light Bulbs .....

## Checking and Maintaining Wiper Blades ....

## Checking and Maintaining Tires

Checking Tires .....	641
Tire and Loading Information Label ...	642
Tire Labeling .....	642
DOT Tire Quality Grading (U.S. Vehicles)....	644
Wear Indicators.....	646
Tire Service Life .....	646

Tire and Wheel Replacement .....	647
----------------------------------	-----

Tire Rotation .....	648
---------------------	-----

Winter Tires .....	649
--------------------	-----

## Battery .....

## Remote Transmitter Care

Replacing the Remote Battery .....	653
------------------------------------	-----

## Climate Control System Maintenance ....

## Cleaning

Interior Care .....	656
---------------------	-----

Exterior Care.....	659
--------------------	-----

## Accessories and Modifications

Accessories .....	662
-------------------	-----

Modifications.....	663
--------------------	-----

\* Not available on all models

## Inspection and Maintenance

For your safety, perform all listed inspections and maintenance to keep your vehicle in good condition. If you become aware of any abnormality (noise, smell, insufficient brake fluid, oil residue on the ground, etc.), have your vehicle inspected by a dealer. (Note, however, that service at a dealer is not mandatory to keep your warranties in effect.)

### Types of Inspection and Maintenance

#### ■ Routine inspections

Perform inspections before long distance trips, when washing the vehicle, or when refueling.

➤ **Maintenance** P. 29

#### ■ Periodic inspections

- Check the brake/clutch\* fluid level monthly.
  - **Brake/Clutch\* Fluid** P. 635
- Check the tire pressure monthly. Examine the tread for wear and foreign objects.
  - **Checking and Maintaining Tires** P. 641
- Check the operation of the exterior lights monthly.
  - **Replacing Light Bulbs** P. 637
- Check the condition of the wiper blades at least every six months.
  - **Checking and Maintaining Wiper Blades** P. 639

### » Inspection and Maintenance

#### U.S. models

**Maintenance, replacement, or repair of emissions control devices and systems may be done by any automotive repair establishment or individuals using parts that are “certified” to EPA standards.**

According to state and federal regulations, failure to perform maintenance on the maintenance main items marked with # will not void your emissions warranties. However, all maintenance services should be performed in accordance with the intervals indicated by the driver information interface.

➤ **Maintenance Service Items** P. 621

If you want to perform complex maintenance tasks that require more skills and tools, you can purchase a subscription to the Service Express website at [www.techinfo.acura.com](http://www.techinfo.acura.com).

➤ **Authorized Manuals** P. 726

If you want to perform maintenance yourself, make sure that you have the necessary tools and skills first. After performing maintenance, update the records in the separate maintenance booklet.

## Safety When Performing Maintenance

Some of the most important safety precautions are given here. However, we cannot warn you of every conceivable hazard that can arise in performing maintenance. Only you can decide whether you should perform a given task.

### Maintenance Safety

- To reduce the possibility of fire or explosion, keep cigarettes, sparks, and flames away from the battery and all fuel related parts.
- Never leave rags, towels, or other flammable objects under the hood.
  - ▶ Heat from the engine and exhaust can ignite them, causing a fire.
- To clean parts, use a commercially available degreaser or parts cleaner, not gasoline.
- Wear eye protection and protective clothing when working with the battery or compressed air.
- Engine exhaust contains carbon monoxide, which is poisonous and can kill you.
  - ▶ Only operate the engine if there is sufficient ventilation.

### Vehicle Safety

- The vehicle must be in a stationary condition.
  - ▶ Make sure your vehicle is parked on level ground, the parking brake is set, and the engine is off.
- Be aware that hot parts can burn you.
  - ▶ Make sure to let the engine and exhaust system cool thoroughly before touching vehicle parts.
- Be aware that moving parts can injure you.
  - ▶ Do not start the engine unless instructed, and keep your hands and limbs away from moving parts.
  - ▶ Do not open the hood while the Auto Idle Stop function is activated.

#### ⚠ Safety When Performing Maintenance

### ⚠ WARNING

Improperly maintaining this vehicle or failing to correct a problem before driving can cause a crash in which you can be seriously hurt or killed.

Always follow the inspection and maintenance recommendations according to the schedules in this owner's manual.

### ⚠ WARNING

Failure to properly follow maintenance instructions and precautions can cause you to be seriously hurt or killed.

Always follow the procedures and precautions in this owner's manual.

## **Parts and Fluids Used in Maintenance Service**

---

The use of Acura genuine parts and fluids is recommended when maintaining and servicing your vehicle. Acura genuine parts are manufactured according to the same high quality standards used in Acura vehicles.

If the engine oil life is less than 15%, you will see the Maintenance Minder messages appear on the driver information interface every time you set the power mode to ON. The messages notify you when to change the engine oil, or when to bring your vehicle to a dealer for indicated maintenance services.

## To Use Maintenance Minder™

### ■ Displaying the Maintenance Minder Information

Maintenance items, which should be serviced at the same time that you replace the engine oil, appear on the driver information interface.

You can view them on the engine oil life screen at any time.

1. Set the power mode to ON.
2. Roll the right selector wheel until the Maintenance Minder screen is displayed.  
The engine oil life appears on the driver information interface along with maintenance items due soon.

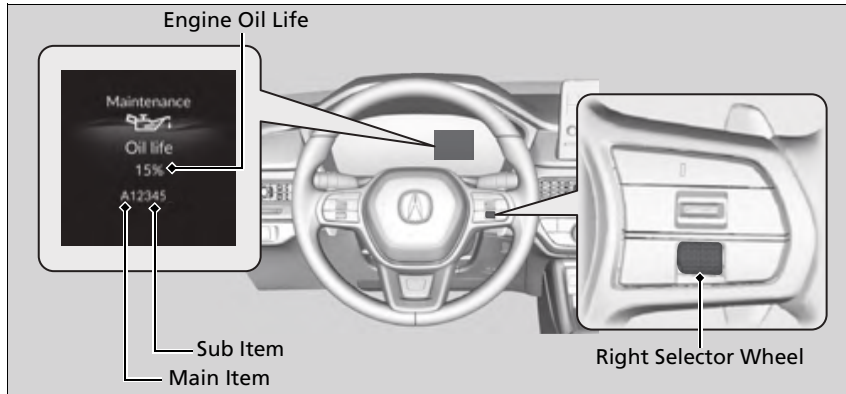

### ►► Displaying the Maintenance Minder Information

Based on the engine operating conditions, the remaining engine oil life is calculated and displayed as a percentage.



Displayed Engine Oil Life (%)	Calculated Engine Oil Life (%)
100	100 to 91
90	90 to 81
80	80 to 71
70	70 to 61
60	60 to 51
50	50 to 41
40	40 to 31
30	30 to 21
20	20 to 16
15	15 to 11
10	10 to 6
5	5 to 1
0	0



There is a list of maintenance main and sub items you can view on the driver information interface.

►► **Maintenance Service Items** P. 621

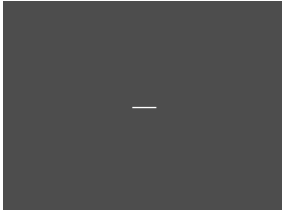
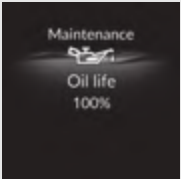
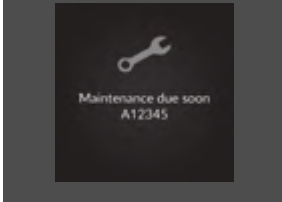

## Maintenance Minder Messages on the Driver Information Interface

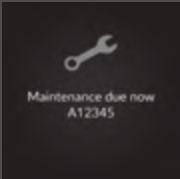
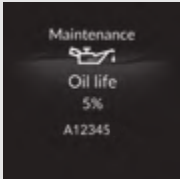
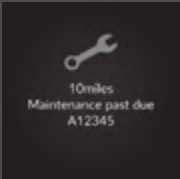
Maintenance Message	Oil Life Display	Explanation	Information
		When you select the Maintenance Minder screen, it displays codes for maintenance items due at the next engine oil change, along with the percentage of engine oil life remaining.	—
<b>Maintenance Due Soon</b> 	15 % 	The remaining engine oil life is 15 to 6 percent. Roll the right selector wheel to switch to another display.	The engine oil is approaching the end of its service life, and the maintenance items should be inspected and serviced soon.

Maintenance Message	Oil Life Display	Explanation	Information
<p><b>Maintenance Due Now</b></p> 	<p>5 %</p> 	<p>The remaining engine oil life is 5 to 1 percent. Roll the right selector wheel to switch to another display.</p>	<p>The engine oil has almost reached the end of its service life, and the maintenance items should be inspected and serviced as soon as possible.</p>
<p><b>Maintenance Past Due</b></p> 	<p>Negative Distance</p> 	<p>The engine oil life has passed its service life, and a negative distance appears after driving over 10 miles (U.S. models) or 10 km (Canadian models). The negative distance on the display blinks. Roll the right selector wheel to switch to another display.</p>	<p>The engine oil life has passed. The maintenance items must be inspected and serviced immediately.</p>

The system message indicator (ⓘ) comes on along with the Maintenance Minder message.

## ■ Maintenance Service Items

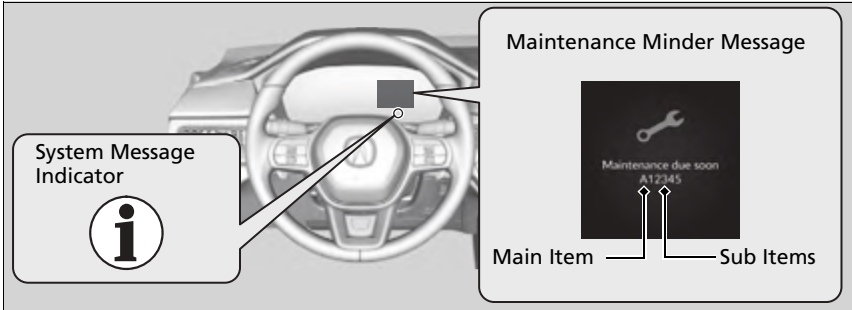

U.S. models

- Maintenance Service Items
- Adjust the valves during services A, B, 1, 2, or 3 if they are noisy.

CODE	Maintenance Main Items
A	<ul style="list-style-type: none"> <li>• Replace engine oil*1</li> </ul>
B	<ul style="list-style-type: none"> <li>• Replace engine oil*1 and oil filter</li> <li>• Inspect front and rear brakes</li> <li>• Check expiry date for tire repair kit bottle</li> <li>• Inspect these items:                             <ul style="list-style-type: none"> <li>• Tie rod ends, steering gearbox, and boots</li> <li>• Suspension components</li> <li>• Driveshaft boots</li> <li>• Brake hoses and lines (including ABS/VSA®)</li> <li>• All fluid levels and condition of fluids</li> <li>• Exhaust system#</li> <li>• Fuel lines and connections#</li> </ul> </li> </ul>

\*1: If a Maintenance Minder message does not appear more than 12 months after the display is reset, change the engine oil every year.  
 #: See information on maintenance and emissions warranty in the first column on page 723.

CODE	Maintenance Sub Items
1	<ul style="list-style-type: none"> <li>• Rotate tires</li> </ul>
2	<ul style="list-style-type: none"> <li>• Replace air cleaner element*2</li> <li>• Replace dust and pollen filter*3</li> <li>• Inspect drive belt</li> </ul>
3	<ul style="list-style-type: none"> <li>• Replace transmission fluid*4</li> </ul>
4	<ul style="list-style-type: none"> <li>• Replace spark plugs</li> <li>• Inspect valve clearance</li> </ul>
5	<ul style="list-style-type: none"> <li>• Replace engine coolant</li> </ul>
7	<ul style="list-style-type: none"> <li>• Replace brake fluid*5</li> </ul>

\*2: If you drive in dusty conditions, replace every 15,000 miles (24,000 km).  
 \*3: If you drive primarily in urban areas that have high concentrations of soot in the air from industry and from diesel powered vehicles, replace every 15,000 miles (24,000 km).  
 \*4: Driving in mountainous areas at very low vehicle speeds results in higher transmission temperature. This requires transmission fluid changes more frequently than recommended by the Maintenance Minder.

**Continuously variable transmission models**  
 If you regularly drive your vehicle under this condition, have the transmission fluid changed every 25,000 miles (40,000 km).

**Manual transmission models**  
 If you regularly drive your vehicle under this condition, have the transmission fluid changed every 37,500 miles (60,000 km).

\*5: If a Maintenance Minder Indicator does not appear more than 36 months after the display for item 7 is reset, change the brake fluid every 3 years.

**Canadian models**

⌘ Maintenance Service Items

- Adjust the valves during services A, 0, 9, 1, 2, or 3 if they are noisy.

CODE	Maintenance Main Items
A	• Replace engine oil* <sup>1</sup>
0	• Replace engine oil* <sup>1</sup> and oil filter

CODE	Maintenance Sub Items
1	• Rotate tires
2	• Replace air cleaner element* <sup>2</sup> • Replace dust and pollen filter* <sup>3</sup> • Inspect drive belt
3	• Replace transmission fluid* <sup>4</sup>
4	• Replace spark plugs • Inspect valve clearance
5	• Replace engine coolant
7	• Replace brake fluid* <sup>5</sup>
9	• Service front and rear brakes • Check expiry date for tire repair kit bottle • Inspect these items: <ul style="list-style-type: none"> <li>• Tie rod ends, steering gearbox, and boots</li> <li>• Suspension components</li> <li>• Driveshaft boots</li> <li>• Brake hoses and lines (including ABS/VSA®)</li> <li>• All fluid levels and condition of fluids</li> <li>• Exhaust system<sup>#</sup></li> <li>• Fuel lines and connections<sup>#</sup></li> </ul>

- \*1: If a Maintenance Minder message does not appear more than 12 months after the display is reset, change the engine oil every year.
- \*2: If you drive in dusty conditions, replace every 24,000 km (15,000 miles).
- \*3: If you drive primarily in urban areas that have high concentrations of soot in the air from industry and from diesel powered vehicles, replace every 24,000 km (15,000 miles).
- \*4: Driving in mountainous areas at very low vehicle speeds results in higher transmission temperature. This requires transmission fluid changes more frequently than recommended by the Maintenance Minder.

**Continuously variable transmission models**

If you regularly drive your vehicle under this condition, have the transmission fluid changed every 40,000 km (25,000 miles).

**Manual transmission models**

If you regularly drive your vehicle under this condition, have the transmission fluid changed every 60,000 km (37,500 miles).

- \*5: If a Maintenance Minder Indicator does not appear more than 36 months after the display for item 7 is reset, change the brake fluid every 3 years.
- #: See information on maintenance and emissions warranty in the first column on page 725.

## ■ Resetting the Display

Reset the maintenance minder information display if you have performed the maintenance service.



1. Set the power mode to ON.
2. Roll the right selector wheel until the Maintenance Minder screen is displayed.
3. Press and hold the right selector wheel for about 10 seconds to enter the reset mode.
4. Roll the right selector wheel to select a maintenance item to reset, or to select **All due items** (You can also select **Cancel** to end the process).
5. Press the right selector wheel to reset the selected item.
6. Repeat from step 3 for other items you wish to reset.

## ▶▶ Resetting the Display

### NOTICE

Failure to reset the Maintenance Minder™ display after a maintenance service results in the system showing incorrect maintenance intervals, which can lead to serious mechanical problems.

The dealer will reset the Maintenance Minder™ display after completing the required maintenance service. If someone other than a dealer performs maintenance service, reset the Maintenance Minder™ display yourself.

### Models with 7-in. Color Touchscreen

You can also reset the Maintenance Minder™ display using the driver information interface.

▶ **Vehicle Settings**\* P. 126

### Models with 9-in. Color Touchscreen

You can also reset the Maintenance Minder™ display using the audio/information screen.

▶ **Customized Features** P. 359

## Maintenance Items Under the Hood

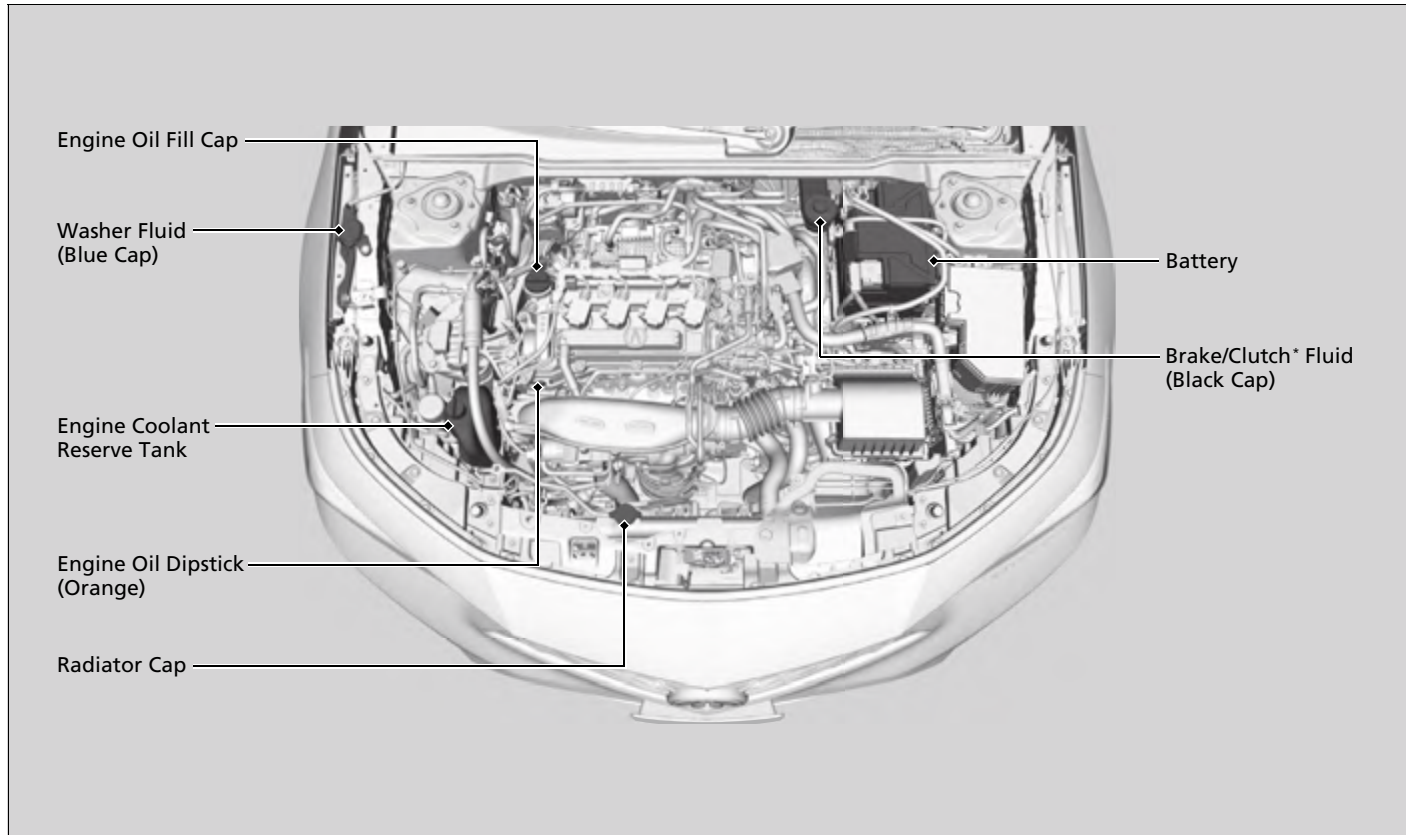

\* Not available on all models

## Opening the Hood

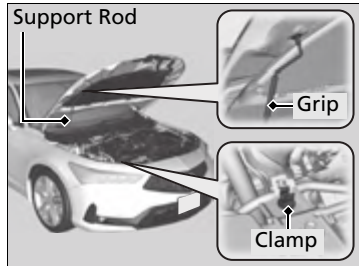
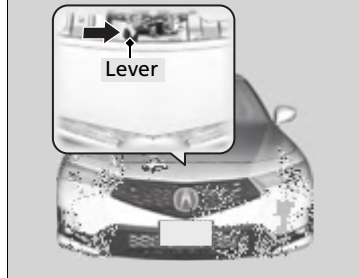
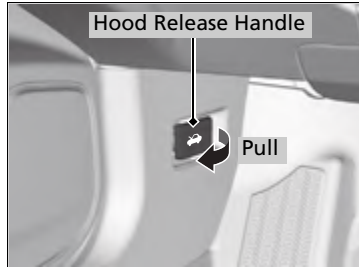

1. Park the vehicle on a level surface, and set the parking brake.
2. Pull the hood release handle under the driver's side lower corner of the dashboard.
  - The hood will pop up slightly.
3. Push the hood latch lever (located under the front edge of the hood to the center) to the side and raise the hood. Once you have raised the hood slightly, you can release the lever.
4. Remove the support rod from the clamp using the grip. Mount the support rod in the hood.

When closing, remove the support rod, and stow it in the clamp, then gently lower the hood. Remove your hand at a height of approximately 12 inches (30 cm) and let the hood close.

### ► Opening the Hood

#### **⚠ WARNING**

The hood support rod can become very hot due to heat from the engine.

To ensure against possible burns, do not handle the metal section of the rod: Use the foam grip instead.

#### **NOTICE**

Do not open the hood when the wiper arms are raised. The hood will strike the wipers, resulting in possible damage to the hood and/or the wipers.

When closing the hood, check that the hood is securely latched.

If the hood latch lever moves stiffly, or if you can open the hood without lifting the lever, the latch mechanism should be cleaned and lubricated.

Do not open the hood while the Auto Idle Stop function is activated.



## Recommended Engine Oil

Use a genuine engine oil or another commercial engine oil of suitable type and viscosity (for the ambient temperature) as shown in the image that follows.

Oil is a major contributor to your engine’s performance and longevity. If you drive the vehicle with insufficient or deteriorated oil, the engine may fail or be damaged.

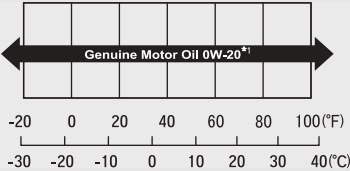
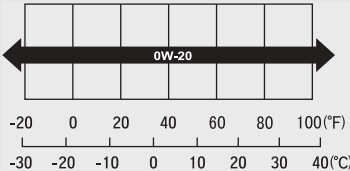
Genuine Engine Oil	Commercial Engine Oil
<ul style="list-style-type: none"> <li>• Acura Genuine Motor Oil</li> </ul>	<ul style="list-style-type: none"> <li>• API service SN or higher grade fuel-efficient oil</li> <li>• API Certification Mark “Starburst”</li> </ul>
 <p style="text-align: center;"><b>Ambient Temperature</b></p>	 <p style="text-align: center;"><b>Ambient Temperature</b></p>

\*1:Formulated to improve fuel economy.

### ■ Synthetic oil

You may also use synthetic motor oil if it is labeled with the API Certification Seal and is the specified viscosity grade.

### ►► Recommended Engine Oil

#### Engine Oil Additives

Your vehicle does not require oil additives. In fact, they may adversely affect the engine performance and durability.

The following seal indicates the oil is energy conserving and that it meets the American Petroleum Institute’s latest requirements.



## Oil Check

We recommend that you check the engine oil level every time you refuel.

Park the vehicle on level ground.

Wait approximately three minutes after turning the engine off before you check the oil.

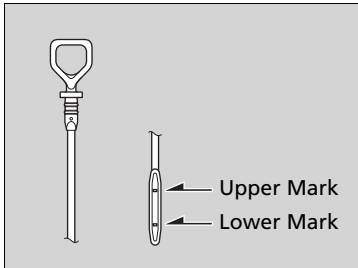
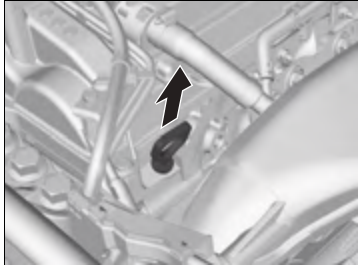

1. Remove the dipstick (orange).
2. Wipe the dipstick with a clean cloth or paper towel.
3. Insert the dipstick back all the way into its hole.
  
4. Remove the dipstick again, and check the level. It should be between the upper and lower marks. Add oil if necessary.

### Oil Check

If the oil level is near or below the lower mark, slowly add oil, being careful not to overfill.

#### NOTICE

Under certain driving conditions, it is normal for the engine oil level to rise above the upper mark. If you have a concern, consult a dealer for details.

## Adding Engine Oil

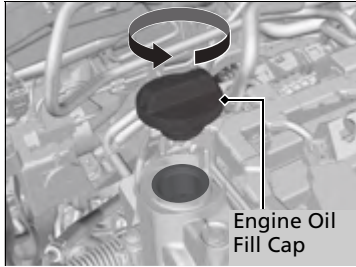

1. Unscrew and remove the engine oil fill cap.
2. Add oil slowly.
3. Reinstall the engine oil fill cap, and tighten it securely.
4. Wait for three minutes and recheck the engine oil dipstick.

### Adding Engine Oil

#### NOTICE

Do not fill the engine oil above the upper mark. Overfilling the engine oil may result in leaks and engine damage.

If any oil spills, wipe it away immediately. Spilled oil may damage the engine compartment components.

## Changing the Engine Oil and Oil Filter

You must change the engine oil and oil filter regularly in order to maintain the engine's lubrication. The engine may be damaged if they are not changed regularly.

Change the oil and filter in accordance with the maintenance message on the driver information interface.

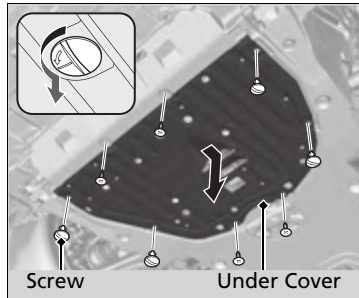

1. Run the engine until it reaches normal operating temperature, and then turn the engine off.
2. Open the hood and remove the engine oil fill cap.
3. Remove the Phillips-head screws and slotted head screws by turning 90° counter-clockwise on the undercarriage and remove the under cover.

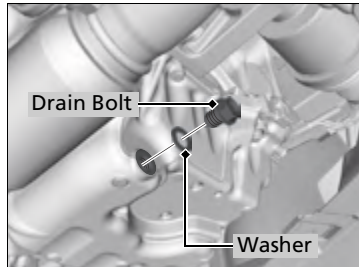

4. Remove the drain bolt and washer from the bottom of the engine, and drain the oil into a suitable container.

### Changing the Engine Oil and Oil Filter

#### NOTICE

You may damage the environment if you do not dispose of the oil in a suitable way. If you are changing the oil by yourself, appropriately dispose of the used oil. Put the oil in a sealed container and take it to a recycling center. Do not throw the oil away into a garbage can or onto the ground.

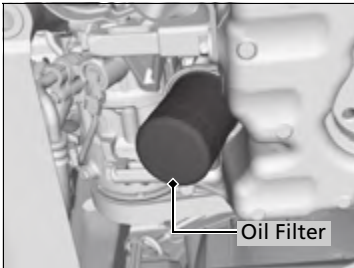

5. Remove the oil filter and dispose of the remaining oil.
6. Check that the filter gasket is not stuck to the engine contact surface.
  - If it is stuck, you must detach it.
7. Wipe away dirt and dust adhering to the contact surface of the engine block, and install a new oil filter.
  - Apply a light coat of new engine oil to the filter gasket.
8. Put a new washer on the drain bolt, then reinstall the drain bolt.
  - Tightening torque:  
30 lbf·ft (40 N·m, 4.0 kgf·m)
9. Pour the recommended engine oil into the engine.
  - Engine oil change capacity (including filter):  
3.7 US qt (3.5 L)
10. Reinstall the engine oil fill cap securely and start the engine.
11. Run the engine for a few minutes, and then check that there is no leak from the drain bolt or oil filter.
12. Stop the engine, wait for three minutes, and then check the oil level on the dipstick.
  - If necessary, add more engine oil.

#### ✘ Changing the Engine Oil and Oil Filter

You will need a special wrench to replace the oil filter. You can buy this wrench from a dealer.

When installing the new oil filter, follow the instructions supplied with the oil filter.

Reinstall the engine oil fill cap. Start the engine. If the low oil pressure warning appears, turn off the engine, and check your work.

## Engine Coolant

### Specified coolant: Acura Long Life Antifreeze/Coolant Type 2

This coolant is premixed with 50% antifreeze and 50% water. Do not add any straight antifreeze or water.

We recommend you check the engine coolant level every time you refuel. Check the reserve tank first. If it is completely empty, also check the coolant level in the radiator. Add the engine coolant accordingly.

### Reserve Tank

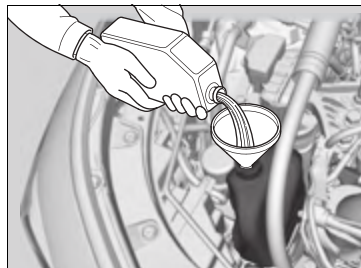
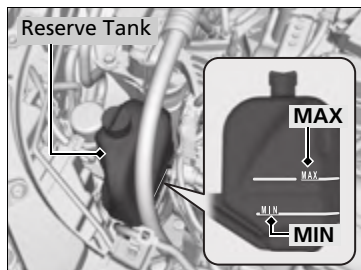

1. **Make sure the engine and radiator are cool.**
2. Check the amount of coolant in the reserve tank.
  - If the coolant level is below the **MIN** mark, add the specified coolant until it reaches the **MAX** mark.
3. Inspect the cooling system for leaks.

### Engine Coolant

## ⚠ WARNING

Removing the radiator cap while the engine is hot can cause the coolant to spray out, seriously scalding you.

Always let the engine and radiator cool down before removing the radiator cap.

### NOTICE

Genuine Acura engine coolant is a 50/50 mixture of antifreeze and water that can withstand freezing at temperatures as low as about  $-31^{\circ}\text{F}$  ( $-35^{\circ}\text{C}$ ). If your vehicle is consistently subjected to temperatures below this, the concentration of antifreeze in the coolant should be increased. Consult a dealer for details.

If Acura antifreeze/coolant is not available, you may use another major brand of non-silicate coolant as a temporary replacement. Check that it is a high quality coolant recommended for aluminum engines. Continued use of any non-Acura coolant can result in corrosion, causing the cooling system to malfunction or fail. Have the cooling system flushed and refilled with Acura antifreeze/coolant as soon as possible.

## Radiator

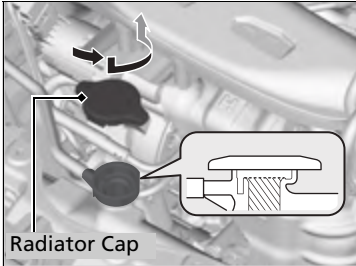

1. **Make sure the engine and radiator are cool.**
2. Turn the radiator cap 1/8 turn counter-clockwise and relieve any pressure in the cooling system.
3. Push down and turn the radiator cap counter-clockwise to remove it.
4. The coolant level should be up to the base of the filler neck. Add coolant if it is low.
5. Put the radiator cap back on, and tighten it fully.

### Engine Coolant

Do not add rust inhibitors or other additives to your vehicle's cooling system. They may not be compatible with the coolant or with the engine components.

### Radiator

#### NOTICE

Pour the fluid slowly and carefully so you do not spill any. Clean up any spills immediately; they can damage components in the engine compartment.

## Transmission Fluid

### Continuously variable transmission models

#### Continuously Variable Transmission (CVT) Fluid

**Specified fluid: Acura HCF-2**

Have a dealer check the fluid level and replace if necessary.

Do not attempt to check or change the continuously variable transmission fluid yourself.

### Manual transmission models

#### Manual Transmission Fluid

**Specified fluid: Acura MTF**

Have a dealer check the fluid level and replace if necessary.

Do not attempt to check or change the manual transmission fluid yourself.

#### Continuously Variable Transmission (CVT) Fluid

##### NOTICE

**Do not mix Acura HCF-2 with other transmission fluids.**

Using a transmission fluid other than Acura HCF-2 may adversely affect the operation and durability of your vehicle's transmission, and damage the transmission. Any damage caused by using a transmission fluid that is not equivalent to Acura HCF-2 is not covered by Acura's new vehicle limited warranty.

#### Manual Transmission Fluid

##### NOTICE

If Acura MTF is not available, you may use the API certified SAE 0W-20 or 5W-20 viscosity motor oil as a temporary measure. Replace with MTF as soon as possible. Motor oil does not contain the proper additives for the transmission and continued use can cause decreased shifting performance and lead to transmission damage.



## Brake/Clutch\* Fluid

**Specified fluid: Acura Heavy Duty Brake Fluid DOT 3**

### Checking the Brake Fluid

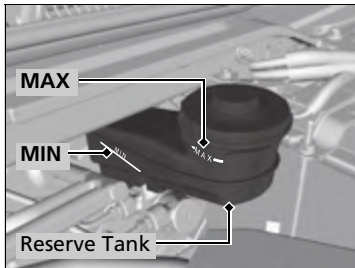

The fluid level should be between the **MIN** and **MAX** marks on the side of the reserve tank.

#### Manual transmission models

The brake fluid reserve tank is also used for your vehicle's clutch fluid. As long as you keep the brake fluid level as instructed above, there is no need for checking the clutch fluid level.

#### Brake/Clutch\* Fluid

##### NOTICE

Brake fluid marked DOT 5 is not compatible with your vehicle's braking system and can cause extensive damage.

If the specified brake fluid is not available, you should use only DOT 3 or DOT 4 fluid from a sealed container as a temporary replacement.

Using any non-Acura brake fluid can cause corrosion and decrease the longevity of the system. Have the brake system flushed and refilled with Acura Heavy Duty Brake Fluid DOT 3 as soon as possible.

If the brake fluid level is at or below the **MIN** mark, have a dealer inspect the vehicle for leaks or worn brake pads as soon as possible.

\* Not available on all models

## Refilling Window Washer Fluid

Check the amount of window washer fluid.

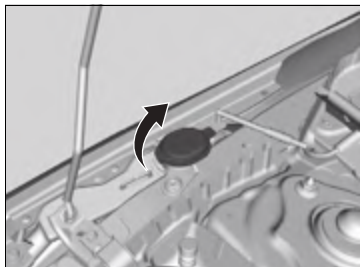

If the level is low, fill the washer reservoir.

### Canadian models

If the washer fluid is low, a message appears on the driver information interface.

Pour the washer fluid carefully. Do not overflow the reservoir.

### ► Refilling Window Washer Fluid

#### NOTICE

Do not use engine antifreeze or a vinegar/water solution in the windshield washer reservoir.

Antifreeze can damage your vehicle's paint. A vinegar/water solution can damage the windshield washer pump.

Use only commercially available windshield washer fluid.

Avoid prolonged use of hard water to prevent lime scale buildup.

## Headlights

---

Headlights are LED type. Have an authorized Acura dealer inspect and replace the light assembly.

## Fog Lights \*

---

Fog lights are LED type. Have an authorized Acura dealer inspect and replace the light assembly.

## Front Turn Signal, Parking/Chicane™ Daytime Running, and Front Side Marker Lights

---

Front turn signal, parking/daytime running, and front side marker lights are LED type. Have an authorized Acura dealer inspect and replace the light assembly.

## Side Turn Signal/Emergency Indicator Lights \*

---

Door mirror side turn lights are LED type. Have an authorized Acura dealer inspect and replace the light assembly.

## Door Outer Handle Ambient Lights \*

---

Door outer handle ambient lights are LED type. Have an authorized Acura dealer inspect and replace the light assembly.

### Headlights

---

The headlight aim is set by the factory, and does not need to be adjusted. However, if you regularly carry heavy items in the cargo area, have the aiming readjusted at a dealer or by a qualified technician.

\* Not available on all models

## **Brake, Rear Side Marker, Brake/Chicane™ Taillights, Back-Up, and Rear Turn Signal Lights**

---

Brake, rear side marker, brake/taillights, back-up, and rear turn signal lights are LED type. Have an authorized Acura dealer inspect and replace the light assembly.

## **Rear License Plate Lights**

---

Rear license plate lights are LED type. Have an authorized Acura dealer inspect and replace the light assembly.

## **High-Mount Brake Light**

---

High-mount brake light is LED type. Have an authorized Acura dealer inspect and replace the light assembly.

## Checking Wiper Blades

If the wiper blade rubber has deteriorated, it will leave streaks, become noisy, and the hard surfaces of the blade may scratch the window glass.

## Changing the Wiper Blade

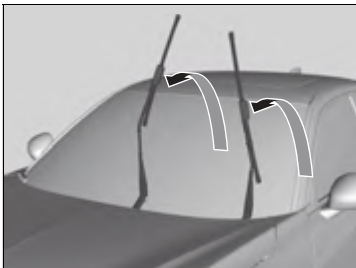
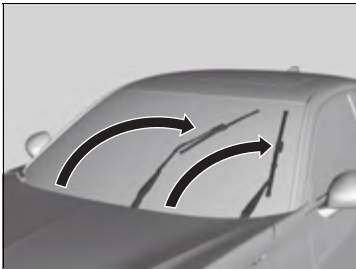

1. Set the power mode to ON, then to VEHICLE OFF.
2. Within 10 seconds of setting the power mode to VEHICLE OFF, hold the wiper switch in the **MIST** position for more than two seconds.
  - ▶ Both wiper arms are set to the maintenance position as shown in the image.
3. Lift both wiper arms.

### Changing the Wiper Blade

#### NOTICE

Avoid dropping the wiper arm onto the windshield, it may damage the wiper arm and/or the windshield.

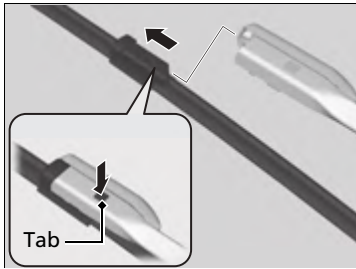

4. Depress the lock tab, then slide the wiper blade off the wiper arm.
5. Slide the new wiper blade onto the wiper arm until it clicks into place.
6. Lower both wiper arms.
7. Set the power mode to ON, then set the wiper switch to the **MIST** position once.
  - ▶ The wiper arms return to the standard position.

## Checking Tires

To safely operate your vehicle, your tires must be of the proper type and size, in good condition with adequate tread, and properly inflated.

### ■ Inflation guidelines

Properly inflated tires provide the best combination of handling, tread life, and comfort. Refer to the driver's doorjamb label or specifications page for the specified pressure.

Underinflated tires wear unevenly, adversely affect handling and fuel economy, and are more likely to fail from overheating.

Overinflated tires make your vehicle ride harshly, are more prone to road hazards, and wear unevenly.

Every day before you drive, look at each of the tires. If one looks lower than the others, check the pressure with a tire gauge.

At least once a month or before long trips, use a gauge to measure the pressure in all tires, including the spare\*. Even tires in good condition can lose 1-2 psi (10-20 kPa, 0.1-0.2 kgf/cm<sup>2</sup>) per month.

### ■ Inspection guidelines

Every time you check inflation, also examine the tires and valve stems. Look for:

- Bumps or bulges on the side or in the tread. Replace the tire if you find any cuts, splits, or cracks in the side of the tire. Replace it if you see fabric or cord.
- Remove any foreign objects and inspect for air leaks.
- Uneven tread wear. Have a dealer check the wheel alignment.
- Excessive tread wear.

📖 **Wear Indicators** P. 646

- Cracks or other damage around valve stem.

\* Not available on all models

### 📖 Checking Tires

## ⚠️ WARNING

Using tires that are excessively worn or improperly inflated can cause a crash in which you can be seriously hurt or killed.

Follow all instructions in this owner's manual regarding tire inflation and maintenance.

Measure the air pressure when tires are cold. This means the vehicle has been parked for at least three hours, or driven less than 1 mile (1.6 km). If necessary, add or release air until the specified pressure is reached.

If checked when hot, tire pressure can be as much as 4–6 psi (30–40 kPa, 0.3–0.4 kgf/cm<sup>2</sup>) higher than if checked when cold.

Have a dealer check the tires if you feel a consistent vibration while driving. New tires and any that have been removed and reinstalled should be properly balanced.

## Tire and Loading Information Label

The label attached to the driver's doorjamb provides necessary tire and loading information.

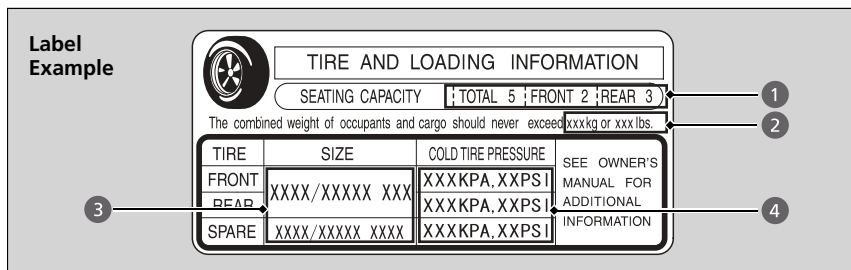

### ▶▶ Tire and Loading Information Label

The tire and loading information label attached to the driver's doorjamb contains:

- 1 The number of people your vehicle can carry.
- 2 The total weight your vehicle can carry. Do not exceed this weight.
- 3 The original tire sizes for front, rear, and spare.
- 4 The proper cold tire pressure for front, rear, and spare.

## Tire Labeling

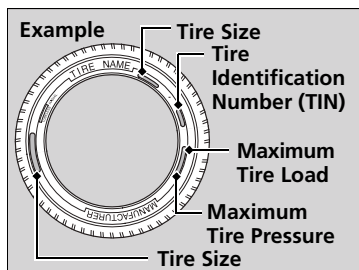

The tires that came on your vehicle have a number of markings. Those you should be aware of are described as shown.

### ▶▶ Tire Sizes

Following is an example of tire size with an explanation of what each component means.

#### **P205/55 R16 89H**

P: Vehicle type (P indicates passenger vehicle).

205: Tire width in millimeters.

55: Aspect ratio (the tire's section height as a percentage of its width).

R: Tire construction code (R indicates radial).

16: Rim diameter in inches.

89: Load index (a numerical code associated with the maximum load the tire can carry).

H: Speed symbol (an alphabetical code indicating the maximum speed rating).

### Tire Sizes

Whenever tires are replaced, they should be replaced with tires of the same size.



## ■ Tire Identification Number (TIN)

The tire identification number (TIN) is a group of numbers and letters that look like the example in the side column. TIN is located on the sidewall of the tire.

## ■ Glossary of Tire Terminology

**Cold Tire Pressure** – The tire air pressure when the vehicle has been parked for at least three hours or driven less than 1 mile (1.6 km).

**Load Rating** – Means the maximum load that a tire is rated to carry for a given inflation pressure.

**Maximum Inflation Pressure** – The maximum tire air pressure that the tire can hold.

**Maximum Load Rating** – Means the load rating for a tire at the maximum permissible inflation pressure for that tire.

**Recommended Inflation Pressure** – The cold tire inflation pressure recommended by the manufacturer.

**Treadwear Indicators (TWI)** – Means the projections within the principal grooves designed to give a visual indication of the degrees of wear of the tread.

### ☒ Tire Identification Number (TIN)

#### **DOT B97R FW6X 2209**

DOT: This indicates that the tire meets all requirements of the U.S. Department of Transportation.

B97R: Manufacturer's identification mark.

FW6X: Tire type code.

22 09: Date of manufacture.

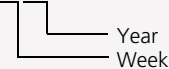

## DOT Tire Quality Grading (U.S. Vehicles)

The tires on your vehicle meet all U.S. Federal Safety Requirements. All tires are also graded for treadwear, traction, and temperature performance according to Department of Transportation (DOT) standards. The following explains these gradings.

### ■ Uniform Tire Quality Grading

Quality grades can be found where applicable on the tire sidewall between tread shoulder and maximum section width.

### ■ Treadwear

The treadwear grade is a comparative rating based on the wear rate of the tire when tested under controlled conditions on a specified government test course. For example, a tire graded 150 would wear one and one-half (1 1/2) times as well on the government course as a tire graded 100. The relative performance of tires depends upon the actual conditions of their use, however, and may depart significantly from the norm due to variations in driving habits, service practices and differences in road characteristics and climate.

### ☒ Uniform Tire Quality Grading

For example:

**Treadwear 200**  
**Traction AA**  
**Temperature A**

All passenger car tires must conform to Federal Safety Requirements in addition to these grades.

## ■ Traction

The traction grades, from highest to lowest, are AA, A, B, and C. Those grades represent the tire's ability to stop on wet pavement as measured under controlled conditions on specified government test surfaces of asphalt and concrete. A tire marked C may have poor traction performance.

## ■ Temperature

The temperature grades are A (the highest), B, and C, representing the tire's resistance to the generation of heat and its ability to dissipate heat when tested under controlled conditions on a specified indoor laboratory test wheel. Sustained high temperature can cause the material of the tire to degenerate and reduce tire life, and excessive temperature can lead to sudden tire failure. The grade C corresponds to a level of performance which all passenger car tires must meet under the Federal Motor Vehicle Safety Standard No. 109. Grades B and A represent higher levels of performance on the laboratory test wheel than the minimum required by law.

### ⌘ Traction

Warning: The traction grade assigned to this tire is based on straight-ahead braking traction tests, and does not include acceleration, cornering, hydroplaning, or peak traction characteristics.

### ⌘ Temperature

Warning: The temperature grade for this tire is established for a tire that is properly inflated and not overloaded. Excessive speed, underinflation, or excessive loading, either separately or in combination, can cause heat buildup and possible tire failure.

## Wear Indicators

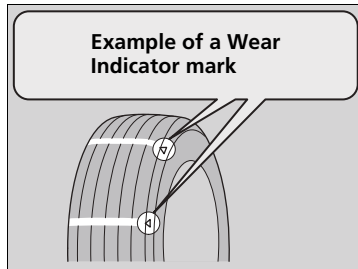

The groove where the wear indicator is located is about 1/16 inch (about 1.6 mm) shallower than elsewhere on the tire. If the tread has worn so that the indicator is exposed, replace the tire.

**Worn out tires have poor traction on wet roads.**

## Tire Service Life

The life of your tires is dependent on many factors, including driving habits, road conditions, vehicle loading, inflation pressure, maintenance history, speed, and environmental conditions (even when the tires are not in use).

In addition to regular inspections and inflation pressure maintenance, it is recommended that you have annual inspections performed once the tires reach five years old. All tires, including the spare\*, should be removed from service after 10 years from the date of manufacture, regardless of their condition or state of wear.

## Tire and Wheel Replacement

Replace your tires with radials of the same size, load range, speed rating, and maximum cold tire pressure rating (as shown on the tire's sidewall). Using tires of a different size or construction can cause certain vehicle systems such as the ABS and Vehicle Stability Assist™ (VSA®) system to work incorrectly.

It is best to replace all four tires at the same time. If that isn't possible, replace the front or rear tires in pairs.

Whenever you have a tire replaced or reset, make sure that the rubber valve stem is replaced and that the TPMS sensor is transferred from the old valve stem to the new one.

If you replace a wheel, make sure that the wheel's specifications match those of the original wheels.

### ▶▶ Tire and Wheel Replacement

#### **WARNING**

Installing improper tires on your vehicle can affect handling and stability. This can cause a crash in which you can be seriously hurt or killed.

Always use the size and type of tires recommended in this owner's manual.

## Tire Rotation

Rotating tires according to the maintenance messages on the driver information interface helps to distribute wear more evenly and increase tire life.

### ■ Tires without rotation marks

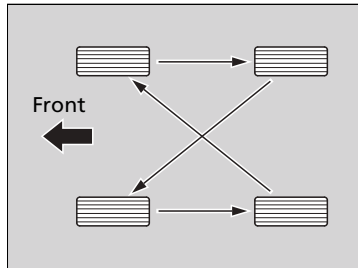

Rotate the tires as shown here.

### ■ Tires with rotation marks

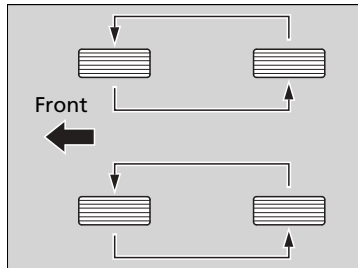

Rotate the tires as shown here.

### ►► Tire Rotation

Tires with directional tread patterns should only be rotated front to back (not from one side to the other). Directional tires should be mounted with the rotation indication mark facing forward, as shown below.

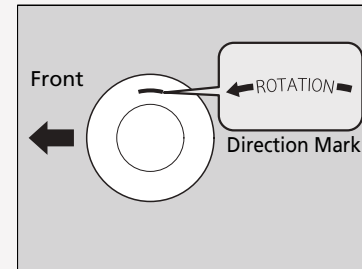

## Winter Tires

If driving on snowy or frozen roads, mount all season marked **M+S** tires, snow tires, or tire chains; reduce speed; and maintain sufficient distance between vehicles when driving.

Be particularly careful when operating the steering wheel or brakes to prevent skidding.

Use tire chains, snow tires, or all season tires when necessary or according to the law.

When mounting, refer to the following points.

For winter tires:

- Select the size and load ranges that are the same as the original tires.
- Mount the tires to all four wheels.

### ❖ Winter Tires

#### **WARNING**

Using the wrong chains, or not properly installing chains, can damage the brake lines and cause a crash in which you can be seriously injured or killed.

Follow all instructions in this owner's manual regarding the selection and use of tire chains.

#### **NOTICE**

Traction devices that are the wrong size or improperly installed can damage your vehicle's brake lines, suspension, body, and wheels. Stop driving if they are hitting any part of the vehicle.

*Continued*

For tire chains:

- Install them on the front tires only.
- Because your vehicle has limited tire clearance, we strongly recommend using the chains listed below:

Models with 215/50R17 tires

**Cable-type: SCC Radial Chain SC1032**

Models with 235/40R18 tires

**Cable-type: SCC Radial Chain SC1034**

- Follow the chain manufacturer's instruction when installing. Mount them as tightly as you can.
- Check that the chains do not touch the brake lines or suspension.
- Drive slowly.

#### ❧ Winter Tires

When tire chains are mounted, follow the chain manufacturer's instructions regarding vehicle operational limits.

If your vehicle is equipped with summer tires, be aware that these tires are not designed for winter driving conditions. For more information, contact a dealer.



## Checking the Battery

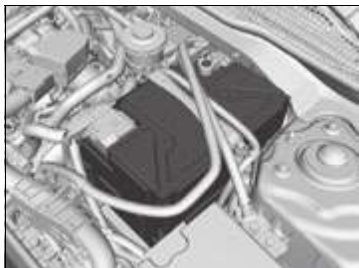

The condition of the battery is monitored by a sensor located on the negative terminal of the battery. If there is a problem with this sensor, the driver information interface will display a warning message. If this happens, have your vehicle inspected by a dealer.

Check the battery terminals for corrosion monthly.

If your vehicle's battery is disconnected or goes dead:

- The audio system is disabled.
  - **Reactivating the audio system** P. 229
- The clock resets.
  - **Clock** P. 142

### Canadian models only

- The immobilizer system needs to be reset.
  - **Immobilizer System Indicator** P. 95

### Battery

## **⚠ WARNING**

The battery gives off explosive hydrogen gas during normal operation.

A spark or flame can cause the battery to explode with enough force to kill or seriously hurt you.

When conducting any battery maintenance, wear protective clothing and a face shield, or have a skilled technician do it.

**WARNING:** Battery post, terminals, and related accessories contain lead and lead compounds.

**Wash your hands after handling.**

## Charging the Battery

Disconnect both battery cables to prevent damaging your vehicle's electrical system. Always disconnect the negative (–) cable first, and reconnect it last.

### ⚠ Battery

When you find corrosion, clean the battery terminals by applying a baking powder and water solution. Clean the terminals with a damp towel. Cloth/towel dry the battery. Coat the terminals with grease to help prevent future corrosion.

When replacing the battery, the replacement must be of the same specifications. Consult a dealer for more information.

The battery installed in this vehicle is specifically designed for a model with Auto Idle Stop. Using a battery other than this specified type may shorten the battery life, and prevent Auto Idle Stop from activating. If you need to replace the battery, make sure to select the specified type and size. Ask a dealer for more details.

The Vehicle Stability Assist™ (VSA®) system, Adaptive Cruise Control (ACC)\*, Adaptive Cruise Control (ACC) with Low Speed Follow (LSF)\*, and safety support indicators may come on in amber along with a message in the gauge when you set the power mode to ON after reconnecting the battery. Drive a short distance at more than 12 mph (20 km/h). Each indicator should go off. If any do not, have your vehicle checked by a dealer.

## Replacing the Remote Battery

### Models without two-way keyless remote

If the indicator does not come on when the button is pressed, replace the battery.

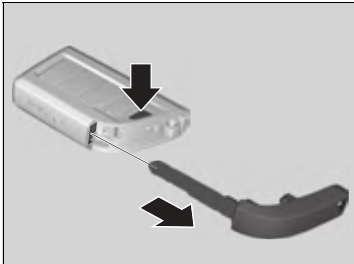

### Battery type: CR2032

1. Remove the built-in key.

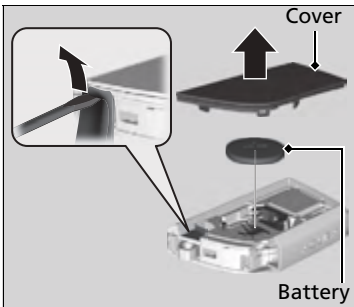

2. Pry on the edge of the cover using a flat-tip screwdriver to remove the cover.

▶ Wrap the flat-tip screwdriver with a cloth to prevent scratches.

3. Make sure to replace the battery with the correct polarity.

### Replacing the Remote Battery

## ⚠ WARNING

### CHEMICAL BURN HAZARD

The battery that powers the remote transmitter can cause severe internal burns and can even lead to death if swallowed. Keep new and used batteries away from children.

If you suspect that a child has swallowed the battery, seek medical attention immediately.

### NOTICE

An improperly disposed of battery can damage the environment. Always confirm local regulations for battery disposal.

Replacement batteries are commercially available or at a dealer.

**Models with two-way keyless remote**

If the indicator does not come on when the button is pressed, replace the battery.

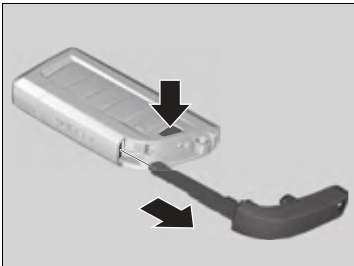

**Battery type: CR2032**

1. Remove the built-in key.

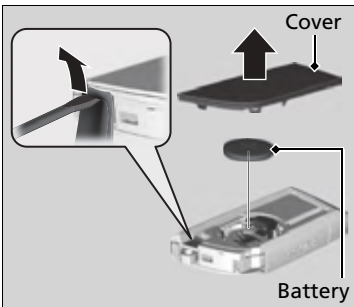

2. Pry on the edge of the cover using a flat-tip screwdriver to remove the cover.

▶ Wrap the flat-tip screwdriver with a cloth to prevent scratches.

3. Make sure to replace the battery with the correct polarity.

▶▶ Replacing the Remote Battery

**Models with two-way keyless remote**

**NOTICE**

The Remote transmitter is equipped with two batteries: A standard replaceable CR2032 coin button battery and an integral non-replaceable rechargeable battery. To prevent permanent damage to the rechargeable battery, replace the CR2032 battery every three to four years.

## Air Conditioning

To ensure proper and safe operation, the Society of Automotive Engineers (SAE J2845) recommends that the refrigerant system only be serviced by trained and certified technicians.

Never repair or replace the air conditioning evaporator (cooling coil) with one removed from a used or salvaged vehicle.

New replacement mobile air conditioning evaporators must be certified (and labeled) as meeting SAE Standard J2842.

## Dust and Pollen Filter

The climate control system is equipped with a dust and pollen filter that collects pollen, dust, and other debris in the air. The Maintenance Minder™ messages will let you know when to replace the filter.

We recommend that you replace the dust and pollen filter sooner when using your vehicle in areas with high concentrations of dust.

### Air Conditioning

#### NOTICE

Vented refrigerant is harmful to the environment. To avoid refrigerant from venting, never replace the evaporator with one removed from a used or salvaged vehicle.

Refrigerant in your vehicle's air conditioning system is flammable and can be ignited during servicing if proper procedures are not followed.

The air conditioner label is found under the hood:

➔ **Safety Labels** P. 82

➔ **Specifications** P. 716

#### Canadian models



 : Caution

 : Flammable Refrigerant

 : Requires Registered Technician to Service

 : Air Conditioning System

### Dust and Pollen Filter

If the airflow from the climate control system deteriorates noticeably, and the windows fog up easily, the filter may need to be replaced. Please contact a dealer for replacement.

## Interior Care

Use a damp cloth with a mixture of mild detergent and warm water to remove dirt. Use a clean cloth to remove detergent residue.

### ■ Cleaning Seat Belts

Use a soft brush with a mixture of mild soap and warm water to clean the seat belts. Let the belts air dry. Wipe the openings of the seat belt anchors using a clean cloth.

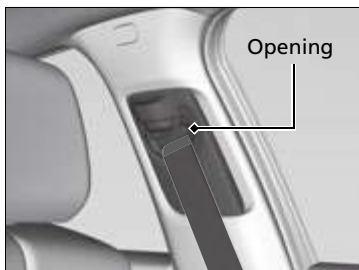

### ▣ Interior Care

Do not spill liquids inside the vehicle. Electrical devices and systems may malfunction if liquids are splashed on them.

Do not use silicone based sprays on electrical devices such as audio devices and switches. Doing so may cause the items to malfunction or cause a fire inside the vehicle.

If a silicone based spray is inadvertently used on electrical devices, consult a dealer.

Depending on their composition, chemicals and liquid aromatics may cause discoloration, wrinkles, and cracking to resin-based parts and textiles. Do not use alkali solvents or organic solvents such as benzene or gasoline.

After using chemicals, make sure to gently wipe them away using a dry cloth.

Do not place used cloths on top of resin based parts or textiles for long periods of time without washing.

## ■ Cleaning the Window

Wipe using a glass cleaner.

## ▣ Cleaning the Window

Wires are mounted to the inside of the rear window. Wipe along the same direction as the wires with a soft cloth so as not to damage them.

Be careful not to spill fluids, such as water or glass cleaner, on or around the cover of both the front wide view camera and the rainfall/light sensor\*.

## ▣ Floor Mats

If you use any floor mats that were not originally provided with your vehicle, make sure they are designed for your specific vehicle, fit correctly, and are securely anchored by the floor anchors. Position the rear seat floor mats properly. If not properly positioned, the floor mats can interfere with the front seat functions.

## ■ Floor Mats

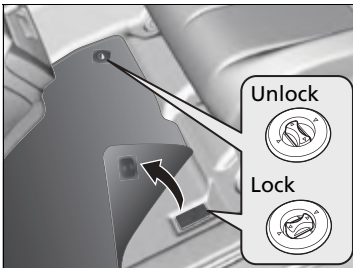

The driver's floor mat hooks over floor anchors, which keep the mat from sliding forward. To remove a mat for cleaning, turn the anchor knobs to the unlock position. When reinstalling the mat after cleaning, turn the knobs to the lock position.

**Do not put additional floor mats on top of the anchored mat.**

\* Not available on all models

## ■ Maintaining Genuine Leather

To properly clean leather:

1. Use a vacuum or soft dry cloth first to remove any dirt or dust.
2. Clean the leather with a soft cloth dampened with a solution comprised of 90% water and 10% neutral soap.
3. Wipe away any soap residue with a clean damp cloth.
4. Wipe away residual water and allow leather to air dry in the shade.

## ▣ Maintaining Genuine Leather

It is important to clean or wipe away dirt or dust as soon as possible. Spills can soak into leather resulting in stains. Dirt or dust can cause abrasions in the leather. In addition, please note that some dark colored clothing can rub onto the leather seats resulting in discoloration or stains.



## Exterior Care

Dust off the vehicle body after you drive. Regularly inspect your vehicle for scratches on painted surfaces. A scratch on a painted surface can result in body rust. If you find a scratch, promptly repair it.

### ■ Washing the Vehicle

Wash the vehicle regularly. Wash more frequently when driving in the following conditions:

- If driving on roads with road salt.
- If driving in coastal areas.
- If tar, soot, bird droppings, insects, or tree sap are stuck to painted surfaces.

### ■ Using an Automated Car Wash

- Make sure to follow the instructions indicated on the automated car wash.
- Fold in the door mirrors.
- For models equipped with automatic intermittent wipers, turn the wipers off.

### ■ Using High Pressure Cleaners

- Keep sufficient distance between the cleaning nozzle and the vehicle body.
- Take particular care around the windows. Standing too close may cause water to enter the vehicle interior.
- Do not spray high pressure water directly into the engine compartment. Instead, use low pressure water and a mild detergent.
- Do not spray water directly onto the camera or the area around it. Water may enter the lens and cause the camera to malfunction.

### ▶▶ Washing the Vehicle

Do not spray water into the air intake vents. It can cause a malfunction.

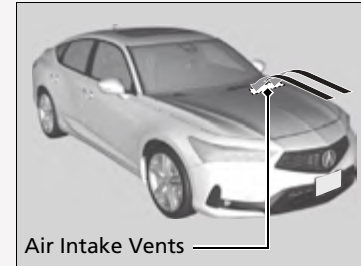

Do not spray water onto the fuel fill door directly. A high-pressure spray may cause it to open.

Do not spray water onto the capless unit when the fuel fill door is open. It can cause damage to the fuel system or engine.

If you need to lift the wiper arms away from the windshield, first set the wiper arms to the maintenance position.

▶▶ **Changing the Wiper Blade** P. 639

## ■ Applying Wax

A good coat of automotive body wax helps protect your vehicle's paint from the elements. Wax will wear off over time and expose your vehicle's paint to the elements, so reapply as necessary.

## ■ Maintaining the Bumpers and Other Resin Coated Parts

If you get gasoline, oil, engine coolant, or battery fluid on resin coated parts, they may be stained or the coating may peel. Promptly wipe it away using a soft cloth and clean water.

## ■ Cleaning the Window

Wipe using a glass cleaner.

## ■ Maintaining Aluminum Wheels

Aluminum is susceptible to deterioration caused by salt and other road contaminants. When necessary, as early as possible use a sponge and mild detergent to wipe away these contaminants. Do not use a stiff brush or harsh chemicals (including some commercial wheel cleaners). These can damage the protective finish on aluminum alloy wheels, resulting in corrosion. Depending on the type of finish, the wheels also may lose their luster or appear burnished. To avoid water stains, wipe the wheels dry with a cloth while they are still wet.

## ▶▶ Applying Wax

### NOTICE

Chemical solvents and strong cleaners can damage the paint, metal, and plastic on your vehicle. Wipe away spills immediately.

## ▶▶ Maintaining the Bumpers and Other Resin Coated Parts

Ask a dealer about the correct coating material when you want to repair the painted surface of the parts made of resin.

## ■ Fogged Exterior Light Lenses

The inside lenses of exterior lights (headlights, brake lights, etc.) may fog temporarily if you have driven in the rain, or after the vehicle has been run through a car wash. Dew condensation also may build up inside the lenses when there is a significant enough difference between the ambient and inside lens temperatures (similar to vehicle windows fogging up in rainy conditions). These conditions are natural processes, not structural design problems in the exterior lights.

Lens design characteristics may result in moisture developing on the light lens frame surfaces. This also is not a malfunction.

However, if you see large amounts of water accumulation, or large water drops building up inside the lenses, have your vehicle inspected by a dealer.

## Accessories

When installing accessories, check the following:

- Do not install accessories on the windshield. They can obstruct your view and delay your reaction to driving conditions.
- Do not install any accessories over areas marked **SRS AIRBAG**, on the sides or backs of the front seats, on the sides of the rear seats, on front or side pillars, or near the side windows.  
Accessories installed in these areas may interfere with proper operation of the vehicle's airbags or may be propelled into you or another occupant if the airbags deploy.
- Be sure electronic accessories do not overload electrical circuits or interfere with proper operation of your vehicle.
  - ▣ **Fuses** P. 705
- Before installing any electronic accessory, have the installer contact a dealer for assistance. If possible, have a dealer inspect the final installation.

### ▣ Accessories and Modifications

## **WARNING**

Improper accessories or modifications can affect your vehicle's handling, stability, and performance, and cause a crash in which you can be seriously hurt or killed.

Follow all instructions in this owner's manual regarding accessories and modifications.

Acura Genuine accessories are recommended to ensure proper operation on your vehicle.

## Modifications

---

Do not modify your vehicle in a manner that may affect its handling, stability, or reliability, or install non-genuine Acura parts or accessories that may have a similar effect.

Even minor modifications to vehicle systems can affect overall vehicle performance. Always make sure all equipment is properly installed and maintained, and do not make any modification to your vehicle or its systems that might cause your vehicle to no longer meet federal, state, province, territory, and local regulations.

The on-board diagnostic port (OBD-II/SAE J1962 connector) installed on this vehicle is intended to be used with automobile system diagnostic devices or with other devices that Acura has approved. Use of any other type of device may adversely affect the vehicle's electronic systems or allow them to be compromised, possibly resulting in a system malfunction, drained battery, or other unexpected problems.

Do not modify or attempt to repair any of the electrical components.

This page intentionally left blank.

# Handling the Unexpected

This chapter explains how to handle unexpected troubles.

## Tools

Types of Tools..... 666

## If a Tire Goes Flat

Temporarily Repairing a Flat Tire..... 667

Changing a Flat Tire..... 682

## Engine Does Not Start

Checking the Engine..... 689

If the Keyless Remote Battery is Weak .. 691

Emergency Engine Start..... 692

Emergency Engine Stop..... 693

## If the Battery Is Dead

Jump Starting Procedure..... 694

**Shift Lever Does Not Move**..... 696

## Overheating

How to Handle Overheating..... 697

## Indicator, Coming On/Blinking

If the Engine oil pressure low Warning

Appears..... 699

If the Charging System Indicator Comes

On..... 700

If the Malfunction Indicator Lamp Comes

On or Blinks..... 700

If the Brake System Indicator (Red) Comes

On or Blinks..... 701

If the Brake System Indicator (Red) Comes On

or Blinks at the Same Time When the Brake

System Indicator (Amber) Comes On.. 703

If the Electric Power Steering (EPS) System

Indicator Comes On..... 702

If the Low Tire Pressure/TPMS Indicator

Comes On or Blinks..... 704

## Fuses

Fuse Locations..... 705

Inspecting and Changing Fuses..... 709

**Emergency Towing**..... 711

**If You Cannot Unlock the Fuel Fill Door**.. 712

**If You Cannot Open the Hatch**..... 713

**Refueling**..... 714

## Types of Tools

### Models with optional spare tire

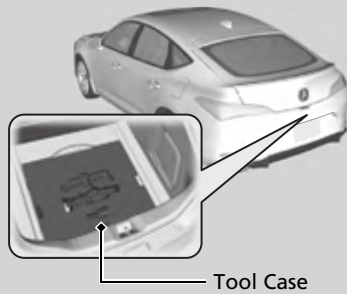

Wheel Nut Wrench/  
Jack Handle



Jack



Jack Handle Bar



Funnel

### Models with temporary tire repair kit

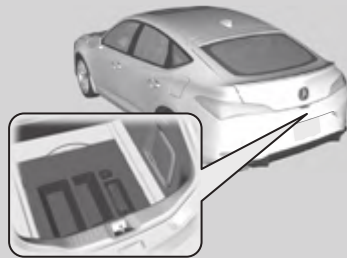

Funnel

### Types of Tools

The tools are stored in the cargo area.



# If a Tire Goes Flat

Models with temporary tire repair kit

## Temporarily Repairing a Flat Tire

If the tire has a large cut or is otherwise severely damaged, you will need to have the vehicle towed. If the tire only has a small puncture, from a nail for instance, you can use the temporary tire repair kit so that you can drive to the nearest service station for a more permanent repair.

If a tire goes flat while driving, grasp the steering wheel firmly, and brake gradually to reduce speed. Then, stop in a safe place.

1. Park the vehicle on a firm, level, and non-slippery surface and apply the parking brake.
2. Put the transmission into **P**.
3. Turn on the hazard warning lights and set the power mode to VEHICLE OFF.

### Temporarily Repairing a Flat Tire

The kit should not be used in the following situations. Instead, contact a dealer or roadside assistance to have the vehicle towed.

- The tire sealant has expired.
- More than one tire is punctured.
- The puncture or cut is larger than 3/16 inch (4.8 mm).
- The tire side wall is damaged or the puncture is outside the contact area.

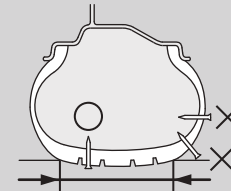

When the puncture is:	Kit Use
Smaller than 3/16 inch (4.8 mm)	Yes
Larger than 3/16 inch (4.8 mm)	No

- Damage has been caused by driving with the tire extremely under inflated.
- The tire bead is no longer seated.
- The rim is damaged.

Do not remove a nail or screw that punctured the tire. If you remove it from the tire, you may not be able to repair the puncture using the kit.

## ■ Getting Ready to Temporarily Repair the Flat Tire

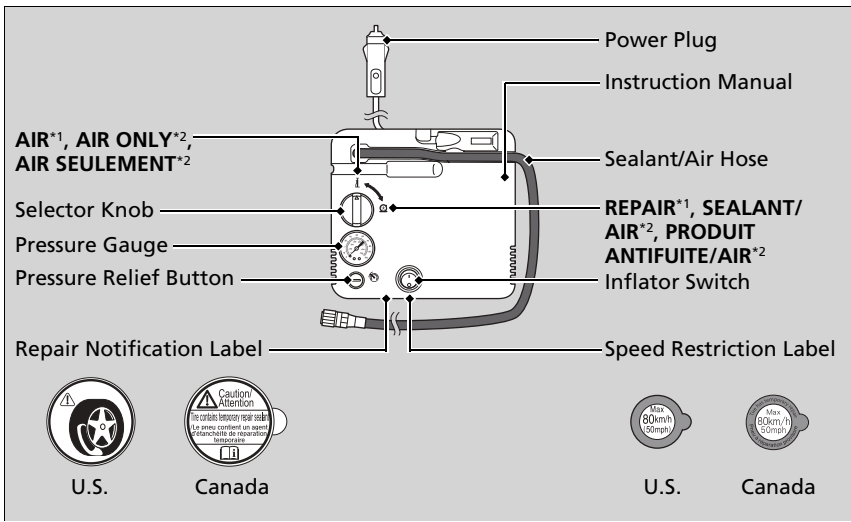

\*1: U.S. models  
\*2: Canadian models

## ▶▶ Temporarily Repairing a Flat Tire

### NOTICE

Do not use a puncture-repairing agent other than the one provided in the kit that came with your vehicle. If a different agent is used, you may permanently damage the tire pressure sensor.

## ▶▶ Getting Ready to Temporarily Repair the Flat Tire

Repair notification label and speed restriction label are applied to the side of the temporary tire repair kit.

When making a temporary repair, carefully read the instruction manual provided with the kit.

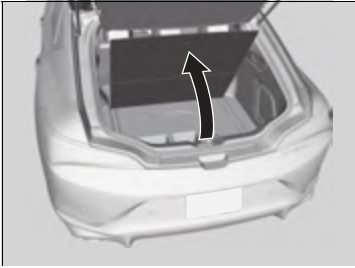

1. Pull the strap on the cargo area floor lid and open the lid.

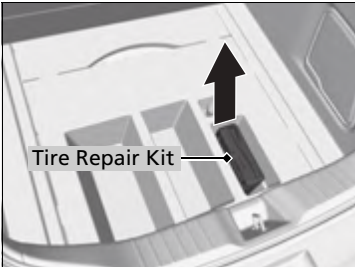

2. Take the kit out of the case.
3. Place the kit face up, on flat ground near the flat tire, and away from traffic. Do not place the kit on its side.

## ■ Injecting Sealant and Air

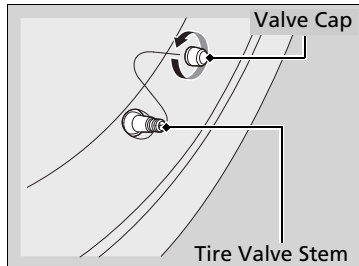

1. Remove the valve cap from the tire valve stem.

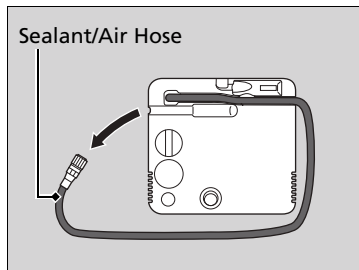

2. Remove the sealant/air hose from the packaging.

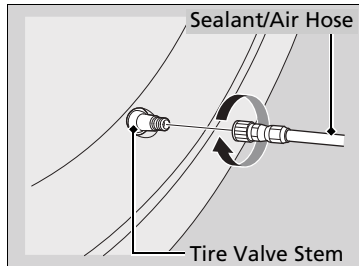

3. Attach the sealant/air hose onto the tire valve stem. Screw it until it is tight.

## ▶▶ Injecting Sealant and Air

### ⚠ CAUTION

Tire sealant contains substances that are harmful if inhaled, ingested or if contact is made with the eyes or skin.

Always use in a well-ventilated area and use gloves and safety glasses for protection; do not ingest.

For skin or eye contact, flush with cool water; if ingested, rinse mouth with water. In all cases, seek medical attention if necessary.

In cold temperatures, the sealant may not flow easily. In this situation, warm it up for five minutes before using.

The sealant can permanently stain clothing and other materials. Be careful during handling and wipe away any spills immediately.

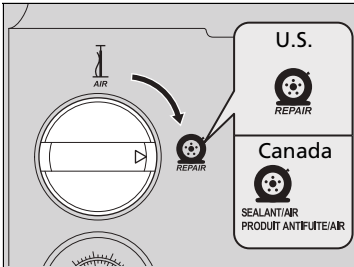
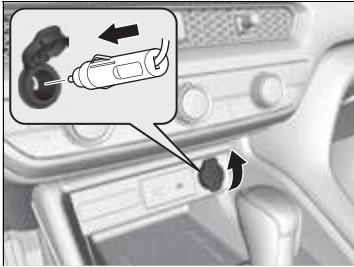

4. Plug in the compressor to the accessory power socket.
  - ▶ Be careful not to pinch the cord in a door or window.
    - **Accessory Power Socket** P. 210
5. Start the engine.
  - **Starting the Engine** P. 430
  - ▶ Keep the engine running while injecting sealant and air.
    - **Carbon Monoxide Gas** P. 81
6. Turn the selector knob to **REPAIR**\*1, **SEALANT/AIR**\*2, **PRODUIT ANTIFUITE/AIR**\*2.

▶▶ Injecting Sealant and Air

**⚠ WARNING**

Running the engine with the vehicle in an enclosed or even partly enclosed area can cause a rapid buildup of toxic carbon monoxide.

Breathing this colorless, odorless gas can cause unconsciousness and even death. Only run the engine to power the air compressor with the vehicle outdoors.

**NOTICE**

Do not operate the temporary tire repair kit compressor for more than 15 minutes. The compressor can overheat and become permanently damaged.

\*1: U.S. models  
\*2: Canadian models

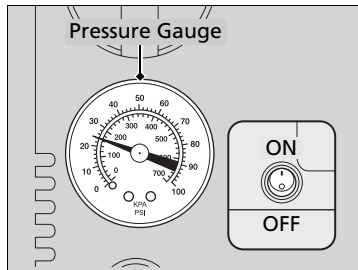

7. Press the inflator switch to turn on the kit.
  - ▶ The compressor starts injecting sealant and air into the tire.
  - ▶ When the sealant injection is complete continue to add air.

**8. Models with 235/40R18 91W tires**

After the air pressure reaches front: 35 psi (240 kPa)/rear: 33 psi (230 kPa), turn off the kit.

**Models with 215/50R17 91H tires**

After the air pressure reaches 33 psi (230 kPa), turn off the kit.

- ▶ To check the pressure, occasionally turn off the compressor, and read the gauge.

9. Unplug the power plug from the accessory power socket.

10. Unscrew the sealant/air hose from the tire valve stem. Reinstall the valve cap.

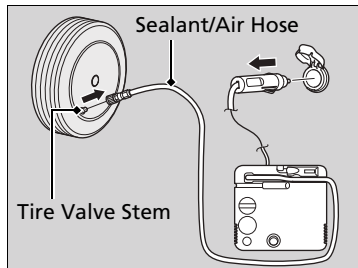

▶▶ Injecting Sealant and Air

Until the sealant injection is complete, the pressure shown on the pressure gauge will appear higher than actual. After the sealant injection is complete the pressure will drop and then begin to rise again as the tire is inflated with air. This is normal. To accurately measure the air pressure using the gauge, turn the air compressor off only after the sealant injection is complete.

If the required air pressure is not reached within 10 minutes, the tire may be too severely damaged for the kit to provide the necessary seal, and your vehicle will need to be towed.

See an Acura dealer for a replacement sealant bottle and proper disposal of an empty bottle.

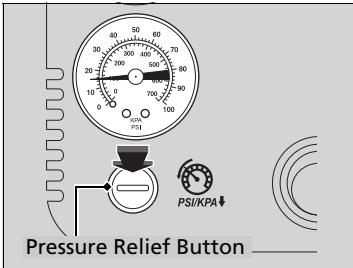

11. Press the pressure relief button until the gauge returns 0 psi (0 kPa).

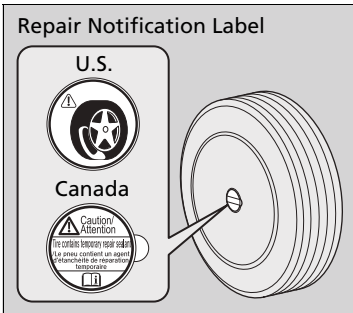

12. Apply the repair notification label to the flat surface of the wheel.
  - ▶ The wheel surface must be clean to ensure the label adheres properly.

## ■ Distributing the Sealant in the Tire

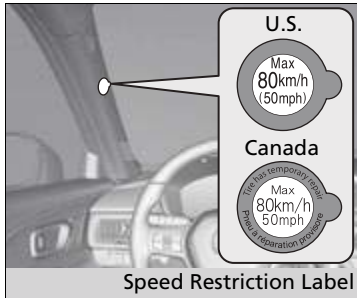

1. Apply the speed restriction label to the location as shown.
2. Drive the vehicle for about 10 minutes.
  - ▶ Do not exceed 50 mph (80 km/h).
3. Stop the vehicle in a safe place.



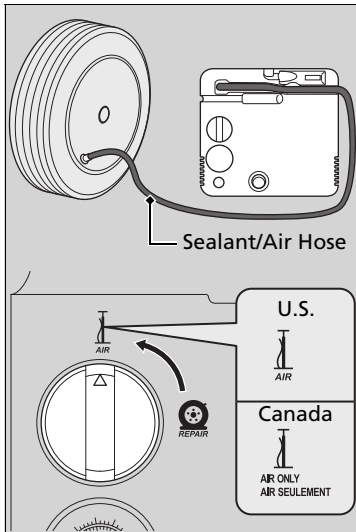

4. Recheck the air pressure using the sealant/air hose on the compressor.
5. Turn the selector knob to **AIR**<sup>\*1</sup>, **AIR ONLY**<sup>\*2</sup>, **AIR SEULEMENT**<sup>\*2</sup>.
  - Do not turn the air compressor on to check the pressure.
  - **Inflating an Under-inflated Tire** P. 679

\*1: U.S. models

\*2: Canadian models

6. If the air pressure is
- Less than 25 psi (175 kPa):  
Do not add air or continue driving. The leak is too severe. Call for help and have your vehicle towed.

➔ **Emergency Towing** P. 711

**Models with 235/40R18 91W tires**

- Front: 35 psi (240 kPa)/rear: 33 psi (230 kPa) or more:

**Models with 215/50R17 91H tires**

- 33 psi (230 kPa) or more:  
Continue driving for another 10 minutes or until you reach the nearest service station, whichever is sooner. Do not exceed 50 mph (80 km/h). If you have not reached a service station after 10 minutes, stop in a safe place and check the tire pressure.
- ▶ If the air pressure does not go down after the 10 minute driving, you do not need to check the pressure any more.

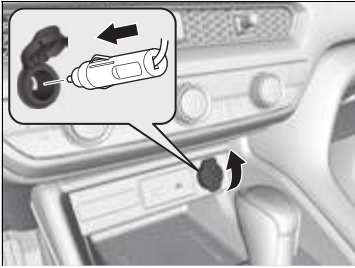

#### Models with 235/40R18 91W tires

- Greater than 25 psi (175 kPa), but less than front: 35 psi (240 kPa)/rear: 33 psi (230 kPa):

Turn the air compressor on to inflate the tire until the tire pressure reaches to front: 35 psi (240 kPa)/rear: 33 psi (230 kPa).

#### Models with 215/50R17 91H tires

- Greater than 25 psi (175 kPa), but less than 33 psi (230 kPa):

Turn the air compressor on to inflate the tire until the tire pressure reaches to 33 psi (230 kPa).

#### ➤ **Inflating an Under-inflated Tire** P. 679

Then, drive carefully for 10 more minutes or until you reach the nearest service station. Do not exceed 50 mph (80 km/h).

- ▶ You should repeat this procedure as long as the air pressure is within this range.

#### ▶▶ Distributing the Sealant in the Tire

### **⚠ WARNING**

Running the engine with the vehicle in an enclosed or even partly enclosed area can cause a rapid buildup of toxic carbon monoxide.

Breathing this colorless, odorless gas can cause unconsciousness and even death. Only run the engine to power the air compressor with the vehicle outdoors.

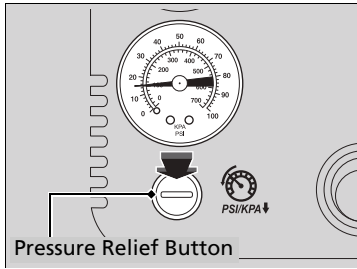

7. Unplug the kit from the accessory power socket.
8. Unscrew the sealant/air hose from the tire valve stem. Reinstall the valve cap.
9. Press the pressure relief button until the gauge returns 0 psi (0 kPa).
10. Repackage and properly stow the kit.

## ■ Inflating an Under-inflated Tire

You can use the kit to inflate a non-punctured under-inflated tire.

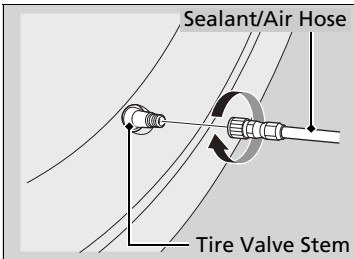
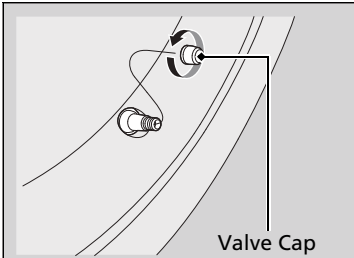
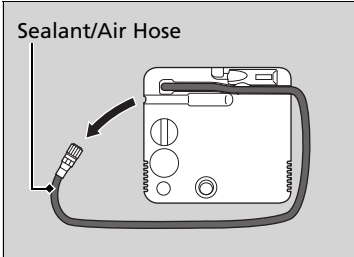

1. Open the cargo area floor lid.
  - **Getting Ready to Temporarily Repair the Flat Tire** P. 668
2. Remove the kit from the case.
3. Place the kit, face up, on flat ground near the tire to be inflated, away from traffic. Do not place the kit on its side.
4. Remove the sealant/air hose from the kit.
5. Remove the valve cap.
6. Attach the sealant/air hose onto the tire valve stem. Screw it until it is tight.

## ▣ Inflating an Under-inflated Tire

### NOTICE

Do not operate the temporary tire repair kit compressor for more than 15 minutes. The compressor can overheat and become permanently damaged.

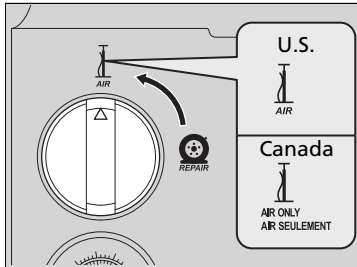

7. Plug in the kit to the accessory power socket.
  - ▶ Be careful not to pinch the cord in a door or window.
    - **Accessory Power Socket** P. 210
8. Start the engine.
  - **Starting the Engine** P. 430
  - ▶ Keep the engine running while injecting air.
    - **Carbon Monoxide Gas** P. 81
9. Turn the selector knob to **AIR**\*1, **AIR ONLY**\*2, **AIR SEULEMENT**\*2.
10. Press the inflator switch to turn on the kit.
  - ▶ The compressor starts to inject air into the tire.
11. Inflate the tire to the specified air pressure.

▶▶ Inflating an Under-inflated Tire

**⚠ WARNING**

Running the engine with the vehicle in an enclosed or even partly enclosed area can cause a rapid buildup of toxic carbon monoxide.

Breathing this colorless, odorless gas can cause unconsciousness and even death. Only run the engine to power the air compressor with the vehicle outdoors.

\*1: U.S. models

\*2: Canadian models

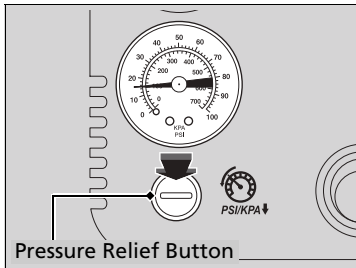

- 12.** Turn off the kit.
  - Check the pressure gauge on the air compressor.
  - If overinflated, press the pressure relief button.
- 13.** Unplug the kit from the accessory power socket.
- 14.** Unscrew the sealant/air hose from the tire valve stem. Reinstall the valve cap.
- 15.** Press the pressure relief button until the gauge returns 0 psi (0 kPa).
- 16.** Repackage and properly stow the kit.

Models with optional spare tire

## Changing a Flat Tire

If a tire goes flat while driving, grasp the steering wheel firmly, and brake gradually to reduce speed. Then, stop in a safe place. Replace the flat tire with a compact spare tire. Go to a dealer as soon as possible to have the full-size tire repaired or replaced.

1. Park the vehicle on a firm, level, non-slippery surface and apply the parking brake.

Continuously variable transmission models

2. Put the transmission into **P**.

Manual transmission models

2. Put the transmission into **R**.

All models

3. Turn on the hazard warning lights and set the power mode to VEHICLE OFF.

### Changing a Flat Tire

Follow compact spare precautions:  
Periodically check the tire pressure of the compact spare. It should be set to the specified pressure.  
Specified Pressure: 60 psi (420 kPa, 4.2 kgf/cm<sup>2</sup>)

When driving with the compact spare tire, keep the vehicle speed under 50 mph (80 km/h). Replace with a full-size tire as soon as possible.

The compact spare tire and wheel in your vehicle are specifically for this model. Do not use them with another vehicle. Do not use another type of compact spare tire or wheel with your vehicle.

Do not mount tire chains on a compact spare tire. If a chain-mounted front tire goes flat, remove one of the full-size rear tires and replace it with the compact spare tire. Remove the flat front tire and replace it with the full-size tire that was removed from the rear. Mount the tire chains on the front tire.

**NOTICE**

Do not use the jack if it doesn't work properly. Call your dealer or a professional towing service.



## ■ Getting Ready to Replace the Flat Tire

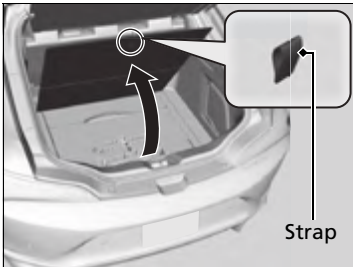

1. Pull the strap on the cargo area floor lid and open the lid.

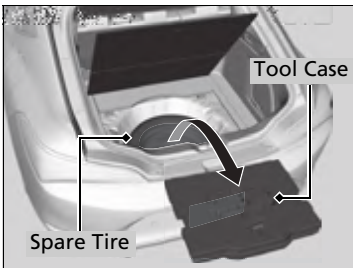

2. Take the tool case out of the cargo area.
3. Take the jack, wheel nut wrench, and jack handle bar out of the tool case.
4. Unscrew the wing bolt, and remove the spacer cone. Then, remove the spare tire.

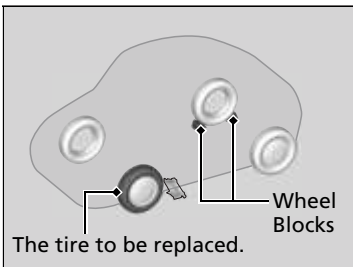

5. Place a wheel block or rock in front and rear of the wheel diagonal to the flat tire.



6. Place the compact spare tire (wheel side up) under the vehicle body, near the tire that needs to be replaced.

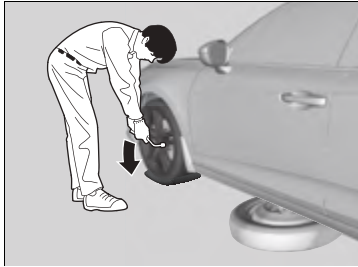

7. Loosen each wheel nut about one turn using the wheel nut wrench.

## How to Set Up the Jack

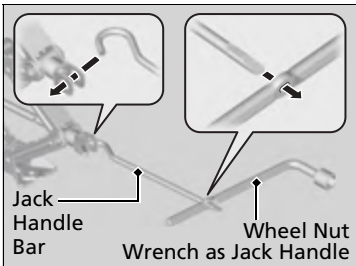
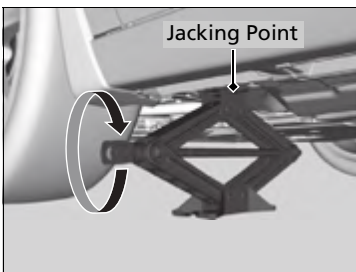
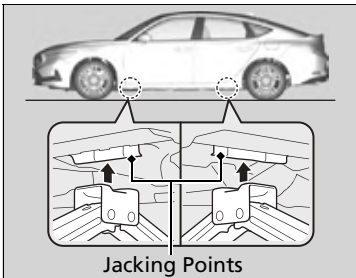

1. Place the jack under the jacking point closest to the tire to be changed.

2. Turn the end bracket clockwise as shown in the image until the top of the jack contacts the jacking point.

▶ Make sure that the jacking point tab is resting in the jack notch.

3. Raise the vehicle, using the jack handle bar and the jack handle, until the tire is off the ground.

### How to Set Up the Jack

## ⚠ WARNING

The vehicle can easily roll off the jack, seriously injuring anyone underneath.

Follow the directions for changing a tire exactly, and never get under the vehicle when it is supported only by the jack.

Do not use the jack with people or luggage in the vehicle.

Use the jack provided in your vehicle. Other jacks may not support the weight ("load") or may not fit the jacking point.

The following instructions must be followed to use the jack safely:

- Do not use while the engine is running.
- Use only where the ground is firm and level.
- Use only at the jacking points.
- Do not get in the vehicle while using the jack.
- Do not put anything on top of or underneath the jack.

## ■ Replacing the Flat Tire



1. Remove the wheel nuts and flat tire.

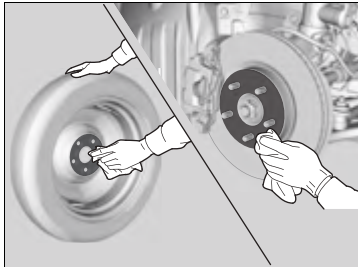

2. Wipe the mounting surfaces of the wheel with a clean cloth.

3. Mount the compact spare tire.

4. Screw the wheel nuts until they touch the lips around the mounting holes, then stop rotating.

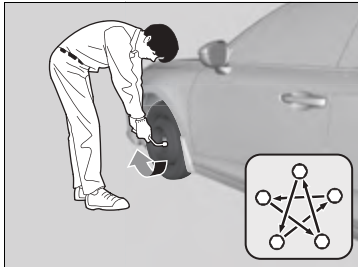

5. Lower the vehicle and remove the jack. Tighten the wheel nuts in the order indicated in the image. Go around, tightening the nuts, two to three times in this order.

**Wheel nut torque:**

80 lbf·ft (108 N·m, 11 kgf·m)

## ▣ Replacing the Flat Tire

Do not over tighten the wheel nuts by applying extra torque using your foot or a pipe.

## ■ Storing the Flat Tire

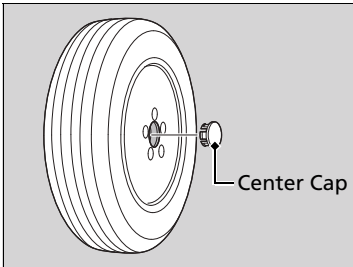

1. Remove the center cap.

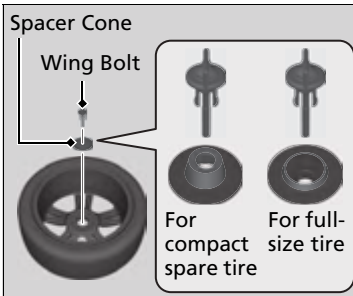

2. Place the flat tire face down in the spare tire well.

3. Remove the spacer cone from the wing bolt, flip it over, and insert it back on the bolt. Secure the flat tire with the wing bolt.

4. Securely store the jack, wheel nut wrench, and jack handle bar back in the tool case. Store the case in the cargo area.

### ▶▶ Storing the Flat Tire

## ⚠ WARNING

Loose items can fly around the interior in a crash and can seriously injure the occupants.

Store the wheel, jack, and tools securely before driving.

## ■ TPMS and the Compact Spare Tire

If you replace a flat tire with the spare tire, the low tire pressure/TPMS indicator comes on while you are driving. After driving for a few miles (kilometers), **Tire pressure monitor system problem. Check tire pressure. See your dealer.** will appear on the driver information interface and the indicator will start blinking for a short time and then stay on; however, this is normal and is no cause for concern.

If you replace the tire with a full-size tire, the warning message on the driver information interface and the low tire pressure/TPMS indicator will go off after a few miles (kilometers).

## ▣ TPMS and the Compact Spare Tire

The system cannot monitor the pressure of the spare tire. Manually check the spare tire pressure to be sure that it is correct.

Use the TPMS specific wheels. Each is equipped with a tire pressure sensor mounted inside the tire behind the valve stem.

## Checking the Engine

If the engine does not start, check the starter.

### ☞ Checking the Engine

If you must start the vehicle immediately, use an assisting vehicle or booster battery to jump start it.

☞ **If the Battery Is Dead** P. 694

Depending on the situation, it may be possible to temporarily start the engine using the emergency start procedure.

☞ **Emergency Engine Start** P. 692

### Starter condition

### Checklist

#### **Starter doesn't turn or turns over slowly.**

The battery may be dead. Check each of the items on the right and respond accordingly.

#### **Check for a message on the driver information interface.**

- If the **To start, touch start button with emblem side of remote** message appears
  - ☞ **If the Keyless Remote Battery is Weak** P. 691
  - ▶ Make sure the keyless remote is in its operating range.
    - ☞ **ENGINE START/STOP Button Operating Range** P. 172

#### **Check the fuses.**

Check all fuses, or have your vehicle checked by a dealer.

☞ **Inspecting and Changing Fuses** P. 709

#### **Check the battery.**

Have the battery checked by a dealer.

☞ **Battery** P. 651

---

Starter condition

Checklist

---

**The starter turns over normally but the engine doesn't start.**

There may be a problem with a fuse. Check each of the items on the right and respond accordingly.

**Review the engine start procedure.**

Follow its instructions, and try to start the engine again.

➤ **Starting the Engine** P. 430

---

**Check the immobilizer system indicator.**

When the immobilizer system indicator is blinking, the engine cannot be started.

➤ **Immobilizer System** P. 165

---

**Check the fuel level.**

There should be enough fuel in the tank.

➤ **Fuel Gauge** P. 105

---

**Check the fuses.**

Check all fuses, or have the vehicle checked by a dealer.

➤ **Inspecting and Changing Fuses** P. 709

---

**If the problem continues:**

➤ **Emergency Towing** P. 711

---



## If the Keyless Remote Battery is Weak

If the beeper sounds, the **To start, touch start button with emblem side of remote** message appears on the driver information interface, and the **ENGINE START/STOP** button flashes, and the engine won't start, start the engine as follows:

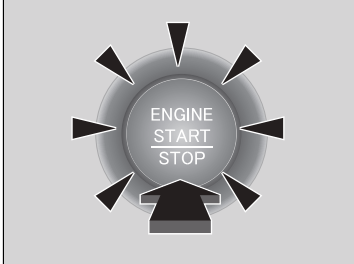
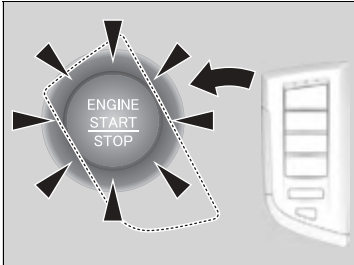

1. Touch the center of the **ENGINE START/STOP** button with the **A** logo on the keyless remote while the **ENGINE START/STOP** button is flashing. The buttons on the keyless remote should be facing you.
  - ▶ The **ENGINE START/STOP** button flashes for about 30 seconds.
2. Depress the brake pedal (continuously variable transmission) or clutch pedal (manual transmission) and press the **ENGINE START/STOP** button within 10 seconds after the beeper sounds and the **ENGINE START/STOP** button changes from flashing to on.
  - ▶ If you don't depress the pedal, the mode will change to ACCESSORY.

Continuously variable transmission models

## Emergency Engine Start

If the engine does not start using the normal engine starting procedure, you may be able to start it using the emergency start procedure below.

Do not use this procedure if it is not an emergency.

1. Make sure the parking brake is applied.
  - ▶ The parking brake and brake system indicator (red) comes on for 30 seconds when you pull up the electric parking brake switch.
2. Check that the transmission is in **[P]**, then set the power mode to ACCESSORY.
3. Firmly depress the brake pedal, then press and hold the **ENGINE START/STOP** button for at least 15 seconds.

This should be considered a system malfunction even if you are able to start the engine using the above procedure.

Have your vehicle checked by a dealer immediately.

### Emergency Engine Start

Refer to the following if you cannot move the shift lever out of the **[P]** position.

➤ **Shift Lever Does Not Move** P. 696

## Emergency Engine Stop

The **ENGINE START/STOP** button may be used to stop the engine due to an emergency situation even while driving. If you must stop the engine, do either of the following operations:

- Press and hold the **ENGINE START/STOP** button for about two seconds.
- Firmly press the **ENGINE START/STOP** button three times.

The steering wheel will not lock. However, because turning off the engine disables the power assist the engine provides to the steering and braking systems, it will require significantly more physical effort and time to steer and slow the vehicle. Use both feet on the brake pedal to slow down the vehicle and stop immediately in a safe place. With manual transmission models you can also downshift the transmission to utilize engine braking.

### Continuously variable transmission models

The power mode is in **ACCESSORY** when the engine is stopped. To change the mode to **VEHICLE OFF**, put the transmission into **P** after the vehicle comes to a complete stop.

### Manual transmission models

The power mode changes to **VEHICLE OFF**.

### Emergency Engine Stop

Do not press the **ENGINE START/STOP** button while driving unless it is absolutely necessary for the engine to be turned off.

If you press the **ENGINE START/STOP** button while driving, the beeper sounds.

## Jump Starting Procedure

Turn off the power to electric devices, such as audio and lights. Turn off the engine, then open the hood.

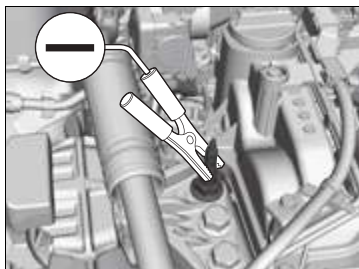
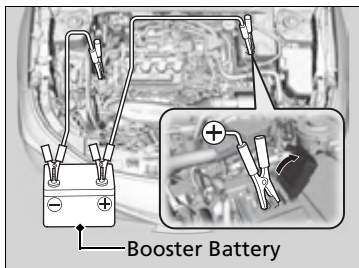

1. Open the cover on the positive  $\oplus$  terminal.
2. Connect the first jumper cable to your vehicle's battery  $\oplus$  terminal.
3. Connect the other end of the first jumper cable to the booster battery  $\oplus$  terminal.
  - ▶ Use a 12-volt booster battery only.
  - ▶ When using an automotive battery charger to boost your 12-volt battery, select a lower charging voltage than 15-volt. Check the charger manual for the proper setting.
4. Connect the second jumper cable to the booster battery  $\ominus$  terminal.
5. Connect the other end of the second jumper cable to the stud bolt as shown. Do not connect this jumper cable to any other part.
6. If your vehicle is connected to another vehicle, start the assisting vehicle's engine and increase its rpm slightly.
7. Attempt to start your vehicle's engine. If it turns over slowly, check that the jumper cables have good metal-to-metal contact.

### ⓘ If the Battery Is Dead

## **⚠ WARNING**

A battery can explode if you do not follow the correct procedure, seriously injuring anyone nearby.

Keep all sparks, open flames, and smoking materials away from the battery.

Securely attach the jumper cables clips so that they do not come off when the engine vibrates. Be careful not to tangle the jumper cables or allow the cable ends to touch each other while attaching or detaching the jumper cables.

Battery performance degrades in cold conditions and may prevent the engine from starting.

## ■ What to Do After the Engine Starts

Once your vehicle's engine has started, remove the jumper cables in the following order.

1. Disconnect the jumper cable from your vehicle's ground.
2. Disconnect the other end of the jumper cable from the booster battery ⊖ terminal.
3. Disconnect the jumper cable from your vehicle's battery ⊕ terminal.
4. Disconnect the other end of the jumper cable from the booster battery ⊕ terminal.

Have your vehicle inspected by a nearby service station or a dealer.

## ⓘ What to Do After the Engine Starts

The Vehicle Stability Assist™ (VSA®) system, Adaptive Cruise Control (ACC)\*, Adaptive Cruise Control (ACC) with Low Speed Follow\*, and safety support indicators may come on in amber along with a message in the gauge when you set the power mode to ON after reconnecting the battery. Drive a short distance at more than 12 mph (20 km/h). Each indicator should go off. If any do not, have your vehicle checked by a dealer.

\* Not available on all models

# Shift Lever Does Not Move

## Continuously variable transmission models

Follow the procedure below if you cannot move the shift lever out of the **P** position.

### Releasing the Lock

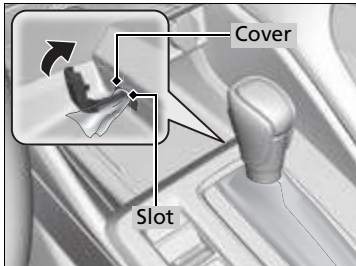

1. Set the parking brake.
2. Set the power mode to VEHICLE OFF.
3. Remove the built-in key from the keyless remote.
4. Wrap a cloth around the tip of the built-in key. Put it into the shift lock release slot as shown in the image, and remove the cover.

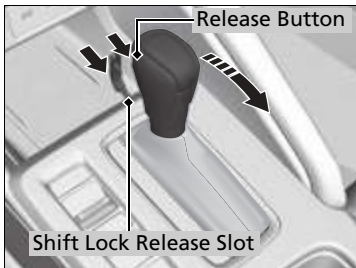

5. Insert the key into the shift lock release slot.
6. While pushing the key in, press the shift lever release button, and place the shift lever into **N**.
  - ▶ The lock is now released. Have the shift lever checked by a dealer as soon as possible.

## How to Handle Overheating

Overheating symptoms are as follows:

- The temperature gauge is at the **H** mark or the engine suddenly loses power.
- The **Engine temperature too hot. Do not drive. Allow engine to cool.** message appears on the driver information interface.
- Steam or spray comes out of the engine compartment.

### ■ First thing to do

1. Immediately park the vehicle in a safe place.
2. Turn off all accessories and turn on the hazard warning lights.
  - ▶ **No steam or spray present:** Keep the engine running and open the hood.
  - ▶ **Steam or spray is present:** Turn off the engine and wait until it subsides. Then, open the hood.

### ▣ How to Handle Overheating

## ⚠ WARNING

Steam and spray from an overheated engine can seriously scald you.

Do not open the hood if steam is coming out.

### NOTICE

Continuing to drive with the temperature gauge at the **H** mark may damage the engine.

Continuing to drive with the **Engine temperature too hot. Do not drive. Allow engine to cool.** message on the driver information interface may damage the engine.

### ■ Next thing to do

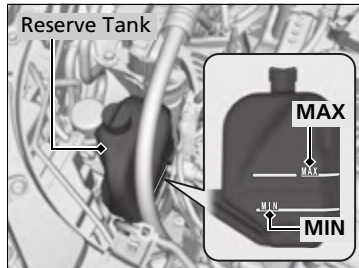

1. Check that the cooling fan is operating and stop the engine once the temperature gauge goes down.
  - If the cooling fan is not operating, immediately stop the engine.
2. Once the engine has cooled down, inspect the coolant level and check the cooling system components for leaks.
  - If the coolant level in the reserve tank is low, add coolant until it reaches the **MAX** mark.
  - If there is no coolant in the reserve tank, check that the radiator is cool. Cover the radiator cap with a heavy cloth and open the cap. If necessary, add coolant up to the base of the filler neck, and put the cap back on.

### ■ Last thing to do

Once the engine has cooled sufficiently, restart it and check the driver information interface.

If the temperature gauge goes down, resume driving. If it appears again, contact a dealer for repairs.

### ►► How to Handle Overheating

## ⚠ WARNING

Removing the radiator cap while the engine is hot can cause the coolant to spray out, seriously scalding you.

Always let the engine and radiator cool down before removing the radiator cap.

If the coolant is leaking, contact a dealer for repairs.

Use water as an emergency/temporary measure only. Have a dealer flush the system with proper antifreeze as soon as possible.



## If the Engine oil pressure low Warning Appears

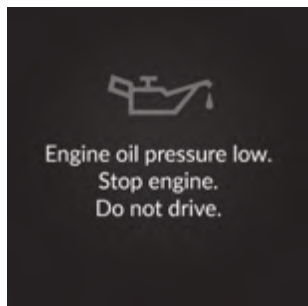

■ **Reasons for the warning to appear**  
Appears when the engine oil pressure is low.

■ **What to do as soon as the warning appears**

1. Immediately park the vehicle on level ground in a safe place.
2. If necessary, turn the hazard warning lights on.

■ **What to do after parking the vehicle**

1. Stop the engine and let it sit for approximately three minutes.
  - ▶ Add oil as necessary.
    - ▣ **Oil Check** P. 628
3. Start the engine and check the **Engine oil pressure low** warning.
  - ▶ The warning disappears: Start driving again.
  - ▶ The warning does not disappear within 10 seconds: Immediately stop the engine and contact a dealer for repairs.

### ▣ If the Engine oil pressure low Warning Appears

#### NOTICE

Running the engine with low oil pressure can cause serious mechanical damage almost immediately.

## If the Charging System Indicator Comes On



### ■ Reasons for the indicator to come on

Comes on when there is a problem with the charging system.

### ■ What to do when the indicator comes on

Stop in a safe place and have your vehicle checked by a dealer immediately.

## If the Malfunction Indicator Lamp Comes On or Blinks



### ■ Reasons for the indicator lamp to come on or blink

- Comes on when there is a problem with the engine emissions control system.
- Blinks when engine misfiring is detected.

### ■ What to do when the indicator lamp comes on

Avoid high speeds and immediately get your vehicle inspected at a dealer.

### ■ What to do when the indicator lamp blinks

Park the vehicle in a safe place with no flammable items and wait at least 10 minutes or more with the engine stopped until it cools.

### ⓘ If the Charging System Indicator Comes On

If you need to stop temporarily, do not turn off the engine. Restarting the engine may rapidly discharge the battery.

### ⓘ If the Malfunction Indicator Lamp Comes On or Blinks

#### NOTICE

If you drive with the malfunction indicator lamp on, the emissions control system and the engine could be damaged.

If the malfunction indicator lamp blinks again when restarting the engine, drive to the nearest dealer at 31 mph (50 km/h) or less. Have your vehicle inspected.

## If the Brake System Indicator (Red) Comes On or Blinks



### ■ Reasons for the indicator to come on

- The brake fluid is low.
- There is a malfunction in the brake system.

### ■ What to do when the indicator comes on while driving

Depress the brake pedal lightly to check pedal pressure.

- If normal, check the brake fluid level the next time you stop.
- If abnormal, take immediate action. If necessary, downshift the transmission to slow the vehicle using engine braking.

### ■ Reasons for the indicator to blink

There is a problem with the electric parking brake system.

### ■ What to do when the indicator blinks

Avoid using the parking brake and have your vehicle checked by a dealer immediately.

### ▶▶ If the Brake System Indicator (Red) Comes On or Blinks

Have your vehicle repaired immediately.

It is dangerous to drive with low brake fluid. If there is no resistance from the brake pedal, stop immediately in a safe place. If necessary downshift the gears.

If the brake system indicator (red) and **ABS** indicator come on simultaneously, the electronic brake distribution system is not working. This can result in vehicle instability under sudden braking. Have your vehicle inspected by a dealer immediately.

If the brake system indicator (red) blinks at the same time when the brake system indicator (amber) comes on, the parking brake may not work. Avoid using the parking brake and have your vehicle checked by a dealer immediately.

▶▶ **If the Brake System Indicator (Red) Comes On or Blinks at the Same Time When the Brake System Indicator (Amber) Comes On**  
P. 703

## If the Electric Power Steering (EPS) System Indicator Comes On

---



### ■ Reasons for the indicator to come on

Comes on when there is a problem with the EPS system.

### ■ What to do when the indicator comes on

- Stop the vehicle in a safe place and restart the engine.  
If the indicator comes on and stays on, immediately have your vehicle inspected by a dealer.
- If **Do not drive** displays on the driver information interface, immediately stop in a safe place and contact a dealer.

## If the Brake System Indicator (Red) Comes On or Blinks at the Same Time When the Brake System Indicator (Amber) Comes On



■ If the brake system indicator (red) comes on or blinks at the same time when the brake system indicator (amber) comes on, release the parking brake manually or automatically.

➤ **Parking Brake** P. 584

- If the brake system indicator (red) continuously comes on or blinks at the same time when the brake system indicator (amber) comes on, stop the vehicle in a safe place and have it inspected by a dealer immediately.

▶ Preventing the vehicle from moving.

**Continuously variable transmission models**

Put the transmission into **P**.

**Manual transmission models**

Put the transmission into **1** or **R**.

- If only the brake system indicator (red) is turned off, avoid using the parking brake and have your vehicle checked by a dealer immediately.



⊗ If the Brake System Indicator (Red) Comes On or Blinks at the Same Time When the Brake System Indicator (Amber) Comes On

If you apply the parking brake, you may not be able to release it.

If the brake system indicator (red) and the brake system indicator (amber) come on at the same time, the parking brake is working.

If the brake system indicator (red) blinks at the same time when the brake system indicator (amber) comes on, the parking brake may not work because it is checking the system.

If you repeatedly operate the electric parking brake in a short period of time, the brake stops operating to prevent heating of the system and the indicator blinks.

It returns to its original state in approximately 1 minute.

## If the Low Tire Pressure/TPMS Indicator Comes On or Blinks



### ■ Reasons for the indicator to come on or blink

A tire pressure is significantly low.

If there is a problem with the TPMS, the indicator blinks for about one minute, and then stay on.

If the compact spare tire\* is installed, the indicator will either come on or it will first blink for about one minute, then stay on.

### ■ What to do when the indicator comes on

Drive carefully and avoid abrupt cornering and hard braking.

Stop your vehicle in a safe place. Check the tire pressure and adjust the pressure to the specified level. The specified tire pressure is on a label on the driver side doorjamb.

If the compact spare tire\* causes the indicator to come on, change the tire to a full-size tire. The indicator goes off after calibrating the TPMS.

### ■ What to do when the indicator blinks, then remains on

Have the tire inspected by a dealer as soon as possible. If the compact spare tire\* causes the indicator to first blink, and then stay on, change the tire to a full-size tire. The indicator goes off after driving for a few miles (kilometers).

## ▶▶ If the Low Tire Pressure/TPMS Indicator Comes On or Blinks

### NOTICE

Driving on an extremely underinflated tire can cause it to overheat. An overheated tire can fail. Always inflate your tires to the prescribed level.

TPMS with Tire Fill Assist provides visual and audible assistance during tire pressure adjustment. With the power mode in ON and transmission in [P], while you adjust tire pressure up or down, the system alerts you as follows:

**Below recommended pressure:** The beeper sounds and exterior lights flash once every five seconds.

**At recommended pressure:** The beeper sounds and exterior lights flash rapidly for three seconds with five seconds intervals.

**Above recommended pressure:** The beeper sounds and lights flash twice every two seconds.

When a certain amount of time has passed since activation, Tire Fill Assist will be canceled until you set the power mode to OFF.

You cannot use Tire Fill Assist if the engine was started by the remote engine start, or if there is a malfunction in the system.

If Tire Fill Assist does not work, use a tire pressure gauge.

## Fuse Locations

If any electrical devices are not working, set the power mode to VEHICLE OFF and check to see if any applicable fuse is blown.

### ■ Engine Compartment Fuse Box

Located near the battery. Push the tabs to open the box.

Fuse locations are shown on the fuse box cover. Locate the fuse in question by the fuse number and box cover number.

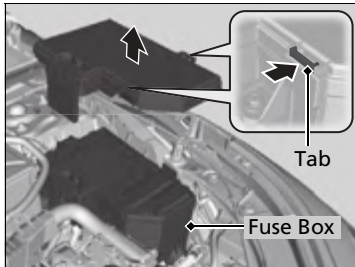

■ **Circuit protected and fuse rating**

	Circuit Protected	Amps
1	BATTERY	125 A
	-	40 A
	-	40 A
2	F/BOX OPTION	60 A
	-	40 A
	F/BOX OPTION2	40 A
	DC/DC2	30 A
	F/BOX MAIN	60 A
3	-	30 A
	-	30 A
	-	70 A
	RR DEFROSTER	30 A
	-	40 A
	-	30 A
	HTR MTR	40 A
	-	30 A
4	ABS/VSA MTR	40 A
	DC/DC	30 A
	-	30 A
	IG MAIN	30 A
	R/M1	30 A
	R/M2	30 A

	Circuit Protected	Amps
5	ST MAGNETIC SW	30 A
	WIPER	30 A
	EPS	70 A
	-	30 A
	ABS/VSA FSR	40 A
	MAIN FAN	30 A
	F/BOX MAIN2	40 A
6	SUB FAN	(30 A)
7	IG MAIN2	30 A
8	-	(7.5 A)
9	EVP*	(30 A)
10	-	(7.5 A)
11	-	-
12	-	-
13	H/STRG BATT SNSR	10 A
14	-	-
15	FR FOG*	(10 A)
16	MG CLUTCH	10 A
17	WASHER	15 A
18	HORN	15 A
19	BACK UP	15 A
20	AUDIO	(15 A)
21	RFC RLY CL+	(7.5 A)
22	DBW	15 A
23	-	-
24	BACKUP FI-ECU	10 A
25	IGP	15 A

	Circuit Protected	Amps
26	TCU*	(15 A)
27	LCM L	15 A
28	INJ	(15 A)
29	STOP	10 A
30	LCM R	15 A
31	IG COIL	15 A
32	-	-
33	HAZARD	15 A
34	AUDIO SUB VST	(7.5 A)
35	-	-
36	AUDIO VST MAIN	(30 A)
37	BACKUP2	(30 A)
38	-	-
39	-	-
40	VBACT	(10 A)
41	IGPS [LAF]	10 A
42	IG1 MON2	(7.5 A)

Handling the Unexpected



## Interior Fuse Box

Located under the dashboard.

Fuse locations are shown on the label under the steering column.

Locate the fuse in question by the fuse number and label number.

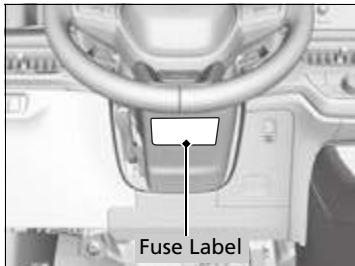
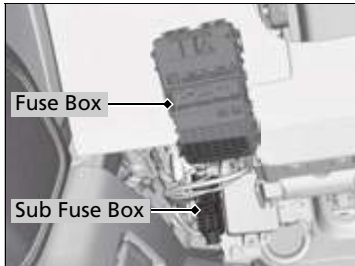

**■ Circuit protected and fuse rating**

	Circuit Protected	Amps
1	P/W DR	20 A
2	P/W AS	20 A
3	P/W RR R	20 A
4	P/W RR L	20 A
5	OPTION	10 A
6	SRS	10 A
7	T/G MTR / TRUNK ACT	10 A
8	IDAS / HUD	(10 A)
9	FR ACC SOCKET	20 A
10	DOOR LOCK	20 A
11	METER	10 A
12	OPTION3 (ST CUT)	10 A
13	-	-
14	OPTION6 (VB SOL)	10 A
15	DR DOOR UNLOCK	10 A
16	SUNROOF	20 A
17	-	-
18	-	-
19	-	-
20	-	-
21	-	-
22	SMART	10 A
23	DR DOOR LOCK	10 A
24	-	-
25	IMG	10 A

	Circuit Protected	Amps
26	SRS	10 A
27	ST CUT RLY	10 A
28	OPTION5	10 A
29	FUEL PUMP	15 A
30	L SIDE DOOR UNLOCK	10 A
31	R SIDE DOOR UNLOCK	10 A
32	-	-
33	-	-
34	-	-
35	-	-
36	-	-
37	-	-
38	-	-
39	R SIDE DOOR LOCK	10 A
40	P/SEAT REC / RR HI	20 A
41	P/SEAT SLIDE / FR HI	20 A
42	BACK LT	(7.5 A)
43	A/C	10 A
44	DRL	10 A
45	ACC	10 A
46	ACC KEY LOCK	10 A
47	L SIDE DOOR LOCK	10 A
48	H/SEAT	20 A
49	AS P/SEAT REC*	(20 A)
50	P/LUMBAR DR*	(10 A)
51	-	-
52	RR H/SEAT*	(20 A)

	Circuit Protected	Amps
53	AS P/SEAT SLI*	(20 A)
54	OPTION1 / FUEL LID	10 A
55	AUDIO AMP*	(30 A)
56	ADS*	(30 A)

**Sub Fuse Box**

	Circuit Protected	Amps
A	BACKUP2 MAIN	(10 A)
B	AUDIO SUB VST	(7.5 A)
C	ACC VST	(10 A)
D	VST 1	(10 A)
E	AUDIO VST	(15 A)
F	EOP	(20 A)
G	-	-
H	VST 2	(10 A)

Handling the Unexpected

## Inspecting and Changing Fuses

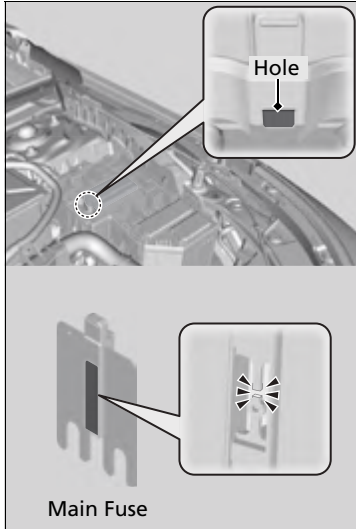

1. Set the power mode to VEHICLE OFF. Turn headlights and all accessories off.
2. Remove the fuse box cover.
3. Check the main fuse in the engine compartment fuse box.
  - ▶ Look at the fuse through the hole.
  - ▶ If the fuse is blown, have it replaced by a dealer.

### Inspecting and Changing Fuses

#### NOTICE

Replacing a fuse with one that has a higher rating greatly increases the chances of damaging the electrical system.

Use the charts to locate the fuse in question and confirm the specified amperage on the fuse label.

➤ **Fuse Locations** P. 705

Replace a fuse with a spare fuse of the same specified amperage.

Continued

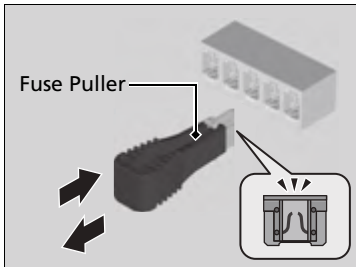
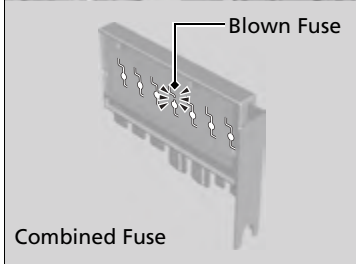
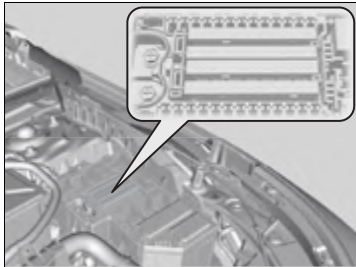

4. Check the combined fuses in the engine compartment fuse box.
  - Look into the space between the fuses.
  - If the fuse is blown, have it replaced by a dealer.

5. Inspect the small fuses in the engine compartment and the vehicle interior.
  - If there is a blown fuse, remove it with the fuse puller and replace it with a new one.

#### ► Inspecting and Changing Fuses

There is a fuse puller on the back of the engine compartment fuse box cover.

Call a professional towing service if you need to tow your vehicle.

## ■ Flatbed equipment

The operator loads your vehicle on the back of a truck.

**This is the best way to transport your vehicle.**

## ■ Wheel lift equipment

The tow truck uses two pivoting arms that go under the front tires and lift them off the ground. The rear tires remain on the ground. **This is an acceptable way to tow your vehicle.**

### » Emergency Towing

#### NOTICE

Trying to lift or tow your vehicle by the bumpers will cause serious damage. The bumpers are not designed to support the vehicle's weight.

Make sure the parking brake is released. If you cannot release the parking brake, your vehicle must be transported by the flatbed equipment.

➔ **Parking Brake** P. 584

#### NOTICE

Improper towing such as towing behind a motorhome or other motor vehicle can damage the transmission.

Never tow your vehicle with just a rope or chain. It is very dangerous since ropes or chains may shift from side to side or break.

# If You Cannot Unlock the Fuel Fill Door

## ■ What to Do If Unable to Unlock the Fuel Fill Door

If you cannot unlock the fuel fill door, use the following procedure.

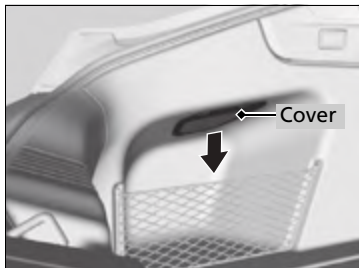

1. Open the hatch and remove the cover on the left side of cargo area.

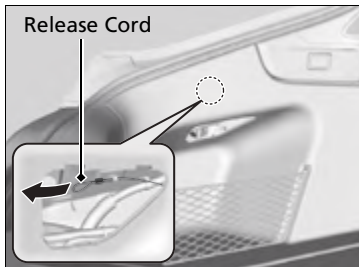

2. Pull the release cord toward you.
  - ▶ The release cord unlocks the fuel fill door when it is pulled.
3. Open the fuel fill door.
  - ▶ **How to Refuel** P. 609

## ☒ If You Cannot Unlock the Fuel Fill Door

After taking these steps, contact a dealer to have the vehicle checked.

## What to Do If Unable to Open the Hatch

If you cannot open the hatch, use the following procedure.

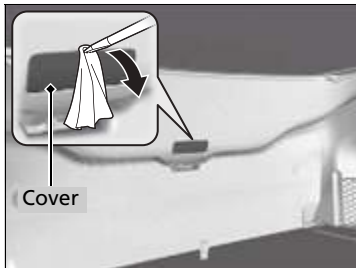

1. Remove the cover on the back of the hatch by prying it off with a small flat-tip screwdriver.

▶ Wrap the flat-tip screwdriver with a cloth to prevent scratches.

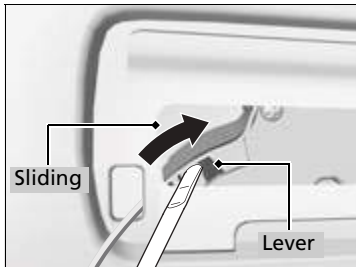

2. Push the release lever until the hatch unlocks. Push the hatch up to open.

## If You Cannot Open the Hatch

When you open the hatch from inside, make sure there is enough space around the hatch, and it does not hit anyone or any object.

Following up:

After taking these steps, contact a dealer to have your vehicle checked.

## Refueling From a Portable Fuel Container

If you have run out of fuel and need to refuel your vehicle from a portable fuel container, use the funnel provided with your vehicle.

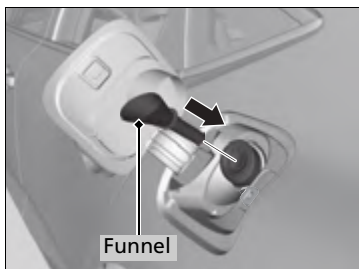

1. Turn off the engine.
2. Press on the edge of the fuel fill door until you hear a click when the driver's door is unlocked.
  - ▶ The fuel fill door opens.
3. Take the funnel out of the tool case in the cargo area.
  - ▶ **Types of Tools** P. 666
4. Place the end of the funnel on the lower part of filler opening, then insert it slowly and fully.
  - ▶ Make sure that the end of the funnel goes down along with the filler pipe.
5. Fill the tank with fuel from the portable fuel container.
  - ▶ Pour fuel carefully so you do not spill any.
6. Remove the funnel from the filler neck.
  - ▶ Wipe up any fuel from the funnel before storing it.
7. Shut the fuel fill door by hand.

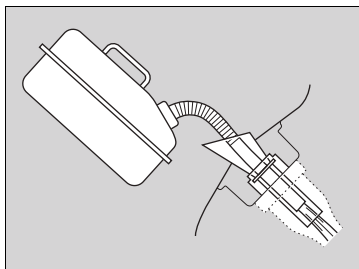

### ▶▶ Refueling From a Portable Fuel Container

#### **⚠ WARNING**

Gasoline is highly flammable and explosive. You can be burned or seriously injured when handling fuel.

- Stop the engine, and keep heat, sparks, and flames away.
- Handle fuel only outdoors.
- Wipe up spills immediately.

#### **NOTICE**

Do not insert the nozzle of a portable fuel container or any funnel other than the one provided with your vehicle. Doing so can damage the fuel system. Do not try to pry open or push open the sealed fuel tank with foreign objects. This can damage the fuel system and its seal.

Make sure the fuel in the portable fuel container is gasoline before you refuel.



# Information

This chapter includes your vehicle's specifications, locations of identification numbers, and other information required by regulation.

<b>Specifications</b> .....	716	<b>Open Source Licenses</b> .....	728
<b>Identification Numbers</b>			
Vehicle Identification Number (VIN), Engine Number, and Transmission Number .....	718		
<b>Devices that Emit Radio Waves</b> .....	719		
<b>Reporting Safety Defects</b> .....	720		
<b>Emissions Testing</b>			
Testing of Readiness Codes .....	721		
<b>Warranty Coverages</b> .....	723		
<b>Authorized Manuals</b> .....	726		
<b>Client Service Information</b> .....	727		

## ■ Vehicle Specifications

Model	INTEGRA
No. of Passengers:	
Front	2
Rear	3
Total	5
<b>Weights:</b>	
Gross Vehicle Weight Rating	See the certification label on the driver's doorjamb
Gross Axle Weight Rating (Front)	See the certification label on the driver's doorjamb
Gross Axle Weight Rating (Rear)	See the certification label on the driver's doorjamb

## ■ Air Conditioning

Refrigerant Type	HFO-1234yf (R-1234yf)
Charge Quantity	15.3 – 17.1 oz (435 – 485 g)
Lubricant Type	RB100EV-01 (POE)
Quantity	6.71 – 7.5 cu-in (110 – 123 cm <sup>3</sup> )

## ■ Engine Specifications

Displacement	91.38 cu-in (1,498 cm <sup>3</sup> )
Spark Plugs	NGK DILKAR8P8SY

## ■ Fuel

Type	Unleaded premium gasoline, pump octane number 91 or higher
Fuel Tank Capacity	12.39 US gal (46.9 L)

## ■ Washer Fluid

Tank Capacity	U.S.: 1.6 US qt (1.5 L) Canada: 4.8 US qt (4.5 L)
---------------	--

## ■ Light Bulbs

Headlights (Low Beam)	LED
Headlights (High Beam)	LED
Fog Lights*	LED
Parking/Chicane™ Daytime Running Lights	LED
Front Side Marker Lights	LED
Front Turn Signal Lights	LED
Side Turn Signal Lights (on Door Mirrors)*	LED
Brake Lights	LED
Rear Turn Signal Lights	LED
Rear Side Marker Lights	LED
Back-Up Lights	LED
Brake/Chicane™ Taillights	LED
High-Mount Brake Light	LED
Rear License Plate Lights	LED
Door Outer Handle Lights*	LED
<b>Interior Lights</b>	
Map Lights	LED
Ceiling Light	LED
Ambient Lights	LED
Vanity Mirror Lights	2 W
Center Console Light	LED
Glove Box Light	LED
Door Inner Handle Lights*	LED
Foot Lights*	LED
Cargo Area Lights	LED

■ Brake/Clutch\* Fluid

Specified	Acura Heavy Duty Brake Fluid DOT 3
-----------	------------------------------------

■ Continuously Variable Transmission Fluid\*

Specified	Acura HCF-2
Capacity	Change 3.9 US qt (3.7 L)

■ Manual Transmission Fluid\*

Specified	Acura MTF
Capacity	Change 2.0 US qt (1.9 L)

■ Engine Oil

Recommended	-Acura Genuine Motor Oil 0W-20	
	-API service SN or higher grade 0W-20	
Capacity	Change	3.4 US qt (3.2 L)
	Change including filter	3.7 US qt (3.5 L)

■ Engine Coolant

Specified	Acura Long-Life Antifreeze/Coolant Type 2
Ratio	50/50 with distilled water
Capacity	1.51 US gal (5.72 L)* <sup>1</sup>
	1.48 US gal (5.59 L)* <sup>2</sup>
	(change including the remaining 0.17 US gal (0.65 L) in the reserve tank)

\*1: Continuously Variable Transmission models  
 \*2: Manual Transmission models

■ Tire

Regular	Size	215/50R17 91H* <sup>1</sup> 235/40R18 91W* <sup>2</sup>	
	Pressure psi (kPa [kgf/cm <sup>2</sup> ])	Front	33 (230 [2.3])* <sup>1</sup> 35 (240 [2.4])* <sup>2</sup>
		Rear	33 (230 [2.3])
Compact Spare* <sup>3</sup>	Size	T125/80R17 99M	
	Pressure psi (kPa [kgf/cm <sup>2</sup> ])	60 (420 [4.2])	
Wheel Size	Regular	17 x 7J* <sup>1</sup> 18 x 8J* <sup>2</sup>	
		Compact Spare* <sup>3</sup>	17 x 4T

\*1: Models with 17 inch wheel  
 \*2: Models with 18 inch wheel  
 \*3: Vehicle with optional spare tire

\* Not available on all models

## Vehicle Identification Number (VIN), Engine Number, and Transmission Number

Your vehicle has a 17-digit vehicle identification number (VIN) used to register your vehicle for warranty purposes, and for licensing and insuring your vehicle.

The locations of your vehicle's VIN, engine number, and transmission number are shown as follows.

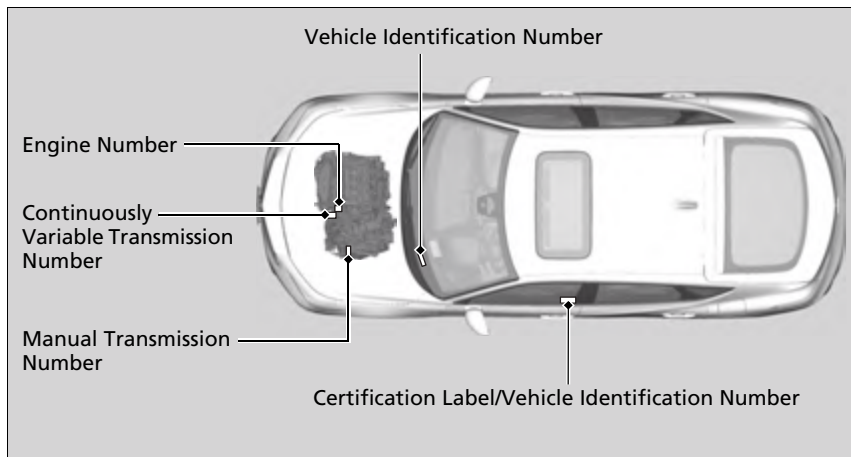

Each radio frequency device installed in the vehicle conforms to the requirements and standards of the regulation listed below:

As required by the FCC:

This device complies with Part 15 of the FCC rules. Operation is subject to the following two conditions: (1) This device may not cause harmful interference, and (2) this device must accept any interference received, including interference that may cause undesired operation.

Changes or modifications not expressly approved by the party responsible for compliance could void the user's authority to operate the equipment.

This device complies with Industry Canada licence-exempt RSS standard(s). Operation is subject to the following two conditions: (1) this device may not cause interference, and (2) this device must accept any interference, including interference that may cause undesired operation of the device.

In the U.S.

If you believe that your vehicle has a defect which could cause a crash or could cause injury or death, you should immediately inform the National Highway Traffic Safety Administration (NHTSA) in addition to notifying American Honda Motor Co., Inc.

If NHTSA receives similar complaints, it may open an investigation, and if it finds that a safety defect exists in a group of vehicles, it may order a recall and remedy campaign. However, NHTSA cannot become involved in individual problems between you, your dealer, or American Honda Motor Co., Inc.

To contact NHTSA, you may call the Vehicle Safety Hotline toll-free at 1-888-327-4236 (TTY: 1-800-424-9153); go to <http://www.safercar.gov>; or write to: Administrator, NHTSA, 1200 New Jersey Avenue, SE., Washington, DC 20590. You can also obtain other information about motor vehicle safety from <http://www.safercar.gov>.

In Canada

If you believe that your vehicle has a defect which could cause a crash or could cause injury or death, you should immediately inform Honda Canada Inc. and you may also inform Transport Canada.

If Transport Canada receives similar complaints, it may open an investigation, and if it finds that a safety defect exists in a group of vehicles, it may lead to a recall and remedy campaign. However, Transport Canada cannot become involved in individual problems between you, your dealer, or Honda Canada Inc.

To contact Transport Canada's Defect Investigations and Recalls Division, you may call 1-800-333-0510. For more information on reporting safety defects or about motor vehicle safety, go to <http://www.tc.gc.ca/roadsafety>.

## Testing of Readiness Codes

Your vehicle has readiness code as part of the onboard self diagnostic system. Some states use these codes for testing to verify whether your vehicle's emissions components are working properly. The codes may not be read properly if testing is performed just after the battery has gone dead or been disconnected.

To check if they are set, set the power mode to ON, without starting the engine. The malfunction indicator lamp will come on for several seconds. If it then goes off, the readiness codes are set. If it blinks five times, the readiness codes are not set.

If you are required to have your vehicle tested before the readiness codes are ready, prepare the vehicle for retesting by doing the following:

1. Fill the gas tank to approximately 3/4 full.
2. Park the vehicle and leave the engine off for 6 hours or more.
3. Make sure the ambient temperature is between 40°F and 95°F (4°C and 35°C).
4. Start the engine without touching the accelerator pedal, and let it idle for 20 seconds.
5. Keep the vehicle in **P** (continuously variable transmission) or **N** (manual transmission). Increase the engine speed to 2,000 rpm, and hold it there for about 3 minutes.
6. Let the engine idle with your foot off the accelerator for 20 seconds.

### Testing of Readiness Codes

The readiness codes are erased when the battery is disconnected, and set again only after several days of driving under a variety of conditions.

If a testing facility determines that the readiness codes are not set, you may be requested to return at a later date to complete the test.

If the testing facility determines the readiness codes are still not set, see a dealer.

- 7.** Select a nearby, lightly traveled major highway where you can maintain a speed of 50 to 60 mph (80 to 97 km/h) for at least 20 minutes. Drive on the highway in **D** (continuously variable transmission) or 5th (manual). Do not use cruise control. When traffic allows, drive for 90 seconds without moving the accelerator pedal. (Vehicle speed may vary slightly; this is okay.) If you cannot do this for a continuous 90 seconds because of traffic conditions, drive for at least 30 seconds, then repeat it two more times (for a total of 90 seconds).
- 8.** Drive in city or suburban traffic for at least 10 minutes. When traffic conditions allow, let the vehicle coast for several seconds without using the accelerator pedal or the brake pedal.
- 9.** Park the vehicle and leave the engine off for 30 minutes.



## ■ U.S. Owners

Your new vehicle is covered by these warranties:

***New Vehicle Limited Warranty*** – covers your new vehicle, except for the emissions control systems and accessories, against defects in materials and workmanship.

***Emissions Control Systems Defects Warranty and Emissions Performance Warranty*** – these two warranties cover your vehicle's emissions control systems. Time, mileage, and coverage are conditional. Please read your warranty booklet for exact information.

***Seat Belt Limited Warranty*** – a seat belt that fails to function properly is covered by a limited warranty. Please read your warranty booklet for details.

***Rust Perforation Limited Warranty*** – all exterior body panels are covered against rusting from the inside out for the specified time period, regardless of mileage.

***Accessory Limited Warranty*** – Acura accessories are covered under this warranty. Time and mileage limits depend on the type of accessory and other factors. Please read your warranty booklet for details.

***Replacement Parts Limited Warranty*** – covers all Acura replacement parts against defects in materials and workmanship.

**Replacement Battery Limited Warranty** – provides prorated coverage for a replacement battery purchased from your dealer.

**Replacement Muffler Lifetime Limited Warranty** – provides coverage for as long as the purchaser of the muffler owns the vehicle.

Restrictions and exclusions apply to all these warranties. Please read the Acura warranty information booklet that came with your vehicle for precise information on warranty coverages. Your vehicle's original tires are covered by their manufacturer. Tire warranty information is in a separate booklet.

■ **Statement on Warranty Coverage for Aftermarket and Recycled Parts**

The Magnuson-Moss Warranty Act, 15 U.S.C. s.2301 et seq., makes it illegal for motor vehicle manufacturers to void a motor vehicle warranty or deny warranty coverage solely because an aftermarket or recycled part has been used to repair the vehicle or someone other than the authorized service provider performed service on the vehicle.

This provision does not apply to a new motor vehicle purchased solely for commercial or industrial use.

Under federal law, a manufacturer may deny warranty coverage and charge for repairs to a vehicle if it is discovered that an aftermarket or recycled part installed on the vehicle is defective or was installed incorrectly and caused damage to another part of the vehicle otherwise covered under warranty.

The Federal Trade Commission requires that a manufacturer demonstrate that an aftermarket or recycled part or service performed by a person other than an authorized service provider caused damage to another part of the vehicle otherwise covered under warranty before denying warranty coverage.

Additionally, federal law allows a manufacturer to void a motor vehicle warranty or deny warranty coverage if the manufacturer provides the article or service to consumers free of charge under the warranty or the manufacturer has secured a waiver from the Federal Trade Commission.

#### ■ Canadian Owners

Please refer to the warranty manual that came with your vehicle.

#### ■ EPA Contact Information

An owner may obtain further information concerning emission warranties or report violations of the terms of the emission warranties by contacting:

Director,  
Light-Duty Vehicle Center,  
U.S. Environmental Protection Agency,  
Attention: Warranty Claim  
2000 Traverwood Drive,  
Ann Arbor, MI 48105;  
[complianceinfo@epa.gov](mailto:complianceinfo@epa.gov)

## ■ Service Express

For electronic copies of service publications, you can purchase a subscription to Service Express. Visit [www.techinfo.acura.com](http://www.techinfo.acura.com) for pricing and options.

## ■ For U.S. Owners

Manuals can be purchased from Helm Incorporated. You can order a manual by phone at 1 (800) 782-4356 (credit card orders only), or online at [www.helminc.com](http://www.helminc.com).

## ■ For Canadian Owners

Please contact a dealer to order any manuals that you may require.

Acura dealership personnel are trained professionals who should be able to deal with any problems you may encounter with your vehicle. If, however, you are faced with a problem that they cannot resolve to your satisfaction, contact Acura Client Relations/Services.

## U.S. Owners

American Honda Motor Co., Inc.  
Acura Client Relations  
Mail Stop CHI-4  
1919 Torrance Blvd.  
Torrance, CA 90501-2746  
Tel: 1 (800) 382-2238

## Canadian Owners

Honda Canada Inc.  
Acura Client Services  
180 Honda Boulevard  
Markham, ON  
L6C 0H9  
Tel: 1-888-9-ACURA-9  
Fax: 1-877-939-0909  
E-mail: [acura\\_cr@ch.honda.com](mailto:acura_cr@ch.honda.com)

## In Puerto Rico and the U.S. Virgin Islands In Guam:

Bella International  
P.O. Box 190816  
San Juan, PR 00919-0816  
Tel: 1 (787) 620-7546

Triple J Autogroup  
157 S. Marine Corps Drive  
Tamuning, GU 96913  
(671) 648-2277

## Client Service Information

When you call or write, please give us the following information:

- Vehicle Identification Number
  - ▣ **Vehicle Identification Number (VIN), Engine Number, and Transmission Number** P. 718
- Date of purchase
- Odometer reading of your vehicle
- Your name, address, and telephone number
- A detailed description of the problem
- Name of the dealer who sold the vehicle to you

### Meter Open Source License

---

The software embedded in this product includes open source software. Refer to the following website for details regarding the open source software.

*[https://www.nippon-seiki.co.jp/business\\_ic\\_meter/](https://www.nippon-seiki.co.jp/business_ic_meter/)*

Models with 9-in. Color Touchscreen

### TCU Open Source License

---

Free/Open Source Software Information

This product contains Free/Open Source Software(FOSS). The license information and/or the source code of such FOSS can be found at the following URL.

*<https://www.denso.com/global/en/opensource/tcu/honda/>*

## Numbers

7-Speed Manual Shift Mode .....	442
Operation .....	443

## A

ABS (Anti-lock Brake System) .....	594
Accessories and Modifications .....	662
Accessory Power Socket .....	210
Acura Integrated Dynamics System .....	447, 449
AcuraLink® .....	305
AcuraWatch™ .....	27, 478
Adaptive Cruise Control (ACC) .....	525
Adaptive Cruise Control (ACC) with Low Speed Follow .....	504
Adding the Coolant .....	632
Additives	
Coolant .....	632
Engine Oil .....	627
Washer .....	636
Additives, Engine Oil .....	627
Adjusting	
Armrest .....	200
Clock .....	142
Front Head Restraints .....	198
Front Seats .....	191
Mirrors .....	189
Rear Seats .....	195
Sound .....	235, 277
Steering Wheel .....	188

Agile Handling Assist .....	468
Air Conditioning System (Climate Control System) .....	218
Changing the Mode .....	218, 219
Defrosting the Windshield and Windows .....	220
Dust and Pollen Filter .....	655
Recirculation/Fresh Air Mode .....	219
Sensor .....	223
Synchronization Mode .....	222
Using Automatic Climate Control .....	218
Air Pressure .....	642, 717
Airbags .....	49
Advanced Airbags .....	55
After a Collision .....	52
Airbag Care .....	67
Driver's Knee Airbag .....	57
Event Data Recorder .....	0
Front Airbags (SRS) .....	52
Indicator .....	64, 91
Passenger Airbag Off Indicator .....	65
Sensors .....	49
Side Airbags .....	60
Side Curtain Airbags .....	63
AM/FM Radio .....	237, 281
Android Auto™ .....	255, 322
Anti-lock Brake System (ABS) .....	594
Indicator .....	91
Apple CarPlay .....	251, 315
Armrest .....	200
Audio Remote Controls .....	230

Audio System .....	226, 234, 259
Adjusting the Sound .....	235, 277
Alexa Built-In .....	280
Android Auto™ .....	255, 322
Apple CarPlay .....	251, 315
Audio/Information Screen .....	261
Display Setup .....	236, 278
Error Messages .....	328
General Information .....	330
Home Screen .....	266
How to Update .....	272
How to Update Wirelessly .....	275
How to Update with a USB Device .....	276
iPod .....	239, 296
Limitations for Manual Operation .....	279, 385, 405
MP3/WMA/AAC .....	242, 299
Reactivating .....	229
Recommended Devices .....	331
Remote Controls .....	230
Security Code .....	229
Selecting an Audio Source .....	279
Start Up .....	260
Status Area .....	271
System Updates .....	272
System Updates Settings .....	273
Theft Protection .....	229
USB Flash Drives .....	331
USB Port(s) .....	227
Wallpaper Setup .....	264

Audio/Information Screen.....	261
Authorized Manuals.....	726
Auto Door Locking/Unlocking.....	161
Auto High-Beam.....	180
Indicator.....	93
Auto Idle Stop.....	455, 461
OFF Button.....	456, 462
Automatic Brake Hold.....	589
Indicator.....	88, 589
Automatic Brake Hold System	
Indicator.....	88, 589
Automatic Lighting.....	177
Average Fuel Economy.....	114
Average Speed.....	116

## B

Battery.....	651
Charging System Indicator.....	89, 700
If the Battery Is Dead.....	694
Maintenance (Checking the Battery).....	651
Maintenance (Replacing).....	653
Belts (Seat).....	40
Beverage Holders.....	204
Blind Spot Information System.....	474
Bluetooth® Audio.....	245, 302
Bluetooth® HandsFreeLink®.....	383, 403
Booster Seats (For Children).....	80
Brake System.....	584
Anti-lock Brake System (ABS).....	594
Automatic Brake Hold.....	589

Brake Assist System.....	595
Fluid.....	635
Foot Brake.....	588
Indicator (Amber).....	88, 703
Indicator (Red).....	86, 87, 701, 703
Parking Brake.....	584
Brightness.....	124
Built-in Key.....	145
Bulb Replacement.....	637
Brake, Rear Side Marker, Brake/Chicane™	
Taillights, Back-Up, and Rear Turn Signal	
Lights.....	638
Door Outer Handle Ambient Lights.....	637
Fog Lights.....	637
Front Turn Signal, Parking/Chicane™	
Daytime Running, and Front Side Marker	
Lights.....	637
Headlights.....	637
High-Mount Brake Light.....	638
Rear License Plate Light.....	638
Side Turn Signal/Emergency Indicator	
Lights.....	637
Bulb Specifications.....	716

## C

Carbon Monoxide Gas.....	81
Cargo Area Cover.....	209
Carrying Cargo.....	425, 427
Certification Label.....	718
Charging Bulbs.....	637

Charging System Indicator.....	89, 700
Chicane™ Daytime Running Lights.....	179
Child Safety.....	68
Childproof Door Locks.....	160
Child Seat.....	68
Booster Seats.....	80
Child Seat for Infants.....	70
Child Seat for Small Children.....	71
Installing a Child Seat with a Lap/Shoulder	
Seat Belt.....	75
Larger Children.....	79
Rear-facing Child Seat.....	70
Selecting a Child Seat.....	72
Using a Tether.....	77
Childproof Door Locks.....	160
Cleaning the Exterior.....	659
Cleaning the Interior.....	656
Client Service Information.....	727
Climate Control System.....	218
Changing the Mode.....	218, 219
Defrosting the Windshield and	
Windows.....	220
Dust and Pollen Filter.....	655
Recirculation/Fresh Air Mode.....	219
Sensors.....	223
Synchronization Mode.....	222
Using Automatic Climate Control.....	218
Clutch Fluid.....	635
CMBS™ (Collision Mitigation Braking	
System™).....	481
Coat Hooks.....	206



Collision Mitigation Braking System™ (CMBS™) .....	481
Compact Spare Tire .....	682, 717
Console Compartment .....	203
Continuously Variable Transmission	
Creeping .....	439
Fluid .....	634
Kickdown .....	439
Operating the Shift Lever .....	24, 441
Shift Lever Does Not Move .....	696
Shifting .....	440
Controls .....	141
Coolant (Engine) .....	632
Adding the Coolant .....	632
Overheating .....	697
Creeping (Continuously Variable Transmission) .....	439
Cross Traffic Monitor .....	602
Cup Holders .....	204
Customize Display .....	109
Customized Features .....	351, 359
<b>D</b>	
Dead Battery .....	694
Defaulting All the Settings .....	358, 382
Defrosting the Windshield and Windows .....	220
Devices that Emit Radio Waves .....	719
Dimming	
Headlights .....	176

Rearview Mirror .....	189
Dipstick (Engine Oil) .....	628
Directional Signals (Turn Signal) .....	175
Display Setup .....	236, 278
Door Mirrors .....	190
Doors .....	144
Auto Door Locking .....	161
Auto Door Unlocking .....	161
Door Open Message .....	39
Keys .....	144
Locking/Unlocking the Doors from the Inside .....	158
Locking/Unlocking the Doors from the Outside .....	147
DOT Tire Quality Grading .....	644
Driver Attention Monitor .....	117
Driver Information Interface .....	108, 111
Switching the Display .....	112
Driver's Knee Airbag .....	57
Driving .....	423
Braking .....	584
Continuously Variable Transmission .....	439
Shifting Gear .....	444
Shifting Position .....	440
Starting the Engine .....	430
Driving Position Memory System .....	186
Dust and Pollen Filter .....	655
Dynamic Mode Switch .....	450

## E

Elapsed Time .....	116
Electric Power Steering (EPS) System	
Indicator .....	91, 702
Electronic Stability Control (ESC) .....	466
Emergency .....	711
Emergency Engine Stop .....	693
Emergency Hatch Opener .....	713
Emissions Testing (Readiness Codes) .....	721
Engine	
Coolant .....	632
If the Battery Is Dead .....	694
Oil .....	627
Starting .....	430
Engine Coolant .....	632
Adding the Coolant .....	632
Overheating .....	697
Temperature Gauge .....	105
Engine Oil .....	627
Adding .....	629
Checking .....	628
Displaying Oil Life .....	618
Engine oil pressure low Warning .....	699
Recommended Engine Oil .....	627
Engine oil pressure low Warning .....	699
ENGINE START/STOP Button .....	172
Exhaust Gas Hazard (Carbon Monoxide) ..	81
Exterior Care (Cleaning) .....	659
Exterior Mirrors .....	190

**F**

<b>Features</b> .....	225
<b>Filters</b>	
Dust and Pollen .....	655
Oil .....	630
<b>Flat Tire</b> .....	667
<b>Floor Mats</b> .....	657
<b>Fluids</b>	
Brake.....	635
Continuously Variable Transmission .....	634
Engine Coolant.....	632
Manual Transmission .....	634
Windshield Washer.....	636
<b>FM/AM Radio</b> .....	237, 281
<b>Fog Light Indicator</b> .....	93
<b>Folding Down the Rear Seats</b> .....	195
<b>Foot Brake</b> .....	588
<b>Front Airbags (SRS)</b> .....	52
<b>Front Head Restraints</b> .....	198
<b>Front Seat Heaters</b> .....	216
<b>Front Seats</b>	
Adjusting.....	191
<b>Front Wide View Camera</b> .....	581
<b>Fuel</b> .....	26, 608
Average Fuel Economy.....	114
Economy .....	611
Gauge .....	105
Instant Fuel Economy.....	114
Low Fuel Indicator .....	91
Range.....	114
Recommendation .....	608

Refueling.....	608, 714
<b>Fuel Economy</b> .....	611
<b>Fuel Fill Door</b> .....	26, 609
<b>Fuses</b> .....	705
Inspecting and Changing.....	709
Locations.....	705, 707

**G**

<b>Gasoline (Fuel)</b>	
Average Fuel Economy .....	114
Economy .....	611
Gauge.....	105
Information .....	608
Instant Fuel Economy .....	114
Low Fuel Indicator .....	91
Refueling.....	608, 714
<b>Gauge Display Settings</b> .....	125
<b>Gauges</b> .....	104
<b>Gear Shift Lever Positions</b>	
Manual Transmission.....	444
<b>Glass (care)</b> .....	657, 660
<b>Glove Box</b> .....	202

**H**

<b>Handling the Unexpected</b> .....	665
<b>HandsFreeLink® (HFL)</b> .....	383, 403
Automatic Import of Cellular Phonebook and Call History.....	395, 413
Automatic Transferring.....	393, 412

Favorite Contacts .....	396, 414
HFL Buttons .....	383, 403
HFL Menus.....	386, 406
HFL Status Display.....	385, 405
In Case of Emergency .....	420
Limitations for Manual Operation....	385, 405
Making a Call .....	398, 416
Options During a Call.....	402, 419
Phone Setup .....	388, 408
Receiving a Call.....	401, 418
Ring Tone .....	393, 412
<b>Hatch</b> .....	162
Light Bulb .....	716
Unable to Open .....	713
<b>Hazard Warning Button</b> .....	6
<b>HD Radio™</b> .....	282
<b>Headlights</b> .....	176
Aiming.....	637
Auto High-Beam .....	180
Automatic Operation .....	177
Dimming.....	176
Operating .....	176
<b>Head-Up Display</b> .....	135
<b>Heated Steering Wheel</b> .....	215
<b>Heaters (Front Seat)</b> .....	216
<b>Heaters (Rear Seat)</b> .....	217
<b>HFL (HandsFreeLink®)</b> .....	383, 403
<b>High Beam Indicator</b> .....	93
<b>Hill Start Assist System</b> .....	436
<b>Honda App License Agreement</b> .....	332

<b>I</b>	
<b>Identification Numbers</b>	
Vehicle Identification.....	718
<b>Immobilizer System</b> .....	165
Indicator.....	95
<b>Indicators</b> .....	84
Adaptive Cruise Control (ACC).....	525
Adaptive Cruise Control (ACC) with	
Low Speed Follow.....	98, 504
Adaptive Cruise Control (ACC) with Low	
Speed Follow Interval.....	99
Anti-lock Brake System (ABS).....	91
Auto High-Beam.....	93
Auto Idle Stop (Green).....	96
Auto Idle Stop OFF.....	96
Auto Idle Stop Suspend.....	97
Auto Idle Stop System (Amber).....	96
Automatic Brake Hold.....	88, 589
Automatic Brake Hold System.....	88, 589
Charging System.....	89, 700
COMFORT Mode.....	94
Cruise Mode.....	99
Electric Power Steering (EPS)	
System.....	91, 702
Fog Light.....	93
High Beam.....	93
Immobilizer System.....	95
INDIVIDUAL Mode.....	94
Lane Keeping Assist System (LKAS).....	99
Lights On.....	93
Low Fuel.....	91
Low Tire Pressure/TPMS.....	92, 472, 704
M (7-speed manual shift mode) Indicator/ Shift.....	89
Malfunction Indicator Lamp.....	89, 700
NORMAL Mode.....	94
Parking Brake and Brake System	
(Amber).....	88, 703
Parking Brake and Brake	
System (Red).....	86, 87, 701, 703
Safety Support.....	100, 103
Seat Belt Reminder.....	42, 90
Security System Alarm.....	95
Shift Position.....	89
SPORT Mode.....	94
Supplemental Restraint System.....	64, 91
System Message.....	94
Transmission System.....	90
Turn Signal and Hazard Warning.....	93
Vehicle Stability Assist™ (VSA®) OFF... ..	92, 467
Vehicle Stability Assist™ (VSA®)	
System.....	92, 466
<b>Information</b> .....	715
<b>Instant Fuel Economy</b> .....	114
<b>Instrument Panel</b> .....	83
<b>Integrated Dynamics System</b> .....	449
Dynamic Mode Switch.....	450
<b>Interior Lights</b> .....	201
<b>Interior Rearview Mirror</b> .....	189
<b>iPod</b> .....	239, 296

<b>J</b>	
<b>Jack (Wheel Nut Wrench)</b> .....	685
<b>Jump Starting</b> .....	694

<b>K</b>	
<b>Key Number Tag</b> .....	145
<b>Keyless Access System</b> .....	147
<b>Keys</b> .....	144
Number Tag.....	145
Rear Door Won't Open.....	160
Remote Transmitter.....	153
Two-way Keyless Remote.....	154
Types and Functions.....	144
<b>Kickdown (Continuously Variable Transmission)</b> .....	439

<b>L</b>	
<b>Lane Keeping Assist System (LKAS)</b> .....	545
<b>LATCH (Child Seats)</b> .....	73

Lights .....	176, 637
Auto High-Beam .....	180
Automatic .....	177
Bulb Replacement .....	637
Chicane™ Daytime Running Lights .....	179
Fog Lights .....	179
High Beam Indicator .....	93
Interior .....	201
Light Switches .....	176
Lights On Indicator .....	93
Turn Signals .....	175
Limited Slip Differential (LSD) .....	469
Load Limits .....	427
Locking/Unlocking .....	144
Auto Door Locking/Unlocking .....	161
Childproof Door Locks .....	160
From Inside .....	158
From Outside .....	147
Keys .....	144
Using a Key .....	155
Low Battery Charge .....	700
Low Fuel Indicator .....	91
Low Remote Key Signal Strength .....	146
Low Speed Braking Control .....	493, 499
Lower Anchors .....	73
Luggage (Maximum Load Limit) .....	427
Lumbar Support .....	192

## M

<b>Maintenance</b> .....	613
Adding the Coolant .....	632
Battery .....	651
Brake Fluid .....	635
Cleaning .....	656, 659
Climate Control System .....	655
Coolant .....	632
Maintenance Minder™ .....	617
Oil .....	628
Precautions .....	614
Remote Transmitter .....	653, 654
Replacing Light Bulbs .....	637
Safety .....	615
Service Items .....	621
Tires .....	641
Transmission Fluid .....	634
Under the Hood .....	625
Malfunction Indicator Lamp .....	89, 700
Manual Transmission .....	444
Map Lights .....	202
Maximum Load Limit .....	427
Meters, Gauges .....	104
Mirrors .....	189
Adjusting .....	189
Door .....	190
Exterior .....	190
Interior Rearview .....	189
Modifications (and Accessories) .....	662
Moonroof .....	171
MP3 .....	242, 299

Multi-View Rear Camera .....	606
------------------------------	-----

## N

Navigation .....	116
Numbers (Identification) .....	718

## O

Odometer .....	105
Oil (Engine) .....	627
Adding .....	629
Checking .....	628
Displaying Oil Life .....	618
Engine oil pressure low Warning .....	699
Recommended Engine Oil .....	627
Viscosity .....	627
Open Source Licenses .....	346, 728
Opening .....	
Hatch .....	713
Hood .....	626
Opening/Closing .....	
Hatch .....	162
Moonroof .....	171
Power Windows .....	168
Outside Temperature Display .....	106
Overheating .....	697

## P

Paddle Shifters (7-Speed Manual Shift Mode) .....	442
---	-----

Panic Mode.....	167
Parking .....	596
Parking Brake.....	584
Parking Brake and Brake System Indicator (Amber).....	88, 703
Parking Brake and Brake System Indicator (Red).....	86, 87, 701, 703
Parking Sensor System.....	598
Passenger Airbag Off Indicator.....	65
Passing Indicators.....	176
Playing <i>Bluetooth</i> ® Audio .....	245, 302
Power Windows.....	168
Precautions While Driving Rain.....	438
Pregnant Women.....	47
Puncture (Tire) .....	667

## R

Radio (FM/AM).....	237, 281
Radio (SiriusXM®).....	285
Radio Data System (RDS).....	238, 283
Range.....	114
RDS (Radio Data System).....	238, 283
Readiness Codes (Emissions Testing) .....	721
Rear Defogger/Heated Door Mirror Button.....	185
Rear Seat Heaters.....	217
Rear Seats (Folding Down).....	195
Rearview Mirror.....	189

Refueling.....	608
Fuel Gauge.....	105
Gasoline .....	608, 714, 716
Low Fuel Indicator .....	91
Regulations .....	472, 644, 719
Remote Transmitter .....	153
Replacement Battery .....	653, 654
Bulbs.....	637
Fuses.....	705, 707
Tires.....	647, 682
Wiper Blade Rubber.....	639
Reporting Safety Defects .....	720
Resetting a Trip Meter .....	113
Rev Match System.....	445
Road Departure Mitigation .....	566
On and Off.....	569

## S

Safe Driving .....	35
Safety Check .....	39
Safety Labels.....	82
Safety Message .....	3
Safety Support.....	121
Seat Belts.....	40
Adjusting the Shoulder Anchor.....	46
Automatic Seat Belt Tensioners.....	44
Checking.....	48
Fastening.....	45

Installing a Child Seat with a Lap/Shoulder Seat Belt.....	75
Pregnant Women .....	47
Reminder .....	42
Warning Indicator .....	42, 90
Seat Heaters.....	216, 217
Seats.....	191
Adjusting .....	191
Front Seat Heaters.....	216
Front Seats.....	191
Lumbar Support .....	192
Rear Seat Heaters.....	217
Rear Seats .....	195
Security System.....	165
Security System Alarm Indicator.....	95
Select Lever.....	444
Operation.....	444
Selecting a Child Seat.....	72
Selector Knob (Audio).....	234
Setting the Clock.....	142
Settings.....	126
Shift Lever.....	24, 440, 444
Releasing.....	696
Won't Move.....	696
Shift Position Indicator .....	89, 441
Shifting (Transmission).....	440, 444
Shoulder Anchor .....	46
Side Airbags.....	60
Side Curtain Airbags .....	63
Siri Eyes Free .....	249
SiriusXM® Radio.....	285

Smart Shortcuts.....	309
Snow Tires.....	649
Sonar Sensors.....	583
Spare Tire.....	717
Spark Plugs.....	716
Specifications.....	716
Specified Fuel.....	608, 716
Speed/Distance Units.....	123
Speedometer.....	104
SRS Airbags (Airbags).....	52
Starting Assist Brake Function.....	460
Starting the Engine.....	430
Does Not Start.....	689
If the Battery Is Dead.....	694
Steering Wheel	
Adjusting.....	188
Stopping.....	596
Summer Tires.....	650
Sunglasses Holder.....	206
Supplemental Restraint System (SRS).....	52
Switches (Around the Steering	
Wheel).....	6, 7, 172
System Message Indicator.....	94
System Updates.....	272

## T

Tachometer.....	105
Temperature	
Gauge.....	105
Outside Temperature Display.....	106

Temperature Sensor.....	106, 223
Temporary Tire Repair Kit.....	668
Tie-down Anchors.....	207
Time (Setting).....	142
Tire Pressure Monitoring System (TPMS)	
with Tire Fill Assist.....	470
Indicator.....	92, 704
Tires.....	641
Air Pressure.....	642, 717
Checking and Maintaining.....	641
Flat Tire (Puncture).....	667
Inspection.....	641
Labeling.....	642
Puncture (Flat Tire).....	667
Regulations.....	644
Rotation.....	648
Spare Tire.....	717
Summer.....	650
Temporary Tire Repair Kit.....	668
Tire Chains.....	649
Wear Indicators.....	646
Winter.....	649
Tools.....	666
Towing Your Vehicle.....	429
Emergency.....	711

### TPMS (Tire Pressure Monitoring System)

with Tire Fill Assist.....	470
Indicator.....	92, 704
Traffic Jam Assist.....	557
Traffic Sign Recognition System.....	574

Transmission.....	440, 444
Continuously Variable Transmission.....	440
Fluid.....	634
Manual.....	444
Shift Position Indicator.....	89, 441
Trip Computer.....	263
Trip Meter.....	113
Troubleshooting.....	665
Blown Fuse.....	705, 707
Brake Pedal Vibrates.....	31
Buzzer Sounds When Opening Door.....	32
Emergency Towing.....	711
Engine Won't Start.....	689
Flat Tire/Puncture.....	667
Noise When Braking.....	34
Overheating.....	697
Puncture/Flat Tire.....	667
Rear Door Won't Open.....	32, 160
Shift Lever Won't Move.....	696
Warning Indicators.....	84
Turbo Engine Vehicle.....	612
Turn Signals.....	175
Indicators (Instrument Panel).....	93
Two-way Keyless Remote.....	154

## U

Under-Floor Storage Area.....	208
Unlocking the Doors.....	147
Unlocking the Front Doors from the	
Inside.....	158

USB Flash Drives .....	226, 242, 299, 331
USB Port(s) .....	227
Using the Keyless Access System .....	147

## V

Vanity Mirrors .....	9
Vehicle Identification Number .....	718
Vehicle Settings .....	126
Vehicle Stability Assist™ (VSA®) .....	466
Off Button .....	467
Off Indicator .....	92
System Indicator .....	92
Viscosity (Oil) .....	627, 717
VSA® (Vehicle Stability Assist™) .....	466

## W

Wallpaper .....	264
Warning Indicator On/Blinking .....	699
Warning Labels .....	82
Warnings .....	125
Warranties (Warranty Manual provided separately) .....	723
Watts .....	716
Wear Indicators (Tire) .....	646
Wheel Nut Wrench (Jack Handle) .....	685
Wi-Fi Connection .....	312
Window Washers .....	183
Adding/Refilling Fluid .....	636
Switch .....	183

Windows (Opening and Closing) .....	168
Windshield .....	183
Cleaning .....	657, 660
Defrosting/Defogging .....	220
Washer Fluid .....	636
Wiper Blades .....	639
Wipers and Washers .....	183
Winter Tires .....	
Snow Tires .....	649
Tire Chains .....	649
Wipers and Washers .....	183
Checking and Replacing Wiper Blades .....	639
Wireless Charger .....	211
WMA .....	242, 299
Worn Tires .....	641



**owners.acura.com (U.S.)**  
**acura.ca (Canada)**

313S5600  
OM-18411  
00X31-3S5-6000

2023 Acura Integra Owner's Manual  
© 2022 Honda Motor Co., Ltd. — All Rights Reserved

Printed in the U.S.A.